

SI-3000V Series

3-Terminal, Low Dropout Voltage Dropper Type

■Features

- TO-3P package 3-terminal regulator
- Output current: 2.0A
- Low dropout voltage: $V_{DIF} \leq 1V$ (at $I_o=2.0A$)
- Built-in foldback overcurrent protection circuit

■Applications

- For stabilization of the secondary stage of switching power supplies
- Electronic equipment

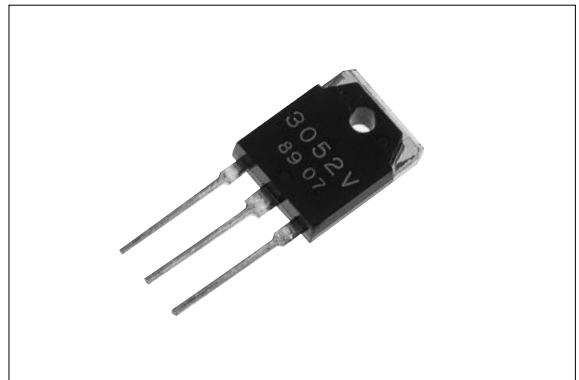

■Absolute Maximum Ratings

($T_a=25^\circ C$)

Parameter	Symbol	Ratings		Unit
		SI-3052V	SI-3122V/3152V	
DC Input Voltage	V_{IN}	25	30	V
DC Output Current	I_o	2.0		A
Power Dissipation	P_{D1}	50($T_c=25^\circ C$)		W
	P_{D2}	1.6(Without heatsink, stand-alone operation)		W
Junction Temperature	T_j	-30 to +125		$^\circ C$
Ambient Operating Temperature	T_{op}	-20 to +100		$^\circ C$
Storage Temperature	T_{stg}	-30 to +125		$^\circ C$
Thermal Resistance (junction to case)	$R_{th(j-c)}$	2.0		$^\circ C/W$

■Electrical Characteristics

($T_a=25^\circ C$)

Parameter	Symbol	Ratings									unit
		SI-3052V			SI-3122V			SI-3152V			
		min.	typ.	max.	min.	typ.	max.	min.	typ.	max.	
Input Voltage	V_{IN}	6		15	13		25	16		25	V
Output Voltage	V_o	4.9	5.0	5.1	11.8	12.0	12.2	14.8	15.0	15.2	V
	Conditions	$V_{IN}=8V, I_o=1.0A$			$V_{IN}=16V, I_o=1.0A$			$V_{IN}=20V, I_o=1.0A$			
Dropout Voltage	V_{DIF}			0.5			0.5			0.5	V
	Conditions	$I_o=1.0A$									
				1.0			1.0			1.0	
Line Regulation	ΔV_{OLINE}		10	30		20	60		20	60	mV
	Conditions	$V_{IN}=6$ to 15V, $I_o=1.0A$			$V_{IN}=13$ to 25V, $I_o=1.0A$			$V_{IN}=16$ to 25V, $I_o=1.0A$			
			40	100		80	200		80	200	
Load Regulation	ΔV_{OLOAD}										mV
	Conditions	$V_{IN}=8V, I_o=0$ to 2.0A			$V_{IN}=16V, I_o=0$ to 2.0A			$V_{IN}=20V, I_o=0$ to 2.0A			
Temperature Coefficient of Output Voltage	$\Delta V_o/\Delta T_a$		± 0.5			+1.5			± 1.5		mV/ $^\circ C$
Ripple Rejection	RREJ		54			54			54		dB
	Conditions	$f=100$ to 120Hz									
Overcurrent Protection Starting Current	I_{s1}	2.4			2.4			2.4			A
	Conditions	$V_{IN}=8V$			$V_{IN}=16V$			$V_{IN}=20V$			

The following are also available: SI-3522V(5.2V), SI-3062V(6V), SI-3082V(8V), SI-3922V(9.2V), SI-3102V(10V), SI-3132V(13.1V), SI-3182V(18V), SI-3202V(20V).

■Outline Drawing

(unit:mm)

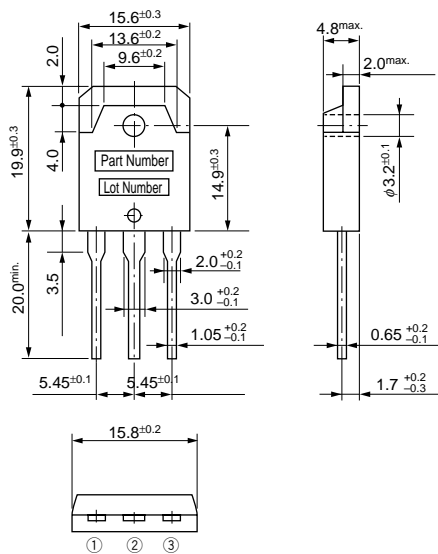

Plastic Mold Package Type (TO-3P)

Flammability: UL94V-0

Weight: Approx. 6g

Terminal Connections

- ① Output
- ② Input (backside of case)
- ③ Ground

■Block Diagram

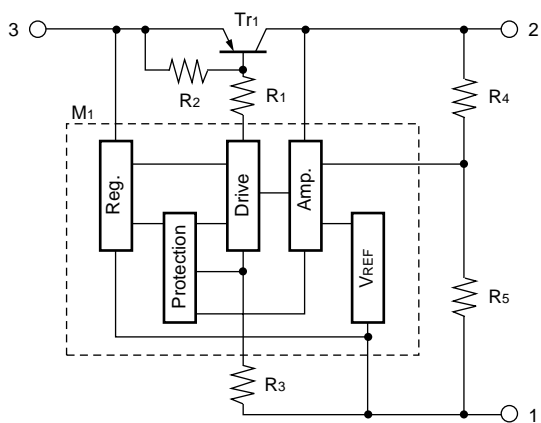

■Standard External Circuit

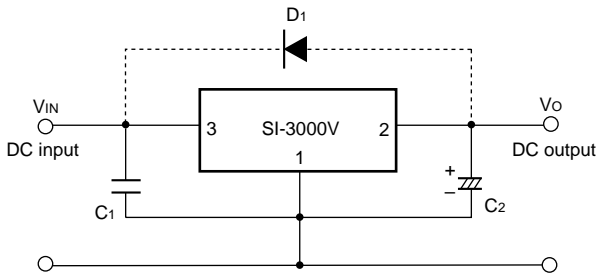

- C1: Oscillation prevention capacitor (approx. 0.33 μ F)
Connection to terminal No.3 must be made as short as possible.
- C2: Output capacitor (47 to 100 μ F)
Connection to terminal No.2 must be made as short as possible.
- D1: Protection diode (RM1Z)
Required for protection against reverse biasing of input and output.

- Note 1: Prevention of oscillation at low temperatures
At low temperatures, oscillation may occur unless an output capacitor with good $\tan\delta$ is used. Be sure to connect a tantalum capacitor (approx. 10 μ F) in parallel with output capacitor C2.
- Note 2: An isolation type diode is provided from input to ground and also from output to ground. These may be destroyed if the device is reverse biased. In this case, use a diode with low V_F to protect them.
- Note 3: The output voltage may not be adjusted by raising the ground voltage (using a diode or resistor).

■ T_a - P_D Characteristics

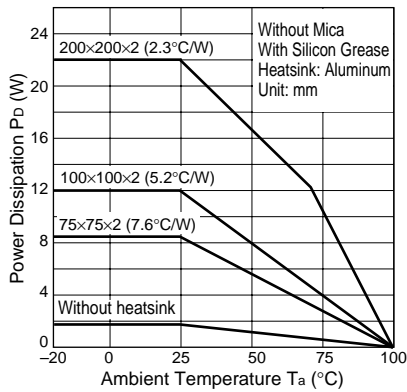

■Typical Characteristics

($T_a=25^\circ\text{C}$)

Io vs. V_{DIF} Characteristics

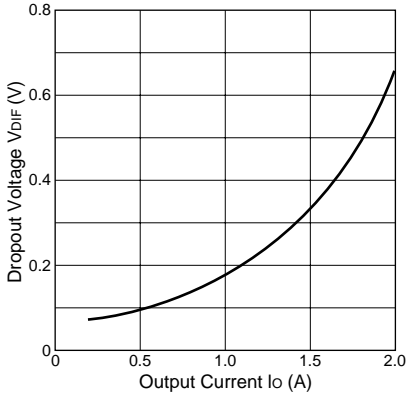

Temperature Coefficient of Output Voltage(SI-3052V)

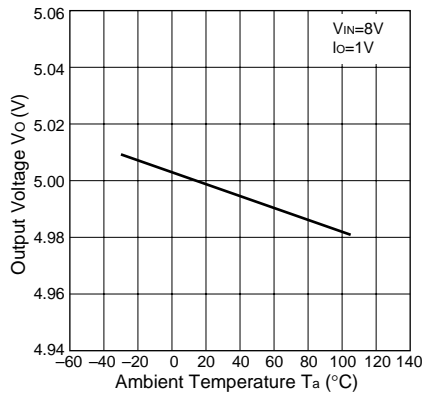

Circuit Current(SI-3052V)

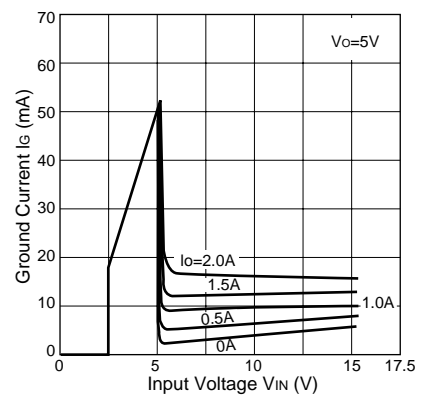

Rise Characteristics(SI-3052V)

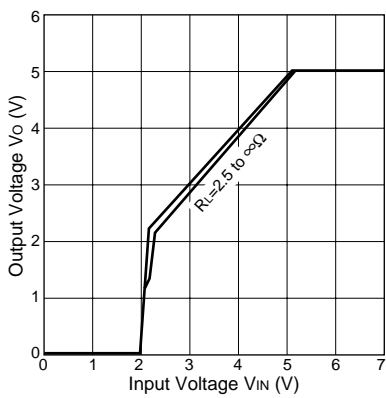

Rise Characteristics(SI-3122V)

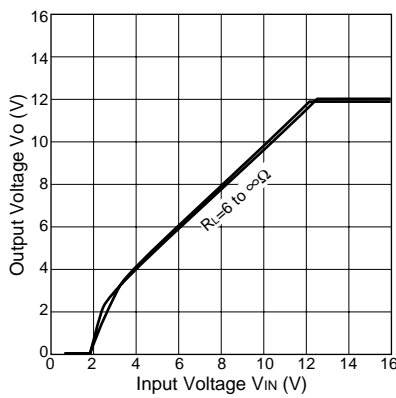

Rise Characteristics(SI-3152V)

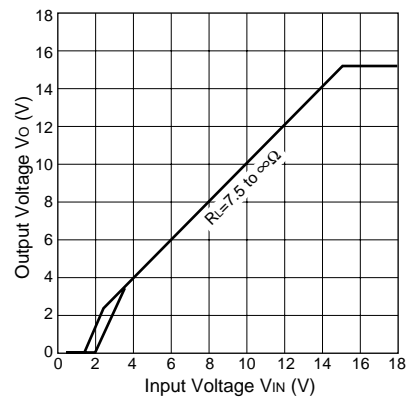

Overcurrent Protection Characteristics(SI-3052V)

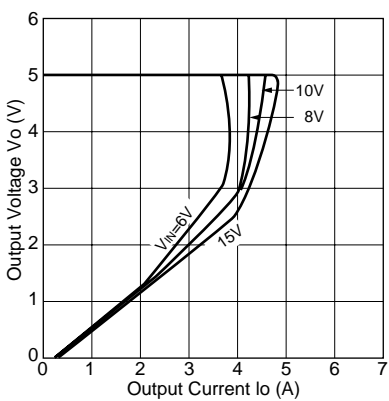

Overcurrent Protection Characteristics(SI-3122V)

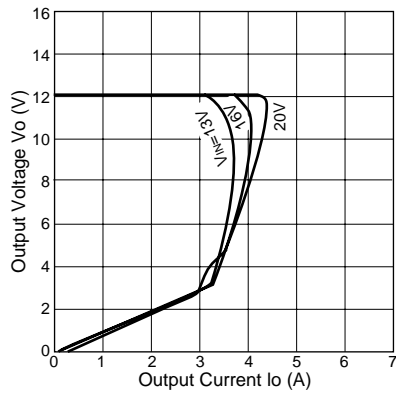

Overcurrent Protection Characteristics(SI-3152V)

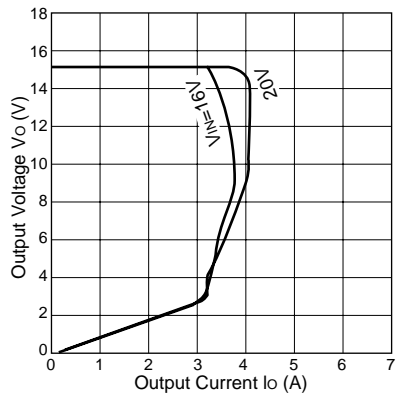

This datasheet has been downloaded from:

www.DatasheetCatalog.com

Datasheets for electronic components.