

Series 3700 System Switch/Multimeter

Quick Start Guide

3700S-903-01 Rev. C / November 2008

WARRANTY

Keithley Instruments, Inc. warrants this product to be free from defects in material and workmanship for a period of one (1) year from date of shipment.

Keithley Instruments, Inc. warrants the following items for 90 days from the date of shipment: probes, cables, software, rechargeable batteries, diskettes, and documentation.

During the warranty period, Keithley Instruments will, at its option, either repair or replace any product that proves to be defective.

To exercise this warranty, write or call your local Keithley Instruments representative, or contact Keithley Instruments headquarters in Cleveland, Ohio. You will be given prompt assistance and return instructions. Send the product, transportation prepaid, to the indicated service facility. Repairs will be made and the product returned, transportation prepaid. Repaired or replaced products are warranted for the balance of the original warranty period, or at least 90 days.

LIMITATION OF WARRANTY

This warranty does not apply to defects resulting from product modification without Keithley Instruments' express written consent, or misuse of any product or part. This warranty also does not apply to fuses, software, non-rechargeable batteries, damage from battery leakage, or problems arising from normal wear or failure to follow instructions.

THIS WARRANTY IS IN LIEU OF ALL OTHER WARRANTIES, EXPRESSED OR IMPLIED, INCLUDING ANY IMPLIED WARRANTY OF MERCHANTABILITY OR FITNESS FOR A PARTICULAR USE. THE REMEDIES PROVIDED HEREIN ARE BUYER'S SOLE AND EXCLUSIVE REMEDIES.

NEITHER KEITHLEY INSTRUMENTS, INC. NOR ANY OF ITS EMPLOYEES SHALL BE LIABLE FOR ANY DIRECT, INDIRECT, SPECIAL, INCIDENTAL, OR CONSEQUENTIAL DAMAGES ARISING OUT OF THE USE OF ITS INSTRUMENTS AND SOFTWARE, EVEN IF KEITHLEY INSTRUMENTS, INC. HAS BEEN ADVISED IN ADVANCE OF THE POSSIBILITY OF SUCH DAMAGES. SUCH EXCLUDED DAMAGES SHALL INCLUDE, BUT ARE NOT LIMITED TO: COST OF REMOVAL AND INSTALLATION, LOSSES SUSTAINED AS THE RESULT OF INJURY TO ANY PERSON, OR DAMAGE TO PROPERTY.

KEITHLEY

A G R E A T E R M E A S U R E O F C O N F I D E N C E

Keithley Instruments, Inc.

Corporate Headquarters • 28775 Aurora Road • Cleveland, Ohio 44139
440-248-0400 • Fax: 440-248-6168 • 1-888-KEITHLEY (1-888-534-8453) • www.keithley.com

The following safety precautions should be observed before using this product and any associated instrumentation. Although some instruments and accessories would normally be used with non-hazardous voltages, there are situations where hazardous conditions may be present.

This product is intended for use by qualified personnel who recognize shock hazards and are familiar with the safety precautions required to avoid possible injury. Read and follow all installation, operation, and maintenance information carefully before using the product. Refer to the user documentation for complete product specifications.

If the product is used in a manner not specified, the protection provided by the product warranty may be impaired.

The types of product users are:

Responsible body is the individual or group responsible for the use and maintenance of equipment, for ensuring that the equipment is operated within its specifications and operating limits, and for ensuring that operators are adequately trained.

Operators use the product for its intended function. They must be trained in electrical safety procedures and proper use of the instrument. They must be protected from electric shock and contact with hazardous live circuits.

Maintenance personnel perform routine procedures on the product to keep it operating properly, for example, setting the line voltage or replacing consumable materials. Maintenance procedures are described in the user documentation. The procedures explicitly state if the operator may perform them. Otherwise, they should be performed only by service personnel.

Service personnel are trained to work on live circuits, perform safe installations, and repair products. Only properly trained service personnel may perform installation and service procedures.

Keithley Instruments products are designed for use with electrical signals that are rated Measurement Category I and Measurement Category II, as described in the International Electrotechnical Commission (IEC) Standard IEC 60664. Most measurement, control, and data I/O signals are Measurement Category I and must not be directly connected to mains voltage or to voltage sources with high transient over-voltages. Measurement Category II connections require protection for high transient over-voltages often associated with local AC mains connections. Assume all measurement, control, and data I/O connections are for connection to Category I sources unless otherwise marked or described in the user documentation.

Exercise extreme caution when a shock hazard is present. Lethal voltage may be present on cable connector jacks or test fixtures. The American National Standards Institute (ANSI) states that a shock hazard exists when voltage levels greater than 30V RMS, 42.4V peak, or 60VDC are present. A good safety practice is to expect that hazardous voltage is present in any unknown circuit before measuring.

Operators of this product must be protected from electric shock at all times. The responsible body must ensure that operators are prevented access and/or insulated from every connection point. In some cases, connections must be exposed to potential human contact. Product operators in these circumstances must be trained to protect themselves from the risk of electric shock. If the circuit is capable of operating at or above 1000V, no conductive part of the circuit may be exposed.

Do not connect switching cards directly to unlimited power circuits. They are intended to be used with impedance-limited sources. NEVER connect switching cards directly to AC mains. When connecting sources to switching cards, install protective devices to limit fault current and voltage to the card.

Before operating an instrument, ensure that the line cord is connected to a properly-grounded power receptacle. Inspect the connecting cables, test leads, and jumpers for possible wear, cracks, or breaks before each use.

When installing equipment where access to the main power cord is restricted, such as rack mounting, a separate main input power disconnect device must be provided in close proximity to the equipment and within easy reach of the operator.

For maximum safety, do not touch the product, test cables, or any other instruments while power is applied to the circuit under test. ALWAYS remove power from the entire test system and discharge any capacitors before: connecting or disconnecting cables or jumpers, installing or removing switching cards, or making internal changes, such as installing or removing jumpers.

Do not touch any object that could provide a current path to the common side of the circuit under test or power line (earth) ground. Always make measurements with dry hands while standing on a dry, insulated surface capable of withstanding the voltage being measured.

The instrument and accessories must be used in accordance with its specifications and operating instructions, or the safety of the equipment may be impaired.

Do not exceed the maximum signal levels of the instruments and accessories, as defined in the specifications and operating information, and as shown on the instrument or test fixture panels, or switching card.

When fuses are used in a product, replace with the same type and rating for continued protection against fire hazard.

Chassis connections must only be used as shield connections for measuring circuits, NOT as safety earth ground connections.

If you are using a test fixture, keep the lid closed while power is applied to the device under test. Safe operation requires the use of a lid interlock.

If a  screw is present, connect it to safety earth ground using the wire recommended in the user documentation.

The  symbol on an instrument indicates that the user should refer to the operating instructions located in the user documentation.

The  symbol on an instrument shows that it can source or measure 1000V or more, including the combined effect of normal and common mode voltages. Use standard safety precautions to avoid personal contact with these voltages.

The  symbol on an instrument shows that the surface may be hot. Avoid personal contact to prevent burns.

The  symbol indicates a connection terminal to the equipment frame.

If this  symbol is on a product, it indicates that mercury is present in the display lamp. Please note that the lamp must be properly disposed of according to federal, state, and local laws.

The **WARNING** heading in the user documentation explains dangers that might result in personal injury or death. Always read the associated information very carefully before performing the indicated procedure.

The **CAUTION** heading in the user documentation explains hazards that could damage the instrument. Such damage may invalidate the warranty.

Instrumentation and accessories shall not be connected to humans.

Before performing any maintenance, disconnect the line cord and all test cables.

To maintain protection from electric shock and fire, replacement components in mains circuits - including the power transformer, test leads, and input jacks - must be purchased from Keithley Instruments. Standard fuses with applicable national safety approvals may be used if the rating and type are the same. Other components that are not safety-related may be purchased from other suppliers as long as they are equivalent to the original component (note that selected parts should be purchased only through Keithley Instruments to maintain accuracy and functionality of the product). If you are unsure about the applicability of a replacement component, call a Keithley Instruments office for information.

To clean an instrument, use a damp cloth or mild, water-based cleaner. Clean the exterior of the instrument only. Do not apply cleaner directly to the instrument or allow liquids to enter or spill on the instrument. Products that consist of a circuit board with no case or chassis (e.g., a data acquisition board for installation into a computer) should never require cleaning if handled according to instructions. If the board becomes contaminated and operation is affected, the board should be returned to the factory for proper cleaning/servicing.

Quick Start Guide

Series 3700 System Switch/Multimeter

©2008, Keithley Instruments, Inc.

Cleveland, Ohio, U.S.A.

All rights reserved.

Any unauthorized reproduction, photocopy, or use the information herein, in whole or in part, without the prior written approval of Keithley Instruments, Inc. is strictly prohibited.

TSP™, TSP-Link™, and TSP-Net™ are trademarks of Keithley Instruments, Inc. All Keithley Instruments product names are trademarks or registered trademarks of Keithley Instruments, Inc. Other brand names are trademarks or registered trademarks of their respective holders.

Document number: 3700S-903-01 Rev. C / November 2008

Introduction

This Quick Start Guide describes how to establish a direct connection between a personal computer (PC) and the Model 3706, 3706-NFP, or 3706-SNFP System Switch/Multimeter. To make the best use of this document, you will need the following accessories:

- 1 LAN crossover cable (supplied with Models 3706-NFP and 3706-SNFP)
- LXI™ Discovery Browser (software provided on the Series 3700 System Switch/Multimeter Product Information CD, or at www.keithley.com)

This document demonstrates automatic TCP/IP addressing (also known as Auto IP) on a PC with Microsoft® Windows® operating system. [Appendix A: Static IP address LAN connection](#) and [Appendix C: Troubleshooting](#) contain additional information on static TCP/IP addressing. For more information about Auto IP, review the Network Connection Tutorial for Ethernet-Based Instruments located on www.keithley.com.

NOTE Before attempting to connect the Series 3706 mainframe to a corporate or public network, contact your network administrator for your specific network requirements. This guide contains instructions for necessary DHCP configuration and static IP address assignments.

Using the Quick Start Guide

This guide summarizes basic measurement functions and a few of the important features of the Keithley Instruments Series 3700 System Switch/Multimeter instruments. Note that only certain front-panel controls are described in this guide; for more detailed information, refer to the Series 3700 System Switch/Multimeter User's and Reference Manuals. The following table identifies topics applicable to your model.

Topic	3706 with module	3706-S with module	3706 without module	3706-S without module	3706-NFP with module
<i>Hardware and software requirements</i>	☑	☑	☑	☑	☑
<i>Connection warning</i>	☑	☑			☑
<i>Install the module</i>	☑	☑			☑
<i>Using the navigation wheel and display</i>	☑	☑	☑	☑	
<i>Remote operation</i>	☑	☑			☑
<i>Front panel procedures</i>					
- <i>Common tasks</i>	☑		☑		
- <i>DMM operation versus switch operation</i>	☑				
- <i>Advanced applications</i>	☑				
- <i>Using the Analog backplane connector to take measurements without a switch module</i>	☑		☑		
<i>Troubleshooting</i>	☑	☑			☑

Hardware and software requirements

The following table defines the hardware and software requirements using in the examples in this Quick Start Guide.

	DMM vs. switch operation	Advanced application	Analog backplane	Remote operation
(1) Multiplexer Module 60 installed in Slot 1	<input checked="" type="checkbox"/>	<input checked="" type="checkbox"/>		<input checked="" type="checkbox"/>
DC power supply or battery; connected across channel		<input checked="" type="checkbox"/>		
(1) Resistor Range from 1 Ω to 120 M Ω	<input checked="" type="checkbox"/>		<input checked="" type="checkbox"/>	
PC with network interface card (NIC) and TCP/IP protocol installed				<input checked="" type="checkbox"/>
PC with JAVA™ Platform, Standard Edition 6 installed				<input checked="" type="checkbox"/>
USB flash drive		<input checked="" type="checkbox"/>		

NOTE Multiplexer switch modules include (but are not limited to) Models 3720, 3721, 3722, and 3723.

Connection warning

WARNING

Connection information for switching modules is intended for qualified service personnel. Do not attempt to connect DUT or external circuitry to a switching module unless qualified to do so.

To prevent electric shock that could result in serious injury or death, comply with these safety precautions:

Before making or breaking any connections to the switching module, make sure the Series 3700 is turned off and power is removed from all external circuitry.

Do not connect signals that will exceed the maximum specifications of any installed switching module.

Test lead insulation must be rated to the highest voltage connection when the Series 3700 rear analog backplane connector and the switching module terminals are simultaneously connected. For example, if 300V is connected to the analog backplane connector, the test lead insulation for the switching module must also be rated for 300V.

Dangerous, explosive electrical arcs that can cause severe personal injury or death are possible if a multimeter that is set to a low-impedance range is connected to a high-energy circuit, causing a "virtual short."

Dangerous arcing can result (even when the multimeter is set to a voltage range) if the minimum voltage spacing is reduced in the external connections. For details about how to safely make high energy measurements, see High-energy circuit safety precautions in the Series 3700 Reference Manual.

IMPORTANT: *Do not connect the Series 3700 to mains; it is designated Installation Category I, as described in the International Electrotechnical Commission (IEC) Standard IEC 664.*

Install the module

WARNING Slot covers must be installed on unused slots to prevent personal contact with high-voltage circuits.

Figure 1: Typical module installation

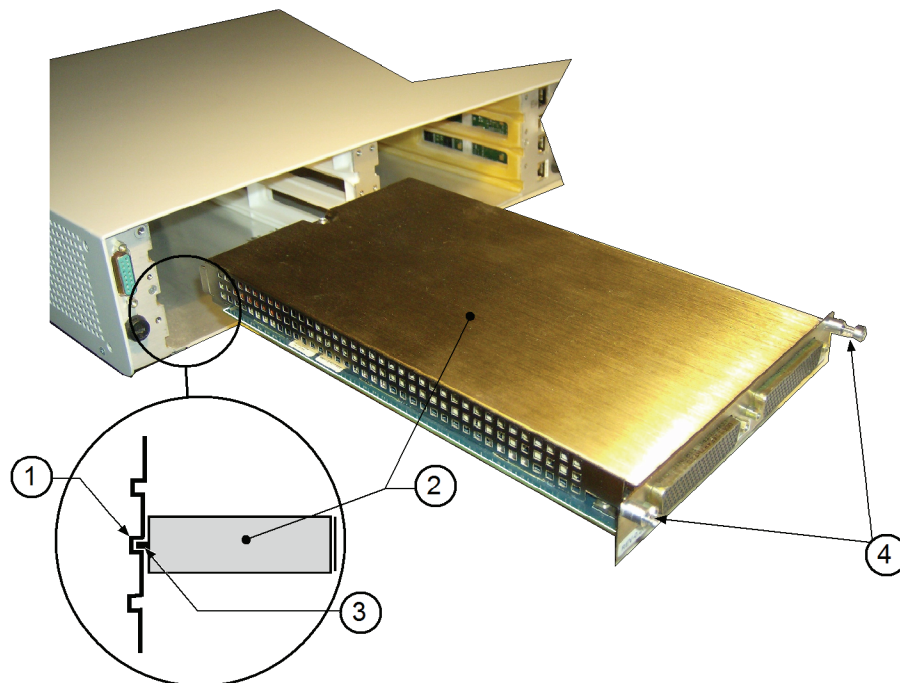

(1) Card guide (part of Series 3700)

(3) Card edge (part of module)

(2) Module

(4) Mounting screw (part of module)

WARNING To prevent electric shock that could result in injury or death, NEVER handle a switching module that has power applied to it.

Before installing (or removing) a switching module, make sure the Series 3700 is turned off and disconnected from line power.

If the switching module is already connected to a device under test (DUT), make sure power is removed from all external circuitry.

Using the navigation wheel and display

The navigation wheel  makes it easy to move through the menus and set parameters. You will use a combination of turning and pressing the wheel to maneuver through the menus and configuration choices. Highlight the parameter you want to select or configure and push the navigation wheel to accept the parameter. Pushing the navigation wheel has the same functionality as pressing the instrument front panel **ENTER** key.

To maneuver within the active channel display:

- Pushing the navigation wheel has the same functionality as the Tab key on a PC. Each push of the navigation wheel sequentially moves the selection through the four main display parameters: slot, channel, end channel, and measurement function.

To configure a parameter in the active channel display:

- Push the navigation wheel until the desired parameter is highlighted: slot, channel, end channel, or function.
- Rotate the navigation wheel to scroll to the desired measurement function or to edit the value of the numeric parameter of the slot, channel, or end channel. Slot parameters are not configurable unless a module is installed in that slot position.
- Push the navigation wheel or press the **ENTER** key to accept your changes.

To configure a parameter within a menu:

- Press the **MENU** key to enter the desired menu.
- Rotate the navigation wheel to scroll to the desired parameter (indicated by **BOLD** in the procedures shown in this guide).
- Push the navigation wheel or press the **ENTER** key to accept your changes. Note that this action is indicated as > in this guide.
- Press the **EXIT** key to return to previous layer of the menu.

Front-panel display

Figure 2: Example of active channel display

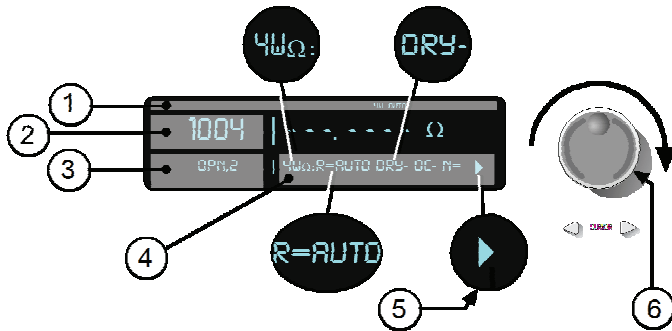

- (1) Measurement function attributes (for example, auto range).
- (2) Slot and active channel. Also start channel of scan list.
- (3) The present state of channel attributes. Also end channel of scan list.
- (4) Measurement function attributes.
- (5) Indicates additional attributes are available for access by turning the wheel.
- (6) Navigation wheel.

Figure 3: Example of MAIN MENU display

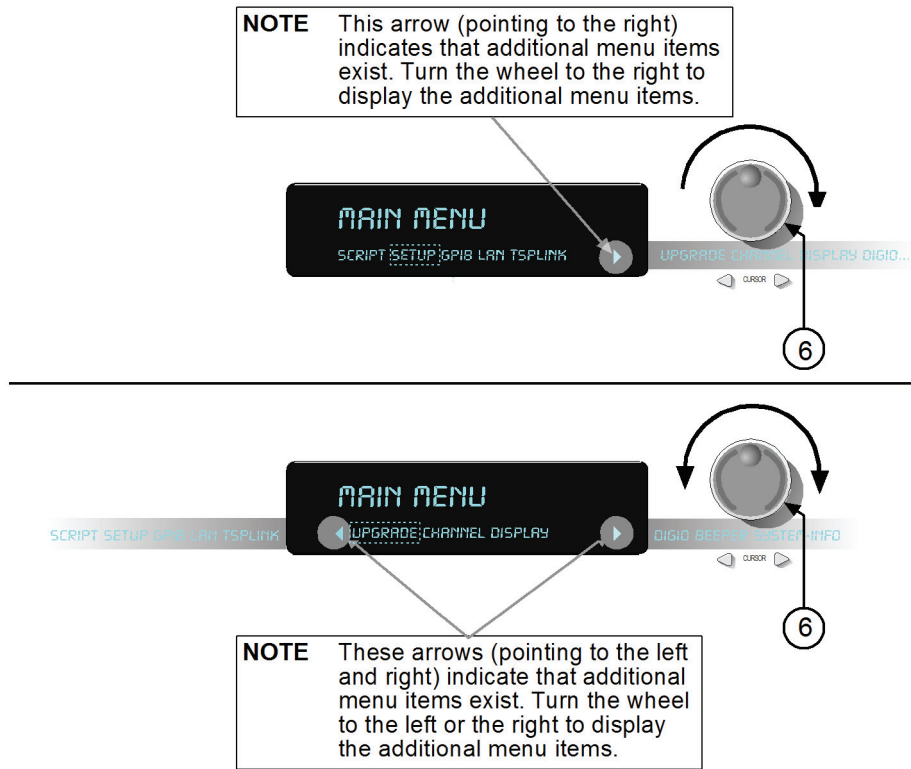

Remote operation

Factory defaults for the communication port settings:

LAN

- Method = Auto (DHCP and auto-IP enabled)
- IP address not assigned
- Default gateway not assigned
- Telnet port = 23
- Raw socket port = 5025
- VXI-11 port = 1024
- Dead socket termination port = 5030

GPIB

- Default address = 16

USB

- VISA Resource ID: USB<#>::0x5E6::0x3706::<serial #>::INSTR

Example: USB0::0x5E6::0x3706::01144435::INSTR

USB connection uses USB TMC driver. NI-VISA™ Run-Time Engine must be installed. Installing Keithley I/O Layer or Keithley Instruments Test Script Builder Suite installs the NI-VISA Runtime application.

Remote operation: LAN connection

Your Series 3700 System Switch/Multimeter has an internal web interface that can be accessed by a PC. There are several methods you can use to remotely control your Series 3700 from a PC. The method described here consists of three steps: Create a direct instrument-to-PC LAN connection; set up an IP address between the PC and the instrument; and then access the instrument's internal web interface.

The procedure below includes setting up an automatically assigned IP address and installing the LXI™ Discovery Browser software on your PC. The alternative to using this software is to manually assign the instrument to a static IP address. See [Appendix A: Static IP address LAN connection](#) for more information.

Overview

The eight steps to using a direct LAN connection to connect to the internal web page:

Step 1: Identify and record the PC's existing IP configuration information.

Step 2: Configure the network interface card (NIC) of the PC to obtain an IP address automatically.

Step 3: Configure the instrument to obtain an IP address automatically by performing a LAN reset

Step 4: Connect the LAN crossover cable from the instrument to the PC

Step 5: Wait for the LAN STATUS indicator on the Series 3700 to turn solid green

Step 6: Install LXI Discovery Browser software on your PC

Step 7: Run LXI Discovery Browser

Step 8: Double-click the IP address in the LXI Discovery Browser window

CAUTION Capture the network configuration before modifying the existing network configuration information on the network interface card. See [Step 1: Identify and record the PC's existing IP configuration information](#). Once you update the network configuration settings, the older information is lost. This may cause a problem when you try to reconnect the PC to a corporate network if DHCP Enabled = NO, DHCP mode is disabled. If you have any problems, contact your system administrator.

Step 1: Identify and record the PC's existing IP configuration information.

CAUTION You are responsible to return ALL settings back to their original configuration PRIOR to reconnecting the PC to a corporate network; failure to do this could result in damage to your equipment or loss of data. These settings include, but are not limited to, the IP address, DHCP enabled mode, and the subnet mask.

Use the command prompt to see the existing IP configuration information. For information about how to open the command prompt, see [Appendix A: Static IP address LAN connection](#).

Record existing settings

Record the existing IP configuration information in the table below so that you can properly return all settings back to their original configuration before reconnecting your PC to a corporate network.

DHCP Enabled	
IP Address	
Subnet Mask	
Default Gateway	
DNS Servers	

Step 2: Configure the network interface card (NIC) of the PC to obtain an IP address automatically.

NOTE Do NOT change your IP address at any time without talking to your system administrator first. Entering an incorrect IP address can prevent your PC from connecting to your corporate network.

Open the Internet Protocol (TCP/IP) Properties dialog box (see [Figure 4](#)).

Select **Obtain an IP address automatically**.

Figure 4: The Internet Protocol (TCP/IP) Properties dialog box

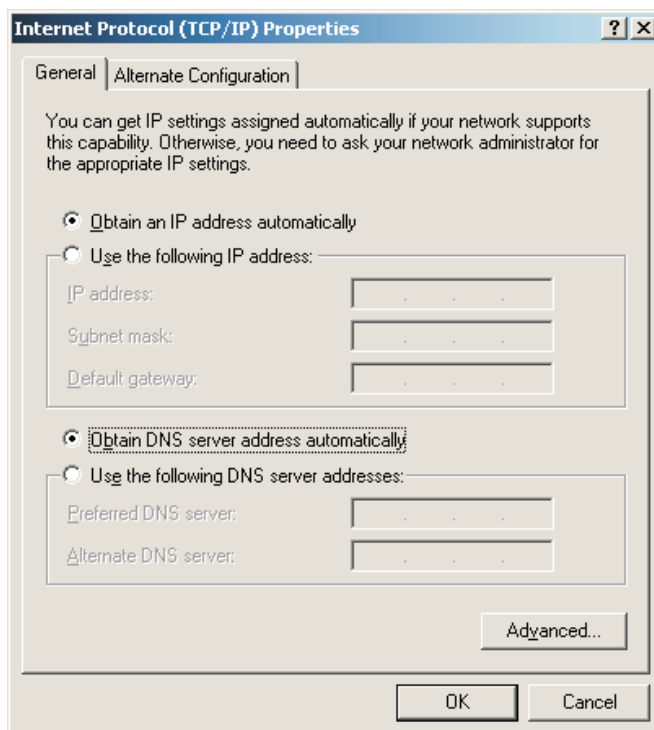



Step 3: Configure the instrument to obtain an IP address automatically by performing a LAN reset

The factory default LAN settings are DHCP and auto-IP enabled (Method = auto). If this is the first time that the Model 3706-NFP or 3706-SNFP has been powered up since being shipped from Keithley Instruments, it is not necessary to reset the LAN. Proceed to Step 4.

To reset the LAN, press the front-panel recessed **Reset** button (see [Figure 5](#)).

For front panel models, the LAN can also be manually reset using the front-panel menu:

1. Press **MENU**.
2. Use the **navigation wheel**  to select **LAN**, and press the **navigation wheel** or **Enter**.
3. Use the **navigation wheel**  to select **RESET**, and press the **navigation wheel** or **Enter**.
4. Use **EXIT** to return to the top layer.

NOTE There will be no visual indication on the front panel display that the LAN has been reset.

Figure 5: LAN reset button



Step 4: Connect the LAN crossover cable from the instrument to the PC

Connect the supplied crossover cable between the computer's network interface card (NIC) and the instrument's Ethernet connector on the rear panel. There are multiple connectors on the instrument rear panel/ be sure to connect to the network Ethernet connector (see [Figure 6](#)).

Figure 6: Rear panel Ethernet connector

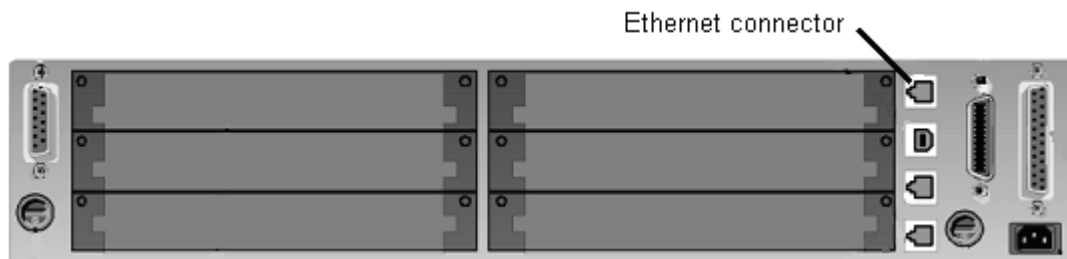

Step 5: Wait for the LAN STATUS indicator on the Series 3700 to turn solid green

The LAN status indicator (see [Figure 7](#)) confirms that the Model 3706-NFP or Model 3706-SNFP has been assigned an IP address. Note that it may take several minutes for the PC and Series 3700 to configure themselves.

Figure 7: LAN status indicator



Step 6: Install LXI Discovery Browser software on your PC

This software helps you determine the IP address assigned to your Series 3700. The software can be found on the Series 3700 Product Information CD.

Step 7: Run LXI Discovery Browser

The software will populate a window with the instruments found on the network and their associated IP addresses (see [Figure 8](#)).

NOTE If the web page does not open in the browser, see [Appendix C: Troubleshooting](#) for additional suggestions.

Figure 8: Keithley LXI Discovery Browser network instruments screen

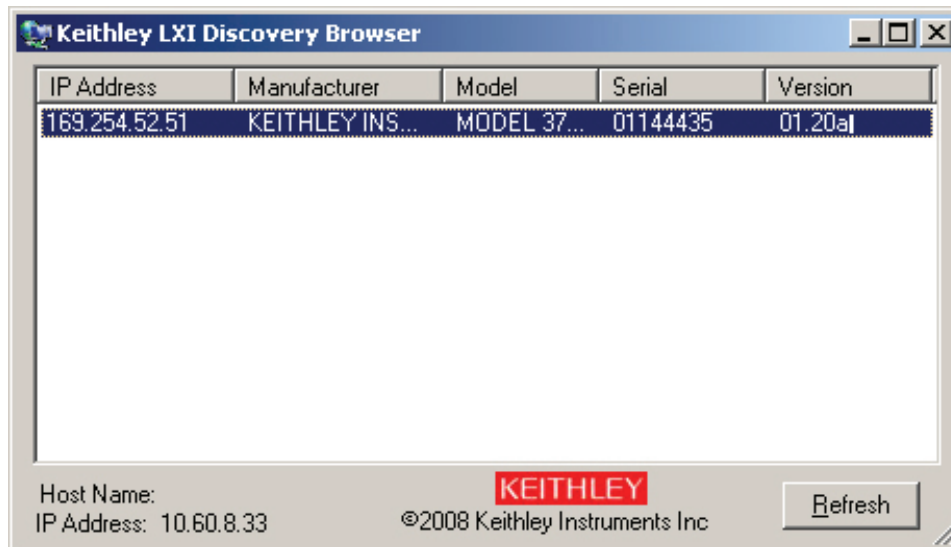

Step 8: Double-click the IP address in the LXI Discovery Browser window

This opens the embedded web interface (see [Figure 9](#)).

Figure 9: Series 3700 home page

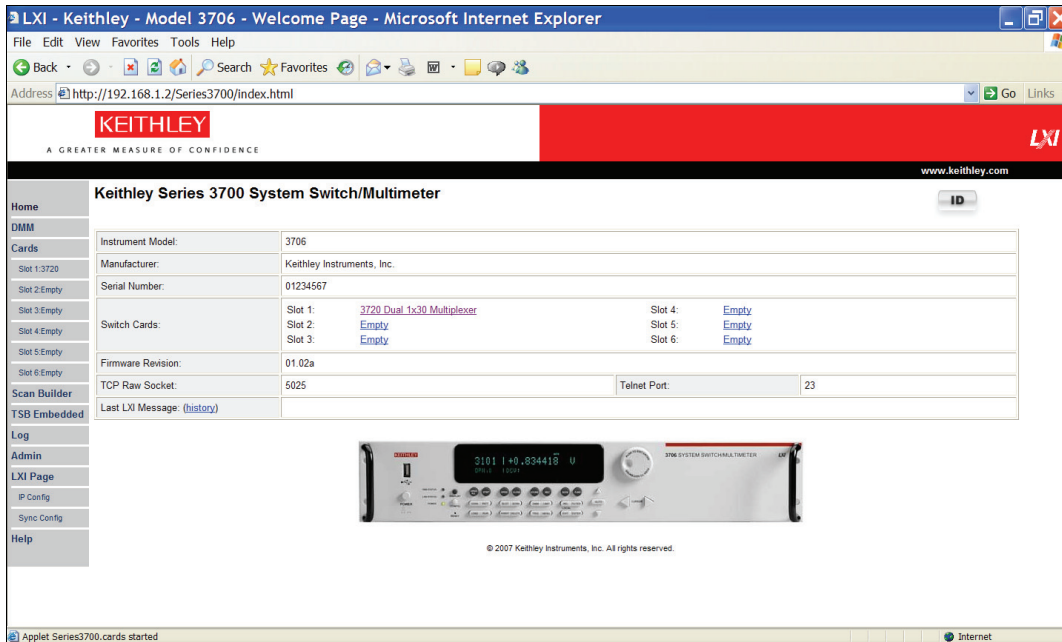

Open the switch diagram to begin closing channels or taking measurements

From the home page, select the installed switch card by clicking **Cards** in the left navigation pane. The switch diagram page for that particular switch module opens. See [Appendix C: Troubleshooting](#) if you are unable to open switch diagram page.

Figure 10: Series 3700 switch diagram page

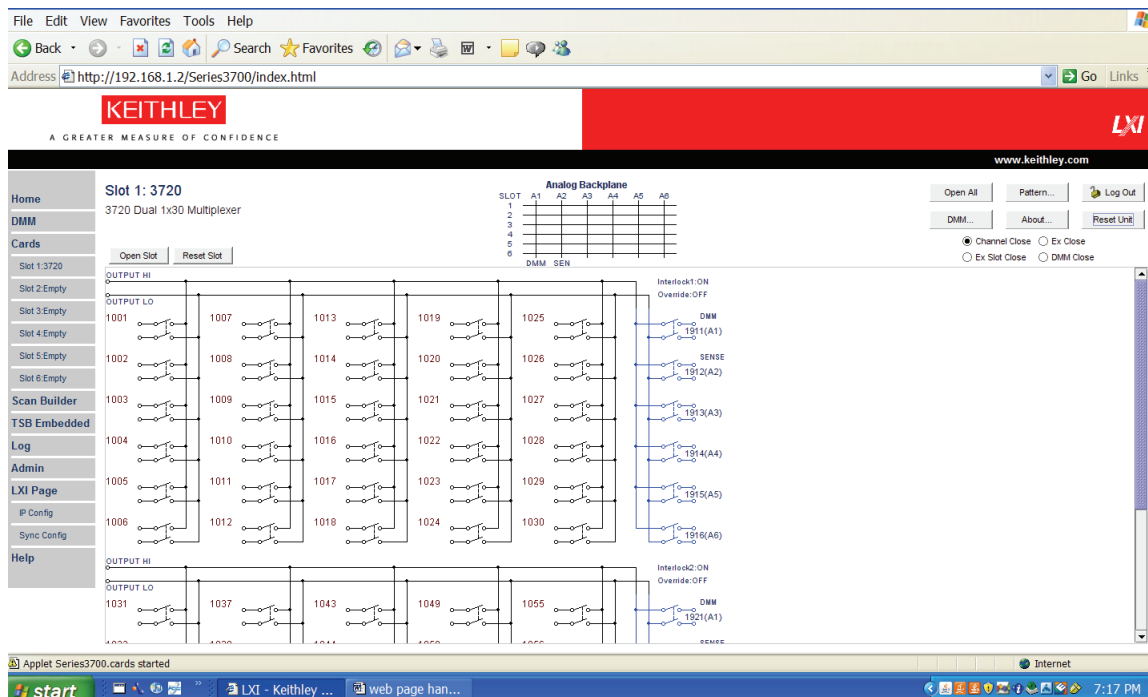

You must log on to control switch operation. The default password is **Admin**.

Right-click the channel to open the channel configuration window and set the channel attributes. Click the channel to open and close the channel.

See the web page online help for more information.

CAUTION Remember to return the computer settings to the original configuration prior to reconnecting the computer to a corporate network. Refer to the [Record existing settings](#) table found on [page 11](#) for your specific recorded configuration details.

Front panel procedures

The front panel procedures use the navigation wheel and display. The desired parameter is indicated in bold print and the symbol > indicates the parameter is located in the next layer of that menu. See [Using the navigation wheel and display](#) prior to performing the following procedures.

Common tasks

Common task: Perform a factory reset

NOTE Perform a factory reset after each of the following procedures.

Figure 11: Instrument factory reset controls



Reset from the SETUP menu.

1. Press the **MENU** key. The MAIN MENU is displayed.
2. Use navigation wheel  to select **SETUP > RESET**, and then **Enter**.

NOTE The factory reset default puts the digital multimeter (DMM) in a one-shot trigger measurement mode.

Common task: Put the instrument in continuous measurement mode

Figure 12: Instrument TRIG button



NOTE The factory reset default puts the DMM in a one-shot trigger measurement mode.

- Press and hold the **TRIG** key for approximately three seconds.
-

NOTE To disable continuous updates, press the **TRIG** key again or perform a factory reset (see [Common task: Perform a factory reset](#) for instructions).

DMM operation versus switch operation

The **OPEN** and **CLOSE** front-panel keys behave differently depending on how the channel is configured. It can be configured as switch operation or DMM operation.

The following two examples show how to take a DMM measurement using each operation. Be sure to connect a resistor to Channel 31 on a switch module and install in Slot 1 prior to performing the following examples.

Example 1: Close a channel and take a measurement using the DMM operation method

By assigning a measurement function to a channel (see [Figure 13](#)), the CLOSE key routes the input signal automatically to the DMM through the appropriate backplane relays. Automatic closure of backplane relays happens when a measurement function is assigned to the channel. This action is referred to as DMM operation.



NOTE Because factory reset default settings assign no function to the channels, the CLOSE key behaves like a switch operation. Input signals are not automatically routed to the DMM input by default.

DMM operation method

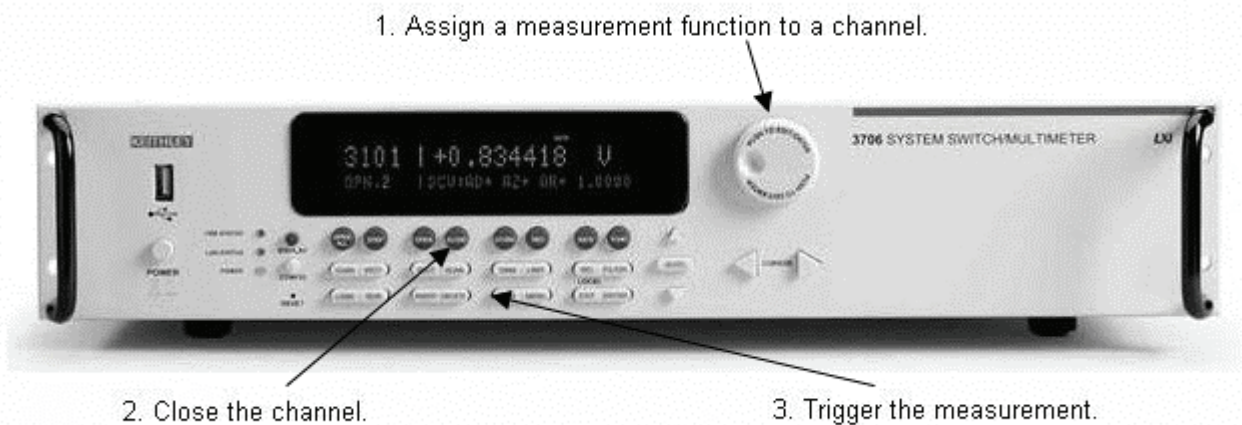
Figure 13: Close a channel and trigger a measurement using the DMM method



To close a channel and take a measurement using the DMM operation method:

1. Assign a measurement function of **twowireohms** to channel 1031:
 - a. Use the navigation wheel  to modify the channel designation from 001 to **031**.
 - b. Use the navigation wheel  to select **twowireohms** as the measurement function.
2. Press the **CLOSE** key to close Channel 1031.
3. Press the **TRIG** key to acquire and display a single measurement.
4. Perform a factory reset (see [Common task: Perform a factory reset](#) for instructions).



Example 2: Close a channel and take a measurement using the switch operation method

In switch operation, backplane relays are not closed automatically. Backplane relays are closed only when they are associated to a channel. When that channel is closed, the associated backplane relay also closes. To take a measurement, the appropriate backplane relay must be associated with the channel to route the signal to the DMM.

NOTE A backplane relay cannot be closed from the front panel as a stand-alone channel.

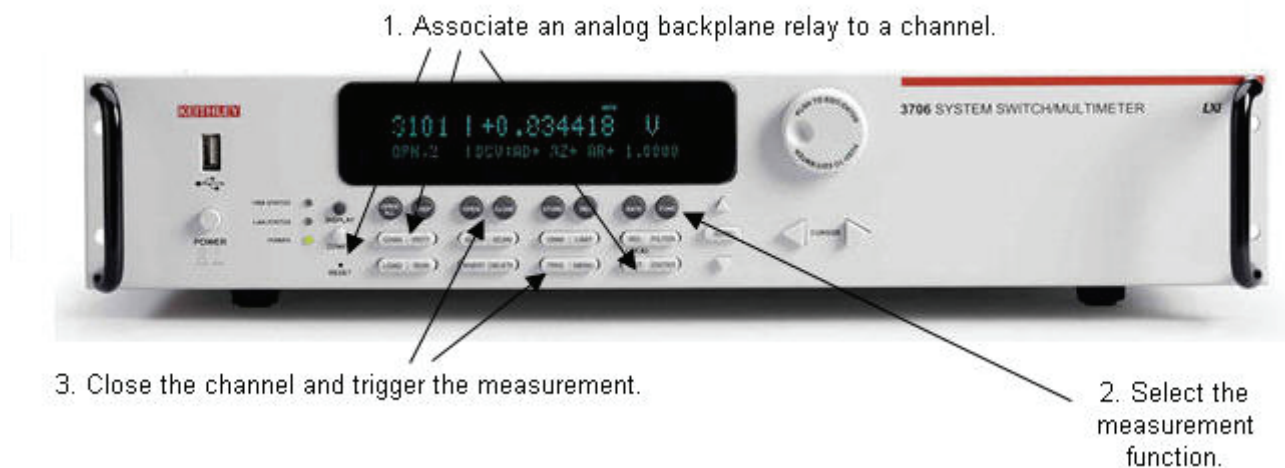
Figure 14: The switch operation method



1. Associate analog backplane relay channel 1921 and channel 1031:
 - c. Use the navigation wheel  to modify the channel designation from 001 to **031**.
 - d. Press the **EXIT** key to return to the assigned channel display.
 - e. Press the **CONFIG** key. **CONFIG+** is displayed.
 - f. Press the **CHAN** key.
 - g. Use the navigation wheel  to select **BACKPLANE > ADD**, and then **Enter**.
 - h. Use the navigation wheel  to modify the backplane relay channel from 1911 to **1921**.
 - i. Press the **EXIT** key twice to return to the assigned channel display.
2. Press the **FUNC** key until **2WΩ** is displayed.
3. Press the **CLOSE** key to close Channel 1031 and the associated analog backplane relay (Channel 1921).
4. Press the **TRIG** key to take a measurement.
5. Perform a factory reset (see [Common task: Perform a factory reset](#) for instructions).

Advanced applications

Perform a scan operation and save data to the USB drive

This example creates a ten-channel scan operation to measure voltage on ten sequential channels. A buffer is created to store the scan data and save it to a standard USB flash drive (not included).

The example assumes a known voltage (or short) is connected across Channels 1 through 5 and 17 through 21 on a multiplexing switch module installed in Slot 1. See [Using the Quick Start Guide](#) and [Hardware and software requirements](#).

Figure 15: Create a scan list



1. Create a scan list.

1. Create a scan list (see [Figure 15](#)).

Using the navigation wheel :

- a. Select and modify the start channel to 001.
- b. Select and modify the end channel to 005.
- c. Select **dcvolts** as the assigned measurement function.
- d. Press **ENTER**.
- e. Press **INSERT** to add more channels to the scan list.

The front panel will display “Add to Scan...”

2. Repeat steps 1.a. through 1.e to add Channels **1017** through **1021** to the scan list.

3. Create a buffer (see [Figure 16](#)):
 - a. Press the **STORE** key on the front panel.
 - b. Use the navigation wheel  to select **CREATE > fbuf**.

NOTE The default buffer name is fbuf, but it can be modified using the navigation wheel  in the edit mode. This example assumes the buffer name is fbuf.

- c. Press **Enter** until **CAPACITY 000010** is displayed.
- d. Press **Enter**. The fbuf MENU is displayed.
- e. Use the navigation wheel  to choose **SELECT > fbuf**, and then **Enter**.
- f. Press the **EXIT** key to return to the active channel display.

Figure 16: Create a buffer to save readings on a USB flash drive



4. Run the scan (see [Figure 17](#)):
 - a. Press the **SCAN** key.
 - b. Use the navigation wheel  to select **BACKGROUND**.
 - c. Press **Enter**.

Figure 17: Run the scan



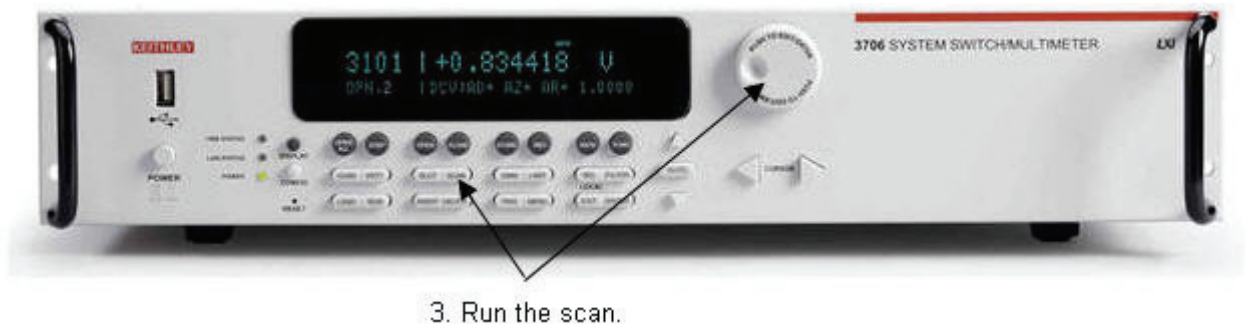

5. Store the buffer on a USB flash drive (see [Figure 18](#)):

Figure 18: Store the buffer on a USB flash drive



4. Store buffer to USB port.

- a. Insert the USB flash drive (not included) into the front panel USB connector.
 - b. Press the **STORE** key to access the buffer menu.
 - c. Use the navigation wheel  to select **SAVE > USB** (hint: SAVE is to the right of DELETE).
 - d. Use the navigation wheel  to select the default buffer name **fpbuf** and change it to a more meaningful name for storage on the USB flash drive.
 - e. Push the navigation wheel  until the **Buffer** menu is displayed. The data file is now stored in the root directory on the USB flash drive.
6. Perform a factory reset (see [Common task: Perform a factory reset](#) for instructions).

Using the Analog backplane connector to take measurements without a switch module

The rear panel analog backplane connector (DB-15) is always connected to the DMM input. Measurements can be performed without a switch module by using the analog backplane connection. Use a standard DB-15 mating connector (not supplied) to connect to the analog backplane on the rear panel as shown in *Figure 19*.

NOTE The switch module and analog backplane connector cannot be used at the same time, because they are connected in parallel.

There is no relay that connects to the DB-15.

Figure 19: Analog backplane connector

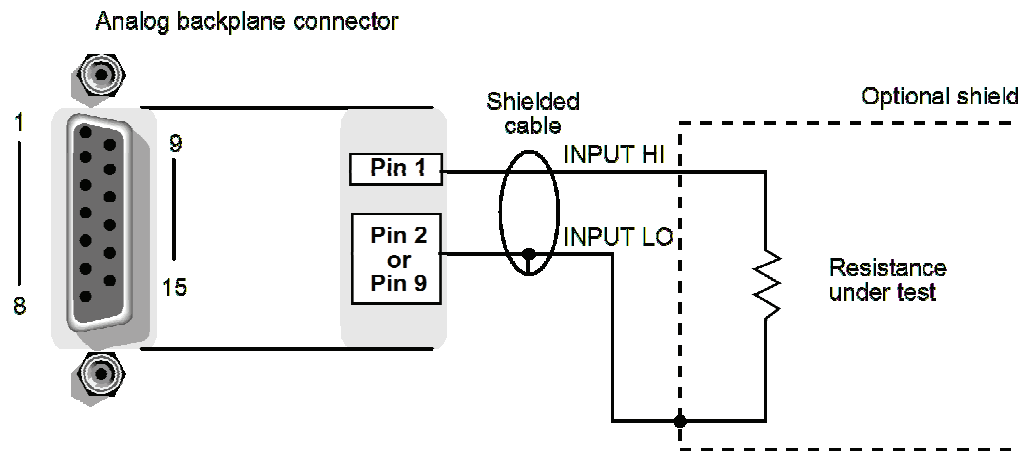

NOTE Source current flows from the connector HI to the connector LO pins.

Figure 20: Take measurements without a scanner module

1. Connect the resistor to the input terminals.

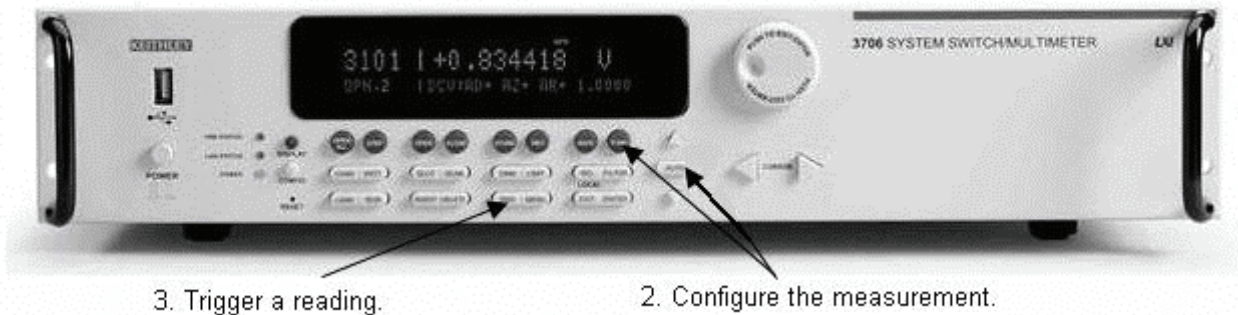

3. Trigger a reading.

2. Configure the measurement.

To take measurements:

1. Connect the resistor to the input terminals.
2. Configure the measurement by pressing the **FUNC** key until **2W Ω** is displayed.
3. Press the **AUTO** key to enable the auto range feature. "Auto" is displayed in upper right corner.
4. Press the **TRIG** key to trigger a reading.
5. Perform a factory reset (see [Common task: Perform a factory reset](#) for instructions).

Appendix A: Static IP address LAN connection

A point-to-point LAN connection to set up a static IP address between the PC and the instrument enables the use of the instrument's internal web page and TSP™ Express.

Use the instructions below to configure the instrument's IP address based on the present IP address of the host PC. Whenever there is an existing IP address configured for the network interface card's network settings, the IP address for the Ethernet instruments should be configured so that they are compatible.

Record all network configurations before modifying any existing network configuration information on the network interface card. Once the network configuration settings are updated, the older information is lost. This may cause a problem reconnecting the PC to a corporate network if DHCP mode is disabled.

CAUTION Be sure to return all settings to their original configuration prior to reconnecting the PC to a corporate network. Failure to do this could result in damage to the equipment and loss of data. Contact your system administrator for more information.

Step 1: Identify and record the PC's existing IP configuration information

1. Open the command prompt to see the existing IP configuration information (see [Figure A-1](#)):
 - In Windows 2000/XP™:
 - a. Click the **Start** button, and then select **Run**.
 - b. Type `cmd` in the **Open** field and click **OK**.
 - In Windows Vista:
 - a. Click the **Start** button.
 - b. Select **All Programs**.
 - c. Select **Accessories**.
 - d. Select **Command Prompt**.

Figure A-1: Computer configuration using the command prompt

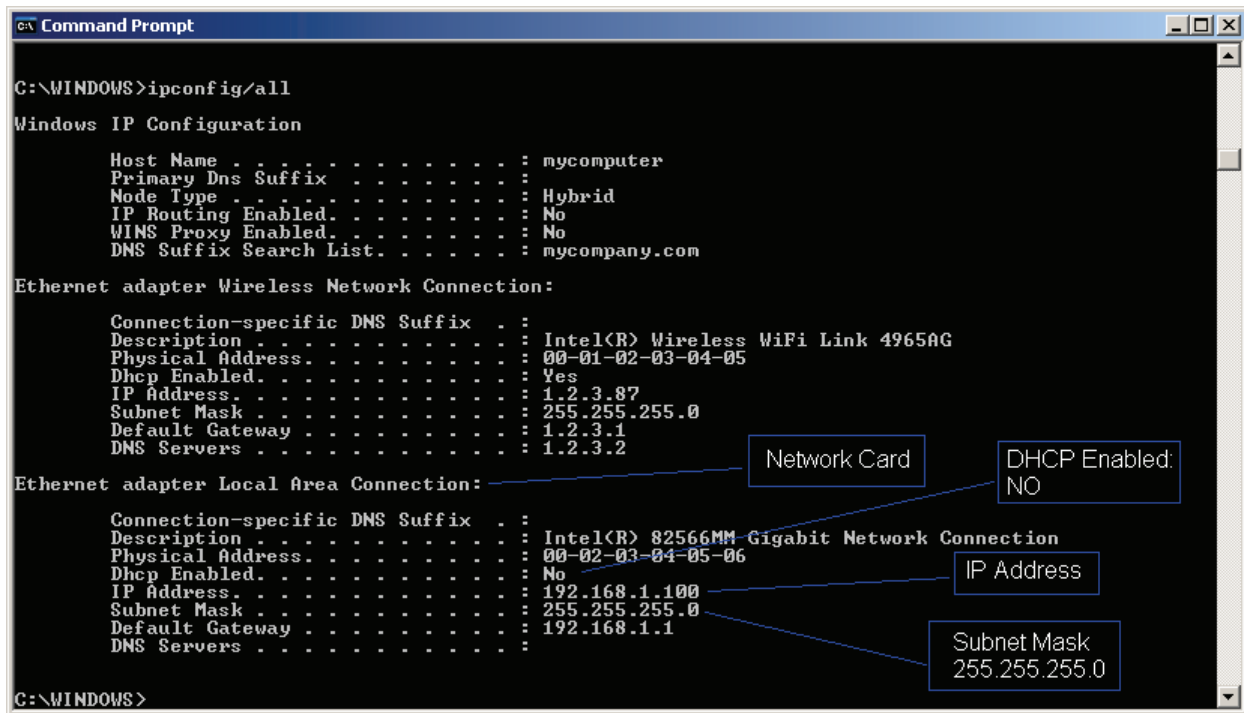

2. At the command prompt, type `ipconfig/all`, and then click **Enter**.
 - a. If the information for the Ethernet adapter displays **Media Disconnected** then close the command prompt and skip to [Step 2: Disable DHCP to use the computer's existing IP address](#).
 - b. When the information is displayed, record the DHCP mode, IP address, subnet mask, default gateway, and DNS server information.

CAUTION The `ipconfig/all` command displays the configuration of all network connections. Be sure to record the information for the proper network card.

3. Verify selected status: DHCP or Static IP
 - To determine the next step, check the DHCP Enabled setting in the IP configuration screen or in the settings recorded earlier:
 - a. If DHCP Enabled = **Yes**, proceed to **Step 2: Disable DHCP to use the computer's existing IP address**.
 - b. If DHCP Enabled = **No**, proceed to **Step 3: Configure the instrument's LAN settings**.

NOTE When DHCP Enabled = Yes, the IP address of the PC is assigned automatically upon power up. However, if DHCP Enabled = No, the network will not recognize the PC if the original settings are changed. If at any time you are unsure how to proceed, contact your system administrator.

4. To exit the IP configuration screen, type `exit` at the command prompt, and then press **ENTER**.

Step 2: Disable DHCP to use the computer's existing IP address

NOTE Do not change the IP address without talking to your system administrator first. Entering an incorrect IP address can prevent your PC from connecting to your corporate network.

1. Open the Internet Protocol (TCP/IP) Properties dialog box (see *Figure A-2*):
 - In Windows 2000:
 - a. Click the **Start** button, select **Settings**, and then open the **Control Panel**.
 - b. Select **Network and Dial-up Connections**.
 - c. Right-click **Local Area Connection**, and then select **Properties**. The Local Area Connection Properties dialog box is displayed.
 - d. Double-click **Internet Protocol (TCP/IP)** in the items list. The Internet Protocol (TCP/IP) Properties dialog box is displayed.
 - In Windows XP:
 - a. Click the **Start** button, and then open the **Control Panel**.
 - b. Select **Network Connections**.
 - c. Right-click **Local Area Connection**, and then select **Properties**. The Local Area Connection Properties dialog box is displayed.
 - d. Double-click **Internet Protocol (TCP/IP)** in the items list. The Internet Protocol (TCP/IP) Properties dialog box is displayed.
 - In Windows Vista:
 - a. Click the **Start** button, and then open the **Control Panel**.
 - b. Select **Network & Sharing Center**.
 - c. In the list, click **View Status** next to **Connection**. The Wireless Network Connection Status dialog box is displayed.
 - d. Click **Properties**. Windows displays a permissions message.
 - e. If you are logged in as administrator, click **Continue**. If you are not logged in as an administrator, enter the administrator's password to continue.
 - f. The Network Connection Properties dialog box is displayed.
 - g. Double-click **Internet Protocol Version 6 (TCP/IPv6)** in the items list. The Internet Protocol Version 6 (TCP/IPv6) Properties dialog box is displayed.

Figure A-2: Internet Protocol (TCP/IP) Properties dialog box

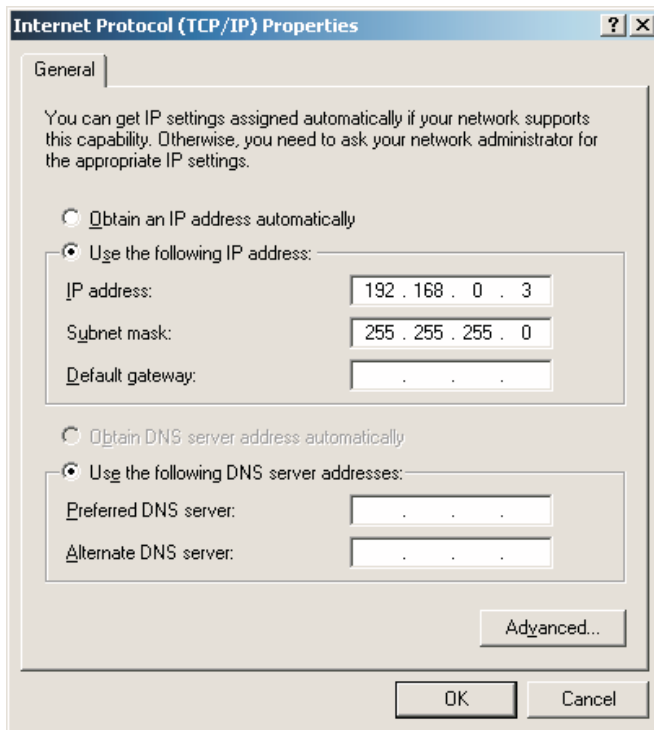

2. Select **Use the following IP address**. The option for **Use the following DNS server** addresses is automatically selected.
3. Set the IP Address:
 - a. Are the IP address and subnet mask fields populated?
 - Yes: If populated, record the address, subnet mask, default gateway, and DNS servers to use in **Step 3: Configure the instrument's LAN settings**.
 - No: If blank, enter the IP address 192.168.0.3 in the IP address field and 255.255.255.0 in the subnet mask field. These will be used to configure the instrument's LAN settings.
 - b. After recording or entering the IP address, click **OK** to close the Internet Protocol (TCP/IP) Properties dialog box.
4. Close the Network Connections window.

Step 3: Configure the Instrument's LAN settings



To configure the Series 3700 using the front panel:

1. Press **MENU** to display the MAIN MENU. Use the **navigation wheel**  to select **LAN** to display the LAN MENU.
2. Change the IP address assignment method:
 - a. Select **CONFIG > METHOD > MANUAL**, then press **MENU**.
 - b. Press **EXIT** once to return to the LAN MENU.

- c. Select **APPLY_SETTINGS > YES**, then press **ENTER**.
3. Enter the IP address using the LAN MENU:
 - a. Select **CONFIG > IP-ADDRESS**.
 - b. Refer to the recorded computer's IP address that you recorded in Step 2. A portion of the computer's IP address will be used as a base for the instrument's unique ID. Only the last three numbers (after the last decimal point) of the PC and instrument will be different. The last three digits may be anything from 1 to 255 (for a subnet mask of 255.255.255.0).

For example, the Internet Protocol (TCP/IP) Properties dialog box shows that the computer's IP address is 192.168.0.3. A unique address for the instrument is 192.168.001.101.

NOTE The instrument's IP address can have leading zeros, but the computer's IP address cannot.

- c. Use the navigation wheel to select and enter an appropriate IP address for the instrument. Be sure to record the instrument's IP address to use in [Step 5: Access the instrument's internal web page](#).
 - d. Press **ENTER** or the navigation wheel  to confirm the changes.
 - e. Press **EXIT** to return to the LAN MENU.
 - f. From the LAN MENU, select **APPLY_SETTINGS > YES**, and then press **ENTER**.
4. Change the subnet mask from within the LAN MENU:
 - a. Select **CONFIG > SUBNETMASK**, and then press **ENTER**. The SUBNET MASK menu item is to the right of GATEWAY. Use the navigation wheel to scroll through the options.
 - b. Modify the **SUBNETMASK** to match the PC settings recorded earlier (or 255.255.255.000 if DHCP Enabled = YES).
 - c. Press **ENTER** or the navigation wheel  when you have finished changing all the characters.
 - d. Press **EXIT** to return to the LAN MENU.
 - e. From the LAN MENU, select **APPLY_SETTINGS > YES**, and then press **ENTER**.

NOTE **APPLY_SETTINGS** must be used before changes to the IP address or subnet mask are applied.

Step 4: Connect the crossover cable from the instrument to the PC network interface card

Connect the supplied crossover cable between the computer's NIC card and the Ethernet connector on the instrument's rear panel. There are multiple connectors on the Series 3700 rear panel; be sure to connect to the LAN connection port.

Connect the crossover cable into the same PC Ethernet port that was used during the configuration of the instrument. This will ensure that the system is using the correct network card.

Step 5: Access the instrument's internal web page

1. Open a web browser on the host PC.
2. Enter the instrument's IP address in the browser's address box. For example, if the instrument's IP address is 192.168.0.3, enter **192.168.0.3** in the browser's address box.
3. Press **ENTER** on the PC keyboard to open the instrument's web page.

NOTE If the web page does not open in the browser, see [Appendix C: Troubleshooting](#).

Appendix B: Assigning a static IP configuration from the embedded web interface

You can assign a static IP address to the Series 3700 using the embedded web interface or by using ICL commands on any command interface (see the Series 3700 Reference Manual for more information about ICL commands).

To assign a static IP address using the embedded web interface:

1. Perform the steps in [Appendix A: Static IP address LAN connection](#) to establish a connection with the instrument. After completing Step 8, the embedded web interface of the Model 3706 mainframe (shown in [Figure 9](#)) appears in your browser window.
2. Navigate to the IP configuration page (see [Figure B-1](#)) by clicking **IP Config** under the **LXI Page** menu on the left side of the embedded web interface screen. Click the **Modify** button. You will be asked for a user name and password. Use the following:

Username: **admin**

Password: **admin**

Click the **OK** button to access and change the IP configuration.

Figure B-1: IP configuration page

The screenshot shows the LXI Keithley Model - Modify IP Configuration Page. The page has a navigation menu on the left and a main content area. The main content area contains a form with the following fields:

Slot 1 Empty	Hostname:	<input type="text" value="K-3706-01144435"/>
Slot 2 Empty	Description:	<input type="text" value="Keithley 3706 #01144435"/>
Slot 3 Empty	TCP/IP Configuration Mode:	<input type="radio"/> Automatic <input checked="" type="radio"/> Manual
Slot 4 Empty	Static IP Address:	<input type="text" value="0.0.0.0"/>
Slot 5 Empty	Subnet Mask:	<input type="text" value="255.255.0.0"/>
Slot 6 Empty	Default Gateway:	<input type="text" value="0.0.0.0"/>
Scan Builder	DNS Servers:	<input type="text"/> <input type="text"/>
TSB Embedded	Domain:	<input type="text"/>
System	Ping:	<input checked="" type="radio"/> Enabled <input type="radio"/> Disabled

At the bottom of the form is a **Submit** button.

3. Select **Manual** next to TCP/IP Configuration Mode.
4. On the Modify IP Configuration page (see *Figure B-2*), type in the desired Static IP address, Default Gateway, and DNS Server information.

Figure B-2: Modify IP Configuration Page

The screenshot shows the 'Modify IP Configuration Page' for an LXI Keithley Model. The page has a navigation menu on the left with options like Home, DMM, Cards, Slot 1-6 Empty, Scan Builder, TSB Embedded, System, Log, Admin, LXI Page, IP Config, Sync Config, and Help. The main content area contains a form with the following fields:

- Hostname: K-3706-01144435
- Description: Keithley 3706 #01144435
- TCP/IP Configuration Mode: Automatic, Manual
- Static IP Address: 0.0.0.0
- Subnet Mask: 255.255.0.0
- Default Gateway: 0.0.0.0
- DNS Servers: (empty)
- Domain: (empty)
- Ping: Enabled, Disabled

A 'Submit' button is located at the bottom of the form. An annotation with three arrows points to the Static IP Address, Subnet Mask, and Default Gateway fields, with the text 'Static IP address, Subnet Mask, and Default Gateway'.

5. Click **Submit** to apply the new settings. The instrument will reconfigure its settings, which may take a few moments (see *Figure B-3*).

NOTE You may lose your connection with the embedded web interface after clicking Submit; this is normal and does not indicate an error or failure of the operation. If this occurs, simply reopen the instrument's web page to continue.

Figure B-3: Reconfiguring settings

The screenshot shows the 'Reconfiguring settings' page. The main content area displays a message: 'Please wait while the web server is reconfigured. If your browser is not redirected to the new server settings in 10 seconds, please click [here](#).' The navigation menu on the left is the same as in Figure B-2.

Appendix C: Troubleshooting

Table C-1: Using the LAN connection with the LXI Discovery tool

Problem	Possible root causes	Suggestions
<p>Not able to connect to web page.</p> <p>LXI Browser network instrument screen not shown.</p>	<ul style="list-style-type: none"> • TCP/IP settings not set to auto. • Network card disabled. • Multiple network cards enabled in one PC with both enabled and TCP/IP settings are configured to obtain IP addresses automatically on more than one NIC. 	<ul style="list-style-type: none"> • Enable automatic TCP/IP address selection (see <i>Step 2: Configure the network interface card (NIC) of the PC to obtain an IP address automatically.</i>) • Enable network connections. • Disable one network card or use the static IP address method. • Contact your system administrator for additional assistance.
Still having problems?		Contact Keithley Applications at 800-552-1115 for more support.

Table C- 2: Front-panel errors

Problem	Possible root causes	Suggestions
Error "1114, settings conflict error," is returned.	The channel that is being closed has "nofunction" assigned to it.	To use <code>dmm.close</code> , you must assign a valid function to a channel during remote operation. For front-panel operation, see <i>Example 1: Close a channel and take a measurement using the DMM operation method.</i>
<p>Error: "1114, Settings conflict with interlock connection" displays.</p> <p>Measurements returned are not as expected.</p>	Some switching modules can switch high-voltage signals. For safety reasons, hardware interlocks are provided on the switching module. These interlocks are designed to keep the switching module disconnected from the system backplane. When the interlock circuit is disengaged, no measurements can be performed through a switching module; channel relays can continue to operate, however.	<ul style="list-style-type: none"> • When the interlock connection is removed, the analog backplane relays are disabled and will be open. • When using a screw terminal panel, the interlock connection is closed and backplane relays are engaged when the screw terminal is connected. • Satisfy interlock requirements on the switch module (for requirement details, refer to Section 9 in the Series 3700 User's Manual).
Still having problems?		Contact Keithley Applications at 800-552-1115 for more support.

Table C- 3: Using the LAN connection with a static IP address

Problem	Possible root causes	Suggestions
Unable to connect to the web page	<ul style="list-style-type: none"> • Entered zeros in the web browser for instrument IP address. 	<ul style="list-style-type: none"> • Verify the instrument IP address is compatible with the IP address on the computer. • Verify instrument IP address is appropriate; from within the LAN menu; select STATUS > IPADDRESS. • See Step 4: Connect the LAN crossover cable from the instrument to the PC. • Review Network Tutorial for Ethernet Instruments. • Do not type any leading zeros.
Unable to open switch card diagram page on web page	<ul style="list-style-type: none"> • JAVA™ Platform, Standard Edition 6 not installed • Switch card not installed 	Install JAVA™ Platform, Standard Edition 6. If the computer is connected to the Internet, a window should appear to prompt you to automatically download and install the JRE. If the computer is not connected to the Internet or the window does not appear, JAVA™ Platform, Standard Edition 6 can be downloaded from www.java.com .
Instrument IP address is 000.000.000.000	<ul style="list-style-type: none"> • Instrument DHCP is set to Auto • Did not apply changes to IP address • Computer DHCP mode is enabled • Crossover cable is not connected to the proper port 	<ul style="list-style-type: none"> • See Step 4: Connect the LAN crossover cable from the instrument to the PC. • See Step 3: Configure the Instrument's LAN settings. Be sure to select APPLY_SETTINGS > YES to apply your changes • See Appendix A: Static IP address LAN connection. • See Step 4: Connect the LAN crossover cable from the instrument to the PC.
Still having problems?		Contact Keithley Applications at 800-552-1115 for more support.

Specifications are subject to change without notice.
All Keithley trademarks and trade names are the property of Keithley Instruments, Inc.
All other trademarks and trade names are the property of their respective companies.



A G R E A T E R M E A S U R E O F C O N F I D E N C E

Keithley Instruments, Inc.

Corporate Headquarters • 28775 Aurora Road • Cleveland, Ohio 44139 • 440-248-0400 • Fax: 440-248-6168 • 1-888-KEITHLEY • www.keithley.com