

---

---

**ADVANTEST<sup>®</sup>**  
**ADVANTEST CORPORATION**

---

---

***R3131***

***Spectrum Analyzer***

***Operation Manual***

**MANUAL NUMBER FOE-8311227D02**

---

## PREFACE

This manual provides the information necessary to check functionality, operate and program the R3131 Spectrum Analyzer. Be sure to read this manual carefully in order to use the spectrum analyzer safely.

- Organization of this manual  
This manual consists of the following chapters:

<p>1. Introduction</p> <ul style="list-style-type: none"> <li>• Product Description</li> <li>• Standard Accessories and Power Cable Options</li> <li>• Operating Environment</li> <li>• Operation Check</li> <li>• Cleaning, Storing and Transporting</li> </ul>	<p>Includes a description of the spectrum analyzer and its' parts along with information on its' operating environment and how to perform a system checkout.</p>
<p>2. Operation</p> <ul style="list-style-type: none"> <li>• Controls and Connectors on the Front and Rear Panels</li> <li>• Screen Annotation</li> <li>• Basic Operation</li> <li>• Measurement Examples</li> </ul>	<p>Describes the names and the functions of each part on the panels. You can learn the basic operation of the spectrum analyzer through the examples shown in this chapter.</p>
<p>3. Reference</p> <ul style="list-style-type: none"> <li>• Menu Index</li> <li>• Menu Map</li> <li>• Functional Description</li> </ul>	<p>Shows a list of operation keys, and describes the function of each key.</p>
<p>4. Remote Control</p> <ul style="list-style-type: none"> <li>• GPIB</li> <li>• RS-232</li> </ul>	<p>Gives an outline of the GPIB and RS-232 interfaces, and how to connect and set them up. Also included are a list of commands necessary for programming and using the program examples.</p>
<p>5. Specifications</p>	<p>Shows the specifications of the spectrum analyzer.</p>
<p>APPENDIX 1. Error Messages</p>	<p>If an error occurs during operation, an error number and its corresponding error message are displayed. The meaning of each error is explained in this section.</p>
<p>APPENDIX 2. Glossary</p>	<p>Terminology related to the spectrum analyzer is explained in this section.</p>

Preface

- Key notations in this manual  
Typeface conventions used in this manual.

Panel keys: In bold type

Example: **MKR, MEAS**

Soft keys: In bold and italic type

Example: ***Normal Marker, Noise/Hz***

The ***1/2, more*** and ***2/2, more*** soft keys are designated by ***1/2\_more*** and ***2/2\_more*** in Chapter 2.

## TABLE OF CONTENTS

1	INTRODUCTION .....	1-1
1.1	Product Description .....	1-1
1.2	Accessories .....	1-2
1.3	Operating Environment .....	1-4
1.3.1	Environmental Conditions .....	1-4
1.3.2	Power Requirements .....	1-5
1.3.3	Power Fuse .....	1-5
1.3.4	Power Cable .....	1-7
1.4	System Checkout .....	1-8
1.5	Cleaning, Storing and Transporting the R3131 Spectrum Analyzer .....	1-11
1.5.1	Cleaning .....	1-11
1.5.2	Storing .....	1-12
1.5.3	Transporting .....	1-12
2	OPERATION .....	2-1
2.1	Panel Description .....	2-1
2.1.1	Front Panel .....	2-1
2.1.2	Screen Annotation .....	2-10
2.1.3	Rear Panel .....	2-12
2.2	Basic Operation .....	2-14
2.2.1	Operating Menus and Entering Data .....	2-14
2.2.2	Displaying Spectrums and Operating the Markers .....	2-17
2.2.3	Measuring Window and the Display Line .....	2-23
2.2.4	Measuring Frequency Using Counter .....	2-28
2.2.5	Auto Tuning .....	2-31
2.2.6	Tracking Operations .....	2-33
2.2.7	UNCAL Messages .....	2-36
2.2.8	Separating Two Signals .....	2-39
2.2.9	Dynamic Range .....	2-42
2.2.10	Input Saturation .....	2-46
2.2.11	Harmonic Distortion .....	2-49
2.2.12	Intermodulation .....	2-52
2.2.13	Calibration .....	2-55
2.2.14	Entering User-definable Antenna Correction Data .....	2-56
2.3	Measurement Examples .....	2-59
2.3.1	Measuring the Channel Power .....	2-59
2.3.2	Measuring the Occupied Bandwidth (OBW) .....	2-62
2.3.3	Measuring Adjacent Channel Leakage Power (ACP) .....	2-65
2.3.3.1	Measurements using the ACP POINT Method .....	2-65
2.3.3.2	Measurements using the ACP GRAPH Method .....	2-68
2.3.4	Measuring the VA Ratio .....	2-71

## Table of Contents

2.3.5	Pass-Fail Judgments .....	2-74
2.3.6	Harmonic Distortion Measurements .....	2-78
2.3.7	Measurements Using TG (Option 74) .....	2-81
2.4	Other Functions .....	2-85
2.4.1	Using Floppy Disks .....	2-85
2.4.2	Saving or Recalling Data .....	2-88
2.4.3	Outputting Screen Data .....	2-95
2.4.4	Setting Date and Time .....	2-99
3	REFERENCE .....	3-1
3.1	Menu Index .....	3-1
3.2	Menu Map .....	3-7
3.3	Menu Function Descriptions .....	3-16
3.3.1	AUTO TUNE Key (Auto Tuning) .....	3-16
3.3.2	BW Key (Bandwidth) .....	3-17
3.3.3	CAL Key (Calibration) .....	3-18
3.3.4	CONFIG Key (Configuration) .....	3-19
3.3.5	COPY Key (Hard Copy) .....	3-21
3.3.6	COUNTER Key (Frequency Counter) .....	3-22
3.3.7	DISPLAY Key (Line and Window) .....	3-23
3.3.8	EMC Key (EMC Measurement) .....	3-26
3.3.9	FREQ Key (Frequency) .....	3-28
3.3.10	Hold Mode .....	3-29
3.3.11	LEVEL Key (Frequency Level) .....	3-30
3.3.12	LOCAL Key (GPIB Remote Control) .....	3-32
3.3.13	MEAS Key (Measurement) .....	3-33
3.3.14	MKR Key (Marker) .....	3-35
3.3.15	MKR → Key (Marker →) .....	3-38
3.3.16	PAS/FAIL Key (Pass-Fail Judgment) .....	3-40
3.3.17	PK SRCH Key (Peak Search) .....	3-41
3.3.18	POWER MEASURE Key (Power Measurement) .....	3-42
3.3.19	PRESET Key (Initialization) .....	3-44
3.3.20	RECALL Key (Data Readout) .....	3-45
3.3.21	REPEAT Key (Continuous Sweep) .....	3-46
3.3.22	SAVE Key (Saving Data) .....	3-47
3.3.23	SELF TEST Key (Self Test) .....	3-48
3.3.24	SINGLE Key (Single Sweep) .....	3-49
3.3.25	SPAN Key (Frequency Span) .....	3-50
3.3.26	SWEEP Key (Sweep Time) .....	3-51
3.3.27	TG Key (Tracking Generator) (Option 74) .....	3-52
3.3.28	TRACE Key (Trace Data) .....	3-54
3.3.29	TRIG Key (Trigger) .....	3-56
3.4	Setting Values .....	3-57

3.4.1	Set Resolution .....	3-57
3.4.2	Set Values for RBW, VBW and SWP Time .....	3-58
3.4.3	Factory Defaults .....	3-59
3.4.4	Defaults Configuration Values .....	3-60
4	REMOTE PROGRAMING .....	4-1
4.1	GPIB Remote Programming .....	4-1
4.1.1	GPIB .....	4-1
4.1.2	GPIB Setup .....	4-1
4.1.3	GPIB Interface Functions .....	4-3
4.1.4	Responses to Interface Messages .....	4-3
4.1.5	Message Exchange Protocol .....	4-5
4.1.6	Command Syntax .....	4-6
4.1.7	Data Formats .....	4-6
4.1.8	Status Bytes .....	4-8
4.1.9	GPIB Command Codes .....	4-14
4.1.10	Basic Programming .....	4-31
4.1.11	Data Output Format (talker) .....	4-33
4.1.12	Trace Data I/O .....	4-37
4.1.13	Using the Status Byte .....	4-42
4.2	RS-232 Remote Control Function .....	4-46
4.2.1	GPIB and RS-232 Compatibility .....	4-46
4.2.2	Features of RS-232 Remote Control .....	4-46
4.2.3	Parameter Setup Window .....	4-46
4.2.4	Interface connection .....	4-47
4.2.5	Data Format .....	4-49
4.2.6	Differences Between RS-232 and GPIB .....	4-50
4.2.7	Panel Control .....	4-50
4.2.8	Remote Control Usage Examples .....	4-50
5	SPECIFICATIONS .....	5-1
	APPENDIX 1 ERROR MESSAGE .....	A1-1
	APPENDIX 2 GLOSSARY .....	A2-1
	DIMENSIONAL OUTLINE DRAWING .....	EXT-1
	ALPHABETICAL INDEX .....	I-1



## LIST OF ILLUSTRATIONS

No.	Title	Page
1-1	Operating Environment .....	1-4
1-2	Replacing the Power Fuse .....	1-6
1-3	Power Cable .....	1-7
1-4	Connecting the Power Supply Cable .....	1-8
1-5	Screen Display after Self Tests have Completed .....	1-9
1-6	Self Test Screen .....	1-9
1-7	Screen Shown after Executing Self Test .....	1-10
1-8	Removing the Display Filter .....	1-11
2-1	Front Panel .....	2-1
2-2	Screen Annotation .....	2-10
2-3	Rear Panel .....	2-12
2-4	Factory Defaults Screen .....	2-18
2-5	Calibration Signal Output Screen .....	2-18
2-6	Active Area Display .....	2-19
2-7	Setting the Center Frequency .....	2-19
2-8	Measuring Settings Screen .....	2-20
2-9	Peak Search Display Screen .....	2-21
2-10	Frequency Difference Between the Peak Point and a Point 3 dB Levels Down .....	2-22
2-11	Frequency Difference Between the Peak Point and a Point 60 dB Levels Down .....	2-22
2-12	Factory Defaults Screen .....	2-23
2-13	Calibration Signal Output .....	2-24
2-14	Measuring Settings Screen .....	2-24
2-15	Activating the Display Line .....	2-25
2-16	Making a Comparison Between Peaks Using Reference Lines .....	2-26
2-17	Screen Display Showing the Measuring Window .....	2-27
2-18	Screen Display after Zoom In .....	2-27
2-19	Factory Defaults Screen .....	2-28
2-20	Calibration Signal Output Screen .....	2-29
2-21	Measuring Settings Screen .....	2-29
2-22	Frequency Counter Measurement (Resolution: 1 kHz) .....	2-30
2-23	Frequency Counter Measurement (Resolution: 10 Hz) .....	2-30
2-24	Screen Display Prior to Auto Tuning .....	2-31
2-25	Screen Display after Auto Tuning .....	2-32
2-26	Signal Tracking Screen .....	2-34
2-27	Continuous Peak Search Screen .....	2-35
2-28	Measuring Settings Screen .....	2-37
2-29	Screen with UNCAL Message .....	2-37
2-30	Normal Measurement Screen .....	2-38
2-31	Setup for Measuring Two Signals Separately .....	2-39
2-32	Two Superimposed Peaks .....	2-40
2-33	Two Discernible Peaks .....	2-41
2-34	Two Distinct Peaks Can Now Be Seen .....	2-41
2-35	Setup for Verifying the Dynamic Range .....	2-42
2-36	Screen Display Prior to Changing the RBW .....	2-43
2-37	Screen Display after Changing the RBW .....	2-44



## List of Illustrations

No.	Title	Page
2-38	Screen Display after Changing the VBW .....	2-44
2-39	The Trace after Averaging .....	2-45
2-40	Setup for Input Saturation .....	2-46
2-41	Screen Display without Saturation .....	2-47
2-42	Screen Display Showing Saturation .....	2-48
2-43	Setup for Measuring Harmonic Distortion .....	2-49
2-44	Screen Display Showing Harmonic Distortion .....	2-50
2-45	Screen Display Showing Reduced Harmonic Distortion .....	2-51
2-46	Setup for Measuring Intermodulation .....	2-52
2-47	Screen Display Showing Intermodulation Distortion .....	2-53
2-48	Screen Display without Intermodulation Distortion .....	2-54
2-49	Screen Display Showing the Cal Menu .....	2-55
2-50	Editing the Correction Data Table .....	2-57
2-51	Screen Display Showing the User-Definable Correction Data Table .....	2-58
2-52	Setup for Measuring the Channel Power .....	2-59
2-53	Setting the Offset Level .....	2-60
2-54	Setting the Measuring Window .....	2-61
2-55	Measuring the Channel Power .....	2-61
2-56	Setup for Measuring the Occupied Bandwidth .....	2-62
2-57	Setting the Detector Mode .....	2-63
2-58	OBW Measurement Screen .....	2-64
2-59	OBW(95%) Measurement Screen .....	2-64
2-60	Setup for Measuring the Adjacent Channel Leakage Power .....	2-65
2-61	Setting the Specified Bandwidth .....	2-67
2-62	Measurement of the Adjacent Channel Power (ACP POINT) .....	2-67
2-63	Setup for Measuring the Adjacent Channel Leakage Power .....	2-68
2-64	Displaying a Graph as a Result of Operation .....	2-70
2-65	Adjacent Channel Leakage Power Measurements (ACP GRAPH) .....	2-70
2-66	Setup for Measuring the VA Ratio .....	2-71
2-67	Performing Max Hold .....	2-72
2-68	Measuring the Video Carrier Level .....	2-73
2-69	Measuring the Audio Carrier Level .....	2-73
2-70	Setup for the Pass-Fail judgment .....	2-74
2-71	Pass-Fail Measurement Screen .....	2-75
2-72	Level Window Setting Screen .....	2-76
2-73	Measuring Window Screen .....	2-76
2-74	Setup for Measuring the Harmonic Distortion .....	2-78
2-75	Measuring the Fundamental Wave .....	2-79
2-76	Measuring the Harmonic Distortion .....	2-80
2-77	Setup for TG Measurements .....	2-81
2-78	Measurement Screen after a Normalization Calibration .....	2-82
2-79	Connecting the Unit under Test .....	2-83
2-80	Insertion Loss Measurement Screen .....	2-84
2-81	3-dB Bandwidth Measurement Screen .....	2-84
2-82	Floppy Disk Write Protection .....	2-85
2-83	Screen for the F.Disk Menu .....	2-87
2-84	Screen Display Showing Floppy Disk as the Destination .....	2-88
2-85	Display for Selecting the Data to be Saved .....	2-89

No.	Title	Page
2-86	Display after Data has been Saved to a File .....	2-90
2-87	Screen Display Showing File Protection Enabled .....	2-91
2-88	Screen Display Showing the Selected File .....	2-92
2-89	Screen Display showing Recalled Data .....	2-92
2-90	Screen as Shown when Deleting a File .....	2-93
2-91	Screen as Shown after Deleting File Data .....	2-94
2-92	Screen Display Showing Floppy Disk as the Specified Destination .....	2-95
2-93	Printer Specification Screen Display .....	2-97
2-94	Printer Setup Screen .....	2-98
2-95	Time/Date Menu .....	2-99
2-96	Screen Showing the Date being Set .....	2-100
2-97	Screen Showing the Hour being Set .....	2-100
4-1	Arrangement of the Three Status Registers .....	4-9
4-2	Details of the Three Status Registers .....	4-10
4-3	Structure of the Status Byte Register .....	4-12
4-4	Parameter Setup .....	4-46
4-5	Connection Between the Controller and the Spectrum Analyzer .....	4-47
4-6	Cable Wiring Diagram .....	4-48
4-7	Data Format .....	4-49
A2-1	Resolution Bandwidth .....	A2-1
A2-2	Reference Level .....	A2-1
A2-3	Spurious Response .....	A2-3
A2-4	Noise Sidebands .....	A2-4
A2-5	Bandwidth Selectivity .....	A2-4
A2-6	Bandwidth Switching Accuracy .....	A2-5



## LIST OF TABLES

No.	Title	Page
1-1	Standard Accessories List .....	1-2
1-2	Power Cable Options .....	1-3
1-3	Power Supply Specifications .....	1-5
2-1	Recommended Compatible Printers .....	2-96
3-1	Center Frequency Set Resolution vs. Frequency Span .....	3-57
3-2	Frequency Span Set Resolution vs. Frequency Span .....	3-57
3-3	Values for RBW, VBW and SWP Time (using AUTO) .....	3-58
3-4	Factory Defaults .....	3-59
3-5	Values for Default Config .....	3-60
4-1	Frequency .....	4-14
4-2	Level .....	4-15
4-3	Unit .....	4-15
4-4	Sweep Mode .....	4-16
4-5	Sweep Time .....	4-16
4-6	Bandwidth .....	4-16
4-7	Marker .....	4-17
4-8	Peak Search .....	4-18
4-9	Sound .....	4-18
4-10	Marker → .....	4-19
4-11	Trigger .....	4-19
4-12	Trace .....	4-20
4-13	Display .....	4-21
4-14	Pass-Fail Judgment .....	4-22
4-15	Measurement .....	4-22
4-16	Auto Tuning .....	4-22
4-17	Counter .....	4-23
4-18	Power Measurement .....	4-23
4-19	OBW .....	4-23
4-20	ACP .....	4-24
4-21	TG (Option 74) .....	4-24
4-22	EMC .....	4-25
4-23	Calibration .....	4-26
4-24	Data Save/Recall .....	4-26
4-25	Hard Copy .....	4-28
4-26	Preset .....	4-28
4-27	Trace Data I/O .....	4-28
4-28	Status Bytes .....	4-28
4-29	Miscellaneous .....	4-29
4-30	Data Input .....	4-30



## 1 INTRODUCTION

This chapter provides the following information:

- Product description
- A list of standard accessories and power cable options
- Operating environment
- How to verify that the spectrum analyzer is functioning properly
- How to clean, store, and transport the spectrum analyzer

### 1.1 Product Description

The R3131 is a spectrum analyzer that provides the user with highly stable spectrum analysis using the synthesized local method.

The key features of the R3131 spectrum analyzer are listed below.

- (1) Frequency Range: 9kHz to 3GHz, Frequency span: Zero, 50kHz to 3GHz.
- (2) Frequency counter function with a resolution of 1Hz.
- (3) A power measurement function useful for evaluating radio instruments using measurements such as occupied bandwidth (OBW), adjacent channel power (ACP), channel power, etc.
- (4) An auto tuning function that searches for a signal with the maximum input level.
- (5) Save and recall functions which you can use to store measurement conditions and data in TEXT format.
- (6) A 3.5-inch floppy disk drive which you can use to save screen images in BMP format.
- (7) Support for ESC/P, ESC/P-R and PCL compatible printers.
- (8) Remote control capabilities which allow you to setup an automatic measurement system. This remote control function complies with GPIB and RS-232 specifications.

## 1.2 Accessories

Table 1-1 lists the standard accessories shipped with the spectrum analyzer. If any of the accessories are damaged or missing or, to order additional accessories, contact the nearest ADVANTEST Field Office or representative.

**Table 1-1 Standard Accessories List**

Accessory Name	Model Number	Quantity	Remarks
Power cable	A01413	1	* 1
N-BNC through connector	JUG-201A/U	1	* 2
R3131 Spectrum Analyzer Operation Manual	ER3131	1	

\* 1: The cable supplied with the spectrum analyzer depends on what type (specified by model number above) was ordered when the spectrum analyzer was purchased.

There are 11 types of power cable available (see Table 1-2).

To order another power cable, contact an ADVANTEST Field Office or representative. When ordering, refer to power cables by their option number or model number.

\* 2: Quantity is 2 when the instrument is equipped with TG option (Option 74).

**Table 1-2 Power Cable Options**

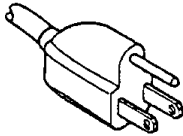
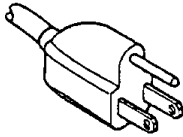
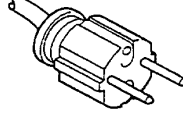
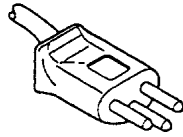
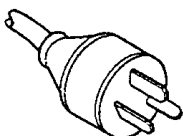
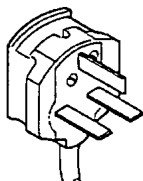
Plug	Standards	Rating, Color	Model Number
	JIS: Japan Law on Electrical Appliances	125V at 7A Black 2m (6ft)	Straight: A01402 Angled: A01412
	UL: United States of America CSA: Canada	125V at 7A Black 2m (6ft)	Straight: A01403 (Option 95) Angled: A01413
	*1	250V at 6A Gray 2m (6ft)	Straight: A01404 (Option 96) Angled: A01414
	SEV: Switzerland	250V at 6A Gray 2m (6ft)	Straight: A01405 (Option 97) Angled: A01415
	SAA: Australia, New Zealand	250V at 6A Gray 2m (6ft)	Straight: A01406 (Option 98) Angled: -----
	BS: United Kingdom	250V at 6A Black 2m (6ft)	Straight: A01407 (Option 99) Angled: A01417

\*1 CEE: Europe, DEMKO: Denmark, NEMKO: Norway, VED: Germany,  
KEMA: The Netherlands, CBEC: Belgium, OVE: Austria, FIMKO: Finland,  
SEMKO: Sweden



1.3 Operating Environment

**1.3 Operating Environment**

This section describes the environmental conditions and power requirements necessary to use the spectrum analyzer.

**1.3.1 Environmental Conditions**

The R3131 should be only be used in an area which satisfies the following conditions:

- Ambient temperature: 0°C to +50°C (operating temperature)
- Relative humidity: 85% or less (without condensation)
- An area free from corrosive gas
- An area away from direct sunlight
- A dust-free area
- An area free from vibrations
- A low noise area

Although the R3131 has been designed to withstand a certain amount of noise riding on the AC power line, it should be used in an area of low noise. Use a noise cut filter when ambient noise is unavoidable.

- An area allowing unobstructed air flow

The R3131 has an exhaust cooling fan on the rear panel and an exhaust vent on the bottom side toward the front. Never block these areas as the resulting internal temperature rise will affect measurement accuracy.

- Avoid operation in the following areas.
- Use a noise cut filter when there is a large amount of noise riding on the power line.

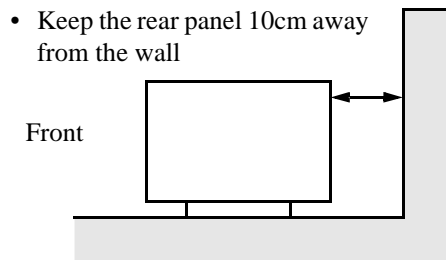
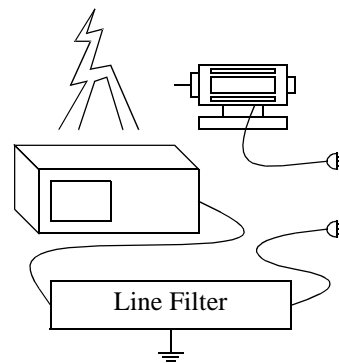
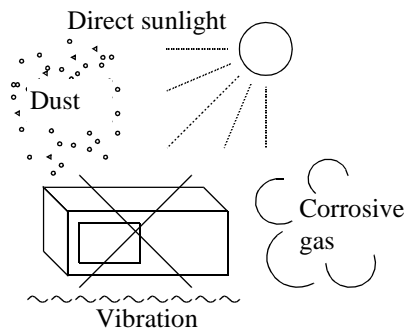

- Keep the rear panel 10cm away from the wall

**Figure 1-1 Operating Environment**

The R3131 can be used safely under the following conditions:

- Altitude: 2000m maximum above the sea level
- Installation category II
- Pollution degree 2

### 1.3.2 Power Requirements

The power supply specifications of the spectrum analyzer are listed in Table 1-3.

**Table 1-3 Power Supply Specifications**

	100VAC Operation	200VAC Operation
Input voltage range	90V to 132V	198V to 250V
Frequency range	48Hz to 66Hz	
Power consumption	200VA or below	

---

**CAUTION:** *To prevent damage, operate the spectrum analyzer within the specified input voltage and frequency ranges.*

---

During operation, the power supply automatically switches between input voltage levels of 100VAC and 200VAC. Be sure, however, to use a power cable that matches the input voltage and meets the related standard (see Table 1-2).

### 1.3.3 Power Fuse

---

**CAUTION:** *When a fuse blows, there may be some problem with the analyzer so contact a qualified ADVANTEST service representative before replacing the fuse.*

---

The power fuse is placed in the fuse holder which is mounted on the rear panel. A spare fuse is located in the fuse holder.

To check or replace the power fuse, use the following procedure:

1. Press the **POWER** switch to the OFF position.
2. Disconnect the power cable from the AC power supply.
3. Remove the fuse holder on the rear panel.
4. Check (and replace if necessary) the power fuse and put it back in the fuse holder.

1.3 Operating Environment

Pull out the fuse holder using a slotted head screwdriver.

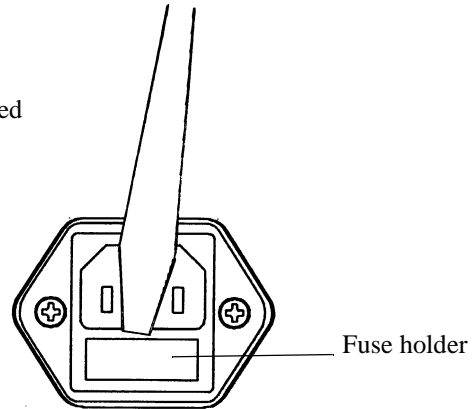

Check (and replace if necessary) the power fuse and put it back into the fuse holder.

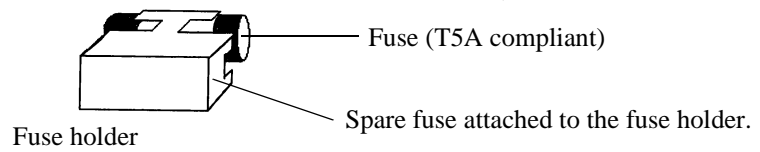
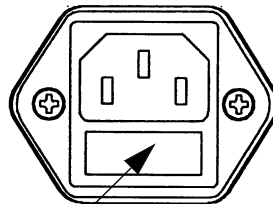
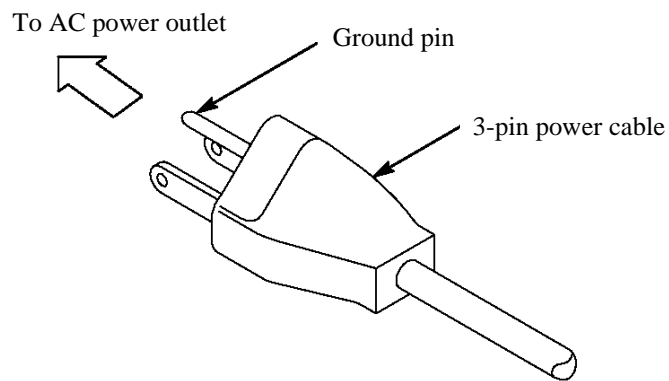

**Figure 1-2 Replacing the Power Fuse**

### 1.3.4 Power Cable

A detachable power cable with a three-contact plug is included with the spectrum analyzer. The protective earth ground contact on the plug connects (through the power cable) to the accessible metal parts of the instrument. For protection against electrical shock, insert the plug into a power-source outlet that has a properly grounded, protective-ground contact.

The manufacturer ships a power cable, as ordered, with the spectrum analyzer. A list of other available power cables is shown in Table 1-2. Contact your ADVANTEST representative or the local ADVANTEST Field Office for information on how to order these.



**Figure 1-3 Power Cable**

## 1.4 System Checkout

### 1.4 System Checkout

This section describes the Self Test which must be performed when operating the spectrum analyzer for the first time. Follow the procedure below:

1. Make sure that the **POWER** switch on the front panel is in the OFF position.
2. Connect the power cable provided to the AC power supply connector on the rear panel.

---

**CAUTION:** *To prevent damage, operate the spectrum analyzer within specified input voltage and frequency ranges.*

---

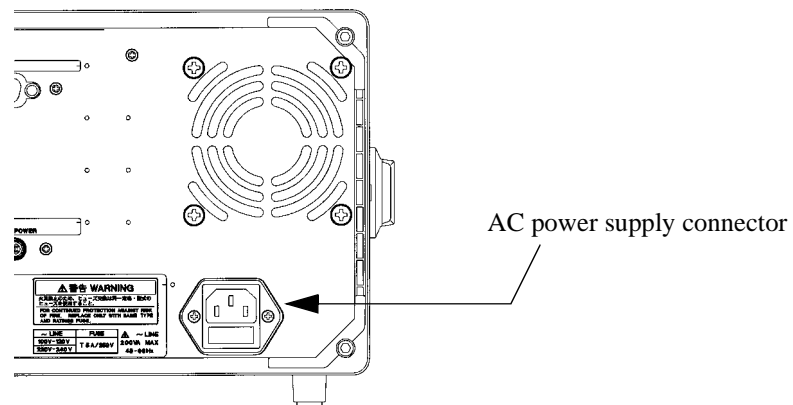

**Figure 1-4 Connecting the Power Supply Cable**

3. Connect the power cable to the outlet.
4. Press the **POWER** switch to the ON position.  
The spectrum analyzer performs the Initial test for approximately three seconds, then displays the start-up screen as shown in Figure 1-5.

---

**NOTE:** *There is a possibility that the screen display is different from the one shown in Figure 1-5, depending on previously saved conditions.*

---

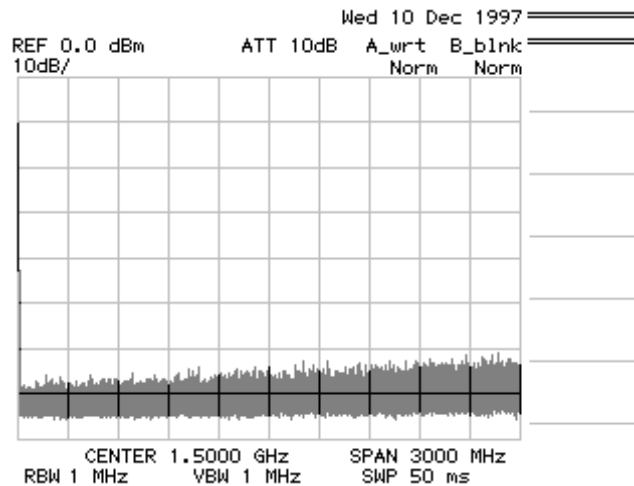

Figure 1-5 Screen Display after Self Tests have Completed

5. Press **SHIFT**.  
The **SHIFT** lamp lights.
6. Press **CONFIG(PRESET)**.  
The factory defaults are reset.  
The startup screen is displayed as shown in Figure 1-5.
7. Press **SHIFT** and **0**.  
The Self Test menu is displayed.

**NOTE:** Pressing **SHIFT** and **0** turns the Self Test mode on. In this mode, only the **SHIFT**, **PRESET** and **COPY** keys, and the currently displayed soft menu can be used. All other panel keys are disabled.

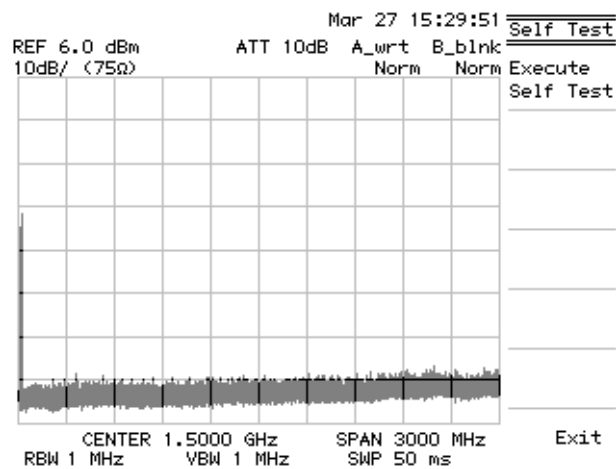

Figure 1-6 Self Test Screen

1.4 System Checkout

8. Press *Execute Self Test*.

The nine test items are executed in order and then the test results are displayed as shown below.

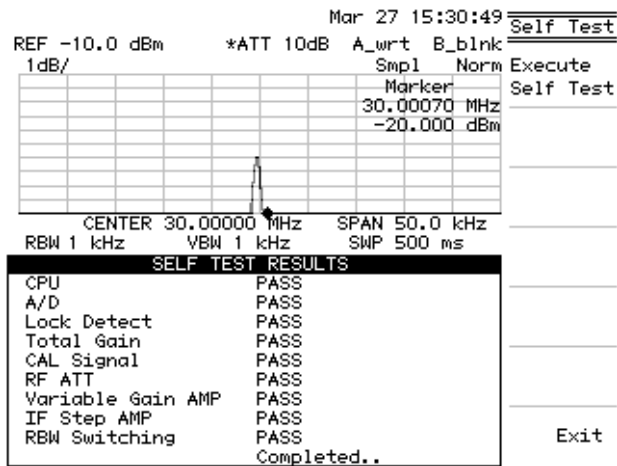

Figure 1-7 Screen Shown after Executing Self Test

**CAUTION:** *If the Self Test detects any errors, do not attempt to use the spectrum analyzer any further. Contact an ADVANTEST service representative as soon as possible.*

9. Press *Exit*.

This exits the Self Test mode.

This completes the system checkout.

## 1.5 Cleaning, Storing and Transporting the R3131 Spectrum Analyzer

### 1.5.1 Cleaning

Remove dust from the outside of the spectrum analyzer by wiping or brushing the surface with a soft cloth or small brush. Use a brush to remove dust from around the panel keys. Hardened dirt can be removed by using a cloth which has been dampened in water containing a mild detergent.

---

**CAUTION:**

1. Do not allow water to get inside the spectrum analyzer.
  2. Do not use organic cleaning solvents, such as benzene, toluene, xylene, acetone or similar compounds, since these solvents may damage the plastic parts.
  3. Do not use abrasive cleaners.
- 

- Cleaning the Display Filter

Normally cleaning the display filter from the front should be sufficient. However, if necessary, the filter itself can be detached from the spectrum analyzer by removing the two screws on the front. Clean the backside of the filter with a soft cloth.

---

**CAUTION:** Do not touch the LCD display with your finger when the filter has been removed.

---

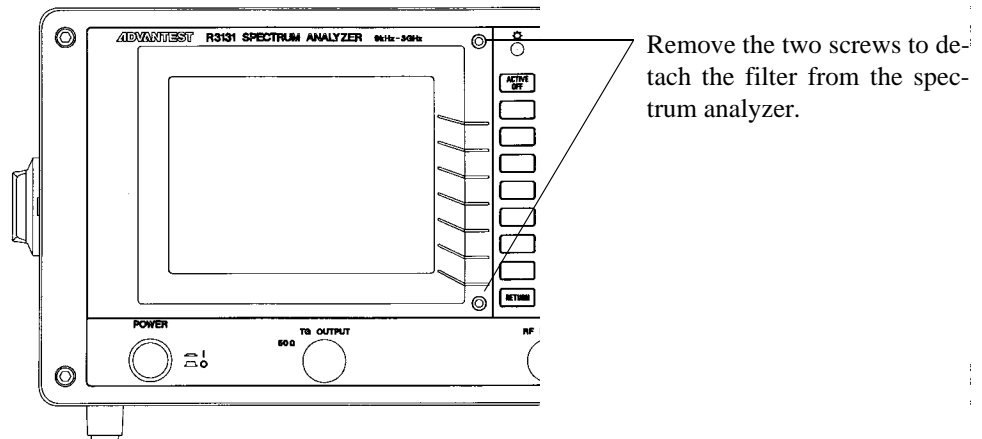

Figure 1-8 Removing the Display Filter



## 1.5 Cleaning, Storing and Transporting the R3131 Spectrum Analyzer

### 1.5.2 Storing

Store the spectrum analyzer in an area which has a temperature from  $-20^{\circ}\text{C}$  to  $+60^{\circ}\text{C}$ . If you plan to store the spectrum analyzer for a long period (more than 90 days), put the spectrum analyzer in a vapor-barrier bag with a drying agent and store the spectrum analyzer in a dust-free location out of direct sunlight.

### 1.5.3 Transporting

When you ship the spectrum analyzer, use the original container and packing material. If the original packaging is not available, pack the spectrum analyzer using the following guidelines:

- To allow for cushioning, use a corrugated cardboard container with inner dimensions that are at least 15 centimeters more than those of the spectrum analyzer.
- Surround the spectrum analyzer with plastic sheeting to protect the finish.
- Cushion the spectrum analyzer on all sides with packing material or plastic foam.
- Seal the container with shipping tape or a heavy-duty, industrial stapler.

If you are shipping the spectrum analyzer to a service center for service or repair, attach a tag to the spectrum analyzer that shows the following information:

- Owner and address
- Name of a contact person at your location
- Serial number of the spectrum analyzer (located on the rear panel)
- Description of the service requested

## 2 OPERATION

This chapter describes the following:

- Front and rear panel controls and connectors
- Screen annotation
- Basic operation
- Measurement examples
- Expanded functions

### 2.1 Panel Description

#### 2.1.1 Front Panel

This section contains detailed views of the front panel and explanations for the panel keys or connectors shown in those views. Figure 2-1 shows the front panel location of the nine detail views.

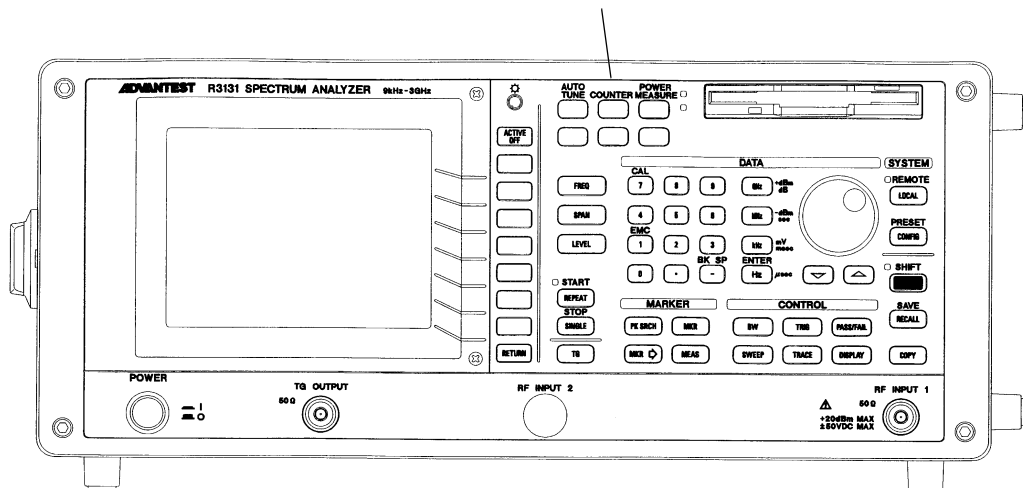
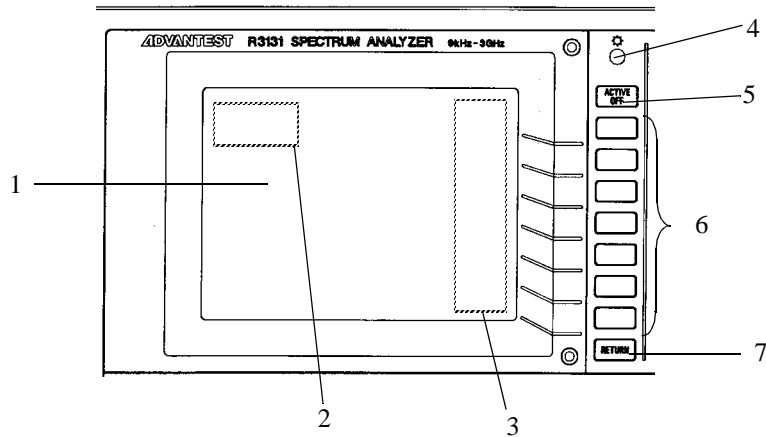

Figure 2-1 Front Panel

2.1 Panel Description

(1) Display Section



Control		Description
1	Liquid crystal display (LCD)	Displays trace and measured data
2	Active area	Displays input data and measurement data
3	Soft-menu display	Displays the function of each soft key (up to 7 at one time)
4	Contrast control	Adjusts the display contrast
5	<b>ACTIVE OFF</b> key	Turns off the active area removing any displayed information
6	Soft keys	Seven keys corresponding to the soft-menu display on the left; pressing a soft key selects the corresponding menu item
7	<b>RETURN</b> key	Used to return the screen display to the previous level of the hierarchical soft-menu structure

(2) Power Switch/Connector Section

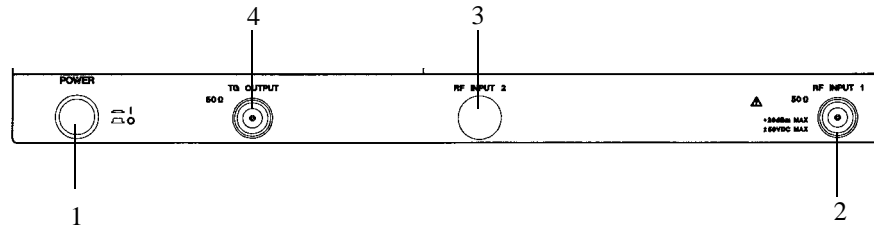

Control		Description
1	<b>POWER</b> switch	Turns the power on or off
2	<b>RF INPUT 1</b> connector	N-type input connector 50Ω Analyzer input connector: Frequency range is 9 kHz to 3 GHz; the maximum input level is +20 dBm or ±50 VDC max
3	<b>RF INPUT 2</b> connector	(Unused)
4	<b>TG OUTPUT</b> connector	TG output connector Frequency range is 100 kHz to 3 GHz Available only when Option 74 is equipped

(3) Floppy Disk Drive Section

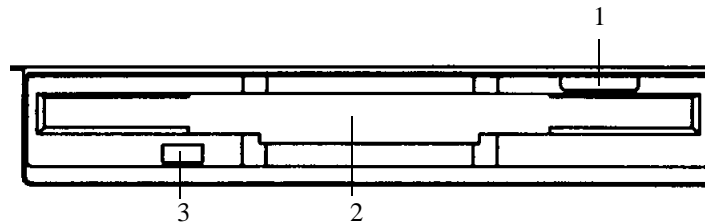

Control		Description
1	Eject button	Used to eject floppy disks from the drive
2	Floppy disk drive door	Insert floppy disks here
3	Access lamp	Turns on when the floppy disk in the drive is being accessed

2.1 Panel Description

(4) MEASUREMENT Section

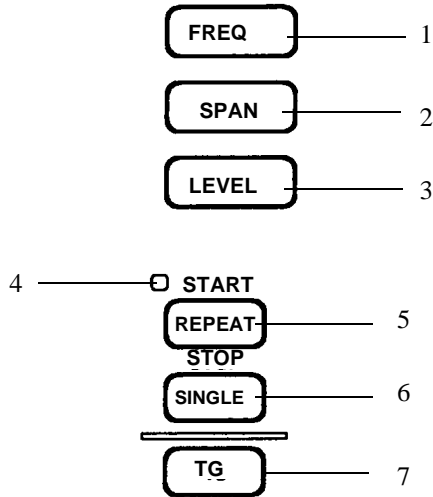

Control		Description
1	<b>FREQ</b> key	Used to set center frequencies
2	<b>SPAN</b> key	Used to set frequency spans
3	<b>LEVEL</b> key	Used to set the reference level
4	<b>SWEEP</b> lamp	Turns on when a sweep is being performed
5	<b>REPEAT (START/STOP)</b> key	Used to execute continuous sweeps or to reset a sweep
6	<b>SINGLE</b> key	Used to execute single sweeps or to reset a sweep
7	<b>TG</b> key	Used to set the TG function Available only when Option 74 is equipped

## (5) DATA Section

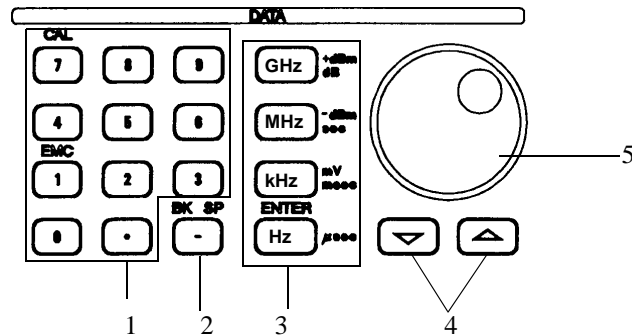

Control		Description
1	Numeric keys (additional function keys)  <b>EMC</b>  <b>CAL</b>	There are ten number keys (0 through 9) and a decimal point key. You can access additional functions by pressing the <b>SHIFT</b> key  Used to set up the conditions for an EMC measurement  Used to execute calibrations for the spectrum analyzer
2	<b>BK SP(-)</b> key	Used to remove data you have entered or to enter a minus(-) sign
3	Units keys <b>GHz</b> key <b>MHz</b> key <b>kHz</b> key <b>Hz (ENTER)</b> key	These are used to select a unit and enter a value Sets GHz, + dBm or dB Sets MHz, - dBm or sec Sets kHz, mV or msec Sets Hz or μsec This key is also used to specify the channel and as a general ENTER key
4	Step keys	Used to enter data in steps
5	Data knob	Used to make fine adjustments when inputting data

2.1 Panel Description

(6) MARKER Section

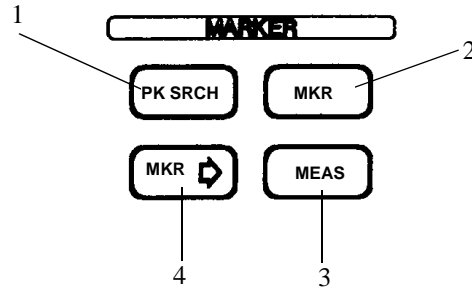

Control		Description
1	<b>PK SRCH</b> key	Used to search for the peak point on the trace
2	<b>MKR</b> key	Used to display the marker
3	<b>MEAS</b> key	Used to set the measurement mode
4	<b>MKR →</b> key	Used to obtain marker values so that they can be used as data for other functions

## (7) CONTROL Section

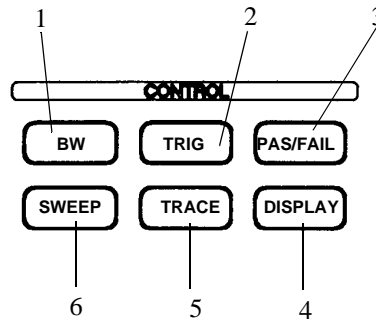

Control		Description
1	<b>BW</b> key	Used to set the resolution bandwidth (RBW) and video bandwidth (VBW)
2	<b>TRIG</b> key	Used to set the trigger conditions
3	<b>PAS/FAIL</b> key	Used to set the conditions in the level window and check if those conditions have been met
4	<b>DISPLAY</b> key	Used to set the display line, the reference line, etc.
5	<b>TRACE</b> key	Used to set the trace function
6	<b>SWEEP</b> key	Used to set the sweep time



2.1 Panel Description

(8) SYSTEM Section

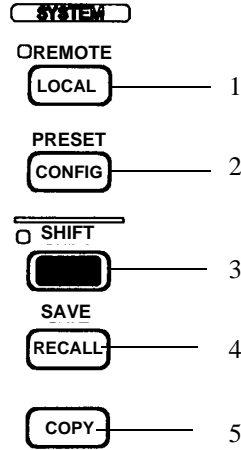

Control		Description
1	<b>LOCAL</b> key <b>REMOTE</b> lamp	Used to disengage GPIB remote control Indicates the spectrum analyzer is in Remote mode when lit
2	<b>CONFIG</b> key <b>PRESET</b> key ( <b>SHIFT, CONFIG</b> )	Used to set the operational conditions for the interface, etc. Used to reset the spectrum analyzer to the factory default settings
3	<b>SHIFT</b> key	Allows you to access additional functions for certain keys (keys that have labels in blue above them). The LED lamp next to the key turns on when SHIFT is pressed.
4	<b>RECALL</b> key <b>SAVE</b> key ( <b>SHIFT, RECALL</b> )	Used to recall previous data Used to save data
5	<b>COPY</b> key	Used to obtain a hard copy of the screen data

## (9) Miscellaneous Section

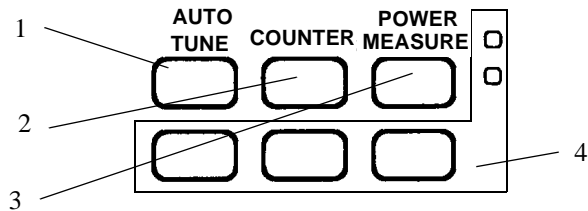

Control		Description
1	<b>AUTO TUNE</b> key	Used to automatically display the maximum peak
2	<b>COUNTER</b> key	Used to measure frequency as a counter
3	<b>POWER MEASURE</b> key	Used to make power measurements
4		(Unused)

2.1 Panel Description

2.1.2 Screen Annotation

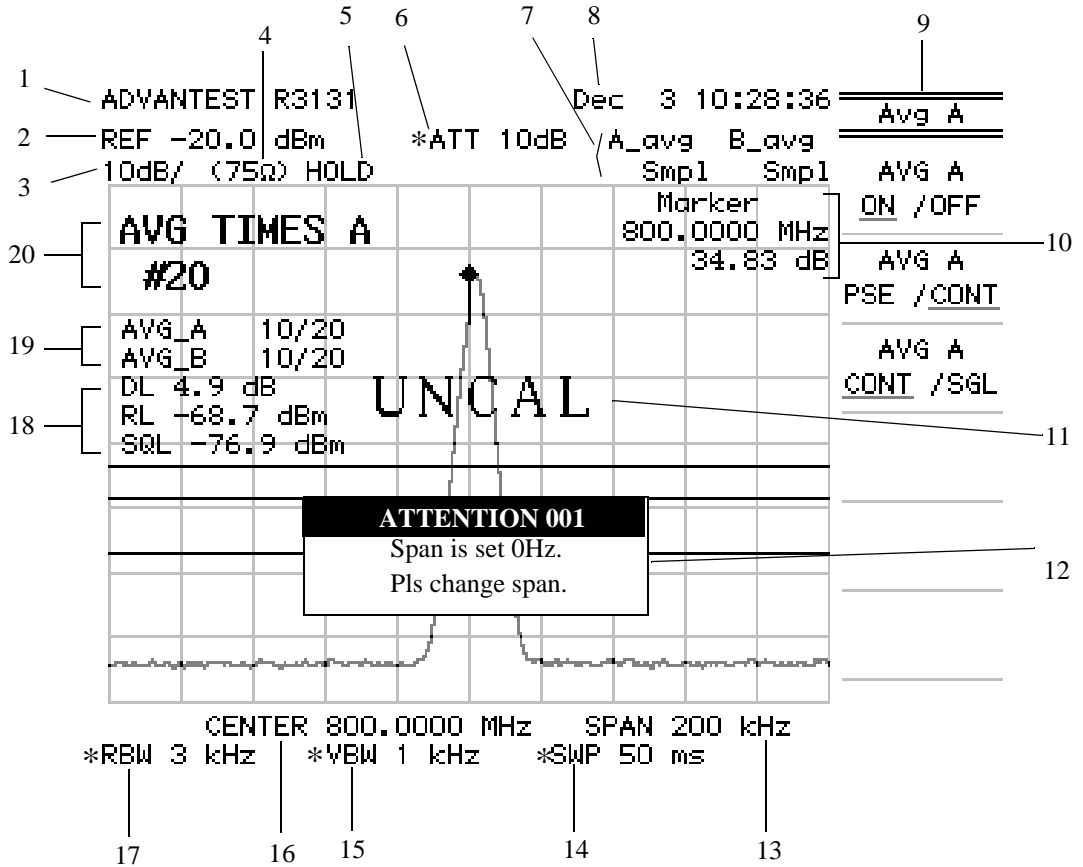

Figure 2-2 Screen Annotation

Annotation		Description
1	Title	Displays the title you have entered to distinguish the current data from other data
2	Reference level	Current reference level
3	Amplitude scale	Current amplitude scale graduation
4	75Ω mode indicator	Indicates that the input impedance is 75Ω (nothing is displayed if the input impedance is 50Ω).
5	HOLD mode indication	Indicates that the panel key is set to the HOLD mode.
6	RF attenuator	Current attenuator level. ATT is preceded by an asterisk (*) when set in the manual mode
7	Trace	Trace mode and search mode which are currently selected
8	Date	Current date and time
9	Soft-menu	Menu item corresponding to the soft key
10	Marker area	Frequency and level of a marker
11	UNCAL message	Indicates that the measurement has not been calibrated
12	Message window	Displays error messages as they occur
13	Frequency span or Stop frequency	Frequency span of the current display (displays may differ depending on the currently active function)
14	Sweep time	Time required to make a single sweep. SWP is preceded by an asterisk (*) when set in manual mode
15	Video bandwidth (VBW)	Frequency selected for the video bandwidth filter. VBW value is preceded by an asterisk (*) when set in manual mode.
16	Center frequency or Start frequency	Indicates the frequency at the center of the current display (the displayed RBW value is preceded by an asterisk (*) when set in manual mode)
17	Resolution bandwidth (RBW)	Displays the current resolution bandwidth (RBW is preceded by an asterisk (*) when set in manual mode)
18	Line setup display	Shows values for the display line, reference line and squelch line
19	Average count display	Displays the averaging number
20	Active area	Used to display the currently active functions (note that the data can be changed) and their related values

## 2.1 Panel Description

## 2.1.3 Rear Panel

This subsection shows the rear panel and describes its terminals and connectors.

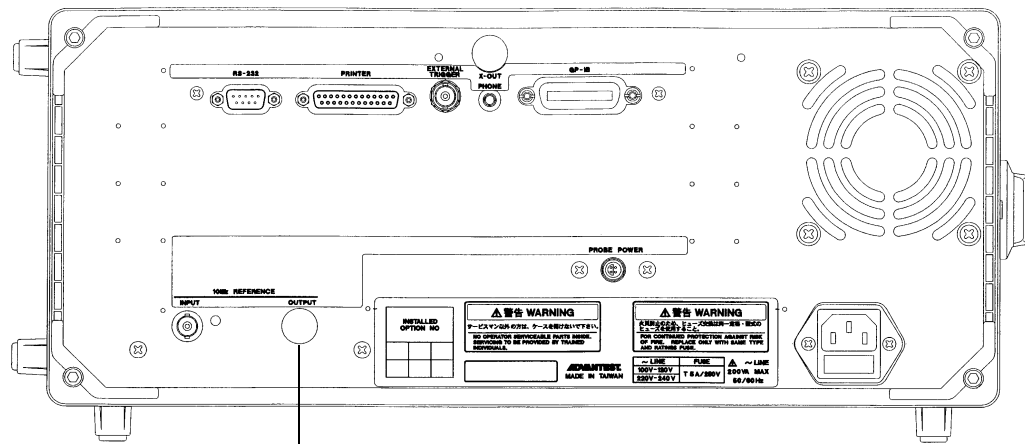



Figure 2-3 Rear Panel

Control		Description
1	<b>RS-232</b> connector	Connector for an external unit used to control the spectrum analyzer through an RS-232 interface
2	<b>PRINTER</b> connector	Connector used when attaching a Centronix printer
3	<b>EXTERNAL TRIGGER</b> terminal	Approximately 10 k $\Omega$ input impedance; starts sweeping at the leading or trailing edge (selectable) of the TTL level input signal. This signal can be used as the gated sweep signal source.
4	<b>X-OUT</b> terminal	(unused)
5	<b>PHONE</b> connector	Connector for an 8 $\Omega$ earphone used for AM/FM demodulated audio output
6	<b>GPIB</b> connector	Connector for an external controller cable
7	Exhaust vent	Used to vent excess heat buildup in the spectrum analyzer  <b>CAUTION: Do not block this vent</b>

Control		Description
8	AC power connector	3-pin type
9	Fuse holder	Holds the line fuse and one spare fuse which is supplied with the spectrum analyzer
10	Fuse information	Lists the line voltages and fuse requirements
11	<b>PROBE POWER</b> terminal	<p>An accessory power supply for the probe, etc. The maximum output current is 100 mA for each pin.</p> <p><b>PROBE POWER</b></p>  <p>1 : NC 2 : GND 3 : -12.4V 4 : +12.4V</p>
12	<b>10 MHz REFERENCE OUTPUT</b> terminal	(Unused)
13	<b>10 MHz REFERENCE INPUT</b> terminal	<p>Input terminal for 10 MHz reference frequency signal Input impedance: Approximately 50Ω Input level: - 10 dBm to + 10 dBm</p>

## 2.2 Basic Operation

### 2.2.1 Operating Menus and Entering Data

You use panel keys and soft keys to operate the spectrum analyzer. When you press a panel key, a menu is usually displayed on the right side of the screen. However, there are some keys, such as **AUTO TUNE** and **COPY**, which do not have an associated soft menu.

Each menu selection is aligned with a soft key. To make a menu selection, press the associated soft key. In some cases, pressing the soft key displays additional selections. The following example shows how the panel and soft keys function.

(1) Selecting the Menu

Press **LEVEL** to display the menu used for setting up a measurement.

A reference line value is displayed in the active area, and the Level menu is displayed on the right side of the screen as shown below.

```

Ref Level
ATT AUTO/MNL
dB/div
Linear
Units
Ref Offset ON/OFF

```

(2) Entering Data

When a value is displayed in the active area, you can change it using the numeric keys, the step keys, or the data knob.

- Entering Data Using the Numeric Keys

You use the following keys to enter data: the number keys (0 through 9), the decimal point key, and the backspace (**BK SP**) or minus (-) key. If you make a mistake when using the numeric keys, you can use the backspace (**BK SP**) key to delete the last digit entered. If you have not entered any data, pressing the **BK SP** key enters a minus (-) sign. After entering the data, pressing the **ENTER** key or one of the other unit keys completes the operation.

---

**NOTE:** *Data entered with the numeric keys that is not terminated with a units terminator is aborted when you press any panel key.*

---

Example: The following example sets the reference level to -20 dBm using the numeric keys:  
Press the **-, 2, 0 and GHz (+dBm)** keys or the **2, 0 and MHz (-dBm)** keys.

- Entering Data Using the Step Keys

The step keys are used to enter data by a predefined step size. Press the ▼ step key to decrement the data; press the ▲ step key to increment the data. You can enter data while looking at the active area on the screen using the step keys. You can also define the step size manually.

Example: The following example sets the reference level to 0 dBm using the step keys:

Press the ▼ step key. This sets the reference level to -10.0 dBm. If you press the ▲ step key once more, the level is set to 0.0 dBm.

- Entering Data Using the Data Knob

The data knob is used to enter data in units of predefined display resolution. This is convenient when making fine adjustments to data which has already been entered.

Example: To set the reference level to 0.5 dBm using the data knob, turn the knob clockwise.

This increases the reference level in increments of 0.1 dBm.

Continue to turn it until the indication in the active area is 0.5 dBm.

Turning the data knob counter clockwise decreases the reference level.

- ACTIVE OFF

Pressing **ACTIVE OFF** turns off the active area and removes any information displayed. You cannot enter data if the active area is off. To turn the active area on again, press any panel or soft key.

### (3) Menu structure

You can access the following submenu by pressing either "*1/2\_more*" or the ► key.

In addition, there is another type of soft key which is used to toggle between two settings (ON/OFF, AUTO/MNL etc.). For these keys, the currently active setting is underlined.

Pressing **MKR** displays the Marker (1) menu as shown below.

*Normal Marker*  
*Delta Marker*  
*Peak Menu* ►  
*Sig Track ON/OFF*  
*Sound* ►  
*Marker Off*  
*1/2\_more* ►

- Displaying submenus

Pressing the soft key ► displays a submenu as shown below.

Press *Sound*. The following Sound menu is displayed.

*Sound AM/FM*  
*Volume*  
*MKR Pause Time*  
*Squelch ON/OFF*  
*Sound Off*

- Switching between settings

To switch the currently active setting for soft keys such as AUTO/MNL, press the key. Pressing the key again changes back the setting. The active setting is underlined.

Example: Press *Squelch ON/OFF*.

The squelch function is activated when ON is selected. When this function is active, a squelch line is displayed and the current value for the squelch line is displayed in the active area.

To remove the squelch line, press *Squelch ON/OFF* again to select OFF.

- RETURN

Used to go back to displaying the Marker (1) menu.

Press **RETURN** to return from the submenu to the original menu.



## 2.2 Basic Operation

- 1/2\_more and 2/2\_more

Pressing *1/2\_more* shows the rest of the soft key menu (those items not currently visible). Likewise, pressing *2/2\_more* at the bottom of this display returns to the top of the soft key display (the previous set of items).

Press *1/2\_more*. The rest of the Marker menu (menu 2), is displayed as shown below.

*Fixed MKR ON/OFF*  
*MKR Step AUTO/MNL*  
*Marker Couple ON/OFF*  
*2/2\_more ▶*

Press *2/2\_more*. The previous items (menu 1) are displayed.

### (4) Using SHIFT

**SHIFT** is used to select the functions that are labeled in blue above the panel keys. There are four such functions:

- PRESET
- SAVE
- CAL
- EMC

To select one of these functions, press **SHIFT** and the desired panel key. Pressing **SHIFT** lights the adjacent LED indicating that the Shift function is active. To cancel the shift function before selecting a blue-labeled function, press **SHIFT** a second time. The green LED goes off, indicating that the Shift function is no longer active. **SHIFT** is also used to activate the hold function which disables the data knob: the hold function is activated when you press **SHIFT** until the green LED goes off. When you want to disable the hold function, repeat the above procedure; when the LED goes off, the hold function has been reset.

### 2.2.2 Displaying Spectrums and Operating the Markers

The following example measures the frequency difference between the peak point and a point 3 dB levels lower, and another frequency difference between the peak point and a point 60 dB levels lower.

Power on

---

**NOTE:** *To take accurate measurements, use the spectrum analyzer within the specified temperature range, and wait at least 30 minutes after turning the power on before using it. For these practice examples, you do not need to warm up the spectrum analyzer.*

---

1. Make sure that the **POWER** switch on the front panel is in the OFF position.
2. Connect the power cable provided to the AC power supply connector on the rear panel.

---

**CAUTION:** *To avoid damage, operate the spectrum analyzer within the specified input voltage and frequency ranges.*

---

3. Connect the power cable to the outlet.
4. Turn the **POWER** switch on.  
When the self-test has completed, the startup screen is displayed.

---

**NOTE:** *The screen display after the power-on may differ from the one shown here due to previous settings.*

---

Initialization

This resets the current settings to the factory defaults.

5. Press **SHIFT**.  
This activates the shift mode so that functions labeled in blue can be used.
6. Press **CONFIG (PRESET)**.  
This resets all spectrum analyzer settings.

2.2 Basic Operation

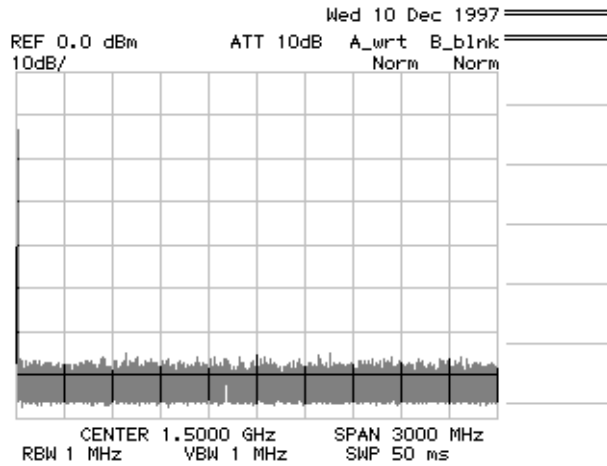

Figure 2-4 Factory Defaults Screen

Calibration signal output

This activates the calibration signal used for the measurement.

7. Press **SHIFT** and **7 (CAL)**.  
 The Cal menu used with calibrations is displayed.
8. Press *Cal Sig Level ON/OFF*.  
*Cal Sig Level ON/OFF* is turned on, and the calibration signal is output.

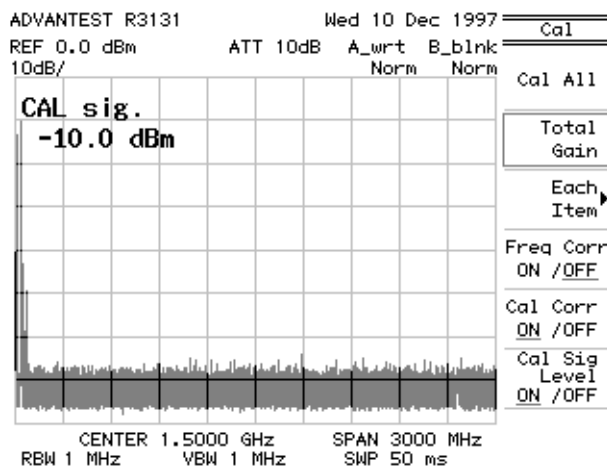

Figure 2-5 Calibration Signal Output Screen

## Setting the measurement conditions

This changes the analyzer settings so that the input signal is displayed more clearly.

9. Press **FREQ.**

The current center frequency is displayed in the active area, and the Freq menu used to select the frequency type appears on the right.

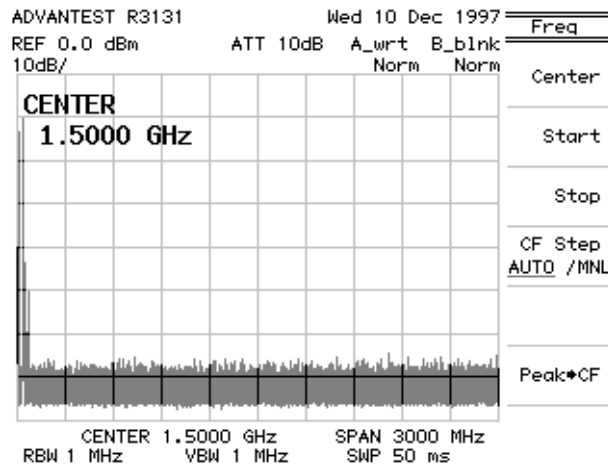

Figure 2-6 Active Area Display

10. Press **3, 0** and **MHz.**

A center frequency of 30 MHz is set.

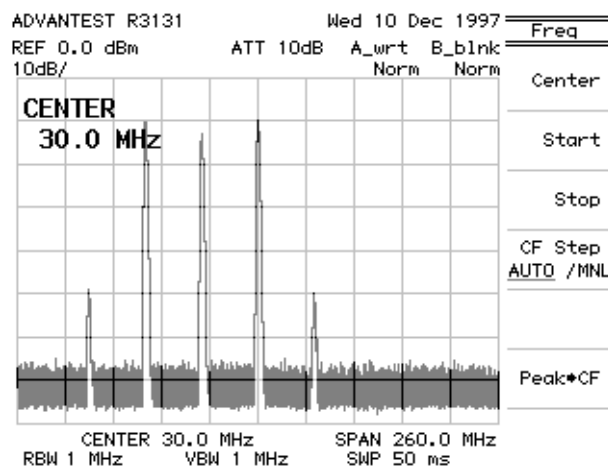

Figure 2-7 Setting the Center Frequency

2.2 Basic Operation

11. Press **SPAN**.  
The current frequency span is displayed in the active area, and the Span menu used for setting the frequency span appears on the right.
12. Press **2, 0** and **MHz**.  
A frequency span of 20 MHz is set.
13. Press **LEVEL**.  
The current reference level is displayed in the active area, and the Level menu used for setting the level appears on the right.
14. Press **1, 0, MHz(-dBm)**.  
A reference level of -10 dBm is set.

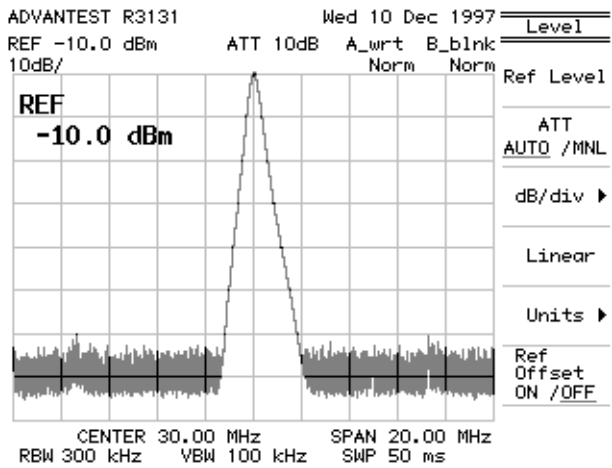
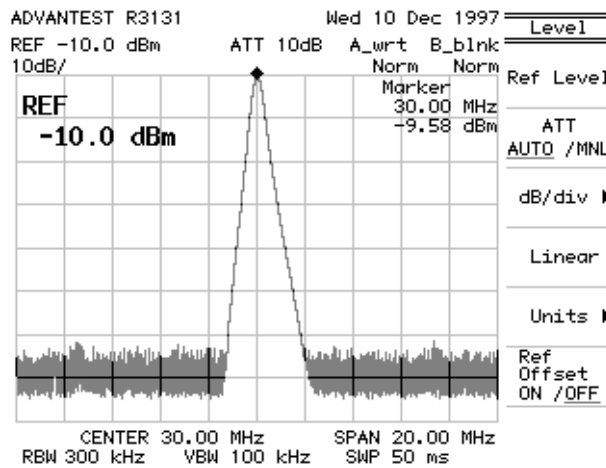

Figure 2-8 Measuring Settings Screen

Displaying a marker on the trace peak

15. Press **PK SRCH**.  
The marker is displayed on the trace peak, and the marker frequency (approximately 30 MHz) and level (approximately -10 dBm) are listed in the marker area.



**Figure 2-9 Peak Search Display Screen**

Using the delta marker

This measures the frequency difference between a point 3 dB levels down and a point 60 dB levels down from the peak.

**16. Press MKR.**

The Marker (1) menu used with the marker function is displayed.

**17. Press *Delta Marker*.**

The delta marker is displayed on the trace peak, and the differences between the marker and delta marker frequency and level are listed in the marker area.

**18. Move the marker to the -3 dB point using the data knob while looking at the level indication in the marker area and set it as precisely as possible (an exact setting may not be possible due to resolution limitations).**

The marker area now lists the frequency difference between the peak point and a point 3 dB levels down from the peak.

2.2 Basic Operation

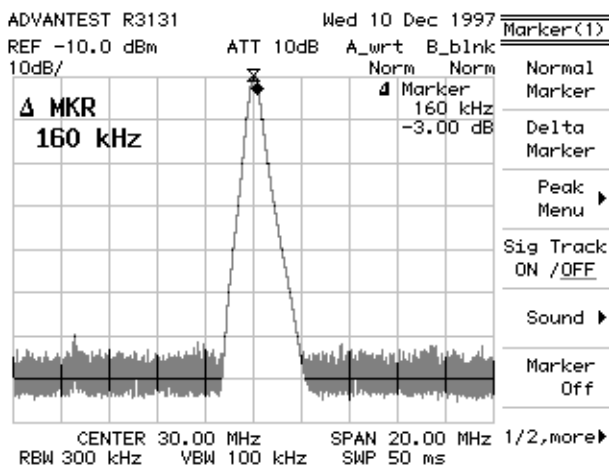

Figure 2-10 Frequency Difference Between the Peak Point and a Point 3 dB Levels Down

19. Next, move the marker to a point 60 dB levels down from the peak using the data knob.

The display in the marker area is the frequency difference between the peak point and a point 60 dB levels down from the peak.

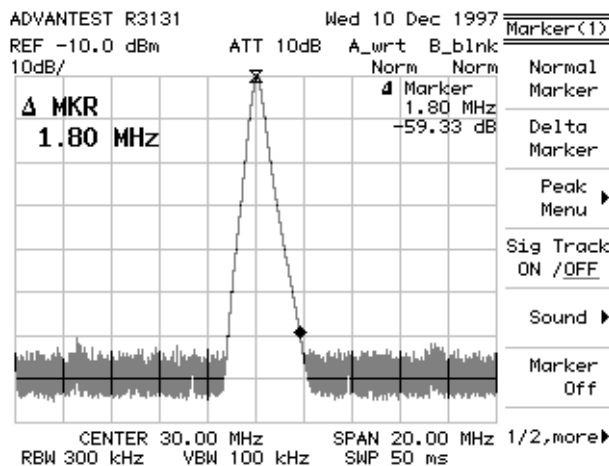

Figure 2-11 Frequency Difference Between the Peak Point and a Point 60 dB Levels Down

### 2.2.3 Measuring Window and the Display Line

This section describes the measuring window which is used to display measurements within a limited area, and the display and reference lines which are used to compare traces.

Power on

1. Turn the spectrum analyzer power on.

Initialization

This resets the current settings to the factory defaults.

2. Press **SHIFT** and **CONFIG (PRESET)**.  
The default settings have now been reset.

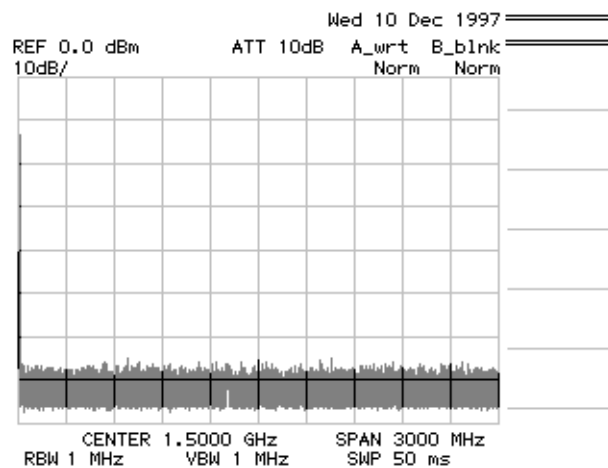

**Figure 2-12 Factory Defaults Screen**

Calibration signal output

This activates the calibration signal used for the measurement.

3. Press **SHIFT**, **7 (CAL)** and *Cal Sig Level ON/OFF*.  
*Cal Sig Level ON/OFF* is turned on, and the calibration signal is output.



2.2 Basic Operation

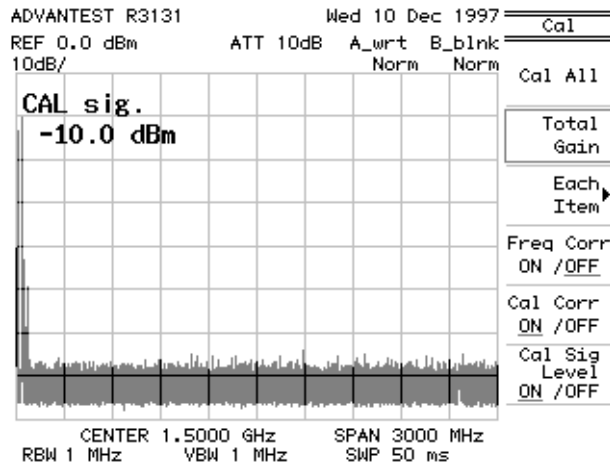

Figure 2-13 Calibration Signal Output

Setting the measurement conditions

This changes the analyzer settings so that the input signal is displayed more clearly.

4. Press **FREQ, 5, 0** and **MHz**.  
A center frequency of 50 MHz is set.
5. Press **SPAN, 8, 0** and **MHz**.  
A frequency span of 80 MHz is set.
6. Press **LEVEL, 1, 0** and **MHz (-dBm)**.  
A reference level of -10 dBm is set.

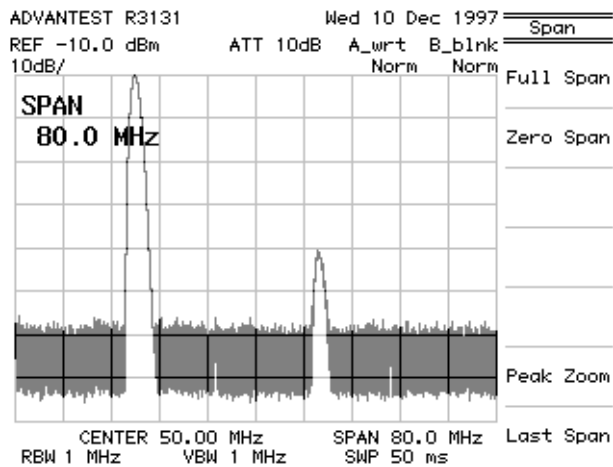
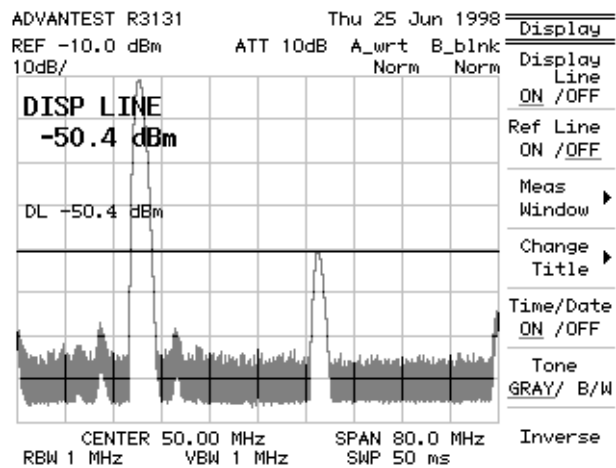

Figure 2-14 Measuring Settings Screen

## Activating the display line

The display line is convenient for comparing one trace level to another.

7. Press **DISPLAY** and *Display Line ON/OFF*.  
The display line is activated.
8. Move the display line vertically so that it aligns with the peak on the right side by turning the data knob.  
This makes it easier to compare trace levels.



**Figure 2-15 Activating the Display Line**

## Activating the reference line

This activates the reference line allowing you to enter reference level settings.

9. Press *Ref Line ON/OFF*.  
The reference line appears, and the reference level can now be set.
10. Move the reference line vertically until it is aligned with the maximum peak so that you can obtain a display line value relative to the maximum peak.

## 2.2 Basic Operation

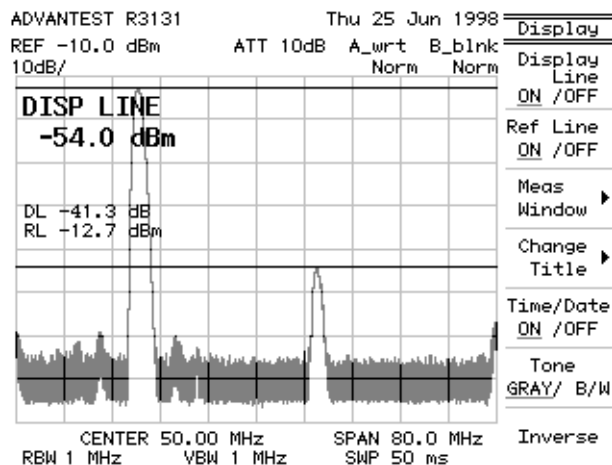

**Figure 2-16 Making a Comparison Between Peaks Using Reference Lines**

#### Removing the lines

This removes the display and reference lines.

11. Press *Display Line ON/OFF* two times.  
OFF is selected and the display line is removed.
12. Press *Ref Line ON/OFF* two times.  
OFF is selected and the reference line is removed.

#### Setting up the measuring window

13. Press *Meas Window*.  
The measuring window appears and the Meas WDO menu associated with the window settings is displayed.  
The frequency for the current window position is listed in the active area, and the window position can now be changed.
14. Move the measuring window by turning the data knob so that the measuring window center is aligned with the center of the peak to the right.

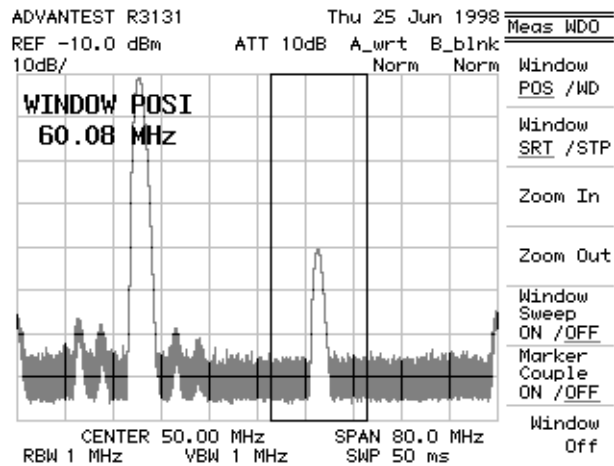

Figure 2-17 Screen Display Showing the Measuring Window

15. Press **Zoom In**.

This displays a magnified view and the range specified by the measuring window now fills the screen.

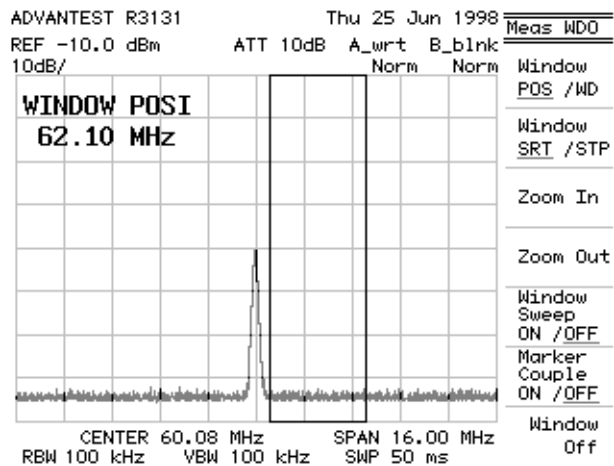

Figure 2-18 Screen Display after Zoom In

16. Press **Zoom Out**.

This changes the screen back to the previous display.

Removing the window

17. Press **Window Off**.

The measuring window is turned off.

## 2.2 Basic Operation

## 2.2.4 Measuring Frequency Using Counter

The counter function measures the signal frequency at the marker with high accuracy.

You do not have to precisely position the marker on the peak you wish to measure however you should note that the displayed amplitude value corresponds to the marker position.

The maximum resolution possible for the counter function display is 1 Hz. As you increase the resolution, you will have to increase the sweep time to compensate.

**NOTE:**

1. *The counter function may not work normally if the span is greater than 200 MHz or the difference between the marker and the noise level is 25 dB or less.*
2. *The signal track mode cannot be used with this function.*

The following example shows how to measure the frequency.

Power on

1. Turn the spectrum analyzer power on.

Initialization

This resets the current settings to the factory defaults.

2. Press **SHIFT** and **CONFIG (PRESET)**.  
The default settings have now been reset.

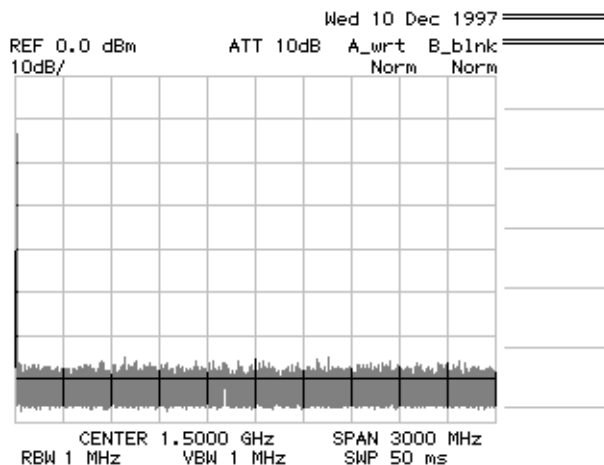

**Figure 2-19 Factory Defaults Screen**

Calibration signal output

This activates the calibration signal used for the measurement.

3. Press **SHIFT**, **7 (CAL)** and *Cal Sig Level ON/OFF*.

*Cal Sig Level ON/OFF* is turned on, and the calibration signal is output.

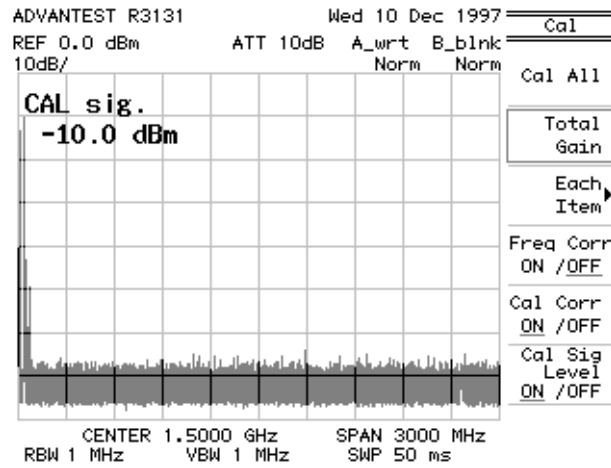
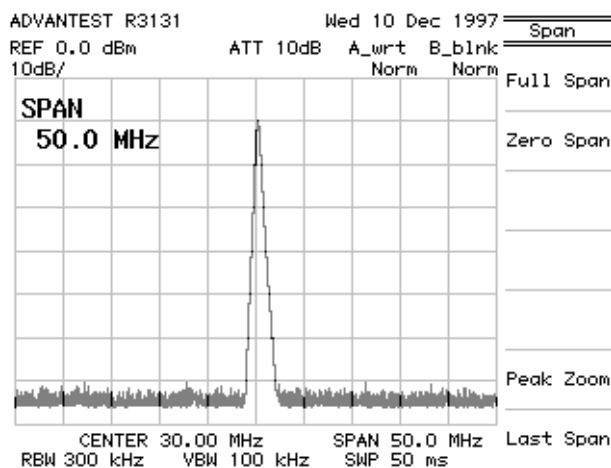

**Figure 2-20 Calibration Signal Output Screen**

Setting the measurement conditions

This changes the analyzer settings so that the input signal is displayed more clearly.

4. Press **FREQ, 3, 0** and **MHz**.  
A center frequency of 30 MHz is set.
5. Press **SPAN, 5, 0** and **MHz**.  
A frequency span of 50 MHz is set.



**Figure 2-21 Measuring Settings Screen**

2.2 Basic Operation

Measuring frequency by counter

This measures the frequency using the counter function.

6. Press **COUNTER**.

The Counter menu (used for setting the frequency counter resolution) and the Frequency Counter window are displayed. The default resolution is 1 kHz.

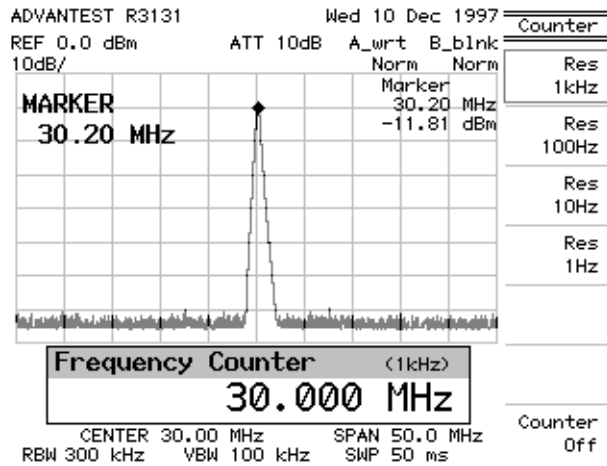

Figure 2-22 Frequency Counter Measurement (Resolution: 1 kHz)

7. Press **Res 10 Hz**.

The frequency counter resolution is set to 10 Hz and is displayed in the frequency counter window.

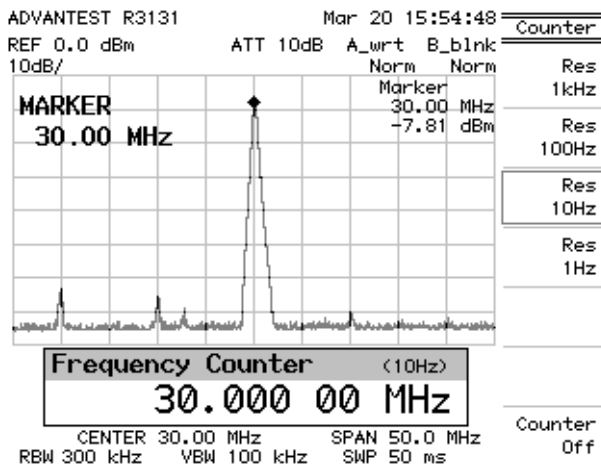

Figure 2-23 Frequency Counter Measurement (Resolution: 10 Hz)

8. Press **Counter Off**.

The counter function is turned off.

### 2.2.5 Auto Tuning

You can display a signal with an unknown frequency using the auto tuning function.

Power on

1. Turn the spectrum analyzer power on.

Initialization

This resets the current settings to the factory defaults.

2. Press **SHIFT** and **CONFIG (PRESET)**.  
The default settings have now been reset.

Calibration signal output

This activates the calibration signal used for the measurement.

3. Press **SHIFT, 7 (CAL)** and *Cal Sig Level ON/OFF*.  
*Cal Sig Level ON/OFF* is turned on, and the calibration signal is output.

Frequency span

This sets the frequency span in preparation for auto-tuning.

4. Press **SPAN, 1, 0, 0** and **kHz**.  
A frequency span of 100 kHz is set.

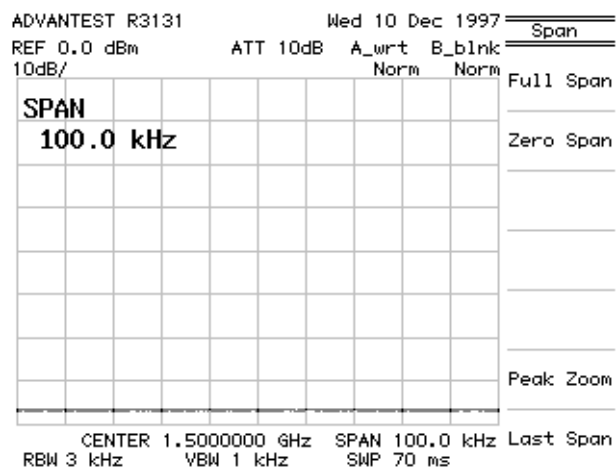

Figure 2-24 Screen Display Prior to Auto Tuning



2.2 Basic Operation

Auto tuning

5. Press **AUTO TUNE**.

Normally, peak searches cover the entire band, and the span gradually returns to the original setting by keeping track of that peak signal.

With this function, the maximum peak is automatically displayed. The reference level is set to the tuned peak level under these conditions.

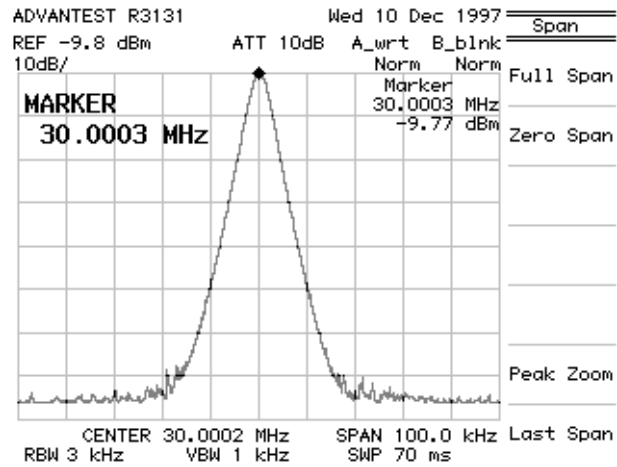

Figure 2-25 Screen Display after Auto Tuning

### 2.2.6 Tracking Operations

Tracking operations consist of signal tracking (which is useful for measuring a signal whose frequency is variable) and continuous peak search functions.

#### Power on

1. Turn the spectrum analyzer power on.

#### Initialization

This resets the current settings to the factory defaults.

2. Press **SHIFT** and **CONFIG (PRESET)**.  
The default settings have now been reset.

#### Calibration signal output

This activates the calibration signal used for the measurement.

3. Press **SHIFT, 7 (CAL)** and *Cal Sig Level ON/OFF*.  
*Cal Sig Level ON/OFF* is turned on, and the calibration signal is output.

#### Setting the measurement conditions

This changes the analyzer settings so that the input signal is displayed more clearly.

4. Press **FREQ, 3, 0** and **MHz**.  
A center frequency of 30 MHz is set.
5. Press **SPAN, 5, 0** and **kHz**.  
A frequency span of 50 kHz is set.

2.2 Basic Operation

Signal tracking

This function performs a peak search using a signal with the marker in each sweep, and the detected frequency is set to the center frequency. The detected peak frequency is always set as the center frequency.

6. Press **MKR** and *Sig Track ON/OFF*.  
Signal tracking is turned on. The detected peak frequency is always set as the center frequency even if the input signal frequency varies.

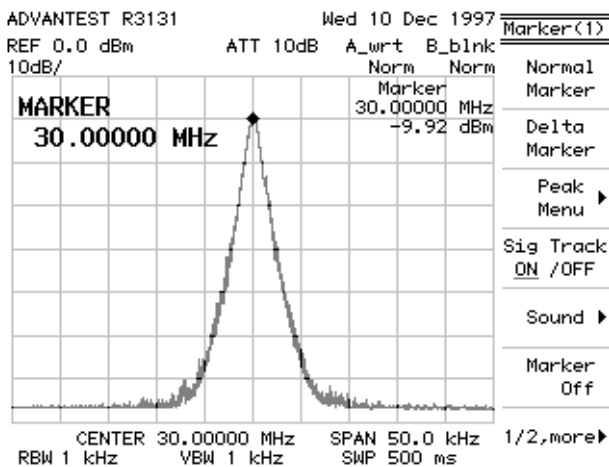

Figure 2-26 Signal Tracking Screen

7. Press *Sig Track ON/OFF*.  
Signal tracking is turned off.

## Continuous peak search

This function detects a peak for each sweep, and always moves the marker to that peak. The marker is always displayed on the peak.

8. Press **Peak Menu** and **Cont Peak ON/OFF**.

The Cont peak search is turned on. A peak is detected in each sweep and the marker is always moved to that peak even if the input signal frequency varies.

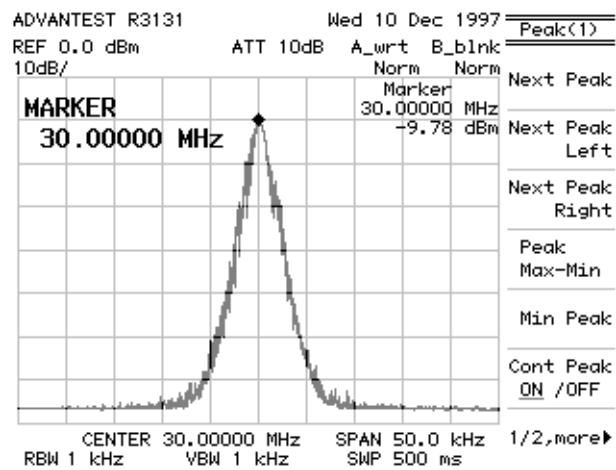

**Figure 2-27 Continuous Peak Search Screen**

9. Press **Cont Peak ON/OFF**.

Continuous peak search is turned off.

## 2.2 Basic Operation

### 2.2.7 UNCAL Messages

Accurate measurements cannot be made if there is an inappropriate combination of parameters when measuring the resolution bandwidth (RBW), the video bandwidth (VBW), the frequency span, the sweep time and so on (the parameters for these measurements affect each other). UNCAL is displayed in the center of the screen when a measurement cannot be made correctly.

If this occurs, perform one or more of the following procedures to correct this problem and remove UNCAL from the screen:

- Widen the resolution band width (RBW).
- Widen the video band width (VBW).
- Make the sweep time longer.
- If RBW or VBW cannot be changed, narrow the frequency span.

#### Power on

1. Turn the spectrum analyzer power on.

#### Initialization

This resets the current settings to the factory defaults.

2. Press **SHIFT** and **CONFIG (PRESET)**.  
The default settings have now been reset.

#### Calibration signal output

This activates the calibration signal used for the measurement.

3. Press **SHIFT, 7 (CAL)** and *Cal Sig Level ON/OFF*.  
*Cal Sig Level ON/OFF* is turned on, and the calibration signal is output.

#### Setting the measurement conditions

This changes the analyzer settings so that the input signal is displayed more clearly.

4. Press **FREQ, 3, 0** and **MHz**.  
A center frequency of 30 MHz is set.
5. Press **SPAN, 1, 0** and **MHz**.  
A frequency span of 10 MHz is set and the following conditions also apply:  
RBW = 100 kHz, VBW = 100 kHz and SWEEP = 50 ms.

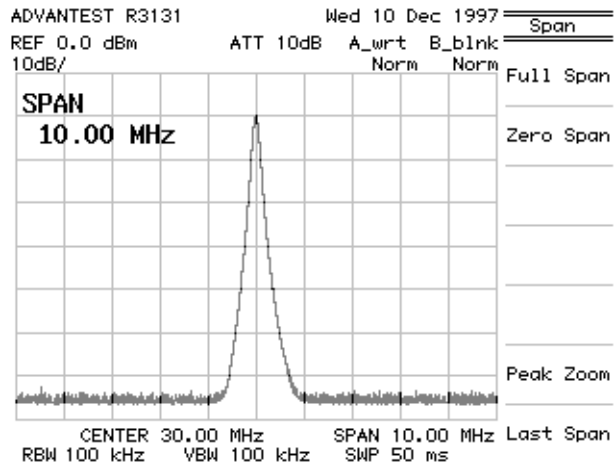

Figure 2-28 Measuring Settings Screen

Manually changing the measurement conditions

6. Press **SWEEP** and **SWP Time AUTO/MNL**.  
Sweep time is set to 50 ms.
7. Press **BW**, **RBW AUTO/MNL**, **3, 0** and **kHz**.  
The RBW is set to 30 kHz.  
A sweep time of 50 ms is too short because of the current settings so **UNCAL** is displayed in the center of the screen.

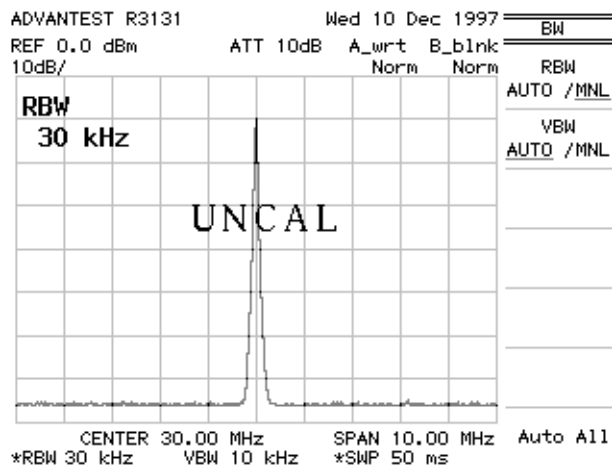

Figure 2-29 Screen with UNCAL Message

2.2 Basic Operation

- 8. Press **VBW AUTO/MNL, 1, 0, 0** and **kHz**.

An accurate measurement can be made now that the video bandwidth has been set to 100 kHz. Note that there is no longer an UNCAL message on the screen.

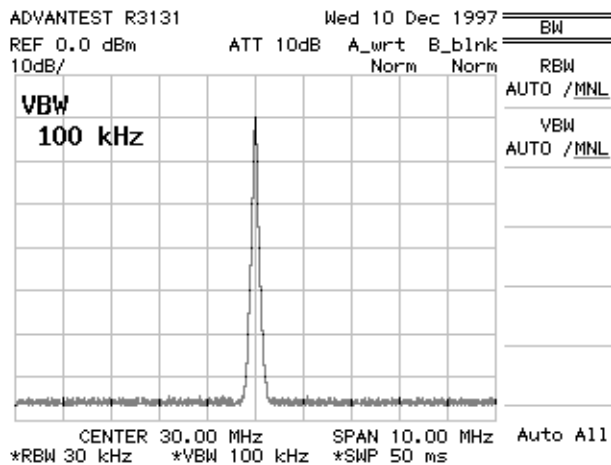

Figure 2-30 Normal Measurement Screen

### 2.2.8 Separating Two Signals

This section describes how RBW should be set to properly observe adjacent signals using the spectrum analyzer.

#### Setup

1. Connect the signal generators as shown in Figure 2-31.

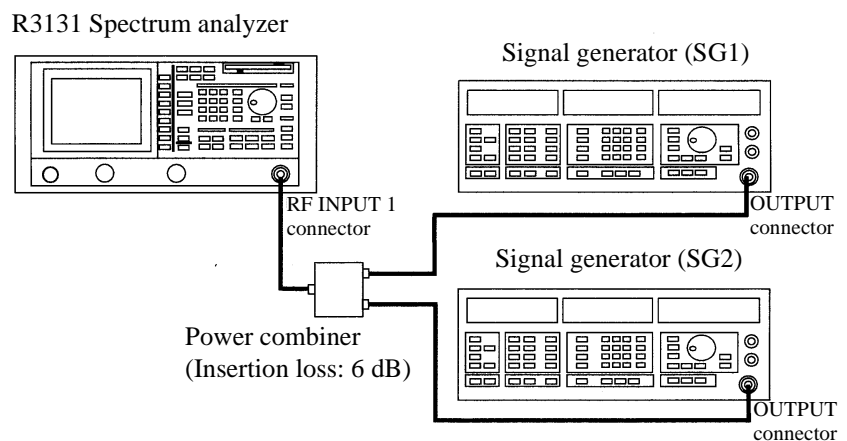

**Figure 2-31 Setup for Measuring Two Signals Separately**

#### Power on

2. Turn the power on.

#### Setting the signal generators

This prepares the signal generators for output.

3. Set the SG1 frequency to 200.00 MHz; the SG1 level to -10 dBm; and the SG1 output to ON.
4. Set the SG2 frequency to 200.25 MHz; the SG2 level to -20 dBm; and the SG2 output to ON.

#### Initialization

This resets the current settings to the factory defaults.

5. Press **SHIFT** and **CONFIG (PRESET)**.  
The default settings have now been reset.

#### Setting the measurement conditions



2.2 Basic Operation

This changes the analyzer settings so that the input signal is displayed more clearly.

6. Press **FREQ, 2, 0, 0** and **MHz**.  
A center frequency of 200 MHz is set.
7. Press **SPAN, 1, 0** and **MHz**.  
A frequency span of 10 MHz is set.
8. Press **LEVEL, 1, 0** and **MHz (-dBm)**.  
The reference level of - 10 dBm is set.
9. Press **ATT AUTO/MNL, 2, 0** and **GHz (dB)**.  
Attenuator level is set to 20 dB.  
The spectrums are not fully separated because the RBW default setting is 100 MHz. As a result, the display shows only one input signal even though there are actually two.

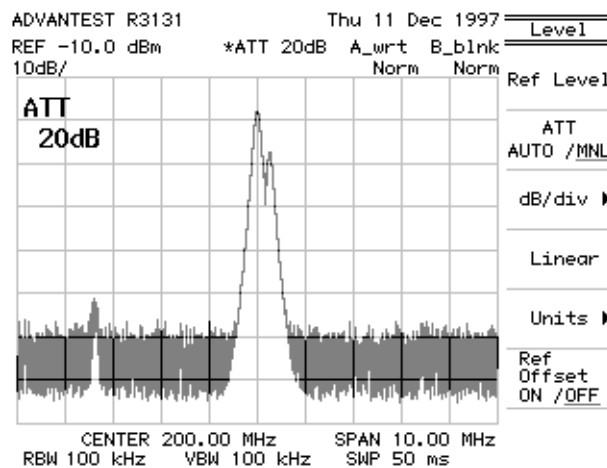

Figure 2-32 Two Superimposed Peaks

10. Press **BW**, **RBW AUTO/MNL**, **3, 0** and **kHz**.

The RBW is set to 30 kHz.

Two peaks are now discernible but they are still not clearly separated.

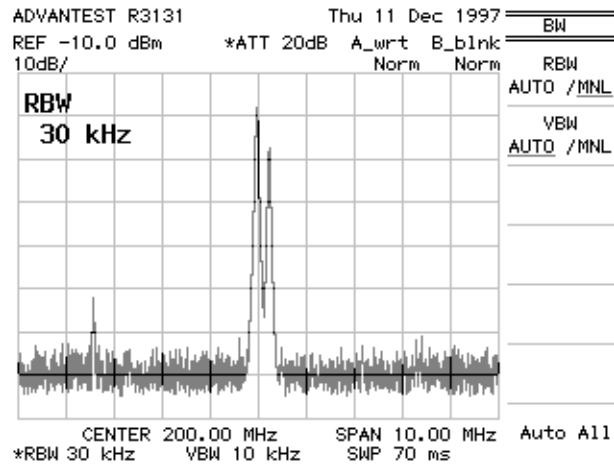

Figure 2-33 Two Discernible Peaks

11. Press **1, 0** and **kHz**.

The RBW is set to 10 kHz.

Two peaks can now be distinctly seen.

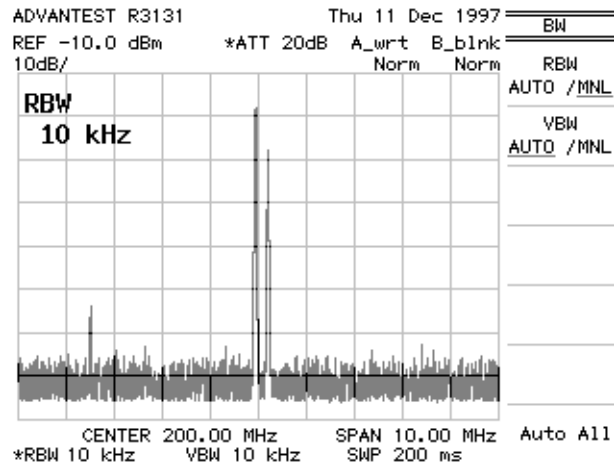

Figure 2-34 Two Distinct Peaks Can Now Be Seen

### 2.2.9 Dynamic Range

The dynamic range can be increased by reducing the noise level, which is accomplished by narrowing the resolution bandwidth. The noise level can be further reduced by setting the video bandwidth (VBW) to approximately 1/10 of the resolution bandwidth (RBW).

#### Setup

1. Connect the signal generator as shown in Figure 2-35.

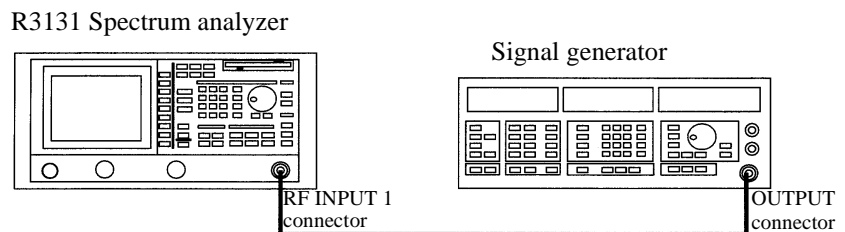

Figure 2-35 Setup for Verifying the Dynamic Range

#### Power on

2. Turn the power on.

#### Setting the signal generator

This prepares the signal generators for output.

3. Set the SG frequency to 200 MHz; the SG1 level to -50 dBm; modulation mode to non-modulated; and output to ON.

#### Initialization

This resets the current settings to the factory defaults

4. Press **SHIFT** and **CONFIG (PRESET)**.  
The default settings have now been reset.

## Setting the measurement conditions

This changes the analyzer settings so that the input signal is displayed more clearly.

5. Press **FREQ, 2, 0, 0** and **MHz**.  
A center frequency of 200 MHz is set.
6. Press **SPAN, 1, 0, 0** and **MHz**.  
A frequency span of 100 MHz is set.
7. Press **LEVEL, 4, 0** and **MHz(-dBm)**.  
The reference level is set to -40 dBm.

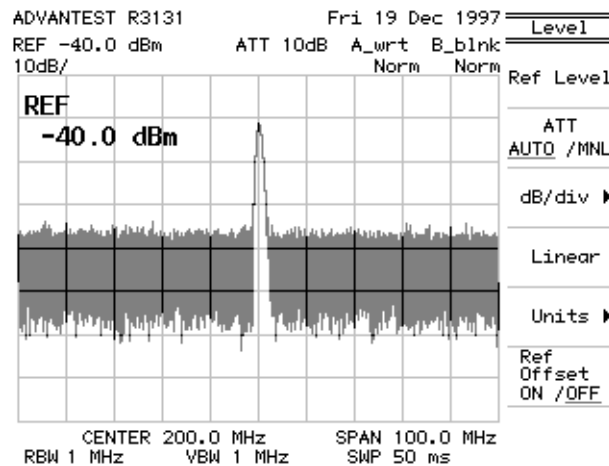

**Figure 2-36** Screen Display Prior to Changing the RBW

## Changing the RBW

The RBW default setting is 1 MHz. The noise level can be reduced by decreasing this value.

8. Press **BW, RBW AUTO/MNL, 1, 0, 0** and **kHz**.  
The RBW mode is changed to manual, and the resolution bandwidth is set to 100 kHz. As a result, the dynamic range has increased and this has reduced the noise level by approximately 10 dB.

2.2 Basic Operation

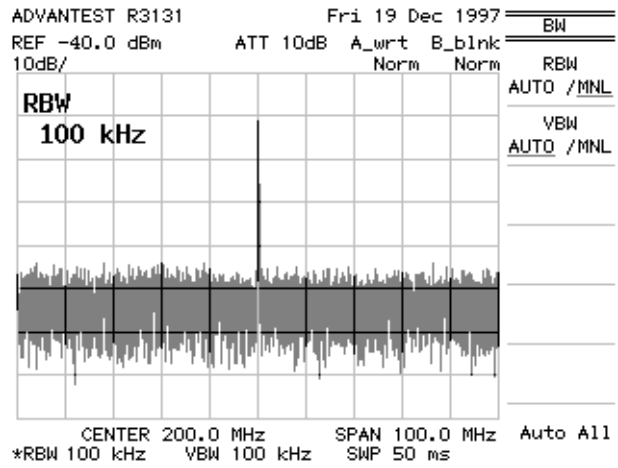

Figure 2-37 Screen Display after Changing the RBW

Changing VBW

The noise width can be further reduced by setting the VBW to 1/10 of the RBW.

9. Press ***VBW AUTO/MNL, 1, 0*** and ***kHz***.  
 VBW is set to MNL, and a video resolution bandwidth of 10 kHz is entered. As a result, the noise width has been reduced.

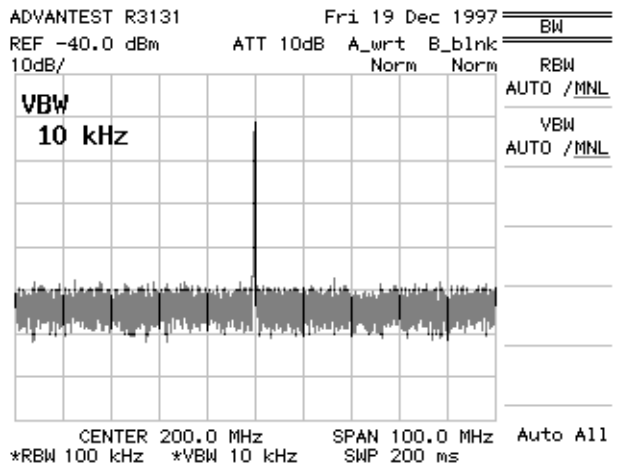

Figure 2-38 Screen Display after Changing the VBW

Performing the averaging function

This function can improve the S/N ratio faster than the VBW method shown above. This function makes it possible to quantify random components and measure signals buried in the noise.

10. Press **TRACE**, *1/2\_more* and **AVG A**.

AVG A (with a default setting of 20) has reduced the noise level considerably.

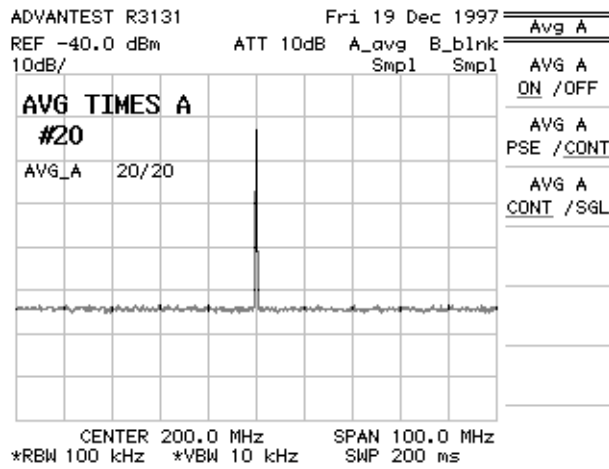

Figure 2-39 The Trace after Averaging

### 2.2.10 Input Saturation

After a signal being sent to the input mixer reaches a certain level, the displayed value is not proportional to the signal input because of saturation. An input level producing a 1 db error due to saturation is defined as the gain compression. In this example, you apply two input signals and verify that an input signal whose value is less than the limit of gain compression produces less output than it would under perfect linearity. This phenomenon is caused by another input signal whose value is larger than the gain compression limit.

Setup

1. Connect the signal generators as shown in Figure 2-40.

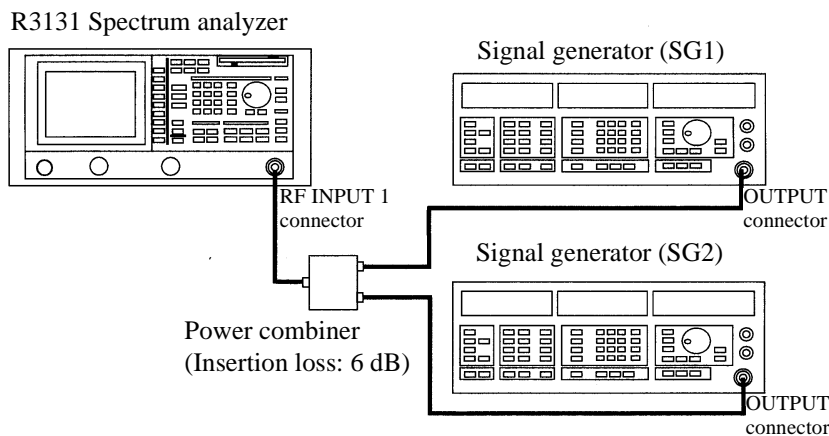

**Figure 2-40 Setup for Input Saturation**

Power on

2. Turn the power on.

Setting the signal generators

This prepares the signal generator outputs.

3. Set SG1 as follows: the frequency to 99.8 MHz; level to -10 dBm; modulation to non-modulated; and output to ON.
4. Set SG2 as follows: the frequency to 100.3 MHz; level to -40 dBm; modulation to non-modulated; and output to ON.

## Initialization

This resets the current settings to the factory defaults.

5. Press **SHIFT** and **CONFIG (PRESET)**.  
The default settings have now been reset.

## Setting the measurement conditions

This changes the analyzer settings so that the input signal is displayed more clearly.

6. Press **FREQ, 1, 0, 0** and **MHz**.  
A center frequency of 100 MHz is set.
7. Press **SPAN, 1** and **MHz**.  
A frequency span of 1 MHz is set.
8. Press **LEVEL, ATT AUTO/MNL, 0** and **GHz (dB)**.  
The Attenuator level is set to 0 dB.  
Under these conditions, the input level at the mixer is -16 dBm, and the measurement is correct without saturation.

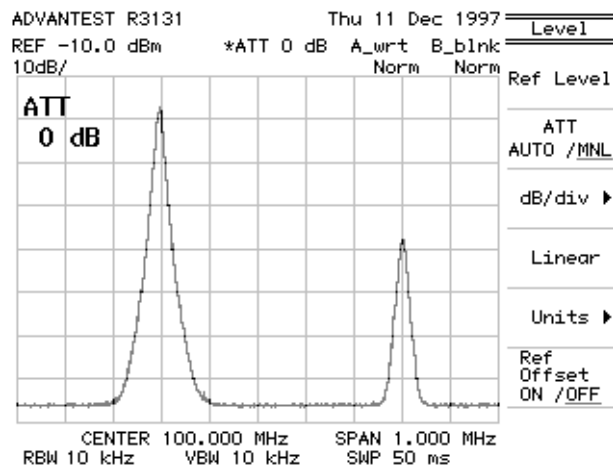

Figure 2-41 Screen Display without Saturation



2.2 Basic Operation

Changing the input signal level

Saturation can be observed as the left side signal level is increased.

- 9. Set SG1 level to +10 dBm.  
Under these conditions, the input level for the mixer is +4 dBm, and the right hand signal level is reduced due to saturation caused by gain compression.

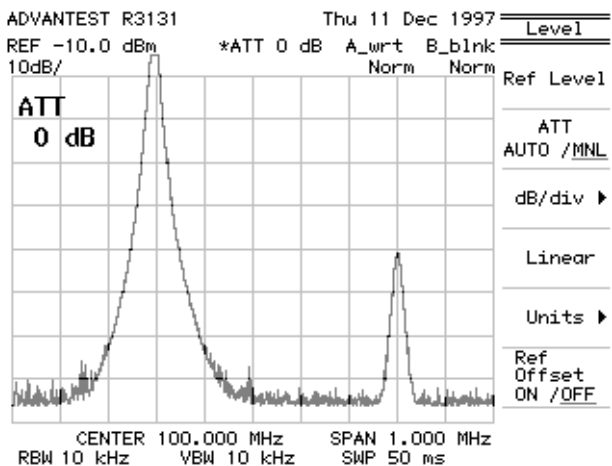

Figure 2-42 Screen Display Showing Saturation

### 2.2.11 Harmonic Distortion

Harmonic distortion is produced by non-linearity from the input mixer if the input exceeds a certain limit. As a result, spurious signals which do not come from the input signal may be observed.

#### Setup

1. Connect the signal generator as shown in Figure 2-43.

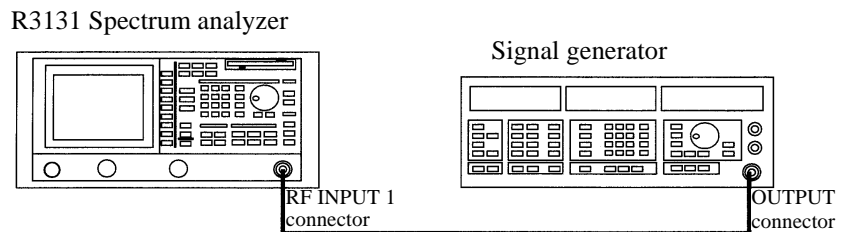

**Figure 2-43 Setup for Measuring Harmonic Distortion**

#### Power on

2. Turn the power on.

#### Setting the signal generator

This prepares the signal generator output.

3. Set the frequency to 200 MHz; the level to 0 dBm; mode of modulation to non-modulated; and output to ON.

#### Initialization

This resets the current settings to the factory defaults.

4. Press **SHIFT** and **CONFIG (PRESET)**.  
The default settings have now been reset.

2.2 Basic Operation

Setting the measurement conditions

This changes the analyzer settings so that the input signal is displayed more clearly.

5. Press **FREQ, 3, 0, 0** and **MHz**.  
A center frequency of 300 MHz is set.
6. Press **SPAN, 5, 0, 0** and **MHz**.  
A frequency span of 500 MHz is set.
7. Press **BW, RBW AUTO/MNL, 1, 0** and **kHz**.  
The RBW is set to 10 kHz.

Verifying harmonic distortion

8. Confirm that harmonic distortion is occurring on the right hand side of the screen.  
When the attenuator is set to 10 dB (default setting), and the mixer input is -10 dBm (= 0 dBm - 10 dB), harmonic distortion occurs.

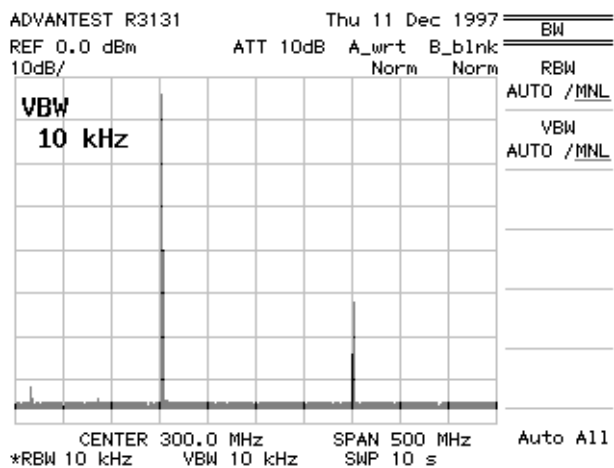
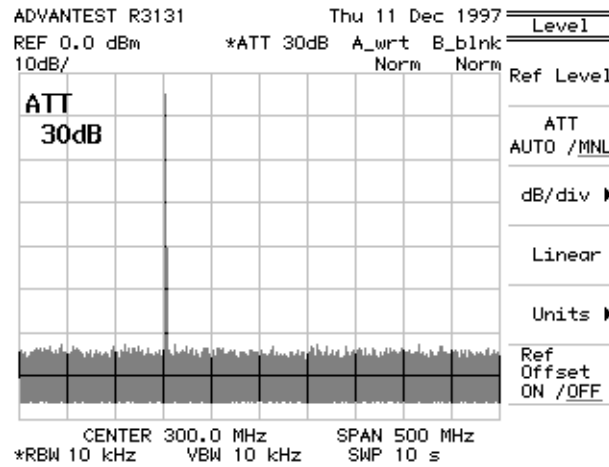

Figure 2-44 Screen Display Showing Harmonic Distortion

9. Press **LEVEL**, **ATT AUTO/MNL**, **3, 0** and **GHz (dB)**.  
The attenuator level is set to 30 dB.



**Figure 2-45 Screen Display Showing Reduced Harmonic Distortion**

Under these conditions, the input level for the mixer is -30 dBm, and the true spectrum can be observed.

## 2.2 Basic Operation

## 2.2.12 Intermodulation

This section describes how to set up the attenuator (ATT) when using a spectrum analyzer which is receiving more than one input signal.

When signals with an excess amplitude are input, spurious signals produced by intermodulation are displayed. It is important that the ATT be adjusted to moderate the mixer input.

## Setup

1. Connect the signal generators as shown in Figure 2-46.

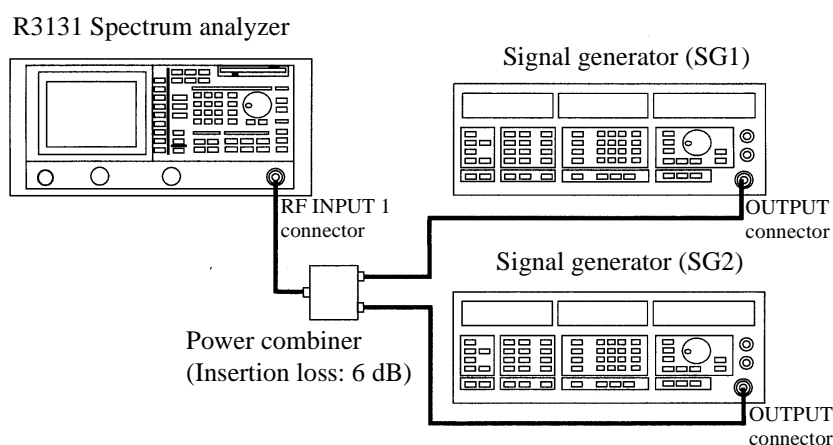

**Figure 2-46 Setup for Measuring Intermodulation**

## Power on

2. Turn the power on.

## Setting the signal generators

This prepares the signal generator outputs.

3. Set SG1 as follows: the frequency to 200.0 MHz; level to -4 dBm; modulation to non-modulated mode; and output to ON.
4. Set SG2 as follows: the frequency to 200.2 MHz; level to -4 dBm; modulation to non-modulated mode; and output to ON.  
Each signal has an input level of -10 dBm.

## Initialization

This resets the current settings to the factory defaults.

5. Press **SHIFT** and **CONFIG (PRESET)**.  
The default settings have now been reset.

#### Setting the measurement conditions

This changes the analyzer settings so that the input signal is displayed more clearly.

6. Press **FREQ, 2, 0, 0** and **MHz**.  
A center frequency of 200 MHz is set.
7. Press **SPAN, 1** and **kHz**.  
A frequency span of 1 kHz is set.
8. Press **BW, RBW AUTO/MNL, 1, 0** and **kHz**.  
The RBW is set to 10 kHz. The attenuator level default setting is 10 dB, which makes the input to the mixer -20 dBm (= -10 dBm - 10 dBm). Since the mixer level exceeds the distortion limit, spurious peaks (3 and 4) appear in addition to the normal peaks (1 and 2).

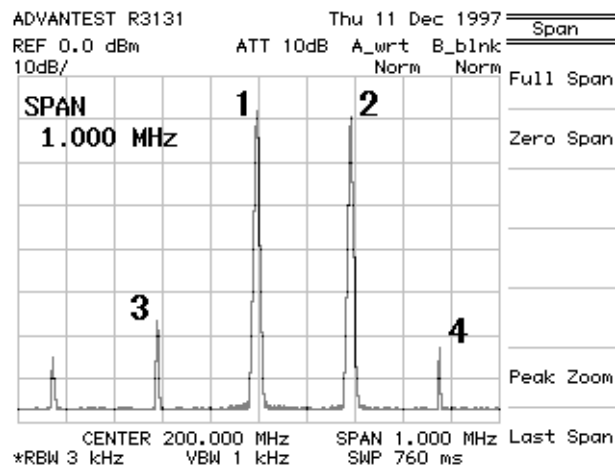
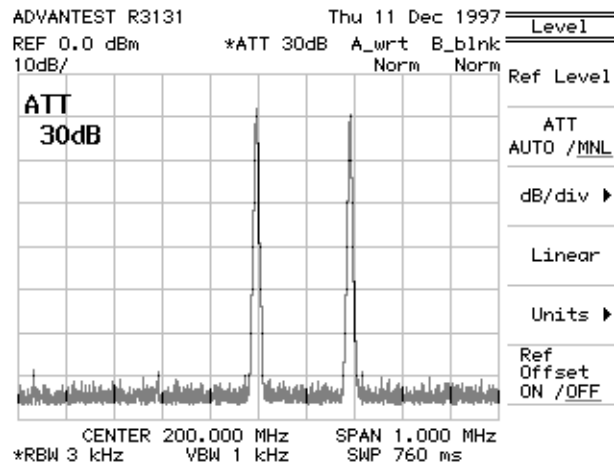

**Figure 2-47 Screen Display Showing Intermodulation Distortion**

#### Changing the attenuator

9. Press **LEVEL, ATT AUTO/MNL, 3, 0** and **GHz (dB)**.  
The attenuator level is set to 30 dB.  
Under these conditions, the mixer input level is -40 dBm, and spurious peaks (peaks 3 and 4 in Figure 2-47) are not produced.

2.2 Basic Operation



**Figure 2-48 Screen Display without Intermodulation Distortion**

The current spectrum has no intermodulation distortion. It is important that the ATT be adjusted in order to moderate the mixer input when using more than one input.

### 2.2.13 Calibration

Wait at least 30 minutes after turning on the spectrum analyzer before attempting to perform any measurements, or the measurements may not be accurate.

---

**Note:** *Do not use any input signals when performing a calibration.*

---

1. Press **SHIFT** and **7 (CAL)**.  
The Cal menu used for calibration appears.

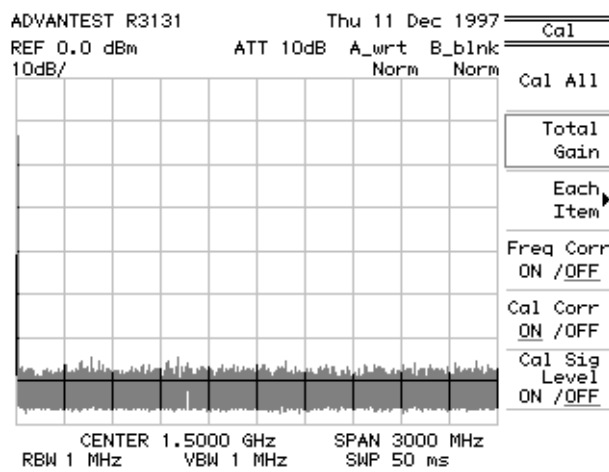

**Figure 2-49** Screen Display Showing the Cal Menu

2. Press **Cal All**.  
Calibrates the spectrum analyzer. After completing all items up to PBW, the spectrum analyzer enters the error correction mode. Press **Each Item**, then select an item you wish to calibrate.

---

**NOTE:** *You may hear some clicking noises during calibration, but this is normal.*

---



### 2.2.14 Entering User-definable Antenna Correction Data

You can define your own antenna correction data in addition to the four regular types of antenna correction data. This section describes how to do this.

#### Creating a correction data table

Save an empty correction data table to a floppy disk using the following procedure.

1. Insert the floppy disk in the disk drive.
2. Press **SHIFT** and **RECALL (SAVE)**.  
The Save menu and file list are displayed.
3. Press *Device RAM/FD* to select FD.  
The floppy disk is selected as the destination for the data table.
4. Press *Save Item*.  
The Save Item menu used for selecting data is displayed
5. Set *Ant Corr* to **ON** in the Save Item menu (do not turn any other settings on).
6. Press **RETURN**.  
The empty correction data table is saved to the floppy disk.
7. Specify the file, and press *Save*.  
This copies the empty correction data table to the floppy disk.

#### Editing the correction data table

The correction data table can be edited using a personal computer.

8. Open the data in the folder SVRCL on the floppy disk.
9. Add the data for frequency (Hz) and correction (dB) after the row <ANT CORR>.

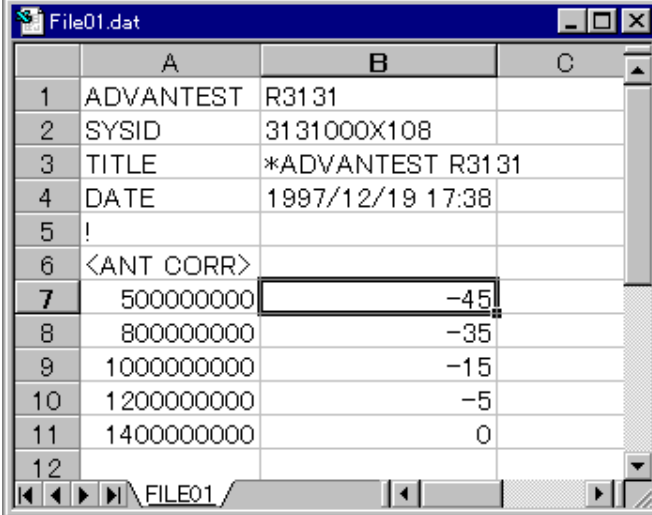

	A	B	C
1	ADVANTEST	R3131	
2	SYSID	3131000X108	
3	TITLE	*ADVANTEST R3131	
4	DATE	1997/12/19 17:38	
5	!		
6	<ANT CORR>		
7	500000000	-45	
8	800000000	-35	
9	1000000000	-15	
10	1200000000	-5	
11	1400000000	0	
12			

**Figure 2-50 Editing the Correction Data Table**

10. Save the data to the floppy disk in text data format.

#### Importing the correction data table

This reads the edited correction data table into the spectrum analyzer.

11. Press **RECALL**.  
The Recall menu used and the file list are displayed.
12. Press **Device RAM/FD** to specify FD.  
Floppy disk is selected.
13. Select the file and press **Recall**.  
The correction data table is read out.

#### Verifying the imported correction data table

This confirms that the correction data table has been read into the spectrum analyzer.

14. Press **SHIFT** and **1(EMC)**.  
The EMC menu is displayed.
15. Press **Field**.  
The Ant Corr menu is displayed.

2.2 Basic Operation

16. Press *User Ant Corr*.

The edited data in the correction data table is displayed.

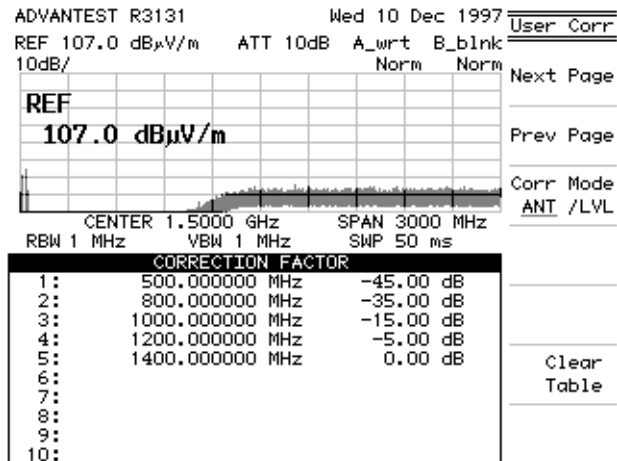

Figure 2-51 Screen Display Showing the User-Definable Correction Data Table

## 2.3 Measurement Examples

### 2.3.1 Measuring the Channel Power

The spectrum analyzer has a power measurement function which can be used to conveniently measure various types of power. This section describes how to measure the power of a specified channel bandwidth using the example below.

**Measurement conditions:**

This example shows how to measure channel power for a unit similar to PHS outputting a frequency of 1917.950 MHz and a level of 20 dBm.

Use appropriate parameter values to make the measurements shown below.

**Setup**

1. Connect the transmitter as shown in Figure 2-52.

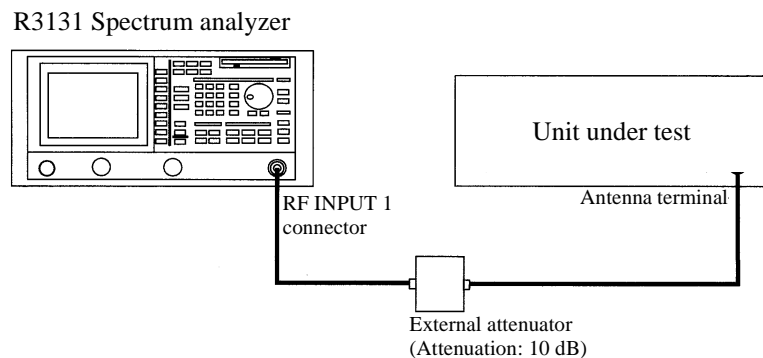

**Figure 2-52 Setup for Measuring the Channel Power**

**Power on**

2. Turn the power on.

**Setting the unit under test**

3. Turn on the signal output for the unit under test.

**Initialization**

This resets the current settings to the factory defaults.

4. Press **SHIFT** and **CONFIG (PRESET)**.  
The default settings have now been reset.

## 2.3 Measurement Examples

## Setting the measurement conditions

This changes the analyzer settings so that the input signal is displayed more clearly.

5. Press **FREQ, 1, 9, 1, 7, ., 9, 5, 0** and **MHz**.  
A center frequency of 1917.950 MHz is set.
6. Press **SPAN, 1** and **MHz**.  
A frequency span of 1 MHz is set.
7. Press **BW, RBW AUTO/MNL, 1, 0** and **kHz**.  
The RBW is set to 10 kHz.
8. Press **LEVEL, 1, 0** and **GHz (+dBm)**.  
The reference level is set to 10 dBm.

## Setting the offset level

9. Press **Ref Offset ON/OFF, 1, 0** and **GHz (dB)**.  
The offset level is set to 10 dB.  
The measurement values, including values for the external attenuator, are now displayed.

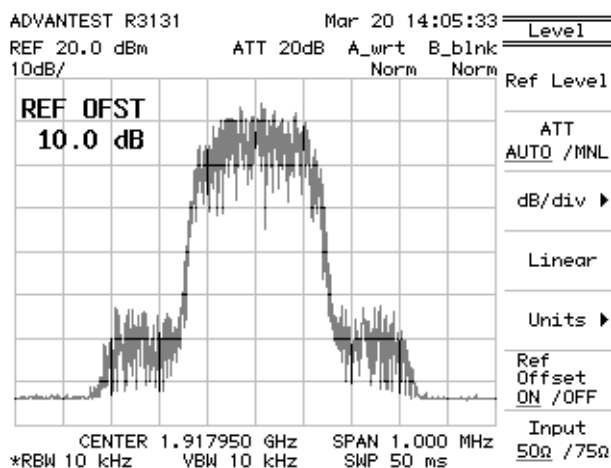

Figure 2-53 Setting the Offset Level

## Measuring the power

10. Press **POWER MEASURE**.  
The Power menu is displayed.
11. Press **Channel Power**.  
The CH Power menu is displayed.

12. Press **1, 9, 1, 7, ., 9, 5, 0** and **MHz**.  
The channel is set to 1917.950 MHz.
13. Press **CH BW POS/WD, 3, 0, 0** and **kHz**.  
The channel width is set to 300 kHz.

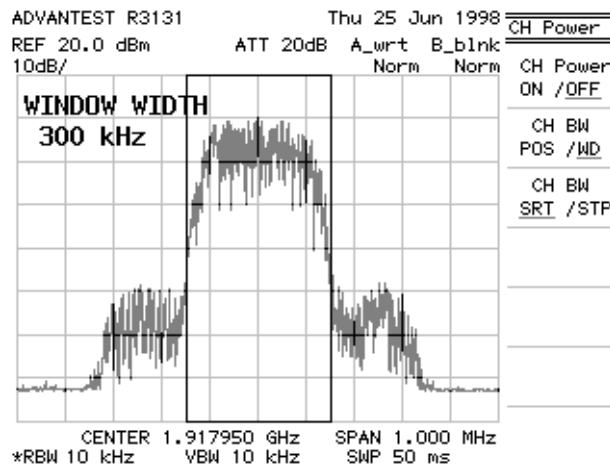

Figure 2-54 Setting the Measuring Window

14. Press **CH Power ON/OFF**.  
The channel window is displayed and channel power measurement starts. The current number of measurements being averaged is displayed in the active area and it can be changed as necessary.  
The measurement result is displayed on the channel power window and a display line indicating the channel power also appears.  
A display line indicating the channel power also appears.

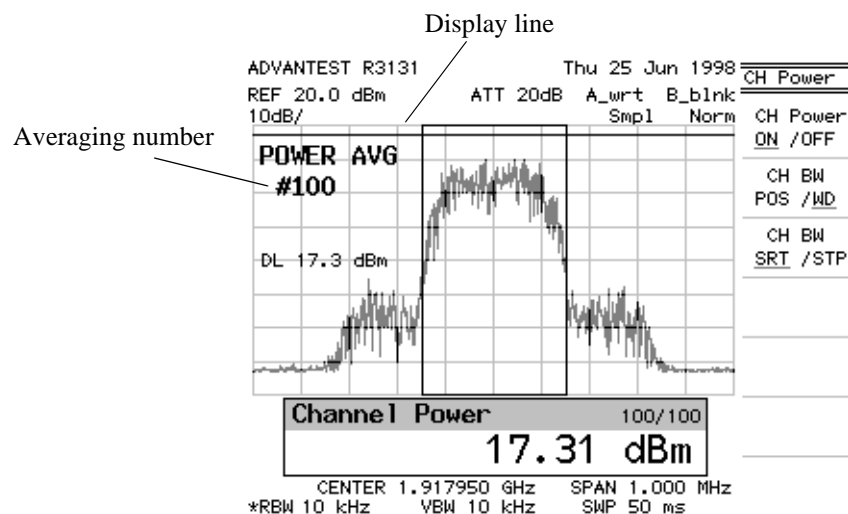

Figure 2-55 Measuring the Channel Power

### 2.3.2 Measuring the Occupied Bandwidth (OBW)

The occupied bandwidth can be calculated from the measured screen data using the OBW function. In this operation, the ratio of the OBW to the total power ranges from 10.0 to 99.8%. The initial setting is 99%.

**Measurement conditions:**

This example shows how to measure the occupied bandwidth for a unit similar to PHS outputting a frequency of 1917.950 MHz, an OBW of 288 kHz and a level of 20 dBm.

Use appropriate parameter values to make the measurements shown below.

---

**NOTE:** *Set the reference level and the frequency span so that the signal amplitude on the screen is 50 dB or more in order to reduce operation error (when the signal amplitude on the screen does not exceed 50 dB, the operation error is large). The optimum span is approximately three times the occupied bandwidth.*

---

**Setup**

1. Connect the unit under test as shown in Figure 2-56.

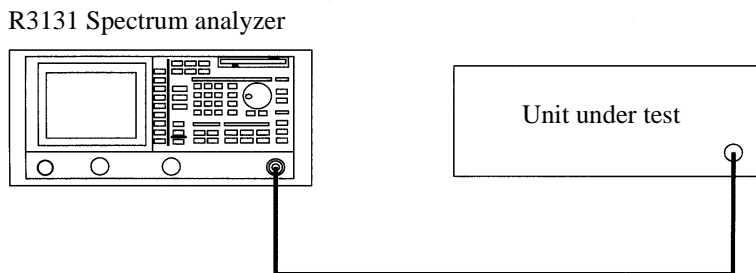

**Figure 2-56 Setup for Measuring the Occupied Bandwidth**

**Power on**

2. Turn the power on.

**Setting the unit under test**

3. Turn on the signal output for the unit under test.

**Initialization**

This resets the current settings to the factory defaults.

4. Press **SHIFT** and **CONFIG (PRESET)**.  
The default settings have now been reset.

## Setting the measurement conditions

This changes the analyzer settings so that the input signal is displayed more clearly.

5. Press **FREQ, 1, 8, 9, 5, ,, 1, 5** and **MHz**.  
A center frequency of 1895.15 MHz is set.
6. Press **SPAN, 8, 0, 0** and **kHz**.  
A frequency span of 800 kHz is set.

## Setting the detector mode

7. Press **TRACE, Detector** and **Posi**.  
The trace is set to positive detector mode.

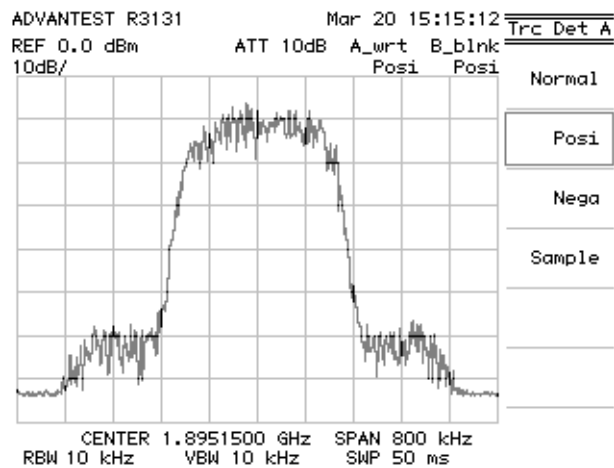

**Figure 2-57 Setting the Detector Mode**

## Measuring the OBW

8. Press **POWER MEASURE, OBW** and **OBW ON/OFF**.  
The OBW measurement is activated and the result displayed.



2.3 Measurement Examples

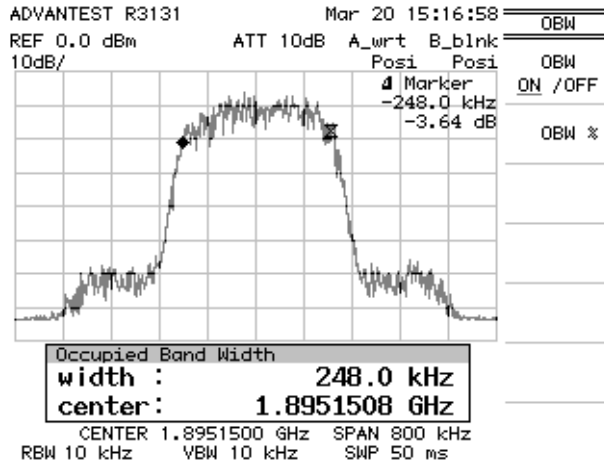

Figure 2-58 OBW Measurement Screen

When the measurement has been completed, a window showing the width and center of the occupied bandwidth is displayed(center refers to center frequency not carrier frequency), and two markers are placed at either end of the occupied bandwidth.

In this example, which has a ratio of 99.0% (initial value), each marker is displayed at 0.5% and 99.5% of the total power.

Changing the ratio to the total power

This changes the ratio to 95%.

9. Press **OBW%**, **9**, **5** and **Hz (ENTER)**.

The ratio to the total power is now 95%.

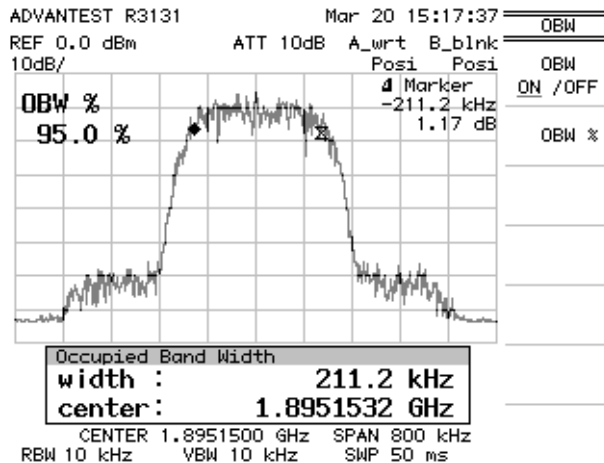

Figure 2-59 OBW(95%) Measurement Screen

### 2.3.3 Measuring Adjacent Channel Leakage Power (ACP)

The adjacent channel leakage power (ACP) function calculates the ratio of the power in the specified bandwidth obtained by integration to the total power (obtained from the data on the screen).

#### Measurement conditions:

This example shows how to measure the ACP at a specified bandwidth of 192 kHz and an offset of 600 kHz or 900 kHz for a unit under test (complying with PHS Standards) PHS outputting a frequency of 1895.15 MHz, and a level of 0 dBm.

Use appropriate parameter values to make the measurements shown below.

There are two methods used to measure ACP:

- ACP POINT: Calculates the channel leakage power using the specified channel spacing.
- ACP GRAPH: Calculates the leakage power within the specified bandwidth for each of the frequency points, displays the resulting trace and temporarily stores it as trace B.

---

**NOTE:** *The dynamic range is reduced when the signal level is considerably less than the reference level. The required span is four to five times the channel spacing.*

---

#### 2.3.3.1 Measurements using the ACP POINT Method

Setup

1. Connect the unit under test as shown in Figure 2-60.

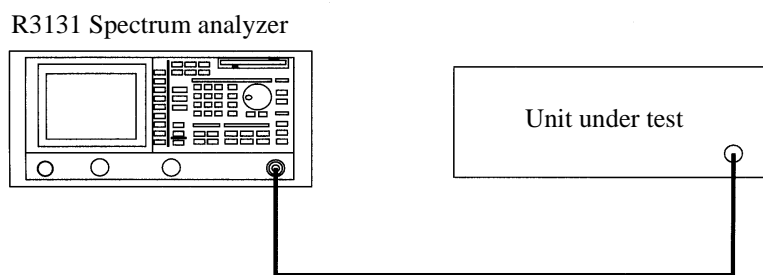

**Figure 2-60 Setup for Measuring the Adjacent Channel Leakage Power**

Power on

2. Turn the power on.

Setting the unit under test

3. Turn on the signal output for the unit under test.

## 2.3 Measurement Examples

### Initialization

This resets the current settings to the factory defaults.

4. Press **SHIFT** and **CONFIG (PRESET)**.  
The default settings have now been reset.

### Setting the measurement conditions

This changes the analyzer settings so that the input signal is displayed more clearly.

5. Press **FREQ, 1, 8, 9, 5, ., 1, 5** and **MHz**.  
A center frequency of 1895.15 MHz is set.
6. Press **SPAN, 3** and **MHz**.  
A frequency span of 3 MHz is set.
7. Press **BW, RBW AUTO/MNL, 1, 0** and **kHz**.  
The RBW is set to 10 kHz.

### Setting the detector mode

8. Press **TRACE, Detector** and **Posi**.  
The trace is set to positive detector mode.

### Setting up the channel spacing

This activates the ACP mode, and then sets the specified bandwidth and channel spacing.

9. Press **POWER MEASURE** and **ACP**.  
The ACP mode is set.
10. Press **Channel Spacing 1, 6, 0, 0** and **kHz**.  
Channel Spacing (adjacent) is set to 600 kHz.
11. Press **Channel Spacing 2 ON/OFF, 9, 0, 0** and **kHz**.  
Channel Spacing (alternate) is set to 900 kHz.
12. Press **Channel Band WD, 1, 9, 2** and **kHz**.  
The specified bandwidth is set to 192 kHz.

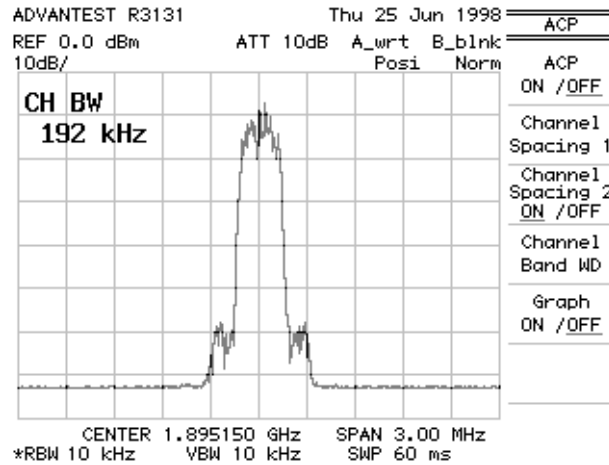

Figure 2-61 Setting the Specified Bandwidth

Performing ACP

This measures the adjacent channel leakage power.

13. Press **ACP ON/OFF**.

Two markers are placed on the frequencies (Channel frequency ± Channel spacing) displayed on the screen, and the ratio between the upper adjacent channel and the lower adjacent channel is displayed on the ACP window.

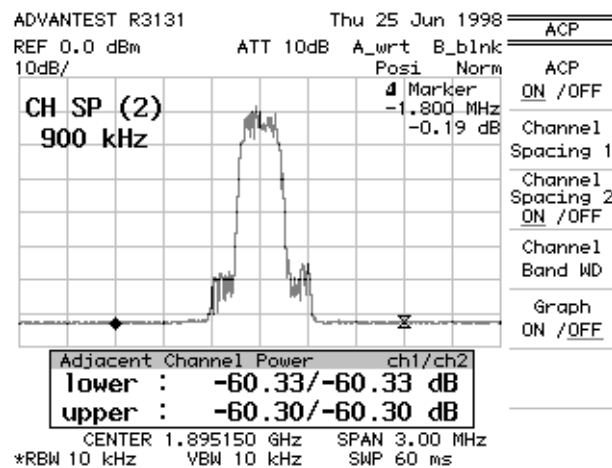

Figure 2-62 Measurement of the Adjacent Channel Power (ACP POINT)

2.3 Measurement Examples

**CAUTION:**

1. Only ACP (adjacent) can be measured when Channel Spacing 2 ON/OFF is turned off.
2. The frequency span is automatically changed to an appropriate value if its value is less than the required one (this incorrect frequency span may have been caused by either the channel spacing or the specified bandwidth). An error message will be displayed if a measurement condition is set incorrectly during the measurement.

**2.3.3.2 Measurements using the ACP GRAPH Method**

Setup

1. Connect the unit under test as shown in Figure 2-63.

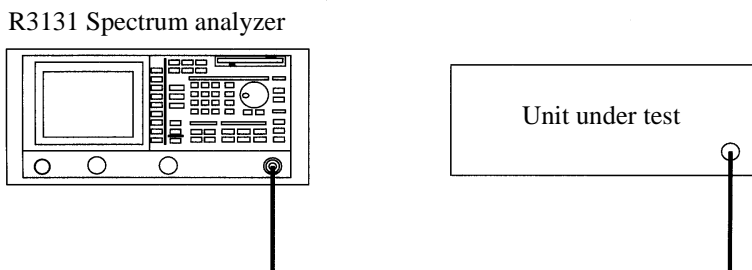

**Figure 2-63 Setup for Measuring the Adjacent Channel Leakage Power**

Power on

2. Turn the power on.

Setting the unit under test

3. Turn on the signal output for the unit under test.

Initialization

This resets the current settings to the factory defaults.

4. Press **SHIFT** and **CONFIG (PRESET)**.  
The default settings have now been reset.

#### Setting the measurement conditions

This changes the analyzer settings so that the input signal is displayed more clearly.

5. Press **FREQ, 1, 8, 9, 5, ., 1, 5** and **MHz**.  
A center frequency of 1895.15 MHz is set.
6. Press **SPAN, 2** and **MHz**.  
A frequency span of 2 MHz is set.
7. Press **BW, RBW AUTO/MNL, 1, 0** and **kHz**.  
The RBW is set to 10 kHz.

#### Setting the detector mode

8. Press **TRACE, Detector** and **Posi**.  
The trace is set to positive detector mode.

#### Setting the specified bandwidth

This sets the adjacent channel leakage mode and specifies the specified bandwidth.

9. Press **POWER MEASURE** and **ACP**.  
The ACP menu is displayed.
10. Press **Channel Band WD, 3, 0, 0** and **kHz**.  
The specified band width is set to 300 kHz.

#### Performing ACP GRAPH

This measures the adjacent channel leakage power.

11. Press **Graph ON/OFF**.  
The fixed delta marker is displayed, and the operation result of the adjacent channel leakage power measurement is displayed as a graph.

2.3 Measurement Examples

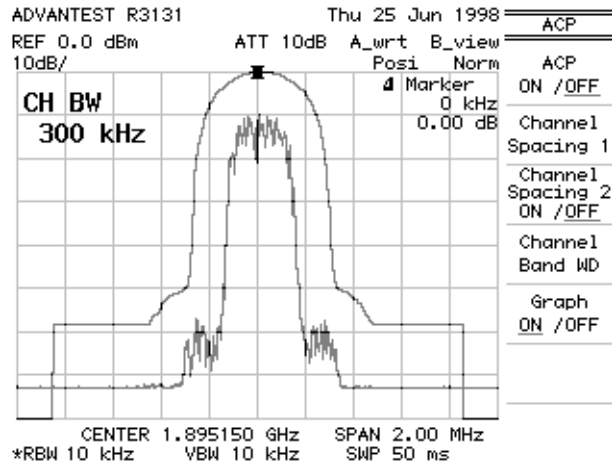

Figure 2-64 Displaying a Graph as a Result of Operation

Moving the marker

This moves the marker to another position along the channel spacing.

13. Press  $\Delta$  MKR.  
The delta marker is displayed.
14. Move the marker to the other adjacent channel (for example, 600 kHz) by turning the data knob. The ratio of each adjacent channel leakage power is displayed in the marker area.

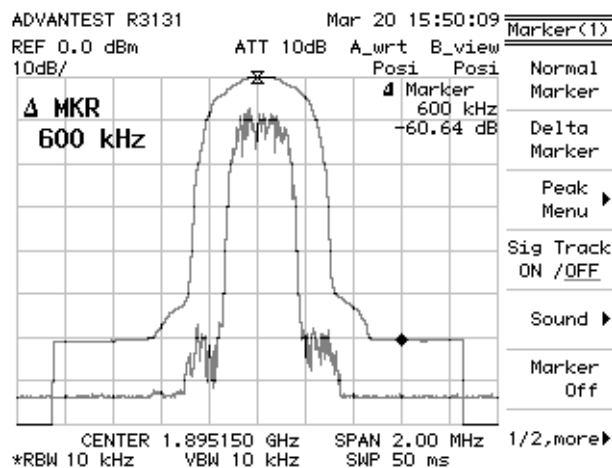

Figure 2-65 Adjacent Channel Leakage Power Measurements (ACP GRAPH)

**NOTE:** This mode does not function if the specified bandwidth is not set or is improperly set.

### 2.3.4 Measuring the VA Ratio

The VA ratio is the ratio between the video signal and the audio signal used in television carriers.

When the audio signal level is too low in relation to the video signal level, bass sound is produced. In the opposite situation, the video signal has interference caused by cross modulation from the audio signal. Therefore, the VA ratio must be kept at a moderate level. The spectrum analyzer provides you with an easy way to adjust this ratio.

#### Measurement conditions:

This example shows how to measure the VA ratio for the first UHF channel(91.25MHz). Use appropriate parameter values to make the measurements shown below.

#### Setup

1. Connect the trunk amplifier as shown in Figure 2-66.

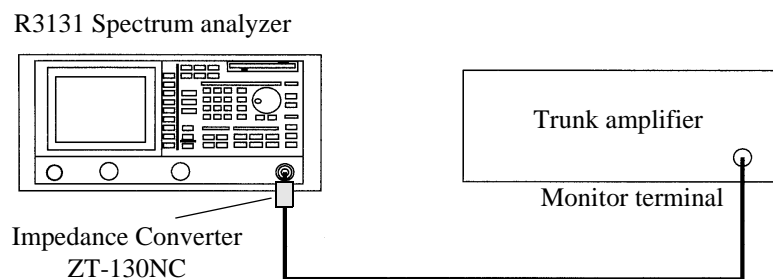

**Figure 2-66 Setup for Measuring the VA Ratio**

#### Power on

2. Turn the power on.

#### Checking the trunk amplifier

3. Activate the output of the trunk amplifier.

#### Initialization

This resets the current settings to the factory defaults.

4. Press **SHIFT** and **CONFIG (PRESET)**.  
The default settings have now been reset.

#### Setting the measurement conditions

This activates the 75  $\Omega$  mode used with an external converter.

5. Press **LEVEL** and **Input 50  $\Omega$ /75  $\Omega$** .



## 2.3 Measurement Examples

This changes the analyzer settings so that the input signal is displayed more clearly.

6. Press **FREQ, 9, 1, ., 2, 5** and **MHz**.  
A center frequency of 91.25 MHz is set.
7. Press **SPAN, 2, 0** and **MHz**.  
A frequency span of 20 MHz is set.
8. Press **LEVEL, Units** and **dB $\mu$ V**.  
The unit is set to dB $\mu$ V.

## Performing the Max Hold

9. Press **TRACE, 1/2\_more**, and **Max Hold**.  
Perform the Max hold function for approximately 1 minute to allow for level fluctuations.

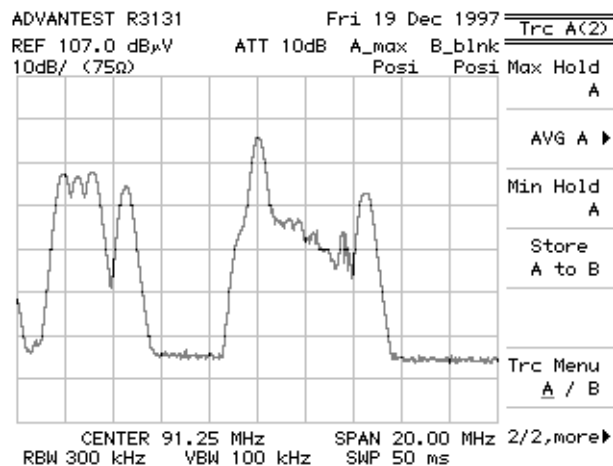

**Figure 2-67 Performing Max Hold**

## Measuring the video carrier level

10. Press **MKR**.  
The marker level previously set is called the video carrier level V (dB $\mu$ V).

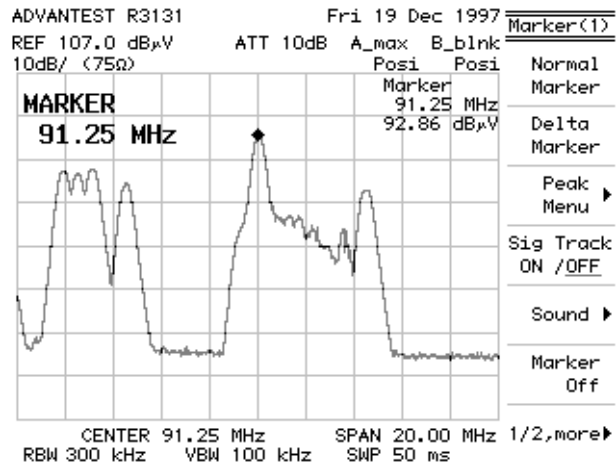

Figure 2-68 Measuring the Video Carrier Level

Measuring the audio carrier level

11. Press **MKR, 9, 5, ,, 7, 5** and **MHz**.

The marker is displayed at 95.75 MHz on the trace.

This marker level is called video carrier level A (dBmV).

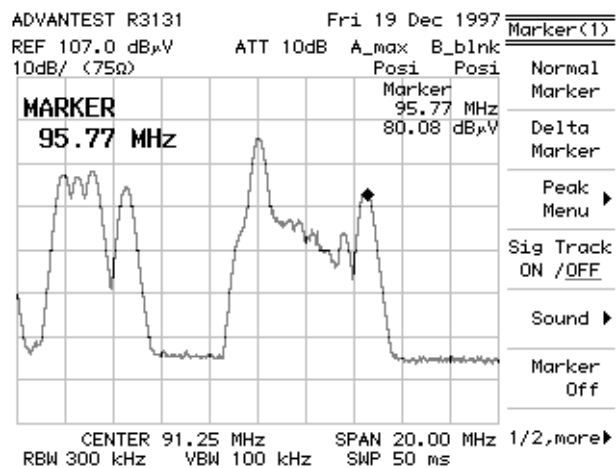

Figure 2-69 Measuring the Audio Carrier Level

12. Calculate the VA ratio using the following formula.

$$\text{VA ratio (dB)} = \text{Video carrier level V (dB}\mu\text{V)} - \text{Audio carrier level A (dB}\mu\text{V)}$$

### 2.3.5 Pass-Fail Judgments

When a marker appears within the level window, the PASS/FAIL judgment result is pass (shown as PASS). The measuring window can be used to make a high speed measurement within a confined area when convenient.

**Measurement conditions:**

This example shows how to make a Pass-Fail judgment for a unit under test outputting a frequency of 30 MHz and a level of -10 dBm.

Use appropriate parameter values to make the measurements shown below.

Setup

1. Connect the unit under test as shown in Figure 2-70.

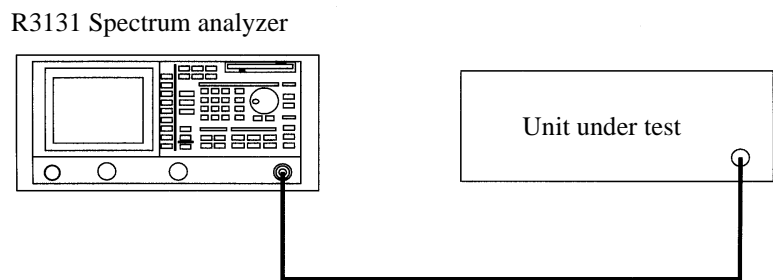

**Figure 2-70 Setup for the Pass-Fail judgment**

Power on

2. Turn the power on.

Setting the unit under test

3. Turn on the signal output for the unit under test.

Initialization

This resets the current settings to the factory defaults.

4. Press **SHIFT** and **CONFIG (PRESET)**.  
The default settings have now been reset.

## Setting the measurement conditions

This changes the analyzer settings so that the input signal is displayed more clearly.

5. Press **FREQ, 3, 0** and **MHz**.  
The center frequency is set to 30 MHz.
6. Press **SPAN, 2, 0** and **MHz**.  
A frequency span of 20 MHz is set.
7. Press **LEVEL, 0** and **GHz (+dBm)**.  
The reference level is set to 0 dBm.

## Pass-Fail judgment

8. Press **PAS/FAIL**.  
The level window is displayed, and a Pass-Fail is judged. The marker is moved to the peak as the sweep repeats, starting from the default search of continuous peak.

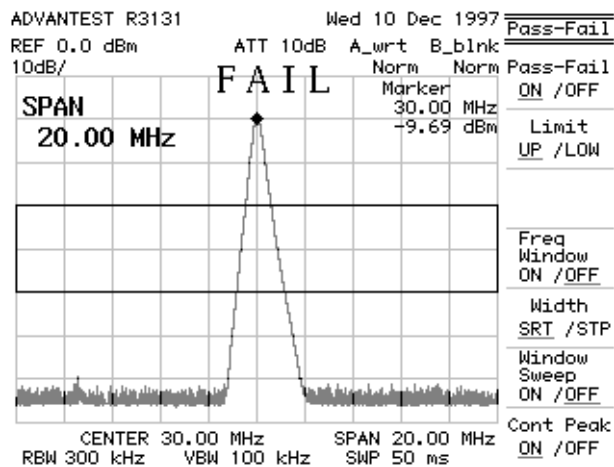

Figure 2-71 Pass-Fail Measurement Screen

9. Press **LimitUP/LOW, 5** and **MHz (-dBm)**.  
The window upper limit setting is turned on and a limit of -5 dBm is set. To turn on the window lower limit, press this key again.

2.3 Measurement Examples

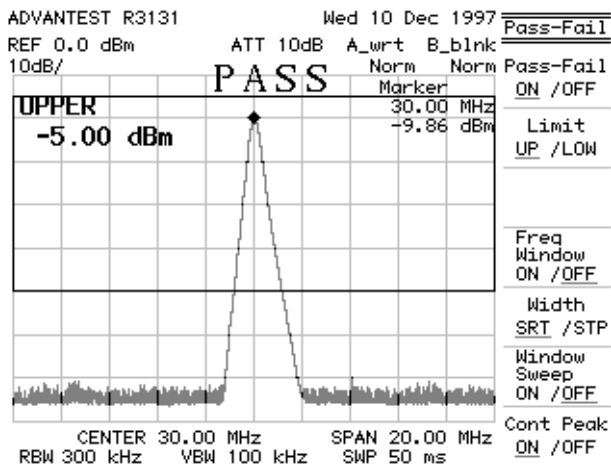

Figure 2-72 Level Window Setting Screen

Setting the measuring window

10. Press **Freq Window ON/OFF**.  
 The measuring window is displayed, and the measuring window position can now be set.
11. Press **2, 7** and **MHz**.  
 The start frequency of the measuring window is activated and set to 27 MHz.
12. Press **Width SRT/STP, 3, 3** and **MHz**.  
 STP is selected, the stop frequency of the measuring window is activated and the stop frequency is set to 33 MHz.

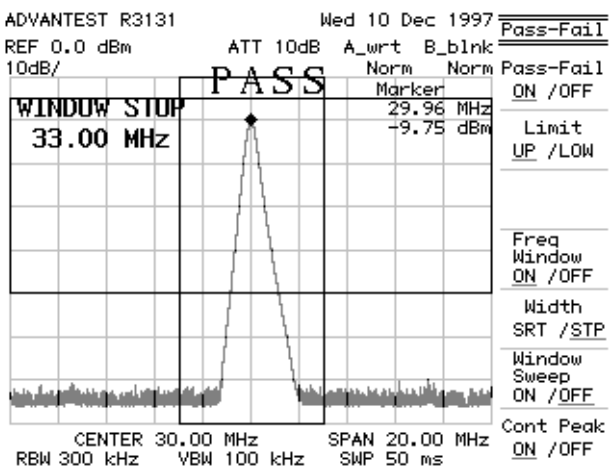

Figure 2-73 Measuring Window Screen

Performing the window sweep

13. Press **Window Sweep ON/OFF**.

A window sweep is performed. The sweep is completed more quickly because only the area within the measuring window is swept.

### 2.3.6 Harmonic Distortion Measurements

This section describes a method for quickly measuring harmonic distortion using the step keys.

**Measurement conditions:**

This example shows how to measure harmonic distortion for a unit outputting a frequency of 800 MHz, a level of -30 dBm and a non-modulated signal.

Use appropriate parameter values to make the measurements shown below.

Setup

1. Connect the unit under test as shown in Figure 2-74.

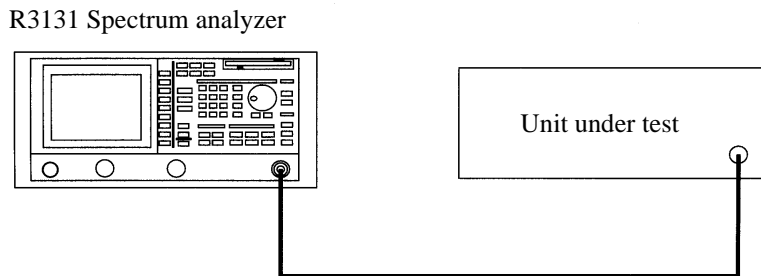

Figure 2-74 Setup for Measuring the Harmonic Distortion

Power on

2. Turn the power on.

Setting the unit under test

3. Turn on the signal output for the unit under test.

Initialization

This resets the current settings to the factory defaults.

4. Press **SHIFT** and **CONFIG (PRESET)**.  
The default settings have now been reset.

## Setting the measurement conditions

This changes the analyzer settings so that the input signal is displayed more clearly.

5. Press **FREQ, 8, 0, 0** and **MHz**.  
The center frequency is set to 800 MHz.
6. Press **SPAN, 1, 0, 0** and **kHz**.  
A frequency span of 100 kHz is set.
7. Press **LEVEL, 3, 0** and **MHz (-dBm)**.  
The reference level is set to -30 dBm.

## Measuring the fundamental wave

8. Press **PK SRCH**.  
The marker is displayed on the peak. The level displayed in the marker area is recorded as the fundamental wave level.

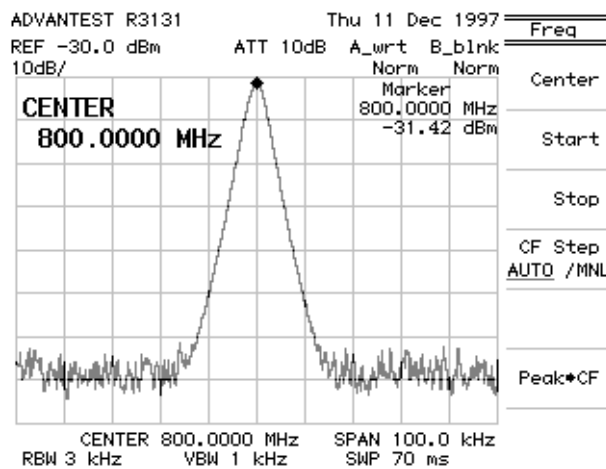

Figure 2-75 Measuring the Fundamental Wave

## Measuring the harmonics

9. Press **MKR →, 1/2\_more** and **MKR → CF Step**.  
Sets the marker frequency as the step size of the center frequency.
10. Press **FREQ**.  
Allows you to set the center frequency.
11. Press the (**▲**) step key.  
A higher harmonic wave is displayed.



2.3 Measurement Examples

12. Change the reference level so that you can easily observe the trace by pressing **Ref Level** as needed.

13. Press **PK SRCH**.

The marker is displayed on the peak of the higher harmonic wave. The level displayed in the marker area is recorded as the higher harmonic wave level. The harmonic distortion is the difference between the higher harmonic wave and the fundamental wave levels.

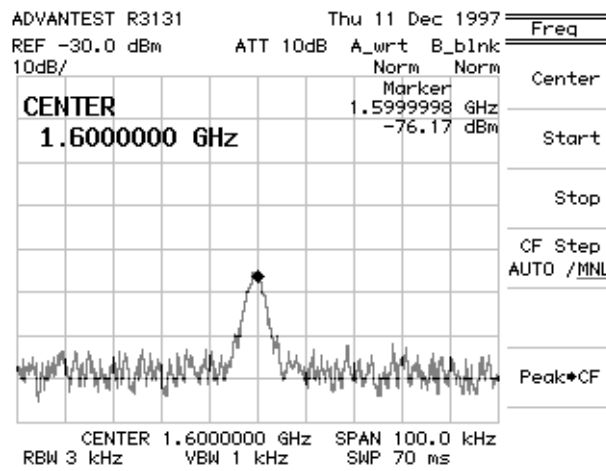

Figure 2-76 Measuring the Harmonic Distortion

### 2.3.7 Measurements Using TG (Option 74)

Band-pass filter characteristics with a passband of approximately 270 MHz, are measured (both the insertion loss and bandwidth are measured).

---

**CAUTION:** *UNCAL messages, displayed when measuring frequency characteristics using this function, do not affect measurement results.*

---

#### Setup

1. Connect the unit under test as shown in Figure 2-77.

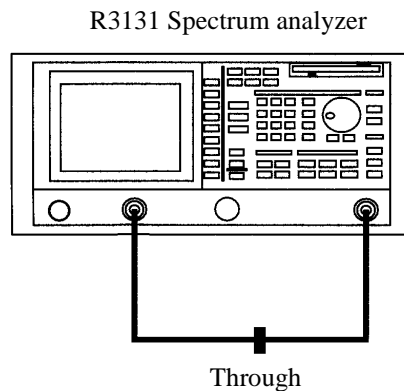

**Figure 2-77 Setup for TG Measurements**

#### Power on

2. Turn the power on.

#### Initialization

This resets the current settings to the factory defaults.

3. Press **SHIFT** and **CONFIG (PRESET)**.  
The default settings have now been reset.

#### Setting the measurement conditions

This changes the analyzer settings so that the input signal is displayed more clearly.

4. Press **FREQ, 2, 7, 0** and **MHz**.  
A center frequency of 270 MHz is set.
5. Press **SPAN, 1, 0, 0** and **MHz**.  
A frequency span of 100 MHz is set.

2.3 Measurement Examples

6. Press **LEVEL, 0** and **GHz (+dBm)**.  
The reference level is set to 0 dBm.
7. Press **LEVEL, dB/div** and **2dB/div**.  
The amplitude scale (vertical axis) graduation is set to 2dB/div.
8. Press **TG, TG Level, 0** and **GHz(+dBm)**.  
The output level of the tracking generator is set to 0 dBm.
9. Press **TG** and **Execute Normalize**.  
The normalization calibration is performed.

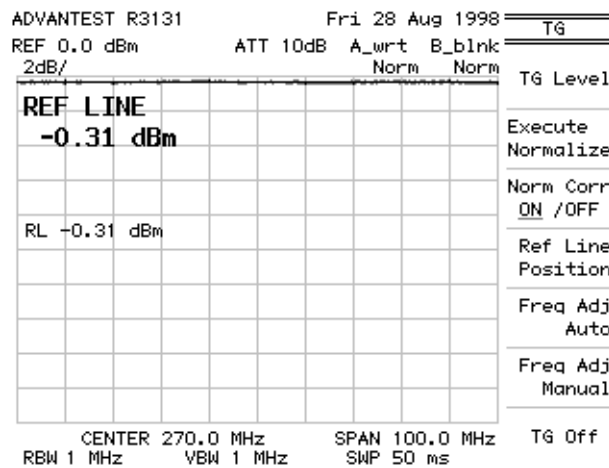

Figure 2-78 Measurement Screen after a Normalization Calibration

---

**Note:** *When you change center frequency, frequency span, reference level, level indication scale and so on after executing a normalization calibration, subsequent normalization results will be incorrect. Be sure to re-execute the normalization operation if you change any of these settings.*

---

Connecting the unit under test

10. Connect the unit under test between TG OUTPUT and RF INPUT1 as shown in Figure 2-79.

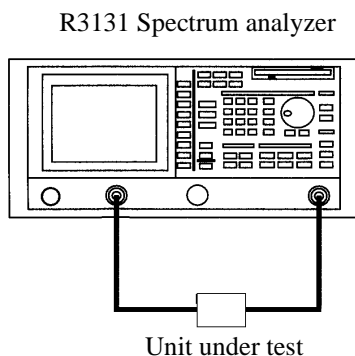

**Figure 2-79 Connecting the Unit under Test**

Setting the sweep time

Set a sweep time long enough to not affect the trace.  
In this step, set it to 50 ms.

11. Press **SWEEP**, **SWP Time AUTO/MNL**, **5, 0** and **kHz (msec)**.

---

**CAUTION:** *If the input signal level changes abruptly, the IF filter in this instrument will not respond to this change. If this occurs, make the sweep slow enough or the span narrow enough until the characteristics and displayed trace are stabilized.*

---

Measuring the insertion loss

12. Press **PK SRCH**.  
The current marker level is the insertion loss of the filter.

---

**CAUTION:** *When the loss of the unit under test is high, you can take measurement by use of an amplifier to keep the dynamic range at a moderate level.*

---

2.3 Measurement Examples

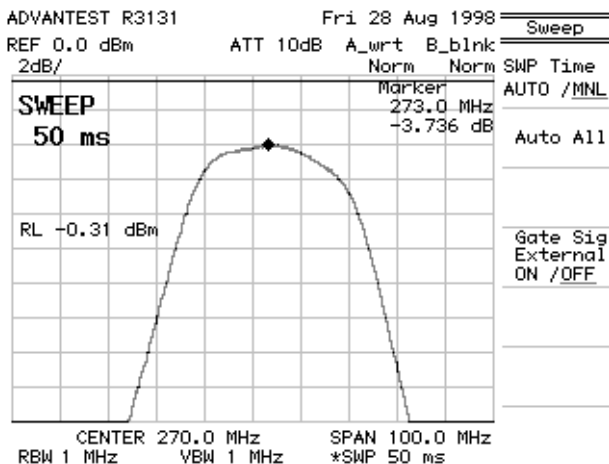

Figure 2-80 Insertion Loss Measurement Screen

Measuring a Bandwidth of 3 dB

This measurement is taken under the same conditions as the insertion loss..

- 13. Press **MEAS, XdB Down, 3, GHz(+dBm)** and **XdB Down**.  
 Two markers are displayed on both sides 3 dB down from peak.  
 The filter bandwidth of 3 dB is displayed in the level field of the marker frequency

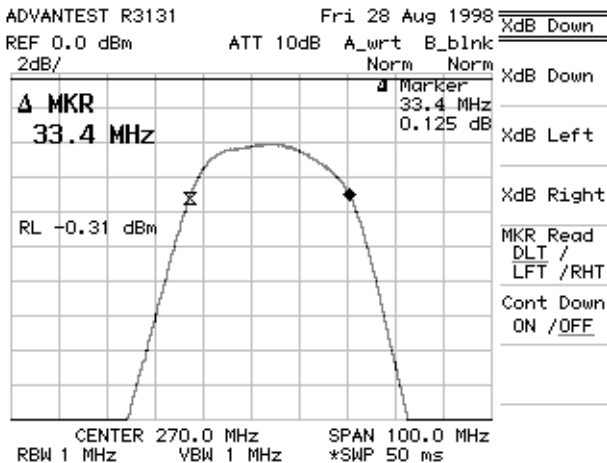

Figure 2-81 3-dB Bandwidth Measurement Screen

## 2.4 Other Functions

### 2.4.1 Using Floppy Disks

The spectrum analyzer is equipped with a 3.5-inch floppy disk drive. You can save text data (settings, trace data and correction data) and BMP data (trace displays) to floppy disks using this drive. The data on floppy disks can be accessed from personal computers.

The following floppy disk formats can be used: 3.5-inch DD 720KB, HD 1.2 MB and 1.44MB (MS-DOS format compatible).

#### (1) Write-protecting the Floppy Disk

This prevents you from accidentally initializing or overwriting a floppy containing previously saved data.

The write protect tab is located in the lower right hand corner of the floppy disk.

To write-protect a disk, slide the tab downwards to the other end (a hole appears).

To disable write protection, slide the tab upwards to the original position until the hole is no longer visible.

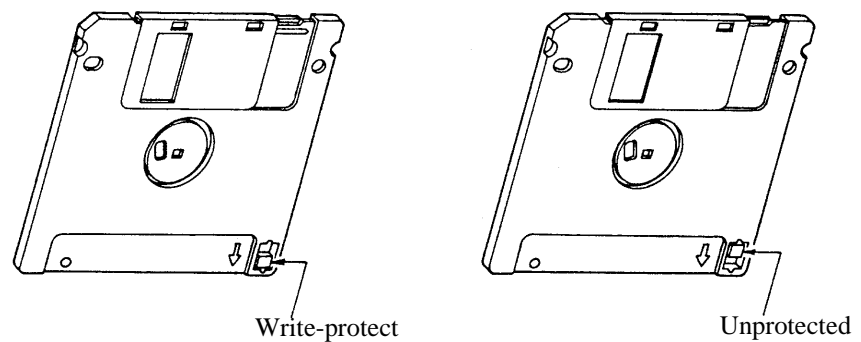

**Figure 2-82 Floppy Disk Write Protection**

## 2.4 Other Functions

### (2) Inserting Floppy Disks

1. Insert a floppy disk into the floppy disk drive with the label surface up.

### (3) Removing Floppy Disks

1. Verify that the lamp on the drive is not lit and then remove the disk.

---

**CAUTION:** *Do not remove the floppy disk while the drive lamp is lit, since this indicates that floppy disk is being accessed. If you remove the disk while the disk is being accessed, you may damage the data contained on the disk.*

---

2. Press the eject button.  
The floppy disk is ejected from the drive.
3. Remove the disk from the drive.

### (4) Initializing Floppy Disks

To prepare a floppy disk for use with the spectrum analyzer, use the following procedure.

---

**CAUTION:** *Only HD floppy disks can be formatted on this spectrum analyzer. Do not try to initialize DD floppy disks.*

---

1. Make sure the floppy disk is not write protected.

---

**CAUTION:** *When you format a floppy disk, all data on the floppy is erased. If you wish to save any data currently on the disk, backup the data first.*

---

2. Insert the floppy disk into the floppy disk drive.
3. Press **CONFIG** and **F.Disk Config**.  
The F.Disk menu appears.

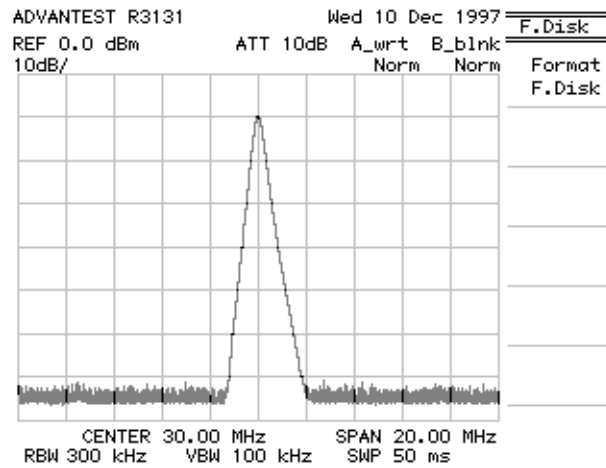

**Figure 2-83** Screen for the F.Disk Menu

4. Press ***Format F.Disk***.  
The floppy disk is formatted with the MS-DOS 1.44MB format.  
While the floppy disk is being formatted, the access lamp turns on. This procedure takes approximately one minute.
5. Press **RETURN**.  
The Config(1) menu returns to the screen.



2.4 Other Functions

2.4.2 Saving or Recalling Data

(1) Saving Data

Data which can be saved to internal memory or to a floppy disk include the following:

- measurement conditions
- 501-point trace A (or B), or trace data for both A and B

---

*NOTE: Trace data can be saved in Write or View mode only.*

---

- The level values for trace data (Floppy disk only)
- Antenna correction data (Floppy disk only)
- Normalize data (Available only when equipped with Option 74)

To save data, use the following procedure:

1. Press **SHIFT** and **RECALL(SAVE)**.  
The Save menu and the file list are displayed.
2. Press *Device RAM/FD*.  
This selects either RAM (internal memory) or FD (floppy disk) as the file destination.

---

*NOTE: FD cannot be selected if a floppy disk is not present in the floppy disk drive.*

---

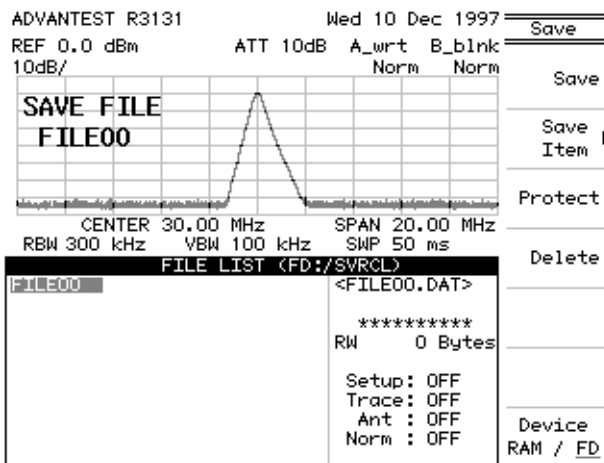

Figure 2-84 Screen Display Showing Floppy Disk as the Destination

Selecting the data to be saved

3. Press **Save Item**.

The Save Item menu is displayed.

4. Select the data you want to save from the Save Item menu.

**Setup ON/OFF** : current settings

**Trace ON/OFF** : 501-point trace A (or B), or data for both trace A and B

**Ant Corr ON/OFF** : correction data

**Norm Corr ON/OFF**: Normalization calibration data (available only when equipped with Option 74).

**Trc Lvl ON/OFF** : level values for the trace data (available when trace data is being saved)

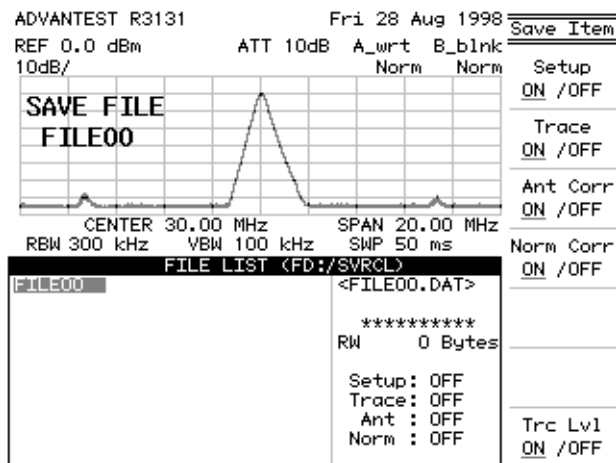

Figure 2-85 Display for Selecting the Data to be Saved

5. Press **RETURN**.

Returns to the Save menu.

Choosing the file name

6. Select the file name you want to save your data under using the data knob or step keys. When the file is being saved to RAM, the file names appear as REG01 or above. For floppy disks, the file names start from FILE00 and continue with 01, 02 etc.

2.4 Other Functions

Saving data

7. Press **Save**.  
The data has now been saved.

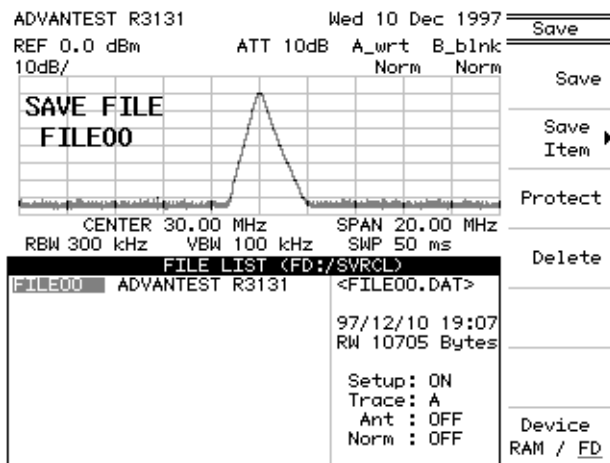

Figure 2-86 Display after Data has been Saved to a File

(2) Protecting Data

To prevent someone from accidentally initializing or overwriting data, you can use the file protection feature.

To protect files using this feature, use the following procedure:

Selecting the file source

1. Press **SHIFT** and **RECALL(SAVE)**.  
The Save menu and file list are displayed.
2. Press **Device RAM/FD**.  
Select either RAM (internal memory) or FD (floppy disk).

Choosing the file

3. Select the file from the file list using the step keys and the data knob.

Protecting the file

4. Press **Protect**.

The selected file changes from RW (read or write) to RO (read only), indicating that data protection has been enabled.

Pressing **Protect** again disables protection, and the setting changes back to RW.

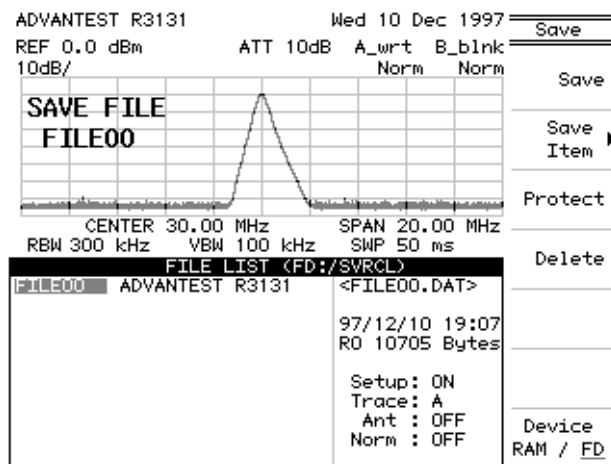

Figure 2-87 Screen Display Showing File Protection Enabled

(3) Loading Data

The saved conditions and trace data can be used for measurements. Use the following procedure to access this data.

Selecting the file source

1. Press **RECALL**.

The Recall menu and file list are displayed.

2. Press **Device RAM/FD**.

Select either RAM (internal memory) or FD (floppy disk). For this example, FD is selected.

Selecting the file

3. Select the file from the file list using the step keys and the data knob.

2.4 Other Functions

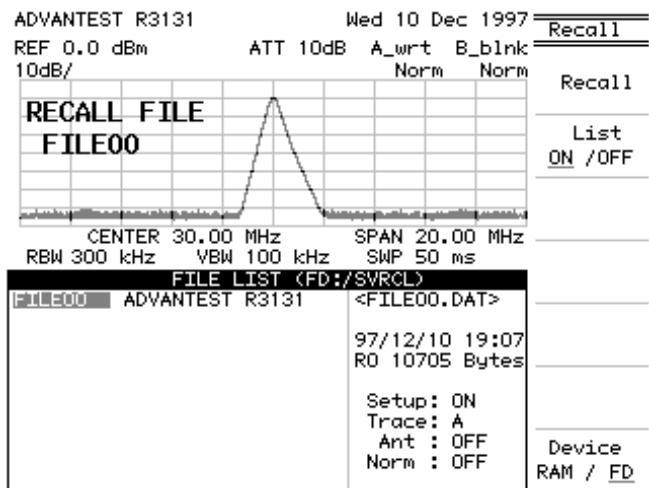

Figure 2-88 Screen Display Showing the Selected File

Recalling the data

4. Press *Recall*.

The data from the selected file is loaded into the spectrum analyzer.

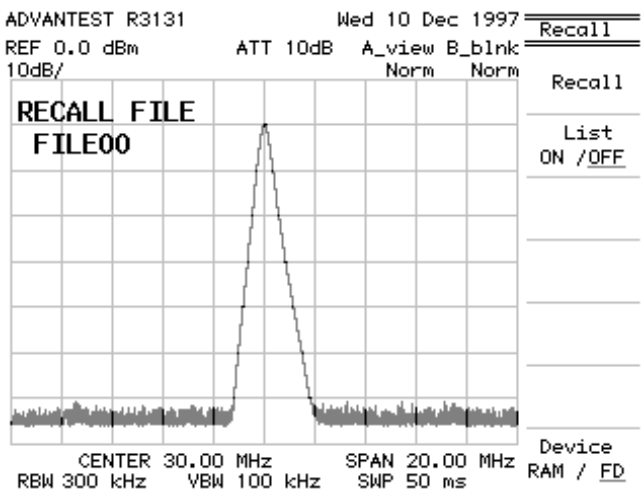

Figure 2-89 Screen Display showing Recalled Data

## (4) Deleting the Data

Data which has been saved to internal memory or to a floppy disk can be deleted. To delete data files, use the following procedure.

## Selecting the file source

1. Press **SHIFT** and **RECALL(SAVE)**.  
The Save menu and file list are displayed.
2. Press **Device RAM/FD**.  
Select either RAM (internal memory) or FD (floppy disk). For this example, select FD.

## Choosing the file

3. Select the file from the file list using the step keys and the data knob.

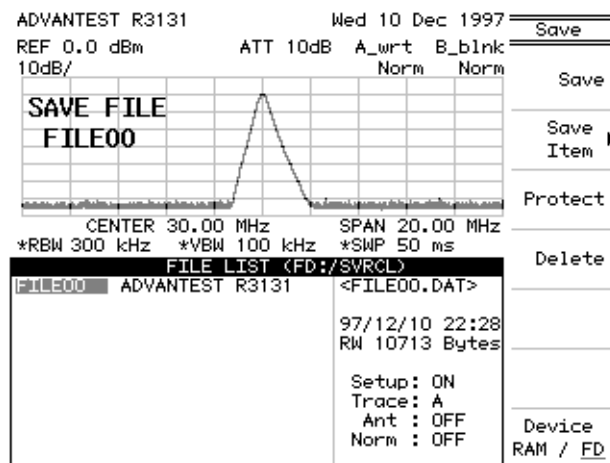

Figure 2-90 Screen as Shown when Deleting a File

2.4 Other Functions

Deleting the data

4. Press *Delete*.  
The data in the selected file is deleted.

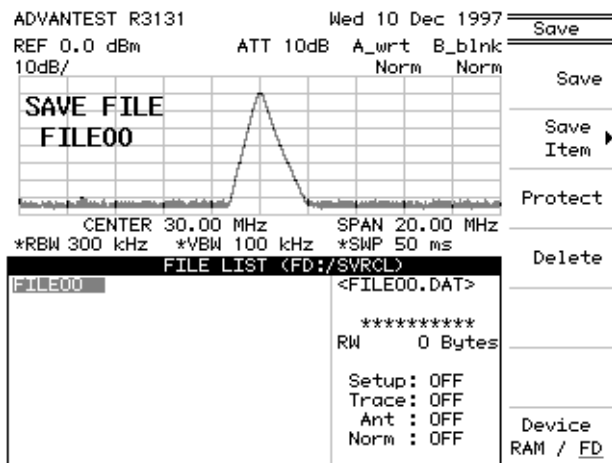

Figure 2-91 Screen as Shown after Deleting File Data

### 2.4.3 Outputting Screen Data

You can save screen data to a floppy disk, or print it out when needed. When outputting screen data, you can use any key except the **COPY** key. You can resume using this key after the data has been output.

#### (1) Saving to a Floppy Disk

Screen data is saved in BMP (bitmap file) format.

Inserting a floppy disk

1. Insert a floppy disk into the floppy drive.

Selecting the destination

2. Press **CONFIG** and *Copy Dev.*  
The Copy Dev menu used for selecting the screen data destination appears.
3. Press *F.Disk*.  
Floppy disk is chosen as the destination for the screen data.

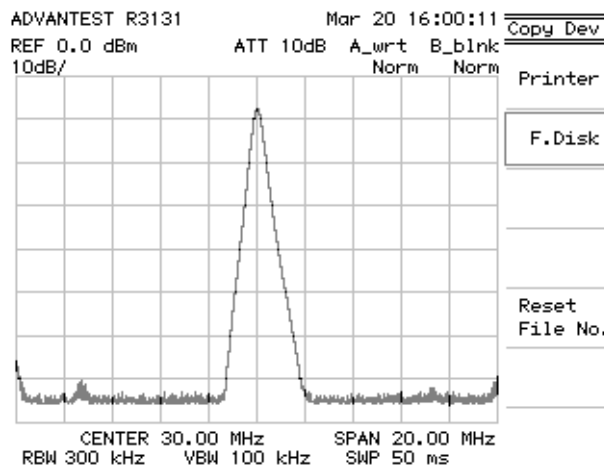

Figure 2-92 Screen Display Showing Floppy Disk as the Specified Destination

4. Press **RETURN**.  
Return to the Config (1) menu.
5. Press **COPY** after displaying the screen data to be saved. The access lamp remains lit while the screen data is being saved to disk, and goes out when the file has been saved.



## 2.4 Other Functions

---

**CAUTION:** *Do not remove the floppy disk while the access lamp is lit, since the floppy disk is being accessed. If you remove the disk while the disk is being accessed, you may damage the data on the disk.*

---

## (2) Printing screen data

You can send data to a Centronix compatible printer attached to the parallel interface. The spectrum analyzer can only output data in monochrome or gray scale, even if it is connected to a color printer.

---

**NOTE:** *The output resolution of the spectrum analyzer is 180 dpi. A printer that uses a resolution which is not a multiple of 180 dpi may print with streaks.*

---

Compatible printers use ESC/P, ESC/P-Raster or HP PCL. Compatible printers use ESC/P, ESC/P-Raster or HP PCL (there may be a certain restrictions depending on the printers used). Suggested printers are listed in Table 2-1.

**Table 2-1 Recommended Compatible Printers**

Manufacturer	Model
Epson	MJ-700V2C, MJ-830C, MJ-930C, PM-750C PM-2000C
Hewlett Packard	DeskJet 505J, DeskJet 694C, LaserJet 5L
Cannon	BJC-410J, BJC-420J, BJC-600J
Brother	HJ-400

## Connecting the printer

1. Connect the printer to the **PARALLEL** connector on the rear panel using the IBM-PC compatible cable provided.

---

**CAUTION:** *Only connect the cable after turning off both the spectrum analyzer and printer power or you may damage the analyzer.*

---

## Output destination setup

2. Press **CONFIG** and *Copy Dev.*  
The Copy Dev menu used for selecting the screen data destination is displayed.
3. Press *Printer*.  
The attached printer is selected as the destination for the screen data.

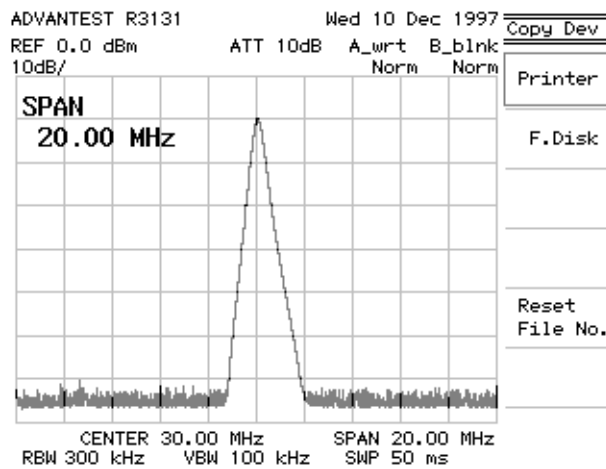

**Figure 2-93 Printer Specification Screen Display**

4. Press **RETURN**.  
Returns to the Config(1) menu.

## Control codes and print mode setup

5. Press *Printer Config*.  
The Printer menu used to set the control codes and print mode appears.

2.4 Other Functions

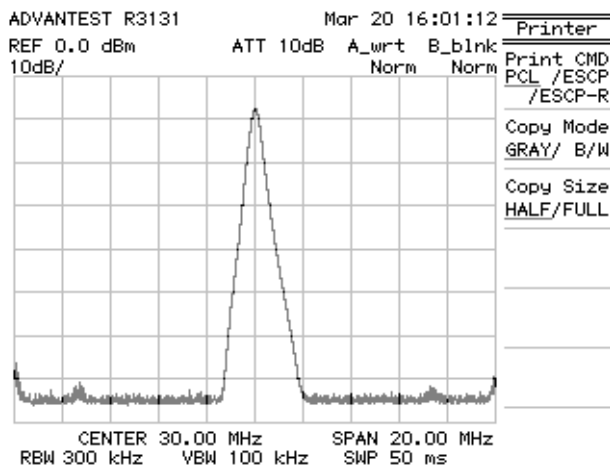

Figure 2-94 Printer Setup Screen

6. Press **Print CMD PCL/ESCP/ESCP-R**.  
This toggles the printer control code between PCL, ESCP and ESCP-R. The spectrum analyzer can use either ESCP (Epson Standard Cord for Printer), ESCP-R (Epson Standard Cord for Printer Raster mode) or HP PCL (Hewlett Packard Printer Command Language). Select as appropriate.
7. Press **Copy Mode GRAY/B/W**.  
Toggles the copy mode between gray scale (four levels) and Black & White. Select as desired.
8. Press **Copy Size HALF/FULL**.  
Selects the size used for the printed copy. HALF is approximately the same size as the screen display while FULL prints the screen horizontally on A4 paper. Select as desired.
9. Press **RETURN**.  
Returns to the Config(1) menu.

Printing

10. Display the screen you wish to print out, and then press **COPY**.  
The screen data is sent to the printer. The time required for the data to print out depends on the mode and printer used.

---

**NOTE:** Press **SHIFT**, **COPY** and **Abort** to abort printing after Copy has been pressed.

---

### 2.4.4 Setting Date and Time

This section explains how to set the date and time for the spectrum analyzer. In the following example, a time and date of 1:35 pm Dec 10 1997 is set.

Setting the date and time

1. Press **CONFIG** and *Time/Date*.  
The Time/Date menu appears.

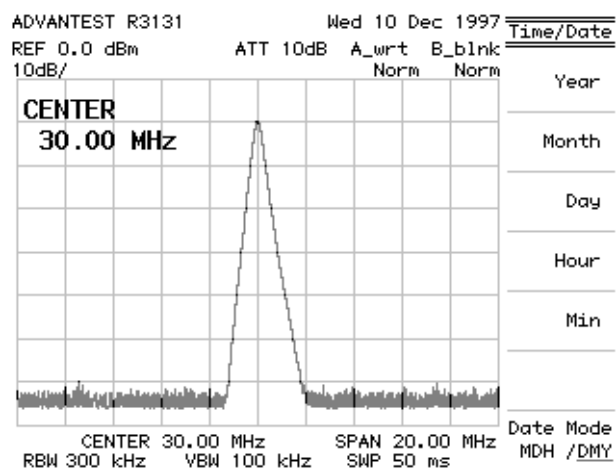

Figure 2-95 Time/Date Menu

2. Press *Year, 1, 9, 9, 7* and **Hz(ENTER)**.  
The year is set to 1997.
3. Press *Month 1, 2* and **Hz(ENTER)**.  
The month is set to December.
4. Press *Day, 1, 0* and **Hz(ENTER)**.  
The date is set to the 10th.

2.4 Other Functions

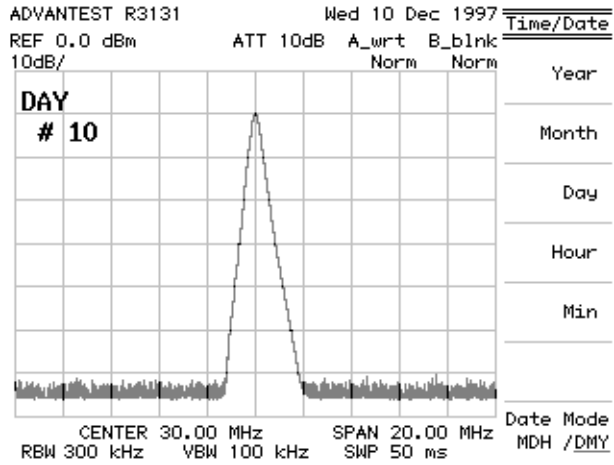

Figure 2-96 Screen Showing the Date being Set

Setting the time

5. Press *Hour*, **1**, **3** and **Hz(ENTER)**  
 The time is set to 1pm.
6. Press *Min*, **3**, **5** and **Hz(ENTER)**.  
 The time is set to 1:35pm.

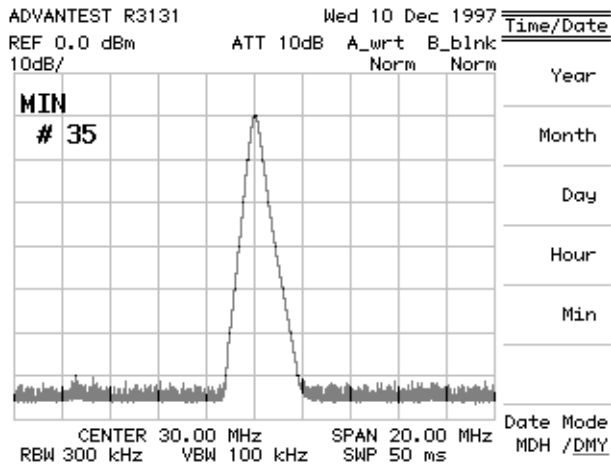

Figure 2-97 Screen Showing the Hour being Set

Setting the date display format

- 7.** Press ***Date Mode MDH/DMY***.  
Toggles between MDH and DMY format each time you press the key.  
MDH: Displays Month/Day/Hour.  
For example: Dec 10 13:35:00  
DMY: Displays Day of the week, Date/Month/Year.  
For example: Wed 10 Dec 1997
- 8.** Press **RETURN**.  
Returns to the Config(1) menu.



## 3 REFERENCE

### 3.1 Menu Index

<u>Operation Key</u>	<u>Menu Map</u>	<u>Functional Description</u>
% AM Meas ON/OFF .....	3-11 .....	3-34
() ‘ , ; : .....	3-9 .....	3-24
+ - < > = . .....	3-9 .....	3-24
/ ? \ [ ] ~ .....	3-9 .....	3-24
@ # \$ % & * .....	3-9 .....	3-24
1 dB/div .....	3-10 .....	3-30
10dB/div .....	3-10 .....	3-30
2 dB/div .....	3-10 .....	3-30
3rd Order Meas .....	3-11 .....	3-34
5 dB/div .....	3-10 .....	3-30
A B C D E F .....	3-9 .....	3-24
Abort (SHIFT, COPY).....	3-7 .....	3-21
ACP .....	3-13 .....	3-43
ACP ON/OFF .....	3-13 .....	3-43
Address .....	3-8 .....	3-19
AMPTD MAG .....	3-7 .....	3-18
Ant Corr ON/OFF .....	3-14 .....	3-47
ATT AUTO/MNL .....	3-10 .....	3-30
Auto All .....	3-7, 3-15 .....	3-17, 3-51
AUTO TUNE .....	3-7 .....	3-16
Average Power .....	3-13 .....	3-42
AVG A (B) .....	3-15 .....	3-54
AVG A (B) CONT/SGL .....	3-15 .....	3-55
AVG A (B) ON/OFF .....	3-15 .....	3-54
AVG A (B) PSE/CONT .....	3-15 .....	3-54
Baud Rate .....	3-8 .....	3-20
BBA9106 .....	3-10 .....	3-26
Blank A (B) .....	3-15 .....	3-54
BW .....	3-7 .....	3-17
CAL (SHIFT, 7) .....	3-7 .....	3-18
Cal All .....	3-7 .....	3-18
Cal Corr ON/OFF .....	3-7 .....	3-18
Cal Sig Level ON/OFF .....	3-7 .....	3-18
Carrier Power .....	3-13 .....	3-42
Center .....	3-10 .....	3-28
CF Step AUTO/MNL .....	3-10 .....	3-28
CH BW POS/WD .....	3-13 .....	3-42
CH BW SRT/STP .....	3-13 .....	3-42
CH Power ON/OFF .....	3-13 .....	3-42
Change Title .....	3-9 .....	3-24
Channel Band WD .....	3-13 .....	3-43



## 3.1 Menu Index

<u>Operation Key</u>	<u>Menu Map</u>	<u>Functional Description</u>
Channel Power .....	3-13 .....	3-42
Channel Spacing 1 .....	3-13 .....	3-43
Channel Spacing 2 ON/OFF .....	3-13 .....	3-43
Clear .....	3-9 .....	3-24
Clear Table .....	3-10 .....	3-27
CONFIG .....	3-8 .....	3-19
Cont Down ON/OFF .....	3-11 .....	3-34
Cont Peak ON/OFF .....	3-11, 3-12 .....	3-35, 3-40
COPY .....	3-8 .....	3-21
Copy Dev .....	3-8 .....	3-19
Copy Mode GRAY/ B/W .....	3-8 .....	3-19
Corr Mode ANT/LVL .....	3-10 .....	3-26
Copy Size HALF/FULL .....	3-8 .....	3-19
Corr Off .....	3-10 .....	3-27
COUNTER .....	3-9 .....	3-22
Counter Off .....	3-9 .....	3-22
Date Mode MDH/DMY .....	3-8 .....	3-20
Day .....	3-8 .....	3-20
dB/div .....	3-10 .....	3-30
dBc/Hz .....	3-11 .....	3-33
dBm .....	3-10 .....	3-30
dBm/Hz .....	3-11 .....	3-33
dBmV .....	3-10 .....	3-30
dB $\mu$ V .....	3-10 .....	3-30
dB $\mu$ V/ $\sqrt{\text{Hz}}$ .....	3-11 .....	3-33
Default Config .....	3-8 .....	3-20
Delete .....	3-14 .....	3-47
Delta $\rightarrow$ CF .....	3-12 .....	3-39
Delta $\rightarrow$ CF Step .....	3-12 .....	3-39
Delta $\rightarrow$ MKR Step .....	3-12 .....	3-39
Delta $\rightarrow$ Span .....	3-12 .....	3-39
Delta Marker .....	3-11 .....	3-35
Detector .....	3-15 .....	3-54
Detector Mode .....	3-10 .....	3-26
Device RAM/FD .....	3-13, 3-14 .....	3-45, 3-47
DISPLAY .....	3-9 .....	3-23
Display Line ON/OFF .....	3-9 .....	3-23
Display ON/OFF .....	3-8 .....	3-19
Each Item .....	3-7 .....	3-18
Edit Done .....	3-9 .....	3-24
EMC (SHIFT, 1) .....	3-10 .....	3-26
EMCO3142 .....	3-10 .....	3-26
Execute Self Test .....	3-14 .....	3-48
Exit .....	3-14 .....	3-48
Ext .....	3-15 .....	3-56
F. Disk .....	3-8 .....	3-19

<u>Operation Key</u>	<u>Menu Map</u>	<u>Functional Description</u>
F. Disk Config .....	3-8 .....	3-19
Field .....	3-10 .....	3-26
Fixed MKR ON/OFF .....	3-11 .....	3-37
Format F. Disk .....	3-8 .....	3-19
Free Run .....	3-15 .....	3-56
FREQ .....	3-10 .....	3-28
Freq Adj Auto .....	3-15 .....	3-52
Freq Adj Manual .....	3-15 .....	3-53
Freq Corr ON/OFF .....	3-7 .....	3-18
Freq Window ON/OFF .....	3-12 .....	3-40
Full Span .....	3-14 .....	3-50
G H I J K L .....	3-9 .....	3-24
Gate Sig External ON/OFF .....	3-15 .....	3-51
GPIB .....	3-8 .....	3-19
Graph ON/OFF .....	3-13 .....	3-43
HOLD (SHIFT).....	3-10 .....	3-29
Hour .....	3-8 .....	3-20
IF Step Amp .....	3-7 .....	3-18
Input 50 $\Omega$ /75 $\Omega$ .....	3-10 .....	3-31
Inverse .....	3-9 .....	3-25
Last Span .....	3-14 .....	3-50
Length 7/8 .....	3-8 .....	3-20
LEVEL .....	3-10 .....	3-30
Limit UP/LOW .....	3-12 .....	3-40
Line .....	3-15.....	3-56
Linear .....	3-10 .....	3-30
List ON/OFF .....	3-13 .....	3-45
LOCAL .....	3-11 .....	3-32
Log Linear .....	3-7 .....	3-18
M N O P Q R .....	3-9 .....	3-24
Marker Couple ON/OFF .....	3-9, 3-11 .....	3-23, 3-37
Marker Off .....	3-11 .....	3-36
Max Hold A (B) .....	3-15 .....	3-54
MEAS .....	3-11 .....	3-33
Meas Window .....	3-9 .....	3-23
Min .....	3-8 .....	3-20
Min Hold A (B) .....	3-15 .....	3-55
Min Peak .....	3-11 .....	3-35
MKR .....	3-11 .....	3-35
MKR $\rightarrow$ .....	3-12 .....	3-38
MKR $\rightarrow$ CF .....	3-12.....	3-38, 3-39
MKR $\rightarrow$ CF Step .....	3-12 .....	3-38, 3-39
MKR $\rightarrow$ MKR Step .....	3-12 .....	3-38, 3-39
MKR $\rightarrow$ Ref .....	3-12 .....	3-38, 3-39
MKR Pause Time .....	3-10, 3-11 .....	3-27, 3-36
MKR Read DLT/LFT/RHT .....	3-11 .....	3-33

## 3.1 Menu Index

<u>Operation Key</u>	<u>Menu Map</u>	<u>Functional Description</u>
MKR Step AUTO/MNL .....	3-11 .....	3-37
MKR Trace .....	3-12 .....	3-38, 3-39
Month .....	3-8 .....	3-20
Nega .....	3-15 .....	3-54
Next Page .....	3-10 .....	3-26
Next Peak .....	3-11 .....	3-35
Next Peak Left .....	3-11 .....	3-35
Next Peak Right .....	3-11 .....	3-35
Noise/Hz .....	3-11 .....	3-33
Noise/Hz Off .....	3-11 .....	3-33
Norm Corr ON/OFF .....	3-14, 3-15 .....	3-47, 3-52
Normal .....	3-10, 3-15 .....	3-26, 3-54
Normal Marker .....	3-11 .....	3-35
OBW .....	3-13 .....	3-42
OBW % .....	3-13 .....	3-43
OBW ON/OFF .....	3-13 .....	3-43
Parity NONE/ODD/EVEN .....	3-8 .....	3-20
PAS/FAIL .....	3-12 .....	3-40
Pass-Fail ON/OFF .....	3-12 .....	3-40
PBW .....	3-7 .....	3-18
Peak .....	3-10 .....	3-26
Peak → CF .....	3-10, 3-12 .....	3-28, 3-38, 3-39
Peak → Ref .....	3-12 .....	3-38, 3-39
Peak Delta Y .....	3-11 .....	3-35
Peak Max-Min .....	3-11 .....	3-35
Peak Menu .....	3-11 .....	3-35
Peak Zoom .....	3-14 .....	3-50
PK SRCH .....	3-12 .....	3-41
Posi .....	3-15 .....	3-54
POWER MEASURE .....	3-13 .....	3-42
PRESET (SHIFT, CONFIG) .....	3-13 .....	3-44
Prev Page .....	3-10 .....	3-26
Print CMD PCL/ESCP/ESCP-R .....	3-8 .....	3-19
Printer .....	3-8 .....	3-19
Printer Config .....	3-8 .....	3-19
Protect .....	3-14 .....	3-47
Pwr Meas Off .....	3-13 .....	3-42
QP .....	3-10 .....	3-26
RBW 120kHz .....	3-10 .....	3-26
RBW 9kHz .....	3-10 .....	3-26
RBW Auto .....	3-10 .....	3-26
RBW AUTO/MNL .....	3-7 .....	3-17
RBW Switch .....	3-7 .....	3-18
RECALL .....	3-13 .....	3-45
Recall .....	3-13 .....	3-45
Ref Level .....	3-10 .....	3-30

<u>Operation Key</u>	<u>Menu Map</u>	<u>Functional Description</u>
Ref Line ON/OFF .....	3-9 .....	3-23
Ref Line Position .....	3-15 .....	3-52
Ref Offset ON/OFF .....	3-10 .....	3-31
REPEAT .....	3-13 .....	3-46
Res 1Hz .....	3-9 .....	3-22
Res 10Hz .....	3-9 .....	3-22
Res 100Hz .....	3-9 .....	3-22
Res 1kHz .....	3-9 .....	3-22
Reset File No. ....	3-8 .....	3-19
Revision .....	3-8 .....	3-20
S T U V W X .....	3-9 .....	3-24
Sample .....	3-15 .....	3-54
SAVE (SHIFT, RECALL) .....	3-14 .....	3-47
Save .....	3-14 .....	3-47
Save Item .....	3-14 .....	3-47
Search ALL/UP/LOW .....	3-11 .....	3-35
SELF TEST (SHIFT, 0) .....	3-14 .....	3-48
Set Up RS232 .....	3-8 .....	3-20
Setup ON/OFF .....	3-14 .....	3-47
SHIFT, COPY.....	3-7.....	3-21
SHIFT,7 (CAL).....	3-7.....	3-18
SHIFT, 1 (EMC).....	3-10.....	3-26
SHIFT .....	3-10.....	3-29
SHIFT, CONFIG (PRESET) .....	3-13.....	3-45
SHIFT, RECALL (SAVE).....	3-14.....	3-47
SHIFT, 0 (Self Test) .....	3-14.....	3-48
Sig Track ON/OFF .....	3-11 .....	3-36
SINGLE .....	3-14 .....	3-49
Slope +/- .....	3-15 .....	3-56
Sound .....	3-10, 3-11 .....	3-27, 3-36
Sound AM/FM .....	3-10, 3-11 .....	3-27, 3-36
Sound Off .....	3-10, 3-11 .....	3-27, 3-36
SPAN .....	3-14 .....	3-50
Squelch ON/OFF .....	3-10, 3-11 .....	3-27, 3-36
Start .....	3-10 .....	3-28
Stop .....	3-10 .....	3-28
Stop Bit 1/2 .....	3-8 .....	3-20
Store A(B) to B(A) .....	3-15 .....	3-55
SWEEP .....	3-15 .....	3-51
SWP Time AUTO/MNL .....	3-15 .....	3-51
TG .....	3-15 .....	3-52
TG Level .....	3-15 .....	3-52
TG Off .....	3-15 .....	3-53
Time/Date .....	3-8 .....	3-20
Time/Date ON/OFF .....	3-9 .....	3-25
Tone GRAY/B/W .....	3-9 .....	3-25

## 3.1 Menu Index

<u>Operation Key</u>	<u>Menu Map</u>	<u>Functional Description</u>
Total Gain .....	3-7 .....	3-18
Total Power .....	3-13 .....	3-42
TR1722 .....	3-10 .....	3-26
TRACE .....	3-15 .....	3-54
Trace ON/OFF .....	3-14 .....	3-47
Trc Lvl ON/OFF .....	3-14 .....	3-47
Trc Menu A/B .....	3-15 .....	3-54, 3-55
TRIG .....	3-15 .....	3-56
UHALP9107 .....	3-10 .....	3-26
Units .....	3-10 .....	3-30
User Ant Corr .....	3-10 .....	3-26
VBW AUTO/MNL .....	3-7 .....	3-17
Video .....	3-15 .....	3-56
View A (B) .....	3-15 .....	3-54
Volts .....	3-10 .....	3-30
Volume .....	3-10, 3-11 .....	3-27, 3-36
Watts .....	3-10 .....	3-30
Width SRT/STP .....	3-12 .....	3-40
Window Off .....	3-9 .....	3-24
Window POS/WD .....	3-9 .....	3-23
Window SRT/STP .....	3-9 .....	3-23
Window Sweep ON/OFF .....	3-9, 3-12 .....	3-23, 3-40
Write A (B) .....	3-15 .....	3-54
XdB Down .....	3-11 .....	3-33
XdB Left .....	3-11 .....	3-33
XdB Right .....	3-11 .....	3-33
XON/XOFF ON/OFF .....	3-8 .....	3-20
Y Z _ # Spc .....	3-9 .....	3-24
Year .....	3-8 .....	3-20
Zero Span .....	3-14 .....	3-50
Zoom In .....	3-9 .....	3-23
Zoom Out .....	3-9 .....	3-23

### 3.2 Menu Map

Abort ( SHIFT , COPY )

Abort

AUTO  
TUNE

[ ]

BW

RBW AUTO/MNL  
VBW AUTO/MNL  
Auto All

CAL ( SHIFT , CAL 7 )

Cal All  
Total Gain  
Each Item  
Freq Corr ON/OFF  
Cal Corr ON/OFF  
Cal Sig Level ON/OFF

IF Step Amp  
RBW Switch  
Log Linear  
AMPTD MAG  
PBW

3.2 Menu Map

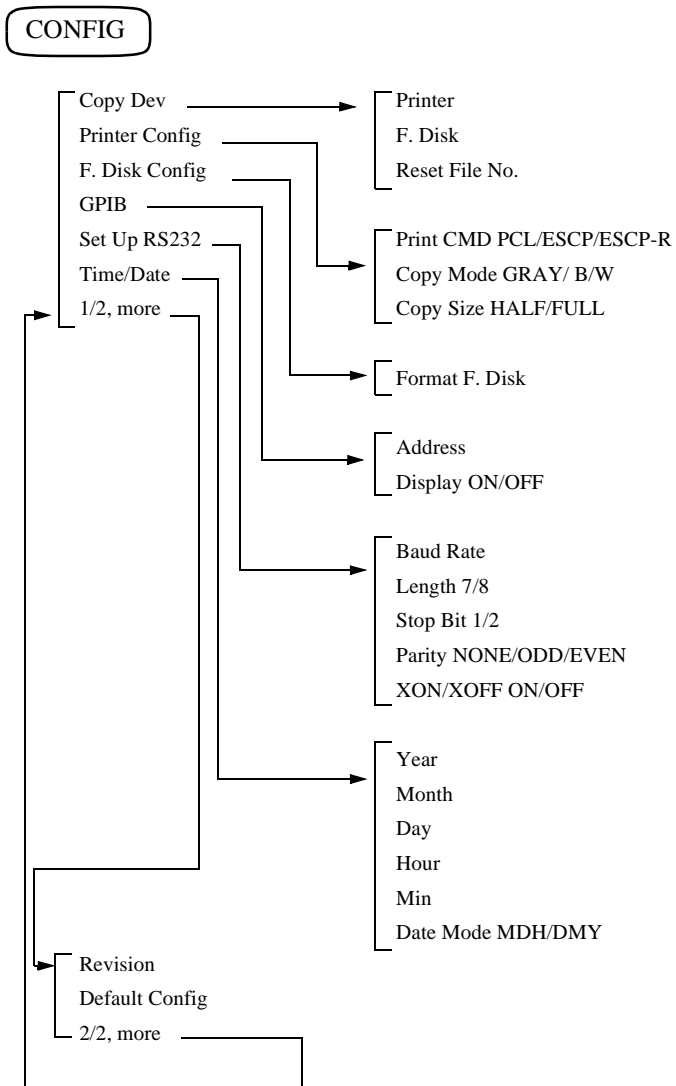

COPY

COUNTER



- Res 1kHz
- Res 100Hz
- Res 10Hz
- Res 1Hz
- Counter Off

DISPLAY

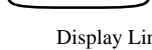

- Display Line ON/OFF
  - Ref Line ON/OFF
  - Meas Window →
  - Change Title →
  - Time/Date ON/OFF
  - Tone GRAY/B/W
  - Inverse
- Window POS/WD
  - Window SRT/STP
  - Zoom In
  - Zoom Out
  - Window Sweep ON/OFF
  - Marker Couple ON/OFF
  - Window Off

- A B C D E F
- G H I J K L
- M N O P Q R
- S T U V W X
- Y Z \_ # Spc
- Clear
- 1/2, more →

- ( ) ' , ; :
- + - < > = .
- / ? \ [ ] ~
- @ # \$ % & \*
- Clear
- Edit Done
- 2/2, more →



3.2 Menu Map

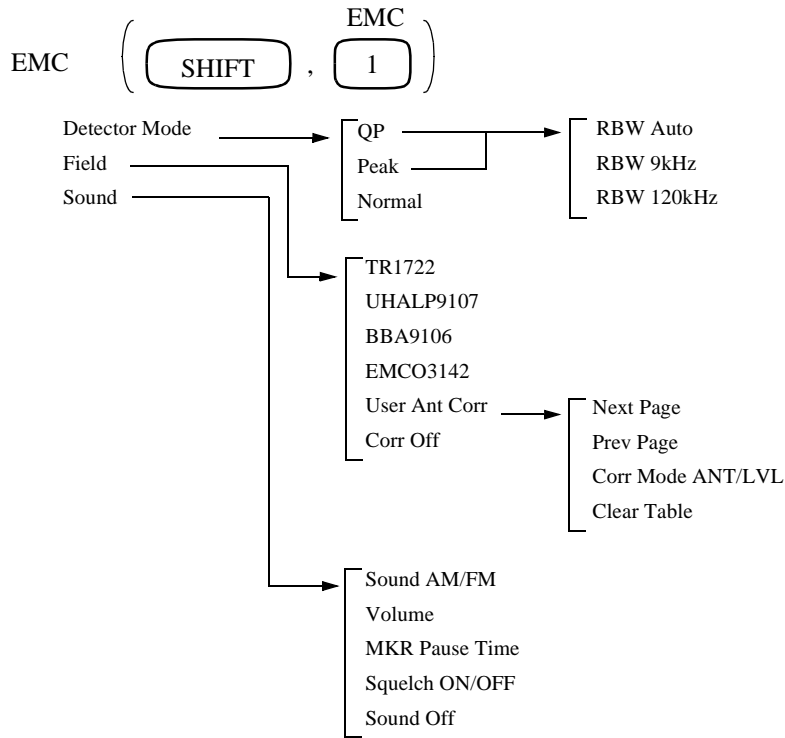

FREQ

- Center
- Start
- Stop
- CF Step AUTO/MNL
- Peak → CF

HOLD ( SHIFT )

LEVEL

- Ref Level → 10dB/div
- ATT AUTO/MNL → 5 dB/div
- dB/div → 2 dB/div
- Linear → 1 dB/div
- Units → dBm
- Ref Offset ON/OFF → dBmV
- Input 50Ω/75Ω → dBμV
- Watts
- Volts

LOCAL

MEAS

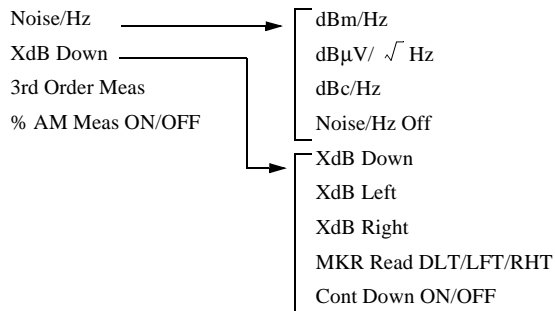

MKR

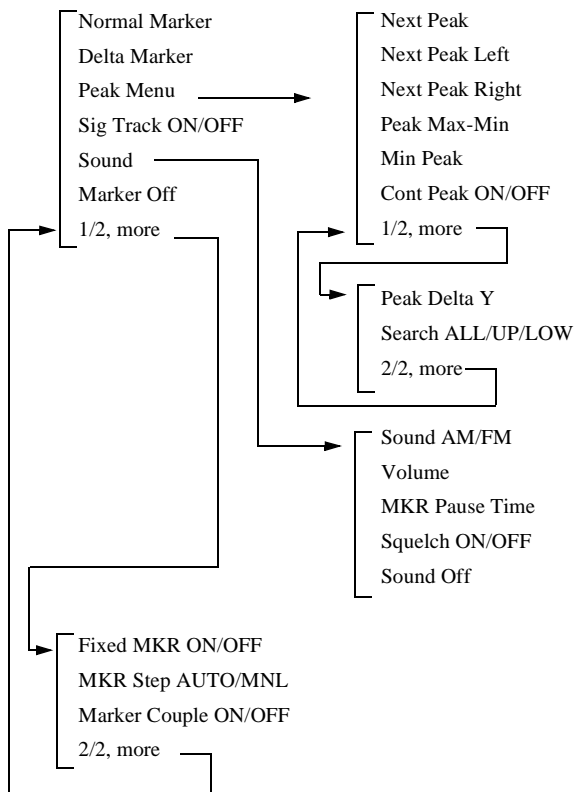

3.2 Menu Map

**MKR →** (when using the normal marker)

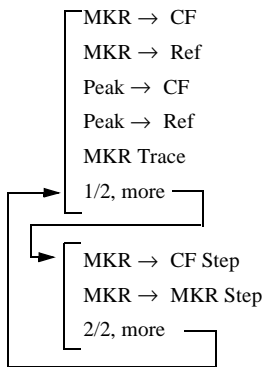

**MKR →** (when using the delta marker)

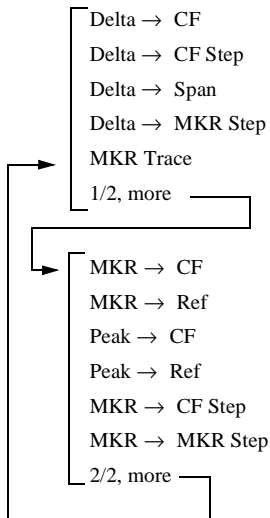

**PAS/FAIL**

- Pass-Fail ON/OFF
- Limit UP/LOW
- Freq Window ON/OFF
- Width SRT/STP
- Window Sweep ON/OFF
- Cont Peak ON/OFF

**PK SRCH**

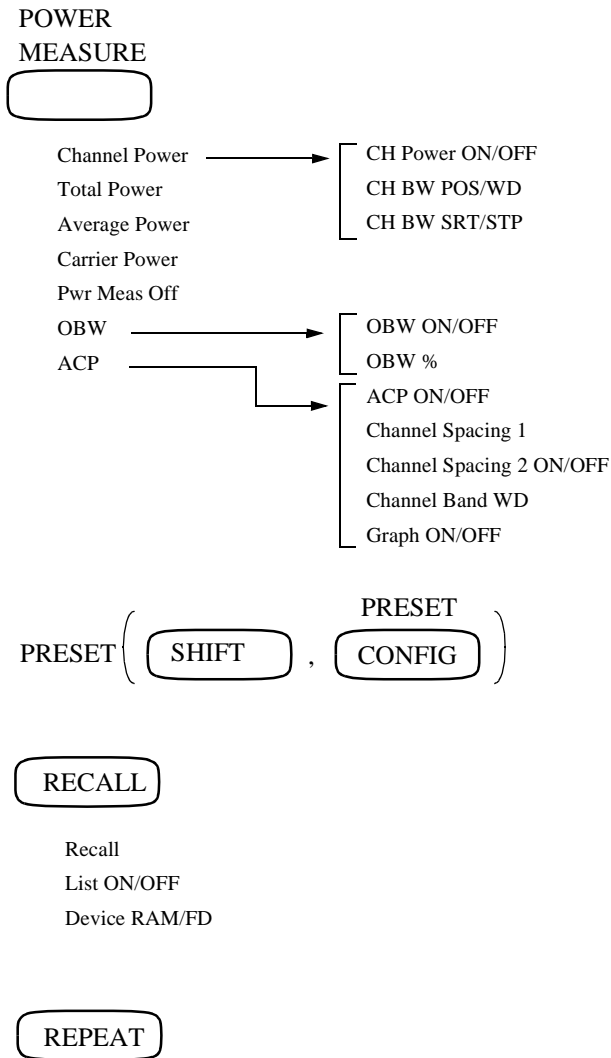

3.2 Menu Map

SAVE ( SHIFT , SAVE RECALL )

Save	→	Setup ON/OFF
Save Item	→	Trace ON/OFF
Protect		Ant Corr ON/OFF
Delete		Norm Corr ON/OFF
Device RAM/FD		Trc Lvl ON/OFF

SELF TEST ( SHIFT , 0 )

Execute Self Test  
Exit

SINGLE

SPAN

Full Span  
Zero Span  
Peak Zoom  
Last Span

**SWEEP**

- SWP Time AUTO/MNL
- Auto All
- Gate Sig External ON/OFF

**TG (Option 74)**

- TG Level
- Execute Normalize
- Norm Corr ON/OFF
- Ref Line Position
- Freq Adj Auto
- Freq Adj Manual
- TG Off

**TRACE**

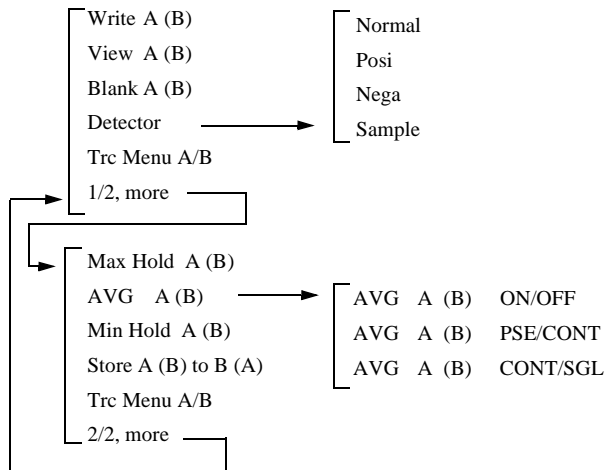

**TRIG**

- Free Run
- Line
- Video
- Ext
- Slope +/-

### 3.3 Menu Function Descriptions

## 3.3 Menu Function Descriptions

This section describes all panel keys and any associated menus displayed when they are pressed.

### 3.3.1 AUTO TUNE Key (Auto Tuning)

Used to display the maximum peak using the current conditions as a target span. When started, this function gradually narrows the frequency span from the full span to the target span. Note that the initial span must be within the band, and that the maximum level signal must be held from the moment it has been found in a peak search to use this operation. Auto tuning can be interrupted by pressing any key on the panel. (Note there is no menu associated with this panel key.)

### 3.3.2 BW Key (Bandwidth)

This section describes the menu displayed when the **BW** key is pressed. From this menu, you can change the parameters for the resolution bandwidth (RBW) and the video bandwidth (VBW) as required.

#### ***RBW AUTO/MNL***

Toggles the video bandwidth between AUTO and MNL.

**AUTO:** Automatically sets an optimum resolution bandwidth according to the span settings.

**MNL:** Allows you to set the resolution bandwidth manually.

#### ***VBW AUTO/MNL***

Toggles the video bandwidth between AUTO and MNL.

**AUTO:** Automatically sets an optimum video bandwidth according to the resolution bandwidth setting.

**MNL:** Allows you to set the video bandwidth manually.

#### ***Auto All***

Automatically sets the resolution bandwidth, the video bandwidth and the sweep time according to the span settings.



## 3.3 Menu Function Descriptions

## 3.3.3 CAL Key (Calibration)

This section describes the menu displayed when the **SHIFT** key and the **7 (CAL)** key are pressed.

<i>Cal All</i>	Executes all calibration routines.
<i>Total Gain</i>	Measures the absolute error using a resolution bandwidth of 300 kHz, and the calibration signal output of both -15dBm and 1dB/DIV.

---

**CAUTION:** *Do not perform a PRESET operation (SHIFT, PRESET) while calibrating the spectrum analyzer because this will erase all calibration data.*

---

<i>Each Item</i>	Changes the display to the Each Item menu.
<i>IF Step Amp</i>	Measures the IF Step AMP switching error and calibrates it.
<i>RBW Switch</i>	Measures the switching error for the IF Filter resolution bandwidth and calibrates it.
<i>Log Linear</i>	Measures the linearity of the ordinate axis at a range of 10 dB/DIV to 1 dB/DIV on the LOG scale and calibrates it.
<i>AMPTD MAG</i>	Measures the switching error at a range of 10 dB/DIV to 1 dB/DIV on the LOG scale and calibrates it.
<i>PBW</i>	Measures PBW (noise power bandwidth) at a resolution bandwidth range of 1 kHz to 1 MHz and calibrates it.
<i>Freq Corr ON/OFF</i>	Toggles the frequency correction function on or off. ON: Frequency characteristics are corrected. OFF: Turns the frequency correction function off.
<i>Cal Corr ON/OFF</i>	Toggles the calibration factor on or off. ON: The calibration factor is used. OFF: The calibration factor is not used.
<i>Cal Sig Level ON/OFF</i>	Toggles the calibration signal output level on or off. ON: Connects the calibration signal to the input part of the spectrum analyzer. The calibration signal output level can be set. OFF: Disconnects the calibration signal from the input part of the spectrum analyzer.

### 3.3.4 CONFIG Key (Configuration)

This section describes the menu displayed when the **CONFIG** key is pressed.

<i>Copy Dev</i>	Displays the Copy Dev menu which is used to select the device for outputting the screen data.
<i>Printer</i>	Selects the printer as the destination for the screen data.
<i>F.Disk</i>	Selects the floppy disk drive as the destination for the screen data.
<i>Reset File No.</i>	Resets the file numbers files are saved under when saving to a disk.
<i>Printer Config</i>	Displays the Printer menu used to set up the printer.
<i>Print CMD PCL/ESCP/ESCP-R</i>	Switches between printer types. PCL: Allows you to use a PCL printer. ESCP: Allows you to use a ESC/P printer. ESCP-R: Allows you to use a ESC/P Raster printer.
<i>Copy Mode GRAY/ B/W</i>	Toggles the printer output mode between gray scale and monochrome modes. GRAY: Sets the printer output mode to gray scale. B/W: Sets the printer output mode to monochrome.
<i>Copy Size HALF/FULL</i>	Toggles the printer output size between HALF and FULL. HALF: Approximately the same size as the screen display. FULL: Prints in A4 size horizontally.
<i>F.Disk Config</i>	Displays the F. Disk menu used to format the floppy disks for use with the analyzer.
<i>Format F.Disk</i>	Initializes the disk currently in the drive.
<i>GPIB</i>	Displays the menu used to set the parameters for GPIB control.
<i>Address</i>	Allows you to set the GPIB address.
<i>Display ON/OFF</i>	Toggles the remote control parameter display on or off. ON : Displays all parameters and measured values. OFF : Displays traces only (this function can also be controlled by the panel settings).

## 3.3 Menu Function Descriptions

When GPIB control is operating with the display set to OFF, the internal processing rate increases.

<b><i>Set Up RS232</i></b>	Displays the RS-232 menu used to set the conditions used with the RS-232 interface.
<b><i>Baud Rate</i></b>	Allows you to set the transfer rate in bauds.
<b><i>Length 7/8</i></b>	Toggles between 7-bit and 8-bit data lengths.
<b><i>Stop Bit 1/2</i></b>	Toggles between 1-bit and 2-bit stop lengths.
<b><i>Parity NONE/ODD/EVEN</i></b>	Sets the parity bit type to NONE, ODD or EVEN.
<b><i>XON/XOFF ON/OFF</i></b>	Toggles the XON/XOFF signal output on or off. ON: Outputs the XON/XOFF signal to the RS-232 port. OFF: Does not output the XON/XOFF signal to the RS-232 port.
<b><i>Time/Date</i></b>	Displays the Time/Date menu used to set the date and time.
<b><i>Year</i></b>	Allows you to set the year.
<b><i>Month</i></b>	Allows you to set the month.
<b><i>Day</i></b>	Allows you to set the day.
<b><i>Hour</i></b>	Allows you to set the hour.
<b><i>Min</i></b>	Allows you to set the minute.
<b><i>Date Mode MDH/DMY</i></b>	Switches the date indication mode between MDH and DMY. MDH: Displays the date in the MDH mode. DMY: Displays the date in the DMY mode.
<b><i>1/2, more</i></b>	Displays the Config (2) menu.
<b><i>Revision</i></b>	Displays the software version number and all options installed in your spectrum analyzer.
<b><i>Default Config</i></b>	Resets all spectrum analyzer settings to the factory defaults. (See Table 3-4.)
<b><i>2/2, more</i></b>	Returns to the Config (1) menu.

### 3.3.5 COPY Key (Hard Copy)

Sends the screen data to the destination selected by the *Copy Dev* item in the Config (1) menu. (Note there is no menu associated with this panel key.)

**\*To abort printing:**

Pressing **SHIFT**, **COPY** and **Abort** aborts the printing currently taking place.

### 3.3 Menu Function Descriptions

#### 3.3.6 COUNTER Key (Frequency Counter)

Activates the Frequency counter mode and displays the associated menu. The current measurement frequency is also displayed.

<i>Res 1kHz</i>	Sets the frequency counter resolution to 1kHz.
<i>Res 100Hz</i>	Sets the frequency counter resolution to 100 Hz.
<i>Res 10Hz</i>	Sets the frequency counter resolution to 10 Hz.
<i>Res 1Hz</i>	Sets the frequency counter resolution to 1 Hz.
<i>Counter Off</i>	Turns the frequency counter mode off.

### 3.3.7 DISPLAY Key (Line and Window)

This section describes the menu displayed when the **DISPLAY** key is pressed.

<i>Display Line ON/OFF</i>	<p>Toggles the display line indication on or off. The display line is used as a base line when comparing trace levels.</p> <p>ON: Turns the display line on. The display line position can be adjusted under this setting.</p> <p>OFF: Turns the display line off.</p>
<i>Ref Line ON/OFF</i>	<p>Toggles the reference line indication on or off. The reference line is used as a base line to which the level value is relative.</p> <p>ON: Displays the reference line. The reference line position can be adjusted under this setting.</p> <p>OFF: Turns the reference line off.</p>
<i>Meas Window</i>	<p>Activates the measuring window and changes to the Meas WDO menu.</p>
<i>Window POS/WD</i>	<p>Allows you to set the position and width of the measuring window.</p> <p>POS: Used to set the position of the measuring window.</p> <p>WD: Used to set the width of the measuring window.</p>
<i>Window SRT/STP</i>	<p>Allows you to set the start and stop frequencies for the measuring window.</p> <p>SRT: Used to set the start frequency of the measuring window.</p> <p>STP: Used to set the stop frequency of the measuring window.</p>
<i>Zoom In</i>	<p>Shows the frequency range specified by the measuring window using the entire screen.</p>
<i>Zoom Out</i>	<p>Returns the expanded display shown by <i>Zoom In</i> to its original size.</p>
<i>Window Sweep ON/OFF</i>	<p>Toggles the window sweep function on or off.</p> <p>ON: Sweeps the range specified by the measuring window.</p> <p>OFF: Sweeps the range specified by the span.</p>
<i>Marker Couple ON/OFF</i>	<p>Toggles the marker couple function on or off.</p> <p>ON: Marker search range is limited to the measuring window.</p>

### 3.3 Menu Function Descriptions

	OFF:	Turns the marker couple function off. The search range covers the entire screen.
<i>Window Off</i>		Closes the measuring window.
<i>Change Title</i>		Displays the Title (1) menu. From this mode, you can set the title used on the spectrum analyzer. While in this mode, all other functions are disabled (however you can reset the default settings by performing an initialization). To exit this mode, switch to the <i>Edit Done</i> mode. The characters you have entered are stored by pressing the <b>ENTER</b> key, and displayed in the title area.
<i>A B C D E F</i>		Displays A through F in the active area.
<i>G H I J K L</i>		Displays G through L in the active area.
<i>M N O P Q R</i>		Displays M through R in the active area.
<i>S T U V W X</i>		Displays S through X in the active area.
<i>Y Z _ # Spc</i>		Displays Y through Spc (space) in the active area.
<i>Clear</i>		Erases any characters you have entered.
<i>1/2, more</i>		Displays the Rename (2) menu.
<i>( ) ' , ; :</i>		Displays ( through : in the active area.
<i>+ - &lt; &gt; = .</i>		Displays + through . in the active area.
<i>/ ? \ [ ] ~</i>		Displays / through ~ in the active area.
<i>@ # \$ % &amp; *</i>		Displays @ through * in the active area.
<i>Clear</i>		Erases the characters you have entered.
<i>Edit Done</i>		Completes the title edit and opens the Display menu.
<i>2/2, more</i>		Displays the Title (1) menu.

***Time/Date ON/OFF***

Turns the Time and Date display on or off.

ON: Time/Date is displayed.

OFF: Time/Date is not displayed.

***Tone GRAY/B/W***

Toggles the screen display mode between GRAY and B/W modes.

GRAY: Sets the screen display mode to gray scale (four levels).

B/W: Set the screen display mode to Black & White.

***Inverse***

Inverts the display.



## 3.3 Menu Function Descriptions

**3.3.8 EMC Key (EMC Measurement)**

This section describes the menu displayed when the **SHIFT** key and the 1(**EMC**) key are pressed.

<i>Detector Mode</i>	Displays the Detector menu.
<i>QP</i>	Displays the QP BW menu and detects the quasi peak value.
<i>RBW Auto</i>	Automatically sets the resolution bandwidth.
<i>RBW 9kHz</i>	Sets the resolution bandwidth to 9 kHz.
<i>RBW 120kHz</i>	Sets the resolution bandwidth to 120 kHz.
<i>Peak</i>	Displays the Peak BW menu and detects the peak value.
<i>RBW Auto</i>	Automatically sets the resolution bandwidth.
<i>RBW 9kHz</i>	Sets the resolution bandwidth to 9 kHz.
<i>RBW 120kHz</i>	Sets the resolution bandwidth to 120 kHz.
<i>Normal</i>	Switches to the current detector as set at <i>Detector</i> (the Trc Det menu) in the <b>TRACE</b> .
<i>Field</i>	Displays the Antenna menu. From here, select the antenna factor you wish to correct for (5D2W cable, 10 m including the cable loss).
<i>TR1722</i>	Corrects for half-wave dipole antennas (TR1722).
<i>UHALP9107</i>	Corrects for log-periodic antennas (UHALP9107).
<i>BBA9106</i>	Corrects for biconical antennas (BBA9106).
<i>EMCO3142</i>	Corrects for bilog antennas (EMCO3142).
<i>User Ant Corr</i>	Opens the user-definable correction table, and displays the correction data list in the User Ant Corr menu.
<i>Next Page</i>	Displays the next page of the correction data list.
<i>Prev Page</i>	Displays the previous page of the correction data list.
<i>Corr Mode ANT/LVL</i>	Toggles between the antenna factor (for the defined correction

data) and the level correction data settings.

ANT: Sets the antenna factor, and automatically sets the unit used for the vertical axis to dB $\mu$ V/m.

LVL: Sets the level correction data, and sets the unit for the vertical axis to the level you have previously chosen.

Any other antenna factors than those chosen by the user are considered invalid, so the displayed unit will automatically be dB $\mu$ V/m.

<b><i>Clear Table</i></b>	Clears the correction data table.
<b><i>Corr Off</i></b>	No longer uses the correction data.
<b><i>Sound</i></b>	Displays the Sound menu, and demodulates the sound at the marker.
<b><i>Sound AM/FM</i></b>	Toggles between AM and FM demodulation.
<b><i>Volume</i></b>	Allows you to set the demodulated sound volume. The volume can be set from a range of 1 to 16.
<b><i>MKR Pause Time</i></b>	Allows you to set the duration of the pause used during demodulation.
<b><i>Squelch ON/OFF</i></b>	Toggles the squelch function on or off. ON: Displays the squelch line which indicates that the sound carrier level below this line is not demodulated. The squelch line position can be adjusted under this setting. OFF: Removes the squelch line, and turns off the squelch function.
<b><i>Sound Off</i></b>	Turns off the sound demodulation function and displays the EMC menu.

### 3.3 Menu Function Descriptions

#### 3.3.9 **FREQ Key (Frequency)**

This key displays the FREQ menu and allows you to set a center frequency. In addition, it displays the current center frequency and frequency span in the area below the bottom scale line.

***Center*** Allows you to set the center frequency, and displays the center frequency and frequency span in the annotation area below the bottom scale line.

***Start*** Allows you to set the start frequency (the frequency furthest to the left on the frequency axis), and displays the start and stop frequencies in the annotation area below the bottom scale line.

***Stop*** Allows you to set the stop frequency (the frequency furthest to the right on the frequency axis), and displays the start and stop frequencies in the annotation area below the bottom scale line.

***CF Step AUTO/MNL*** Toggles the step size function between AUTO and MNL. This function is used to change a center frequency using the step keys.  
AUTO: Automatically sets the step size to 1/10 of the frequency span.  
MNL: Allows you to set the step size manually.

***Peak → CF*** Sets the marker at the peak point within the search range, and the marker frequency (at the peak point) is then set to the center frequency.

### 3.3.10 Hold Mode

Pressing the **SHIFT** key for several seconds until the word “**HOLD**” appears on the screen activates the Hold mode. This mode disables all panel and soft key input, except for the **PRESET** key (**SHIFT, CONFIG**).

Pressing the **SHIFT** until “**HOLD**” is removed from the screen deactivates Hold mode.

### 3.3.11 LEVEL Key (Frequency Level)

This section describes the menu displayed when the **LEVEL** key is pressed.

<i>Ref Level</i>	Allows you to set the reference level.
<i>ATT AUTO/MNL</i>	Toggles the input attenuator between AUTO and MNL. <b>AUTO:</b> Automatically sets an optimum input attenuator in accordance with the reference level setting. <b>MNL:</b> Allows you to set an input attenuator within a range of 0 to 50 dB (in 10 dB step). Setting the attenuation to 0 dB is possible only by using the numeric keys.
<i>dB/div</i>	Displays the dB/div menu which is used to set the graduation of amplitude scale (vertical axis).
<i>10dB/div</i>	Sets the amplitude scale graduation (vertical axis) to 10 dB/div.
<i>5dB/div</i>	Sets the amplitude scale graduation (vertical axis) to 5 dB/div.
<i>2dB/div</i>	Sets the amplitude scale graduation (vertical axis) to 2 dB/div.
<i>1dB/div</i>	Sets the amplitude scale graduation (vertical axis) to 1 dB/div.
<i>Linear</i>	Displays the reference level data between 0 V and the REF level on a linear scale (in volts).
<i>Units</i>	Displays the Units menu which sets the units used for the reference level, the display line and the marker level.
<i>dBm</i>	Sets the unit to dBm.
<i>dBmV</i>	Sets the unit to dBmV.
<i>dBμV</i>	Sets the unit to dBμV.
<i>Watts</i>	Sets the unit to W.
<i>Volts</i>	Sets the unit to V.

***Ref Offset ON/OFF***

Toggles the reference level offset function on or off.

ON: Allows you to set the offset level in a range of 0 to  $\pm 100.0$  dB. The relationships between the displayed reference level, the set reference level and the offset are shown below:

Reference level (displayed) = Reference level (set) + Offset.

OFF: Turns off the offset.

***Input 50 $\Omega$  /75 $\Omega$*** 

Sets the impedance input level for the display. The 75  $\Omega$  setting is used when a 75  $\Omega$  impedance converter (ZT-130NC) is connected to the RF input.

### **3.3.12 LOCAL Key (GPIB Remote Control)**

Turns off GPIB remote control. (Note there is no menu associated with this panel key.)

### 3.3.13 MEAS Key (Measurement)

This section describes the menu displayed when the **MEAS** key is pressed.

<i>Noise/Hz</i>	Displays the Noise/Hz menu, and allows you to set the frequency width for noise measurement.
<i>dBm/Hz</i>	Sets the vertical axis unit to dBm, and sets the marker readout signal level unit to dBm/Hz. In addition, the detector is automatically set to the sample detection mode.
<i>dB<math>\mu</math>V/ <math>\sqrt{\text{Hz}}</math></i>	Sets the vertical axis unit to dB $\mu$ V, and sets the marker readout signal level unit to dB $\mu$ V/ $\sqrt{\text{Hz}}$ . In addition, the detector is automatically set to the sample detection mode.
<i>dBc/Hz</i>	Sets the unit of delta marker signal level to dBc/Hz and turns the marker fixed function (delta marker) ON, then sets the detector to the sample detection mode.
<i>Noise/Hz Off</i>	Turns off the noise measurement mode, and displays the Measure menu.
<i>XdB Down</i>	Displays the XdB Down menu.
<i>X dB Down</i>	Moves the normal marker to an intersection point on the trace x dB down from the present location according to the <b>MKR Read DLT/LFT/RHT</b> setting.
<i>X dB Left</i>	Moves the normal marker to the left to an intersection point on the trace x dB down from the present location.
<i>X dB Right</i>	Moves the normal marker to the right to an intersection point on the trace x dB down from the present location.
<i>MKR Read DLT/LFT/RHT</i>	Selects the marker display under the x dB down function to either DLT, LFT or RHT. DLT: The delta marker is displayed on the left; and the normal marker, on the right. LFT: The normal marker is displayed on the left. RHT: The normal marker is displayed on the right.



### 3.3 Menu Function Descriptions

***Cont Down ON/OFF***

Toggles the count down function on or off.

ON: Sets the x dB down function to repeat continuously. Establishes the trace peak point for each sweep which is used as the reference point of the marker down.

OFF: Turns off the count down function.

***3rd Order Meas***

Displays the delta marker on the peak of the fundamental wave and the normal marker on the peak of the third order intermodulation distortion.

***% AM Meas ON/OFF***

Toggles the %AM Meas function on or off.

ON: Calculates an AM modulation factor using a peak search, and displays the result as a percentage (%).

OFF: Turns off the %AM Meas.

### 3.3.14 MKR Key (Marker)

This section describes the menu displayed when the **MKR** key is pressed. When this key is pressed, the Marker (1) menu is displayed and the normal marker is displayed in the center of the trace.

<i>Normal Marker</i>	Allows you to set the normal marker, and displays the marker in the center of the trace. The frequency and the level at the marker are displayed in the marker area.
<i>Delta Marker</i>	Allows you to set the delta marker, and displays it in the same position as that of the normal marker. The frequency and the level values of this marker are relative to those of the normal marker.
<i>Peak Menu</i>	Displays the Peak (1) menu, and allows you to quickly move the normal marker to any point on the trace.
<i>Next Peak</i>	Moves the present marker to the next highest peak within the search range.
<i>Next Peak Left</i>	Moves the present marker to the next lower frequency peak on the left side of the current marker.
<i>Next Peak Right</i>	Moves the present marker to the next higher frequency peak on the right side of the current marker.
<i>Peak Max-Min</i>	Displays the normal marker on the maximum peak, and the delta marker on the minimum peak within the search range.
<i>Min Peak</i>	Moves the delta marker to the minimum peak within the search range.
<i>Cont Peak ON/OFF</i>	Toggles the continuous peak search function on or off. ON: Displays the frequency and the level of the marker after moving the marker to the maximum peak in each sweep. OFF: Turns off the continuous peak search function.
<i>1/2, more</i>	Displays the Peak (2) menu.
<i>Peak Delta Y</i>	Allows you to set the amplitude settings used for the next peak search.
<i>Search ALL/UP/LOW</i>	Selects the next peak search range with respect to the threshold value of the display line. All: Removes the display line after repeating the next peak search for all peaks. UP: Performs the next peak search for all the peaks above the display line. The display line can be adjusted from

3.3 Menu Function Descriptions

	this setting.
	LOW: Performs the next peak search for all the peaks under the display line. The display line can be adjusted from this setting.
<i>2/2, more</i>	Returns to the Peak (1) menu.
<i>Sig Track ON/OFF</i>	Toggles the signal track function on or off. ON: Sets the marker frequency to the center frequency for each sweep, after performing the peak search for the same peak. OFF: Turns off the signal track function.
<i>Sound</i>	Displays the Sound menu, and demodulates the sound at the marker.
<i>Sound AM/FM</i>	Toggles between AM and FM demodulation.
<i>Volume</i>	Allows you to set the demodulated sound volume. You can set the sound volume from a range of 1 to 16.
<i>MKR Pause Time</i>	Allows you to set the duration of the pause used during demodulation.
<i>Squelch ON/OFF</i>	Toggles the squelch function on or off. ON: Displays the squelch line which indicates that sound carrier levels below this line are not demodulated. The squelch line can be adjusted when the squelch function is activated. OFF: Removes the squelch line, and turns off the squelch function.
<i>Sound Off</i>	Turns off the sound demodulation function.
<i>Marker Off</i>	Turns off all marker functions.
<i>1/2, more</i>	Displays the Marker (2) menu.

***Fixed MKR ON/OFF***

Toggles the Fixed Marker function on or off.

ON: Stores the frequency and level of the displayed delta marker and fixes the marker at the current physical position on the screen.

OFF: Turns off the Fixed Marker function.

***MKR Step AUTO/MNL***

Toggles the step size function on or off. This function allows you to control the movement of the marker using the step key.

AUTO: Automatically sets the step size to 1/10 of the span.

MNL: Allows you to manually set the step size to any value.

***Marker Couple ON/OFF***

Toggles the Marker Couple function on or off.

ON: Specifies the peak search range used within the measuring window.

OFF: Turns off the Marker Couple function.

***2/2, more***

Returns to the Marker (1) menu.

## 3.3 Menu Function Descriptions

**3.3.15 MKR → Key (Marker →)**

This section describes the menu displayed when the Mkr → key is pressed. This menu allows you to use the active marker data (such as frequency and level) as the data for some other function. Item(s) in the Mkr → (1) menu may be different depending on the marker you use (either normal or delta marker).

(1) When using the normal marker:

<i>MKR → CF</i>	Sets the active marker frequency as the center frequency.
<i>MKR → Ref</i>	Sets the active marker level as the reference level.
<i>Peak → CF</i>	Moves the marker to the maximum peak within the search range, and sets the marker frequency as the center frequency.
<i>Peak → Ref</i>	Moves the marker to the maximum peak within the search range, and sets the marker level as the reference level.
<i>MKR Trace</i>	Selects one of the two traces so that the marker is available when traces A and B are displayed simultaneously.
<i>1/2, more</i>	Displays the Mkr → (2) menu.
<i>MKR → CF step</i>	Sets the marker frequency as the center frequency for the step size.
<i>MKR → MKR Step</i>	Sets the marker frequency as the step size of the marker.
<i>2/2, more</i>	Returns to the Mkr → (1) menu.

(2) When using the delta marker:

<i>Delta → CF</i>	Sets the frequency difference between the delta and normal marker as the center frequency.
<i>Delta → CF step</i>	Sets the frequency difference between the delta and normal marker as the step size for the center frequency.
<i>Delta → Span</i>	Sets the frequency difference between the delta and normal marker as the frequency span.
<i>Delta → MKR Step</i>	Sets the frequency difference between the delta and normal marker as the step size of the marker.
<i>MKR Trace</i>	Selects one of the two traces so that the marker is available when traces A and B are displayed simultaneously.
<i>1/2, more</i>	Displays the Mkr → (2) menu.
<i>MKR → CF</i>	Sets the active marker frequency as the reference level.
<i>MKR → Ref</i>	Sets the active marker level as the reference level.
<i>Peak → CF</i>	Moves the marker to the maximum peak within the search range, and sets the marker frequency as the center frequency.
<i>Peak → Ref</i>	Moves the marker to the maximum peak within the search range, and sets the marker level as the reference level.
<i>MKR → CF step</i>	Sets the active marker frequency as the step size of the center frequency.
<i>MKR → MKR Step</i>	Sets the active marker frequency as the step size of the marker.
<i>2/2, more</i>	Returns to the Mkr → (1) menu.

### 3.3.16 PAS/FAIL Key (Pass-Fail Judgment)

This section describes the menu displayed when the **PAS/FAIL** key is pressed. When this key is pressed, the level window is displayed.

#### ***Pass-Fail ON/OFF***

Toggles the Pass-Fail judgment function on or off.

ON: Performs a Pass-Fail judgment according to the level window settings (as set by ***Limit UP/LOW***) after finishing each sweep. "PASS" is displayed when the marker is within the level window.

OFF: Removes the level window, and Pass-Fail judgments do not occur.

#### ***Limit UP/LOW***

Allows you to set the upper and lower limits of the level window.

UP: Allows you to set the upper limit of the level window.

LOW: Allows you to set the lower limit of the level window.

#### ***Freq Window ON/OFF***

Toggles the measuring window on or off.

ON: Displays the measuring window.

OFF: Removes the measuring window.

#### ***Width SRT/STP***

Allows you to set the start and stop frequencies for the measuring window.

SRT: Allows you to set the start frequency for the measuring window.

STP: Allows you to set the stop frequency for the measuring window.

#### ***Window Sweep ON/OFF***

Toggles the Window Sweep function on or off.

ON: Sweeps within the range specified by the measuring window.

OFF: Sweeps within the span.

#### ***Cont Peak ON/OFF***

Toggles the continuous peak search function on or off.

ON: Displays the frequency and level after moving the marker to the maximum peak for each sweep.

OFF: Turns off the continuous peak search function.

### **3.3.17 PK SRCH Key (Peak Search)**

Pressing this key displays the frequency and level of the marker after moving the marker to the maximum level of the trace within the search range. (Note there is no menu associated with this panel key.)



### 3.3.18 POWER MEASURE Key (Power Measurement)

This section describes the menu displayed when the **POWER MEASURE** key is pressed.

<i>Channel Power</i>	Displays the CH Power menu.
<i>CH Power ON/OFF</i>	Allows you to measure the total power in a specified channel bandwidth. ON: Measures the total power in a channel bandwidth specified by the measuring window. Allows you to set the averaging count. OFF: Turns off total power measurement.
<i>CH BW POS/WD</i>	Allows you to set the position and width of the measuring window (channel bandwidth). POS: Allows you to set the center position of the measuring window (channel bandwidth). WD: Allows you to set the width of the measuring window (channel bandwidth).
<i>CH BW SRT/STP</i>	Allows you to set the start and stop frequencies for the measuring window (channel bandwidth). SRT: Start frequency for the measuring window (channel bandwidth). STP: Stop frequency for the measuring window (channel bandwidth).
<i>Total Power</i>	Measures the total power in the object range (the entire measurement span or window). Allows you to set the averaging count.
<i>Average Power</i>	Measures the power averaged over the object range (the entire measurement span or window). Allows you to set the averaging count.
<i>Carrier Power</i>	Moves the marker to the peak point on the trace, and measures the carrier power.
<i>Pwr Meas Off</i>	Turns off the power measurement function.
<i>OBW</i>	Displays the OBW menu.

---

<b><i>OBW ON/OFF</i></b>	Toggles the OBW measurement function on or off. ON: Shows the occupied bandwidth together with the carrier frequency set by the OBW % setting. OFF: Turns off the OBW measurement function.
<b><i>OBW %</i></b>	Sets the percentage of occupied power compared to the total power when measuring the occupied bandwidth.
<b><i>ACP</i></b>	Displays the ACP menu.
<b><i>ACP ON/OFF</i></b>	Toggles the ACP measurement function on or off. ON: Displays the adjacent channel leakage power due to channel spacing and bandwidth after completing the measurement. OFF: Turns off the ACP measurement function.
<b><i>Channel Spacing 1</i></b>	Turns on the channel spacing (adjacent) setting used in the ACP measurement. In addition, the marker moves to the measurement point while measuring the alternate channel.
<b><i>Channel Spacing 2 ON/OFF</i></b>	Toggles ACP measurements for the alternate channel on or off. ON: Turns on the ACP measurement function for the alternate channel. Used to display up to the alternate channel power and move the marker to the alternate channel. OFF: Turns off the ACP measurement function for the alternate channel.
<b><i>Channel Band WD</i></b>	Allows you to set the bandwidth for the ACP measurement.
<b><i>Graph ON/OFF</i></b>	Toggles the graph display on or off. ON: Displays the leakage power graph as Trace B and puts the delta marker in the center of the screen. OFF: Turns off the leakage power graph.

### 3.3 Menu Function Descriptions

#### 3.3.19 **PRESET Key (Initialization)**

This key is used to reset the spectrum analyzer to its' default settings. This key is accessed by pressing the **SHIFT** key and then the **CONFIG** key. All previous settings are cleared when this is done. (Note there is no menu associated with this panel key.)

### 3.3.20 RECALL Key (Data Readout)

This section describes the menu displayed when the **RECALL** key is pressed.

*Recall* Reads out the data from a file selected from the file list.

*List ON/OFF* Toggles the file list display on or off.

ON: Displays the file list.

OFF: Turns off the file list display.

*Device RAM/FD* Selects a source for the data.

RAM: Reads out the data from internal memory.

FD: Reads out the data from a floppy disk.

### 3.3 Menu Function Descriptions

#### 3.3.21 REPEAT Key (Continuous Sweep)

Pressing this key activates the continuous sweep mode.

If this key is pressed during a sweep, the sweep is paused and the sweep lamp is turned off. Pressing the **REPEAT** key again causes the analyzer to wait for another sweep to start and then the sweep lamp turns back on. The sweep will start after a signal is received (which in turn depends on the current trigger mode setting). (Note there is no menu associated with this panel key.)

### 3.3.22 SAVE Key (Saving Data)

This section describes the menu displayed when the **SHIFT** key and the **RECALL (SAVE)** key are pressed.

<i>Save</i>	Saves the data selected by <i>Save Item</i> to the file selected in the file list.
<i>Save Item</i>	Displays the Save Item menu.
<i>Setup ON/OFF</i>	Toggles the SAVE setup condition function on or off. ON: Saves the setup conditions. OFF: Does not save the setup conditions.
<i>Trace ON/OFF</i>	Toggles the SAVE trace data function on or off. ON: Saves the trace data. OFF: Does not save the trace data.
<i>Ant Corr ON/OFF</i>	Toggles the SAVE correction data function on or off. ON: Saves the correction data. OFF: Does not save the correction data.
<i>Norm Corr ON/OFF</i>	Toggles the save function (of normalization calibration data) on or off (this function is available only when equipped with Option 74). ON: Saves normalization calibration data. OFF: Does not save normalization calibration data.
<i>Trc Lvl ON/OFF</i>	Toggles the trace data SAVE function on or off. ON: Stores the trace data level (at the present level). OFF: Does not store the trace data level.
<i>Protect</i>	Enables the write protect for the file selected in the file list.
<i>Delete</i>	Removes the selected file from the file list.
<i>Device RAM/FD</i>	Selects the location used to store the data. RAM: Stores the data in internal memory. FD: Stores the data on the floppy disk in the disk drive.

### 3.3 Menu Function Descriptions

#### 3.3.23 SELF TEST Key (Self Test)

Pressing SHIFT and 0 activates the self test mode, and displays the Self Test menu.

---

*Note:* In Self Test mode, all soft menus and panel keys except for those displayed in the soft menu, and the SHIFT, PRESET and COPY keys are disabled.

---

##### *Execute Self Test*

Nine test items are displayed in SELF TEST RESULTS window, and are tested in order.

As each test is completed, PASS or FAIL and Completed are displayed on the screen. After all test items have been completed, The self test ends.

---

*CAUTION:* If FAIL appears for any test item, Contact an ADVAN-TEST service representative for repair. The address and telephone are found at the end of this manual.

---

##### *Exit*

Exits the self test mode.

### 3.3.24 SINGLE Key (Single Sweep)

If this key is pressed during a sweep, the sweep is paused and the sweep lamp is turned off. Pressing the **SINGLE** key again causes the analyzer to wait until a sweep starts again (which in turn depends on when it receives a signal). This is controlled by the trigger mode setting. (Note there is no menu associated with this panel key.)



### 3.3 Menu Function Descriptions

#### 3.3.25 SPAN Key (Frequency Span)

When pressed, this key displays the SPAN menu, and allows you to set a frequency span. In addition, the center frequency and frequency span are displayed in the annotation area below the bottom scale line.

***Full Span*** Sets a center frequency of 1.5 GHz, and a frequency span of 3 GHz.

***Zero Span*** Set a zero span at the center frequency. In zero span mode, the frequency span is 0 Hz, and the spectrum analyzer operates as a tuned receiver. The horizontal axis is the time axis. The receiving bandwidth is determined according to the selected resolution bandwidth.

***Peak Zoom*** Moves the marker to the maximum peak within the search object range, and sets the marker frequency as the center frequency. In addition, the frequency span is changed to 1/10 of the current frequency span.

***Last Span*** Resets the frequency span to the previous value.

### 3.3.26 SWEEP Key (Sweep Time)

This section describes the menu displayed when the **SWEEP** key is pressed.

#### *SWP Time AUTO/MNL*

Toggles the sweep time between AUTO and MNL.

**AUTO:** Automatically sets an optimum sweep time according to the span setting.

**MNL:** Sets the sweep time manually.

#### *Auto All*

Automatically sets the resolution bandwidth, video bandwidth and sweep time according to the span settings.

#### *Gate Sig External ON/OFF*

Toggles the gated sweep function on or off.

**ON:** Performs a gated sweep using the External Trigger connector signal as the gate signal.

For more information on how to set the gate signal, refer to Section 3.4.5 "Specifications for the External Gate Signal".

**OFF:** Performs a normal sweep.

Uses the input signal at the External Trigger connector as the trigger signal for the Ext Trig mode.

## 3.3 Menu Function Descriptions

**3.3.27 TG Key (Tracking Generator) (Option 74)**

This section describes the TG menu which is displayed when the tracking generator is turned on.

---

**CAUTION:** *Do not apply voltages that exceed ( 10 V or power that exceeds + 15 dBm to the TG OUTPUT connector, or you may damage this instrument.*

---

**TG Level** Allows you to set tracking generator's output level.

**Execute Normalize**

Pressing this key causes the following to occur.

1. Displays the reference line at the midpoint between the maximum and minimum level points which are currently displayed.  
The reference line position cannot be changed if it was displayed by previous operation.
2. The current trace is saved in the memory as correction data.
3. The normalization calibration function is activated.

A normalization calibration is performed for the trace which is set to the Write mode. However, normalization calibration is performed for trace A only when both traces A and B are set to the Write mode, or when no trace is set to the Write mode.

---

**CAUTION:** *Make sure TG OUTPUT is connected to RF INPUT1 before executing the above normalization calibration.*

---

**Norm Corr ON/OFF**

Toggles the normalization function on or off.

ON: Executes a normalization using the correction data saved in the memory.

OFF: Disables the normalization function.

**Ref Line Position**

Allows you to change the position of the reference line.

**Freq Adj Auto**

For each RBW, the compensation value for tracking generator's output frequency is obtained to prevent the tracking error (a kind of level error caused by the difference in displacement between tracking generator's output frequency and spectrum analyzer's tuning frequency).

---

**CAUTION:** *Make sure TG OUTPUT is connected to RF INPUT1 before executing the above normalization calibration.*

---

*Freq Adj Manual*

For the current RBW, the compensation value for tracking generator's output frequency is set.

*TG Off*

Turns the tracking generator off.

## 3.3 Menu Function Descriptions

**3.3.28 TRACE Key (Trace Data)**

This section describes the menu displayed when the **TRACE** key is pressed.

<b><i>Write A(B)</i></b>	Sets the Write mode which updates the data in the A(B) memory for each sweep.
<b><i>View A(B)</i></b>	Sets the View mode which holds the data in the A(B) memory.
<b><i>Blank A(B)</i></b>	Sets the Blank mode which erases the trace.
<b><i>Detector</i></b>	Displays the Trc Det A(B) menu from which you can set the detection mode used.
<b><i>Normal</i></b>	Sets the normal mode which automatically detects positive or negative peak points for each trace point.
<b><i>Posi</i></b>	Sets the positive peak mode (when you select the Max Hold mode, the positive mode is automatically selected. Refer to <b><i>Max Hold A(B)</i></b> .)
<b><i>Nega</i></b>	Sets the negative peak mode.
<b><i>Sample</i></b>	Sets the sample mode.
<b><i>Trc Menu A/B</i></b>	Toggles between trace A and trace B.
<b><i>1/2, more</i></b>	Displays the Trc A(B) (2) menu.
<b><i>Max Hold A(B)</i></b>	Executes the Max Hold mode which displays the maximum value for each trace sample (when you select the Max Hold mode, the positive mode is automatically selected). Refer to <b><i>Posi</i></b> .
<b><i>AVG A(B)</i></b>	Displays the AVG A(B) menu.
<b><i>AVG A(B) ON/OFF</i></b>	Toggles the averaging function on or off. ON: Turns averaging on. OFF: Turns averaging off.
<b><i>AVG A(B) PSE/CONT</i></b>	Toggles between PSE (pause) and CONT (continue) while the averaging function is being used. PSE: Temporarily pauses averaging and displays the current averaging count. CONT: Resumes averaging from the point at which the pause occurred.

---

<i>AVG A(B) CONT/SGL</i>	Toggles between CONT (continuation) and SGL (single) modes. CONT: Continues to average using the current data which is used until the set averaging count is reached. SGL: Automatically switches to View mode as soon as the desired averaging count has been reached.
<i>Min Hold A(B)</i>	Sets the Min Hold mode which is used to display the minimum value for each trace sample.
<i>Store A(B) to B(A)</i>	Stores trace A(B) data as trace B(A).
<i>Trc Menu A/B</i>	Toggles between trace A and trace B.
<i>2/2, more</i>	Returns to the Trc A(B) menu.

### 3.3 Menu Function Descriptions

#### 3.3.29 TRIG Key (Trigger)

This section describes the menu displayed when the **TRIG** key is pressed.

<i>Free Run</i>	Performs sweeps automatically.
<i>Line</i>	Sweeps are synchronized with the AC power supply.
<i>Video</i>	Sweeps are synchronized with the video signal.
<i>Ext</i>	Sweeps are synchronized with the external signal.
<i>Slope +/-</i>	Switches between positive (+) and negative (-) polarities. This applies only to the video trigger and the external trigger.

### 3.4 Setting Values

This section shows the values of various settings used with the spectrum analyzer.

#### 3.4.1 Set Resolution

This section lists the center frequency set resolution and the frequency span set resolution for each frequency span.

**Table 3-1 Center Frequency Set Resolution vs. Frequency Span**

Frequency span	Center frequency set resolution
$100\text{MHz} \leq \text{Span}$	100kHz
$10\text{MHz} \leq \text{Span} < 100\text{MHz}$	10kHz
$1\text{MHz} \leq \text{Span} < 10\text{MHz}$	1kHz
$100\text{kHz} \leq \text{Span} < 1\text{MHz}$	100Hz
$50\text{kHz} \leq \text{Span} < 100\text{kHz}$	10Hz
$0\text{Hz} = \text{Span}$	10Hz

**Table 3-2 Frequency Span Set Resolution vs. Frequency Span**

Frequency span	Frequency span set resolution
$400\text{MHz} < \text{Span}$	1MHz
$40.0\text{MHz} < \text{Span} \leq 400.0\text{MHz}$	100kHz
$1.00\text{MHz} < \text{Span} \leq 40.00\text{MHz}$	10kHz
$100\text{kHz} < \text{Span} \leq 1.000\text{MHz}$	1kHz
$50.0\text{kHz} \leq \text{Span} \leq 100.0\text{kHz}$	100Hz



## 3.4 Setting Values

**3.4.2 Set Values for RBW, VBW and SWP Time**

When set to AUTO, the values for RBW, VBW and SWP Time are as listed in the table below.

**Table 3-3 Values for RBW, VBW and SWP Time (using AUTO)**

Frequency span	RBW	VBW	SWP Time (sec)
$60\text{MHz} \leq \text{Span}$	1MHz	1MHz	When RBW is set to 3kHz or more: $\text{RBW} \leq \text{VBW}$ $\text{SWP} = \text{SPAN}/(\text{RBW} \times \text{RBW} \times 0.5)$ $\text{RBW} > \text{VBW}$ $\text{SWP} = \text{SPAN}/(\text{RBW} \times \text{VBW} \times 0.5)$  When RBW is set to 1 kHz: $\text{SPAN} < 101\text{kHz}$ $\text{SWP} = 500\text{msec}$ $\text{SPAN} \geq 101\text{kHz}$ $\text{SWP} = \text{two times the value obtained by using the formula above.}$
$20\text{MHz} \leq \text{Span} < 60\text{MHz}$	300kHz	100kHz	
$6\text{MHz} \leq \text{Span} < 20\text{MHz}$	100kHz	100kHz	
$2\text{MHz} \leq \text{Span} < 6\text{MHz}$	30kHz	10kHz	
$300\text{kHz} \leq \text{Span} < 2\text{MHz}$	10kHz	10kHz	
$100\text{kHz} \leq \text{Span} < 300\text{kHz}$	3kHz	1kHz	
$50\text{kHz} \leq \text{Span} < 100\text{kHz}$	1kHz	1kHz	

### 3.4.3 Factory Defaults

The table below lists the factory defaults (for both the analyzer parameters and settings). These values are used when the **SHIFT** and **CONFIG (PRESET)** keys are pressed.

**Table 3-4 Factory Defaults**

Parameter	Factory defaults
Center frequency	1.5GHz
Frequency span	3GHz
Reference level	0dBm
Sweep time	AUTO 50ms
Resolution bandwidth (RBW)	AUTO 1MHz
Video bandwidth (VBW)	AUTO 1MHz
Input attenuator	AUTO 10dB
Trigger mode	Free Run
Trace mode	A Write B Blank
Detector mode	A Normal B Normal
Marker	OFF
Line	OFF
Window	OFF
Title function	OFF
Vertical graduation	10dB/div

---

### 3.4 Setting Values

#### 3.4.4 Defaults Configuration Values

These are the default settings used when the *Defaults Config* softkey is pressed.

**Table 3-5 Values for Default Config**

Parameter	Default Setting
Copy destination setting	Printer
Printer type	PCL
Screen output mode	GRAY SCALE MODE
GPIB address	8
Baud rate	9600bps
Data length	8
Stop bit length	1
Parity bit type	None
XON/XOFF signal output	ON
Bit map file number	1
Date display	ON
Date display mode	Month/day/time

## 4 REMOTE PROGRAMING

### 4.1 GPIB Remote Programming

The spectrum analyzer is equipped with a GPIB (General Purpose Interface Bus) that complies with IEEE Standard 488.1-1978. This bus allows you to attach and use an external device to remotely control the spectrum analyzer.

#### 4.1.1 GPIB

The GPIB is a high-performance interface bus used to connect measuring instruments to a computer. IEEE Standard 488.1-1978 defines the operations of the GPIB. Since the GPIB has a bus-configured interface, connected devices are designated by assigning them a specific address. You can connect up to 15 devices in parallel using a single bus. GPIB devices perform one or more of the following functions:

- **Talker** Sends data to the bus. Only one active talker can exist on the GPIB bus.
- **Listener** Receives data from the bus. Multiple active listeners can exist on the GPIB bus.
- **Controller** Specifies which devices are designated as “talkers” or “listeners”. Only one active controller can operate on the GPIB bus. Controllers used to control IFC and REN messages are referred to as system controllers.

When there are multiple controllers attached to the bus, the system controller becomes the active controller by default. Other devices that can act as controllers operate as addressable devices when the system is activated.

The TCT (Take Control) interface message is used to set a controller other than the system controller as the active controller. After this setting is made, the system controller becomes inactive.

The controller controls the entire system by sending interface messages or device messages to each measuring instrument. The functions of the messages are:

- **Interface message:** messages used to control the GPIB bus
- **Device message:** messages used to control specific devices

#### 4.1.2 GPIB Setup

##### (1) Connecting the GPIB

The following figure shows the standard GPIB connector and how it can be connected in parallel, or “stacked” with other connectors. Attach the GPIB connectors and secure them by tightening the screws to prevent them from coming apart during use.

#### 4.1 GPIB Remote Programming

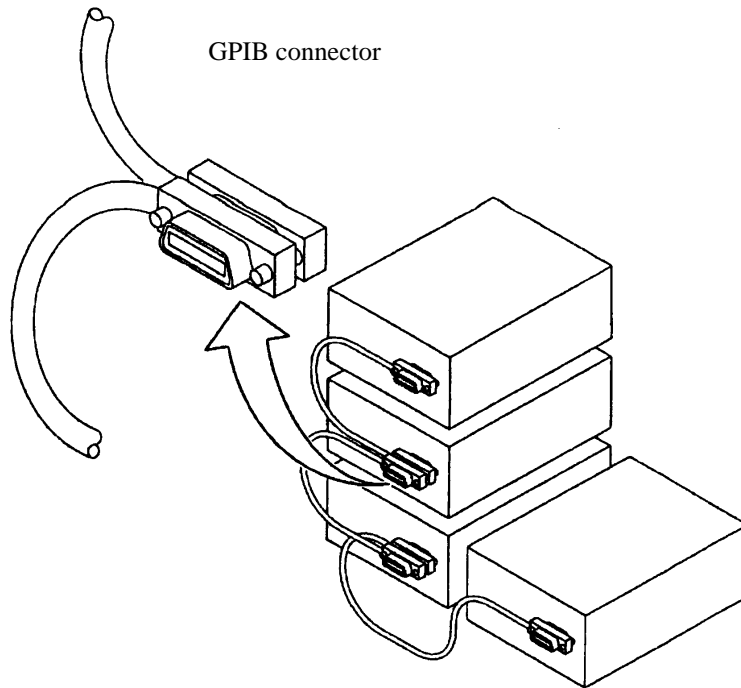

The following conditions should be observed when using a GPIB interface:

- The total GPIB cable length in a single bus system must not be more than 20m (you can calculate the current cable length using the formula total length =  $n \times 2m$ , where,  $n$  is the number of devices to be connected, including the GPIB controller).
- No more than 15 devices can be connected to a single bus system.
- There are no restrictions concerning the method of connection between cables. However, no more than three GPIB connectors should be connected to a single device, since more than this may damage the connector mounting due to excessive strain.

(Example) The total cable length in a system with five devices should be 10m or less ( $2m \times 5$  devices = 10m). There is no restriction on the length of the cables between the individual devices as long as the total length does not exceed 10m. However, if you connect 10 devices or more, make sure that at least some of the cables attaching the devices are less than 2m so that the total is less than 20m.

##### (2) Setting the GPIB Address

Use the following procedure to set the GPIB address for the spectrum analyzer:

1. Press **CONFIG** and **GPIB**.  
This displays the GPIB menu.
2. Press **Address**.  
The current GPIB address is displayed in the active area.
3. Use the data knob, the step keys, or the numeric keys to set the GPIB address as required.
4. Press **ENTER (Hz)** to set the address.

## (3) Turning the display off

If the screen display is turned off, the speed of measurements made using GPIB control increases.

1. Press **CONFIG** and **GPIB**.  
The GPIB menu is displayed.
2. Press **Display ON/OFF**.  
OFF is selected, and all indications except for the trace are removed.

### 4.1.3 GPIB Interface Functions

Code	Description
SH1	Source handshake
AH1	Acceptor handshake
T6	Basic talker, serial polling, listener-specified talker cancel
TE0	Extended talker (not available)
L4	Basic listener function, talker-specified listener cancel
LE0	Extended listener (not available)
SR1	Service request function
RL1	Remote, local, local lockout
PP0	Parallel polling (not available)
DC1	Device clear
DT0	Device trigger (not available)
C0	System controller (not available)
E1	Using open-collector bus driver

### 4.1.4 Responses to Interface Messages

The IEEE Standard 488.1-1978 defines how the spectrum analyzer responds to interface messages. The responses are described in this section.

For information on how to send interface messages to the spectrum analyzer, refer to the instruction manual of the controller you are using.

## (1) Interface Clear (IFC)

The IFC message is transmitted directly to the spectrum analyzer through a signal line. The message allows the spectrum analyzer to stop the operation of the GPIB bus. Although all input/output operation is stopped, the input/output buffer is not cleared. Note that the DCL is used to clear the buffer.

## (2) Remote Enable (REN)

The REN message is transmitted directly to the spectrum analyzer through a signal line. If the spectrum analyzer is specified as a listener when the message is true, the spectrum analyzer is in remote mode. The spectrum analyzer remains in remote mode until the GTL message is received, REN becomes false, or you press the **LOCAL** key.

When the spectrum analyzer is in local mode, it ignores all received data, and key inputs (except for LOCAL key input) and when the spectrum analyzer is in LOCAL LOCKOUT mode, it ignores all key input.

#### 4.1 GPIB Remote Programming

(3) Serial Polling Enable (SPE)

When the spectrum analyzer is receiving a message from an external device, it is in serial polling mode. If the spectrum analyzer is specified as a talker in this mode, it sends status bytes instead of normal messages. The spectrum analyzer remains in the serial polling mode until the SPD (Serial Polling Disable) message or the IFC message is received.

When the spectrum analyzer sends an SRQ (Service Request) message to the controller, bit 6 (RQS bit) of the response data is set to 1 (true). When the spectrum analyzer has finished sending this message, the RQS bit reverts to 0 (false). The SRQ message is sent directly through a signal line.

(4) Device Clear (DCL)

When the spectrum analyzer receives a DCL message, it performs the following actions:

- Clears the input and output buffers.
- Resets syntax analysis, execution control, and response data generation.
- Cancels all commands that prevent the remote command from being executed next.
- Cancels commands that are paused to wait for other parameters.

When the spectrum analyzer receives the DCL message, it does not do the following:

- Changes data set or stored in the spectrum analyzer.
- Interrupt front panel operation.
- Modify or interrupt any spectrum analyzer operations being executed.
- Change any status bytes other than MAV (MAV becomes 0 when the output buffer is cleared).

(5) Selected Device Clear (SDC)

The SDC message operates in the same manner as the DCL message. However, it is executed only when the spectrum analyzer is a listener. In other cases, the SDC message is ignored.

(6) Go to Local (GTL)

The GTL message puts the spectrum analyzer into local mode. In local mode, all the operations normally accessible from the front panel are available.

(7) Local Lockout (LLO)

The LLO message puts the spectrum analyzer in the local lockout mode. If the spectrum analyzer is set to the remote mode when this is done, all operations normally available from the front panel are disabled (note that in the normal remote mode, you can perform front panel operations using the **LOCAL** key).

You can use one of the following three methods to set the spectrum analyzer to local mode from the local lockout mode:

- Send a GTL message to the spectrum analyzer
- Set the REN message to false (the local lockout mode will be canceled)
- Turn the spectrum analyzer power off and on again

### 4.1.5 Message Exchange Protocol

The spectrum analyzer receives program messages from controllers or other devices through the GPIB bus and generates response data. Program messages include commands, queries (commands used to query response data) and data. The procedure used to exchange these commands, queries and data is explained in this section.

#### (1) GPIB Buffers

The spectrum analyzer is equipped with the following two buffers:

##### (a) Input Buffer

The input buffer is used to store data temporarily for command analysis (it has a length of 1024 bytes so an input larger than this is ignored.)

Use either of the following two methods to clear this buffer:

- Turn the spectrum analyzer power on.
- Execute DCL or SDC.

##### (b) Output Buffer

The output buffer is used to store data which is going to be read from the controller (1024 bytes).

Use either of the following two methods to clear this buffer:

- Turn the spectrum analyzer power on.
- Execute DCL or SDC.

#### (2) Message Exchange

GPIB control between a controller and a device consists of two main elements ; command message analysis (by the parser) and response data generation. These are explained below.

##### (a) Parser

The parser receives command messages in the order of reception from the input buffer, analyzes the syntax, and determines what the received command is.

##### (b) Response Data Generation

When the parser determines what the query is, the spectrum analyzer generates data in the output buffer in response (that is, to output data a query must be sent immediately before the data).



### 4.1.6 Command Syntax

Command programs for the spectrum analyzer are defined using the following format:

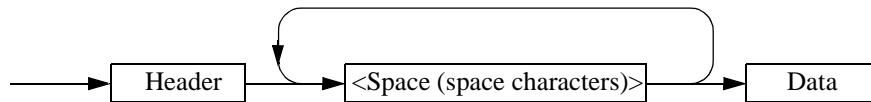

(1) Header

Two types of header are available: the common command header and the simple header. The common command header has an asterisk (\*) at the beginning of the mnemonic.

The simple header is a functionally independent command that has no hierarchical structure.

You can form a query command by attaching a "?" in the rear of a header.

(2) Space (Space Character)

You should separate the header from the data by one or more spaces, however spaces may be omitted.

(3) Data

When the command requires multiple data, data is separated by commas. A space may be inserted before or after each comma. For more information on data types, see Section 4.1.7 "Data Format."

(4) Writing Multiple Commands

You can write multiple commands by separating them with semicolons in one line.

### 4.1.7 Data Formats

The spectrum analyzer uses the following data formats for the input and output data.

(1) Numeric Data

There are three numeric data formats, any of which can be used for input.

Some commands add units to the data when the data is input.

The following shows the three numeric data formats.

- Integer type: NR1 format

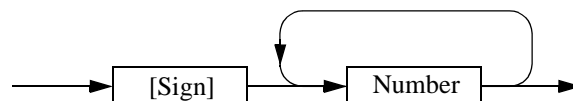

- Fixed-point type: NR2 format

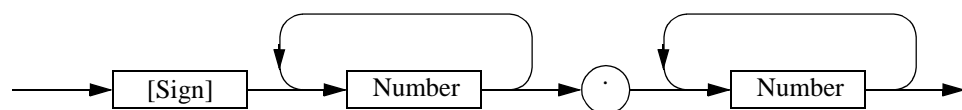

- Floating-point type: NR3 format

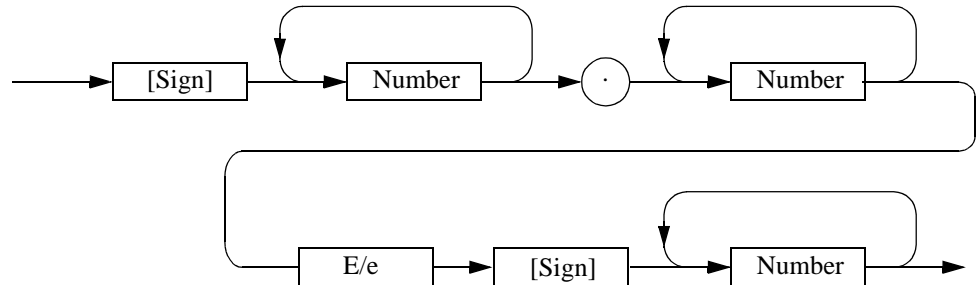

(2) Units

The table below lists the units that you can use.

Unit		
GZ	$10^9$	Frequency
MZ	$10^6$	Frequency
KZ	$10^3$	Frequency
HZ	$10^0$	Frequency
VOLT	$10^0$	Voltage
MV	$10^{-3}$	Voltage
UV	$10^{-6}$	Voltage
NV	$10^{-9}$	Voltage
MW	$10^{-3}$	Power
DB	$10^0$	dB correspondence
MA	$10^{-3}$	Electric Current
SC	$10^0$	Second
MS	$10^{-3}$	Second
US	$10^{-6}$	Second
PER	$10^0$	Percentage
%	$10^0$	Percentage

### 4.1.8 Status Bytes

The spectrum analyzer has a hierarchical status register structure which complies with IEEE Standard 488.2-1987. This is used to send information on the status of various aspects of a device to the controller. This section explains the status byte and event assignments operation models.

(1) Status Register

The spectrum analyzer uses the status register model defined by IEEE Standard 488.2-1987. This consists of a condition register, an event register and an enable register.

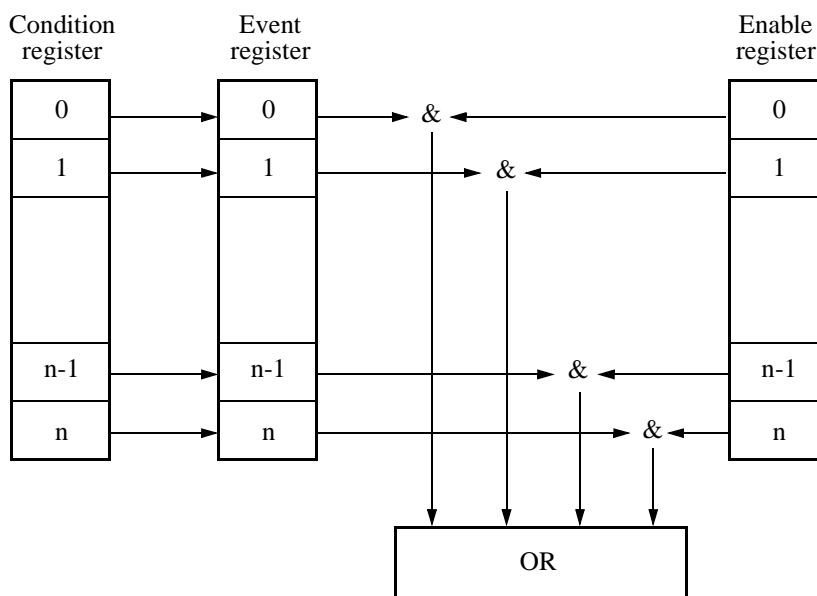

(a) Condition Register

The condition register continuously monitors the status of devices, showing their latest status. However, this register is used internally, so no data can be written into or read out from this register.

(b) Event Register

The event register latches and retains the status information from the condition register (in some cases, it retains status changes). Once the register is set, the condition is maintained until a query command reads out the information or the register is reset by means of the \*CLS command. No data can be written into the event register.

(c) Enable Register

The enable register specifies which bit in the event register is to be used as the valid status to generate a summary. The enable register is ANDed with the event register. The OR of the result of the AND operation is generated as a summary. The summary is written into the following status byte registers.

Any data can be written into the enable register.

The following three types of status registers are used in the spectrum analyzer:

- Status byte register
- Standard event register
- Standard operation status register

The arrangement of the status registers of the spectrum analyzer are shown in Figure 4-1. The status registers are shown in detail in Figure 4-2.

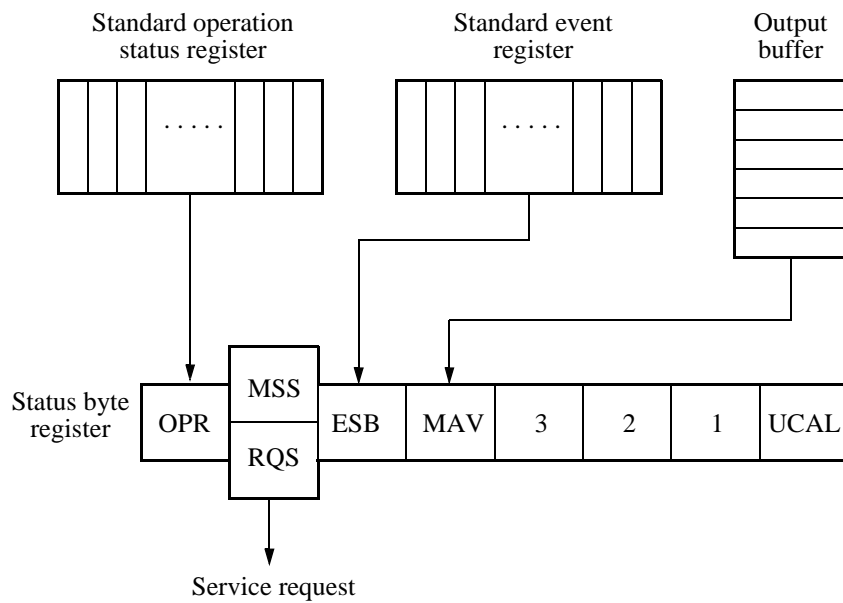

**Figure 4-1 Arrangement of the Three Status Registers**

4.1 GPIB Remote Programming

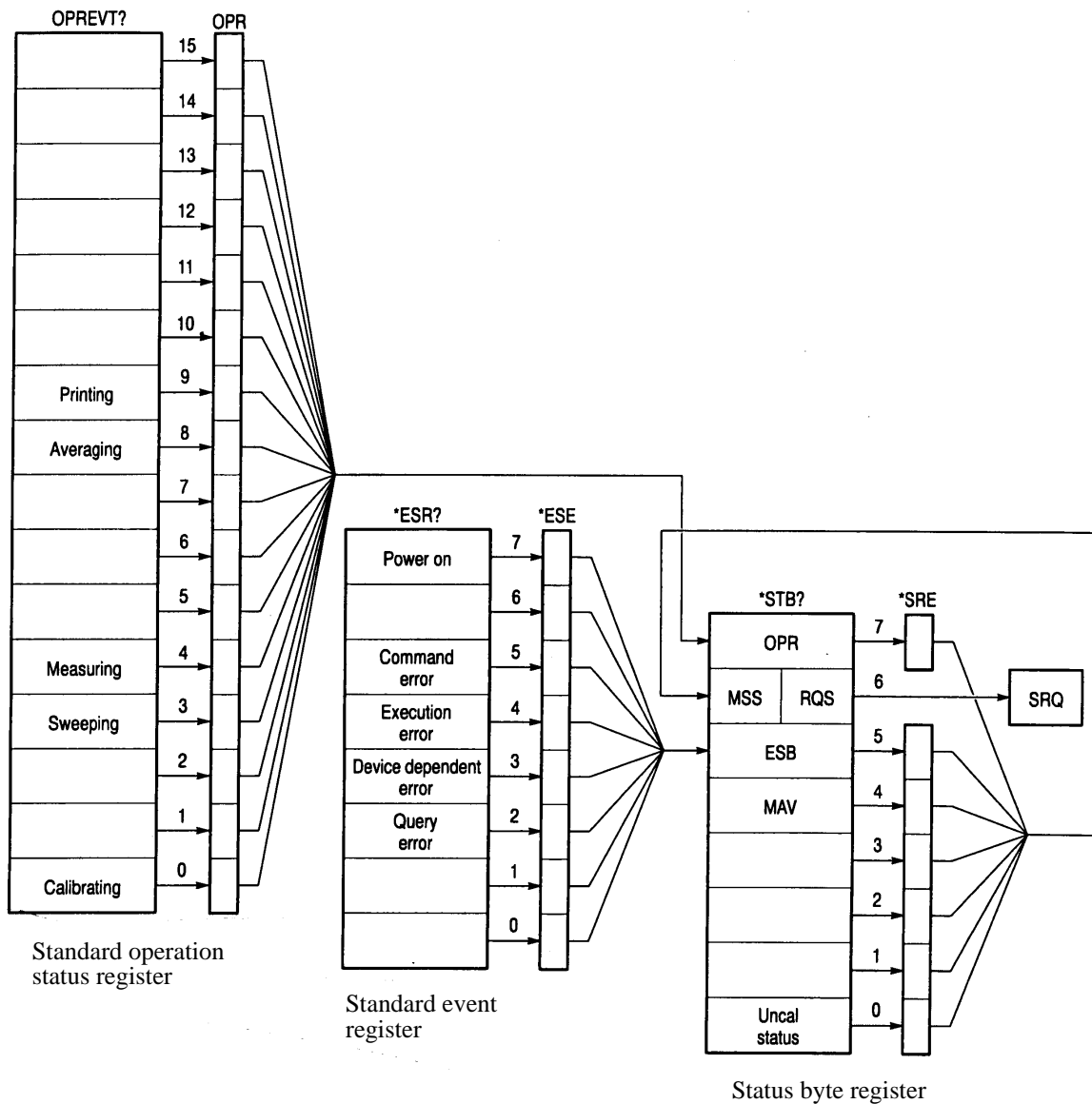

Figure 4-2 Details of the Three Status Registers

## (2) Event Enable Register

Each event register has an enable register to determine which bit is available. The enable register sets the corresponding bit in decimal value.

- Set of Service Request Enable Register: \*SRE
- Set of Standard Even Status Enable Register: \*ESE
- Set of Operation Status Enable Register: OPR

Example: Only the Measuring bit in the operation status register is available.

The OPR bit of the status byte register is set to 1 when the Measuring bit of the operation status register is set to one.

PRINT @8;"OPR16" (An example of the program in N88BASIC)

OUTPUT 708;"\*OPR16" (An example of the program for the HP200 and 300 series)

Example: The OPR (the summary of Operation Status Register) bit and ESB (the summary of Event Status Register) bit of the status byte register are available.

The MSS bit of the status byte register is set to 1 when the OPR bit or the ESB bit is set to one.

PRINT @8;"SRE160" (An example of the program in N88BASIC)

OUTPUT 708;"\*SRE160" (An example of the program for the HP200 and 300 series)

## (3) Standard Operation Status Register

Bit assignments for the event register (which represents the standard operation status) is listed below:

Bit	Functional definition	Description
15 to 10		This is always 0
9	Printing	This is set to 1 at the end of printing
8	Averaging	This is set to 1 when averaging is completed
7 to 5		This is always 0
4	Measuring	This is set to 1 at the end of sequence measurement
3	Sweeping	This is set to 1 when sweeping is completed
2 to 1		This is always 0
0	Calibrating	This is set to 1 when calibration data acquisition finishes

4.1 GPIB Remote Programming

(4) Status Byte Register

The status byte register summarizes the information from the status register. In addition, a summary of the status byte register is sent to the controller as a service request. As a result, this register operates slightly differently from the status register. This section explains the status byte register. The structure of the status byte register is shown in Figure 4-3.

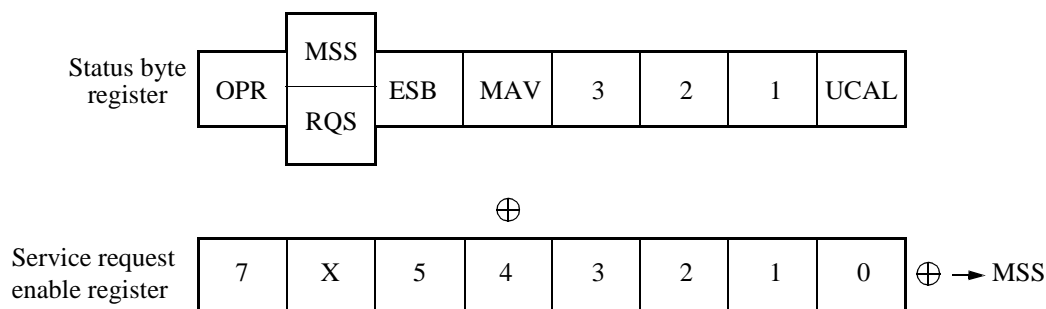

Figure 4-3 Structure of the Status Byte Register

This status byte register has the same functions as the status register, except for the following three points:

- The summary of the status byte register is written in bit 6 of the status byte register.
- Bit 6 of the enable register is always valid and cannot be changed.
- Bit 6 (MSS) of the status byte register writes the RQS of the service request.

The register responds to serial polling from the controller. On doing so, bits 0 to 5 and bit 7 of the status byte register and the RQS are read out, and then the RQS is reset to 0. Other bits are not cleared until each factor has been reset to 0.

When the \*CLS and S2 commands are executed, the status byte register, the RQS bit, and the MSS bit can be cleared. Consequently, the SRQ line is now false.

The table below explains the meanings of the bits in the status byte register.

Bit	Function	Description
7	OPR	The OPR bit is a summary of the standard operation status register
6	MSS	The RQS bit is true when the MSS bit of the status byte register is set to 1. The MSS bit is the summary bit for the entire status data structure.  The serial poll cannot read out the MSS bit. (However, the MSS bit is understood to be 1 when the RQS bit is 1.)  To read the MSS bit, use the common command *STB?. The *STB? command can read out bit 0 to 5 and bit 7 of the status byte register and the MSS bit. In this case, neither the status byte register nor the MSS bit can be cleared.  The MSS bit cannot become 0 until all the unmasked factors in the status register structure have been cleared
5	ESB	The ESB bit is a summary of the standard event register
4	MAV	Summary bit for the output buffer. This instrument does not use this bit.
3 to 1		This is always 0
0	UCAL	This is set to 1 when an signal level error occurs because the sweep is too fast

(5) Standard event register

The table below explains the meanings of the bits in the standard event register.

Bit	Functional definition	Description
7	Power on	This is set to 1 when the spectrum analyzer is switched on
6		This is always 0
5	Command Error	This is set to 1 when the parser finds a syntax error
4	Execution Error	This is set to 1 when the system fails to execute an instruction received as a GPIB command for some reason (such as out-of-range parameter)
3	Device Dependent Error	This is set to 1 when errors other than command errors, execution errors, or query errors occur
2	Query Error	This is set to 1 when no data exists or data has been deleted when the controller attempts to read out data from the spectrum analyzer
1	Request Control	Not supported in the spectrum analyzer
0	Operation Complete	Not supported in the spectrum analyzer



4.1 GPIB Remote Programming

**4.1.9 GPIB Command Codes**

The following tables list the GPIB commands by function.

- Listener Code Column:** An asterisk (\*) in the Listener Code Column indicates that the function requires numeric data together with the function code.  
 The sign /\*\*\*/ in the Listener Code Column indicates that the function requires character string data together with the function code.  
 [ON], [ON,] and numeric data are omissible.  
 String data such as file name, label and so on can receive characters, which are found after the command and prior to the delimiter, as input values. However, when data begins with a “/”, the characters between “/” and “/” are received as input.
- Output Format Column:** A comma (,) in the Output Format column indicates that multiple items are output.  
 ON/OFF or AUTO/MANUAL in the Output Format column indicates that the code outputs 1 or 0, respectively.  
 All frequencies are in hertz (Hz), and all times are in seconds. Levels are output in the currently displayed unit.

**Table 4-1 Frequency**

Function	Listener Code	Talker Request	
		Code	Output Format
Center frequency	CF*	CF?	Center frequency
CF Step size	CS*	CS?	CF Step frequency
CF Step AUTO	CA	CA?	0:Manual/ 1:Auto
Start frequency	FA*	FA?	Start frequency
Stop frequency	FB*	FB?	Stop frequency
Frequency span	SP*	SP?	Span frequency
Full span	FS	—	—
Zero span	ZS	—	—
Peak zoom	PKZOOM	—	—
Last span	LTSP	—	—
	LSPAN	—	—

Table 4-2 Level

Function	Listener Code	Talker Request	
		Code	Output Format
Reference level	RL*	RL?	Reference level
Attenuator	AT*	AT?	ATT level
Attenuator auto	AA	AA?	0:Manual/ 1:Auto
Input impedance			
50Ω	OHM 50	OHM?	0: 50ohm 1: 75ohm
75Ω	OHM 75		
XdB/div	DD*	DD?	0: 10dB 1: 5dB 2: 2dB 3: 1dB
Linear X1	LL1	---	---
Level offset	RO*, (RON*)	RO?	Level
ON	RO*, (RON*)	ROON?	0:OFF 1:ON
OFF	ROF		

Table 4-3 Unit

Function	Listener Code	Talker Request	
		Code	Output Format
Displayed unit	---	UNIT?	See *1.
	---	UN?	See *1.
dBm	AUNITS DBM	AUNITS?	See *1.
	KSA	---	---
	UB	---	---
dBmV	AUNITS DBMV	AUNITS?	See *1.
	KSB	---	---
	UM	---	---
dBμV	AUNITS DBUV	AUNITS?	See *1.
	KSC	---	---
	UU	---	---
Volts	AUNITS V	AUNITS?	See *1.
	KSD	---	---
Watts	AUNITS W	AUNITS?	See *1.

\*1 0: dBm / 1: dBm V / 2: dBμ V / 5: V / 6: W

4.1 GPIB Remote Programming

**Table 4-4 Sweep Mode**

Function	Listener Code	Talker Request	
		Code	Output Format
Sweep mode Normal <hr/> Single	CONTS	SWM?	0:Normal & Full 1:Normal & Window 20:Single & Full 21:Single & Window
	SN		
	SI		
	SNGLS		
Reset & Start (Take sweep)	TS	---	---
Reset & Start	SR	---	---

**Table 4-5 Sweep Time**

Function	Listener Code	Talker Request	
		Code	Output Format
Sweep time	SW*	SW?	Sweep Time
	ST*	ST?	Sweep Time
Sweep auto	AS	AS?	0:Manual/ 1:Auto
Gate Sig External ON <hr/> OFF	GEX1	GEXON?	0:OFF 1:ON
	GEX0		

**Table 4-6 Bandwidth**

Function	Listener Code	Talker Request	
		Code	Output Format
RBW	RB*	RB?	RBW frequency
RBW auto	BA	BA?	0:Manual/ 1:Auto
VBW	VB*	VB?	VBW frequency
VBW auto	VA	VA?	0:Manual/ 1:Auto
Couple all auto	AL	AL?	0:Manual/ 1:Auto

Table 4-7 Marker

Function	Listener Code	Talker Request	
		Code	Output Format
Marker ON	MN* (*1)	MN?	0: OFF 1: Normal 2: Delta
Marker frequency	---	MF?	Marker frequency (*2)
Marker level	---	ML?	Marker level (*2)
Frequency + Level	---	MFL?	MKR Frequency, Level (*2)
Marker OFF	MKOFF	---	---
	MO	---	---
Normal marker (Delta Marker OFF)	MKN*	---	---
	MK*	---	---
Delta Marker ON	MKD*	---	---
	MT*	---	---
Normal marker absolute value	---	---	---
	Frequency	---	MDF1?
Level	---	MDL1?	Normal MKR level
Delta marker absolute value	---	---	---
	Frequency	---	MDF2?
Level	---	MDL2?	Delta MKR level
Fixed delta marker	ON FXN*	FX?	0:OFF 1:ON
	OFF FXF		
Marker step size	MPM*	MPM?	Frequency
Marker step auto	MPA	MPA?	0:Manual/ 1:Auto
Signal track	ON SGN	SG?	0:OFF 1:ON
	OFF SGF		
Couple to Marker	ON CPLMK ON	CPLMK?	0:OFF 1:ON
	OFF CPLMK OFF		

\*1: When using the delta mode, enter the frequency relative to the normal marker.

\*2: When using the delta mode, the frequency or level difference is used.

## 4.1 GPIB Remote Programming

Table 4-8 Peak Search

Function	Listener Code	Talker Request		
		Code	Output Format	
Peak search	MKPK	---	---	
	PS	---	---	
NEXT peak	NXP	---	---	
NEXT peak left	NXL	---	---	
NEXT peak right	NXR	---	---	
MIN search	MIS	---	---	
MAX-MIN search	MMS	---	---	
Continuously peak ON	CPN	CP?	0:OFF 1:ON	
	OFF			CPF
Peak $\Delta Y$ div	DY*	DY?	$\Delta Y$ (real value)	
Peak range Normal	PSN	PKRNG?	0:ALL 1:Up 2:Low	
	Upper side			PSU
	Lower side			PSL

Table 4-9 Sound

Function	Listener Code	Talker Request	
		Code	Output Format
Sound ON (AM or FM)	SON	SD?	0: OFF 1: ON (AM) 2: ON (FM)
	(AM)	SAM	
	(FM)	SFM	
	OFF	SOF	
Volume	SDV*	SDV?	Volume (integer)
Pause time	PU*	PU?	Pause time (hour)
Squelch level	SQE [ON]*	SQE?	Squelch level 0: OFF 1: ON
	ON	SQE ON	
	OFF	SQE OFF	

Table 4-10 Marker →

Function	Listener Code	Talker Request	
		Code	Output Format
MKR→CF	MKCF	---	---
	MC	---	---
MKRA→CF	MTCF	---	---
MKR→REF	MKRL	---	---
	MR	---	---
Peak→CF	PKCF	---	---
Peak→REF	PKRL	---	---
MKRA→SPAN	MTSP	---	---
	DS	---	---
MKR→CF step	MKCS	---	---
	M0	---	---
MKRA→CF step	MTCS	---	---
	M1	---	---
MKR→MKR step	MKMKS	---	---
	M2	---	---
MKRA→MKR step	MTMKS	---	---
	M3	---	---
Marker→Trace A	MKTRACE TRA	MKTRACE?	0: Blank 1: A Trace 2: B Trace
Marker→Trace B	MKTRACE TRB		

Table 4-11 Trigger

Function	Listener Code	Talker Request	
		Code	Output Format
Trigger mode	---	TM?	0: Free run 1: Line 2: Video 5: Ext
FREE RUN	TM FREE	---	---
	FR	---	---
LINE Trigger	TM LINE	---	---
	LI	---	---
VIDEO Trigger	TM VID	---	---
	VI*	VI?	Level (integer)
External Trigger	TM EXT	---	---
	EX*	EX?	Level (real value)
Trigger slope +	TRIGSLP+	TRIGSLP?	0: + 1: -
-	TRIGSLP-		

## 4.1 GPIB Remote Programming

Table 4-12 Trace (1 of 2)

Function	Listener Code	Talker Request	
		Code	Output Format
Trace A	—	TA?	0: Write 1: View 2: Blank 3: Max Hold 4: Min Hold 5: Averaging
A write	AW	—	—
A view	AV	—	—
A blank	AB	—	—
A max hold	AM	—	—
A min hold	AMIN	—	—
A averaging times	AG*	AG?	Average times
Start	AGR	—	—
Stop	AGS	—	—
Pause	AGP	AGP?	0: Continue 1: Pause
Continue	AGC		
1 time	AGSGL	AGSGL?	0: Continuous 1:1 time
	AG1		
Continuous	AGCNT		
	AG0		
Trace B	—	TB?	0: Write 1: View 2: Blank 3: Max Hold 4: Min Hold 5: Averaging
B write	BW	—	—
B view	BV	—	—
B blank	BB	—	—
B max hold	BM	—	—
B min hold	BMIN	—	—
B averaging times	BG*	BG?	Average times
Start	BGR	—	—
Stop	BGS	—	—
Pause	BGP	BGP?	0: Continue 1: Pause
Continue	BGC		
1 time	BGSGL	BGSGL?	0: Continuous 1:1 time
	BG1		
Continuous	BGCNT		
	BG0		
Store A→B	BSTORE	—	—
Store B→A	ASTORE	—	—

Table 4-12 Trace (2 of 2)

Function	Listener Code	Talker Request	
		Code	Output Format
Detector mode A Normal  Positive  Negative  Sample	DET NRM	DET? DM?	0: Normal 1: Positive 2: Negative 3: Sample
	DTN		
	DET POS		
	DTP		
	DET NEG		
	DTG		
	DET SMP		
	DTS		
Detector mode B Normal  Positive  Negative  Sample	DETB NRM	DETB? DMB?	0: Normal 1: Positive 2: Negative 3: Sample
	DTBN		
	DETB POS		
	DTBP		
	DETB NEG		
	DTBG		
	DETB SMP		
	DTBS		

Table 4-13 Display

Function	Listener Code	Talker Request	
		Code	Output Format
Display line	DL*, (DLN*)	DL?	Level
ON	DL*, (DLN*)	DLON?	0: OFF
OFF	DLF		1: ON
Reference line	RLN*	RLN?	Level
ON	RLN*	RLON?	0: OFF
OFF	RLF		1: ON
Window ON	WDO ON	WDO?	0:OFF/ 1:ON
	WN	WN?	
OFF	WDO OFF		
	WF		
Window center position	WLX*	WLX?	Frequency
width	WDX*	WDX?	Frequency
start position	WTF*	WTF?	Frequency
exit position	WPF*	WPF?	Frequency
Zoom in	WDOZM IN	---	---
out	WDOZM OUT	---	---
Window sweep ON	WDOSWP ON	---	---
OFF	WDOSWP OFF	---	---
Title ON	LON/***/	LB?	Label
OFF	LOF		



## 4.1 GPIB Remote Programming

**Table 4-14 Pass-Fail Judgment**

Function	Listener Code	Talker Request	
		Code	Output Format
Pass/Fail ON	PFN	PFON?	0: OFF
OFF	PFF		1: ON
Limit Upper position	WUL*	WUL?	Level
Limit Lower position	WLL*	WLL?	Level
Test result	—	PCM?	0:Fail/ 1:Pass

**Table 4-15 Measurement**

Function	Listener Code	Talker Request	
		Code	Output Format
Noise/Hz	NI*	NI?	Frequency
dBm/Hz	NIM	NION?	0: OFF
dB $\mu$ V/ $\sqrt{\text{Hz}}$	NIU		1: dBm/Hz
dBc/Hz	NIC		2: dB $\mu$ V/ $\sqrt{\text{Hz}}$
OFF	NIF		3: dBc/Hz
Noise/Hz value	—	NIRES?	Level
XdB down width	MKBW*	MKBW?	Level
XdB down	XDB	—	—
XdB down left	XDL	—	—
XdB down right	XDR	—	—
XdB relative	DC0	DC?	0:Relative
abs. left	DC1		1:Absolute (left side)
abs. right	DC2		2:Absolute (right side)
Continuous dB down ON	CDB ON	CDB?	0:OFF/ 1:ON
OFF	CDB OFF		
3rd Order meas	PKTHIRD	—	—
AM Modulation (% AM)	—	AMMOD?	%
ON	AMMOD [ON]	AMMODON?	0: OFF
OFF	AMMOD OFF		1: ON

**Table 4-16 Auto Tuning**

Function	Listener Code	Talker Request	
		Code	Output Format
Auto Tune	TN	—	—

**Table 4-17 Counter**

Function	Listener Code	Talker Request	
		Code	Output Format
Resolution 1kHz	CN0	CNORD?	0: 1kHz 1: 100Hz 2: 10Hz 3: 1Hz
100Hz	CN1		
10Hz	CN2		
1Hz	CN3		
Counter ON	COUNT ON	COUNT?	0: OFF 1: ON
OFF	COUNT OFF		
	CNF		
Counter value	—	CNRES?	Frequency

**Table 4-18 Power Measurement**

Function	Listener Code	Talker Request	
		Code	Output Format
Channel power	PWCH	PWCH?	Level
		PWCHON?	0: OFF/ 1: ON
Total power	PWTOTAL	PWTOTAL?	Level
		PWTOTALON?	0: OFF/ 1: ON
Average power	PWAvg	PWAvg?	Level
		PWAvgON?	0: OFF/ 1: ON
Carrier power	PWCARR	PWCARR?	Level
Average time	PWTM*	PWTM?	1-999
Power OFF	PWM	—	—

**Table 4-19 OBW**

Function	Listener Code	Talker Request	
		Code	Output Format
OBW execution (%)	OBW [ON]*	OBW?	Center, OBW
ON	OBW [ON]	OBWON?	0: OFF 1: ON
OFF	OBW OFF		
OBW percent	OBW PER*	OBWPER?	OBW %

## 4.1 GPIB Remote Programming

Table 4-20 ACP

Function	Listener Code	Talker Request	
		Code	Output Format
ACP execution	ACP	ACP?	Lower, Upper
	ON	ACP	0: OFF
	OFF	ACP OFF	1: ON
ACP CS	ADCH*	ADCH?	Channel Spacing (adjacent)
ACP BS	ADBS*	ADBS?	Specified Bandwidth
ACP (alternate)	ADCHSC[ON]*	ADCHSC?	Channel Spacing (alternate)
	—	ACPSC?	Lower 1, Upper 1, Lower 2, Upper 2
	ON	ADCHSC[ON]	0: OFF
	OFF	ADCHSC OFF	1: ON
ACP graph	ON	ADG [ON]	0: OFF
	OFF	ADG OFF	1: ON

Table 4-21 TG (Option 74)

Function	Listener Code	Talker Request	
		Code	Output Format
TG	ON	TG?	0: OFF
	OFF	TGF	1: ON
TG level	TGL*	TGL?	TG level
TG freq. adjust	TGM*	TGM?	Frequency
TG freq. adjust auto	TGA	—	—
Execute Normalize	NORM EX	—	—
Normalize	ON	NORM?	0: OFF
	OFF	NORM OFF	1: ON

Table 4-22 EMC

Function	Listener Code	Talker Request			
		Code	Output Format		
EMC trace direction					
QP	EMCDET QP	EMCDET?	0:Normal 1:QP 3:PEAK		
Peak	EMCDET PEAK				
Normal	EMCDET NRM				
QP BW 9kHz	QP1	QPAUTO? QA?	0:AUTO 2:9kHz 3:120kHz		
120kHz	QP2				
AUTO	QPAUTO QA				
Antenna selection		ANT?	0:OFF 1:Dipole 2:Log-periodic 3:Biconical 4:Bi-log 5:User correctable		
Dipole (TP1722)	ANT0 AN0				
Log-periodic (UHALP9107)	ANT1 AN1				
Biconical (BBA9106)	ANT2 AN2				
Bi-log (EMCO3142)	ANT3 AN3				
User correctable	ANT4 AN4				
Antenna OFF	ANT OFF AF				
User-definable					
Table input	CRIN *,* (*1)			—	—
Table deletion	CRDEL			—	—
Antenna mode	CR ANT	CR?	0: Antenna 1: Level		
Level mode	CR LVL				

(\*1): When specifying the parameters, enter the frequency followed by the level.

## 4.1 GPIB Remote Programming

Table 4-23 Calibration

Function	Listener Code	Talker Request	
		Code	Output Format
CAL ALL	CLA	---	---
Total gain	CLG	---	---
IF step AMP	CLSTEP	---	---
	IT1	---	---
RBW switch	CLRBW	---	---
	IT2	---	---
Log linearity	CLLOG	---	---
	IT3	---	---
AMPTD MAG	CLMAG	---	---
	IT4	---	---
PBW	CLPWB	---	---
	IT6	---	---
CAL level	CLN*	CL?	Level
ON	CLN*	CLON?	0: OFF
OFF	CLF		1: ON
f correction ON	FC ON	FC?	0:OFF/ 1:ON
	FCN		
	OFF		
	FCF		
CAL correction ON	CC ON	CC?	0:OFF/ 1:ON
	CCN		
	OFF		
	CCF		

Table 4-24 Data Save/Recall (1 of 2)

Function	Listener Code	Talker Request	
		Code	Output Format
Save register	SV1	---	---
	SV2	---	---
	SV3	---	---
	SV4	---	---
	SV5	---	---
	SV6	---	---
	SV7	---	---
	SV8	---	---
	SV9	---	---
	SV10	---	---
Save file	SV FD: file name (* )	---	---

\*: "FD:" means the floppy disk drive.

Figure 4-24 Data Save/Recall (2 of 2)

Function	Listener Code	Talker Request			
		Code	Output Format		
Delete register	DEL1	---	---		
	DEL2	---	---		
	DEL3	---	---		
	DEL4	---	---		
	DEL5	---	---		
	DEL6	---	---		
	DEL7	---	---		
	DEL8	---	---		
	DEL9	---	---		
	DEL10	---	---		
Delete file	DEL FD: file name (* )	---	---		
Recall register	RC1	---	---		
	RC2	---	---		
	RC3	---	---		
	RC4	---	---		
	RC5	---	---		
	RC6	---	---		
	RC7	---	---		
	RC8	---	---		
	RC9	---	---		
	RC10	---	---		
Recall file	RC FD: file name (*1)	---	---		
Save item	Setup	ON	SVSET ON	SVSET?	0: OFF 1: ON
		OFF	SVSET OFF		
	Trace	ON	SVTRC ON	SVTRC?	0: OFF 1: ON
		OFF	SVTRC OFF		
	Antenna correction	ON	SVANT ON	SVANT?	0: OFF 1: ON
		OFF	SVANT OFF		
Trace level	ON	SVLVL ON	SVLVL?	0: OFF 1: ON	
	OFF	SVLVL OFF			
Normalize Data (*2)	ON	SVNRM ON	SVNRM?	0: OFF 1: ON	
	OFF	SVNRM OFF			

(\*1) : "FD:" means the floppy disk drive.

(\*2) : Available only when equipped with Option 74.

## 4.1 GPIB Remote Programming

Table 4-25 Hard Copy

Function	Listener Code	Talker Request	
		Code	Output Format
Command selection			
ESC/P	PRTCMD ESC	PRTCMD?	0: PCL 1: ESCP 2: ESCP-R
ESC/P Raster	PRTCMD ESCPR		
PCL	PRTCMD PCL		
Print size			
Large	PSIZE LRG	PSIZE?	0: Small 1: Large
Small	PSIZE SML		
Mode selection			
Gray	HCIMAG GRY	HCIMAG?	0: Gray 1: B&W
Monochrome	HCIMAG MON		
Device selection			
Printer	HCDEV PRT	HCDEV?	0: Printer 1: Floppy
Floppy	HCDEV FDD		
Execution	HCOPY	—	—

Table 4-26 Preset

Function	Listener Code	Talker Request	
		Code	Output Format
Preset	IP	—	—

Table 4-27 Trace Data I/O

Function	Listener Code	Talker Request	
		Code	Output Format
A trace I/O ASCII	TAA	TAA?	ASCII Trace
binary	TBA	TBA?	BIN Trace
B trace I/O ASCII	TAB	TAB?	ASCII Trace
binary	TBB	TBB?	BIN Trace

Table 4-28 Status Bytes

Function	Listener Code	Talker Request	
		Code	Output Format
Status bytes clear	*CLS	—	—
STB readout	—	*STB?	0-255
SRE Read/Write	*SRE*	*SRE?	0-255
ESR readout	—	*ESR?	0-255
ESE Read/Write	*ESE*	*ESE?	0-255
OSR readout	—	OPREVT?	0-65535
OSER readout	OPR	OPR?	0-65535
SRQ interruption ON	S0	—	—
SRQ interruption OFF	S1	—	—
SRQ status clear	S2	—	—
Service request mask	RQS*	RQS?	0-255

Table 4-29 Miscellaneous

Function	Listener Code	Talker Request	
		Code	Output Format
Delimiter			
CR LF<EOI>	DL0	---	---
LF	DL1	---	---
<EOI>	DL2	---	---
CR LF	DL3	---	---
LF<EOI>	DL4	---	---
↑ step up	UP	---	---
↓ step down	DN	---	---
knob-up coarse	CU	---	---
fine	FU	---	---
knob-down coarse	CD	---	---
fine	FD	---	---
Indication ON	ANNOT ON	ANNOT?	0: OFF 1: ON
OFF	ANNOT OFF		
Date	SETDATE	SETDATE?	YYMMDD (for example: 980528)
Time	SETTIME	SETTIME?	HHMMSS (for example: 130530)
Device ID output	---	*IDN?	Manufacturer name, Model, 0, Revision (for example: ADVANTEST, R3131, 0, A00)
Self Test	---	*TST?	1 : CPU (*1) 2 : A/D 4 : Lock Detector 8 : Total Gain 16: Cal Signal 32: RF ATT 64: Variable Gain AMP 128: IF Step AMP 256: RBW SWB
Error number output	---	ERRNO?	Integer (*2)

(\*1): When an error occurs, the corresponding bit OR value is the return value.

(\*2): See error number(s) listed in APPENDIX 1 ERROR MESSAGE.



**Table 4-30 Data Input**

Function	Parameter
Numeric value	0
	1
	2
	3
	4
	5
	6
	7
	8
	9
Decimal point	.
Minus sign	-
Plus sign	+
Exponent	EXP
	E
GHz	GZ
MHz	MZ
KHz	KZ
Hz	HZ
mW	MW
dB	DB
mA	MA
Second	SC
Millisecond	MS
	MSEC
Microsecond	US
	USEC
Nanosecond	NSEC
Enter	ENT
Volt	VOLT
Millivolt	MV
Microvolt	UV
Nanovolt	NV
%	PER
	%

### 4.1.10 Basic Programming

N88BASIC is used in PC9801 series and HP-BASIC is used in HP200 and 300 series.

- (1) Sample Programs for PC9801 series (GPIB address = 8).

**Example PC-1:** Master reset the device and set center frequency to 30 MHz.

```

10 ISET IFC:ISET REN      ' Execute interface clear and remote enable.
20 PRINT @8;"IP"         ' Execute interface master reset.
30 PRINT @8;"CF30MHZ"    ' Set center frequency to 30 MHz
40 STOP
50 END

```

**Example PC-2:** Set reference level to 87 dBmV, 5 dB/div and RBW to 100 kHz.

```

10 ISET IFC:ISET REN      '
20 PRINT @8;"UU RL87DB"   ' Set REF level to 87 dBμV
30 PRINT @8;"DD5DB"      ' Set 5 dB/div
40 PRINT @8;"RB100KZ"    ' Set RBW to 100 kHz
50 STOP
60 END

```

**Example PC-3:** Assign numeric value to variable.

```

10 ISET IFC:ISET REN      '
20 SPA=8:A=10:B=2:C=20    ' Assign a set value to each variable.
30 PRINT @SPA;"CF",A,"MZ" ' Set center frequency to 10 MHz
40 PRINT @SPA;"SP",B,"MZ" ' Set frequency span to 2 MHz
50 PRINT @SPA;"AT",C,"DB" ' Set ATT to 20 dB.
60 STOP
70 END

```

**Example PC-4:** Save set data to or recall it from register 5.

```

10 ISET IFC:ISET REN      '
20 TITLE$="R3131 SPECTRUM ANALYZER" ' Define a label.
30 PRINT @8;"CF30MZ SP1MZ DTP" ' Set each data.
40 PRINT @8;"LON/" +TITLE$ +"/" ' Label ON
50 PRINT @8;"SV5"        ' Save values in register 5.
60 PRINT @8;"CF1GZ SP200MZ" ' Change center frequency and
                             ' frequency span.
70 PRINT @8;"RC5"        ' Recall values from register 5.
80 STOP
90 END

```

## 4.1 GPIB Remote Programming

- (2) Sample Programs for HP200 and HP300 series (GPIB address = 1)

**Example HP-1:** Master reset the device and set center frequency to 30 MHz.

```

10  OUTPUT 701;"IP"
20  OUTPUT 701;"CF30MZ"
30  END

```

**Example HP-2:** Set reference level to -20 dBm (5 dB/div), resolution bandwidth to 100 kHz and detector mode to Posi.

```

10  OUTPUT 701;"RL-20DB"
20  OUTPUT 701;"DD5DB"
30  OUTPUT 701;"RB100KZ"
40  OUTPUT 701;"DTP"
50  END

```

**Example HP-3:** Set trigger mode to SINGLE and sweep time to 2 seconds, and position a marker at the maximum level for each sweep.

```

10  OUTPUT 701;"SI"
20  OUTPUT 701;"SW2SC"
30  OUTPUT 701;"SR"           ! Start sweep.
40  WAIT 2.5                 ! Wait for sweep end (or use service request).
50  OUTPUT 701;"PS"         ! Marker peak search
60  GOTO 30
70  STOP
80  END

```

**Example HP-4:** Set to MAX HOLD (A)

```

OUTPUT 701;"AM"           ! Set to DIRECT.

```

**Example HP-5:** Accessing the files.

```

OUTPUT 701;"RC5"         ! Recall the register 5.
OUTPUT 701;"RC/FD:FILE01.DAT/" ! Recall values from the card.

```

---

**NOTE:** The same format is used to access files with RC, DEL, SV commands.

---

### 4.1.11 Data Output Format (talker)

In order to output internal data such as measured data and set conditions, it is necessary to specify the data using the "xx?" command. This data is then output when the device is in the talker mode. Available output formats are as listed in the table below. The delimiter positioned at the end of data can be specified from 5 types (refer to "Others" in the GPIB code list). Once set, "xx?" command continues to be valid until it is changed.

	Output Format
Frequency	$\pm$ D.DDDDDDDDDDD <u>E±DD</u> <u>CR LF</u> ↑                    ↑                    ↑                    ↑ 1                    2                    3                    4 • Data size (1 to 3) is maximum 18 bytes, and the unit is Hz. Example) Specify "CF?" and output as center frequency.
Level	$\pm$ D.DDDDDDD <u>E±DD</u> <u>CR LF</u> ↑            ↑            ↑            ↑ 1            2            3            4 • Data size (1 to 3) is maximum 18 bytes, and the unit corresponds to each UNIT setting. Example) Specify "ML?" and output as marker level.
Time	$\pm$ D.DDD <u>E±DD</u> <u>CR LF</u> ↑    ↑    ↑    ↑ 1    2    3    4 • Data size (1 to 3) is maximum 20 bytes, and the unit is sec. Example) Specify "SW?" and output sweep time.
Constant	<u>DDDD</u> <u>CR LF</u> ↑            ↑ 2            4 • The maximum byte of the data size corresponds to the maximum size of the output data. Example) ON/OFF status is output or Averaging count is output.

<Supplement>

1= Sign (a space for plus sign; "-" for minus sign)

2= Mantissa of data

3= Exponent of data

4 = Delimiter (CR/LF in initial setting can be changed with "DLn" code.)

## 4.1 GPIB Remote Programming

- (1) Sample Programs for PC9801 series (GPIB address = 8)

**Example PC-5:** Output marker level (numerical variable)

```

10  ISET IFC:ISET REN          '
20  PRINT @8;"CF30MZ SP1MZ MK30MZ" ' Center frequency, frequency span, marker
                                     ON
30  PRINT @8;"ML?"            ' Marker level?
40  PRINT @8;ML                ' Read marker level.
50  PRINT "MARKER LEVEL=",ML   ' Display the result.
60  STOP
70  END

```

Sample result: MARKER LEVEL=-16.22

**Example PC-6:** Output center frequency (character variable)

```

10  ISET IFC:ISET REN          '
20  PRINT @8;"CF?"
30  INPUT @8;CF$               ' Read center frequency.
40  PRINT CF$                  ' Display the result.
50  STOP
60  END

```

Sample result: 30.000E+6

**Example PC-7:** Output level and its unit

```

10  ISET IFC:ISET REN          '
20  PRINT @8;"RL?"
30  INPUT @8;RE$               ' Read REF level.
40  PRINT @8;"UN?"
50  INPUT @8;UN                ' Read unit for level
60  PRINT RE$,":",UN           ' Display the result
70  STOP
80  END

```

Sample result: 0.0E+0:0

**Example PC-8:** Execute 6 dB down and then output frequency and level values (multiple items).

```

10  ISET IFC:ISET REN          '
20  PRINT @8;"CF30MZ SP20MZ"   ' Set center frequency and frequency span.
30  PRINT @8;"MKBW6DB PS XDB" ' Execute 6 dB down.
40  PRINT @8;"MFL?"           ' Read frequency and level for marker position
                                     at the same time.
50  INPUT @8;MF,ML
60  PRINT "MARKER FREQ=";MF;" :MARKER LEVEL=";ML
70  STOP
80  END

```

Sample result: MARKER FREQ=400000: MARKER LEVEL=1.16

**Example PC-9:** Execute OBW and output the result.

```

10  ISET IFC:ISET REN          '
20  PRINT @8;"CF30MZ"         ' Set individual data.
30  PRINT @8;"SP10MZ"
40  PRINT @8;"MK30MZ"
50  PRINT @8;"OBWPER 95%"     ' Set OBW%.
60  PRINT @8;"OBW"           ' Execute OBW.
70  INPUT @8;"OBW?"          ' Read the result of OBW.
80  INPUT @8;"FC,OBW"        ' Carrier frequency, and occupied bandwidth.
90  PRINT "OBW=";OBW;"Fc=";FC"
100 STOP
110 END

```

Sample result: OBW = 171000 : Fc = 2.503E+07

**Example PC-10:** Output level values for the maximum, 2nd and 3rd peak points of the signal.

```

10  ISET IFC:ISET REN          '
20  PRINT @8;"CF0MZ"         ' Set central frequency and frequency span
30  PRINT @8;"SP100MZ"
40  PRINT @8;"PS"
50  INPUT @8;"ML?"
60  INPUT @8;A                ' Read peak level.
70  PRINT @8;"NXP"
80  INPUT @8;"ML?"
90  INPUT @8;B                ' Read 2nd peak level.
100 PRINT @;"NXP"
110 INPUT @8;"ML?"
120 INPUT @8;C                ' Read 3rd peak level.
130 PRINT"1st PK=";A;"2nd Pk=";B;"3rd PK=";C
140 STOP
150 END

```

Sample result: 1st PK=-9.44:2nd PK=-10.06:3rd PK=-11.84

## 4.1 GPIB Remote Programming

- (2) Sample Programs for HP200 and HP300 series (GPIB address = 1)

**Example HP-6:** Output marker frequency (integral)

```
10  OUTPUT 701;"MF?"
20  ENTER 701;A
30  END
```

Sample result: A=1.8E+9

**Example HP-7:** Output center frequency (character string)

```
10  DIM A$[30]
20  OUTPUT 701;"CF?"
30  ENTER 701;A$
40  END
```

Sample result: A\$=1.234567E+9

**Example HP-8:** Output status of the unit.

```
10  OUTPUT 701;"UN?"
20  ENTER 701;A
30  END
```

Sample result: A=2(dBuV)

**Example HP-9:** Output frequency and level values for marker position at the same time (multiple values).

```
10  OUTPUT 701;"MFL?"
20  ENTER 701;Mf,MI
30  END
```

Sample result: Mf=1.8E+9 MI=-65.15

**Example HP-10:** With NEXT PEAK function, read 2nd and following 10 peak levels of the signal.

```
10  DIM MI(9)
20  OUTPUT 701;"PS"
30  FOR I=0 to 9
40  OUTPUT 701;"NXP"
50  OUTPUT 701;"ML?"
60  ENTER 701;MI(I)
70  NEXT I
80  END
```

Sample result: MI(0)=-55.01 MI(1)=-58.22....MI(9)=-70.26

### 4.1.12 Trace Data I/O

Trace data on the screen includes data for 501 points on the frequency axis. To input and output this data, it is necessary to transfer data in order for all 501 points, starting from the left most point (start frequency). Each point level is expressed by an integer from 512 to 3392 (however, when the trace exceeds the upper limit of the vertical scale, a value greater than 3392 is transferred).

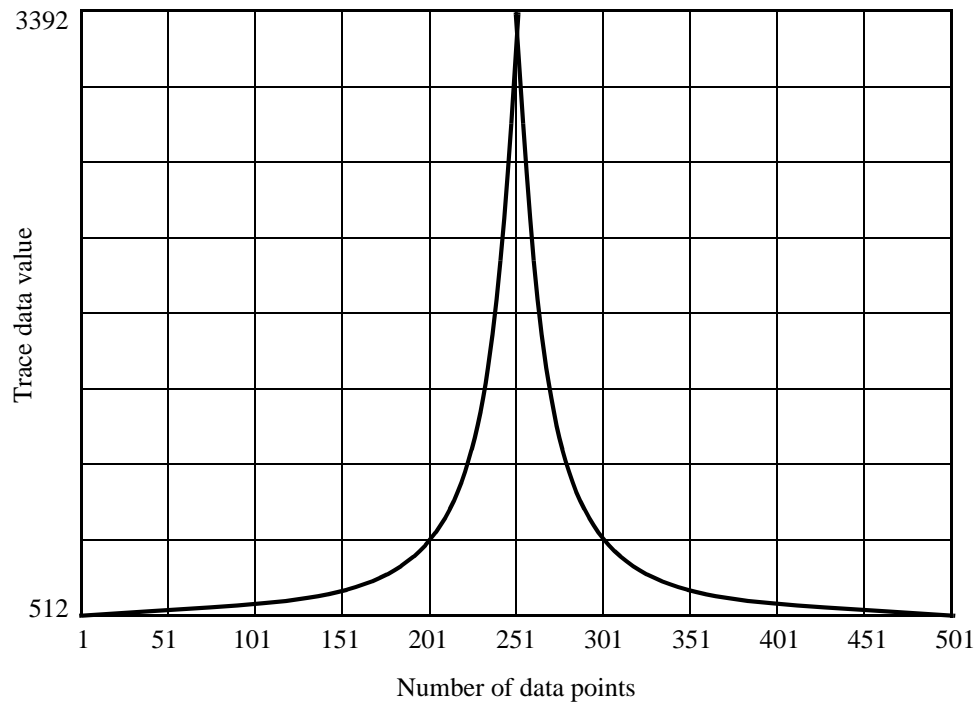





**Example PC-12:** Output data from memory A in binary format.

```

10  ISET IFC:ISET REN          ' Execute interface clear and remote enable.
20  DIM TR(501)
30  PRINT @8;"DL2DTG"         ' Set to negative detector.
40  PRINT @8;"TBA?"           ' Specify binary output from memory A.
50  WBYTE &H3F,&H5F, &H3E, &H48; ' Cancel listener and address PC9801 to #30 as
60                                     ' listener and this device to #8 as talker.
70  FOR I=0 TO 500
80  RBYTE;UP,LO                ' Repeat fetching data, high-order bytes for 1501
90  TR(I)=UP*256+LO            ' Points and then low-order bytes for 1001 points
100 PRINT I;"=";TR(I)
110 NEXT I
120 WBYTE&H3F, &5F;           ' Cancel listener and talker.
130 STOP
140 END

```

**Example PC-13:** Input data to memory A in ASCII format.

```

10  ISET IFC:ISET REN          ' Execute interface clear and remote enable.
20  A=0:ST=3.14/100
30  PRINT @8;"AB TAA"         ' Specify ASCII input to memory A.
40  FOR I=0 TO 500
50      N=INT(SIN(A)*1000)+2000
60      A=A+ST
70      PRINT @8;N
80  NEXT I
90  PRINT @8;"AV"             ' A VIEW
100 STOP
110 END

```

## 4.1 GPIB Remote Programming

**Example PC-14:** Input data to memory A in binary format.

```

10   ISET IFC:ISET REN           '   Execute interface clear and remote
                                     enable.
20   DIM DT(501)
30   A=0:ST=3.14/100
40   PRINT @8;"AB TBA"         '   Specify binary input to memory A.
50   FOR I=0 TO 500
60       DI(I)=INT(COS(A)*1000+2000
70       A=A+ST
80   NEXT I
90                                     '   Cancel listener and address PC9801 to
                                     #30 as
100                                    '   talker and this device to #8 as listener.
110  WBYTE &H3F,&H5F,&H5E,&H28;DT(0)\256,DT(0) MOD 256
120  FOR I=1 to 499
130      WBYTE;DT(I)\256,DT(I)  MOD 256   '   Transfer data, first high-order bytes and
                                     then low-order bytes.
140  NEXT I
150  WBYTE;DT(500)\256,DT(500) MOD256@   '   When the last data is input, send EOI
                                     signal.
160  PRINT @8;"AV"             '   A VIEW
170  STOP
180  END

```

- (2) Sample Programs for HP200, HP300 series (GPIB address = 1)

**Example HP-11:** Output data from memory A in ASCII format.

```

10  DIM Tr(500)                ! Reserve 501 variables.
20  OUTPUT 701;"DL3"          ! Set delimiter to CR LF.
30  OUTPUT 701;"TAA?"        ! Specify ASCII output from memory A.
40  FOR I=0 TO 500            ! Repeat data fetching 501 times.
50  ENTER 701;Tr(I)
60  NEXT I
70  END

```

**Example HP-12:** Output data from memory B in binary format.

```

10  DIM Tr(500)                ! Reserve 501 variables.
20  OUTPUT 701;"DL2"          ! Set delimiter to EOI
30  OUTPUT 701;"TBB?"        ! Specify binary output from memory B.
40  ENTER 701 USING"%W";Tr(*) ! Read the data repeating word type conversion till
                               ! EOI is encountered.
50  END

```

---

**NOTE:** For ASCII data, make sure the number of I/O operations is set to 501. For binary data, reserve data for 501 points, and use EOI as the delimiter.

---

**Example HP-13:** Output data from memory A in ASCII format.

```

10  INTEGER Tr(500)           !
20  OUTPUT 701;"TAA"          ! Specify ASCII input to memory A.
30  FOR I=0 TO 500            ! Repeat inputting variable Tr (501 variables
                               ! reserved) 501 times
40  OUTPUT 701;Tr(I)
50  NEXT I
60  END

```

---

**NOTE:** It is necessary to set the spectrum analyzer to VIEW mode before executing the program. After the program has been executed, pressing the VIEW key allows you to check the input result.

---

**Example HP-14:** Output data from memory B in binary format.

```

10  INTEGER Tr(500)           !
20  OUTPUT 701;"TBB"          ! Specify binary input to memory B.
30  OUTPUT 701 USING"#W";Tr(*),END ! Input 501 pieces of word size data and
                                     ! attach EOI following the last data.
40  END

```

---

**NOTE:**

1. It is necessary to set the spectrum analyzer to VIEW mode before executing the program. After the program has been executed, pressing the VIEW key enables the user to check the input result.
  2. For ASCII data, make sure the number of I/O operations is set to 501. For binary data, reserve data for 501 points, and use EOI as the delimiter.
-

## 4.1 GPIB Remote Programming

## 4.1.13 Using the Status Byte

- (1) Sample Programs for PC9801 series (GPIB address = 8)

**Example PC-15:** Execute single sweeping and wait the end of the sweeping (when not using SRQ signal).

10	ISET IFC:ISET REN	'	Send IFC signal and set REN signal in one.
20	SPA=8	'	Set GPIB address (8) in a variable.
30	PRINT @SPA;"SI"	'	Set in the single sweeping mode.
40	PRINT @SPA;"OPR8"	'	Make Sweep-end bit of operation
50		'	status register enable.
60	PRINT @SPA;"CLS"	'	Clear the status byte.
70	PRINT @SPA;"SR"	'	Begin the sweeping.
80	*LOOP		
90	PRINT @SPA;"STB?":INPUT @SPA;S	'	Read the status byte.
100	IF (S AND 128)=0 THEN GOTO *LOOP	'	Wait until the operation status bit (end of
110		'	sweeping) is set in one.
120	STOP		

**Example PC-16:** Execute ACP measurement and begin reading the result after the measurement is ended (when not using SRQ signal).

10	ISET IFC:ISET REN	'	Send IFC signal and set REN signal in one.
20	SPA=8	'	Set GPIB address (8) in a variable.
30	PRINT @SPA;"CF1500MZ"	'	Set the center frequency to 1500 MHz.
40	PRINT @SPA;"SP250KZ"	'	Set the frequency span to 250kHz.
50	PRINT @SPA;"RB1KZ;VB10KZ"	'	Set RBW to 1kHz and VBW to 10kHz.
60	PRINT @SPA;"ST20SC"	'	Set the sweep time at 20 seconds.
70	PRINT @SPA;"DTP"	'	Set the detector mode to positive.
80	PRINT @SPA;"ADCH50KZ"	'	Set the channel space to 50kHz.
90	PRINT @SPA;"ADBS21KZ"	'	Set the bandwidth to 21kHz.
100	PRINT @SPA;"OPR8"	'	Make the sweep-end bit of the
110		'	operation status register enable.
120	PRINT @SPA;"*CLS"	'	Clear the status byte.
130	PRINT @SPA;"ACP"	'	Begin ACP measurement.
140	*LOOP	'	
150	PRINT @SPA;"*STB?": INPUT	'	Read the status byte.
	@SPA;S		
160	IF(S AND 128)=0 THEN GOTO	'	Wait the end of ACP measurement.
	*LOOP		
170	PRINT @SPA;"ACP?"	'	Request the output of the ACP measurement
		'	result.
180	INPUT @SPA;LO,UP	'	Read the ACP measurement result.
190	PRINT"-50K:";LO;" "+50K:";UP	'	Display the measurement result.
200	STOP		

**Example PC-17:** Read the peak frequency and the level on every end of single sweeping. (when using SRQ signal).

10	ISET IFC:ISET REN	'	Send IFC signal and set REN signal in one.
20	SPA=8	'	Set GPIB address (8) in variable.
30	PRINT @SPA;"SI"	'	Set in single sweeping mode.
40	ON SRQ GOSUB *SSRQ	'	Decline the SRQ interrupt processing routine.
50	PRINT @SPA;"*CLS"	'	Clear the status byte
60	PRINT @SPA:"OPR8"	'	Make the Sweep-end bit of the operation status register enable.
70	PRINT @SPA;"*SRE128"	'	Make the Operation Status bit of the status byte enable.
80	PRINT @SPA;"S0"	'	Specify the sending out mode of SRQ signal.
90	*LOOP		
100	SEND=0	'	Clear the Sweep-end flag.
110	PRINT @SPA;"SR"	'	Begin the sweeping.
120	SRQ ON	'	Make the SRQ interruption of PC enable.
130	*WINT		
140	IF SEND=0 THEN GOTO *WINT	'	Wait until SRQ interruption occurs.
150	PRINT @SPA;"PS"	'	Execute the peak search.
160	PRINT @SPA;"MFL?"	'	Request the output of the marker data.
170	INPUT @SPA:MF,ML	'	Read the peak frequency and the level.
180	PRINT "Peak Freq:";MF;"Peak Level:";ML	'	Display the read data.
190	GOTO *LOOP	'	Repeat the sweeping.
200			
210	*SSRQ	'	SRQ interrupt processing routine.
220	POLL SPA,S	'	Read the status byte.
230	SEND=1	'	Set the Sweep-end flag in one.
240	RETURN	'	Return to the main routine.
250			
260	END		

## 4.1 GPIB Remote Programming

- (2) Sample Programs for HP200, HP300 series (GPIB address = 8)

**Example HP-15:** Execute a single sweep and wait the end of the sweeping (when not using SRQ signal).

```

10 Spa=708                ! Set GPIB address (8) in a variable.
20 OUTPUT Spa;"SI"        ! Set in the single sweeping mode.
30 OUTPUT Spa;"OPR8"     ! Make the Sweep-end bit of the
40                        ! operation status register enable.
50 OUTPUT Spa;"*CLS"     ! Clear the status byte.
60 OUTPUT Spa;"SR"       ! Begin the sweeping.
70 Mloop:!
80 OUTPUT Spa;"*STB?"    ! Request the output of the status byte.
90 ENTER Spa;S           ! Read the status byte.
100 IF BIT(S,7)=0 THEN GOTO Mloop ! Wait until the operation status bit
110                        ! (end of sweeping) is set in one.
120 STOP
130 END

```

**Example HP-16:** Execute ACP measurement and begin reading the result after the measurement is ended (when not using SRQ signal).

```

10 Spa=708                ! Set GPIB address (8) in a variable.
20 OUTPUT Spa;"CF1500MZ" ! Set the center frequency to 1500 MHz.
30 OUTPUT Spa;"SP250KZ"  ! Set the frequency span to 250kHz.
40 OUTPUT Spa;"RB1KZ;VB10KZ" ! Set RBW to 1kHz and VBW to 10kHz.
50 OUTPUT Spa;"ST20SC"   ! Set the sweeping time at 20 seconds.
60 OUTPUT Spa;"DTP"      ! Set the detector mode to positive.
70 OUTPUT Spa;"ADCH50KZ" ! Set the channel space to 50kHz.
80 OUTPUT Spa;"ADBS21KZ" ! Set the bandwidth to 21kHz.
90 OUTPUT Spa;"OPR8"     ! Make the sweep-end bit of the
100                        ! operation status register enable.
110 OUTPUT Spa;"*CLS"    ! Clear the status byte.
120 OUTPUT Spa;"SI"     ! Set in the single sweeping mode.
130 OUTPUT Spa;"ACP"    ! Begin ACP measurement.
140 OUTPUT Spa;"*SR"    ! Begin the sweeping.
150 Mloop:
160 OUTPUT Spa;"*STB?"  ! Request the output of the status byte.
170 ENTER Spa;S         ! Read the status byte.
180 IF BIT(S, 7)=0 THEN GOTO Mloop ! Wait the end of ACP measurement.
190 OUTPUT Spa;"ACP?"   ! Request the output of the ACP measurement
                        ! result.
200 ENTER Spa;"Lo,Up"  ! Read the ACP measurement result.
210 PRINT"-50K:";Lo;" +50K:";Up ! Display the measurement result.
220 END                !

```

**Example HP-17:** Read both the peak frequency and the level at the end of a single sweep (when using SRQ signal).

```

10 Spa=708 ! Set GPIB address (8) in a variable.
20 OUTPUT Spa;"SI" ! Set in single sweeping mode.
30 ON INTR 7 GOSUB Ssrq ! Define the SRQ interrupt processing
! routine.
40 OUTPUT Spa;"*CLS" ! Clear the status byte.
50 OUTPUT Spa;"OPR8" ! Make the Sweep-end bit of the
60 ! operation status register enable.
70 OUTPUT Spa;"*SRE128" ! Make the Operation Status bit of
80 ! the status byte enable.
90 OUTPUT Spa;"S0" ! Specify the sending out mode of SRQ
! signal.

100 Mloop: !
110 Mend=0 ! Clear the Sweep-end flag.
120 OUTPUT Spa;"SR" ! Begin the sweeping.
130 ENABLE INTR 7;2 ! Make the SRQ interruption enable.
140 Wint: !
150 IF Mend=0 TEHN GOTO Wint ! Wait until SRQ interruption occurs.
160 OUTPUT Spa;"PS" ! Execute the peak search.
170 OUTPUT Spa;"MFL?" ! Request the output of the marker data.
180 ENTER Spa;MF,ML ! Read the peak frequency and the level.
190 PRINT "Peak Freq:";MF;" ,Peak Level:";ML ! Display the read data.
200 GOTO Mloop ! Repeat the sweeping.
210 !
220 Ssrq: ! SRQ interrupt processing routine.
230 S=SPOLL(Spa) ! Read the status byte.
240 Mend=1 ! Set the Sweep-end flag in one.
250 RETURN ! Return to the main routine.
260 !
270 END

```



4.2 RS-232 Remote Control Function

**4.2 RS-232 Remote Control Function**

Most controllers (such as personal computers) do not have a GPIB interface, but the R3131 series can still be controlled using the RS-232 interface.

**4.2.1 GPIB and RS-232 Compatibility**

The control codes and functions are the same as those used for serial control, except for those which especially refer to the GPIB interface.

**4.2.2 Features of RS-232 Remote Control**

The following functions can be controlled by serial control.

- Measurement conditions setup: Measurement conditions each can be input in much the same as the key operation on the front panel.
- Output of the setup status: Both the setup status and data can be read out.
- Status: Status bytes which show the current status of the spectrum analyzer can be read out in the same way GPIB readouts.

**4.2.3 Parameter Setup Window**

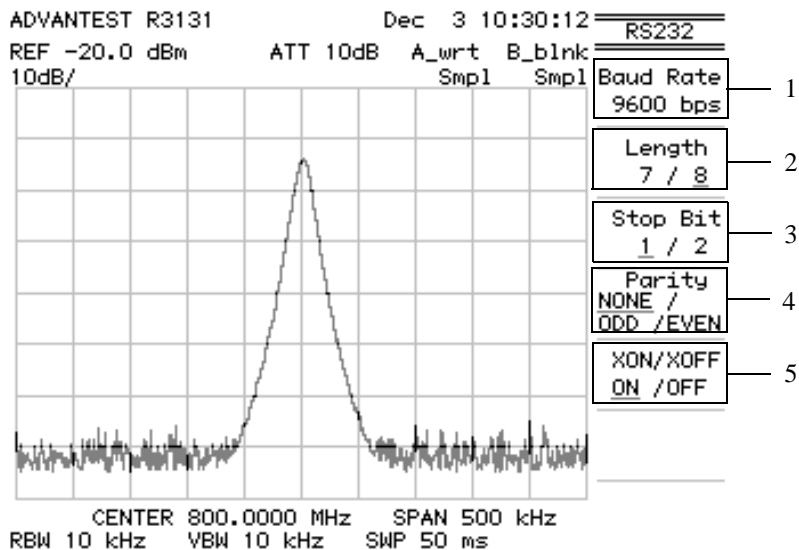

**Figure 4-4 Parameter Setup**

1. Transmission speed: Select from 600, 1200, 2400, 4800, 9600 or 19200.
2. Data length: Select seven bits or eight bits as the number of data bits.
3. Stop bit: Select one or two bits.
4. Parity check: Select from NONE, ODD or EVEN.
5. Flow control: Select either XON or XOFF.

#### 4.2.4 Interface connection

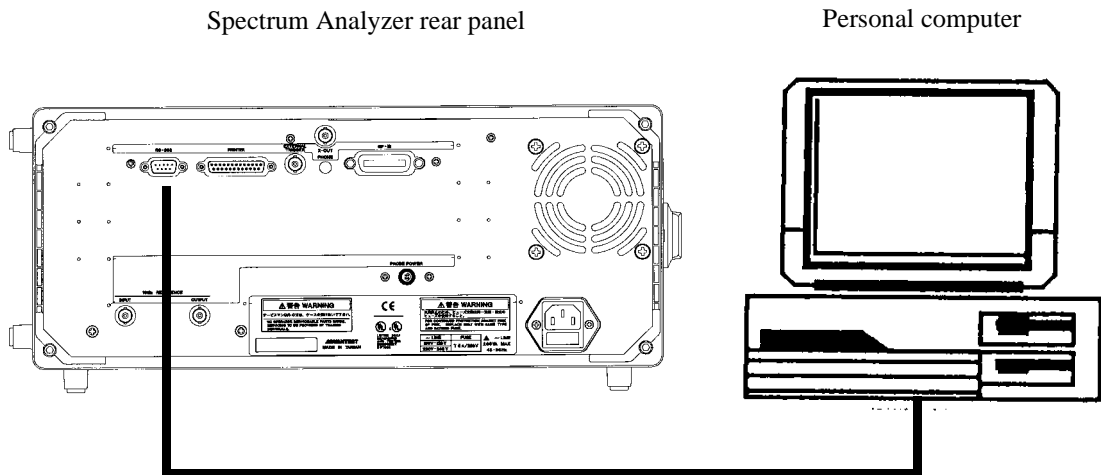

**Figure 4-5 Connection Between the Controller and the Spectrum Analyzer**

Although the spectrum analyzer uses only three pins, the controller side needs more connections for input and output.

**NOTE:**

1. When you send or receive data using the cable connections shown in Figure 4-6, set XON/XOFF to valid (ON).
2. DCD, DTR and DSR are not used in the spectrum analyzer. When you use CTS and RTS, use a cable with cross-connection to connect the controller to the spectrum analyzer. Flow control is not performed using CTS or RTS. Set XON/XOFF to valid (ON) to perform flow control.

4.2 RS-232 Remote Control Function

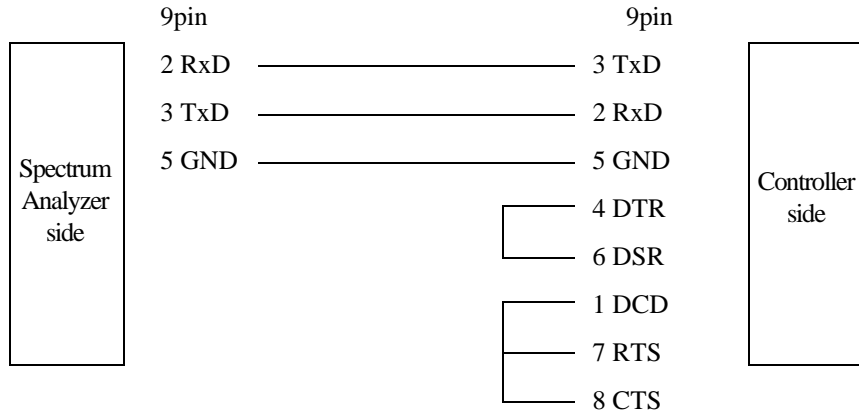

Pin No.(9pin)	Signal name	Contents
1	DCD:Data Carrier Detector	Receive carrier detection
2	RxD: Receive Data	Receive data
3	TxD: Transmit Data	Transmission data
4	DTR: Data Terminal Ready	Data terminal ready
5	GND: Ground	Signal ground
6	DSR: Data set Ready	Data set ready
7	RTS: Request To Send	Request signal for sending
8	CTS: Clear to Send	Clear signal for sending
9	CI:	N.C

Figure 4-6 Cable Wiring Diagram

### 4.2.5 Data Format

Transmission messages between the spectrum analyzer and the controller are in ASCII code character strings and followed by carriage returns (CR) and line feeds (LF).

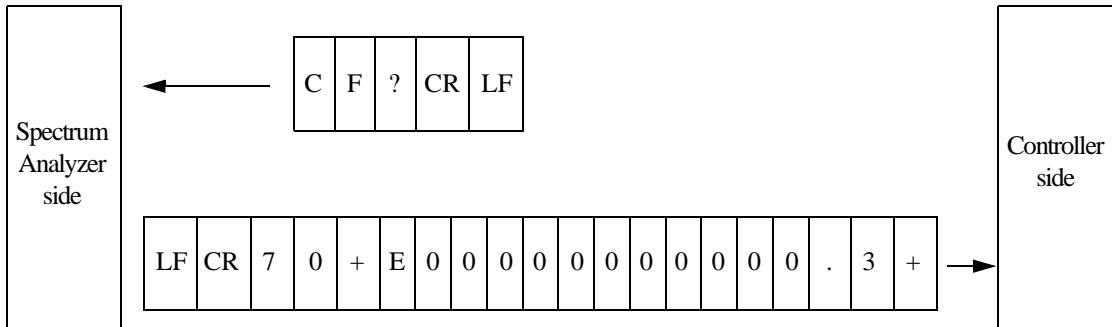

Figure 4-7 Data Format

**NOTE:**

1. *Transmission data must be in ASCII code.*
2. *Delimit the data from the controller with CR or CR and LF. Query data and the GPIB delimiters are the same. Therefore, send DL0 or DL3 after serial port was opened (refer to the example of RS-232 remote program).*

Data transmission example: Personal computers can recognize both CF 30.0MZ CR and CF 30.0MZ CR LF.

The format for query data is +3.0000000000E+07 CR LF (send DL0 or DL3). The output data of this RS-232 and GPIB are the same number of characters except delimiters (CR and LF).

### 4.2.6 Differences Between RS-232 and GPIB

- Command code

Trace data input or output can only be formatted in ASCII.

---

*NOTE: The following commands are unavailable: TBA and TBB.*

---

### 4.2.7 Panel Control

During remote control operation, spectrum analyzer panel control is affected as follows.

- The remote lamp does not light.
- The key panel is not disabled.
- CAUTION: If any settings are changed during remote control, the operation of the spectrum analyzer may become unstable.

### 4.2.8 Remote Control Usage Examples

The following examples show typical remote control commands, and are written in "Microsoft Quick Basic" (licensed by Microsoft Corporation).

The Open command statement OPEN" COM1: 9600, N, 8, 1, ASC" FOR RANDOM AS #1 shown below has the following characteristics: baud rate is 9600 bps, no parity, 8 bit data length, stop bit of 1, ASCII format and random access mode.

Example: This program is used to check the status byte register to see if the sweep has been completed.

```

OPEN "COM1:9600,N,8,1,ASC" FOR RANDOM AS #1
PRINT #1, "DL3"           ' CR and LF are set as the GPIB delimiter.
PRINT #1, "SI"           ' Single sweep is performed.
PRINT #1, "OPR8"        ' Sweep completion bit in the GPIB operation register is set.
PRINT #1, "CLS"         ' Clearing the status bytes.
PRINT #1, "TS"          ' Single sweep is performed.
MEAS.LOOP:
PRINT #1, "*STB?"       ' Read out the status bytes.
INPUT #1, STAT
IF (STAT AND 128) = 0 THEN GOTO MEAS.LOOP
PRINT #1, "PS"          ' Peak search.
PRINT #1, "ML?"         ' Read out the peak level.
INPUT#1,MLEVEL
PRINT MLEVEL
END

```

## 5 SPECIFICATIONS

### (1) Frequency

Characteristics	Description
Frequency range	9kHz to 3GHz
Frequency read accuracy	$\pm$ (Frequency reading x Frequency reference accuracy + Span $\times$ Span accuracy + 0.15 $\times$ Resolution bandwidth + 1kHz)
Marker frequency counter accuracy	$\pm$ (Marker frequency x Frequency reference accuracy + 1LSD) (S/N $\geq$ 25dB, SPAN $\leq$ 200MHz)
Marker frequency counter resolution	1Hz to 1kHz
Frequency reference source accuracy	$\pm$ 2ppm/Year $\pm$ 5ppm/Operating environment range
Frequency span	zero, 50kHz to 3GHz
Frequency span accuracy	$\leq \pm 3\%$
Frequency stability Residual FM	$\leq 100\text{Hzp-p}/100\text{ms}$ (Zero span)
Sideband noise	$\leq 100\text{dBc}/\text{Hz}$ (20kHz offset)
Resolution bandwidth (3dB) Bandwidth accuracy Selectivity (60dB : 3dB)	1kHz to 1MHz      1,3 sequence $\leq \pm 20\%$ $\leq 15 : 1$
6dB bandwidth	9kHz, 120kHz
Video bandwidth	10Hz to 1MHz      1,10 sequence

## 5 SPECIFICATIONS

## (2) Amplitude Range

Characteristics	Description
Amplitude measurement range	+20dBm to Average indicated noise level
Maximum input level	+20dBm, 50VDC
Display range Logarithmic Linear	10dB/div      8div 1,2,5dB/div    10div (10% of the reference level)/div
Reference level range Logarithmic Linear	-64dBm to +40dBm +141.1 $\mu$ V to +22.36V
Input attenuator range	0 to 50dB      10dB step

## (3) Sweep

Characteristics	Description
Sweep time	50ms to 500ms
Sweep time accuracy	$\leq \pm 3\%$
Trigger mode	FREE RUN, VIDEO, EXT, LINE
Sweep mode	REPEAT, SINGLE

## (4) Dynamic Range

Characteristics	Description
Average noise level	-113dBm + 2 f (GHz)dB (RBW 1kHz, VBW 10Hz, ATT 0dB, $f \geq 1$ MHz)
1dB gain compression	> -5dBm (Mixer input level, $f \geq 20$ MHz)
Secondary harmonic distortion	$\leq -70$ dB ( $f \geq 10$ MHz, Mixer input level -30dBm)
Two-signal third order intermodulation distortion	$\leq -70$ dB ( $f \geq 10$ MHz, Mixer input level -30dBm, Frequency difference between 2 signals)
Other spurious factors related to the input	$\leq -60$ dB (Offset $\geq 20$ kHz, Mixer input level -30 dBm)
Residual responses	$\leq -100$ dB ( $f \geq 10$ MHz, ATT -0dBm, Input termination with 50 $\Omega$ )

## (5) Amplitude Accuracy

Characteristics	Description
Calibration signal	30MHz, -20dBm $\pm$ 0.3dB
Frequency response	$\leq \pm 0.5$ dB (100kHz to 3GHz, ATT = 10dB) $\leq \pm 1$ dB (100kHz to 2GHz) $\leq \pm 2$ dB (9kHz to 3GHz) (after the calibration, and in reference to 30MHz)
Scale indication accuracy Logarithmic	$\leq \pm 0.5$ dB, (0 to -20dB) (after self calibration) $\leq \pm 1.5$ dB/70dB (after self calibration) $\leq \pm 1.0$ dB/10dB (after self calibration)
Linear	$\leq \pm 0.2$ dB/1dB (after self calibration) within $\pm 5\%$ of the reference level
Input attenuator switching accuracy	$\leq \pm 0.3$ dB (0 to 50dB) (in reference to an attenuation of 10dB at 30MHz)
Resolution bandwidth switching accuracy	$\leq \pm 0.5$ dB (after self calibration)
IF gain error	$\leq \pm 0.5$ dB (after self calibration)
Overall level accuracy	$\pm 1.5$ dB (REF = -50 to 0dBm, ATT = 10dB, 2dB/div, RBW = 300kHz, f > 100kHz, after self calibration)

## (6) Input/Output

Characteristics	Description
RF input Connector/Impedance VSWR	N-type female, 50 $\Omega$ (nominal) $\leq 1.5$ (100kHz to 2GHz, ATT $\geq$ 10dB) $\leq 2.0$ (9kHz to 3GHz, ATT $\geq$ 10dB)
10 MHz reference input Input range	BNC female, 50 $\Omega$ -10dBm to + 10dBm
External trigger input	BNC female, 10k $\Omega$ (nominal), DC connection Refer to item (7) for the external gate signal specifications.
Phone output	Small size monophonic female 8 $\Omega$
GPIB interface	IEEE-488 bus connector
Serial interface	D-SUB 9 pin
Printer interface	D-SUB 25 pin, ESC/P, ESC/P-R, PCL
Floppy drive	3.5 inch, MS-DOS format
Probe power supply output voltage	+12.4V, -12.4V (Maximum output current: 100mA for each voltage source)



5 SPECIFICATIONS

(7) Specifications for the External Gate Signal

The specifications for the external gate signal used with gated sweeps are shown below.

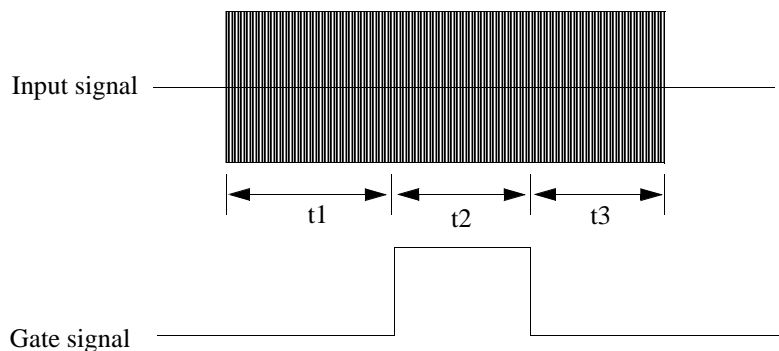

(a)  $t_1$

RBW	$t_1$
1MHz	more than 2 $\mu$ sec
300kHz	more than 15 $\mu$ sec
100kHz	more than 20 $\mu$ sec
30kHz	more than 50 $\mu$ sec
10kHz	more than 180 $\mu$ sec

(b)  $t_2$

$$t_2 \geq 1\mu\text{sec}$$

(c)  $t_3$

SWP Time	$t_3$
SWP Time < 50sec	more than 18 $\mu$ sec
50sec $\leq$ SWP Time < 100sec	more than 28 $\mu$ sec
100sec $\leq$ SWP Time < 200sec	more than 58 $\mu$ sec
200sec $\leq$ SWP Time	more than 108 $\mu$ sec

## (8) General Specifications

Characteristics	Description
Operating environment range	0°C to +50°C, Relative humidity 85% or less (without condensation)
Storage environment range	-20°C to +60°C, Relative humidity 85% or less
AC input power source	Automatic switching to 100VAC or 200VAC For 100VAC : 100 to 120VAC, 50 to 60Hz For 200VAC : 220 to 240VAC, 50 to 60Hz
Power consumption	200VA or below
Mass	12 kg or less
Dimensions	approximately 424 (W) x 177 (H) x 300 (D) mm (not including projections such as rubber feet and connectors)

## (9) Specifications for the instrument equipped with TG option (Option 74)

Characteristics	Description
Frequency range	100kHz to 3.0GHz
Output level range (Resolution)	0 to -59.9dBm (0.1dB step)
Output level accuracy	$\leq \pm 0.5\text{dB}$ (30MHz, -10dBm, 20°C to 30°C)
Output level flatness	$\leq \pm 1.0\text{dB}$ (100kHz to 1GHz) $\leq \pm 1.5\text{dB}$ (100kHz to 3GHz) (-10dBm, referenced to 30MHz)
Output level switching error	$\leq \pm 1.0\text{dB}$ (100kHz to 1GHz) (output level $\geq -30\text{dBm}$ ) $\leq \pm 2.0\text{dB}$ (100kHz to 2.6GHz) $\leq \pm 3.0\text{dB}$ (9kHz to 3.0GHz) (referenced to -10dBm)
Output spurious Harmonics Non-harmonics	$\leq -20\text{dBc}$ (output level = -10dBm) $\leq -30\text{dBc}$ (output level = -10dBm)
Dynamic range (TG leakage)	$\leq -100\text{dBm}$ (input ATT 0dB)
Output VSWR	$\leq 2$ (nominal) (output level $\leq -10\text{dBm}$ )
Maximum input signal level	$\pm 15\text{dBm}$ $\pm 10\text{V}$
Mass	1 kg or less



**APPENDIX 1 ERROR MESSAGE**

Error No.	Error Message	Description
001	Span is set 0 Hz. Pls change span.	Zero Span is selected Please set the correct span.
002	Scale is Linear Mode. Pls select dB/div scale.	Vertical scale is set to Linear mode Please select dB/div scale.
003	QP detector is activate Pls change to Normal.	QP detection mode is selected. Please change to Normal mode.
004	Antenna correction is ON Pls turn correction off.	Antenna correction is active. Please turn Antenna correction off.
005	Scale is not 10 dB/div. Pls select dB/div scale.	The vertical scale is not set to 10 dB/div. Please select 10 dB/div scale.
006	$\Delta$ Marker is not activate. Pls activate $\Delta$ Marker.	The delta marker is not active. Please activate the delta marker.
007	Blank mode is selected. Pls change to Write mode	Cannot execute because the blank mode is selected. Please change to Write mode.
008	Calculated power is out of range.	The display line cannot be displayed because the measurement result is out of range
009	No peak is detected.	No corresponding peak has been detected
010	Parameter is set over the scale.	The set parameter is incorrect
011	Ant Corr data is not save to RAM. Pls select device FD.	Antenna correction data cannot be saved to RAM. Please select floppy disk as the destination.
100	IF STEP AMP: Calibration failure.	A calibration error occurred
101	LOG LINEARITY: Calibration failure.	A calibration error occurred
102	TOTAL GAIN: Calibration failure.	A calibration error occurred
103	RBW SWITCHING: Calibration failure.	A calibration error occurred
104	AMPTD MAG: Calibration failure.	A calibration error occurred
105	Cal data is not enough. Pls execute Cal All.	Conditions required for execution have not been met. Please execute Cal All.
106	Calibration signal is not detected.	No calibration signal has been detected
150	Self Test failure. Pls report to qualified service person.	Self test detected an error. Please contact a qualified service representative.

## APPENDIX 1 ERROR MESSAGE

Error No.	Error Message	Description
151	Self Test failure. Pls report to qualified service person.	Self test detected an error. Please contact a qualified service representative.
152	Self Test failure. Pls report to qualified service person.	Self test detected an error. Please contact a qualified service representative.
153	Self Test failure. Pls report to qualified service person.	Self test detected an error. Please contact a qualified service representative.
154	Self Test failure. Pls report to qualified service person.	Self test detected an error. Please contact a qualified service representative.
155	Broken Freq-Corr data. Pls report to qualified service person.	Freq-Corr data has been destroyed. Please contact a qualified service representative.
200	Illegal parameters.	The specified parameter is wrong
201	Software version unmatched.	This software version is incompatible
202	Can't format a device.	The disk cannot be formatted properly
203	File or register empty.	The recall command could not be executed successfully because the file or register is empty
204	Trace buffer full.	The area reserved for trace data is full
205	Device not ready.	The device is not communicable
206	Read error.	The file cannot be read out
207	File not found.	No file has been found
208	Invalid BPB. Pls format a disk.	The BPB has been erased. Please format the disk.
209	Can't delete a file. (read-only file)	This is a read-only file and cannot be deleted
210	Media changed.	The disk was replaced with another while it was being accessed
211	No disk space.	There is no space on the disk
212	Read-only file.	This is a read-only file
213	Read-only media.	This is a read-only media
214	Root directory full.	The Root directory is full
215	Invalid boot sector signature.	The boot sector signature cannot be recognized
216	CRC error	A CRC error occurred
217	Invalid disk geometry.	An invalid disk geometry was found
218	File number is over 999. Pls reset file counter.	The file number exceeded 999. Please reset the file counter.

Error No.	Error Message	Description
300	Printer is not ready. Pls check a printer setting.	Cannot print. Please check the printer settings.
301	Printer cable problem. Pls check a cable or connection.	There is a problem with the printer cable. Please check the cable connection.
302	Printer is not active.	The printer is not enabled
303	Printer is busy.	The printer is currently being used.
800	TG output signal is not detected.	TG output signals cannot be detected.
801	TG Freq Adjust failure. Pls report to qualified service person.	Automatic TG frequency adjustments cannot be performed. Please contact qualified service personnel for repair information.
802	TG Unleveled. Pls report to qualified service person.	An abnormal TG level is detected. Please contact qualified service personnel for repair information.
803	Normalize buffer full.	There is not enough memory to store the normalization data.



## APPENDIX 2 GLOSSARY

### Resolution Bandwidth

The spectrum analyzer uses the bandpass filter (BPF) to analyze the frequency components contained in the input signal. The 3dB bandwidth of the BPF is called the resolution bandwidth (See Figure A2-1(a) below). BPF characteristics should be set according to the sweep width and the sweep speed used for the trace. This spectrum analyzer sets the optimal value for the sweep width. In general, smaller bandwidths improve resolution so the resolution of the spectrum analyzer should be expressed using the narrowest resolution bandwidth (See Figure A2-1(b) below).

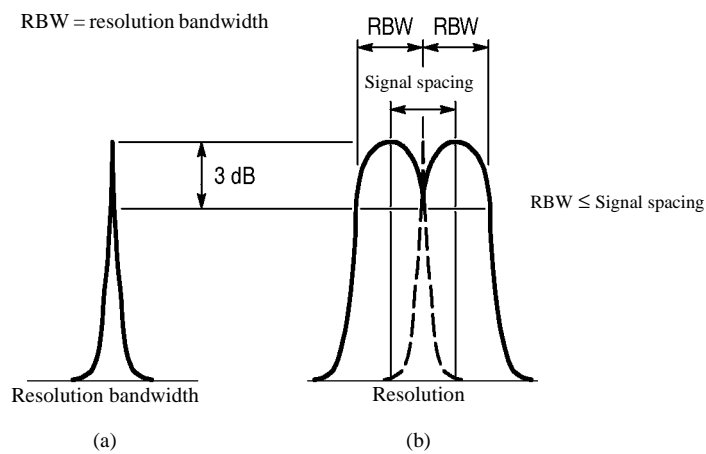
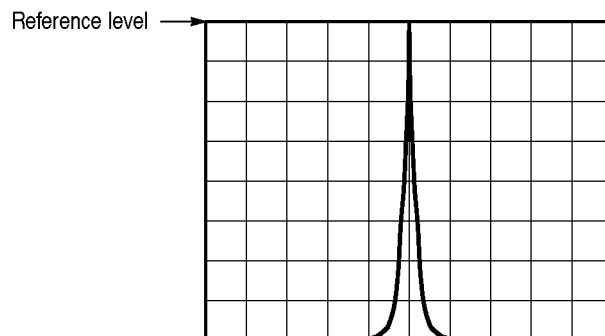

**Figure A2-1 Resolution Bandwidth**

### Reference Level Display Accuracy

When reading the absolute level of an input signal on the spectrum analyzer, the level is determined by the distance in dB from the uppermost scale on the screen. The level set for this uppermost scale is called the reference level.

The reference level is modified by the IF GAIN key and the input attenuator, and is displayed in dBm or dBμ. The absolute accuracy of this display is the reference level accuracy.



**Figure A2-2 Reference Level**



APPENDIX 2 GLOSSARY

**Gain Compression**

If the input signal is greater than a certain value, the correct value is not displayed on the screen, and the input signal appears as if it were compressed. This phenomenon is called gain compression, and it reflects an error in the linearity of the input signal range. Normally, the gain compression for a spectrum analyzer is specified as the input signal level that produces a 1 dB error from a perfect linear response.

**Maximum Input Sensitivity**

This is the maximum sensitivity of the spectrum analyzer for detecting signals. Sensitivity depends on the resolution bandwidth and is affected by the noise generated by the spectrum analyzer itself. The maximum input sensitivity is normally reflected as the average noise level in the minimum resolution bandwidth of the spectrum analyzer.

**Maximum Input Level**

This is the maximum level allowed for the input circuit of the spectrum analyzer. The level can be modified by the input attenuator.

**Residual FM**

The short-term frequency stability of the local oscillators built in the spectrum analyzer is expressed as residual FM. The frequency width fluctuating per unit time is expressed as p-p. This also determines the measurement limit value when measuring the residual FM of a signal.

**Residual Response**

Residual response is a measure of how much (in the input level calculation) the spurious signal generated by the spectrum analyzer is suppressed. Residual response is generated by leaks of signals such as local oscillation output in the spectrum analyzer. This should be taken into consideration when analyzing a low-level input signal.

**Quasi Peak Value Measurements**

Reception interference for wireless communication generally occurs as impulse noise. Interference due to noise energy is evaluated in proportion to the quasi peak value. The parameters required for this evaluation, such as measurement bandwidth, detection time constant and so on, are defined as the quasi peak value. There are two standards which affect this sort of measurement: JRTC for Japan only, and CISPR (International Special Committee on Radio Interference ) which applies internationally.

**Frequency Response**

This term represents amplitude characteristics (frequency characteristics) for a given frequency. In the spectrum analyzer, frequency response means the frequency characteristics (flatness) of the input attenuator and mixer for the input frequency, and is given in  $\pm \Delta\text{dB}$ .

**Zero Span**

The spectrum analyzer sweeps at any frequency along the horizontal axis as the time axis but will not sweep in zero span mode.

**Spurious**

Spurious signals are undesired signals that can interfere with the target signal. Spurious signals can be divided into several types as follows.

**Higher Harmonic Spurious:**

This is the higher harmonic level generated by the spectrum analyzer itself (normally in the mixer circuit) when an ideal undistorted signal is fed to the analyzer. This determines the ability to measure higher harmonic distortion.

**Non-higher Harmonic Spurious:** This is a spurious signal of a certain inherent frequency generated by the spectrum analyzer itself. This is also called residual response.

### Spurious Response

This is distortion caused by higher harmonic spurious signals generated in the input mixer when the signal level is increased.

The range that can be used without distortion varies according to the input level of the basic wave: in the example shown below, the range is -70 dB for an input level of -30dBm. If the input signal level is too great, the input attenuator is used to decrease the signal fed to the mixer so that a proper input level can be obtained.

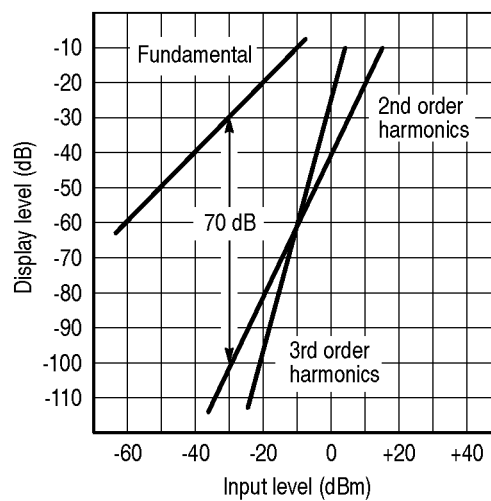

**Figure A2-3 Spurious Response**

### Noise Sidebands

Spectrum analyzer efficiency is reduced by noise generated in the local oscillator and phase lock loop of the analyzer. This noise will appear in the vicinity of the spectrum on the screen.

To compensate for this, the sideband of the analyzer is defined so that signals out of the sideband can be analyzed in a certain range. This range is called the noise sideband.

The spectrum analyzer's noise sideband characteristics are shown in the following example:

**Example:** Suppose the noise level measured in the resolution bandwidth of 1 kHz is -70 dB at 20 kHz apart from the carrier. The noise level is normally expressed by the energy contained in the 1 Hz bandwidth (Figure A2-4(b)).

With a bandwidth of 1 Hz, the following applies: Since the value is -70 dB when the bandwidth is 1 kHz, the signals within the 1 Hz bandwidth will be lower than this by about  $10 \log 1 \text{ Hz}/1 \text{ kHz}$  [dB], or about 30 dB; consequently, it is expressed as -100 dB/Hz at 20 kHz apart from the carrier when the resolution bandwidth is 1 kHz.

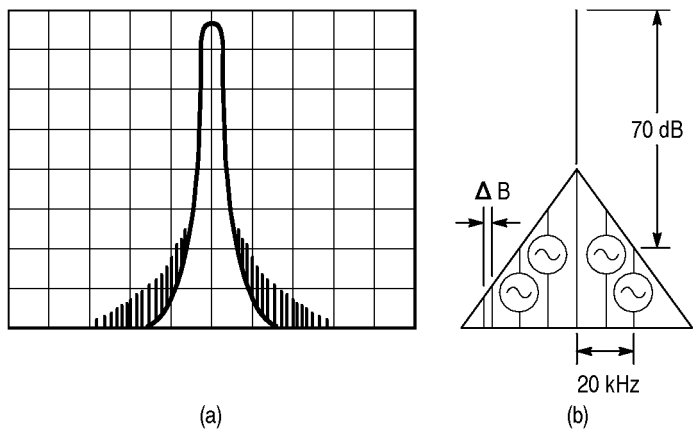

Figure A2-4 Noise Sidebands

**Bandwidth Selectivity**

The bandpass filter normally attenuates using a Gaussian distribution instead of the so-called rectangular characteristic. Consequently, if two adjacent signals of different sizes are mixed, the smaller signal hides at the tail of the larger signal (Figure A2-5).

Therefore, the bandwidth at a certain attenuation range (60 dB) should also be defined. The ratio between the 3 dB width and 60 dB width is expressed as the bandwidth selectivity (BW60 dB/BW3 dB).

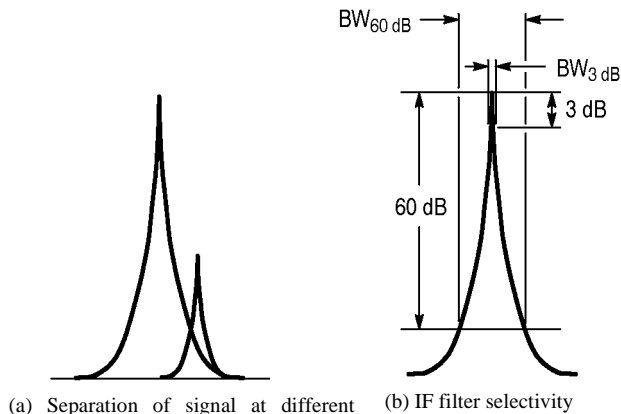

Figure A2-5 Bandwidth Selectivity

**Bandwidth Accuracy**

The bandwidth accuracy of the IF filter is expressed by the deviation from the nominal value of the 3 dB lowered point. This deficiency has almost no effect on measurement of normal signals at a continuous level, but it should be taken into consideration when measuring the level of a noise signal.

**Bandwidth Switching Accuracy**

Several IF filters are used to obtain an optimal resolution (in signal spectrum analysis) according to the scan width. When switching from one IF filter to another while measuring one and the same signal, an error is generated for the difference in loss. This error is defined as the bandwidth switching accuracy.

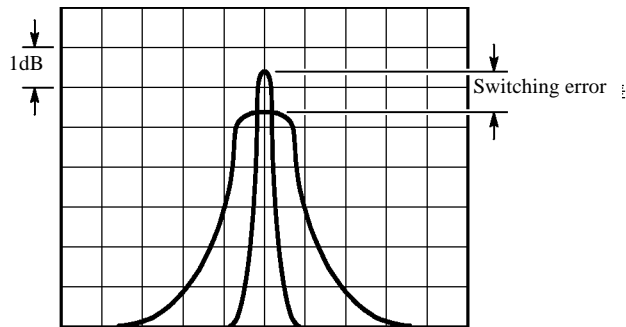

**Figure A2-6 Bandwidth Switching Accuracy**



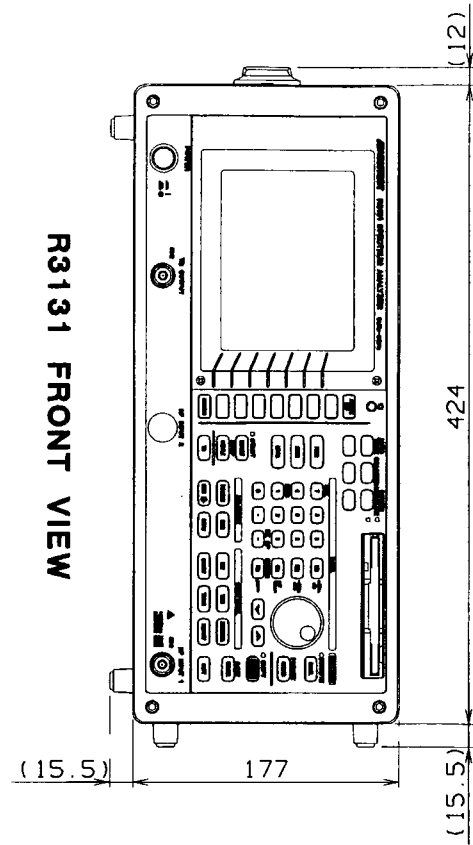

Unit : mm

**CAUTION**

This drawing shows external dimensions of this instrument.

The difference in products and options used can cause a change in the appearance of the instrument.

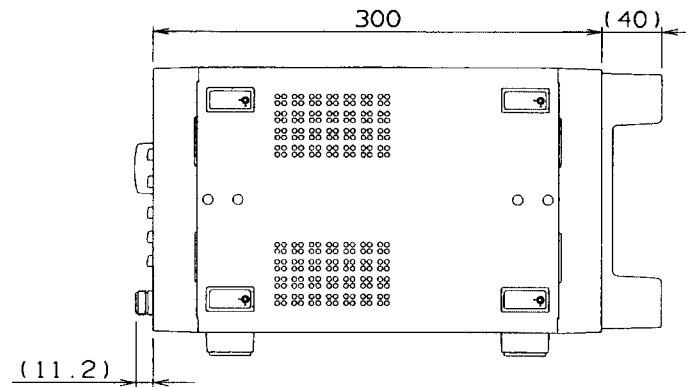
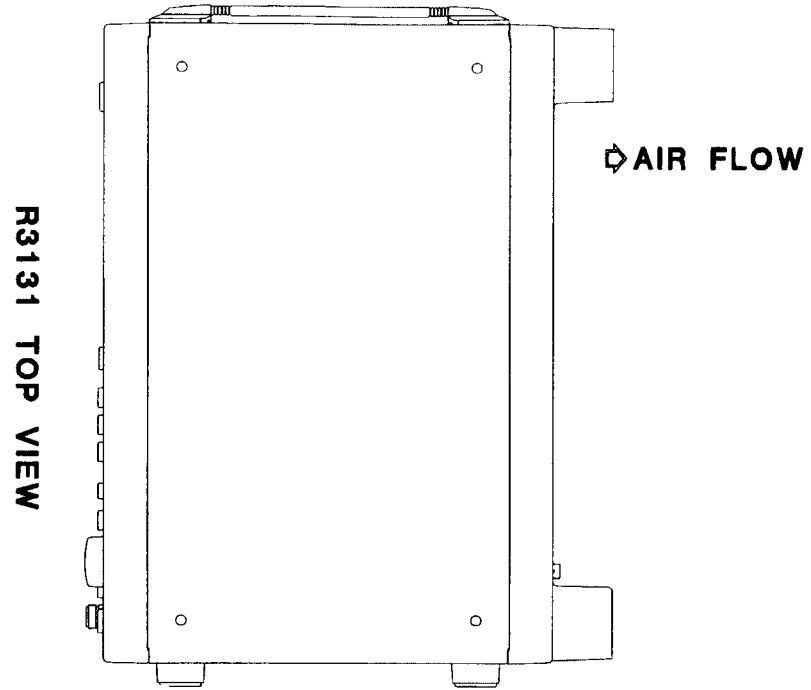

**DIMENSIONAL  
OUTLINE DRAWING**

**R3131 RIGHT SIDE VIEW**



## ALPHABETICAL INDEX

### [Symbols]

% AM Meas ON/OFF .....	3-11, 3-34
()', ; : .....	3-9, 3-24
+ - < > = . .....	3-9, 3-24
@ # \$ % & * .....	3-9, 3-24
/ ? \ [ ] ~ .....	3-9, 3-24

### [Numerics]

1dB/div .....	3-10, 3-30
1/2_more, 2/2_more .....	2-16
10 MHz REFERENCE INPUT terminal .....	2-13
10 MHz REFERENCE OUTPUT terminal .....	2-13
10dB/div .....	3-10, 3-30
2dB/div .....	3-10, 3-30
3rd Order Meas .....	3-11, 3-34
5dB/div .....	3-10, 3-30
75Ω Mode Indicator .....	2-11

### [A]

A B C D E F .....	3-9, 3-24
Abort .....	3-7, 3-21
AC power connector .....	2-13
Access lamp .....	2-3
Accessories .....	1-2
ACP .....	2-65, 3-13, 3-43, 4-24
ACP GRAPH .....	2-68
ACP ON/OFF .....	3-13, 3-43
ACP POINT .....	2-65
Active area .....	2-2, 2-11
ACTIVE OFF .....	2-2, 2-15
additional function keys .....	2-5
Address .....	3-8, 3-19
Amplitude accuracy .....	5-3
Amplitude range .....	5-2
Amplitude scale .....	2-11
AMPTD MAG .....	3-7, 3-18
Ant Corr ON/OFF .....	3-14, 3-47
Antenna Correction Data .....	2-56
Arrangement of the three status registers .....	4-9
ATT AUTO/MNL .....	3-10, 3-30
Auto All .....	3-7, 3-15, 3-17, 3-51
AUTO TUNE .....	2-9, 3-7, 3-16
Auto Tuning .....	2-31, 3-16, 4-22
Average count display .....	2-11
Average Power .....	3-13, 3-42
AVG A(B) .....	3-15, 3-54
AVG A(B) CONT/SGL .....	3-15, 3-55
AVG A(B) ON/OFF .....	3-15, 3-54
AVG A(B) PSE/CONT .....	3-15, 3-54

### [B]

Bandwidth .....	3-17, 4-16
Bandwidth Accuracy .....	A2-4
Bandwidth Selectivity .....	A2-4
Bandwidth Switching Accuracy .....	A2-5
Basic Operation .....	2-14
Basic Programming .....	4-31
Baud Rate .....	3-8, 3-20
BBA9106 .....	3-10, 3-26
BK SP(-) .....	2-5
Blank A(B) .....	3-15, 3-54
BW .....	2-7, 3-7, 3-17

### [C]

Cable wiring diagram .....	4-48
CAL .....	2-5, 3-7, 3-18
Cal All .....	3-7, 3-18
Cal Corr ON/OFF .....	3-7, 3-18
Cal Sig Level ON/OFF .....	3-7, 3-18
Calibration .....	2-55, 3-18, 4-26
Calibration signal output .....	2-18
Carrier Power .....	3-13, 3-42
Center .....	3-10, 3-28
Center frequency .....	2-11
CF Step AUTO/MNL .....	3-10, 3-28
CH BW POS/WD .....	3-13, 3-42
CH BW SRT/STP .....	3-13, 3-42
CH Power ON/OFF .....	3-13, 3-42
Change Title .....	3-9, 3-24
Channel Band WD .....	3-13, 3-43
Channel Power .....	3-13, 3-42
Channel Spacing 1 .....	3-13, 3-43
Channel Spacing 2 ON/OFF .....	3-13, 3-43
Cleaning .....	1-11
Clear .....	3-9, 3-24
Clear Table .....	3-10, 3-27
Command Syntax .....	4-6
Condition Register .....	4-8
CONFIG .....	2-8, 3-8, 3-19
Configuration .....	3-19
Connecting the GPIB .....	4-1
Connection between the controller and the spectrum analyzer .....	4-47
Connector Section .....	2-3
Cont Down ON/OFF .....	3-11, 3-34
Cont Peak ON/OFF .....	3-11, 3-12, 3-35, 3-40
Continuous peak search .....	2-35
Continuous Sweep .....	3-46
Contrast control .....	2-2



## Alphabetical Index

CONTROL Section ..... 2-7  
 COPY ..... 2-8, 3-8, 3-21  
 Copy Dev ..... 3-8, 3-19  
 Copy Mode GRAY/ B/W ..... 3-8, 3-19  
 Copy Size HALF/FULL ..... 3-8, 3-19  
 Corr Mode ANT/LVL ..... 3-10, 3-26  
 Corr Off ..... 3-10, 3-27  
 COUNTER ..... 2-9, 3-9, 3-22  
 Counter ..... 4-23  
 counter function ..... 2-28  
 Counter Off ..... 3-9, 3-22  
 Creating a correction data table ..... 2-56

**[D]**

Data format ..... 4-6, 4-49  
 Data input ..... 4-30  
 Data knob ..... 2-5  
 Data Output Format ..... 4-33  
 Data Readout ..... 3-45  
 Data Save/Recall ..... 4-26  
 DATA Section ..... 2-5  
 Date ..... 2-11  
 Date Mode MDH/DMY ..... 3-8, 3-20  
 Day ..... 3-8, 3-20  
 dB/div ..... 3-10, 3-30  
 dBc/Hz ..... 3-11, 3-33  
 dBm ..... 3-10, 3-30  
 dBm/Hz ..... 3-11, 3-33  
 dB $\mu$ V ..... 3-10, 3-30  
 dB $\mu$ V  $\sqrt{\text{Hz}}$  ..... 3-11, 3-33  
 DCL ..... 4-4  
 Default Config ..... 3-8, 3-20, 3-60  
 Delete ..... 3-14, 3-47  
 Deleting the data ..... 2-93  
 Delta  $\rightarrow$  CF ..... 3-12, 3-39  
 Delta  $\rightarrow$  CF Step ..... 3-12, 3-39  
 Delta  $\rightarrow$  MKR Step ..... 3-12, 3-39  
 Delta  $\rightarrow$  Span ..... 3-12, 3-39  
 Delta Marker ..... 3-11, 3-35  
 Details of the three status registers ..... 4-10  
 Detector ..... 3-15, 3-54  
 Detector Mode ..... 3-10, 3-26  
 Device Clear ..... 4-4  
 Device RAM/FD ..... 3-13, 3-14, 3-45, 3-47  
 Differences between RS-232 and GPIB ..... 4-50  
 DISPLAY ..... 2-7, 3-9, 3-23, 4-21  
 display format of date ..... 2-101  
 Display Line ON/OFF ..... 3-9, 3-23  
 Display ON/OFF ..... 3-8, 3-19  
 Display Section ..... 2-2  
 Displaying Off ..... 4-3

Displaying Spectrums and Operating  
 the Markers ..... 2-17  
 Displaying submenu ..... 2-15  
 Dynamic range ..... 2-42, 5-2

**[E]**

Each Item ..... 3-7, 3-18  
 Edit Done ..... 3-9, 3-24  
 Editing the correction data table ..... 2-56  
 Eject button ..... 2-3  
 EMC ..... 2-5, 3-10, 3-26, 4-25  
 EMC Measurement ..... 3-26  
 EMCO3142 ..... 3-10, 3-26  
 Enable Register ..... 4-8  
 Entering Data ..... 2-14  
 Entering Data Using the Data Knob ..... 2-15  
 Entering Data Using the Numeric Keys ..... 2-14  
 Entering Data Using the Step Keys ..... 2-14  
 Environmental Conditions ..... 1-4  
 ERROR MESSAGE ..... A1-1  
 Event Enable Register ..... 4-11  
 Event Register ..... 4-8  
 Execute Normalize ..... 3-15, 3-52  
 Execute Self Test ..... 3-14, 3-48  
 Exhaust vent ..... 2-12  
 Exit ..... 3-14, 3-48  
 Ext ..... 3-15, 3-56  
 EXTERNAL TRIGGER terminal ..... 2-12

**[F]**

F.Disk ..... 3-8, 3-19  
 F.Disk Config ..... 3-8, 3-19  
 Factory Defaults ..... 3-59  
 Features of RS-232 Remote Control ..... 4-46  
 Field ..... 3-10, 3-26  
 Fixed MKR ON/OFF ..... 3-11, 3-37  
 Floppy disk drive door ..... 2-3  
 Floppy Disk Drive Section ..... 2-3  
 Format F.Disk ..... 3-8, 3-19  
 Free Run ..... 3-15, 3-56  
 FREQ ..... 2-4, 3-10, 3-28  
 Freq Adj Auto ..... 3-15, 3-52  
 Freq Adj Manual ..... 3-15, 3-53  
 Freq Corr ON/OFF ..... 3-7, 3-18  
 Freq Window ON/OFF ..... 3-12, 3-40  
 Frequency ..... 3-28, 4-14, 5-1  
 Frequency Counter ..... 3-22  
 Frequency Level ..... 3-30  
 Frequency Response ..... A2-2  
 Frequency span ..... 2-11, 3-50  
 Front Panel ..... 2-1

Full Span ..... 3-14, 3-50  
 Functional Description ..... 3-16  
 Fuse ..... 1-5  
 Fuse holder ..... 2-13  
 Fuse information ..... 2-13

**[G]**

G H I J K L ..... 3-9, 3-24  
 Gain Compression ..... A2-2  
 Gate Sig External ON/OFF ..... 3-15, 3-51  
 General specifications ..... 5-5  
 GHz ..... 2-5  
 GLOSSARY ..... A2-1  
 Go to Local ..... 4-4  
 GPIB ..... 3-8, 3-19, 4-1  
 GPIB and RS-232 Compatibility ..... 4-46  
 GPIB Command Codes ..... 4-14  
 GPIB connector ..... 2-12  
 GPIB Interface Functions ..... 4-3  
 GPIB Remote Control ..... 3-32  
 GPIB Remote Programming ..... 4-1  
 GPIB Setup ..... 4-1  
 Graph ON/OFF ..... 3-13, 3-43  
 GTL ..... 4-4

**[H]**

Hard Copy ..... 3-21, 4-28  
 Harmonic Distortion ..... 2-49  
 Harmonic Distortion Measurements ..... 2-78  
 Header ..... 4-6  
 Higher Harmonic Spurious ..... A2-2  
 HOLD ..... 3-10, 3-29  
 HOLD mode indication ..... 2-11  
 Hour ..... 3-8, 3-20  
 Hz (ENTER) ..... 2-5

**[I]**

IF Step Amp ..... 3-7, 3-18  
 IFC ..... 4-3  
 Importing the correction data table ..... 2-57  
 Initialization ..... 2-17, 3-44  
 Initializing the floppy disk ..... 2-86  
 Input Buffer ..... 4-5  
 Input Saturation ..... 2-46  
 Input 50 $\Omega$  /75 $\Omega$  ..... 3-10, 3-31  
 Input/output ..... 5-3  
 Interface Clear ..... 4-3  
 Inverse ..... 3-9, 3-25

**[K]**

kHz ..... 2-5

**[L]**

Last Span ..... 3-14, 3-50  
 Length 7/8 ..... 3-8, 3-20  
 LEVEL ..... 2-4, 3-10, 3-30  
 Level ..... 3-30, 4-15  
 Limit UP/LOW ..... 3-12, 3-40  
 Line ..... 3-15, 3-56  
 Line and Window ..... 3-23  
 Line setup display ..... 2-11  
 Linear ..... 3-10, 3-30  
 Liquid crystal display ..... 2-2  
 List ON/OFF ..... 3-13, 3-45  
 LLO ..... 4-4  
 LOCAL ..... 2-8, 3-11, 3-32  
 Local Lockout ..... 4-4  
 Log Linear ..... 3-7, 3-18

**[M]**

M N O P Q R ..... 3-9, 3-24  
 Marker ..... 3-35, 4-17  
 Marker  $\rightarrow$  ..... 3-38, 4-19  
 Marker area ..... 2-11  
 Marker Couple ON/OFF ..... 3-9, 3-11, 3-23, 3-37  
 Marker Off ..... 3-11, 3-36  
 MARKER Section ..... 2-6  
 Max Hold A(B) ..... 3-15, 3-54  
 Maximum Input Level ..... A2-2  
 Maximum Input Sensitivity ..... A2-2  
 MEAS ..... 2-6, 3-11, 3-33  
 Meas Window ..... 3-9, 3-23  
 Measurement ..... 3-33, 4-22  
 Measurement Examples ..... 2-59  
 MEASUREMENT Section ..... 2-4  
 Measurements Using TG ..... 2-81  
 Measuring Adjacent Channel Leakage Power ... 2-65  
 Measuring Frequency ..... 2-28  
 Measuring frequency as a counter ..... 2-30  
 Measuring the Channel Power ..... 2-59  
 Measuring the Occupied Bandwidth ..... 2-62  
 Measuring the VA Ratio ..... 2-71  
 Measuring Window and the Display Line ..... 2-23  
 Menu Index ..... 3-1  
 Menu structure ..... 2-15  
 Message Exchange ..... 4-5  
 Message Exchange Protocol ..... 4-5  
 Message window ..... 2-11  
 MHz ..... 2-5  
 Min ..... 3-8, 3-20  
 Min Hold A(B) ..... 3-15, 3-55  
 Min Peak ..... 3-11, 3-35  
 Miscellaneous ..... 4-29

## Alphabetical Index

MKR ..... 2-6, 3-11, 3-35  
 MKR → ..... 2-6, 3-38  
 MKR → (when using the delta marker) ..... 3-12  
 MKR → (when using the normal marker) ..... 3-12  
 MKR → CF ..... 3-12, 3-38, 3-39  
 MKR → CF Step ..... 3-12  
 MKR → CF step ..... 3-38, 3-39  
 MKR → MKR Step ..... 3-12, 3-38, 3-39  
 MKR → Ref ..... 3-12, 3-38, 3-39  
 MKR Pause Time ..... 3-10, 3-11, 3-27, 3-36  
 MKR Read DLT/LFT/RHT ..... 3-11, 3-33  
 MKR Step AUTO/MNL ..... 3-11, 3-37  
 MKR Trace ..... 3-12, 3-38, 3-39  
 Month ..... 3-8, 3-20

**[N]**

Nega ..... 3-15, 3-54  
 Next Page ..... 3-10, 3-26  
 Next Peak ..... 3-11, 3-35  
 Next Peak Left ..... 3-11, 3-35  
 Next Peak Right ..... 3-11, 3-35  
 Noise Sidebands ..... A2-3  
 Noise/Hz ..... 3-11, 3-33  
 Noise/Hz Off ..... 3-11, 3-33  
 Non-higher Harmonic Spurious ..... A2-3  
 Norm Corr ON/OFF ..... 3-14, 3-15, 3-47, 3-52  
 Normal ..... 3-10, 3-15, 3-26, 3-54  
 Normal Marker ..... 3-11, 3-35  
 Numeric Data ..... 4-6  
 Numeric keys ..... 2-5

**[O]**

OBW ..... 2-62, 3-13, 3-42, 4-23  
 OBW % ..... 3-13, 3-43  
 OBW ON/OFF ..... 3-13, 3-43  
 Operating environment ..... 1-4  
 Operating Menu and Entering Data ..... 2-14  
 OPERATION ..... 2-1  
 Output Buffer ..... 4-5  
 Outputting the Screen Data ..... 2-95

**[P]**

Panel control ..... 4-50  
 Panel description ..... 2-1  
 Parameter Setup Window ..... 4-46  
 Parity NONE/ODD/EVEN ..... 3-8, 3-20  
 Parser ..... 4-5  
 PAS/FAIL ..... 2-7, 3-12, 3-40  
 Pass-Fail judgment ..... 2-74, 3-40, 4-22  
 Pass-Fail ON/OFF ..... 3-12, 3-40  
 PBW ..... 3-7, 3-18

Peak ..... 3-10, 3-26  
 Peak → CF ..... 3-10, 3-12, 3-28, 3-38, 3-39  
 Peak → Ref ..... 3-12, 3-38, 3-39  
 Peak Delta Y ..... 3-11, 3-35  
 Peak Max-Min ..... 3-11, 3-35  
 Peak Menu ..... 3-11, 3-35  
 Peak search ..... 3-41, 4-18  
 Peak Zoom ..... 3-14, 3-50  
 Performing auto tuning ..... 2-32  
 Performing the average function ..... 2-45  
 Performing the window sweep ..... 2-77  
 PHONE connector ..... 2-12  
 PK SRCH ..... 2-6, 3-12, 3-41  
 Posi ..... 3-15, 3-54  
 Power cable ..... 1-7  
 Power cable options ..... 1-3  
 POWER MEASURE ..... 2-9, 3-13, 3-42  
 Power measurement ..... 3-42, 4-23  
 Power ON ..... 2-17  
 Power Requirements ..... 1-5  
 POWER switch ..... 2-3  
 PRESET ..... 2-8, 3-13, 3-44, 4-28  
 Prev Page ..... 3-10, 3-26  
 Print CMD PCL/ESCP/ESCP-R ..... 3-8, 3-19  
 Printer ..... 3-8, 3-19  
 Printer Config ..... 3-8, 3-19  
 PRINTER connector ..... 2-12  
 Printing screen data ..... 2-96  
 PROBE POWER terminal ..... 2-13  
 Product Description ..... 1-1  
 Protect ..... 3-14, 3-47  
 Protecting the data ..... 2-90  
 Pwr Meas Off ..... 3-13, 3-42

**[Q]**

QP ..... 3-10, 3-26  
 Quasi Peak Value Measurements ..... A2-2

**[R]**

RBW ..... 2-11, 3-58  
 RBW Auto ..... 3-10, 3-26  
 RBW AUTO/MNL ..... 3-7, 3-17  
 RBW Switch ..... 3-7, 3-18  
 RBW 120kHz ..... 3-10, 3-26  
 RBW 9kHz ..... 3-10, 3-26  
 Rear Panel ..... 2-12  
 RECALL ..... 2-8, 3-13, 3-45  
 Recall ..... 3-13, 3-45  
 Ref Level ..... 3-10, 3-30  
 Ref Line ON/OFF ..... 3-9, 3-23  
 Ref Line Position ..... 3-15, 3-52

- Ref Offset ON/OFF ..... 3-10, 3-31  
REFERENCE ..... 3-1  
Reference level ..... 2-11  
Reference Level Display Accuracy ..... A2-1  
Remote control usage examples ..... 4-50  
Remote Enable ..... 4-3  
REMOTE lamp ..... 2-8  
REMOTE PROGRAMING ..... 4-1  
Removing the window ..... 2-27  
REN ..... 4-3  
REPEAT ..... 3-13, 3-46  
REPEAT (START/STOP) ..... 2-4  
Res 1Hz ..... 3-9, 3-22  
Res 1kHz ..... 3-9, 3-22  
Res 10Hz ..... 3-9, 3-22  
Res 100Hz ..... 3-9, 3-22  
Reset File No. .... 3-8, 3-19  
Residual FM ..... A2-2  
Residual Response ..... A2-2  
Resolution bandwidth ..... 2-11, A2-1  
Responses to Interface Messages ..... 4-3  
RETURN ..... 2-2, 2-15  
Revision ..... 3-8, 3-20  
RF attenuator ..... 2-11  
RF INPUT 1 connector ..... 2-3  
RF INPUT 2 connector ..... 2-3  
RS-232 connector ..... 2-12  
RS-232 Remote Control Function ..... 4-46
- [S]**
- S T U V W X ..... 3-9, 3-24  
Sample ..... 3-15, 3-54  
SAVE ..... 2-8, 3-14, 3-47  
Save ..... 3-14, 3-47  
Save Item ..... 3-14, 3-47  
Saving Data ..... 2-88, 3-47  
Saving or Recalling Data ..... 2-88  
Screen Annotation ..... 2-10  
SDC ..... 4-4  
Search ALL/UP/LOW ..... 3-11, 3-35  
Selected Device Clear ..... 4-4  
Selecting Menu ..... 2-14  
Self Test ..... 3-14, 3-48  
Separating Two Signals ..... 2-39  
Serial Polling Enable ..... 4-4  
Set Resolution ..... 3-57  
Set Up RS232 ..... 3-8, 3-20  
Setting Date ..... 2-99  
Setting GPIB address ..... 4-2  
Setting Time ..... 2-99  
Setting up the measuring window ..... 2-26  
Setting Values ..... 3-57  
Setup ON/OFF ..... 3-14, 3-47  
SHIFT ..... 2-8, 3-10  
SHIFT, CONFIG(PRESET) ..... 2-8, 3-13  
SHIFT, COPY(Abort) ..... 3-7, 3-21  
SHIFT, RECALL(SAVE) ..... 2-8, 3-14  
SHIFT, 0(Self Test) ..... 3-14  
SHIFT, 1(EMC) ..... 3-10  
SHIFT, 7(CAL) ..... 3-7  
Sig Track ON/OFF ..... 3-11, 3-36  
Signal tacking ..... 2-34  
SINGLE ..... 2-4, 3-14, 3-49  
Single Sweep ..... 3-49  
Slope +/- ..... 3-15, 3-56  
Soft key ..... 2-2  
Soft-menu ..... 2-11  
Soft-menu display ..... 2-2  
Sound ..... 3-10, 3-11, 3-27, 3-36, 4-18  
Sound AM/FM ..... 3-10, 3-11, 3-27, 3-36  
Sound Off ..... 3-10, 3-11, 3-27, 3-36  
SPAN ..... 2-4, 3-14, 3-50  
SPE ..... 4-4  
SPECIFICATIONS ..... 5-1  
Specifications for the External Gate Signal ..... 5-4  
Specifications for the instrument equipped  
with TG option ..... 5-5  
Spurious ..... A2-2  
Spurious Response ..... A2-3  
Squelch ON/OFF ..... 3-10, 3-11, 3-27, 3-36  
Standard accessories list ..... 1-2  
Standard event register ..... 4-13  
Standard Operation Status Register ..... 4-11  
Start ..... 3-10, 3-28  
Start frequency ..... 2-11  
Status Byte Register ..... 4-12  
Status bytes ..... 4-8, 4-28  
Status Register ..... 4-8  
Step keys ..... 2-5  
Stop ..... 3-10, 3-28  
Stop Bit 1/2 ..... 3-8, 3-20  
Stop frequency ..... 2-11  
Store A(B) to B(A) ..... 3-15, 3-55  
Storing ..... 1-12  
SWEEP ..... 2-7, 3-15, 3-51, 5-2  
SWEEP lamp ..... 2-4  
Sweep mode ..... 4-16  
Sweep time ..... 2-11, 3-51, 4-16  
Switching between the settings ..... 2-15  
SWP Time ..... 3-58  
SWP Time AUTO/MNL ..... 3-15, 3-51  
System checkout ..... 1-8

## Alphabetical Index

SYSTEM Section ..... 2-8

**[T]**

talker ..... 4-33  
 TG ..... 2-4, 3-15, 3-52, 4-24  
 TG Level ..... 3-15, 3-52  
 TG Off ..... 3-15, 3-53  
 TG OUTPUT connector ..... 2-3  
 Time/Date ..... 3-8, 3-20  
 Time/Date ON/OFF ..... 3-9, 3-25  
 Title ..... 2-11  
 To abort printing ..... 3-21  
 Tone GRAY/B/W ..... 3-9, 3-25  
 Total Gain ..... 3-7, 3-18  
 Total Power ..... 3-13, 3-42  
 TRACE ..... 2-7, 2-11, 3-15, 3-54, 4-20, 4-21  
 Trace Data ..... 3-54  
 Trace data I/O ..... 4-28, 4-37  
 Trace ON/OFF ..... 3-14, 3-47  
 Tracking Generator ..... 3-52  
 Transporting ..... 1-12  
 Trc Lvl ON/OFF ..... 3-14, 3-47  
 Trc Menu A/B ..... 3-15, 3-54, 3-55  
 TRIG ..... 2-7, 3-15, 3-56  
 Trigger ..... 3-56, 4-19  
 TR1722 ..... 3-10, 3-26

**[U]**

UHALP9107 ..... 3-10, 3-26  
 UNCAL message ..... 2-11, 2-36  
 Unit ..... 4-15  
 Units ..... 3-10, 3-30, 4-7  
 Units keys ..... 2-5  
 User Ant Corr ..... 3-10, 3-26  
 Using Floppy Disks ..... 2-85  
 Using SHIFT ..... 2-16  
 Using the delta marker ..... 2-21  
 Using the Expansion Function ..... 2-85  
 Using the Status Byte ..... 4-42

**[V]**

VBW ..... 2-11, 3-58  
 VBW AUTO/MNL ..... 3-7, 3-17  
 Video ..... 3-15, 3-56  
 Video bandwidth ..... 2-11  
 View A(B) ..... 3-15, 3-54  
 Volts ..... 3-10, 3-30  
 Volume ..... 3-10, 3-11, 3-27, 3-36

**[W]**

Watts ..... 3-10, 3-30

Width SRT/STP ..... 3-12, 3-40  
 Window Off ..... 3-9, 3-24  
 Window POS/WD ..... 3-9, 3-23  
 Window SRT/STP ..... 3-9, 3-23  
 Window Sweep ON/OFF ..... 3-9, 3-12, 3-23, 3-40  
 Write A(B) ..... 3-15, 3-54

**[X]**

X dB Down ..... 3-11, 3-33  
 X dB Left ..... 3-11, 3-33  
 X dB Right ..... 3-11, 3-33  
 XON/XOFF ON/OFF ..... 3-8, 3-20  
 X-OUT terminal ..... 2-12

**[Y]**

Y Z \_ # Spc ..... 3-9, 3-24  
 Year ..... 3-8, 3-20

**[Z]**

Zero Span ..... 3-14, 3-50, A2-2  
 Zoom In ..... 3-9, 3-23  
 Zoom Out ..... 3-9, 3-23