

**FLUKE®**

# **Fluke 43B**

## Power Quality Analyzer

Getting Started

EN  
June 2005

© 2001-2005 Fluke Corporation, All rights reserved. Printed in The Netherlands.

All product names are trademarks of their respective companies.

## **PLACING ORDERS AND GETTING ASSISTANCE**

To locate an authorized service center,  
visit us on the World Wide Web:

**<http://www.fluke.com>**

or call Fluke using any of the phone numbers listed below:

+1-888-993-5853 in U.S.A. and Canada

+31-40-2675200 in Europe

+1-425-446-5500 from other countries

## Unpacking

The following items are included in your Fluke 43B kit...

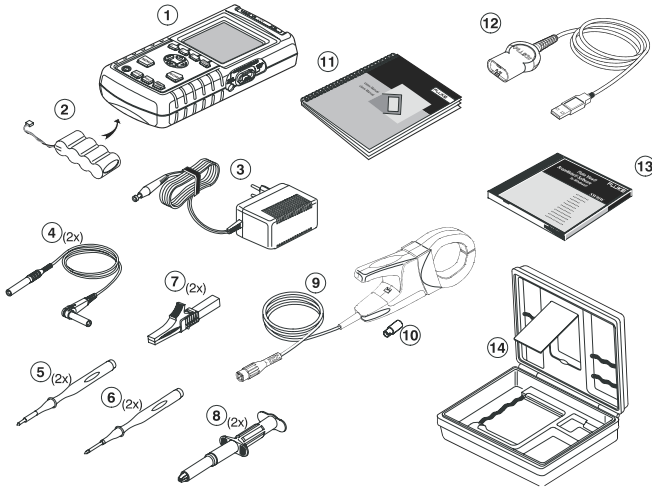

**Figure 1. Carrying Case Contents**

1	Fluke 43B	Power Quality Analyzer
2	BP120MH	Ni-MH Battery Pack (installed)
3	PM8907/8xx	Power Adapter/Battery Charger
4	TL24	Test Leads, red and black
5	TP1	Flat blade Test Pins, red and black
6	TP4	4mm Test Pins, red and black
7	AC85A	Large Jaw Alligator Clips for Banana Plugs, red and black
8	AC20	Industrial Alligator Clips for Banana Plugs, red and black
9	i400s	Clamp-on AC Current Probe
10	BB120	Shielded Banana-to-BNC Adapter Plugs (1x black)
11		Getting Started Manual incl. User / Application Manual CD
12	OC4USB	Optically Isolated USB Adapter/Cable
13	SW43W	FlukeView® Power Quality Analyzer software
14	C120	Hard Carrying Case

## **Safety Information: Read First**











Read the safety information before using the Fluke 43B.

Specific warning and caution statements, where they apply, will be found throughout the manual.

**A “Warning” identifies conditions and actions that pose hazard(s) to the user.**

**A “Caution” identifies conditions and actions that may damage the Fluke 43B.**

The following international symbols are used on the Fluke 43B and in this manual:

 Read the safety information in the manual	 Double Insulation (Protection Class)
 Earth	 Equipotential inputs, connected internally
 UL 3111 listed	 UL 1244 listed
 Conformité Européenne	 CSA listed for USA and Canada
 Recycling information	 Disposal information

### **Warning**

**To avoid electrical shock, use only a Fluke power supply, Model PM8907 (Power Adapter/Battery Charger).**



## Warning



Do the following to avoid electrical shock or fire if a Fluke 43B common input  is connected to more than 42 V peak (30 V rms):

- Use only test leads and test lead adapters supplied with the Fluke 43B (or safety-designed equivalents as specified in the accessory list, see Users Manual.)
- Do not use conventional exposed metal banana plug connectors.
- Use only one common connection  to the Fluke 43B.
- Remove all test leads that are not in use.
- The maximum allowable input voltage is 600V. Use test lead adapters that have a rating of 600V or more.
- When powering the Fluke 43B, first connect the power adapter to the outlet before connecting it to the Fluke 43B.
- Do not insert metal objects into the power adapter connector of the Fluke 43B.

## Warning

In the scope function it is possible to select AC coupling and to operate time base ranges and amplitude manually. In this case, the measuring results displayed on the screen may not be representative of the total signal. This can result in the presence of dangerous voltages of more than 42 V peak (30 V rms) not being detected. To guarantee user safety, all signals should first be measured with DC coupling. This ensures that the full signal is measured.

## **Fluke 43B**

### *Getting Started*

---

The terms 'Isolated' or 'Electrically floating' are used in this manual to indicate a measurement in which the Fluke 43B COM (common, also called ground) is connected to a voltage different from earth ground.

The term "Grounded" is used in this manual to indicate a measurement in which the Fluke 43B COM (common) is connected to an earth ground potential.

The Fluke 43B common inputs (red INPUT 1 shield, gray INPUT 2 shield, and black 4-mm banana COM input) are connected internally via self-recovering fault protection. This is denoted by the  symbol.

The input connectors have no exposed metal and are fully insulated to protect against electrical shock. The black 4 mm banana jack COM (common) can be connected to a voltage above earth ground for isolated (electrically floating) measurements and is rated up to 600V rms above earth ground.

### **If Safety-Precautions are Impaired**

**Using the Fluke 43B in a manner not specified may impair the protection provided by the equipment.** Before using, inspect the test leads for mechanical damage and replace damaged test leads!

If it is likely that safety has been impaired, turn the Fluke 43B off and disconnect it from the line power. The matter should then be referred to qualified personnel. Safety is likely to be impaired if, for example, the Fluke 43B fails to perform the intended measurements or shows visible damage.

### **Current Probe**



**Warning**



- **Use extreme caution when clamping the current probe around uninsulated conductors or bus bars.**
- **Never use the current probe on circuits rated higher than 600V in measurement category III (CAT III) of EN/IEC61010-1**
- **Keep your fingers behind the finger guard.**

Do not use a probe that is cracked, damaged, or has a defective cable. Such probes should be made inoperative by taping the clamp shut to prevent operation.

# Introducing the Fluke 43B

## Powering the Fluke 43B

To power the Fluke 43B from a standard AC outlet, perform steps 1-3. For battery power, see Chapter 2.

- 1 Plug the power adapter into the AC outlet.
- 2 Connect the power adapter cable to the Fluke 43B (see Figure 2).

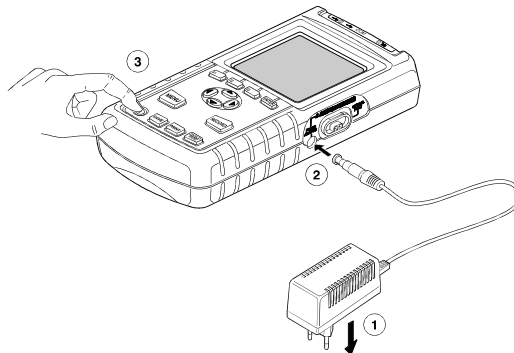

**Figure 2. Powering the Fluke 43B**

- 3  Turn the Fluke 43B on.

The opening screen will appear on the display (see Figure 3).

### Note

*If the Fluke 43B does not turn on, the batteries may be dead. Leave the Fluke 43B connected to the outlet for 15 minutes and try again.*

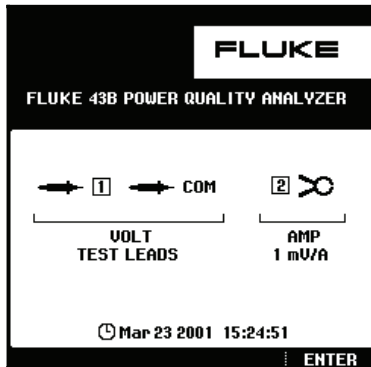

**Figure 3. Opening Screen**

The screen shows which test leads or probes you should use on the inputs.

Note that in the screen shown in Figure 3, for example, you should use **TEST LEADS** for voltage measurements and a **1 mV/A** current probe for current measurements.

**4**  Continue.



## Inputs

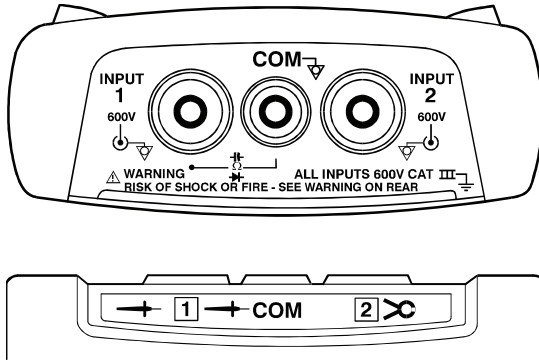





Figure 4. Measurement Connections

**INPUT 1:** Use the red test lead on input 1 (  **1** ).

**COM** : Use the black test lead on the COM input (  **COM** ).

Use these inputs for all voltage measurements, and for Ohm, continuity, diode capacitance and temperature measurements.

The Fluke 43B common inputs  (red INPUT 1 shield, gray INPUT 2 shield, and black COM input) are connected internally via self-recovering fault protection.

**INPUT 2:** Use the i400s AC current probe on input 2 ( **2**  ).



This input is mainly used for current measurements. Use the BB120 banana-to-BNC adapter to connect the current probe.

### Note

*If you use other test leads or probes, change the probe settings in the instrument setup menu (see “Selecting Probes”).*

## Main Menu

All functions can be easily selected from the main menu.

- 1  Open the main menu.
- 2  **VOLTS/AMPS/HERTZ**  
(for example) 

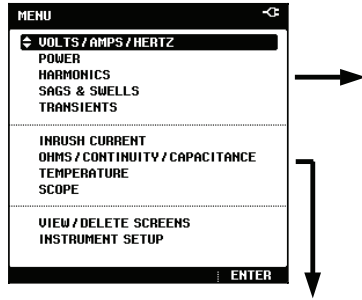

### INRUSH CURRENT

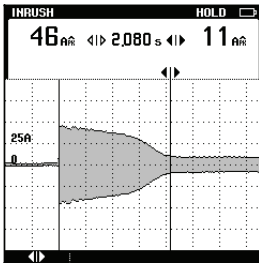

Measures inrush current and inrush time (motor start-ups).

### OHMS / CONTINUITY / CAPACITANCE

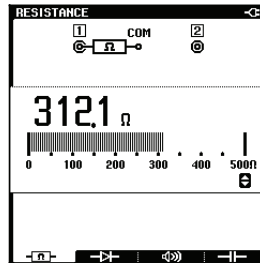

Measures resistance, diodes, continuity and capacitance (DMM).

### TEMPERATURE

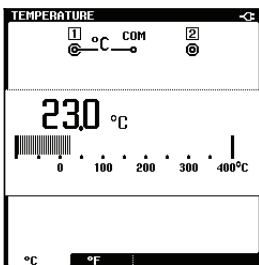

Measures temperature with optional temperature probe.

### SCOPE

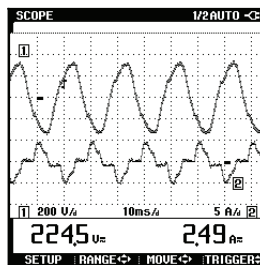

Dual channel oscilloscope: Volts on input 1 and Amps on input 2.

**VOLTS / AMPS / HERTZ**

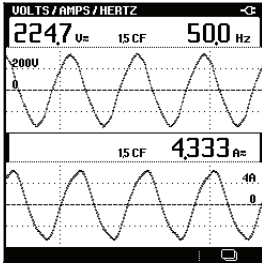

Gives a fast overview of Volts, Amps and Hertz.

**POWER**

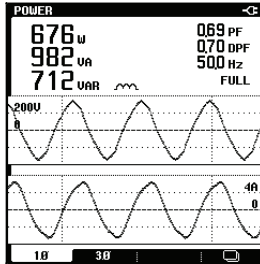

Shows all power readings in one screen.

**HARMONICS**

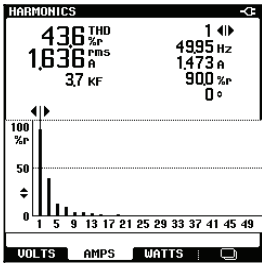

Measures up to 51 harmonics.

**SAGS & SWELLS**

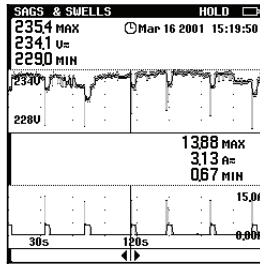

Shows dips and surges as short as one cycle. With time stamp.

**TRANSIENTS**

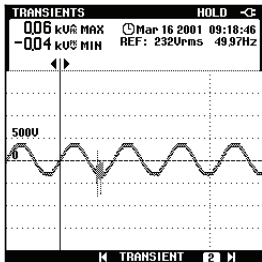

Captures and stores up to 40 voltage transients.

## Volts / Amps / Hertz

This function simultaneously shows the voltage and current signal. Also the Crest factor is shown. Use this function to get a first impression of the voltage and current signal before examining the signal in more detail with the other functions.

With the ENTER key you can toggle between Volts / Amps / Hertz, Power, and Harmonics functions.

## Power

This function measures and displays the following power readings: active power (W), apparent power (VA), reactive power (VAR), power factor (PF), displacement power factor (DPF or  $\cos \varphi$ ) and frequency. The voltage and current waveforms give a visual representation of the phase shifts

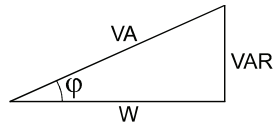

Fluke 43B can perform power measurements on balanced 3-phase, 3-conductor power systems. The load must be well balanced and have either a wye or delta configuration. This makes it possible to measure 3 phase power using single phase connections. The 3 phase power mode measures the fundamental power only.

With the ENTER key you can toggle between Power, Harmonics, and Volts / Amps / Hertz functions.

## Harmonics

Harmonics are periodic distortions of the voltage, current, or power sine wave. The signal can be conceived of as a combination of various sine waves with different frequencies. The contribution of each of these components to the full signal is shown as a bar.

The large numbers refer to the full signal; the small numbers belong to the selected harmonic component.

With the ENTER key you can toggle between Harmonics, Volts / Amps / Hertz, and Power functions.

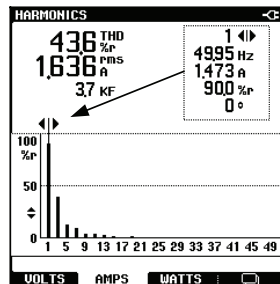

## Sags & Swells

Sags and swells measures fast deviations (from one cycle to a few seconds) from the normal voltage signal, and displays current simultaneously.

The results are plotted on the screen as a graph. The graph shows the minimum and maximum values at each point of the graph.

The **SAGS & SWELLS** function is particularly useful to record flicker.

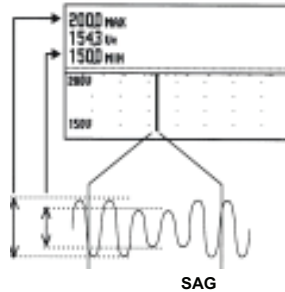

## Transients

Transients are fast spikes on the voltage (or current) signal. Spikes may contain enough energy to damage sensitive electronic equipment.

This function detects spikes on the voltage signal and stores a picture of the signal in memory. A transient is detected when it crosses an envelope around the voltage waveform. The width of the envelope can be set manually.

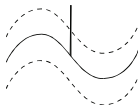

DETECTED



NOT DETECTED



DETECTED

## Inrush Current



Inrush currents are surge currents which occur, for example, when a large motor is started.

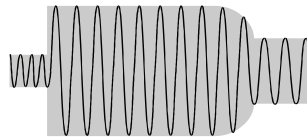



This function shows the current signal at the moment of the surge. If the current exceeds a specified level, the signal appears as a gray band on the display formed by the peak-peak values of the waveshape.



Use **INRUSH CURRENT** to look for inrush currents or other surge currents. Measure the peak current and duration of the surge current.



## Selecting Probes

For standard operation, use the red test lead on input **1** , the black test lead on COM  and the current clamp on input **2** . If you are using other test leads or probes, you must change the probe settings accordingly.

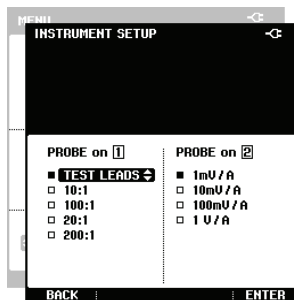
-  Open the main MENU.
-  **INSTRUMENT SETUP**  

-  **PROBES**  





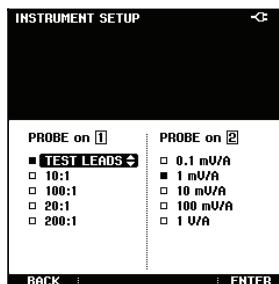

Select the type of probe you are going to use on input 1. For all applications in the Applications Guide, you must use test leads.

-  **TEST LEADS**  
(for example)
-  Accept the probe settings for input 1. *The screen closes.*
-  Select **PROBES** again.



Select the sensitivity of the current probe you are going to use on input 2. For all applications in the Applications Guide, use the i400s current probe and choose **1 mV/A**.

- 7  Move to the probe settings for input 2.
- 8    
(for the i400s current probe)
- 9  Accept the probe settings for input 2.

*Note*









*Select 1V/A when using testleads on input [2] in the Scope Mode. A reading of 1A then equals 1V.*

## Selecting a Language

You can choose between English and other languages. To change the language for example into Spanish, do the following:

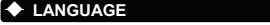
### Note

*Combinations of languages (one or more) depend on the version ordered.*

- 1  Open the main MENU.
- 2   → 
- 3   → 
- 4   (for example)
- 5  Accept the new language.

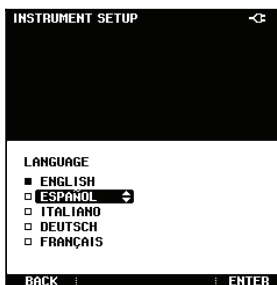
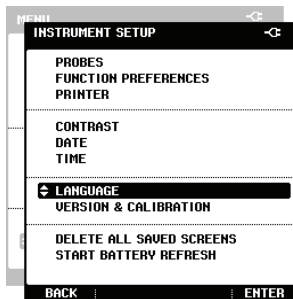

All text on the display immediately changes to the new language.



## **Using FlukeView Software**

This section explains how to connect the Fluke 43B to a PC for use with the FlukeView® Power Quality Analyzer software or to create reports in MS-Word®.

Use the Optically Isolated USB Cable on the optical port to connect the Fluke 43B to a PC (see Figure 5).

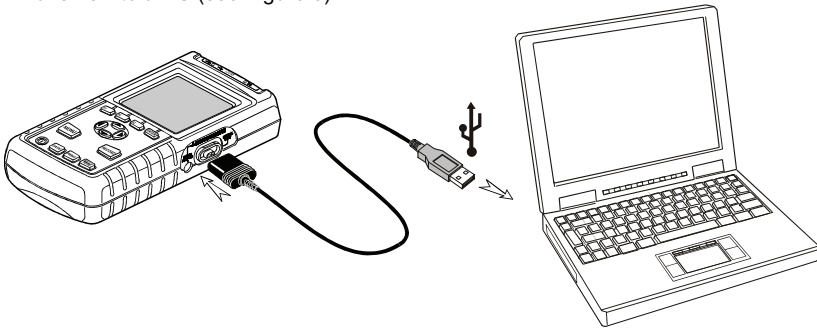

**Figure 5. Connecting a Computer**

*Note*



*For information about how to install and use the FlukeView software, please read the FlukeView SW43W Users Manual as supplied on CD-ROM.*

*To create a report in MS-Word, see: "Creating Reports" in Chapter 5 of the Applications Guide.*

## Resetting the Fluke 43B

To restore the Fluke 43B to its factory settings and return to the opening screen, reset the Fluke 43B. Resetting does not clear screen memories.

Turn the Fluke 43B off and proceed as follows:

- 1**  Press and hold.
- 2**  Press and release.

The Fluke 43B turns on, and you should hear a double beep, indicating that the reset operation was successful.

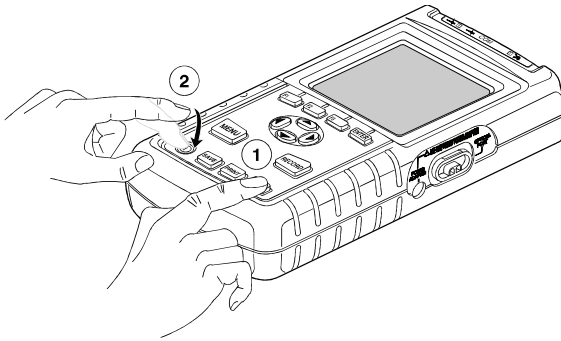

**Figure 8. Resetting the Fluke 43B**

- (3)**  Release the HOLD key.

The opening screen with default settings appears on the display.

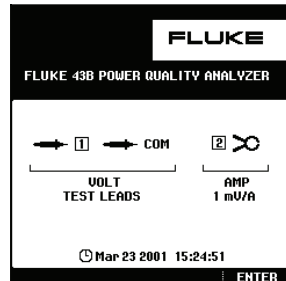

- 4**  Continue.