

FLUKE®

5520A

Multi-Product Calibrator

Operators Manual

PN 688739

August 1998 Rev.6, 1/03

© 1998 -2003 Fluke Corporation, All rights reserved. Printed in U.S.A.
All product names are trademarks of their respective companies.

LIMITED WARRANTY AND LIMITATION OF LIABILITY

Each Fluke product is warranted to be free from defects in material and workmanship under normal use and service. The warranty period is one year and begins on the date of shipment. Parts, product repairs, and services are warranted for 90 days. This warranty extends only to the original buyer or end-user customer of a Fluke authorized reseller, and does not apply to fuses, disposable batteries, or to any product which, in Fluke's opinion, has been misused, altered, neglected, contaminated, or damaged by accident or abnormal conditions of operation or handling. Fluke warrants that software will operate substantially in accordance with its functional specifications for 90 days and that it has been properly recorded on non-defective media. Fluke does not warrant that software will be error free or operate without interruption.

Fluke authorized resellers shall extend this warranty on new and unused products to end-user customers only but have no authority to extend a greater or different warranty on behalf of Fluke. Warranty support is available only if product is purchased through a Fluke authorized sales outlet or Buyer has paid the applicable international price. Fluke reserves the right to invoice Buyer for importation costs of repair/replacement parts when product purchased in one country is submitted for repair in another country.

Fluke's warranty obligation is limited, at Fluke's option, to refund of the purchase price, free of charge repair, or replacement of a defective product which is returned to a Fluke authorized service center within the warranty period.

To obtain warranty service, contact your nearest Fluke authorized service center to obtain return authorization information, then send the product to that service center, with a description of the difficulty, postage and insurance prepaid (FOB Destination). Fluke assumes no risk for damage in transit. Following warranty repair, the product will be returned to Buyer, transportation prepaid (FOB Destination). If Fluke determines that failure was caused by neglect, misuse, contamination, alteration, accident, or abnormal condition of operation or handling, including overvoltage failures caused by use outside the product's specified rating, or normal wear and tear of mechanical components, Fluke will provide an estimate of repair costs and obtain authorization before commencing the work. Following repair, the product will be returned to the Buyer transportation prepaid and the Buyer will be billed for the repair and return transportation charges (FOB Shipping Point).

THIS WARRANTY IS BUYER'S SOLE AND EXCLUSIVE REMEDY AND IS IN LIEU OF ALL OTHER WARRANTIES, EXPRESS OR IMPLIED, INCLUDING BUT NOT LIMITED TO ANY IMPLIED WARRANTY OF MERCHANTABILITY OR FITNESS FOR A PARTICULAR PURPOSE. FLUKE SHALL NOT BE LIABLE FOR ANY SPECIAL, INDIRECT, INCIDENTAL, OR CONSEQUENTIAL DAMAGES OR LOSSES, INCLUDING LOSS OF DATA, ARISING FROM ANY CAUSE OR THEORY.

Since some countries or states do not allow limitation of the term of an implied warranty, or exclusion or limitation of incidental or consequential damages, the limitations and exclusions of this warranty may not apply to every buyer. If any provision of this Warranty is held invalid or unenforceable by a court or other decision-maker of competent jurisdiction, such holding will not affect the validity or enforceability of any other provision.

Fluke Corporation
P.O. Box 9090
Everett, WA 98206-9090
U.S.A.

Fluke Europe B.V.
P.O. Box 1186
5602 BD Eindhoven
The Netherlands

Safety Information

This Calibrator complies with IEC publication 1010-1 (1992-1), Safety Requirements for Electrical Measuring, Control and Laboratory Equipment, and ANSI/ISA-S82.01-1994, and CAN/CSA-C22.2 No. 1010.1-92. This manual contains information, warnings, and cautions that must be followed to ensure safe operation and to maintain the Calibrator in a safe condition. Use of this Calibrator in a manner not specified herein may impair the protection provided by the Calibrator.

This Calibrator is designed for IEC 1010-1 Installation Category II use. It is not designed for connection to circuits rated over 4800 VA.

Warning statements identify conditions or practices that could result in personal injury or loss of life.

Caution statements identify conditions or practices that could result in damage to equipment.

SYMBOLS MARKED ON THE CALIBRATOR



WARNING Risk of electric shock. Refer to the manual (see the Index for references).



GROUND Ground terminal to chassis (earth).



Attention Refer to the manual (see the Index for references). This symbol indicates that information about usage of a feature is contained in the manual.

AC POWER SOURCE

The Calibrator is intended to operate from an ac power source that will not apply more than 264V ac rms between the supply conductors or between either supply conductor and ground. A protective ground connection by way of the grounding conductor in the power cord is required for safe operation.

USE THE PROPER FUSE

To avoid fire hazard, use only the specified replacement fuse:

- For 100 V or 120 V operation, use a 5A/250V time delay fuse (Fluke PN 109215).
- For 220 V or 240 V operation, use a 2.5A/250V time delay fuse (Fluke PN 851931).

GROUNDING THE CALIBRATOR

The Calibrator uses controlled overvoltage techniques that require the Calibrator to be grounded whenever normal mode or common mode ac voltages or transient voltages may occur. The enclosure must be grounded through the grounding conductor of the power cord, or through the rear panel CHASSIS GROUND binding post.

USE THE PROPER POWER CORD

Use only the power cord and connector appropriate for the voltage and plug configuration in your country.

Use only a power cord that is in good condition.

Refer power cord and connector changes to qualified service personnel.

DO NOT OPERATE IN EXPLOSIVE ATMOSPHERES

To avoid explosion, do not operate the Calibrator in an atmosphere of explosive gas.

CHECK INSULATION RATINGS

Verify that the voltage applied to the unit under test does not exceed the insulation rating of the UUT and the interconnecting cables.

DO NOT REMOVE COVER DURING OPERATION

To avoid personal injury or death, do not remove the Calibrator cover without first removing the power source connected to the rear panel. Do not operate the Calibrator without the cover properly installed. Normal calibration is accomplished with the cover closed. Access procedures and the warnings for such procedures are contained in the Service Manual. Service procedures are for qualified service personnel only.

DO NOT ATTEMPT TO OPERATE IF PROTECTION MAY BE IMPAIRED

If the Calibrator appears damaged or operates abnormally, protection may be impaired. Do not attempt to operate the Calibrator under these conditions. Refer all questions of proper Calibrator operation to qualified service personnel.

Table of Contents

Chapter	Contents	Page
1	Introduction and Specifications	1-1
	1-1. Introduction.....	1-3
	1-2. Operation Overview.....	1-4
	1-3. Local Operation.....	1-4
	1-4. Remote Operation (RS-232).....	1-4
	1-5. Remote Operation (IEEE-488).....	1-5
	1-6. Where to Go from Here	1-6
	1-7. Instruction Manuals	1-7
	1-8. 5520A Operators Manual	1-8
	1-9. 5520A Operators Guide.....	1-8
	1-10. 5520A Programmers Guide.....	1-8
	1-11. 5520A Service Manual	1-8
	1-12. Specifications.....	1-9
	1-13. General Specifications.....	1-10
	1-14. DC Voltage Specifications	1-11
	1-15. DC Current Specifications	1-12
	1-16. Resistance Specifications	1-14
	1-17. AC Voltage (Sine Wave) Specifications.....	1-15
	1-18. AC Current (Sine Wave) Specifications	1-17
	1-19. Capacitance Specifications.....	1-19
	1-20. Temperature Calibration (Thermocouple) Specifications.....	1-20
	1-21. Temperature Calibration (RTD) Specifications	1-21
	1-22. DC Power Specification Summary.....	1-22
	1-23. AC Power (45 Hz to 65 Hz) Specification Summary, PF=1	1-22
	1-24. Power and Dual Output Limit Specifications	1-23
	1-25. Phase Specifications	1-24
	1-26. Calculating Power Uncertainty	1-25
	1-27. Additional Specifications	1-26
	1-28. Frequency Specifications	1-26
	1-29. Harmonics (2nd to 50th) Specifications.....	1-27
	1-30. AC Voltage (Sine Wave) Extended Bandwidth Specifications	1-28
	1-31. AC Voltage (Non-Sine Wave) Specifications.....	1-29
	1-32. AC Voltage, DC Offset Specifications	1-30
	1-33. AC Voltage, Square Wave Characteristics	1-31
	1-34. AC Voltage, Triangle Wave Characteristics (typical)	1-31
	1-35. AC Current (Sine Wave) Extended Bandwidth Specifications.....	1-31

1-36.	AC Current (Non-Sine Wave) Specifications	1-32
1-37.	AC Current, Square Wave Characteristics (typical)	1-34
1-38.	AC Current, Triangle Wave Characteristics (typical)	1-34
2	Preparing for Operation	2-1
2-1.	Introduction.....	2-3
2-2.	Unpacking and Inspection	2-3
2-3.	Replacing the Fuse.....	2-4
2-4.	Selecting Line Voltage	2-4
2-5.	Connecting to Line Power	2-5
2-6.	Selecting Line Frequency	2-5
2-7.	Service Information	2-7
2-8.	Placement and Rack Mounting	2-8
2-9.	Cooling Considerations	2-8
3	Features	3-1
3-1.	Introduction.....	3-3
3-2.	Front Panel Features	3-3
3-3.	Rear Panel Features	3-3
3-4.	Softkey Menu Trees.....	3-3
4	Front Panel Operation.....	4-1
4-1.	Introduction.....	4-3
4-2.	Turning on the Calibrator	4-3
4-3.	Warming up the Calibrator	4-4
4-4.	Using the Softkeys	4-4
4-5.	Using the Setup Menu	4-4
4-6.	Using the Instrument Setup Menu	4-5
4-7.	Utility Functions Menu	4-5
4-8.	Using the Format EEPROM Menu	4-6
4-9.	Resetting the Calibrator	4-6
4-10.	Zeroing the Calibrator.....	4-6
4-11.	Using the Operate and Standby Modes	4-8
4-12.	Connecting the Calibrator to a UUT.....	4-9
4-13.	Recommended Cable and Connector Types.....	4-9
4-14.	When to Use EARTH and EXGRD	4-10
4-15.	Earth	4-10
4-16.	External Guard	4-10
4-17.	Four-Wire versus Two-Wire Connections	4-11
4-18.	Cable Connection Instructions	4-12
4-19.	RMS Versus p-p Amplitude	4-17
4-20.	Auto Range Versus Locked Range.....	4-18
4-21.	Setting the Output	4-18
4-22.	Setting DC Voltage Output	4-19
4-23.	Setting AC Voltage Output	4-20
4-24.	Setting DC Current Output.....	4-23
4-25.	Setting AC Current Output.....	4-24
4-26.	Setting DC Power Output.....	4-26
4-27.	Setting AC Power Output.....	4-28
4-28.	Setting a Dual DC Voltage Output.....	4-32
4-29.	Setting a Dual AC Voltage Output.....	4-34
4-30.	Setting Resistance Output	4-37
4-31.	Setting Capacitance Output.....	4-38

4-32.	Setting Temperature Simulation (Thermocouple).....	4-40
4-33.	Setting Temperature Simulation (RTD).....	4-42
4-34.	Measuring Thermocouple Temperatures.....	4-45
4-35.	Waveform Types.....	4-46
4-36.	Sine Wave.....	4-47
4-37.	Triangle Wave	4-47
4-38.	Square Wave.....	4-47
4-39.	Truncated Sine Wave	4-48
4-40.	Setting Harmonics.....	4-48
4-41.	Adjusting the Phase	4-49
4-42.	Entering a Phase Angle	4-50
4-43.	Entering a Power Factor	4-51
4-44.	Entering a DC Offset	4-52
4-45.	Editing and Error Output Settings	4-53
4-46.	Editing the Output Setting.....	4-53
4-47.	Displaying the UUT Error.....	4-54
4-48.	Using Multiply and Divide.....	4-54
4-49.	Setting Output Limits	4-55
4-50.	Setting Voltage and Current Limits.....	4-55
4-51.	Measuring Pressure.....	4-56
4-52.	Synchronizing the Calibrator using 10 MHz IN/OUT.....	4-58
4-53.	Using an External 10 MHz Clock	4-58
4-54.	Sourcing AC Current with Parallel-Connected 5520As.....	4-58
4-55.	Three-Phase Power Calibration.....	4-60
4-56.	Sample Applications.....	4-61
4-57.	Calibrating an 80 Series Handheld Multimeter.....	4-61
4-58.	Cables.....	4-61
4-59.	EARTH Connection.....	4-61
4-60.	Testing the Meter	4-62
4-61.	Calibrating the Meter	4-66
4-62.	Testing a Model 41 Power Harmonics Analyzer	4-67
4-63.	Testing Watts, VA, VAR Performance.....	4-67
4-64.	Testing Harmonics Volts Performance.....	4-69
4-65.	Testing Harmonics Amps Performance	4-71
4-66.	Calibrating a Fluke 51 Thermometer	4-71
4-67.	Testing the Thermometer	4-72
4-68.	Calibrating the Thermometer.....	4-73

5 Remote Operation 5-1

5-1.	Introduction.....	5-4
5-2.	Setting up the IEEE-488 Port for Remote Control	5-6
5-3.	IEEE-488 Port Setup Procedure	5-8
5-4.	Testing the IEEE-488 Port.....	5-9
5-5.	Setting up the RS-232 Host Port for Remote Control	5-10
5-6.	RS-232 Host Port Setup Procedure	5-10
5-7.	Testing the RS-232 Host Port.....	5-13
5-8.	Testing RS-232 Host Port Operation using a Terminal	5-13
5-9.	Testing RS-232 Host Port Operation using Visual Basic	5-15
5-10.	Setting up the RS-232 UUT Port for Remote Control.....	5-16
5-11.	RS-232 UUT Port Setup Procedure.....	5-16
5-12.	Testing the RS-232 UUT Port via RS-232 Host Port.....	5-18
5-13.	Testing RS-232 UUT Port Operation via a Terminal	5-18
5-14.	Testing RS-232 UUT Port Operation using Visual Basic	5-19
5-15.	Testing the RS-232 UUT Port via IEEE-488 Port.....	5-20

5-16.	Changing between Remote and Local Operation	5-22
5-17.	Local State	5-22
5-18.	Local with Lockout State	5-22
5-19.	Remote State	5-22
5-20.	Remote with Lockout State	5-22
5-21.	RS-232 Interface Overview	5-23
5-22.	IEEE-488 Interface Overview	5-24
5-23.	Using Commands	5-26
5-24.	Types of Commands	5-26
5-25.	Device-Dependent Commands	5-26
5-26.	Common Commands	5-27
5-27.	Query Commands	5-27
5-28.	Interface Messages (IEEE-488)	5-27
5-29.	Compound Commands	5-29
5-30.	Coupled Commands	5-29
5-31.	Overlapped Commands	5-30
5-32.	Sequential Commands	5-30
5-33.	Commands that Require the Calibration Switch	5-31
5-34.	Commands for RS-232 Only	5-31
5-35.	Commands for IEEE-488 Only	5-32
5-36.	Command Syntax	5-33
5-37.	Parameter Syntax Rules	5-33
5-38.	Extra Space or Tab Characters	5-34
5-39.	Terminators	5-35
5-40.	Incoming Character Processing	5-35
5-41.	Response Message Syntax	5-36
5-42.	Checking 5520A Status	5-37
5-43.	Serial Poll Status Byte (STB)	5-37
5-44.	Service Request (SRQ) Line	5-39
5-45.	Service Request Enable Register (SRE)	5-39
5-46.	Programming the STB and SRE	5-40
5-47.	Event Status Register (ESR)	5-40
5-48.	Event Status Enable (ESE) Register	5-40
5-49.	Bit Assignments for the ESR and ESE	5-40
5-50.	Programming the ESR and ESE	5-41
5-51.	Instrument Status Register (ISR)	5-42
5-52.	Instrument Status Change Registers	5-42
5-53.	Instrument Status Change Enable Registers	5-42
5-54.	Bit Assignments for the ISR, ISCR, and ISCE	5-42
5-55.	Programming the ISR, ISCR, and ISCE	5-44
5-56.	Output Queue	5-44
5-57.	Error Queue	5-45
5-58.	Remote Program Examples	5-45
5-59.	Guidelines for Programming the Calibrator	5-45
5-60.	Writing an SRQ and Error Handler	5-46
5-61.	Verifying a Meter on the IEEE-488 Bus	5-47
5-62.	Verifying a Meter on the RS-232 UUT Serial Port	5-47
5-63.	Using *OPC?, *OPC, and *WAI	5-47
5-64.	Taking a Thermocouple Measurement	5-48
5-65.	Taking a Pressure Measurement	5-48
5-66.	Using the RS-232 UUT Port to Control an Instrument	5-49
5-67.	Input Buffer Operation	5-49

6	Remote Commands.....	6-1
6-1.	Introduction.....	6-3
6-2.	Command Summary by Function	6-3
6-3.	Common Commands	6-3
6-4.	Error Mode Commands	6-4
6-5.	External Connection Commands.....	6-4
6-6.	Oscilloscope Commands	6-5
6-7.	Output Commands.....	6-5
6-8.	Pressure Measurement Commands.....	6-7
6-9.	RS-232 Host Port Commands.....	6-7
6-10.	RS-232 UUT Port Commands	6-7
6-11.	Setup and Utility Commands.....	6-8
6-12.	Status Commands	6-9
6-13.	Thermocouple (TC) Measurement Commands	6-9
6-14.	Commands	6-10
7	Maintenance.....	7-1
7-1.	Introduction.....	7-3
7-2.	Replacing the Line Fuse	7-3
7-3.	Cleaning the Air Filter	7-5
7-4.	General Cleaning	7-6
7-5.	Performance Tests	7-7
8	Oscilloscope Calibration Options	8-1
	5520A-SC600 Option	8-3
8-1.	Introduction.....	8-5
8-2.	SC600 Option Specifications.....	8-5
8-3.	Volt Specifications	8-6
8-4.	Edge Specifications	8-7
8-5.	Leveled Sine Wave Specifications.....	8-8
8-6.	Time Marker Specifications	8-9
8-7.	Wave Generator Specifications.....	8-9
8-8.	Pulse Generator Specifications.....	8-10
8-9.	Trigger Signal Specifications (Pulse Function)	8-11
8-10.	Trigger Signal Specifications (Time Marker Function).....	8-11
8-11.	Trigger Signal Specifications (Edge Function).....	8-11
8-12.	Trigger Signal Specifications (Square Wave Voltage Function).....	8-11
8-13.	Trigger Signal Specifications	8-11
8-14.	Oscilloscope Input Resistance Measurement Specifications	8-12
8-15.	Oscilloscope Input Capacitance Measurement Specifications.....	8-12
8-16.	Overload Measurement Specifications.....	8-12
8-17.	Oscilloscope Connections.....	8-13
8-18.	Starting the SC600 Option.....	8-13
8-19.	The Output Signal	8-14
8-20.	Adjusting the Output Signal	8-14
8-21.	Keying in a Value	8-14
8-22.	Adjusting Values with the Rotary Knob.....	8-15
8-23.	Using $\boxed{\text{MULT}}$ and $\boxed{\text{DIV}}$	8-15
8-24.	Resetting the SC600 Option.....	8-16
8-25.	Calibrating the Voltage Amplitude on an Oscilloscope	8-16
8-26.	The VOLT Function.....	8-16
8-27.	The V/DIV Menu	8-17

8-28.	Shortcuts for Setting the Voltage Amplitude.....	8-17
8-29.	Oscilloscope Amplitude Calibration Procedure.....	8-18
8-30.	Calibrating the Pulse and Frequency Response on an Oscilloscope	8-19
8-31.	The Edge Function	8-19
8-32.	Oscilloscope Pulse Response Calibration Procedure.....	8-20
8-33.	Pulse Response Calibration Using a Tunnel Diode Pulser	8-21
8-34.	The Leveled Sine Wave Function	8-21
8-35.	Shortcuts for Setting the Frequency and Voltage.....	8-22
8-36.	The MORE OPTIONS Menu	8-23
8-37.	Sweeping Through a Frequency Range.....	8-24
8-38.	Oscilloscope Frequency Response Calibration Procedure.....	8-24
8-39.	Calibrating the Time Base of an Oscilloscope	8-26
8-40.	The Time Marker Function	8-26
8-41.	Time Base Marker Calibration Procedure for an Oscilloscope	8-27
8-42.	Testing the Trigger SC600 option	8-28
8-43.	Testing Video Triggers	8-30
8-44.	Verifying Pulse Capture	8-31
8-45.	Measuring Input Resistance and Capacitance	8-32
8-46.	Input Impedance Measurement	8-32
8-47.	Input Capacitance Measurement	8-33
8-48.	Testing Overload Protection.....	8-33
8-49.	Remote Commands and Queries.....	8-34
8-50.	General Commands	8-35
8-51.	Edge Function Commands.....	8-38
8-52.	Marker Function Commands.....	8-38
8-53.	Video Function Commands.....	8-38
8-54.	Overload Function Commands.....	8-39
8-55.	Impedance/Capacitance Function Commands.....	8-40
8-56.	Verification Tables	8-41
8-57.	DC Voltage Verification	8-41
8-58.	AC Voltage Amplitude Verification	8-42
8-59.	AC Voltage Frequency Verification	8-42
8-60.	Wave Generator Amplitude Verification: 1 M Ω Output Impedance	8-43
8-61.	Wave Generator Amplitude Verification: 50 Ω Output Impedance	8-44
8-62.	Leveled Sine Wave Verification: Amplitude	8-45
8-63.	Leveled Sine Wave Verification: Frequency	8-45
8-64.	Leveled Sine Wave Verification: Harmonics.....	8-46
8-65.	Leveled Sine Wave Verification: Flatness.....	8-47
8-66.	Edge Verification: Amplitude	8-53
8-67.	Edge Verification: Frequency	8-53
8-68.	Edge Verification: Duty Cycle.....	8-53
8-69.	Edge Verification: Rise Time.....	8-54
8-70.	Tunnel Diode Pulser Verification	8-54
8-71.	Marker Generator Verification.....	8-55
8-72.	Pulse Generator Verification: Period	8-55
8-73.	Pulse Generator Verification: Pulse Width.....	8-55
8-74.	Input Impedance Verification: Resistance	8-56
8-75.	Input Impedance Verification: Capacitance.....	8-56
5520A-SC300 Option		8-57
8-76.	Introduction.....	8-59
8-77.	Oscilloscope Calibration Option Specifications.....	8-60
8-78.	Volt Function Specifications.....	8-60
8-79.	Edge Function Specifications.....	8-61

8-80.	Leveled Sine Wave Function Specifications.....	8-62
8-81.	Time Marker Function Specifications.....	8-63
8-82.	Wave Generator Specifications.....	8-63
8-83.	Trigger Signal Specifications for the Time Marker Function.....	8-64
8-84.	Trigger Signal Specifications for the Edge Function.....	8-64
8-85.	Oscilloscope Connections.....	8-65
8-86.	Starting the Oscilloscope Calibration Option.....	8-66
8-87.	The Output Signal.....	8-66
8-88.	Adjusting the Output Signal.....	8-67
8-89.	Keying in a Value.....	8-67
8-90.	Adjusting Values with the Rotary Knob.....	8-67
8-91.	Using $\boxed{\text{MULT}}$ and $\boxed{\text{DIV}}$	8-68
8-92.	Resetting the Oscilloscope Option.....	8-68
8-93.	Calibrating the Voltage Amplitude on an Oscilloscope.....	8-69
8-94.	The Volt Function.....	8-69
8-95.	The V/DIV Menu.....	8-70
8-96.	Shortcuts for Setting the Voltage Amplitude.....	8-70
8-97.	Amplitude Calibration Procedure for an Oscilloscope.....	8-71
8-98.	Calibrating the Pulse and Frequency Response on an Oscilloscope....	8-72
8-99.	The Edge Function.....	8-72
8-100.	Pulse Response Calibration Procedure for an Oscilloscope.....	8-73
8-101.	The Leveled Sine Wave Function.....	8-74
8-102.	Shortcuts for Setting the Frequency and Voltage.....	8-74
8-103.	The MORE OPTIONS Menu.....	8-75
8-104.	Sweeping through a Frequency Range.....	8-77
8-105.	Frequency Response Calibration Procedure for an Oscilloscope....	8-78
8-106.	Calibrating the Time Base of an Oscilloscope.....	8-80
8-107.	The Time Marker Function.....	8-80
8-108.	Time Base Marker Calibration Procedure for an Oscilloscope.....	8-81
8-109.	Testing the Trigger.....	8-82
8-110.	Summary of Commands and Queries.....	8-83
8-111.	Verification Tables.....	8-86
8-112.	Voltage Function Verification: AC Voltage into a 1 M Ω Load.....	8-86
8-113.	Voltage Function Verification: AC Voltage into a 50 Ω Load.....	8-87
8-114.	Voltage Function Verification: DC Voltage into a 50 Ω Load.....	8-88
8-115.	Voltage Function Verification: DC Voltage into a 1 M Ω Load.....	8-89
8-116.	Edge Function Verification.....	8-90
8-117.	Wave Generator Function Verification: 1 M Ω Load.....	8-90
8-118.	Wave Generator Function Verification: 50 Ω Load.....	8-91
8-119.	Leveled Sine Wave Function Verification: Amplitude.....	8-91
8-120.	Leveled Sine Wave Function Verification: Flatness.....	8-92
8-121.	Leveled Sine Wave Function Verification: Frequency.....	8-95
8-122.	Marker Generator Function Verification.....	8-96

9 Accessories 9-1

9-1.	Introduction.....	9-3
9-2.	Rack Mount Kit.....	9-4
9-3.	IEEE-488 Interface Cables.....	9-4
9-4.	RS-232 Null-Modem Cables.....	9-4
9-5.	RS-232 Modem Cables.....	9-4
9-6.	5500A/LEADS.....	9-4

Appendices

A	Glossary.....	A-1
B	ASCII and IEEE-488 Bus Codes.....	B-1
C	RS-232/IEEE-488 Cables and Connectors.....	C-1
D	Creating a Visual Basic Test Program	D-1
E	Error Messages.....	E-1

Index

List of Tables

Table	Title	Page
2-1.	Standard Equipment	2-3
2-2.	Line Power Cord Types Available from Fluke	2-7
3-1.	Front Panel Features.....	3-4
3-2.	Rear Panel Features.....	3-10
3-3.	Factory Default Settings for the SETUP Menus.....	3-22
4-1.	UUT connections	4-12
4-2.	Keys That Exit Error Mode.....	4-53
4-3.	Watts Performance, Text Screen.....	4-68
4-4.	Harmonics Performance for Volts, Harmonics Screen.....	4-70
4-5.	Harmonics Performance for AMPS, Harmonics screen.	4-71
4-6.	Thermocouple Performance	4-73
5-1.	Operating State Transitions.....	5-23
5-2.	RS-232 Interface Wiring	5-23
5-3.	RS-232 Emulation of IEEE-488 Messages	5-24
5-4.	IEEE-488 Interface Messages (Received).....	5-28
5-5.	IEEE-488 Interface Messages (Sent)	5-29
5-6.	Commands for RS-232 Only	5-31
5-7.	Commands for IEEE-488 Only	5-32
5-8.	Units Accepted in Parameters and Used in Responses	5-33
5-9.	Terminator Characters.....	5-35
5-10.	Response Data Types	5-36
5-11.	Status Register Summary	5-37
7-1.	Replacement Fuses.....	7-3
7-2.	Verification Tests for DC Voltage (Normal)	7-7
7-3.	Verification Tests for DC Voltage (AUX).....	7-8
7-4.	Verification Tests for DC Current (AUX).....	7-9
7-5.	Verification Tests for Resistance.....	7-10
7-6.	Verification Tests for AC Voltage (Normal)	7-12
7-7.	Verification Tests for AC Voltage (AUX).....	7-14
7-8.	Verification Tests for AC Current	7-15
7-9.	Verification Tests for Capacitance	7-18
7-10.	Verification Tests for Thermocouple Simulation	7-19
7-11.	Verification Tests for Thermocouple Measurement	7-19
7-12.	Verification Tests for Phase Accuracy, V and V	7-20
7-13.	Verification Tests for Phase Accuracy, V and I	7-21

7-14.	Verification Tests for Frequency	7-22
8-1.	Volt Specifications	8-6
8-2.	Edge Specifications	8-7
8-3.	Leveled Sine Wave Specifications	8-8
8-4.	Time Marker Specifications	8-9
8-5.	Wave Generator Specifications	8-9
8-6.	Pulse Generator Specifications	8-10
8-7.	Trigger Signal Specifications	8-11
8-8.	Trigger Signal Specifications (Time Marker Function).....	8-11
8-9.	Trigger Signal Specifications (Edge Function).....	8-11
8-10.	Trigger Signal Specifications (Square Wave Voltage Function).....	8-11
8-11.	TV Trigger Signal Specifications	8-11
8-12.	Oscilloscope Input Resistance Measurement Specifications	8-12
8-13.	Oscilloscope Input Capacitance Measurement Specifications	8-12
8-14.	Overload Measurement Specifications	8-12
8-15.	SCOPE Command Parameters	8-35
8-16.	DC Voltage Verification	8-41
8-17.	AC Voltage Amplitude Verification	8-42
8-18.	AC Voltage Frequency Verification	8-42
8-19.	Wave Generator Amplitude Verification (1 M Ω output impedance).....	8-43
8-20.	Wave Generator Amplitude Verification (50 Ω output impedance)	8-44
8-21.	Leveled Sine Wave Verification	8-45
8-22.	Leveled Sine Wave Verification: Frequency output.....	8-45
8-23.	Leveled Sine Wave Verification:Harmonics	8-46
8-24.	Leveled Sine Wave Verification: Flatness.....	8-47
8-25.	Edge Verification: Amplitude	8-53
8-26.	Edge Verification: Frequency	8-53
8-27.	Edge Verification: Duty Cycle.....	8-53
8-28.	Edge Verification: Rise Time	8-54
8-29.	Tunnel Diode Pulser Verification	8-54
8-30.	Marker Generator Verification	8-55
8-31.	Marker Generator Verification: Period.....	8-55
8-32.	Marker Generator Verification: Pulse Width.....	8-55
8-33.	Input Impedance Verification: Resistance	8-56
8-34.	Input Impedance Verification: Capacitance.....	8-56
9-1.	Options and Accessories	9-3
C-1.	IEEE-488 Connection Cables.....	C-1
C-2.	Serial Port Connection Cables	C-2
E-1.	Error Message Format.....	E-1

List of Figures

Figure	Title	Page
1-1.	5520A Multi-Product Calibrator.....	1-3
1-2.	RS-232 Remote Connections	1-6
1-3.	5520A Calibrator Dimensional Outline	1-9
1-4.	Allowable Duration of Current >11 A	1-13
2-1.	Accessing the Fuse and Selecting Line Voltage	2-6
2-2.	Line Power Cord Types Available from Fluke	2-7
3-1.	Front Panel View	3-4
3-2.	Rear Panel View.....	3-10
3-3.	SETUP Softkey Menu Tree	3-12
3-4.	SETUP softkey menu displays.....	3-13
4-1.	EARTH AND EXGRD Internal Connections.....	4-10
4-2.	UUT Connection: Resistance (Four-Wire Compensation)	4-13
4-3.	UUT Connection: Resistance (Two-Wire Compensation)	4-13
4-4.	UUT Connection: Resistance (Compensation Off)	4-14
4-5.	UUT Connection: Capacitance (Two-Wire Compensation).....	4-15
4-6.	UUT Connection: Capacitance (Compensation Off).....	4-15
4-7.	UUT Connection: DC Voltage/AC Voltage	4-16
4-8.	UUT Connection: DC Current/AC Current	4-16
4-9.	UUT Connection: Temperature (RTD).....	4-17
4-10.	UUT Connection: Temperature (Thermocouple)	4-17
4-11.	Sine Wave	4-47
4-12.	Triangle Wave.....	4-47
4-13.	Square Wave and Duty Cycle	4-48
4-14.	Truncated Sine Wave	4-48
4-15.	Measuring Pressure	4-57
4-16.	Two 5520As Sourcing Current in Parallel.....	4-59
4-17.	Three-Phase Power Calibration	4-60
4-18.	Cable Connections for Testing an 80 Series General Functions.....	4-62
4-19.	Cable Connections for Testing an 80 Series Current Function.....	4-64
4-20.	Cable Connections for Testing an 80 Series High Amps Function	4-66
4-21.	Cable Connections for Testing a 40 Series Watts Function	4-68
4-22.	Cable Connections for Testing a 50 Series Thermometer	4-72
5-1.	Typical IEEE-488 Remote Control Connections	5-5
5-2.	Typical RS-232 Remote Control Connections.....	5-7
5-3.	Testing the IEEE-488 Port	5-9

5-4.	Testing the RS-232 Host Port	5-13
5-5.	Testing the RS-232 UUT Port via RS-232 Host Port.....	5-18
5-6.	Testing the RS-232 UUT Port via IEEE-488 Port	5-20
5-7.	IEEE-488 Remote Message Coding.....	5-25
5-8.	Status Register Overview	5-38
5-9.	Status Byte and SRE Bit Definitions	5-39
5-10.	Event Status Register (ESR) and Event Status Enable (ESE)	5-41
5-11.	Bit Assignments for the ISR, ISCEs and ISCRs	5-43
7-1.	Accessing the Fuse	7-4
7-2.	Accessing the Air Filter	7-6
8-1.	Oscilloscope Connection: Channel and External Trigger.....	8-13
8-2.	Tunnel Diode Pulser Connections.....	8-21
8-3.	Oscilloscope Connection: Channel and External Trigger.....	8-65
C-1.	IEEE-488 Connector Pinout (connection side).....	C-1
C-2.	SERIAL 1 FROM HOST Port Connector Pinout	C-2
C-3.	SERIAL 2 TO UUT Port Connector Pinout (connection side).....	C-2
C-4.	Serial Port Connections (DB-9/DB-9)	C-3
C-5.	Serial Port Connections (DB-9/DB-25)	C-4

Chapter 1

Introduction and Specifications

Contents	Page
1-1. Introduction.....	1-3
1-2. Operation Overview.....	1-4
1-3. Local Operation.....	1-4
1-4. Remote Operation (RS-232).....	1-4
1-5. Remote Operation (IEEE-488).....	1-5
1-6. Where to Go from Here.....	1-6
1-7. Instruction Manuals.....	1-7
1-8. 5520A Operators Manual.....	1-8
1-9. 5520A Operators Guide.....	1-8
1-10. 5520A Programmers Guide.....	1-8
1-11. 5520A Service Manual.....	1-8
1-12. Specifications.....	1-9
1-13. General Specifications.....	1-10
1-14. DC Voltage Specifications.....	1-11
1-15. DC Current Specifications.....	1-12
1-16. Resistance Specifications.....	1-14
1-17. AC Voltage (Sine Wave) Specifications.....	1-15
1-18. AC Current (Sine Wave) Specifications.....	1-17
1-19. Capacitance Specifications.....	1-19
1-20. Temperature Calibration (Thermocouple) Specifications.....	1-20
1-21. Temperature Calibration (RTD) Specifications.....	1-21
1-22. DC Power Specification Summary.....	1-22
1-23. AC Power (45 Hz to 65 Hz) Specification Summary, PF=1.....	1-22
1-24. Power and Dual Output Limit Specifications.....	1-23
1-25. Phase Specifications.....	1-24
1-26. Calculating Power Uncertainty.....	1-25
1-27. Additional Specifications.....	1-26
1-28. Frequency Specifications.....	1-26
1-29. Harmonics (2nd to 50th) Specifications.....	1-27
1-30. AC Voltage (Sine Wave) Extended Bandwidth Specifications.....	1-28
1-31. AC Voltage (Non-Sine Wave) Specifications.....	1-29
1-32. AC Voltage, DC Offset Specifications.....	1-30

1-33.	AC Voltage, Square Wave Characteristics	1-31
1-34.	AC Voltage, Triangle Wave Characteristics (typical)	1-31
1-35.	AC Current (Sine Wave) Extended Bandwidth Specifications.....	1-31
1-36.	AC Current (Non-Sine Wave) Specifications	1-32
1-37.	AC Current, Square Wave Characteristics (typical)	1-34
1-38.	AC Current, Triangle Wave Characteristics (typical).....	1-34

1-1. Introduction

⚠ Warning

If the 5520A Calibrator is operated in any way not specified by this manual or other documentation provided by Fluke, the protection provided by the Calibrator may be impaired.

The 5520A Calibrator is a fully programmable precision source of the following:

- DC voltage from 0 V to ± 1000 V.
- AC voltage from 1 mV to 1000 V, with output from 10 Hz to 500 kHz.
- AC current from 100 μ A to 20.5 A, with variable frequency limits.
- DC current from 0 to ± 20.5 A.
- Resistance values from a short circuit to 1100 M Ω .
- Capacitance values from 190 pF to 110 mF.
- Simulated output for eight types of Resistance Temperature Detectors (RTDs).
- Simulated output for eleven types of thermocouples.

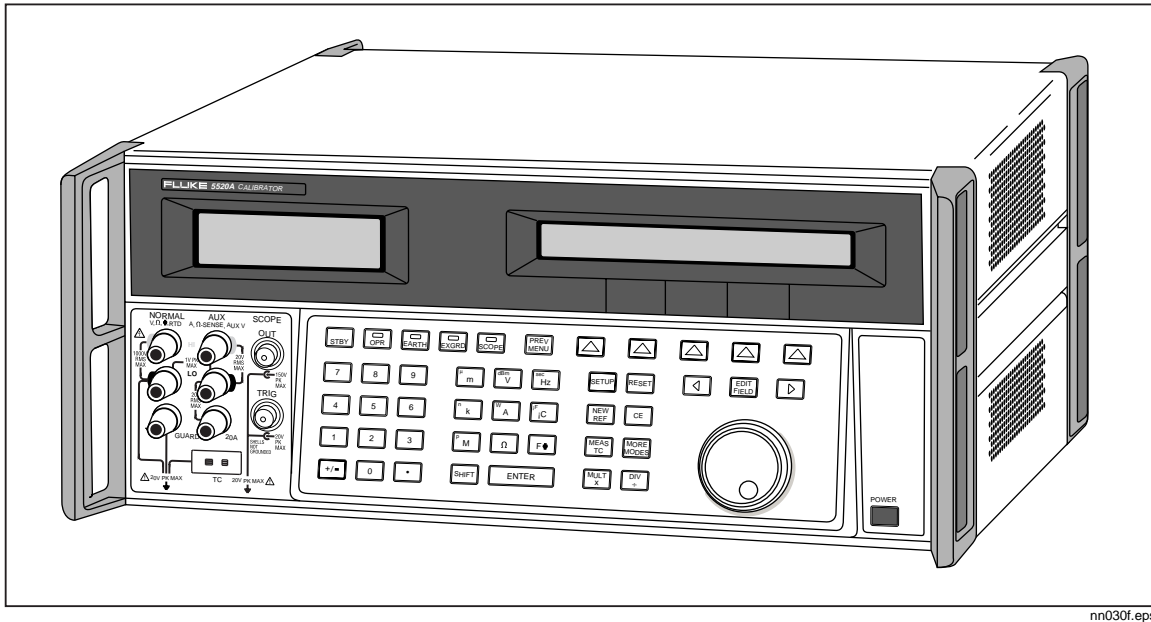

nn030f.eps

Figure 1-1. 5520A Multi-Product Calibrator

Features of the 5520A Calibrator include the following:

- Automatic meter error calculation.
- **MULT** \times and **DIV** \div keys that change the output value to pre-determined cardinal values for various functions.
- Programmable entry limits that prevent invalid amounts from being entered.
- Simultaneous output of voltage and current, up to an equivalent of 20.9 kW.
- Pressure measurement when used with Fluke 700 Series pressure modules.
- 10 MHz reference input and output. Use this to input a high-accuracy 10 MHz reference to transfer the frequency accuracy to the 5520A, or to synchronize one or more additional 5520As to a master 5520A.
- Simultaneous output of two voltages.
- Extended bandwidth mode outputs multiple waveforms down to 0.01 Hz, and sine waves to 2 MHz.
- Variable phase signal output.
- Standard IEEE-488 (GPIB) interface, complying with ANSI/IEEE Standards 488.1-1987 and 488.2-1987.
- EIA Standard RS-232-C serial data interface for printing, displaying, or transferring internally stored calibration constants, and for remote control of the 5520A.
- Pass-through RS-232-C serial data interface for communicating with the Unit Under Test (UUT).

1-2. Operation Overview

The 5520A Calibrator may be operated at the front panel in the local mode, or remotely using RS-232 or IEEE-488 ports. For remote operations, several software options are available to integrate 5520A operation into a wide variety of calibration requirements.

1-3. Local Operation

Typical local operations include front panel connections to the Unit Under Test (UUT), and then manual keystroke entries at the front panel to place the calibrator in the desired output mode. The front panel layout facilitates hand movements from left to right, and multiply and divide keys make it easy to step up or down at the press of a single key. You can also review 5520A Calibrator specifications at the push of two buttons. The backlit liquid crystal display is easy to read from many different viewing angles and lighting conditions, and the large, easy-to-read keys are color-coded and provide tactile feedback.

1-4. Remote Operation (RS-232)

There are two rear-panel serial data RS-232 ports: SERIAL 1 FROM HOST, and SERIAL 2 TO UUT (Figure 1-2). Each port is dedicated to serial data communications for operating and controlling the 5520A during calibration procedures. For complete information on remote operations, see Chapter 5.

The SERIAL 1 FROM HOST serial data port connects a host terminal or personal computer to the 5520A. You have several choices for sending commands to the 5520A: you can enter commands from a terminal (or a PC running a terminal program), you can write your own programs using BASIC, or you can run optional Windows-based

software such as 5500/CAL or MET/CAL. The 5500/CAL software includes more than 200 example procedures covering a wide range of test tools the 5520A can calibrate. (See Chapter 6 for a discussion of the RS-232 commands.)

The SERIAL 2 TO UUT serial data port connects a UUT to a PC or terminal via the 5520A (see Figure 1-2). This “pass-through” configuration eliminates the requirement for two COM ports at the PC or terminal. A set of four commands control the operation of the SERIAL 2 TO UUT serial port. See Chapter 6 for a discussion of the UUT_* commands. The SERIAL 2 TO UUT port is also used to connect to the Fluke 700 series pressure modules.

1-5. Remote Operation (IEEE-488)

The 5520A rear panel IEEE-488 port is a fully programmable parallel interface bus meeting standard IEEE-488.1 and supplemental standard IEEE-488.2. Under the remote control of an instrument controller, the 5520A Calibrator operates exclusively as a “talker/listener.” You can write your own programs using the IEEE-488 command set or run the optional Windows-based MET/CAL software. (See Chapter 6 for a discussion of the commands available for IEEE-488 operation.)

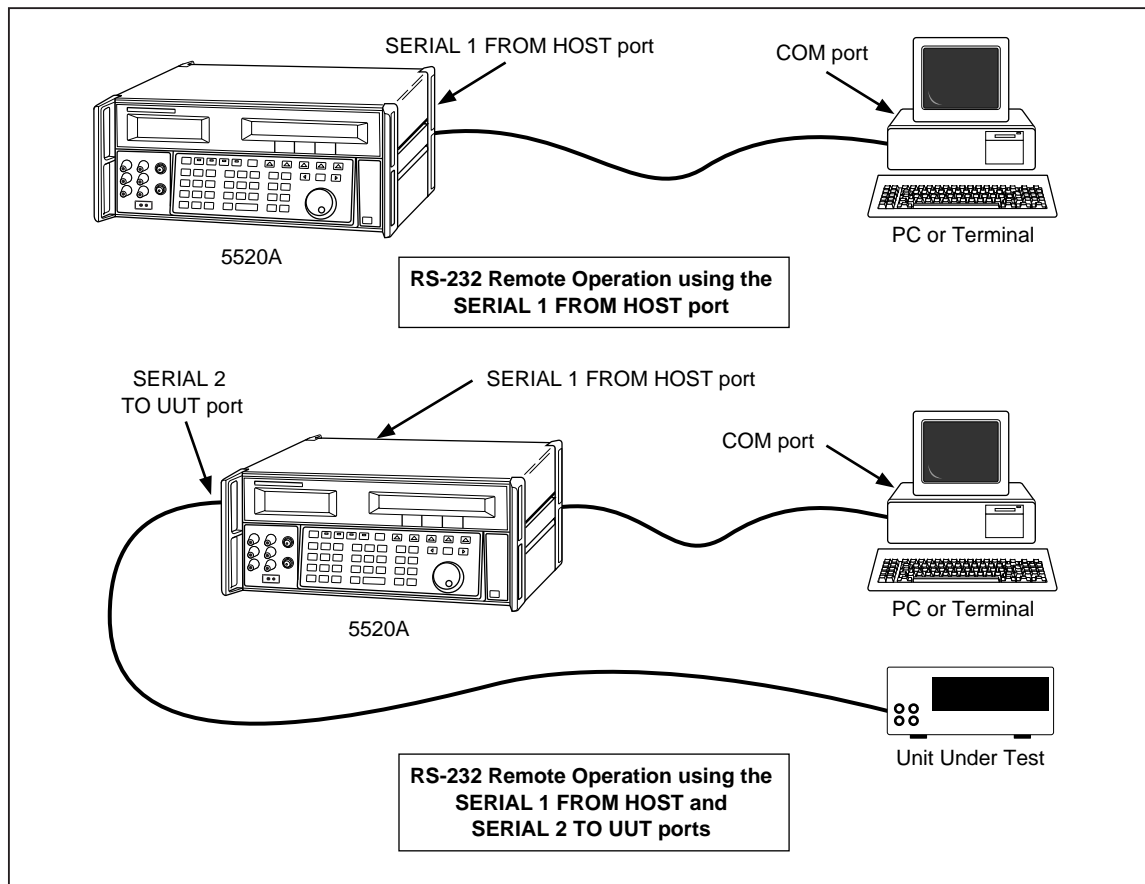

Figure 1-2. RS-232 Remote Connections

1-6. Where to Go from Here

To locate specific information concerning the installation and operation of the 5520A calibrator, refer to the following list:

- Unpacking and setup: Chapter 2, “Preparing for Operation”
- Installation and rack mounting: Chapter 2, “Preparing for Operation,” and the rack mount kit instruction sheet
- AC line power and interface cabling: Chapter 2, “Preparing for Operation”
- Controls, indicators, and displays: Chapter 3, “Features”
- Front panel operation: Chapter 4, “Front Panel Operation”
- Cabling to a UUT (Unit Under Test): Chapter 4, “Front Panel Operation”
- Remote operation (IEEE-488 or serial): Chapter 5, “Remote Operation”
- Calibrating an Oscilloscope: Chapter 8, “Oscilloscope Calibration Options”
- Accessories to the 5520A Calibrator: Chapter 9, “Accessories”
- Performance Specifications: Chapter 1, “Introduction and Specifications”

1-7. **Instruction Manuals**

The 5520A Manual Set provides complete information for operators and service or maintenance technicians. The set includes:

- *5520A Operators Manual* (PN 688739)
- *5520A Operators Guide*
 - English (PN 688754)
 - French (PN 688751)
 - German (PN 688762)
 - Italian (PN 690511)
 - Spanish (PN 688769)
 - Japanese (PN 688770)
 - Simplified Chinese (PN 688777)
- *5520A Programmers Guide* (PN 688744)
- *5520A Service Manual* (PN 688747)

One of each manual listed above is shipped with the instrument, except for the *5520A Service Manual*, which is optional. The two reference guides are packaged inside this *5520A Operators Manual*. Order additional copies of the manuals or reference guides separately using the part number provided. For ordering instructions, refer to the Fluke Catalog, or ask a Fluke sales representative (see “Service Information” in Chapter 2).

1-8. 5520A Operators Manual

This 5520A Operators Manual provides complete information for installing the 5520A Calibrator and operating it from the front panel keys and in remote configurations. This manual also provides a glossary of calibration, specifications, and error code information. The Operators Manual includes the following topics:

- Installation
- Operating controls and features, including front panel operation
- Remote operation (IEEE-488 bus or serial port remote control)
- Serial port operation (printing, displaying, or transferring data, and setting up for serial port remote control)
- Operator maintenance, including verification procedures and calibration approach for the 5520A
- Oscilloscope calibration options
- Accessories
- The 5520A Operator Manual includes two pocket-sized booklets: one for front panel operation and one for remote programming.

1-9. 5520A Operators Guide

The *5520A Operators Guide* contains a summary of operating instructions, and a front panel and rear panel feature reference. This guide is included with this manual, and is available in seven languages (listed on the previous page).

1-10. 5520A Programmers Guide

The *5520A Programmers Guide* contains a summary of remote commands and reference information useful in determining system status using the status byte and related registers. This guide is included with this manual.

1-11. 5520A Service Manual

The *5520A Service Manual* can be ordered through your local Fluke Sales or Service representative (see “Service Information” in Chapter 2). The *5520A Service Manual* includes: theory of operation, performance testing, maintenance, and calibration information.

1-12. Specifications

The following tables list the 5520A specifications. All specifications are valid after allowing a warm-up period of 30 minutes, or twice the time the 5520A has been turned off. (For example, if the 5520A has been turned off for 5 minutes, the warm-up period is 10 minutes.)

All specifications apply for the temperature and time period indicated. For temperatures outside of $t_{cal} \pm 5^\circ\text{C}$ (t_{cal} is the ambient temperature when the 5520A was calibrated), the temperature coefficient as stated in the General Specifications must be applied.

The specifications also assume the Calibrator is zeroed every seven days or whenever the ambient temperature changes more than 5°C . The tightest ohms specifications are maintained with a zero cal every 12 hours within $\pm 1^\circ\text{C}$ of use. (See “Zeroing the Calibrator” in Chapter 4.)

Also see additional specifications later in this chapter for information on extended specifications for ac voltage and current. The dimensional outline for the 5520A Calibrator is shown in Figure 1-3.

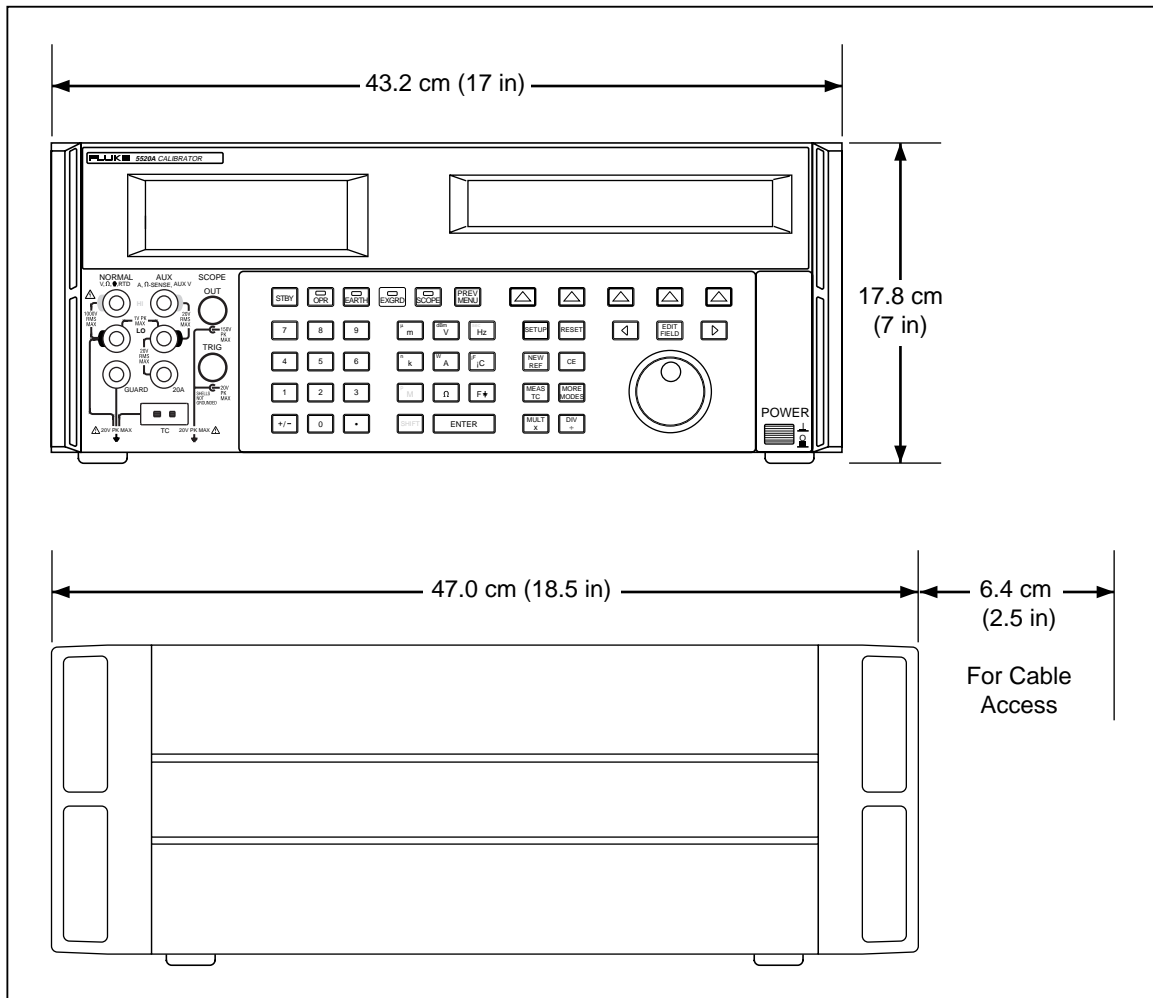

Figure 1-3. 5520A Calibrator Dimensional Outline

1-13. General Specifications

Warmup Time	Twice the time since last warmed up, to a maximum of 30 minutes.
Settling Time	Less than 5 seconds for all functions and ranges except as noted.
Standard Interfaces	IEEE-488 (GPIB), RS-232, 5725A Amplifier
Temperature Performance	<ul style="list-style-type: none"> • Operating: 0 °C to 50 °C • Calibration (tcal): 15 °C to 35 °C • Storage: -20 °C to 70 °C [3]
Temperature Coefficient	Temperature Coefficient for temperatures outside tcal +5 °C is 0.1X/°C of the 90-day specification (or 1-year, as applicable) per °C.
Relative Humidity [1]	<ul style="list-style-type: none"> • Operating: <80% to 30 °C, <70% to 40 °C, <40% to 50 °C • Storage: <95%, non-condensing
Altitude	<ul style="list-style-type: none"> • Operating: 3,050 m (10,000 ft) maximum • Non-operating: 12,200 m (40,000 ft) maximum
Safety	Complies with IEC 1010-1 (1992-1); ANSI/ISA-S82.01-1994; CAN/CSA-C22.2 No. 1010.1-92
Analog Low Isolation	20 V
EMC	Designed to comply with FCC Rules Part 15; VFG 243/1991. If used in areas with Electromagnetic fields of 1 to 3 V/m, resistance outputs have a floor adder of 0.508 *. Performance not specified above 3 V/m. This instrument may be susceptible to electro-static discharge (ESD) from direct contact to the binding posts. Good static aware practices should be followed when handling this and other pieces of electronic equipment.
Line Power [2]	<ul style="list-style-type: none"> • Line Voltage (selectable): 100 V, 120 V, 220 V, 240 V • Line Frequency: 47 Hz to 63 Hz • Line Voltage Variation: ±10% about line voltage setting
Power Consumption	5500A Calibrator, 300 VA; 5725A Amplifier, 750 VA
Dimensions	5500A Calibrator: <ul style="list-style-type: none"> • Height: 17.8 cm (7 inches), standard rack increment, plus 1.5 cm (0.6 inch) for feet on bottom of unit; • Width: 43.2 cm (17 inches), standard rack width • Depth: 47.3 cm (18.6 inches) overall 5725A Amplifier: <ul style="list-style-type: none"> • Height, 13.3 cm (5.25 inches), standard rack increment, plus 1.5 cm (0.6 inch) for feet on bottom of unit; • Width, 43.2 cm (17 inches), standard rack width • Depth, 63.0 cm (24.8 inches) overall.
Weight (without options)	5500A Calibrator, 22 kg (49 lb); 5725A Amplifier 32 kg (70 pounds)
Absolute Uncertainty Definition	The 5500A specifications include stability, temperature coefficient, linearity, line and load regulation, and the traceability of the external standards used for calibration. You do not need to add anything to determine the total specification of the 5520A for the temperature range indicated.
Specification Confidence Interval	99%
<p>[1] After long periods of storage at high humidity, a drying out period (with the power on) of at least one week may be required.</p> <p>[2] For optimal performance at full dual outputs (e.g. 1000 V, 20A) choose a line voltage setting that is ± 7.5% from nominal.</p> <p>[3] The DC Current ranges 0 to 1.09999 A and 1.1 A to 2.99999 A are sensitive to storage temperatures above 50 °C. If the 5520A is stored above 50 °C for greater than 30 minutes, these ranges must be re-calibrated. Otherwise, the 90 day and 1 year uncertainties of these ranges double.</p>	

1-14. DC Voltage Specifications

Range	Absolute Uncertainty, tcal $\pm 5^{\circ}\text{C}$ \pm (ppm of output + μV)		Stability	Resolution μV	Max Burden [1]
	90 days	1 year	24 hours, $\pm 1^{\circ}\text{C}$ \pm (ppm output + μV)		
0 to 329.9999 mV	15 + 1	20 + 1	3 + 1	0.1	50 Ω
0 to 3.299999 V	9 + 2	11 + 2	2 + 1.5	1	10 mA
0 to 32.99999 V	10 + 20	12 + 20	2 + 15	10	10 mA
30 V to 329.9999 V	15 + 150	18 + 150	2.5 + 100	100	5 mA
100 V to 1000.000 V	15 + 1500	18 + 1500	3 + 300	1000	5 mA
Auxiliary Output (dual output mode only) [2]					
0 to 329.999 mV	300 + 350	400 + 350	30 + 100	1	5 mA
0.33 V to 3.29999 V	300 + 350	400 + 350	30 + 100	10	5 mA
3.3 V to 7 V	300 + 350	400 + 350	30 + 100	100	5 mA
TC Simulate and Measure in Linear 10 $\mu\text{V}/^{\circ}\text{C}$ and 1 $\text{mV}/^{\circ}\text{C}$ modes [3]					
0 to 329.999 mV	40 + 3	50 + 3	5 + 2	0.1	10 Ω
<p>[1] Remote sensing is not provided. Output resistance is $< 5\text{ m}\Omega$ for outputs $\geq 0.33\text{ V}$. The AUX output has an output resistance of $< 1\ \Omega$. TC simulation has an output impedance of $10\ \Omega \pm 1\ \Omega$.</p> <p>[2] Two channels of dc voltage output are provided.</p> <p>[3] TC simulating and measuring are not specified for operation in electromagnetic fields above 0.4 V/m.</p>					

Range	Noise	
	Bandwidth 0.1 Hz to 10 Hz p-p \pm (ppm output + floor)	Bandwidth 10 Hz to 10 kHz rms
0 to 329.9999 mV	0 + 1 μV	6 μV
0 to 3.299999 V	0 + 10 μV	60 μV
0 to 32.99999 V	0 + 100 μV	600 μV
30 to 329.9999 V	10 + 1 mV	20 mV
100 to 1000.000 V	10 + 5 mV	20 mV
Auxiliary Output (dual output mode only) [1]		
0 to 329.999 mV	0 + 5 μV	20 μV
0.33 V to 3.29.999 V	0 + 20 μV	200 μV
3.3 V to 7 V	0 + 100 μV	1000 μV
<p>[1] Two channels of dc voltage output are provided.</p>		

1-15. DC Current Specifications

Range	Absolute Uncertainty, tcal \pm 5 °C \pm (ppm of output + μ A)		Resolution	Max Compliance Voltage V	Max Inductive Load mH
	90 days	1 year			
0 to 329.999 mA	120 + 0.02	150 + 0.02	1 nA	10	400
0 to 3.29999 mA	80 + 0.05	100 + 0.05	0.01 mA	10	
0 to 32.99999 mA	80 + 0.25	100 + 0.25	0.1 mA	7	
0 to 329.999 mA	80 + 2.5	100 + 2.5	1 mA	7	
0 to 1.09999 A	160 + 40	200 + 40	10 mA	6	
1.1 to 2.99999 A	300 + 40	380 + 40	10 mA	6	
0 to 10.9999 A (20 A Range)	380 + 500	500 + 500	100 mA	4	
11 to 20.5 A [1]	800 + 750 [2]	1000 + 750 [2]	100 mA	4	

[1] Duty Cycle: Currents < 11 A may be provided continuously. For currents >11 A, see Figure 1-4. The current may be provided 60-T-I minutes any 60 minute period where T is the temperature in °C (room temperature is about 23 °C) and I is the output current in amperes. For example, 17 A, at 23 °C could be provided for 60-17-23 = 20 minutes each hour.

[2] Floor specification is 1500 μ A within 30 seconds of selecting operate. For operating times > 30 seconds, the floor specification is 750 μ A.

Range	Noise	
	Bandwidth 0.1 Hz to 10 Hz p-p	Bandwidth 10 Hz to 10 kHz rms
0 to 329.999 μ A	2 nA	20 nA
0 to 3.29999 mA	20 nA	200 nA
0 to 32.99999 mA	200 nA	2.0 μ A
0 to 329.999 mA	2000 nA	20 μ A
0 to 2.99999 A	20 μ A	1 mA
0 to 20.5 A	200 μ A	10 mA

DC Current Specifications (cont)

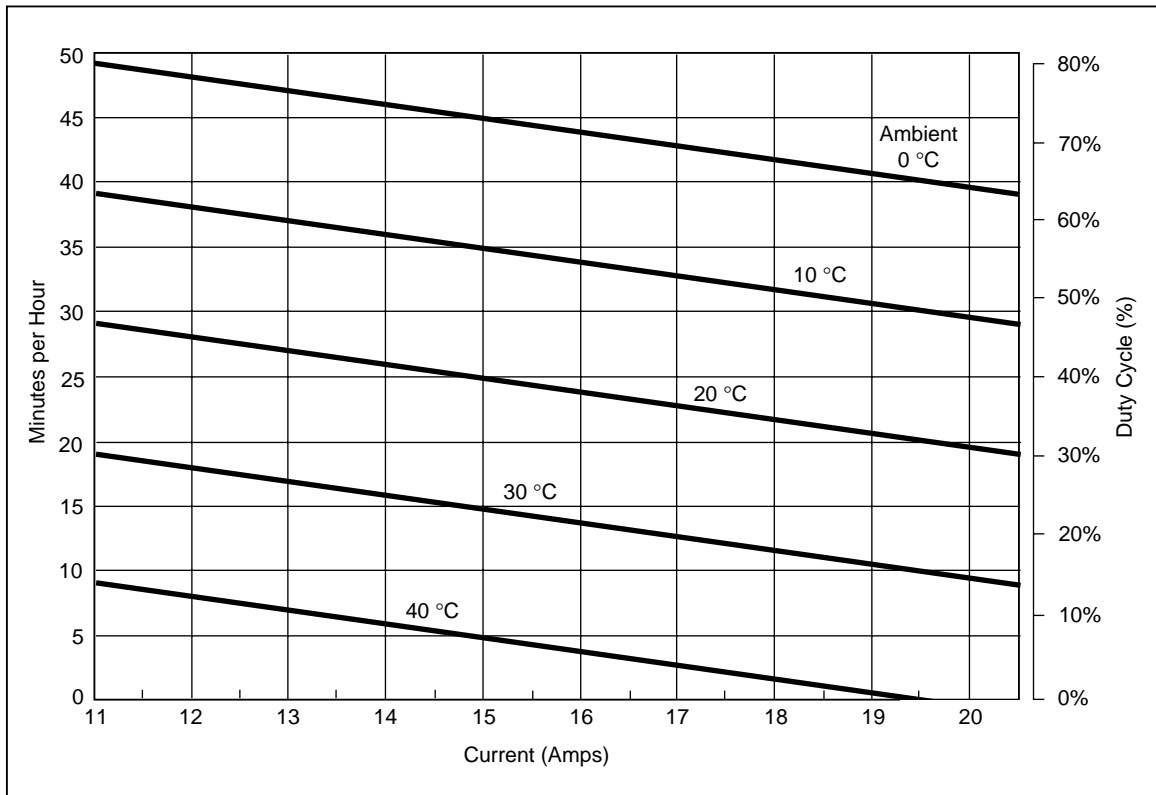

nn326f.eps

Figure 1-4. Allowable Duration of Current >11 A

1-16. Resistance Specifications

Range [1]	Absolute Uncertainty, tcal ± 5 °C ± (ppm of output + floor) [2]				Resolution Ω	Allowable Current [3]
	ppm of output		Floor			
	90 days	1 year	Time & temp since ohms zero cal 12 hrs ± 1 °C	7 days ± 5 °C		
0 to 10.9999 Ω	35	40	0.001	0.01	0.0001	1 mA to 125 mA
11 Ω to 32.9999 Ω	25	30	0.0015	0.015	0.0001	1 mA to 125 mA
33 Ω to 109.9999 Ω	22	28	0.0014	0.015	0.0001	1 mA to 70 mA
110 Ω to 329.9999 Ω	22	28	0.002	0.02	0.0001	1 mA to 40 mA
330 Ω to 1.099999 kΩ	22	28	0.002	0.02	0.001	1 mA to 18 mA
1.1 kΩ to 3.299999 kΩ	22	28	0.02	0.2	0.001	100 μA to 5 mA
3.3 kΩ to 10.99999 kΩ	22	28	0.02	0.1	0.01	100 μA to 1.8 mA
11 kΩ to 32.99999 kΩ	22	28	0.2	1	0.01	10 μA to 0.5 mA
33 kΩ to 109.9999 kΩ	22	28	0.2	1	0.1	10 μA to 0.18 mA
110 kΩ to 329.9999 kΩ	25	32	2	10	0.1	1 μA to 0.05 mA
330 kΩ to 1.099999 MΩ	25	32	2	10	1	1 μA to 0.018 mA
1.1 MΩ to 3.299999 MΩ	40	60	30	150	1	250 nA to 5 μA
3.3 MΩ to 10.99999 MΩ	110	130	50	250	10	250 nA to 1.8 μA
11 MΩ to 32.99999 MΩ	200	250	2500	2500	10	25 nA to 500 nA
33 MΩ to 109.9999 MΩ	400	500	3000	3000	100	25 nA to 180 nA
110 MΩ to 329.9999 MΩ	2500	3000	100000	100000	1000	2.5 nA to 50 nA
330 MΩ to 1100 MΩ	12000	15000	500000	500000	10000	1 nA to 13 nA

[1] Continuously variable from 0 Ω to 1.1 G Ω.

[2] Applies for 4-WIRE compensation only. For 2-WIRE and 2-WIRE COMP, add 5 μV per Amp of stimulus current to the floor specification. For example, in 2-WIRE mode, at 1 kΩ, the floor specification within 12 hours of an ohms zero cal for a measurement current of 1 mA is:
 $0.002 \Omega + 5 \mu V / 1 \text{ mA} = (0.022 + 0.005) \Omega = 0.007 \Omega$.

[3] For currents lower than shown, the floor adder increases by $\text{Floor}_{(\text{new})} = \text{Floor}_{(\text{old})} \times I_{\text{min}}/I_{\text{actual}}$. For example, a 50 μA stimulus measuring 100 Ω has a floor specification of: $0.0014 \Omega \times 1 \text{ mA}/50 \mu\text{A} = 0.028 \Omega$, assuming an ohms zero calibration within 12 hours.

1-17. AC Voltage (Sine Wave) Specifications

NORMAL (Normal Output)						
Range	Frequency	Absolute Uncertainty, tcal ± 5 °C ± (ppm of output + µV)		Resolution	Max Burden	Max Distortion and Noise 10 Hz to 5 MHz Bandwidth ± (% output + floor)
		90 days	1 year			
1.0 mV to 32.999 mV	10 Hz to 45 Hz	600 + 6	800 + 6	1 µV	50 Ω	0.15 + 90 µV
	45 Hz to 10 kHz	120 + 6	150 + 6			0.035 + 90 µV
	10 kHz to 20 kHz	160 + 6	200 + 6			0.06 + 90 µV
	20 kHz to 50 kHz	800 + 6	1000 + 6			0.15 + 90 µV
	50 kHz to 100 kHz	3000 + 12	3500 + 12			0.25 + 90 µV
	100 kHz to 500 kHz	6000 + 50	8000 + 50			0.3 + 90 µV [1]
33 mV to 329.999 mV	10 Hz to 45 Hz	250 + 8	300 + 8	1 µV	50 Ω	0.15 + 90 µV
	45 Hz to 10 kHz	140 + 8	145 + 8			0.035 + 90 µV
	10 kHz to 20 kHz	150 + 8	160 + 8			0.06 + 90 µV
	20 kHz to 50 kHz	300 + 8	350 + 8			0.15 + 90 µV
	50 kHz to 100 kHz	600 + 32	800 + 32			0.20 + 90 µV
	100 kHz to 500 kHz	1600 + 70	2000 + 70			0.20 + 90 µV [1]
0.33 V to 3.29999 V	10 Hz to 45 Hz	250 + 50	300 + 50	10 µV	10 mA	0.15 + 200 µV
	45 Hz to 10 kHz	140 + 60	150 + 60			0.035 + 200 µV
	10 kHz to 20 kHz	160 + 60	190 + 60			0.06 + 200 µV
	20 kHz to 50 kHz	250 + 50	300 + 50			0.15 + 200 µV
	50 kHz to 100 kHz	550 + 125	700 + 125			0.20 + 200 µV
	100 kHz to 500 kHz	2000 + 600	2400 + 600			0.20 + 200 µV [1]
3.3 V to 32.9999 V	10 Hz to 45 Hz	250 + 650	300 + 650	100 µV	10 mA	0.15 + 2 mV
	45 Hz to 10 kHz	125 + 600	150 + 600			0.035 + 2 mV
	10 kHz to 20 kHz	220 + 600	240 + 600			0.08 + 2 mV
	20 kHz to 50 kHz	300 + 600	350 + 600			0.2 + 2 mV
	50 kHz to 100 kHz	750 + 1600	900 + 1600			0.5 + 2 mV
33 V to 329.999 V	45 Hz to 1 kHz	150 + 2000	190 + 2000	1 mV	5 mA, except 20 mA for 45 Hz to 65 Hz	0.15 + 10 mV
	1 kHz to 10 kHz	160 + 6000	200 + 6000			0.05 + 10 mV
	10 kHz to 20 kHz	220 + 6000	250 + 6000			0.6 + 10 mV
	20 kHz to 50 kHz	240 + 6000	300 + 6000			0.8 + 10 mV
	50 kHz to 100 kHz	1600 + 50000	2000 + 50000			1.0 + 10 mV
330 V to 1020 V	45 Hz to 1 kHz	250 + 10000	300 + 10000	10 mV	2 mA, except 6 mA for 45 Hz to 65 Hz	0.15 + 30 mV
	1 kHz to 5 kHz	200 + 10000	250 + 10000			0.07 + 30 mV
	5 kHz to 10 kHz	250 + 10000	300 + 10000			0.07 + 30 mV

[1] Max Distortion for 100 kHz to 200 kHz. For 200 kHz to 500 kHz, the maximum distortion is 0.9% of output + floor as shown.

Note

- Remote sensing is not provided. Output resistance is < 5 mΩ for outputs ≥ 0.33 V. The AUX output resistance is < 1Ω. The maximum load capacitance is 500 pF, subject to the maximum burden current limits.

AC Voltage (Sine Wave) Specifications (cont)

AUX (Auxiliary Output) [dual output mode only] [1]						
Range	Frequency	Absolute Uncertainty, tcal ± 5 °C ± (% of output + μV)		Res- olution	Max Burden	Max Distortion and Noise 10 Hz to 100 kHz Bandwidth ± (% output + floor)
		90 days	1 year			
10 mV to 329.999 mV	10 Hz to 20 Hz	0.15 + 370	0.2 + 370	1 μV	5 mA	0.2 + 200 μV
	20 Hz to 45 Hz	0.08 + 370	0.1 + 370			0.06 + 200 μV
	45 Hz to 1 kHz	0.08 + 370	0.1 + 370			0.08 + 200 μV
	1 kHz to 5 kHz	0.15 + 450	0.2 + 450			0.3 + 200 μV
	5 kHz to 10 kHz	0.3 + 450	0.4 + 450			0.6 + 200 μV
	10 kHz to 30 kHz	4.0 + 900	5.0 + 900			1 + 200 μV
0.33 V to 3.29999 V	10 Hz to 20 Hz	0.15 + 450	0.2 + 450	10 μV	5 mA	0.2 + 200 μV
	20 Hz to 45 Hz	0.08 + 450	0.1 + 450			0.06 + 200 μV
	45 Hz to 1 kHz	0.07 + 450	0.09 + 450			0.08 + 200 μV
	1 kHz to 5 kHz	0.15 + 1400	0.2 + 1400			0.3 + 200 μV
	5 kHz to 10 kHz	0.3 + 1400	0.4 + 1400			0.6 + 200 μV
	10 kHz to 30 kHz	4.0 + 2800	5.0 + 2800			1 + 200 μV
3.3 V to 5 V	10 Hz to 20 Hz	0.15 + 450	0.2 + 450	100 μV	5 mA	0.2 + 200 μV
	20 Hz to 45 Hz	0.08 + 450	0.1 + 450			0.06 + 200 μV
	45 Hz to 1 kHz	0.07 + 450	0.09 + 450			0.08 + 200 μV
	1 kHz to 5 kHz	0.15 + 1400	0.2 + 1400			0.3 + 200 μV
	5 kHz to 10 kHz	0.3 + 1400	0.4 + 1400			0.6 + 200 μV

[1] There are two channels of voltage output. The maximum frequency of the dual output is 30 kHz.

Note

- Remote sensing is not provided. Output resistance is < 5 mΩ for outputs ≥ 0.33 V. The AUX output resistance is < 1Ω. The maximum load capacitance is 500 pF, subject to the maximum burden current limits.

1-18. AC Current (Sine Wave) Specifications

LCOMP off						
Range	Frequency	Absolute Uncertainty, tcal ± 5 °C ± (% of output + μA)		Compliance adder ± (μA/V)	Max Distortion & Noise 10 Hz to 100 kHz BW ± (% output + floor)	Max Inductive Load μH
		90 days	1 year			
29.00 μA to 329.99 μA	10 Hz to 20 Hz	0.16 + 0.1	0.2 + 0.1	0.05	0.15 + 0.5 μA	200
	20 Hz to 45 Hz	0.12 + 0.1	0.15 + 0.1	0.05	0.1 + 0.5 μA	
	45 Hz to 1 kHz	0.1 + 0.1	0.125 + 0.1	0.05	0.05 + 0.5 μA	
	1 kHz to 5 kHz	0.25 + 0.15	0.3 + 0.15	1.5	0.5 + 0.5 μA	
	5 kHz to 10 kHz	0.6 + 0.2	0.8 + 0.2	1.5	1.0 + 0.5 μA	
	10 kHz to 30 kHz	1.2 + 0.4	1.6 + 0.4	10	1.2 + 0.5 μA	
0.33 mA to 3.2999 mA	10 Hz to 20 Hz	0.16 + 0.15	0.2 + 0.15	0.05	0.15 + 1.5 μA	200
	20 Hz to 45 Hz	0.1 + 0.15	0.125 + 0.15	0.05	0.06 + 1.5 μA	
	45 Hz to 1 kHz	0.08 + 0.15	0.1 + 0.15	0.05	0.02 + 1.5 μA	
	1 kHz to 5 kHz	0.16 + 0.2	0.2 + 0.2	1.5	0.5 + 1.5 μA	
	5 kHz to 10 kHz	0.4 + 0.3	0.5 + 0.3	1.5	1.0 + 1.5 μA	
	10 kHz to 30 kHz	0.8 + 0.6	1.0 + 0.6	10	1.2 + 0.5 μA	
3.3 mA to 32.999 mA	10 Hz to 20 Hz	0.15 + 2	0.18 + 2	0.05	0.15 + 5 μA	50
	20 Hz to 45 Hz	0.075 + 2	0.09 + 2	0.05	0.05 + 5 μA	
	45 Hz to 1 kHz	0.035 + 2	0.04 + 2	0.05	0.07 + 5 μA	
	1 kHz to 5 kHz	0.065 + 2	0.08 + 2	1.5	0.3 + 5 μA	
	5 kHz to 10 kHz	0.16 + 3	0.2 + 3	1.5	0.7 + 5 μA	
	10 kHz to 30 kHz	0.32 + 4	0.4 + 4	10	1.0 + 0.5 μA	
33 mA to 329.99 mA	10 Hz to 20 Hz	0.15 + 20	0.18 + 20	0.05	0.15 + 50 μA	50
	20 Hz to 45 Hz	0.075 + 20	0.09 + 20	0.05	0.05 + 50 μA	
	45 Hz to 1 kHz	0.035 + 20	0.04 + 20	0.05	0.02 + 50 μA	
	1 kHz to 5 kHz	0.08 + 50	0.10 + 50	1.5	0.03 + 50 μA	
	5 kHz to 10 kHz	0.16 + 100	0.2 + 100	1.5	0.1 + 50 μA	
	10 kHz to 30 kHz	0.32 + 200	0.4 + 200	10	0.6 + 50 μA	
0.33 A to 1.09999 A	10 Hz to 45 Hz	0.15 + 100	0.18 + 100		0.2 + 500 μA	2.5
	45 Hz to 1 kHz	0.036 + 100	0.05 + 100		0.07 + 500 μA	
	1 kHz to 5 kHz	0.5 + 1000	0.6 + 1000	[3]	1 + 500 μA	
	5 kHz to 10 kHz	2.0 + 5000	2.5 + 5000	[4]	2 + 500 μA	
1.1 A to 2.99999 A	10 Hz to 45 Hz	0.15 + 100	0.18 + 100		0.2 + 500 μA	2.5
	45 Hz to 1 kHz	0.05 + 100	0.06 + 100		0.07 + 500 μA	
	1 kHz to 5 kHz	0.5 + 1000	0.6 + 1000	[3]	1 + 500 μA	
	5 kHz to 10 kHz	2.0 + 5000	2.5 + 5000	[4]	2 + 500 μA	
3 A to 10.9999 A	45 Hz to 100 Hz	0.05 + 2000	0.06 + 2000		0.2 + 3 mA	1
	100 kHz to 1 kHz	0.08 + 2000	0.10 + 2000		0.1 + 3 mA	
	1 kHz to 5 kHz	2.5 + 2000	3.0 + 2000		0.8 + 3 mA	
11A to 20.5 A [2]	45 Hz to 100 Hz	0.1 + 5000	0.12 + 5000		0.2 + 3 mA	1
	100 Hz to 1 kHz	0.13 + 5000	0.15 + 5000		0.1 + 3 mA	
	1 kHz to 5 kHz	2.5 + 5000	3.0 + 5000		0.8 + 3 mA	

[1] Max Distortion for 100 kHz to 200 kHz. For 200 kHz to 500 kHz, the maximum distortion is 0.9% of output + floor as shown.

[2] Duty Cycle: Currents < 11 A may be provided continuously. For currents > 11 A, see Figure 1-4. The current may be provided 60-T-I minutes any 60 minute period where T is the temperature in °C (room temperature is about 23°C) and I is the output current in Amps. For example, 17 A, at 23°C could be provided for 60-17-23 = 20 minutes each hour.

[3] For compliance voltages greater than 1 V, add 1 mA/V to the floor specification from 1 kHz to 5 kHz.

[4] For compliance voltages greater than 1 V, add 5 mA/V to the floor specification from 5 kHz to 10 kHz.

AC Current (Sine Wave) Specifications (cont)

LCOMP on					
Range	Frequency	Absolute Uncertainty, tcal ± 5 °C ± (% of output + μA)		Max Distortion & Noise, 10 Hz to 100 kHz BW ± (% output + μA)	Max Inductive Load μH
		90 days	1 year		
29.00 μA to 329.99 μA	10 Hz to 100 Hz	0.2 + 0.2	0.25 + 0.2	0.1 + 1.0	400
	100 Hz to 1 kHz	0.5 + 0.5	0.6 + 0.5	0.05 + 1.0	
0.33 mA to 3.2999 mA	10 Hz to 100 Hz	0.2 + 0.3	0.25 + 0.3	0.15 + 1.5	
	100 Hz to 1 kHz	0.5 + 0.8	0.6 + 0.8	0.06 + 1.5	
3.3 mA to 32.999 mA	10 Hz to 100 Hz	0.07 + 4	0.08 + 4	0.15 + 5	
	100 Hz to 1 kHz	0.18 + 10	0.2 + 10	0.05 + 5	
33 mA to 329.99 mA	10 Hz to 100 Hz	0.07 + 40	0.08 + 40	0.15 + 50	
	100 Hz to 1 kHz	0.18 + 100	0.2 + 100	0.05 + 50	
0.33 A to 2.99999 A	10 Hz to 100 Hz	0.1 + 200	0.12 + 200	0.2 + 500	
	100 to 440 Hz	0.25 + 1000	0.3 + 1000	0.25 + 500	
3 A to 20.5 A [1]	10 Hz to 100 Hz	0.1 + 2000 [2]	0.12 + 2000 [2]	0.1 + 0	400 [4]
	100 Hz to 1 kHz	0.8 + 5000 [3]	1.0 + 5000 [3]	0.5 + 0	

[1] Duty Cycle: Currents < 11 A may be provided continuously. For currents >11 A, see Figure 1-4. The current may be provided 60-T-I minutes any 60 minute period where T is the temperature in °C (room temperature is about 23 °C) and I is the output current in amperes. For example, 17 A, at 23 °C could be provided for 60-17-23 = 20 minutes each hour.

[2] For currents >11 A, Floor specification is 4000 μA within 30 seconds of selecting operate. For operating times >30 seconds, the floor specification is 2000 μA.

[3] For currents >11 A, Floor specification is 1000 μA within 30 seconds of selecting operate. For operating times >30 seconds, the floor specification is 5000 μA.

[4] Subject to compliance voltages limits.

Range	Resolution μA	Max Compliance Voltage V rms
0.029 mA to 0.32999 mA	0.01	7
0.33 mA to 3.29999 mA	0.01	7
3.3 mA to 32.9999 mA	0.1	5
33 mA to 329.999 mA	1	5
0.33 A to 2.99999 A	10	4
3 A to 20.5 A	100	3

[1] Subject to specification adder for compliance voltages greater than 1 V rms.

1-19. Capacitance Specifications

Range	Absolute Uncertainty, $t_{cal} \pm 5^\circ C$ \pm (% of output + floor)		Res- olu- tion	Allowed Frequency or Charge-Discharge Rate		
	90 days	1 year		Min and Max to Meet Specification	Typical Max for <0.5% Error	Typical Max for <1% Error
0.19 nF to 0.3999 nF	0.38 + 0.01 nF	0.5 + 0.01 nF	0.1 pF	10 Hz to 10 kHz	20 kHz	40 kHz
0.4 nF to 1.0999 nF	0.38 + 0.01 nF	0.5 + 0.01 nF	0.1 pF	10 Hz to 10 kHz	30 kHz	50 kHz
1.1 nF to 3.2999 nF	0.38 + 0.01 nF	0.5 + 0.01 nF	0.1 pF	10 Hz to 3 kHz	30 kHz	50 kHz
3.3 nF to 10.9999 nF	0.19 + 0.01 nF	0.25 + 0.01 nF	0.1 pF	10 Hz to 1 kHz	20 kHz	25 kHz
11 nF to 32.9999 nF	0.19 + 0.1 nF	0.25 + 0.1 nF	0.1 pF	10 Hz to 1 kHz	8 kHz	10 kHz
33 nF to 109.999 nF	0.19 + 0.1 nF	0.25 + 0.1 nF	1 pF	10 Hz to 1 kHz	4 kHz	6 kHz
110 nF to 329.999 nF	0.19 + 0.3 nF	0.25 + 0.3 nF	1 pF	10 Hz to 1 kHz	2.5 kHz	3.5 kHz
0.33 μ F to 1.09999 μ F	0.19 + 1 nF	0.25 + 1 nF	10 pF	10 Hz to 600 Hz	1.5 kHz	2 kHz
1.1 μ F to 3.29999 μ F	0.19 + 3 nF	0.25 + 3 nF	10 pF	10 Hz to 300 Hz	800 Hz	1 kHz
3.3 μ F to 10.9999 μ F	0.19 + 10 nF	0.25 + 10 nF	100 pF	10 Hz to 150 Hz	450 Hz	650 Hz
11 μ F to 32.9999 μ F	0.30 + 30 nF	0.40 + 30 nF	100 pF	10 Hz to 120 Hz	250 Hz	350 Hz
33 μ F to 109.999 μ F	0.34 + 100 nF	0.45 + 100 nF	1 nF	10 Hz to 80 Hz	150 Hz	200 Hz
110 μ F to 329.999 μ F	0.34 + 300 nF	0.45 + 300 nF	1 nF	0 to 50 Hz	80 Hz	120 Hz
0.33 μ F to 1.09999mF	0.34 + 1 μ F	0.45 + 1 μ F	10 nF	0 to 20 Hz	45 Hz	65 Hz
1.1 mF to 3.2999 mF	0.34 + 3 μ F	0.45 + 3 μ F	10 nF	0 to 6 Hz	30 Hz	40 Hz
3.3 mF to 10.9999 mF	0.34 + 10 μ F	0.45 + 10 μ F	100 nF	0 to 2 Hz	15 Hz	20 Hz
11 mF to 32.9999 mF	0.7 + 30 μ F	0.75 + 30 μ F	100 nF	0 to 0.6 Hz	7.5 Hz	10 Hz
33 mF to 110 mF	1.0 + 100 μ F	1.1 + 100 μ F	10 μ F	0 to 0.2 Hz	3 Hz	5 Hz

[1] The output is continuously variable from 190 pF to 110 mF.

[2] Specifications apply to both dc charge/discharge capacitance meters and ac RCL meters. The maximum allowable peak voltage is 3 V. The maximum allowable peak current is 150 mA, with an rms limitation of 30 mA below 1.1 μ F and 100 mA for 1.1 μ F and above.

[3] The maximum lead resistance for no additional error in 2-wire COMP mode is 10 Ω .

1-20. Temperature Calibration (Thermocouple) Specifications

TC Type [1]	Range °C [2]	Absolute Uncertainty Source/Measure tcal ±5 °C ± °C [3]		TC Type [1]	Range °C [2]	Absolute Uncertainty Source/Measure tcal ±5 °C ± °C [3]	
		90 days	1 year			90 days	1 year
B	600 to 800	0.42	0.44	L	-200 to -100	0.37	0.37
	800 to 1000	0.34	0.34		-100 to 800	0.26	0.26
	1000 to 1550	0.30	0.30		800 to 900	0.17	0.17
	1550 to 1820	0.26	0.33	N	-200 to -100	0.30	0.40
C	0 to 150	0.23	0.30		-100 to -25	0.17	0.22
	150 to 650	0.19	0.26		-25 to 120	0.15	0.19
	650 to 1000	0.23	0.31		120 to 410	0.14	0.18
	1000 to 1800	0.38	0.50		410 to 1300	0.21	0.27
	1800 to 2316	0.63	0.84	R	0 to 250	0.48	0.57
E	-250 to -100	0.38	0.50		250 to 400	0.28	0.35
	-100 to -25	0.12	0.16		400 to 1000	0.26	0.33
	-25 to 350	0.10	0.14		1000 to 1767	0.30	0.40
	350 to 650	0.12	0.16	S	0 to 250	0.47	0.47
	650 to 1000	0.16	0.21		250 to 1000	0.30	0.36
J	-210 to -100	0.20	0.27		1000 to 1400	0.28	0.37
	-100 to -30	0.12	0.16	1400 to 1767	0.34	0.46	
	-30 to 150	0.10	0.14	T	-250 to -150	0.48	0.63
	150 to 760	0.13	0.17		-150 to 0	0.18	0.24
	760 to 1200	0.18	0.23		0 to 120	0.12	0.16
K	-200 to -100	0.25	0.33		120 to 400	0.10	0.14
	-100 to -25	0.14	0.18	U	-200 to 0	0.56	0.56
	-25 to 120	0.12	0.16		0 to 600	0.27	0.27
	120 to 1000	0.19	0.26				
	1000 to 1372	0.30	0.40				

[1] Temperature standard ITS-90 or IPTS-68 is selectable.
TC simulating and measuring are not specified for operation in electromagnetic fields above 0.4 V/m.

[2] Resolution is 0.01 °C

[3] Does not include thermocouple error

1-21. Temperature Calibration (RTD) Specifications

RTD Type	Range °C [1]	Absolute Uncertainty tcal ±5 °C ± °C [2]		RTD Type	Range °C [1]	Absolute Uncertainty tcal ±5 °C ± °C [2]	
		90 days	1 year			90 days	1 year
Pt 395, 100 Ω	-200 to -80	0.04	0.05	Pt 385, 500 Ω	-200 to -80	0.03	0.04
	-80 to 0	0.05	0.05		-80 to 0	0.04	0.05
	0 to 100	0.07	0.07		0 to 100	0.05	0.05
	100 to 300	0.08	0.09		100 to 260	0.06	0.06
	300 to 400	0.09	0.10		260 to 300	0.07	0.08
	400 to 630	0.10	0.12		300 to 400	0.07	0.08
	630 to 800	0.21	0.23		400 to 600	0.08	0.09
Pt 3926, 100 Ω	-200 to -80	0.04	0.05	Pt 385, 1000 Ω	600 to 630	0.09	0.11
	-80 to 0	0.05	0.05		-200 to -80	0.03	0.03
	0 to 100	0.07	0.07		-80 to 0	0.03	0.03
	100 to 300	0.08	0.09		0 to 100	0.03	0.04
	300 to 400	0.09	0.10		100 to 260	0.04	0.05
400 to 630	0.10	0.12	260 to 300		0.05	0.06	
Pt 3916, 100 Ω	-200 to -190	0.25	0.25		300 to 400	0.05	0.07
	-190 to -80	0.04	0.04	400 to 600	0.06	0.07	
	-80 to 0	0.05	0.05	600 to 630	0.22	0.23	
	0 to 100	0.06	0.06	PtNi 385, 120 Ω (Ni120)	-80 to 0	0.06	0.08
	100 to 260	0.06	0.07		0 to 100	0.07	0.08
	260 to 300	0.07	0.08		100 to 260	0.13	0.14
300 to 400	0.08	0.09	Cu 427, 10 Ω [3]	-100 to 260	0.3	0.3	
400 to 600	0.08	0.10					
600 to 630	0.21	0.23					
Pt 385, 200 Ω	-200 to -80	0.03	0.04				
	-80 to 0	0.03	0.04				
	0 to 100	0.04	0.04				
	100 to 260	0.04	0.05				
	260 to 300	0.11	0.12				
	300 to 400	0.12	0.13				
	400 to 600	0.12	0.14				
	600 to 630	0.14	0.16				

[1] Resolution is 0.003 °C
 [2] Applies for COMP OFF (to the 5520A Calibrator front panel NORMAL terminals) and 2- wire and 4-wire compensation.
 [3] Based on MINCO Application Aid No. 18

1-22. DC Power Specification Summary

	Voltage Range	Current Range		
		0.33 mA to 329.99 mA	0.33 A to 2.9999 A	3 A to 20.5 A
		Absolute Uncertainty, tcal ± 5 °C, \pm (% of watts output) [1]		
90 days	33 mV to 1020 V	0.021	0.019 [2]	0.06 [2]
1 year	33 mV to 1020 V	0.023	0.022 [2]	0.07 [2]

[1] To determine dc power uncertainty with more precision, see the individual "AC Voltage Specifications," "AC Current Specifications," and "Calculating Power Uncertainty."

[2] Add 0.02% unless a settling time of 30 seconds is allowed for output currents > 10 A or for currents on the highest two current ranges within 30 seconds of an output current > 10 A.

1-23. AC Power (45 Hz to 65 Hz) Specification Summary, PF=1

	Voltage Range	Current Range			
		3.3 mA to 8.999 mA	9 mA to 32.999 mA	33 mA to 89.99 mA	90 mA to 329.99 mA
		Absolute Uncertainty, tcal ± 5 °C, \pm (% of watts output) [1]			
90 days	33 to 329.999 mV	0.13	0.09	0.13	0.09
	330 mV to 1020 V	0.11	0.07	0.11	0.07
1 year	33 to 329.999 mV	0.14	0.10	0.14	0.10
	330 mV to 1020 V	0.12	0.08	0.12	0.08

	Voltage Range	Current Range [2]			
		0.33 A to 0.8999 A	0.9 A to 2.1999 A	2.2 A to 4.4999 A	4.5 A to 20.5 A
		Absolute Uncertainty, tcal ± 5 °C, \pm (% of watts output) [1]			
90 days	33 to 329.999 mV	0.12	0.10	0.12	0.10
	330 mV to 1020 V	0.10	0.08	0.11	0.09
1 year	33 to 329.999 mV	0.13	0.11	0.13	0.11
	330 mV to 1020 V	0.11	0.09	0.12	0.10

[1] To determine ac power uncertainty with more precision, see the individual "DC Voltage Specifications" and "DC Current Specifications" and "Calculating Power Uncertainty."

[2] Add 0.02% unless a settling time of 30 seconds is allowed for output currents > 10A or for currents on the highest two current ranges within 30 seconds of an output current > 10A.

1-24. Power and Dual Output Limit Specifications

Frequency	Voltages (NORMAL)	Currents	Voltages (AUX)	Power Factor (PF)
dc	0 to ± 1020 V	0 to ± 20.5 A	0 to ± 7 V	—
10 Hz to 45 Hz	33 mV to 32.9999 V	3.3 mA to 2.99999 A	10 mV to 5 V	0 to 1
45 Hz to 65 Hz	33 mV to 1000 V	3.3 mA to 20.5 A	10 mV to 5 V	0 to 1
65 Hz to 500 Hz	330 mV to 1000 V	33 mA to 2.99999 A	100 mV to 5 V	0 to 1
65 Hz to 500 Hz	3.3 V to 1000 V	33 mA to 20.5 A	100 mV to 5 V	0 to 1
500 Hz to 1 kHz	330 mV to 1000 V	33 mA to 20.5 A	100 mV to 5 V	1
1 kHz to 5 kHz	3.3 V to 1000 V [1]	33 mA to 2.99999 A	100 mV to 5 V [1]	1
5 kHz to 10 kHz	3.3 V to 1000 V [2]	33 mA to 329.99 mA	1 V to 5 V [2]	1

[1] In dual voltage output mode, voltage is limited to 3.3 V to 500 V in the NORMAL output.
[2] In dual voltage output mode, voltage is limited to 3.3 V to 250 V in the NORMAL output.

Notes

- The range of voltages and currents shown in “DC Voltage Specifications,” “DC Current Specifications,” “AC Voltage (Sine Wave) Specifications,” and “AC Current (Sine Wave) Specifications” are available in the power and dual output modes (except minimum current for ac power is 0.33 mA). However, only those limits shown in this table are specified. See “Calculating Power Uncertainty” to determine the uncertainty at these points.
- The phase adjustment range for dual ac outputs is 0° to $\pm 179.99^\circ$. The phase resolution for dual ac outputs is 0.01° .

1-25. Phase Specifications

1-Year Absolute Uncertainty, tcal ± 5 °C, (Δ Φ °)					
10 Hz to 65 Hz	65 Hz to 500 Hz	500 Hz to 1 kHz	1 kHz to 5 kHz	5 kHz to 10 kHz	10 kHz to 30 kHz
0.10°	0.25°	0.5°	2.5°	5°	10°

Phase (Φ) Watts	Phase (Φ) VARs	PF	Power Uncertainty Adder due to Phase Error					
			10 Hz to 65 Hz	65 Hz to 500 Hz	500 Hz to 1 kHz	1 kHz to 5 kHz	5 kHz to 10 kHz	10 kHz to 30 kHz
0°	90°	1.000	0.00%	0.00%	0.00%	0.10%	0.38%	1.52%
10°	80°	0.985	0.03%	0.08%	0.16%	0.86%	1.92%	4.58%
20°	70°	0.940	0.06%	0.16%	0.32%	1.68%	3.55%	7.84%
30°	60°	0.866	0.10%	0.25%	0.51%	2.61%	5.41%	11.54%
40°	50°	0.766	0.15%	0.37%	0.74%	3.76%	7.69%	16.09%
50°	40°	0.643	0.21%	0.52%	1.04%	5.29%	10.77%	22.21%
60°	30°	0.500	0.30%	0.76%	1.52%	7.65%	15.48%	31.60%
70°	20°	0.342	0.48%	1.20%	2.40%	12.08%	24.33%	49.23%
80°	10°	0.174	0.99%	2.48%	4.95%	24.83%	49.81%	100.00%
90°	0°	0.000	—	—	—	—	—	—

Note

- To calculate exact ac watts power adders due to phase uncertainty for values not shown, use the following formula: $Adder(\%) = 100(1 - \frac{\cos(\Phi + \Delta\Phi)}{\cos(\Phi)})$. For example: for a PF of .9205 (Φ = 23) and a phase uncertainty of ΔΦ = 0.15, the ac watts power adder is: $Adder(\%) = 100(1 - \frac{\cos(23+0.15)}{\cos(23)}) = 0.11\%$

1-26. Calculating Power Uncertainty

Overall uncertainty for power output in watts (or VARs) is based on the root sum square (rss) of the individual uncertainties in percent for the selected voltage, current, and power factor parameters:

$$\text{Watts uncertainty} \quad U_{\text{power}} = \sqrt{U^2_{\text{voltage}} + U^2_{\text{current}} + U^2_{\text{PFadder}}}$$

$$\text{VARs uncertainty} \quad U_{\text{VARs}} = \sqrt{U^2_{\text{voltage}} + U^2_{\text{current}} + U^2_{\text{VARsadder}}}$$

Because there are an infinite number of combinations, you should calculate the actual ac power uncertainty for your selected parameters. The method of calculation is best shown in the following examples (using 90-day specifications):

Example 1 Output: 100 V, 1 A, 60 Hz, Power Factor = 1.0 ($\Phi=0$), 1 year specifications

Voltage Uncertainty Uncertainty for 100 V at 60 Hz is 150 ppm + 2 mV, totaling:
 $100 \text{ V} \times 190 \times 10^{-6} = 15 \text{ mV}$ added to 2 mV = 17 mV. Expressed in percent:
 $17 \text{ mV}/100 \text{ V} \times 100 = \underline{0.017\%}$ (see “AC Voltage (Sine Wave) Specifications”).

Current Uncertainty Uncertainty for 1 A is 0.036% + 100 μA , totaling:
 $1 \text{ A} \times 0.00036 = 360 \mu\text{A}$ added to 100 μA = 0.46 mA. Expressed in percent:
 $0.46 \text{ mA}/1 \text{ A} \times 100 = \underline{0.046\%}$ (see “AC Current (Sine Waves) Specifications”).

PF Adder Watts Adder for PF = 1 ($\Phi=0$) at 60 Hz is 0% (see “Phase Specifications”).

$$\text{Total Watts Output Uncertainty} = U_{\text{power}} = \sqrt{0.017^2 + 0.046^2 + 0^2} = 0.049\%$$

Example 2 Output: 100 V, 1 A, 400 Hz, Power Factor = 0.5 ($\Phi=60$)

Voltage Uncertainty Uncertainty for 100 V at 400 Hz is, 150 ppm + 2 mV, totaling:
 $100 \text{ V} \times 190 \times 10^{-6} = 15 \text{ mV}$ added to 2 mV = 17 mV. Expressed in percent:
 $17 \text{ mV}/100 \text{ V} \times 100 = \underline{0.017\%}$ (see “AC Voltage (Sine Wave) Specifications”).

Current Uncertainty Uncertainty for 1 A is 0.036% + 100 μA , totaling:
 $1 \text{ A} \times 0.00036 = 360 \mu\text{A}$ added to 100 μA = 0.46 mA. Expressed in percent:
 $0.46 \text{ mA}/1 \text{ A} \times 100 = \underline{0.046\%}$ (see “AC Current (Sine Waves) Specifications”).

PF Adder Watts Adder for PF = 0.5 ($\Phi=60$) at 400 Hz is 0.76% (see “Phase Specifications”).

$$\text{Total Watts Output Uncertainty} = U_{\text{power}} = \sqrt{0.017^2 + 0.046^2 + 0.76^2} = 0.76\%$$

VARs When the Power Factor approaches 0.0, the watts output uncertainty becomes unrealistic because the dominant characteristic is the VARs (volts-amps-reactive) output. In these cases, calculate the Total VARs Output Uncertainty, as shown in example 3:

Example 3 Output: 100 V, 1 A, 60 Hz, Power Factor = 0.174 ($\Phi=80$)

Voltage Uncertainty Uncertainty for 100 V at 400 Hz is, 150 ppm + 2 mV, totaling:
 $100 \text{ V} \times 190 \times 10^{-6} = 15 \text{ mV}$ added to 2 mV = 17 mV. Expressed in percent:
 $17 \text{ mV}/100 \text{ V} \times 100 = \underline{0.017\%}$ (see “AC Voltage (Sine Wave) Specifications”).

Current Uncertainty Uncertainty for 1 A is 0.036% + 100 μA , totaling:
 $1 \text{ A} \times 0.00036 = 360 \mu\text{A}$ added to 100 μA = 0.46 mA. Expressed in percent:
 $0.46 \text{ mA}/1 \text{ A} \times 100 = \underline{0.046\%}$ (see “AC Current (Sine Waves) Specifications”).

VARs Adder VARs Adder for $\Phi = 80$ at 60 Hz is 0.02% (see “Phase Specifications”).

$$\text{Total VARs Output Uncertainty} = U_{\text{VARs}} = \sqrt{0.017^2 + 0.046^2 + 0.02^2} = 0.058\%$$

1-27. Additional Specifications

The following paragraphs provide additional specifications for the 5520A Calibrator ac voltage and ac current functions. These specifications are valid after allowing a warm-up period of 30 minutes, or twice the time the 5520A has been turned off. All extended range specifications are based on performing the internal zero-cal function at weekly intervals, or when the ambient temperature changes by more than 5 °C. (See Chapter 4, “Front Panel Operation.”)

1-28. Frequency Specifications

Frequency Range	Resolution	1-Year Absolute Uncertainty, tcal ± 5°C	Jitter
0.01 Hz to 119.99 Hz	0.01 Hz	2.5 ppm ± 5 µHz [1]	100 nS
120.0 Hz to 1199.9 Hz	0.1 Hz		
1.200 kHz to 11.999 kHz	1.0 Hz		
12.00 kHz to 119.99 kHz	10 Hz		
120.0 kHz to 1199.9 kHz	100 Hz		
1.200 MHz to 2.000 MHz	1 kHz		
[1] With REF CLK set to ext, the frequency uncertainty of the 5520A is the uncertainty of the external 10 MHz clock ±5 µHz. The amplitude of the 10 MHz external reference clock signal should be between 1 V and 5 V p-p.			

1-29. Harmonics (2nd to 50th) Specifications

Fundamental Frequency [1]	Voltages NORMAL Terminals	Currents	Voltages AUX Terminals	Amplitude Uncertainty
10 Hz to 45 Hz	33 mV to 32.9999 V	3.3 mA to 2.99999 A	10 mV to 5 V	Same % of output as the equivalent single output, but twice the floor adder.
45 Hz to 65 Hz	33 mV to 1000 V	3.3 mA to 20.5 A	10 mV to 5 V	
65 Hz to 500 Hz	33 mV to 1000 V	33 mA to 20.5 A	100 mV to 5 V	
500 Hz to 5 kHz	330 mV to 1000 V	33 mA to 20.5 A	100 mV to 5 V	
5 kHz to 10 kHz	3.3 V to 1000 V	33 mA to 329.9999 mA	100 mV to 5 V	
10 kHz to 30 kHz	3.3 V to 1000 V	33 mA to 329.9999 mA	100 mV to 3.29999 V	

[1] The maximum frequency of the harmonic output is 30 kHz (10 kHz for 3 V to 5 V). For example, if the fundamental output is 5 kHz, the maximum selection is the 6th harmonic (30 kHz). All harmonic frequencies (2nd to 50th) are available for fundamental outputs between 10 Hz and 600 Hz (200 Hz for 3 V to 5 V).

Note

1. Phase uncertainty for harmonic outputs is 1 degree, or the phase uncertainty shown in “Phase Specifications” for the particular output, whichever is greater. For example, the phase uncertainty of a 400 Hz fundamental output and 10 kHz harmonic output is 10° (from “Phase Specifications”). Another example, the phase uncertainty of a 60 Hz fundamental output and a 400 Hz harmonic output is 1 degree.

Example of determining Amplitude Uncertainty in a Dual Output Harmonic Mode

What are the amplitude uncertainties for the following dual outputs?

NORMAL (Fundamental) Output: 100 V, 100 Hz

From “AC Voltage (Sine Wave) Specifications” the single output specification for 100 V, 100 Hz, is 0.015% + 2 mV. For the dual output in this example, the specification is 0.015% + 4 mV as the 0.015% is the same and the floor is twice the value (2 x 2 mV).

AUX (50th Harmonic) Output: 100 mV, 5 kHz

From “AC Voltage (Sine Wave) Specifications” the auxiliary output specification for 100 mV, 5 kHz, is 0.15% + 450 mV. For the dual output in this example, the specification is 0.15% + 900 mV as the 0.15% is the same and the floor is twice the value (2 x 450 mV).

1-30. AC Voltage (Sine Wave) Extended Bandwidth Specifications

Range	Frequency	1-Year Absolute Uncertainty total $\pm 5^\circ\text{C}$	Max Voltage Resolution
Normal Channel (Single Output Mode)			
1.0 mV to 33 mV	0.01 Hz to 9.99 Hz	$\pm (5.0\% \text{ of output} + 0.5\% \text{ of range})$	Two digits, e.g., 25 mV
34 mV to 330 mV			Three digits
0.4 V to 33 V			Two digits
0.3 V to 3.3 V	500.1 kHz to 1 MHz	-10 dB at 1 MHz, typical	Two digits
	1.001 MHz to 2 MHz	-31 dB at 2 MHz, typical	
Auxiliary Output (Dual Output Mode)			
10 mV to 330 mV	0.01 Hz to 9.99 Hz	$\pm (5.0\% \text{ of output} + 0.5\% \text{ of range})$	Three digits
0.4 V to 5 V			Two digits

1-31. AC Voltage (Non-Sine Wave) Specifications

Triangle Wave & Truncated Sine Range, p-p [1]	Frequency	1-Year Absolute Uncertainty, $t_{cal} \pm 5^\circ C$, \pm (% of output + % of range) [2]	Max Voltage Resolution
Normal Channel (Single Output Mode)			
2.9 mV to 93 V	0.01 Hz to 10 Hz	5.0 + 0.5	Two digits on each range
	10 Hz to 45 Hz	0.25 + 0.5	Six digits on each range
	45 Hz to 1 kHz	0.25 + 0.25	
	1 kHz to 20 kHz	0.5 + 0.25	
	20 kHz to 100 kHz [3]	5.0 + 0.5	
Auxiliary Output (Dual Output Mode)			
93 mV to 14 V	0.01 Hz to 10 Hz	5.0 + 0.5	Two digits on each range
	10 Hz to 45 Hz	0.25 + 0.5	Six digits on each range
	45 Hz to 1 kHz	0.25 + 0.25	
	1 kHz to 10 kHz	5.0 + 0.5	
<p>[1] To convert p-p to rms for triangle wave, multiply the p-p value by 0.2886751. To convert p-p to rms for truncated sine wave, multiply the p-p value by 0.2165063.</p> <p>[2] Uncertainty is stated in p-p. Amplitude is verified using an rms-responding DMM.</p> <p>[3] Uncertainty for Truncated Sine outputs is typical over this frequency band.</p>			

Square wave Range (p-p) [1]	Frequency	1-Year Absolute Uncertainty, $t_{cal} \pm 5^\circ C$, \pm (% of output + % of range) [2]	Max Voltage Resolution
Normal Channel (Single Output Mode)			
2.9 mV to 66 V	0.01 Hz to 10 Hz	5.0 + 0.5	Two digits on each range
	10 Hz to 45 Hz	0.25 + 0.5	Six digits on each range
	45 Hz to 1 kHz	0.25 + 0.25	
	1 kHz to 20 kHz	0.5 + 0.25	
	20 kHz to 100 kHz	5.0 + 0.5	
Auxiliary Output (Dual Output Mode)			
66 mV to 14 V	0.01 Hz to 10 Hz	5.0 + 0.5	Two digits on each range
	10 Hz to 45 Hz	0.25 + 0.5	Six digits on each range
	45 Hz to 1 kHz	0.25 + 0.25	
	1 kHz to 10 kHz [3]	5.0 + 0.5	
<p>[1] To convert p-p to rms for square wave, multiply the p-p value by 0.5000000.</p> <p>[2] Uncertainty is stated in p-p. Amplitude is verified using an rms-responding DMM.</p> <p>[3] Limited to 1 kHz for Auxiliary outputs ≥ 6.6 V p-p.</p>			

1-32. AC Voltage, DC Offset Specifications

Range [1] (Normal Channel)	Offset Range [2]	Max Peak Signal	1-Year Absolute Offset Uncertainty, tcal ± 5 °C [3] \pm (% dc output + floor)
Sine Waves (rms)			
3.3 mV to 32.999 mV	0 to 50 mV	80 mV	0.1 + 33 μ V
33 mV to 329.999 mV	0 to 500 mV	800 mV	0.1 + 330 μ V
0.33 mV to 3.29999 V	0 to 5 V	8 V	0.1 + 3300 μ V
3.3 V to 32.9999 V	0 to 50 V	55 V	0.1 + 33 mV
Triangle Waves and Truncated Sine Waves (p-p)			
9.3 mV to 92.999 mV	0 to 50 mV	80 mV	0.1 + 93 μ V
93 mV to 929.999 mV	0 to 500 mV	800 mV	0.1 + 930 μ V
0.93 mV to 9.29999 V	0 to 5 V	8 V	0.1 + 9300 μ V
9.3 mV to 92.9999 V	0 to 50 V	55 V	0.1 + 93 mV
Square Waves (p-p)			
6.6 mV to 65.999 mV	0 to 50 mV	80 mV	0.1 + 66 μ V
66 mV to 659.999 mV	0 to 500 mV	800 mV	0.1 + 660 μ V
0.66 mV to 6.59999 V	0 to 5 V	8 V	0.1 + 6600 μ V
6.6 mV to 65.9999 V	0 to 50 V	55 V	0.1 + 66 mV
<p>[1] Offsets are not allowed on ranges above the highest range shown above.</p> <p>[2] The maximum offset value is determined by the difference between the peak value of the selected voltage output and the allowable maximum peak signal. For example, a 10 V p-p square wave output has a peak value of 5 V, allowing a maximum offset up to ± 50 V to not exceed the 55 V maximum peak signal. The maximum offset values shown above are for the minimum outputs in each range.</p> <p>[3] For frequencies 0.01 Hz to 10 Hz, and 500 kHz to 2 MHz, the offset uncertainty is 5% of output, $\pm 1\%$ of the offset range.</p>			

1-33. AC Voltage, Square Wave Characteristics

Risetime @ 1 kHz Typical	Settling Time @ 1 kHz Typical	Overshoot @ 1 kHz Typical	Duty Cycle Range	Duty Cycle Uncertainty
<1 μ s	<10 μ s to 1% of final value	<2%	1% to 99%, <3.3 V p-p, 0.01 Hz to 100 kHz	\pm (0.8% of period +100 ns) \pm (0.02% of period + 100 ns), 50% duty cycle \pm (0.05% of period + 100 ns), other duty cycles from 10% to 90%

1-34. AC Voltage, Triangle Wave Characteristics (typical)

Linearity to 1 kHz	Aberrations
0.3% of p-p value, from 10% to 90% point	<1% of p-p value, with amplitude >50% of range

1-35. AC Current (Sine Wave) Extended Bandwidth Specifications

Range	Frequency	1-Year Absolute Uncertainty tcal \pm 5 $^{\circ}$ C \pm (% of output + % of range)	Max Current Resolution
All current ranges, <330 mA	0.01 Hz to 10 Hz	5.0 + 0.5	2 digits

1-36. AC Current (Non-Sine Wave) Specifications

Triangle Wave & Truncated Sine Wave Range p-p	Frequency	1-Year Absolute Uncertainty tcal ± 5 °C ± (% of output + % of range)	Max Current Resolution
0.047 mA to 0.92999 mA [1]	0.01 Hz to 10 Hz	5.0 + 0.5	Two digits
	10 Hz to 45 Hz	0.25 + 0.5	Six digits
	45 Hz to 1 kHz	0.25 + 0.25	
	1 kHz to 10 kHz	10 + 2	
0.93 mA to 9.29999 mA [1]	0.01 Hz to 10 Hz	5.0 + 0.5	Two digits
	10 Hz to 45 Hz	0.25 + 0.5	Six digits
	45 Hz to 1 kHz	0.25 + 0.25	
	1 kHz to 10 kHz	10 + 2	
9.3 mA to 92.9999 mA [1]	0.01 Hz to 10 Hz	5.0 + 0.5	Two digits
	10 Hz to 45 Hz	0.25 + 0.5	Six digits
	45 Hz to 1 kHz	0.25 + 0.25	
	1 kHz to 10 kHz	10 + 2	
93 mA to 929.999 mA [1]	0.01 Hz to 10 Hz	5.0 + 0.5	Two digits
	10 Hz to 45 Hz	0.25 + 0.5	Six digits
	45 Hz to 1 kHz	0.25 + 0.5	
	1 kHz to 10 kHz	10 + 2	
0.93 A to 8.49999 A	10 Hz to 45 Hz	0.5 + 1.0	Six digits
	45 Hz to 1 kHz	0.5 + 0.5	
	1 kHz to 10 kHz	10 + 2	
8.5 A to 57 A [2]	45 Hz to 500 Hz	0.5 + 0.5	Six digits
	500 Hz to 1 kHz	1.0 + 1.0	
[1] Frequency limited to 1 kHz with LCOMP on.			
[2] Frequency limited to 440 Hz with LCOMP on			

AC Current (Non-Sine Wave) Specifications (cont)

Square Wave Range p-p	Frequency	1-Year Absolute Uncertainty, $t_{cal} \pm 5^{\circ}C$, \pm (% of output + % of range)	Max Current Resolution
0.047 mA to 0.65999 mA [1]	0.01 Hz to 10 Hz	5.0 + 0.5	Two digits
	10 Hz to 45 Hz	0.25 + 0.5	Six digits
	45 Hz to 1 kHz	0.25 + 0.25	
	1 kHz to 10 kHz	10 + 2	
0.66 mA to 6.59999 mA [1]	0.01 Hz to 10 Hz	5.0 + 0.5	Two digits
	10 Hz to 45 Hz	0.25 + 0.5	Six digits
	45 Hz to 1 kHz	0.25 + 0.25	
	1 kHz to 10 kHz	10 + 2	
6.6 mA to 65.9999 mA [1]	0.01 Hz to 10 Hz	5.0 + 0.5	Two digits
	10 Hz to 45 Hz	0.25 + 0.5	Six digits
	45 Hz to 1 kHz	0.25 + 0.25	
	1 kHz to 10 kHz	10 + 2	
66 mA to 659.999 mA [1]	0.01 Hz to 10 Hz	5.0 + 0.5	Two digits
	10 Hz to 45 Hz	0.25 + 0.5	Six digits
	45 Hz to 1 kHz	0.25 + 0.5	
	1 kHz to 10 kHz	10 + 2	
0.66 A to 5.99999 A [2]	10 Hz to 45 Hz	0.5 + 1.0	Six digits
	45 Hz to 1 kHz	0.5 + 0.5	
	1 kHz to 10 kHz	10 + 2	
6 A to 41 A [2]	45 Hz to 500 Hz	0.5 + 0.5	Six digits
	500 Hz to 1 kHz	1.0 + 1.0	
[1] Frequency limited to 1 kHz with LCOMP on.			
[2] Frequency limited to 440 Hz with LCOMP on.			

1-37. AC Current, Square Wave Characteristics (typical)

Range	LCOMP	Risetime	Settling Time	Overshoot
I < 6 A @ 400 Hz	off	25 μ s	40 μ s to 1% of final value	< 10% for < 1 V Compliance
3 A & 20 A Ranges	on	100 μ s	200 μ s to 1% of final value	< 10% for < 1 V Compliance

1-38. AC Current, Triangle Wave Characteristics (typical)

Linearity to 400 Hz	Aberrations
0.3% of p-p value, from 10% to 90% point	< 1% of p-p value, with amplitude > 50% of range

Chapter 2

Preparing for Operation

	Contents	Page
2-1.	Introduction.....	2-3
2-2.	Unpacking and Inspection	2-3
2-3.	Replacing the Fuse.....	2-4
2-4.	Selecting Line Voltage	2-4
2-5.	Connecting to Line Power	2-5
2-6.	Selecting Line Frequency	2-5
2-7.	Service Information	2-7
2-8.	Placement and Rack Mounting	2-8
2-9.	Cooling Considerations	2-8

⚠ Warning

The 5520A Calibrator can supply lethal voltages. To avoid shock hazard, read this section before operating the calibrator.

2-1. Introduction

This chapter provides instructions for unpacking and installing the 5520A, selecting the line voltage, replacing the fuse, and connecting to line power. Instructions for cable connections other than line power can be found in the following chapters:

- UUT (Unit Under Test) connections: Chapter 4, “Front Panel Operation”
- IEEE-488 parallel interface connection: Chapter 5, “Remote Operation”
- RS-232C serial interface connection: Chapter 5, “Remote Operation”

2-2. Unpacking and Inspection

The calibrator is shipped in a container designed to prevent damage during shipping. Inspect the calibrator carefully for damage and immediately report any damage to the shipper. Instructions for inspection and claims are included in the shipping container.

When you unpack the calibrator, check for all the standard equipment listed in Table 2-1 and check the shipping order for any additional items ordered. Refer to Chapter 9, “Accessories” for more information. Report any shortage to the place of purchase or to the nearest Fluke Service Center (see “Service Information” in this section). A performance test is provided in Chapter 7, “Maintenance.”

If reshipping the calibrator, use the original container. If it is not available, you can order a new container from Fluke by indicating the Calibrator's model and serial number.

Table 2-1. Standard Equipment

Item	Model or Part Number
Calibrator	5520A
Line Power Cord	See Table 2-2 and Figure 2-2
<i>5520A Operators Manual</i> (English)	688739
<i>5520A Operators Guide</i> (English)	688754
<i>5520A Operators Guide</i> (French)	688751
<i>5520A Operators Guide</i> (Italian)	690511
<i>5520A Operators Guide</i> (German)	688762
<i>5520A Operators Guide</i> (Spanish)	688769
<i>5520A Operators Guide</i> (Japanese)	688770
<i>5520A Operators Guide</i> (Simplified Chinese)	688777
<i>5520A Programmers Guide</i> (English)	688744
Certificate of Calibration	–

2-3. Replacing the Fuse

CAUTION

To prevent possible damage to the instrument, verify the correct fuse is installed for the selected line voltage setting 100 V and 120 V, use 5.0 A/250 V time delay (slow blow); 200 V and 240 V, use 2.5 A/250 V time delay (slow blow).

The line power fuse is accessible on the rear panel. The fuse rating is 5 A/250 V slow blow fuse for the 100 V/120 V line voltage setting; 2.5 A/250 V slow blow fuse for the 220 V/240 V line voltage setting. Fuses that are not user replaceable are discussed in Chapter 7, "Maintenance."

To check or replace the fuse, refer to Figure 2-1 and proceed as follows:

1. **Disconnect line power.**
2. Open the fuse compartment by inserting a screwdriver blade in the tab located at the left side of the compartment and gently pry until it can be removed with the fingers.
3. Remove the fuse from the compartment for replacement or verification. Be sure the correct fuse is installed.
4. Reinstall the fuse compartment by pushing it back into place until the tab locks.

2-4. Selecting Line Voltage

The calibrator arrives from the factory configured for the line voltage normally appropriate for the country of purchase, or as specified at the time of your purchase order. You can operate the 5520 A Calibrator from one of four line voltage settings: 100 V, 120 V, 200 V, and 240 V (47 Hz to 63 Hz). To check the line voltage setting, note the voltage setting visible through the window in the power line fuse compartment cover (Figure 2-1). The allowed line voltage variation is 10% above or below the line voltage setting.

To change the line voltage setting, complete the following procedure:

1. **Disconnect line power.**
2. Open the fuse compartment by inserting a screwdriver blade in the tab located at the left side of the compartment and gently pry until it can be removed with the fingers.
3. Remove the line voltage selector assembly by gripping the line voltage indicator tab with pliers and pulling it straight out of its connector.
4. Rotate the line voltage selector assembly to the desired voltage and reinsert.
5. Verify the appropriate fuse for the selected line voltage (100 V/120 V, use 5 A/250 V slow blow; 220 V/240 V, use 1.25 A/250 V slow blow) and reinstall the fuse compartment by pushing it back into place until the tab locks.

2-5. Connecting to Line Power

Warning

To avoid shock hazard, connect the factory supplied three-conductor line power cord to a properly grounded power outlet. Do not use a two-conductor adapter or extension cord; this will break the protective ground connection.

Use the rear-panel CHASSIS GROUND terminal for a protective grounding wire if there is any question about the effectiveness of instrument earth grounding through the line power cord ground wire.

The calibrator is shipped with the appropriate line power plug for the country of purchase. If you need a different type, refer to Table 2-2 and Figure 2-2 for a list and illustration of the line power plug types available from Fluke.

After you verify that the line voltage selection is set correctly and that the correct fuse for that line voltage is installed, connect the calibrator to a properly grounded three-prong outlet.

2-6. Selecting Line Frequency

The calibrator is shipped from the factory for nominal operation at 60 Hz line frequency. For calibrators with Main software version 1.9 or greater, and if you are using 50 Hz line voltage, you should re-configure the 5520A for optimal performance at 50 Hz. To do so, from the front panel, go into SETUP, INSTMT SETUP, OTHER SETUP, and then turn MAINS50H to “on”. Store the change. After the instrument is properly warmed up (on for 30 minutes or longer), you must re-zero the complete instrument. For details, see the section on “Zeroing the Calibrator” in Chapter 4.

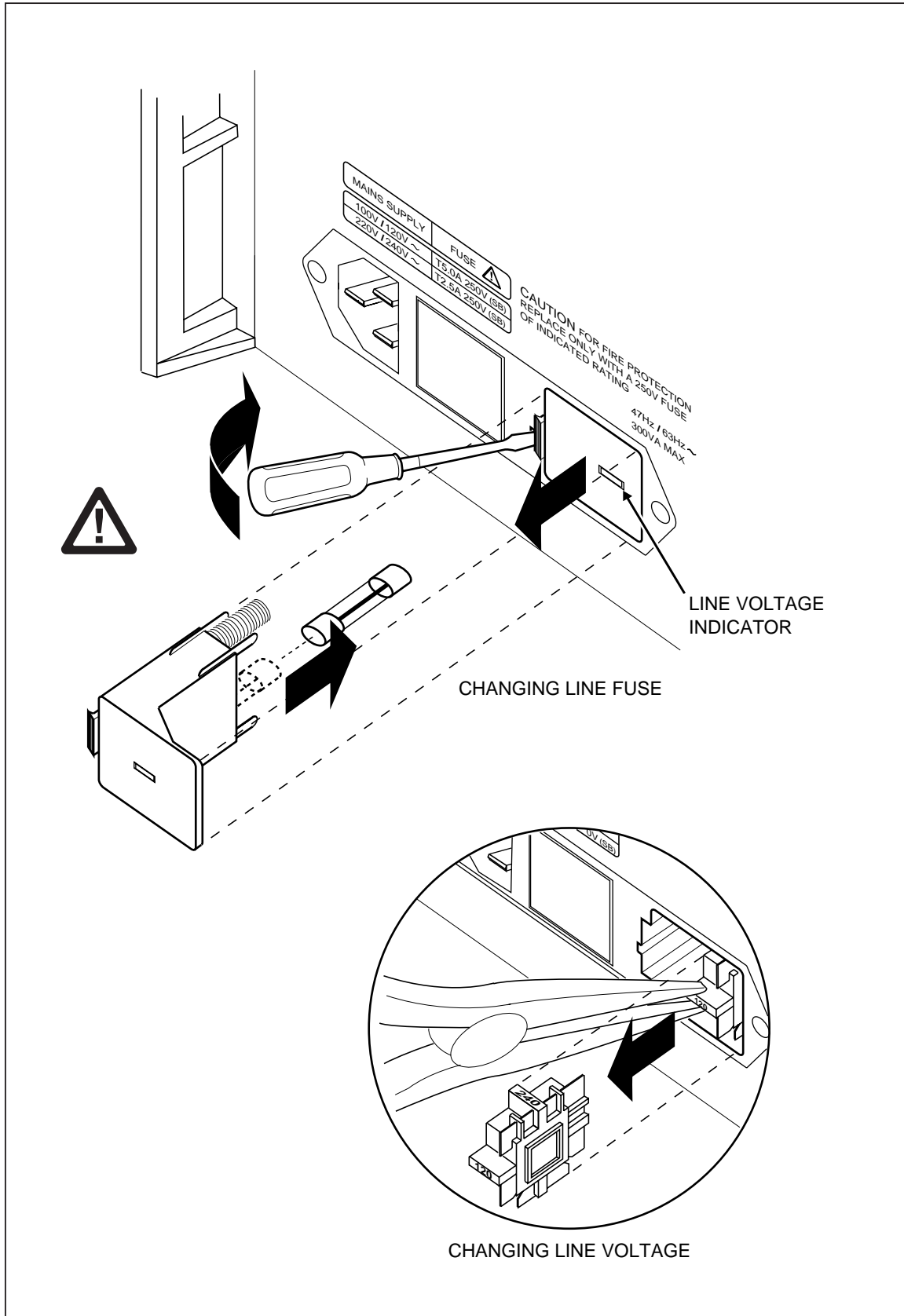

nn007f.eps

Figure 2-1. Accessing the Fuse and Selecting Line Voltage

Table 2-2. Line Power Cord Types Available from Fluke

Type	Voltage/Current	Fluke Option Number
North America	120 V/15 A	LC-1
North America	240 V/15 A	LC-2
Universal Euro	220 V/16 A	LC-3
United Kingdom	240 V/13 A	LC-4
Switzerland	220 V/10 A	LC-5
Australia	240 V/10 A	LC-6
South Africa	240 V/5 A	LC-7

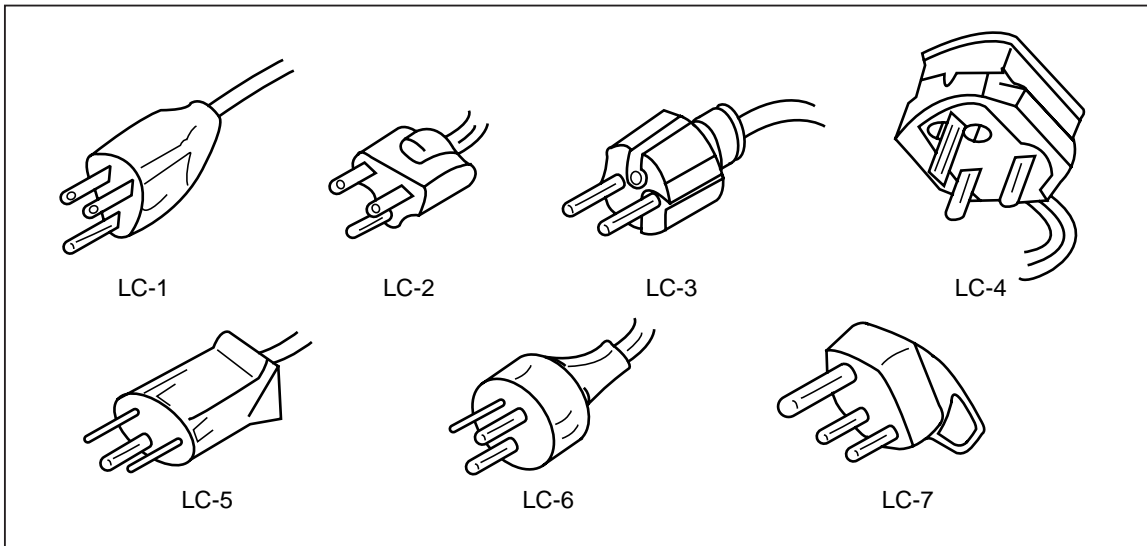

nn08f.eps

Figure 2-2. Line Power Cord Types Available from Fluke

2-7. Service Information

Each Model 5520A Calibrator is warranted to the original purchaser for a period of 1 year beginning on the date received. The warranty is located at the front of this manual.

To locate an authorized service center, call Fluke using any of the phone numbers listed below, or visit us on the World Wide Web: www.fluke.com

USA: 1-888-99-FLUKE (1-888-993-5853)
 Canada: 1-800-36-FLUKE (1-800-363-5853)
 Europe: +31 402-678-200
 Japan: +81-3-3434-0181
 Singapore: +65-738-5655
 Anywhere in the world: +1-425-446-5500

After-warranty service is available, but you may choose to repair the calibrator using the information in the Troubleshooting Chapter of the 5520A Service Manual and the Module Exchange Program. Refer to the Fluke catalog or contact a Fluke Service Center representative for the module exchange procedure.

2-8. Placement and Rack Mounting

You may place the calibrator on a bench top or mount it in a standard-width, 24-inch (61-cm) deep equipment rack. For bench-top use, the calibrator is equipped with non-slipping, non-marring feet. To mount the calibrator in an equipment rack, use the 5520A Rack Mount Kit, Model Y5537. Instructions for rack mounting the calibrator are packed with the rack mount kit.

2-9. Cooling Considerations

Warning

To avoid risk of injury, never operate or power the calibrator without the fan filter in place.

Caution

Damage caused by overheating may occur if the area around the air intake is restricted, the intake air is too warm, or the air filter becomes clogged.

Baffles direct cooling air from the fan throughout the chassis to internally dissipate heat during operation. The accuracy and dependability of all internal parts of the calibrator are enhanced by maintaining the coolest possible internal temperature. You can lengthen the life of the calibrator and enhance its performance by observing the following rules:

- The area around the air filter must be at least 3 inches from nearby walls or rack enclosures.
- The exhaust perforations on the sides of the calibrator must be clear of obstructions.
- The air entering the instrument must be at room temperature: make sure the exhaust air from another instrument is not directed into the fan inlet.
- Clean the air filter every 30 days or more frequently if the calibrator is operated in a dusty environment. (See Chapter 7, “Maintenance” for instructions on cleaning the air filter.)

Chapter 3

Features

	Contents	Page
3-1.	Introduction.....	3-3
3-2.	Front Panel Features	3-3
3-3.	Rear Panel Features	3-3
3-4.	Softkey Menu Trees.....	3-3

3-1. Introduction

This chapter is a reference for the functions and locations of the 5520A Calibrator's front and rear panel features. Please read this information before operating the calibrator. Front panel operating instructions for the calibrator are provided in Chapter 4, "Front Panel Operation"; remote operating instructions are provided in Chapter 5, "Remote Operation."

3-2. Front Panel Features

Front panel features (including all controls, displays, indicators, and terminals) are shown in Figure 3-1. Each front panel feature is described in Table 3-1.

3-3. Rear Panel Features

Rear panel features (including all terminals, sockets, and connectors) are shown in Figure 3-2. Each rear panel feature is described in Table 3-2.

3-4. Softkey Menu Trees

The Setup softkeys are identified in Figures 3-3 and 3-4. The Setup softkeys are associated with the 5520A Calibrator front panel **SETUP** key. The functions of the five softkeys are identified by label information displayed directly above each key. The softkey labels change during operation so that many different functions are quickly accessible.

A group of softkey labels is called a menu. A group of interconnected menus is called a menu tree. Figure 3-3 shows the SETUP menu tree structure; Figure 3-4 describes each SETUP menu tree display. Table 3-3 shows the factory default settings for the SETUP menu tree. To return the SETUP menus to their default values, use the softkey SETUP in the Format NV Memory menu (see Figure 3-4, menu F).

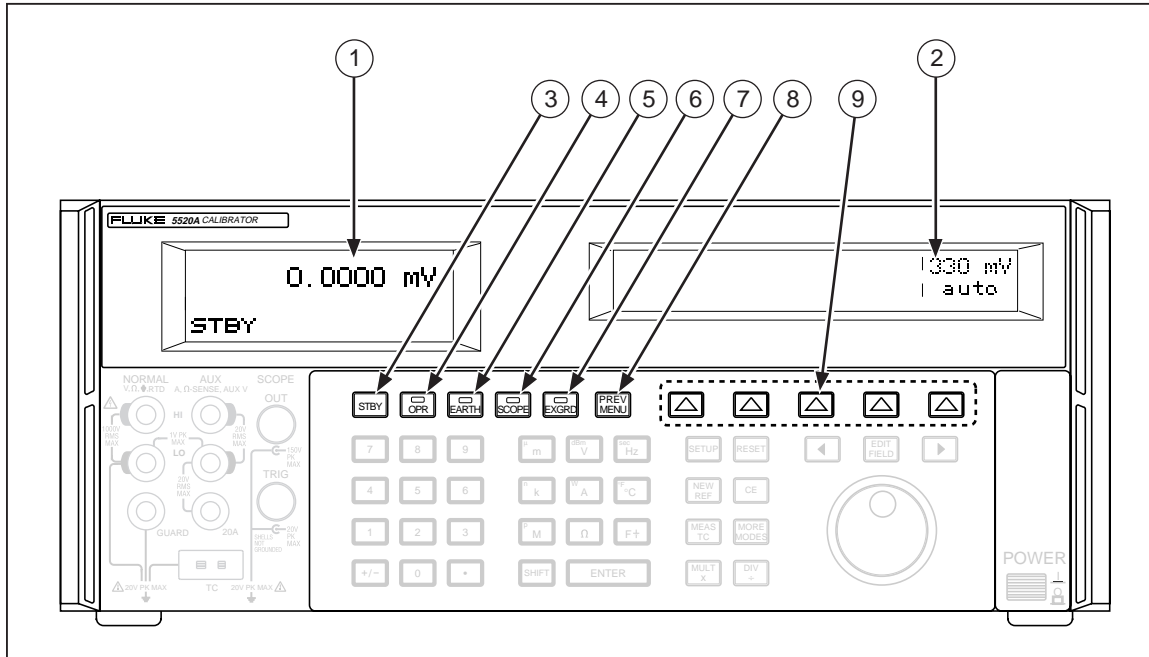

nn009f.eps

Figure 3-1. Front Panel View

Table 3-1. Front Panel Features

<p>①</p>	<p>Output Display</p> <p>The Output Display is a two-line backlit LCD that shows output amplitudes, frequency and calibrator status. Output values (or potential output values if in standby) are displayed using up to seven digits plus a polarity sign. Output frequencies (or potential output frequencies if the 5520A is in standby) are displayed using four digits. Calibrator status is indicated by displaying the following abbreviations:</p> <p>OPR Displayed when an output is active at the front panel terminals.</p> <p>STBY Displayed when the 5520A is in standby.</p> <p>ADDR Displayed when the 5520A is addressed over the IEEE-488 interface.</p> <p>u When you change the output, a “u” (unsettled) is displayed until the output settles to within the specified accuracy.</p> <p>m Displayed when the calibrator is making a measurement. (Thermocouple, pressure, and impedance measurement features only.)</p> <p>? Displayed when the amplitude is specified as typical only, and/or reduced resolution. This occurs when operating the 5520A in the extended bandwidth mode.</p> <p>C Displayed when unstored calibration constants are in use.</p>
<p>②</p>	<p>Control Display</p> <p>The Control Display is a multipurpose backlit LCD used for displaying data entries, UUT error adjustments, softkey labels, phase angles, watts, power factors, and other prompts and messages. When there isn't enough room on the Output Display, output frequency is displayed on the Control Display. Softkey labels identify the function of the softkey directly below them. Several softkey labels together are called a menu. The changing menus provide access to many different functions through the five softkeys plus the PREV MENU key. (See Figure 3-3, Softkey Menu Tree.)</p>

- ③ **STBY**
- The **STBY** (Standby) key places the 5520A in standby mode. Standby mode is indicated by “STBY” in the lower left corner of the Output Display. In standby mode, the **NORMAL**, **AUX** and **20A** output terminals are internally disconnected from the 5520A. The 5520A starts up in standby mode. The 5520A automatically switches to standby if one of the following occurs:
- The RESET key is pressed.
 - A voltage ≥ 33 V is selected when the previous output voltage was less than 33 V.
 - Output function is changed, except when going between ac or dc voltage < 33 V.
 - A current output above 3 A is selected. This is when the output location changes to the **20A** terminal.
 - An overload condition is detected.
- ④ **OPR**
- The **OPR** (Operate) key places the 5520A in operate mode. Operate mode is indicated by “OPR” in the lower left corner of the Output Display and the lit indicator on the OPR key.
- ⑤ **EARTH**
- The **EARTH** (Earth Ground) key opens and closes an internal connection between the NORMAL LO terminal and earth ground. An indicator on the key indicates when this connection is made. The power-up default condition is earth disabled (indicator off).
- ⑥ **SCOPE**
- The **SCOPE** (Oscilloscope) key activates or deactivates an oscilloscope calibration option if it is installed. An indicator on the key indicates when the option is activated. If an oscilloscope calibration option is not installed in the calibrator and the **SCOPE** key is pressed, the calibrator displays an error message.
- ⑦ **EXGRD**
- The **EXGRD** (External Guard) key opens and closes an internal connection between the internal NORMAL LO signal ground and the internal guard shield. An indicator on the key indicates when this connection is made. The power-up default condition is external guard disabled (indicator off).
- ⑧ **PREV MENU**
- The **PREV MENU** (Previous Menu) key recalls the previous set of menu choices. Each press of this key backs up one level of the menu tree until the display indicates the top level menu selection of the function selected.
- ⑨ **Softkeys**
- The functions of the five unlabeled blue softkeys are identified by labels on the Control Display directly above each key. The functions change during operation so that many different functions are accessible through these keys. A group of softkey labels is called a menu. A group of interconnected menus is called a menu tree.

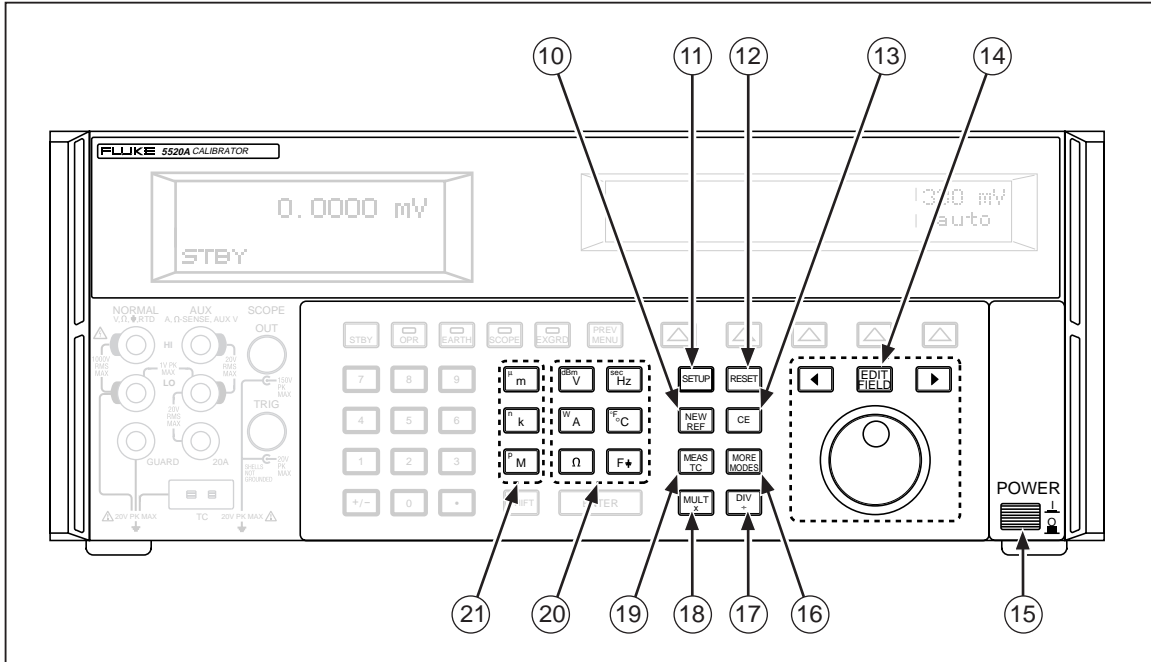

nn010f.eps

Figure 3-1. Front Panel View (cont)

Table 3-1. Front Panel Features (cont)

10	NEW REF	The NEW REF (New Reference) key is active during error mode operation, and establishes the present output value as a new reference for meter error computation.
11	SETUP	The SETUP (Setup Menu) key puts the 5520A in the setup mode, displaying the setup menu in the Control Display. Setup options can be selected using the softkeys under the Control Display.
12	RESET	The RESET (Reset Calibrator) key aborts the current operating state of the 5520A and returns it to the power-up default state, except when operating under remote control.
13	CE	The CE (Clear Entry) key clears a partially completed keypad entry from the Control Display. If there is a partially completed entry when CE is pressed, the output is unaffected.
14	EDIT FIELD	The EDIT FIELD (Edit Output Display Field) key and associated left/right arrow keys provide step adjustment of the output signals. If any of these keys are pressed or the knob is rotated, a digit on the Output Display becomes highlighted and the output increments or decrements as the knob is rotated. If a digit rolls past 0 or 9, the digit to its left or right is carried. An error display appears on the Control Display, showing the difference between the original (reference) output and the new output. The EDIT FIELD key allows you to move from voltage or current to frequency and back. In practice, for voltage and current outputs, the knob and arrow keys are used to adjust output until the UUT reads correctly. The error display then displays UUT deviation from the reference.

15 The power switch turns the power on and off. The switch is a latching push-push type. When the switch is latched in, power is on.

16  The **MORE MODES** key provides access to the measure pressure function. You need a Fluke 700 Series pressure module to measure pressure.







17  The **DIV** (Divide) key immediately changes the output to 1/10th reference value (not necessarily the present output value) if the value is within performance limits. In the SCOPE mode, the DIV key changes the output to the next lower range.

18  The **MULT** (Multiply) key immediately changes the output to 10X the reference value (not necessarily the present output value) if the value is within performance limits. This key sets the 5520A to standby if this change is from below 33 V. In the SCOPE mode, the MULT key changes the output to the next higher range.

19  The **MEAS TC** (Measure Thermocouple) key enables the TC (Thermocouple) input connection and causes the 5520A to compute a temperature based on the voltage present at the input.



20 **Output Units Keys**



The output units keys determine the function of the 5520A. Some keys have a second unit if the SHIFT key is pressed just before the units key. The output units are as follows:

-  Voltage or Decibels relative to 1 mW into 600 ohms (impedance changeable).
-  Watts or Current
-  Resistance
-  Frequency or Seconds (Seconds is applicable to the SCOPE functions only)
-  Capacitance
-  Temperature in Fahrenheit or Celsius

When a frequency (Hz) value is entered, the 5520A automatically switches to ac. When a new signed (+ or -) output value is entered without specifying Hz, the 5520A automatically switches back to dc (or enter "0" Hz to move back to volts dc).

21 **Multiplier Keys**

Select output value multipliers. Some keys have a second function if the SHIFT key is pressed just before the multiplier key. For example, if you enter 33, then SHIFT, then , then , then ENTER, the 5520A output value is 33 pF. The multiplier keys are as follows:

-  milli (10^{-3} or 0.001) or micro (10^{-6} or 0.000001)
-  kilo (10^3 or 1,000) or nano (10^{-9} or 0.000000001)
-  mega (10^6 or 1,000,000) or pico (10^{-12} or 0.000000000001)

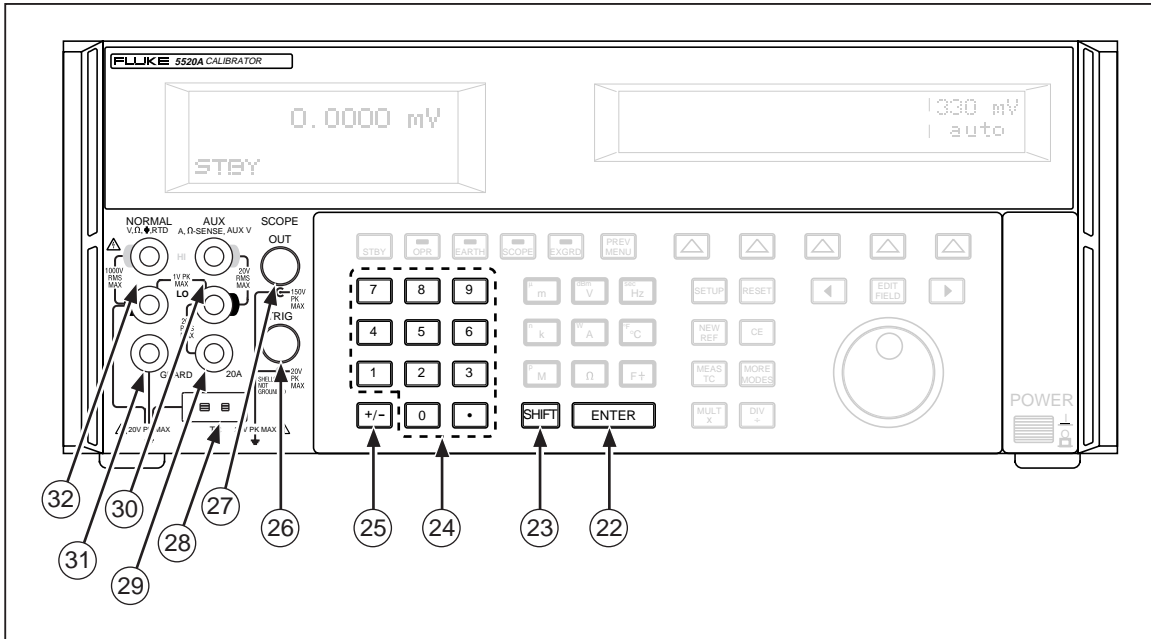

nn011f.eps

Figure 3-1. Front Panel View (cont)

Table 3-1. Front Panel Features (cont)

22	ENTER	<p>The ENTER key loads a newly entered output value shown on the Control Display into the 5520A, which appears on the Output Display. The new value can come from the numeric keypad. If you press ENTER without identifying the units for the entry, in most cases the 5520A keeps the units that were last used. This allows you, for example, to enter 1 mV, and then later enter 10 to obtain 10 V. (The "V" units were saved from the last entry, but not the multiplier, "m".) In the Error (edit) mode, ENTER with no value restores the output to the value of the reference.</p>
23	SHIFT	<p>The SHIFT key selects alternate functions of the units keys and alternate multipliers of the multiplier keys. These alternate selections are labeled with small letters in the upper left hand corner of the keys.</p>
24	Numeric Keypad	<p>Used to enter the digits of the output amplitude and frequency. The proper sequence to enter a value is to press the digits of the output value, a multiplier key (if necessary), an output units key, then ENTER. For example, to obtain an output of 20 mV, you would press the following sequence of keys: 2 0 μ m dBm V. Press OPR to enable the output. Pressing a digit key once the entry field is full, and pressing the decimal point key more than once in a single number will sound the beeper.</p>
25	+/-	<p>The +/- (Polarity) key changes the polarity of the output for dc voltage or dc current functions. Press the +/- key then ENTER to toggle the output polarity.</p>
26	SCOPE TRIG	<p>The SCOPE TRIG (Scope Trigger) BNC connector is used to trigger the oscilloscope during oscilloscope calibration. This is active only when an oscilloscope option is installed.</p>
27	SCOPE OUT	<p>The SCOPE OUT (Oscilloscope) BNC connector is used for outputs during oscilloscope calibration. This is active only when an oscilloscope calibration option is installed.</p>

- ②⑧ The **TC** (Thermocouple) minijack is used for thermocouple simulation during thermometer calibration, and thermocouple measurements. You must use the correct thermocouple wire and plug when using this connector. For example, if simulating a type K thermocouple, use type K thermocouple wire and type K plug for making connections.
- ②⑨ The **20A** terminal is the source of current output when the 20 A range is selected (3 A - 20 A).
- ③⑩ The **AUX (Auxiliary Output)** terminals are used for ac and dc current outputs, the second voltage output in dual voltage modes, and ohms sense for 2-wire and 4-wire compensated resistance and capacitance measurements, and RTD simulation.
- ③① The **GUARD** terminal is always connected internally to the internal guard shield. This shield is tied to the NORMAL LO signal ground inside the Calibrator unless the  key is pressed so that its indicator is lit.
- ③② The **NORMAL** (Normal Output) terminals are used for ac and dc voltage, ohms and capacitance sourcing, and Resistance Temperature Detector (RTD) simulation.

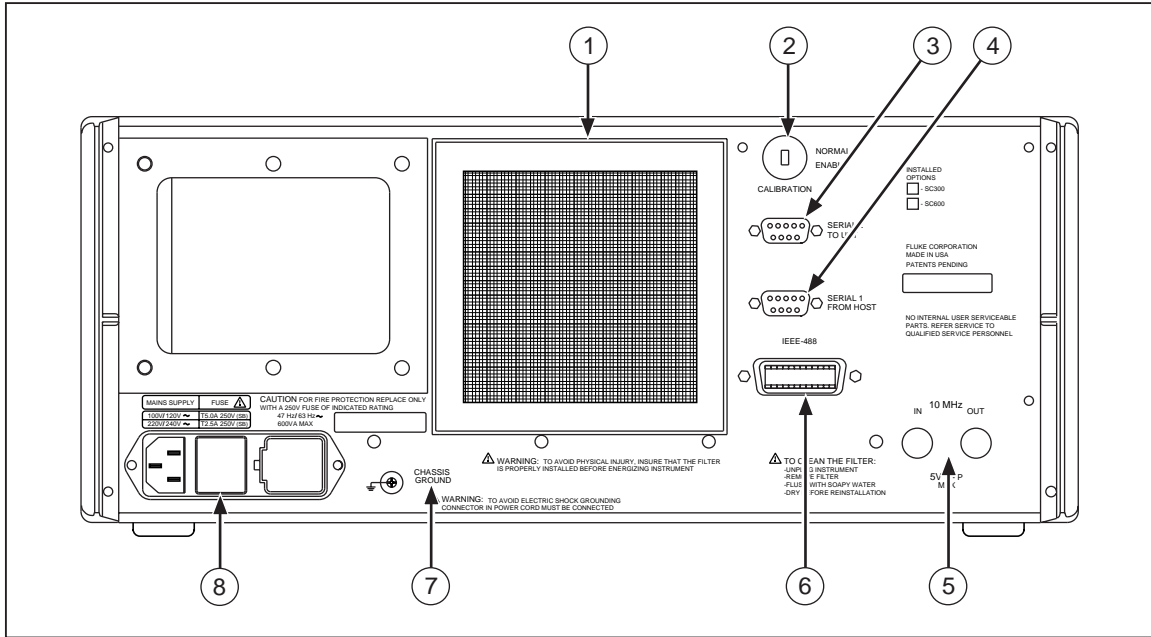

nn012f.eps

Figure 3-2. Rear Panel View

Table 3-2. Rear Panel Features

①	The Fan Filter covers the air intake to keep dust and debris out of the chassis air baffles. The 5520A fan provides a constant cooling air flow throughout the chassis. Instructions for fan filter maintenance are in Chapter 7, Maintenance.
②	The CALIBRATION NORMAL/ENABLE slide switch is used to write enable and disable the nonvolatile memory that stores calibration constants. Switching to ENABLE allows changes to be written into memory, and switching to NORMAL protects data in memory from being overwritten. The switch is recessed to allow it to be covered with a calibration sticker to guarantee calibration integrity.
③	The SERIAL 2 TO UUT connector is used for transmitting and receiving RS-232 serial data between the 5520A and a Unit Under Test (UUT) or a Fluke 700 Series pressure module. Chapter 6, “Remote Commands” describes how to use the RS-232 serial interface for UUT communications. Chapter 4 described how to measure pressure.
④	The SERIAL 1 FROM HOST connector is used for remote control of the 5520A and for transmitting internal-constant RS-232 serial data to a printer, monitor, or host computer. Chapter 5, “Remote Operation” describes how to use the RS-232 serial interface for remote control.
⑤	The 10 MHz IN BNC connector is for applying an optional external clock signal to the 5520A. This replaces the normal internal 10 MHz clock signal in the 5520A. Frequency accuracy of the 5520A is governed by the frequency accuracy of the clock signal internal or external. The 10 MHz OUT BNC connector passes the internal or external 10 MHz clock signal to another 5520A to synchronize one or more slave 5520As to a master 5520A.
⑥	The IEEE-488 connector is a standard parallel interface for operating the 5520A in remote control as a Talker/Listener on the IEEE-488 bus. Refer to Chapter 5, “Remote Operation” for bus connection and remote programming instructions.

⑦

⚠ Warning

To avoid shock hazard, connect the factory supplied three-conductor line power cord to a properly grounded power outlet. Do not use a two-conductor adapter or extension cord; this will break the protective ground connection.

Use the rear-panel CHASSIS GROUND terminal for a protective grounding wire if there is any question about the effectiveness of instrument earth grounding through the line power cord ground wire.

The **CHASSIS GROUND** terminal is internally grounded to the chassis. If the 5520A is the location of the ground reference point in a system, this binding post can be used for connecting other instruments to earth ground. Refer to “Connecting the Calibrator to a UUT” in Chapter 4, “Front Panel Operation” for details.

⑧

The **AC Power Input Module** provides a grounded three-prong connector that accepts the line power cord, a switch mechanism to select the operating line voltage, and a line power fuse. See Chapter 2, “Preparing for Operation” for information on selecting the operating line voltage, and fuse rating and replacement information.

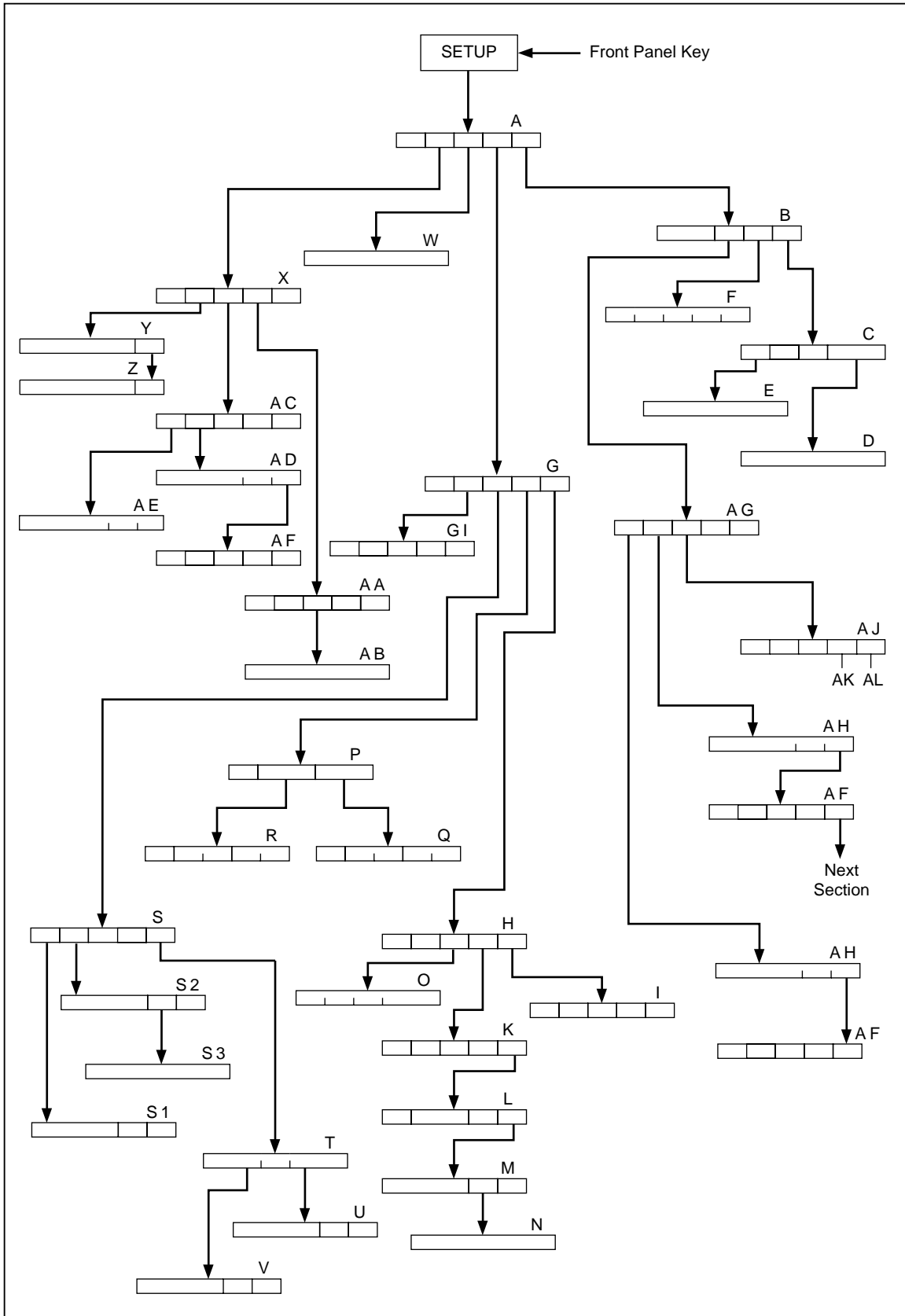

nn013f.eps

Figure 3-3. SETUP Softkey Menu Tree

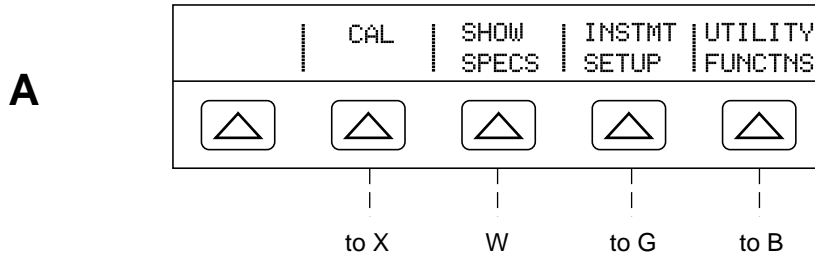

SHOW SPECS is an online summary of the programmed output specifications.

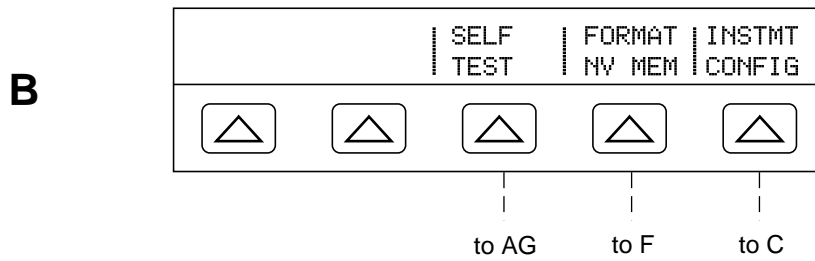

If self test does not pass, error codes are displayed. (See chapter 7, "Maintenance")

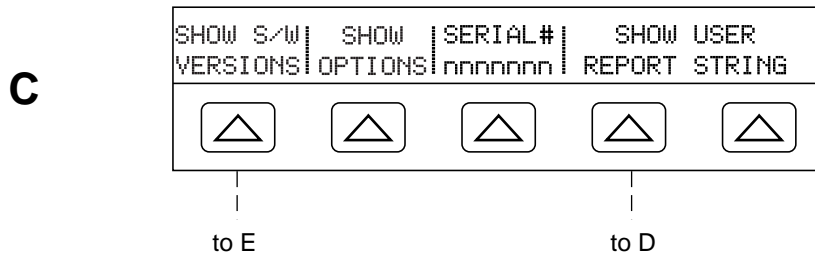

SERIAL # displays the serial number of the instrument. When corresponding with the factory, always include the serial number of the instrument.

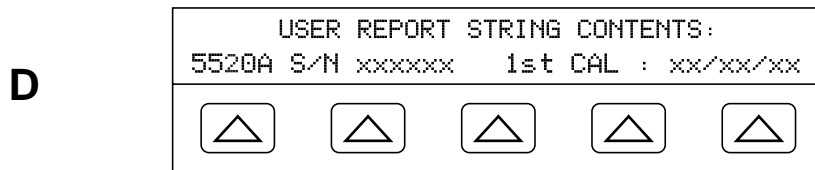

USER REPORT STRING CONTENTS refer to a string of characters entered by the user for reporting purposes.

Figure 3-4. SETUP Softkey Menu Displays

nn014f.eps

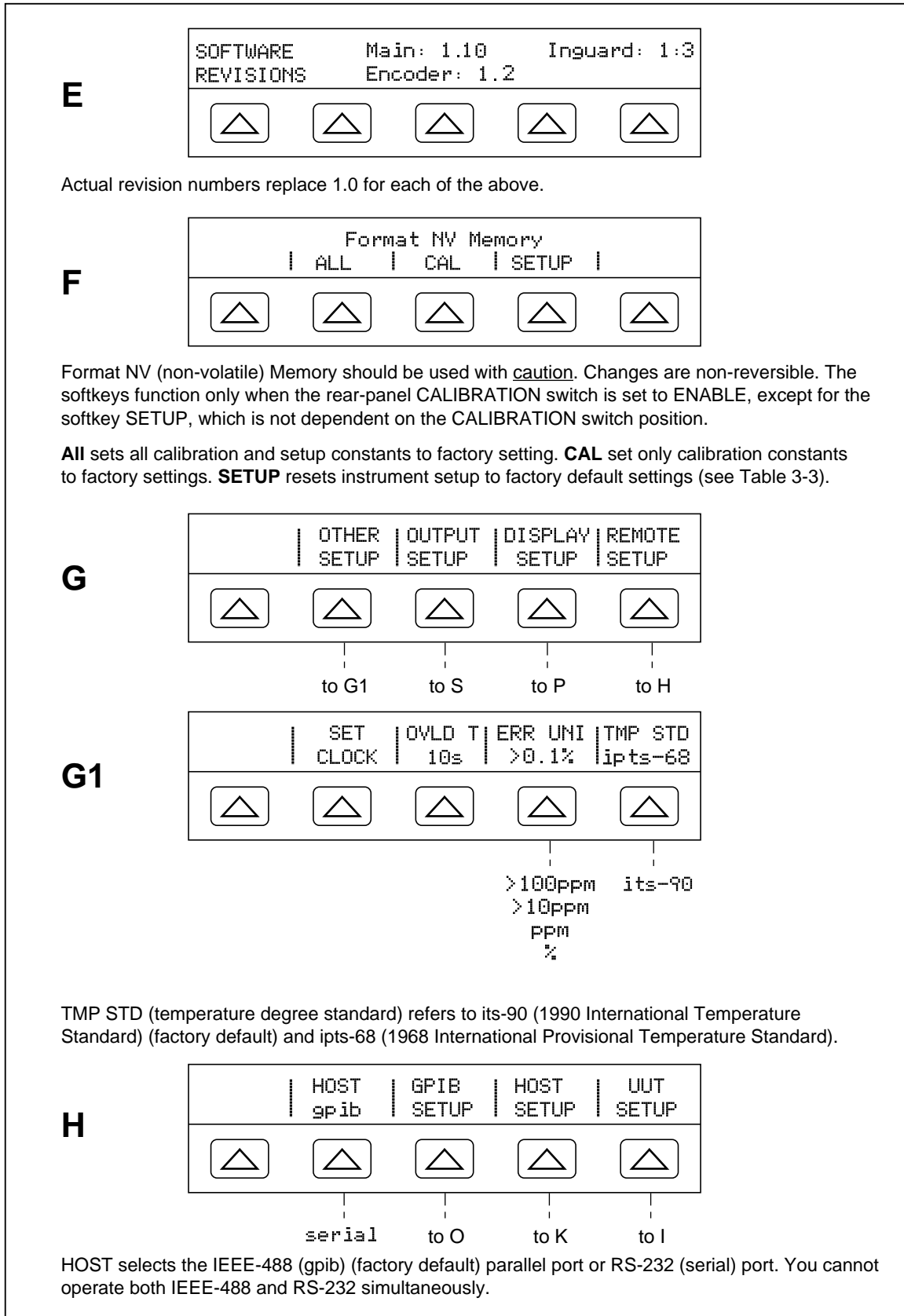

Figure 3-4. SETUP Softkey Menu Displays (cont)

nn015f.eps

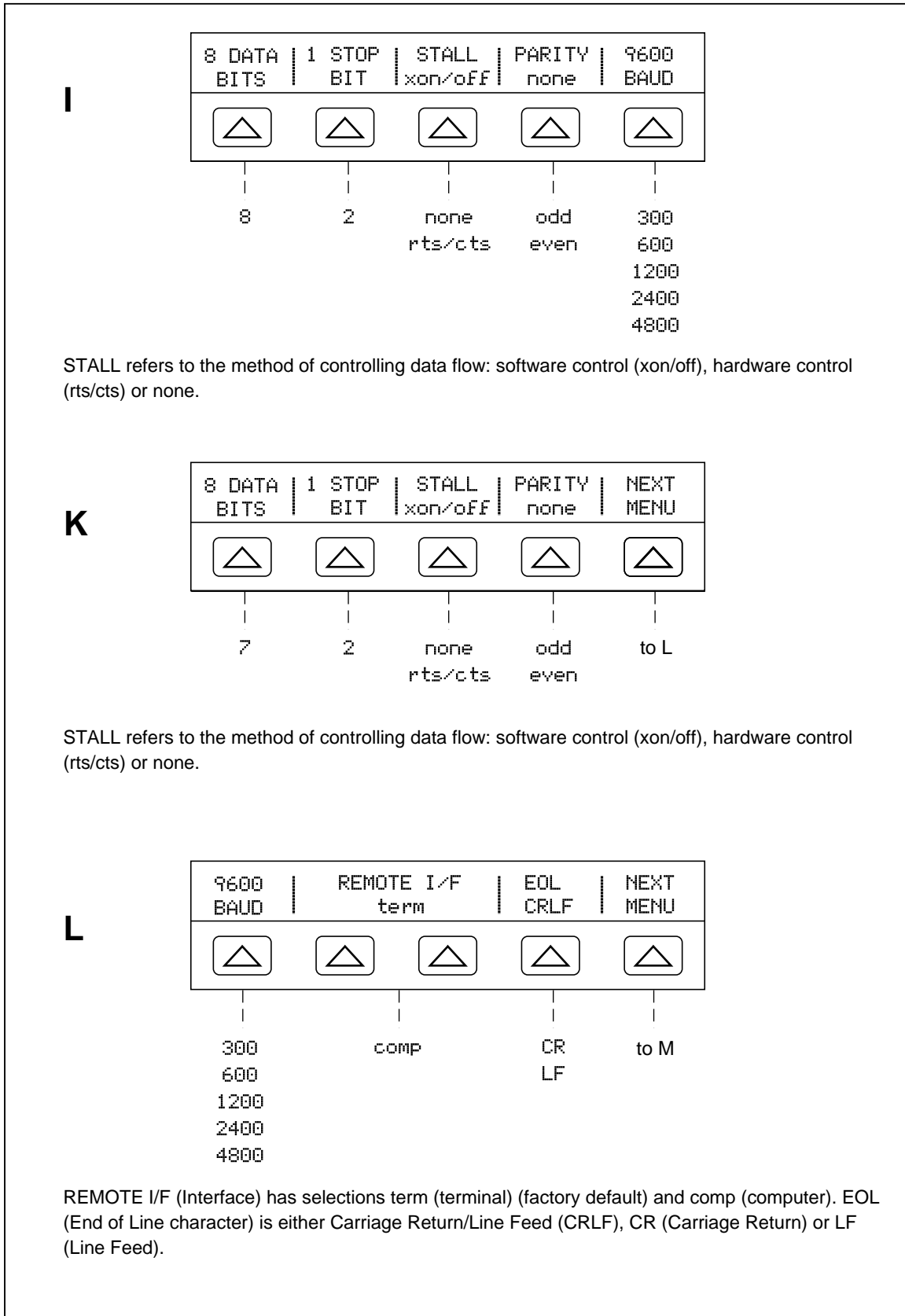

Figure 3-4. SETUP Softkey Menu Displays (cont)

nn016f.eps

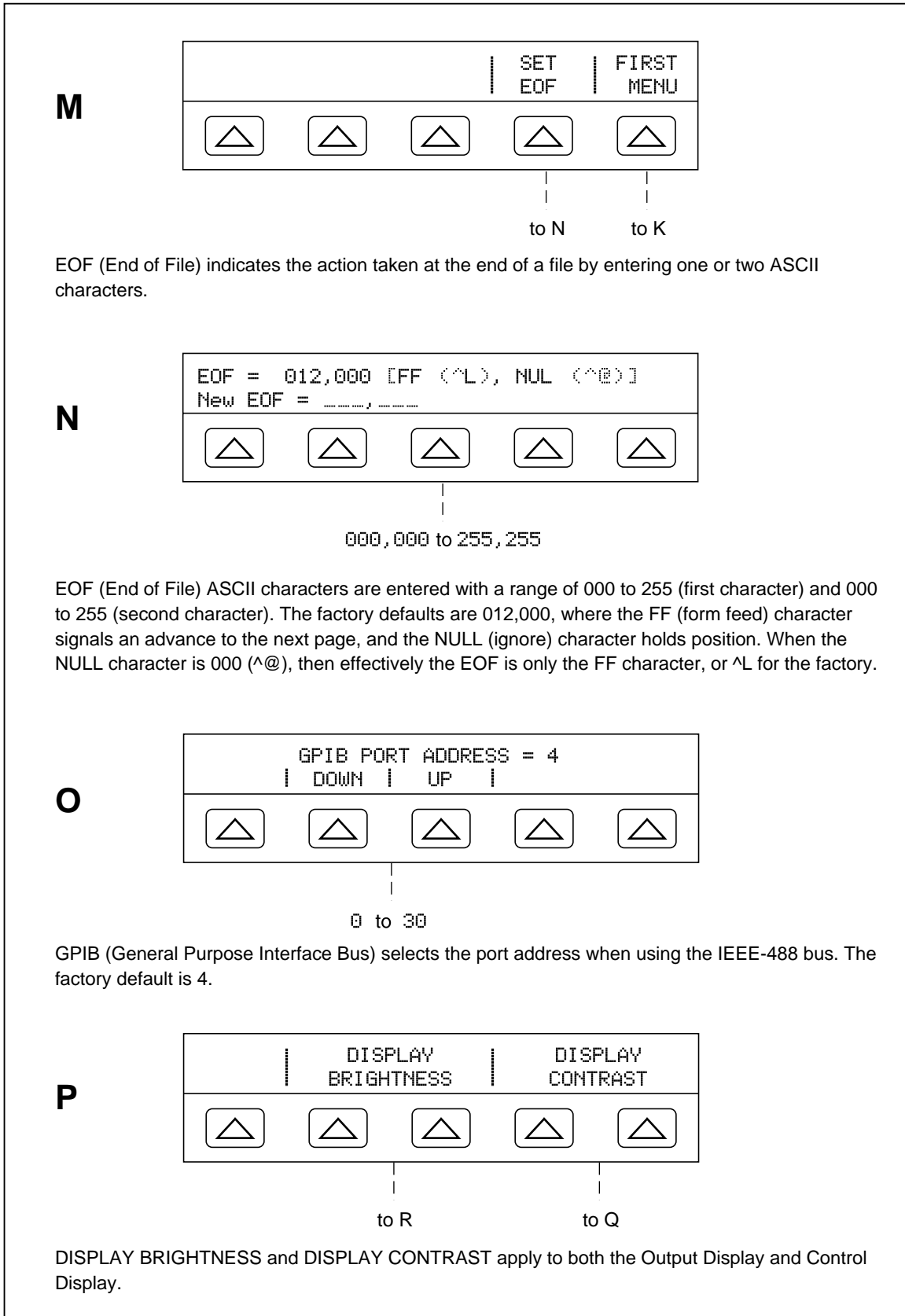

Figure 3-4. SETUP Softkey Menu Displays (cont)

nn017f.eps

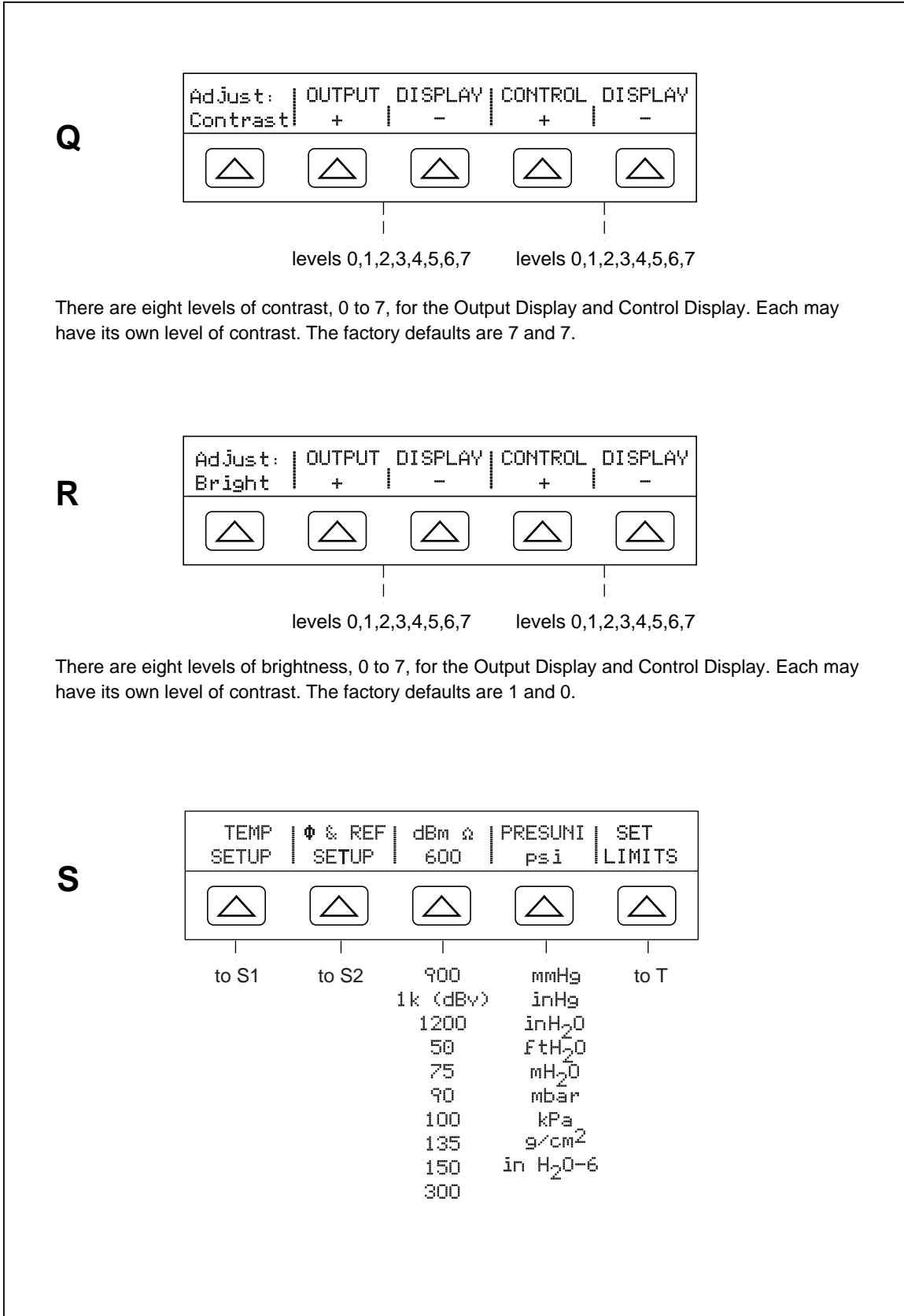
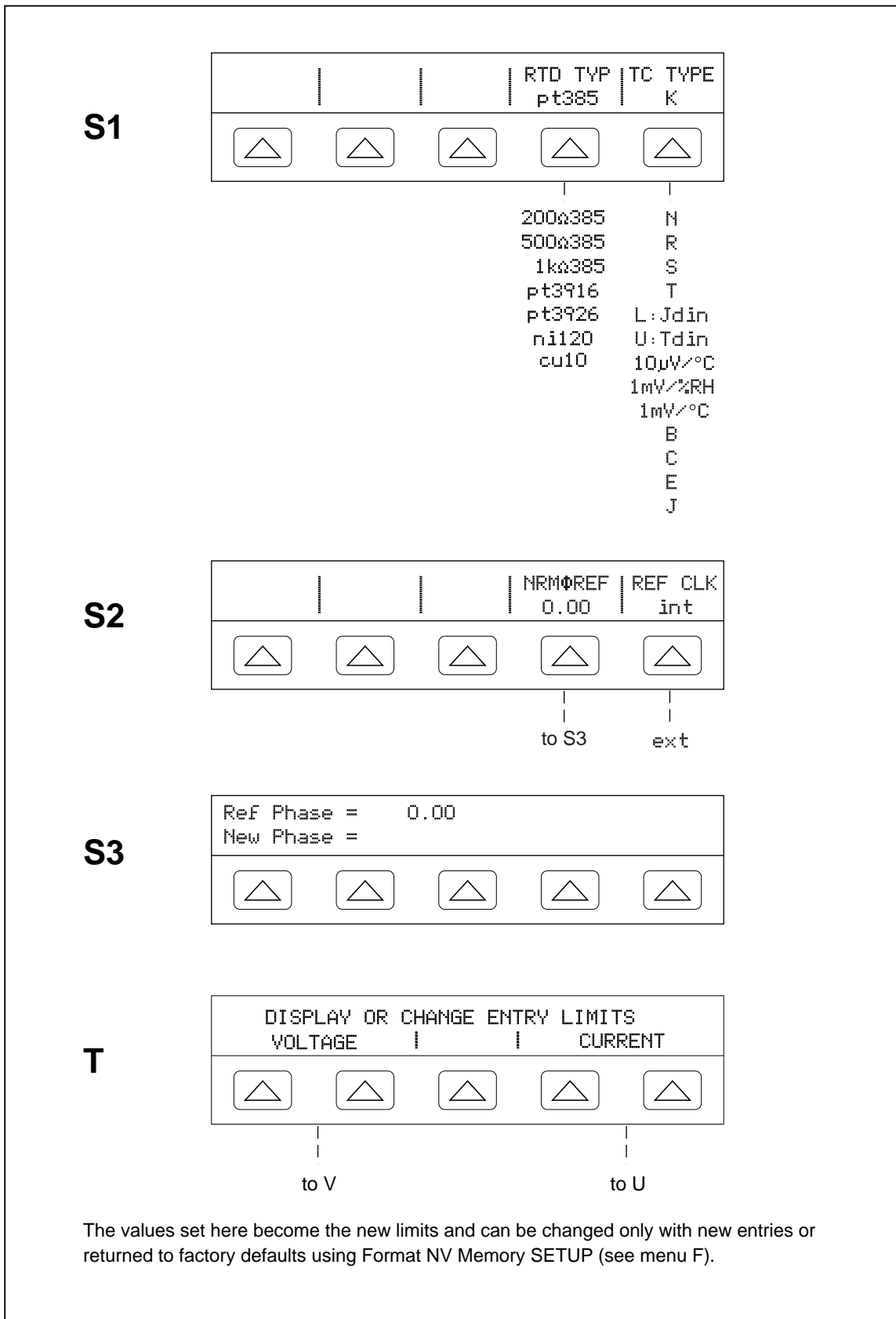

Figure 3-4. SETUP Softkey Menu Displays (cont)

nn018f.eps



nn019f.eps

Figure 3-4. SETUP Softkey Menu Displays (cont)

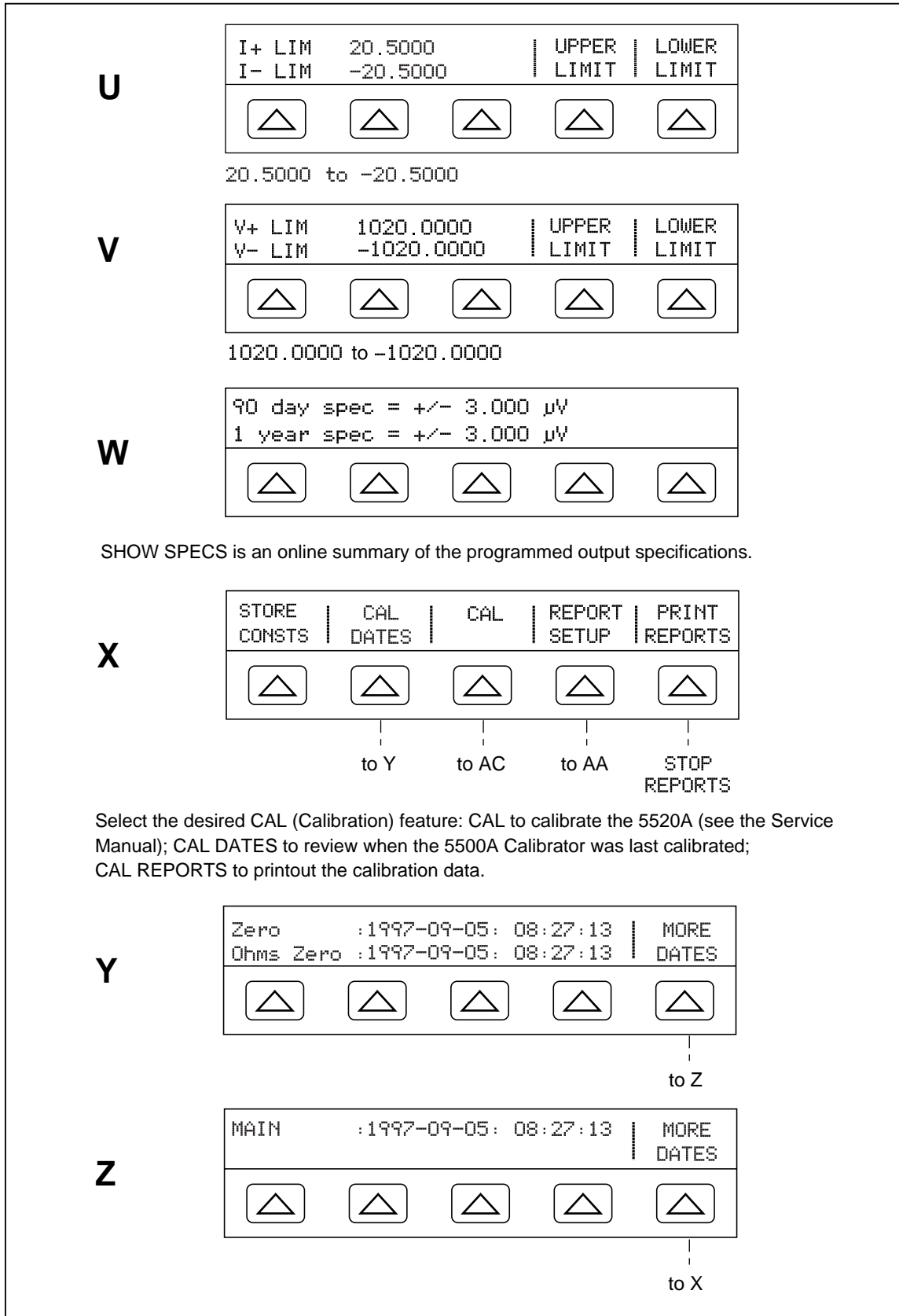

Figure 3-4. SETUP Softkey Menu Displays (cont)

nn020f.eps

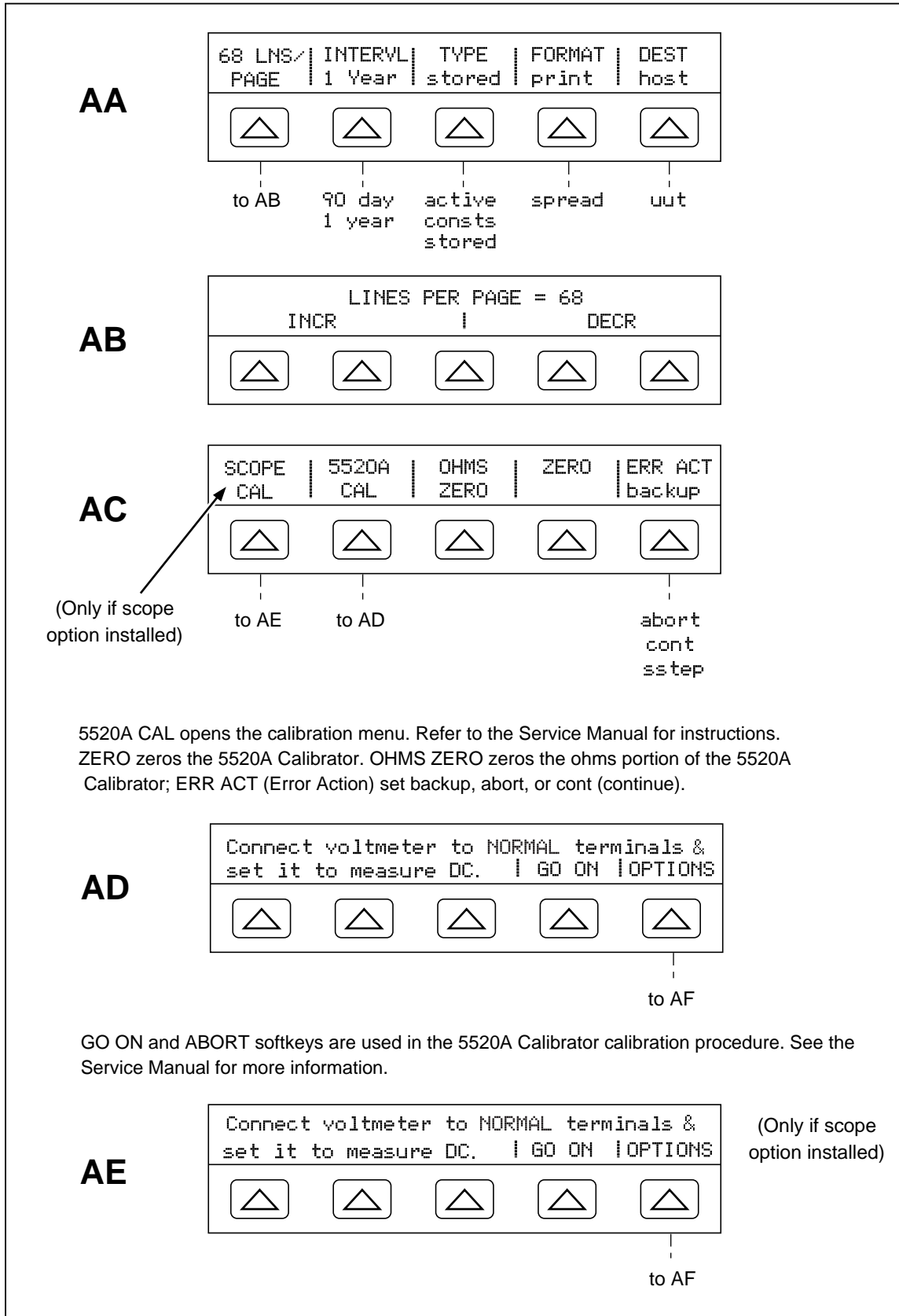

Figure 3-4. SETUP Softkey Menu Displays (cont)

nn021f.eps

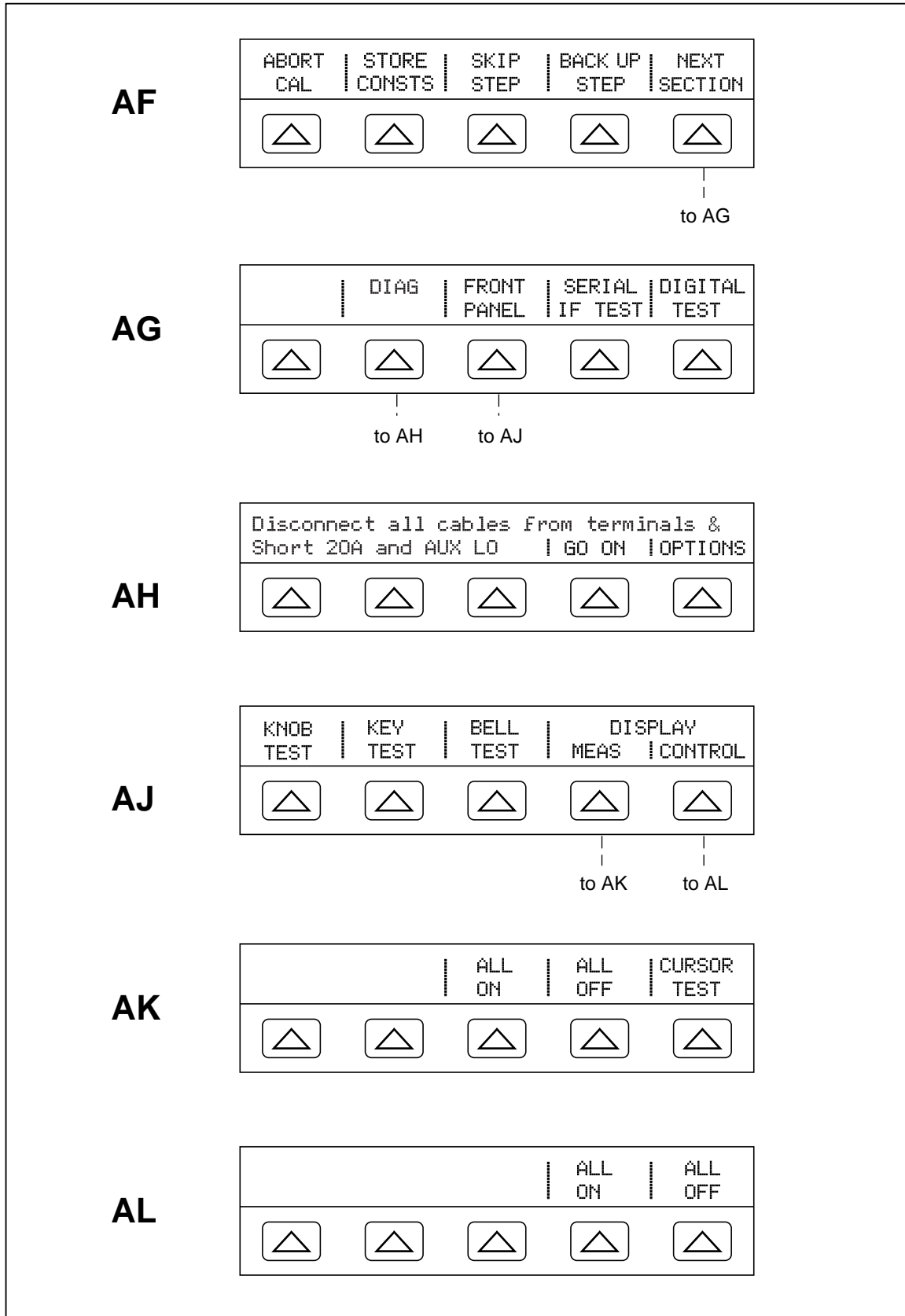

Figure 3-4. SETUP Softkey Menu Displays (cont)

nn022f.eps

Table 3-3. Factory Defaults for SETUP Menus Power-Up Defaults

Parameter	Setting	SETUP Menu in Figure 3-4.
User report string (*PUD string)	Cleared.	D
Error units	> 0.1%	G1
SC-600 option overload test safety timeout	10 s	G1
Temperature standard	its-90	G1
Host interface	gpib (IEEE-488)	G1
UUT serial interface	8 bits, 1 stop bit, xon/xoff, parity none, 9600 baud	I
Host serial interface	term, 8 bits, 1 stop bit, xon/xoff, parity none, 9600 baud, CRLF, 012,000	K, L, M, N
GPIB Port Address	4	O
Display brightness (Note)	level 1,0	P
Display contrast (Note)	level 7,7	P
dBm impedance	600 Ω	S
Pressure units	psi	S
RTD type	pt385	S1
Thermocouple type	K	S1
Phase reference	0.00°	S3
10 MHz reference clock	internal	S2
Current limits	± 20.5 A	U
Voltage limits	± 1020 V	V

Note: Output Display and Control Display, respectively. There are 8 levels: 0,1,2,3,4,5,6,7.

Chapter 4

Front Panel Operation

Contents		Page
4-1.	Introduction.....	4-3
4-2.	Turning on the Calibrator	4-3
4-3.	Warming up the Calibrator	4-4
4-4.	Using the Softkeys	4-4
4-5.	Using the Setup Menu	4-4
4-6.	Using the Instrument Setup Menu	4-5
4-7.	Utility Functions Menu	4-5
4-8.	Using the Format EEPROM Menu	4-6
4-9.	Resetting the Calibrator	4-6
4-10.	Zeroing the Calibrator.....	4-6
4-11.	Using the Operate and Standby Modes	4-8
4-12.	Connecting the Calibrator to a UUT.....	4-9
4-13.	Recommended Cable and Connector Types.....	4-9
4-14.	When to Use EARTH and EXGRD	4-10
4-15.	Earth	4-10
4-16.	External Guard	4-10
4-17.	Four-Wire versus Two-Wire Connections	4-11
4-18.	Cable Connection Instructions	4-12
4-19.	RMS Versus p-p Amplitude	4-17
4-20.	Auto Range Versus Locked Range.....	4-18
4-21.	Setting the Output	4-18
4-22.	Setting DC Voltage Output	4-19
4-23.	Setting AC Voltage Output	4-20
4-24.	Setting DC Current Output.....	4-23
4-25.	Setting AC Current Output.....	4-24
4-26.	Setting DC Power Output.....	4-26
4-27.	Setting AC Power Output.....	4-28
4-28.	Setting a Dual DC Voltage Output.....	4-32
4-29.	Setting a Dual AC Voltage Output.....	4-34
4-30.	Setting Resistance Output	4-37
4-31.	Setting Capacitance Output	4-38
4-32.	Setting Temperature Simulation (Thermocouple).....	4-40
4-33.	Setting Temperature Simulation (RTD).....	4-42
4-34.	Measuring Thermocouple Temperatures.....	4-45
4-35.	Waveform Types.....	4-46

4-36.	Sine Wave.....	4-47
4-37.	Triangle Wave	4-47
4-38.	Square Wave.....	4-47
4-39.	Truncated Sine Wave	4-48
4-40.	Setting Harmonics.....	4-48
4-41.	Adjusting the Phase	4-49
4-42.	Entering a Phase Angle	4-50
4-43.	Entering a Power Factor	4-51
4-44.	Entering a DC Offset	4-52
4-45.	Editing and Error Output Settings	4-53
4-46.	Editing the Output Setting.....	4-53
4-47.	Displaying the UUT Error.....	4-54
4-48.	Using Multiply and Divide.....	4-54
4-49.	Setting Output Limits	4-55
4-50.	Setting Voltage and Current Limits.....	4-55
4-51.	Measuring Pressure.....	4-56
4-52.	Synchronizing the Calibrator using 10 MHz IN/OUT.....	4-58
4-53.	Using an External 10 MHz Clock	4-58
4-54.	Sourcing AC Current with Parallel-Connected 5520As.....	4-58
4-55.	Three-Phase Power Calibration.....	4-60
4-56.	Sample Applications.....	4-61
4-57.	Calibrating an 80 Series Handheld Multimeter.....	4-61
4-58.	Cables.....	4-61
4-59.	EARTH Connection.....	4-61
4-60.	Testing the Meter	4-62
4-61.	Calibrating the Meter	4-66
4-62.	Testing a Model 41 Power Harmonics Analyzer	4-67
4-63.	Testing Watts, VA, VAR Performance.....	4-67
4-64.	Testing Harmonics Volts Performance	4-69
4-65.	Testing Harmonics Amps Performance	4-71
4-66.	Calibrating a Fluke 51 Thermometer	4-71
4-67.	Testing the Thermometer	4-72
4-68.	Calibrating the Thermometer.....	4-73

4-1. Introduction

⚠ Warning

The 5520A Calibrator is capable of supplying lethal voltages. To avoid shock hazard, do not make connections to the output terminals when any voltage is present. Placing the instrument in standby may not be enough to avoid shock hazard, since the **OPR** key could be pressed accidentally. Press the **RESET** key and verify that the 5520A Calibrator is in standby before making connections to the output terminals.

This chapter presents instructions for operating the 5520A Calibrator from the front panel. For a description of front panel controls, displays, and terminals, see Chapter 3, “Features.”

4-2. Turning on the Calibrator

⚠ Warning

To avoid electric shock, make sure the 5520A Calibrator is safely grounded as described in Chapter 2.

Caution

Before turning the 5520A Calibrator on, make sure that the line voltage selection is set properly. Refer to “Selecting Line Voltage” in Chapter 2 to check the line voltage setting.

When the 5520A Calibrator is powered, the initial display is “Starting Up...” (see below) and it completes a self-test routine. If a self-test fails, the Control Display identifies an error code. For a description of error codes, see Chapter 7, “Maintenance.”

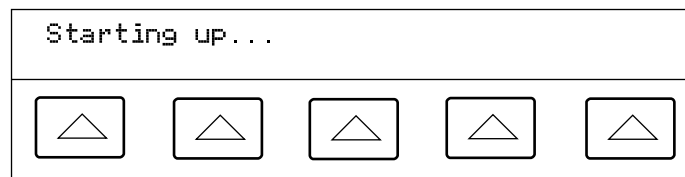

NN062F.EPS

After self-test, the control display shows the reset condition (below).

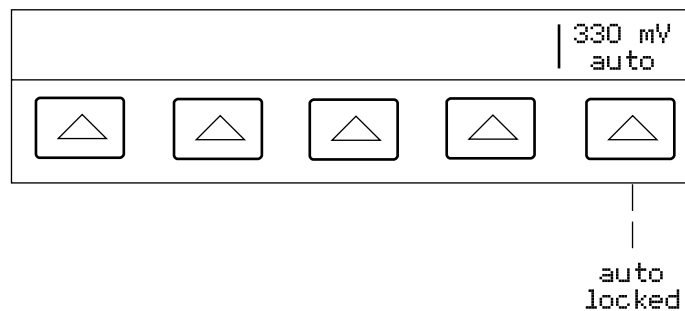

nn063f.eps



For a discussion of the softkey selection shown above (auto/locked), see “Auto Range Versus Locked Range” later in this chapter.

4-3. Warming up the Calibrator

When you turn on the 5520A, allow a warm-up period of at least 30 minutes for the internal components to stabilize. This ensures that the calibrator meets or exceeds the specifications listed in Chapter 1.

If you turn the 5520A Calibrator off after warm-up and then on again, allow a warm-up period of at least twice the length of time it was turned off (maximum of 30 minutes). For example, if the calibrator is turned off for 10 minutes and then on again, allow a warm-up period of at least 20 minutes.

4-4. Using the Softkeys

The five keys just to the right of the  (Previous Menu) key are called softkeys. Softkey key functions are based on the label that appears directly above the key in the Control Display. Pressing a softkey either changes a value or causes a submenu with new selections to appear on the Control Display. Softkey menus are arranged in varying levels, as described in “Softkey Menu Tree” in Chapter 3. You can move backwards to previous menu selections by repeatedly pressing . Although pressing R will also return you to the top level menu, it will also reset all volatile settings and return the 5520A Calibrator to 0 V dc in the standby mode. Use the  key as your main navigating tool for moving around the menu levels.

4-5. Using the Setup Menu

Press the front panel  key for access to various operations and changeable parameters. Most parameters are nonvolatile, meaning they will be saved during reset or when power is turned off. Chapter 3 shows a map of the menu tree, lists the parameters, and has a table of factory default settings.

When you press  from the power-up state, the display changes as follows:

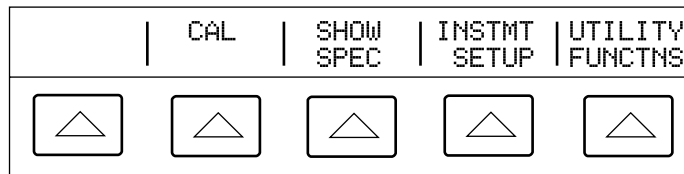

This is the primary instrument setup menu. The list below describes submenus available through each softkey and tells you where you can find further information in the manuals. nn064f.eps

- CAL (Calibration) Opens the calibration menu. You use softkeys in this menu to view the calibration dates, print a calibration report, and perform 5520A calibration, and to run the Zero calibration routine. Zero calibration is described later in this chapter.
- SHOW SPECS (Show Specifications) Displays published 5520A Calibrator specifications for the output value that is currently selected.
- INSTMT SETUP (Instrument Setup) Lets you change the power-up or reset default setting for various instrument parameters. Many of the same parameters in this menu can be changed during operation, but the changes you make during operation are volatile. Changing them here makes them nonvolatile. To restore factory defaults, use the Format NV Memory menu under the UTILITY FUNCTNS menu.

- **UTILITY FUNCTNS (Utility Functions)** Allows you to initiate self-tests, format the nonvolatile memory (restore factory default settings), and review the instrument configuration software versions and user report string. These features are explained under “Utilities Function Menu” later in this chapter.

4-6. Using the Instrument Setup Menu

The softkeys in the instrument setup menu (accessed by pressing INSTMT SETUP softkey in the Setup Menu) are shown below.

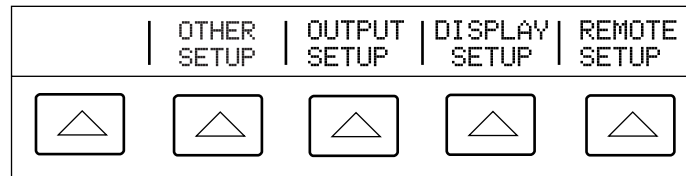

nn065f.eps

The list below describes submenus accessed by each softkey.

- **OTHER SETUP** Opens a menu that lets you toggle the degree reference between the 1968 International Provisional Temperature Standard (ipts-68) and the 1990 International Temperature Standard (its-90) (factory default). This is also where you set the clock, and set the power-up and reset defaults for the SC-600 Oscilloscope Calibration Options’s Overload test safety timeout function (OVLD T), and displayed error units. For Main software version 1.9 or greater, this is where you configure the instrument for best operation with a 50 Hz line frequency.
- **OUTPUT SETUP** Opens a menu to change the power-up and reset defaults for current and voltage output limits, default thermocouple and RTD types, set the phase reference, internal or external phase reference source, impedance for dBm display, and pressure units.
- **DISPLAY SETUP** Opens submenus to set the brightness and contrast of both the Control Display and Output Display.
- **REMOTE SETUP** Allows you to change the configuration of the two RS-232 ports, SERIAL 1 FROM HOST and SERIAL 2 TO UUT, and IEEE-488 General Purpose Interface Bus (GPIB). (See Chapter 5, “Remote Operation” for more information.)

4-7. Utility Functions Menu

The Setup Menu softkey labeled UTILITY FUNCTNS (Utility Functions) provides access to Self Test, Format Nonvolatile Memory, and Instrument Configuration.

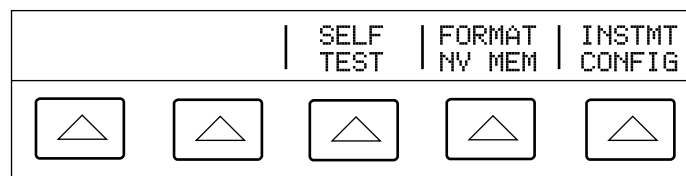

nn066f.eps

- **SELF TEST** This softkey opens a menu with calibrator self-test choices.
- **FORMAT NV MEM (Format Nonvolatile Memory)** Opens a menu to restore all or part of the data in the nonvolatile memory (EEPROM) to factory defaults.
- **INSTMT CONFIG (Instrument Configuration)** Allows you to view the versions of software installed in the calibrator as well as the user-entered report string.

4-8. Using the Format EEPROM Menu

Caution

Use with extreme care. The format nonvolatile memory menu softkeys permanently erase calibration constants. Pressing ALL or CAL invalidates the state of calibration of the 5520A.

Pressing FORMAT NV MEM in the utility functions menu opens the following:



nn067f.eps

All the softkeys in this menu require the rear panel CALIBRATION switch to be in the ENABLE position. The nonvolatile memory contains calibration constants and dates, setup parameters, and the user report string. In the case of calibration constants, factory defaults are the same for all Calibrators. They are not the calibration constants obtained when the 5520A was calibrated by the factory before shipment. The softkeys are:

- ALL replaces the entire contents of the EEPROM with factory defaults. This would be used by service personnel after replacing the EEPROM, for example. It is not required in normal use.
- CAL replaces all calibration constants with factory defaults but leaves all the setup parameters unchanged. This is also not required in normal use.
- SETUP replaces the setup parameters with factory defaults (Table 3-3) but leaves the state of calibration unchanged. You do not have to break the calibration sticker for this operation. Remote commands can also change the setup parameters. (See these commands in Chapter 6: SRQSTR, SPLSTR, *PUD, SP_SET, UUT_SET, TEMP_STD, DATEFMT, PRES_UNIT_D, RTD_TYPE_D, TC_TYPE_D, LIMIT.)

4-9. Resetting the Calibrator

At any time during front panel operation (not remote operation), you can return the 5520A Calibrator to the power-up state by pressing R, except after an error message, which is cleared by pressing a blue softkey. Pressing the R key does the following:

- Returns the calibrator to the power-up state: 0 V dc, standby, 330 mV range and all OUTPUT SETUP menus set to their most recent default values.
- Clears the stored values for limits and error mode reference.

4-10. Zeroing the Calibrator

Zeroing recalibrates internal circuitry, most notably dc offsets in all ranges of operation. To meet the specifications in Chapter 1, zeroing is required every seven days, or when the 5520A Calibrator ambient temperature changes by more than 5°C. The tightest ohms specifications are maintained with a zero cal every 12 hours within $\pm 1^\circ\text{C}$ of use. The Calibrator displays a message when it is time to zero the calibrator. Zeroing is particularly important when your calibration workload has 1 m Ω and 1 mV resolution, and when there has been a significant temperature change in the 5520A Calibrator work

environment. There are two zeroing functions: total instrument zero (ZERO) and ohms-only zero (OHMS ZERO).

Complete the following procedure to zero the calibrator. (Note: The 5520A Calibrator rear-panel CALIBRATION switch does not have to be enabled for this procedure.)

1. Turn on the Calibrator and allow a warm-up period of at least 30 minutes.
2. Press the **RESET** key.
3. Press the **SETUP** key, opening the setup menu (below).

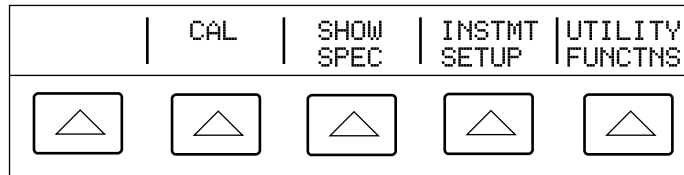

5. Press the CAL softkey, opening the calibration information menu (below).

nn068f.eps

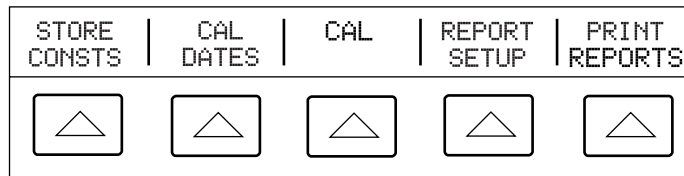

6. Press the CAL softkey, opening the calibration activity menu (below). SCOPE CAL appears as an option if it is installed.

nn069f.eps

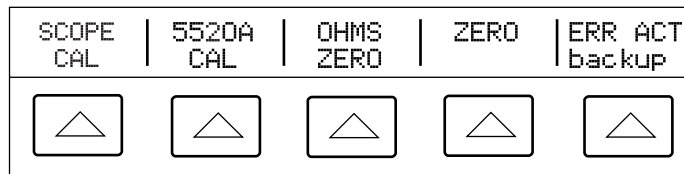

nn070f.eps

7. Press the ZERO softkey to totally zero the 5520A Calibrator; press the OHMS ZERO softkey to zero only the ohms function. After the zeroing routine is complete (several minutes), press the **RESET** key to reset the calibrator.

4-11. Using the Operate and Standby Modes

When the OPERATE annunciator is lit and OPR is displayed, the output value and function shown on the Output Display is active at the selected terminals. When STBY is displayed in the Output Display, all calibrator outputs are open-circuited except for the front panel thermocouple (TC) terminals. To enable the operate mode, press **OPR**. To place the calibrator in standby, press **SETUP**.

If the calibrator is operating and any of the following events occur, the calibrator automatically goes into the standby mode:

- The **RESET** key is pressed.
- A voltage ≥ 33 V is selected when the previous output voltage was less than 33 V.
- Output function is changed between ac or dc voltage when the output voltage is ≥ 33 V; ac or dc current; temperature and any other function; resistance and any other function; capacitance and any other function.
- A p-p voltage output (square wave, triangle wave, or truncated sine wave) changes to rms voltage output ≥ 33 V (sine wave). For example, if a p-p output of 40 V is changed to rms output of 40 V by changing the wave form using the WAVE softkey, the calibrator goes into the standby mode.
- The output location for current is changed from AUX to 20 A, or vice versa.
- An overload condition is detected.

4-12. Connecting the Calibrator to a UUT

⚠ Warning

The 5520A Calibrator is capable of supplying lethal voltages. Do not make connections to the output terminals when a voltage is present. Placing the instrument in standby may not be enough to avoid shock hazard, since the **OPR key could be pressed accidentally. Press reset and verify that the STBY annunciator appears on the Control Display before making connections to the output terminals.**

The outputs labeled NORMAL (HI and LO) are used to source voltages, resistances, capacitance and simulate resistance temperature detector (RTD) outputs. The LO terminal connects to the analog signal ground inside the guard shield. This signal line may or may not be tied to the guard shield and/or to chassis ground, depending on the settings of the **EARTH** and **EXGRD** keys. See “When to Use EARTH and EXGRD” on the next page for an explanation of these internal connections.

The outputs labeled AUX (HI and LO) source current and low voltages in the dual voltage function. These outputs are also used for four-wire or remote sensing in the resistance, capacitance and RTD functions.

When an oscilloscope calibration option is installed, the BNC connectors labeled SCOPE OUT and TRIG deliver signals for oscilloscope calibration.

The socket labeled TC is used to measure thermocouples and to generate simulated thermocouple outputs.

4-13. Recommended Cable and Connector Types

⚠ Warning

Using standard banana plugs on the calibrator output will expose lethal voltages when not completely inserted into a mating terminal.

To avoid electric shock, use only cables with correct voltage ratings.

Cables to the calibrator are connected to the NORMAL and AUX terminals. To avoid errors induced by thermal voltages (thermal emfs), use connectors and conductors made of copper or materials that generate small thermal emfs when joined to copper. Avoid using nickel-plated connectors. Optimum results can be obtained by using Fluke Model 5440A-7002 Low Thermal EMF Test Leads, which are constructed of well-insulated copper wire and tellurium copper connectors. (See Chapter 9, “Accessories.”)

4-14. When to Use EARTH and EXGRD

Figure 4-1 shows the internal connections made by the $\overline{\text{EARTH}}$ and $\overline{\text{EXGRD}}$ keys.

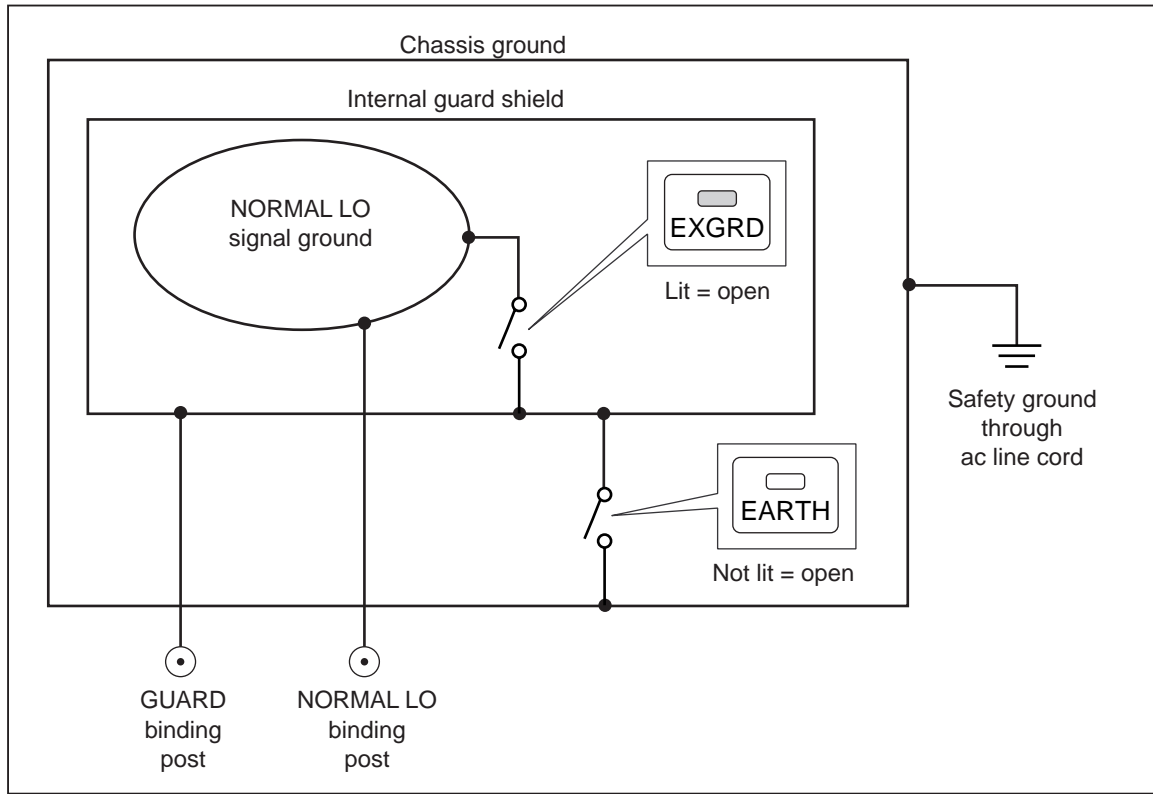

nn003f.eps

Figure 4-1. EARTH and EXGRD Internal Connections

4-15. Earth

The 5520A Calibrator front panel NORMAL LO terminal is normally isolated from earth (chassis) ground. When it is desired to make a connection between the NORMAL LO terminal and earth ground, press the $\overline{\text{EARTH}}$ key, lighting the key annunciator.

To avoid ground loops and noise you must have only one earth ground-to-LO terminal connection in the system. Usually you make all signal ground connections at the UUT and verify the $\overline{\text{EARTH}}$ annunciator is off. Generally, $\overline{\text{EARTH}}$ is on only for ac and dc volts where the UUT is isolated from earth ground. There must, however, be a safety ground for the 5520A. See “Connecting to Line Power” in Chapter 2. When enabled by the sourced output, a softkey LOs appears, which allows you to tie or open an internal connection between the NORMAL LO terminal and AUX LO terminal. When tied and $\overline{\text{EARTH}}$ is on, then both LO terminals are tied to chassis ground.

4-16. External Guard

The guard is an electrical shield, isolated from the chassis, that protects the analog circuitry. The guard provides a low-impedance path for common-mode noise and ground loop currents. There is normally an internal connection between the guard and the NORMAL LO terminal. By pressing the $\overline{\text{EXGRD}}$ key, you break this internal connection, which allows you to connect a lead from the GUARD terminal to earth ground on another instrument in an interconnected system. Use this external guard connection

whenever you are testing a UUT that has a grounded LO terminal. Remember to always maintain only one earth ground tie point in a system.

4-17. Four-Wire versus Two-Wire Connections

Four-wire and two-wire connections refer to methods of connecting the 5520A to the UUT to cancel out test lead resistance to assure the highest precision of the calibration output. Figures 4-2 through 4-4 illustrate the connection configurations for resistance; Figures 4-5 and 4-6 illustrate connection configurations for capacitance. The external sensing capability of the four- and two-wire compensated connections provides increased precision for resistance values below 110 k Ω and capacitance values 110 nF and above. Part of the setting up the calibrator output for resistance and capacitance includes selections for four-wire compensation (COMP 4-wire), two-wire compensation (COMP 2-wire) and two-wire no compensation (COMP off). (See “Setting Resistance Output” and “Setting Capacitance Output” later in this chapter.) Note that compensated connections for capacitance are to compensate for lead and internal resistances, not for lead and internal capacitances.

Four-Wire Connection The four-wire connection is typical for calibrating laboratory measurement equipment. Increased precision is provided for resistance values below 110 k Ω . For other values, the lead resistances do not degrade the calibration and the Calibrator changes the compensation to off (COMP off).

Two-Wire Compensation The two-wire connection is typical for calibrating precision handheld Digital Multimeters (DMMs) with a two-wire input. Increased precision is provided for resistance values below 110 k Ω and capacitance values 110 nF and above. For other values, the Calibrator changes the compensation to off (COMP off).

Compensation Off Compensation off is a typical connection for calibrating handheld analog meters or DMMs with a two-wire input. This connection is used for all values of resistance and capacitance and is usually selected when the analog meter or DMM level of accuracy does not require the additional precision. This is the default condition whenever an ohms or capacitance output is made, following an output that was not ohms or capacitance.

4-18. Cable Connection Instructions

Table 4-1 indicates a figure reference for each type of connection between a UUT and the 5520A Calibrator, referencing Figures 4-2 through 4-10.

When calibrating Resistance Temperature Detectors (RTDs) using the three-terminal connection shown in Figure 4-9, be sure the test leads have identical resistances to cancel any errors due to lead resistance. This can be accomplished, for example, by using three identical test lead lengths and identical connector styles.

When calibrating thermocouples, it is especially important to use the correct hookup wire and miniconnector between the Calibrator front panel TC terminal and the UUT. You must use thermocouple wire and miniconnectors that match the type of thermocouple. For example, if simulating a temperature output for a type K thermocouple, use type K thermocouple wire and type K miniplugs for the hookup.

To connect the calibrator to a UUT, proceed as follows:

1. If the calibrator is turned on, press **RESET** to remove the output from the calibrator terminals.
2. Make the connections to the UUT by selecting the appropriate figure from Table 4-1.

For capacitance outputs, null out stray capacitance by connecting the test leads to the UUT, routing them (but not connecting) to the 5520A Calibrator on a non-conductive surface. Null out the reading on the UUT using “rel,” “offset,” or “null,” whichever method applies, and then connect the test leads to the 5520A Calibrator.

Table 4-1. UUT Connections

5520A Output	Figure Reference
Resistance	4-2 Resistance - four-wire compensated 4-3 Resistance - two-wire compensated 4-4 Resistance - compensation off
Capacitance	4-5 Capacitance - two-wire compensated 4-6 Capacitance - compensation off
DC Voltage	4-7 DC Voltage/AC Voltage
AC Voltage	4-7 DC Voltage/AC Voltage
DC Current	4-8 DC Current/AC Current
AC Current	4-8 DC Current/AC Current
RTD Simulation	4-9 Temperature (RTD)
Thermocouple Simulation	4-10 Temperature (Thermocouple)
Note: See the discussion under “Four-Wire versus Two-Wire Connections” above.	

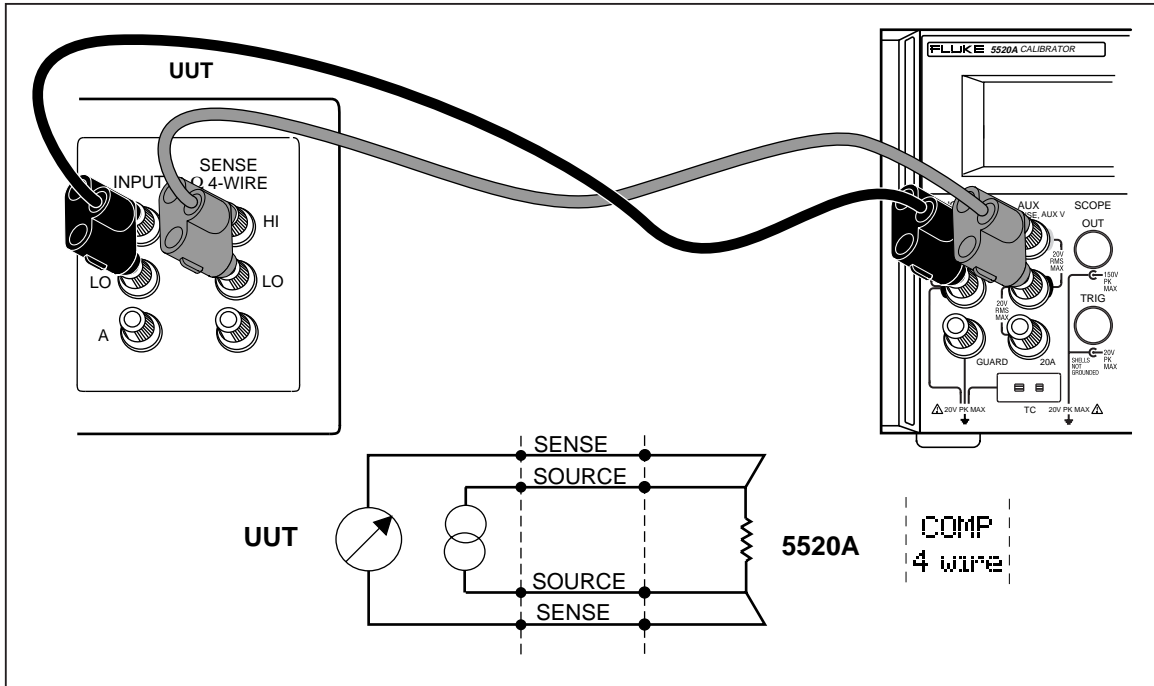

nn040f.eps

Figure 4-2. UUT Connection: Resistance (Four-Wire Compensation)

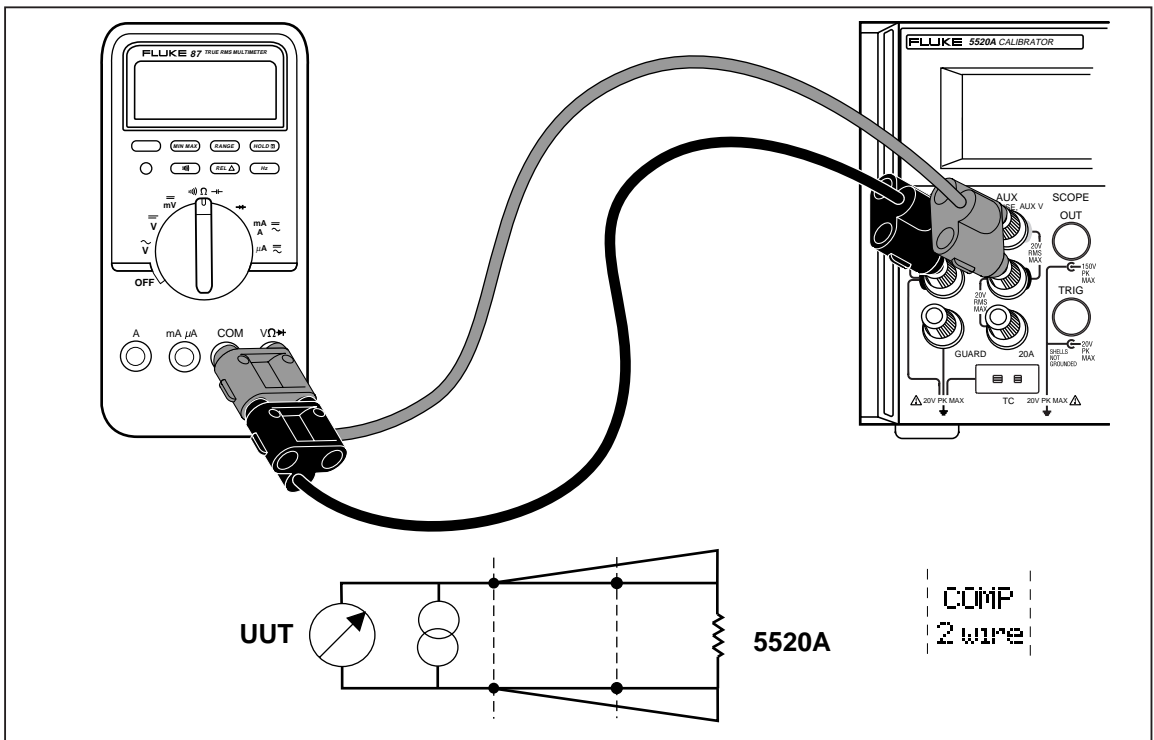

nn041f.eps

Figure 4-3. UUT Connection: Resistance (Two-Wire Compensation)

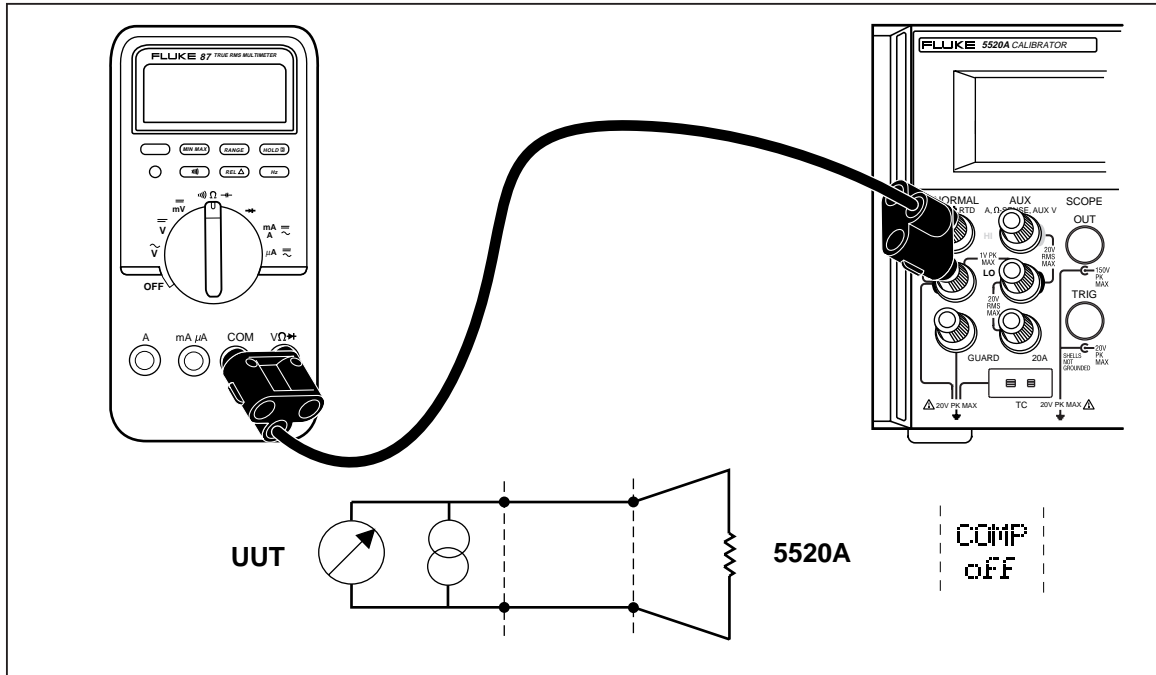

nn042f.eps

Figure 4-4. UUT Connection: Resistance (Compensation Off)

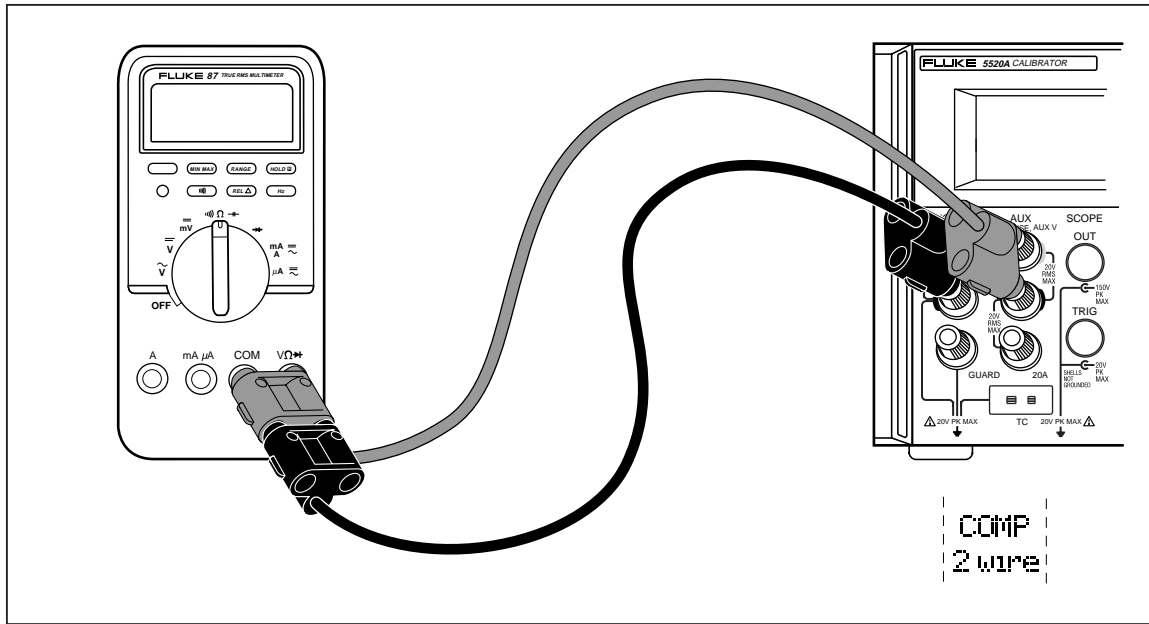

nn044f.eps

Figure 4-5. UUT Connection: Capacitance (Two-Wire Compensation)

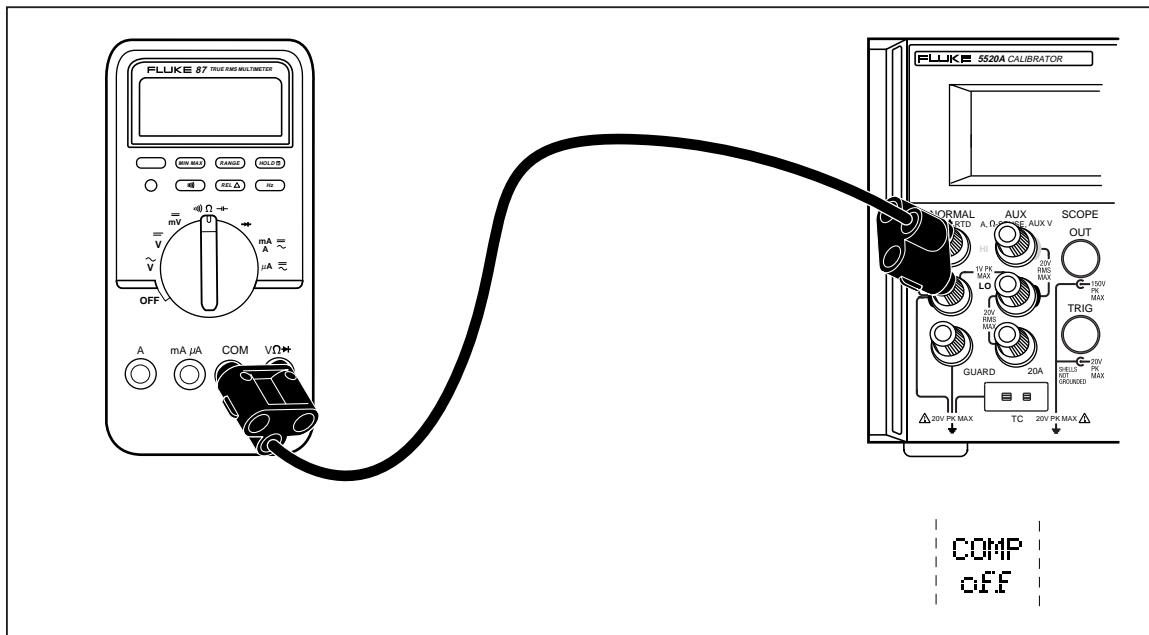

nn045f.eps

Figure 4-6. UUT Connection: Capacitance (Compensation Off)

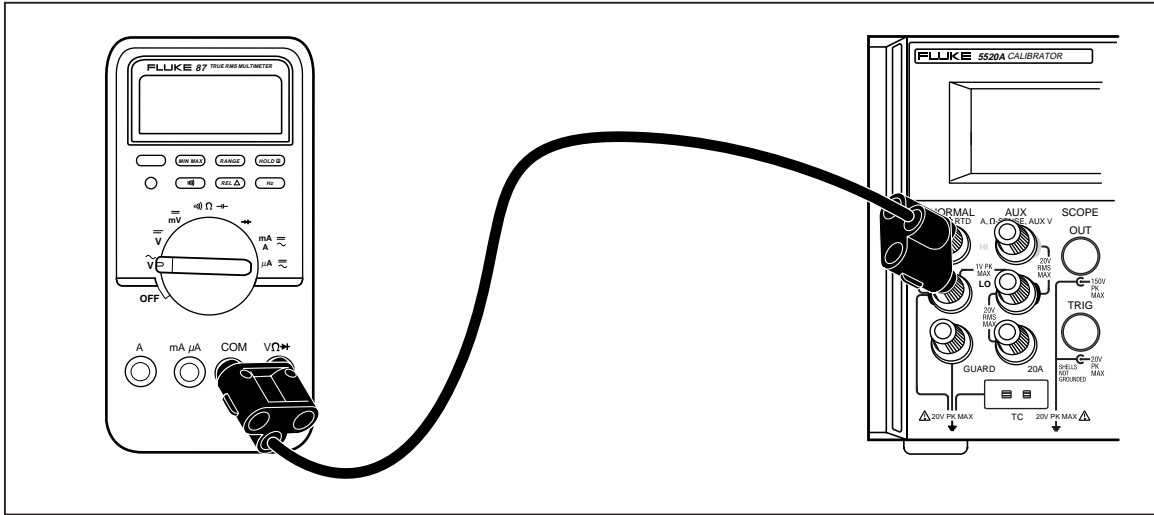

nn046f.eps

Figure 4-7. UUT Connection: DC Voltage/AC Voltage

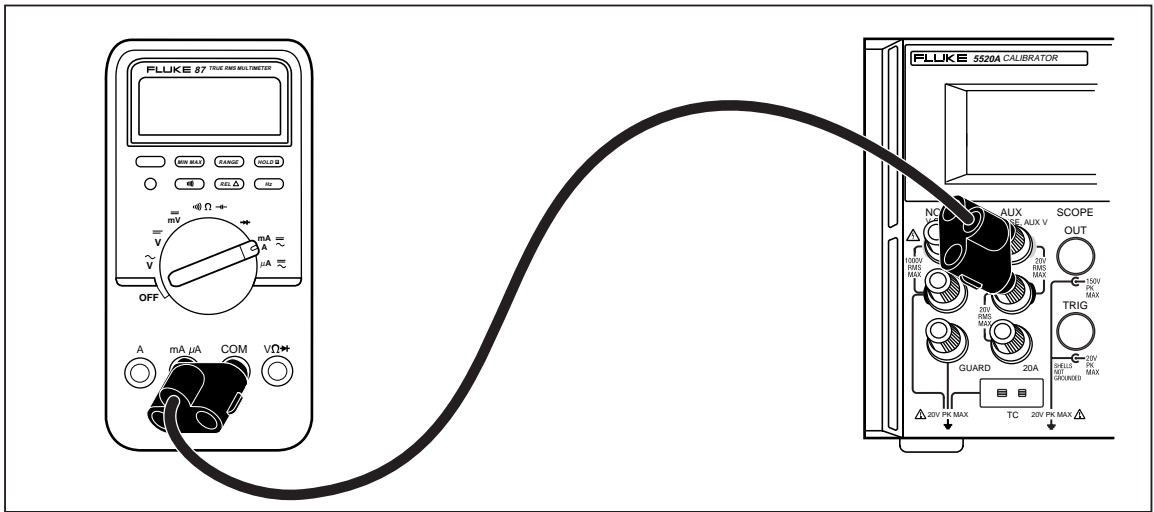

nn047f.eps

Figure 4-8. UUT Connection: DC Current/AC Current

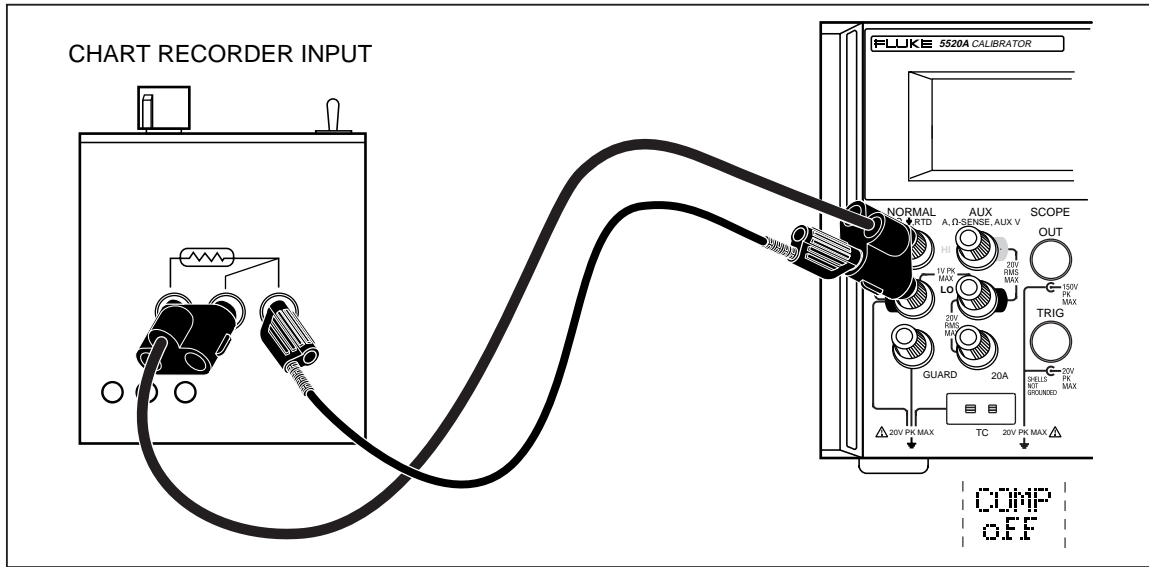

nn048f.eps

Figure 4-9. UUT Connection: Temperature (RTD)

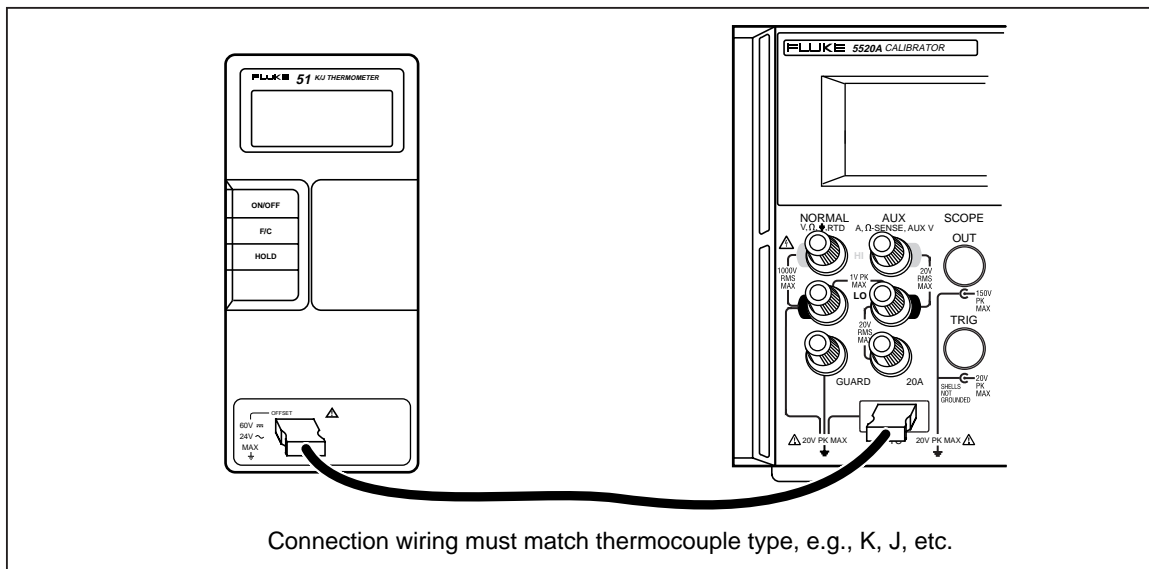

nn049f.eps

Figure 4-10. UUT Connection: Temperature (Thermocouple)

4-19. RMS Versus p-p Amplitude

The 5520A Calibrator ranges for sinusoidal ac functions are specified in rms (root-mean-square; the effective value of the wave form). For example, 1.0 to 32.999 mV, 33 to 329.999 mV, 0.33 to 3.29999 V and so forth. The sine wave outputs are in rms, while the triangle wave, square wave, and truncated sine wave outputs are in p-p. The relationship between p-p and rms for the non-sine wave types are as follows:

- Square wave $p-p \times 0.5000000 = rms$
- Triangle wave $p-p \times 0.2886751 = rms$
- Truncated Sine wave $p-p \times 0.2165063 = rms$

While the ac function ranges are directly compatible for sine waves, the rms content of the other waveforms is less apparent. This characteristic leads to subtle calibrator range changes. For example, if you enter a sine wave voltage of 6 V (rms assumed), the selected range is 3.3 to 32.9999 V. If you then use the softkeys to change from a sine wave to a triangle wave, for example, the display changes from 6 V rms to 6 V p-p. This translates to $6 \text{ V p-p} \times 0.2886751 = 1.73205 \text{ V rms}$, and the range switches to 0.33 to 3.29999 V. The Output Display shows the range change because the sine wave voltage is displayed as 6.0000, the resolution for the 3.3 to 32.9999 V range, while the triangle wave is displayed as 6.00000, the resolution for the 0.33 to 3.29999 V range.

You need to know the active range to enter the correct values for voltage offset because the maximum offsets are range specific. For example, the maximum peak signal for the 3.3 to 32.9999 V range is 55 V while the maximum peak signal for the 0.33 to 3.29999 V range is 8 V. This means in the example above, the 6 V rms sine wave could have offsets applied up to the maximum peak signal of 55 V because the active range is 3.3 to 32.9999 V, while the 6 V p-p triangle wave could have offsets applied up to the maximum peak signal of 8 V because the active range is 0.33 to 3.29999 V. See “Specifications” in Chapter 1 and “Entering a DC Offset” later in this chapter for more information about dc offset voltages.

4-20. Auto Range Versus Locked Range

A softkey is provided to toggle between the ranging method auto or locked. This feature is available only for single-output dc volts and dc current outputs.

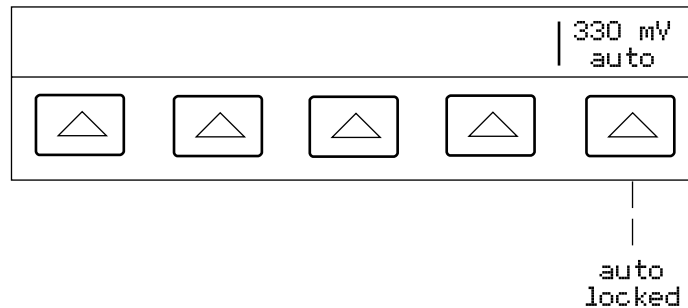

nn063f.eps

When auto is selected (the default setting), the calibrator automatically selects the range that provides the best output resolution. When locked is selected, the calibrator locks the selected range and will not change ranges when you are editing the output, or entering new outputs. Values lower or higher than the locked range are not allowed. The locked selection is usually made when you do not want range changes that may cause a small perturbation in the output, e.g., when checking the linearity of a given multimeter range.

4-21. Setting the Output

Setting the calibrator output is similar to entering values into a calculator: press the keys that represent the value you desire and then press a units key to identify which of the volts, amps, hertz, etc. you want the value to represent. The control display indicates the value and units you select as you type them into the calibrator. Once you are satisfied with the value and units, press **ENTER**. If the output display indicates STBY, press **OPR** to output the selection. The display of a small “u” (unsettled) in the Output Display indicates the calibrator is allowing for its internal circuitry to settle.

For example, to set the output to 10 V dc, press:

1 → **0** → **dBm V** → **ENTER** → **OPR**

To set the output to 20 V ac at 60 Hz, press:

2 → **0** → **^{dBm}V** → **6** → **0** → **^{SEC}Hz** → **ENTER** → **$\overline{\text{OPR}}$**

To change the output to dc, press:

0 → **^{SEC}Hz** → **ENTER** or **+/-** → **ENTER**

Step-by-step procedures are provided for each output function as follows:

- DC voltage
- AC voltage
- DC current
- AC current
- DC power
- AC power
- Dual DC voltage
- Dual AC voltage
- Capacitance
- Temperature - RTD
- Temperature - Thermocouple
- Resistance

4-22. Setting DC Voltage Output

Complete the following procedure to set a dc voltage output at the 5520A front panel NORMAL terminals. If you make an entry error, press **CE** to clear the display, then reenter the value.

Caution

Verify the applied voltage to the UUT does not exceed the rating of the UUT insulation and the interconnecting wiring.

1. Press **RESET** to clear any output from the 5520A.
2. Connect the UUT as described earlier in this chapter under “Connecting the Calibrator to a UUT.”
3. Set the UUT to measure dc voltage on the desired range.
4. Press the numeric keys and decimal point key to enter the desired voltage output (maximum seven numeric keys). For example, 123.4567.

Note

At voltage outputs of 100 volts and above (nominal), you may notice a slight high-pitched sound. This is normal.

5. Press **+/-** to select the polarity of the voltage (default is +).
6. Press a multiplier key, if necessary. For example, press **μ m**.
7. Press **^{dBm}V**.
8. The Control Display now shows the amplitude of your entry. For example, 123.4567 mV (below).

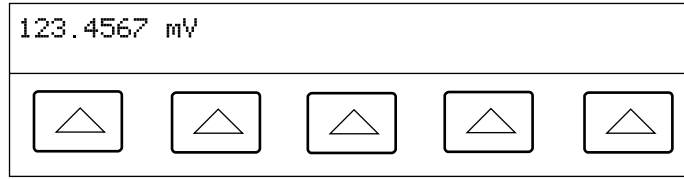

9. Press **ENTER**. The calibrator clears your entry from the Control Display and copies it into the Output Display (below is typical). nn071f.eps

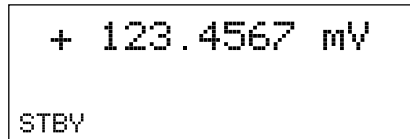

10. Press **OPR** to activate the calibrator output. nn072f.eps

A softkey label for range appears on the Control Display in the dc voltage function:

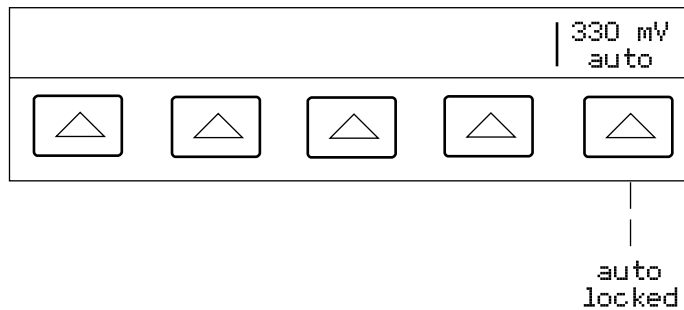

- Range (Operating Range) selects autorange (auto) or lock (locked) for the present range. When auto (the default setting) is selected, the calibrator automatically selects the range that provides the best output resolution. When locked is selected, the calibrator will not change ranges when you are editing the output. The locked selection is usually made when you do not want range changes that may cause a small perturbation in the output, e.g., when checking the linearity of a given multimeter range. nn063f.eps

4-23. Setting AC Voltage Output

You may select an ac voltage output in volts or as a power output in dBm, where dBm is $10 \log(P_{out}/.001)$, where P_{out} is expressed in watts. The output range is 1 mV to 1000 V. When selecting dBm outputs, the 5520A calculates dBm at a selected impedance level. Based on this, the formula is:

$$20 \log(V) - 10 \log(\text{Impedance} * .001) = \text{dBm}.$$

Complete the following procedure to set an ac voltage output at the 5520A front panel NORMAL terminals. If you make an entry error, press **CE** to clear the display, then reenter the value.

Caution

Verify the applied voltage to the UUT does not exceed the rating of the UUT insulation and the interconnecting wiring.

1. Press **RESET** to clear any output from the 5520A.
2. Connect the UUT as described earlier in this chapter under “Connecting the Calibrator to a UUT.”
3. Set the UUT to measure ac voltage on the desired range.
4. Output in volts Press the numeric keys and decimal point key to enter the desired voltage output (maximum six numeric keys). For example, 2.44949.

Output in dBm Press the numeric keys and decimal point key to enter the desired power output (maximum six numeric keys). For example, 10.0000. For a power output less than 1 mW (negative dBm values), press **+/-** to append the numeric entry with the negative (-) symbol.

When you press the dBm key, the right most softkey becomes active. This allows the dBm value and output impedance to be entered as a unit.

When output is entered in dBm, the Control Display appears as follows:

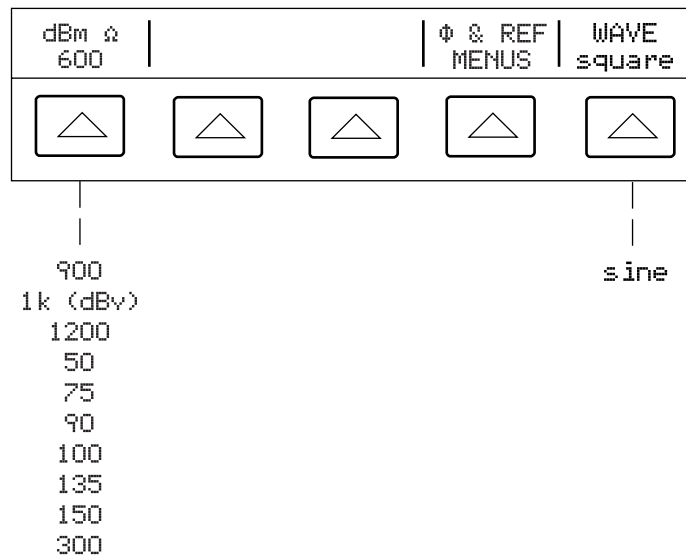

nn227f.eps

Note

At voltage outputs of 100 V and above (nominal), you may notice a slight high-pitched sound. This is normal.

5. Press a multiplier key, if necessary. For example, press μ m.
6. Output in volts. Press $\text{dBm} \mathbf{V}$.
Output in dBm. Press $\text{SHIFT} \text{dBm} \mathbf{V}$. Select an impedance for dBm from a list on the Control Display using the rightmost softkey.
7. The Control Display now shows the amplitude of your entry. For example, 2.44949 V (below).

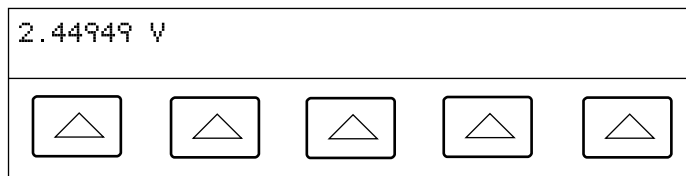

8. Press the numeric keys and decimal point key to enter the desired frequency output (maximum five numeric keys). Press a multiplier key, if necessary. For example, press the kilo multiplier key μ k. Then press the Hz key. For example, 1.1234 kHz (below).

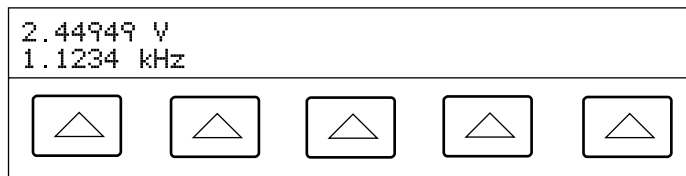

9. Press ENTER . The calibrator clears your entry from the Control Display and copies it into the Output Display (below is typical).

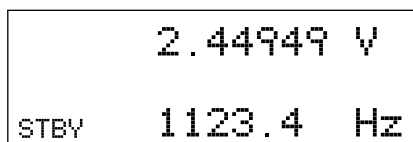

10. Press OPR to activate the calibrator output.

Several softkey labels appear on the Control Display in the ac voltage function, depending on which waveform is selected: DUTY, OFFSET and WAVE.

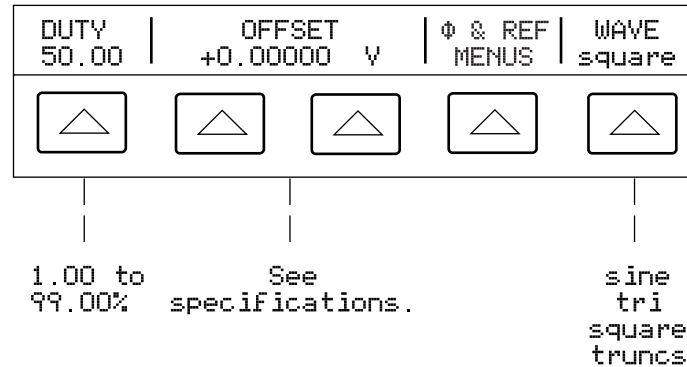

nn076f.eps

- **DUTY (Duty Cycle)** When the square wave is selected, DUTY appears, allowing you to modify the duty cycle of the square wave. The range is 1.00 to 99.00%. The default is 50.00%. The duty cycle must be 50.00% if you want to enter an OFFSET (see below).
- **OFFSET (Voltage Offset)** appears when the desired output is less than 33 V (sine waves), 65 V (square waves) or 93 V (triangle waves and truncated sine waves). This softkey allows you to add a positive or negative dc offset voltage to the ac output signal. See “Entering a DC Offset” later in this chapter for more information. When a voltage output is expressed in dBm, voltage offset is not available. You can enter an offset for a square wave output only when the duty cycle is 50.00% (see DUTY above).
- **φ & REF MENU (Phase Difference and 10 MHz reference source.)** Selects the phase difference between the NORMAL and AUX outputs, selects internal or external 10 MHz reference, and sets the phase difference between an external master 5520A (using 10 MHz IN/OUT) and the NORMAL output. See “Adjusting the Phase” and “Synchronizing the Calibrator using 10 MHz IN/OUT” later in this chapter.
- **WAVE (Waveform)** allows you to select one of four different types of waveforms: sine wave, triangle wave, square wave, and truncated sine wave. (See “Waveform Types” later in this chapter for more information). Whenever a non-sinusoidal waveform is selected, the Output Display shows Pp (p-p). Only sine wave is allowed for output in dBm.

4-24. Setting DC Current Output

Complete the following procedure to set a dc current output between AUX HI and LO or AUX 20A and LO, depending on the current level selected. Current greater than ± 3 A is sourced between the AUX 20A and LO terminals. If you make an entry error, press **CE** to clear the display, then reenter the value.

Note

See Figure 1-4 in Chapter 1 for a chart that shows duration or duty cycle limitations for current greater than 11 A. If the duration or duty cycle is exceeded, the 5520A will shut down abruptly. After a cool-off period, the 5520A will work normally.

1. Press **RESET** to clear any output from the calibrator.
2. Connect the UUT as described earlier in this chapter under “Connecting the Calibrator to a UUT.”
3. Set the UUT to measure dc current on the desired range.

4. Press the numeric keys and decimal point key to enter the desired current output (maximum six numeric keys). For example, 234.567.
5. Press $\boxed{+/-}$ to select the polarity of the current (default is +).
6. Press a multiplier key, if necessary. For example, press $\boxed{\mu m}$.
7. Press $\boxed{^w A}$.
8. The Control Display now shows the amplitude of your entry. For example, 234.567 mA.

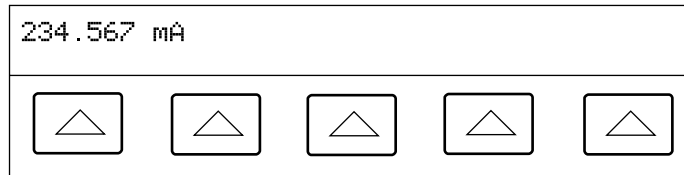

9. Press \boxed{ENTER} . The calibrator clears your entry from the Control Display and copies it into the Output Display (below is typical). nn077f.eps

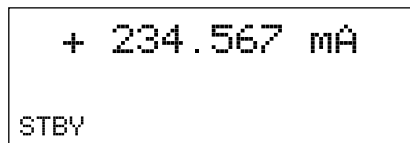

10. Press \boxed{OPR} to activate the calibrator output. nn078f.eps

A range softkey appears on the Control Display in the dc current function (operating range). This selects autorange (auto) or lock (locked) for the present range. When auto (the default setting) is selected, the calibrator automatically selects the range that provides the best output resolution. When locked is selected, the calibrator will not change ranges when you are editing the output. The locked selection is usually made when you do not want range changes that may cause a small perturbation in the output, e.g., when checking the linearity of a given multimeter range.

Another softkey appears: OUTPUT. When you select 20 A for this parameter, or you select a current above 3 A, the calibrator switches to standby, and you must change the test lead to the 20A terminal and press \boxed{OPR} to activate the output.

4-25. Setting AC Current Output

Complete the following procedure to set an ac current output at the AUX or 20A terminals. If you make an entry error, press G to clear the display, then reenter the value.

1. Press \boxed{RESET} to clear any output from the 5520A.
2. Connect the UUT as described earlier in this chapter under "Connecting the Calibrator to a UUT."
3. Set the UUT to measure ac current on the desired range.
4. Press the numeric keys and decimal point key to enter the desired current output (maximum six numeric keys). For example, 123.456.
5. Press a multiplier key, if necessary. For example, press $\boxed{\mu m}$.
6. Press $\boxed{^w A}$.

7. The Control Display now shows the amplitude of your entry. For example, 123.456 mA (below).

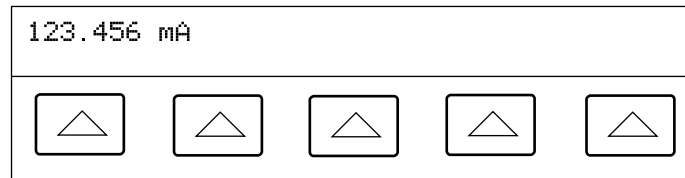

nn079f.eps

8. Press the numeric keys and decimal point key to enter the desired frequency output (maximum five numeric keys). Press a multiplier key, if necessary. For example, press the kilo multiplier key $\overset{n}{\text{k}}$. Then press the $\overset{50c}{\text{Hz}}$ key. For example, 1.1234 kHz (below).

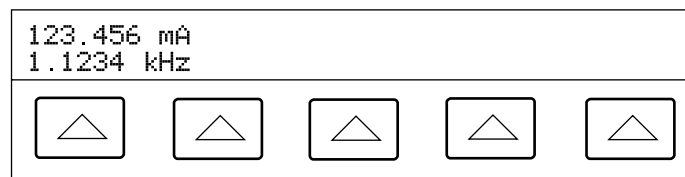

nn080f.eps

9. Press ENTER . The calibrator clears your entry from the Control Display and copies it into the Output Display (below is typical).

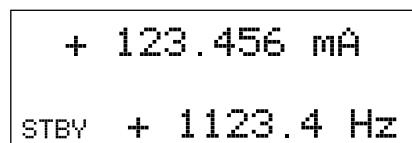

nn081f.eps

10. Press OPR to activate the calibrator output.

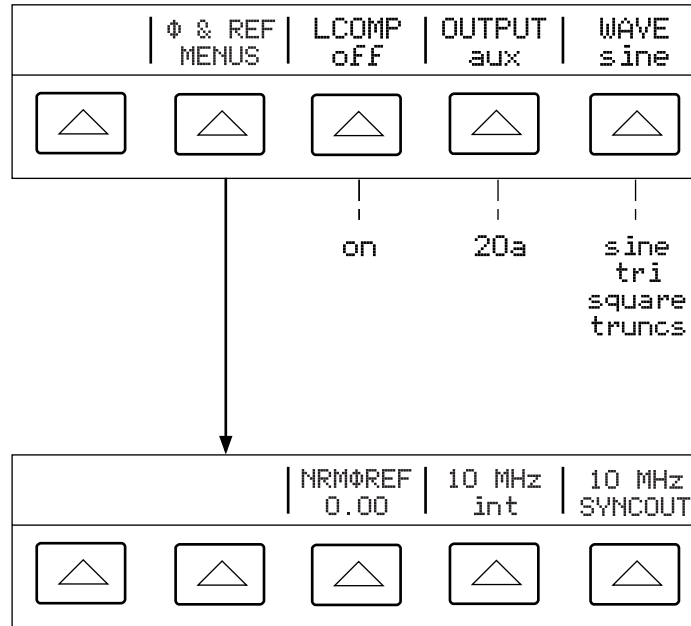

nn321f.eps

- & REF MENUS (Phase Difference and 10 MHz reference source.) Selects the phase difference between the NORMAL and AUX outputs, selects internal or external 10 MHz reference, and sets the phase difference between an external master 5520A (using 10 MHz IN/OUT) and the NORMAL output. See “Adjusting the Phase” and “Synchronizing the Calibrator using 10 MHz IN/OUT” later in this chapter.
- LCOMP turns inductive compensation on and off. Inductive compensation is available for frequencies up to 1 kHz at outputs up to 239.999 mA, and for frequencies up to 440 Hz above 239.999 mA.
- OUTPUT shows whether the output is on the AUX or 20A terminals. Outputs 3A or above are always on the 20A terminals.
- WAVE (waveform) selects one of four different types of waveforms: sine wave, triangle wave, square wave, and truncated sine wave. (See “Waveform Types” later in this chapter for more information). Whenever a non-sinusoidal waveform is selected, the Output Display will convert the RMS reading to p-p (PP).

4-26. Setting DC Power Output

Note

Tie the terminals NORMAL LO and AUX LO together at the UUT or at the 5520A, via the “LO”s softkey selection “tied.”

The calibrator produces a dc power output by sourcing a dc voltage on the NORMAL outputs and a dc current on the AUX outputs. Complete the following procedure to set a dc power output. If you make an entry error, press **CE** one or more times to clear the display, then reenter the value.

Caution

Verify the applied voltage to the UUT does not exceed the rating of the UUT insulation and the interconnecting wiring.

1. Press **RESET** to clear any output from the 5520A.
2. Connect the UUT as described earlier in this chapter under “Connecting the Calibrator to a UUT” by adapting the voltage and current connections.

3. Set the UUT to measure dc power on the desired range.
4. Press the numeric keys and decimal point key to enter the desired voltage output (maximum seven numeric keys). For example, 123.4567.

Note

At voltage outputs of 100 volts and above (nominal), you may notice a slight high-pitched sound. This is normal.

5. Press **+/-** to select the polarity of the voltage (default is +).
6. Press a multiplier key, if necessary. For example, press **μ m**.
7. Press **dBm V**.
8. The Control Display now shows the amplitude of your entry. For example, 123.4567 mV (below).

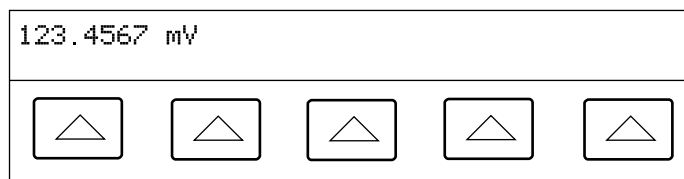

9. Press the numeric keys and decimal point key to enter the desired current output (maximum six numeric keys). For example, 234.567.
10. Press **+/-** to select the polarity of the current (default is +).
11. Press a multiplier key, if necessary. For example, press **μ m**.
12. Press **W A**.
13. The Control Display now shows the amplitude of your entries. For example, 123.4567 mV and 234.567 mA (below).

nn071f.eps

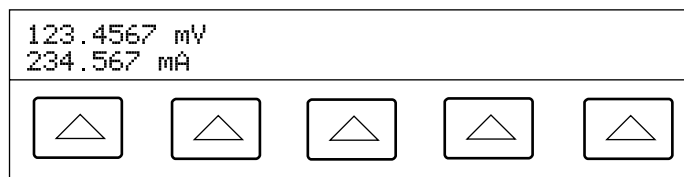

nn082f.eps

14. Press **ENTER**. The calibrator clears your entry from the Control Display and copies it into the Output Display (below is typical).

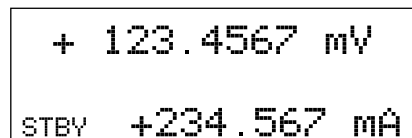

15. Press **OPR** to activate the calibrator output. When changing power output levels, you must reenter both voltage and current (in either order).

nn083f.eps

(Enter voltage or current and then a watts entry value using **SHIFT** **W A**. The remaining volts or current value is calculated and displayed.)

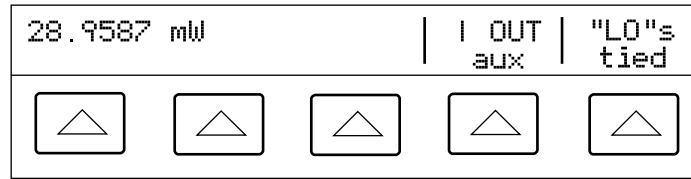

nn322f.eps

- I OUT selects AUX or 20A terminals. Current outputs 3 A or above are always on the 20A terminals.
- "LO"s ties or opens a connection between front panel NORMAL LO and AUX LO terminals. The front panel NORMAL LO and AUX LO terminals must be tied together either at the UUT or at the 5520A. The default is tied.

4-27. Setting AC Power Output

Note

Tie the terminals NORMAL LO and AUX LO together at the UUT, or at the 5520A via the "LO"s softkey selection "tied." For optimum phase performance, tie the LO terminals at the UUT. At current levels > 2.2 A, tie the terminals at the UUT using heavy gauge wire < 10 mΩ resistance.

The calibrator produces an ac power output by sourcing an ac voltage on the NORMAL outputs and an ac current on the AUX outputs.

See “Setting AC Voltage Output” above for information on selecting an ac voltage output in dBm; this procedure assumes an ac voltage output in volts.

Complete the following procedure to set an ac power output. If you make an entry error, press **CE** one or more times to clear the display, then reenter the value.

⚠ Caution

Verify the applied voltage to the UUT does not exceed the rating of the UUT insulation and the interconnecting wiring.

1. Press **RESET** to clear any output from the 5520A.
2. Connect the UUT as described earlier in this chapter under “Connecting the Calibrator to a UUT.” (Adapt the voltage and current connections to suit your application.)
3. Set the UUT to measure ac power on the desired range.
4. Press the numeric keys and decimal point key to enter the desired voltage output (maximum six numeric keys). For example, 123.456.

Note

At voltage outputs of 100 volts and above (nominal), you may notice a slight high-pitched sound. This is normal.

5. Press a multiplier key, if necessary. For example, press **μ m**.
6. Press **dBm V** .
7. The Control Display now shows the amplitude of your voltage entry. For example, 123.456 mV (below).

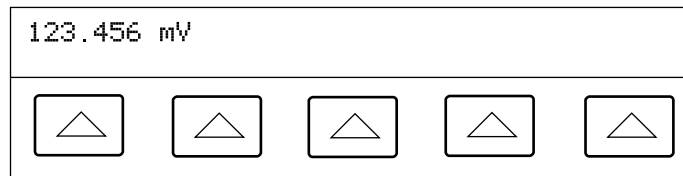

nn084f.eps

8. Press the numeric keys and decimal point key to enter the desired current output (maximum six numeric keys). For example, 234.567.
9. Press a multiplier key, if necessary. For example, press **μ m**.
10. Press **W A** .
11. The Control Display now shows the amplitude of your voltage and current entries. For example, 123.456 mV and 234.567 mA (below).

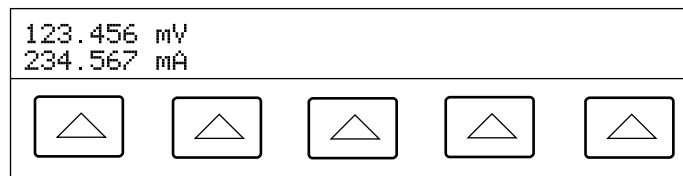

nn085f.eps

12. Press the numeric keys and decimal point key to enter the desired frequency output (maximum five numeric keys). Press a multiplier key, if necessary. For example, press the kilo multiplier key **k** . Then press the **Hz** key. For example, 1.1234 kHz.

13. The Control Display now shows your entries. For example, 123.456 mV and 234.567 mA at 1.1234 kHz (below).

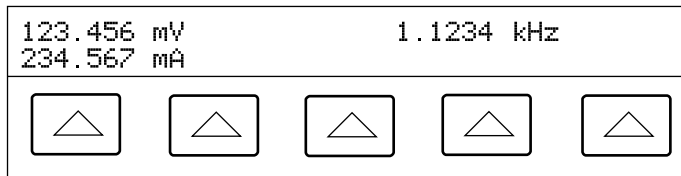

14. Press **ENTER**. The calibrator clears your entry from the Control Display and copies it into the Output Display (below is typical). nn086f.eps

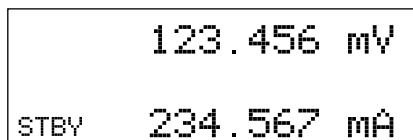

15. Press **OPR** to activate the calibrator output. When changing power output levels, you must reenter both voltage and current (in either order). nn087f.eps

(Enter voltage or current and then a watts entry value using **SHIFT** **W A**. The remaining volts or current value is calculated and displayed.)

Three softkey labels appear on the Control Display: WAVE MENUS, I OUT (AUX or 20A terminals), and LCOMP (off or on). The Control Display also shows the real power output for sine waves. Power out is computed as $\text{Power} = \text{Cosine } \Phi \text{ (Volts x Current)}$ where Φ is the phase difference between the volts and current waveforms. Cosine Φ is also known as the Power Factor (PF).

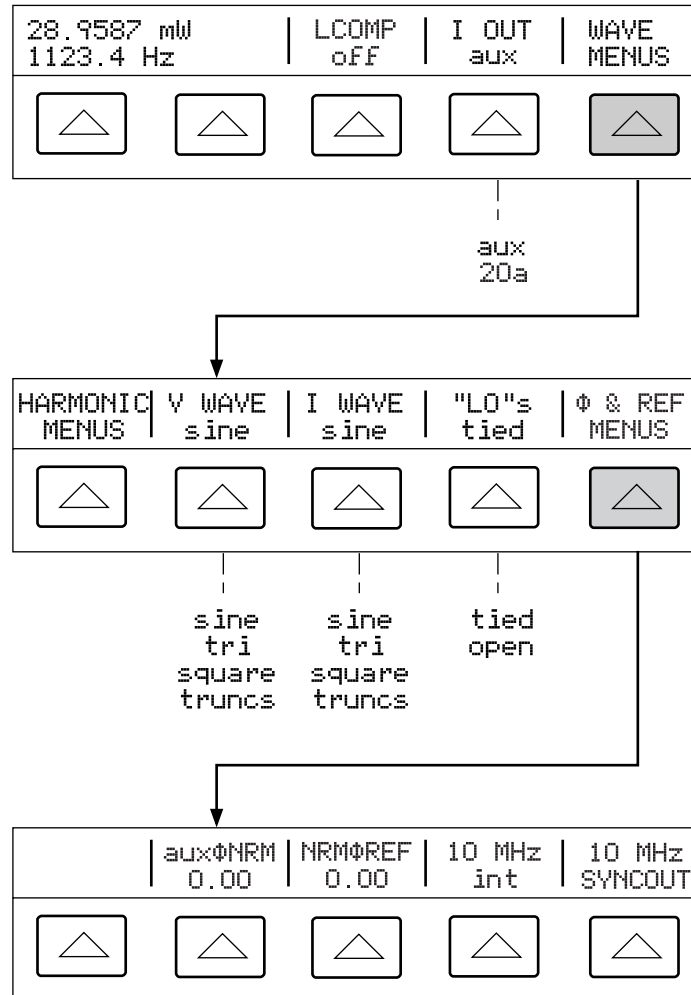

- **WAVE MENUS (Waveform Menus)** Opens submenus for selecting the type of harmonic, waveform, front panel LO terminal condition, and phase. nn088f.eps
- **HARMONIC MENUS (Harmonic Frequency Menus)** Opens submenus for selecting harmonic outputs. See “Setting Harmonics” later in this chapter.
- **V WAVE (Voltage Waveform)** Selects the waveform for the voltage output at the NORMAL terminals. See “Waveform Types” later in this chapter.
- **I WAVE (Current Waveform)** Selects the waveform for the current output at the front panel AUX terminals. See “Waveform Types” later in this chapter.
- **“LO”s (Low Potential Output Terminals)** The front panel NORMAL LO and AUX LO terminals must be tied together either at the UUT or at the 5520A. When tied at the UUT, select “open.” The default is tied.
- **φ & REF MENUS (Phase Difference and 10 MHz reference source.)** Selects the phase difference between the NORMAL and AUX outputs, selects internal or external 10 MHz reference, and sets the phase difference between an external master 5520A (using 10 MHz (IN/OUT) and the NORMAL output. See “Adjusting the Phase” and “Synchronizing the Calibrator using 10 MHz ON/OUT” later in this chapter.

4-28. Setting a Dual DC Voltage Output

Note

Tie the terminals *NORMAL LO* and *AUX LO* together at the UUT or at the 5520A, via the “LO”s softkey selection “*tied.*”

The calibrator produces a dual dc voltage output by sourcing one dc voltage on the *NORMAL* outputs and a second on the *AUX* terminals. Complete the following procedure to set a dual dc voltage output. If you make an entry error, press **CE** one or more times to clear the display, then reenter the value.

Caution

Verify the applied voltage to the UUT does not exceed the rating of the UUT insulation and the interconnecting wiring.

1. Press **RESET** to clear any output from the 5520A.
2. Connect the UUT as described earlier in this chapter under “Connecting the Calibrator to a UUT.”
3. Set the UUT to measure dual dc voltage on the desired range.
4. Press the numeric keys and decimal point key to enter the desired voltage output at the *NORMAL* terminals (maximum seven numeric keys). For example, 123.4567.
5. Press **+/-** to select the polarity of the voltage (default is +).
6. Press a multiplier key, if necessary. For example, press **μ m**.
7. Press **dBmV** .
8. The Control Display now shows the amplitude of your entry for the *NORMAL* terminals. For example, 123.4567 mV (below).

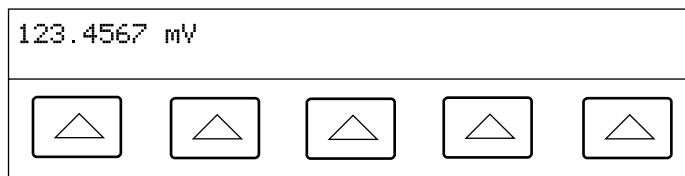

nn071f.eps

Note

Voltage on the AUX output is limited to 3.3 V maximum.

9. Press the numeric keys and decimal point key to enter the desired voltage output at the AUX terminals (maximum six numeric keys). For example, 234.567.
10. Press **+/-** to select the polarity of the voltage (default is +).
11. Press a multiplier key, if necessary. For example, press **μ m**.
12. Press **δ mV**.
13. The Control Display now shows the amplitude of your entries for the NORMAL terminals (upper reading) and AUX terminals (lower reading) (see below).

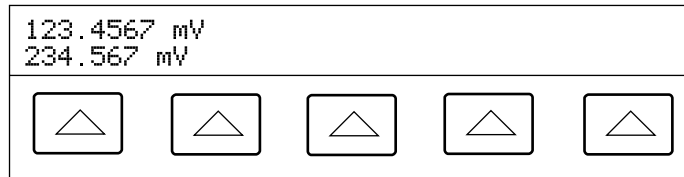

14. Press **ENTER**. The calibrator clears your entry from the Control Display and copies it into the Output Display (below is typical). nn089f.eps

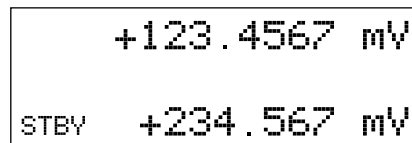

15. Press **OPR** to activate the calibrator output. nn090f.eps

A softkey labeled "LO"s appears on the Control Display.

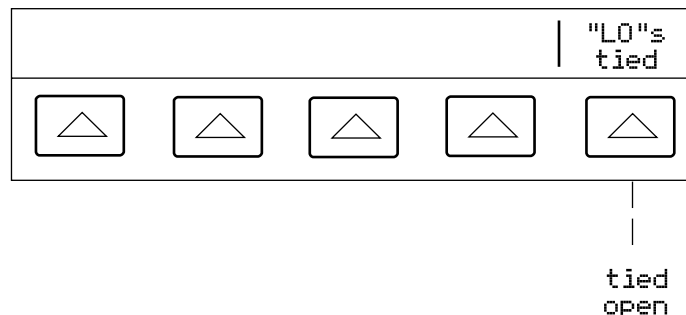

- "LO"s (Low Potential Output Terminals) The front panel NORMAL LO and AUX LO terminals must be tied together either at the UUT or at the 5520A. When the front panel NORMAL LO and AUX LO terminals are tied at the UUT, select "open" with the "LO"s softkey. If the NORMAL LO and AUX LO terminals are not tied at the UUT, select "tied" with the "LO"s softkey. The default is tied. nn091f.eps

4-29. Setting a Dual AC Voltage Output

Note

Tie the terminals NORMAL LO and AUX LO together at the UUT or at the 5520A, via the “LO”s softkey selection “tied.”

The calibrator produces a dual ac voltage output by sourcing one ac voltage on the NORMAL outputs and a second on the AUX terminals.

Complete the following procedure to set a dual ac voltage output. If you make an entry error, press **CE** one or more times to clear the display, then reenter the value.

Caution

Verify the applied voltage to the UUT does not exceed the rating of the UUT insulation and the interconnecting wiring.

1. Press **RESET** to clear any output from the 5520A.
2. Connect the UUT as described earlier in this chapter under “Connecting the Calibrator to a UUT.”
3. Set the UUT to measure dual ac voltage on the desired range.
4. Press the numeric keys and decimal point key to enter the desired voltage output at the NORMAL terminals (maximum six numeric keys). For example, 123.456.
5. Press a multiplier key, if necessary. For example, press **μ m**.
6. Press **dBm V** .
7. The Control Display now shows the amplitude of your voltage entry. For example, 123.456 mV (below).

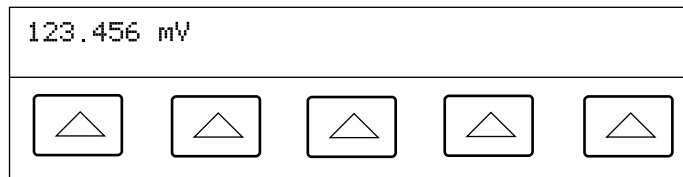

nn084f.eps

Note

The AUX output is limited to 3.3 V rms for sine waves, 6.6 V p-p for square waves, 9.3 V p-p for triangle and truncated sine waves.

8. Press the numeric keys and decimal point key to enter the desired voltage output at the AUX terminals (maximum six numeric keys). For example, 234.567.
9. Press a multiplier key, if necessary. For example, press **μ m**.
10. Press **dBm V** .
11. The Control Display now shows the amplitude of your entries for the NORMAL terminals (upper reading) and AUX terminals (lower reading) (below is typical).

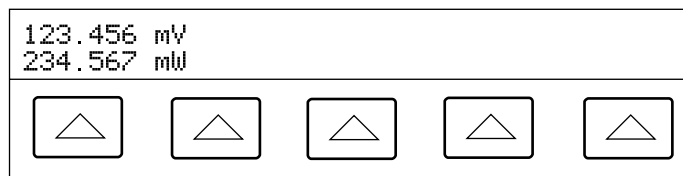

nn092f.eps

12. Press the numeric keys and decimal point key to enter the desired frequency output (maximum five numeric keys). Press a multiplier key, if necessary. For example, press the kilo multiplier key \boxed{k} . Then press the \boxed{Hz} key. For example, 1.1234 kHz.
13. The Control Display now shows your voltage and frequency entries. For example, 123.456 mV and 234.567 mV at 1.1234 kHz (below).

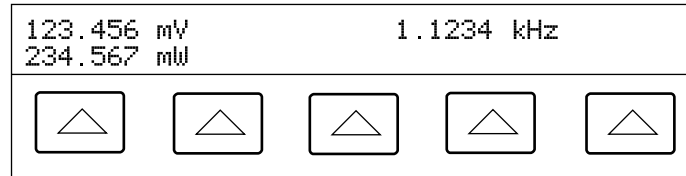

14. Press \boxed{ENTER} . The calibrator clears your entry from the Control Display and copies it into the Output Display (below is typical). nn093f.eps

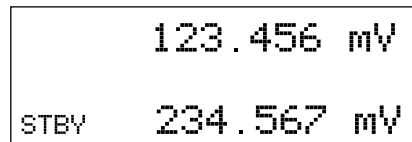

15. Press \boxed{OPR} to activate the calibrator output. nn094f.eps

Two softkey labels appear on the Control Display: V@NOR/V@AUX and WAVE MENUS.

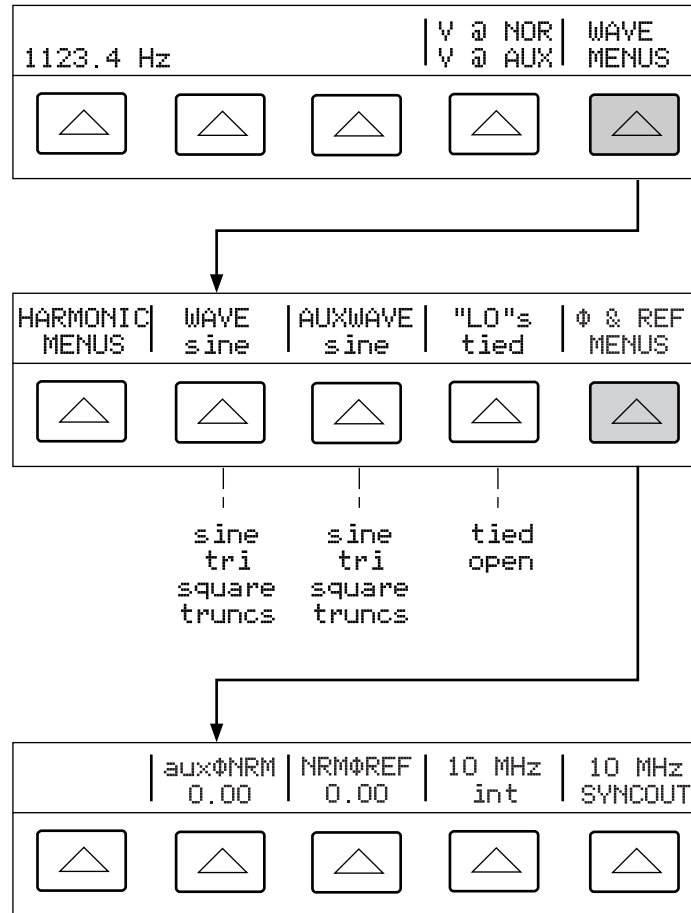

nn095f.eps

- V @ NOR (Voltage at NORMAL Terminals) V @ AUX (Voltage at AUX Terminals) This is an information-only softkey position and does not have an associated function. It shows the output function is dual ac voltage.
- WAVE MENUS (Waveform Menus) Opens submenus for selecting the type of harmonic, waveform, front panel LO terminal condition, and phase.
 - HARMONIC MENUS (Harmonic Frequency Menus) Opens submenus for selecting harmonic outputs. See “Setting Harmonics” later in this chapter for more information.
 - WAVE (Normal Waveform) Selects the waveform for the voltage at the front panel NORMAL terminals. See “Waveform Types” later in this chapter for more information.
 - AUXWAVE (Auxiliary Waveform) Selects the waveform for the voltage at the front panel AUX terminals. See “Waveform Types” later in this chapter for more information.
 - “LO”s (Low Potential Output Terminals) The front panel NORMAL LO and AUX LO terminals must be tied together either at the UUT or at the 5520A. When the front panel NORMAL LO and AUX LO terminals are tied at the UUT, select “open” with the “LO”s softkey. If the NORMAL LO and AUX LO terminals are not tied at the UUT, select “tied” with the “LO”s softkey. The default is tied.
 - phi & REF MENUS (Phase Difference and 10 MHz reference source.) Selects the phase difference between the NORMAL and AUX outputs, selects internal or

external 10 MHz reference, and sets the phase difference between an external master 5520A (using 10 MHz IN/OUT) and the NORMAL output. See “Adjusting the Phase” and “Synchronizing the Calibrator using 10 MHz IN/OUT” later in this chapter.

4-30. Setting Resistance Output

Complete the following procedure to set a synthesized resistance output at the 5520A front panel NORMAL terminals. If you make an entry error, press **CE** to clear the display, then reenter the value.

1. Press **RESET** to clear any output from the 5520A.
2. Connect the UUT as described earlier in this chapter under “Connecting the Calibrator to a UUT.”

Note

Since this is a synthesized output, be sure the terminal connections from the 5520A to the UUT are LO to LO and HI to HI.

3. Set the UUT to measure resistance on the desired range.
4. Press the numeric keys and decimal point key to enter the desired resistance output (maximum six numeric keys). For example, 12.3456.
5. Press a multiplier key, if necessary. For example, press **k**.
6. Press **Ω**.
7. The Control Display now shows the amplitude of your resistance entry. For example, 12.3456 kΩ (below).

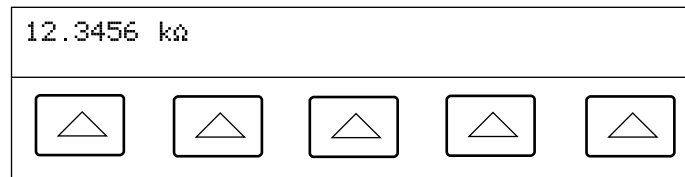

8. Press **ENTER**. The calibrator clears your entry from the Control Display and copies it into the Output Display (below is typical). nn096f.eps

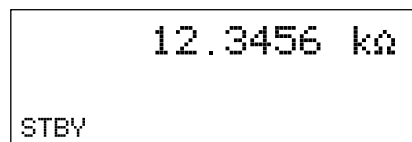

9. Press **OPR** to activate the calibrator output. nn097f.eps

The softkeys allow selection of three lead-compensation settings and ohms zero.

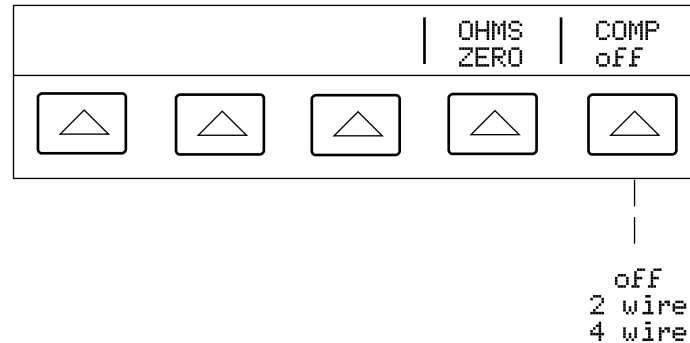

nn098f.eps

- **OHMS ZERO** Press to recalibrate internal circuitry for the ohms function (allow several minutes).
- **COMP (Compensation)** Applies 4-wire compensation, 2-wire compensation or turns compensation off. Compensation is available for resistances up to (but not including) 110 k Ω . See “Four-Wire versus Two-Wire Connections” earlier in this chapter for more information.

4-31. **Setting Capacitance Output**

Complete the following procedure to set a synthesized capacitance output at the front panel NORMAL terminals. If you make an entry error, press **CE** to clear the display, then reenter the value.

1. Press **RESET** to clear any output from the 5520A.
2. Connect the UUT as described earlier in this chapter under “Connecting the Calibrator to a UUT.” Also refer to “Cable Connection Instructions” for a procedure to null out stray capacitances due to the test cable connections.

Note

Since this is a synthesized output, be sure the terminal connections from the 5520A to the UUT are LO to LO and HI to HI.

3. Set the UUT to measure capacitance on the desired range.
4. Press the numeric keys and decimal point key to enter the desired capacitance output (maximum five numeric keys). For example, 123.45.
5. Press a multiplier key (preceded with the **SHIFT** key) for the desired output. For example, press **SHIFT** then **μ m** for μF . The other multiplier keys include **P M** for pF and **n k** for nF.
6. Press **F $\frac{1}{2}$** .

7. The Control Display now shows the amplitude of your capacitance entry. For example, 123.45 μF (below).

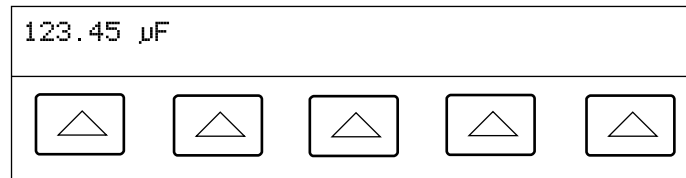

8. Press **ENTER**. The calibrator clears your entry from the Control Display and copies it into the Output Display (below is typical). nn099f.eps

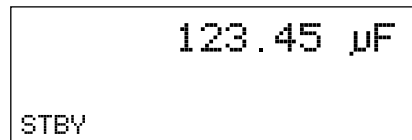

9. Press **OPR** to activate the calibrator output. nn100f.eps

The softkey in the Control Display labeled COMP allows you to select one of three lead-compensation settings.

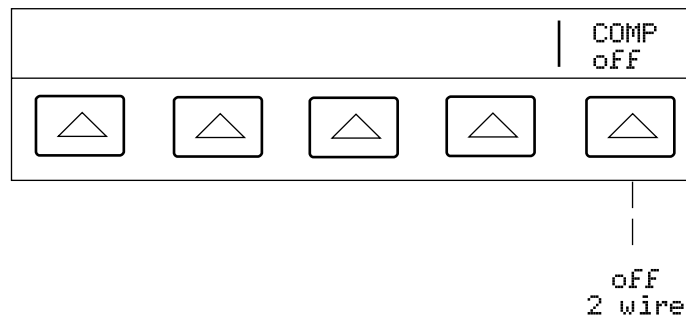

- **COMP (Compensation)** Applies 2-wire compensation or turns compensation off. Compensation refers to methods of connecting the 5520A to the UUT to cancel out test lead resistance (NOT capacitance). Compensation is available for capacitances of 110 nF and above. This softkey will not function below 110 nF. See “Four-Wire versus Two-Wire Connections” earlier in this chapter for more information. nn101f.eps

4-32. Setting Temperature Simulation (Thermocouple)

Note

Thermocouples have no electrical isolation.

Make sure the thermocouple wire and plug are not affected by extraneous temperature sources. For example, do not place your fingers on the thermocouple plug or wire when simulating a temperature.

Thermocouples generate a small dc voltage at specific temperatures. The simulated output, therefore, is a small dc voltage based on the selected temperature and type of thermocouple being simulated. To toggle the temperature reference between the 1968 International Provisional Temperature Standard (ipts-68) and the 1990 International Temperature Standard (its-90), see “Using the Instrument Setup Menu.”

Complete the following procedure to set a simulated thermocouple temperature output at the 5520A front panel TC connector. If you make an entry error, press **CE** to clear the display, then reenter the value.

1. Press **RESET** to clear any output from the 5520A.
2. Connect the UUT as described earlier in this chapter under “Connecting the Calibrator to a UUT.”

Note

You must use thermocouple wire and miniconnectors that match the type of thermocouple. For example, if simulating a temperature output for a type K thermocouple, use type K thermocouple wire and type K miniconnectors.

3. Set the UUT to measure temperature on the desired range.
4. Press the numeric keys and decimal point key to enter the desired temperature output (maximum 6 numeric keys). For example, 123.456.
5. For an output in °C, press the **°C** key. For an output in °F, press **SETUP** and then the **°C** key.
6. The Control Display now shows the amplitude of your temperature output. For example, 123.456 °C (below).

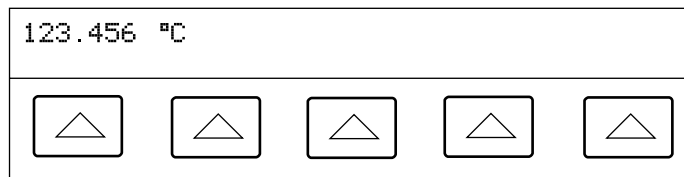

7. Press **ENTER**. The calibrator clears your entry from the Control Display and copies it into the Output Display (below is typical). nn102f.eps

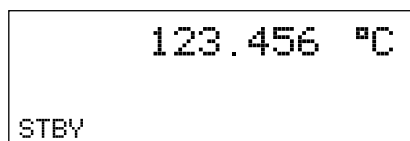

8. Press **OPR** to activate the calibrator output. Four softkey labels appear on the Control Display. nn103f.eps

Note

The entered temperature will be cleared to 0 °C (32 °F) if you change between tc and rtd, or change the type of thermocouple (except for a type B thermocouple, which clears to 600 °C). If this should occur, select OUTPUT tc, the desired thermocouple TYPE, and then reenter the temperature.

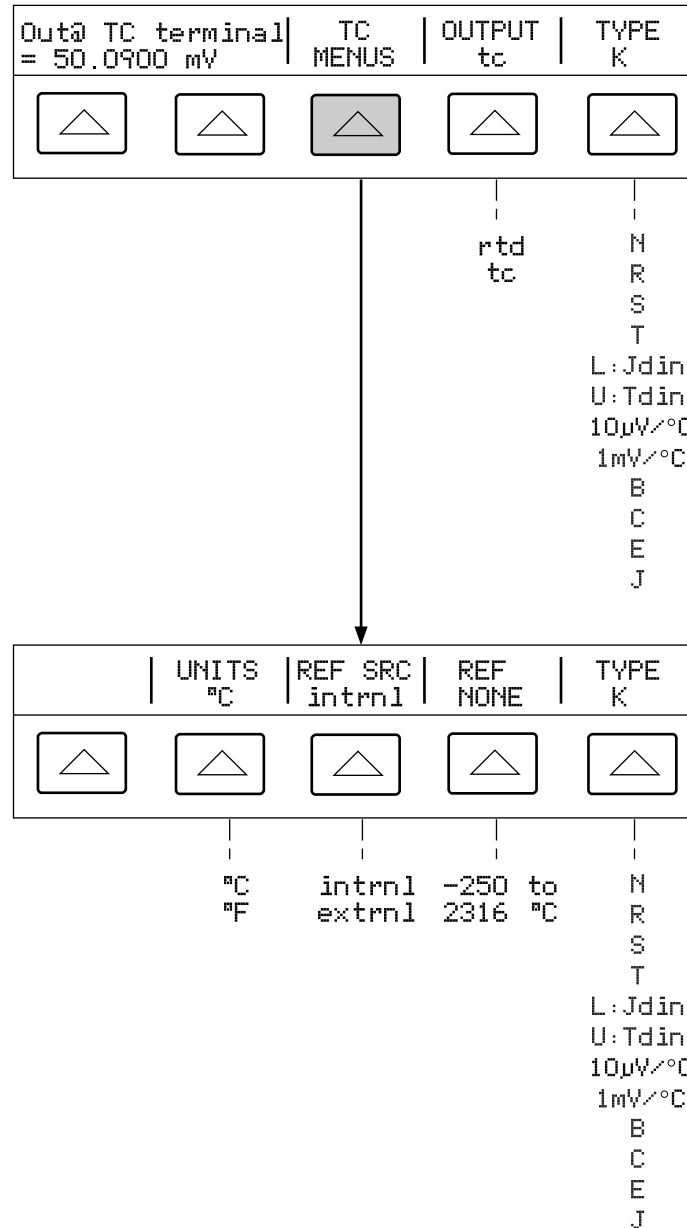

- Out@TC terminal (Output at the front panel TC terminals) Displays the actual dc voltage at the front panel TC terminals. This is a display only, not a softkey function.
- TC MENUS (Thermocouple Menu) Shows submenus for thermocouple outputs.
 - UNITS (Temperature Units) Selects °C or °F as the temperature unit.
 - REF SRC (Reference Source) Selects intrnl (Internal) or extrnl (External) temperature reference source. Select intrnl when the selected thermocouple has

nn104f.eps

alloy wires and you are using the isothermal block internal to the 5520A Calibrator. Select `extrnl` when using an external isothermal block, and when the selected thermocouple has copper wires. Press the REF softkey to enter the value of the external temperature reference. The best accuracy is obtained when you use `extrnl` and the external isothermal block is maintained at 0 °C.

- REF (Temperature Reference) Displays the value of the temperature reference. When the Reference Source is Internal, the display shows the internal reference, or NONE if the 5520A is in Standby. When the Reference Source is External, the display shows the value you entered for external reference.
- OUTPUT (Temperature Output Device) Selects the temperature device: thermocouple (`tc`) or resistance temperature detector (`rtd`). Select `tc`.
- TYPE (Thermocouple Type) Selects the thermocouple type simulated by the 5520A Calibrator. The default is type K. (The 10 $\mu\text{V}/^\circ\text{C}$ and 1 $\text{mV}/^\circ\text{C}$ settings are used as an accurate output voltage source for user-supplied linearizations.)

Note: The “u” indicator that occasionally appears in the Output Display indicates an internal adjustment to the measured isothermal block temperature and is normal. If it appears for more than 10 seconds (nominal), or if it appears to flash continuously, check to see that you are not externally heating the thermocouple miniconnector or wires.

4-33. **Setting Temperature Simulation (RTD)**

RTDs have a characteristic resistance at specific temperatures. The simulated output, then, is a resistance value based on the selected temperature and type of RTD being simulated. To toggle the degree reference between the 1968 International Provisional Temperature Standard (`ipts-68`) and the 1990 International Temperature Standard (`its-90`), see “Using the Instrument Setup Menu” earlier in this chapter.

Complete the following procedure to set a simulated RTD temperature output at the 5520A front panel NORMAL terminals. If you make an entry error, press `CE` to clear the display, then reenter the value.

1. Press `RESET` to clear any output from the 5520A.
2. Connect the UUT as described earlier in this chapter under “Connecting the Calibrator to a UUT.”

Note

When calibrating Resistance Temperature Detectors (RTDs) using the three-terminal connection shown in Figure 4-9, be sure the test leads have identical resistances to cancel any errors due to lead resistance. This can be accomplished, for example, by using three identical test lead lengths and identical connector styles.

3. Set the UUT to measure temperature on the desired range.
4. Press the numeric keys and decimal point key to enter the desired temperature output (maximum 6 numeric keys). For example, 123.456.
5. For an output in °C, press the `°C` key. For °F, press `SHIFT` and then the `°C` key.

6. The Control Display now shows the amplitude of your temperature output. For example, 123.456 °C (below).

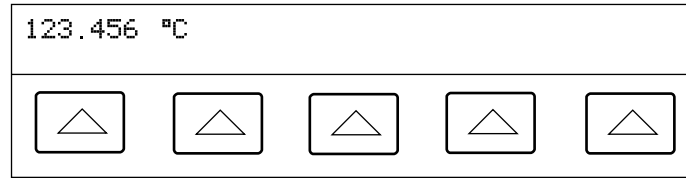

7. Press **ENTER**. The calibrator clears your entry from the Control Display and copies it into the Output Display (below is typical). nn102f.eps

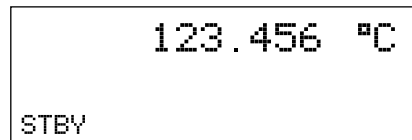

8. Press **OPR** to activate the calibrator output. nn103f.eps

Four softkey labels appear on the Control Display. Press the OUTPUT softkey to toggle the rtd selection, displaying the rtd setup menu and four softkey positions.

Note

The temperature you entered above will be cleared to 0 °C (32 °F) if you change between tc (thermocouple) and rtd (resistance temperature detector), or change the type of rtd. If this occurs, select OUTPUT rtd, the desired rtd TYPE, and then reenter the temperature following steps 4 to 8.

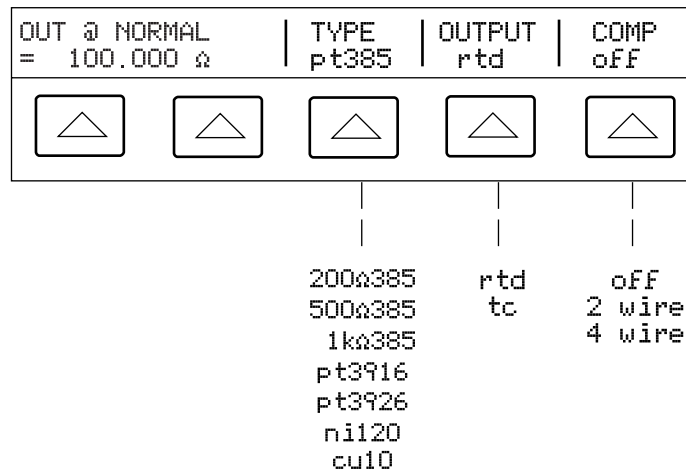

nn105f.eps

- Out @ NORMAL displays the location of the output terminals (always NORMAL) for rtd connections.
- TYPE (RTD Type) selects the rtd curve from a list.
- OUTPUT (Temperature Output Device) Selects the temperature device: thermocouple (tc) or resistance temperature detector (rtd). Select rtd.
- COMP (Compensation) Applies 4-wire compensation, 2-wire compensation or turns compensation off. Compensation refers to methods of connecting the 5520A to the UUT to cancel out test lead resistance. See “Four-Wire versus Two-wire Connections” earlier in this chapter for more information. For the 3-lead connection (Figure 4-9) select COMP off.

4-34. Measuring Thermocouple Temperatures

Complete the following procedure to measure the output of a thermocouple connected to the TC input. If you make an entry error, press **CE** to clear the display, then reenter.

1. Press **RESET** to clear any output from the 5520A.
2. Connect the thermocouple to the front panel TC connector.

Note

Use thermocouple wire and miniconnectors that match the type of thermocouple. For example, type K wire and type K miniconnectors.

3. Press **MEAS_{TC}** to display the TC menu (below).

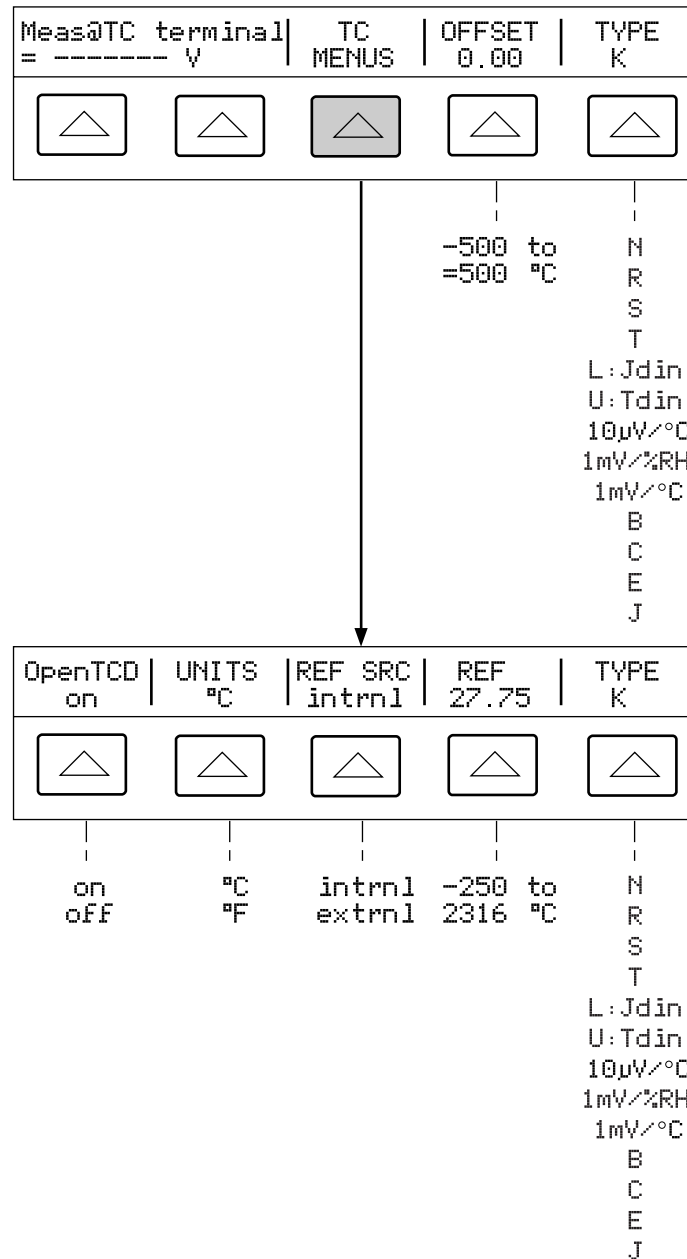

nn106f.eps

- The measured temperature appears in the Output Display (below is typical). (The lower-case m blinks on when a measurement is being taken.)

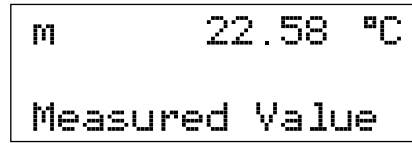

- Meas@TC terminal (Measurement at the front panel TC terminals) Displays the actual dc voltage at the front panel TC terminals. This is a display only, not a softkey function. nn107f.eps
- TC MENUS (Thermocouple Menus) Opens the submenu supporting thermocouple outputs.
 - Open TCD (Open Thermocouple Detect) Selects on or off for the Open TCD feature. When Open TCD is on, a small electrical pulse checks for thermocouple continuity that, in most cases, will have no effect on the measurement. If you are measuring the thermocouple with the 5520A Calibrator in parallel with another temperature measuring device, select off for Open TCD. When an open thermocouple is detected, “Open TC” is displayed in the TC menu, providing positive identification of the fault.
 - UNITS (Temperature Units) Selects °C or °F as the temperature unit.
 - REF SRC (Reference Source) Selects intrnl (Internal) or extrnl (External) temperature reference source. The reference source indicates the ambient temperature contribution to the thermocouple output, which is taken into account when simulating an accurate temperature output. Select intrnl when the selected thermocouple has alloy wires and you are using the isothermal block internal to the 5520A Calibrator. Select extrnl when using an external isothermal block, and when the selected thermocouple has copper wires. Press the REF softkey to enter the value of the external temperature reference.
 - REF (Temperature Reference) Displays the value of the temperature reference. When the Reference Source is Internal, the display shows the internal reference. When the Reference Source is External, the display shows the value you entered for external reference.
 - OFFSET (Measurement Display Offset) Selects an offset value to be added or subtracted from the actual measurement. This is useful for differential measurements (temperatures above and below a desired temperature).
 - TYPE (Thermocouple Type) Selects the thermocouple type used for measurement. The default is K. (The 10µV/°C setting is used for customer-supplied linearizations. 1 mV/%RH and 1 mV/°C settings are used for the Vaisala humidity/temperature probes.)

4-35. Waveform Types

AC voltage, ac current, dual ac voltage, and ac power functions provide a softkey to select between four different waveform types: sine wave (sine), triangle wave (tri), square wave (square), and truncated sine wave (truncs). When the calibrator output is sine wave ac power or dual ac voltage, the Control Display shows additional softkeys for harmonics and fundamental frequencies.

4-36. Sine wave

When the wave selection is sine, a sine wave current or voltage signal is present on the calibrator outputs (Figure 4-11). The variables for the sine wave are amplitude, frequency, and dc offset voltage.

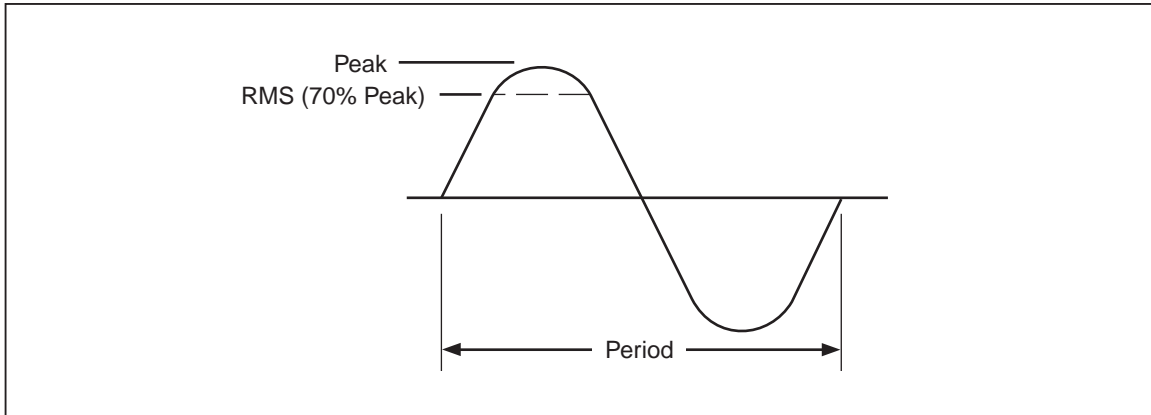

Figure 4-11. Sine wave

4-37. Triangle wave

When the wave selection is tri, the triangle wave is present on the calibrator outputs (Figure 4-12). The variables for the triangle wave are amplitude, frequency, and dc offset voltage. Whenever a triangle wave is selected, the Output Display indicates amplitudes in p-p units.

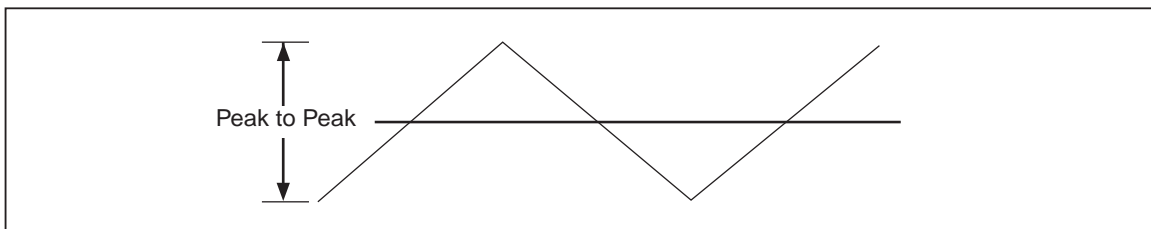
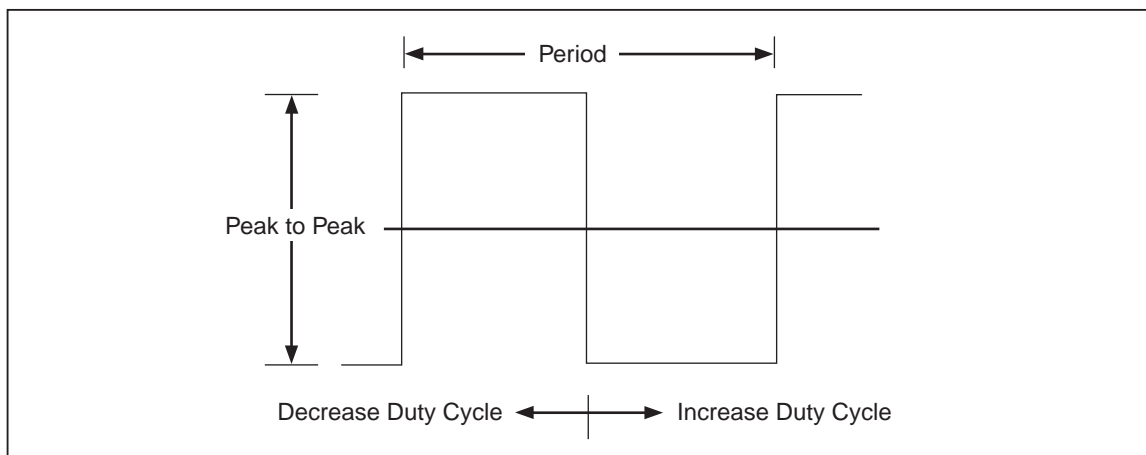

Figure 4-12. Triangle Wave

4-38. Square Wave

When the wave selection is square, a square wave current or voltage signal is present on the calibrator outputs (Figure 4-13). The variables for the square wave are duty cycle, amplitude, frequency, and dc offset voltage. Whenever a square wave is selected, the Output Display indicates amplitude in p-p units. If the calibrator is set for a single voltage or current output, the duty cycle of the signal can be set through the keypad. To enter a new duty cycle, press the DUTY CYCLE softkey and up to five numeric keys followed by . The negative-going edge of the square wave will move based on the duty cycle setting.



nn028f.eps

Figure 4-13. Square Wave and Duty Cycle

4-39. Truncated Sine Wave

When the wave selection is trunks, a truncated sine wave current or voltage signal is present on the calibrator outputs (Figure 4-14). The variables for the truncated sine wave are amplitude and frequency. Whenever a truncated sine wave is selected, the Output Display indicates amplitudes in p-p units.

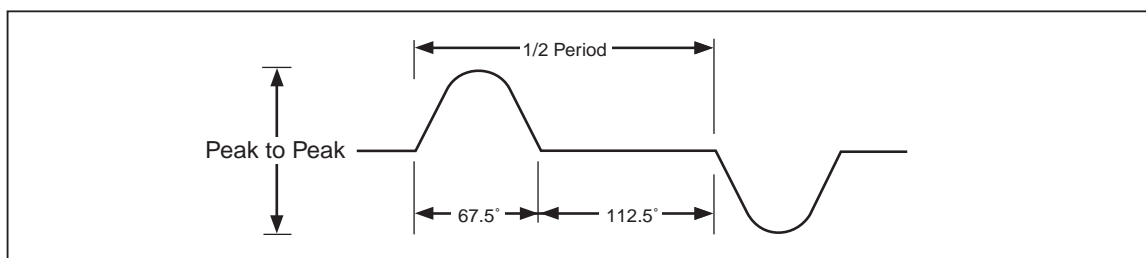

nn029f.eps

Figure 4-14. Truncated Sine Wave

4-40. Setting Harmonics

When the calibrator is outputting dual ac voltages or ac power (sine waves only), the calibrator sources two signals with adjustable harmonic difference, with a maximum harmonic frequency output of 10 kHz. For example, a 120 V, 60 Hz signal can be set on the front panel NORMAL terminals, and a 1 V, 300 Hz (5th harmonic) output on the AUX terminals. The fundamental can be configured on either the NORMAL or the AUX terminals, with the harmonic output on the opposite terminals. Note that the maximum AUX output is 3.3 V, while the maximum NORMAL output is 1000 V. Unless both the fundamental and harmonic frequencies are allowed for the given amplitude, the output is not allowed.

Complete the following procedure to enter a harmonic output. This procedure assumes you have already sourced a dual ac voltage or ac power output.

1. Press the softkey WAVE MENUS, opening the waveform menu.
2. Press the softkey HARMONIC MENUS, opening the harmonic submenu (below is typical).

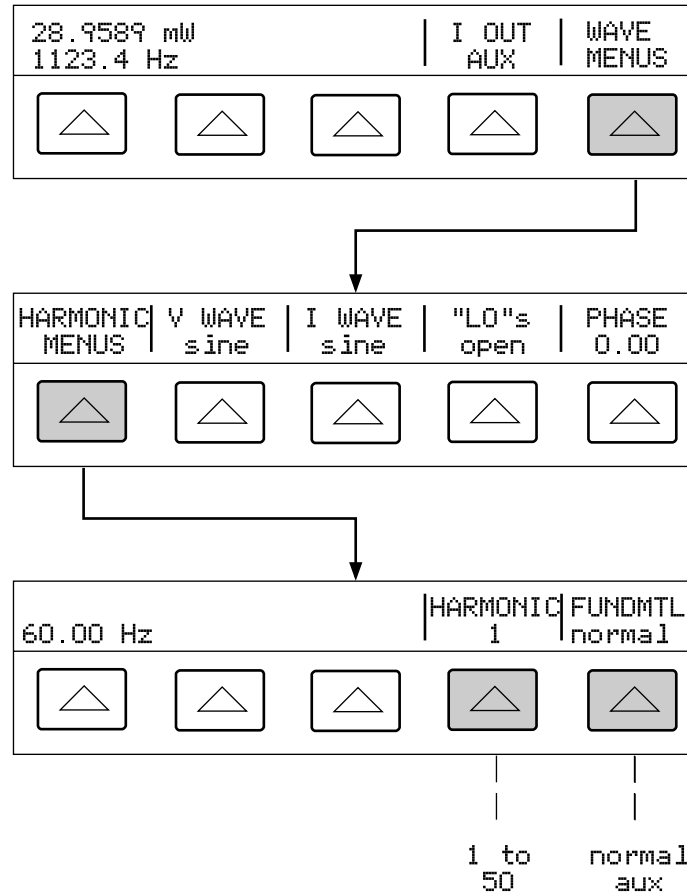

3. Press the softkey FUNDMTL to select the 5520A Calibrator front panel terminals for the fundamental output, either NORMAL or AUX. The harmonic appears on the 5520A AUX terminals. nn108f.eps
4. Press the softkey HARMONIC to enter the desired harmonic (1 to 50), with a maximum frequency output of 10 kHz. For example, entering the 7th harmonic (below). When the control display shows the desired value, press **ENTER**.

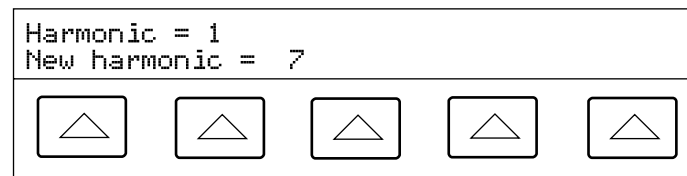

5. Press **PREV MENU** one or more times to return to previous menus. nn109f.eps

4-41. Adjusting the Phase

When in the dual ac voltage and ac power output modes, you can set the calibrator to source two signals with adjustable phase difference. All phase adjustments shift the AUX waveform in relation to the NORMAL waveform. Phase shift adjustments are entered into the calibrator either as degrees (0 to ± 180.00) or as a power factor (PF). A leading or positive phase shift will cause the AUX waveform to lead the NORMAL waveform; a lagging or negative phase shift will cause the AUX waveform to lag the NORMAL waveform.

The softkey PHASE is available after pressing the WAVE MENUS softkey that appears when outputting dual ac voltages or ac power (shown below for ac power output).

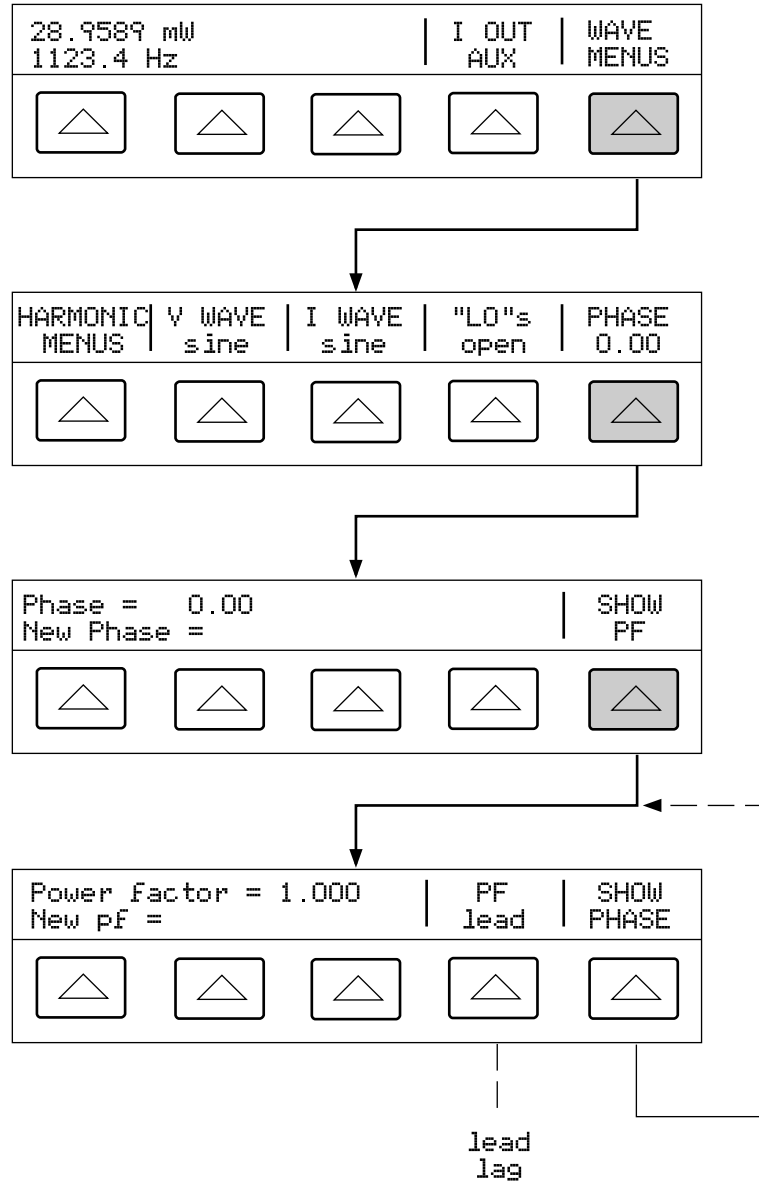

When one output is a harmonic of the other, the phase shift is based on the phase angle or power factor (cosine) of the harmonic signal. For example, when the AUX output is generating a 60-Hz signal, and the NORMAL output is generating a 120-Hz (2nd Harmonic) signal, a phase shift of 60° (PF of .5) would move the AUX signal 60° of 120-Hz (30° of 60 Hz).

nn110f.eps

4-42. Entering a Phase Angle

Complete the following procedure to enter a phase shift in degrees. This procedure assumes you have already sourced a dual ac voltage or ac power output.

1. Press the softkey WAVE MENUS, opening the waveform menu.
2. Press the softkey PHASE, opening the phase entry menu.

3. Press the numeric keys and decimal point key to enter the desired phase angle (maximum five numeric keys). For example, 123.45.
4. Press **+/-** to select leading (+) or lagging (-) phase shift (default is +).
5. The Control Display now shows the value of your entry. For example, a leading phase angle of 123.45 degrees (below). (SHOW PF appears only for sine waves.)

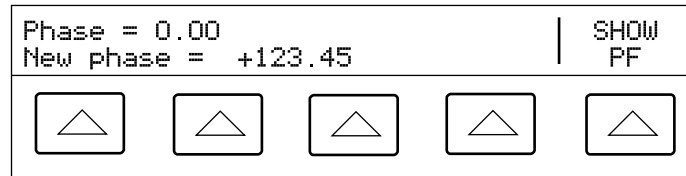

6. Press **ENTER**. The calibrator clears your entry from the "New phase =" line and copies it to the "Phase =" line of the Control Display. nn111f.eps
7. Press **CE** one or more times to return to previous menus.

4-43. Entering a Power Factor

Complete the following procedure to enter a phase shift as a power factor (PF). PF = Cosine Φ , where Φ is the phase shift. This procedure assumes you have already sourced a dual ac voltage or ac power output using sine waves as the waveform.

1. Press the softkey WAVE MENUS, opening the waveform menu.
2. Press the softkey PHASE, opening the phase entry menu.
3. Press the softkey SHOW PF, opening the power factor entry menu.
4. Press the decimal point key and numeric keys to enter the desired power factor (maximum three numeric keys). For example, .678.
5. Press the softkey PF to toggle between a leading (lead) or lagging (lag) power factor (default is lead).
6. The Control Display now shows the value of your entry. For example, a leading power factor of .678 (below).

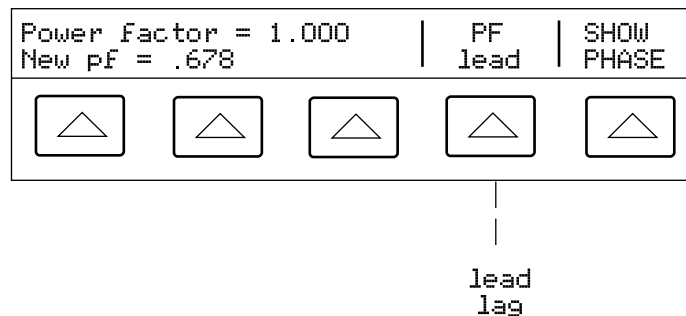

7. Press **ENTER**. The calibrator clears your entry from the "New pf=" line and copies it to the "Power Factor =" line of the Control Display. nn112f.eps
8. Press **PREV MENU** one or more times to return to previous menus.

4-44. Entering a DC Offset

When the calibrator single output is an ac voltage of sine waves, triangle waves, square waves or truncated sine waves, you can apply a +dc offset. When applying an offset to square wave outputs, the duty cycle must be 50.00% (default). The offset selection is entered using the softkey OFFSET, which appears when the ac voltage output is less than 33 V (sine waves), 66 V p-p (square waves) or 93 V p-p (triangle waves and truncated sine waves). The softkey OFFSET will not appear and offsets may not be entered when the output is a voltage sine wave measured in dBm.

The maximum offset value allowed depends on the maximum offset and maximum peak signal for each range. For example, a square wave output of 10 V p-p is within the range 6.6 to 65.9999 V p-p, a range that allows a maximum peak signal of 55 V. For this example, the square wave peak value is 5 V, thus allowing a maximum \pm offset of 50 V for a maximum peak signal of 55 V.

Check the specifications in Chapter 1 for offset limits. If you are using an offset voltage and you cause the output to move into a range where offset is not allowed (for example, above 33 V for a sine wave output), the calibrator will go into the standby mode and the offset function will be disabled.

Complete the following procedure to enter a dc voltage offset. If you make an entry error, press **CE** to clear the display, then reenter the value. This procedure assumes you have already sourced a single ac voltage output not exceeding 33 V (sine waves), 65 V p-p (square waves) or 93 V p-p (triangle waves and truncated sine waves), thus displaying the softkey OFFSET (below).



nn113f.eps

1. Press the softkey WAVE to select the desired waveform: sine waves (sine), triangle waves (tri), square waves (square) or truncated sine wave (truncs).
2. Press the softkey OFFSET, opening the offset entry display. Enter the desired offset using the numeric keys and decimal point key. For example, 0.123 V (below).

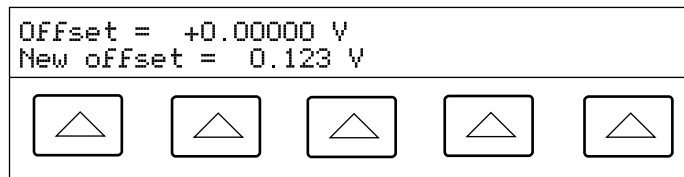

nn114f.eps

3. Press the **ENTER** key to enter the offset and then **PREV MENU**.

4-45. Editing and Error Output Settings















All 5520A Calibrator outputs can be edited using the front panel Edit Field knob and associated , , and  keys. In addition, multiply  and divide  keys edit the output by decades. The difference between the original output (reference) and edited output is displayed as an “error” between the two settings. This allows you to edit a value to achieve a correct reading at the UUT and thereby calculate an error in $\pm\%$ or ppm (parts per million) if it is less than ± 1000 ppm. Table 4-2 lists the actions that cause the calibrator to exit the error mode and return to the original reference output, or to output a new reference, as selected.

Table 4-2. Keys That Exit Error Mode

Keys	Action
	Returns to the previous reference value.
 + 	Establishes a new reference.
A new keypad entry + 	Establishes a new reference.
	Establishes the present output as a new reference.
	Sets the calibrator to ten times the reference value and establishes a new reference.
	Sets the calibrator to one-tenth the reference value and establishes a new reference.
	Returns to the power-up state.

4-46. Editing the Output Setting

When you initially source an output from the Calibrator, you enter a specific value. For example, 10.00000 V dc. To edit the output value to suit your application, turn the front panel Edit Field knob clockwise to increase the value or counter-clockwise to decrease the value. (The Edit Field controls will not operate if you are in any setup function. Press the  key one or more times to exit a setup function.)

To select a higher order digit, use an Edit Field cursor key  or . The output digit in edit is always underlined (see below).

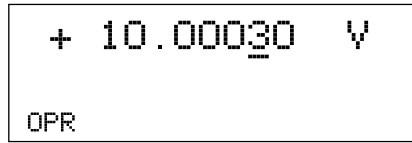

nn115f.eps

The momentary display of the letter u in the Output Display when editing during OPR (Operate) indicates “unsettled,” that is, the Calibrator output is settling with a new value.

4-47. **Displaying the UUT Error**

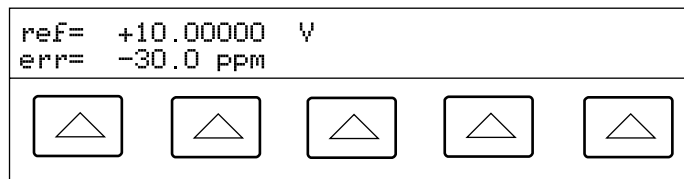

When you edit the output value, the Control Display shows the difference between the reference value (the value you originally entered) and the edit value (the value shown in the Output Display), displaying error difference in parts per million (ppm) or percent (%). For example, if ERR UNI is set to > 100 ppm, the error will be displayed in ppm up to 99 and then the error will change to 0.0100% at 100 ppm. This allows you to edit the output such that the UUT displays the expected value and thus give an indication of the UUT accuracy.



nn116f.eps

For example, an edited difference of .00030 volts for an output of 10.00000 V represents $0.00030/10.00000=0.000030$, or 30 parts per million. The sign is negative (-30.0 ppm) because the output necessary to display 10.00000 at the UUT shows the UUT is reading below the output value. When the reference is negative, the error sign is relative to the magnitude. For example, if the reference is -10.00000 V and the output display is -10.00030, the error is -30 ppm.

4-48. **Using Multiply and Divide**

The 5520A output value (or reference value if you have edited the output) can be multiplied by a factor of 10 by pressing the  key. Similarly, the output value (or reference value if you have edited the output) can be divided a factor of 10 by pressing the  key. The output will be placed in STBY (Standby) if the multiplied value exceeds 33 V. Press the  key if you wish to continue. This feature is useful for UUTs with ranges organized in decades.

4-49. Setting Output Limits

An output limit feature is available to help prevent accidental damage to a UUT from overcurrent or overvoltage conditions. This feature allows you to preset the maximum positive and negative allowable voltage or current output. Entry limits you set prevent any output greater than the limit from being activated by entry through the front panel keys or the output adjustment controls. Positive limits for voltage and current set the limits for ac voltage and current. Your limit selections are saved in the nonvolatile memory. Voltage limits are expressed as rms values, and any voltage offsets are ignored.

4-50. Setting Voltage and Current Limits

To set voltage and current entry limits, proceed as follows:

1. Press **RESET** to clear any output from the 5520A.
2. Press **SETUP**. Press the softkey INSTMT SETUP to open the setup submenus.
3. Press the softkey OUTPUT SETUP to open the output setup submenus.
4. Press the softkey SET LIMITS to open the set limits menu (below).

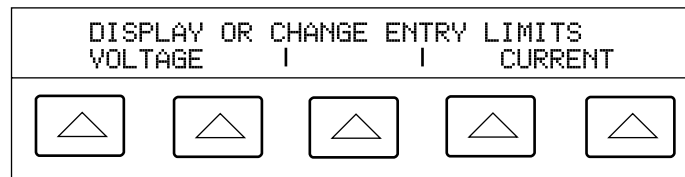

5. To Limit Voltage (applies to both dc and ac voltages). Press a softkey under VOLTAGE to open the voltage limits menu (below).

nn117f.eps

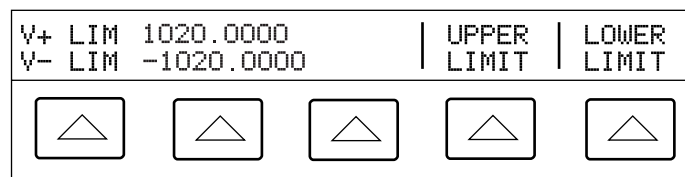

nn118f.eps

- a. Press the “Upper Limit” or the “Lower Limit” softkey, as desired, and enter the new limit.
- b. Press **ENTER** then **PREV MENU** one or more times to return to a previous menu.
6. To Limit Current (applies to both dc and ac currents). Press a softkey under CURRENT to open the current limits menu (below).

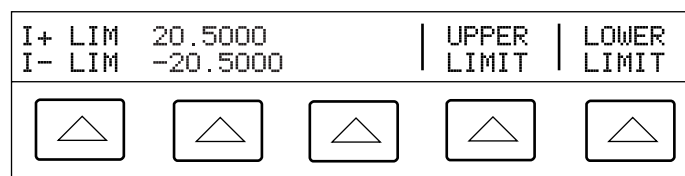

nn119f.eps

- a. Press the “Upper Limit” or the “Lower Limit” softkey, as desired, and enter the new limit.
- b. Press **ENTER** then **PREV MENU** one or more times to return to a previous menu.

4-51. Measuring Pressure

The 5520A can be used as a pressure calibrator when you use it with the following accessories:

To measure pressure:

- Fluke 700-Series Pressure Module
- Model 700PCK Pressure Calibration Kit (necessary because it provides the interface module)

To source pressure:

- A stable, hand-operated or automated pressure source
- Fluke 700-Series Pressure Module
- Model 700PCK Pressure Calibration Kit (necessary because it provides the interface module)

See Figure 4 for how to connect a 700 Series Pressure Module to the 5520A.

To connect a pressure module to the 5520A and display a pressure measurement, proceed as follows:

1. Connect the 700 Series Pressure Module to the 700PCK input jack, and connect the 700PCK power supply to line power.
2. Using the adapter supplied by the 700PCK, connect the serial data cable from the 700PCK to the SERIAL 2 TO UUT connector on the 5520A rear panel.
3. Press the **MORE MODES** key on the 5520A. This activates pressure mode.
4. The Output Display shows the pressure value measured by the 700 Series Pressure Module. The Control Display contains three softkeys: DAMPEN (on, off), SET OFFSET (zeros the pressure module), and UNITS (pressure units).
5. If you are using any 700 Series Pressure Module except an absolute-pressure type (Model Number starts with “700PA”), vent the pressure module to atmosphere and press OFFSET to zero the pressure module.
6. If you are using an absolute-pressure type module (Model Number starts with “700PA”) zero the pressure module as follows:
7. Vent the module to atmosphere.
8. Press SET OFFSET.
9. Enter the ambient atmospheric pressure in the units currently displayed.

Note

Do not rely on airport pressure reports. Use a barometric pressure standard in the same area as the calibrator.

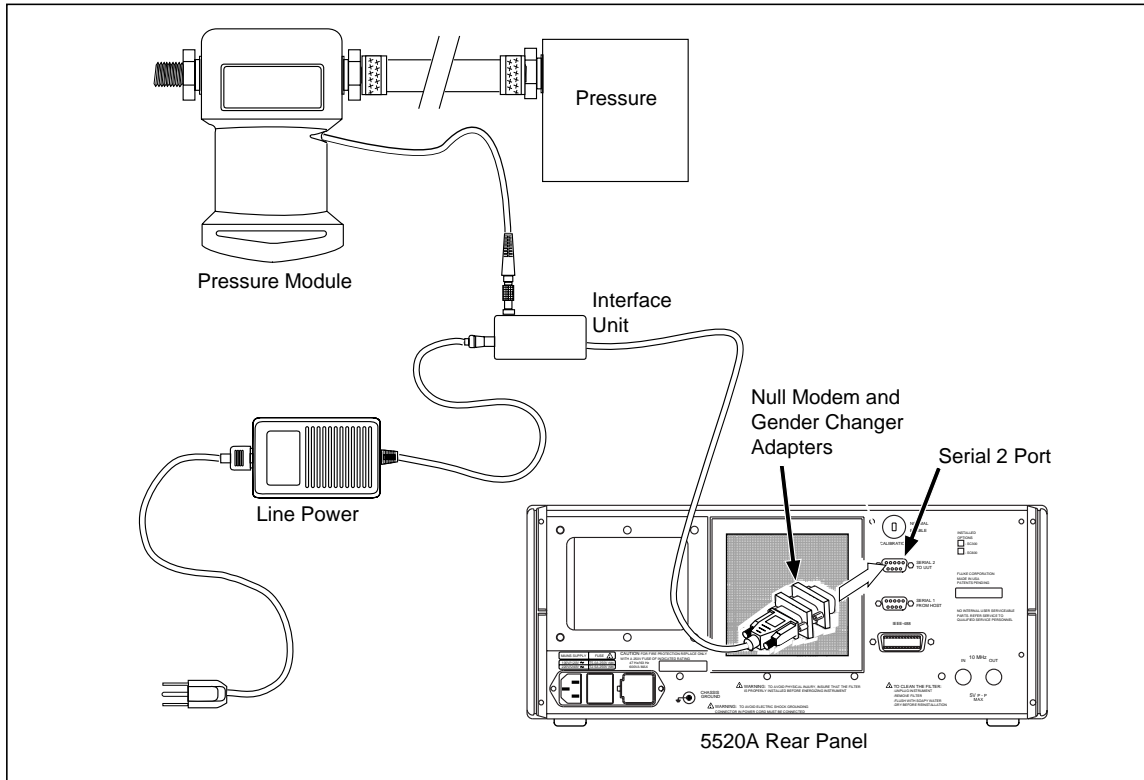

Figure 4-15. Measuring Pressure

nn226f.eps

4-52. Synchronizing the Calibrator using 10 MHz IN/OUT

You can synchronize one or more 5520A Calibrators using the 10 MHz IN and OUT input/output on the rear panel. Example applications of this capability are connecting two or more calibrators in parallel in the current output function to sum their outputs, or using three calibrators to calibrate a three-phase power meter.

Another use for the 10 MHz IN reference input is to improve the frequency performance of the 5520A by injecting a reference 10 MHz clock signal. That application is described next.

4-53. Using an External 10 MHz Clock

The calibrator uses an internal 10 MHz clock signal as a reference for all ac functions. Although this internal clock is very accurate and stable, you may have a lab standard that you want to have govern the frequency performance of the calibrator. To apply an external clock to the calibrator, you have two choices. You can make external reference the power-up and reset default condition, or you can select external reference as a volatile setting for the operating session only.

To make external reference the power-up and reset default setting, proceed as follows:

1. Connect a 10 MHz square wave signal of 5 V p-p (maximum) to the rear panel 10 MHz IN BNC connector.
2. Press the **SETUP** key.
3. Press the following sequence of softkeys: INSTMT SETUP, OUTPUT SETUP, ϕ & REF SETUP.
4. Press the REF CLK softkey to select “ext.”
5. Press the **PREV MENU** key.

To use an external 10 MHz reference on a temporary (volatile) basis, proceed as follows:

1. Connect a 10 MHz square wave signal of 1 to 5 V p-p to the rear panel 10 MHz IN BNC connector.
2. Press the **SETUP** key.
3. Set the calibrator output to an ac voltage or current function.
4. Press the following sequence of softkeys: INSTMT SETUP, OUTPUT SETUP, ϕ & REF SETUP.
5. Press the REF CLK softkey to select “ext.”
6. Press the **PREV MENU** key.

4-54. Sourcing AC Current with Parallel-Connected 5520As

You can connect two or more 5520As to source current in parallel. This technique allows you to source current greater than ± 20 A. If you are sourcing ac current, you must synchronize the calibrators in order to have their output currents in phase. Proceed as follows to accomplish this:

1. With both 5520As in standby mode, make the connections as shown in Figure 4-16.

2. On 5520A #2 (the slave), make the following settings:
 - Press the **SETUP** key.
 - Press the following sequence of softkeys: INSTMT SETUP, OUTPUT SETUP, ϕ & REF SETUP.
 - Press the REF CLK softkey to select “ext.”
 - Press the **PREV MENU** key.
3. On both 5520As, make the following settings:
 - Remaining in standby mode, set the outputs to the desired ac current level and frequency.
 - Set NRM ϕ REF in the ϕ & REF SETUP menus to 0.00.
4. On 5520A #2 (the slave), press **OPR** for operate mode.
5. On 5520A #1 (the master), press **OPR** for operate mode. Now the two 5520As are synchronized. There are two ways to synchronize: pressing **OPR** on the master, or pressing the SYNC softkey on the master.

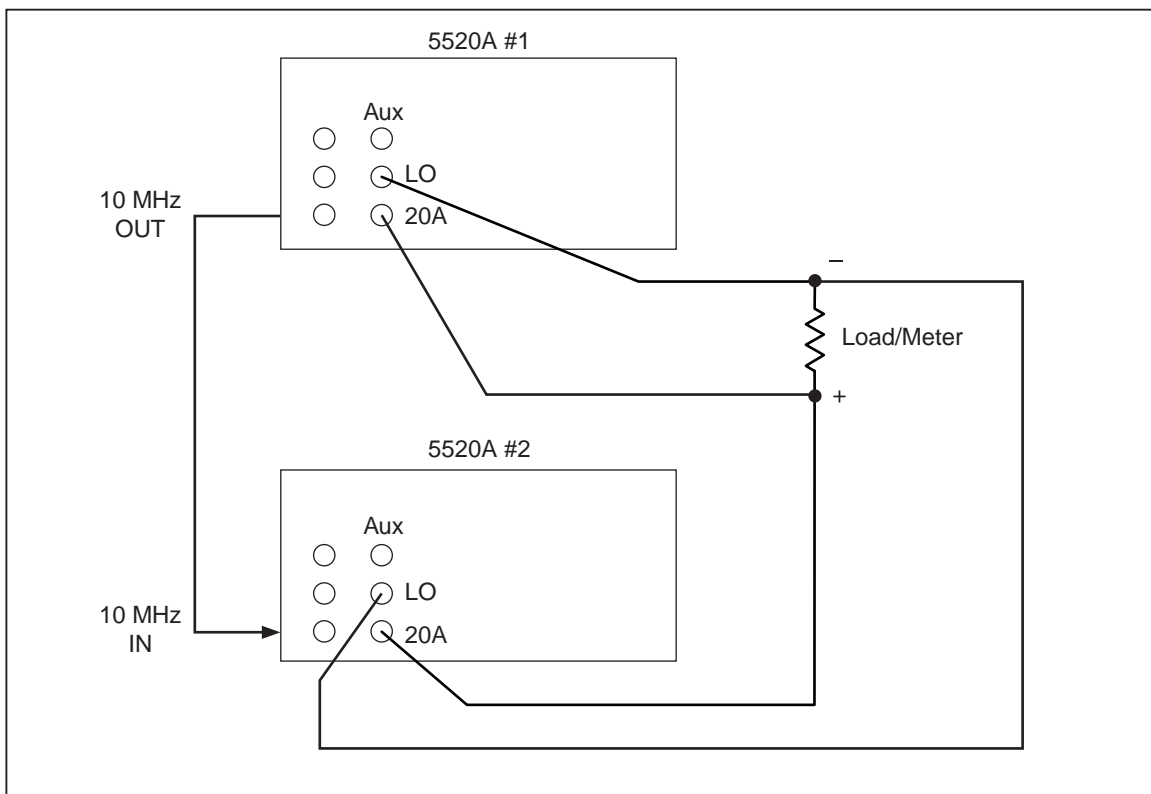

nn001f.eps

Figure 4-16. Two 5520As Sourcing Current in Parallel

4-55. Three-Phase Power Calibration

You can configure three 5520As to calibrate a three-phase power meter. This example uses the assumption that you want to apply a perfectly balanced calibration output with a unity power factor. By changing the phase relationships, you can apply other test stimulus. The figure shows the phase relationship of each 5520A. By changing the phase relationships, you can apply other test stimulus.

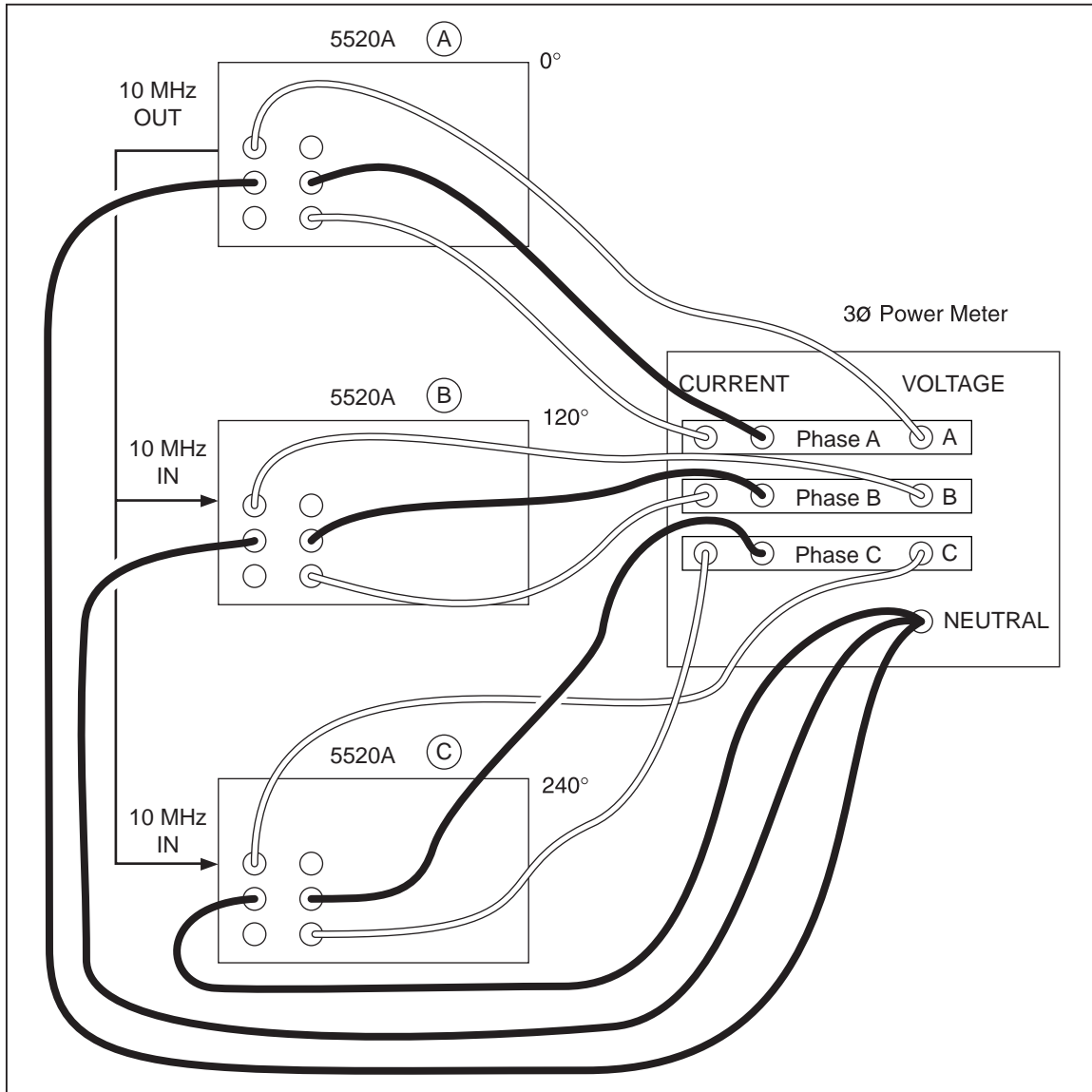

nn225f.eps

Figure 4-17. Three-Phase Power Calibration

4-56. Sample Applications

Samples of a few selected applications are provided here:

- Calibrating a Fluke 80 Series 3-1/2 digit handheld multimeter
- Calibrating a Fluke Model 41 Power Harmonics Analyzer for Power and Harmonics
- Calibrating a Fluke Model 51 Digital Thermometer

4-57. Calibrating an 80 Series Handheld Multimeter

This example goes through the steps necessary to calibrate a Fluke 80 Series handheld multimeter.

Note

These procedures are included here as an example. The 80 Series Service Manual contains the authoritative testing and calibration procedures for 80 Series meters.

Two procedures are provided. The first tests each function and range for compliance to specifications. The second is the calibration procedure for the 80 Series meters. The 80 Series Service Manual gives instructions for disassembly and access to the pca (printed circuit assembly). You will need to access the pca for the calibration procedure.

Before connecting the calibrator to the 80 Series DMM, you need to determine what type of cables to use and whether to use **EARTH** or not. This decision-making process is covered next.

4-58. Cables

Fluke 5440A-7002 Low-Thermal Cables are recommended for many calibrations connections, but they are not specifically required for 80 Series calibration. Thermal emf errors that the Low-Thermal cables are designed to reduce are not significant when calibrating a 3-1/2 digit meter. The cables support the following measurements:

- AC and dc voltages
- All resistances
- AC and dc currents up to 20 A

4-59. EARTH Connection

Because the 80 Series DMMs are battery operated, their inputs have no connection to earth ground. Therefore, enabling the calibrator's earth (chassis) ground to guard and LO is appropriate. connection is appropriate. (Press the **EARTH** key so that the indicator is lit, and make sure the **EXGRD** indicator is off.)

4-60. Testing the Meter

You can use the error mode feature of the calibrator to test the meter. To verify that all ranges of all functions are within specifications, proceed as follows:

1. Turn on the calibrator and allow it to warm up.

⚠ Warning

Ensure that the calibrator is in standby mode before making any connection between the calibrator and tester. Dangerous voltages may be present on the leads and connectors.

2. Verify that the calibrator is in standby and connect the DMM as shown in Figure 4-18.

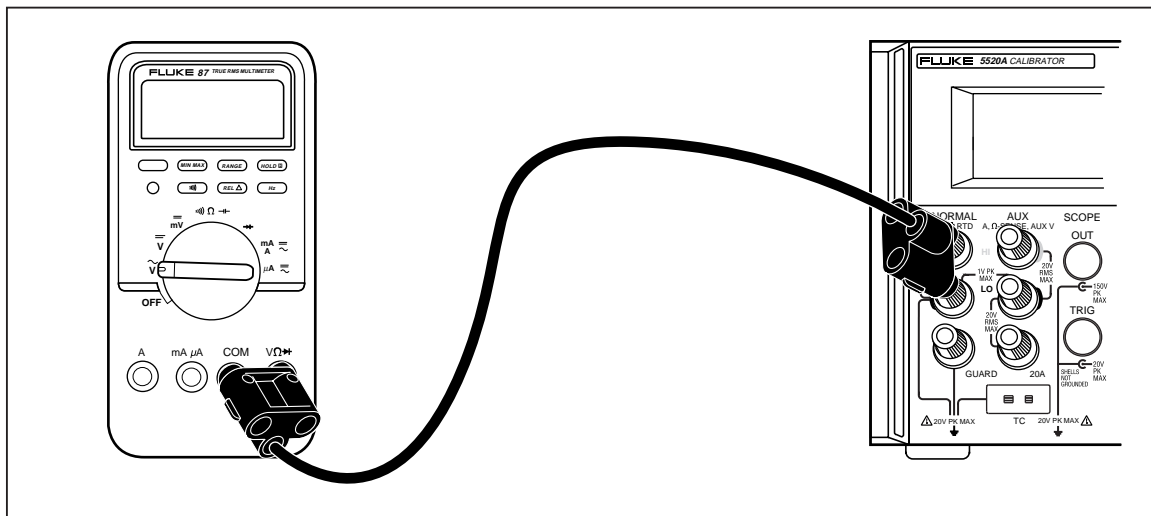

nn046f.eps

Figure 4-18. Cable Connections for Testing an 80 Series General Functions

3. Test the dc voltage function as follows:
 - a. Turn on the DMM and set its function switch to \bar{V} .
 - b. Set the warmed up calibrator to 3.5 V dc. Press **OPR**.
 - c. Use the output adjustment controls to adjust the calibrator output for a reading of +3.5000 on the DMM display.
 - d. Verify that the error shown on the control display is less than the specification for the DMM in its Users Manual.
 - e. Check the DMM error at 35.0 V, -35.0 V, 350.0 V. Hint: use the **MULT X**. Verify the errors are within specification. When **MULT X** causes the output to go over 33 V, the calibrator goes into standby. When this happens, press **OPR** to operate.
 - f. Check the DMM error at 1000 V to verify it is within specification.
 - g. Set the output of the calibrator to 350 mV and press **OPR**. Verify the errors are within specifications.

4. Test the ac voltage function:
 - a. Press **RESET** on the calibrator and set the DMM function switch to \tilde{V} .
 - b. Set the output of the calibrator to 350 mV at 60 Hz. and press **OPR**. Verify the errors are within specifications.
 - c. Check the error against specifications at the following voltages and frequencies:

Voltage	Frequency
350 mV	60 Hz, 5 kHz, & 20 kHz
3.500 V	60 Hz, 5 kHz, & 20 kHz
35.00 V	60 Hz, 5 kHz, & 20 kHz
329.0 V	60 Hz, 5 kHz, & 20 kHz
100.0 V	20 kHz
200.0 V	20 kHz
300.0 V	20 kHz
1000 V	60 Hz & 5 kHz

5. Test the Frequency function:
 - a. Press **RESET** on the calibrator, set the DMM function switch to \tilde{V} , and press Hz on the DMM.
 - b. Set the calibrator to 150 mV at 19.0 kHz and press **OPR**. Verify the error is within specification.
 - c. Set the calibrator to 150 mV at 190 kHz. Hint: press **EDIT FIELD** twice to move the cursor to the frequency reading in the output display and press **MULT X**. Verify the error is within specification.
6. Test Frequency Sensitivity and Trigger Levels:
 - a. Press **RESET** on the calibrator, set the DMM function switch to \tilde{V} and press Hz on the DMM to choose the frequency mode.
 - b. Set the calibrator to 300 mV at 1 kHz and press **OPR**. Verify the frequency error is within specification.
 - c. Change the calibrator output to 1.7 V. Verify the frequency error is within specification.
 - d. Change the calibrator output to 1.0 V. Verify that the DMM displays 000.0 frequency.
 - e. Change the DMM range to 40 V by pressing RANGE. Change the calibrator output to 6.0 V. Verify the frequency error is within specification.
 - f. Change the calibrator output to 2.0 V. Verify that the DMM displays 000.0 frequency.

7. Test the Ohms function as follows:
 - a. Press **RESET** on the calibrator and set the DMM function switch to $\Omega \rightarrow \vdash$.
 - b. Set the calibrator to 190.0 Ω with 2-wire compensation (see Figure 4-3). Press **OPR**. Verify the error is within specifications.
 - c. Repeat the previous step for 19.00 k Ω , 1.900 M Ω , and 19.00 M Ω . Verify the errors are within specifications.
 - d. Press RANGE on the DMM to enter the 40-nS range, used for conductance tests of high resistances.
 - e. Set the calibrator output to 100 M Ω . Verify the error is within specification.
8. Test the capacitance function as follows (use the REL feature of the 80 Series to subtract cable capacitance):
 - a. Press **RESET** on the calibrator and set the DMM function switch to $\Omega \rightarrow \vdash$ and press the blue key.
 - b. Set the calibrator output to 1.0 μF with compensation off. Press **OPR**. Verify the error is within specification.
 - c. Repeat the previous step using 0.470 μF , 0.047 μF , and 4.70 nF. Verify the errors are within specifications.
9. Test the Diode Test function as follows:
 - a. Press **RESET** on the calibrator and set the DMM function switch to $\rightarrow \vdash$.
 - b. Set the calibrator to 3.0 V dc and press **OPR**. Verify the error is within specification.
10. Test the ac and dc current function:
 - a. Press **RESET** on the calibrator and set the DMM function switch to mA $\equiv \equiv$.
 - b. Verify that the calibrator is in standby and connect the DMM as shown in Figure 4-19.

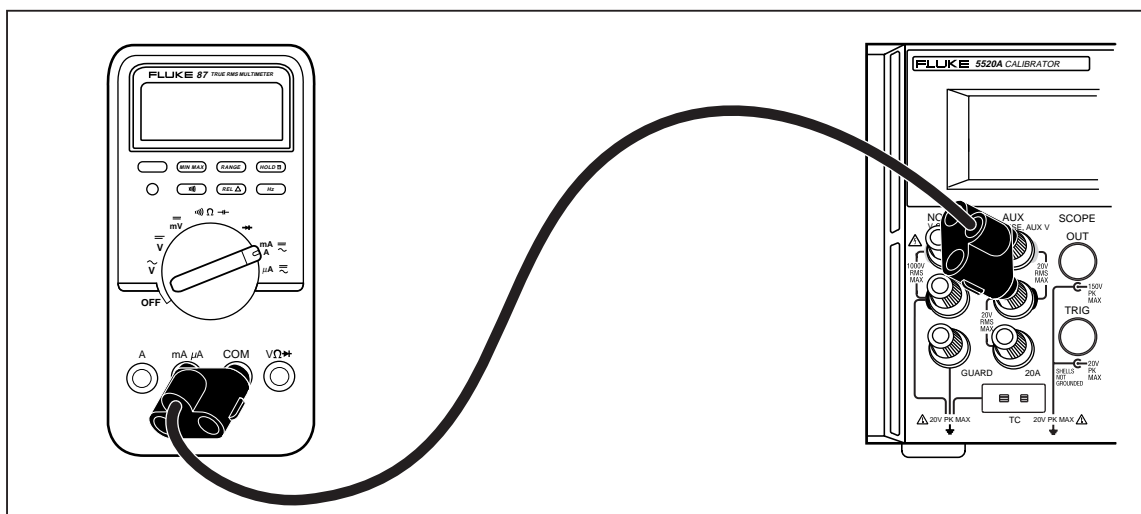

nn047f.eps

Figure 4-19. Cable Connections for Testing an 80 Series Current Function

- c. Set the calibrator to 35.0 mA and press **OPR**.
- d. Use the output adjustment controls to adjust the calibrator output for a reading of +35.00 mA on the DMM. Verify that the error shown on the control display is within specification.
- e. Repeat using 350.0 mA. Verify the error is within specification.
- f. Press the blue key on the DMM to switch to ac current measurement.
- g. Set the calibrator output to 35.0 mA at 60 Hz. Verify the error is within specification.
- h. Repeat the previous step with the following calibrator settings:

AC Current	Frequency
35.0 mA	1.0 kHz
350.0 mA	60 Hz
350.0 mA	1.0 kHz

- i. Press **STBY** on the calibrator and switch the DMM function switch to μA .
- j. Set the calibrator output to 350 μA at 0 Hz. and press **OPR**. Verify the error is within specification.
- k. Repeat the previous step using 3500 μA at 0 Hz.
- l. Press **STBY** on the calibrator and press the blue key on the DMM to switch to ac measurements.
- m. Set the calibrator output to 350.0 μA at 60 Hz and press **OPR**. Verify the error is within specification.
- n. Repeat the previous step with the following calibrator settings:

AC Current	Frequency
350.0 μA	1.0 kHz
3500.0 μA	60 Hz
3500.0 μA	1.0 kHz

11. Test the High current function.

- a. Press **RESET** on the calibrator.
- b. Verify that the calibrator is in standby and connect the DMM as shown in Figure 4-20.

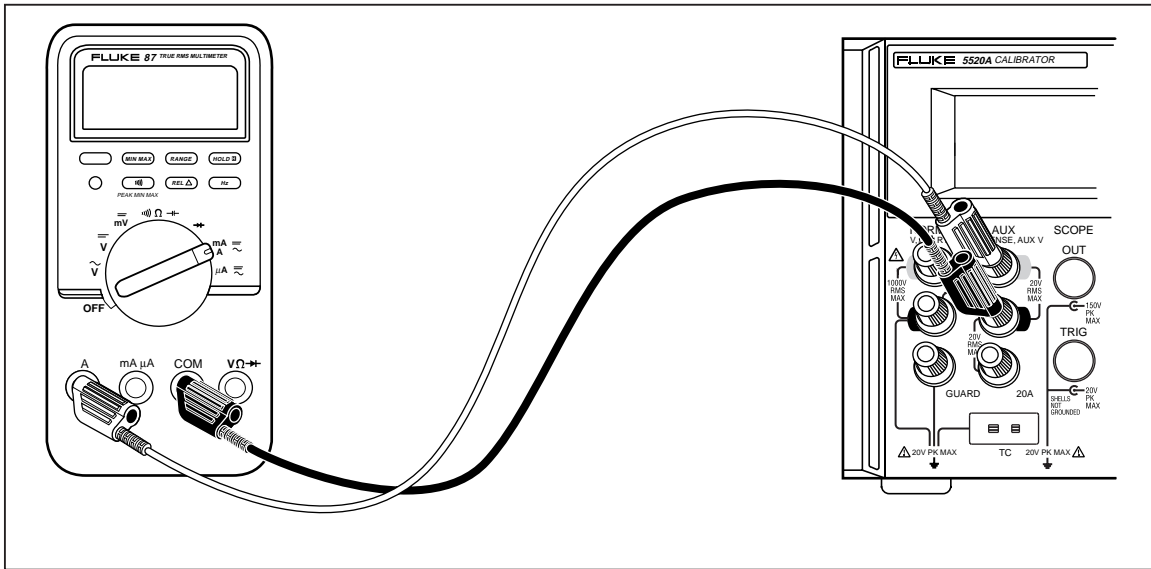

nn050f.eps

Figure 4-20. Cable Connections for Testing an 80 Series High Amps Function

- c. Set the calibrator output to 3.5 A at 0 Hz and press **OPR**. Verify the error is within specification.
- d. Repeat the previous step using 10.0 A at 0 Hz. Verify the error is within specification.
- e. Press **STBY** on the calibrator and press the blue key on the DMM to switch to ac measurements.
- f. Set the calibrator output to 3.5 A at 60 Hz and press **OPR**. Verify the error is within specification.
- g. Repeat the previous step using the following calibrator settings:

AC Current	Frequency
3.5 A	1.0 kHz
10.0 A	60 Hz
10.0 A	1.0 kHz

4-61. Calibrating the Meter

Continue with calibration if any range was out of tolerance in the previous procedure.

Note

The adjustment for calibrating the meter requires disassembling the meter. Refer to the diagrams and access procedures in the 80 Series Service Manual.

1. Verify that the calibrator is set to 0 V dc in standby. Press **RESET** if it is not.
2. Turn on the 80 Series DMM, and set its function switch to $\overline{\text{V}}$.
3. Connect a set of test leads to the DMM as shown in Figure 4-18.
4. Set the calibrator to 3.5 V dc and press **OPR**.
5. The DMM should now display 3.500 ± 0.001 . If necessary, adjust R21 to obtain the proper display.
6. Set the DMM function switch to $\tilde{\text{V}}$ and set the calibrator output to 3.500 V at 100 Hz.
7. The DMM should display 3.500 ± 0.002 . If necessary, adjust R34 to obtain the proper display.
8. Change the calibrator output to 10 kHz.
9. The DMM should display 3.500 ± 0.004 . If necessary, adjust C2 to obtain the proper display.
10. Change the calibrator output to 35.00 V at 10 kHz.
11. The DMM should display 35.00 ± 0.04 . If necessary, adjust C3 to obtain the proper display.

4-62. Testing a Model 41 Power Harmonics Analyzer

The Model 41 Power Harmonics Analyzer, hereafter referred to as the Tester, requires two voltages at varying phase relationships to test the functionality of the Power and Harmonics features. The procedure for testing these two functions of the Tester are included here to demonstrate the operation of the dual voltage function of the Fluke 5520A.

Note

These procedures are included here as an example. The Model 41 Service Manual contains the complete authoritative testing and calibration procedures.

4-63. Testing Watts, VA, VAR Performance

Perform the following procedure to test the Watts, VA, and VAR functions of the Tester. Refer to Table 4-3.

⚠ Warning

Ensure that the calibrator is in standby mode before making any connection between the calibrator and Tester. Dangerous voltages may be present on the leads and connectors.

Table 4-3. Watts Performance, Text Screen

Calibrator Outputs			Performance Limits							
Normal V ac @ 60 Hz	Phase in DEG.	AUX mV ac @ 60 Hz	W/KW		VA/KVA		VAR/KVAR Model 41 Only		Phase Harmonics Screen	
			MIN	MAX	MIN	MAX	MIN	MAX	MIN	MAX
5.0 V	0.0	30.0 mV	145	156	145	156	0	4	-2	2
8.0 V	0.0	30.0 mV	234	246	234	246	0	4	-2	2
100.0 V	157.0	150.0 mV	-14.3k	-13.3k	14.5k	15.6k	5.4k	6.3k	155	159
100.0 V	157.0	360.0 mV	-37k	-29k	32k	40k	10k	18k	155	159
10.0 V	46.0	1.40 V	9.2	10.2	13.5	14.5	9.6	10.6	44	48
100.0 V	46.0	1.40 V	92	102	135	145	96	106	44	48

1. Connect the calibrator to the Model 41 as shown in Figure 4-21.

Note

Voltage is connected to the Model 41 amps channel to simulate current clamp operation (1 mV = 1 A).

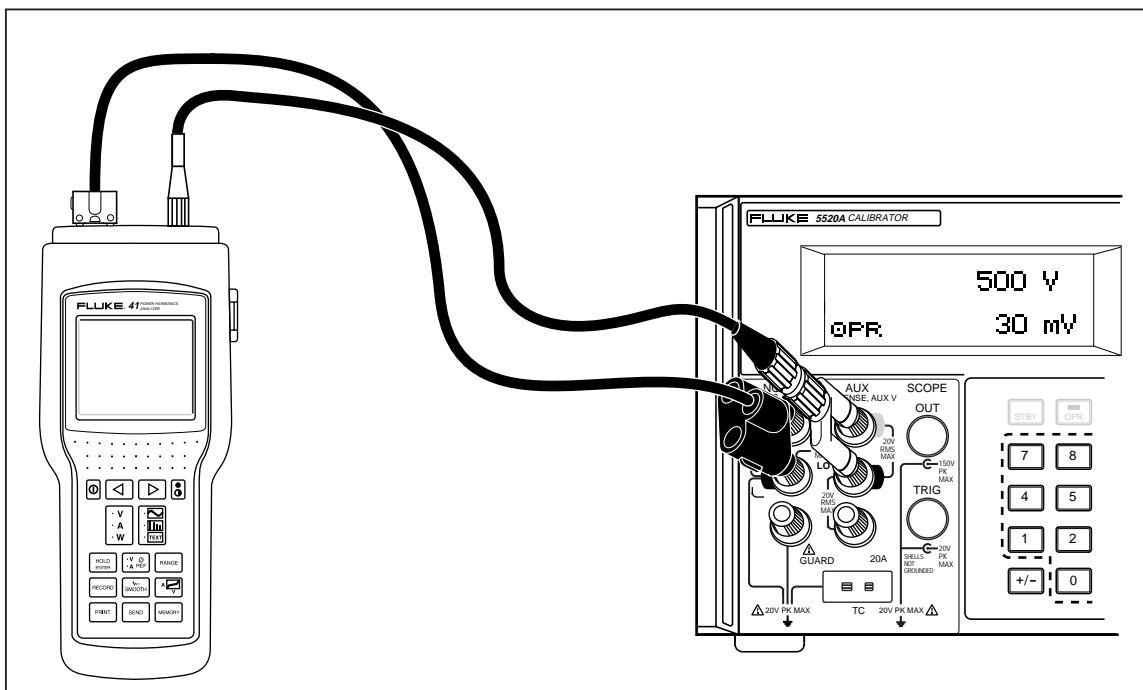

nn051f.eps

Figure 4-21. Cable Connections for Testing a 40 Series Watts Function

2. Verify that the EARTH indicator is lit; if not, press **EARTH**.
3. Set the calibrator output to 5.0 V at 60 Hz on the NORMAL output and 30 mV at 60 Hz on the AUX output.
4. Press the WAVE MENUS ,then the ϕ & REF MENUS softkey on the calibrator. Ensure the AUX ϕ NRM angle is 0.00 degrees. Press **OPR**.
5. Select W from VAW on the Tester.
6. Press the mode button on the Tester for the text screen mode. Verify that the W/KW, VA/KVA, and VAR/KVAR readings are within the minimum and maximum limits specified in Table 4-3.
7. Press the mode button on the Tester for the harmonics screen mode. Verify that the fundamental frequency phase angle readings are between the minimum and maximum readings listed in Table 4-3.
8. Repeat the previous three steps using the calibrator outputs and performance limits listed in Table 4-3.
9. Press **STBY** on the calibrator to remove the voltage from the Tester.

4-64. *Testing Harmonics Volts Performance*

1. Press the mode button on the Tester for the harmonics screen.
2. Press the VAW button on the Tester until V is displayed above the upper right corner of the harmonics screen.
3. Press the VA ϕ REF button on the Tester until A ϕ is displayed in the top status line.
4. Press the SMOOTH button on the Tester until ~20s is displayed in the top status line.
5. Connect the calibrator NORMAL output to the V and COM connectors on the Tester.
6. Connect the calibrator AUX output to the Current Probe connector on the Tester.
7. Set the calibrator output to 7.0 V at 60 Hz on the NORMAL output and 700 mV at 60-Hz on the AUX output. Press the WAVE MENUS, then the ϕ & REF MENUS softkey and ensure the phase angle is -10.0 degrees. Press the HARMONIC MENU softkey and ensure the HARMONIC selection is set to "1" and the FUNDMTL selection is set to "aux." Press **OPR**.
8. Move the Tester cursor to the corresponding harmonic number.

9. Verify that the harmonic amplitude and phase angle readings displayed by the Tester are within the minimum and maximum limits listed in Table 4-4. (Note: The Tester will read a positive phase when the 5520A output is a negative phase because, on the 5520A, the polarity of the phase is always relative to the NORMAL channel output.)
10. Repeat the previous three steps using the settings and limits in Table 4-4.

Table 4-4. Harmonics Performance for Volts, Harmonics Scree

5520A Normal Output			Fluke Tester	Performance Limits			
Amplitude (V)	Harmonic No.	Phase (deg.)	Harmonic cursor No.	Amplitude		Phase	
				MIN	MAX	MIN	MAX
7.00	1	-10	1	6.7	7.3	8	12
7.00	3	-20	3	6.7	7.3	14	26
7.00	9	-30	9	6.7	7.3	21	39
7.00	13	-40	13	6.7	7.3	29	51
7.00	21	-50	21	6.5	7.5	35	65
7.00	31	-60	31	6.2	7.8	40	80

11. Press to remove the voltage from the Tester.

4-65. Testing Harmonics Amps Performance

1. Press the VAW button on the Tester until A is displayed above the upper right corner of the harmonics display.
2. Press the VA ϕ REF button on the Tester until V ϕ is displayed in the top status line.
3. Press the SMOOTH button on the Tester until ~20s is displayed in the top status line of the Tester.
4. Connect the calibrator NORMAL output to the V and COM connectors on the Tester.
5. Connect the calibrator AUX output to the Current Probe connector on the Tester.
6. Set the calibrator output to 7.0 V at 60 Hz on the NORMAL output and 20 mV at 60 Hz on the AUX output. Press the WAVE MENUS, then the ϕ & REF MENUS softkey and ensure the phase angle is 10.00 degrees. Press the HARMONIC MENU softkey and ensure the HARMONIC selection is set to "1" and the FUNDMTL selection is set to "normal." Press **OPR**.
7. Verify that the harmonic amplitude and phase angle readings displayed by the Tester are within the minimum and maximum limits listed in Table 4-5.

Table 4-5. Harmonics Performance for Amps, Harmonics screen

5520A AUX Output			Fluke Tester	Performance Limits			
Amplitude (mV)	Harmonic No.	Phase (deg.)	Harmonic cursor No.	Amplitude		Phase	
				MIN	MAX	MIN	MAX
20.0	1	10	1	19.1	20.9	8	12
20.0	3	20	3	19.1	20.9	14	26
20.0	9	30	9	19.1	20.9	21	39
20.0	13	40	13	19.1	20.9	29	51
20.0	21	50	21	18.7	21.3	35	65
20.0	31	60	31	18.1	21.9	40	80

4-66. Calibrating a Fluke 51 Thermometer

The Fluke 51 Thermometer measures temperature using a type J or K thermocouple. The calibrator simulates both thermocouples, simplifying testing and calibration. The following demonstrates how the calibrator is used to calibrate this thermometer.

Note

These procedures are included here as an example. The Model 51 Service Manual contains the authoritative testing and calibration procedures.

4-67. Testing the Thermometer

The following test should be conducted only after the thermometer has had time to stabilize to an ambient temperature of $23\text{ }^{\circ}\text{C} \pm 5\text{ }^{\circ}\text{C}$ ($73\text{ }^{\circ}\text{F} \pm 9\text{ }^{\circ}\text{F}$).

1. Connect the Fluke 51 Thermometer to the calibrator using the appropriate connection cable (Figure 4-22). The connection cable and miniconnector material must match the thermocouple type. For example, if testing a K thermocouple, the cable and miniconnector are for a type K thermocouple.

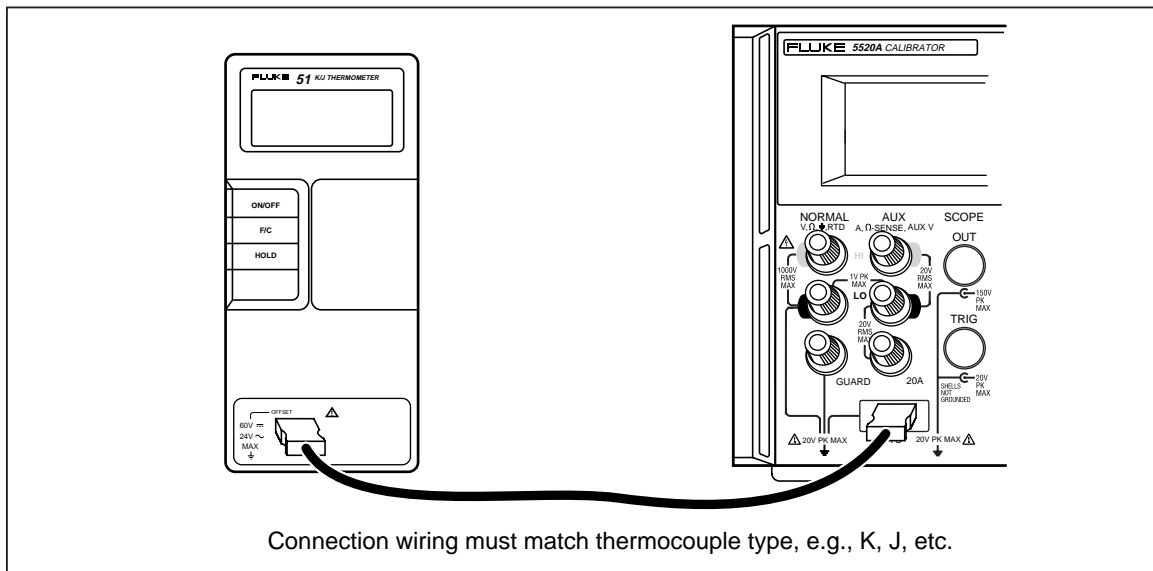

nn049f.eps

Figure 4-22. Cable Connections for Testing a 50 Series Thermometer

2. Verify that the EARTH indicator is lit; if not, press **EARTH**.
3. Set up the calibrator by pressing **0** **°C** **ENTER**. Ensure the softkey labeled OUTPUT indicates “tc”. If not, press the OUTPUT softkey until it does.
4. Select the thermocouple type and reference source by pressing the TC MENU softkey. Ensure the REF SRC softkey selection indicates “intrnl.” If not, press the REF SRC softkey. Ensure the TYPE softkey indicates either J or K, depending on which one the 51 is set to. Continue to press the TYPE softkey until the selected thermocouple type is displayed.
5. Enter the calibrator settings listed in Table 4-6 and verify performance is within specifications (see Chapter 1).

Table 4-6. Thermocouple Performance

Thermocouple Type [1]	5520A Setting	Display Readings	
		Degrees C	Degrees F
K	-182.0 °C	-182.0 ±(0.9)	-295.6 ±(1.6)
K	-80.0 °C	-80.0±(0.8)	-112.0 ±(1.4)
K	530.0 °C	530.0 ±(1.2)	986.0 ±(2.3)
K	1355.0 °C	1355.0 ±(2.1)	2471.0 ±(3.8)
J	-197.0 °C	-197.0 ±(1.0)	-322.6 ±(1.7)
J	258.0 °C	258.0 ±(1.1)	496.4 ±(1.9)
J	705.0 °C	705.0 ±(1.5)	1301.0 ±(2.7)

[1] When changing thermocouple types, be use to change the corresponding hookup wire, e.g., K-type thermocouple wire changes to J-type thermocouple wire.

4-68. Calibrating the Thermometer

The following procedure refers to the Fluke 51 as the Unit Under Test (UUT). Use copper hookup wire for all connections, except for steps 17 to 20.

Caution

When you are directed to short a switch grid on the 51, use only the elastomeric switch pad that is supplied, because you could damage the printed circuit assembly (pca) if a hard tool is used.

1. Turn the UUT off and remove the top case, leaving the pca in the bottom case.
2. Ensure the calibrator is in standby and connect the UUT to the calibrator as shown in Figure 4-22. When making this connection with the UUT case top removed, make sure that the wide blade is oriented the same as the case top would normally allow.
3. Simultaneously short the TP1 grid and turn on the UUT by shorting the ON/OFF switch grid. Hold the elastomeric switch pad on TP1 for at least 3 seconds after turn on. This puts the UUT into the Thermocouple Calibration mode.
4. Select °C mode and T1 on the UUT.

Note

The next few steps require specific voltages to be present on the inputs of the Thermometer. By using the 10 µV/ °C type thermocouple selection of the calibrator, you can specify the output voltage on the TC terminals.

5. Press **0**, **°C** and **ENTER**. Ensure the softkey labeled OUTPUT indicates “tc”. If not, press the OUTPUT softkey until it does.
6. Press the TYPE softkey until 10µV/°C is displayed. This selection allows you to specify the voltage on the TC terminal.
7. Press the TC MENU softkey.

8. Press REF SRC softkey until “external” is displayed.
9. Press the REF softkey to enter an external reference value.
10. Press **0** and **ENTER** to set the external reference to 0 °C.
11. Press **PREV MENU** to go back one menu level.
12. Press **OPR**.
13. Allow the UUT reading to settle and then adjust the T1 offset adjustment (R7) for a display reading of 25.2 °C ± 0.1 °C.
14. Change the calibrator output to 5380.7 °C. This places 53.807 mV on the tc terminals.
15. Allow the UUT reading to settle and adjust R21 for a display reading of +1370.0 °C ± 0.4°C.
16. Press **STBY** on the calibrator to remove voltage from the UUT. Disconnect the UUT from the 5520A. Power down the UUT by shorting the ON/OFF switch grid.
17. With an elastomeric switch pad in both hands, use the left one to short out the TP2 grid, and use the right one to first turn on the instrument and then quickly short out the VIEW switch grid. Hold this position until the display is held in self-test. This puts the UUT into the Reference Junction Sensor calibration mode, and the VIEW maneuver turns off a filter so that the reading settled immediately.
18. Using a type K thermocouple bead (supplied with the 5500A/LEADS test lead kit) and the 5520A Calibrator MEAS TC mode (press **MEAS TC**), measure the reference junction transistor temperature by placing the K-bead into the middle hole of the isothermal block. The bead tip should be placed into the well, against the body of Q1. Hint: Covering the well and positioning the bead with a piece of tissue may help the bead stay in place. Do not hold the bead in place with your hands as this may introduce a measurement error. Wait for the temperature reading to stabilize.
19. Adjust R16 for a temperature reading on the UUT that is the same as displayed on the 5520A Calibrator.

Power down the UUT and reassemble.

Chapter 5

Remote Operation

Contents		Page
5-1.	Introduction.....	5-4
5-2.	Setting up the IEEE-488 Port for Remote Control	5-6
5-3.	IEEE-488 Port Setup Procedure	5-8
5-4.	Testing the IEEE-488 Port.....	5-9
5-5.	Setting up the RS-232 Host Port for Remote Control	5-10
5-6.	RS-232 Host Port Setup Procedure	5-10
5-7.	Testing the RS-232 Host Port.....	5-13
5-8.	Testing RS-232 Host Port Operation using a Terminal	5-13
5-9.	Testing RS-232 Host Port Operation using Visual Basic	5-15
5-10.	Setting up the RS-232 UUT Port for Remote Control.....	5-16
5-11.	RS-232 UUT Port Setup Procedure.....	5-16
5-12.	Testing the RS-232 UUT Port via RS-232 Host Port.....	5-18
5-13.	Testing RS-232 UUT Port Operation via a Terminal	5-18
5-14.	Testing RS-232 UUT Port Operation using Visual Basic	5-19
5-15.	Testing the RS-232 UUT Port via IEEE-488 Port.....	5-20
5-16.	Changing between Remote and Local Operation	5-22
5-17.	Local State.....	5-22
5-18.	Local with Lockout State	5-22
5-19.	Remote State.....	5-22
5-20.	Remote with Lockout State	5-22
5-21.	RS-232 Interface Overview	5-23
5-22.	IEEE-488 Interface Overview.....	5-24
5-23.	Using Commands.....	5-26
5-24.	Types of Commands.....	5-26
5-25.	Device-Dependent Commands.....	5-26
5-26.	Common Commands	5-27
5-27.	Query Commands.....	5-27
5-28.	Interface Messages (IEEE-488)	5-27
5-29.	Compound Commands.....	5-29
5-30.	Coupled Commands	5-29
5-31.	Overlapped Commands.....	5-30
5-32.	Sequential Commands.....	5-30
5-33.	Commands that Require the Calibration Switch.....	5-31
5-34.	Commands for RS-232 Only.....	5-31
5-35.	Commands for IEEE-488 Only	5-32

5-36.	Command Syntax	5-33
5-37.	Parameter Syntax Rules	5-33
5-38.	Extra Space or Tab Characters.....	5-34
5-39.	Terminators	5-35
5-40.	Incoming Character Processing.....	5-35
5-41.	Response Message Syntax	5-36
5-42.	Checking 5520A Status	5-37
5-43.	Serial Poll Status Byte (STB).....	5-37
5-44.	Service Request (SRQ) Line	5-39
5-45.	Service Request Enable Register (SRE)	5-39
5-46.	Programming the STB and SRE.....	5-40
5-47.	Event Status Register (ESR).....	5-40
5-48.	Event Status Enable (ESE) Register	5-40
5-49.	Bit Assignments for the ESR and ESE	5-40
5-50.	Programming the ESR and ESE.....	5-41
5-51.	Instrument Status Register (ISR).....	5-42
5-52.	Instrument Status Change Registers.....	5-42
5-53.	Instrument Status Change Enable Registers	5-42
5-54.	Bit Assignments for the ISR, ISCR, and ISCE	5-42
5-55.	Programming the ISR, ISCR, and ISCE.....	5-44
5-56.	Output Queue	5-44
5-57.	Error Queue	5-45
5-58.	Remote Program Examples.....	5-45
5-59.	Guidelines for Programming the Calibrator	5-45
5-60.	Writing an SRQ and Error Handler.....	5-46
5-61.	Verifying a Meter on the IEEE-488 Bus	5-47
5-62.	Verifying a Meter on the RS-232 UUT Serial Port.....	5-47
5-63.	Using *OPC?, *OPC, and *WAI.....	5-47
5-64.	Taking a Thermocouple Measurement.....	5-48
5-65.	Taking a Pressure Measurement.....	5-48
5-66.	Using the RS-232 UUT Port to Control an Instrument	5-49
5-67.	Input Buffer Operation	5-49

⚠ Warning

The 5520A Calibrator (hereafter referred to as “The Calibrator”) can produce voltages up to 1000 V rms and must be programmed with caution to prevent hazardous voltages from being produced without sufficient warning to the operator.

Write programs carefully and test them extensively to ensure safe operation of the Calibrator. Fluke suggests that you include error-catching routines in your programs. These error-catching routines will help you identify programming errors that may cause the Calibrator to behave other than intended. You can program the Calibrator to cause an SRQ when an error is detected by setting the Service Request Enable (SRQ) register. The following skeleton program includes error-catching code:

```
10 PRINT @4, "*CLS"           ! Clear status
20 PRINT @4, "*SRE 8"         ! Set SRE Error Available
30 ON SRQ GOTO 1000          ! Enable SRQ Function
100                           ! Place body of program here

900 STOP                     ! End of program

1000 REM Start of SRQ Handler ! Start routine
1010 PRINT @4, "FAULT?"      ! Request fault code
1020 INPUT @4, A%            ! Input fault code
1030 PRINT @4, "EXPLAIN? ";A% ! Request fault text
1040 INPUT @4, A$            ! Input fault text
1050 PRINT "Fault ";A$ detected" ! Print message
1060 PRINT @4, "STBY"        ! Place 5520A in standby
1070 STOP
```

5-1. Introduction

This chapter describes methods for operating the Calibrator by remote control. Remote control can be interactive, with the user controlling each step from a terminal, or under the control of a computer program running the Calibrator in an automated system. The Calibrator rear panel has three ports for remote operations: IEEE-488 parallel port (also known as a General Purpose Interface Bus, or GPIB port), and two RS-232 serial ports, SERIAL 1 FROM HOST and SERIAL 2 TO UUT.

IEEE-488 The IEEE-488 parallel port is usually used in larger control and calibration systems. An IEEE-488 system is more costly to set up, but has the ability to serve multiple Calibrators and multiple UUTs. Also, parallel system throughput is faster than serial system throughput. The controller in an IEEE-488 system is typically a MS-DOS compatible personal computer (PC) equipped with one or more IEEE-488 ports. You can write your own computer programs for system operation using the command set, or you can purchase optional Fluke calibration software MET/CAL or 5520A/CAL, and property management software MET/TRACK. Typical IEEE-488 configurations are shown in Figure 5-1. The configuration showing the PC with two IEEE-488 ports is used with MET/CAL, which prefers UUTs on a separate IEEE-488 port. You can also “piggy-back” the connectors on a single IEEE-488 port.

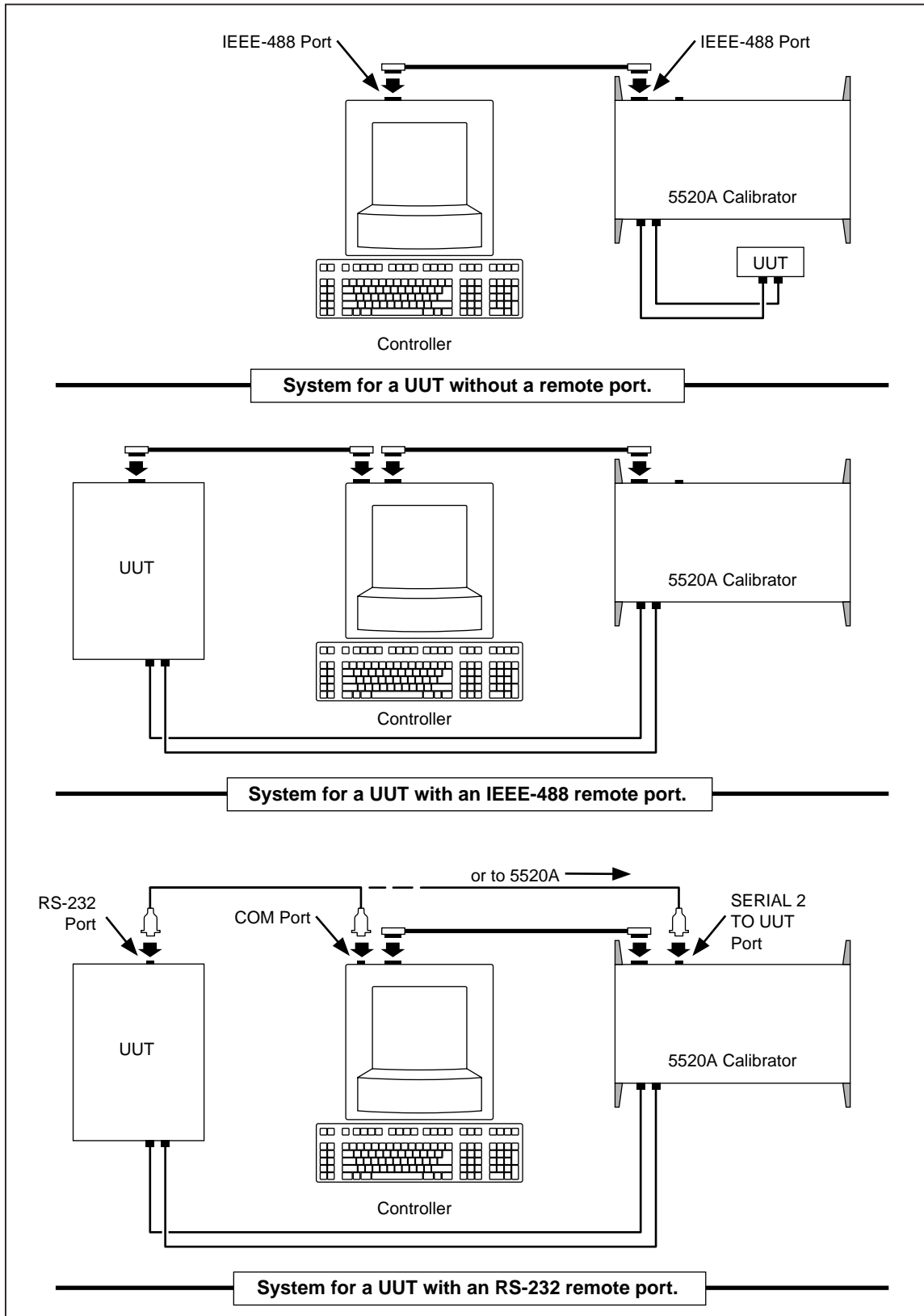

NN300F.EPS

Figure 5-1. Typical IEEE-488 Remote Control Connections

RS-232 The SERIAL 1 FROM HOST serial port connects the PC and Calibrator, while the SERIAL 2 TO UUT serial port acts as a pass-through port, passing commands from the PC to UUT via the Calibrator. You can write your own computer programs using the command set, or operate the PC as a terminal and enter individual commands, or you can purchase optional Fluke MET/CAL or 5520/CAL software for RS-232 system operations. Typical RS-232 remote configurations are shown in Figure 5-2.

After configuring the IEEE-488 or RS-232 port for remote operation, you are ready to begin using the command set. The operation of the command set is described under “Using Commands” in this chapter. A summary of remote commands is in Chapter 6, “Remote Commands.”

5-2. Setting up the IEEE-488 Port for Remote Control

The Calibrator is fully programmable for use on the IEEE Standard 488.1 interface bus. The IEEE-488 interface is also designed in compliance with supplemental standard IEEE-488.2, which describes additional IEEE-488 features. Devices connected to the IEEE-488 bus are designated as talkers, listeners, talker/listeners, or controllers. Under remote control of an instrument, the Calibrator operates as a talker/listener.

A PC equipped with an IEEE-488 interface, controls the the Calibrator. Compatible software for IEEE-488 operation may be purchased from Fluke, including METCAL and METRACK. Another software package, 5520/CAL, is also available but operates only on the RS-232 serial interface.

When using the IEEE-488 remote control interface, there are two restrictions:

1. **Number of Devices** A maximum of 15 devices can be connected in a single IEEE-488 bus system. For example, one instrument controller, one Calibrator, and thirteen units under test (UUTs).
2. **Cable Length** The total length of IEEE-488 cables used in one IEEE-488 system is 2 meters times the number of devices in the system, or 20 meters, whichever is less. For example, if 8 devices are connected, the maximum cable length is $2 \times 8 = 16$ meters. If 15 devices are connected, the maximum cable length is 20 meters.

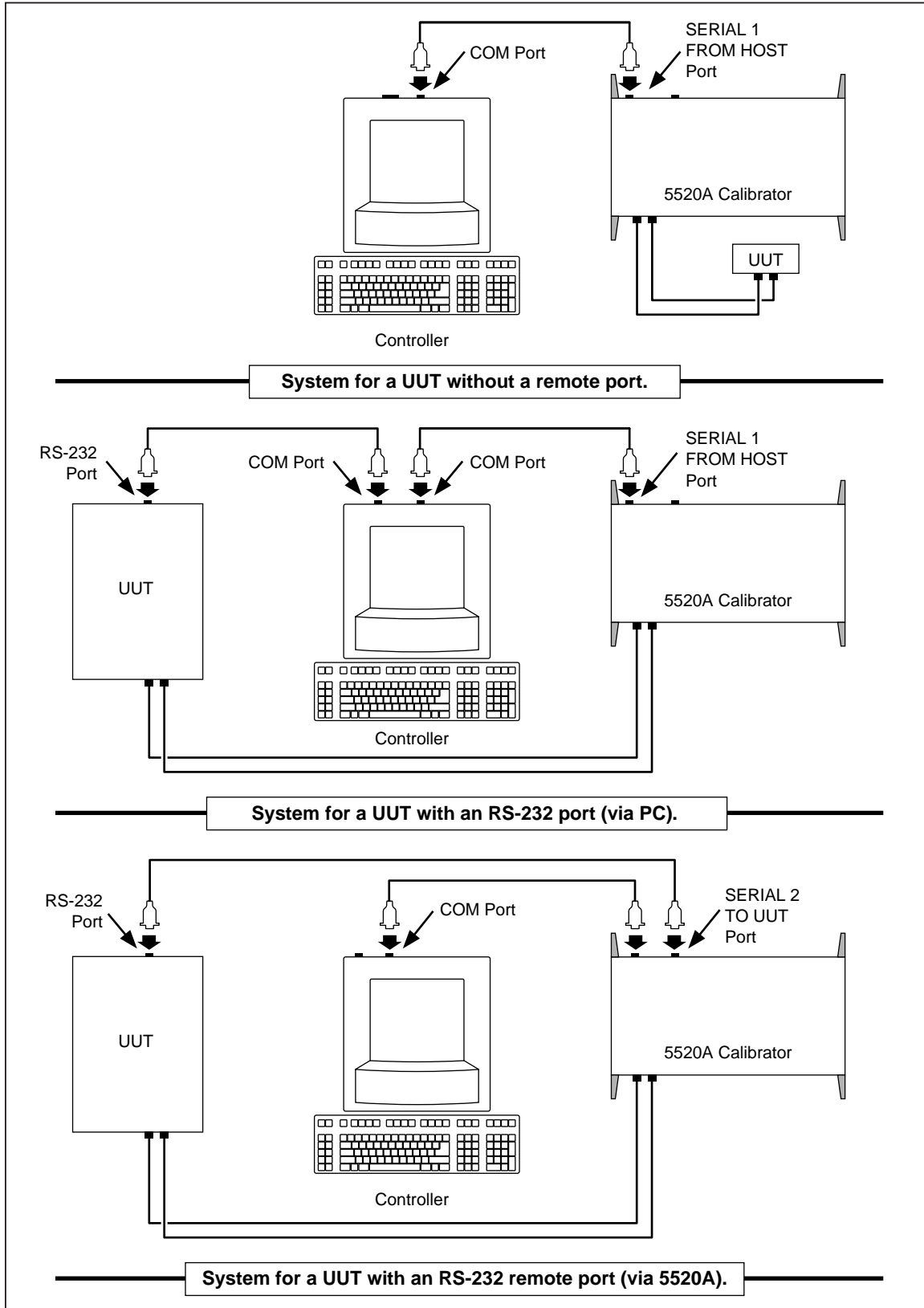

nn301f.eps

Figure 5-2. Typical RS-232 Remote Control Connections

5-3. IEEE-488 Port Setup Procedure

Complete the following procedure to set up the Calibrator for remote operations using the IEEE-488 remote control port. The purpose is to select GPIB as the interface and to select the GPIB address for the interface.

1. Turn the Calibrator power on. You may operate the Calibrator during warmup, but specifications are not guaranteed until warmup is complete.
2. Press **SETUP** on the Calibrator front panel.
3. Negotiate the softkey selections shown below. Verify the HOST port selection is gpib. Select the desired GPIB port address (0 to 30) using the UP/DOWN softkeys. The factory default is 4.

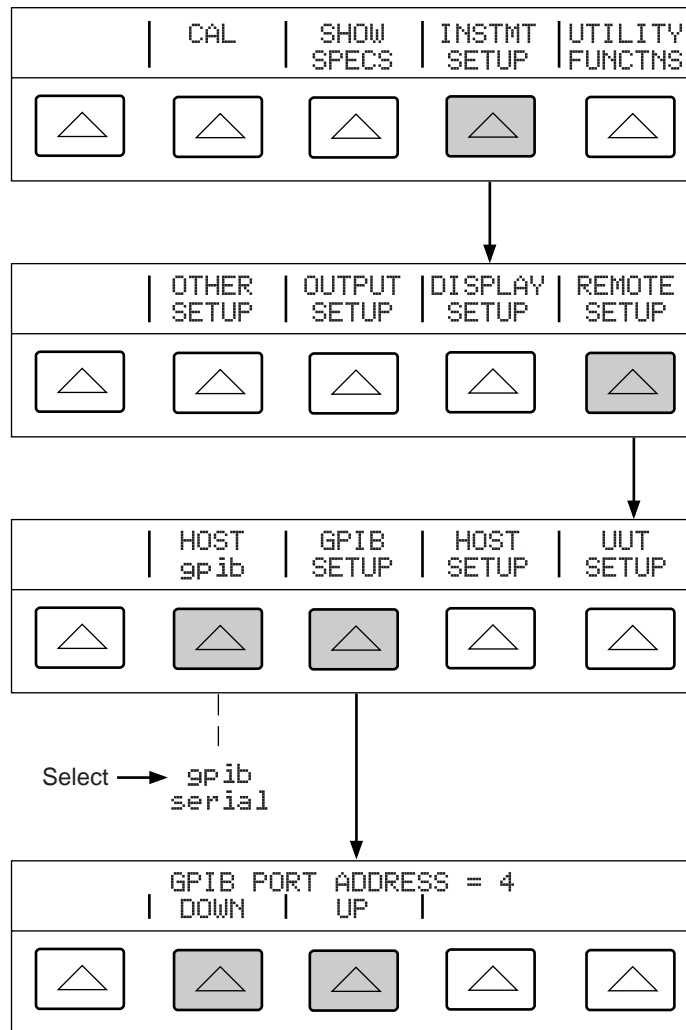

4. Press **PREV MENU** (not **ENTER**) several times until the message STORE CHANGES/DISCARD CHANGES appears or, if there were no changes, the reset display. If you select STORE CHANGES, the gpib and host port setting are saved in the instrument non-volatile memory.

nn120f.eps

5-4. Testing the IEEE-488 Port

The procedure below tests IEEE-488 communications between the PC and the Calibrator using the Win32 Interactive Control utility. This utility is supplied with National Instruments interface cards for the PC, which are the recommended interfaces. (See Chapter 9, “Accessories.”) A typical connection is shown in Figure 5-3.

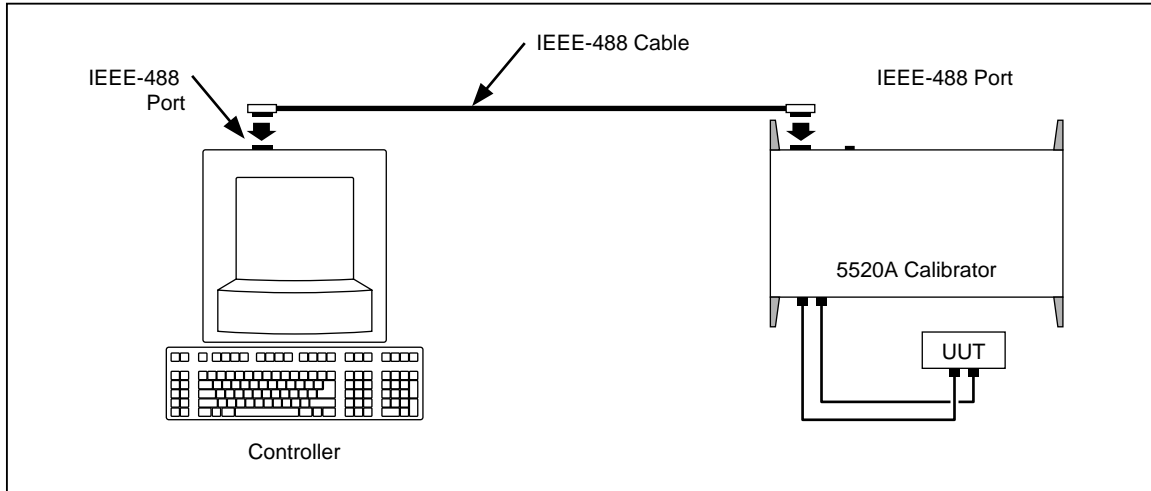
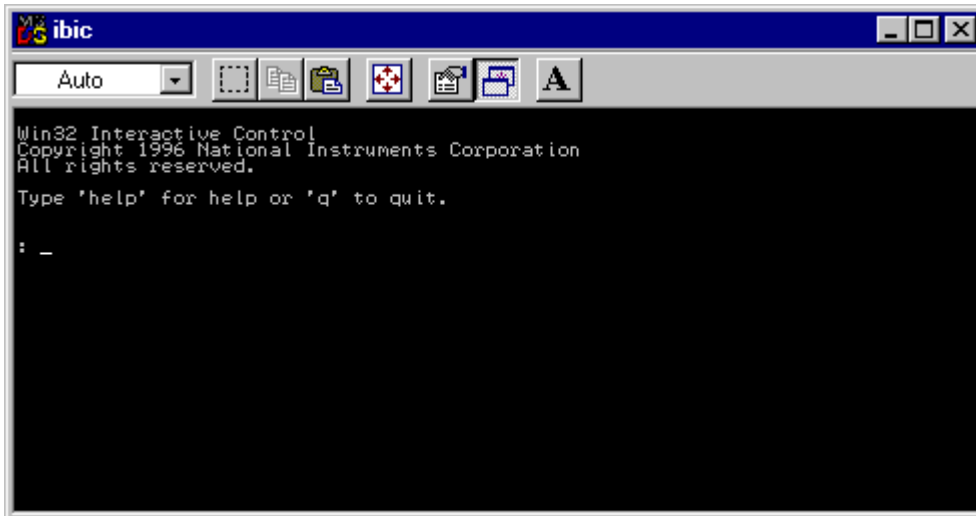

Figure 5-3. Testing the IEEE-488 Port

nn302f.eps

Complete the following procedure to test IEEE-488 operation using Win32 Interactive Control.

1. Complete the “IEEE-488 Port Setup Procedure” earlier in this chapter to set up the 5520A for GPIB operation. Note the GPIB Address Port (default is 4).
2. Connect the PC and 5520A IEEE-488 ports using a standard IEEE-488 cable. (See Chapter 9, “Accessories,” for IEEE-488 cables available from Fluke.)
3. From the programs menu, select "NI-488.2M software for...(your operating system)".
4. From the NI488.2M software menu, select "Win32 interactive control".
5. A DOS window opens with a prompt as shown here:



- At the prompt type the following line to activate the IEEE interface card:

```
<ibdev 0 4 0 10 1 0>
```

The second number in this line is the primary address of the calibrator. If the address has been changed from the factory default, change this line accordingly.
- The prompt reads <ud0:>. From this prompt type <ibwrt "remote"> then press the ENTER (or RETURN) key.
- Verify that the calibrator is now in remote control.
- Select the Local command from the Control menu, then click OK in the Parameter Input Window. Observe the Calibrator Control Display changes back to the reset condition (below).

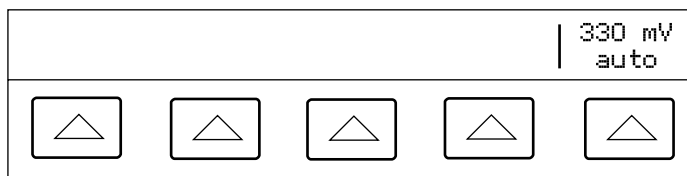

nn323f.eps

- From the ud0: prompt, type <q> and then press the ENTER (or RETURN) key.

5-5. Setting up the RS-232 Host Port for Remote Control

The Calibrator is fully programmable over an RS-232 link with a PC the rear panel SERIAL 1 FROM HOST port (Figure 5-2). You can enter individual commands from a terminal, write your own programs using, for example, a Windows-based language such as Visual Basic, or run optional Windows-based Fluke software such as 5520/CAL or MET/CAL.

The RS-232 cable length for the port should not exceed 15 meters (50 feet), although longer cable lengths are permitted if the load capacitance measured at a connection point (including signal terminator) does not exceed 2500 pF.

5-6. RS-232 Host Port Setup Procedure

Complete the following procedure to set up the SERIAL 1 FROM HOST port. The RS-232 parameters you select here must match the parameters set for the PC COM port. The factory defaults (shown on the display below) are 9600 baud, 8 data bits, 1 stop bit, and no parity. Other parameters include flow control, EOL (end-of-line) character, and EOF (end-of-file) characters.

- Turn the Calibrator power on. You may operate the Calibrator during warmup, but specifications are not guaranteed until warmup is complete.
- Press **SETUP** on the Calibrator front panel.
- Negotiate the softkey selections shown below to select the serial port for remote operation, then continue to Step 4.

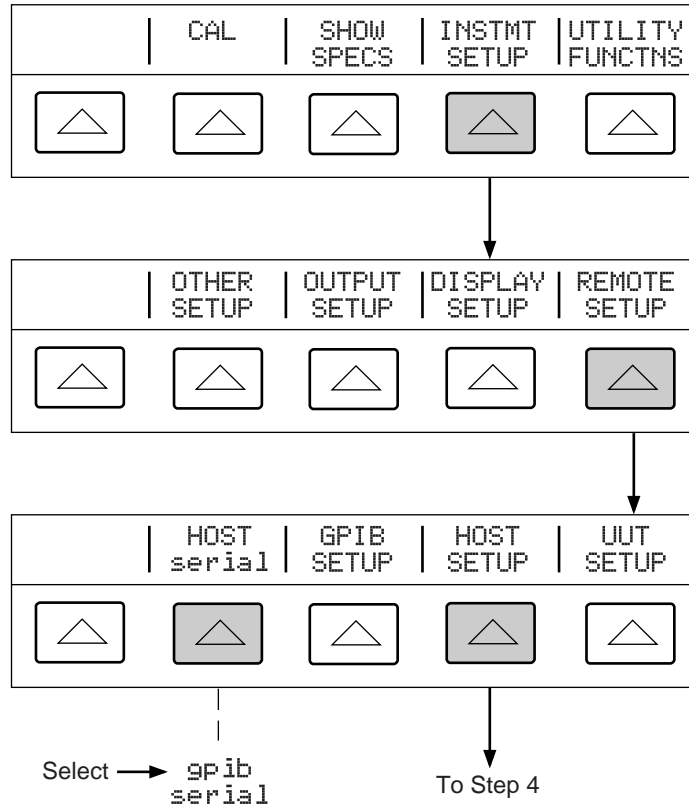

nn121f.eps

4. Negotiate the softkey selections shown below to select the HOST serial port parameters to match the PC COM parameters. (Individual softkey functions are discussed in Chapter 3, "Features.") If operating the port with a computer program instead of individual commands from a terminal, select Remote I/F **comp**.

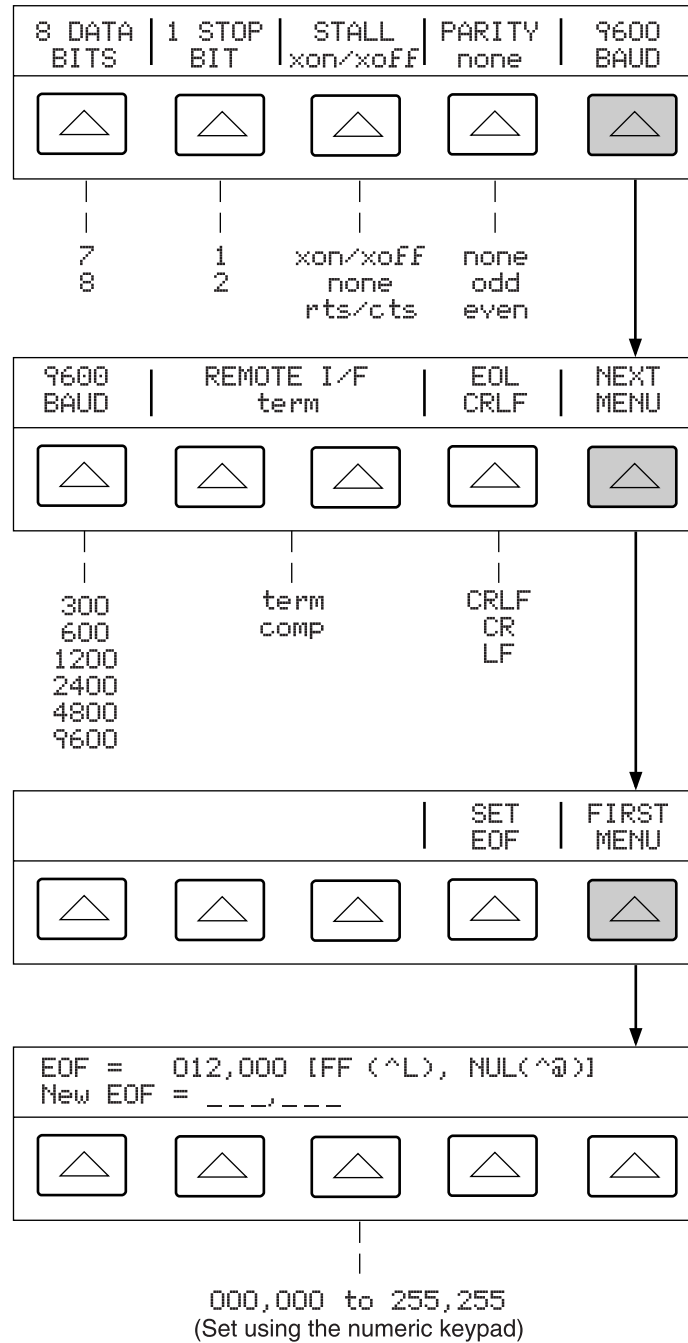

nn122f.eps

5. Press **PREV MENU** (not **ENTER**) several times until the message STORE CHANGES/DISCARD CHANGES appears or, if there were no changes, the reset display. If you select STORE CHANGES, the serial and host port setting are saved in the instrument non-volatile memory.

5-7. Testing the RS-232 Host Port

Choose or adapt one of the following test procedures to test the Calibrator RS-232 Host port connected to a PC COM port. A typical connection is shown in Figure 5-4. Note the use of a null modem cable for connection. (See Appendix C for information about RS-232 cables and connectors.)

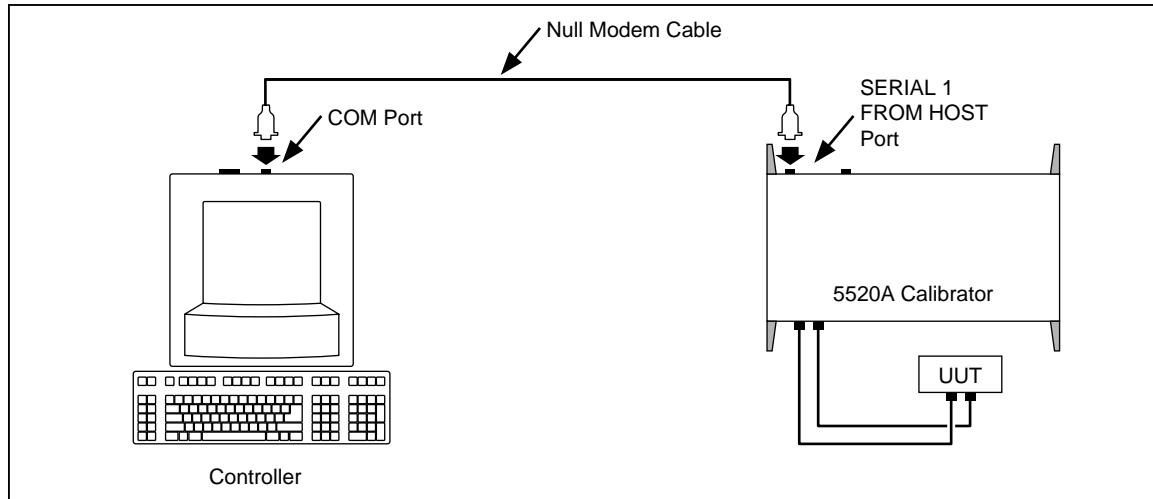

Figure 5-4. Testing the RS-232 Host Port

nn307f.bmp

Terminal This procedure uses the Terminal accessory supplied with Windows (or equal) to test RS-232 Host port operation. To use this method, you must select term as the Remote I/F in Step 4 in the procedure “RS-232 Host Port Setup Procedure.”

Visual Basic This procedure uses Visual Basic (see Appendix D) to test RS-232 Host port and RS-232 UUT port operation.

5-8. Testing RS-232 Host Port Operation using a Terminal

Complete the following procedure to test RS-232 Host port operation using the Windows Terminal accessory (or equal).

1. Complete the “RS-232 Host Port Setup Procedure” earlier in this chapter to set up the 5520A for RS-232 Host port operation. Note the RS-232 Host port parameters that you selected in this procedure.
2. Connect the selected COM port on the PC to the 5520A SERIAL 1 FROM HOST port using a standard null-modem RS-232 cable. (See Appendix C for information on RS-232 cables and connectors.)
3. Open Windows to the Program Manager screen on your PC.
4. Open Terminal from the Accessory group of Program Manager (below). If a terminal configuration file already exists, e.g., `host.term`, select the desired file using the Open command from the File menu and go to Step 7. Otherwise, go to Step 5.

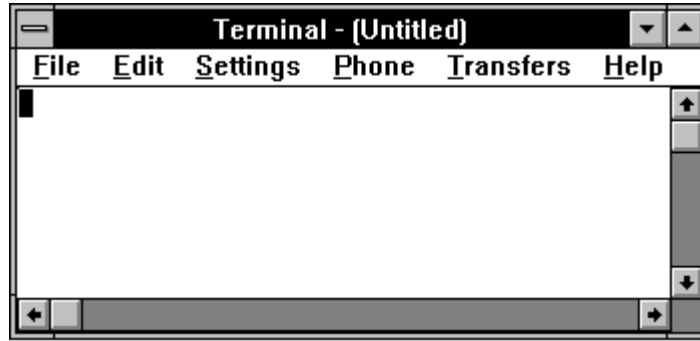

nn308f.bmp

5. Select the Communications command from the Setting menu. Enter the RS-232 parameters that match those selected at the Calibrator for the Host port. If using the 5520A factory defaults, the Communications dialog box for COM1 will appear as shown below. Select COM as required. Click OK.

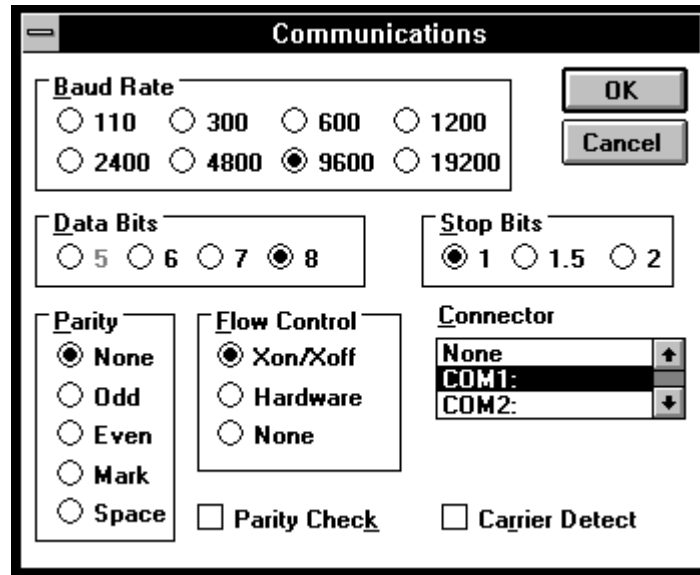

nn309f.bmp

6. Verify the Calibrator is powered and in the reset condition. (If in doubt, press **RESET** on the Calibrator front panel.)
7. On the Terminal screen, type the command REMOTE and press <Enter>. Observe the Calibrator Control Display changes to REMOTE CONTROL (below).

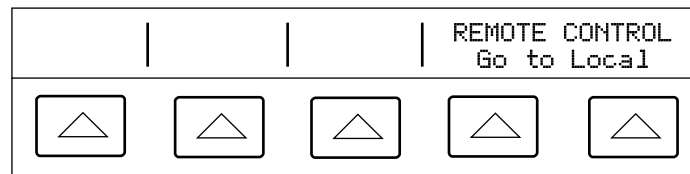

nn325f.eps

The characters REMOTE should have appeared on the terminal screen as they were entered. If they did not appear on the screen, but the Control Display changed to REMOTE CONTROL, then refer to step 4 of the “RS-232 Host Port Setup Procedure” and change the REMOTE I/F setting from comp to term.

If nonsense characters appeared on the screen, then you have a mismatch in RS-232 parameters. Refer to step 4 of the “RS-232 Host Port Setup Procedure” procedure for the correct RS-232 settings and then repeat this procedure starting at Step 5.

If no characters appeared on the screen, then refer to step 3 of the “RS-232 Host Port Setup Procedure” procedure to verify serial was selected for the Host port. Check that you used the correct RS-232 cable. It must be in a null-modem configuration where the RX and TX lines are reversed (see Appendix C) Also verify you have connected to the correct COM port on the PC.

8. Type the command LOCAL and press <Enter>. Observe the Calibrator Control Display changes back to the reset condition (below).

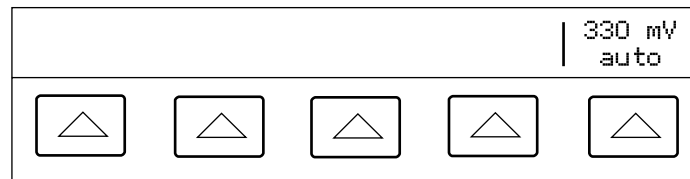

nn323f.eps

If you want to experiment with other commands in the command set, see Chapter 6, “Remote Commands.” When finished, select the Exit command from the File menu to close the Terminal accessory.

Hint: To save the communication parameters in Terminal for future operations, first select Save from the File menu and then assign a name, for example, `host . term`.

5-9. Testing RS-232 Host Port Operation using Visual Basic

Complete the following procedure to test RS-232 (Host) operation using the Windows-based programming language Visual Basic. This procedure assumes you have completed Appendix D, “Creating a Visual Basic Test Program” to create the group RS-232 Test.

Complete the following procedure to test RS-232 operation using Visual Basic.

1. Complete the “RS-232 Host Port Setup Procedure” earlier in this chapter to set up the 5520A for RS-232 Host port operation. Note the RS-232 Host port parameters that you selected in this procedure.
2. Connect the selected COM port on the PC to the 5520A SERIAL 1 FROM HOST port using a standard null-modem RS-232 cable. (See Appendix C for information on RS-232 cables and connectors.)
3. To start the program, open the Test Ports icon from the RS-232 Test group (below).

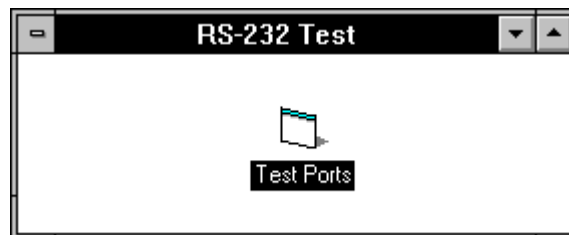

nn310f.bmp

- Verify the Calibrator is powered and in the reset condition (if in doubt, press **RESET**), then click the Command1 button (below).

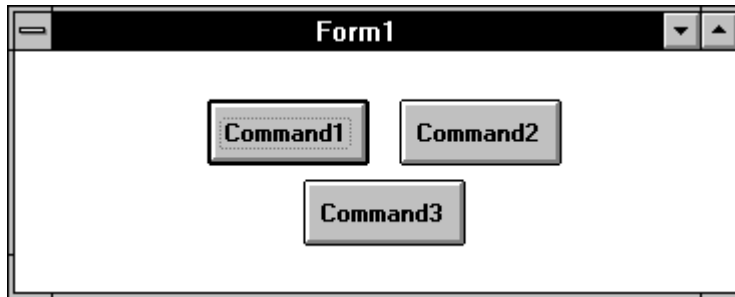

nn311f.bmp

- Observe the Calibrator Control Display changes to REMOTE CONTROL (below).

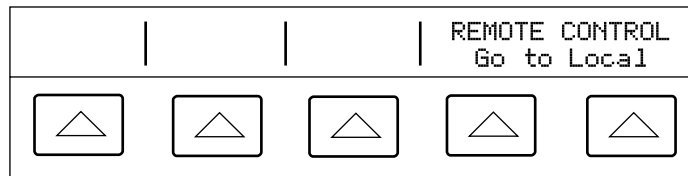

nn325f.eps

- Click the Command2 button. Observe the Calibrator Control Display changes back to the reset condition (below).

(The Command3 button is used for RS-232 UUT port testing later in this chapter.)

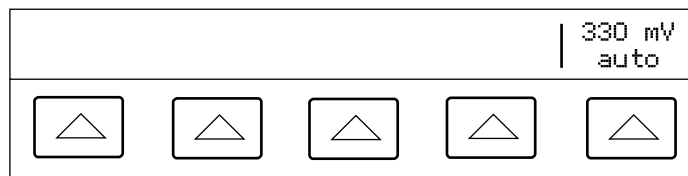

nn323f.sps

- Close the program by clicking the top-left corner and Close.

5-10. Setting up the RS-232 UUT Port for Remote Control

The SERIAL 2 TO UUT serial data port connects a UUT to a PC or terminal via the Calibrator (Figures 5-1 and 5-2). This “pass-through” configuration eliminates the requirement for two COM ports at the PC or Terminal. The UUT_* commands (see Chapter 6) handle the UUT port data flow.

The RS-232 cable length for each port should not exceed 15 meters, although longer cable lengths are permitted if the load capacitance measured at a connection point (including signal terminator) does not exceed 2500 pF.

5-11. RS-232 UUT Port Setup Procedure

Complete the following procedure to set up the SERIAL 2 TO UUT port (defaults in **bold**). The RS-232 parameters you are selecting must match the RS-232 parameters of the UUT. This port operates independently, whether the Calibrator is controlled from the IEEE-488 port or from the RS-232 Host serial port. (See Figures 5-1 and 5-2.)

1. Turn the Calibrator power on. You may operate the Calibrator during warmup, but specifications are not guaranteed until warmup is complete.
2. Press **SETUP** on the Calibrator front panel.
3. Negotiate the softkey selections shown below to configure the UUT serial port to match the settings of the UUT RS-232 port. The factory defaults (shown below in **bold**) are 9600 baud, 8 data bits, 1 stop bit, and no parity. Other parameters include flow control (STALL).

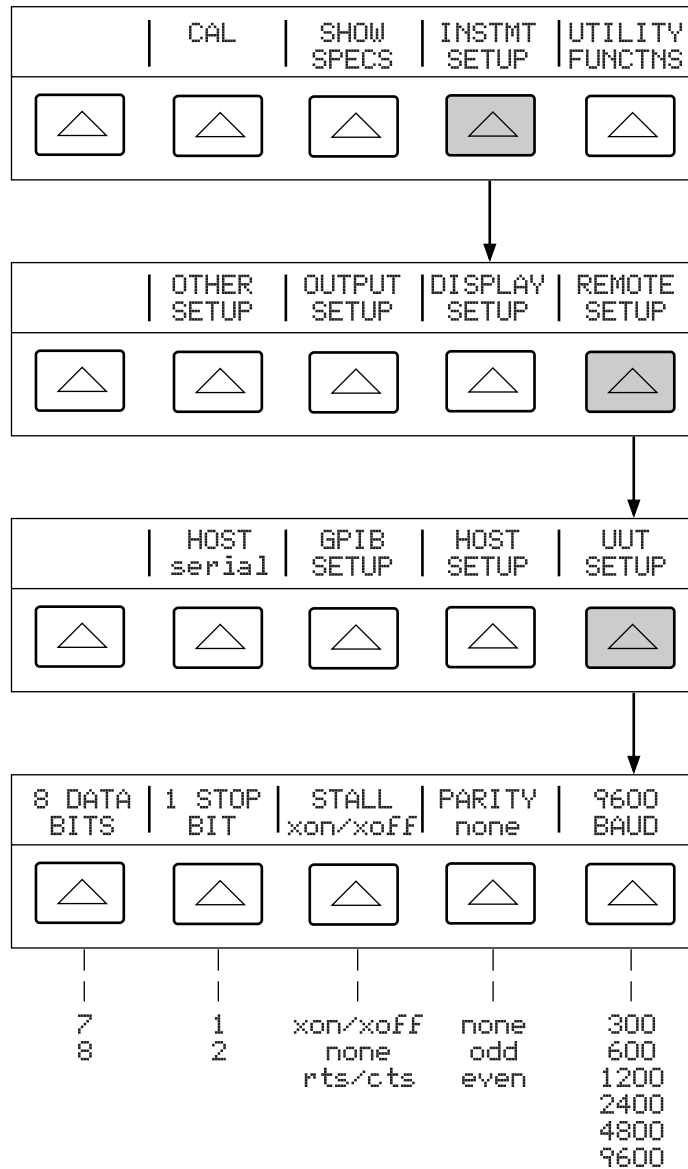

nn125f.eps

5-12. Testing the RS-232 UUT Port via RS-232 Host Port

Choose or adapt one of the following test procedures to test the Calibrator RS-232 UUT port via the RS-232 Host port. Connect the UUT and PC as shown in 5-5. Note the use of a modem cable (NOT null modem) for UUT connection. (See Appendix C for information about RS-232 cables and connectors.)

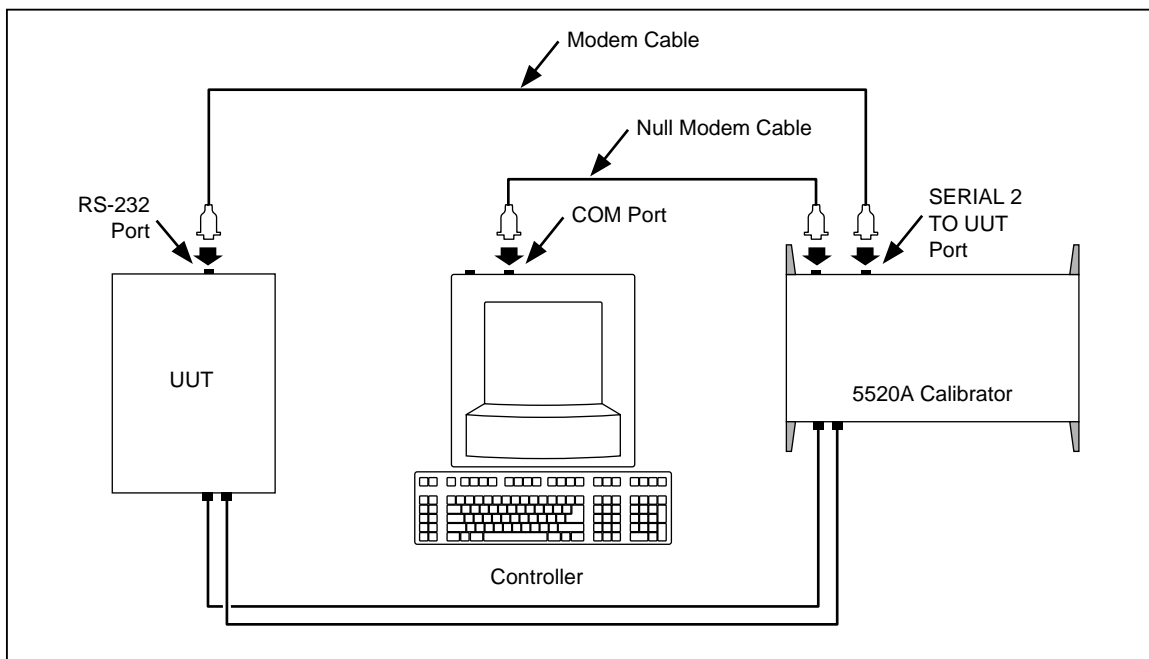

Figure 5-5. Testing the RS-232 UUT Port via RS-232 Host Port

Terminal This procedure uses the Terminal accessory supplied with Windows (or equal) to test RS-232 UUT port operation.

Visual Basic This procedure uses Visual Basic (see Appendix D) to test RS-232 Host port and RS-232 UUT port operation.

5-13. Testing RS-232 UUT Port Operation via a Terminal

Complete the following procedure to test RS-232 UUT port operation via the RS-232 Host port using the Windows Terminal accessory (or equal).

1. Complete "RS-232 UUT Port Setup Procedure" to the 5520A RS-232 UUT port to match the parameters of the UUT RS-232 port.
2. Complete "Testing RS-232 Host Port Operation using a Terminal" to set up the 5520A RS-232 Host port to match the parameters of the PC COM port. After Step 9, return to this procedure and continue to Step 3 below.
3. On the Terminal screen, type UUT_SEND "<uut command>" where <uut command> is the command you selected for the UUT response, then press <Enter>. Observe the UUT responds. For example, to send the command REMS to a UUT, use UUT_SEND "REMS\n" and press <Enter>.

Note the use of \n, which indicates a Carriage Return (CR) as the end-of-line character. Other characters include \r (Line Feed), \t (Tab), \b (Backspace) and \f (Form Feed). If your UUT commands require an end-of-line character, select one or more of the above.

The characters UUT_SEND "<uut command>" should have appeared as they were entered. If they did not appear on the screen, the RS-232 interface between the PC and 5520A Host port is not operating. Review the "RS-232 Host Port Setup Procedure" and correct the problem.

4. If the UUT command does not execute, refer to step 3 of the "RS-232 UUT Port Setup Procedure" procedure to verify the RS-232 UUT port parameters. Also check the cable for UUT connection was a modem (not null modem) cable. Be sure your command was entered correctly had the proper end-of-line character(s), if required.
5. When finished testing UUT commands, select the Exit command from the File menu to close the Terminal accessory.

5-14. Testing RS-232 UUT Port Operation using Visual Basic

Complete the following procedure to test RS-232 UUT port operation via the RS-232 Host port using a Visual Basic test program. This procedure assumes you have already completed Appendix D, "Creating a Visual Basic Test Program" to create the program used for this test.

Complete the following procedure to test RS-232 operation using Visual Basic.

1. Complete the "RS-232 UUT Port Setup Procedure" earlier in this chapter to set up the 5520A RS-232 UUT port to match the parameters of the UUT RS-232 port.
2. Complete "Testing RS-232 Host Port Operation using Visual Basic" to prepare the Calibrator RS-232 Host port. After Step 6, return to this procedure and continue to Step 3 below.
3. Click the Command3 button (below is typical). Observe the UUT responds to the command you used when you completed Appendix D, "Creating a Visual Basic Test Program."

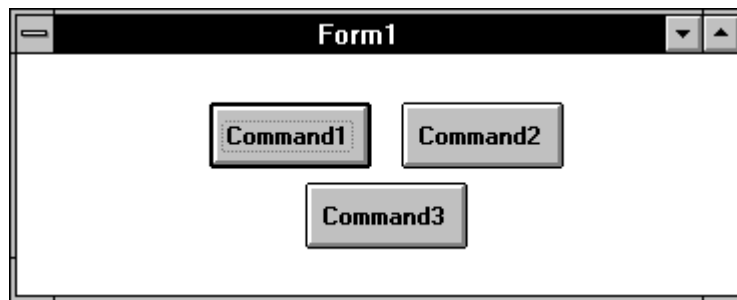

nn311f.bmp

If the UUT did not respond, check the RS-232 parameters set for the Calibrator UUT port and set for the UUT port. Verify you used a modem (not null modem) cable for the 5520A to UUT connection. Check the Visual Basic program to make sure the UUT command was entered correctly, including the end-of-line character, if any.

4. Close the program by clicking the top-left corner and Close.

5-15. Testing the RS-232 UUT Port via IEEE-488 Port

This procedure uses the Win32 Interactive Control utility supplied by National Instruments with the recommended interface cards. Connect the UUT, Calibrator, and PC as shown in Figure 5-6. Note the use of a modem cable (NOT null modem) for the UUT connection. (See Appendix C for information about RS-232 cables and connectors.)

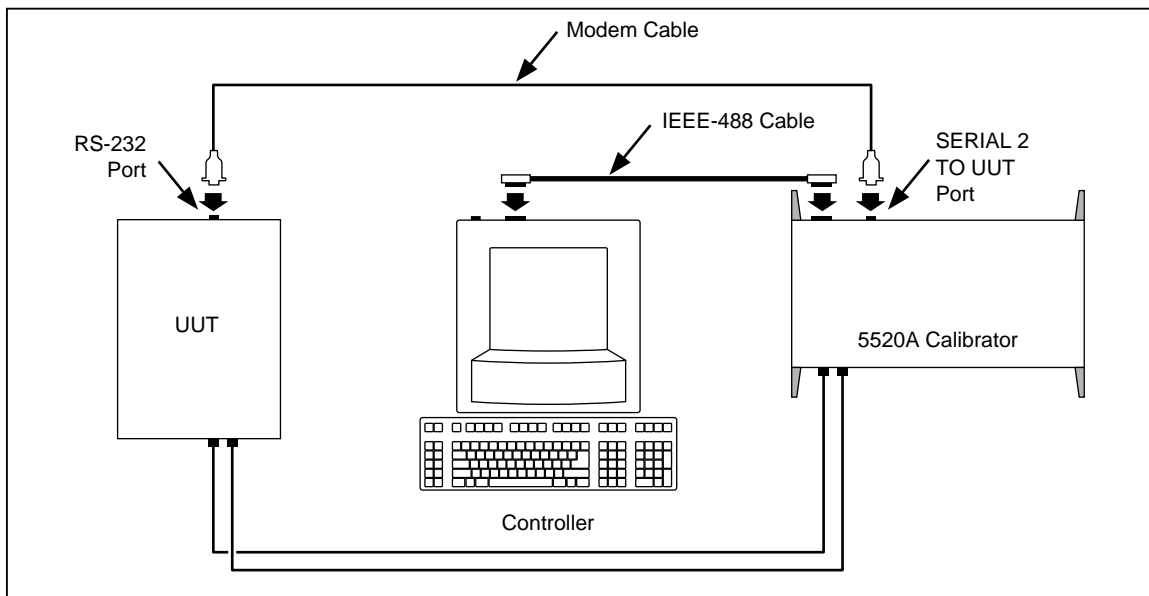
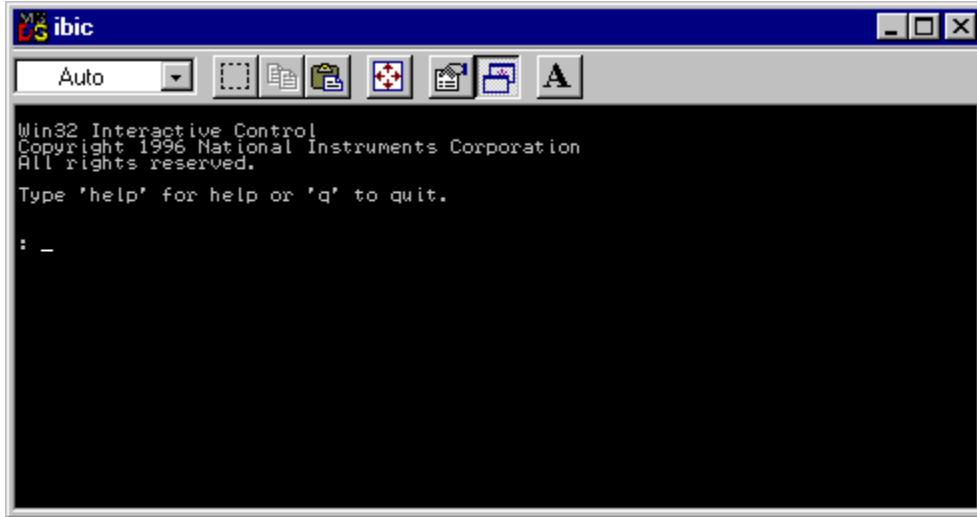

Figure 5-6. Testing the RS-232 UUT Port via IEEE-488 Port

nn314f.eps

Complete the following procedure to test RS-232 UUT port operation via the IEEE-488 port using the Win32 Interactive Control utility.

1. Complete the "IEEE-488 Port Setup Procedure" earlier in this chapter to set up the 5520A for GPIB operation.
2. Complete "Testing the IEEE-488 Port" to prepare the Calibrator IEEE-488 port for testing. Before the final step, return to this procedure and continue to Step 3 below.
3. Go to Start then to the Programs menu.
4. Select "NI-488.2M software for... (your operating system)".
5. From the NI488.2M software menu, select "Win32 interactive control".
6. A DOS window opens with a prompt as shown here:



- At the prompt, type the following line to activate the IEEE interface card:

```
<ibdev 0 4 0 10 1 0>
```

The second number in this line is the primary address of the calibrator. If the address has been changed from the factory default, change this line accordingly.

- The prompt reads <ud0:>. From this prompt, type

```
<ibwrt "uut_sendb 82,69,77,83,11,13">
```

- Press the ENTER (or RETURN) key. This command will send REMS<CR><LF> to the UUT serial port. After the command is entered, the Win32 Interactive Control shows the status of the command. If an error is encountered, check the typing or consult the National Instruments manual regarding Win32 Interactive control. The count message is the amount of characters sent over the bus.

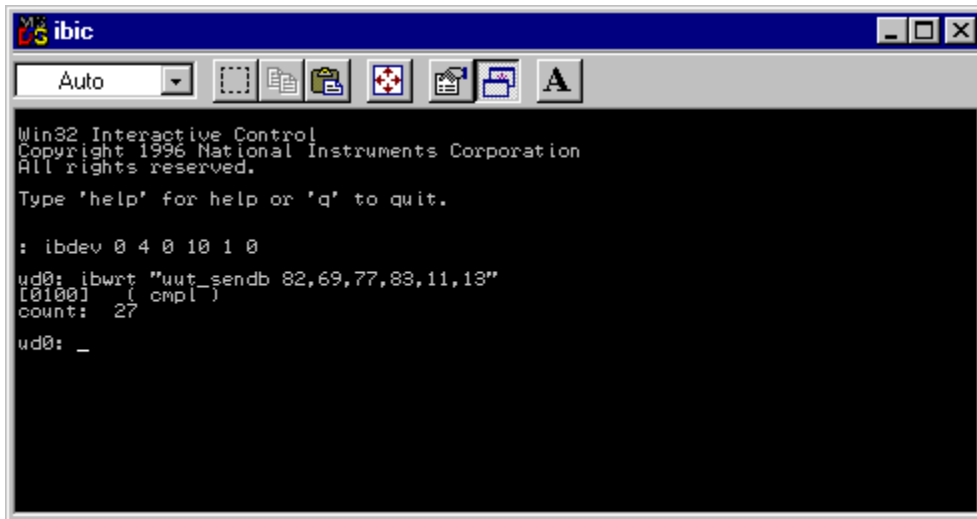

- Verify that the UUT is in remote.
- From the ud0: prompt type <q> then press the ENTER (or RETURN) key.

5-16. Changing between Remote and Local Operation

In addition to local mode (front panel operation) and remote, the Calibrator can be placed in a local lockout condition at any time by command of the controller. Combined, the local, remote, and lockout conditions yield four possible operating states described as follows.

5-17. Local State

The Calibrator responds to local and remote commands. This is normal front panel operation. All remote commands are allowed to execute.

5-18. Local with Lockout State

Local with lockout is identical to local, except the Calibrator will go into the remote with lockout state instead of the remote state when it receives a remote command.

5-19. Remote State

When the Calibrator is placed in remote, either via RS-232 REMOTE command, or via IEEE-488 asserting the REN line, it enters the remote state. In the remote state, the Output Display continues to display the output setting or measurement as in local operation. The Control Display changes to:

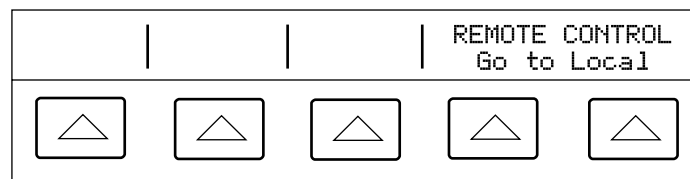

nn325f.eps

The left side of the Control Display shows information regarding the present output function. However, front panel operation is restricted to use of the power switch and the "Go To Local" softkeys. Pressing either of these softkeys, using RS-232 to send the command LOCAL, or IEEE-488 to send the GTL (Go To Local) message returns the Calibrator to the local state.

5-20. Remote with Lockout State

When the Calibrator is placed in lockout, either via RS-232 LOCKOUT command, or via the IEEE-488 message LLO, the 5520A front panel controls are totally locked out. In remote with lockout, the Control Display changes to:

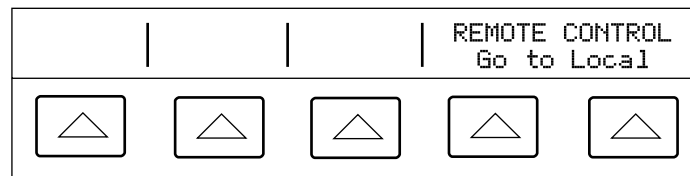

nn325f.eps

The left side of the Control Display shows information regarding the present output function. However, front panel operation is restricted to use of the power switch. To return the Calibrator to the local with lockout state, send the RS-232 LOCAL command or the IEEE-488 GTL (Go To Local) message.

Table 5-1 summarizes the possible Remote/Local state transitions. (For more information on IEEE-488 GPIB messages, see “IEEE-488 Overview.”)

Table 5-1. Operating State Transitions

From	To	Front Panel	GPIB Message	Serial Command
Local	Remote		MLA (REN True)	REMOTE
	Local With Lockout		LLO	LOCKOUT
Remote	Local	Go to Local softkey	GTL or REN False	LOCAL
	Remote with Lockout		LLO	LOCKOUT
Local with Lockout	Local		REN False	LOCAL
	Remote with Lockout		MLA (REN True)	REMOTE
Remote with Lockout	Local		REN False	LOCAL
	Local with Lockout		GTL	

5-21. RS-232 Interface Overview

The two Calibrator RS-232 ports are designed in accordance with EIA (Electronic Industries Association) standard RS-232-C. RS-232 is a serial binary data interchange operating from 300 to 9600 baud (selectable), and distances up to 50 feet. The Calibrator rear panel SERIAL 1 FROM HOST port is configured as DTE (Data Terminal Equipment) while the SERIAL 2 TO UUT is configured as DCE (Data Communications Equipment). See Appendix C for RS-232 cable and connector information. For detailed information, see the EIA standard RS-232-C.

A summary of RS-232 terms, interface lines and mnemonics are shown in Table 5-2.

Table 5-2. RS-232 Interface Wiring

Mnemonic	Description
CTS	Clear to Send
DB-9	Type DB connector, 9 pins
DB-25	Type DB connector, 25 pins
DCD	Data Carrier Detect
DCE	Data Communications Equipment
DSR	Data Set Ready
DTE	Data Terminal Equipment
DTR	Data Terminal Ready
GND	Ground
RI	Ring Indicator
RLSD	Received Line Signal Detector
RTD	Request to Send
RX	Receive Line
TX	Transmit Line

5-22. IEEE-488 Interface Overview

The IEEE-488 parallel interface sends commands as data and receives measurements and messages as data. The maximum data exchange rate is 1 Mbyte, with a maximum distance of 20 meters for the sum length of the connecting cables. A single cable should not exceed 4 meters in length. Some commands are reserved for RS-232 serial operation because these functions must be implemented as IEEE messages per the IEEE Standards. For example, the command REMOTE could be sent as data over the IEEE-488 interface to place the Calibrator into remote, but it is not because the IEEE Standards call for the remote function to be sent to the device as the uniline message REN. This is also true for several other commands and functions, as shown below, with their equivalent RS-232 emulation. A summary of IEEE-488 messages is shown in Table 5-3.

Table 5-3. RS-232 Emulation of IEEE-488 Messages

IEEE-488 Message	RS-232 Equivalent
GTL	LOCAL command
GTR	REMOTE command
LLO	LOCKOUT command
SDC, DCL	^C (<Cntl> C) character [clear the device]
GET	^T (<Cntl> T) character [execute a group trigger]
SPE, SPD	^P (<Cntl> P) character [print the serial poll string]
UNL, UNT	(not emulated on RS-232)

The IEEE-488 interface is based on the IEEE Standards 488.1 and 488.2. For detailed information, refer to the standards IEEE-488.1 and IEEE-488.2.

IEEE-488.1 IEEE-488.1 is the hardware portion of the interface. The parallel signal lines are divided into eight lines for the data bus, three lines for the handshake, and five lines for bus management. The handshake lines take care of the timing for data exchange. The bus management lines control the operation of data exchange. The ATN line indicates the use of the DIO lines for addresses or messages (true), or for DIO data (false). The EOI line is used with the data lines to mark the end of a message, and with the ATN line for polling. The SRQ line is used by the devices to indicate to the controller that they require service. The IFC line is used by the controller to quickly get all the devices on the bus to stop talking and start listening. The REN line is used to implement the remote/local states.

IEEE-488.2 IEEE-488.2 is the software portion of the interface, specifying data formats, common commands, message exchange protocol and the status register implementation.

Use the following to decode the columns in Figure 5-7. Appendix C shows a typical IEEE-488 connector and pin assignments.

Type	M - Multiline U - Uniline	
Class	AC - Addressed Command AD - Address (Talk or listen) UC - Universal Command ST - Status	DD - Device Dependent HS - Handshake SE - Secondary
Other	B1, B2, etc. - Information Bits Blanks - Doesn't Care condition	Logic Zero = 0 = False Logic One = 1 = True

MESSAGE DESCRIPTION			DATA BUS									HAND-SHAKE			BUS MANAGEMENT				
M N E M	MESSAGE NAME	T Y P E	C L A S S	D I O 8	D I O 7	D I O 6	D I O 5	D I O 4	D I O 3	D I O 2	D I O 1	D A V	N R F D	N D A C	A T N	E O I	S R Q	I F C	R E N
ACG	Addressed Command Group	M	AC		0	0	0									1			
ATN	Attention	U	UC													1			
DAB	Data Byte	M	DD	B8	B7	B6	B5	B4	B3	B2	B1				0				
DAC	Data Accepted	U	HS											0					
DAV	Data Valid	U	HS									1							
DCL	Device Clear	M	UC		0	0	1	0	1	0	0				1				
END	End	U	ST												0	1			
EOS	End Of String	M	DD	B8	B7	B6	B5	B4	B3	B2	B1				0				
GET	Group Execute Trigger	M	AC		0	0	0	1	0	0	0				1				
GTL	Go To Local	M	AC		0	0	0	0	0	0	1				1				
IDY	Identify	U	UC													1			
IFC	Interface Clear	U	UC															1	
LAG	Listen Address Group	M	AD		0	1									1				
LLO	Local Lock Out	M	UC		0	0	1	0	0	0	1				1				
MLA	My Listen Address	M	AD		0	1	B5	B4	B3	B2	B1				1				
MTA	My Talk Address	M	AD		1	0	B5	B4	B3	B2	B1				1				
MSA	My Secondary Address	M	SE		1	1	B5	B4	B3	B2	B1				1				
NUL	Null Byte	M	DD		0	0	0	0	0	0	0								
OSA	Other Secondary Address	M	SE	(OSA = SCG and MSA-NOT)															
OTA	Other Talk Address	M	AD	(OTA = TAG and MTA-NOT)															
PCG	Primary Command Group	M	----	(PCG = ACG or UCG or LAG or TAG)															
PPC	Parallel Poll Configure	M	AC		0	0	0	0	1	0	1				1				
PPE	Parallel Poll Enable	M	SE		1	1	0	B4	B3	B2	B1				1				
PPD	Parallel Poll Disable	M	SE		1	1	1	B4	B3	B2	B1				1				
PPR1	Parallel Poll Response 1	U	ST								1				1	1			
PPR2	Parallel Poll Response 2	U	ST							1					1	1			
PPR3	Parallel Poll Response 3	U	ST						1						1	1			
PPR4	Parallel Poll Response 4	U	ST					1							1	1			
PPR5	Parallel Poll Response 5	U	ST				1								1	1			
PPR6	Parallel Poll Response 6	U	ST			1									1	1			
PPR7	Parallel Poll Response 7	U	ST		1										1	1			
PPR8	Parallel Poll Response 8	U	ST	1											1	1			
PPU	Parallel Poll Unconfigure	M	UC		0	0	1	0	1	0	1				1				
REN	Remote Enable	U	UC																1
RFD	Ready For Data	U	HS										0						
RQS	Request For Service	U	ST		1										0				
SCG	Secondary Command Group	M	SE		1	1									1				
SDC	Selected Device Clear	M	AC		0	0	0	0	1	0	0				1				
SPD	Serial Poll Disable	M	UC		0	0	1	1	0	0	1				1				
SPE	Serial Poll Enable	M	UC		0	0	1	1	0	0	0				1				
SRQ	Service Request	U	ST														1		
STB	Status Byte	M	ST	B8		B6	B5	B4	B3	B2	B1				0				
TCT	Take Control	M	AC		0	0	0	1	0	0	1				1				
TAG	Talk Address Group	M	AD		1	0									1				
UCG	Universal Command Group	M	UC		0	0	1								1				
UNL	Unlisten	M	AD		0	1	1	1	1	1	1				1				
UNT	Untalk	M	AD		1	0	1	1	1	1	1				1				

Figure 5-7. IEEE-488 Remote Message Coding

5-23. Using Commands

Communications between the controller and the Calibrator consists of commands, queries, and interface messages. Although the commands are based on the 488.2 standard, they can be used on either the IEEE-488 or RS-232 interface, except for a few specialized RS-232 commands described in “Commands for RS-232 Only.” (For more information on command structures, see the IEEE 488.2 standard.)

Refer to Chapter 6, “Remote Commands” when you require additional information about command references used this chapter.

All commands and units may be entered in UPPER or lower case.

There are four specific remote control configurations that use commands, queries and interface messages: IEEE-488, RS-232 Terminal Mode, RS-232 Computer Mode, and RS-232 Pass-Through Mode. (Setting up and testing each mode is discussed earlier in this chapter.)

IEEE-488 Mode The IEEE-488 mode is used when the Calibrator is operated by computer program. In this mode, requested information is returned by query, and interface messages are queued and returned by command.

RS-232 Terminal Mode The RS-232 terminal mode is an interactive mode where an operator inputs commands, with immediate returns for requested information (queries) and interface messages.

RS-232 Computer Mode The RS-232 computer mode is used when the Calibrator is operated by computer program. In this mode, requested information is returned by query, and interface messages are queued and returned by command.

RS-232 Pass-Through Mode The RS-232 pass-through mode is used to pass commands from the PC to a UUT, but via the Calibrator. This configuration is used when the UUT has an RS-232 port. Commands are sent to the UUT by using the UUT_SEND command, returns use the UUT_RECV? query, and UUT_FLUSH clears the UUT receive buffer in the Calibrator.

5-24. Types of Commands

The commands for the Calibrator can be grouped into one or more categories, depending on how they function. Each category is described below.

5-25. Device-Dependent Commands

Device-dependent commands are unique to the Calibrator. An example of a device-dependent command is,

```
OUT 100 V, 1 A, 60 HZ
```

instructing the Calibrator to source 100 watts of ac power.

5-26. Common Commands

Common commands are defined by the IEEE 488.2 standard and are common to most bus devices. Common commands always begin with an * character. Common commands are available whether you are using the IEEE-488 or RS-232 interface for remote control. An example of a common command is,

```
*IDN?
```

instructing the Calibrator to return the instrument identification string.

5-27. Query Commands

Query commands request information, which is returned as the command executes, or placed in a buffer until requested. An example of a query, which always ends with a question mark, is,

```
RANGE?
```

returning the Calibrator primary and secondary outputs.

5-28. Interface Messages (IEEE-488)

Interface messages manage traffic on the IEEE-488 interface bus. Device addressing and clearing, data handshaking, and commands to place status bytes on the bus are all directed by interface messages. Some of the interface messages occur as state transitions of dedicated control lines. The rest of the interface messages are sent over the data lines with the ATN signal true. (All device-dependent and common commands are sent over the data lines with the ATN signal false.)

An important thing to note about interface messages is that unlike device-dependent and common commands, interface messages are not sent literally (in a direct way). For example, when you send a device-dependent query to the Calibrator, the controller automatically sends the interface message MTA (My Talk Address).

IEEE-488 standards define interface messages. Table 5-4 lists the interface messages that the Calibrator accepts. Table 5-4 also shows the BASIC statement to generate the interface message. Table 5-5 lists the interface messages that the Calibrator sends. The mnemonics listed in the tables are not sent in BASIC PRINT statements as commands are; in this way they are different from device-dependent and common commands.

Interface messages are handled automatically in most cases. For example, handshake messages DAV, DAC, and RFD automatically occur under the direction of an instrument's interface itself as each byte is sent over the bus.

Table 5-4. IEEE-488 Interface Messages (Received)

Mnemonic	Name	Function
ATN	Attention	A control line that, when asserted, notifies all instruments on the bus that the next data bytes are an interface message. When ATN is low, the next data bytes are interpreted as device-dependent or common commands addressed to a specific instrument.
DAC	Data Accepted	Sets the handshake signal line NDAC low.
DAV	Data Valid	Asserts the handshake signal line DAV.
DCL	Device Clear	Clears the input/output buffers
END	End	A message that occurs when the Controller asserts the EOI signal line before sending a byte.
GET	Group Execute Trigger	Trigger a TC measurement and put the reading in the output buffer.
GTL	Go To Local	Transfer control of the 5520A from one of the remote states to one of the local states. (See Table 5-1)
LLO	Local Lockout	Transfers remote/local control of the 5520A. (See Table 5-1)
IFC	Interface Clear	A control line that sets the interface to a quiescent state.
MLA	My Listen Address	Addresses a specific device on the bus as a listener. The controller sends MLA automatically whenever it directs a device-dependent or common command to a specific instrument.
MTA	My Talk Address	Addresses a specific device on the bus as a talker. The controller sends MTA automatically whenever it directs a device-dependent or common query to a specific instrument.
REN	Remote Enable	Transfer remote/local control of the 5520A. (See Table 5-1.)
RFD	Ready For Data	Sets the handshake signal line NRFD low.
SDC	Selected Device Clear	Does the same thing as DCL, but only if the 5520A is currently addressed as a listener.
SPD	Serial Poll Disable	Cancels the effect of a Serial Poll Enable.
SPE	Serial Poll Enable	After the 5520A receives this message, it sends the Status Byte the next it is addressed as a listener, no matter what the command is.
UNL	Unlisten	"Unaddresses" a specific device on the bus as a listener. The controller sends UNL automatically after the device has successfully received a device-dependent or common command.
UNT	Untalk	"Unaddresses" a specific device on the bus as a listener. The controller sends UNL automatically after the device has successfully received a device-dependent or common query.

Table 5-5. IEEE-488 Interface Messages (Sent)

Mnemonic	Name	Function
END	End	A message that occurs when the 5520A asserts the EOI control line. The 5520A asserts EOI while it transmits the ASCII character LF for its termination sequence or terminator.
DAC	Data Accepted	Set the handshake signal line NDAC low.
DAV	Data Valid	Asserts the handshake signal line DAV.
RFD	Ready for Data	Sets the handshake line NRFD low.
SRQ	Service Request	A control line that any device on the bus can assert to indicate that it requires attention. Refer to “Checking 5520A Status” for details.
STB	Status Byte	The status byte is what the 5520A sends when it responds to a serial poll (interface message SPE).

5-29. Compound Commands.

A compound command is two or more commands in a single command line. For example, the following two commands could be entered individually,

```
OUT 1 V, 60 HZ  
OPER
```

where the Calibrator sources 1 V ac at 60 Hz, and then goes into operate, or they could be combined into a compound command,

```
OUT 1 V, 60 HZ ; OPER
```

using a semi-colon as a separator. Care must be taken when a compound command includes any of the coupled commands. (See “Coupled Commands.”)

5-30. Coupled Commands

A coupled command refers to two or more commands that appear in a compound command (see “Compound Commands”) that perform actions that could interfere with each other causing a fault. Commands in a compound command are separated by using the ; character. Compound commands using only coupled commands are not order-dependent.

In Chapter 6, the command graphic Coupled shows a check for coupled commands.

The coupled commands, excluding scope commands, are:

```
CUR_POST    DBMZ    DC_OFFSET    HARMONIC    OUT    WAVE
```

An example of the coupled command interference is the command

```
*RST; OUT 100V, 1KHZ; WAVE SINE
```

followed by the commands

```
WAVE TRI  
OUT 10V, 1KHZ
```

The `WAVE TRI` causes an error. At 100 V, only sine waves are allowed. Both `WAVE` and `OUT` are coupled commands. So, the compound command

```
WAVE TRI; OUT 10V, 1KHZ
```

executes successfully. The `WAVE` and `OUT` are programmed together and at 10 V, triangle waves are allowed.

5-31. *Overlapped Commands*

Commands that begin execution but require slightly more time to complete are called overlapped commands, because they can be overlapped by the next command before they have completed execution.

In Chapter 6, the command graphic  `Overlapped` shows a check for overlapped commands.

The overlapped commands, excluding scope commands, are:

CUR_POST	MULT	STBY
DBM	OLDREF	SYNCOUT
DC_OFFSET	OPER	TC_OFFSET
DPF	OUT	TC_OTCD
DUTY	PHASE	TC_REF
EARTH	PRES_UNIT	TC_TYPE
EXTGUARD	RANGELCK	TSENS_TYPE
HARMONIC	REFCLOCK	WAVE
INCR	REFPHASE	ZCOMP
LCOMP	*RST	
LOWS	RTD_TYPE	

You can use the command `*WAI` to wait until the overlapped command has completed execution before executing the next command. For example,

```
OUT 1 V, 1 A, 60 HZ ; *WAI
```

You can also use the status commands `*OPC` and `*OPC?` to detect completion of overlapped commands. (See “Checking 5520A Status.”)

5-32. *Sequential Commands*

Commands that execute immediately are called sequential commands.

In Chapter 6, the command graphic  `Sequential` shows a check for sequential commands.

The majority of the commands are sequential.

5-33. Commands that Require the Calibration Switch

The following commands do not work unless the rear panel CALIBRATION switch is in the ENABLE position:

```
CLOCK          (when setting date but not time)
FORMAT ALL
FORMAT CAL
*PUD
```

Attempting to use any of these commands with the CALIBRATION switch in the NORMAL position logs an error into the error queue. (Or it returns the error message if in the RS-232 Terminal Mode.)

5-34. Commands for RS-232 Only

The graphic IEEE-488 RS-232 indicates RS-232 interface commands.

The IEEE-488 and RS-232 interfaces both send commands to the Calibrator as data, except for those IEEE-488 functions that must be implemented as a message as specified in the IEEE-488 standards. For example, the RS-232 interface uses the command REMOTE to place the Calibrator in the remote mode. Although the IEEE-488 interface could also send a command REMOTE as data, it does not because this is one of the functions that must be implemented per IEEE-488 Standards. The relationship between these IEEE-488 messages and the equivalent RS-232 emulation is shown in Table 5-6.

Table 5-6. Commands for RS-232 Only

IEEE-488 Message [1]	RS-232 Equivalent
GTL	LOCAL command
GTR	REMOTE command
LLO	LOCKOUT command
SRQ	SRQSTR command
SDC, DCL	^C (<Cntl> C) character [clear the device]
GET	^T (<Cntl> T) character [execute a group trigger]
SPE, SPD	^P (<Cntl> P) character [print the serial poll string]
[1]	See "How IEEE-488 Operates" later in this chapter.

In addition to the commands and special characters that emulate the IEEE-488 functions shown above, there are several more commands that are related to operation and control of the actual RS-232 Host port and are therefore completely unrelated to IEEE-488 operations. These include the following six commands.

```
SP_SET          SPLSTR          SRQSTR
SP_SET?        SPLSTR?        SRQSTR?
```

5-35. Commands for IEEE-488 Only

The command graphic  IEEE-488 indicates commands that are used for the IEEE-488 interface. This is all the commands, except for those used for RS-232 operations. (See “Commands for RS-232 Only.”) All commands are transferred over the IEEE-488 as data, except for the commands LOCAL, REMOTE, and LOCKOUT, which are implemented per IEEE Standards as messages (see Table 5-7).

Table 5-7. Commands for IEEE-488 Only

IEEE-488 Message [1]	Command Representation
GTL	LOCAL command
GTR	REMOTE command
LLO	LOCKOUT command
SDC, DCL	Clear the device
GET	Execute a group trigger
SPE, SPD	Print the serial poll string
[1]	See “How IEEE-488 Operates” later in this chapter.

5-36. Command Syntax

The following syntax rules apply to all the remote commands. Information about syntax of response messages is also given.

5-37. Parameter Syntax Rules

Table 5-8 lists the units accepted in command parameters and used in responses. All commands and units may be entered in UPPER or lower case.

Table 5-8. Units Accepted in Parameters and Used in Responses

Units	Meaning
HZ	Frequency in units of hertz
KHZ	Frequency in units of kilohertz
MHZ	Frequency in units of megahertz
UV	Volts in units of microvolts
MV	Volts in units of millivolts
V	Volts in units of volts
KV	Volts in units of kilovolts
UA	Current in units of microamperes
MA	Current in units of milliamps
A	Current in units of amps
PCT	Percent
PPM	Parts-per-million
DBM	Volts in units of decibels referenced to 1 milliwatt into 600 Ω load
OHM	Resistance in units of ohms
KOHM	Resistance in units of kilohms
MOHM	Resistance in units of megohms
NF	Capacitance in units of nanofarads
PF	Capacitance in units of picofarads
UF	Capacitance in units of microfarads
MF	Capacitance in units of millifarads
F	Capacitance in units of farads
CEL	Temperature in degrees Celsius
FAR	Temperature in degrees Fahrenheit
NS	Period in units of nanoseconds
US	Period in units of microseconds
MS	Period in units of milliseconds
S	Period in units of seconds

Table 5-8. Units Accepted in Parameters and Used in Responses (cont)

Units	Meaning
PSI	Pressure in pound-force per square inch
MHG	Pressure in meters of mercury
INHG	Pressure in inches of mercury
INH2O	Pressure in inches of water
FTH2O	Pressure in feet of water
MH2O	Pressure in meters of water
BAR	Pressure in bar
PAL	Pressure in Pascal
G/CM2	Pressure in grams per centimeter squared
INH2O60F	Pressure in inches of water at 60 degrees Fahrenheit

General Rules The general rules for parameter usage is as follows:

1. When a command has more than one parameter, the parameters must be separated by commas. For example: OUT 1V, 2A.
2. Numeric parameters may have up to 15 significant digits and their exponents can be in the range +/-1.0E+/-20.
3. Including too many or too few parameters causes a command error.
4. Null parameters cause an error, e.g., the adjacent commas in OUT 1V, , 2A.
5. Expressions, for example 4+2*13, are not allowed as parameters.
6. Binary Block Data can be in one of two forms: Indefinite Length and Definite Length format (both IEEE-488.2 standards).

Indefinite Length The Indefinite Length format accepts data bytes after the #0 until the ASCII Line Feed character is received with an EOI signal (for RS-232 just a line feed or carriage return will terminate the block).

Definite Length The Definite Length format specifies the number of data bytes. The data bytes are preceded by #n and an n-digit number. The n-digit number identifies how many data bytes follow. For examples, see the UUT_SEND and *PUD command descriptions in Chapter 6.

5-38. Extra Space or Tab Characters

In the command descriptions in Chapter 6, parameters are shown separated by spaces. One space after a command is required (unless no parameters are required). All other spaces are optional. Spaces are inserted for clarity in the manual and may be left in or omitted as desired. You can insert extra spaces or tabs between parameters as desired. Extra spaces within a parameter are generally not allowed, except for between a number and its associated multiplier or unit. Chapter 6 contains examples for commands whose parameters or responses are not self-explanatory.

5-39. Terminators

Table 5-9 summarizes the terminator characters for both the IEEE-488 and RS-232 remote interfaces.

Table 5-9. Terminator Characters

Terminator	ASCII Character		Control Command	Language Command
Function	Number	Program	Terminator	Terminator
Carriage Return (CR)	13	Chr(13)	<Cntl> M	\n
Line Feed (LF)	10	Chr(10)	<Cntl> J	\r
Backspace (BS)	8	Chr(8)	<Cntl> H	\b
Form Feed (FF)	12	Chr(12)	<Cntl> L	\f
<p>Examples:</p> <p>RS-232 Terminal Mode OUT 1 V, 60 Hz <Enter> UUT_SEND "REMS\n" <Enter> UUT_SEND #205REMS^M <Enter> (^M means <Cntl> M)</p> <p>RS-232 Computer Mode Comm1.Output = "OUT 1 V, 60 HZ" + Chr(10) (typical to Visual Basic) Comm1.Output = "UUT_SEND ""REMS\n"" " + Chr(10)</p> <p>IEEE-488 Mode OUT 1 V, 60 Hz (command only) UUT_SEND "REMS\n"</p>				

IEEE-488 Interface The Calibrator sends the ASCII character Line Feed with the EOI control line held high as the terminator for response messages. The calibrator recognizes the following as terminators when encountered in incoming data:

- ASCII LF character
- Any ASCII character sent with the EOI control line asserted

RS-232 Interface The Calibrator returns an EOL (End of Line) character with each response to the PC. This is selectable as Carriage Return (CR), Line Feed (LF) or both CRLF. (See "RS-232 Host Port Setup Procedure" earlier in this chapter.) Commands sent to the Calibrator must end in either a CR or LF, or both. (See Table 5-9 above.)

5-40. Incoming Character Processing

The Calibrator processes all incoming data as follows (except Binary Block Data as described under Parameter Syntax Rules):

1. The most significant data bit (DIO8) is ignored.
2. All data is taken as 7-bit ASCII.
3. Lower-case or upper-case characters are accepted.
4. ASCII characters whose decimal equivalent is less than 32 (Space) are discarded, except for characters 10 (LF) and 13 (CR) and in the *PUD command argument. Binary Block Data allows all characters in its argument and terminates in a special way.

5-41. Response Message Syntax

In the command descriptions in Chapter 6, responses from the Calibrator are described wherever appropriate. In order to know what type of data to read in, refer to the first part of the entry under "Response" in the tables. The response is identified as one of the data types in Table 5-10.

Table 5-10. Response Data Types

Data Type	Description
Integer	<p>Integers for some controllers or computers are decimal numbers in the range -32768 to 32768.</p> <p>Responses in this range are labeled Integer.</p> <p>Example: *ESE 123; *ESE?</p> <p>returns: 123</p>
Floating	<p>Numbers that may have up to 15 significant figures plus an exponent that may range from $\pm E20$.</p> <p>Example: DC_OFFSET?</p> <p>returns: 1.4293E+00</p>
String	<p>Any ASCII characters including quotation mark delimiters.</p> <p>Example: SRQSTR "SRQ from 5520A"; SRQSTR?</p> <p>returns: "SRQ from 5520A"</p>
Character Response Data (CRD)	<p>This type of response is always a keyword.</p> <p>Example: OUT 10V, 100HZ; FUNC?</p> <p>returns: ACV</p>
Indefinite ASCII (IAD)	<p>Any ASCII characters followed by EOM. Queries with this type of response MUST be the last Query in a program message.</p> <p>Example: *OPT?</p> <p>returns: SC600</p> <p>CAL reports and lists which contains Line Feeds are typically of this type.</p>
Binary Block Data	<p>A special data type defined by the IEEE-488.2 standard. This type is used in *PUD? query. It is defined as follows:</p> <p>#(non-zero digit) (digits) (user data)</p> <p>The non-zero digit specifies the number of characters that will follow in the <digits> field. Characters allowed in the digits field are 0 through 9 (ASCII 48 through 57 decimal). The value of the number in the <digits> field in decimal defines the number of user data bytes that follow in the <user data> field. The maximum response is 64 characters.</p> <p>Example: *PUD "test1"; *PUD?</p> <p>returns: #205test1</p>

5-42. Checking 5520A Status

The programmer has access to status registers, enable registers, and queues in the Calibrator to indicate various conditions in the instrument as shown in Figure 5-8. Some registers and queues are defined by the IEEE-488.2 standard. The rest are specific to the Calibrator. In addition to the status registers, the Service Request (SRQ) control line, and a 16-element buffer called the Error Queue provide status information. Table 5-11 lists the status registers and gives the read/write commands and associated mask registers.

Table 5-11. Status Register Summary

Status Register	Read Command	Write Command
Serial Poll Status Byte (STB)	*STB?	—
Service Request Enable Register (SRE)	*SRE?	*SRE
Event Status Register (ESR)	*ESR?	—
Event Status Enable Register (ESE)	*ESE?	*ESE
Instrument Status Register (ISR)	ISR?	—
Instrument Status Change Register (ISCR)	ISCR?	—
ISCR 1 to 0 transition	ISCR0?	—
ISCR 0 to 1 transition	ISCR1?	—
Instrument Status Change Enable Register (ISCE)	ISCE?	ISCE
ISCE 1 to 0 transition	ISCE0?	ISCE0
ISCE 0 to 1 transition	ISCE1?	ISCE1

Each status register and queue has a summary bit in the Serial Poll Status Byte. Enable registers are used to mask various bits in the status registers and generate summary bits in the Serial Poll Status Byte. For IEEE-488 interface operation, the Service Request Enable Register is used to assert the SRQ control line on detection of any status condition or conditions the programmer chooses. For RS-232 interface operation, the SRQSTR string is sent over the serial interface when the SRQ line is set. (See the SRQSTR command description in Chapter 6 for more information.)

5-43. Serial Poll Status Byte (STB)

The Calibrator sends the serial poll status byte (STB) when it responds to a serial poll. This byte is cleared (set to 0) when the power is turned on. The STB byte is defined as shown in Figure 5-9. If you are using the RS-232 as the remote control interface, transmitting the ^P character (in the Terminal mode, hold down the <Cntl> key and press P) returns the SPLSTR (Serial Poll String) and the status byte. Refer to the *STB command, and for RS-232 interface operation, the SPLSTR and SPLSTR? commands, in Chapter 6 for more information.

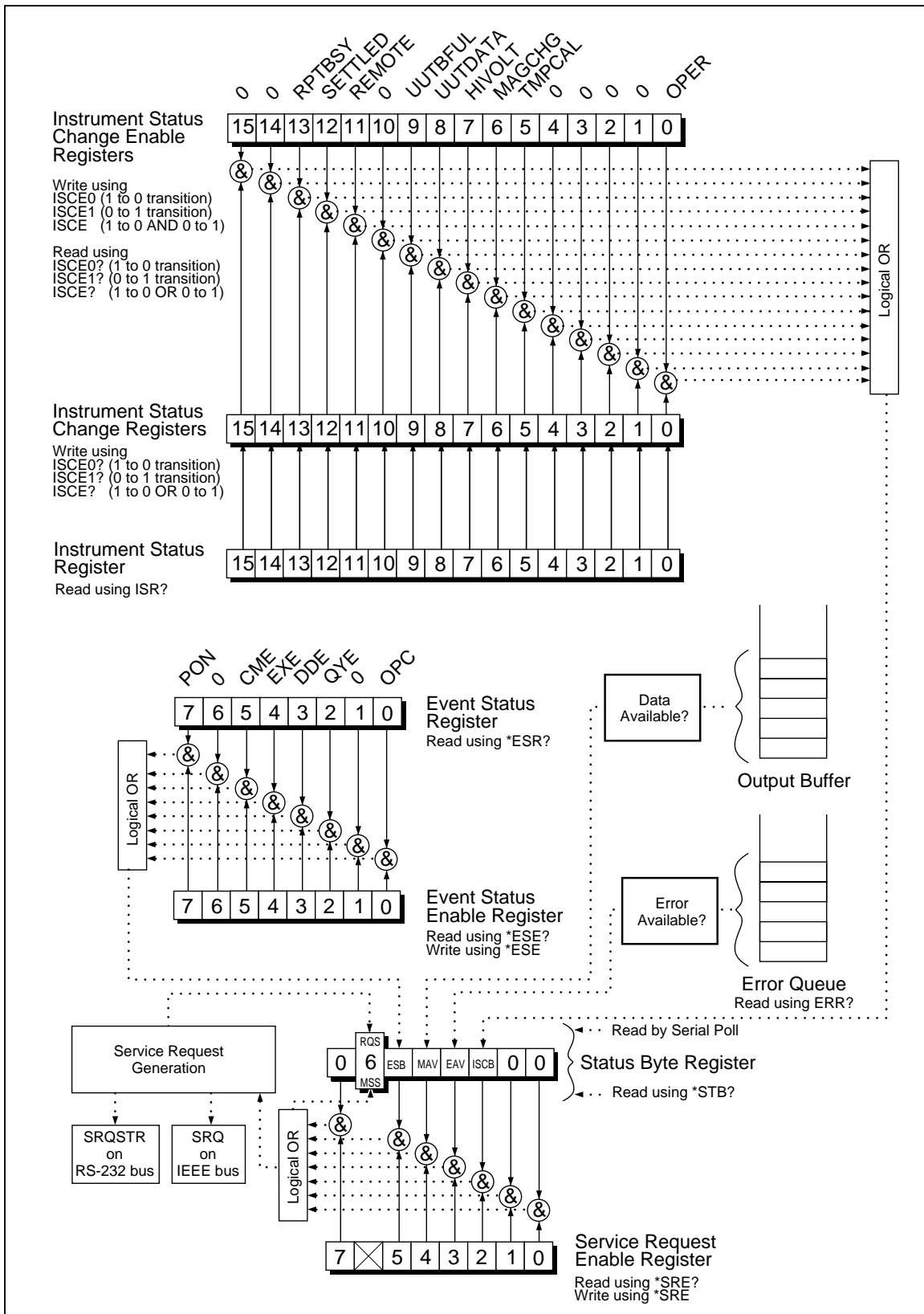

nn317f.eps

Figure 5-8. Status Register Overview

7	6	5	4	3	2	1	0
0	RQS	ESB	MAV	EAV	ISCB	0	0
	MSS						

RQS Requesting service. The RQS bit is set to 1 whenever bits ESB, MAV, EAV, or ISCB change from 0 to 1 and are enabled (1) in the SRE. When RQS is 1, the 5520A asserts the SRQ control line on the IEEE-488 interface. You can do a serial poll to read this bit to see if the 5520A is the source of an SRQ.

MSS Master summary status. Set to 1 whenever bits ESB, MAV, EAV, or ISCB are 1 and enabled (1) in the SRE. This bit can be read using the *STB? command in serial remote control in place of doing a serial poll.

ESB Set to 1 when one or more enabled ESR bits are 1.

MAV Message available. The MAV bit is set to 1 whenever data is available in the 5520A's IEEE-488 interface output buffer.

EAV Error available. An error has occurred and an error is available to be read from the error queue by using the ERR? query.

OPER ISCB One or more enabled ISCR bits are 1.

nn318f.eps

Figure 5-9. Serial Poll Status Byte (STB) and Service Request Enable (SRE)

5-44. *Service Request (SRQ) Line*

IEEE-488 Service Request (SRQ) is an IEEE-488.1 bus control line that the Calibrator asserts to notify the controller that it requires some type of service. Many instruments can be on the bus, but they all share a single SRQ line. To determine which instrument set SRQ, the Controller normally does a serial poll of each instrument. The calibrator asserts SRQ whenever the RQS bit in its Serial Poll Status Byte is 1. This bit informs the controller that the Calibrator was the source of the SRQ.

RS-232 Remote operations using the RS-232 interface emulate the IEEE-488 SRQ line by sending the SRQSTR string over the serial interface when the SRQ line is set. (See the SRQSTR command description in Chapter 6 for more information.)

The Calibrator clears SRQ and RQS whenever the controller/host performs a serial poll, sends *CLS, or whenever the MSS bit is cleared. The MSS bit is cleared only when ESB, MAV, EAV, and ISCB are 0, or they are disabled by their associated enable bits in the SRE register being set to 0.

5-45. *Service Request Enable Register (SRE)*

The Service Request Enable Register (SRE) enables or masks the bits of the Serial Poll Status Byte. The SRE is cleared at power up. Refer to Figure 5-9 for the bit functions.

5-46. Programming the STB and SRE

By resetting (to 0) the bits in the SRE, you can mask (disable) associated bits in the serial poll status byte. Bits set to 1 enable the associated bit in the serial poll status byte. The following sample BASIC program enables the Error Available (EAV) bit.

```
10 ! THIS PROGRAM SETS EAV IN THE SRE
20 PRINT @6, "*SRE 8"                ! LOAD THE REGISTER
30 PRINT @6, "*SRE?"                ! ASK FOR THE SRE CONTENTS
40 INPUT @6, A%                     ! RETRIEVE THE REGISTER CONTENTS
50 PRINT "SRE = ";A%
60 RETURN
```

The following BASIC program generates an error and checks the Serial Poll Status Byte. Enable the EAV bit with the example above.

```
10 ! THIS PROGRAM GENERATES AN ERROR AND CHECKS IT
20 PRINT @6, "OUT 1300V"             ! 1300V IS OUT OF 5520A RANGE
30 A% = SPL(6)                       ! DO A SERIAL POLL
40 IF ((A% AND 72%)=0%) THEN PRINT "EAV and RQS should have been set"
50 PRINT @6, "*STB?"                ! RETRIEVE BYTE
60 INPUT @6, A%
70 IF ((A% AND 8%)=0%) THEN PRINT "EAV should have been set"
```

5-47. Event Status Register (ESR)

The Event Status Register event status register (ESR)ESR (event status register)is a two-byte register in which the higher eight bits are always 0, and the lower eight bits represent various conditions of the Calibrator. The ESR is cleared (set to 0) when the power is turned on, and every time it is read.

Many of the remote commands require parameters. Improper use of parameters causes command errors to occur. When a command error occurs, bit CME (5) in the Event Status Register (ESR) goes to 1 (if enabled in ESE register), and the error is logged in the error queue.

5-48. Event Status Enable (ESE) Register

A mask register called the event status enable register (ESE)ESE (event status enable register)Event Status Enable register (ESE) allows the controller to enable or mask (disable) each bit in the ESR. When a bit in the ESE is 1, the corresponding bit in the ESR is enabled. When any enabled bit in the ESR is 1, the ESB bit in the Serial Poll Status Byte also goes to 1. The ESR bit stays 1 until the controller reads the ESR or does a device clear, a selected device clear, or sends the reset or *CLS command to the Calibrator. The ESE is cleared (set to 0) when the power is turned on.

5-49. Bit Assignments for the ESR and ESE

The bits in the Event Status Register (ESR) and Event Status Enable register (ESE) are assigned as shown in Figure 5-10.

15	14	13	12	11	10	9	8
0	0	0	0	0	0	0	0

7	6	5	4	3	2	1	0
PON	0	CME	EXE	DDE	QYE	0	OPC

PON	Power on. This bit is set to 1 if line power has been turned off and on since the last time the ESR was read.
CME	Command error. The 5520A's IEEE-488 interface encountered an incorrectly formed command. (The command ERR? fetches the earliest error code in the error queue, which contains error codes for the first 15 errors that have occurred.)
EXE	Execution error. An error occurred while the 5520A tried to execute the last command. This could be caused, for example, by a parameter being out of range. (The command ERR? fetches the earliest error in the error queue, which contains error codes for the first 15 errors that have occurred.)
DDE	Device-dependent error. An error related to a device-dependent command has occurred.
QYE	Query error. The 5520A was addressed to talk when no response data was available or appropriate, or when the controller failed to retrieve data on the output queue.
OPC	Operation complete. All commands previous to reception of a *OPC command have been executed, and the interface is ready to accept another message.

nn319f.eps

Figure 5-10. Event Status Register (ESR) and Event Status Enable (ESE)

5-50. Programming the ESR and ESE

To read the contents of the ESR, send the remote command, *ESR?. The ESR is cleared (set to 0) every time it is read. To read the contents of the ESE, send the remote command, *ESE?. The ESE is not cleared when it is read. When you read either register, the Calibrator responds by sending a decimal number that when converted to binary represents bits 0 through 15. The following sample BASIC program retrieves the contents of both registers:

```

10 ! THIS PROGRAM READS THE ESR AND THE ESE REGISTERS
20 PRINT @6, "*ESR?"           ! ASK FOR THE ESR CONTENTS
30 INPUT @6, A%               ! RETRIEVE THE REGISTER CONTENTS
40 PRINT @6, "*ESE?"          ! ASK FOR THE ESE CONTENTS
50 INPUT @6, B%               ! RETRIEVE THE REGISTER CONTENTS
60 PRINT "ESR = ";A%           ! DISPLAY THE ESR REGISTER CONTENTS VALUE
70 PRINT "ESE = ";B%           ! DISPLAY THE ESE REGISTER CONTENTS VALUE
80 END

```

Convert the contents of variables A and B into binary, and you can read the status of the registers. For example if A is 32, its binary equivalent is: 00000000 00100000. Therefore, bit 5 (CME) in the ESR is set (1) and the rest of the bits are reset (0). This means that the Calibrator tried to execute an incorrectly formed command.

By setting the bits in the ESE, you can mask (disable) the associated bits in the ESR. For example, to prevent the occurrence of a command error from causing bit 5 (ESB) in the serial poll status byte to go to 1, you can reset (to 0) bit 5 in the ESE register. The following sample program accomplishes this by checking the status of the CME bit, then toggling it if it is 1.

```
10 ! THIS PROGRAM RESETS BIT 5 (CME) IN THE ESE
20 PRINT @6,"*ESE 33" ! INITIAL ESE IS CME + OPC
30 GOSUB 100 ! GET AND PRINT INITIAL ESE
40 IF (A% AND 32%) THEN A% = A% - 32% ! CLEAR CME (BIT 5)
50 PRINT @6, "*ESE ";A% ! LOAD ESE WITH NEW VALUE
60 GOSUB 100 ! GET AND PRINT NEW ESE
70 END
100 PRINT @6, "*ESE?" ! ASK FOR ESE CONTENTS
110 INPUT @6, A% ! RETRIEVE REGISTER CONTENTS
120 PRINT "ESE = ";A%
130 RETURN
```

5-51. Instrument Status Register (ISR)

The Instrument Status Register (ISR) instrument status register (ISR)ISR (instrument status register)gives the controller access to the state of the Calibrator, including some of the information presented to the operator on the Control Display and the display annunciators during local operation.

5-52. Instrument Status Change Registers

There are two registers dedicated to monitoring changes in the ISR. These are the ISCR0 (Instrument Status 1-0 Change Register) instrument status change registers (ISCR0 and 1)ISCR0, ISCR1 (instrument status change registers)and the ISCR1 (Instrument Status 0-1 Change Register). Each status change register has an associated mask register. Each ISCR is cleared (set to 0) when the Calibrator is turned on, every time it is read, and at each *CLS (Clear Status) command.

5-53. Instrument Status Change Enable Registers

The Instrument Status Change Enable registers (ISCE0 and ISCE1) are instrument status change enable registers (ISCRE and 1)ISCE0, ISCE1 (instrument status change enable registers)mask registers for the ISCR0 and ISCR1 registers. If a bit in the ISCE is enabled (set to 1) and the corresponding bit in the ISCR makes the appropriate transition, the ISCB bit in the Status Byte is set to 1. If all bits in the ISCE are disabled (set to 0), the ISCB bit in the Status Byte never goes to 1. The contents of the ISCE registers are set to 0 at power-up.

5-54. Bit Assignments for the ISR, ISCR, and ISCE

The bits in the Instrument Status, Instrument Status Change, and Instrument Status Change Enable registers are assigned as shown in Figure 5-11.

15	14	13	12	11	10	9	8
0	0	RPTBUSY	SETTLED	REMOTE	0	UUTBFUL	UUTDATA

7	6	5	4	3	2	1	0
HIVOLT	MAGCHG	TMPCAL	0	0	0	0	OPER

RPTBUSY Set to 1 when a calibration report is being printed to the serial port.

SETTLED Set to 1 when the output has stabilized to within specification or the TC measurement has settled and is available.

REMOTE Set to 1 when the 5520A is under remote control.

UUTBFUL Set to 1 when data from the UUT port has filled up the UUT buffer.

UUTDATA Set to 1 when there is data available from the UUT port.

HIVOLT Set to 1 when the 5520A is programmed to a voltage above 33 Volts.

MAGCHG Set to 1 when the output magnitude has changed as a result of another change (e.g. RTD_TYPE). This bit is always 0 in the ISR. It changes to 1 only in the ISCR0 and ISCR1 registers.

TMPCAL Set to 1 when the 5520A is using temporary (non-stored) calibration data.

OPER Set to 1 when the 5520A is in operate, 0 when it is in standby.

nn320f.eps

Figure 5-11. Bit Assignments for the ISR, ISCEs and ISCRs

5-55. Programming the ISR, ISCR, and ISCE

To read the contents of the ISR, send the remote command, ISR?. To read the contents of the ISCR0 or 1, send the remote command, ISCR0?, or ISCR1?. To read the contents of the ISCE0 or 1, send the remote command, ISCE0?, or ISCE1?. The Calibrator responds by sending a decimal number that represents bits 0 through 15. Every time you read the ISCR0 or 1, its contents are zeroed. The following sample program reads all five registers:

```
10 ! THIS PROGRAM READS THE ISR, ISCR, AND ISCE REGISTERS
20 ! NOTE THAT THE ICSR? COMMANDS CLEAR THE ISCR CONTENTS
30 PRINT @6, "ISR?" ! ASK ISR CONTENTS
40 INPUT @6, A% ! RETRIEVE REGISTER CONTENTS FROM 5520A
50 PRINT @6, "ISCR0?" ! ASK FOR AND CLEAR ISCR0 CONTENTS
60 INPUT @6, B% ! RETRIEVE REGISTER CONTENTS FROM 5520A
70 PRINT @6, "ISCE0?" ! ASK FOR ISCE0 CONTENTS
80 INPUT @6, C% ! RETRIEVE REGISTER CONTENTS FROM 5520A
90 PRINT @6, "ISCR1?" ! ASK FOR AND CLEAR ISCR1 CONTENTS
100 INPUT @6, D% ! RETRIEVE REGISTER CONTENTS FROM 5520A
110 PRINT @6, "ISCE1?" ! ASK FOR ISCE1 CONTENTS
120 INPUT @6, E% ! RETRIEVE REGISTER CONTENTS FROM 5520A
130 PRINT "ISR = ";A% ! DISPLAY ISR
140 PRINT "ISCR0 = ";B% ! DISPLAY ISCR0
150 PRINT "ISCE0 = ";C% ! DISPLAY ISCE0
160 PRINT "ISCR1 = ";D% ! DISPLAY ISCR1
170 PRINT "ISCE1 = ";E% ! DISPLAY ISCE1
180 END
```

Convert the returned variables into binary, and you can read the status of the instrument. For example if a register contains 128, its binary equivalent is: 00000000 10000000. Therefore, bit 7 (HIVOLT) is set (1) and the rest of the bits are reset (0).

By setting the bits in an ISCE register, you can mask (disable) the associated bits in the ISCR. For example, to cause an SRQ interrupt when the output has settled, bit 12 (SETTLED) in the ISCE1 register must be 1. (The ISCB bit must also be enabled in the SRE.) The following sample program loads a decimal 1024 into the ISCE, which sets bit 12 and resets the other bits:

```
10 ! THIS PROGRAM LOADS 00010000 00000000 BINARY INTO THE ISCE
20 PRINT @6, "ISCE 4096" ! LOAD DECIMAL 4096 INTO ISCE
30 PRINT @6, "ISCE?" ! READ BACK ISCE VALUE
40 INPUT @6, A% ! "
50 PRINT "ISCE = ";A% ! PRINT IT, IT SHOULD BE 4096
60 END
```

5-56. Output Queue

The output queue is loaded whenever a query is processed, and holds up to 800 characters. The controller reads it with a statement such as a BASIC INPUT statement, removing what it reads from the queue. If the queue is empty, the Calibrator does not respond to the INPUT statement from the controller. The Message Available (MAV) bit in the Serial Poll Status Byte is 1 if there is something in the output queue and 0 if the output queue is empty.

5-57. Error Queue

When a command error, execution error, or device-dependent error occurs, its error code is placed in the error queue where it can be read by the `ERR?` command. (See Appendix E for a list of error messages.) A way to decode an error code is to send the command, `EXPLAIN?`, which returns a description of a error code. Reading the first error with the `ERR?` command removes that error from the queue. A response of 0 means the error queue is empty. The Error Available (EAV) bit in the Serial Poll Status Byte indicates whether the queue is empty. The error queue is cleared when you turn off the power, and when you use the `*CLS` (Clear Status) common command.

The error queue contains up to 16 entries. If many errors occur, only the first 15 errors are kept in the queue. A 16th entry in the queue is always an "error queue overflow" error, and all later errors are discarded until the queue is at least partially read. The first errors are kept, because if many errors occur before the user can acknowledge and read them, the earliest errors are the most likely to point to the problem. The later errors are usually repetitions or consequences of the original problem.

5-58. Remote Program Examples

The following programming examples illustrate ways to handle errors, to take measurements, take a number of successive readings, lock the range, and calibrate the Calibrator. These excerpts from programs are written in DOS BASIC.

5-59. Guidelines for Programming the Calibrator

Commands are processed one at a time as they are received. Some commands require a previous condition be set before the command will be accepted by the Calibrator. For example, the waveform must be `SQUARE` before the `DUTY` command will be accepted. Using the following programming guidelines will insure that the output is programmed to the desired state.

- All external connections commands should be programmed first. The calibrator will be placed in standby and the output may be changed to accommodate the new external connection. The setting may be set even if the present output does not use the setting (for example, setting the current post while sourcing voltage).
- The output and output mode should be programmed next with the `OUT` command.
- All other output parameters such as impedance compensation, offset, and waveforms should be programmed next. The `DUTY` command must follow the `WAVE` command.
- The error status should be checked with the `ERR?` command. The calibrator will not process the `OPER` command if an unacknowledged error exists.
- Finally, the Calibrator should be placed in operate with the `OPER` command.

A controller program first needs to initialize the interface and the Calibrator. Refer to following sample program:

```
10 INIT PORT 0 \ REMOTE @6      ! PUT THE 5520A INTO THE REMOTE STATE
20 PRINT @6, "*RST;OUT 10V;OPER" ! RESET THE 5520A, PROGRAM IT TO
                                ! OUTPUT 10 VOLTS DC
```

If you wish to use SRQs, first use the `*SRE`, `*ESE`, and `ISCE` commands to enable the desired event. Refer to "Checking 5520A Status."

You retrieve instrument parameters with a query (a programming command that ends with a question mark):

```
200 PRINT @6, "FUNC?"           ! RETRIEVE OUTPUT FUNCTION
210 INPUT LINE @6, A$
220 PRINT "Function is: "; A$
230 PRINT @6, "ONTIME?"         ! RETRIEVE ON TIME
240 INPUT LINE @6, A$
250 PRINT "The instrument has been on for "; A$;" minutes"
```

This program generates the following sample output:

```
Function is: DCV
The instrument has been on for 134 minutes
```

Check for programming errors as in the following sample programs. Check the Error Available (EAV) bit in the serial poll register using a serial poll.

```
300 A = SPL(6)                   ! CHECK FOR ERRORS
310 IF (A AND 8) THEN PRINT "There was an error"
320 PRINT @6, "*CLS"             ! CLEAR ERRORS
```

Retrieve errors and explanations as follows. Since errors are accumulated in a queue, you must read the entire queue to retrieve and clear all the errors.

```
400 PRINT @6, "ERR?"            ! CHECK FOR ERRORS
410 INPUT @6, A, A$              ! READ IN THE ERROR
420 IF (A = 0) THEN GOTO 500     ! NO MORE ERRORS
430 PRINT "Error# :";A, A$       ! PRINT ERROR# AND EXPLANATION
440 GOTO 400
500 END
```

5-60. Writing an SRQ and Error Handler

It is good practice to include fault (error) handling routines in your applications. The following sample program lines show a method for halting program execution on occurrence of an SRQ (Service Request) on the bus, checking to see if the Calibrator is the source of the SRQ, retrieving its fault messages, and acting on the faults. You should modify and extend this code as necessary for your application.

If you want to use SRQs, first use the *SRE, *ESE, and ISCE commands to enable the desired event. Refer to "Checking 5520A Status" for more information.

```
10 INIT PORT0                     ! IFC the bus
20 CLEAR PORT0                    ! DCL the bus
30 ! INITIALIZE THE 5520A SRQ HANDLER
40 PRINT @6, "*SRE 8"             ! Enable STB.EAV (error available)
50 ON SRQ GOTO 1100              ! Install SRQ handler
60 ! Body of the application goes here
1100 ! Bus SRQ handler
1110 CLEAR PORT0                  ! Make sure devices are not confused
1120 IF (SPL(6) AND 64) THEN GOSUB 1200 ! If (STB.RQS) call SRQ
1130 ! TEST OTHER DEVICES RQS BITS IF DESIRED
1140 RESUME
1200 ! 5520A SRQ handler
1210 IF (SPL(6) AND 8) THEN GOSUB 1300 ! If (STB.EAV) call handler
1220 ! Test other STB bits if desired here
1299 RETURN
1300 ! 5520A STB.EAV (error) handler
1320 PRINT @6, "ERR?"            ! Read and clear error
1330 INPUT @6, E%, E$             ! Read in error # and explanation
1340 PRINT "Error# :";E, E$       ! Print error # and explanation
1350 IF (E% <> 0) THEN GOTO 1320 ! Until no more errors
1360 STOP                         ! Other commands for your app
1370 END
```

5-61. Verifying a Meter on the IEEE-488 Bus

This program selects 10 V dc output, verifies that the Calibrator is set to 10 V, then triggers a Fluke 45 to take a reading. It displays calibrator output, Fluke 45 reading, and the meter error in ppm. The program assumes that the Calibrator bus address is 4 and the Fluke 45 bus address is 1.

```
10 REM THIS PROGRAM VERIFIES THE ACCURACY OF A FLUKE 45 AT 10V DC
20 INIT PORT 0 ! INITIALIZE THE INTERFACE
30 CLEAR PORT 0 ! "
40 PRINT @1, "VDC;RATE 5;AUTO;TRIGGER 2" ! SETS FLUKE 45 TO 10V DC
50 PRINT @1, "OUT 10 V ; OPER;" ! SET THE 5520A TO 10V DC
60 PRINT @4, "*WAI; OUT?" ! WAIT FOR SETTLE, REQUEST THE OUTPUT VALUE
70 PRINT @4, V,U$,F,V2,U2$ ! GET THE DATA FROM THE 5520A
80 PRINT @1, "*TRG;VAL?" ! TRIGGER 45 TO TAKE READING
90 INPUT @1, VM ! GET THE DATA FROM THE 45
100 ER = ABS(V - VM)/V * 1E6 ! COMPUTE ERROR
110 PRINT "5520 OUTPUT: ";V;U$ ! PRINT THE RESULTS
120 PRINT "45 MEASURED: ";VM;"V"
130 PRINT "ERROR: ";ER;"PPM"
140 END
```

5-62. Verifying a Meter on the RS-232 UUT Serial Port

This program selects 10 V dc output, verifies that the Calibrator is set to 10 V, then triggers a Fluke 45 to take a reading. It displays Calibrator output, the Fluke 45 reading, and the meter error in ppm. The program assumes that the Calibrator uses the IEEE-488 interface with bus address is 4 and the Fluke 45 is on the Calibrator SERIAL 2 TO UUT port.

```
10 REM THIS PROGRAM VERIFIES THE ACCURACY OF A FLUKE 45 AT 10V DC
20 INIT PORT 0 ! INITIALIZE THE INTERFACE
30 CLEAR PORT 0 ! "
40 PRINT @4, "UUT_SEND `VDC;RATE S;AUTO;TRIGGER 2\n'" ! SET FLUKE 45
50 PRINT @4, "UUT_RECV" ! SEND THE FLUKE 45 PROMPT
60 PRINT @4, P$ ! GET THE FLUKE 45 PROMPT
70 PRINT @4, "OUT 10 V ; OPER" ! SET THE 5520A TO 10 V DC
80 PRINT @4, "*WAI; OUT?" ! WAIT FOR SETTLE; GET VALUE
90 PRINT @4, "V,U$,F,V2,U2$" ! GET THE DATA FROM 5520A
100 PRINT @4, "UUT_SEND `*TRG; VAL?\n'" ! TRIGGER FLUKE 45 READING
110 PRINT @4, "UUT_RECV?" ! SEND 45 READING TO 5520A
120 INPUT @4, VM, P$ ! GET 45 READING AND PROMPT
130 ER = ABS(V - VM)/V * 1E6 ! COMPUTE ERROR
140 PRINT "5520 OUTPUT: ";V;U$ ! PRINT THE RESULTS
150 PRINT "FLUKE 45 MEASURED: ";ER;"PPM" ! PRINT THE RESULTS
160 END
```

5-63. Using *OPC?, *OPC, and *WAI

The *OPC?, *OPC, and *WAI commands let you maintain control of the order of execution of commands that could otherwise be passed up by subsequent commands.

If you had sent an OUT command, you can check if the output has settled by sending the query *OPC?. As soon as the OUT command has completed (output settled), a "1" appears in the output buffer. You should always follow an *OPC? command with a read command. The read command causes program execution to pause until the addressed instrument responds. The following sample program shows how you can use *OPC?.

```
10 PRINT @4, "OUT 100V,1KHZ;OPER; *OPC?" ! 5520A ADDRESS IS 4
20 INPUT @4, A ! READ THE "1" FROM THE 5520A
30 !PROGRAM HALTS HERE UNTIL A "1" IS PUT INTO THE OUTPUT BUFFER
40 PRINT "OUTPUT SETTLED"
```

The *OPC command is similar in operation to the *OPC? query, except that it sets bit 0 (OPC for “Operation Complete”) in the Event Status Register to 1 rather than sending a 1 to the output buffer. One simple use for *OPC is to include it in the program in order for it to generate an SRQ (Service Request). Then an SRQ handler written into the program can detect the operation complete condition and respond appropriately. You can use *OPC similarly to *OPC?, except your program must read the ESR to detect the completion of all operations. The following sample program shows how you can use *OPC.

```
10 REMOTE
20 PRINT @4, "OUT 100V,1KHZ;OPER;*OPC" ! 5520A ADDRESS IS 4
30 PRINT @4, "*ESR?" ! PUT THE ESR BYTE IN BUFFER
40 INPUT @4, A% ! READ THE ESR BYTE
50 IF (A% AND 1%) = 0% GOTO 30 ! TRY AGAIN IF NO OPC
60 PRINT "OUTPUT SETTLED"
70 END
```

The *WAI command causes the Calibrator to wait until any prior commands have been completed before continuing on to the next command, and takes no other action. Using *WAI is a convenient way to halt operation until the command or commands preceding it have completed. The following sample program shows how you can use *WAI.

```
10 REMOTE
20 PRINT @4, "OUT 100V,1KHZ;OPER;*WAI" ! 5520A ADDRESS IS 4
30 PRINT @4, "OUT?" ! READ THE OUTPUT VALUE
40 PRINT @4, A$,B$,C$ ! A$ CONTAINS THE OUTPUT VALUE
50 PRINT "OUTPUT SETTLED"
60 PRINT "OUTPUT IS: ";A$;B$;" at ";C$
70 END
```

5-64. Taking a Thermocouple Measurement

The following program takes one temperature measurement at a time.

```
10 REM Set Bus Timeout to 20 seconds, Init IEEE Bus
20 TIMEOUT 20 * 1000
30 INIT PORT 0
40 CLEAR @6
100 REM Reset 5520A, TC measurement mode
110 PRINT @6,"*RST; TC_TYPE J; TC_MEAS FAR"
200 PRINT "Hit Carriage Return to take a Reading"
210 INPUTLINE A$
220 REM Request the measurement value
230 PRINT @6, "VAL?"
240 REM Read measurement, unit
250 INPUT @6, M,U$
260 GOTO 200
```

5-65. Taking a Pressure Measurement

The following program takes one pressure measurement at a time.

```
10 REM Set Bus Timeout to 20 seconds, Init IEEE Bus
20 TIMEOUT 20 * 1000
30 INIT PORT 0
40 CLEAR @6
100 REM Reset 5520A, pressure measurement mode
110 PRINT @6,"*RST; PRES_MEAS "
200 PRINT "Hit Carriage Return to take a Reading"
210 INPUTLINE A$
220 REM Request the measurement value
230 PRINT @6, "VAL?"
240 REM Read measurement, unit
250 INPUT @6, M,U$
260 GOTO 200
```

5-66. Using the RS-232 UUT Port to Control an Instrument

The SERIAL 2 TO UUT RS-232 port is used to pass commands on to another instrument. For example, a meter that is being calibrated can have its RS-232 port connected to the Calibrator SERIAL 2 TO UUT serial port. Commands sent from a controller can be routed through the Calibrator's UUT port and received by the meter or UUT. There are seven special UUT_* commands incorporated into the Calibrator for passing commands on to an instrument connected to the UUT port. Refer to Chapter 6.

5-67. Input Buffer Operation

As the Calibrator receives each data byte from the controller, it places the bytes in a portion of memory called the input buffer. The input buffer holds up to 350 data bytes and operates in a first in, first out fashion.

IEEE-488 The Calibrator treats the EOI IEEE-488 control line as a separate data byte and inserts it into the input buffer if it is encountered as part of a message terminator. Input buffer operation is transparent to the program running on the controller. If the controller sends commands faster than the Calibrator can process them, the input buffer fills to capacity. When the input buffer is full, the Calibrator holds off the IEEE-488 bus with the NRFD (Not Ready For Data) handshake line. When the Calibrator has processed a data byte from the full input buffer, it then completes the handshake, allowing the controller to send another data byte. The calibrator clears the input buffer on power-up and on receiving the DCL (Device Clear) or SDC (Selected Device Clear) messages from the controller.

RS-232 Under RS-232-C serial port remote control using ^S (<Cntl> S) XOFF protocol, the Calibrator issues a ^S XOFF when the input buffer becomes 80% full. The calibrator issues a ^Q (<Cntl> Q) when it has read enough of the input buffer so that it is less than 40% full. When using RTS (Request to Send) protocol (selected as part of the "RS-232 Host Port Setup Procedure"), the serial interface asserts and unasserts RTS in response to same conditions as for XON/XOFF protocol.

Chapter 6

Remote Commands

	Contents	Page
6-1.	Introduction.....	6-3
6-2.	Command Summary by Function	6-3
6-3.	Common Commands	6-3
6-4.	Error Mode Commands	6-4
6-5.	External Connection Commands.....	6-4
6-6.	Oscilloscope Commands	6-5
6-7.	Output Commands.....	6-5
6-8.	Pressure Measurement Commands.....	6-7
	commands, remote:pressure measurement	
6-9.	RS-232 Host Port Commands.....	6-7
6-10.	RS-232 UUT Port Commands	6-7
6-11.	Setup and Utility Commands.....	6-8
6-12.	Status Commands	6-9
6-13.	Thermocouple (TC) Measurement Commands	6-9
6-14.	Commands	6-10

6-1. Introduction

This chapter documents the IEEE-488/RS-232 remote commands for the 5520A Calibrator (hereafter referred to as “the Calibrator”). Remote commands duplicate activities that can be initiated from the front panel in local operation. Following the summary table is a complete alphabetical listing of all commands complete with protocol details. Separate headings in the alphabetical listing provide the parameters and responses, plus an example for each command. For information on using commands, see Chapter 5, “Remote Operation.”

6-2. Command Summary by Function

6-3. Common Commands

*CLS	(Clear status.) Clears the ESR, ISCR0, ISCR1, the error queue, and the RQS bit in the status byte. This command terminates pending operation complete commands (*OPC or *OPC?).
*ESE	Loads a byte into the Event Status Enable register.
*ESE?	Returns the contents of the Event Status Enable register.
*ESR?	Returns the contents of the Event Status Register and clears the register.
*IDN?	Identification query. Returns instrument model number, serial number, and firmware revision levels for the main and front panel CPUs, and inguard PGA.
*OPC	Enables setting of bit 0 (OPC for "Operation Complete") in the Event Status Register to 1 when all pending device operations are complete.
*OPC?	Returns a 1 after all pending operations are complete. This commands causes program execution to pause until all operations are complete. (See also *WAI.)
*OPT?	Returns a list of the installed hardware and software options.
*PUD	Protected user data command. This command allows you to store a string of bytes in nonvolatile memory. This command works only when the CALIBRATION switch is in the ENABLE position.
*PUD?	Returns the contents of the *PUD (Protected User Data) memory.
*RST	Resets the state of the instrument to the power-up state. This command holds off execution of subsequent commands until it is complete. (Overlapped command.)
*SRE	Loads a byte into the Service Request Enable register (SRE).
*SRE?	Returns the byte from the Service Request Enable register.
*STB?	Returns the status byte.
*TRG	Changes the operating mode to thermocouple MEASURE, triggers a measurement, and returns the value of the measurement. This command is equivalent to sending "TC_MEAS;*OPC;VAL?".
*TST?	Initiates a series of self-tests, then returns a "0" for pass or a "1" for fail. If any faults are detected, they are logged into the fault queue where they can be read by the ERR? query.
*WAI	Prevents further remote commands from being executed until all previous remote commands have been executed.

6-4. Error Mode Commands

EDIT	Sets the edit field. PRI is specified for the output value in single output functions and the primary output value in dual output functions.
EDIT?	Returns the edit field setting.
ERR_UNIT	Chooses how UUT error is shown.
ERR_UNIT?	Returns presently selected value of ERR_UNIT.
INCR	Increments or decrements the output (as selected by the edit field) and enters error mode, the same as using the output adjustment knob in local operation.
MULT	Multiplies the reference magnitude (as selected by the edit field).
NEWREF	Sets the reference value to be the present Calibrator output value, the same as pressing the NEW REF key in local operation.
OLDREF	Sets the Calibrator output to the previously programmed reference value, the same as pressing the ENTER key in local operation.
OUT_ERR?	Returns the UUT error computed after shifting the output with the INCR command.
REFOUT?	Returns the value of the reference, which is the output values of the Calibrator the last time a new reference was established with an OUT, NEWREF, or MULT.

6-5. External Connection Commands

CUR_POST	Selects the active binding posts for current output. This applies to current and power outputs.
CUR_POST?	Returns the active binding posts for current output.
EARTH	Connects or disconnects the internal guard shield from earth (chassis) ground.
EARTH?	Returns whether the internal guard shield is connected or disconnected from earth (chassis) ground.
EXTGUARD	Connects or disconnects the internal guard shield from the LO binding post.
EXTGUARD?	Returns whether the internal guard shields are connected or disconnected from earth (chassis) ground.
LOWS?	Returns whether or not the low terminals are internally open or tied together.
LOWS	Selects whether or not the low terminals are internally open or tied together for dual outputs.
PRES_UNIT	Sets the pressure display units.
PRES_UNIT?	Returns the pressure display units.
RTD_TYPE	Sets the Resistance Temperature Detector (RTD) type.
RTD_TYPE?	Returns the Resistance Temperature Detector (RTD) type.
TC_REF	Sets whether the internal temperature sensor or an external reference value is used for Thermocouple (TC) outputs and measurements.
TC_REF?	Returns the source and value of the temperature being used as a reference for thermocouple simulation and measurement.
TC_TYPE	Sets the thermocouple (TC) temperature type.
TC_TYPE?	Returns the thermocouple (TC) type.
TSENS_TYPE	Sets temperature sensor type when output is set to a temperature with OUT command.
TSENS_TYPE?	Returns the temperature sensor type.

6-6. Oscilloscope Commands

(See Chapter 8 for usage information.)

OL_TRIP?	Returns the detected state of scope overload protection.
OUT_IMP	Sets the output impedance of the SCOPE BNC.
OUT_IMP?	Returns the output impedance of the SCOPE BNC.
RANGE	Sets the Calibrator range when in OVERLD, PULSE, or MEASZ scope modes.
SCOPE	Sets the calibrator output to an oscilloscope mode.
SCOPE?	Returns the present oscilloscope mode.
TDPULSE	Activates or deactivates the tunnel diode pulser drive for the -SC600 EDGE mode.
TDPULSE?	Returns whether the tunnel diode pulser drive for the -SC600 EDGE mode is active.
TLIMIT	Sets the time limit for -SC600 OVERLD mode to stay in operate.
TLIMIT?	Returns the time limit for -SC600 OVERLD mode to stay in operate.
TLIMIT_D	Sets the power-up and reset default for the time limit for -SC600 OVERLD mode to stay in operate.
TLIMIT_D?	Returns the power-up and reset default for the time limit for -SC600 OVERLD mode to stay in operate.
TMWAVE	Selects the waveform for MARKER mode.
TMWAVE?	Returns the timemark waveform setting for MARKER mode.
TRIG	Sets the frequency of the signal at the TRIG OUT BNC.
TRIG?	Returns the frequency of the signal at the TRIG OUT BNC.
VAL?	Returns the last thermocouple, pressure, or, for the -SC600, impedance measurement value.
VIDEOFMT	Selects the format for VIDEO mode.
VIDEOFMT?	Returns the VIDEO mode format.
VIDEOMARK	Sets the VIDEO mode line marker location.
VIDEOMARK?	Returns the VIDEO mode line marker location.
ZERO_MEAS	Zeros the pressure module or sets the zero offset for capacitance measurement using the -SC600.
ZERO_MEAS?	Returns the zero offset for the pressure module or capacitance measurement using the -SC600.

6-7. Output Commands

CFREQ?	Returns the optimum frequency value for stimulus for capacitance modes.
DBMZ	Sets the impedance used for dBm outputs (ac volts).
DBMZ?	Returns the impedance used for dBm outputs (ac volts).
DC_OFFSET	Applies a dc offset to an ac output voltage.
DC_OFFSET?	Returns the dc offset voltage.

Output Commands (cont)

DPF	Sets the displacement power factor (phase angle) between the NORMAL and AUX terminals for ac power output only.
DPF?	Returns the displacement power factor (phase angle) between the NORMAL and AUX terminals.
DUTY	Sets the duty cycle of square wave outputs.
DUTY?	Returns the duty cycle of square wave outputs.
FUNC?	Returns the present output, measurement, or calibration function.
HARMONIC	Makes the frequency of one output be a harmonic (multiple) of the other output (called the fundamental).
HARMONIC?	Returns the present instrument harmonic and fundamental locations.
LCOMP	Activates or deactivates inductive load compensation for ac current output.
LCOMP?	Returns whether inductive load compensation for ac current output is active.
OPER	Activates the Calibrator output if it is in standby.
OPER?	Returns the operate/standby setting.
OUT	Sets the output of the Calibrator and establishes a new reference point for the error mode.
OUT?	Returns the output amplitudes and frequency of the Calibrator.
PHASE	Sets the phase difference between the NORMAL and AUX terminals for dual outputs. The NORMAL terminal output is the phase reference.
PHASE?	Returns the phase difference between the NORMAL and AUX terminals.
POWER?	Returns the equivalent power for dc and ac power output.
RANGE?	Returns the present output ranges.
RANGELCK	Locks in the present range, or selects auto ranging.
RANGELCK?	Returns whether or not the preset output range is locked.
REFCLOCK	Sets the reference clock source (internal or through the 10 MHz IN BNC connector).
REFCLOCK?	Returns the reference clock source (internal or through the 10 MHz IN BNC connector).
REFPHASE	If two Calibrators are synchronized using 10 MHz IN/OUT, sets the phase difference between the NORMAL terminals on the slave Calibrator and the NORMAL terminals of the master Calibrator.
REFPHASE?	If two Calibrators are synchronized using 10 MHz IN/OUT, returns the phase difference between the NORMAL terminals on the slave Calibrator and the NORMAL terminals of the master Calibrator.
STBY	Puts the Calibrator in standby.
SYNCOUT	Sends a synchronization pulse out to a slave Calibrator through the 10 MHz OUT BNC connector.
WAVE	Sets the waveforms for ac outputs.
WAVE?	Returns the waveforms of the output.
ZCOMP	Activates (2-wire or 4-wire) or deactivates impedance compensation.
ZCOMP?	Returns whether or not impedance compensation is active and if active, which type.

6-8. Pressure Measurement Commands

DAMPEN	Activates or deactivates dampening (averaging) of pressure readings.
DAMPEN?	Returns whether dampening (averaging) of pressure readings is active.
PRES?	Queries the attached pressure module for its model and serial number.
PRES_MEAS	Changes the operating mode to pressure measurement.
VAL?	Returns the last thermocouple, pressure, or, for the -SC600, impedance measurement value.
ZERO_MEAS	Zeros the pressure module or sets the zero offset for capacitance measurement using the -SC600.
ZERO_MEAS?	Returns the zero offset for the pressure module or capacitance measurement using the -SC600.

6-9. RS-232 Host Port Commands

LOCAL	Puts the Calibrator into the local state.
LOCKOUT	Puts the Calibrator into the lockout state. This command duplicates the IEEE-488 LLO (Local Lockout) message.
REMOTE	Puts the Calibrator into the remote state. This command duplicates the IEEE-488 REN (Remote Enable) message.
SPLSTR	Sets the serial remote mode Serial Poll response string.
SPLSTR?	Returns the string programmed for serial remote mode Serial Poll responses.
SRQSTR	Sets the serial remote mode SRQ (Service Request) response (up to 40 characters).
SRQSTR?	Returns the string programmed for Serial Mode SRQ response.
UUT_RECVB?	Returns binary data from the UUT serial port as integers.
UUT_SENDB	Sends binary data to the UUT serial port as integers.
^P (<cntl>p)	Control-P character prints the serial poll string. (See SPLSTR for string format.)
^C (<cntl>c)	Control-C character clears the device.
^T (<cntl>t)	Control-T character executes a group trigger.

6-10. RS-232 UUT Port Commands

UUT_FLUSH	Flush the UUT receive buffer.
UUT_RECV?	Returns data from the UUT serial port.
UUT_RECVB?	Returns binary data as integers from the UUT serial port.
UUT_SEND	Sends a string to the UUT serial port.
UUT_SET	Sets the UUT serial port communication parameters and saves them in nonvolatile memory.
UUT_SET?	Returns the UUT serial port communication parameters contained in nonvolatile memory.

6-11. Setup and Utility Commands

CLOCK	Sets the real-time clock.
CLOCK?	Queries the real-time clock.
DBMZ_D	Sets the power-up and reset default impedance used for dBm outputs (ac volts).
DBMZ_D?	Returns the power-up and reset default impedance used for dBm outputs (ac volts).
FORMAT	Use with extreme care. Restores the contents of the nonvolatile memory device to factory defaults.
LIMIT	Sets the maximum permissible output magnitudes, negative and positive.
LIMIT?	Returns the programmed output magnitude limits for voltage and current.
PR_RPT	Prints the Stored, Active or CAL-Constant CAL_Report through either the HOST or UUT Serial Port.
PRES_UNIT_D	Sets the power-up and reset default pressure display units.
PRES_UNIT_D?	Returns the power-up and reset default pressure display units.
REFCLOCK_D	Sets the power-up and reset default for the reference clock source (internal or through the 10 MHz IN BNC connector).
REFCLOCK_D?	Returns the power-up and reset default for the reference clock source (internal or through the 10 MHz IN BNC connector).
REFPHASE_D	If two Calibrators are synchronized using 10 MHz IN/OUT, sets the power-up and reset default phase difference between the NORMAL terminals on the slave Calibrator and the NORMAL terminals of the master Calibrator.
REFPHASE_D?	If two Calibrators are synchronized using 10 MHz IN/OUT, returns the power-up and reset default phase difference between the NORMAL terminals on the slave Calibrator and the NORMAL terminals of the master Calibrator.
RTD_TYPE_D	Set the default Resistance Temperature Detector (RTD) sensor type.
RTD_TYPE_D?	Returns the default Resistance Temperature Detector (RTD) sensor type.
SP_SET	Sets the HOST serial port communication parameters and saves them in nonvolatile memory.
SP_SET?	Returns the HOST serial port communication parameters contained in nonvolatile memory.
TC_TYPE_D	Sets the power-up and reset default thermocouple type.
TC_TYPE_D?	Returns the power-up and reset default thermocouple type.
TEMP_STD	Sets the temperature degree standard, ipts-68 or its-90.
TEMP_STD?	Returns the temperature degree standard, ipts-68 or its-90.
TLIMIT_D	Sets the power-up and reset default for the time limit for -SC600 OVERLD mode to stay in operate.
TLIMIT_D?	Returns the power-up and reset default for the time limit for -SC600 OVERLD mode to stay in operate.
UNCERT?	Returns specified uncertainties for the present output. If there are no specifications for an output, returns zero.

6-12. Status Commands

ERR?	Returns the first error code with an explanation contained in the Calibrator error queue, then removes that error code from the queue.
EXPLAIN?	Explains an error code. This command returns a string that explains the error code furnished as the parameter.
FAULT?	Returns the first error code contained in the Calibrator error queue, then removes that error from the queue.
FUNC?	Returns the present output, measurement, or calibration function.
ISCE	Loads two bytes into both the Instrument Status 1 to 0 Change Enable register and the Instrument Status 0 to 1 Change Enable register.
ISCE?	Returns the OR of the contents of the Instrument Status 1 to 0 Change Enable register and the Instrument Status 0 to 1 Change Enable register.
ISCE0	Loads two bytes into the Instrument Status 1 to 0 Change Enable register.
ISCE0?	Returns the contents of the Instrument Status 1 to 0 Change Enable register.
ISCE1	Loads two bytes into the Instrument Status 0 to 1 Change Enable register.
ISCE1?	Returns the contents of the Instrument Status 0 to 1 Change Enable register.
ISCR?	Returns the OR of the contents of the Instrument Status 1 to 0 Change Register and the Instrument Status 0 to 1 Change Register and clears both registers.
ISCR0?	Returns and clears the contents of the Instrument Status 1 to 1 Change Register.
ISCR1?	Returns and clears the contents of the Instrument Status 0 to 0 Change Register.
ISR?	Returns the contents of the Instrument Status Register.
ONTIME?	Returns the time since the Calibrator was powered up last.

6-13. Thermocouple (TC) Measurement Commands

TC_MEAS	Changes the operating mode to thermocouple measurement.
TC_OFFSET	Sets a temperature offset for the thermocouple measurement mode.
TC_OFFSET?	Returns the temperature offset when in the thermocouple measurement mode.
TC_OTCD?	Returns whether or not the open thermocouple detection circuit is set.
TC_OTCD	Activates or deactivates the open thermocouple detection circuit in thermocouple measurement mode.
VAL?	Returns the last thermocouple, pressure, or, for the -SC600, impedance measurement value.
VVAL?	Returns the last value of the thermocouple measurement in volts.

6-14. Commands

The following is an alphabetical list of all Calibrator commands and queries, including common commands and device-dependent commands. Each command title includes a graphic that indicates remote interface applicability, IEEE-488 and RS-232, and command group: Sequential, Overlapped, and Coupled.

IEEE-488 (GPIB) and RS-232 Applicability IEEE-488 RS-232 Each command and query has a check box indicating applicability to IEEE-488 (general purpose interface bus, or GPIB) and RS-232 remote operations. For sorting purposes, this list ignores the * character that precedes the common commands.

Sequential Commands Sequential Commands executed immediately as they are encountered in the data stream are called sequential commands. For more information, see “Sequential Commands” in Chapter 5.

Overlapped Commands Overlapped Commands that require additional time to execute are called overlapped commands because they can overlap the next command before completing execution. To be sure an overlapped command is not interrupted during execution, use the *OPC, *OPC?, and *WAI commands to detect command completion. For more information, see “Overlapped Commands” in Chapter 5.

Coupled Commands Coupled These are called coupled commands (examples: CUR_POST and OUT) because they “couple” in a compound command sequence. Care must be taken to be sure the action of one command does not disable the action of a second command and thereby cause a fault. For more information, see “Coupled Commands” in Chapter 5.

CFREQ? IEEE-488 RS-232 Sequential Overlapped Coupled

(Capacitance Frequency query) Returns the optimal frequency for stimulus when measuring or calibrating capacitance output.

Response: <value> of the optimal frequency

Example: CFREQ? returns 1.0E+2

Returns 100 Hz as the optimal frequency for the selected capacitance output (1.0 μ F for this example). The return is 0 if not sourcing capacitance.

CLOCK IEEE-488 RS-232 Sequential Overlapped Coupled

(Real-Time Clock command) Sets the real time clock, time only, or date and time. To set the date, the CALIBRATION switch must be in the ENABLE position.

Parameters:

1. (optional) year in the format YYYY
2. (optional) month in the format MM
3. (optional) day in the format DD
4. hour in the format HH
5. minute in the format MM
6. second in the format SS

Examples: `CLOCK 1998,6,1,9,52,10`
sets clock to June 1, 1998, 9:52:10 AM
`CLOCK 13,10,10` sets clock time only to 1:10:10 PM

CLOCK? IEEE-488 RS-232 Sequential Overlapped Coupled

(Real_Time Clock query) Returns the date and time the real time clock.

Response: (character) 1. date in the format YYYY-MM-DD
(character) 2. time in the format HH:MM:SS

Example: `CLOCK?` returns `1998-12-04,13:03:50`

The clock is set to December 4, 1998, 13:03:50.

***CLS** IEEE-488 RS-232 Sequential Overlapped Coupled

(Clear Status command) Clears the ESR, ISCR0, ISCR1, the error queue, and the RQS bit in the status byte. This command terminates pending operation complete commands (*OPC or *OPC?).

Parameter: (None)

Example: `*CLS`

Clear the ESR, ISCR0, ISCR1, the error queue, and the RQS bit in the status byte.

CUR_POST IEEE-488 RS-232 Sequential Overlapped Coupled

(Current Post command) Selects the binding posts for current output. This also applies to power outputs. The current post setting is retained until the power is turned off or the **RESET** button is pressed.

Parameters: AUX (selects the AUX terminals)
A20 (selects the 20A terminals)

Example: `CUR_POST AUX`

Selects the Calibrator front panel AUX terminals for the output current.

CUR_POST? IEEE-488 RS-232 Sequential Overlapped Coupled

(Current Post query) Returns the active front panel binding post terminals used for current output: AUX or 20A.

Responses: AUX (AUX terminals are selected)
A20 (20A terminals are selected)

Example: `CUR_POST?` returns `AUX`

Returns AUX when the AUX terminals are selected for output current.

DAMPEN IEEE-488 RS-232 Sequential Overlapped Coupled

(Dampen Mode for Pressure Measurement command) Activates or deactivates dampening (averaging) of pressure readings.

Parameter: ON (dampen on)
OFF (dampen off)

Example: DAMPEN ON

DAMPEN? IEEE-488 RS-232 Sequential Overlapped Coupled

(Dampen Mode for Pressure Measurement query) Returns whether dampening (averaging) of pressure readings is active.

Response: (character) ON (dampen on)
(character) OFF (dampen off)

Example: DAMPEN returns ON

DBMZ IEEE-488 RS-232 Sequential Overlapped Coupled

(dBm Impedance command) Sets the impedance used for dBm outputs (ac volts).

Parameters: Z50 (50 ohms)
Z75 (75 ohms)
Z90 (90 ohms)
Z100 (100 ohms)
Z135 (135 ohms)
Z150 (150 ohms)
Z300 (300 ohms)
Z600 (600 ohms)
Z900 (900 ohms)
Z1000 (1000 ohms = dBv)
Z1200 (1200 ohms)

Example: DBMZ Z600

DBMZ? IEEE-488 RS-232 Sequential Overlapped Coupled

(dBm Impedance query) Returns the impedance used for dBm outputs (ac volts).

Response: (character) Impedance keyword

Example: DBMZ? returns Z600

DBMZ_D IEEE-488 RS-232 Sequential Overlapped Coupled

(dBm Impedance Default command) Sets the power-up and reset default impedance used for dBm outputs (ac volts).

Parameters: Z50 (50 ohms)
Z75 (75 ohms)
Z90 (90 ohms)
Z100 (100 ohms)
Z135 (135 ohms)
Z150 (150 ohms)
Z300 (300 ohms)
Z600 (600 ohms)
Z900 (900 ohms)
Z1000 (1000 ohms = dBv)
Z1200 (1200 ohms)

Example: DBMZ_D Z600

This setting only applies when single output AC voltages are being sourced. The dBm impedance is set to the default at power on, reset, and when going into single output AC mode.

DBMZ_D? IEEE-488 RS-232 Sequential Overlapped Coupled

(dBm Impedance Default query) Returns the power-up and reset default impedance used for dBm outputs (ac volts).

Response: (character) Impedance keyword

Example: DBMZ_D? returns Z600

DC_OFFSET IEEE-488 RS-232 Sequential Overlapped Coupled

(DC Voltage Offset command) Applies a dc offset to an ac output voltage (maximum six digits). This command applies only to single ac voltage outputs. If the selected offset is too large for the active ac voltage range, an error message is returned.

Parameter: <value> signed offset amplitude

Example: DC_OFFSET +123.45 MV

Load a dc offset of +123.45 mV to the ac output signal.

DC_OFFSET?

IEEE-488 RS-232 Sequential Overlapped Coupled

(DC Voltage Offset query) Returns the value of the dc offset voltage.

Response: <value> signed offset amplitude

Example: DC_OFFSET? returns +1.44E-03

Returns 1.44 mV as the value of the applied dc offset. If +0.00000E+00 is returned, the dc offset is zero.

DPF IEEE-488 RS-232 Sequential Overlapped Coupled

(Displacement Power Factor command) Sets the displacement power factor (phase angle) between the Calibrator front panel terminals NORMAL and AUX (for sine waves output only). The NORMAL terminal output is the phase reference. The phase offset is expressed as the cosine of the phase offset (0.000 to 1.000) and a LEAD (default) or LAG term, which determines whether the AUX output leads or lags the NORMAL output.

Parameters: <value>, LEAD
<value>, LAG

Example: DPF .123, LEAD

Set the current output on the Calibrator AUX terminals to lead the voltage output on the NORMAL terminals by 82.93 degrees. (Cosine of 82.93 degrees is 0.123, nominal.)

DPF? IEEE-488 RS-232 Sequential Overlapped Coupled

(Displacement Power Factor query) Returns the displacement power factor (cosine of the phase angle) between the Calibrator front panel NORMAL and AUX terminals for sine wave outputs.

Responses: <value>, LEAD
<value>, LAG

Example: DPF? returns 5.00E-01, LEAD

Returns a leading power factor of .5 when the current output on the Calibrator AUX terminals leads the voltage output on the NORMAL terminals by 60 degrees. (Cosine of 60 degrees is 0.5.) The return is 0 if power factor does not apply to the output.

DUTY IEEE-488 RS-232 Sequential Overlapped Coupled

(Duty Cycle command) Sets the duty cycle of the square wave output. The duty cycle is the percentage of time the waveform is in the positive part of its cycle (1.00 to 99.00 percent). Duty cycle applies only to single-output square waves.

Parameter: <value> of duty cycle with optional PCT (percent) unit

Example: DUTY 12.34 PCT

Set the square wave duty cycle to 12.34%.

DUTY? IEEE-488 RS-232 Sequential Overlapped Coupled

(Duty Cycle query) Returns the value of the square wave output duty cycle (1.00 to 99.00).

Response: <value> of duty cycle in percent

Example: DUTY? returns 1.234E+01

Returns 12.34% for the value of the square wave duty cycle.

EARTH IEEE-488 RS-232 Sequential Overlapped Coupled

(Earth Ground command) Selects whether or not the Calibrator front panel NORMAL LO terminal is tied to chassis (earth) ground. Once set, the Calibrator retains the earth setting until power off or reset.

Parameters: OPEN (disconnect front panel LO terminal from chassis ground)
TIED (connect front panel LO terminal to chassis ground)

Example: EARTH TIED

Load TIED to tie the Calibrator front panel NORMAL LO terminal to earth (the front panel EARTH key annunciator is on).

EARTH? IEEE-488 RS-232 Sequential Overlapped Coupled

(Earth Ground query) Returns whether or not the Calibrator front panel NORMAL LO terminal is tied to chassis (earth) ground.

Responses: (character) OPEN (front panel LO terminal disconnected from chassis ground)
(character) TIED (front panel LO terminal connected to chassis ground)

Example: EARTH? returns OPEN

Returns OPEN when EARTH is not tied to the NORMAL LO terminal (the front panel EARTH key annunciator is off).

EDIT IEEE-488 RS-232 Sequential Overlapped Coupled

(Edit command) Sets the edit field to the primary, secondary or frequency field.

Parameters: PRI (edit the value in single output functions and the primary output value in dual output functions)
SEC (edit the secondary value in dual output functions)
FREQ (edit the frequency value in single ac output functions)
OFF (edit is off, which is the same as using the NEWREF command)

Example: EDIT FREQ

Load FREQ into the edit field to edit frequency.

EDIT? IEEE-488 RS-232 Sequential Overlapped Coupled

(Edit query) Returns the edit field setting.

Responses: (character) PRI (value in single output functions, and the primary output value in dual output functions is in edit)
(character) SEC (secondary value in dual output functions is in edit)
(character) FREQ (frequency value in single ac output functions is in edit)
(character) OFF (no value is in edit.)

Example: EDIT? returns OFF

Returns OFF when no value is in edit.

ERR? IEEE-488 RS-232 Sequential Overlapped Coupled

(Error query) Returns the first error code contained in the Calibrator error queue, then removes that error code from the queue. Following the error code is an explanation of the error code, similar to but sometimes containing more specific information than the EXPLAIN? command. The explanation sent in response to this query can contain variables specific to a particular error event. See Appendix E for a list of error codes and error messages.

A zero value is returned when the error queue is empty. To read the entire contents of the error queue, repeat ERR? until the response 0, "No Error" is returned. For terminal users, the error queue Returns for ERR? is always 0, "No Error" because error messages are returned instead of queued.

Response: <value>, (error code value)
<string> (text string explaining the error)

Example: ERR? returns 0, "No Error"

Returns 0, "No Error" when the error queue is empty.

ERR_UNIT IEEE-488 RS-232 Sequential Overlapped Coupled

(UUT Error Unit Thresh Hold command) Chooses how UUT error is shown (this is nonvolatile).

Parameter:	GT1000	UUT error is displayed in % above 1000 ppm, ppm below
	GT100	UUT error is displayed in % above 100 ppm, ppm below
	GT10	UUT error is displayed in % above 10 ppm, ppm below
	PPM	UUT error is displayed in ppm always
	PCT	UUT error is displayed in % always

ERR_UNIT? IEEE-488 RS-232 Sequential Overlapped Coupled

(UUT Error Unit Thresh Hold query) Returns presently selected values of ERR_UNIT.

Responses: GT1000 UUT error is displayed in % above 1000 ppm, ppm below
GT100 UUT error is displayed in % above 100 ppm, ppm below
GT10 UUT error is displayed in % above 10 ppm, ppm below
PPM UUT error is displayed in ppm always
PCT UUT error is displayed in % always

***ESE** IEEE-488 RS-232 Sequential Overlapped Coupled

(Event Status Enable command) Loads a byte into the Event Status Enable (ESE) register. (See “Event Status Enable Register (ESE)” in Chapter 5)

Parameter: <value> (decimal equivalent of the ESE byte, 0 to 255)

Example: *ESE 140

Load decimal 140 (binary 10001100) to enable bits 7 (PON), 3 (DDE) and 2 (QYE).

***ESE?** IEEE-488 RS-232 Sequential Overlapped Coupled

(Event Status Enable query) Returns the contents of the Event Status Enable (ESE) register. (See “Event Status Enable Register (ESE)” in Chapter 5)

Response: <value> (decimal equivalent of the ESE byte, 0 to 255)

Example: *ESE? returns 133

Returns decimal 133 (binary 10000101) when bits 7 (PON), 2 (QYE), 1 (OPC) are enabled.

***ESR?** IEEE-488 RS-232 Sequential Overlapped Coupled

(Event Status Register query) Returns the contents of the Event Status Register (ESR) and clears the register. (See Event Status Register (ESR)” in Chapter 5)

Response: <value> (decimal equivalent of the ESR byte, 0 to 255)

Example: *ESR? returns 189

Returns decimal 189 (binary 10111101) when bits 7 (PON), 5 (CME), 4 (EXE), 3 (DDE), 2 (QYE) and 0 (OPC) are enabled.

EXPLAIN? IEEE-488 RS-232 Sequential Overlapped Coupled

(Explain Error query) Explains an error code. This command returns a string that explains the error code furnished as the parameter. The error code (same as the parameter) is originally obtained by sending the FAULT? query. (See the ERR? command, which returns both the error code and the explanation string.) See Appendix E for a list of error codes and error messages.

Parameter: <value> if the error code (an integer)

Response: <string> that explains the error code, with the parameter (if there is one) shown as a percent sign followed by d (integer parameter), f (floating point parameter), or s (string parameter)

Example: EXPLAIN? 539 returns “Can’t change compensation now.”
Returns the explanation of error 539: “Can’t change compensation now.”

EXTGUARD IEEE-488 RS-232 Sequential Overlapped Coupled

(External guardcommand) Connects or disconnects the internal guard shield from the LO binding post.

Parameter: ON (external guard is on, i.e. external)
OFF (external guard is off, i.e. internal)

Once set, the Calibrator retains the external guard setting until power off or reset.

Example: EXTGUARD ON

EXTGUARD? IEEE-488 RS-232 Sequential Overlapped Coupled

(External guard query) Returns whether the internal guard shields are connected or disconnected from earth (chassis) ground.

Response: (character) ON (external guard is on, i.e., external)
(character) OFF (external guard is off, i.e., internal)

Example: EXTGUARD? returns ON

FAULT? IEEE-488 RS-232 Sequential Overlapped Coupled

(Fault query) Returns the first error code contained in the Calibrator error queue, then remove that error from the queue. After obtaining the error code, use the EXPLAIN? command to view an explanation. A zero value is returned when the error queue is empty. To read the entire contents of the error queue, repeat FAULT? until the response is 0. (Only system errors appear in the error queue.)

Response: <value> of the error code

Example: FAULT? returns 539

Returns the first error code in the error queue, number 539. To view an explanation of the error, enter the command EXPLAIN? 539.

FORMAT IEEE-488 RS-232 Sequential Overlapped Coupled

(Format command) **Use with extreme care.** Restores the contents of the nonvolatile memory device to factory defaults. The memory holds calibration constants and setup parameters. You lose all calibration data permanently. The CALIBRATION switch on the rear panel of the Calibrator must be set in the ENABLE position or an execution error occurs, except for FORMAT SETUP.

Parameter: ALL (replaces the whole contents with factory defaults)
 CAL (replaces all cal constants with factory defaults)
 SETUP (replaces setup parameters with factory defaults)

Example: FORMAT SETUP

Replace the setup parameters with the default setup values (below). (The FORMAT ALL command is the same as FORMAT CAL and then FORMAT SETUP.) The FORMAT SETUP command also clears the *PUD string (see the *PUD command) and SRQSTR is set to "SRQ: %02x %02x %04x %04x" (see the SRQSTR command) and SPLSTR is set to "SPL: %02x %02x %04x %04x" (see the SPLSTR command).

Features			
Temperature Standard	its-90	Display Contrast*	level 7,7
Host Connection	gpib (IEEE-488)	Display Brightness*	level 1,0
GPiB Port Address	4	RTD Power Up Default Type	pt385
Serial Ports	8 bits, 1 stop bit, xon/xoff, parity none, 9600 baud	Thermocouple Power Up Default Type	K
EOL (end of line)	CRLF	Current Limits	±20.5 A
EOF (end of file)	012,000	Voltage Limits	±1020 V
Remote I/F	term		
Remote commands (see Chapter 6)			
SRQSTR	SRQ: %02x %02x %04x %04x	*PUD string	cleared
* Output Display and Control Display, respectively. There are 8 levels: 0,1,2,3,4,5,6,7.			
Defaults			
Reference Clock	Internal	Reference Phase	0°
dBm Impedance	600 Ω	Pressure Unit	PSI

FUNC? IEEE-488 RS-232 Sequential Overlapped Coupled

(Function query) Returns the present output, measurement, or calibration function. See the response below for output & measurement modes.

Responses:

DCV	(dc volts function)
ACV	(ac volts function)
DCI	(dc current function)
ACI	(ac current function)
RES	(ohms function)
CAP	(capacitance function)
RTD	(temperature with an rtd function)
TC_OUT	(temperature with a thermocouple function)
DC_POWER	(dc power function)
AC_POWER	(ac power function)
DCV_DCV	(dual dc volts function)
ACV_ACV	(dual ac volts function)
TC_MEAS	(measure temperature with a thermocouple)
SACV	(oscilloscope ac volts function)
SDCV	(oscilloscope dc volts function)
MARKER	(oscilloscope marker function)
LEVSINE	(oscilloscope leveled sine function)
EDGE	(oscilloscope edge function)

Example: FUNC? returns DCV_DCV

Returns DCV_DCV when the Calibrator output function dual dc volts.

HARMONIC IEEE-488 RS-232 Sequential Overlapped Coupled

(Harmonic command) Makes the frequency of one output a multiple of another output for the ac voltage or ac power functions (sine waves only). For example, in dual ac voltage, have the frequency of the voltage output on the Calibrator front panel NORMAL terminals at 60 Hz and the frequency of the voltage output on the AUX terminals at the 7th harmonic (420 Hz). The range for the harmonics is 1 to 50.

Parameters: <value>, PRI (fundamental at 5520A NORMAL terminals)
<value>, SEC (fundamental at 5520A AUX terminals)

Example: HARMONIC 5, PRI

Load the fundamental frequency at the primary (PRI) output (NORMAL terminals), and the 5th harmonic frequency is at the secondary output (AUX terminals). For example, if the fundamental frequency output is 60 Hz, the harmonic frequency output is 300 Hz.

HARMONIC? IEEE-488 RS-232 Sequential Overlapped Coupled

(Harmonic query) Returns the present instrument harmonic characteristic and location of the fundamental output PRI (primary, the NORMAL terminals) or SEC (secondary, the AUX terminals).

Response: <value>, PRI (harmonic value, fundamental at primary output)
<value>, SEC (harmonic value, fundamental at secondary output)

Example: HARMONIC? returns 5, SEC

Returns that the 5th harmonic frequency is selected, and the fundamental is at the secondary output (AUX terminals). Therefore, the harmonic frequency appears at the primary, or NORMAL terminals.

***IDN?** IEEE-488 RS-232 Sequential Overlapped Coupled

(Identification query) Returns instrument model number, serial number, and firmware revision levels for the main, encoder, and inguard CPUs.

Responses: (Indefinite ASCII) A message containing four fields separated by commas as follows:

1. Manufacturer
2. Model number
3. Serial number
4. Firmware revision levels for the Main CPU+Front Panel CPU+Inguard PGA

Example: *IDN? returns FLUKE,5520A,5248000,1.2+1.3+1.3

Returns Fluke manufacturer, model 5520A, serial number 5248000, main firmware version 1.2, encoder firmware 1.3, and inguard PGA 1.3.

INCR IEEE-488 RS-232 Sequential Overlapped Coupled

(Increment command) Increments or decrements the output (as selected using the EDIT command, or defaults to the primary output) and enters error mode; the same as using the Calibrator output adjustment knob in local operation.

Parameters: <+ value> (increment value) (optional unit matching edit field)
<- value> (decrement value)

Example: INCR +.00001 mV

Load the error mode and increment the selected edit field by .00001 mV.

ISCE IEEE-488 RS-232 Sequential Overlapped Coupled

(Instrument Status Change Enable command) Loads two bytes into the two 16-bit ISCE mask registers (ISCE1 and ISCE0). (See “Instrument Status Change Enable Registers” in Chapter 5 for more information.)

Parameter: <value> (decimal equivalent of the 16 bits, 0 to 32767)

Example: ISCE 6272

Load decimal 6272 (binary 0001010001000000) to enable bits 12 (SETTLED), 10 (REMOTE) and 6 (HIVOLT). This is equivalent to sending the commands ISCE0 6272 and ISCE1 6272 (see below).

ISCE? IEEE-488 RS-232 Sequential Overlapped Coupled

(Instrument Status Change Enable query) Returns the two bytes from the two 16-bit ISCE mask registers (ISCE1 and ISCE0). (See “Instrument Status Change Enable Registers” in Chapter 5 for more information.)

Response: <value> (decimal equivalent of the 16 bits, 0 to 32767)

Example: ISCE? returns 6272

Returns decimal 6272(binary 0001010001000000) if bits 12 (SETTLED), 10 (REMOTE), and 6 (HIVOLT) are set to 1.

ISCE0 IEEE-488 RS-232 Sequential Overlapped Coupled

(Instrument Status 0 to 1 Change Enable command) Loads the two bytes into the 16-bit ISCE0 register. (See “Instrument Status Change Enable Registers” in Chapter 5 for more information.)

Parameter: <value> (decimal equivalent of the 16 bits, 0 to 32767)

Example: ISCE0 6272

Load decimal 6272 (binary 0001010001000000) to enable bits 12 (SETTLED), 10 (REMOTE) and 6 (HIVOLT).

ISCE0? IEEE-488 RS-232 Sequential Overlapped Coupled

(Instrument Status 0 to 1 Change Enable query) Returns the two bytes from the 16-bit ISCE0 register. (See “Instrument Status Change Enable Registers” in Chapter 5 for more information.)

Response: <value> (decimal equivalent of the 16 bits, 0 to 32767)

Example: ISCE0? returns 6272

Returns decimal 6272(binary 0001010001000000) if bits 12 (SETTLED), 10 (REMOTE), and 6 (HIVOLT) are set to 1.

ISCE1 IEEE-488 RS-232 Sequential Overlapped Coupled

(Instrument Status 1 to 0 Change Enable command) Loads the two bytes into the 16-bit ISCE1 register. (See “Instrument Status Change Enable Registers” in Chapter 5 for more information.)

Parameter: <value> (decimal equivalent of the 16 bits, 0 to 32767)

Example: ISCE1 6272

Load decimal 6272 (binary 0001010001000000) to enable bits 12 (SETTLED), 10 (REMOTE) and 6 (HIVOLT).

ISCE1? IEEE-488 RS-232 Sequential Overlapped Coupled

(Instrument Status 1 to 0 Change Enable query) Returns the two bytes from the 16-bit ISCE1 register. (See “Instrument Status Change Enable Registers” in Chapter 5 for more information.)

Response: <value> (decimal equivalent of the 16 bits, 0 to 32767)

Example: ISCE1? returns 6272

Returns decimal 6272 (binary 0001010001000000) if bits 12 (SETTLED), 10 (REMOTE), and 6 (HIVOLT) are set to 1.

ISCR? IEEE-488 RS-232 Sequential Overlapped Coupled

(Instrument Status Change Register query) Returns and clears the contents of the Instrument Status 0 to 1 Change Register (ISCR0) and Instrument Status 1 to 0 Change Register (ISCR1). (See “Instrument Status Change Register” in Chapter 5 for more information.)

Response: <value> (decimal equivalent of the 16 bits, 0 to 32767)

Example: ISCR? returns 6272

Returns decimal 6272 (binary 0001010001000000) if bits 12 (SETTLED), 10 (REMOTE), and 6 (HIVOLT) are set to 1.

ISCR0? IEEE-488 RS-232 Sequential Overlapped Coupled

(Instrument Status 0 to 1 Change Register query) Returns and clears the contents of the Instrument Status 0 to 1 Change Register.

Response: <value> (decimal equivalent of the 16 bits, 0 to 32767)

Example: ISCR0? returns 6272

Returns decimal 6272 (binary 0001010001000000) if bits 12 (SETTLED), 10 (REMOTE), and 6 (HIVOLT) are set to 1.

ISCR1? IEEE-488 RS-232 Sequential Overlapped Coupled

(Instrument Status 1 to 0 Change Register query) Returns and clears the contents of the Instrument Status 1 to 0 Change Register.

Response: <value> (decimal equivalent of the 16 bits, 0 to 32767)

Example: ISCR1? returns 6272

Returns decimal 6272 (binary 0001010001000000) if bits 12 (SETTLED), 10 (REMOTE), and 6 (HIVOLT) are set to 1.

ISR? IEEE-488 RS-232 Sequential Overlapped Coupled

(Instrument Status Register query) Returns contents of the Instrument Status Register.

Response: <value> (decimal equivalent of the 16 bits, 0 to 32767)

Example: ISR? returns 6272

Returns decimal 6272 (binary 0001010001000000) if bits 12 (SETTLED), 10 (REMOTE), and 6 (HIVOLT) are set to 1.

LCOMP IEEE-488 RS-232 Sequential Overlapped Coupled

(Inductive compensation command) Activates or deactivates inductive load compensation for ac current output. For current output, compensation is allowed when the frequency is less than 440 Hz and the amplitude is less than 0.33 A. Compensation is also allowed when the frequency is less than 1 kHz and the amplitude is greater than or equal to 0.33 A.

Parameters: OFF (turns off the inductive load compensation circuitry)
ON (turns on the inductive load compensation circuitry)

Example: LCOMP ON

LCOMP? IEEE-488 RS-232 Sequential Overlapped Coupled

(Inductive compensation query) Returns whether inductive load compensation for ac current output is active.

Responses: (character) OFF (Inductive load compensation circuitry is off)
(character) ON (Inductive load compensation circuitry is on)

Example: LCOMP? returns ON

LIMIT IEEE-488 RS-232 Sequential Overlapped Coupled

(Limit command) Sets the maximum permissible output magnitude, negative and positive, for voltage and current, which is saved in the Calibrator non-volatile memory. (While saving configuration data in the non-volatile memory, a period of about 2 seconds, the Calibrator does not respond to remote commands.) Both negative and positive values must be entered. Once set, the Calibrator retains the limit settings until either another limit is entered, or the `FORMAT SETUP` command resets the limits (and all other defaults) to the factory settings (± 1000 V, ± 11 A). See the `FORMAT` command.

The magnitude of the limit has the following effect on different waveforms:

dc	magnitude of limit
ac (sine wave)	magnitude of limit (rms)
ac (non-sine wave)	magnitude of limit x 3 (peak-to-peak)
ac (with dc offset)	magnitude of limit x 2.4 (absolute peak) (volts only)

Parameters: <positive value>, <negative value>

Example: `LIMIT 100V, -100V`

Limit the voltage output to ± 100 V dc, 100 V ac rms, 300 V peak-to-peak, 240 V peak.

Example: `LIMIT 1A, -1A`

Limit the current output to ± 1 A dc, 1 A ac rms, 3 A peak-to-peak.

LIMIT? IEEE-488 RS-232 Sequential Overlapped Coupled

(Limit query) Returns the programmed output magnitude limits for voltage and current.

Response: <positive value voltage>, <negative value voltage>, <positive value current>, <negative value current>

Example: `LIMIT?`
returns `1020.0000, -1020.0000, 20.5000, -20.5000`

Returns the present value of the voltage and current limits (reset values shown).

LOCAL IEEE-488 RS-232 Sequential Overlapped Coupled

(Local command) Puts the Calibrator into the local state, clearing the remote state (see the `REMOTE` command) and front panel lockout (see the `LOCKOUT` command). This command duplicates the IEEE-488 GTL (Go To Local) message.

Parameter: (None)

Example: `LOCAL`

Set the instrument into the local state, clearing the remote state and front panel lockout (if enable).

LOCKOUT IEEE-488 RS-232 Sequential Overlapped Coupled

(Lockout command) Puts the Calibrator into the lockout state when in remote control (see the `REMOTE` command). This means no local operation at the front panel is allowed during remote control. To clear the lockout condition, use the `LOCAL` command. This command duplicates the IEEE-488 LLO (Local Lockout) message.

Parameter: (None)

Example: LOCKOUT

Set the instrument into the front panel lockout state. The front panels controls cannot be used.

LOWS IEEE-488 RS-232 Sequential Overlapped Coupled

(Low Potential Output Terminals command) Selects whether or not the Calibrator front panel NORMAL LO terminal and AUX LO terminal are internally tied together (default) or are open. This feature is used for ac power, dc power, dual dc volts and dual ac volts outputs. Once set, the Calibrator retains the LO setting until power off or reset.

Parameter: OPEN (disconnect NORMAL LO and AUX LO terminals)
TIED (connect NORMAL LO and AUX LO terminals)

Example: LOWS TIED

Tie the front panel NORMAL LO and AUX LO terminals together.

LOWS? IEEE-488 RS-232 Sequential Overlapped Coupled

(Low Potential Output Terminals query) Returns whether or not the Calibrator front panel NORMAL LO terminal and AUX LO terminal are internally tied together (default) or are open.

Response: OPEN (disconnected NORMAL LO and AUX LO terminals)
TIED (connected NORMAL LO and AUX LO terminals)

Example: LOWS? returns OPEN

Returns OPEN when the Calibrator front panel NORMAL LO and AUX LO terminals are not tied together.

MULT IEEE-488 RS-232 Sequential Overlapped Coupled

(Multiply command) Multiplies the reference magnitude (as selected with the EDIT command or default to the primary output). The reference magnitude is the present reference in either direct mode or in error mode.

Parameter: <value> (multiplier expressed as a floating point number)

Example: MULT 2.5

Multiply the existing reference by 2.5, creating a new reference. For example, an existing reference of 1 V is multiplied to 2.5 V.

NEWREF IEEE-488 RS-232 Sequential Overlapped Coupled

(New Reference command) Sets the new reference to the present Calibrator output value and exit the error mode (if selected). For example, you might edit the Calibrator output using the EDIT and INCR commands, and then use the NEWREF command to establish a new reference point and exit the error mode. This is the same as pressing the Calibrator front panel  key.

Parameter: (None)

Example: NEWREF

Set the reference value to the current Calibrator output value.

OLDREF IEEE-488 RS-232 Sequential Overlapped Coupled

(Old Reference command) Sets the Calibrator output to the reference value and exit the error mode (if selected). If editing the output using the EDIT and INCR commands and you want to return to the reference value, use the OLDREF command. If editing the output and you want to make the edited value the new reference, use the NEWREF command.

Parameter: (None)

Example: OLDREF

Set the output to the existing reference value, clearing editing changes.

ONTIME? IEEE-488 RS-232 Sequential Overlapped Coupled

(Calibrator On Time query) Returns the time in minutes since the Calibrator was most recently powered up.

Response: <days> , <hours> (24-hour clock)

Example: ONTIME? returns 47

Returns the time since the Calibrator was last powered up: 47 minutes.

***OPC** IEEE-488 RS-232 Sequential Overlapped Coupled

(Operations Complete command) Sets bit 0 (OPC) of the Event Status Register to 1 when all pending device operations are complete. Also see the *ESR? command.

Parameter: (None)

Example: *OPC

Set bit 0 of the Event Status Register to 1 when all pending device operations are done.

***OPC?** IEEE-488 RS-232 Sequential Overlapped Coupled

(Operations Complete query) Returns a 1 after all pending operations are complete. This command causes program execution to pause until operations are complete. (See *WAI.)

Response: 1 (all operations are complete)

Example: *OPC? returns 1

Returns 1 when all pending operations are complete.

OPER IEEE-488 RS-232 Sequential Overlapped Coupled

(Operate command) Activates the Calibrator output if it is in standby. This is the same as pressing the Calibrator front panel OPR key. If there are errors in the error queue, the OPER command is inhibited for outputs 33 V and over. (Also see the ERR? command and STBY command.)

Parameter: (None)

Example: OPER

Connect the selected output to the Calibrator front panel terminals. Also lights the annunciator in the OPR key.

OPER? IEEE-488 RS-232 Sequential Overlapped Coupled

(Operate query) Returns the operate/standby setting.

Response: 1 (Operate)
0 (Standby)

Example: OPER? returns 1

Returns 1 when the Calibrator is in operate.

***OPT?** IEEE-488 RS-232 Sequential Overlapped Coupled

(Options command) Returns a list of the installed hardware and software options.

Responses: <option string> , <option string> , ... (options list, separated by commas)
0 (no options are installed)

Example: *OPT? returns SC600

Returns SC600 when the Oscilloscope Calibration Option is installed.

OUT IEEE-488 RS-232 Sequential Overlapped Coupled

(Output command) Sets the output of the Calibrator and establishes a new reference point for the error mode. If only one amplitude is supplied, the Calibrator sources a single output. If two amplitudes are supplied, the Calibrator sources two outputs. The second amplitude will be sourced at the AUX terminals for dual voltage outputs. If the frequency is not supplied, the Calibrator will use the frequency that is presently in use.

To source or measure a temperature, select the desired sensor and sensor parameters first. (See the `TSENS_TYPE`, `RTD_*`, and `TC_*` commands.)

To source a signal using the Calibrator scope options, refer to the `SCOPE` command in Chapter 8.

If you change the frequency of an ac function and the harmonic output is not explicitly set at the same time with the `HARMONIC` command, the harmonic will be set to 1.

Use multipliers e.g., k, M, μ with the `OUT` command, as desired.

Parameters: <value> V	Volts dc or update volts ac
<value> DBM	Volts ac dBm update
<value> V, <value> Hz	Volts ac or volts dc with 0 Hz
<value> DBM, <value> Hz	Volts ac in dBm
<value> A	Current dc or update current ac
<value> A, <value> Hz	Current ac
<value> OHM	Resistance
<value> F	Capacitance
<value> CEL	Temperature (Celsius)
<value> FAR	Temperature (Fahrenheit)
<value> HZ	Update frequency
<value> V, <value> A	Power dc or update power ac
<value> V, <value> A, <value> HZ	Power ac
<value> V, <value> V	Dual volts dc or update dual ac
<value> V, <value> V, <value> HZ	Dual volts ac in volts
<value>	For single output, changes amplitude keeping unit and frequency the same.

Examples: OUT 15.2 V (volts; 15.2 V @ same frequency)
 OUT 20 DBM (volts; 20 dBm @ same frequency)
 OUT 10 V, 60 Hz (volts ac; 10 V @ 60 Hz)
 OUT 10 DBM, 50 HZ (volts ac; 10 dBm @ 50 Hz)
 OUT 1.2 MA (current; 1.2 mA @ same frequency)
 OUT 1 A, 400 HZ (current ac; 1 A @ 400 Hz)
 OUT 1 KOHM (ohms; 1 k Ω)
 OUT 1 UF (capacitance; 1 μ F)
 OUT 100 CEL (temperature; 100 $^{\circ}$ C)
 OUT -32 FAR (temperature; -32 $^{\circ}$ F)
 OUT 60 HZ (frequency update; 60 Hz)
 OUT 10 V, 1 A (power; 10 watts @ same frequency)
 OUT 1 V, 1 A, 60 HZ (power ac; 1 watts @ 60 Hz)
 OUT 1 V, 2 V (dual volts; 1 V, 2 V @ same freq.)
 OUT 10 MV, 20 MV, 60 HZ (dual volts; .01 V, .02 V @ 60 Hz)

Each example shows a value and unit, e.g., -15.2 V. If a value is entered without a unit, the value of the existing output is changed, when logically allowed.

OUT? IEEE-488 RS-232 Sequential Overlapped Coupled

(Output query) Returns the output amplitudes and frequency of the Calibrator. Multipliers (e.g., K or M) are not used in the response.

Parameters: V (optional for ac voltage and TC modes)
 DBM (optional for ac voltage modes)
 CEL (optional for RTD and TC modes, Celsius)
 FAR (optional for RTD and TC modes, Fahrenheit)
 OHM (optional for RTD modes, ohms)

Response: <primary amplitude value>,<primary units>,
 <secondary amplitude value>,<secondary units>,
 <fundamental frequency value>

Examples: OUT? returns -1.520000E+01,V,0E+00,0,0.00E+00
 OUT? returns 1.88300E-01,A,0E+00,0,4.420E+02
 OUT? returns 1.23000E+00,V,2.34000E+00,V,6.000E+01
 OUT? returns 1.92400E+06,OHM,0E+00,0,0.00E+00
 OUT? returns 1.52000E+01,V,1.88300E-01,A,4.420E+02
 OUT? DBM returns 2.586E+01,DBM,0E+00,A,4.420E+02
 OUT? returns 1.0430E+02,CEL,0E+00,0,0.00E+00
 OUT? FAR returns 2.19740000E+02,FAR,0E+00,0,0.00E+00
 OUT? V returns 4.2740E-03,V,0E+00,0,0.00E+00
 OUT? OHM returns 1.40135E+02,OHM,0E+00,0,0.00E+00

The respective values for the above examples are:

-15.2 V
188.3 mA, 442 Hz
1.23 V, 2.34 V, 60 Hz
1.924 M Ω
15.2 V, 188.3 mA, 442 Hz
25.86 dBm, 442 Hz (25.86 dBm = 15.2 V at 600 Ω)
104.3 $^{\circ}$ C
219.74 $^{\circ}$ F (same value as 104.3 $^{\circ}$ C, in Fahrenheit)
4.274 mV (same value as 104.3 $^{\circ}$ C for a K-type thermocouple, in volts)
140.135 Ω (same value as 104.3 $^{\circ}$ C for a pt385 RTD, in ohms)

The primary and secondary units are: V, DBM, A, OHM, F, CEL, FAR. The units for the <frequency value> is always assumed to be Hz.

OUT_ERR? IEEE-488 RS-232 Sequential Overlapped Coupled

(Output Error query) Returns the UUT error and units computed by the Calibrator after shifting the output with the INCR command. The return units are PPM (parts per million), PCT (percent), DB (decibels) or 0 if there is no error. The UUT error is not computed when editing frequency.

Response: <value of error>, <units>

Example: OUT_ERR? returns -1.00000E+01, PCT

Returns -10% when the UUT is reading low by 10%.

PHASE IEEE-488 RS-232 Sequential Overlapped Coupled

(Phase Difference command) Sets a phase difference between the Calibrator front panel NORMAL and AUX or 20A terminals for ac power and ac dual voltage outputs. The NORMAL terminal output is the phase reference. The set range is 0.00 to \pm 180.00 degrees, with + for a leading phase difference and - for a lagging phase difference.

Parameter: <phase value> DEG (DEG, for degree, is optional)

Example: PHASE -60 DEG

Set the phase difference so the frequency output at the AUX terminals lags the frequency output at the NORMAL terminals by 60 degrees.

PHASE? IEEE-488 RS-232 Sequential Overlapped Coupled

(Phase Difference query) Returns the phase difference between the Calibrator front panel NORMAL and AUX terminals for ac power and ac dual voltage outputs.

Response: <phase value>

Example: PHASE? returns -6.000E+01

Returns -60 when the frequency output at the AUX terminals is lagging the frequency output at the NORMAL terminals by 60 degrees.

POWER? IEEE-488 RS-232 Sequential Overlapped Coupled

(Calculate Power Output query) Returns the equivalent real power for ac and dc power outputs, based on the voltage and current settings, and power factor (ac only). If the output is not ac or dc power, the return is 0E+00 (zero) watts.

Response: <value> (in watts)

Example: POWER? returns 1.00000E+01

Returns 10 when the output voltage is 10 V dc and output current 1 A dc, for 10 watts real power.

Example: POWER? returns 1.00000E+01

Returns 10 when the output voltage is 10 V ac and output current 2 A ac and power factor is .5, for 10 watts real power.

PR_PRT X IEEE X RS=232

IEEE-488 RS-232 Sequential Overlapped Coupled

Description: Prints a self calibration report out the selected serial port.

- Parameters:
1. Type of report to print: **STORED, ACTIVE, or CONSTS**
 2. Format of report: **PRINT** (designed to be read), **SPREAD** (designed to be loaded into a spreadsheet)
 3. Calibration interval to be used for instrument specifications in the report: **I90D** (90 day spec), **I1Y** (1 year spec)
 4. Serial port through which to print: **HOST, UUT**

Example: PR-PRT STORED, PRINT, I90D, HOST

PRES? IEEE-488 RS-232 Sequential Overlapped Coupled

(Pressure Module query) Queries the attached pressure module for its model and serial number.

Responses: (Indefinite ASCII) A message containing four fields separated by commas as follows:

1. Manufacturer
2. Model number
3. Serial number
4. Firmware revision (0)

Example: FLUKE, 700P05, 9467502, 0

PRES_MEAS IEEE-488 RS-232 Sequential Overlapped Coupled

(Pressure Measurement mode command) Changes the operating mode to pressure measurement.

Parameter: (Optional) Pressure units

Example: PRES_MEAS PSI

Displays the previously selected units if no parameter is supplied.

PRES_UNIT IEEE-488 RS-232 Sequential Overlapped Coupled

(Pressure Units command) Sets the pressure display units.

Parameters:	PSI	(pound-force per square inch)
	MHG	(meters of mercury)
	INHG	(inches of mercury)
	INH2O	(inches of water)
	FTH2O	(feet of water)
	MH2O	(meters of water)
	BAR	(bar)
	PAL	(Pascal)
	G/CM2	(grams per centimeter squared)
	INH2O60F	(Inches of water @ 60 degrees Fahrenheit)

Once set, the Calibrator retains the pressure units until power off or reset.

Example: PRES_UNIT BAR

PRES_UNIT? IEEE-488 RS-232 Sequential Overlapped Coupled

(Pressure Units query) Returns the pressure display units.

Responses:	(character) PSI	(pound-force per square inch)
	(character) MHG	(meters of mercury)
	(character) INHG	(inches of mercury)
	(character) INH2O	(inches of water)
	(character) FTH2O	(feet of water)
	(character) MH2O	(meters of water)
	(character) BAR	(bar)
	(character) PAL	(Pascal)
	(character) G/CM2	(grams per centimeter squared)
	(character) INH2O60F	(Inches of water @ 60 degrees Fahrenheit)

Example: PRES_UNIT? returns BAR

Once set, the Calibrator retains the pressure units until power off or reset.

PRES_UNIT_D

IEEE-488 RS-232 Sequential Overlapped Coupled

(Pressure Units Default command) Sets the power-up and reset default pressure display units.

Parameters: PSI (pound-force per square inch)
 MHG (meters of mercury)
 INHG (inches of mercury)
 INH2O (inches of water)
 FTH2O (feet of water)
 MH2O (meters of water)
 BAR (bar)
 PAL (Pascal)
 G/CM2 (grams per centimeter squared)
 INH2O60F (Inches of water @ 60 degrees Fahrenheit)

Example: PRES_UNIT_D PSI

The pressure unit is set to the default at power on and reset.

PRES_UNIT_D?

IEEE-488 RS-232 Sequential Overlapped Coupled

(Pressure Units Default query) Returns the power-up and reset default pressure display units.

Responses: (character) PSI (pound-force per square inch)
 (character) MHG (meters of mercury)
 (character) INHG (inches of mercury)
 (character) INH2O (inches of water)
 (character) FTH2O (feet of water)
 (character) MH2O (meters of water)
 (character) BAR (bar)
 (character) PAL (Pascal)
 (character) G/CM2 (grams per centimeter squared)
 (character) INH2O60F (Inches of water @ 60 degrees Fahrenheit)

Example: PRES_UNIT_D? returns PSI

***PUD** IEEE-488 RS-232 Sequential Overlapped Coupled

(Protected User Data command) Stores a string of 64 characters (maximum), which is saved in the 5520A non-volatile memory. (While saving configuration data in the non-volatile memory, a period of about 2 seconds, the 5520A does not respond to remote commands.) This command works only when the CALIBRATION switch on the rear panel of the Calibrator is in the ENABLE position. Include a line feed (RS-232) character to terminate the block data or End or Identify (EOI) command (IEEE-488).

Parameter: #2<nn><nn characters string> (definite length)
 #0<character string> (indefinite length)
 "<character string>" (character string)
 '<character string>' (character string)

Example: *PUD #0CAL LAB NUMBER 1

Store the string CAL LAB NUMBER 1 in the protected user data area using the indefinite length format.

Example: *PUD #216CAL LAB NUMBER 1

Store the string CAL LAB NUMBER 1 in the protected user data area using the definite length format, where #2 means two digits follow which represent the number of text characters nn in CAL LAB NUMBER 1 (including spaces=16).

Example: *PUD "CAL LAB NUMBER 1"

Store the string CAL LAB NUMBER 1 in the protected user data area using the character string format.

***PUD?** IEEE-488 RS-232 Sequential Overlapped Coupled

(Protected User Data query) Returns the contents of the *PUD (Protected User Data) memory in definite length format.

Response: #2nn<nn characters>

Example: *PUD? returns #216CAL LAB NUMBER 1

Returns #2 then 16 then 16 characters of text (including spaces) stored in the nonvolatile memory.

RANGE? IEEE-488 RS-232 Sequential Overlapped Coupled

(Range query) Returns the present output ranges. Both the primary output and secondary outputs are returned. If there is no secondary output, 0 is returned. Dual outputs are noted with P for primary output (front panel NORMAL terminals) and S for secondary output (front panel AUX terminals).

Response: <primary output> , <secondary output>

Examples: DC330MV, 0 (dc volts 330 mV range)
DC33MA_A, 0 (dc current 33 mA range)
AC3_3V, 0 (ac volts 3.3 V range)
AC330MA_A, 0 (ac current 330 mA range)
R110OHM, 0 (ohms 110 Ω range)
C1_1UF, 0 (capacitance 1.1 μ F range)
TCSRC, 0 (temperature thermocouple source)
RTD_110, 0 (temperature RTD 110 Ω range)
DC3_3V_P, DC3A_AS (dc power 3.3 V, 3 A ranges)
AC330V_P, AC20A_2S (ac power 330 V, 20 A ranges)
DC330MV_P, DC3_3V_S (dual dc volts 330 mV, 3.3 V ranges)
AC330V_P, AC3_3V_S (dual ac volts 330 V, 3.3 V ranges)

Returns the symbolic name of the single or first output, and return the symbolic name of the second output (0 if there is no second output).

RANGELCK IEEE-488 RS-232 Sequential Overlapped Coupled

(Range Lock command) Locks in the present range, or selects auto ranging for dc voltage and dc current single outputs. The range automatically unlocks if the output function changes, for example from dc volts to dc current. When RANGELCK is on, this is equivalent to the softkey range lock showing locked. When RANGELCK is off, this is equivalent to the softkey range lock showing auto.

Parameter: ON (Locks the dc volts or dc current range)
OFF (Unlocks the dc volts or dc current range for autoranging)

Example: RANGELCK OFF

Set the range lock off to allow autoranging for dc volts or dc current.

RANGELCK? IEEE-488 RS-232 Sequential Overlapped Coupled

(Range Lock query) Returns whether or not the preset dc volts or dc current single output range is locked.

Response: ON (range is locked and autoranging is not allowed)
OFF (range is not locked and autoranging is allowed)

Example: RANGELCK? returns OFF

Returns OFF when the range for dc volts or dc current is not locked (autoranging enabled).

REFCLOCK IEEE-488 RS-232 Sequential Overlapped Coupled

(Reference Clock command) Sets the reference clock source (internal or through the 10 MHz IN BNC connector).

Parameter INT (Sets internal reference clock)
 EXT (Sets external reference clock)

Example: REFCLOCK INT

Once set, the Calibrator retains the external guard setting until power off or reset.

REFCLOCK? IEEE-488 RS-232 Sequential Overlapped Coupled

(Reference Clock query) Returns the reference clock source (internal or through the 10 MHz IN BNC connector).

Response: (character) INT (Reference clock is internal)
 (character) EXT (Reference clock is external)

Example: REFCLOCK? returns INT

REFCLOCK_D

IEEE-488 RS-232 Sequential Overlapped Coupled

(Reference Clock Default command) Sets the power-up and reset default for the reference clock source (internal or through the 10 MHz IN BNC connector).

Parameters INT (Sets internal reference clock)
 EXT (Sets external reference clock)

The reference clock is set to the default at power on, reset, and when going into an ac function.

Example: REFCLOCK_D INT

REFCLOCK_D?

IEEE-488 RS-232 Sequential Overlapped Coupled

(Reference Clock Default query) Returns the power-up and reset default for the reference clock source (internal or through the 10 MHz IN BNC connector).

Responses: (character) INT (Reference clock is internal)
 (character) EXT (Reference clock is external)

Example: REFCLOCK_D? returns INT

REFOUT? IEEE-488 RS-232 Sequential Overlapped Coupled

(Reference Output query) Returns the present value of the reference when editing the output (error mode). If not editing the output using the INCR command, the return is 0 (0E+00). The reference value is set with the OUT, NEWREF or MULT commands. To determine which quantity is being edited, use the EDIT? and OUT? commands.

Response: <reference value>

Example: REFOUT? returns 0E+00

Returns 0 when the output is not being edited.

Example: REFOUT? returns 2.500000E-01

Returns .250 when the output is being edited and the reference is, for example, 250 mV.

REFPHASE IEEE-488 RS-232 Sequential Overlapped Coupled

(Reference Phase command) If two Calibrators are synchronized using 10 MHz IN/OUT, sets the phase difference between the primary channel on the Calibrator relative to the sync pulse on the 10 MHz IN or OUT terminal. The primary channel is the NORMAL, AUX, or 20A terminal for single outputs and the NORMAL terminal for ac power and ac dual voltage outputs. The sync pulse on the 10 MHz IN or OUT terminal is the phase reference. The set range is 0.00 to ± 180.00 degrees, with + for a leading phase difference and – for a lagging phase difference.

Parameter: Phase with optional multiplier and DEG unit

Example: REFPHASE 1.5 DEG (1.5 degrees)

On either Calibrator, set the phase of the primary channel to lead the sync pulse by 1.5 degrees.

REFPHASE? IEEE-488 RS-232 Sequential Overlapped Coupled

(Reference Phase query) If two Calibrators are synchronized using 10 MHz IN/OUT, returns the phase difference between the primary channel on the Calibrator and the sync pulse on the 10 MHz IN or OUT terminal.

Response: (float) Phase in degrees

Example: REFPHASE? returns 1.50E+00 (1.5 degrees)

REFPHASE_D IEEE-488 RS-232 Sequential Overlapped Coupled

(Reference Phase Default command) If two Calibrators are synchronized using 10 MHz IN/OUT, sets the power-up and reset default phase difference between the primary channel on the Calibrator relative to the sync pulse on the 10 MHz IN or OUT terminal. The primary channel is the NORMAL, AUX, or 20A terminal for single outputs and the NORMAL terminal for ac power and ac dual voltage outputs. The sync pulse on the 10 MHz IN or OUT terminal is the phase reference. The set range is 0.00 to ± 180.00 degrees, with + for a leading phase difference and – for a lagging phase difference.

Parameter: Phase with optional multiplier and DEG unit

Example REFPHASE_D 1.5 DEG (1.5 degrees)

On either Calibrator, set the power-up and reset default phase of the primary channel to lead the sync pulse by 1.5 degrees.

REFPHASE_D?

IEEE-488 RS-232 Sequential Overlapped Coupled

(Reference Phase Default query) If two Calibrators are synchronized using 10 MHz IN/OUT, returns the power-up and reset default phase difference between the primary channel on the Calibrator and the sync pulse on the 10 MHz IN or OUT terminal.

Response: (Float) Phase in degrees

Example: REFPHASE_D? returns 1.50E+00 (1.5 degrees)

REMOTE IEEE-488 RS-232 Sequential Overlapped Coupled

(Remote command) Places the Calibrator into the remote state. This command duplicates the IEEE-488 REN (Remote Enable) message. When in the remote state, the Control Display shows the softkey “REMOTE CONTROL Go to Local.” Pressing this softkey returns the Calibrator to local operation. If the front panel is locked out, the Control Display shows the softkey “REMOTE CONTROL LOCAL LOCK OUT.” (See the LOCKOUT command.) To unlock the front panel, use the LOCAL command, or cycle the Calibrator power switch.

Parameter: (None)

Example: REMOTE

Place the Calibrator in the remote state and display this state on the front panel Control Display with a softkey REMOTE CONTROL.

RPT_STR IEEE-488 RS-232 Sequential Overlapped Coupled

(Report String command) Loads the user report string. The user report string can be read on the Control Display in local operation, and appears on calibration reports. The CALIBRATION switch must be set to ENABLE. (Sequential command.)

Parameter: String of up to 40 characters

RPT_STR? IEEE-488 RS-232 Sequential Overlapped Coupled

(Report String query) Returns the user report string. The user report string can be read on the Control Display in local operation, and appears on calibration reports. (Sequential command.)

Parameter: None

Response: (String) Up to 40 characters

***RST** IEEE-488 RS-232 Sequential Overlapped Coupled

(Reset Instrument command) Resets the Calibrator to the power-up state. *RST holds off execution of subsequent commands until the reset operation is complete. This command is the same as pressing the front panel **RESET** key.

A reset action evokes the following commands and values:

Command	Value	Command	Value
CUR_POST	AUX	REFCLOCK	<REFCLOCK_D value>
DBMZ	<DBMZ_D value>	REFPHASE	<REFPHASE_D value>
DC_OFFSET	0V	RTD_TYPE	<RTD_TYPE_D value>
DUTY	50PCT	SCOPE	OFF
EARTH	OPEN	STBY	(No output)
EXTGUARD	OFF	TC_OFFSET	0 CEL
HARMONIC	1, PRI	TC_OTCD	ON
LCOMP	OFF	TC_REF	INT
LOWS	TIED	TC_TYPE	<TC_TYPE_D value>
OUT	0V, 0HZ	TRIG	OFF
OUT_IMP	Z1M	TSENS_TYPE	TC
PHASE	0DEG	WAVE	NONE, NONE
PRES_UNIT	<PRES_UNIT_D value>	ZCOMP	OFF
RANGELCK	OFF	ZERO_MEAS	OFF

Changes made to the setup menus that are not saved in memory are discarded on reset.

Response: (None)

Example: *RST

Place the Calibrator in a reset condition, evoking the commands and values shown above.

RTD_TYPE IEEE-488 RS-232 Sequential Overlapped Coupled

(Resistance Temperature Detector Type command) Sets the Resistance Temperature Detector (RTD) sensor type.

Before using RTD_TYPE, select RTD using the TSENS_TYPE command. After using RTD_TYPE, select the output temperature using the OUT command. Changes in temperature sensors changes the output to 0 °C. Once set, the Calibrator retains the RTD type until power off or reset.

Parameters: PT385 (100-ohm RTD, curve $\alpha=0.00385$ ohms/ohm/°C)
PT385_200 (200-ohm RTD, curve $\alpha=0.00385$ ohms/ohm/°C)
PT385_500 (500-ohm RTD, curve $\alpha=0.00385$ ohms/ohm/°C)
PT385_1000 (1000-ohm RTD, curve $\alpha=0.00385$ ohms/ohm/°C)
PT3926 (100-ohm RTD, curve $\alpha=0.003926$ ohms/ohm/°C)
PT3916 (100-ohm RTD, curve $\alpha=0.003916$ ohms/ohm/°C)
CU10 (10-ohm RTD, empirical curve)
NI120 (120-ohm RTD, empirical curve)

Example: RTD_TYPE PT3926

Set the RTD type to a 100-ohm type, using the pt3926 curve ($\alpha=0.003926$ ohms/ohm/°C). The resistance of 100 ohms refers to the ice point characteristic, (the resistance of the RTD at 0 °C (32 °F)).

RTD_TYPE? IEEE-488 RS-232 Sequential Overlapped Coupled

(Resistance Temperature Detector Type query) Returns the Resistance Temperature Detector (RTD) type used for RTD temperature simulations.

Responses: PT385 (100-ohm RTD, curve $\alpha=0.00385$ ohms/ohm/°C)
PT385_200 (200-ohm RTD, curve $\alpha=0.00385$ ohms/ohm/°C)
PT385_500 (500-ohm RTD, curve $\alpha=0.00385$ ohms/ohm/°C)
PT385_1000 (1000-ohm RTD, curve $\alpha=0.00385$ ohms/ohm/°C)
PT3926 (100-ohm RTD, curve $\alpha=0.003926$ ohms/ohm/°C)
PT3916 (100-ohm RTD, curve $\alpha=0.003916$ ohms/ohm/°C)
CU10 (10-ohm RTD, empirical curve)
NI120 (120-ohm RTD, empirical curve)

Example: RTD_TYPE? returns PT3926

Returns PT3926 when a 100-ohm RTD with curve $\alpha=0.003926$ ohms/ohm/°C is set as the RTD type.

RTD_TYPE_D IEEE-488 RS-232 Sequential Overlapped Coupled

(Resistance Temperature Detector Type Default command) Sets the default Resistance Temperature Detector (RTD) at power on and reset, which is saved in the Calibrator non-volatile memory. (While saving configuration data in the non-volatile memory, a period of about 2 seconds, the Calibrator does not respond to remote commands.)

Parameters: PT385 (100-ohm RTD, curve $\alpha=0.00385$ ohms/ohm/°C)
PT385_200 (200-ohm RTD, curve $\alpha=0.00385$ ohms/ohm/°C)
PT385_500 (500-ohm RTD, curve $\alpha=0.00385$ ohms/ohm/°C)
PT385_1000 (1000-ohm RTD, curve $\alpha=0.00385$ ohms/ohm/°C)
PT3926 (100-ohm RTD, curve $\alpha=0.003926$ ohms/ohm/°C)
PT3916 (100-ohm RTD, curve $\alpha=0.003916$ ohms/ohm/°C)
CU10 (10-ohm RTD, empirical curve)
NI120 (120-ohm RTD, empirical curve)

Example: RTD_TYPE_D PT3926

Set the RTD default type to a 100-ohm RTD with curve $\alpha=0.003926$ ohms/ohm/°C.

RTD_TYPE_D? IEEE-488 RS-232 Sequential Overlapped Coupled

(Resistance Temperature Detector Type Default query) Returns the default Resistance Temperature Detector (RTD) used at power on and reset.

Responses: PT385 (100-ohm RTD, curve $\alpha=0.00385$ ohms/ohm/°C)
PT385_200 (200-ohm RTD, curve $\alpha=0.00385$ ohms/ohm/°C)
PT385_500 (500-ohm RTD, curve $\alpha=0.00385$ ohms/ohm/°C)
PT385_1000 (1000-ohm RTD, curve $\alpha=0.00385$ ohms/ohm/°C)
PT3926 (100-ohm RTD, curve $\alpha=0.003926$ ohms/ohm/°C)
PT3916 (100-ohm RTD, curve $\alpha=0.003916$ ohms/ohm/°C)
CU10 (10-ohm RTD, empirical curve)
NI120 (120-ohm RTD, empirical curve)

Example: RTD_TYPE_D? returns PT3926

Returns PT3926 when the RTD default type is a 100-ohm RTD with curve $\alpha=0.003926$ ohms/ohm/°C.

SP_SET IEEE-488 RS-232 Sequential Overlapped Coupled

(Host Serial Port Set command) Sets the RS-232-C settings for the Calibrator rear panel SERIAL 1 FROM HOST serial port, which is saved in the Calibrator non-volatile memory. (While saving configuration data in the non-volatile memory, a period of about 2 seconds, the Calibrator does not respond to remote commands.) (To set the parameters for the rear panel SERIAL 2 TO UUT serial port, see the UUT_SET command.) The factory default values are shown below in **bold** type. (To return to the factory defaults, see the FORMAT SETUP command.)

The interface selection sets the command response, with command echo back for commands and error messages with TERM (terminal) or no echo back with COMP (computer).

Parameters: <baud rate value>, 300, 600, 1200, 2400, 4800, **9600**
<interface>, **TERM** (terminal), COMP (computer)
<flow control>, **XON** (xon/xoff), NOSTALL (none), RTS (rts/cts)
<number data bits>, DBIT7 (7 bits) or **DBIT8** (8 bits)
<number stop bits>, **SBIT1** (1 bit) or SBIT2 (2 bits)
<parity>, **PNONE** (none), PODD (odd), PEVEN (even)
<end of line char.> CR (carriage return), LF (line feed),
CRLF (carriage return/line feed)

Example: `SP_SET 9600,TERM,XON,DBIT8,SBIT1,PNONE,CRLF`

Set the parameters for the rear panel SERIAL 1 FROM HOST serial port to the factory default values.

SP_SET? IEEE-488 RS-232 Sequential Overlapped Coupled

(Host Serial Port Set query) Returns the RS-232-C settings for the Calibrator rear panel SERIAL 1 FROM HOST serial port. (To return the parameters for the rear panel SERIAL 2 TO UUT serial port, see the UUT_SET? command.) The factory default values are shown below in **bold** type. (To return to the factory defaults, see the FORMAT SETUP command.)

Responses: <baud rate value>, 300, 600, 1200, 2400, 4800, **9600**
 <interface>, **TERM** (terminal), COMP (computer)
 <flow control>, **XON** (xon/xoff), NOSTALL (none), RTS (rts/cts)
 <number data bits>, DBIT7 (7 bits) or **DBIT8** (8 bits)
 <number stop bits>, **SBIT1** (1 bit) or SBIT2 (2 bits)
 <parity>, **PNONE** (none), PODD (odd),PEVEN (even)
 <end of line char.> CR (carriage return), LF (line feed),
CRLF (carriage return/line feed)

Example: `SP_SET?` returns `9600,TERM,XON,DBIT8,SBIT1,PNONE,CRLF`

Returns the parameters for the rear panel SERIAL 1 FROM HOST serial port, as shown, when set to the factory default values.

SPLSTR IEEE-488 RS-232 Sequential Overlapped Coupled

(Serial Poll String command) Sets the Serial Poll String (string up to 40 characters) which is saved in the Calibrator non-volatile memory. (While saving configuration data in the non-volatile memory, a period of about 2 seconds, the Calibrator does not respond to remote commands.) The SPLSTR is sent to the host over the serial interface when a ^P (<cntl> P) character is sent. The default format is:

SPL: %02x %02x %04x %04x

where the term %02x (8 bits) means print the value in hexadecimal with exactly 2 hex digits, and %04x (16 bits) means print the value in hexadecimal with exactly 4 hex digits. The string representations are:

SPL: (STB) (ESR) (ISCR0) (ISCR1)

See the commands, respectively, *STB?, *ESR?, ISCR0?, and ISCR1?. A typical string in the default format sent to the host is: SPL: 44 00 0000 1000. This command is for format. For values instead of format, enter a ^P (<cntl> p) character. Also see the SRQSTR command.

Parameter: "<string>\n" (\n represents the NEWLINE character, hex 0A)

Example: SPLSTR "SPL: %02x %02x %04x %04x\n"

Set the SPLSTR to the default values SPL: %02x %02x %04x %04x\n.

SPLSTR? IEEE-488 RS-232 Sequential Overlapped Coupled

(Serial Poll Response String query) Returns the string programmed for Serial Poll response. For values, enter a ^P (<cntl> p) character. Also see the SRQSTR command.

Response: <string>

Example: SRQSTR returns SRQ: %02x %02x %04x %04x\n

Returns the SPLSTR string format (default settings in this example).

***SRE** IEEE-488 RS-232 Sequential Overlapped Coupled

(Service Request Enable command) Loads a byte into the Service Request Enable (SRE) register. (See "Service Request Enable Register (SRE)" in Chapter 5. Since bit 6 is not used (decimal value 64), the maximum entry is $255 - 64 = 191$.)

Parameter: <value> (the decimal equivalent of the SRE byte, 0 to 191)

Example: *SRE 56

Enable bits 3 (EAV), 4 (MAV), and 5 (ESR).

***SRE?** IEEE-488 RS-232 Sequential Overlapped Coupled

(Service Request Enable query) Returns the byte in the Service Request Enable (SRE).

Response: <value> (the decimal equivalent of the SRE byte, 0 to 191)

Example: *SRE? returns 56

Returns 56 when bits 3 (EAV), 4 (MAV), and 5 (ESR) are enabled.

SRQSTR IEEE-488 RS-232 Sequential Overlapped Coupled

(Service Request String command) Sets the Serial Mode SRQ (Service Request) response (up to 40 characters) in the Calibrator non-volatile memory. (While saving configuration data in the non-volatile memory, a period of about 2 seconds, the Calibrator does not respond to remote commands.) The SRQSTR is sent to the host over the serial interface when the SRQ line is asserted (terminal mode only). Default format is:

SRQ: %02x %02x %04x %04x

where the term %02x (8 bits) means print the value in hexadecimal with exactly 2 hex digits, and %04x (16 bits) means print the value in hexadecimal with exactly 4 hex digits. The string representations are:

SRQ: (STB) (ESR) (ISCR0) (ISCR1)

See the commands, respectively, *STB?, *ESR?, ISCR0?, and ISCR1? A typical string in the default format sent to the host is: SRQ: 44 00 0000 1000. This command is for format. See the SPLSTR command for the serial poll response.

Parameter: "<string>\n" (\n represents the Line Feed character, hex 0A)

Example: SRQSTR "SRQ: %02x %02x %04x %04x\n"

Set the SRQSTR to the default values SRQ: %02x %02x %04x %04x\n.

SRQSTR? IEEE-488 RS-232 Sequential Overlapped Coupled

(Service Request String query) Returns the string programmed for Serial Mode SRQ response. This is the format of the Service Request String; actual values come from the registers. Also see the SPLSTR command.

Response: <string>

Example: SRQSTR returns SRQ: %02x %02x %04x %04x\n

Returns the SRQSTR string format (default settings in this example).

***STB?** IEEE-488 RS-232 Sequential Overlapped Coupled

(Status Byte Register query) Returns the byte for the Status Byte Register. (See "Status Byte Register (STB)" in Chapter 5.)

Response: <value> (the decimal equivalent of the STB byte, 0 to 255)

Example: *STB? returns 72

Returns 72 if bits 3 (EAV) and 6 (MSS) are set.

STBY IEEE-488 RS-232 Sequential Overlapped Coupled

(Standby command) Deactivates the Calibrator output if it is in operate. This is the same as pressing the Calibrator front panel key.

Parameter: (None)

Example: STBY

Disconnect the selected output from the Calibrator front panel terminals.

SYNCOUT IEEE-488 RS-232 Sequential Overlapped Coupled

(Synchronization Pulse command) Sends a synchronization pulse out to a slave Calibrator through the 10 MHZ OUT BNC connector.

Parameter: (None)

Example: SYNCOUT

TC_MEAS IEEE-488 RS-232 Sequential Overlapped Coupled

(Thermocouple Measure command) Selects the measure thermocouple mode.

Parameters: CEL (Celsius) (optional)
FAR (Fahrenheit) (optional)

Example: TC_MEAS CEL

Measure the thermocouple temperature that is attached to the Calibrator TC terminals, in Celsius.

TC_OFFSET IEEE-488 RS-232 Sequential Overlapped Coupled

(Thermocouple Temperature Measurement Offset command) Adds a temperature offset to thermocouple measurements (± 500 °C). This command does not apply to thermocouple sourcing.

Parameters: <value> CEL (offset in Celsius) (optional)
<value> FAR (offset in Fahrenheit) (optional)

Example: TC_O+FFSET +10 CEL

Add a temperature offset of +10 °C to the thermocouple measurements.

TC_OFFSET? IEEE-488 RS-232 Sequential Overlapped Coupled

(Thermocouple Temperature Measurement Offset query) Returns the temperature offset used for thermocouple measurements (± 500 °C).

Responses: <value> CEL (offset in Celsius) (optional)
<value> FAR (offset in Fahrenheit) (optional)

Example: TC_OFFSET? returns 1.000E+01,CEL

Returns 10 Celsius when a temperature offset of +10 °C has been added to the thermocouple measurements.

TC_OTCD IEEE-488 RS-232 Sequential Overlapped Coupled

(Thermocouple Open Detection command) Activates or deactivates the open thermocouple detection circuit in thermocouple measurement mode. Once set, the Calibrator retains open thermocouple detection circuit setting until power off or reset.

Parameters: ON (turn on thermocouple detection circuit) (default)
OFF (turn off thermocouple detection circuit)

Example: TC_OTCD ON

Activate the open thermocouple detection circuit. If an open thermocouple is detected, this condition is displayed on the front panel.

TC_OTCD? IEEE-488 RS-232 Sequential Overlapped Coupled

(Thermocouple Open Detection query) Returns the status of the open thermocouple detection circuit in thermocouple measurement mode.

Responses: ON (thermocouple detection circuit is on)
OFF (thermocouple detection circuit is off)

Example: TC_OTCD? returns ON

Returns ON when the open thermocouple detection circuit is activated.

TC_REF IEEE-488 RS-232 Sequential Overlapped Coupled

(Thermocouple Reference command) Sets whether the internal temperature sensor (INT) or an external reference value (EXT) is used for Thermocouple (TC) outputs and measurements. If the first parameter is EXT, the second parameter must be the temperature value to use as the reference for the thermocouple reference junction temperature. Once set, the Calibrator retains reference setting until power off or reset.

Parameters: INT
EXT, <value of external reference> CEL (or FAR)

Example: TC_REF EXT, 25.6 CEL

Set the thermocouple reference to external, with a value of 25.6 °C.

TC_REF? IEEE-488 RS-232 Sequential Overlapped Coupled

(Thermocouple Reference query) Returns the source and value of the temperature being used as a reference for thermocouple simulation and measurement (in Celsius, CEL, or Fahrenheit, FAR, depending on active units). The choices are Internal reference (INT) or External reference (EXT).

If INT is returned, the reference temperature return is 0 unless you are in a thermocouple mode of operation and the Calibrator is in Operate.

Responses: INT, <value of reference temperature>, CEL (or FAR)
EXT, <value of reference temperature>, CEL (or FAR)

Example: TC_REF? returns INT, 2.988E+01, CEL

Returns Internal, 29.88, Celsius, when the thermocouple reference is internal and at 29.88 °C. (If the temperature return for the internal reference is 0 (0.00E+00), the Calibrator is not in Operate, and/or the Calibrator is not in a thermocouple mode.)

TC_TYPE IEEE-488 RS-232 Sequential Overlapped Coupled

(Thermocouple Type command) Sets the Thermocouple (TC) temperature sensor type. The TC type is used when the output is set to a temperature value with the OUT command and the temperature sensor type is set to TC with the TSENS_TYPE command. When the thermocouple type is changed while simulating a temperature output, the temperature is changed to 0 °C. Once set, the Calibrator retains the TC type until power off or reset.

Parameters: B (B-type thermocouple)
C (C-type thermocouple)
E (E-type thermocouple)
J (J-type thermocouple)
K (K-type thermocouple) (default)
N (N-type thermocouple)
R (R-type thermocouple)
S (S-type thermocouple)
T (T-type thermocouple)
X (10 µV/°C linear output)
Y (% relative humidity)
Z (1 mV/°C linear output)

Example: TC_TYPE J

Set the thermocouple type for simulating a temperature output to a J-type thermocouple.

TC_TYPE? IEEE-488 RS-232 Sequential Overlapped Coupled

(Thermocouple Type query) Returns the Thermocouple (TC) temperature sensor type. When the thermocouple type is changed while simulating a temperature output, the temperature is changed to 0 °C.

Responses:

B	(B-type thermocouple)
C	(C-type thermocouple)
E	(E-type thermocouple)
J	(J-type thermocouple)
K	(K-type thermocouple) (default)
N	(N-type thermocouple)
R	(R-type thermocouple)
S	(S-type thermocouple)
T	(T-type thermocouple)
X	(10 μ V/°C linear output)
Y	(% relative humidity)
Z	(1 mV/°C linear output)

Example: TC_TYPE? returns K

Returns K when the thermocouple type for simulating a temperature output is a K-type thermocouple.

TC_TYPE_D IEEE-488 RS-232 Sequential Overlapped Coupled

(Thermocouple Type Default command) Sets the default thermocouple (TC) sensor type, which is saved in the Calibrator non-volatile memory. (While saving configuration data in the non-volatile memory, a period of about 2 seconds, the Calibrator does not respond to remote commands.) The TC type is set to the default at power on and reset.

Parameters:

B	(B-type thermocouple)
C	(C-type thermocouple)
E	(E-type thermocouple)
J	(J-type thermocouple)
K	(K-type thermocouple) (default)
N	(N-type thermocouple)
R	(R-type thermocouple)
S	(S-type thermocouple)
T	(T-type thermocouple)
X	(10 μ V/°C linear output)
Y	(% relative humidity)
Z	(1 mV/°C linear output)

Example: TC_TYPE_D J

Set the thermocouple type default to a type-J thermocouple.

TC_TYPE_D? IEEE-488 RS-232 Sequential Overlapped Coupled

(Thermocouple Type Default query) Returns the default thermocouple (TC) sensor type.

Responses: B (B-type thermocouple)
C (C-type thermocouple)
E (E-type thermocouple)
J (J-type thermocouple)
K (K-type thermocouple) (default)
N (N-type thermocouple)
R (R-type thermocouple)
S (S-type thermocouple)
T (T-type thermocouple)
X (10 μ V/ $^{\circ}$ C linear output)
Y (% relative humidity)
Z (1 mV/ $^{\circ}$ C linear output)

Example: TC_TYPE_D? returns K

Returns K when the thermocouple type default is a type-K thermocouple.

TEMP_STD IEEE-488 RS-232 Sequential Overlapped Coupled

(Temperature Degree Standard command) Selects the temperature standard ipts-68 (1968 International Provisional Temperature Standard) or its-90 (1990 International Temperature Standard), which is saved in the Calibrator non-volatile memory. (While saving configuration data in the non-volatile memory, a period of about 2 seconds, the Calibrator does not respond to remote commands.) The default is its-90.

Parameters: IPTS_68
ITS_90

Example: TEMP_STD ITS-90

See the temperature standard to its-90.

TEMP_STD? IEEE-488 RS-232 Sequential Overlapped Coupled

(Temperature Degree Standard command) Returns the temperature standard ipts-68 (1968 International Provisional Temperature Standard) or its-90 (1990 International Temperature Standard).

Responses: IPTS_68
ITS_90

Example: TEMP_STD? returns ITS-90

Returns ITS-90 when the temperature degree standard is the 1990 International Temperature Standard.

***TRG** IEEE-488 RS-232 Sequential Overlapped Coupled

(Trigger Thermocouple Measurement command) Triggers a thermocouple temperature measurement and return the value of the measurement. Also changes the operating mode

to thermocouple measurement if this is not already the operating mode. (This command is equivalent to sending TC_MEAS ; *WAI ; VAL?)

Responses: <measurement value> , CEL (value is in Celsius)
 <measurement value> , FAR (value is in Fahrenheit)
 0 . 00E+00 , OVER (value is over or under capability)
 0 . 00E+00 , OPENTC (open thermocouple)
 0 . 00E+00 , NONE (wrong mode or no measurement)

Example: *TRG returns +2 . 500E+01 , CEL

Trigger a thermocouple measurement and return 25.00 Celsius when the thermocouple temperature measurement is 25 °C.

TSENS_TYPE IEEE-488 RS-232 Sequential Overlapped Coupled

(Temperature Sensor Type command) Sets the temperature sensor type to thermocouple (TC) or Resistance Temperature Detector (RTD) for temperature measurements. The Calibrator simulates the RTD temperature as a resistance output on the NORMAL terminals, and simulates the thermocouple temperature as a dc voltage output on the TC terminals. If the temperature sensor type is changed, the temperature output is reset to 0 degrees C. Once set, the Calibrator retains the temperature sensor type until power off or reset.

Parameters: TC (Thermocouple)
 RTD (Resistance Temperature Detector)

Example: TSENS_TYPE RTD

Set the temperature sensor type to an RTD.

TSENS_TYPE? IEEE-488 RS-232 Sequential Overlapped Coupled

(Temperature Sensor Type query) Returns the temperature sensor type thermocouple (TC) or Resistance Temperature Detector (RTD) for temperature measurements.

Responses: TC (Thermocouple)
 RTD (Resistance Temperature Detector)

Example: TSENS_TYPE? returns TC

Returns TC when the temperature sensor type is a thermocouple.

***TST?** IEEE-488 RS-232 Sequential Overlapped Coupled

(Self Test command) Initiates self-test and returns a 0 for pass or a 1 for fail. If any faults are detected, they are displayed on screen (terminal mode) or are logged into the fault queue where they can be read by the ERR? query (computer mode).

Response: 0 (pass self test)
1 (fail self test)

Example: *TST? returns 1

Returns 1 when self test is successful.

UNCERT? IEEE-488 RS-232 Sequential Overlapped Coupled

(Uncertainties command) Returns specified uncertainties for the present output. If there are no specifications for an output, returns zero.

Parameter: 1. (optional) Preferred unit of primary output uncertainty or PCT (default)
2. (optional) Preferred unit of secondary output uncertainty or PCT (default)

Response: 1. (float) 90-day specified uncertainty of primary unit
2. (float) 1-year specified uncertainty of primary output
3. (character) Unit of primary output uncertainty
4. (float) 90-day specified uncertainty of secondary unit
5. (float) 1-year specified uncertainty of secondary output
6. (character) Unit of secondary output uncertainty.

Example: UNCERT? returns 6.120E-01, 6.150E-01, PCT, 9.50E-02, 1.150E-01, PCT

UUT_FLUSH IEEE-488 RS-232 Sequential Overlapped Coupled

(Flush UUT Receive Buffer command) Flushes the UUT receive buffer for data received from the UUT over the Calibrator rear panel SERIAL 2 TO UUT serial port. The command may be sent over gpib or RS-232 ports, but applies to SERIAL 2 TO UUT serial port operation.

Parameter: (None)

Example: UUT_FLUSH

Flush the Calibrator receive data buffer for the UUT.

UUT_RECV? IEEE-488 RS-232 Sequential Overlapped Coupled

(UUT Receive Data query) Returns data from the UUT in IEEE-488.2 Standard format over the Calibrator rear panel SERIAL 2 TO UUT serial port. The command may be sent over gpib or RS-232 ports, but applies to SERIAL 2 TO UUT serial port operation.

Response: <data> (binary block data in definite length format from UUT)

Example: UUT_RECV? returns #211+1.99975E+0

Returns (for example) a measurement from the UUT. The format is #2 (two numbers follow) 11 (characters follow) +1.99975E+0 (11 characters).

UUT_RECVB? IEEE-488 RS-232 Sequential Overlapped Coupled

(UUT Receive Binary Data query) Returns binary data as integers from the UUT serial port. Use the UUT_RECV? command instead if receiving ASCII data.

Parameter: (Optional) Maximum number of integers per line

Response: (Indefinite ASCII) Comma separated integers as follows:

1. (integer) Number of data bytes returned excluding the count
2. (integer) Data from the UUT serial port as series of comma separated integers

Example: "=>" followed by a carriage return and a line feed returns 4,61,62,13,10

UUT_SEND IEEE-488 RS-232 Sequential Overlapped Coupled

(Send UUT Data command) Sends data to the UUT serial port in binary block or string data format over the Calibrator rear panel SERIAL 2 TO UUT serial port. The command may be sent over gpib or RS-232 ports, but applies to SERIAL 2 TO UUT serial port operation. Include a line feed (RS-232) character to terminate the block data or End or Identify (EOI) command (IEEE-488).

Parameter: #2<nn><nn characters string> (definite length)
 #0<character string> (indefinite length)
 "<character string>" (character string)

Examples:

UUT_SEND #206F1S2R0 (definite length format)

Sends the data F1S2R0 to the UUT in definite length format. The format is #2 (two numbers follow) 06 (characters follow) F1S2R0 (6 characters).

UUT_SEND #0F1S2R0 (indefinite length format)

Sends the data F1S2R0 to the UUT in indefinite length format. The format is #0 then the characters.

UUT_SEND "F1S2R0" (character string)

Sends the data F1S2R0 to the UUT as a character string.

Special Case When the character string sent to a UUT must end in a carriage return (CR) command or line feed (LF) command or both, you must use the following:

Definite Length Format Follow the instructions above and after the character string add a command ^J for CR or ^M for LF or both, where ^J means hold down the <Cntl> key and type the letter J. For example, sending the string REMS in this format with both CR and LF, you would count 4 characters for REMS and 1 character each for ^J and ^M for a total of 6 characters. The command would be UUT_SEND #206REMS^J^M then <enter>. (The ^J and ^M "characters" actually perform the CR and LF functions.)

Indefinite Length Format This format may not be used when a character string requires CR and LF commands.

Character String Follow the instructions above and after the character string, add a \n for CR or \r for LF or both, where the alpha character is entered in lower case. For example, in the terminal mode to send the string REMS in this format with both CR and LF, the command would be UUT_SEND "REMS\n\r". In the computer mode where commands are entered as part of a command string, use double quotes to show embedded quotes. For example, "uut_send "REMS\n\r"" ".

The following characters and commands may be implemented as described above:

Carriage Return	^J	\n
Line Feed	^M	\r
Tab	Tab	\t
Backspace	^H	\b
Form Feed	^L	\f

UUT_SENDB IEEE-488 RS-232 Sequential Overlapped Coupled

(Send UUT Binary Data command) Send binary data to the UUT serial port (Calibrator rear panel SERIAL 2 to UUT serial port). Use the UUT_SEND command instead of sending ASCII data. The command may be sent over gpib or RS-232 ports, but applies to SERIAL 2 TO UUT serial port operation.

Parameter: Comma separated integers to send (maximum of 10)

Example: UUT_SENDB 42,73,68,78,63,10

Send the ASCII characters "*IDN?" followed by a new line (ASCII 10) to the UUT serial port.

UUT_SET IEEE-488 RS-232 Sequential Overlapped Coupled

(UUT Serial Port Set command) Sets the RS-232-C settings for the Calibrator rear panel SERIAL 2 TO UUT serial port, which is saved in the Calibrator non-volatile memory. (While saving configuration data in the non-volatile memory, a period of about 2 seconds, the Calibrator does not respond to remote commands.) (To set the parameters for the rear panel SERIAL 1 FROM HOST serial port, see the SP_SET command.) The factory default values are shown below in **bold** type. (To return to the factory defaults, see the FORMAT SETUP command.)

The interface selection sets the command response, with command echo back with TERM (terminal) and no echo back with COMP (computer).

Parameters: <baud rate value>, 300, 600, 1200, 2400, 4800, **9600**
<flow control>, **XON** (xon/xoff), NOSTALL (none), RTS (rts/cts)
<number data bits>, DBIT7 (7 bits) or **DBIT8** (8 bits)
<number stop bits>, **SBIT1** (1 bit) or SBIT2 (2 bits)
<parity> **PNONE** (none), PODD (odd),PEVEN (even)

Example: UUT_SET 9600,XON,DBIT8,SBIT1,PNONE

Set the parameters for the rear panel SERIAL 2 TO UUT serial port to the factory default values.

UUT_SET? IEEE-488 RS-232 Sequential Overlapped Coupled

(UUT Serial Port Set query) Returns the RS-232-C settings for the Calibrator rear panel SERIAL 2 TO UUT serial port. (To return the parameters for the rear panel SERIAL 1 FROM HOST serial port, see the SP_SET? command.) The factory default values are shown below in **bold** type. (To return to the factory defaults, see the FORMAT SETUP command.)

Responses: <baud rate value>, 300, 600, 1200, 2400, 4800, **9600**
<flow control>, **XON** (xon/xoff), NOSTALL (none), RTS (rts/cts)
<number data bits>, DBIT7 (7 bits) or **DBIT8** (8 bits)
<number stop bits>, **SBIT1** (1 bit) or SBIT2 (2 bits)
<parity> **PNONE** (none), PODD (odd), PEVEN (even)

Example: UUT_SET? returns 9600 , XON , DBIT8 , SBIT1 , PNONE

Returns the parameters for the rear panel SERIAL 2 TO UUT serial port, as shown, when set to the factory default values.

VAL? IEEE-488 RS-232 Sequential Overlapped Coupled

(Measurement Value command) Returns the last value of the thermocouple temperature, pressure, or scope impedance measurement. The unit returns indicates the status of the reading.

Parameter: (Optional) Units to return

Responses: 1. (Float) Measured temperature or pressure
2. (Character) CEL, FAR, OHM, F, PSI, MHG, INHG, INH2O, FTH2O, MH2O, BAR, PAL, G/CM2, INH2O60F, OVER (value is over or under capability), OPENTC (open thermocouple), or NONE (wrong mode or no measurement)

Example: VAL? returns 0.00E+00 , NONE

Returns 0 and NONE when there is no recent measurement either because the Calibrator is not in a measurement mode, or because no measurement has been made yet.

VVAL? IEEE-488 RS-232 Sequential Overlapped Coupled

(Thermocouple Measurement Voltage command) Returns the last value of the thermocouple temperature measurement in volts. If the last measurement was an overload or open thermocouple condition, or there is no measurement, returns 0E+00.

Responses: <measurement value in volts> (valid measurement)
0E+00 (overload, open TC, or no measurement)

Example: VVAL? returns 1.1047E-03 (1.1047 mV, equivalent to 50°C with type K thermocouple and TC reference = 23.0°C)

***WAI** IEEE-488 RS-232 Sequential Overlapped Coupled

(Wait-to-Continue command) Prevents further remote commands from being executed until all previous remote commands have been executed. For example, if you send an OUT command, you can cause the Calibrator to wait until the output has settled before continuing on to the next command if you follow OUT with a *WAI command. The

*WAI command is useful with any overlapped command, preventing the Calibrator from processing other commands until the overlapped command is processed.

Example: *WAI

Process all existing commands before continuing.

WAVE IEEE-488 RS-232 Sequential Overlapped Coupled

(Waveform command) Sets the waveforms for ac outputs. If the Calibrator is sourcing one output, one parameter is required. If the Calibrator is sourcing two outputs, two parameters are required or one parameter to set the waveform to both outputs. Waveform choices are SINE (sine wave), TRI (triangle wave), SQUARE (square wave), TRUNCS (truncated sine wave), or NONE (waveform does not apply).

Parameter: <1st waveform> , (SINE, TRI, SQUARE, TRUNCS, NONE)
<2nd waveform> (SINE, TRI, SQUARE, TRUNCS, NONE)

Example: WAVE SINE , SQUARE

Set the waveforms for a dual output to Sine wave on the primary output (Calibrator front panel NORMAL terminals) and Square wave on the secondary output (front panel AUX or 20A terminals).

WAVE? IEEE-488 RS-232 Sequential Overlapped Coupled

(Waveform query) Returns the waveform types for ac outputs. Waveform choices are SINE (sine wave), TRI (triangle wave), SQUARE (square wave), TRUNCS (truncated sine wave), or NONE (waveform does not apply).

Responses: <1st waveform> , (SINE, TRI, SQUARE, TRUNCS, NONE)
<2nd waveform> (SINE, TRI, SQUARE, TRUNCS, NONE)

Example: WAVE? returns SQUARE , NONE

Returns SQUARE when the ac primary output (Calibrator front panel NORMAL terminals) is a square wave and NONE when there is no secondary output on the front panel AUX terminals.

ZCOMP IEEE-488 RS-232 Sequential Overlapped Coupled

(Impedance Compensation command) Activates or deactivates 2-wire or 4-wire impedance compensation. For resistance output, compensation is allowed when the resistance is less than 110 k Ω . For capacitance output, compensation is allowed when the capacitance is equal to or greater than 110 nF. For all other resistances and capacitances, the compensation is NONE and attempts to use other parameters results in the error message "Can't change compensation now." For RTD temperature simulation, compensation is allowed for all temperatures.

Parameter: NONE (Turns off impedance compensation circuitry)
WIRE2 (Turns on the 2-wire impedance compensation circuitry)
WIRE4 (Turns on the 4-wire impedance compensation circuitry)

Example: ZCOMP WIRE2

Set 2-wire impedance compensation for the Calibrator UUT connection. (Resistance if the ohms value is less than 110 k Ω , capacitance if the farads value is 110 nF or more, or RTD temperature simulation, any value.)

ZCOMP? IEEE-488 RS-232 Sequential Overlapped Coupled

(Impedance Compensation query) Returns status of 2-wire or 4-wire impedance compensation.

Responses: NONE (impedance compensation is turns off)
WIRE2 (2-wire impedance compensation is on)
WIRE4 (4-wire impedance compensation is off)

Example: ZCOMP? returns NONE

Returns NONE when no impedance compensation is applied to the resistance, capacitance or RTD output.

ZERO_MEAS IEEE-488 RS-232 Sequential Overlapped Coupled

(Zero Offset for Pressure Measurement command) Zeros the pressure module or sets the zero offset for capacitance measurement using the -SC600. For pressure measurements, if the pressure module is an absolute module, the reference parameter must be supplied along with optional units as the second argument.

Parameter: 1. (boolean) ON
(boolean) OFF
2. Reference value for absolute pressure modules

Example: ZERO_MEAS ON

Sets the zero offset to the present measurement value.

Example: ZERO_MEAS ON, 14.7

Sets the zero offset to 14.7 for an absolute pressure module.

ZERO_MEAS? IEEE-488 RS-232 Sequential Overlapped Coupled

(Zero Offset for Pressure Measurement query) Returns the zero offset for the pressure module or capacitance measurement using the -SC600.

Parameter: (optional) units of returned value

Responses: 1. (character) OFF (no zero in effect)
(character) ON (zero in effect)
2. (float) offset value
3. (character) units (F, PSI, MHG, INHG, INH2O, FTH2O, MH2O, BAR, PAL, G/CM2, INH2O60F)

Example: ZERO_MEAS? returns ON, -3.66E-02, PSI

Chapter 7

Maintenance

	Contents	Page
7-1.	Introduction.....	7-3
7-2.	Replacing the Line Fuse	7-3
7-3.	Cleaning the Air Filter	7-5
7-4.	General Cleaning	7-6
7-5.	Performance Tests	7-7

7-1. Introduction

This chapter explains how to perform the routine maintenance and calibration task required to keep a normally operating 5520A Calibrator in service. These tasks include:

- Replacing the fuse
- Cleaning the air filter
- Cleaning the external surfaces
- Calibration verification

Refer to the Service manual for intensive maintenance tasks such as troubleshooting, calibration or repair, and all procedures that require opening the cover of the instrument. The Service Manual also contains complete, detailed verification and calibration procedures.

7-2. Replacing the Line Fuse

The line power fuse is accessible on the rear panel. The fuse rating label above the ac power input module shows the correct replacement fuse for each line voltage setting. Table 7-1 lists the fuse part numbers for each line voltage setting.

To check or replace the fuse, refer to Figure 7-1 and proceed as follows:

1. **Disconnect line power.**
2. The line power fuse and line voltage switch are located in a compartment on the right end of the ac input module. To open the compartment and remove the fuse, insert the blade of a standard screwdriver to the left of the tab located at the left side of the compartment cover.
3. Pry the tab out of the slot and the compartment cover will pop part way out.
4. Remove the compartment cover with your fingers.
5. The fuse comes out with the compartment cover and can be easily replaced.
6. To reinstall the fuse, push the compartment cover back into the compartment until the tab locks with the ac input module.

Table 7-1. Replacement Fuses

Part Number	Fuse Description	Line Voltage Setting
△ 109215	5A/250 V Time Delay	100 V or 120 V
△ 851931	2.5A/250 V Time Delay	200 V or 240 V

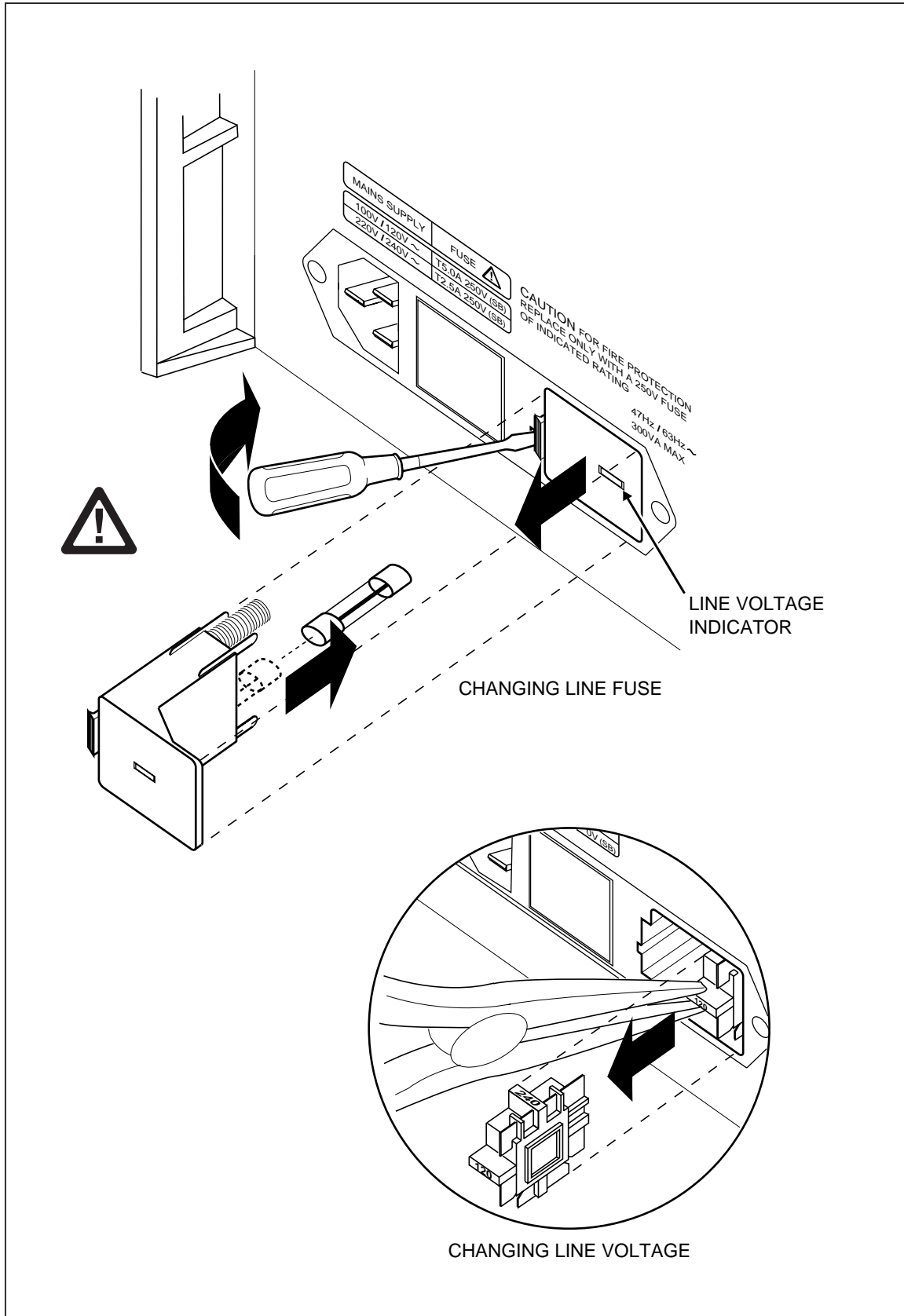

Figure 7-1. Accessing the Fuse

nn007f.eps

7-3. Cleaning the Air Filter

Warning

To avoid risk of injury, never operate or power the 5520A calibrator without the fan filter in place.

CAUTION

Damage caused by overheating may occur if the area around the fan is restricted, the intake air is too warm, or the filter becomes clogged.

The air filter must be removed and cleaned every 30 days or more frequently if the calibrator is operated in a dusty environment. The air filter is accessible from the rear panel of the calibrator.

To clean the air filter, refer to Figure 7-2 and proceed as follows:

1. Turn off the power, let the fan come to rest, and unplug the ac line cord.
2. Remove the filter element.
 - a. Grasp the top and bottom of the air filter frame.
 - b. Squeeze the edges of the frame towards each other to disengage the filter tabs from the slots in the calibrator.
 - c. Pull the filter frame straight out from the calibrator.
3. Clean the filter element.
 - a. Wash the filter element in soapy water.
 - b. Rinse the filter element thoroughly.
 - c. Shake out the excess water, then allow the filter element to dry thoroughly before reinstalling it.
4. Reinstall the filter element by performing the filter removal steps in reverse order.

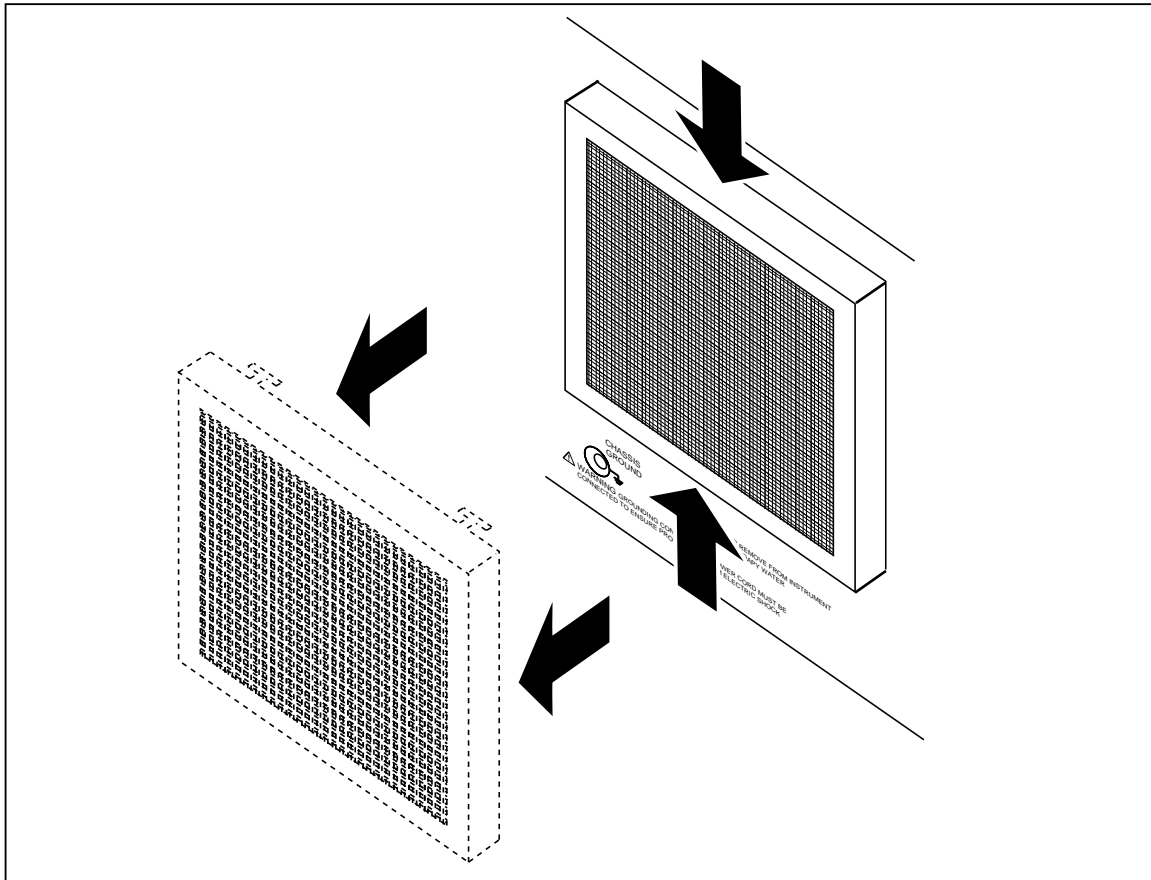

oqo62f.eps

Figure 7-2. Accessing the Air Filter

7-4. General Cleaning

For general cleaning, wipe the case, front panel keys, and lens using a soft cloth slightly dampened with water or a non-abrasive mild cleaning solution that does not harm plastics.

CAUTION

Do not use aromatic hydrocarbons or chlorinated solvents for cleaning. They can damage the plastic materials used in the calibrator.

7-5. Performance Tests

To verify that the 5520A meets its specifications, you can use Tables 7-2 through 7-14. The tables are for qualified metrology personnel who have access to a standards laboratory that is properly equipped to test calibration equipment of this level of accuracy. The tables show the recommended test points and the acceptable upper and lower limits for each point. The limits were computed simply by adding or subtracting the 90-day specification from the output value. There is no built-in factor for measurement uncertainty. If you need more detailed verification and calibration adjustment instructions, order the *5520A Service Manual*, PN 802303.

Table 7-2. Verification Tests for DC Voltage (Normal)

Range	Output	Lower Limit	Upper Limit
329.9999 mV	0.0000 mV	-0.0010 mV	0.0010 mV
329.9999 mV	329.0000 mV	328.9941 mV	329.0059 mV
329.9999 mV	-329.0000 mV	-329.0059 mV	-328.9941 mV
3.299999 V	0.000000 V	-0.000002 V	0.000002 V
3.299999 V	1.000000 V	0.999989 V	1.000011 V
3.299999 V	-1.000000 V	-1.000011 V	-0.999989 V
3.299999 V	3.290000 V	3.289968 V	3.290032 V
3.299999 V	-3.290000 V	-3.290032 V	-3.289968 V
32.99999 V	0.00000 V	-0.00002 V	0.00002 V
32.99999 V	10.00000 V	9.99988 V	10.00012 V
32.99999 V	-10.00000 V	-10.00012 V	-9.99989 V
32.99999 V	32.90000 V	32.89965 V	-32.90035 V
32.99999 V	-32.90000 V	32.90035 V	-32.89965 V
329.9999 V	50.0000 V	49.9991 V	50.0009 V
329.9999 V	329.0000 V	328.9949 V	329.0051 V
329.9999 V	-50.0000 V	-50.0009 V	-49.9991 V
329.9999 V	-329.0000 V	-329.0051 V	-328.9949 V
1000.000 V	334.000 V	333.993 V	334.007 V
1000.000 V	900.000 V	899.985 V	900.015 V
1000.000 V	1020.000 V	1019.983 V	1020.017 V
1000.000 V	-334.000 V	-334.007 V	-333.993 V
1000.000 V	-900.000 V	-900.015 V	-899.985 V
1000.000 V	-1020.000 V	-1020.017 V	-1019.983 V

Table 7-3. Verification Tests for DC Voltage (AUX)

Range	Output	Lower Limit	Upper Limit
329.999 mV	0.000 mV	-0.350 mV	0.350 mV
329.999 mV	329.000 mV	328.551 mV	329.449 mV
329.999 mV	-329.000 mV	-329.449 mV	-328.551 mV
3.29999 V	0.33000 V	0.32955 V	0.33045 V
3.29999 V	3.29000 V	3.28866 V	3.29134 V
3.29999 V	-3.29000 V	-3.29134 V	-3.28866 V
7.0000 V	7.0000 V	6.9976 V	7.0025 V
7.0000 V	-7.0000 V	-7.0025 V	-6.9976 V

Table 7-4. Verification Tests for DC Current (AUX)

Range	Output	Lower Limit	Upper Limit
329.999 μ A	0.000 μ A	-0.020 μ A	0.020 μ A
329.999 μ A	190.000 μ A	189.957 μ A	190.043 μ A
329.999 μ A	-190.000 μ A	-190.043 μ A	-189.957 μ A
329.999 μ A	329.000 μ A	328.941 μ A	329.059 μ A
329.999 μ A	-329.000 μ A	-329.059 μ A	-328.941 μ A
3.29999 mA	0.00000 mA	-0.00005 mA	0.00005 mA
3.29999 mA	1.90000 mA	1.89980 mA	1.90020 mA
3.29999 mA	-1.90000 mA	-1.90020 mA	-1.89980 mA
3.29999 mA	3.29000 mA	3.28969 mA	3.29031 mA
3.29999 mA	-3.29000 mA	-3.29031 mA	-3.28969 mA
32.9999 mA	0.0000 mA	-0.00025 mA	0.00025 mA
32.9999 mA	19.0000 mA	18.9982 mA	19.0018 mA
32.9999 mA	-19.0000 mA	-19.0018 mA	-18.9982 mA
32.9999 mA	32.9000 mA	32.8971 mA	32.9029 mA
32.9999 mA	-32.9000 mA	-32.9029 mA	-32.8971 mA
329.999 mA	0.000 mA	-0.0025 mA	0.0025 mA
329.999 mA	190.000 mA	189.982 mA	190.018 mA
329.999 mA	-190.000 mA	-190.018 mA	-189.982 mA
329.999 mA	329.000 mA	328.971 mA	329.029 mA
329.999 mA	-329.000 mA	-329.029 mA	-328.971 mA
2.99999 A	0.00000 A	-0.00004 A	0.00004 A
2.99999 A	1.09000 A	1.08979 A	1.09021 A
2.99999 A	-1.09000 A	-1.09021 A	-1.08979 A
2.99999 A	2.99000 A	2.98906 A	2.99094 A
2.99999 A	-2.99000 A	-2.99094 A	-2.98906 A
20.5000 A	0.0000 A	-0.0005 A	0.0005 A
20.5000 A	10.9000 A	10.8954 A	10.9046 A
20.5000 A	-10.9000 A	-10.9046 A	-10.8954 A
20.5000 A	20.0000 A	19.9833 A	20.0168 A
20.5000 A	-20.0000 A	-20.0168 A	-19.9833 A

Table 7-5. Verification Tests for Resistance

Range	Output	Lower Limit	Upper Limit
10.9999 Ω	0.0000 Ω	-0.0010 Ω	0.0010 Ω
10.9999 Ω	2.0000 Ω	1.9989 Ω	2.0011 Ω
10.9999 Ω	10.9000 Ω	10.8986 Ω	10.9014 Ω
32.9999 Ω	11.9000 Ω	11.8982 Ω	11.9018 Ω
32.9999 Ω	19.0000 Ω	18.9980 Ω	19.0020 Ω
32.9999 Ω	30.0000 Ω	29.9978 Ω	30.0023 Ω
109.9999 Ω	33.0000 Ω	32.9979 Ω	33.0021 Ω
109.9999 Ω	109.0000 Ω	108.9962 Ω	109.0038 Ω
329.9999 Ω	119.0000 Ω	118.9954 Ω	119.0046 Ω
329.9999 Ω	190.0000 Ω	189.9938 Ω	190.0062 Ω
329.9999 Ω	300.0000 Ω	299.9914 Ω	300.0086 Ω
1.099999 kΩ	0.330000 kΩ	0.329991 kΩ	0.330009 kΩ
1.099999 kΩ	1.090000 kΩ	1.089974 kΩ	1.090026 kΩ
3.299999 kΩ	1.190000 kΩ	1.189954 kΩ	1.190046 kΩ
3.299999 kΩ	1.900000 kΩ	1.899938 kΩ	1.900062 kΩ
3.299999 kΩ	3.000000 kΩ	2.999914 kΩ	3.000086 kΩ
10.99999 kΩ	3.30000 kΩ	3.29991 kΩ	3.30009 kΩ
10.99999 kΩ	10.90000 kΩ	10.89974 kΩ	10.90026 kΩ
32.99999 kΩ	11.90000 kΩ	11.89954 kΩ	11.90046 kΩ
32.99999 kΩ	19.00000 kΩ	18.99938 kΩ	19.00062 kΩ
32.99999 kΩ	30.00000 kΩ	29.99914 kΩ	30.00086 kΩ
109.9999 kΩ	33.0000 kΩ	32.9991 kΩ	33.0009 kΩ
109.9999 kΩ	109.0000 kΩ	108.9974 kΩ	109.0026 kΩ
329.9999 kΩ	119.0000 kΩ	118.9950 kΩ	119.0050 kΩ
329.9999 kΩ	190.0000 kΩ	189.9933 kΩ	190.0068 kΩ
329.9999 kΩ	300.0000 kΩ	299.9905 kΩ	300.0095 kΩ
1.099999 MΩ	0.330000 MΩ	0.329990 MΩ	0.330010 MΩ
1.099999 MΩ	1.090000 MΩ	1.089971 MΩ	1.090029 MΩ
3.299999 MΩ	1.190000 MΩ	1.189922 MΩ	1.190078 MΩ
3.299999 MΩ	1.900000 MΩ	1.899894 MΩ	1.900106 MΩ
3.299999 MΩ	3.000000 MΩ	2.999850 MΩ	3.000150 MΩ

Table 7-5. Verification Tests for Resistance (cont)

Range	Output	Lower Limit	Upper Limit
10.99999 MΩ	3.30000 MΩ	3.29959 MΩ	3.30041 MΩ
10.99999 MΩ	10.90000 MΩ	10.89875 MΩ	10.90125 MΩ
32.99999 MΩ	11.90000 MΩ	11.89512 MΩ	11.90488 MΩ
32.99999 MΩ	19.00000 MΩ	18.99370 MΩ	19.00630 MΩ
32.99999 MΩ	30.00000 MΩ	29.99150 MΩ	30.00850 MΩ
109.9999 MΩ	33.0000 MΩ	32.9838 MΩ	33.0162 MΩ
109.9999 MΩ	109.0000 MΩ	108.9534 MΩ	109.0466 MΩ
329.9999 MΩ	119.0000 MΩ	118.6025 MΩ	119.3975 MΩ
329.9999 MΩ	290.0000 MΩ	289.1750 MΩ	290.8250 MΩ
1100.000 MΩ	400.000 MΩ	394.700 MΩ	405.300 MΩ
1100.000 MΩ	640.000 MΩ	631.820 MΩ	648.180 MΩ
1100.000 MΩ	1090.000 MΩ	1076.420 MΩ	1103.580 MΩ

Table 7-6. Verification Tests for AC Voltage (Normal)

Range	Output	Frequency	Lower Limit	Upper Limit
32.999 mV	3.000 mV	45 Hz	2.994 mV	3.006 mV
32.999 mV	3.000 mV	10 kHz	2.994 mV	3.006 mV
32.999 mV	30.000 mV	9.5 Hz	28.335 mV	31.665 mV
32.999 mV	30.000 mV	10 Hz	29.976 mV	30.024 mV
32.999 mV	30.000 mV	45 Hz	29.990 mV	30.010 mV
32.999 mV	30.000 mV	1 kHz	29.990 mV	30.010 mV
32.999 mV	30.000 mV	10 kHz	29.990 mV	30.010 mV
32.999 mV	30.000 mV	20 kHz	29.989 mV	30.011 mV
32.999 mV	30.000 mV	50 kHz	29.970 mV	30.030 mV
32.999 mV	30.000 mV	100 kHz	29.898 mV	30.102 mV
32.999 mV	30.000 mV	450 kHz	29.770 mV	30.230 mV
329.999 mV	33.000 mV	45 Hz	32.987 mV	33.013 mV
329.999 mV	33.000 mV	10 kHz	32.987 mV	33.013 mV
329.999 mV	300.000 mV	9.5 Hz	283.350 mV	316.650 mV
329.999 mV	300.000 mV	10 Hz	299.917 mV	300.083 mV
329.999 mV	300.000 mV	45 Hz	299.950 mV	300.050 mV
329.999 mV	300.000 mV	1 kHz	299.950 mV	300.050 mV
329.999 mV	300.000 mV	10 kHz	299.950 mV	300.050 mV
329.999 mV	300.000 mV	20 kHz	299.947 mV	300.053 mV
329.999 mV	300.000 mV	50 kHz	299.902 mV	300.098 mV
329.999 mV	300.000 mV	100 kHz	299.788 mV	300.212 mV
329.999 mV	300.000 mV	500 kHz	299.450 mV	300.550 mV
3.29999 V	0.33000 V	45 Hz	0.32989 V	0.33011 V
3.29999 V	0.33000 V	10 kHz	0.32989 V	0.33011 V
3.29999 V	3.00000 V	9.5 Hz	2.83350 V	3.16650 V
3.29999 V	3.00000 V	10 Hz	2.99920 V	3.00080 V
3.29999 V	3.00000 V	45 Hz	2.99952 V	3.00048 V
3.29999 V	3.00000 V	1 kHz	2.99952 V	3.00048 V
3.29999 V	3.00000 V	10 kHz	2.99952 V	3.00048 V
3.29999 V	3.00000 V	20 kHz	2.99946 V	3.00054 V
3.29999 V	3.00000 V	50 kHz	2.99920 V	3.00080 V
3.29999 V	3.00000 V	100 kHz	2.99823 V	3.00178 V

Table 7-6. Verification Tests for AC Voltage (Normal) (cont)

Range	Output	Frequency	Lower Limit	Upper Limit
3.29999 V	3.00000 V	450 kHz	2.99340 V	3.00660 V
3.29999 V	3.29000 V	2 MHz	0.07500 V (Note)	
32.9999 V	3.3000 V	45 Hz	3.2990 V	3.3010 V
32.9999 V	3.3000 V	10 kHz	3.2990 V	3.3010 V
32.9999 V	30.0000 V	9.5 Hz	28.3350 V	31.6650 V
32.9999 V	30.0000 V	10 Hz	29.9919 V	30.0082 V
32.9999 V	30.0000 V	45 Hz	29.9957 V	30.0044 V
32.9999 V	30.0000 V	1 kHz	29.9957 V	30.0044 V
32.9999 V	30.0000 V	10 kHz	29.9957 V	30.0044 V
32.9999 V	30.0000 V	20 kHz	29.9928 V	30.0072 V
32.9999 V	30.0000 V	50 kHz	29.9904 V	30.0096 V
32.9999 V	30.0000 V	90 kHz	29.9759 V	30.0241 V
329.999 V	33.000 V	45 Hz	32.993 V	33.007 V
329.999 V	33.000 V	10 kHz	32.989 V	33.011 V
329.999 V	300.000 V	45 Hz	299.953 V	300.047 V
329.999 V	300.000 V	1 kHz	299.953 V	300.047 V
329.999 V	300.000 V	10 kHz	299.946 V	300.054 V
329.999 V	300.000 V	18 kHz	299.928 V	300.072 V
329.999 V	300.000 V	50 kHz	299.922 V	300.078 V
329.999 V	200.000 V	100 kHz	199.630 V	200.370 V
1020.00 V	330.00 V	45 Hz	329.91 V	330.09 V
1020.00 V	330.00 V	10 kHz	329.91 V	330.09 V
1020.00 V	1000.00 V	45 Hz	999.74 V	1000.26 V
1020.00 V	1000.00 V	1 kHz	999.79 V	1000.21 V
1020.00 V	1000.00 V	5 kHz	999.79 V	1000.21 V
1020.00 V	1000.00 V	8 kHz	999.74 V	1000.26 V
1020.00 V	1020.00 V	1 kHz	1019.79 V	1020.21 V
1020.00 V	1020.00 V	8 kHz	1019.74 V	1020.27 V
Note: Typical specification is -24 dB at 2 MHz				

Table 7-7. Verification Tests for AC Voltage (AUX)

Range	Output, AUX (Note)	Frequency	Lower Limit	Upper Limit
329.999 mV	10.000 mV	45 Hz	9.622 mV	10.378 mV
329.999 mV	10.000 mV	1 kHz	9.622 mV	10.378 mV
329.999 mV	10.000 mV	5 kHz	9.535 mV	10.465 mV
329.999 mV	10.000 mV	10 kHz	9.520 mV	10.480 mV
329.999 mV	10.000 mV	30 kHz	8.700 mV	11.300 mV
329.999 mV	300.000 mV	9.5 Hz	283.350 mV	316.650 mV
329.999 mV	300.000 mV	10 Hz	299.180 mV	300.820 mV
329.999 mV	300.000 mV	45 Hz	299.390 mV	300.610 mV
329.999 mV	300.000 mV	1 kHz	299.390 mV	300.610 mV
329.999 mV	300.000 mV	5 kHz	299.100 mV	300.900 mV
329.999 mV	300.000 mV	10 kHz	298.650 mV	301.350 mV
329.999 mV	300.000 mV	30 kHz	287.100 mV	312.900 mV
3.29999 V	3.00000 V	9.5 Hz	2.825 V	3.175 V
3.29999 V	3.00000 V	10 Hz	2.99505 V	3.00495 V
3.29999 V	3.00000 V	45 Hz	2.99745 V	3.00255 V
3.29999 V	3.00000 V	1 kHz	2.99745 V	3.00255 V
3.29999 V	3.00000 V	5 kHz	2.99410 V	3.00590 V
3.29999 V	3.00000 V	10 kHz	2.98960 V	3.01040 V
3.29999 V	3.00000 V	30 kHz	2.87720 V	3.12280 V
5.00000 V	5.00000 V	9.5 Hz	4.72500 V	5.27500 V
5.00000 V	5.00000 V	10 Hz	4.99205 V	5.00795 V
5.00000 V	5.00000 V	45 Hz	4.99605 V	5.00395 V
5.00000 V	5.00000 V	1 kHz	4.99605 V	5.00395 V
5.00000 V	5.00000 V	5 kHz	4.99110 V	5.00890 V
5.00000 V	5.00000 V	10 kHz	4.98360 V	5.01640 V
Note: set the NORMAL output to 300 mV.				

Table 7-8. Verification Tests for AC Current

Range	Output	Frequency	Lower Limit	Upper Limit
329.99 μ A	33.00 μ A	1 kHz	32.87 μ A	33.13 μ A
329.99 μ A	33.00 μ A	10 kHz	32.60 μ A	33.40 μ A
329.99 μ A	33.00 μ A	30 kHz	32.20 μ A	33.80 μ A
329.99 μ A	190.00 μ A	45 Hz	189.71 μ A	190.29 μ A
329.99 μ A	190.00 μ A	1 kHz	189.71 μ A	190.29 μ A
329.99 μ A	190.00 μ A	10 kHz	188.66 μ A	191.34 μ A
329.99 μ A	190.00 μ A	30 kHz	187.32 μ A	192.68 μ A
329.99 μ A	329.00 μ A	10 Hz	328.37 μ A	329.63 μ A
329.99 μ A	329.00 μ A	45 Hz	328.57 μ A	329.43 μ A
329.99 μ A	329.00 μ A	1 kHz	328.57 μ A	329.43 μ A
329.99 μ A	329.00 μ A	5 kHz	328.03 μ A	329.97 μ A
329.99 μ A	329.00 μ A	10 kHz	326.83 μ A	331.17 μ A
329.99 μ A	329.00 μ A	30 kHz	324.65 μ A	333.35 μ A
3.2999 mA	0.3300 mA	1 kHz	0.3296 mA	0.3304 mA
3.2999 mA	0.3300 mA	5 kHz	0.3293 mA	0.3307 mA
3.2999 mA	0.3300 mA	30 kHz	0.3268 mA	0.3332 mA
3.2999 mA	1.9000 mA	1 kHz	1.8983 mA	1.9017 mA
3.2999 mA	1.9000 mA	10 kHz	1.8921 mA	1.9079 mA
3.2999 mA	1.9000 mA	30 kHz	1.8842 mA	1.9158 mA
3.2999 mA	3.2900 mA	10 Hz	3.2846 mA	3.2954 mA
3.2999 mA	3.2900 mA	45 Hz	3.2872 mA	3.2928 mA
3.2999 mA	3.2900 mA	1 kHz	3.2872 mA	3.2928 mA
3.2999 mA	3.2900 mA	5 kHz	3.2845 mA	3.2955 mA
3.2999 mA	3.2900 mA	10 kHz	3.2765 mA	3.3035 mA
3.2999 mA	3.2900 mA	30 kHz	3.2631 mA	3.3169 mA
32.999 mA	3.3000 mA	1 kHz	3.297 mA	3.303 mA
32.999 mA	3.3000 mA	5 kHz	3.296 mA	3.304 mA
32.999 mA	3.3000 mA	30 kHz	3.285 mA	3.315 mA
32.999 mA	19.0000 mA	1 kHz	18.991 mA	19.009 mA
32.999 mA	19.0000 mA	10 kHz	18.967 mA	19.033 mA

Table 7-8. Verification Tests for AC Current (cont)

Range	Output	Frequency	Lower Limit	Upper Limit
32.999 mA	19.0000 mA	30 kHz	18.935 mA	19.065 mA
32.999 mA	32.9000 mA	10 Hz	32.849 mA	32.951 mA
32.999 mA	32.9000 mA	1 kHz	32.886 mA	32.914 mA
32.999 mA	32.9000 mA	5 kHz	32.877 mA	32.923 mA
32.999 mA	32.9000 mA	10 kHz	32.844 mA	32.956 mA
32.999 mA	32.9000 mA	30 kHz	32.791 mA	33.009 mA
329.99 mA	33.0000 mA	1 kHz	32.97 mA	33.03 mA
329.99 mA	33.0000 mA	5 kHz	32.92 mA	33.08 mA
329.99 mA	33.0000 mA	30 kHz	32.69 mA	33.31 mA
329.99 mA	190.0000 mA	1 kHz	189.91 mA	190.09 mA
329.99 mA	190.0000 mA	10 kHz	189.60 mA	190.40 mA
329.99 mA	190.0000 mA	30 kHz	189.19 mA	190.81 mA
329.99 mA	329.0000 mA	10 Hz	328.49 mA	329.51 mA
329.99 mA	329.0000 mA	45 Hz	328.86 mA	329.14 mA
329.99 mA	329.0000 mA	1 kHz	328.86 mA	329.14 mA
329.99 mA	329.0000 mA	5 kHz	328.69 mA	329.31 mA
329.99 mA	329.0000 mA	10 kHz	328.37 mA	329.63 mA
329.99 mA	329.0000 mA	30 kHz	327.75 mA	330.25 mA
2.99999 A	0.33000 A	1 kHz	0.32978 A	0.33022 A
2.99999 A	0.33000 A	5 kHz	0.32735 A	0.33265 A
2.99999 A	0.33000 A	10 kHz	0.31840 A	0.34160 A
2.99999 A	1.09000 A	10 Hz	1.08827 A	1.09174 A
2.99999 A	1.09000 A	45 Hz	1.08951 A	1.09049 A
2.99999 A	1.09000 A	1 kHz	1.08951 A	1.09049 A
2.99999 A	1.09000 A	5 kHz	1.08355 A	1.09645 A
2.99999 A	1.09000 A	10 kHz	1.06320 A	1.11680 A
2.99999 A	2.99000 A	10 Hz	2.98542 A	2.99459 A
2.99999 A	2.99000 A	45 Hz	2.98840 A	2.99160 A
2.99999 A	2.99000 A	1 kHz	2.98840 A	2.99160 A
2.99999 A	2.99000 A	5 kHz	2.97405 A	3.00595 A

Table 7-8. Verification Tests for AC Current (cont)

Range	Output	Frequency	Lower Limit	Upper Limit
2.99999 A	2.99000 A	10 kHz	2.92520 A	3.05480 A
20.5000 A	3.3000 A	500 Hz	3.2954 A	3.3046 A
20.5000 A	3.3000 A	1 kHz	3.2954 A	3.3046 A
20.5000 A	3.3000 A	5 kHz	3.2155 A	3.3845 A
20.5000 A	10.9000 A	45 Hz	10.8926 A	10.9075 A
20.5000 A	10.9000 A	65 Hz	10.8926 A	10.9075 A
20.5000 A	10.9000 A	500 Hz	10.8893 A	10.9107 A
20.5000 A	10.9000 A	1 kHz	10.8893 A	10.9107 A
20.5000 A	10.9000 A	5 kHz	10.6255 A	11.1745 A
20.5000 A	20.0000 A	45 Hz	19.9750 A	20.0250 A
20.5000 A	20.0000 A	65 Hz	19.9750 A	20.0250 A
20.5000 A	20.0000 A	500 Hz	19.9690 A	20.0310 A
20.5000 A	20.0000 A	1 kHz	19.9690 A	20.0310 A
20.5000 A	20.0000 A	5 kHz	19.4950 A	20.5050 A

Table 7-9. Verification Tests for Capacitance

Range	Output	Test Frequency or Current	Lower Limit	Upper Limit
0.3999 nF	0.1900 nF	5 kHz	0.1793 nF	0.2007 nF
0.3999 nF	0.3500 nF	1 kHz	0.3387 nF	0.3613 nF
1.0999 nF	0.4800 nF	1 kHz	0.4682 nF	0.4918 nF
1.0999 nF	0.6000 nF	1 kHz	0.5877 nF	0.6123 nF
1.0999 nF	1.0000 nF	1 kHz	0.9862 nF	1.0138 nF
3.2999 nF	2.0000 nF	1 kHz	1.9824 nF	2.0176 nF
10.9999 nF	7.0000 nF	1 kHz	6.9767 nF	7.0233 nF
10.9999 nF	10.9000 nF	1 kHz	10.8693 nF	10.9307 nF
32.9999 nF	20.0000 nF	1 kHz	19.8620 nF	20.1380 nF
109.999 nF	70.000 nF	1 kHz	69.767 nF	70.233 nF
109.999 nF	109.000 nF	1 kHz	108.693 nF	109.307 nF
329.999 nF	200.000 nF	1 kHz	199.320 nF	200.680 nF
329.999 nF	300.000 nF	1 kHz	299.130 nF	300.870 nF
1.09999 μ F	0.70000 μ F	100 Hz	0.69767 μ F	0.70233 μ F
1.09999 μ F	1.09000 μ F	100 Hz	1.08693 μ F	1.09307 μ F
3.29999 μ F	2.00000 μ F	100 Hz	1.99320 μ F	2.00680 μ F
3.29999 μ F	3.00000 μ F	100 Hz	2.99130 μ F	3.00870 μ F
10.9999 μ F	7.0000 μ F	100 Hz	6.9767 μ F	7.0233 μ F
10.9999 μ F	10.9000 μ F	100 Hz	10.8693 μ F	10.9307 μ F
32.9999 μ F	20.0000 μ F	100 Hz	19.9100 μ F	20.0900 μ F
32.9999 μ F	30.0000 μ F	100 Hz	29.8800 μ F	30.1200 μ F
109.999 μ F	70.000 μ F	50 Hz	69.662 μ F	70.338 μ F
109.999 μ F	109.000 μ F	50 Hz	108.529 μ F	109.471 μ F
329.999 μ F	200.000 μ F	54 μ A dc	199.020 μ F	200.980 μ F
329.999 μ F	300.000 μ F	80 μ A dc	298.680 μ F	301.320 μ F
1.09999 mF	0.33000 mF	90 μ A dc	0.32788 mF	0.33212 mF
1.09999 mF	0.70000 mF	180 μ A dc	0.69662 mF	0.70338 mF
1.09999 mF	1.09000 mF	270 μ A dc	1.08529 mF	1.09471 mF
3.2999 mF	1.1000 mF	270 μ A dc	1.0933 mF	1.1067 mF
3.2999 mF	2.0000 mF	540 μ A dc	1.9902 mF	2.0098 mF
3.2999 mF	3.0000 mF	800 μ A dc	2.9868 mF	3.0132 mF

Table 7-9. Verification Tests for Capacitance (cont)

Range	Output	Test Frequency or Current	Lower Limit	Upper Limit
10.9999 mF	3.3000 mF	900 μ A dc	3.2788 mF	3.3212 mF
10.9999 mF	10.9000 mF	2.7 mA dc	10.8529 mF	10.9471 mF
32.9999 mF	20.0000 mF	5.4 mA dc	19.8300 mF	20.1700 mF
32.9999 mF	30.0000 mF	8.0 mA dc	29.7600 mF	30.2400 mF
110.000 mF	33.000 mF	9.0 mA dc	32.570 mF	33.430 mF
110.000 mF	110.000 mF	27.0 mA dc	108.800 mF	111.200 mF

Table 7-10. Verification Tests for Thermocouple Simulation

TC Type	Output, °C	Lower Limit, mV	Upper Limit, mV
10 μ V/°C	0.00 °C (0.0000 mV)	-0.0030	0.0030
	100.00 °C (1.0000 mV)	0.99696	1.00304
	-100.00 °C (-1.0000 mV)	-1.00304	-.99696
	1000.00 °C (10.0000 mV)	9.99660	10.00340
	-1000.00 °C (-10.0000 mV)	-10.0034	-9.9966
	10000.00 °C (100.0000 mV)	99.9930	100.0070
	-10000.00 °C (-100.0000 mV)	-100.0070	-99.9930

Table 7-11. Verification Tests for Thermocouple Measurement

TC Type	Input, mV	Lower Limit, °C	Upper Limit, °C
10 μ V/°C	0.00 °C (0.0000 mV)	-0.30	0.30
	10000.00 °C (100.0000 mV)	9999.30	10000.70
	-10000.00 °C (-100.0000 mV)	-10000.70	-9999.30
	30000.00 °C (300.0000 mV)	29998.50	30001.50
	-30000.00 °C (-300.0000 mV)	-30001.50	-29998.50

Table 7-12. Verification Tests for Phase Accuracy, V and V

Range, Normal Output, V	Output, Normal V	Frequency	Range, AUX Output	Output, AUX	Phase °	Lower Limit °	Upper Limit °
3.29999	3.00000	65 Hz	3.29999 V	3.00000 V	0	-0.10	0.10
		400 Hz				-0.25	0.25
		1 kHz				-0.50	0.50
		5 kHz				-2.50	2.50
		10 kHz				-5.00	5.00
		30 kHz				-10.00	10.00
		65 Hz			60	59.90	60.10
		400 Hz				59.75	60.25
		1 kHz				59.50	60.50
		5 kHz				57.50	62.50
		10 kHz				55.00	65.00
		30 kHz				50.00	70.00
		65 Hz			90	89.90	90.10
		400 Hz				89.75	90.25
		1 kHz				89.50	90.50
		5 kHz				87.50	92.50
		10 kHz				85.00	95.00
		30 kHz				80.00	100.00
32.9999	30.0000	65 Hz				89.90	90.10
329.999	50.000	65 Hz				89.90	90.10

Table 7-13. Verification Tests for Phase Accuracy, V and I

Range, Normal Output	Output, Normal	Freq- uency	Range, AUX Output	Output, AUX	Phase °	Lower Limit °	Upper Limit °
329.999 mV	30.000 mV	65 Hz	329.99 mA	300.00 mA	0	-0.10	0.10
329.999 mV	30.000 mV	1 kHz	329.99 mA	300.00 mA	0	-0.50	0.50
329.999 mV	30.000 mV	30 kHz	329.99 mA	300.00 mA	0	-10.00	10.00
329.999 mV	200.000 mV	65 Hz	2.99999 A	2.00000 A	0	-0.10	0.10
329.999 mV	50.000 mV	65 Hz	20.5000 A	5.0000 A	0	-0.10	0.10
329.999 mV	50.000 mV	400 Hz	20.5000 A	5.0000 A	0	-0.25	0.25
329.999 mV	30.000 mV	65 Hz	329.99 mA	300.00 mA	60	59.90	60.10
329.999 mV	200.000 mV	65 Hz	2.99999 A	2.00000 A	60	59.90	60.10
329.999 mV	200.000 mV	65 Hz	20.5000 A	20.0000 A	60	59.90	60.10
329.999 mV	200.000 mV	400 Hz	20.5000 A	20.0000 A	60	59.75	60.25
32.9999 V	3.3000 V	65 Hz	329.99 mA	300.00 mA	0	-0.10	0.10
32.9999 V	3.3000 V	65 Hz	2.99999 A	2.00000 A	0	-0.10	0.10
32.9999 V	3.3000 V	65 Hz	20.5000 A	5.0000 A	0	-0.10	0.10
32.9999 V	3.3000 V	400 Hz	20.5000 A	5.0000 A	0	-0.25	0.25
32.9999 V	3.3000 V	65 Hz	329.99 mA	300.00 mA	90	89.90	90.10
32.9999 V	3.3000 V	65 Hz	2.99999 A	2.00000 A	90	89.90	90.10
32.9999 V	3.3000 V	65 Hz	20.5000 A	20.0000 A	90	89.90	90.10
32.9999 V	3.3000 V	400 Hz	20.5000 A	20.0000 A	90	89.75	90.25
329.999 V	33.000 V	65 Hz	329.99 mA	300.00 mA	0	-0.10	0.10
329.999 V	33.000 V	65 Hz	2.99999 A	2.00000 A	0	-0.10	0.100
329.999 V	33.000 V	65 Hz	20.5000 A	5.0000 A	0	-0.10	0.10
329.999 V	33.000 V	400 Hz	20.5000 A	5.0000 A	0	-0.25	0.25
329.999 V	33.000 V	65 Hz	329.99 mA	300.00 mA	90	89.90	90.10
329.999 V	33.000 V	65 Hz	2.99999 A	2.00000 A	90	89.90	90.10
329.999 V	33.000 V	65 Hz	20.5000 A	20.0000 A	90	89.90	90.10
329.999 V	33.000 V	400 Hz	20.5000 A	20.0000 A	90	89.75	90.25

Table 7-14. Verification Tests for Frequency

Range, Normal Output, V	Output, Normal, V	Frequency	Lower Limit (Note)	Upper Limit (Note)
3.29999	3.00000	119.00 Hz	118.99970 Hz	119.00030Hz
		120.0 Hz	119.99970 Hz	120.00031 Hz
		1000.0 Hz	999.9975 Hz	1000.0025 Hz
		100.00 kHz	99,999.75 Hz	100,000.25 Hz
Note: Frequency accuracy is specified for 1 year				

Chapter 8

Oscilloscope Calibration Options

- Option SC600: see page 8-3.
- Option SC300: see page 8-57.

5520A-SC600 Option

	Contents	Page
8-1.	Introduction.....	8-5
8-2.	SC600 Option Specifications.....	8-5
8-3.	Volt Specifications	8-6
8-4.	Edge Specifications	8-7
8-5.	Leveled Sine Wave Specifications	8-8
8-6.	Time Marker Specifications	8-9
8-7.	Wave Generator Specifications	8-9
8-8.	Pulse Generator Specifications.....	8-10
8-9.	Trigger Signal Specifications (Pulse Function)	8-11
8-10.	Trigger Signal Specifications (Time Marker Function).....	8-11
8-11.	Trigger Signal Specifications (Edge Function).....	8-11
8-12.	Trigger Signal Specifications (Square Wave Voltage Function).....	8-11
8-13.	Trigger Signal Specifications	8-11
8-14.	Oscilloscope Input Resistance Measurement Specifications	8-12
8-15.	Oscilloscope Input Capacitance Measurement Specifications.....	8-12
8-16.	Overload Measurement Specifications.....	8-12
8-17.	Oscilloscope Connections.....	8-13
8-18.	Starting the SC600 Option.....	8-13
8-19.	The Output Signal	8-14
8-20.	Adjusting the Output Signal	8-14
8-21.	Keying in a Value	8-14
8-22.	Adjusting Values with the Rotary Knob.....	8-15
8-23.	Using $\boxed{\text{MULT}}$ and $\boxed{\text{DIV}}$	8-15
8-24.	Resetting the SC600 Option	8-15
8-25.	Calibrating the Voltage Amplitude on an Oscilloscope	8-16
8-26.	The VOLT Function.....	8-16
8-27.	The V/DIV Menu	8-17
8-28.	Shortcuts for Setting the Voltage Amplitude.....	8-17
8-29.	Oscilloscope Amplitude Calibration Procedure.....	8-18
8-30.	Calibrating the Pulse and Frequency Response on an Oscilloscope	8-19
8-31.	The Edge Function	8-19
8-32.	Oscilloscope Pulse Response Calibration Procedure.....	8-20
8-33.	Pulse Response Calibration Using a Tunnel Diode Pulser	8-21
8-34.	The Leveled Sine Wave Function	8-21
8-35.	Shortcuts for Setting the Frequency and Voltage.....	8-22
8-36.	The MORE OPTIONS Menu	8-23

8-37.	Sweeping Through a Frequency Range.....	8-24
8-38.	Oscilloscope Frequency Response Calibration Procedure.....	8-24
8-39.	Calibrating the Time Base of an Oscilloscope	8-26
8-40.	The Time Marker Function	8-26
8-41.	Time Base Marker Calibration Procedure for an Oscilloscope	8-27
8-42.	Testing the Trigger SC600 option	8-28
8-43.	Testing Video Triggers	8-30
8-44.	Verifying Pulse Capture	8-31
8-45.	Measuring Input Resistance and Capacitance	8-32
8-46.	Input Impedance Measurement	8-32
8-47.	Input Capacitance Measurement	8-33
8-48.	Testing Overload Protection	8-33
8-49.	Remote Commands and Queries.....	8-34
8-50.	General Commands	8-35
8-51.	Edge Function Commands.....	8-38
8-52.	Marker Function Commands	8-38
8-53.	Video Function Commands	8-38
8-54.	Overload Function Commands	8-39
8-55.	Impedance/Capacitance Function Commands.....	8-40
8-56.	Verification Tables	8-41
8-57.	DC Voltage Verification	8-41
8-58.	AC Voltage Amplitude Verification	8-42
8-59.	AC Voltage Frequency Verification	8-42
8-60.	Wave Generator Amplitude Verification:	
	1 M Ω Output Impedance.....	8-43
8-61.	Wave Generator Amplitude Verification: 50 Ω Output Impedance	8-44
8-62.	Leveled Sine Wave Verification: Amplitude	8-45
8-63.	Leveled Sine Wave Verification: Frequency	8-45
8-64.	Leveled Sine Wave Verification: Harmonics.....	8-46
8-65.	Leveled Sine Wave Verification: Flatness	8-47
8-66.	Edge Verification: Amplitude	8-53
8-67.	Edge Verification: Frequency	8-53
8-68.	Edge Verification: Duty Cycle	8-53
8-69.	Edge Verification: Rise Time.....	8-54
8-70.	Tunnel Diode Pulser Verification	8-54
8-71.	Marker Generator Verification.....	8-55
8-72.	Pulse Generator Verification: Period	8-55
8-73.	Pulse Generator Verification: Pulse Width.....	8-55
8-74.	Input Impedance Verification: Resistance	8-56
8-75.	Input Impedance Verification: Capacitance	8-56

8-1. Introduction

The SC600 Option provides functions that help you maintain your oscilloscope's accuracy by verifying and calibrating the following oscilloscope characteristics:

- Vertical deflection characteristics are calibrated and verified. The VOLT function lets you compare the voltage gain to the graticule lines on the oscilloscope.
- Pulse transient response is checked and calibrated, verifying the accuracy of the oscilloscope's measurement of pulse transitions using the EDGE function. Also, the calibrator supports even faster pulse response checks using an external tunnel diode pulser.
- Frequency response is checked by verifying the bandwidth using the Leveled Sine Wave (LEVSINE) function. Vertical deflection is monitored until the -3 dB point is observed on the oscilloscope.
- Horizontal (time base) deflection characteristics are calibrated and verified using the Time MARKER function. This calibration procedure is similar to the one for verifying the vertical deflection characteristics, except that it checks the horizontal axis.
- The oscilloscope's ability to display, capture, and measure pulse width is checked using the PULSE function. This function allows you to vary both the pulse width and the period.
- The oscilloscope's ability to trigger on different waveforms is checked using the Wave Generator (WAVEGEN) function.
- The oscilloscope's ability to trigger on and capture complex TV Trigger signals is checked using the VIDEO function.
- The oscilloscope's input characteristics can be measured using the Input Resistance and Capacitance (MEAS Z) function.
- The oscilloscope's input protection circuit can be tested using the Overload (OVERLD) function.

The menus that implement these functions also include parameters for altering the way the output signal responds to voltage, frequency, and time settings, giving you control of the signal during calibration, and providing more methods for observing the signal's characteristics.

8-2. SC600 Option Specifications

These specifications apply only to the SC600 Option. General specifications that apply to the 5520A (hereafter termed the Calibrator) can be found in Chapter 1. The specifications are valid under the following conditions:

- The Calibrator is operated under the conditions specified in Chapter 1.
- The Calibrator has completed a warm-up period of at least twice the length of time the calibrator was powered off, up to a maximum of 30 minutes.
- The SC600 Option has been active longer than 5 minutes.

8-3. Volt Specifications

Table 8-1. Volt Specifications

	Volt Function			
	dc Signal		Square Wave Signal [1]	
	50 Ω Load	1 M Ω Load	50 Ω Load	1 M Ω Load
Amplitude Characteristics				
Range	0 V to ± 6.6 V	0 V to ± 130 V	± 1 mV to ± 6.6 V p-p	± 1 mV to ± 130 V p-p
Resolution	Range 1 mV to 24.999 mV 25 mV to 109.99 mV 110 mV to 2.1999 V 2.2 V to 10.999 V 11 V to 130 V		Resolution 1 μ V 10 μ V 100 μ V 1 mV 10 mV	
Adjustment Range	Continuously adjustable			
1-Year Absolute Uncertainty, tcal ± 5 $^{\circ}$ C	$\pm (0.25\%$ of output + 40 μ V)	$\pm (0.05\%$ of output + 40 μ V)	$\pm (0.25\%$ of output + 40 μ V)	$\pm (0.1\%$ of output + 40 μ V) [2]
Sequence	1-2-5 (e.g., 10 mV, 20 mV, 50 mV)			
Square Wave Frequency Characteristics				
Range	10 Hz to 10 kHz			
1-Year Absolute Uncertainty, tcal ± 5 $^{\circ}$ C	$\pm (2.5$ ppm of setting)			
Typical Aberration within 4 μ s from 50% of leading/trailing edge	< (0.5% of output + 100 μ V)			
[1] Selectable positive or negative, zero referenced square wave.				
[2] For square wave frequencies above 1 kHz, $\pm (0.25\%$ of output + 40 μ V).				

8-4. Edge Specifications

Table 8-2. Edge Specifications

Edge Characteristics into 50 Ω Load		1-Year Absolute Uncertainty, tcal ± 5 °C
Rise Time	≤ 300 ps	(+0 ps / -100 ps)
Amplitude Range (p-p)	5.0 mV to 2.5 V	± (2% of output + 200 μV)
Resolution	4 digits	
Adjustment Range	± 10% around each sequence value (indicated below)	
Sequence Values	5 mV, 10 mV, 25 mV, 50 mV, 60 mV, 80 mV, 100 mV, 200 mV, 250 mV, 300 mV, 500 mV, 600 mV, 1 V, 2.5 V	
Frequency Range	1 kHz to 10 MHz [1]	± (2.5 ppm of setting)
Typical Jitter, edge to trigger	< 5 ps (p-p)	
Leading Edge Aberrations [2]	within 2 ns from 50% of rising edge	< (3% of output + 2 mV)
	2 to 5 ns	< (2% of output + 2 mV)
	5 to 15 ns	< (1% of output + 2 mV)
	after 15 ns	< (0.5% of output + 2 mV)
Typical Duty Cycle	45% to 55%	
Tunnel Diode Pulse Drive	Square wave at 100 Hz to 100 kHz, with variable amplitude of 60 V to 100 V p-p.	
[1] Above 2 MHz, the rise time specification is < 350 ps.		
[2] All edge aberration measurements are made with a Tektronix 11801 mainframe with an SD26 input module.		

8-5. Leveled Sine Wave Specifications

Table 8-3. Leveled Sine Wave Specifications

Leveled Sine Wave Characteristics into 50 Ω	Frequency Range			
	50 kHz (reference)	50 kHz to 100 MHz	100 MHz to 300 MHz	300 MHz to 600 MHz
Amplitude Characteristics (for measuring oscilloscope bandwidth)				
Range (p-p)	5 mV to 5.5 V			
Resolution	< 100 mV: 3 digits ≥ 100 mV: 4 digits			
Adjustment Range	continuously adjustable			
1-Year Absolute Uncertainty, tcal $\pm 5^\circ\text{C}$	\pm (2% of output + 300 μV)	\pm (3.5% of output + 300 μV)	\pm (4% of output + 300 μV)	\pm (6% of output + 300 μV)
Flatness (relative to 50 kHz)	not applicable	\pm (1.5% of output + 100 μV)	\pm (2% of output + 100 μV)	\pm (4% of output + 100 μV)
Short-Term Amplitude Stability	$\leq 1\%$ [1]			
Frequency Characteristics				
Resolution	10 kHz			
1-Year Absolute Uncertainty, tcal $\pm 5^\circ\text{C}$	± 2.5 ppm			
Distortion Characteristics				
2nd Harmonic	≤ -33 dBc			
3rd and Higher Harmonics	≤ -38 dBc			
[1] Within one hour after reference amplitude setting, provided temperature varies no more than $\pm 5^\circ\text{C}$.				

8-6. Time Marker Specifications

Table 8-4. Time Marker Specifications

Time Marker into 50 Ω	5 s to 50 ms	20 ms to 100 ns	50 ns to 20 ns	10 ns	5 ns to 2 ns
1-Year Absolute Uncertainty at Cardinal Points, tcal ± 5 °C	± (25 + t *1000) ppm [1]	± 2.5 ppm	± 2.5 ppm	± 2.5 ppm	± 2.5 ppm
Wave Shape	spike or square	spike, square, or 20%-pulse	spike or square	square or sine	sine
Typical Output Level	> 1 V p-p [2]	> 1 V p-p [2]	> 1 V p-p [2]	>1 V p-p [2]	> 1 V p-p
Typical Jitter (rms)	<10 ppm	< 1 ppm	< 1 ppm	<1 ppm	<1 ppm
Sequence	5-2-1 from 5 s to 2 ns (e.g., 500 ms, 200 ms, 100 ms)				
Adjustment Range [3]	At least ± 10% around each sequence value indicated above.				
Amplitude Resolution	4 digits				
<p>[1] t is the time in seconds.</p> <p>[2] Typical rise time of square wave and 20%-pulse (20% duty cycle pulse) is < 1.5 ns.</p> <p>[3] Time marker uncertainty is ± 50 ppm away from the cardinal points.</p>					

8-7. Wave Generator Specifications

Table 8-5. Wave Generator Specifications

Wave Generator Characteristics	Square Wave, Sine Wave, and Triangle Wave into 50 Ω or 1 MΩ
Amplitude	
Range	into 1 MΩ: 1.8 mV to 55 V p-p into 50 Ω: 1.8 mV to 2.5 V p-p
1-Year Absolute Uncertainty, tcal ± 5 °C, 10 Hz to 10 kHz	± (3% of p-p output + 100 μV)
Sequence	1-2-5 (e.g., 10 mV, 20 mV, 50 mV)
Typical DC Offset Range	0 to ± (≥40% of p-p amplitude) [1]
Frequency	
Range	10 Hz to 100 kHz
Resolution	4 or 5 digits depending upon frequency
1-Year Absolute Uncertainty, tcal ± 5 °C	± (25 ppm + 15 mHz)
[1] The DC offset plus the wave signal must not exceed 30 V rms.	

8-8. Pulse Generator Specifications

Table 8-6. Pulse Generator Specifications

Pulse Generator Characteristics	Positive pulse into 50 Ω	
Typical rise/fall times	1 ns	
Available Amplitudes	2.5 V, 1 V, 250 mV, 100 mV, 25 mV, 10 mV	
Pulse Width		
Range	4 ns to 44.9 ns [1]	45 ns to 500 ns [1]
Uncertainty (typical)	5% ±500 ps	5% ±4ns
Pulse Period		
Range	20 ms to 200 ns (50 Hz to 5 MHz)	
Resolution	4 or 5 digits depending upon frequency and width	
1-Year Absolute Uncertainty at Cardinal Points, tcal ± 5 °C	± 2.5 ppm	
[1] Pulse width not to exceed 40% of period.		
[2] Pulse width uncertainties for periods below 2 μs are not specified.		

8-9. Trigger Signal Specifications (Pulse Function)

Table 8-7. Trigger Signal Specifications (Pulse Function)

Time Marker Period	Division Ratio [1]	Amplitude into 50 Ω (p-p)	Typical Rise Time
20 ms to 150 ns	off/1/10/100	≥ 1 V	≤ 2 ns

8-10. Trigger Signal Specifications (Time Marker Function)

Table 8-8. Trigger Signal Specifications (Time Marker Function)

Pulse Period	Division Ratio [1]	Amplitude into 50 Ω (p-p)	Typical Rise Time
5s to 750 ns	off/1	≥ 1 V	≤ 2 ns
34.9 ms to 7.5 ns	off/10	≥ 1 V	≤ 2 ns
34.9 ms to 2 ns	off/100	≥ 1 V	≤ 2 ns

8-11. Trigger Signal Specifications (Edge Function)

Table 8-9. Trigger Signal Specifications (Edge Function)

Edge Signal Frequency	Division Ratio	Typical Amplitude into 50 Ω (p-p)	Typical Rise Time	Typical Lead Time
1 kHz to 10 MHz	off/1	≥ 1 V	≤ 2 ns	40 ns

8-12. Trigger Signal Specifications (Square Wave Voltage Function)

Table 8-10. Trigger Signal Specifications (Square Wave Voltage Function)

Edge Signal Frequency	Division Ratio	Typical Amplitude into 50 Ω (p-p)	Typical Rise Time	Typical Lead Time
10 Hz to 10 kHz	off/1	≥ 1 V	≤ 2 ns	1 μs

8-13. Trigger Signal Specifications

Table 8-11. TV Trigger Signal Specifications

Trigger Signal Type	Parameters
Field Formats	Selectable NTSC, SECAM, PAL, PAL-M
Polarity	Selectable inverted or uninverted video
Amplitude into 50 Ω (p-p)	Adjustable 0 to 1.5 V p-p into 50 ohm load, (±7% accuracy)
Line Marker	Selectable Line Video Marker

8-14. Oscilloscope Input Resistance Measurement Specifications

Table 8-12. Oscilloscope Input Resistance Measurement Specifications

Scope input selected	50 Ω	1 M Ω
Measurement Range	40 Ω to 60 Ω	500 k Ω to 1.5 M Ω
Uncertainty	0.1 %	0.1 %

8-15. Oscilloscope Input Capacitance Measurement Specifications

Table 8-13. Oscilloscope Input Capacitance Measurement Specifications

Scope input selected	1 M Ω
Measurement Range	5 pF to 50 pF
Uncertainty	\pm (5% of input + 0.5 pF) [1]
[1] Measurement made within 30 minutes of capacitance zero reference. Scope option must be selected for at least five minutes prior to any capacitance measurement, including the zero process.	

8-16. Overload Measurement Specifications

Table 8-14. Overload Measurement Specifications

Source Voltage	Typical 'On' current indication	Typical 'Off' current indication	Maximum Time Limit DC or AC (1 kHz)
5 V to 9 V	100 mA to 180 mA	10 mA	setable 1s to 60s

8-17. Oscilloscope Connections

Using the cable supplied with the SC600 Option, connect the SCOPE output on the Calibrator to one of the channel connectors on your oscilloscope (see Figure 8-1).

To use the external trigger, connect the TRIG OUT output on the Calibrator to the external trigger connection on your oscilloscope. To use the external trigger and view its signal with the calibration signal, connect the TRIG OUT output to another channel. See your oscilloscope manual for details on connecting and viewing an external trigger.

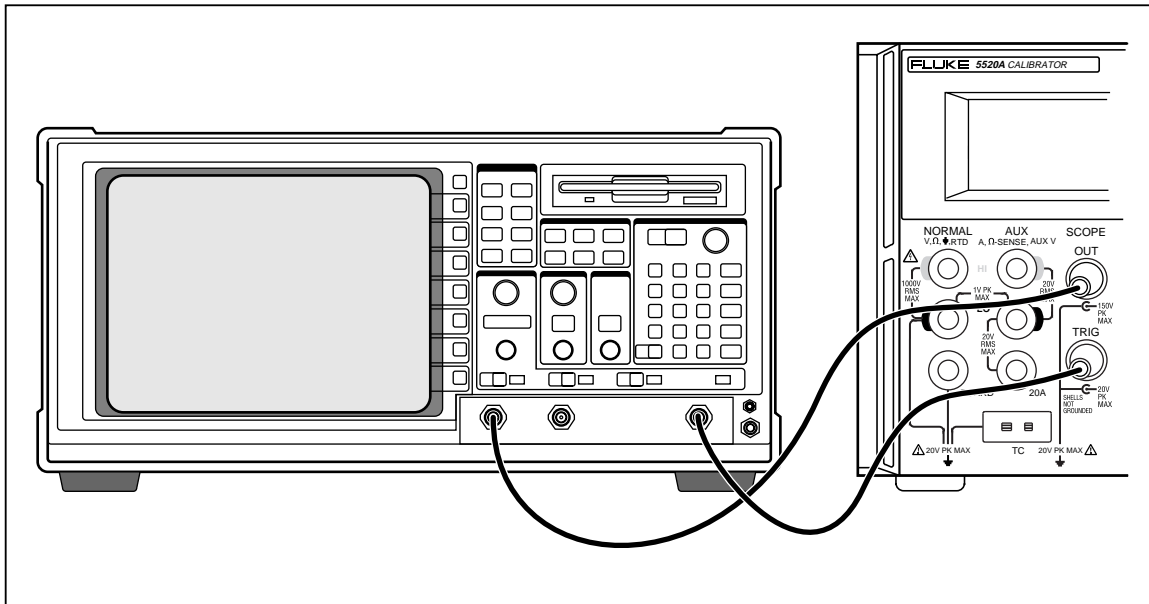

nn228f.eps

Figure 8-1. Oscilloscope Connection: Channel and External Trigger



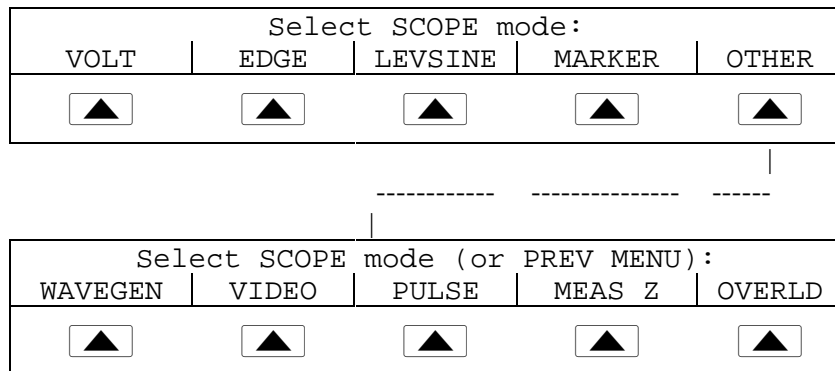

8-18. Starting the SC600 Option

Press **SCOPE** (LED lit) to select the SC600 Option. The SCOPE menu, shown below, appears in the Control Display. You can press any of the first four softkeys to go directly to the VOLT, EDGE, LEVSINE, and MARKER calibration menus. Press the last softkey to go to the OTHER menu (also shown below), allowing access to WAVEGEN, VIDEO, PULSE, Impedance/Capacitance measurement (MEAS Z), and Overload (OVERLD) menus. Press **PREV MENU** to return to the SCOPE menu from the OTHER menu. This chapter describes each of these menus in detail.



8-19. The Output Signal

The following description assumes that you have selected VOLT mode from the SCOPE menu. The Control Displays appears as follows with VOLT mode selected:

Output @ SCOPE. 1 MΩ	DC←-AC	TRIG off	V/DIV MENU	MODE volt
				

The location of the output signal is indicated on the Control Display (the display on the right side). If your Calibrator is connected, but the output does not appear on the oscilloscope, you may have the Calibrator in standby mode. The settings for the output signal are indicated in the Output Display (the display on the left side).





If STBY is displayed, press the  key. The Output Display will show OPR and the output should appear on the oscilloscope.

8-20. Adjusting the Output Signal

The Calibrator provides several ways to change the settings for the output signal during calibration. Since oscilloscope calibration requires many adjustments of the output signal, the three available methods for changing these settings for oscilloscope calibration are summarized below. These methods provide the means of jumping to a new value or sweeping through a range of values.

8-21. Keying in a Value





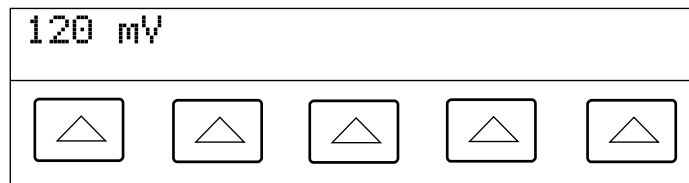



The following example is for use in the LEVSINE mode. To key a specific value directly into the Calibrator from its front panel:

1. Key in the value you want to enter, including the units and prefixes. For example to enter 120 mV press     . The Control Display will show:



g1002i.eps

Note

Units and prefixes printed in red in the upper left corner of the keys are accessed through the  key. For example, to enter 200 μs, press       .

If you make an error, press  to clear the Control Display and return to the menu.

2. Press  to activate the value and move it to the Output Display.

Other settings in the display will remain unaltered unless you key in an entry and specify the units for that setting.

8-22. Adjusting Values with the Rotary Knob

To adjust values in the Output Display using the rotary knob:

1. Turn the rotary knob. A cursor appears in the Output Display under the lowest digit and begins changing that digit. If you wish to place the cursor in the field without changing the digit, press **EDIT FIELD**.

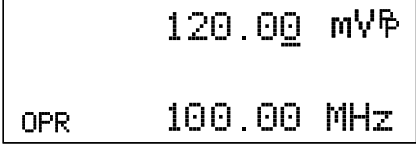

```

      120.00 mVp
OPR  100.00 MHz
  
```

gl003i.eps

2. To move the cursor between the voltage and frequency fields, press **EDIT FIELD**.

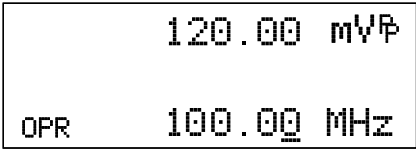

```

      120.00 mVp
OPR  100.00 MHz
  
```

gl004i.eps

3. Use the **◀** and **▶** keys to move the cursor to the digit you want to change.
4. Turn the rotary knob to change the value.

When you use the rotary knob in either VOLT mode or MARKER mode, the Control Display shows the new value's percentage change from the reference value. This is useful for determining the percentage of error on the oscilloscope. You can set the reference value to the new value by pressing **NEW REF**.

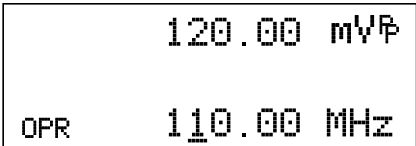

```

      120.00 mVp
OPR  110.00 MHz
  
```

gl005i.eps

5. Press **ENTER** to remove the cursor from the Output Display and save the new value as the reference value.

Note

If you attempt to use the rotary knob to adjust a value to an amount that is invalid for the function you are using, or is outside the value's range limit, the value will not change and the Calibrator will beep.

8-23. Using **MULT X and **DIV****

The **MULT X** and **DIV** keys cause the current value of the signal to jump to a pre-determined cardinal value, whose amount is determined by the current function. These keys are described in more detail under the descriptions for each function.

8-24. Resetting the SC600 Option

You can reset all parameters in the Calibrator to their default settings at any time during front panel operations by pressing the **RESET** key on the front panel.

After resetting the Calibrator, press **SCOPE** to return to the SC600 Option (the SCOPE menu appears.) Press **OPR** to reconnect the signal output.

8-25. Calibrating the Voltage Amplitude on an Oscilloscope

The oscilloscope voltage (vertical) gain is calibrated by applying a dc or low frequency square wave signal and adjusting its gain to meet the height specified for different voltage levels, as designated by the graticule line divisions on the oscilloscope. The signal is applied from the Calibrator in VOLT mode. The specific voltages that you should use for calibration, and the graticule line divisions that need to be matched, vary for different oscilloscopes and are specified in your oscilloscope's service manual.

8-26. The VOLT Function

You can calibrate the Voltage gain using the VOLT function. Access this function through the VOLT menu, which appears when you press **SCOPE**, or when you press the VOLT softkey from the SCOPE menu.

Output @ SCOPE. 1 MΩ	DC<-AC	TRIG off	V/DIV MENU	MODE volt
1 MΩ 50Ω	DC<-AC DC->AC	off /1	(see "The V/DIV Menu")	volt edge levsine marker wavegen video pulse meas Z overld

You can press the MODE softkey to cycle through the functions in the order shown, or you can press **PREV MENU** to return directly to the SCOPE menu.

Each menu item is described below:

- **OUTPUT @ SCOPE** Indicates the location of the signal output. If the signal does not appear on the oscilloscope, press **OPR**. To disconnect the signal, press **STBY**.
- **1 MΩ** Toggles between 1 MΩ and 50Ω to match the input impedance of the oscilloscope.
- **DC<-AC** toggles from ac to dc, producing the dc equivalent output. **DC->AC** Toggles from dc to ac.
- **TRIG** If you are using square wave to calibrate the external trigger, use this key to toggle the trigger off and on. When on, the reading will show "/1", which indicates that the external trigger is at the same frequency as the volt output. The external trigger can be useful for many oscilloscopes that have difficulty triggering on low amplitude signals. You can also toggle the trigger off and on by pressing **TRIG OUT**.
- **V/DIV MENU** Opens the voltage scaling menu, which lets you select the scale of the signal in volts per division. This menu is described below in detail, under "The V/DIV Menu."

- **MODE** Indicates you are in VOLT mode. Use the softkey to change modes and open menus for other oscilloscope calibration modes.

8-27. The V/DIV Menu

The V/DIV menu, shown below, sets the number of volts denoted by each division on the oscilloscope. This menu provides alternative methods for changing the output amplitude that may be more convenient for certain oscilloscope applications. To access the V/DIV menu, press V/DIV from the VOLT menu.

20.00 mV/div		#DIV = 1		MODE
up	down	up	down	volt
-----		-----		volt
1 mV	0.5 V	1		edge
2 mV	1 V	2		levsine
5 mV	2 V	3		marker
10 mV	5 V	4		wavegen
20 mV	10 V	5		video
50 mV	20 V	6		pulse
100 mV	50 V	7		meas Z
200 mV	100 V	8		overld

Each item in the V/DIV menu is described below:

- **V/div** Changes the number of volts per division in the Output Display so that the values selected correspond to the oscilloscope’s input sensitivity (VOLTS/DIV.) The available settings, shown in the figure above, are provided in 1-2-5 step increments. Press the softkey under UP to increase the volts per division. Press the softkey under DOWN to decrease the volts per division.
- **#DIV** Specifies the number of divisions that establish the peak-to-peak value of the waveform. The value can be adjusted from one to eight divisions. The amount denoted by each division is displayed in the V/div field. Press the softkey under UP to increase the signal’s height, and press the softkey under DOWN to decrease it.

8-28. Shortcuts for Setting the Voltage Amplitude

The and keys step the voltages through cardinal point values of an oscilloscope in a 1-2-5 step sequence. For example, if the voltage is 40 mV, pressing increases the voltage to the nearest cardinal point, which is 50 mV. Pressing decreases the voltage to the nearest cardinal point, which is 20 mV.

8-29. Oscilloscope Amplitude Calibration Procedure

The following example describes how to use the VOLT menu to calibrate the oscilloscope's amplitude gain. During calibration, you will need to set different voltages and verify that the gain matches the graticule lines on the oscilloscope according to the specifications for your particular oscilloscope. See your oscilloscope manual for the recommended calibration settings and appropriate gain values.

Before you start this procedure, verify that you are running the SC600 Option in VOLT mode. If you are, the Control Display shows the following menu.

Output @ SCOPE. 1 MΩ	DC<-AC	TRIG off	V/DIV MENU	MODE volt
▲	▲	▲	▲	▲

Perform the following sample procedure to calibrate the vertical gain:

1. Connect the calibrator to Channel 1 on the oscilloscope, making sure the oscilloscope is terminated at the proper impedance (1 MΩ for this example). Verify that the **OPR** key on the Calibrator is lit, indicating that the signal is connected.
2. Key in the voltage level that is recommended for your oscilloscope. For example to enter 20 mV, press **2** **0** **μm** **V**, then press **ENTER**. See “Keying in a Value” earlier in this chapter.
3. Adjust the oscilloscope as necessary. The waveform should be similar to the one shown below, with the gain at exactly the amount specified for the calibration settings for your oscilloscope. This example shows the gain at 20 mV to be 4 divisions, at 5 mV per division.

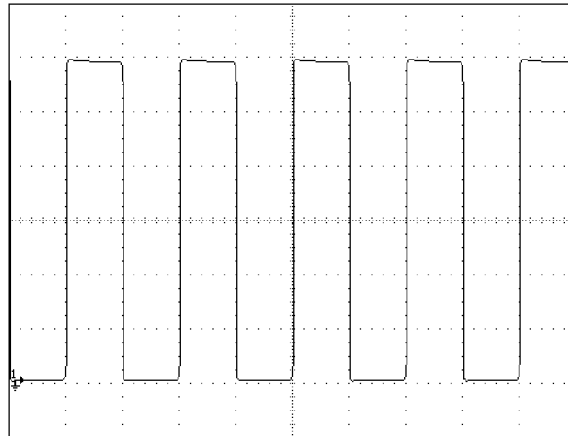

gl006i.bmp

4. Change the voltage to the next value recommended for calibrating your oscilloscope model, and repeat this procedure at the new voltage level, verifying the gain is correct according to the specifications in your manual.
5. Repeat the procedure for each channel.





8-30. Calibrating the Pulse and Frequency Response on an Oscilloscope

The pulse response is calibrated with a square-wave signal that has a fast leading edge rise-time. Using this signal, you adjust the oscilloscope as necessary until it meets its particular specifications for rise time and pulse aberrations.

Following pulse verification, the frequency response is checked by applying a leveled sine wave and acquiring a frequency reading at the -3 dB point, when the amplitude drops approximately 30%.



8-31. The Edge Function

The EDGE function is used for calibrating the pulse response for your oscilloscope. To reach the EDGE menu, press the softkey under MODE until “edge” appears.

Output at SCOPE terminal (50Ω).	TDPULSE off	TRIG off	MODE edge
			
	off on	off /1	volt edge levsine marker wavegen video pulse meas Z overld

You can press the MODE softkey to cycle through the functions in the order shown, or you can press  to return directly to the SCOPE menu.

Each option in the EDGE menu is described below:

- OUTPUT @ SCOPE terminal (50Ω)** Indicates the location and impedance of the signal output. If the signal does not appear on the oscilloscope, press . To disconnect the signal, press .





You cannot change the output impedance in EDGE mode.
- TD PULSE** Press once to turn the Tunnel Diode Pulser drive signal on, again to turn the Pulser drive off. This signal sources up to 100 V p-p to drive a Tunnel Diode Pulser (Fluke Part Number 606522, Tektronix 067-0681-01, or equivalent.)
- TRIG** If you are using the external trigger, use this key to toggle the trigger off and on. When on, the reading will show “/1” which indicates that the external trigger is at the same frequency as the edge output. The external trigger can be useful for many oscilloscopes that have difficulty triggering on low amplitude signals.

You can also toggle the trigger off and on by pressing .
- MODE** Indicates you are in EDGE mode. Use the softkey to change modes and open menus for other oscilloscope calibration modes.

8-32. Oscilloscope Pulse Response Calibration Procedure

This sample procedure shows how to check the oscilloscope's pulse response. Before you check your oscilloscope, see your oscilloscope's manual for the recommended calibration settings.

Before you start this procedure, verify that you are running the SC600 Option in EDGE mode. If you are, the Control Display shows the following menu.

Output at SCOPE terminal (50 Ω).	TDPULSE off	TRIG off	MODE edge
			

Perform the following sample procedure to calibrate the pulse response:

1. Connect the Calibrator to Channel 1 on the oscilloscope. Select 50 Ω impedance or use a 50 Ω termination directly at the oscilloscope input. Verify that the **OPR** key is lit, indicating that the signal is connected.
2. Alter the voltage setting for the signal so it matches the amplitude value recommended by your oscilloscope manufacturer for calibrating the edge response. The default setting is 25.00 mV p-p, 1.0000 MHz.

For example, on an HP 54522C oscilloscope, start with a signal of 1 V @ 1 MHz.

3. Adjust the scale on your oscilloscope to achieve a good picture of the edge.
4. Adjust the time base on your oscilloscope to the fastest position available (20.0 or 50.0 ns/div).

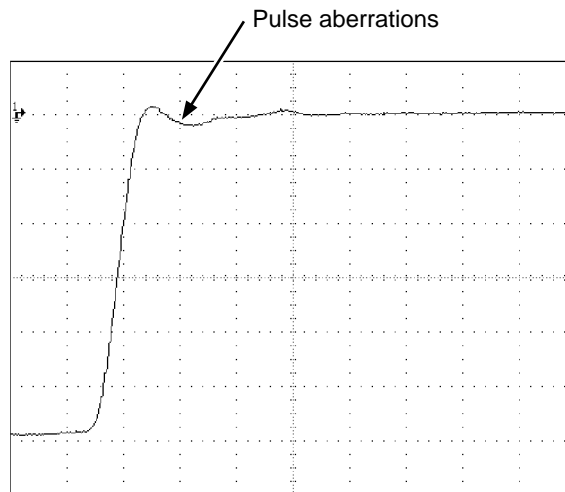

gl007i.eps

5. Verify that your oscilloscope exhibits the proper rise time and pulse aberration characteristics.
6. Remove the input signal by pressing **STBY**.

8-33. Pulse Response Calibration Using a Tunnel Diode Pulser

You can use the calibrator to drive a tunnel diode pulser (Fluke Part Number 606522, or Tektronix 067-0681-01, or equivalent), allowing you to check for pulse edge rise times as fast as 125 ps.

The calibrator sources a maximum pulser drive signal of 100 V p-p at 100 kHz. The recommended (and default) output setting is 80 V p-p at 100 kHz.

Perform the following procedure to use a tunnel diode pulser:

1. Connect the calibrator, tunnel diode pulser, and oscilloscope as shown in Figure 8-2.
2. With the SC600 Option in EDGE mode, press the TDPULSE softkey to “on”.
3. Press **OPR**.
4. Rotate the control on the pulser box to the minimum setting necessary to trigger a reading.

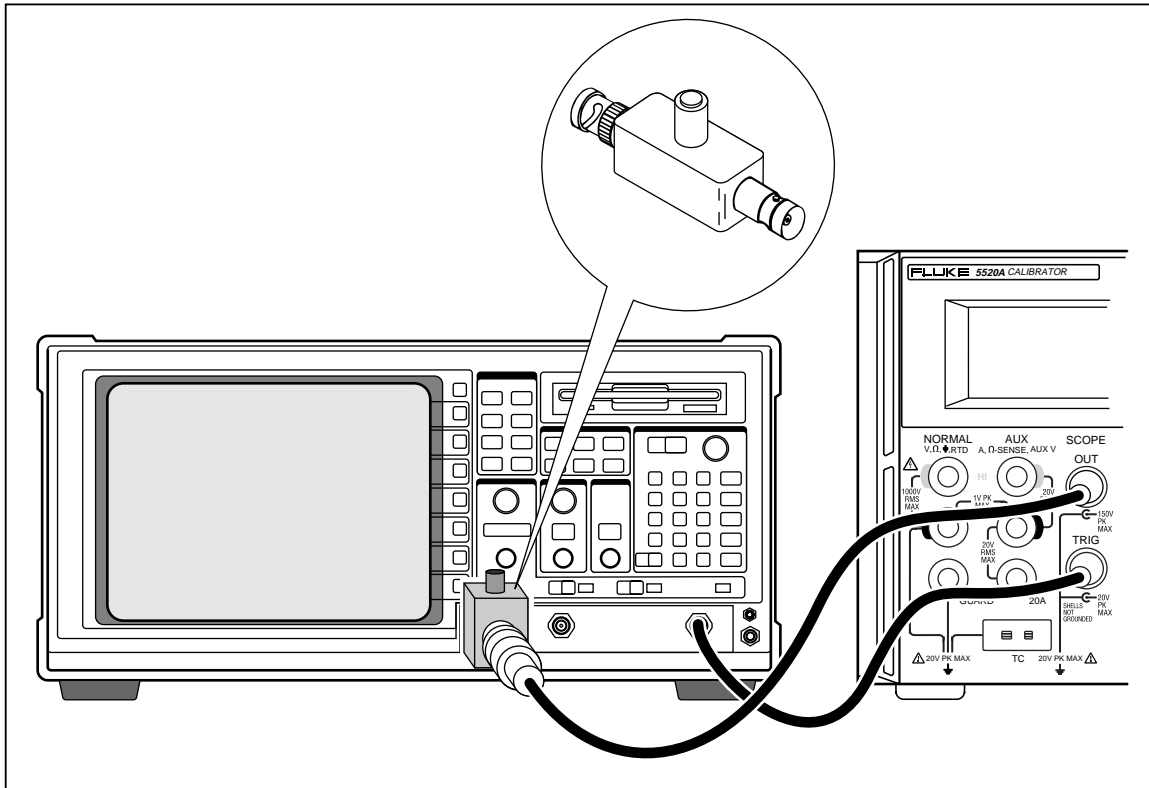

nn229f.eps

Figure 8-2. Tunnel Diode Pulser Connections

8-34. The Leveled Sine Wave Function

The Leveled Sine Wave (LEVSINE) function uses a leveled sine wave, whose amplitude remains relatively constant over a range of frequencies, to check the oscilloscope’s bandwidth. When you check your oscilloscope, you change the wave’s frequency until the amplitude displayed on the oscilloscope drops 30%, which is the amplitude that corresponds to the -3 dB point. Default values are 30 mV p-p, 50 kHz.

To access the LEVSINE menu, press the softkey under MODE until “levsine” appears.

Output @ SCOPE terminal (50Ω).	MORE OPTIONS	SET TO LAST F	MODE levsine
▲	▲	▲	▲
	(see "The MORE OPTIONS Menu")	LAST F 50 kHz	volt edge levsine marker wavegen video pulse meas Z overld

You can press the MODE softkey to cycle through the functions in the order shown, or you can press **PREV MENU** to return directly to the SCOPE menu.

Each option in the LEVSINE menu is described below:

- **OUTPUT @ SCOPE terminal (50Ω)** Indicates the location and impedance of the signal output. If the signal does not appear on the oscilloscope, press **OPR**. To disconnect the signal, press **STBY**. You cannot change the impedance while you are in LEVSINE mode.
- **MORE OPTIONS** Opens additional menu items, which are described in detail under "The MORE OPTIONS Menu."
- **SET TO LAST F** Toggles between the current frequency setting and the reference value of 50 kHz. This option is useful for reverting to the reference to check the output after you make adjustments at another frequency.
- **MODE** Indicates you are in LEVSINE mode. Use the softkey to change modes and open menus for other calibration modes.

8-35. Shortcuts for Setting the Frequency and Voltage

The following three options are available for controlling the sine wave settings:

- **SET TO LAST F** toggles between the last frequency used and the reference frequency of 50 kHz, letting you check the output at the reference after you make adjustments at a different frequency.
- **MORE OPTIONS** lets you use an automatic frequency sweep and lock the voltage range, if necessary. The following section provides details on this menu.
- The **MULT X** and **DIV** keys step frequencies up or down in amounts that let you quickly access a new set of frequencies. For example, if the value is 250 kHz, **MULT X** changes it to 300 kHz, and **DIV** changes it to 200 kHz. For voltage values, **MULT X** and **DIV** step through cardinal point values in a 1.2-3-6 sequence.

8-36. The MORE OPTIONS Menu

When you select MORE OPTIONS, you open options that give you more control over the frequency and voltage. To access the MORE OPTIONS menu, press the softkey under MORE OPTIONS in the LEVSINE menu.

FREQ CHG	RATE	Range = 40 mV	MODE
jump	1 MHz	auto	levsine
jump	1 MHz	-----	volt
sweep	10 MHz	auto	edge
	100 kHz	locked	levsine
		10 mV	marker
		40 mV	wavegen
		100 mV	video
		400 mV	pulse
		1.3 V	meas Z
		5.5 V	overld

Each option in the MORE OPTIONS menu is described below:

- FREQ CHG** Toggles between two settings that control the way the output signal adjusts to a new frequency. “Jump” is the default setting.

“Jump” causes the output signal to jump immediately to a new frequency setting. “Sweep” causes the signal to sweep through a series of frequency values, over a range you set. Use the sweep function to watch the signal gradually change over a given bandwidth and see the point at which its amplitude changes. Details for using the sweep function are provided under “Sweeping Through a Frequency Range.”
- RATE** Used when FREQ CHANGE is set to “sweep” to select a sweep speed of 100 kHz, 1 MHz, or 10 MHz.

A slower sweep rate lets you watch the frequency change very slowly. After a faster sweep, you may want to pinpoint a certain frequency with a slower sweep over a subset of your previous frequency range.
- RANGE** The softkeys toggle between two settings. The first setting (“auto”) changes the range limit automatically in accordance with the voltage level. The second setting (“locked”) freezes the present range limit; subsequent changes in voltage level are then measured with this range limit.

There are six range limits in LEVSINE mode: 10 mV, 40 mV, 100 mV, 400 mV, 1.3 V, and 5.5 V. When set to “auto” the calibrator uses your voltage setting to automatically set the range limit that provides the most accurate output.

When set to “locked” the range limit remains fixed and you can decrease the voltage down to the bottom of the range.

For example, assume the range limit is 40 mV. If you enter 5 mV with “auto” selected, the calibrator will automatically change the range limit to 10 mV and output 5 mV from within the 10 mV range. However, if you start with the 40 mV range “locked” and then enter 5 mV, the calibrator will output 5 mV from within the 40 mV range.

The default range setting is “auto,” which should always be used unless you are troubleshooting discontinuities in your oscilloscope’s vertical gain. The range setting will always return to “auto” after you leave LEVSINE mode.

- **MODE** Indicates you are in LEVSINE mode. Use the softkey to change modes and open menus for other calibration modes.

8-37. Sweeping Through a Frequency Range

When you change frequencies using the sweep method, the output sine wave sweeps through a specified range of frequencies. This feature lets you identify the frequency at which the oscilloscope’s signal exhibits certain behavior; you can quickly see the frequency response of the oscilloscope. Before you start this procedure, make sure you are in the MORE OPTIONS menu and the sine wave is displayed on the oscilloscope.

Perform the following procedure to sweep through frequencies:

1. Make sure the output signal shows the starting frequency. If not, key in the starting frequency; then press **ENTER**.
2. Toggle **FREQ CHANGE** to “sweep.” Toggle the **RATE** to a lower frequency if you want to observe a very slow sweep over a small range.
3. Key in the end frequency; then press **ENTER**. After you press **ENTER**, the signal sweeps through frequencies between the two values you entered, and the Sweep menu (“Sweeping from previous to displayed frequency”) appears on the Control Display.
4. You can let the signal sweep through the entire range, or you can halt the sweep if you need to record the frequency at a certain point.

To interrupt the sweep, press the softkey under **HALT SWEEP**. The current frequency will appear on the Output Display and the MORE OPTIONS menu will reappear on the Control Display.

Note

*When you interrupt the frequency sweep by pressing **HALT SWEEP**, the **FREQ CHANGE** method switches back to “jump.”*

5. Repeat the procedure if necessary. For example, if you did a fast sweep, you may want to pinpoint a certain frequency with a slow sweep over a subset of your previous frequency range.

8-38. Oscilloscope Frequency Response Calibration Procedure

This sample procedure, which verifies the frequency response on your oscilloscope, is usually performed after the pulse response is verified.

This procedure checks the bandwidth by finding the frequency at the -3 dB point for your oscilloscope. The reference sine wave in this procedure has an amplitude of 6 divisions, so that the -3 dB point can be found when the amplitude drops to 4.2 divisions.

Before you start this example procedure, verify that you are running the SC600 Option in LEVSINE mode. If you are, the Control Display shows the following menu.

Output @ SCOPE terminal (50Ω)	MORE OPTIONS	SET TO LAST F	MODE levsine
▲	▲	▲	▲

Perform the following sample procedure to calibrate the frequency response:

1. Reconnect the signal by pressing the **OPR** key on the Calibrator. Select 50Ω impedance or use a 50Ω external termination directly at the oscilloscope input.
2. Adjust the sine wave settings in the Output Display according to the calibration recommendations in your oscilloscope manual. For example, for the HP 54522C oscilloscope, start at 600 mV @ 1 MHz. To enter 600 mV, press **6** **0** **0** **μm** **dbm** **V**; then press **ENTER**.
3. Adjust the oscilloscope as necessary. The sine wave should appear at exactly six divisions, peak-to-peak, as shown below.

If necessary, make small adjustments to the voltage amplitude until the wave reaches exactly six divisions. To fine-tune the voltage, press **EDIT FIELD** to bring a cursor into the Output Display, move the cursor with the **◀** key, and turn the rotary knob to adjust the value. (See “Adjusting Values with the Rotary Knob” earlier in this chapter.)

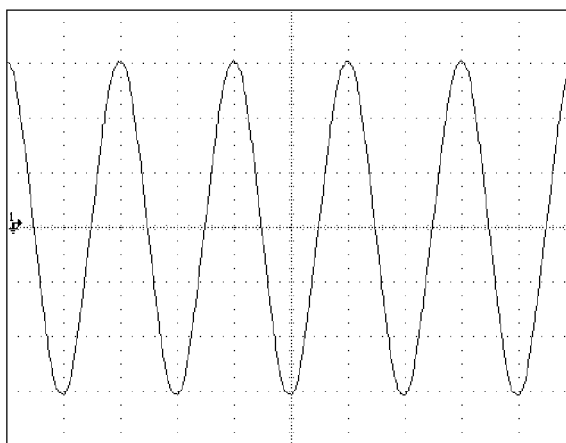

gl009i.eps

4. Increase the frequency to 400 MHz (for 500-MHz instruments), or 500 MHz (for 600-MHz instruments). To enter 400 MHz, press **4** **0** **0** **P** **M** **Hz**; then press **ENTER**.
5. Continue to increase the frequency slowly until the waveform decreases to 4.2 divisions, as shown below.

To increase the frequency slowly, fine-tune it using the rotary knob. To do this, press **EDIT FIELD** to place a cursor in the Output Display. Press **EDIT FIELD** again to place it in the frequency field, and use the **◀** and **▶** keys to move it to the digit you want to change. Then change the value by turning the rotary knob. Continue making small increments in the frequency until the signal drops to 4.2 divisions. At 4.2 divisions, the signal is at the frequency that corresponds to the -3 dB point.

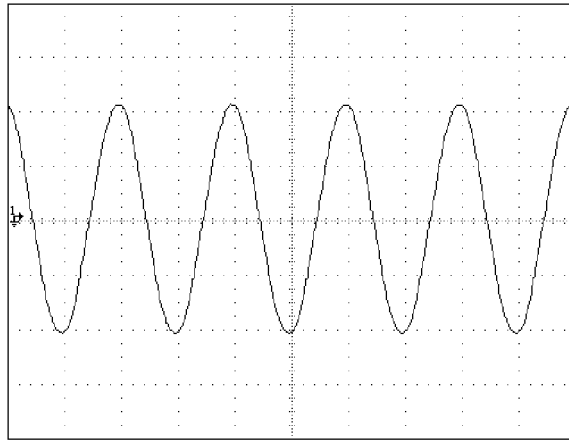

gl010i.eps

6. Remove the input signal by pressing **STBY**.
7. Repeat this procedure for the remaining channels on your oscilloscope.

8-39. Calibrating the Time Base of an Oscilloscope

The horizontal deflection (time base) of an oscilloscope is calibrated using a method similar to the vertical gain calibration. A time marker signal is generated from the Calibrator and the signal's peaks are matched to the graticule line divisions on the oscilloscope.

8-40. The Time Marker Function

The Time MARKER function, which is available through the MARKER menu, lets you calibrate the timing response of your oscilloscope. To access the MARKER menu, press the softkey under MODE until "marker" appears.

Output at SCOPE terminal (50Ω).	SHAPE	TRIG	MODE
▲	spike	off	marker
▲	sine	off	volt
▲	spike	/1	edge
▲	square	/10	levsine
▲	sq20%	/100	marker
			wavegen
			video
			pulse
			meas Z
			overld

You can press the MODE softkey to cycle through the functions in the order shown, or you can press **PREV MENU** to return directly to the SCOPE menu.

Each option in the MARKER menu is described below:

- **OUTPUT @ SCOPE terminal (50Ω)** Indicates the location of the signal output. If the signal does not appear on the oscilloscope, press **OPR**. To disconnect the signal, press **STBY**.

- **SHAPE** Indicates the type of waveform. Depending on frequency setting, possible selections are sine, spike, square (50% duty cycle square wave), and sq20% (20% duty cycle square wave.) Note that selections available under SHAPE depend on the selected marker period (frequency), as follows:

Selection	Period (Frequency)
sine	10 ns - 2 ns (100 MHz - 500 MHz)
spike	5s - 20 ns (0.2 Hz - 50 MHz)
square	5s - 10 ns (0.2 Hz - 100 MHz)
sq20%	20 ms - 100 ns (50 kHz - 10 MHz)

- **TRIG** If you are using the external trigger, use this key to cycle through the trigger settings. The available trigger settings are: off, /1 (trigger signal appears on each marker), /10 (trigger signal appears on every tenth marker), and /100 (trigger signal appears at every 100th marker).

You can also toggle the trigger off and on by pressing **TRIG OUT**.

- **MODE** Indicates you are in MARKER mode. Use the softkey to change modes and open menus for other oscilloscope calibration modes.

Default marker values are 1.000 ms, SHAPE = spike.

The **MULT** and **DIV** keys step the voltages through cardinal point values of an oscilloscope in a 1-2-5 step sequence. For example, if the period is 1.000 ms, pressing **MULT** increases the period to the nearest cardinal point, which is 2.000 ms. Pressing **DIV** decreases the voltage to the nearest cardinal point, which is 500 μ s.

8-41. Time Base Marker Calibration Procedure for an Oscilloscope

This sample procedure uses the Time MARKER function to check the horizontal deflection (time base) of your oscilloscope. See your oscilloscope's manual for the exact time base values recommended for calibration.

Before you begin this procedure, verify that you are in MARKER mode. If you are, the Control Display shows the following menu.

Output at SCOPE terminal (50 Ω)	SHAPE spike	TRIG off	MODE marker
▲	▲	▲	▲

Perform the following sample procedure to calibrate the time base:

1. Connect the calibrator to Channel 1 on the oscilloscope. Select 50 Ω impedance or use an external 50 Ω termination. Make sure the oscilloscope is dc-coupled.
2. Apply a time marker value according to the recommended calibration settings in your oscilloscope manual. For example, to enter 200 ns, press

2 **0** **0** **SHIFT** **n** **K** **SHIFT** **Hz**, then press **ENTER**.

Note

*You may enter the equivalent frequency instead of the time marker value.
For example, instead of entering 200 ns, you may enter 5 MHz.*

3. Set your oscilloscope's time base to show 10 time markers. The time markers should align with the oscilloscope divisions, as shown in the example below.

For an accurate reading, align the signal's peaks with the horizontal center axis.

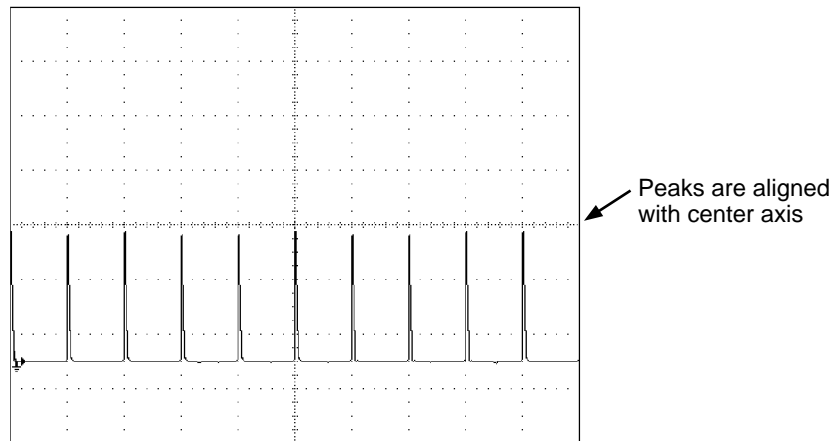

g1011i.eps

4. Repeat this procedure for all time marker values recommended for your oscilloscope. Repeat for digital and analog mode as required. Some oscilloscopes may need the magnification changed while calibrating in analog mode.
5. Remove the signal by pressing **STBY**.

8-42. Testing the Trigger SC600 option

The oscilloscope's ability to trigger on different waveforms can be tested using the wave generator. When the wave generator is used, a square, sine, or triangle wave is transmitted and the wave's output impedance, offset, and voltage can be varied in order to test the triggering capability at different levels.

Note

The wave generator should not be used for checking the accuracy of your oscilloscope.

The wave generator is available through the WAVEGEN menu, shown below. To access this menu, press the softkey under MODE until “wavegen” appears.

Output @ SCOPE	WAVE	SCOPE Z	OFFSET	MODE
▲	square	1 MΩ	+0.0 V	wavegen
	square	1 MΩ		volt
	sine	50Ω		edge
	tri			levsine
				marker
				wavegen
				video
				pulse
				meas Z
				overld

You can press the MODE softkey to cycle through the functions in the order shown, or you can press **PREV MENU** to return directly to the OTHER modes menu.

Each option in the WAVEGEN menu is described below:

- **OUTPUT @ SCOPE** Indicates the location of the signal output. If the signal does not appear on the oscilloscope, press **OPR**. To disconnect the signal, press **STBY**.
- **WAVE** Scrolls through the three types of waveforms that are available. You can select a square, sine, or triangle wave as the output.
- **SCOPE Z** Toggles the calibrator’s output impedance setting between 50Ω and 1 MΩ.
- **OFFSET** Displays the offset of the generated wave. To change the offset, key in the new value, and press **ENTER**. Using the rotary knob does not change the offset; it changes the actual voltage output.

When you change the offset, you must remain within certain limits to avoid clipping the peaks. The limit depends on the wave’s peak-to-peak value. Specifically, the peak excursion equals the absolute value of the offset plus half of the wave’s peak-to-peak value. See “Wave Generator Specifications” at the beginning of this chapter.

- **MODE** Indicates you are in WAVEGEN mode. Use the softkey to change modes and open menus for other oscilloscope calibration modes.

Default Wavegen settings are 20 mV p-p, 1000.0 Hz, WAVE = square, and offset = 0.0 V.

8-43. Testing Video Triggers

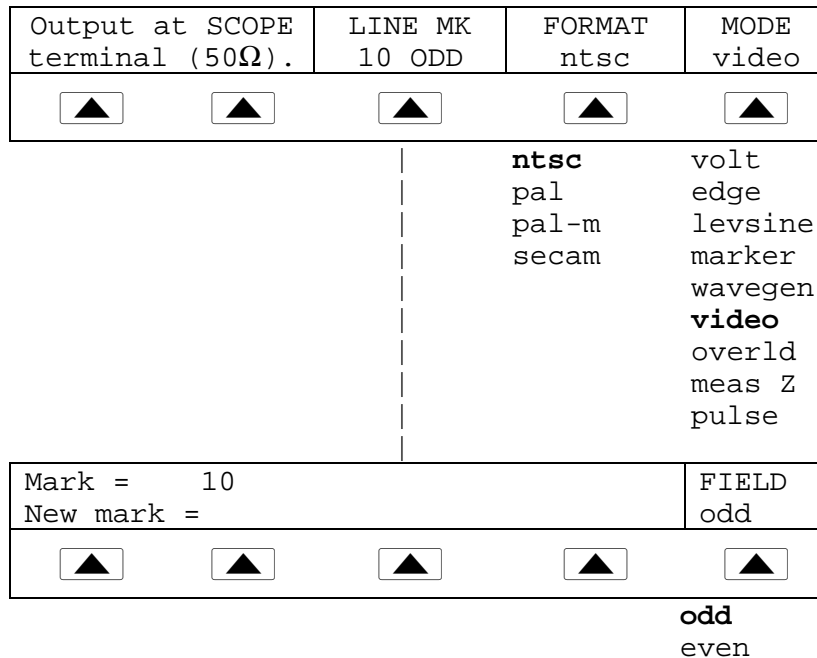

You can press the MODE softkey to cycle through the functions in the order shown, or you can press **PREV MENU** to return directly to the OTHER modes menu.

Each option in the VIDEO menu is described below:

- **Output @ SCOPE terminal (50Ω)** Indicates the location of the signal output. If the signal does not appear on the oscilloscope, press **OPR**. To disconnect the signal, press **STBY**.
- **LINE MK** Allows you to select the marker line number. For ntsc and pal-m formats, you can also select field (“odd” or “even”). For pal and secam formats, the field (“ODD” or “EVEN”) is selected automatically based on marker line number.
- **FORMAT** Scrolls through the available formats. You can select ntsc, pal, pal-m, and secam.
- **MODE** Indicates the calibrator is in VIDEO mode. Use the softkey to change modes and open menus for other oscilloscope calibration modes.

Default video settings are + 100 %, format = NTSC, and videomark = 10.

8-44. Verifying Pulse Capture

Output @ SCOPE		AMPL 2.5 V	TRIG off	MODE pulse
▲	▲	▲	▲	▲
		2.5 V	off	volt
		1.0 V	/1	edge
		250 mV	/10	levsine
		100 mV	/100	marker
		25 mV		wavegen
		10 mV		video
				pulse
				meas Z
				overld

You can press the **MODE** softkey to cycle through the functions in the order shown, or you can press **PREV MENU** to return directly to the **OTHER** modes menu.

Each option in the **PULSE** menu is described below:

- **OUTPUT @ SCOPE** Indicates the location of the signal output. If the signal does not appear on the oscilloscope, press **OPR**. To disconnect the signal, press **STBY**.
- **AMPL** Indicates the output level. You can select 2.5 V, 1.0 V, 250 mV, 100 mV, 25 mV, or 10 mV.
- **TRIG** If you are using the external trigger, use this key to cycle through the trigger settings. The available trigger settings are: off, /1 (trigger signal appears on each marker), /10 (trigger signal appears on every tenth marker), and /100 (trigger signal appears at every 100th marker).

You can also toggle the trigger off and on by pressing **TRIG OUT**.

- **MODE** Indicates you are in **PULSE** mode. Use the softkey to change modes and open menus for other oscilloscope calibration modes.

Default Pulse settings are 100.0 ns width and 1.000 ms period. To change these values, you have several options. Usually, you will enter values for both pulse width and period. Do this by entering the pulse width value with units first, followed immediately by the period value and units, followed by **ENTER**. For example, you could enter a pulse width of 50 ns and a period of 200 ns with the following sequence:

5 **0** **SHIFT** **n** **k** **SHIFT** **sec** **Hz** **2** **0** **0** **SHIFT** **n** **k** **SHIFT** **sec** **Hz**
ENTER.

To change only the pulse width, enter a value in seconds. You can enter this value with units (e.g., 200 ns) or without units (e.g., 0.0000002). To change only the period, enter a frequency with units (e.g., 20 MHz, changing the period to 50 ns).

8-45. Measuring Input Resistance and Capacitance

Measured @ SCOPE terminal.		MEASURE res 50Ω	MODE meas Z
▲	▲	▲	▲

res 50Ω volt
res 1MΩ edge
cap levsine
 marker
 wavegen
 video
 pulse
 meas Z
 overl d

You can press the MODE softkey to cycle through the functions in the order shown, or you can press **PREV MENU** to return directly to the OTHER modes menu.

Each option in the Impedance/Capacitance (MEAS Z) menu is described below:

- **Measured @ SCOPE terminal** Indicates the location of the measured input.
- **MEASURE** Indicates the type of test. You can select res 50Ω or res 1 MΩ termination (for impedance) or cap (capacitance).
- **MODE** Indicates the Calibrator is in MEAS Z mode. Use the softkey to change modes and open menus for other oscilloscope calibration modes.

If you have selected Capacitance measurement, the menu appears as follows:

Measured @ SCOPE terminal.	SET OFFSET	MEASURE cap	MODE meas Z
▲	▲	▲	▲

CLEAR
OFFSET

- **SET OFFSET** With the cable disconnected at the oscilloscope but still connected at the Calibrator, press to cancel the capacitance of the Calibrator. Press again to **CLEAR OFFSET** and return to the capacitance reading.

Default Impedance Measurement range = 50 ohm.

8-46. Input Impedance Measurement

With MEAS Z mode selected, perform the following procedure to measure the input impedance of an oscilloscope:

1. Use the MEASURE softkey to select “res 50Ω” or “res 1 MΩ” termination.
2. Connect the SCOPE terminal on the calibrator to Channel 1 on the oscilloscope.
3. Press **OPR** to initiate the measurement.

8-47. Input Capacitance Measurement

With MEAS Z mode selected, perform the following procedure to measure the input capacitance of an oscilloscope:

1. Set the oscilloscope for 1 MΩ input impedance. Note that input capacitance testing cannot be done with 50Ω input impedance.
2. Use the MEASURE softkey to select “cap”.
3. With the output cable connected to the Calibrator but not connected to the oscilloscope, press the SET OFFSET softkey to cancel stray capacitances.
4. Connect the output cable to Channel 1 on the oscilloscope.
5. Press **OPR** to initiate the measurement.

8-48. Testing Overload Protection

Caution

This test checks the power handling capability of the 50Ω input of your oscilloscope. Before proceeding, ensure that the power rating of your oscilloscope can handle the voltages and currents that this test can output. Failing to do so could damage your oscilloscope.

Output @ SCOPE	UUTTRIP in 4.1s	T LIMIT 10s	OUT VAL DC	MODE overld
▲	▲	▲	▲	▲
			DC AC	volt edge levsine marker wavegen video pulse meas Z overld

You can press the MODE softkey to cycle through the functions in the order shown, or you can press **PREV MENU** to return directly to the OTHER modes menu.

Each option in the OVERLD menu is described below:

- **OUTPUT @ SCOPE** Indicates the location of the output signal.
- **UUTTRIP** Indicates test results. “NO” appears if the overload protection did not trip within the selected time limit. A value in seconds appears (e.g. “4.1s”) if the overload protection has tripped within the time limit.
- **T LIMIT** indicates the selected time limit for application of the output value. Press this softkey to key in or edit a different time limit (1s to 60s allowed.)
- **OUT VAL** Indicates the output voltage type. You can select DC or AC and a value ranging from 5 V to 9 V (shown in Output Display). Key in or edit this value.
- **MODE** Indicates you are in OVERLD (Overload) mode. Use the softkey to change modes and open menus for other oscilloscope calibration modes.

Default overload settings are + 5.000 V and DC.

At any time, you can also set the overload time limit with the following command sequence:

	INSTMT SETUP	OTHER SETUP	TLIMDEF	
<input type="checkbox"/> SETUP	<input type="checkbox"/> ▲	<input type="checkbox"/> ▲	<input type="checkbox"/> ▲	(Choose 1s to 60s.)

Perform the following procedure to test the overload protection of an oscilloscope:

1. Connect the calibrator to Channel 1 on the oscilloscope.
2. Select the voltage type (DC or AC) using the OUT VAL softkey.
3. Key in the voltage level. (The default value is 5 V.)
4. If necessary, change the duration. (Refer to the procedure described above.) The default duration is 10s.
5. Check for test results displayed with the UUTTRIP softkey.

8-49. Remote Commands and Queries

This section describes commands and queries that are used specifically for the SC600 Option. Each command description indicates whether it can be used with IEEE-488 and RS-232 remote interfaces and identifies it as a Sequential, Overlapped, or Coupled command.

IEEE-488 (GPIB) and RS-232 Applicability Each command and query has a check box indicating applicability to IEEE-488 (general purpose interface bus, or GPIB) and RS-232 remote operations.

Sequential Commands Commands executed immediately as they are encountered in the data stream are called sequential commands. For more information, see “Sequential Commands” in Chapter 5.

Overlapped Commands Commands SCOPE, TRIG, and OUT_IMP are designated as overlapped commands because they may be overlapped (interrupted) by the next command before they have completed execution. When an overlapped command is interrupted, it may take longer to execute while it waits for other commands to be completed. To prevent an overlapped command from being interrupted during execution, use *OPC, *OPC?, or *WAI. These commands prevent interruptions until they detect the command’s completion. For more information, see “Overlapped Commands” in Chapter 5.

Coupled Commands SCOPE and OUT_IMP are coupled commands because they can be coupled (combined) with other commands to form a compound command sequence. Care must be taken to ensure that commands are not coupled in a way that may cause them to disable each other, since this may result in a fault. For more information, see “Coupled Commands” in Chapter 5.

Table 8-15. SCOPE Command Parameters (cont.)

Parameter	Description/Example
VIDEO	Oscilloscope VIDEO mode. Programs 100% output (1 V p-p), line marker 10, format NTSC. FUNC? returns VIDEO.
	Examples: SCOPE VIDEO; OUT 90 (Video, 90% output) SCOPE VIDEO; OUT -70 (Video, -70% output, inverse video)
PULSE	Oscilloscope PULSE mode. Programs 100 ns pulse width, 1.000 μ s period, 2.5 V range. FUNC? returns PULSE.
	Example: SCOPE PULSE; OUT 50 ns, 500 ns; RANGE TP8DB (Pulse, 50 ns pulse width, 500 ns period, 1.5 V range)
MEASZ	Oscilloscope Impedance/Capacitance measurement (MEAS Z) mode. Programs 50 Ω range. FUNC? returns MEASZ.
	Example: SCOPE MEASZ; RANGE TZCAP (MEAS Z mode, capacitance range)
OVERLD	Oscilloscope Overload mode. Programs 5 V dc range. FUNC? returns OVERLD.
	Example: SCOPE OVERLD; OUT 7 V; RANGE TOLAC (Overload, 7 V output, ac range)

SCOPE?

(IEEE-488, RS-232, Sequential)

Returns the oscilloscope's current mode of operation. Returns OFF if the oscilloscope is off.

Parameter: (None)

Response: <character> (Returns OFF, VOLT, EDGE, LEVSINE, MARKER, WAVEGEN, VIDEO, PULSE, MEASZ, or OVERLD.)

TRIG

(IEEE-488, RS-232, Overlapped)

Programs the oscilloscope's trigger output BNC.

Parameters: OFF (Turns the trigger output off.)
 DIV1 (Turns the trigger output on. Frequency is the same as the signal at SCOPE output.)
 DIV10 (Turns the trigger output on. Frequency is 1/10 of the signal at SCOPE output.)
 DIV100 (Turns the trigger output on. Frequency is 1/100 of the signal at SCOPE output.)

Example: TRIG DIV10

TRIG?

(IEEE-488, RS-232, Sequential)

Returns the output setting of the oscilloscope's trigger.

Parameters: (None)

Response: <character> (Returns OFF, DIV1, DIV10, or DIV100.)

OUT_IMP

(IEEE-488, RS-232, Sequential)

Programs the oscilloscope's output impedance.

Parameters: Z50 (Programs the oscilloscope's output impedance to 50Ω.)

Z1M (Programs the oscilloscope's output impedance to 1 MΩ.)

Example: OUT_IMP Z50

OUT_IMP?

(IEEE-488, RS-232, Sequential)

Returns the impedance setting of the oscilloscope's output.

Parameters: (None)

RANGE

(IEEE-488, RS-232, Sequential)

Programs the instrument range in PULSE, MEAS Z, OVERLD modes.

Parameters:

Pulse	TP0DB	TP8DB	TP20DB	TP28DB	TP40DB	TP48DB
Range	2.5 V	1.0 V	250 mV	100 mV	25 mV	10 mV

Impedance Measure	TZ50OHM	TZ1MOHM	TZCAP
Range	res 50Ω	res 1MΩ	cap

Overload	TOLDC	TOLAC
Range	DC	AC

Example: RANGE TP20DB

8-51. Edge Function Commands

TDPULSE

(IEEE-488, RS-232, Sequential)

Turns tunnel diode pulse drive on/off in EDGE mode.

Parameters: ON (or non-zero) or OFF (or zero)

Example: TDPULSE ON

Returns the tunnel diode pulse drive setting in EDGE mode.

Parameters: None

Response: 1 if ON, 0 if OFF.

8-52. Marker Function Commands

TMWAVE

(IEEE-488, RS-232, Sequential)

Selects the waveform for MARKER mode.

Parameters: SINE Sine wave (2 ns to 15 ns)

SPIKE Triangular/sawtooth pulse (15 ns to 5s)

SQUARE Square wave (50% duty cycle) (4 ns to 5s)

SQ20PCT Square wave (20% duty cycle) (85 ns to 5s)

Example: TMWAVE SPIKE

TMWAVE?

(IEEE-488, RS-232, Sequential)

Returns the MARKER mode waveform setting.

Parameters: None

Response: <character> (Returns SINE, SPIKE, SQUARE, or SQ20PCT.)

8-53. Video Function Commands

VIDEOFMT

(IEEE-488, RS-232, Sequential)

Selects the format for VIDEO mode.

Parameters: NTSC, PAL, PALM (for PAL-M), or SECAM

Example: VIDEOFMT SECAM

VIDEOFMT?

(IEEE-488, RS-232, Sequential)

Returns the VIDEO mode format.

Parameters: None

Response: NTSC, PAL, PALM (for PAL-M), or SECAM

VIDEOMARK

(IEEE-488, RS-232, Sequential)

Programs the VIDEO mode line marker location.

Parameters: Line marker number.

Example: VIDEOMARK 10

VIDEOMARK?

(IEEE-488, RS-232, Sequential)

Returns the VIDEO mode line marker setting.

Parameters: None.

Response: <character> SINE, SPIKE, SQUARE or SQ20PCT

8-54. Overload Function Commands

OL_TRIP?

(IEEE-488, RS-232, Sequential)

Returns the detected state of scope overload protection.

Parameters: (None)

Response: Returns the number of seconds before protection was tripped. Returns 0 if protection has not been tripped or if OVERLD mode not active.

TLIMIT

(IEEE-488, RS-232, Sequential)

Sets the OPERATE time limit for the OVERLD mode signal. The Calibrator automatically returns to STANDBY if the UUT protection trips within this interval or at the end of this interval if the protection has not tripped.

Parameters: 1 to 60 (seconds)

Example: TLIMIT 30

TLIMIT?

(IEEE-488, RS-232, Sequential)

Returns the programmed OPERATE time limit for the OVERLD mode signal.

Response: <Integer> Time limit in seconds.

TLIMIT_D

(IEEE-488, RS-232, Sequential)

Sets the default OPERATE time limit for the OVERLD mode signal.

Parameters: 1 to 60 (seconds)

Example: TLIMIT_D 15

TLIMIT_D?

(IEEE-488, RS-232, Sequential)

Returns the default overload time limit.

Response: <Integer> Default time limit in seconds.

8-55. Impedance/Capacitance Function Commands

ZERO_MEAS

(IEEE-488, RS-232, Sequential)

Sets the measurement offset to the capacitance value.

Parameters: (boolean) ON or OFF.

***TRG**

(IEEE-488, RS-232, Sequential)

Triggers and returns a new impedance measurement value when used with the SC600 option in MEAS Z mode. (See Chapter 6 for *TRG use in all cases except MEAS Z mode with the SC600 option.)

Responses: <measurement value>, OHM (input impedance value in ohms)
<measurement value>, F (input capacitance value in farads)
<measurement value>, NONE (no measurement is available)

Example: *TRG returns 1.00E+03, OHM (1 k Ω input impedance).

Note

*You can also use the VAL? query to return an impedance measurement value with the SC600 option. VAL? returns the last measurement, whereas *TRG gets a new measurement. Responses are the same as shown above for the *TRG command. (See Chapter 6 for VAL? use with thermocouple measurements.)*

8-56. Verification Tables

The verification test points are provided here as a guide when verification to one-year specifications is desired.

8-57. DC Voltage Verification

Table 8-16. DC Voltage Verification

(1 M Ω output impedance unless noted)			
Nominal Value (V dc)	Measured Value (V dc)	Deviation (V dc)	1-Year Spec. (V dc)
0			0.00004
0.00125			0.000040625
-0.00125			0.000040625
0.00249			0.000041245
-0.00249			0.000041245
0.0025			0.00004125
-0.0025			0.00004125
0.00625			0.000043125
-0.00625			0.000043125
0.0099			0.00004495
-0.0099			0.00004495
0.01			0.000045
-0.01			0.000045
0.0175			0.00004875
-0.0175			0.00004875
0.0249			0.00005245
-0.0249			0.00005245
0.025			0.0000525
-0.025			0.0000525
0.0675			0.00007375
-0.0675			0.00007375
0.1099			0.00009495
-0.1099			0.00009495
0.11			0.000095
-0.11			0.000095
0.305			0.0001925
-0.305			0.0001925
0.499			0.0002895
-0.499			0.0002895
0.5			0.00029
-0.5			0.00029
1.35			0.000715
-1.35			0.000715
2.19			0.001135
-2.19			0.001135
2.2			0.00114
-2.2			0.00114
6.6			0.00334
-6.6			0.00334

Table 8-16. DC Voltage Verification (cont.)

Nominal Value (V dc)	Measured Value (V dc)	Deviation (V dc)	1-Year Spec. (V dc)
10.99			0.005535
-10.99			0.005535
11			0.00554
-11			0.00554
70.5			0.03529
-70.5			0.03529
130			0.06504
-130			0.06504
6.599 (50 Ω)			0.0165375

8-58. AC Voltage Amplitude Verification

Table 8-17. AC Voltage Amplitude Verification

(1 MΩ output impedance unless noted)				
Nominal Value (V p-p)	Frequency (Hz)	Measured Value (V p-p)	Deviation (V p-p)	1-year Spec. (V p-p)
0.001	1000			0.000041
-0.001	1000			0.000041
0.01	1000			0.00005
-0.01	1000			0.00005
0.025	1000			0.000065
-0.025	1000			0.000065
0.11	1000			0.00015
-0.11	1000			0.00015
0.5	1000			0.00054
-0.5	1000			0.00054
2.2	1000			0.00224
-2.2	1000			0.00224
11	1000			0.01104
-11	1000			0.01104
130	1000			0.13004
-130	1000			0.13004
6.599 (50 Ω)	1000			0.0165375

8-59. AC Voltage Frequency Verification

Table 8-18. AC Voltage Frequency Verification

(1 MΩ output impedance unless noted)				
Nominal Value (V p-p)	Frequency (Hz)	Measured Value (Hz)	Deviation (Hz)	1-year Spec. (Hz)
2.1	10			0.000025
2.1	100			0.00025
2.1	1000			0.0025
2.1	10000			0.025

8-60. Wave Generator Amplitude Verification: 1 M Ω Output Impedance**Table 8-19. Wave Generator Amplitude Verification (1 M Ω output impedance)**

Wave Shape	Nominal Value (V p-p)	Frequency (Hz)	Measured Value (V p-p)	Deviation (V p-p)	1-Year Spec. (V p-p)
square	0.0018	1000			0.000154
square	0.0119	1000			0.000457
square	0.0219	1000			0.000757
square	0.022	1000			0.00076
square	0.056	1000			0.00178
square	0.0899	1000			0.002797
square	0.09	1000			0.0028
square	0.155	1000			0.00475
square	0.219	1000			0.00667
square	0.22	1000			0.0067
square	0.56	1000			0.0169
square	0.899	1000			0.02707
square	0.9	1000			0.0271
square	3.75	1000			0.1126
square	6.59	1000			0.1978
square	6.6	1000			0.1981
square	30.8	1000			0.9241
square	55	10			1.6501
square	55	100			1.6501
square	55	1000			1.6501
square	55	10000			1.6501
sine	0.0018	1000			0.000154
sine	0.0219	1000			0.000757
sine	0.0899	1000			0.002797
sine	0.219	1000			0.00667
sine	0.899	1000			0.02707
sine	6.59	1000			0.1978
sine	55	1000			1.6501
triangle	0.0018	1000			0.000154
triangle	0.0219	1000			0.000757
triangle	0.0899	1000			0.002797
triangle	0.219	1000			0.00667
triangle	0.899	1000			0.02707
triangle	6.59	1000			0.1978
triangle	55	1000			1.6501

8-61. Wave Generator Amplitude Verification: 50 Ω Output Impedance

Table 8-20. Wave Generator Amplitude Verification (50 Ω output impedance)

Wave Shape	Nominal Value (V p-p)	Frequency (Hz)	Measured Value (V p-p)	Deviation (V p-p)	1-Year Spec. (V p-p)
square	0.0018	1000			0.000154
square	0.0064	1000			0.000292
square	0.0109	1000			0.000427
square	0.011	1000			0.00043
square	0.028	1000			0.00094
square	0.0449	1000			0.001447
square	0.045	1000			0.00145
square	0.078	1000			0.00244
square	0.109	1000			0.00337
square	0.11	1000			0.0034
square	0.28	1000			0.0085
square	0.449	1000			0.01357
square	0.45	1000			0.0136
square	0.78	1000			0.0235
square	1.09	1000			0.0328
square	1.1	1000			0.0331
square	1.8	1000			0.0541
square	2.5	10			0.0751
square	2.5	100			0.0751
square	2.5	1000			0.0751
square	2.5	10000			0.0751
sine	0.0018	1000			0.000154
sine	0.0109	1000			0.000427
sine	0.0449	1000			0.001447
sine	0.109	1000			0.00337
sine	0.449	1000			0.01357
sine	1.09	1000			0.0328
sine	2.5	1000			0.0751
triangle	0.0018	1000			0.000154
triangle	0.0109	1000			0.000427
triangle	0.0449	1000			0.001447
triangle	0.109	1000			0.00337
triangle	0.449	1000			0.01357
triangle	1.09	1000			0.0328
triangle	2.5	1000			0.0751

8-62. Leveled Sine Wave Verification: Amplitude

Table 8-21. Leveled Sine Wave Verification: Amplitude

Nominal Value (V p-p)	Frequency	Measured Value (V p-p)	Deviation (V p-p)	1-Year Spec. (V p-p)
0.005	50 kHz			0.0004
0.0075	50 kHz			0.00045
0.0099	50 kHz			0.000498
0.01	50 kHz			0.0005
0.025	50 kHz			0.0008
0.039	50 kHz			0.00108
0.04	50 kHz			0.0011
0.07	50 kHz			0.0017
0.099	50 kHz			0.00228
0.1	50 kHz			0.0023
0.25	50 kHz			0.0053
0.399	50 kHz			0.00828
0.4	50 kHz			0.0083
0.8	50 kHz			0.0163
1.2	50 kHz			0.0243
1.3	50 kHz			0.0263
3.4	50 kHz			0.0683
5.5	50 kHz			0.1103

8-63. Leveled Sine Wave Verification: Frequency

Table 8-22. Leveled Sine Wave Verification: Frequency

Nominal Value (V p-p)	Frequency	Measured Value (Hz)	Deviation (Hz)	1-Year Spec. (Hz)
5.5	50 kHz			0.125
5.5	500 kHz			1.25
5.5	5 MHz			12.5
5.5	50 MHz			125
5.5	500 MHz			1250

8-64. Leveled Sine Wave Verification: Harmonics

Table 8-23. Leveled Sine Wave Verification: Harmonics

Harmonic	Nominal Value (V p-p)	Frequency	Measured Value (dB)	Deviation (dB)	1-Year Spec. (dB)
2nd harmonic	0.0399	50 kHz			-33
3rd+ harmonic	0.0399	50 kHz			-38
2nd harmonic	0.099	50 kHz			-33
3rd+ harmonic	0.099	50 kHz			-38
2nd harmonic	0.399	50 kHz			-33
3rd+ harmonic	0.399	50 kHz			-38
2nd harmonic	1.2	50 kHz			-33
3rd+ harmonic	1.2	50 kHz			-38
2nd harmonic	5.5	50 kHz			-33
3rd+ harmonic	5.5	50 kHz			-38
2nd harmonic	5.5	100 kHz			-33
3rd+ harmonic	5.5	100 kHz			-38
2nd harmonic	5.5	200 kHz			-33
3rd+ harmonic	5.5	200 kHz			-38
2nd harmonic	5.5	400 kHz			-33
3rd+ harmonic	5.5	400 kHz			-38
2nd harmonic	5.5	800 kHz			-33
3rd+ harmonic	5.5	800 kHz			-38
2nd harmonic	5.5	1 MHz			-33
3rd+ harmonic	5.5	1 MHz			-38
2nd harmonic	5.5	2 MHz			-33
3rd+ harmonic	5.5	2 MHz			-38
2nd harmonic	5.5	4 MHz			-33
3rd+ harmonic	5.5	4 MHz			-38
2nd harmonic	5.5	8 MHz			-33
3rd+ harmonic	5.5	8 MHz			-38
2nd harmonic	5.5	10 MHz			-33
3rd+ harmonic	5.5	10 MHz			-38
2nd harmonic	5.5	20 MHz			-33
3rd+ harmonic	5.5	20 MHz			-38
2nd harmonic	5.5	40 MHz			-33
3rd+ harmonic	5.5	40 MHz			-38
2nd harmonic	5.5	80 MHz			-33
3rd+ harmonic	5.5	80 MHz			-38
2nd harmonic	5.5	100 MHz			-33
3rd+ harmonic	5.5	100 MHz			-38
2nd harmonic	5.5	200 MHz			-33
3rd+ harmonic	5.5	200 MHz			-38
2nd harmonic	5.5	400 MHz			-33
3rd+ harmonic	5.5	400 MHz			-38
2nd harmonic	5.5	600 MHz			-33
3rd+ harmonic	5.5	600 MHz			-38

8-65. Leveled Sine Wave Verification: Flatness

Table 8-24. Leveled Sine Wave Verification: Flatness

Nominal Value (V p-p)	Frequency	Measured Value (V p-p)	Deviation (V p-p)	1-Year Spec. (V p-p)
0.005	50 kHz		na	na
0.005	30 MHz			0.000175
0.005	70 MHz			0.000175
0.005	120 MHz			0.0002
0.005	290 MHz			0.0002
0.005	360 MHz			0.0003
0.005	390 MHz			0.0003
0.005	400 MHz			0.0003
0.005	480 MHz			0.0003
0.005	570 MHz			0.0003
0.005	580 MHz			0.0003
0.005	590 MHz			0.0003
0.005	600 MHz			0.0003
0.0075	50 kHz		na	na
0.0075	30 MHz			0.0002125
0.0075	70 MHz			0.0002125
0.0075	120 MHz			0.00025
0.0075	290 MHz			0.00025
0.0075	360 MHz			0.0004
0.0075	390 MHz			0.0004
0.0075	400 MHz			0.0004
0.0075	480 MHz			0.0004
0.0075	570 MHz			0.0004
0.0075	580 MHz			0.0004
0.0075	590 MHz			0.0004
0.0075	600 MHz			0.0004
0.0099	50 kHz		na	na
0.0099	30 MHz			0.0002485
0.0099	70 MHz			0.0002485
0.0099	120 MHz			0.000298
0.0099	290 MHz			0.000298
0.0099	360 MHz			0.000496
0.0099	390 MHz			0.000496
0.0099	400 MHz			0.000496
0.0099	480 MHz			0.000496
0.0099	570 MHz			0.000496
0.0099	580 MHz			0.000496
0.0099	590 MHz			0.000496
0.0099	600 MHz			0.000496

Table 8-24. Leveled Sine Wave Verification: Flatness (cont.)

Nominal Value (V p-p)	Frequency	Measured Value (V p-p)	Deviation (V p-p)	1-Year Spec. (V p-p)
0.01	50 kHz		na	na
0.01	30 MHz			0.00025
0.01	70 MHz			0.00025
0.01	120 MHz			0.0003
0.01	290 MHz			0.0003
0.01	360 MHz			0.0005
0.01	390 MHz			0.0005
0.01	400 MHz			0.0005
0.01	480 MHz			0.0005
0.01	570 MHz			0.0005
0.01	580 MHz			0.0005
0.01	590 MHz			0.0005
0.01	600 MHz			0.0005
0.025	50 kHz		na	na
0.025	30 MHz			0.000475
0.025	70 MHz			0.000475
0.025	120 MHz			0.0006
0.025	290 MHz			0.0006
0.025	360 MHz			0.0011
0.025	390 MHz			0.0011
0.025	400 MHz			0.0011
0.025	480 MHz			0.0011
0.025	570 MHz			0.0011
0.025	580 MHz			0.0011
0.025	590 MHz			0.0011
0.025	600 MHz			0.0011
0.039	50 kHz		na	na
0.039	30 MHz			0.000685
0.039	70 MHz			0.000685
0.039	120 MHz			0.00088
0.039	290 MHz			0.00088
0.039	360 MHz			0.00166
0.039	390 MHz			0.00166
0.039	400 MHz			0.00166
0.039	480 MHz			0.00166
0.039	570 MHz			0.00166
0.039	580 MHz			0.00166
0.039	590 MHz			0.00166
0.039	600 MHz			0.00166
0.04	50 kHz		na	na
0.04	30 MHz			0.0007

Table 8-24. Leveled Sine Wave Verification: Flatness (cont.)

Nominal Value (V p-p)	Frequency	Measured Value (V p-p)	Deviation (V p-p)	1-Year Spec. (V p-p)
0.04	70 MHz			0.0007
0.04	120 MHz			0.0009
0.04	290 MHz			0.0009
0.04	360 MHz			0.0017
0.04	390 MHz			0.0017
0.04	400 MHz			0.0017
0.04	480 MHz			0.0017
0.04	570 MHz			0.0017
0.04	580 MHz			0.0017
0.04	590 MHz			0.0017
0.04	600 MHz			0.0017
0.07	50 kHz		na	na
0.07	30 MHz			0.00115
0.07	70 MHz			0.00115
0.07	120 MHz			0.0015
0.07	290 MHz			0.0015
0.07	360 MHz			0.0029
0.07	390 MHz			0.0029
0.07	400 MHz			0.0029
0.07	480 MHz			0.0029
0.07	570 MHz			0.0029
0.07	580 MHz			0.0029
0.07	590 MHz			0.0029
0.07	600 MHz			0.0029
0.099	50 kHz		na	na
0.099	30 MHz			0.001585
0.099	70 MHz			0.001585
0.099	120 MHz			0.00208
0.099	290 MHz			0.00208
0.099	360 MHz			0.00406
0.099	390 MHz			0.00406
0.099	400 MHz			0.00406
0.099	480 MHz			0.00406
0.099	570 MHz			0.00406
0.099	580 MHz			0.00406
0.099	590 MHz			0.00406
0.099	600 MHz			0.00406
0.1	50 kHz		na	na
0.1	30 MHz			0.0016
0.1	70 MHz			0.0016
0.1	120 MHz			0.0021

Table 8-24. Leveled Sine Wave Verification: Flatness (cont.)

Nominal Value (V p-p)	Frequency	Measured Value (V p-p)	Deviation (V p-p)	1-Year Spec. (V p-p)
0.1	290 MHz			0.0021
0.1	360 MHz			0.0041
0.1	390 MHz			0.0041
0.1	400 MHz			0.0041
0.1	480 MHz			0.0041
0.1	570 MHz			0.0041
0.1	580 MHz			0.0041
0.1	590 MHz			0.0041
0.1	600 MHz			0.0041
0.25	50 kHz		na	na
0.25	30 MHz			0.00385
0.25	70 MHz			0.00385
0.25	120 MHz			0.0051
0.25	290 MHz			0.0051
0.25	360 MHz			0.0101
0.25	390 MHz			0.0101
0.25	400 MHz			0.0101
0.25	480 MHz			0.0101
0.25	570 MHz			0.0101
0.25	580 MHz			0.0101
0.25	590 MHz			0.0101
0.25	600 MHz			0.0101
0.399	50 kHz		na	na
0.399	30 MHz			0.006085
0.399	70 MHz			0.006085
0.399	120 MHz			0.00808
0.399	290 MHz			0.00808
0.399	360 MHz			0.01606
0.399	390 MHz			0.01606
0.399	400 MHz			0.01606
0.399	480 MHz			0.01606
0.399	570 MHz			0.01606
0.399	580 MHz			0.01606
0.399	590 MHz			0.01606
0.399	600 MHz			0.01606
0.4	50 kHz		na	na
0.4	30 MHz			0.0061
0.4	70 MHz			0.0061
0.4	120 MHz			0.0081
0.4	290 MHz			0.0081
0.4	360 MHz			0.0161

Table 8-24. Leveled Sine Wave Verification: Flatness (cont.)

Nominal Value (V p-p)	Frequency	Measured Value (V p-p)	Deviation (V p-p)	1-Year Spec. (V p-p)
0.4	390 MHz			0.0161
0.4	400 MHz			0.0161
0.4	480 MHz			0.0161
0.4	570 MHz			0.0161
0.4	580 MHz			0.0161
0.4	590 MHz			0.0161
0.4	600 MHz			0.0161
0.8	50 kHz		na	na
0.8	30 MHz			0.0121
0.8	70 MHz			0.0121
0.8	120 MHz			0.0161
0.8	290 MHz			0.0161
0.8	360 MHz			0.0321
0.8	390 MHz			0.0321
0.8	400 MHz			0.0321
0.8	480 MHz			0.0321
0.8	570 MHz			0.0321
0.8	580 MHz			0.0321
0.8	590 MHz			0.0321
0.8	600 MHz			0.0321
1.2	50 kHz		na	na
1.2	30 MHz			0.0181
1.2	70 MHz			0.0181
1.2	120 MHz			0.0241
1.2	290 MHz			0.0241
1.2	360 MHz			0.0481
1.2	390 MHz			0.0481
1.2	400 MHz			0.0481
1.2	480 MHz			0.0481
1.2	570 MHz			0.0481
1.2	580 MHz			0.0481
1.2	590 MHz			0.0481
1.2	600 MHz			0.0481
1.3	50 kHz		na	na
1.3	30 MHz			0.0196
1.3	70 MHz			0.0196
1.3	120 MHz			0.0261
1.3	290 MHz			0.0261
1.3	360 MHz			0.0521
1.3	390 MHz			0.0521
1.3	400 MHz			0.0521

Table 8-24. Leveled Sine Wave Verification: Flatness (cont.)

Nominal Value (V p-p)	Frequency	Measured Value (V p-p)	Deviation (V p-p)	1-Year Spec. (V p-p)
1.3	480 MHz			0.0521
1.3	570 MHz			0.0521
1.3	580 MHz			0.0521
1.3	590 MHz			0.0521
1.3	600 MHz			0.0521
3.4	50 kHz		na	na
3.4	30 MHz			0.0511
3.4	70 MHz			0.0511
3.4	120 MHz			0.0681
3.4	290 MHz			0.0681
3.4	360 MHz			0.1361
3.4	390 MHz			0.1361
3.4	400 MHz			0.1361
3.4	480 MHz			0.1361
3.4	570 MHz			0.1361
3.4	580 MHz			0.1361
3.4	590 MHz			0.1361
3.4	600 MHz			0.1361
5.5	50 kHz		na	na
5.5	30 MHz			0.0826
5.5	70 MHz			0.0826
5.5	120 MHz			0.1101
5.5	290 MHz			0.1101
5.5	360 MHz			0.2201
5.5	390 MHz			0.2201
5.5	400 MHz			0.2201
5.5	480 MHz			0.2201
5.5	570 MHz			0.2201
5.5	580 MHz			0.2201
5.5	590 MHz			0.2201
5.5	600 MHz			0.2201

8-66. Edge Verification: Amplitude

Table 8-25. Edge Verification: Amplitude

Nominal Value (V p-p)	Frequency (Hz)	Measured Value (V p-p)	Deviation (V p-p)	1-Year Spec. (V p-p)
0.005	1 kHz			0.0003
0.005	10 kHz			0.0003
0.005	100 kHz			0.0003
0.01	100 kHz			0.0004
0.025	100 kHz			0.0007
0.05	100 kHz			0.0012
0.1	100 kHz			0.0022
0.25	100 kHz			0.0052
0.5	100 kHz			0.0102
1	100 kHz			0.0202
2.5	100 kHz			0.0502
2.5	10 kHz			0.0502
2.5	1 kHz			0.0502

8-67. Edge Verification: Frequency

Table 8-26. Edge Verification: Frequency

Nominal Value (V p-p)	Frequency	Measured Value (Hz)	Deviation (Hz)	1-Year Spec. (Hz)
2.5	1 kHz			0.0025
2.5	10 kHz			0.025
2.5	100 kHz			0.25
2.5	1 MHz			2.5
2.5	10 MHz			25

8-68. Edge Verification: Duty Cycle

Table 8-27. Edge Verification: Duty Cycle

Nominal Value (V p-p)	Frequency	Measured Value (%)	Deviation (from 50%)	1-Year Spec. (%)
2.5	1 MHz			5

8-69. Edge Verification: Rise Time

Table 8-28. Edge Verification: Rise Time

Nominal Value (V p-p)	Frequency	Measured Value (s)	Deviation (ns)	1-Year Spec. (ns)
0.25	1 kHz			0.3 ns
0.25	100 kHz			0.3 ns
0.25	10 MHz			0.3 ns
0.5	1 kHz			0.3 ns
0.5	100 kHz			0.3 ns
0.5	10 MHz			0.3 ns
1	1 kHz			0.3 ns
1	100 kHz			0.3 ns
1	10 MHz			0.3 ns
2.5	1 kHz			0.3 ns
2.5	100 kHz			0.3 ns
2.5	10 MHz			0.3 ns

8-70. Tunnel Diode Pulser Verification

Table 8-29. Tunnel Diode Pulser Verification

Nominal Value (V p-p)	Frequency (Hz)	Measured Value (V p-p)	Deviation (V p-p)	1-Year Spec. (V p-p)
11	100			0.2202
11	10000			0.2202
55	100			1.1002
55	10000			1.1002
100	100			2.0002
100	10000			2.0002

8-71. Marker Generator Verification

Table 8-30. Marker Generator Verification

Period (s)	Measured Value (s)	Deviation (s)	1-Year Spec. (s)
5			0.0251 s
2			0.00405 s
0.05			3.75E-06 s
0.02			5E-8
0.01			2.5E-8
1e-7			2.5E-13
5e-8			1.25E-13
2e-8			5E-14
1e-8			2.5E-14
5e-9			1.25E-14
2e-9			5E-15

8-72. Pulse Generator Verification: Period

Table 8-31. Pulse Generator Verification: Period

Nominal Value (V p-p)	Pulse Width (s)	Period (s)	Measured Value (s)	Deviation (s)	1-Year Spec. (s)
2.5	8E-08	2E-06			5E-12
2.5	0.0000005	0.01			2.5E-08
2.5	0.0000005	0.02			5E-08

8-73. Pulse Generator Verification: Pulse Width

Table 8-32. Pulse Generator Verification: Pulse Width

Nominal Value (V p-p)	Pulse Width (s)	Period (s)	Measured Value (s)	Deviation (s)	1-Year Spec. typical (s)
2.5	4.0E-09	2.0E-06			6.2E-9
2.5	4.0E-09	2.0E-05			6.2E-9
2.5	4.0E-09	2.0E-04			6.2E-9
2.5	4.0E-08	2.0E-03			4.4E-8

8-74. Input Impedance Verification: Resistance

Table 8-33. Input Impedance Verification: Resistance

Nominal Value (Ω)	Measured Value (Ω)	Deviation (Ω)	1-Year Spec. (Ω)
40			0.04
50			0.05
60			0.06
600000			600
1000000			1000
1500000			1500

8-75. Input Impedance Verification: Capacitance

Table 8-34. Input Impedance Verification: Capacitance

Nominal Value (pF)	Measured Value (pF)	Deviation (pF)	1-Year Spec. (pF)
5 pF			0.75 pF
29 pF			1.95 pF
49 pF			2.95 pF

5520A-SC300 Option

Contents		Page
8-76.	Introduction.....	8-59
8-77.	Oscilloscope Calibration Option Specifications.....	8-60
8-78.	Volt Function Specifications.....	8-60
8-79.	Edge Function Specifications.....	8-61
8-80.	Leveled Sine Wave Function Specifications.....	8-62
8-81.	Time Marker Function Specifications.....	8-63
8-82.	Wave Generator Specifications.....	8-63
8-83.	Trigger Signal Specifications for the Time Marker Function.....	8-64
8-84.	Trigger Signal Specifications for the Edge Function.....	8-64
8-85.	Oscilloscope Connections.....	8-65
8-86.	Starting the Oscilloscope Calibration Option.....	8-66
8-87.	The Output Signal.....	8-66
8-88.	Adjusting the Output Signal.....	8-67
8-89.	Keying in a Value.....	8-67
8-90.	Adjusting Values with the Rotary Knob.....	8-67
8-91.	Using $\boxed{\text{MULT}}$ and $\boxed{\text{DIV}}$	8-68
8-92.	Resetting the Oscilloscope Option.....	8-68
8-93.	Calibrating the Voltage Amplitude on an Oscilloscope.....	8-69
8-94.	The Volt Function.....	8-69
8-95.	The V/DIV Menu.....	8-70
8-96.	Shortcuts for Setting the Voltage Amplitude.....	8-70
8-97.	Amplitude Calibration Procedure for an Oscilloscope.....	8-71
8-98.	Calibrating the Pulse and Frequency Response on an Oscilloscope....	8-72
8-99.	The Edge Function.....	8-72
8-100.	Pulse Response Calibration Procedure for an Oscilloscope.....	8-73
8-101.	The Leveled Sine Wave Function.....	8-74
8-102.	Shortcuts for Setting the Frequency and Voltage.....	8-74
8-103.	The MORE OPTIONS Menu.....	8-75
8-104.	Sweeping through a Frequency Range.....	8-77
8-105.	Frequency Response Calibration Procedure for an Oscilloscope....	8-78
8-106.	Calibrating the Time Base of an Oscilloscope.....	8-80
8-107.	The Time Marker Function.....	8-80
8-108.	Time Base Marker Calibration Procedure for an Oscilloscope.....	8-81
8-109.	Testing the Trigger.....	8-82
8-110.	Summary of Commands and Queries.....	8-83

8-111.	Verification Tables	8-86
8-112.	Voltage Function Verification: AC Voltage into a 1 M Ω Load	8-86
8-113.	Voltage Function Verification: AC Voltage into a 50 Ω Load	8-87
8-114.	Voltage Function Verification: DC Voltage into a 50 Ω Load	8-88
8-115.	Voltage Function Verification: DC Voltage into a 1 M Ω Load	8-89
8-116.	Edge Function Verification	8-90
8-117.	Wave Generator Function Verification: 1 M Ω Load	8-90
8-118.	Wave Generator Function Verification: 50 Ω Load	8-91
8-119.	Leveled Sine Wave Function Verification: Amplitude	8-91
8-120.	Leveled Sine Wave Function Verification: Flatness	8-92
8-121.	Leveled Sine Wave Function Verification: Frequency	8-95
8-122.	Marker Generator Function Verification	8-96

8-76. Introduction

The Oscilloscope Calibration Option provides functions that help you maintain your oscilloscope's accuracy by verifying the following oscilloscope characteristics:

- Vertical deflection characteristics are verified by calibrating the voltage gain. The Volt function lets you compare the voltage gain to the graticule lines on the oscilloscope.
- Pulse response is checked using the Edge function, by verifying the accuracy of the oscilloscope's measurement of pulse transitions.
- Frequency response is checked by verifying the bandwidth using the Leveled Sine Wave function. A leveled sine wave is monitored until the -3 dB point is observed on the oscilloscope.
- Horizontal deflection characteristics are verified by calibrating the time base using the Time Marker function. This calibration procedure is similar to the one for verifying the vertical deflection characteristics, except that it checks the horizontal axis.
- The oscilloscope's ability to trigger on different waveforms is checked using the Wave Generator function.

The menus that implement these functions also include parameters for altering the way the output signal responds to voltage, frequency, and time settings, giving you control of the signal during calibration, and providing more methods for observing the signal's characteristics.

8-77. Oscilloscope Calibration Option Specifications

These specifications apply only to the Oscilloscope Calibration Option. General specifications that apply to the 5520A Calibrator can be found in Chapter 1. The specifications are valid providing the 5520A is operated under the conditions specified in Chapter 1, and has completed a warm-up period of at least twice the length of time the calibrator was powered off, up to a maximum of 30 minutes.

8-78. Volt Function Specifications

Volt Function	dc Signal		Square Wave Signal	
	into 50 Ω	into 1 M Ω	into 50 Ω	into 1 M Ω
Amplitude Characteristics				
Range	0 V to ± 2.2 V	0 V to ± 33 V	1.8 mV to 2.2 V p-p	1.8 mV to 105 V p-p [1]
Resolution	<100 V: 4 digits or 10 μ V, whichever is greater ≥ 100 V: 5 digits			
Adjustment Range	Continuous [1]			
1-Year Absolute Uncertainty, tcal $\pm 5^\circ\text{C}$	$\pm (0.25\%$ of output + 100 μ V) [2] [3]			
Sequence	1-2-5 (e.g., 10 mV, 20 mV, 50 mV)			
Square Wave Frequency Characteristics				
Range	10 Hz to 10 kHz			
1-Year Absolute Uncertainty, tcal $\pm 5^\circ\text{C}$	$\pm (25$ ppm of setting + 15 mHz)			
Typical Aberration within 20 μ s from leading edge	< (2% of output + 100 μ V)			
<p>[1] The square wave signal into 1 MΩ is a positive square wave from 1.8 mV to 55 V p-p. From 95 V to 105 V, its output is a square wave-like signal that alternates between the negative peak and the positive peak, with the centerline at -10 V. Signals between 55 V and 95 V p-p are not available.</p> <p>[2] The uncertainty for 50 Ω loads does not include the input impedance uncertainty of the oscilloscope. Square wave signals below 4.5 mV p-p have an uncertainty of $\pm (0.25\%$ of output + 200 μV).</p> <p>[3] Signals from 95 to 105 V p-p have an uncertainty of 0.5% of output in the frequency range 100 Hz to 1 kHz. Typical uncertainty is 1.5% of output for 95 V to 105 V p-p signals in the frequency range 10 Hz to 100 Hz, and 0.5% of output in the frequency range 1 kHz to 10 kHz.</p>				

8-79. Edge Function Specifications

Edge Characteristics into 50 Ω		1-Year Absolute Uncertainty, $t_{cal} \pm 5^{\circ}\text{C}$
Amplitude		
Range (p-p)	4.5 mV to 2.75 V	\pm (2% of output + 200 μV)
Resolution	4 digits	
Adjustment Range	$\pm 10\%$ around each sequence value (indicated below)	
Sequence	5 mV, 10 mV, 25 mV, 50 mV, 100 mV, 250 mV, 500 mV, 1 V, 2.5 V	
Other Edge Characteristics		
Frequency Range	1 kHz to 1 MHz	\pm (25 ppm of setting + 15 mHz)
Rise Time	< 400 ps	
Leading Edge Aberrations	within 10 ns	< (3% of output + 2 mV)
	10 to 30 ns	< (1% of output + 2 mV)
	after 30 ns	< (0.5% of output + 2 mV)
Typical Duty Cycle	45% to 55%	

8-80. Leveled Sine Wave Function Specifications

Leveled Sine Wave	Frequency Range		
Characteristics into 50 Ω	50 kHz Reference	50 kHz to 100 MHz	100 to 300 MHz [1]
Amplitude Characteristics			
Range (p-p)	5 mV to 5.5 V [1]		
Resolution	< 100 mV: 3 digits ≥ 100 mV: 4 digits		
Adjustment Range	continuously adjustable		
1-Year Absolute Uncertainty, tcal ± 5 °C	± (2% of output + 200 μ V)	± (3.5% of output + 300 μ V)	± (4% of output + 300 μ V)
Flatness (relative to 50 kHz)	not applicable	± (1.5% of output + 100 μ V)	± (2.0% of output + 100 μ V)
Short-term Stability	≤ 1% [2]		
Frequency Characteristics			
Resolution	10 Hz	10 kHz [3]	10 kHz
1-Year Absolute Uncertainty, tcal ± 5 °C	± (25 ppm + 15 mHz)	± 25 ppm [4]	± 25 ppm
Distortion Characteristics			
2nd Harmonic	≤ -35 dBc		
3rd and Higher Harmonics	≤ -40 dBc		
<p>[1] Extended frequency range to 350 MHz is provided, but flatness is not specified. Amplitude is limited to 3 V for frequencies above 250 MHz.</p> <p>[2] Within one hour after reference amplitude setting, provided temperature varies no more than ± 5°C.</p> <p>[3] At frequencies below 120 kHz, the resolution is 10 Hz. For frequencies between 120 kHz and 999.9 kHz, the resolution is 100 Hz.</p> <p>[4] ± (25 ppm + 15 mHz) for frequencies of 1 MHz and below.</p>			

8-81. Time Marker Function Specifications

Time Marker into 50 Ω	5 s to 100 μs	50 μs to 2 μs	1 μs to 20 ns	10 ns to 2 ns
1-Year Absolute Uncertainty, tcal ± 5°C	± (25 + t *1000) ppm [1]	± (25 + t *15,000) ppm [1]	± 25 ppm	± 25 ppm
Wave Shape	pulsed sawtooth	pulsed sawtooth	pulsed sawtooth	sine
Typical Output Level	> 1 V pk	> 1 V pk	> 1 V pk	> 2 V p-p [2]
Sequence	5-2-1 from 5 s to 2 ns (e.g., 500 ms, 200 ms, 100 ms)			
Adjustment Range	At least ± 10% around each sequence value indicated above.			
Resolution	4 digits			
[1] t is the time in seconds.				
[2] The 2 ns time marker is typically > 0.5 V p-p.				

8-82. Wave Generator Specifications

Wave Generator Characteristics	Square Wave, Sine Wave, and Triangle Wave into 50 Ω or 1 MΩ
Amplitude	
Range	into 1 MΩ: 1.8 mV to 55 V p-p into 50 Ω: 1.8 mV to 2.2 V p-p
1-Year Absolute Uncertainty, tcal ± 5 °C, 10 Hz to 10 kHz	± (3% of p-p output + 100 μV)
Sequence	1-2-5 (e.g., 10 mV, 20 mV, 50 mV)
Typical dc Offset Range	0 to ± (≥40% of p-p amplitude) [1]
Frequency	
Range	10 Hz to 100 kHz
Resolution	4 or 5 digits depending upon frequency
1-Year Absolute Uncertainty, tcal ± 5°C	± (25 ppm + 15 mHz)
[1] The DC offset plus the wave signal must not exceed 30 V rms.	

8-83. Trigger Signal Specifications for the Time Marker Function

Time Marker Period	Division Ratio [1]	Amplitude into 50 Ω (p-p)	Typical Rise Time
5 to 1s	off/1	≥ 1 V	≤ 2 ns
0.5 to 0.1s	off/1/10	≥ 1 V	≤ 2 ns
50 ms to 100 ns	off/1/10/100	≥ 1 V	≤ 2 ns
50 to 10 ns	off/10/100	≥ 1 V	≤ 2 ns
5 to 2 ns	off/100	≥ 1 V	≤ 2 ns
[1] Divider is internally limited to prevent trigger output from frequencies that are either lower than 0.2 Hz (5s period) or higher than 10 MHz.			

8-84. Trigger Signal Specifications for the Edge Function

Edge Signal Frequency	Division Ratio	Amplitude into 50 Ω (p-p)	Typical Rise Time
1 kHz to 1 MHz	off/1	≥ 1 V	≤ 2 ns

8-85. Oscilloscope Connections

Using the cable supplied with the Oscilloscope Calibration Option, attach the SCOPE connector on the 5520A to one of the channel connectors on your oscilloscope (see Figure 8-3).

To use the external trigger, attach the TRIG OUT connector on the 5520A to the external trigger connection on your oscilloscope. To use the external trigger and view its signal with the calibration signal, attach the TRIG OUT connector to another channel. See your oscilloscope manual for details on connecting and viewing an external trigger.

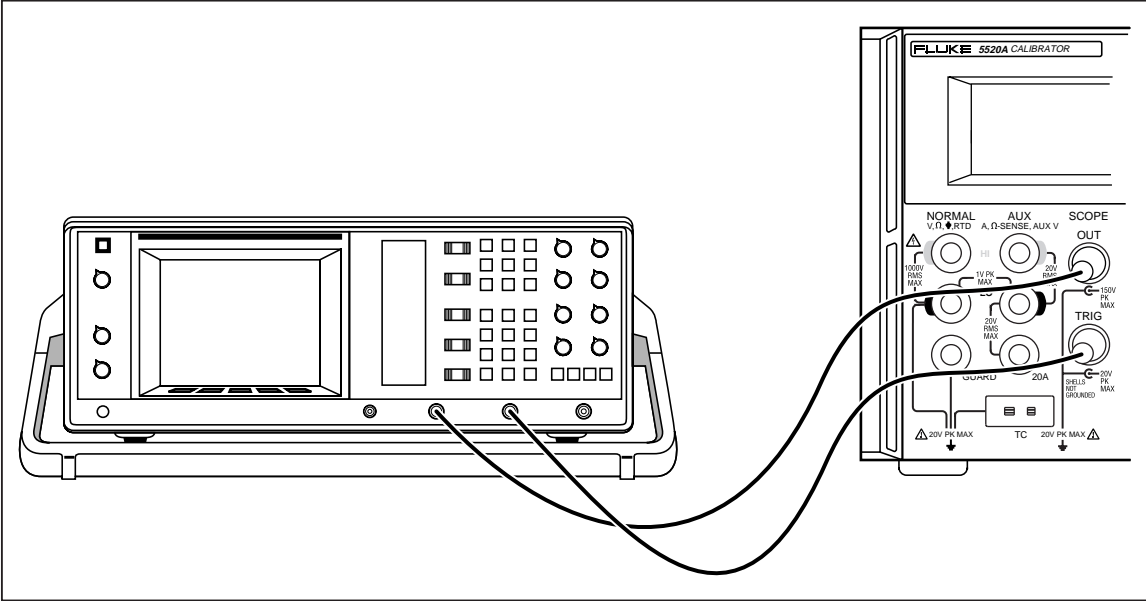
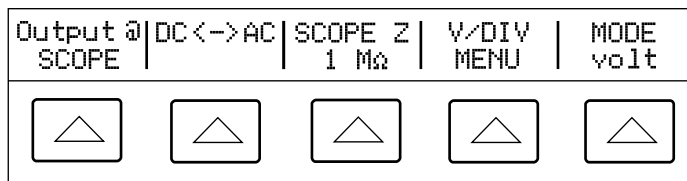

Figure 8-3. Oscilloscope Connection: Channel and External Trigger

nn230f.eps

8-86. Starting the Oscilloscope Calibration Option

Press **SCOPE** to start the Oscilloscope Calibration Option. The Control Display opens the Volt menu, shown below, which contains options for calibrating the vertical gain on your oscilloscope. This is the first of five calibration menus, which you can scroll through by pressing the softkey under MODE. Each menu is described in detail in this chapter.



g1021i.eps

8-87. The Output Signal

The location of the output signal is indicated on the Control Display (the display on the right side). If your 5520A is connected, but the output does not appear on the oscilloscope, you may have the 5520A in standby mode.

The settings for the output signal are indicated in the Output Display (the display on the left side). The following example shows the default settings for Volt mode, which are set when you start the Oscilloscope Calibration Option.

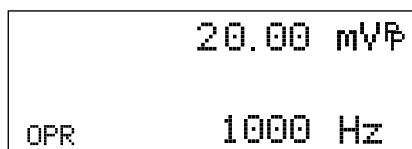

g1022i.eps

If STBY is displayed, press the **OPR** key. The Output Display will show OPR and the output should appear on the oscilloscope.

8-88. Adjusting the Output Signal

The 5520A provides several ways to change the settings for the output signal during calibration. Since oscilloscope calibration requires many adjustments of the output signal, the three available methods for changing these settings for oscilloscope calibration are summarized below. These methods provide the means of jumping to a new value or sweeping through a range of values.

8-89. Keying in a Value

To key a specific value directly into the 5520A from its front panel:

1. Key in the value you want to enter, including the units and prefixes. For example to enter 120 mV press **1** **2** **0** **μ m** **dBm V**. The Control Display will show:

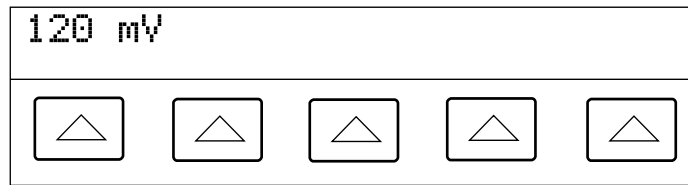

gl002i.eps

Note

Units and prefixes printed in purple in the upper left corner of the keys are accessed through the **SHIFT** key. For example, to enter 200 μ s, press **2** **0** **0** **SHIFT μ m** **SHIFT SEC Hz**.

If you make an error, press **CE** to clear the Control Display and return to the menu.

2. Press **ENTER** to activate the value and move it to the Output Display.

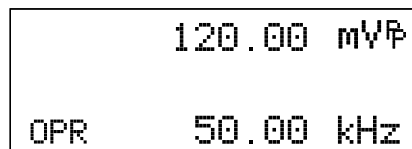

gl003i.eps

Other settings in the display will remain unaltered unless you key in an entry and specify the units for that setting.

8-90. Adjusting Values with the Rotary Knob

To adjust values in the Output Display using the rotary knob:

1. Turn the rotary knob. A cursor appears in the output display under the lowest digit and begins changing that digit. If you wish to place the cursor in the field without changing the digit, press **EDIT FIELD**.

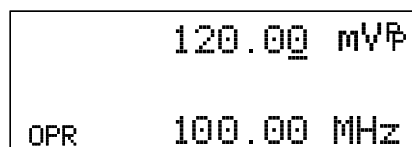

gl003i.eps

- To move the cursor between the voltage and frequency fields, press **EDIT FIELD**.

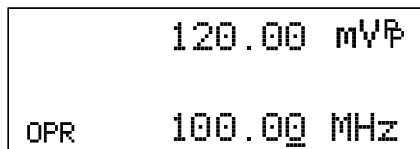

g1004i.eps

- Use the **◀** and **▶** keys to move the cursor to the digit you want to change.
- Turn the rotary knob to change the value.

When you use the rotary knob in either Volt mode or Marker mode, the Control Display shows the new value's percentage change from the reference value. This is useful for determining the percentage of error on the oscilloscope. You can set the reference value to the new value by pressing **NEW REF**.

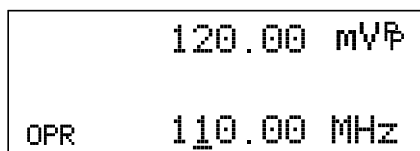

g1005i.eps

- Press **ENTER** to remove the cursor from the Output Display and save the new value as the reference value.

Note

If you attempt to use the rotary knob to adjust a value to an amount that is invalid for the function you are using, or is outside the value's range limit, the value will not change and the 5520A will beep. If you need to reach a different range of values, turn the knob quickly to jump to the new range.

8-91. Using **MULT X and **DIV ±****

The **MULT X** and **DIV ±** keys cause the current value of the signal to jump to a pre-determined cardinal value, whose amount is determined by the current function. These keys are described in more detail under the descriptions for each function.

8-92. Resetting the Oscilloscope Option

You can reset all parameters in the 5520A to their default settings at any time during front panel operations by pressing the **RESET** key on the front panel.

After resetting the 5520A, press **SCOPE** to return to the Oscilloscope Calibration Option (the Volt menu appears). Press **OPR** to reconnect the signal output.

8-93. Calibrating the Voltage Amplitude on an Oscilloscope

The oscilloscope voltage gain is calibrated by applying a low frequency square wave signal and adjusting its gain to meet the height specified for different voltage levels, designated by the graticule line divisions on the oscilloscope. The signal is applied from the 5520A in Volt mode. The specific voltages that you should use for calibration, and the graticule line divisions that need to be matched, vary for different oscilloscopes and are specified in your oscilloscope's service manual.

8-94. The Volt Function

The Voltage gain is calibrated using the Volt function. This function is accessed through the Volt menu, which appears when you start the SCOPE option, or when you press the softkey under MODE to scroll through the oscilloscope calibration menus.

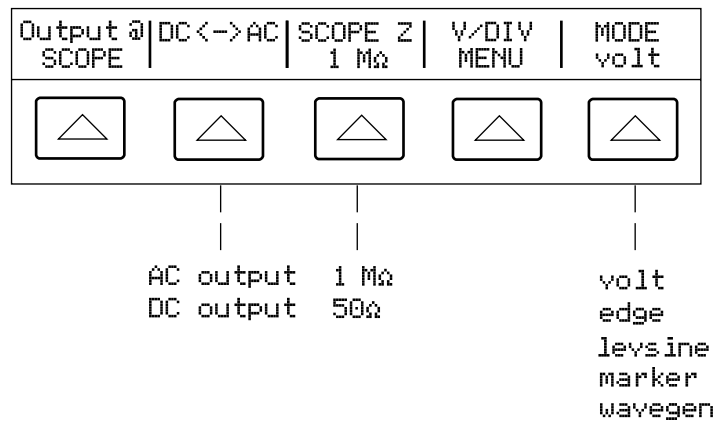

g1024i.eps

Each menu item is described below:

- **OUTPUT @ SCOPE** Indicates the location of the signal output. If the signal does not appear on the oscilloscope, press **[OPR]**. To disconnect the signal, press **[STBY]**.
- **DC <-> AC** Toggles between a dc and ac signal. Pressing the softkey from the ac signal produces the dc equivalent output.
- **SCOPE Z** Toggles the calibrator's output impedance setting between 1 MΩ and 50 Ω.
- **V/DIV MENU** Opens the voltage scaling menu, which lets you select the scale of the signal in volts per division. This menu is described below in detail, under "The V/DIV Menu."
- **MODE** Indicates you are in Volt mode. Use the softkey to change modes and open the corresponding menus for the other four oscilloscope calibration modes.

8-95. The V/DIV Menu

The V/DIV menu, shown below, sets the number of volts denoted by each division on the oscilloscope. This menu provides alternative methods for changing the output amplitude that may be more convenient for certain oscilloscope applications. To access the V/DIV menu, press V/DIV from the Volt menu.

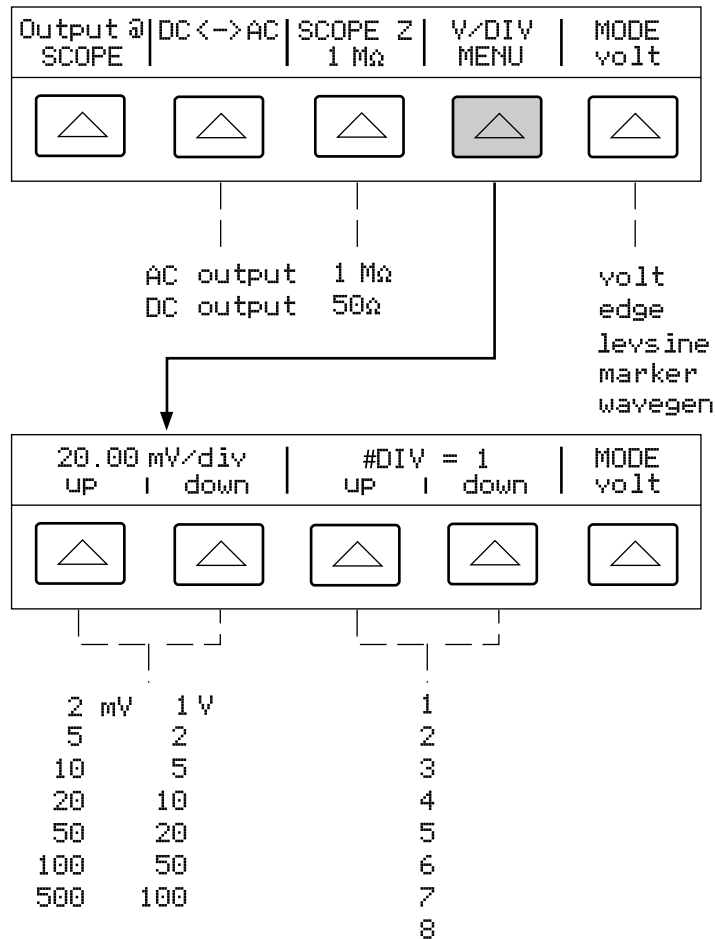

gl025i.eps

Each item in the V/DIV menu is described below.

- **V/div** Changes the scale of the output display by changing the number of volts that are represented by each division. The available settings, shown in the figure above, are provided in 1-2-5 step increments. Press the softkey under UP to increase the volts per division. Press the softkey under DOWN to decrease the volts per division.
- **# DIV** Specifies the number of divisions that establish the p-p value of the waveform. The value can be adjusted from one to eight divisions. The amount denoted by each division is displayed in the V/div field. Press the softkey under UP to increase the signal's height, and press the softkey under DOWN to decrease it.

8-96. Shortcuts for Setting the Voltage Amplitude

The **MULT** and **DIV** keys step the voltages through cardinal point values of an oscilloscope in a 1-2-5 step sequence. For example, if the voltage is 40 mV, then pressing **MULT** increases the voltage to the nearest cardinal point, which is 50 mV. Pressing **DIV** decreases the voltage to the nearest cardinal point, which is 20 mV.

8-97. Amplitude Calibration Procedure for an Oscilloscope

This example procedure describes how to use the Volt menu to calibrate the oscilloscope's amplitude gain. During calibration, you will need to set different voltages and verify that the gain matches the graticule lines on the oscilloscope according to the specifications for your particular oscilloscope. See your oscilloscope manual for the recommended calibration settings and appropriate gain values.

Before you start this procedure, verify that you are running the oscilloscope option in Volt mode. If you are, the Control Display shows the following menu.

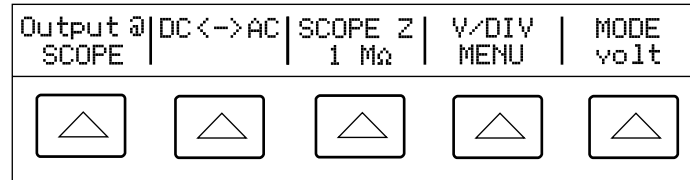

gl026i.eps

Perform the following sample procedure to calibrate the vertical gain.

1. Connect the calibrator to Channel 1 on the oscilloscope, making sure the oscilloscope is terminated at the proper impedance (1 MΩ for this example). Verify that the **OPR** key on the 5520A is lit, indicating that the signal is connected.
2. Key in the voltage level that is recommended for your oscilloscope. For example to enter 20 mV, press **2** **0** **μm** **dBmV**, then press **ENTER**. See “Keying in a Value” earlier in this chapter.
3. Adjust the oscilloscope as necessary. The waveform should be similar to the one shown below, with the gain at exactly the amount specified for the calibration settings for your oscilloscope.

This example shows the gain at 20 mV to be 4 divisions, at 5 mV per division.

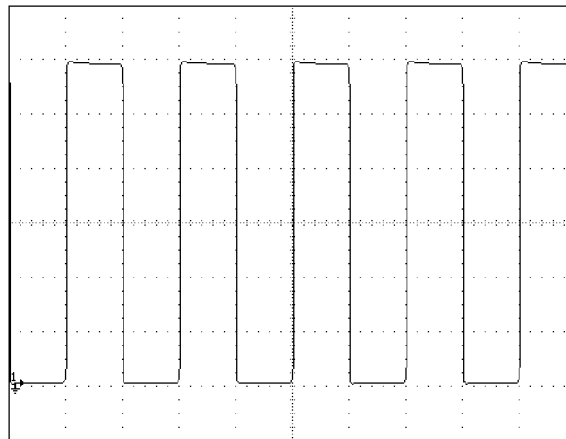

gl006i.bmp

4. Change the voltage to the next value recommended for calibrating your oscilloscope model, and repeat this procedure at the new voltage level, verifying the gain is correct according to the specifications in your manual.
5. Repeat the procedure for each channel.

8-98. Calibrating the Pulse and Frequency Response on an Oscilloscope

The pulse response is calibrated with a square-wave signal that has a fast leading edge rise-time. Using this signal, you adjust the oscilloscope as necessary until it meets its particular specifications for rise time and pulse aberrations.

Following pulse verification, the frequency response is checked by applying a leveled sine wave and acquiring a frequency reading at the -3 dB point, when the amplitude drops approximately 30%.

8-99. The Edge Function

The Edge function is used for calibrating the pulse response for your oscilloscope. To reach the Edge menu, press the softkey under MODE until “edge” appears.

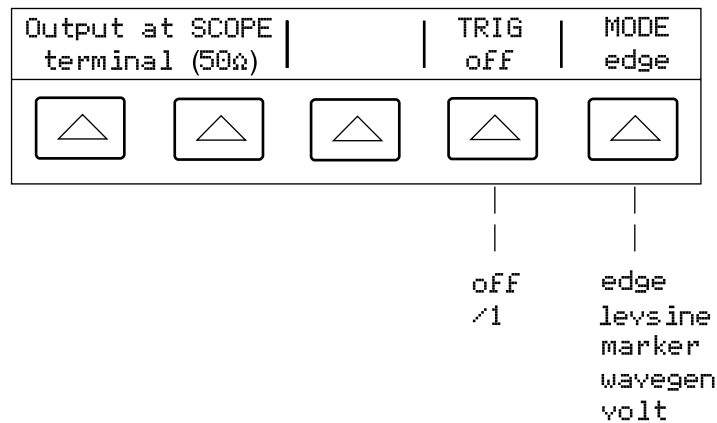

gl027i.eps

Each option in the Edge menu is described below.

- **OUTPUT @ SCOPE terminal (50Ω)** Indicates the location and impedance of the signal output. If the signal does not appear on the oscilloscope, press **OPR**. To disconnect the signal, press **STBY**.

You cannot change the output impedance in Edge mode.

- **TRIG** If you are using the external trigger, use this key to toggle the trigger off and on. When on, the reading will show “/1” which indicates that the external trigger is at the same frequency as the edge output.

The external trigger can be useful for many digital storage oscilloscopes that have difficulty triggering on fast rise time signals.

You can also toggle the trigger off and on by pressing **TRIG OUT**.

- **MODE** Indicates you are in Edge mode. Use the softkey to change modes and open the corresponding menus for the other four oscilloscope calibration modes.

8-100. Pulse Response Calibration Procedure for an Oscilloscope

This sample procedure shows how to check the oscilloscope's pulse response. Before you check your oscilloscope, see your oscilloscope's manual for the recommended calibration settings.

Before you start this procedure, verify that you are running the oscilloscope option in Edge mode. If you are, the Control Display shows the following menu.

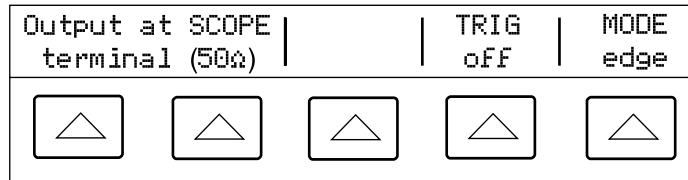

gl028i.eps

Perform the following sample procedure to calibrate the pulse response.

1. Connect the 5520A to Channel 1 on the oscilloscope. Select 50Ω impedance or use a 50Ω termination directly at the oscilloscope input. Verify that the **OPR** key is lit, indicating that the signal is connected.
2. Alter the voltage setting for the signal so it matches the amplitude value recommended by your oscilloscope manufacturer for calibrating the edge response. The default setting is 25 mV @ 1 MHz.

For example, on a Fluke PM3392A oscilloscope, start with a signal of 1 V @ 1 MHz.

3. Adjust the scale on your oscilloscope to achieve a good picture of the edge. For example, on a Fluke PM3392A oscilloscope with a 1 V @ 1 MHz signal, use 200 mV/div.
4. Adjust the time base on your oscilloscope to the fastest position available (20.0 or 50.0 ns/div).

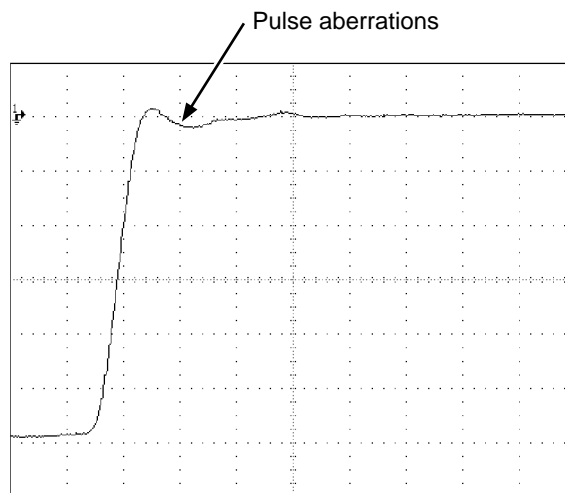

gl007i.eps

5. Verify that your oscilloscope exhibits the proper rise time and pulse aberration characteristics.
6. Remove the input signal by pressing **STBY**.

8-101. The Leveled Sine Wave Function

The Leveled Sine Wave (Levsine) function uses a leveled sine wave, whose amplitude remains relatively constant over a range of frequencies, to check the oscilloscope's bandwidth. When you check your oscilloscope, you change the wave's frequency until the amplitude displayed on the oscilloscope drops 30%, which is the amplitude that corresponds to the -3 dB point.

To access the Levsine menu, press the softkey under MODE until "levsine" appears.

Note

Make sure there is no cable connected to TRIG OUT while using the Levsine function..

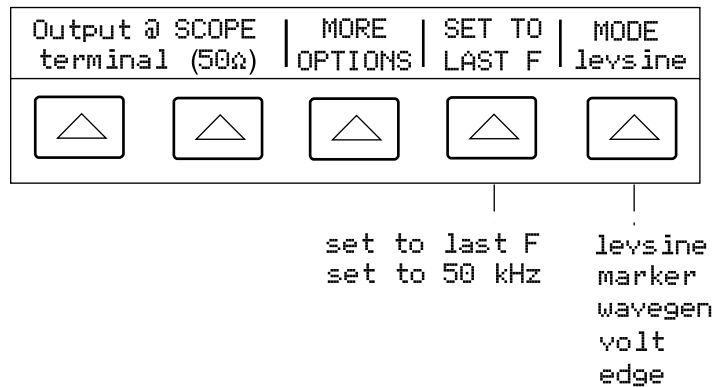

gl029i.eps

Each option in the Levsine menu is described below.

- **OUTPUT @ SCOPE terminal (50Ω)** Indicates the location and impedance of the signal output. If the signal does not appear on the oscilloscope, press **OPR**. To disconnect the signal, press **STBY**. You cannot change the impedance while you are in Levsine mode.
- **MORE OPTIONS** Opens additional menu items, which are described in detail under "The MORE OPTIONS Menu."
- **SET TO LAST F** Toggles between the current frequency setting and the reference value of 50 kHz. This option is useful for reverting to the reference to check the output after you make adjustments at another frequency.
- **MODE** Indicates you are in Levsine mode. Use the softkey to change modes and open the corresponding menus for the other four calibration modes.

Note

If a question mark appears in the Output Display, then no specifications are available for the frequency you are using. This will occur at frequencies greater than 250 MHz.

8-102. Shortcuts for Setting the Frequency and Voltage

Three options are available for controlling the sine wave settings.

- **SET TO LAST F** toggles between the last frequency used and the reference frequency of 50 kHz, letting you check the output at the reference after you make adjustments at a different frequency.
- **MORE OPTIONS** lets you use an automatic frequency sweep and lock the voltage range, if necessary. The following section provides details on this menu.

- The **MULT** and **DIV** keys step frequencies up or down in amounts that let you quickly access a new set of frequencies. For example, if the value is 250 kHz, **MULT** changes it to 300 kHz, and **DIV** changes it to 200 kHz. For voltage values, **MULT** and **DIV** step through cardinal point values in a 1.2-3-6 sequence.

8-103. The MORE OPTIONS Menu

When you select MORE OPTIONS, you open options that give you more control over the frequency and voltage. To access the MORE OPTIONS menu, press the softkey under MORE OPTIONS in the Levsine menu.

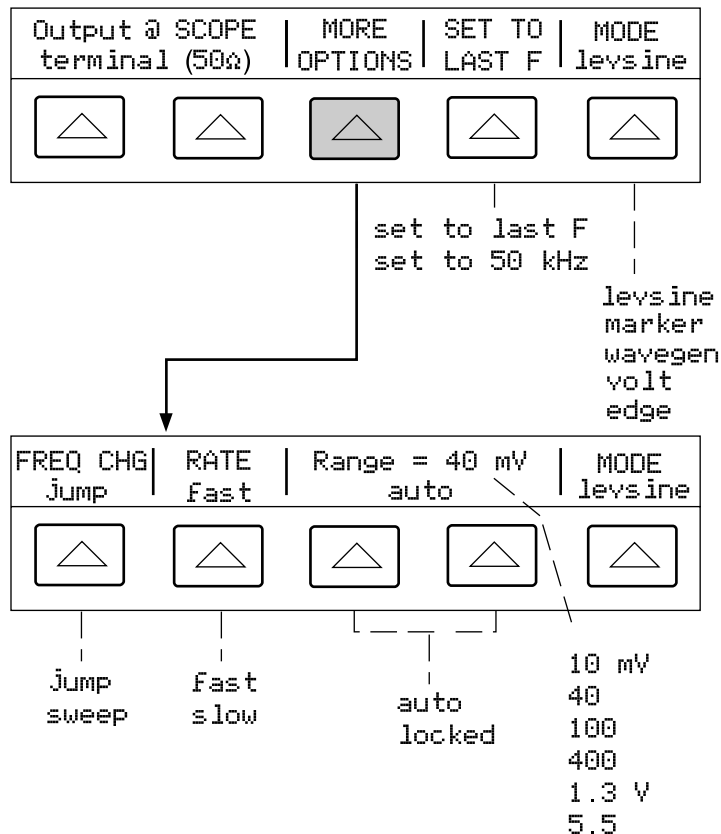

gl030i.eps

Each option in the MORE OPTIONS menu is described below.

- **FREQ CHANGE** Toggles between two settings that control the way the output signal adjusts to a new frequency. This is the default setting.
 - “Jump” causes the output signal to jump immediately to a new frequency setting.
 - “Sweep” causes the signal to sweep through a series of frequency values, over a range you set. Use the sweep function to watch the signal gradually change over a given bandwidth and see the point at which its amplitude changes. Details for using the sweep function are provided under “Sweeping Through a Frequency Range.”
- **RATE** Used when FREQ CHANGE is set to “sweep” to toggle the sweep speed between “fast” and “slow.” The slow speed is one tenth the fast speed.
 - The slow sweep rate lets you watch the frequency change very slowly. After a fast sweep, you may want to pinpoint a certain frequency with a slow sweep over a subset of your previous frequency range.

- **RANGE** The softkeys toggle between two settings: “auto,” which adjusts the range limit automatically in accordance with the voltage level, and “locked,” which sets the available voltages to one range.

There are six range limits in Levsine mode: 10 mV, 40 mV, 100 mV, 400 mV, 1.3 V, and 5.5 V. When set to “auto” the calibrator uses your voltage setting to automatically set the range limit that provides the most accurate output. When set to “locked” the range limit remains fixed and you can decrease the voltage down to 0 V within any range limit.

For example, assume the range limit is 40 mV. If you set the 40 mV range to “auto” and then enter 1 mV, the calibrator will adjust the range limit to 10 mV and will output 1 mV from within the 10 mV range. If you set the 40 mV range to “locked” and then enter 1 mV, the calibrator will output 1 mV from within the 40 mV range.

The default range setting is “auto,” which should always be used unless you are troubleshooting discontinuities in your oscilloscope’s vertical gain. The range setting will always return to “auto” after you leave Levsine mode.

8-104. Sweeping through a Frequency Range

When you change frequencies using the sweep method, the output sine wave sweeps through a specified range of frequencies, letting you identify the frequency at which the oscilloscope's signal exhibits certain behavior (e.g., changes amplitude). Before you start this procedure, make sure you are in the MORE OPTIONS menu and the sine wave is displayed on the oscilloscope.

Perform the following procedure to sweep through frequencies.

1. Make sure the output signal shows the starting frequency. If not, key in the starting frequency; then press **ENTER**.
2. Toggle **FREQ CHANGE** to "sweep." Toggle the **RATE** to "slow" if you want to observe a very slow sweep over a small range.
3. Key in the end frequency; then press **ENTER**.

After you press **ENTER**, the signal sweeps through frequencies between the two values you entered, and the Sweep menu appears on the Control Display as shown below.

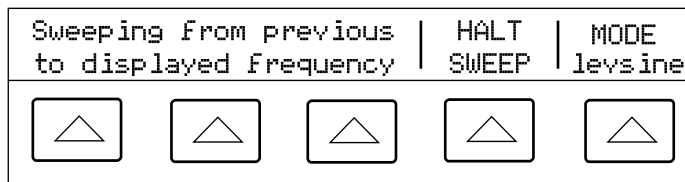

g1031i.eps

4. You can let the signal sweep through the entire range, or you can halt the sweep if you need to record the frequency at a certain point.

To interrupt the sweep, press the softkey under **HALT SWEEP**. The current frequency will appear on the Output Display and the MORE OPTIONS menu will reappear on the Control Display.

Note

When you interrupt the frequency sweep by pressing HALT SWEEP, the FREQ CHANGE method switches back to "jump."

5. Repeat the procedure if necessary. For example, if you did a fast sweep, you may want to pinpoint a certain frequency with a slow sweep over a subset of your previous frequency range.

8-105. Frequency Response Calibration Procedure for an Oscilloscope

This sample procedure, which verifies the frequency response on your oscilloscope, is usually performed after the pulse response is verified.

This procedure checks the bandwidth by finding the frequency at the -3 dB point for your oscilloscope. The reference sine wave in this procedure has an amplitude of 6 divisions, so that the -3 dB point can be found when the amplitude drops to 4.2 divisions.

Before you start this example procedure, verify that you are running the oscilloscope option in Levsine mode. If you are, the Control Display shows the following menu.

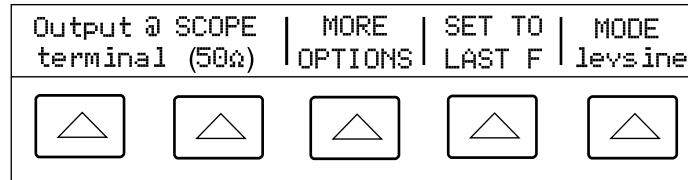

gl032i.eps

Perform the following sample procedure to calibrate the frequency response.

1. Reconnect the signal by pressing the **OPR** key on the 5520A. Select 50Ω impedance or use a 50 Ω external termination directly at the oscilloscope input
2. Adjust the sine wave settings in the Output Display according to the calibration recommendations in your oscilloscope manual. For example, for the Fluke PM3392A oscilloscope, start at 120 mV @ 50 kHz. To enter 120 mV, press **1** **2** **0** **μm** **dBm** **V**; then press **ENTER**.
3. Adjust the oscilloscope as necessary. The sine wave should appear at exactly six divisions, p-p, as shown below.

If necessary, make small adjustments to the voltage amplitude until the wave reaches exactly six divisions. To fine-tune the voltage, press **EDIT FIELD** to bring a cursor into the Output Display, move the cursor with the **◀** key, and turn the rotary knob to adjust the value. (See “Fine-Tuning Values” earlier in this chapter.)

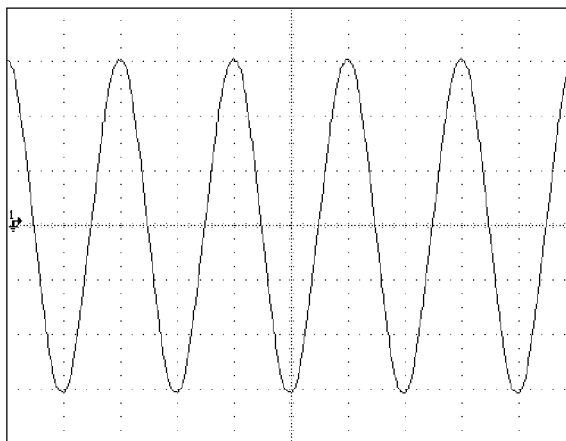

gl009i.bmp

4. Increase the frequency to 60 MHz (for 100-MHz instruments), or 150 MHz (for 200-MHz instruments). To enter 60 MHz, press **6** **0** **M** **Hz**; then press **ENTER**.
5. Continue to increase the frequency slowly until the waveform decreases to 4.2 divisions, as shown below.

To increase the frequency slowly, fine-tune it using the rotary knob. To do this, press **EDIT FIELD** to place a cursor in the Output Display. Press **EDIT FIELD** again to place it in the frequency field, and use the **◀** and **▶** keys to move it to the digit you want to change. Then change the value by turning the rotary knob.

Continue making small increments in the frequency until the signal drops to 4.2 divisions. At 4.2 divisions, the signal is at the frequency that corresponds to the -3 dB point.

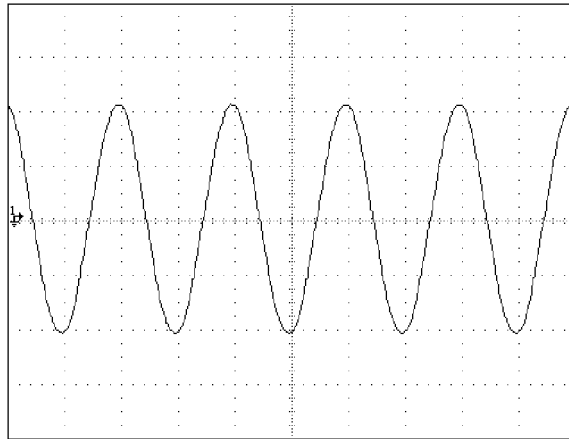

gl010i.bmp

6. Remove the input signal by pressing **STBY**.
7. Repeat this procedure for the remaining channels on your oscilloscope.

8-106. Calibrating the Time Base of an Oscilloscope

The horizontal deflection (time base) of an oscilloscope is calibrated using a method similar to the vertical gain calibration. A time marker signal is generated from the 5520A and the signal's peaks are matched to the graticule line divisions on the oscilloscope.

8-107. The Time Marker Function

The Time Marker function, which is available through the Marker menu, lets you calibrate the timing response of your oscilloscope. To access the Marker menu, press the softkey under MODE until "marker" appears.

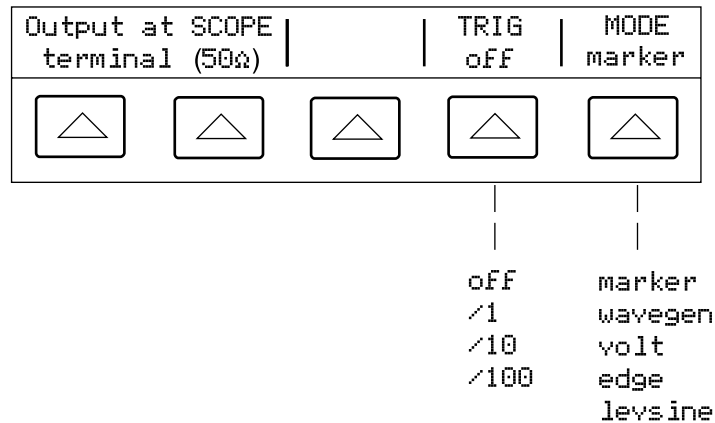

gl033i.eps

Each option in the Marker menu is described below.

- **OUTPUT @ SCOPE terminal** Indicates the location of the signal output. If the signal does not appear on the oscilloscope, press **OPR**. To disconnect the signal, press **STBY**.
- **TRIG** If you are using the external trigger, use this key to cycle through the trigger settings. The available trigger settings are: off, /1 (trigger signal appears on each marker), /10 (trigger signal appears on every tenth marker), and /100 (trigger signal appears at every 100th marker).

You can also toggle the trigger off and on by pressing **TRIG OUT**.

- **MODE** Indicates you are in Marker mode. Use the softkey to change modes and open the corresponding menus for the other four oscilloscope calibration modes.

8-108. Time Base Marker Calibration Procedure for an Oscilloscope

This sample procedure uses the Time Marker function to check the horizontal deflection (time base) of your oscilloscope. See your oscilloscope’s manual for the exact time base values recommended for calibration.

Before you begin this procedure, verify that you are in Marker mode. If you are, the Control Display shows the following menu.

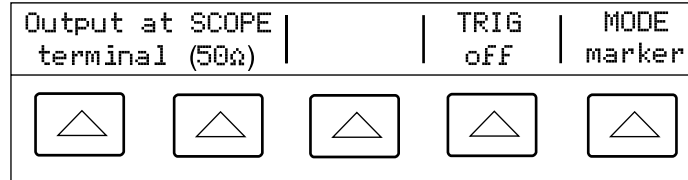

g1034i.eps

Perform the following sample procedure to calibrate the time base.

1. Connect the calibrator to Channel 1 on the oscilloscope. Select 50Ω impedance or use an external 50 Ω termination. Make sure the oscilloscope is dc-coupled.
2. Apply a time marker value according to the recommended calibration settings in your oscilloscope manual. For example, to enter 200 ns, press **2** **0** **0** **SHIFT** **n** **k** **SHIFT** **Hz**, then press **ENTER**.

Note

You may enter the equivalent frequency instead of the time marker value. For example, instead of entering 200 ns, you may enter 5 MHz.

3. Set your oscilloscope’s time base to show 10 time markers. The time markers should align with the oscilloscope divisions, as shown in the example below. For an accurate reading, align the signal’s peaks with the horizontal center axis.

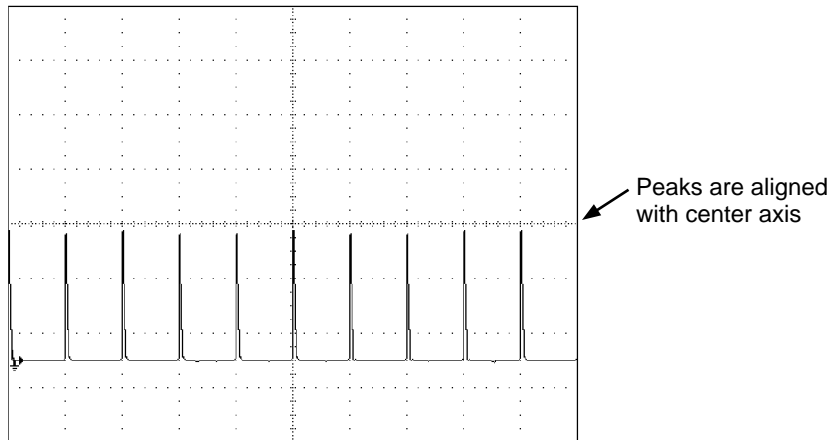

g1011i.eps

4. Repeat this procedure for all time marker values recommended for your oscilloscope. Repeat for digital and analog mode as required. Some oscilloscopes may need the magnification changed while calibrating in analog mode.
5. Remove the signal by pressing **STBY**.

8-109. Testing the Trigger

The oscilloscope's ability to trigger on different waveforms can be tested using the wave generator. When the wave generator is used, a square, sine, or triangle wave is transmitted and the wave's output impedance, offset, and voltage can be varied in order to test the triggering capability at different levels.

Note

The wave generator should not be used for checking the accuracy of your oscilloscope. The question mark in the Output Display indicates the amplitude values are not accurate enough to use for checking the oscilloscope's accuracy.

The wave generator is available through the Wavegen menu, shown below. To access this menu, press the softkey under MODE until "wavegen" appears.

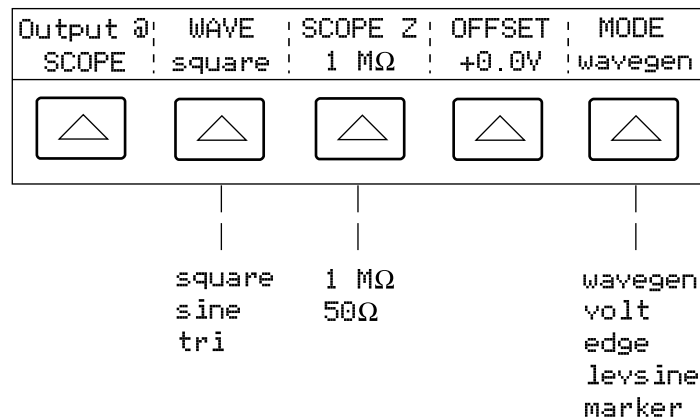

g1035i.eps

Each option in the Wavegen menu is described below.

- **OUTPUT @ SCOPE** Indicates the location of the signal output. If the signal does not appear on the oscilloscope, press **[OPR]**. To disconnect the signal, press **[STBY]**.
- **WAVE** Scrolls through the three types of waveforms that are available. You can select a square, sine, or triangle wave as the output.
- **SCOPE Z** Toggles the calibrator's output impedance setting between 50Ω and 1 MΩ.
- **OFFSET** Displays the offset of the generated wave. To change the offset, key in the new value, and press **[ENTER]**. Using the rotary knob does not change the offset; it changes the actual voltage output.

When you change the offset, you must remain within certain limits to avoid clipping the peaks. The limit depends on the wave's p-p value. Specifically, the maximum peak excursion equals the offset plus half of the wave's p-p value. See "Wave Generator Specifications" at the beginning of this chapter.

- **MODE** Indicates you are in Wavegen mode. Use the softkey to change modes and open the corresponding menus for the other four oscilloscope calibration modes.

8-110. Summary of Commands and Queries

This section describes commands and queries that are used specifically for the oscilloscope calibration option. Each command description indicates whether it can be used with IEEE-488 and RS-232 remote interfaces and identifies it as a Sequential, Overlapped, or Coupled command.

IEEE-488 (GPIB) and RS-232 Applicability IEEE-488 RS-232 Each command and query have a check box indicating applicability to IEEE-488 (general purpose interface bus, or GPIB) and RS-232 remote operations.

Sequential Commands Sequential Commands executed immediately as they are encountered in the data stream are called sequential commands. For more information, see “Sequential Commands” in Chapter 5.

Overlapped Commands Overlapped Commands SCOPE, TRIG, and OUT_IMP are designated as overlapped commands because they may be overlapped (interrupted) by the next command before they have completed execution. When an overlapped command is interrupted, it may take longer to execute while it waits for other commands to be completed. To prevent an overlapped command from being interrupted during execution, use *OPC, *OPC?, or *WAI . These commands prevent interruptions until they detect the command’s completion. For more information, see “Overlapped Commands” in Chapter 5.

Coupled Commands Coupled SCOPE and OUT_IMP are coupled commands because they can be coupled (combined) with other commands to form a compound command sequence. Care must be taken to ensure that commands are not coupled in a way that may cause them to disable each other, since this may result in a fault. For more information, see “Coupled Commands” in Chapter 5.

SCOPE IEEE-488 RS-232 Sequential Overlapped Coupled

Programs the oscilloscope calibration option hardware, if installed. The instrument settings are determined by this command's parameter. Once in SCOPE mode, use the OUT command to program new output.

OPER, STBY, *OPC, *OPC?, and *WAI all operate as described in Chapter 6. The state of the oscilloscope's output while in SCOPE mode is reflected by the bit in the ISR that is assigned to SETTLED.

The FUNC? query returns SDCV, SACV, LEVSINE, MARKER, EDGE, and WAVEGEN for the corresponding oscilloscope modes.

Parameters:	OFF	Turns the oscilloscope hardware off. Programs 0 V, 0 Hz, output at the NORMAL terminals, standby.
	VOLT	Oscilloscope ac and dc voltage mode. Programs 20 mV p-p, 1 kHz, output at the SCOPE BNC, output impedance 1 M Ω , standby if from OFF or previously in standby.
	EDGE	Oscilloscope Edge mode. Programs 25 mV peak-to-peak, 1 MHz, output at the SCOPE BNC, standby if from OFF or previously in standby.
	LEVSINE	Oscilloscope-leveled sine mode. Programs 30 mV p-p, 50 kHz, output at the SCOPE BNC, standby if from OFF or previously in standby.
	MARKER	Oscilloscope Marker mode. Programs the period to 1 ms, output at the SCOPE BNC, standby if from OFF or previously in standby.
	WAVEGEN	Oscilloscope Wavegen mode. Programs 20 mV p-p, square wave, 1 kHz, no offset, output impedance 1 M Ω , standby if from OFF or previously in standby.

Example:	SCOPE VOLT;	OUT -2 V, 0 Hz	(dc voltage, -2 V)
	SCOPE VOLT;	OUT 4 V, 1 kHz	(ac voltage, 4 V peak-to-peak, 1 kHz.)
	SCOPE EDGE;	OUT 0.5 V, 5 kHz	(Edge, 0.5 V p-p, 5 kHz.)
	SCOPE LEVSINE;	OUT 1 V, 20 kHz	(Leveled sine wave, 2 V p-p, 20 kHz.)
	SCOPE MARKER;	OUT 2 MS	(Marker, period of 2 ms.)
	SCOPE WAVEGEN;	OUT 1 V, 1 kHz	(Wave Generator, 1 V p-p, 1 kHz.)

SCOPE? IEEE-488 RS-232 Sequential Overlapped Coupled

Returns the oscilloscope's current mode of operation. Returns OFF if the oscilloscope is off.

Parameter: (None)

Response: <character> (Returns OFF, VOLT, EDGE, LEVSINE, MARKER, or WAVEGEN.)

TRIG IEEE-488 RS-232 Sequential Overlapped Coupled

Programs the oscilloscope's trigger output BNC.

Parameters: OFF (Turns the trigger output off.)
 DIV1 (Turns the trigger output on. Frequency is the same as the signal at SCOPE output.)
 DIV10 (Turns the trigger output on. Frequency is 1/10 of the signal at SCOPE output.)
 DIV100 (Turns the trigger output on. Frequency is 1/100 of the signal at SCOPE output.)

TRIG? IEEE-488 RS-232 Sequential Overlapped Coupled

Returns the output setting of the oscilloscope's trigger.

Parameters: (None)

Response: <character> (Returns OFF, DIV1, DIV10, or DIV100.)

OUT_IMP IEEE-488 RS-232 Sequential Overlapped Coupled

Programs the oscilloscope's output impedance.

Parameters: Z50 (Programs the oscilloscope's output impedance to 50Ω.)
 Z1M (Programs the oscilloscope's output impedance to 1 MΩ.)

OUT_IMP? IEEE-488 RS-232 Sequential Overlapped Coupled

Returns the impedance setting of the oscilloscope's output.

Parameters: (None)

Response: <character> (Returns Z50 or Z1M.)

8-111. Verification Tables

Before the SC300 Option leaves the Fluke factory, it is verified to meet its specifications at the following test points. The verification test points are provided here as a guide when re-verification is desired.

8-112. Voltage Function Verification: AC Voltage into a 1 M Ω Load

Nominal Value (p-p)	Frequency	Measured Value (p-p)	Deviation (mV)	1-Year Spec. (mV)
5.0 mV	10 Hz			0.11
5.0 mV	100 Hz			0.11
5.0 mV	1 kHz			0.11
5.0 mV	5 kHz			0.11
5.0 mV	10 kHz			0.11
10.0 mV	10 kHz			0.12
20.0 mV	100 Hz			0.15
20.0 mV	1 kHz			0.15
20.0 mV	10 kHz			0.15
50.0 mV	10 kHz			0.23
89.0 mV	10 Hz			0.32
89.0 mV	10 kHz			0.32
100.0 mV	10 kHz			0.35
200.0 mV	100 Hz			0.60
200.0 mV	1 kHz			0.60
200.0 mV	10 kHz			0.60
500.0 mV	10 kHz			1.35
890.0 mV	10 Hz			2.32
890.0 mV	10 kHz			2.32
1.0 V	100 Hz			2.60
1.0 V	1 kHz			2.60
1.0 V	10 kHz			2.60
2.0 V	10 kHz			5.10
5.0 V	10 Hz			12.60
5.0 V	10 kHz			12.60
10.0 V	10 kHz			25.10
20.0 V	10 kHz			50.10

Voltage Function Verification: AC Voltage into a 1 M Ω Load (cont.)

Nominal Value (p-p)	Frequency	Measured Value (p-p)	Deviation (mV)	1-Year Spec. (mV)
50.0 V	10 Hz			125.10
50.0 V	100 Hz			125.10
50.0 V	1 kHz			125.10
50.0 V	10 kHz			125.10
105.0 V	100 Hz			262.60
105.0 V	1 kHz			262.60

8-113. Voltage Function Verification: AC Voltage into a 50 Ω Load

Nominal Value (p-p)	Frequency	Measured Value (p-p)	Deviation (mV)	1-Year Spec. (mV)
5.0 mV	10 Hz			0.11
5.0 mV	100 Hz			0.11
5.0 mV	1 kHz			0.11
5.0 mV	5 kHz			0.11
5.0 mV	10 kHz			0.11
10.0 mV	100 Hz			0.12
10.0 mV	1 kHz			0.12
10.0 mV	10 kHz			0.12
20.0 mV	10 kHz			0.15
44.9 mV	10 Hz			0.21
44.9 mV	10 kHz			0.21
50.0 mV	10 kHz			0.23
100.0 mV	100 Hz			0.35
100.0 mV	1 kHz			0.35
100.0 mV	10 kHz			0.35
200.0 mV	10 kHz			0.60
449.0 mV	10 Hz			1.22
449.0 mV	10 kHz			1.22
500.0 mV	10 kHz			1.35
1.0 V	100 Hz			2.60
1.0 V	1 kHz			2.60
1.0 V	10 kHz			2.60
2.0 V	10 Hz			5.10

Voltage Function Verification: AC Voltage into a 50 Ω Load (cont.)

Nominal Value (p-p)	Frequency	Measured Value (p-p)	Deviation (mV)	1-Year Spec. (mV)
2.0 V	100 Hz			5.10
2.0 V	1 kHz			5.10
2.0 V	5 kHz			5.10
2.0 V	10 kHz			5.10

8-114. Voltage Function Verification: DC Voltage into a 50 Ω Load

Nominal Value (dc)	Measured Value (dc)	Deviation (mV)	1-Year Spec. (mV)
0.0 mV			0.10
5.0 mV			0.11
-5.0 mV			0.11
10.0 mV			0.12
-10.0 mV			0.12
22.0 mV			0.15
-22.0 mV			0.15
25.0 mV			0.16
-25.0 mV			0.16
55.0 mV			0.24
-55.0 mV			0.24
100.0 mV			0.35
-100.0 mV			0.35
220.0 mV			0.65
-220.0 mV			0.65
250.0 mV			0.72
-250.0 mV			0.72
550.0 mV			1.47
-550.0 mV			1.47
700.0 mV			1.85
-700.0 mV			1.85
2.2 V			5.60
-2.2 V			5.60

8-115. Voltage Function Verification: DC Voltage into a 1 M Ω Load

Nominal Value (dc)	Measured Value (dc)	Deviation (mV)	1-Year Spec. (mV)
0.0 mV			0.10
5.0 mV			0.11
-5.0 mV			0.11
22.0 mV			0.15
-22.0 mV			0.15
25.0 mV			0.16
-25.0 mV			0.16
45.0 mV			0.21
-45.0 mV			0.21
50.0 mV			0.23
-50.0 mV			0.23
220.0 mV			0.65
-220.0 mV			0.65
250.0 mV			0.72
-250.0 mV			0.72
450.0 mV			1.22
-450.0 mV			1.22
500.0 mV			1.35
-500.0 mV			1.35
3.3 V			8.35
-3.3 V			8.35
4.0 V			10.10
-4.0 V			10.10
33.0 V			82.60
-33.0 V			82.60

8-116. Edge Function Verification

Nominal Value (p-p)	Frequency	Pulse Response Time (ns)	1-Year Spec. (ps)
25.0 mV	1 MHz		400
250.0 mV	1 MHz		400
250.0 mV	10 kHz		400
250.0 mV	100 kHz		400
250.0 mV	1 MHz		400
2.5 V	1 MHz		400

8-117. Wave Generator Function Verification: 1 MΩ Load

Waveform	Nominal Value (p-p)	Frequency	Measured Value (p-p)	Deviation (mV)	1-Year Spec. (mV)
Square	5.0 mV	10 kHz			0.25 mV
Square	20.0 mV	10 kHz			0.70 mV
Square	89.0 mV	10 kHz			2.77 mV
Square	219.0 mV	10 kHz			6.67 mV
Square	890.0 mV	10 kHz			26.80 mV
Square	6.5 V	10 kHz			195.10 mV
Square	55.0 V	10 kHz			1.65 V
Sine	5.0 mV	10 kHz			0.25 mV
Sine	20.0 mV	10 kHz			0.70 mV
Sine	89.0 mV	10 kHz			2.77 mV
Sine	219.0 mV	10 kHz			6.67 mV
Sine	890.0 mV	10 kHz			26.80 mV
Sine	6.5 V	10 kHz			195.10 mV
Sine	55.0 V	10 kHz			1.65 V
Triangle	5.0 mV	10 kHz			0.25 mV
Triangle	20.0 mV	10 kHz			0.70 mV
Triangle	89.0 mV	10 kHz			2.77 mV
Triangle	219.0 mV	10 kHz			6.67 mV
Triangle	890.0 mV	10 kHz			26.80 mV
Triangle	6.5 V	10 kHz			195.10 mV
Triangle	55.0 V	10 kHz			1.65 V

8-118. Wave Generator Function Verification: 50 Ω Load

Waveform	Nominal Value (p-p)	Frequency	Measured Value (p-p)	Deviation (mV)	1-Year Spec. (mV)
Square	5.0 mV	10 kHz			0.25 mV
Square	10.9 mV	10 kHz			0.43 mV
Square	44.9 mV	10 kHz			1.45 mV
Square	109.0 mV	10 kHz			3.37 mV
Square	449.0 mV	10 kHz			13.57 mV
Square	1.1 V	10 kHz			32.50 mV
Square	2.2 V	10 kHz			66.10 mV
Sine	5.0 mV	10 kHz			0.25 mV
Sine	10.9 mV	10 kHz			0.43 mV
Sine	44.9 mV	10 kHz			1.45 mV
Sine	109.0 mV	10 kHz			3.37 mV
Sine	449.0 mV	10 kHz			13.57 mV
Sine	1.1 V	10 kHz			32.50 mV
Sine	2.2 V	10 kHz			66.10 mV
Triangle	5.0 mV	10 kHz			0.25 mV
Triangle	10.9 mV	10 kHz			0.43 mV
Triangle	44.9 mV	10 kHz			1.45 mV
Triangle	109.0 mV	10 kHz			3.37 mV
Triangle	449.0 mV	10 kHz			13.57 mV
Triangle	1.1 V	10 kHz			32.50 mV
Triangle	2.2 V	10 kHz			66.10 mV

8-119. Leveled Sine Wave Function Verification: Amplitude

Nominal Value (p-p)	Frequency	Measured Value (p-p)	Deviation (mV)	1-Year Spec. (mV)
5.0 mV	50 kHz			0.300
10.0 mV	50 kHz			0.400
20.0 mV	50 kHz			0.600
40.0 mV	50 kHz			1.000
50.0 mV	50 kHz			1.200
100.0 mV	50 kHz			2.200
200.0 mV	50 kHz			4.200

Leveled Sine Wave Function Verification: Amplitude (cont.)

Nominal Value (p-p)	Frequency	Measured Value (p-p)	Deviation (mV)	1-Year Spec. (mV)
400.0 mV	50 kHz			8.200
500.0 mV	50 kHz			1.200
1.3 V	50 kHz			26.200
2.0 V	50 kHz			40.200
5.5 V	50 kHz			110.200

8-120. Leveled Sine Wave Function Verification: Flatness

Nominal Value (p-p)	Frequency	Measured Value (p-p)	Deviation (mV)	1-Year Spec. (mV)
5.0 mV	500 kHz			0.17
5.0 mV	1 MHz			0.17
5.0 mV	1 MHz			0.17
5.0 mV	2 MHz			0.17
5.0 mV	5 MHz			0.17
5.0 mV	10 MHz			0.17
5.0 mV	20 MHz			0.17
5.0 mV	50 MHz			0.17
5.0 mV	100 MHz			0.17
5.0 mV	125 MHz			0.20
5.0 mV	160 MHz			0.20
5.0 mV	200 MHz			0.20
5.0 mV	220 MHz			0.20
5.0 mV	235 MHz			0.20
5.0 mV	250 MHz			0.20
10.0 mV	500 kHz			0.25
10.0 mV	1 MHz			0.25
10.0 mV	1 MHz			0.25
10.0 mV	2 MHz			0.25
10.0 mV	5 MHz			0.25
10.0 mV	10 MHz			0.25
10.0 mV	20 MHz			0.25
10.0 mV	50 MHz			0.25
10.0 mV	100 MHz			0.25
10.0 mV	125 MHz			0.30

Leveled Sine Wave Function Verification: Flatness (cont.)

Nominal Value (p-p)	Frequency	Measured Value (p-p)	Deviation (mV)	1-Year Spec. (mV)
10.0 mV	160 MHz			0.30
10.0 mV	200 MHz			0.30
10.0 mV	220 MHz			0.30
10.0 mV	235 MHz			0.30
10.0 mV	250 MHz			0.30
40.0 mV	500 kHz			0.70
40.0 mV	1 MHz			0.70
40.0 mV	1 MHz			0.70
40.0 mV	2 MHz			0.70
40.0 mV	5 MHz			0.70
40.0 mV	10 MHz			0.70
40.0 mV	20 MHz			0.70
40.0 mV	50 MHz			0.70
40.0 mV	100 MHz			0.70
40.0 mV	125 MHz			0.90
40.0 mV	160 MHz			0.90
40.0 mV	200 MHz			0.90
40.0 mV	220 MHz			0.90
40.0 mV	235 MHz			0.90
40.0 mV	250 MHz			0.90
100.0 mV	500 kHz			1.60
100.0 mV	1 MHz			1.60
100.0 mV	1 MHz			1.60
100.0 mV	2 MHz			1.60
100.0 mV	5 MHz			1.60
100.0 mV	10 MHz			1.60
100.0 mV	20 MHz			1.60
100.0 mV	50 MHz			1.60
100.0 mV	100 MHz			1.60
100.0 mV	125 MHz			2.10
100.0 mV	160 MHz			2.10
100.0 mV	200 MHz			2.10

Leveled Sine Wave Function Verification: Flatness (cont.)

Nominal Value (p-p)	Frequency	Measured Value (p-p)	Deviation (mV)	1-Year Spec. (mV)
100.0 mV	220 MHz			2.10
100.0 mV	235 MHz			2.10
100.0 mV	250 MHz			2.10
400.0 mV	500 kHz			6.10
400.0 mV	1 MHz			6.10
400.0 mV	1 MHz			6.10
400.0 mV	2 MHz			6.10
400.0 mV	5 MHz			6.10
400.0 mV	10 MHz			6.10
400.0 mV	20 MHz			6.10
400.0 mV	50 MHz			6.10
400.0 mV	100 MHz			6.10
400.0 mV	125 MHz			8.10
400.0 mV	160 MHz			8.10
400.0 mV	200 MHz			8.10
400.0 mV	220 MHz			8.10
400.0 mV	235 MHz			8.10
400.0 mV	250 MHz			8.10
1.3 V	500 kHz			19.60
1.3 V	1 MHz			19.60
1.3 V	1 MHz			19.60
1.3 V	2 MHz			19.60
1.3 V	5 MHz			19.60
1.3 V	10 MHz			19.60
1.3 V	20 MHz			19.60
1.3 V	50 MHz			19.60
1.3 V	100 MHz			19.60
1.3 V	125 MHz			26.10
1.3 V	160 MHz			26.10
1.3 V	200 MHz			26.10
1.3 V	220 MHz			26.10
1.3 V	235 MHz			26.10

Leveled Sine Wave Function Verification: Flatness (cont.)

Nominal Value (p-p)	Frequency	Measured Value (p-p)	Deviation (mV)	1-Year Spec. (mV)
1.3 V	250 MHz			26.10
5.5 V	500 kHz			82.5
5.5 V	1 MHz			82.5
5.5 V	1 MHz			82.5
5.5 V	2 MHz			82.5
5.5 V	5 MHz			82.5
5.5 V	10 MHz			82.5
5.5 V	20 MHz			82.5
5.5 V	50 MHz			82.5
5.5 V	100 MHz			82.5
5.5 V	125 MHz			110.00
5.5 V	160 MHz			110.00
5.5 V	200 MHz			110.00
5.5 V	220 MHz			110.00
5.5 V	235 MHz			110.00
5.5 V	250 MHz			110.00

8-121. Leveled Sine Wave Function Verification: Frequency

Nominal Value (p-p)	Frequency	Measured Frequency	Deviation	1-Year Spec.
1.3 V	50 kHz			0.0013 kHz
1.3 V	10 MHz			0.0003 MHz
1.3 V	250 MHz			0.0063 MHz

8-122. Marker Generator Function Verification

Nominal Interval	Measured Interval	Deviation	1-Year Spec.
5s			25.12 ms
2.00s			4.05 ms
1s			1.03 ms
500.00 ms			262.50 μ s
200.00 ms			45.00 μ s
100.00 ms			12.50 μ s
50.00 ms			3.75 μ s
20.00 ms			900.000 ns
10.00 ms			350.00 ns
5.00 ms			150.00 ns
2.00 ms			54.000 ns
1.00 ms			26.000 ns
500.00 μ s			12.750 ns
200.00 μ s			5.040 ns
100.00 μ s			2.510 ns
50.00 μ s			1.287 ns
20.00 μ s			0.506 ns
10.00 μ s			0.252 ns
5.00 μ s			0.125 ns
2.00 μ s			0.050 ns
1.00 μ s			0.025 ns
500.000 ns			0.013 ns
200.000 ns			5.000 ps
100.000 ns			2.500 ps
50.000 ns			1.250 ps
20.000 ns			0.500 ps
10.000 ns			0.250 ps
5.000 ns			0.125 ps
2.000 ns			0.050 ps

Chapter 9

Accessories

	Contents	Page
9-1.	Introduction.....	9-3
9-2.	Rack Mount Kit	9-4
9-3.	IEEE-488 Interface Cables	9-4
9-4.	RS-232 Null-Modem Cables	9-4
9-5.	RS-232 Modem Cables.....	9-4
9-6.	5500A/LEADS.....	9-4

9-1. Introduction

Table 9-1 summarizes the available models, options and accessories, including cables and components.

Table 9-1. Options and Accessories

Model	Description
802303	5520A Service Manual
5500-SC300	Oscilloscope Calibration Option
5500-SC600	Oscilloscope Calibration Option
5500A/CASE	Transit Case
5500A/HNDL	Side Handle
5500A/LEADS	Comprehensive Lead Set
△ 109215	Replacement fuse; 5 A/250 V Time Delay (100 V or 120 V line voltage)
△ 851931	Replacement fuse; 2.5 A/250 V Time Delay (200 V or 240 V line voltage)
664828	MET/CAL-IEEE NT, Option, IEEE Interface
666339	MET/CAL-IEEE PCI, Option, IEEE Interface (PCI)
943738	RS-232 Modem Cable, 2.44 m (8 ft) (SERIAL 2 TO UUT) to UUT (DB-9)
MET/CAL-5	Version 5.0 (Plus) Automated Calibration Software. Single user floating license. Requires MET/BASE-5 for operation.
5500/CAL-5	Version 5.0 (Plus) Automated Calibration Software. Single user floating license. RS-232 control only. Requires MET/BASE-5 for operation.
MET/TRACK-5	Verion 5.0 (Plus) T&M Asset management Software. Single user floating license. Requires MET/BASE-5 for operation.
MET/BASE-5	System engine. Requires licenses for one or more client applications (MET/CAL-5, 5500/CAL-5 and/or MET/TRACK-5).
MET/CAL-IEEE NT	IEEE Interface Kit.
PM2295/05	IEEE-488 Cable, 0.5 m (1.64 ft)
PM2295/10	IEEE-488 Cable, 1 m (3.28 ft)
PM2295/20	IEEE-488 Cable, 2 m (6.56 ft)
PM8914/001	RS-232 Null Modem Cable, 1.5 m (5 ft) (SERIAL 1 FROM HOST) to PC COM (DB-9)
RS40	RS-232 Null Modem Cable, 1.83 m (6 ft) (SERIAL 1 FROM HOST) to PC COM (DB-25)
TC100	Test Instrument Cart
Y5537	24 in. (61 cm) Rack Mount Kit for 5520A
Y8021	Shielded IEEE-488 Cable 0.5 m (1.64 ft)
Y8022	Shielded IEEE-488 Cable 2 m (6.56 ft)
Y8023	Shielded IEEE-488 Cable 4 m (13 ft)

9-2. Rack Mount Kit

The Y5537 rack mount kit provides all the hardware necessary to mount the 5520A on slides in a 24-inch (61 cm) equipment rack. Instructions are provided in the kit. (To rack mount the 5725A Amplifier, order kit Y5735.)

9-3. IEEE-488 Interface Cables

Shielded IEEE-488 cables are available in three lengths (See Table 9-1). The cables attach to the 5520A to any other IEEE-488 device. Each cable has double 24-pin connectors at both ends to allow stacking. Metric threaded mounting screws are provided with each connector. Appendix D shows the pinout for the IEEE-488 connector.

9-4. RS-232 Null-Modem Cables

The PM8914/001 and RS40 null modem cables connect the 5520A SERIAL 1 FROM HOST port to a printer, video display terminal, computer, or other serial device configured as DTE (Data Terminal Equipment). Appendix D shows the pinouts for the serial connectors.

9-5. RS-232 Modem Cables

The modem cable (PN 943738) connects the 5520A SERIAL 2 TO UUT port to a unit under test serial port (with DB-9 male connector). Appendix D shows the pinouts for the serial connectors.

9-6. 5500A/LEADS

The optional test lead kit, 5500A/LEADS, is a kit of test leads for voltage and current, thermocouple extension wires, thermocouple miniconnectors, and thermocouple measuring “beads.”

Appendices

Appendix	Contents	Page
A	Glossary.....	A-1
B	ASCII and IEEE-488 Bus Codes.....	B-1
C	RS-232/IEEE-488 Cables and Connectors.....	C-1
D	Creating a Visual Basic Test Program.....	D-1
E	Error Messages.....	E-1

Appendix A

Glossary

adc (analog-to-digital converter)

A device or circuit that converts an analog signal to digital signals.

absolute uncertainty

Uncertainty specifications that include the error contributions made by all equipment and standards used to calibrate the instrument. Absolute uncertainty is the numbers to compare with the UUT for determining test uncertainty ratio.

accuracy

The degree to which the measured value of a quantity agrees with the true (correct) value of that quantity. For example, an instrument specified to $\pm 1\%$ uncertainty is 99% accurate.

apparent power

The power value obtained by simply multiplying the ac current by the ac voltage on a circuit without consideration of any phase relationship between the two waveforms. (See “true power” for comparison.)

assert

To cause a digital signal to go into a logic true state.

af (audio frequency)

The frequency range of human hearing; normally 15 - 20,000 Hz.

artifact standard

An object that produces or embodies a physical quantity to be standardized, for example a Fluke 732A dc Voltage Reference Standard.

base units

Units in the SI system that are dimensionally independent. All other units are derived from base units. The only base unit in electricity is the ampere.

buffer

1. An area of digital memory for temporary storage of data.
2. An amplifier stage before the final amplifier.

burden voltage

The maximum sustainable voltage across the terminals of a load.

compliance voltage

The maximum voltage a constant-current source can supply.

control chart

A chart devised to monitor one or more processes to detect the excessive deviation from a desired value of a component or process.

crest factor

The ratio of the peak voltage to the rms voltage of a waveform (with the dc component removed).

dac (digital-to-analog converter)

A device or circuit that converts a digital waveform to an analog voltage.

dBm

A reference power level of 1 mW expressed in decibels.

derived units

Units in the SI system that are derived from base units. Volts, ohms, and watts are derived from amperes and other base and derived units.

displacement power factor

Refers to the displacement component of power factor; the ratio of the active power of the fundamental wave, in watts, to the apparent power of the fundamental wave, in volt-amperes.

distortion

Undesired changes in the waveform of a signal. Harmonic distortion disturbs the original relationship between a frequency and other frequencies naturally related to it. Intermodulation distortion (imd) introduces new frequencies by the mixing of two or more original frequencies. Other forms of distortion are phase distortion and transient distortion.

errors

The different types of errors described in this glossary are “offset error,” “linearity error,” “random error,” “scale error,” “systematic errors,” and “transfer error.”

flatness

A measure of the variation of the actual output of an ac voltage source at different frequency points when set to the same nominal output level. A flat voltage source exhibits very little error throughout its frequency range.

floor

The part of the uncertainty specification of an instrument that is typically a fixed offset plus noise. Floor can be expressed as units, such as microvolts or counts of the least significant digit. For the 5520A, the floor specification is combined with fixed range errors in one term to determine total uncertainty.

full scale

The maximum reading of a range of a meter, analog-to-digital converter, or other measurement device, or the maximum attainable output on a range of a calibrator.

gain error

Same as scale error. Scale or gain error results when the slope of the meter's response curve is not exactly 1. A meter with only gain error (no offset or linearity error), will read 0V with 0V applied, but something other than 10V with 10V applied.

ground

The voltage reference point in a circuit. Earth ground is a connection through a ground rod or other conductor to the earth, usually accessible through the ground conductor in an ac power receptacle.

ground loops

Undesirable currents induced when there is more than one chassis ground potential in a system of instruments. Ground loops can be minimized by connecting all instruments in a system to ground to one point.

guard

See "voltage guard" and "current guard."

harmonics

A waveform that is an integral multiple of the fundamental frequency. For example, a waveform that is twice the frequency of a fundamental is called the second harmonic.

IPTS-68

Refers to the International Provisional Temperature Standard (1968), replaced by the International Temperature Standard (1990). This specifies the definition of the °C temperature standard.

ITS-90

Refers to the International Temperature Standard (1990), which replaced the International Provisional Temperature Standard (1968). This specifies the definition of the °C temperature standard.

International Systems of Units

Same as "SI System of Units," the accepted system of units. See also "units," "base units," and "derived units."

legal units

The highest echelon in a system of units, for example the U.S. National Bureau of Standards volt.

life-cycle cost

The consideration of all elements contributing to the cost of an instrument throughout its useful life. This includes initial purchase cost, service and maintenance cost, and the cost of support equipment.

linearity

The relationship between two quantities when a change in the first quantity is directly proportional to a change in the second quantity.

linearity error

Linearity error occurs when the response curve of a meter is not exactly a straight line. This type of error is measured by fixing two points on the response curve, drawing a line through the points, then measuring how far the curve deviates from the straight line at various points in the response curve.

MAP (Measurement Assurance Program)

A program for measurement process. A MAP provides information to demonstrate that the total uncertainty of the measurements (data), including both random error and systematic components of error relative to national or other designated standards is quantified, and sufficiently small to meet requirements.

MTBF (Mean Time Between Failures)

The time interval in operating hours that can be expected between failure of equipment. MTBF can be calculated from direct observation or mathematically derived through extrapolation.

MTTF (Mean Time To Fail)

The time interval in operating hours that can be expected until the first failure of equipment. MTTF can be calculated from direct observation or mathematically derived through extrapolation.

MTTR (Mean Time to Repair)

The average time in hours required to repair failed equipment.

metrology

The science of, and the field of knowledge concerned with measurement.

minimum use specifications

A compilation of specifications that satisfies the calibration requirements of a measurement system or device. The minimum use specifications are usually determined by maintaining a specified test uncertainty ratio between the calibration equipment and the unit under test.

noise

A signal containing no useful information that is superimposed on a desired or expected signal.

normal mode noise

An undesired signal that appears between the terminals of a device.

offset error

Same as zero error. The reading shown on a meter when an input value of zero is applied is its offset or zero error.

parameters

Independent variables in a measurement process such as temperature, humidity, test lead resistance, etc.

power factor

The ratio of actual power used in a circuit, expressed in watts, to the power which is apparently being drawn from the source, expressed in volt-amperes.

precision

The precision of a measurement process is the coherence, or the closeness to the one result, of all measurement results. High precision, for example would result in a tight pattern of arrow hits on a target, without respect to where on the target the tight pattern falls.

predictability

A measure of how accurately the output value of a device can be assumed after a known time following calibration. If a device is highly stable, it is also predictable. If a device is not highly stable, but its value changes at the same rate every time after calibration, its output has a higher degree of predictability than a device that exhibits random change.

primary standard

A standard defined and maintained by some authority and used to calibrate all other secondary standards.

process metrology

Tracking the accuracy drift of calibration and other equipment by applying statistical analysis to correction factors obtained during calibration.

random error

Any error which varies in an unpredictable manner in absolute value and in sign when measurements of the same value of a quantity are made under effectively identical conditions.

range

The stated upper end of a measurement device's span. Usually, however, a measurement device can measure quantities for a specified percentage overrange. (The absolute span including overrange capability is called "scale.") In the 5520A, however, range and scale are identical.

reference standard

The highest-echelon standard in a laboratory; the standard that is used to maintain working standards that are used in routine calibration and comparison procedures.

relative uncertainty

5520A uncertainty specifications that exclude the effects of external dividers and standards, for use when range constants are adjusted. Relative uncertainty includes only the stability, temperature coefficient, noise, and linearity specifications of the 5520A itself.

reliability

A measure of the "uptime" of an instrument.

repeatability

The degree of agreement among independent measurements of a quantity under the same conditions.

resistance

A property of a conductor that determines the amount of current that will flow when a given amount of voltage exists across the conductor. Resistance is measured in ohms. One ohm is the resistance through which one volt of potential will cause one ampere of current to flow.

resolution

The smallest change in quantity that can be detected by a measurement system or device. For a given parameter, resolution is the smallest increment that can be measured, generated, or displayed.

rf (radio frequency)

The frequency range of radio waves; from 150 kHz up to the infrared range.

rms (root-mean-square)

The value assigned to an ac voltage or current that results in the same power dissipation in a resistance as a dc current or voltage of the same value.

rms sensor

A device that converts ac voltage to dc voltage with great accuracy. RMS sensors operate by measuring the heat generated by a voltage through a known resistance (i.e., power); therefore, they sense true rms voltage.

resistance temperature detector (RTD)

A resistance device that provides a proportional resistance output for a temperature of the device. Most RTDs are characterized by their resistance at 0 °C, called the ice point. The most common ice point is 100 Ω at 0 °C. The curve of resistance vs. temperature can be one of several: pt385 (0.00385 ohms/ohm/°C) and pt3926 (0.003926 ohms/ohm/°C) are examples.

scale

The absolute span of the reading range of a measurement device including overrange capability.

scale error

Same as gain error. Scale or gain error results when the slope of the meter's response curve is not exactly 1. A meter with only scale error (no offset or linearity error), will read 0V with 0V applied, but something other than 10V with 10V applied.

secondary standard

A standard maintained by comparison against a primary standard.

sensitivity

The degree of response of a measuring device to the change in input quantity, or a figure of merit that expresses the ability of a measurement system or device to respond to an input quantity.

shield

A grounded covering device designed to protect a circuit or cable from electromagnetic interference.

SI System of Units

The accepted International System of Units. See also "units," "base units," and "derived units."

specifications

A precise statement of the set of requirements satisfied by a measurement system or device.

stability

A measure of the freedom from drift in value over time and over changes in other variables such as temperature. Note that stability is not the same as uncertainty.

standard

A device that is used as an exact value for reference and comparison.

standard cell

A primary cell that serves as a standard of voltage. The term “standard cell” often refers to a “Weston normal cell,” which is a wet cell with a mercury anode, a cadmium mercury amalgam cathode, and a cadmium sulfate solution as the electrolyte.

systematic errors

Errors in repeated measurement results that remain constant or vary in a predictable way.

temperature coefficient

A factor per °C deviation from a nominal value or range that the uncertainty of an instrument increases. This specification is necessary to account for the thermal coefficients in a calibrator’s analog circuitry.

test uncertainty ratio

The numerical ratio of the uncertainty of the measurement system or device being calibrated to the uncertainty of the measurement system or device used as the calibrator. (Also called “test accuracy ratio.”)

thermal emf

The voltage generated when two dissimilar metals joined together are heated.

thermocouple

Two dissimilar metals that, when welded together, develop a small voltage dependent on the relative temperature between the hotter and colder junction.

traceability

The ability to relate individual measurement results to national standards or nationally accepted measurement systems through an unbroken chain of comparisons, i.e., a calibration “audit trail.”

Measurements, measurement systems or devices have traceability to the designated standards if and only if scientifically rigorous evidence is produced in a continuing basis to show that the measurement process is producing measurement results for which the total measurement uncertainty relative to national or other designated standards is qualified.

transfer error

The sum of all new errors induced during the process of comparing one quantity against another.

transfer standard

Any working standard used to compare a measurement process, system, or device at one location or level with another measurement process, system, or device at another location or level.

transport standard

A transfer standard that is rugged enough to allow shipment by common carrier to another location.

true power

The actual power (real power) used to produce heat or work. Compare to ‘apparent power.’”

true value

Also called legal value, the accepted, consensus, i.e., the correct value of the quantity being measured.

uncertainty

The maximum difference between the accepted, consensus, or true value and the measured value of a quantity. Uncertainty is normally expressed in units of ppm (parts per million) or as a percentage.

units

Symbols or names that define the measured quantities. Examples of units are: V, mV, A, kW, and dBm. See also “SI System of Units.”

UUT (Unit Under Test)

An abbreviated name for an instrument that is being tested or calibrated.

var

Symbol for voltampere reactive, the unit of reactive power, as opposed to real power in watts.

verification

Checking the functional performance and uncertainty of an instrument or standard without making adjustments to it or changing its calibration constants.

volt

The unit of emf (electromotive force) or electrical potential in the SI system of units. One volt is the difference of electrical potential between two points on a conductor carrying one ampere of current, when the power being dissipated between these two points is equal to one watt.

voltage guard

A floating shield around voltage measurement circuitry inside an instrument. The voltage guard provides a low-impedance path to ground for common-mode noise and ground currents, thereby eliminating errors introduced by such interference.

watt

The unit of power in the SI system of units. One watt is the power required to do work at the rate of one joule/second. In terms of volts and ohms, one watt is the power dissipated by one ampere flowing through a one-ohm load.

working standard

A standard that is used in routine calibration and comparison procedures in the laboratory, and is maintained by comparison to reference standards.

zero error

Same as offset error. The reading shown on a meter when an input value of zero is applied is its zero or offset error.

Appendix B
ASCII and IEEE-488 Bus Codes

ASCII CHAR.	DECIMAL	OCTAL	HEX	BINARY 7654 3210	DEV. NO.	MESSAGE ATN=TRUE	ASCII CHAR.	DECIMAL	OCTAL	HEX	BINARY 7654 3210	DEV. NO.	MESSAGE ATN=TRUE
NUL	0	000	00	0000 0000			@	64	100	40	0100 0000	0	MTA
SQH	1	001	01	0000 0001			A	65	101	41	0100 0001	1	MTA
STX	2	002	02	0000 0010		GTL	B	66	102	42	0100 0010	2	MTA
ETX	3	003	03	0000 0011			C	67	103	43	0100 0011	3	MTA
EOT	4	004	04	0000 0100			D	68	104	44	0100 0100	4	MTA
ENQ	5	005	05	0000 0101		SDC PPC	E	69	105	45	0100 0101	5	MTA
ACH	6	006	06	0000 0110			F	70	106	46	0100 0110	6	MTA
BELL	7	007	07	0000 0111			G	71	107	47	0100 0111	7	MTA
BS	8	010	08	0000 1000			H	72	110	48	0100 1000	8	MTA
HT	9	011	09	0000 1001		GET TCT	I	73	111	49	0100 1001	9	MTA
LF	10	012	0A	0000 1010			J	74	112	4A	0100 1010	10	MTA
VT	11	013	0B	0000 1011			K	75	113	4B	0100 1011	11	MTA
FF	12	014	0C	0000 1100			L	76	114	4C	0100 1100	12	MTA
CR	13	015	0D	0000 1101			M	77	115	4D	0100 1101	13	MTA
SO	14	016	0E	0000 1110			N	78	116	4E	0100 1110	14	MTA
SI	15	017	0F	0000 1111			O	79	117	4F	0100 1111	15	MTA
DLE	16	020	10	0001 0000			P	80	120	50	0101 0000	16	MTA
DC1	17	021	11	0001 0001		LLO	Q	81	121	51	0101 0001	17	MTA
DC2	18	022	12	0001 0010			R	82	122	52	0101 0010	18	MTA
DC3	19	023	13	0001 0011			S	83	123	53	0101 0011	19	MTA
DC4	20	024	14	0001 0100		DCL PPU	T	84	124	54	0101 0100	20	MTA
NAK	21	025	15	0001 0101			U	85	125	55	0101 0101	21	MTA
SYN	22	026	16	0001 0110			V	86	126	56	0101 0110	22	MTA
ETB	23	027	17	0001 0111			W	87	127	57	0101 0111	23	MTA
CAN	24	030	18	0001 1000		SPE SPD	X	88	130	58	0101 1000	24	MTA
EM	25	031	19	0001 1001			Y	89	131	59	0101 1001	25	MTA
SUB	26	032	1A	0001 1010			Z	90	132	5A	0101 1010	26	MTA
ESC	27	033	1B	0001 1011			[91	133	5B	0101 1011	27	MTA
FS	28	034	1C	0001 1100			\	92	134	5C	0101 1100	28	MTA
GS	29	035	1D	0001 1101]	93	135	5D	0101 1101	29	MTA
RS	30	036	1E	0001 1110			^	94	136	5E	0101 1110	30	MTA
US	31	037	1F	0001 1111			_	95	137	5F	0101 1111	30	MTA UNT
SPACE	32	040	20	0010 0000	0	MLA	,	96	140	60	0111 0000	0	MSA
!	33	041	21	0010 0001	1	MLA	a	97	141	61	0111 0001	1	MSA
"	34	042	22	0010 0010	2	MLA	b	98	142	62	0111 0010	2	MSA
#	35	043	23	0010 0011	3	MLA	c	99	143	63	0111 0011	3	MSA
\$	36	044	24	0010 0100	4	MLA	d	100	144	64	0111 0100	4	MSA
%	37	045	25	0010 0101	5	MLA	e	101	145	65	0111 0101	5	MSA
&	38	046	26	0010 0110	6	MLA	f	102	146	66	0111 0110	6	MSA
'	39	047	27	0010 0111	7	MLA	g	103	147	67	0111 0111	7	MSA
(40	050	28	0010 1000	8	MLA	h	104	150	68	0111 1000	8	MSA
)	41	051	29	0010 1001	9	MLA	i	105	151	69	0111 1001	9	MSA
*	42	052	2A	0010 1010	10	MLA	j	106	152	6A	0111 1010	10	MSA
+	43	053	2B	0010 1011	11	MLA	k	107	153	6B	0111 1011	11	MSA
,	44	054	2C	0010 1100	12	MLA	l	108	154	6C	0111 1100	12	MSA
-	45	055	2D	0010 1101	13	MLA	m	109	155	6D	0111 1101	13	MSA
.	46	056	2E	0010 1110	14	MLA	n	110	156	6E	0111 1110	14	MSA
/	47	057	2F	0010 1111	15	MLA	o	111	157	6F	0111 1111	15	MSA
0	48	060	30	0011 0000	16	MLA	p	112	160	70	0111 0000	16	MSA
1	49	061	31	0011 0001	17	MLA	q	113	161	71	0111 0001	17	MSA
2	50	062	32	0011 0010	18	MLA	r	114	162	72	0111 0010	18	MSA
3	51	063	33	0011 0011	19	MLA	s	115	163	73	0111 0011	19	MSA
4	52	064	34	0011 0100	20	MLA	t	116	164	74	0111 0100	20	MSA
5	53	065	35	0011 0101	21	MLA	u	117	165	75	0111 0101	21	MSA
6	54	066	36	0011 0110	22	MLA	v	118	166	76	0111 0110	22	MSA
7	55	067	37	0011 0111	23	MLA	w	119	167	77	0111 0111	23	MSA
8	56	070	38	0011 1000	24	MLA	x	120	170	78	0111 1000	24	MSA
9	57	071	39	0011 1001	25	MLA	y	121	171	79	0111 1001	25	MSA
:	58	072	3A	0011 1010	26	MLA	z	122	172	7A	0111 1010	26	MSA
;	59	073	3B	0011 1011	27	MLA	{	123	173	7B	0111 1011	27	MSA
<	60	074	3C	0011 1100	28	MLA		124	174	7C	0111 1100	28	MSA
=	61	075	3D	0011 1101	29	MLA	}	125	175	7D	0111 1101	29	MSA
>	62	076	3E	0011 1110	30	MLA	~	126	176	7E	0111 1110	30	MSA
?	63	077	3F	0011 1111	31	UNL		127	177	7F	0111 1111	31	UNS

TALK ADDRESSES

SECONDARY ADDRESSES

Appendix C

RS-232/IEEE-488 Cables and Connectors

IEEE-488 Connector

The IEEE-488 connector on the rear panel mates with an IEEE-488 standard cable. The pin assignments of the rear-panel IEEE-488 connector are shown in Figure C-1. IEEE-488 connection cables are available from Fluke as shown in Table C-1. See Chapter 9, "Accessories," for ordering information.

Table C-1. IEEE-488 Connection Cables

IEEE-488 Connection Cable	Fluke Part Number
0.5 m (1.64 feet)	PM2295/05
1 m (3.28 feet)	PM2295/10
2 m (6.56 feet)	PM2295/20

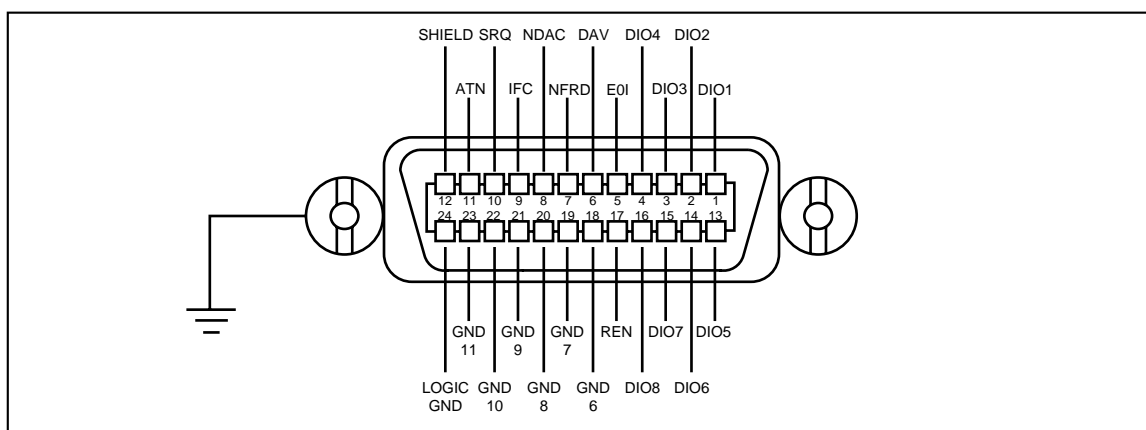

Figure C-1. IEEE-488 Connector Pinout (connection side)

FE-01.EPS

Serial Connectors

The two 9-pin serial connectors on the rear panel of the 5520A Calibrator are used to interface with a computer, or controller, and an instrument serial port. The pin assignments of the rear-panel serial connectors are in conformance to EIA/TIA-574 standard and are shown in Figures C-1 (Host) and C-2 (UUT).

Serial connection cables are available from Fluke are shown in Table C-2. See Chapter 9, “Accessories,” for ordering information.

Table C-2. Serial Port Connection Cables

Connection Cable		Fluke Part Number
5520A SERIAL 1 FROM HOST	PC COM port (DB-9)	PM8914/001
5520A SERIAL 1 FROM HOST	PC COM port (DB-25)	RS40
5520A SERIAL 2 TO UUT	UUT serial port (DB-9)	943738
5520A SERIAL 2 TO UUT	UUT serial port (DB-25)	n/a

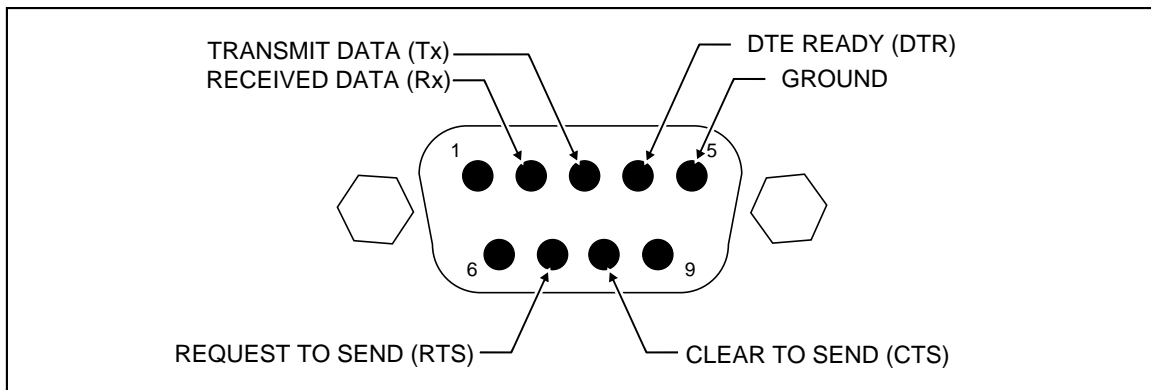

Figure C-2. SERIAL 1 FROM HOST Port Connector Pinout

FE-02.EPS

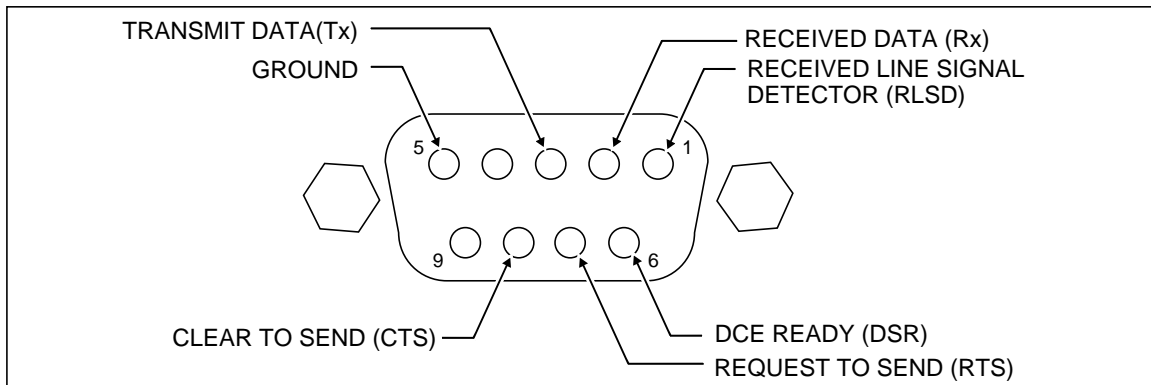
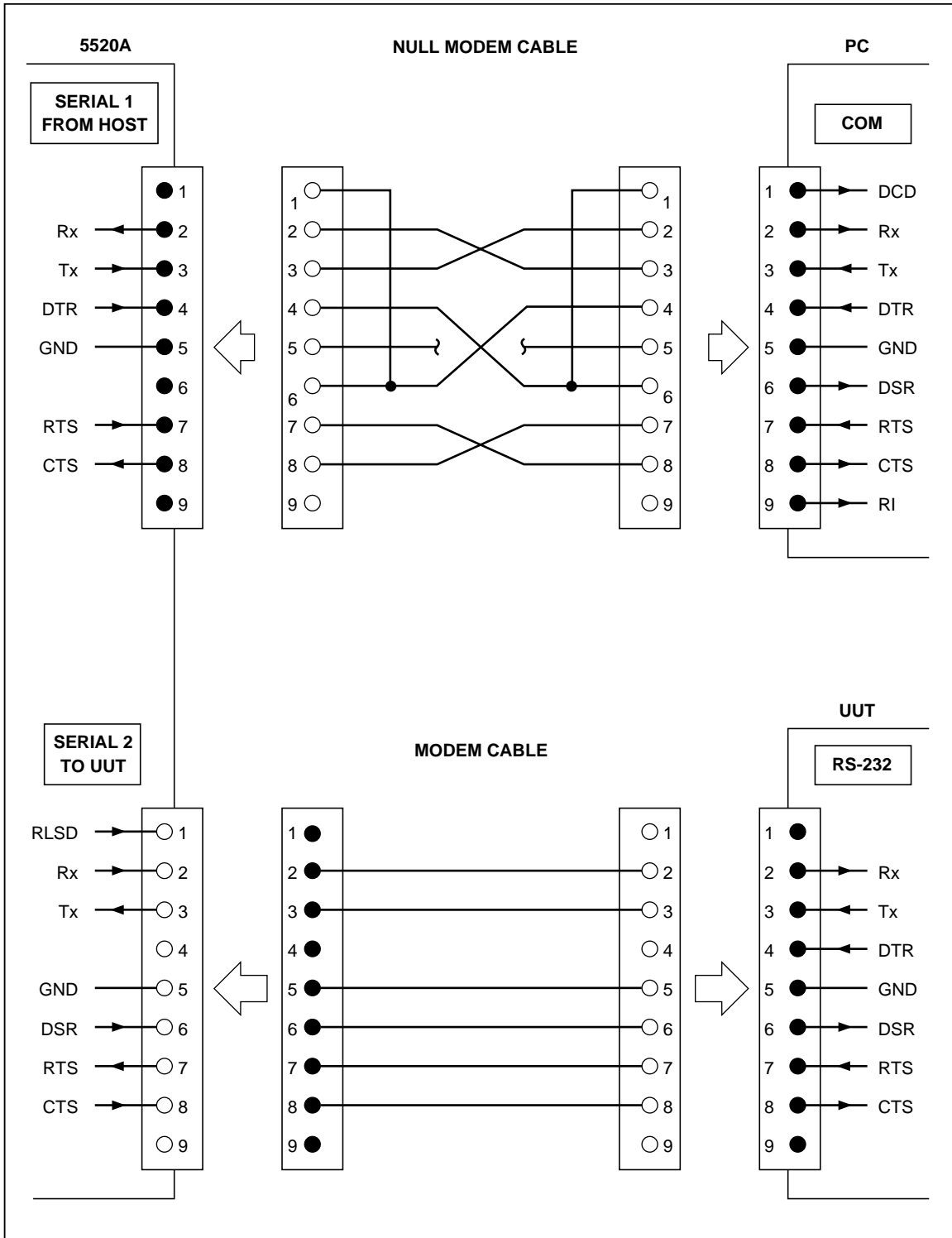

Figure C-3. SERIAL 2 TO UUT Port Connector Pinout (connection side)

FE-03.EPS



FE-04.EPS

Figure C-4. Serial Port Connections (DB-9/DB-9)

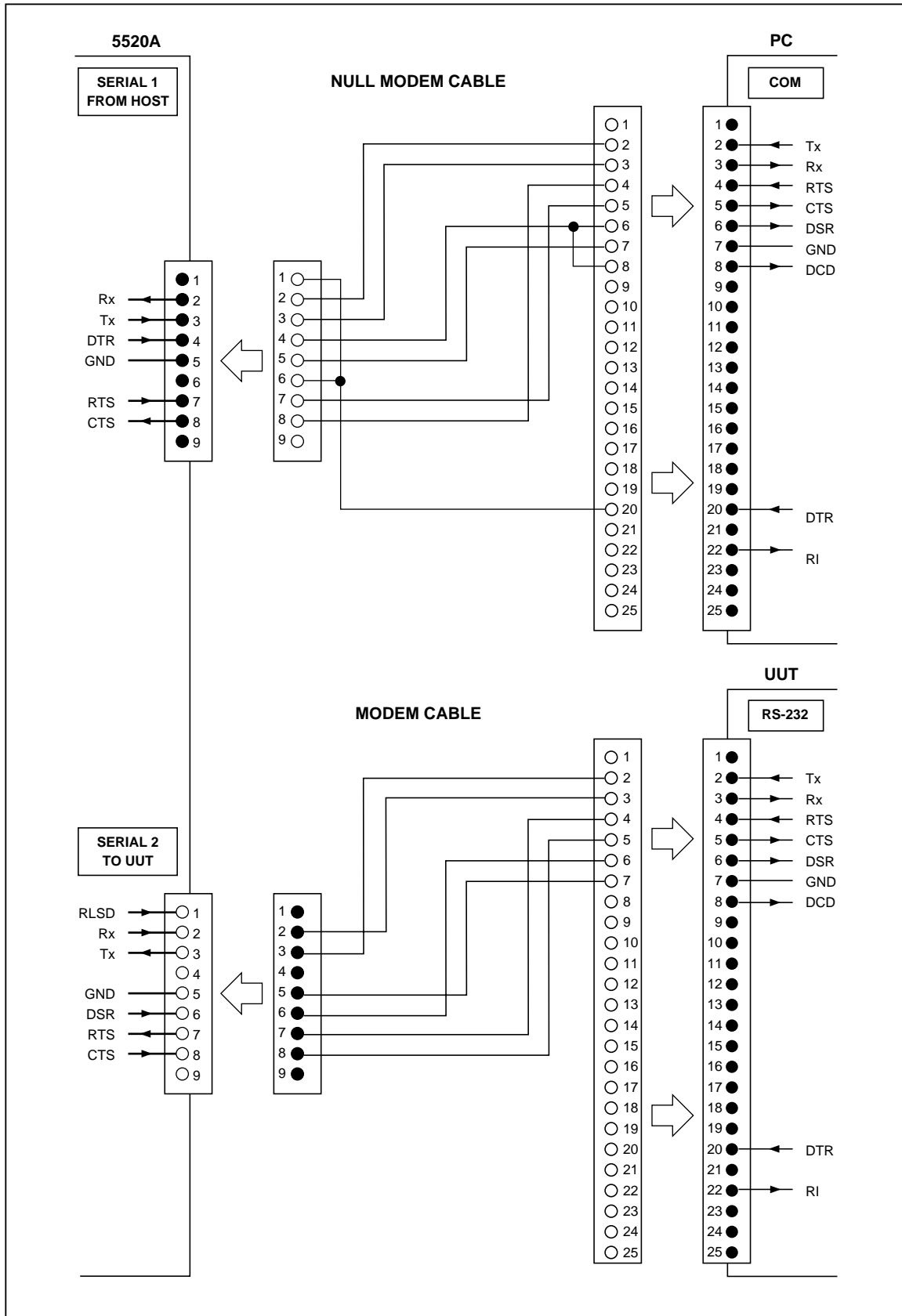

Figure C-5. Serial Port Connections (DB-9/DB-25)

FE-05.EPS

Appendix D

Creating a Visual Basic Test Program

Creating a Visual Basic Test Program

The following procedure creates a test program in Visual Basic that you may use to test 5520A Calibrator RS-232 Host port and RS-232 UUT port operation. This program is referenced in Chapter 4 under “Testing RS-232 (Host) Operation using Visual Basic” and “Testing RS-232 (UUT) Operation using Visual Basic.” This procedure assumes you have access to the Custom Control Icons in your edition of Visual Basic, and creates the least complicated program for RS-232 testing.

Complete the following procedure to create an RS-232 test program in Visual Basic.

1. Open Microsoft Visual Basic from the Visual Basic group, displaying the Form1 screen (below).

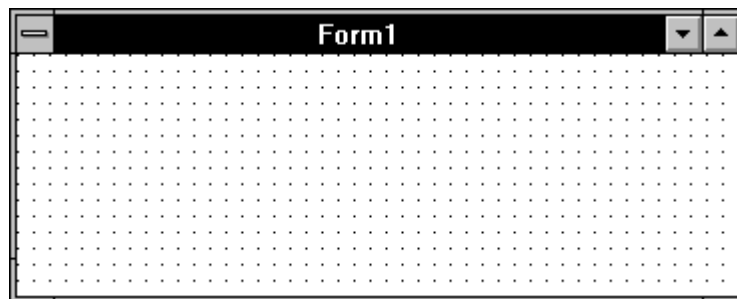

2. From the Toolbox, double click the Command icon , creating a Command1 button on the Form1 screen. Repeat, creating a Command2 button. Repeat again creating a Command3 button.

3. Separate the Command buttons and resize the form for ease of use (below is typical).

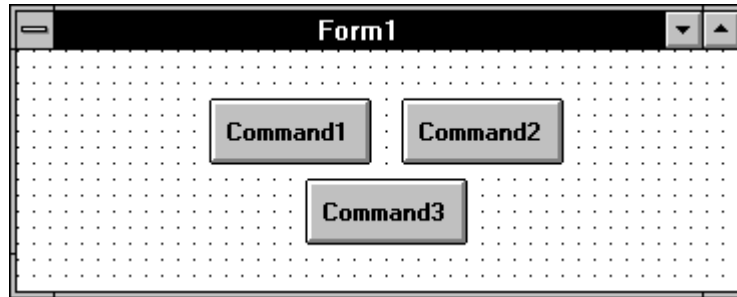

4. From the Toolbox, double click the Communications icon , placing the icon on the Form1 screen. This custom control icon provides complete serial communications capabilities for this program. Position the icon anywhere on the Form1 screen that is convenient.
5. Double click on a clear area of the Form1 screen to open the Code window for Form1. Enter the code shown below. If using COM2 on the PC, change the command to `Comm1.CommPort = 2`. If not using the factory default settings for the RS-232 ports, then change the command `Comm1.Settings` as required.

```
Sub Form_Load ()  
    Comm1.CommPort = 1           [if using COM2, enter = 2]  
    Comm1.Settings = "9600,N,8,1" [baud, parity, data, stop]  
    Comm1.PortOpen = True  
End Sub
```

6. While still in the Code window, select Command1 from the Object list. Enter the code shown below. The `Chr(10)` means ascii character 10 (line feed).

```
Sub Command1_Click ()  
    Comm1.Output = "REMOTE" + Chr(10)  
End Sub
```

7. Select Command2 from the Object list. Enter the code shown below.

```
Sub Command2_Click ()  
    Comm1.Output = "LOCAL" + Chr(10)  
End Sub
```

8. Select Command3 from the Object list. Enter the code shown below, where `<uut command>` is the command you selected for the UUT response.

```
Sub Command3_Click ()  
    Comm1.Output = "UUT_SEND "<uut command>" " + Chr(10)  
End Sub
```

For example, `"UUT_SEND "REMS\n" "`. Note the use of `\n`, which indicates a Carriage Return (CR) as the end-of-line character. Other characters include `\r` (Line Feed), `\t` (Tab), `\b` (Backspace) and `\f` (Form Feed). Also note the double quotes around `<uut command>` to show embedded quotes.

9. On the Visual Basic Toolbar, click the Start button  to run the RS-232 test program (below is typical). If there are no errors, continue to Step 10.

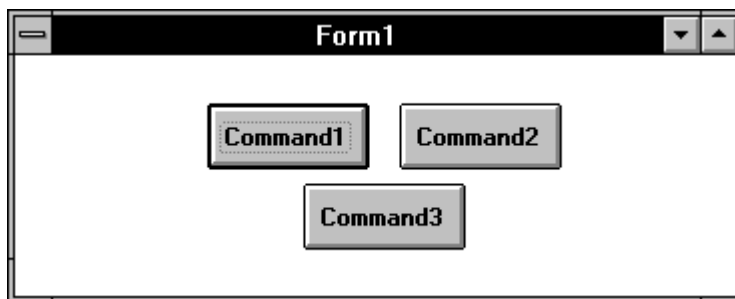

10. Click the Stop button  on the Toolbar to stop the program.
 (Hint: Before continuing to the next step, connect the 5520A Calibrator and UUT (if applicable) and test the program in actual operation.)
11. Save the program as `vb_rs232.exe` by selecting the Make EXE File command from the File menu. Save the program files by selecting the Save Program command from the File menu.
12. Select the Exit command from the File menu to exit Visual Basic.
13. In Program Manager, select New from the File menu. Check Program Group, then click OK. In the Description box, enter RS-232 Test then click OK. This creates and opens the RS-232 Test group.
14. With the RS-232 Test group still open, select New from the File menu. Check Program Item, then click OK. In the Description box, enter Test Ports. Use Browse to locate your `vb_rs232.exe` file, then click OK to enter this file in the Command Line box. Click OK. This creates the Test Ports icon (below).

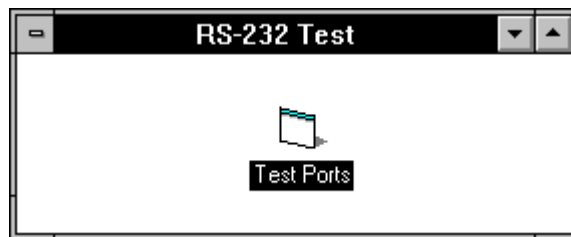

FF-0C.BMP

Appendix E

Error Messages

Error Messages

The following is a list of the 5520A Calibrator error messages. The error message format is shown in Table E-1.

Table E-1. Error Message Format

Error Number	(Message Class : Description)	Text characters
0 to 65535	QYE Query Error, caused by a full input buffer, unterminated action or interrupted action F Error is displayed on the front panel as it occurs	Up to 36 text characters
	DDE Device-Specific Error, caused by the 5520A due to some condition, for example, overrange R Error is queued to the remote interface as it occurs	
	EXE Execution Error, caused by an element outside of, or inconsistent with, the 5520A capabilities S Error causes instrument to go to Standby	
	CME Command Error, caused by incorrect command syntax, unrecognized header, or parameter of the wrong type D Error causes instrument returns to the power up state	
	(none) Error is returned to the initiator only (i.e., local initiator or remote initiator)	

- 0 (QYE:) No Error
- 1 (DDE:FR) Error queue overflow
- 100 (DDE:FR D) Inguard not responding (send)

101	(DDE:FR D)	Inguard not responding (recv)
102	(DDE:FR D)	Lost sync with inguard
103	(DDE:FR)	Invalid guard xing command
104	(DDE:FR D)	Hardware relay trip occurred
105	(DDE:FR D)	Inguard got impatient
106	(DDE:FR D)	A/D fell asleep
107	(DDE:FR D)	Inguard watchdog timeout
108	(DDE:FR)	Inguard is obsolete
109	(DDE:FR D)	Inguard parity error
110	(DDE:FR D)	Inguard overrun error
111	(DDE:FR D)	Inguard framing error
112	(DDE:FR D)	Inguard fault error
113	(DDE:FR D)	Inguard fault input error
114	(DDE:FR D)	Inguard fault detect error
115	(DDE:FR D)	Inguard read/write error
300	(DDE:)	Invalid procedure number
301	(DDE:)	No such step in procedure
302	DDE:)	Can't change that while busy
303	(DDE:)	Can't begin/resume cal there
304	(DDE:)	Wrong unit for reference
305	(DDE:)	Entered value out of bounds
306	(DDE:)	Not waiting for a reference
307	(DDE:)	Continue command ignored
308	(DDE:FR)	Cal constant outside limits
309	(DDE:FR)	Cal try to null failed
310	(DDE:FR D)	Sequence failed during cal
311	(DDE:FR D)	A/D measurement failed
312	(DDE:FR)	Invalid cal step parameter
313	(DDE:)	Cal switch must be ENABLED
314	(DDE:FR)	Divide by zero encountered
315	(DDE:FR)	Must be in OPER at this step
316	(DDE:FR)	Open thermocouple for RJ cal
317	(DDE:FR)	Bad reference Z or entry
318	(DDE:FR)	Cal takes DAC over top limit
319	(DDE: R)	Zero cal needed every 7 days
320	(DDE: R)	Ohms zero needed every 12 hours
398	(QYE:F)	Unusual cal fault %d
399	QYE:F)	Fault during %s
400	(DDE:FR D)	Encoder not responding VERS
401	(DDE:FR D)	Encoder not responding COMM
402	(DDE:FR D)	Encoder not responding STAT
403	(DDE:FR)	Encoder self-test failed
405	(DDE:FR)	Message over display R side
406	(DDE:FR)	Unmappable character #%d
407	(DDE:FR)	Encoder did not reset
408	(DDE:FR)	Encoder got invalid command

409	(DDE:FR D)	Encoder unexpectedly reset
500	(DDE:)	Internal state error
501	(DDE:)	Invalid keyword or choice
502	(DDE:)	Harmonic must be 1 - 50
503	(DDE:)	Frequency must be ≥ 0
504	(DDE:)	AC magnitude must be > 0
505	(DDE:)	Impedance must be ≥ 0
506	(DDE:)	Function not available
507	(DDE:)	Value not available
508	(DDE:)	Cannot enter watts by itself
509	(DDE:)	Output exceeds user limits
510	(DDE:)	Duty cycle must be 1.0-99.0
511	(DDE:)	Power factor must be 0.0-1.0
512	(DDE:)	Can't select that field now
513	(DDE:)	Edit digit out of range
514	(DDE:)	Can't switch edit field now
515	(DDE:)	Not editing output now
516	(DDE:)	dBm only for single sine ACV
517	(DDE:)	Freq too high for non-sine
518	(DDE:)	Value outside locked range
519	(DDE:)	Must specify an output unit
520	(DDE:)	Can't do two freqs at once
521	(DDE:)	Can't source 3 values at once
522	(DDE:)	Temp must be degrees C or F
523	(DDE:)	Can't do that now
526	(DDE:)	Limit too small or large
527	(DDE:)	No changes except RESET now
528	(DDE:)	Offset out of range
529	(DDE:)	Cannot edit to or from 0 Hz
530	(DDE:)	Bad state image - not loaded
531	(DDE:)	TC offset limited to ± 500 C
532	(DDE:)	Can't go to STBY in Meas TC
533	(DDE:)	Can't set an offset now
534	(DDE:)	Can't lock this range
535	(DDE:)	Can't set phase or PF now
536	(DDE:)	Can't set wave now
537	(DDE:)	Can't set harmonic now
538	(DDE:)	Can't change duty cycle now
539	(DDE:)	Can't change compensation now
540	(DDE:FR)	Current OUTPUT moved to 5725A
541	(DDE:)	TC ref must be valid TC temp
542	(DDE:)	Can't turn EARTH on now
543	(DDE: D)	STA couldn't update OTD
544	(DDE:)	Can't enter W with non-sine
545	(DDE:)	Can't edit now
546	(DDE:)	Can't set trigger to that now

547	(DDE:)	Can't set output imp. now
548	(DDE:FR)	Compensation is now OFF
549	(DDE:)	Period must be >= 0
550	(DDE:)	A report is already printing
551	(DDE:)	ScopeCal option not installed
552	(DDE:)	Not a ScopeCal function
553	(DDE:)	Can't set marker shape now
554	(DDE:)	Can't set video parameter now
555	(DDE:)	Marker location out of range
556	(DDE:)	Pulse width must be 1 - 255
557	(DDE:)	Can't set range directly now
558	(DDE:)	Not a range for this function
559	(DDE:)	Can't set TD pulse now
560	(DDE:)	ZERO_MEAS only for C or PRES meas
561	(DDE:FR)	That requires a -SC option
562	(DDE:FR)	That requires a -SC600 option
563	(DDE:)	Time limit must be 1s-60s
564	(DDE:)	Can't set ref. phase now
565	(DDE:)	ZERO_MEAS reading not valid
566	(DDE:)	Can't set dampen now
567	(DDE:)	Can't turn EXGRD on now
600	(DDE:FR D)	Outguard watchdog timeout
601	(DDE:FR)	Power-up RAM test failed
602	(DDE:FR)	Power-up GPIB test failed
700	(DDE: R)	Saving to NV memory failed
701	(DDE: R)	NV memory invalid
702	(DDE: R)	NV invalid so default loaded
703	(DDE: R)	NV obsolete so default loaded
800	(DDE:FR)	Serial parity error %s
801	(DDE:FR)	Serial framing error %s
802	(DDE:FR)	Serial overrun error %s
803	(DDE:FR)	Serial characters dropped %s
900	(DDE:FR)	Report timeout - aborted
1000	(DDE:FR)	Sequence failed during diag
1001	(DDE:FR)	Guard xing link diag fail
1002	(DDE:FR)	Inguard bus r/w diag fail
1003	(DDE:FR)	A6 A/D comm fault
1004	(DDE:FR)	A6 A/D or DAC fault
1005	(DDE:FR)	A6 DAC fine channel fault
1006	(DDE:FR)	A6 DCI loop fault
1007	(DDE:FR)	A6 ACI loop fault
1008	(DDE:FR)	A6 TC fault
1009	(DDE:FR)	A6 DCV loop fault
1010	(DDE:FR)	A6 ACV loop fault
1011	(DDE:FR)	A6 33 mV divider fault
1012	(DDE:FR)	A6 330 mV DC fault

1013	(DDE:FR)	A6 +3.3V DC fault
1014	(DDE:FR)	A6 -3.3V DC fault
1015	(DDE:FR)	A8 33V DC fault
1016	(DDE:FR)	A6 33 mV AC fault
1017	(DDE:FR)	A6 330 mV AC fault
1018	(DDE:FR)	A6 3.3V AC fault
1019	(DDE:FR)	A8 33V AC fault
1020	(DDE:FR)	A6 vloop error amp fault
1021	(DDE:FR)	A6 3.3V amp fault
1022	(DDE:FR)	A6 polarity inverter fault
1023	(DDE:FR)	A6 3.3V sense buffer fault
1024	(DDE:FR)	A6 33V sense buffer fault
1025	(DDE:FR)	A6 330V sense buffer fault
1026	(DDE:FR)	A6 1000V sense buffer fault
1027	(DDE:FR)	A6 trim DAC 0 (3.3V) fault
1028	(DDE:FR)	A6 trim DAC 0 (33V) fault
1029	(DDE:FR)	A6 trim DAC 1 fault
1030	(DDE:FR)	A8 33V DC offset fault
1031	(DDE:FR)	A8 330V AC low F fault
1032	(DDE:FR)	A8 330V AC high F fault
1033	(DDE:FR)	A8 330V DC fault
1034	(DDE:FR)	A8 1000V AC low F fault
1035	(DDE:FR)	A8 1000V AC high F fault
1036	(DDE:FR)	A8 1000V DC fault
1040	(DDE:FR)	A5 interface fault
1041	(DDE:FR)	A5 X1 input amp fault
1042	(DDE:FR)	A5 lo comp amp fault
1043	(DDE:FR)	A5 coarse ZDAC fault
1044	(DDE:FR)	A5 fine ZDAC fault
1045	(DDE:FR)	A5 inverting amp fault
1046	(DDE:FR)	A5 X2.45 input amp fault
1047	(DDE:FR)	A5 X3 input amp fault
1048	(DDE:FR)	A5 X13.1 input amp fault
1049	(DDE:FR)	A5 input leakage fault
1050	(DDE:FR)	A5 offset comp fault
1051	(DDE:FR)	A5 input voltage detect fault
1052	(DDE:FR)	A5 12.75 ohm reference fault
1053	(DDE:FR)	A5 33.25 ohm reference fault
1054	(DDE:FR)	A5 100 ohm reference fault
1055	(DDE:FR)	A5 325 ohm reference fault
1056	(DDE:FR)	A5 1 kohm reference fault
1057	(DDE:FR)	A5 3.25 kohm reference fault
1058	(DDE:FR)	A5 10 kohm reference fault
1059	(DDE:FR)	A5 33 kohm reference fault
1060	(DDE:FR)	A5 100 kohm reference fault
1061	(DDE:FR)	A5 325 kohm reference fault

1062	(DDE:FR)	A5 1 Mohm reference fault
1063	(DDE:FR)	A5 2W comp open ckt fault
1064	(DDE:FR)	A5 2W comp fault
1065	(DDE:FR)	A7 Shunt amp fault (2.2A)
1066	(DDE:FR)	A7 Shunt amp fault (3.3 mA)
1067	(DDE:FR)	A7 Shunt amp fault (33 mA)
1068	(DDE:FR)	A7 Shunt amp fault (330 mA)
1069	(DDE:FR)	A7 Shunt amp fault (11A)
1070	(DDE:FR)	A7 Leakage current fault
1071	(DDE:FR)	A7 Output amp leakage fault
1072	DDE:FR)	A7 Undercurrent fault +3.3 mA
1073	(DDE:FR)	A7 Overcurrent fault +3.3 mA
1074	(DDE:FR)	A7 Undercurrent fault -3.3 mA
1075	(DDE:FR)	A7 Overcurrent fault -3.3 mA
1076	(DDE:FR)	A7 Undercurrent fault +33 mA
1077	(DDE:FR)	A7 Overcurrent fault +33 mA
1078	(DDE:FR)	A7 Undercurrent fault -33 mA
1079	(DDE:FR)	A7 Overcurrent fault -33 mA
1080	(DDE:FR)	A7 Undercurrent fault -330 mA
1081	(DDE:FR)	A7 Overcurrent fault -330 mA
1082	(DDE:FR)	A7 Undercurrent fault +330 mA
1083	(DDE:FR)	A7 Overcurrent fault +330 mA
1084	(DDE:FR)	A7 Undercurrent fault -2.2A
1085	(DDE:FR)	A7 Overcurrent fault -2.2A
1086	(DDE:FR)	A7 Undercurrent fault +2.2A
1087	(DDE:FR)	A7 Overcurrent fault +2.2A
1088	(DDE:FR)	A7 Aux amp fault
1089	(DDE:FR)	A7 Monitor fault (+DC)
1090	(DDE:FR)	A7 Monitor fault (-DC)
1200	(DDE:FR)	Sequence name too long
1201	(DDE:FR)	Sequence RAM table full
1202	(DDE:FR)	Sequence name table full
1300	(CME: R)	Bad syntax
1301	(CME: R)	Unknown command
1302	(CME: R)	Bad parameter count
1303	(CME: R)	Bad keyword
1304	(CME: R)	Bad parameter type
1305	(CME: R)	Bad parameter unit
1306	(EXE: R)	Bad parameter value
1307	(QYE: R)	488.2 I/O deadlock
1308	(QYE: R)	488.2 interrupted query
1309	(QYE: R)	488.2 unterminated command
1310	(QYE: R)	488.2 query after indefinite response
1311	(DDE: R)	Invalid from GPIB interface
1312	(DDE: R)	Invalid from serial interface
1313	(DDE: R)	Service only

1314	(EXE: R)	Parameter too long
1315	(CME: R)	Invalid device trigger
1316	(EXE: R)	Device trigger recursion
1317	(CME: R)	Serial buffer full
1318	(EXE: R)	Bad number
1319	(EXE: R)	Service command failed
1320	(CME: R)	Bad binary number
1321	(CME: R)	Bad binary block
1322	(CME: R)	Bad character
1323	(CME: R)	Bad decimal number
1324	(CME: R)	Exponent magnitude too large
1325	(CME: R)	Bad hexadecimal block
1326	(CME: R)	Bad hexadecimal number
1328	(CME: R)	Bad octal number
1329	(CME: R)	Too many characters
1330	(CME: R)	Bad string
1331	(DDE: R)	OPER not allowed while error pending
1332	(CME:FR)	Can't change UUT settings now
1500	(DDE:FRS)	Compliance voltage exceeded
1501	(DDE:FRS)	Shunt amp over or underload
1502	(DDE:FRS)	Current Amp Thermal Limit Exceeded
1503	(DDE:FRS)	Output current lim exceeded
1504	(DDE:FRS)	Input V or A limit exceeded
1505	(DDE:FRS)	VDAC counts out of range
1506	(DDE:FRS)	IDAC counts out of range
1507	(DDE:FRS)	AC scale dac counts out of range
1508	(DDE:FRS)	DC scale dac counts out of range
1509	(DDE:FRS)	Frequency dac counts out of range
1510	(DDE:FRS)	IDAC counts (DC OFFSET) out of range
1511	(DDE:FRS)	ZDAC counts out of range
1512	(DDE:FRS)	Can't read External Clock register
1513	(DDE:FRS)	External Clock too Fast
1514	(DDE:FRS)	External Clock too Slow
1515	(DDE:FR D)	Can't load waveform for scope mode
1600	(DDE:FR D)	OPM transition error
1601	(DDE:FR D)	TC measurement fault
1602	(DDE:FR D)	Z measurement fault
65535	(DDE:FR)	Unknown error %d

Index

- *CLS remote command, 6-11
- *ESE remote command, 6-17
- *ESE? remote command, 6-17
- *ESR? remote command, 6-17
- *IDN? remote command, 6-21
- *OPC command, using, 5-47
- *OPC remote command, 6-27
- *OPC? command, using, 5-47
- *OPC? remote command, 6-28
- *OPT? remote command, 6-28
- *PUD remote command, 6-35
- *PUD? remote command, 6-35
- *RST remote command, 6-40
- *SRE remote command, 6-44
- *SRE? remote command, 6-45
- *STB? remote command, 6-45
- *TEMP_STD? remote command, 6-50
- *TRG remote command, 6-50
- *TRG remote command, SC600 option, 8-40
- *TST? remote command, 6-52
- *WAI command, using, 5-47
- *WAI remote command, 6-55
- +/- key, 3-8
- 10 MHz IN BNC connector, 3-10
- 10 MHz IN BNC connector, using, 4-58
- 10 MHz OUT BNC connector, 3-10
- 10 MHz OUT BNC connector, using, 4-58
- 20A terminal, 3-9
- 3-phase power calibration, 4-60
- 80 Series DMM, calibrating, 4-61
- ac current
 - (non-sine wave) specifications, 1-32
 - (sine wave) extended bandwidth specifications, 1-31
 - connections, 4-16
 - setting the output, 4-24
 - square wave characteristics (typical), 1-34
 - triangle wave characteristics (typical), 1-34
- ac power
 - (45 Hz to 65 Hz) specification summary, 1-22
 - setting the output, 4-28
- AC POWER INPUT module, 3-11
- ac voltage
 - (non-sine wave) specifications, 1-29
 - (sine wave) extended bandwidth specifications, 1-28
 - connections, 4-16
 - dc offset specifications, 1-30
 - square wave characteristics, 1-31
 - triangle wave characteristics (typical), 1-31
- accessing the fuse and selecting line voltage, 2-6
- accessories and options (Chapter 8), 9-3
- air filter, cleaning, 7-5
- arrow keys, 3-6
- AUX terminals, 3-9
- cable connection instructions, 4-12
- CALIBRATION switch, 3-10, 5-31
- capacitance
 - (compensation off) connections, 4-15
 - (two-wire compensation) connections, 4-15
 - setting the output, 4-38
 - specifications, 1-19
- Caution, 4-73, 7-6
- CAUTION, 2-4, 2-8, 4-3, 4-6, 4-19, 4-20, 4-26, 4-29, 4-32, 4-34, 7-5
- CE key, 3-6
- CFREQ? remote command, 6-10
- character processing, incoming, 5-35
- CHASSIS GROUND terminal, 3-11
- cleaning, general, 7-6, 7-7
- CLOCK remote command, 6-10
- clock, external 10 MHz, 4-58
- CLOCK? remote command, 6-11
- commands, remote

- setup and utility, 6-8
- status, 6-9
- thermocouple (TC), 6-9
- commands, remote
 - pressure measurement, 6-7
 - common, 6-3
 - common, 5-27
 - compound, 5-29
 - coupled, 5-29
 - error mode, 6-4
 - external connection, 6-4
 - for IEEE-488 only, 5-32
 - for RS-232 only, 5-31
 - grouped by function, 6-3
 - listed alphabetically, 6-10
 - oscilloscope, 6-5
 - output commands, 6-5
 - overlapped, 5-30
 - query, 5-27
 - RS-232 Host port, 6-7
 - sequential, 5-30
 - syntax information, 5-33
 - types of, 5-26
 - using, 5-26
- commands,remote
 - RS-232 UUT Port, 6-7
- common commands, 5-27, 6-3
- compound commands, 5-29
- controlling an instrument using RS-232, 5-49
- coupled commands, 5-29
- CUR_POST remote command, 6-11
- CUR_POST? remote command, 6-11
- DAMPEN remote command, 6-11
- DAMPEN? remote command, 6-12
- DBMZ remote command, 6-12
- DBMZ? remote command, 6-12
- DBMZ_D remote command, 6-13
- DBMZ_D? remote command, 6-13
- dc current
 - connections, 4-16
 - setting the output, 4-23
 - specifications, 1-13
- dc power
 - setting the output, 4-26
 - specification summary, 1-22
- dc voltage
 - connections, 4-16
- DC_OFFSET remote command, 6-13
- DC_OFFSET? remote command, 6-13
- defaults for setup menus, 3-22
- device-dependent commands, 5-26
- display
 - control, 3-4
 - output, 3-4
- DIV (divide) key, using, 4-54
- DIVIDE key, 3-7
- DPF remote command, 6-14
- DPF? remote command, 6-14
- dual ac voltage, setting the output, 4-34
- dual dc voltage, setting the output, 4-32
- DUTY remote command, 6-14
- DUTY? remote command, 6-14
- EARTH key, 3-5
- EARTH remote command, 6-15
- EARTH? remote command, 6-15
- EDIT FIELD key, 3-6
- EDIT FIELD keys and knob, using, 4-53
- EDIT remote command, 6-15
- EDIT? remote command, 6-15
- ENTER key, 3-8
- ERR? remote command, 6-16
- ERR_UNIT remote command, 6-16
- ERR_UNIT? remote command, 6-17
- error
 - handler, 5-3
 - handler, writing, 5-46
 - mode operation, 4-18
 - mode remote commands, 6-4
 - queue, 5-45
- ESE (event status enable register), 5-40
- ESR (event status register), 5-40
- event status enable register (ESE), 5-40
- event status register (ESR), 5-40
- EXGRD key, 3-5
- EXPLAIN? remote command, 6-17
- external connection commands, 6-4
- external guard, using, 4-10
- EXTGUARD remote command, 6-18
- EXTGUARD? remote command, 6-18
- fan filter, 3-10
- FAULT? remote command, 6-18
- filter, fan, 3-10
- FORMAT remote command, 6-19
- frequency
 - response calibration, SC300 option, 8-74
 - response calibration, SC600 option, 8-24
 - specifications, 1-26
 - sweep for oscilloscope calibration, SC600 option, 8-24
 - sweep for SC300 option, 8-77
- frequency response calibration, SC300 option, 8-78
- front panel features, 3-3
- front panel operation (Chapter 4), 4-3
- FUNC? remote command, 6-20
- fuse
 - ratings, 2-4
 - replacement, 7-3
- fuse, accessing the, 2-6
- GUARD terminal, 3-9
- HARMONIC remote command, 6-20
- HARMONIC? remote command, 6-21

- harmonics (2nd - 50th) specifications, 1-27
- IEEE-488
 - connector, 3-10
 - interface cable, 9-4
 - interface messages, 5-27
 - interface overview, 5-24
 - interface, description, 5-6
 - interface, setting up, 5-8
 - interface, testing the, 5-9
 - remote control connections, 5-5
- INCR remote command, 6-21
- input buffer operation, 5-49
- input capacitance measurement, SC600
 - option, 8-33
- input impedance measurement, SC600
 - option, 8-32
- instrument status change enable registers (ISCRE and 1), 5-42
- instrument status change registers (ISCR0 and 1), 5-42
- instrument status register (ISR), 5-42
- interface messages (IEEE-488), 5-27
- ISCE remote command, 6-22
- ISCE? remote command, 6-22
- ISCE0 remote command, 6-22
- ISCE0, ISCE1 (instrument status change enable registers), 5-42
- ISCE0? remote command, 6-22
- ISCE1 remote command, 6-22
- ISCE1? remote command, 6-23
- ISCR? remote command, 6-23
- ISCR0, ISCR1 (instrument status change registers), 5-42
- ISCR0? remote command, 6-23
- ISCR1? remote command, 6-23
- ISR (instrument status register), 5-42
- ISR? remote command, 6-24
- LCOMP remote command, 6-24
- LCOMP? remote command, 6-24
- LIMIT remote command, 6-25
- LIMIT? remote command, 6-25
- line
 - power cord types - table of, 2-7
 - voltage, selecting, 2-6
- LOCAL remote command, 6-25
- local state, 5-22
- local with lockout state, 5-22
- LOCKOUT remote command, 6-25
- Lockout State
 - Local with, 5-22
- LOWS remote command, 6-26
- LOWS? remote command, 6-26
- maintenance (Chapter 7), 7-3
- MEAS TC key, 3-7
- modem cables, 9-4
- module, pressure, 4-56
- MORE MODES key, 3-7
- MULT remote command, 6-26
- multiplier keys, 3-7
- MULTIPLY key, 3-7
- NEW REF key, 3-6
- NEWREF remote command, 6-27
- NORMAL terminals, 3-9
- null-modem cables, 9-4
- numeric keys, 3-8
- OL_TRIP remote command, SC600 option, 8-39
- OLDREF remote command, 6-27
- ONTIME? remote command, 6-27
- OPER remote command, 6-28
- OPER? remote command, 6-28
- OPR key, 3-5
- options and accessories (Chapter 8), 9-3
- oscilloscope calibration
 - SC300 connections, 8-65
 - SC300 specifications, 8-60
 - SC600 connections, 8-13
- oscilloscope calibration with the SC300, 8-59
- oscilloscope calibration with the SC600, 8-5
- oscilloscope commands, 6-5
- OUT remote command, 6-29
- OUT? remote command, 6-30
- OUT_ERR? remote command, 6-31
- OUT_IMP remote command, for SC300, 8-85
- OUT_IMP remote command, SC600
 - option, 8-37
- OUT_IMP? remote command, for SC300, 8-85
- OUT_IMP? remote command, SC600
 - option, 8-37
- output queue, 5-44
- overlapped commands, 5-30
- overload protection, testing (SC600), 8-33
- parallel-connected 5520As, current output, 4-58
- parameter syntax rules, 5-33
- phase
 - specifications, 1-24
- PHASE remote command, 6-31
- PHASE? remote command, 6-31
- plus/minus key, 3-8
- power and dual output limit specifications, 1-23
- power cords, 2-7
- power uncertainty, calculating, 1-25
- POWER? remote command, 6-32
- PR_PRT X IEEE X RS=232 remote command, 6-32
- PRES? remote command, 6-32
- PRES_MEAS remote command, 6-33
- PRES_UNIT remote command, 6-33
- PRES_UNIT? remote command, 6-33
- PRES_UNIT_D remote command, 6-34
- PRES_UNIT_D? remote command, 6-34
- pressure measurement, remote example, 5-48
- pressure, measuring, 4-56

- PREV MENU key, 3-5
- pulse capture, verifying (SC600), 8-31
- pulse response calibration, SC300
 - option, 8-72, 8-73
- pulse response calibration, SC600 option, 8-19
- query commands, 5-27
- queue, error, 5-45
- queue, output, 5-44
- rack mount kit, 9-4
- RANGE remote command, SC600 option, 8-37
- RANGE? remote command, 6-35
- RANGELCK remote command, 6-36
- RANGELCK? remote command, 6-36
- rear panel features, 3-3
- REFCLOCK remote command, 6-37
- REFCLOCK? remote command, 6-37
- REFCLOCK_D remote command, 6-37
- REFCLOCK_D? remote command, 6-37
- REFOUT? remote command, 6-38
- REFPHASE remote command, 6-38
- REFPHASE? remote command, 6-38
- REFPHASE_D remote command, 6-39
- REFPHASE_D? remote command, 6-39
- registers
 - ESE (event status enable register), 5-40
 - ESR (event status register), 5-40
 - ISCE0 and 1 (instrument status change enable registers), 5-42
 - ISCR0 and 1 (instrument status change registers), 5-42
 - ISR (instrument status register), 5-42
 - SRE (service request enable), 5-39
- remote commands
 - SC300 oscilloscope commands, detailed, 8-83
 - SC600 oscilloscope calibration, 8-34
- remote commands (Chapter 6), 6-3
- remote example, verifying a meter, 5-47
- remote operation (Chapter 5), 5-4
- REMOTE remote command, 6-39
- remote state, 5-22
- remote with lockout state, 5-22
- remote/local operation, changing between, 5-22
- RESET key, 3-6
- resetting parameters, SC600 option, 8-16
- resistance
 - (compensation off) connections, 4-14
 - (four-wire) connections, 4-13
 - (two-wire) connections, 4-13
 - setting the output, 4-37
- response message syntax, 5-36
- RPT_STR remote command, 6-40
- RPT_STR? remote command, 6-40
- RS-232
 - interface overview, 5-23
 - interface, using for remote control, 5-10
 - modem cables, 9-4
 - null-modem cables, 9-4
 - remote control connections, 5-7
- RTD connections, 4-17
- RTD_TYPE remote command, 6-41
- RTD_TYPE? remote command, 6-41
- RTD_TYPE_D remote command, 6-41
- RTD_TYPE_D? remote command, 6-42
- SC300 option
 - verification tables, 8-86
- SC300 oscilloscope calibration option, 8-59
- SC600 option
 - verification tables, 8-41
- SC600 oscilloscope calibration
 - introduction, 8-5
- SCOPE key, 3-5
- SCOPE OUT BNC connector, 3-8
- SCOPE remote command, for SC300, 8-84
- SCOPE remote command, SC600 option, 8-35
- SCOPE TRIG BNC connector, 3-8
- SCOPE? remote command, for SC300, 8-85
- SCOPE? remote command, SC600 option, 8-36
- sequential commands, 5-30
- SERIAL 1 FROM HOST connector, 3-10
- SERIAL 2 TO UUT connector, 3-10
- serial poll
 - status byte, 5-37
- service request (SRQ line), 5-39
- service request enable register (SRE), 5-39
- SETUP key, 3-6
- SETUP softkey menu tree, 3-12
- SHIFT key, 3-8
- sine wave, 4-47
- softkey menu trees, 3-3
- softkeys, 3-5
- SP_SET, 6-42
- SP_SET? remote command, 6-43
- space or tab characters, 5-34
- specifications
 - ac current (non-sine wave), 1-32
 - ac current (sine wave) extended band width, 1-31
 - ac current, square wave characteristics (typical), 1-34
 - ac current, triangle wave characteristics (typical), 1-34
 - ac power (45 Hz to 65 Hz) summary, 1-22
 - ac voltage
 - dc offset, 1-30
 - ac voltage (non-sine wave), 1-29
 - ac voltage (sine wave) extended bandwidth, 1-28
 - ac voltage, square wave characteristics, 1-31
 - ac voltage, triangle wave characteristics (typical), 1-31
 - capacitance, 1-19
 - dc current, 1-13

- dc power summary, 1-22
- frequency, 1-26
- harmonics (2nd - 50th), 1-27
- phase, 1-24
- power and dual output limit, 1-23
- power uncertainty, 1-25
- SC300 oscilloscope calibration option, 8-60
- SC600 Oscilloscope Calibration Option, 8-5
- temperature calibration (RTD), 1-21
- temperature calibration (thermocouple), 1-20
- SPLSTR remote command, 6-44
- SPLSTR? remote command, 6-44
- square wave and duty cycle, 4-48
- SRE (service request enable register), 5-39
- SRE register, 5-39
- SRQ, 5-37
- SRQ error handler example, 5-3
- SRQ, service request line, 5-39
- SRQSTR remote command, 6-45
- SRQSTR? remote command, 6-45
- standard equipment table, 2-3
- status
 - checking 5520A, 5-37
 - commands, 6-9
 - register overview - figure, 5-38
 - register summary - table, 5-37
 - STB, 5-37
- STB, 5-37
- STBY remote command, 6-46
- synchronizing using 10 MHz IN/OUT, 4-58
- SYNCOUT remote command, 6-46
- tab or space characters, 5-34
- TC (thermocouple) minijack, 3-9
- TC_MEAS remote command, 6-46
- TC_OFFSET remote command, 6-46
- TC_OFFSET? remote command, 6-46
- TC_OTCD remote command, 6-47
- TC_OTCD? remote command, 6-47
- TC_REF remote command, 6-47
- TC_REF? remote command, 6-47
- TC_TYPE remote command, 6-48
- TC_TYPE? remote command, 6-49
- TC_TYPE_D remote command, 6-49
- TC_TYPE_D? remote command, 6-50
- TDPULSE remote command, SC600
 - option, 8-38
- TEMP_STD remote command, 6-50
- temperature
 - (thermocouples), measuring, 4-45
 - calibration (RTD) specifications, 1-21
 - calibration (thermocouple)
 - specifications, 1-20
 - simulation (RTD), setting the output, 4-42
 - simulation (thermocouple), setting the output, 4-40
- terminators, 5-35
- test lead kit, 5500A/Leads accessory, 9-4
- thermocouple connections, 4-17
- thermocouple measurement, remote
 - example, 5-48
- thermocouples, measuring, 4-45
- three-phase power calibration, 4-60
- time marker calibration, SC300 option, 8-80
- time marker calibration, SC600 option, 8-26
- TLIMIT remote command, SC600 option, 8-39
- TLIMIT? remote command, SC600 option, 8-39
- TLIMIT_D remote command, SC600
 - option, 8-40
- TLIMIT_D? remote command, SC600
 - option, 8-40
- TMWAVE remote command, SC600
 - option, 8-38
- TMWAVE? remote command, SC600
 - option, 8-38
- triangle wave, 4-47
- TRIG remote command, for SC300, 8-85
- TRIG remote command, SC600 option, 8-36
- TRIG? remote command, for SC300, 8-85
- TRIG? remote command, SC600 option, 8-37
- trigger testing, SC300 option, 8-82
- truncated sine wave, 4-48
- TSENS_TYPE remote command, 6-51
- TSENS_TYPE? remote command, 6-51
- two 5520As sourcing current in parallel, 4-59
- UNCERT? remote command, 6-52
- unit keys, 3-7
- UUT connections, 4-12
- UUT_FLUSH remote command, 6-52
- UUT_RECV? remote command, 6-52
- UUT_RECVB? remote command, 6-53
- UUT_SEND remote command, 6-53
- UUT_SENDB remote command, 6-54
- UUT_SET remote command, 6-54
- UUT_SET? remote command, 6-55
- V/DIV menu, SC300 option, 8-70
- VAL? remote command, 6-55
- VIDEOFMT remote command, SC600
 - option, 8-38
- VIDEOFMT? remote command, SC600
 - option, 8-39
- VIDEOMARK remote command, SC600
 - option, 8-39
- VIDEOMARK? remote command, SC600
 - option, 8-39
- Visual Basic, using to test the Host RS-232
 - interface, 5-15
- Visual Basic, using to test the UUT RS-232
 - interface, 5-19
- VVAL? remote command, 6-55
- WAVE remote command, 6-56
- WAVE? remote command, 6-56
- ZCOMP remote command, 6-57

ZCOMP? remote command, 6-57

ZERO_MEAS remote command, 6-57

ZERO_MEAS remote command, SC600
option, 8-40

ZERO_MEAS? remote command, 6-58