

FLUKE®

87 V/AN

Digital Multimeter

Service Manual

**Limited permission for the U.S. Government to reproduce Fluke
Item #2153596 is provided pursuant to FAR 52.227.14 Alt. II.**

PN 2153596

July 2004

© 2004 Fluke Corporation, All rights reserved. Printed in USA
All product names are trademarks of their respective companies.

LIMITED WARRANTY AND LIMITATION OF LIABILITY

Each Fluke product is warranted to be free from defects in material and workmanship under normal use and service. The warranty period is one year and begins on the date of shipment. Parts, product repairs, and services are warranted for 90 days. This warranty extends only to the original buyer or end-user customer of a Fluke authorized reseller, and does not apply to fuses, disposable batteries, or to any product which, in Fluke's opinion, has been misused, altered, neglected, contaminated, or damaged by accident or abnormal conditions of operation or handling. Fluke warrants that software will operate substantially in accordance with its functional specifications for 90 days and that it has been properly recorded on non-defective media. Fluke does not warrant that software will be error free or operate without interruption.

Fluke authorized resellers shall extend this warranty on new and unused products to end-user customers only but have no authority to extend a greater or different warranty on behalf of Fluke. Warranty support is available only if product is purchased through a Fluke authorized sales outlet or Buyer has paid the applicable international price. Fluke reserves the right to invoice Buyer for importation costs of repair/replacement parts when product purchased in one country is submitted for repair in another country.

Fluke's warranty obligation is limited, at Fluke's option, to refund of the purchase price, free of charge repair, or replacement of a defective product which is returned to a Fluke authorized service center within the warranty period.

To obtain warranty service, contact your nearest Fluke authorized service center to obtain return authorization information, then send the product to that service center, with a description of the difficulty, postage and insurance prepaid (FOB Destination). Fluke assumes no risk for damage in transit. Following warranty repair, the product will be returned to Buyer, transportation prepaid (FOB Destination). If Fluke determines that failure was caused by neglect, misuse, contamination, alteration, accident, or abnormal condition of operation or handling, including overvoltage failures caused by use outside the product's specified rating, or normal wear and tear of mechanical components, Fluke will provide an estimate of repair costs and obtain authorization before commencing the work. Following repair, the product will be returned to the Buyer transportation prepaid and the Buyer will be billed for the repair and return transportation charges (FOB Shipping Point).

THIS WARRANTY IS BUYER'S SOLE AND EXCLUSIVE REMEDY AND IS IN LIEU OF ALL OTHER WARRANTIES, EXPRESS OR IMPLIED, INCLUDING BUT NOT LIMITED TO ANY IMPLIED WARRANTY OF MERCHANTABILITY OR FITNESS FOR A PARTICULAR PURPOSE. FLUKE SHALL NOT BE LIABLE FOR ANY SPECIAL, INDIRECT, INCIDENTAL, OR CONSEQUENTIAL DAMAGES OR LOSSES, INCLUDING LOSS OF DATA, ARISING FROM ANY CAUSE OR THEORY.

Since some countries or states do not allow limitation of the term of an implied warranty, or exclusion or limitation of incidental or consequential damages, the limitations and exclusions of this warranty may not apply to every buyer. If any provision of this Warranty is held invalid or unenforceable by a court or other decision-maker of competent jurisdiction, such holding will not affect the validity or enforceability of any other provision.

Fluke Corporation
P.O. Box 9090
Everett, WA 98206-9090
U.S.A.

Fluke Europe B.V.
P.O. Box 1186
5602 BD Eindhoven
The Netherlands

11/99

To register your product online, visit register.fluke.com

Table of Contents

Title	Page
Introduction	1
Contacting Fluke	1
Unpacking the Meter.....	2
Inspection.....	2
Inspection Interval	2
Preparations for Use	2
Precautions and Safety Information	2
Electrical Symbols	4
Specifications	5
General Specifications	5
Detailed Specifications	5
Theory of Operation	9
Functional Block Diagram.....	9
Power Supply and Voltage Reference	10
Function Selection and Overload Protection	11
Analog Signal Conditioning	13
VAC.....	13
VDC.....	14
mVDC	14
Temperature.....	14
Ohms Below the 6 M Ω Range.....	14
Ohms in the 6 M Ω & 50 M Ω Range and Siemens in the 60 nS Range....	15
Continuity in all Ohms and the Siemens Ranges.....	15
Capacitance.....	15
Diode Test	15
mA, μ A and AAC.....	15
mA, μ A and ADC.....	16
Active Filter	16
800 Hz Low Pass Filter.....	16
RMS to DC Converter	16
Analog to Digital Converter	17
Secondary Analog Circuits	17
Keypad.....	17
Microprocessor & Support Circuits.....	18
LCD	18

Backlight.....	18
Beeper	18
Troubleshooting	19
Restoration Actions.....	19
Basic Maintenance	19
Cleaning the Meter.....	19
Opening the Meter Case	20
Accessing the PCA and Replacing the LCD.....	21
Reassembling the Meter Case.....	22
Replacing the Battery.....	22
Testing Fuses and Current Circuitry	22
Replacing the Fuses	23
Required Equipment.....	24
Performance Tests	24
Basic Operability Tests	25
Testing the Fuses	25
Testing the Display	25
Testing the Pushbuttons	27
Testing Meter Accuracy.....	27
Calibration Adjustment	29
Calibration Adjustment Counter	29
Calibration Adjustment Password.....	29
Changing the Password	29
Restoring the Default Password	30
Meter Buttons Used in the Calibration Steps.....	31
Calibration Adjustment Procedure.....	31
Service and Parts	33
Schematic Diagrams.....	38

List of Tables

Table	Title	Page
1.	Electrical Symbols.....	4
2.	AC Voltage Function Specifications	6
3.	DC Voltage, Resistance, and Conductance Function Specifications.....	6
4.	Temperature Specifications	6
5.	Current Function Specifications	7
6.	Capacitance and Diode Function Specifications	7
7.	Frequency Counter Specifications.....	7
8.	Frequency Counter Sensitivity and Trigger Levels.....	8
9.	Electrical Characteristics of the Terminals.....	8
10.	MIN MAX Recording Specifications.....	8
11.	Input Path Components	11
12.	Overload Protection Components.....	12
13.	Required Tools and Equipment	24
14.	Display Features	25
15.	Accuracy Tests	27
16.	Calibration Adjustment Steps.....	32
17.	87 V/AN Final Assembly	33
18.	A1 Main PCA.....	35

List of Figures

Figure	Title	Page
1.	87 V/AN Block Diagram.....	10
2.	Opening the Meter, Battery and Fuse Replacement	20
3.	Removing LCD Mask to Access LCD	21
4.	Testing the Current Input Fuses.....	23
5.	Display Features	25
6.	Restoring the Default Password	30
7.	87 V/AN Final Assembly	34
8.	A1 LED PCA.....	39

Introduction

Warning

To avoid shock or injury:

- Read “Precautions and Safety Information” before performing the verification tests or calibration adjustment procedures documented in this manual.
- Do not perform the verification tests or calibration adjustment procedures described in this manual unless you are qualified to do so.
- The information provided in this manual is for the use of qualified personnel only.

Caution

- The 87 V/AN Digital Multimeter contains parts that can be damaged by static discharge.
- Follow the standard practices for handling static sensitive devices.

The *87 V/AN Service Manual* provides the following information:

- Safety information
- Specifications
- Theory of operation
- Basic maintenance (cleaning, replacing the battery and fuses)
- Performance test procedures
- Calibration adjustment procedures
- Replaceable parts and schematics

For complete operating instructions, refer to the *87 V/AN Users Manual*.

Contacting Fluke

To contact Fluke or locate the nearest Service Center, call one of the following telephone numbers:

USA: 1-888-44-FLUKE (1-888-443-5853)
Canada: 1-800-36-FLUKE (1-800-363-5853)
Europe: +31 402-675-200
Japan: +81-3-3434-0181
Singapore: +65-738-5655
Anywhere in the world: +1-425-446-5500

Or, visit Fluke's Web site at www.fluke.com.

To register your product, visit register.fluke.com

Unpacking the Meter

Open the Multimeter box. Inside you will find the 87 V/AN Digital Multimeter (hereafter referred to as “the Meter”) the test leads, the *Product Manuals CD*, the printed *87 V/AN User Manual*, and the printed *87 V/AN Service Manual* (this manual). Remove the Meter from its plastic wrapping.

Inspection

Inspect all contents for any visible shipping damage. Look for scratches or any other damage. If the unit is damaged, contact Fluke immediately using the contact information stated previously.

Inspection Interval

Inspect the Meter and test leads before each use.

Warning

To avoid possible electric shock or personal injury, inspect the test leads for damaged insulation or exposed metal. Check the test leads for continuity. Replace damaged test leads before using the Meter.

Preparations for Use

Before using or servicing the Meter, read all associated safety information. Make sure you have complete understanding of all safety issues.

Precautions and Safety Information

In this manual, a **Warning** identifies conditions and actions that pose hazard(s) to the user; a **Caution** identifies conditions and actions that may damage the Meter or the test instruments.

Warning

To avoid possible electric shock or personal injury, follow these guidelines:

- **Use this Meter only as specified in this manual or the protection provided by the Meter might be impaired.**
- **Do not use the Meter if it is damaged. Before using the Meter, inspect the case. Look for cracks or missing plastic. Pay particular attention to the insulation surrounding the connectors.**
- **Make sure the battery door is closed and latched before operating the Meter.**
- **Replace the battery as soon as the battery indicator () appears.**
- **Remove test leads from the Meter before opening the battery door.**
- **Inspect the test leads for damaged insulation or exposed metal. Check the test leads for continuity. Replace damaged test leads before using the Meter.**

- Do not apply more than the rated voltage, as marked on the Meter, between the terminals or between any terminal and earth ground.
- Never operate the Meter with the cover removed or the case open.
- Use caution when working with voltages above 30 V ac rms, 42 V ac peak, or 60 V dc. These voltages pose a shock hazard.
- Use only the replacement fuses specified in this manual.
- Use the proper terminals, function, and range for measurements.
- Avoid working alone.
- When measuring current, turn off circuit power before connecting the Meter in the circuit. Remember to place the Meter in series with the circuit.
- When making electrical connections, connect the common test lead before connecting the live test lead; when disconnecting, disconnect the live test lead before disconnecting the common test lead.
- Do not use the Meter if it operates abnormally. Protection may be impaired. When in doubt, have the Meter serviced.
- Do not operate the Meter around explosive gas, vapor, or dust.
- Use only a single 9 V battery, properly installed in the Meter case, to power the Meter.
- When servicing the Meter, use only specified replacement parts.
- When using probes, keep fingers behind the finger guards on the probes.
- Do not use the Low Pass Filter option to verify the presence of hazardous voltages. Voltages greater than what is indicated may be present. Make a voltage measurement without the filter to detect the possible presence of hazardous voltage, then select the filter function.

⚠ Caution















To avoid possible damage to the Meter or to the equipment under test, follow these guidelines:

- Disconnect circuit power and discharge all high-voltage capacitors before testing resistance, continuity, diodes, or capacitance.
- Before measuring current, check the Meter's fuses. See " Testing Fuses (F1 and F2) ”.

Electrical Symbols

Electrical symbols used on the Meter and in this manual are explained in Table 1.

Table 1. Electrical Symbols

	AC (Alternating Current)		Earth ground
	DC (Direct Current)		Fuse
	Hazardous voltage.		Conforms to European Union directives
	Risk of Danger. Important information. See Manual.		Conforms to relevant Canadian Standards Association directives
	Battery		Double insulated
	Continuity test or continuity beeper tone.		Capacitance
	Underwriters Laboratories		Diode
CAT III	IEC overvoltage category III CAT III equipment is designed to protect against transients in equipment in fixed-equipment installations, such as distribution panels, feeders and short branch circuits, and lighting systems in large buildings.	CAT IV	IEC overvoltage category IV CAT IV equipment is designed to protect against transients from the primary supply level, such as an electricity meter or an overhead or underground utility service.
	Inspected and licensed by TÜV Product Services.		

Specifications

General Specifications

Maximum Voltage between any Terminal and Earth Ground: 1000 V rms

⚠ Fuse Protection for mA or μ A inputs: 44/100 A, 1000 V FAST Fuse

⚠ Fuse Protection for A input: 11 A, 1000 V FAST Fuse

Display: Digital: 6000 counts updates 4/sec. The Meter also has 19,999 counts in high-resolution mode.

Analog Bargraph: 33 segments, updates 40/sec. Frequency: 19,999 counts, updates 3/sec at > 10 Hz.

Temperature: Operating: -20 °C to +55 °C; Storage: -40 °C to +60 °C

Altitude: Operating: 2000 m; Storage: 10,000 m

Temperature Coefficient: 0.05 x (specified accuracy)/ °C (< 18 °C or > 28 °C)

Electromagnetic Compatibility: All ranges unless otherwise noted: In an RF field of 3 V/m total accuracy = specified accuracy + 20 counts

Except: Temperature not specified.

Relative Humidity: 0 % to 90 % (0 °C to 35 °C); 0 % to 70% (35 °C to 55 °C)

Battery Type: 9 V zinc, NEDA 1604 or 6F22 or 006P

Battery Life: 400 hrs typical with alkaline (with backlight off)

Vibration: Per MIL-PRF-28800 for a Class 2 instrument

Shock: 1 Meter drop per IEC 61010-1:2001

Size (HxWxL): 1.25 in x 3.41 in x 7.35 in (3.1 cm x 8.6 cm x 18.6 cm)

Size with Holster and Flex-Stand: 2.06 in x 3.86 in x 7.93 in (5.2 cm x 9.8 cm x 20.1 cm)

Weight: 12.5 oz (355 g)

Weight with Holster and Flex-Stand: 22.0 oz (624 g)

Safety: Complies with ANSI/ISA S82.01-2004, CSA 22.2 No. 1010.1:2004 to 1000 V Overvoltage Category III, IEC 664 to 600 V Overvoltage Category IV. UL listed to UL61010-1. Licensed by TÜV to EN61010-1.

Detailed Specifications

For all detailed specifications:

Accuracy is given as \pm ([% of reading] + [number of least significant digits]) at 18 °C to 28 °C, with relative humidity up to 90 %, for a period of one year after calibration adjustment. In the 4 ½-digit mode, multiply the number of least significant digits (counts) by 10. AC conversions are ac-coupled and valid from 3 % to 100 % of range. The Meter is true rms responding. AC crest factor can be up to 3 at full scale, 6 at half scale. For non-sinusoidal wave forms add -(2 % R_{dg} + 2 % full scale) typical, for a crest factor up to 3.

Tables 2 through 10 list the Meter's detailed specifications.

Table 2. AC Voltage Function Specifications

Function	Range	Resolution	Accuracy						
			45 - 65 Hz	30 - 200 Hz	200 - 440 Hz	440 Hz - 1 kHz	1 - 5 kHz	5 - 20 kHz ¹	
\tilde{V} 2,4	600.0 mV 6.000 V 60.00 V 600.0 V	0.1 mV 0.001 V 0.01 V 0.1 V	$\pm (0.7\% + 4)$	$\pm (1.0\% + 4)$	$\pm (1.0\% + 4)$	unspecified	unspecified	$\pm (2.0\% + 4)$	$\pm (2.0\% + 20)$
			$\pm (0.7\% + 2)$					$\pm (2.0\% + 4)^3$	unspecified
			1000 V					1 V	unspecified
	Low pass filter	$\pm (0.7\% + 2)$	$\pm (1.0\% + 4)$					+1 % + 4 -6 % - 4 ⁵	unspecified

1. Below 10 % of range, add 12 counts.
2. The Meter is a true rms responding meter. When the input leads are shorted together in the ac functions, the Meter may display a residual reading between 1 and 30 counts. A 30 count residual reading will cause only a 2-digit change for readings over 3 % of range. Using REL to offset this reading may produce a much larger constant error in later measurements.
3. Frequency range: 1 kHz to 2.5 kHz.
4. A residual reading of up to 13 digits with leads shorted, will not affect stated accuracy above 3 % of range.
5. Specification increases from -1% at 200 Hz to -6% at 440 Hz when filter is in use.

Table 3. DC Voltage, Resistance, and Conductance Function Specifications

Function	Range	Resolution	Accuracy
\bar{V}	6.000 V	0.001 V	$\pm (0.05\% + 1)$
	60.00 V	0.01 V	$\pm (0.05\% + 1)$
	600.0 V	0.1 V	$\pm (0.05\% + 1)$
	1000 V	1 V	$\pm (0.05\% + 1)$
\bar{mV}	600.0 mV	0.1 mV	$\pm (0.1\% + 1)$
Ω	600.0 Ω	0.1 Ω	$\pm (0.2\% + 2)^1$
	6.000 k Ω	0.001 k Ω	$\pm (0.2\% + 1)$
	60.00 k Ω	0.01 k Ω	$\pm (0.2\% + 1)$
	600.0 k Ω	0.1 k Ω	$\pm (0.6\% + 1)$
	6.000 M Ω	0.001 M Ω	$\pm (0.6\% + 1)$
nS	50.00 M Ω	0.01 M Ω	$\pm (1.0\% + 3)^2$
	60.00 nS	0.01 nS	$\pm (1.0\% + 10)^1$

1. When using the REL Δ function to compensate for offsets.
2. Add 0.5 % of reading when measuring above 30 M Ω in the 50 M Ω range.

Table 4. Temperature Specifications

Temperature	Resolution	Accuracy ^{1,2}
-200 °C to +1090 °C	0.1 °C	1 % + 10
-328 °F to +1994 °F	0.1 °F	1 % + 18



1. Does not include error of the thermocouple probe.
2. Accuracy specification assumes ambient temperature stable to ± 1 °C. For ambient temperature changes of ± 5 °C, rated accuracy applies after 1 hour.

Table 5. Current Function Specifications

Function	Range	Resolution	Accuracy ^{1, 2}	Burden Voltage (typical)
mA A~ (45 Hz to 2 kHz)	60.00 mA	0.01 mA	± (1.0 % + 2)	1.8 mV/mA
	400.0 mA ⁴	0.1 mA	± (1.0 % + 2)	1.8 mV/mA
	6.000 A	0.001 A	± (1.0 % + 2)	0.03 V/A
	10.00 A ³	0.01 A	± (1.0 % + 2)	0.03 V/A
mA A=	60.00 mA	0.01 mA	± (0.2 % + 4)	1.8 mV/mA
	400.0 mA ⁴	0.1 mA	± (0.2 % + 2)	1.8 mV/mA
	6.000 A	0.001 A	± (0.2 % + 4)	0.03 V/A
	10.00 A ³	0.01 A	± (0.2 % + 2)	0.03 V/A
µA ~ (45 Hz to 2 kHz)	600.0 µA	0.1 µA	± (1.0 % + 2)	100 µV/µA
	6000 µA	1 µA	± (1.0 % + 2)	100 µV/µA
µA=	600.0 µA	0.1 µA	± (0.2 % + 4)	100 µV/µA
	6000 µA	1 µA	± (0.2 % + 2)	100 µV/µA

- AC conversions are ac coupled, true rms responding, and valid from 3 % to 100 % of range, except 400 mA range (5 % to 100 % of range) and 10 A range (15 % to 100 % of range).
- The Meter is a true rms responding meter. When the input leads are shorted together in the ac functions, the Meter may display a residual reading between 1 and 30 counts. A 30 count residual reading will cause only a 2 digit change for readings over 3 % of range. Using REL to offset this reading may produce a much larger constant error in later measurements
- Δ 10 A continuous up to 35 °C; < 20 minutes on, 5 minutes off at 35 °C to 55 °C. 20 A for 30 seconds maximum; > 10 A unspecified.
- 400 mA continuous; 600 mA for 18 hrs maximum.

Table 6. Capacitance and Diode Function Specifications

Function	Range	Resolution	Accuracy
	10.00 nF	0.01 nF	± (1 % + 2) ¹
	100.0 nF	0.1 nF	± (1 % + 2) ¹
	1.000 µF	0.001 µF	± (1 % + 2)
	10.00 µF	0.01 µF	± (1 % + 2)
	100.0 µF	0.1 µF	± (1 % + 2)
	9999 µF	1 µF	± (1 % + 2)
	3.000 V	0.001 V	± (2 % + 1)

- With a film capacitor or better, using Relative mode to zero residual.

Table 7. Frequency Counter Specifications

Function	Range	Resolution	Accuracy
Frequency (0.5 Hz to 200 kHz, pulse width > 2 µs)	199.99	0.01 Hz	± (0.005 % + 1)
	1999.9	0.1 Hz	± (0.005 % + 1)
	19.999 kHz	0.001 kHz	± (0.005 % + 1)
	199.99 kHz	0.01 kHz	± (0.005 % + 1)
	> 200 kHz	0.1 kHz	unspecified

Table 8. Frequency Counter Sensitivity and Trigger Levels

Input Range ¹	Minimum Sensitivity (RMS Sine wave)		Approximate Trigger Level (DC Voltage Function)
	5 Hz - 20 kHz	0.5 Hz - 200 kHz	
600 mV dc	70 mV (to 400 Hz)	70 mV (to 400 Hz)	40 mV
600 mV ac	150 mV	150 mV	—
6 V	0.3 V	0.7 V	1.7 V
60 V	3 V	7 V (≤ 140 kHz)	4 V
600 V	30 V	70 V (≤ 14.0 kHz)	40 V
1000 V	100 V	200 V (≤ 1.4 kHz)	100 V
Duty Cycle Range	Accuracy		
0.0 to 99.9 %	Within $\pm (0.2\%$ per kHz + 0.1 %) for rise times < 1 μ s.		
1. Maximum input for specified accuracy = 10X Range or 1000 V.			

Table 9. Electrical Characteristics of the Terminals

Function	Overload Protection ¹	Input Impedance (nominal)	Common Mode Rejection Ratio (1 k Ω unbalance)		Normal Mode Rejection					
\bar{V}	1000 V rms	10 M Ω < 100 pF	> 120 dB at dc, 50 Hz or 60 Hz		> 60 dB at 50 Hz or 60 Hz					
\bar{mV}	1000 V rms	10 M Ω < 100 pF	> 120 dB at dc, 50 Hz or 60 Hz		> 60 dB at 50 Hz or 60 Hz					
\tilde{V}	1000 V rms	10 M Ω < 100 pF (ac-coupled)	> 60 dB, dc to 60 Hz							
		Open Circuit Test Voltage	Full Scale Voltage			Typical Short Circuit Current				
	To 6.0 M Ω		50 M Ω or 60 nS		600 Ω	6 k	60 k	600 k	6 M	50 M
Ω	1000 V rms	< 7.5 V dc	< 4.1 V dc	< 4.5 V dc	1 mA	100 μ A	10 μ A	1 μ A	1 μ A	0.5 μ A
\rightarrow	1000 V rms	< 3.9 V dc	3.000 V dc		0.6 mA typical					
1. 10^6 V Hz max										

Table 10. MIN MAX Recording Specifications

Nominal Response	Accuracy
100 ms to 80 % (dc functions)	Specified accuracy ± 12 counts for changes > 200 ms in duration
120 ms to 80 % (ac functions)	Specified accuracy ± 40 counts for changes > 350 ms and inputs > 25 % of range
250 μ s (peak) ¹	Specified accuracy ± 100 counts for changes > 250 μ s in duration (add ± 100 counts for readings over 6000 counts) (add ± 100 counts for readings in Low Pass mode)
1. For repetitive peaks: 1 ms for single events.	

Theory of Operation

This section provides the theory of operation for the 87 V/AN Digital Multimeter to a depth that is required for troubleshooting to the component level. The functional block diagram provides an overview for the description. The schematic diagrams included in the manual are referred to during the following detailed circuit descriptions.

Functional Block Diagram

Figure 1 shows the top-level function block diagram for the Meter. Each of the blocks in this diagram is discussed in detail in the following paragraphs.

The parameter to be measured is connected with test leads to the appropriate two input terminals shown at the left of the block diagram. After the Meter is set to the desired function, the signal is routed to the signal conditioning circuit. Either automatically or manually, a range is selected that puts the signal to be measured within the dynamic range of the analog-to-digital converter (ADC) or other signal conditioning circuits like the RMS-to-DC converter discussed in “RMS to DC Converter”. A scaled AC signal voltage is routed directly, or via an 800-Hz low-pass filter, to the RMS-to-DC converter circuit. A DC input signal or DC output of the RMS-to-DC converter (for AC functions) is routed to a low-pass, 6-Hz, 2-pole active filter to prepare it for ADC measurement. The conditioned analog input signal voltage is converted to a digital value by the ADC and sent to the microprocessor. The microprocessor converts this digital value for display on the LCD based on the function, range and keypad entered options. The output of the signal-conditioning block is also routed to the secondary analog circuits block to be further conditioned for input to the fast ADC contained within the microprocessor block. Other analog circuits that control the behavior of the Meter are located in the secondary analog circuits block and are discussed later.

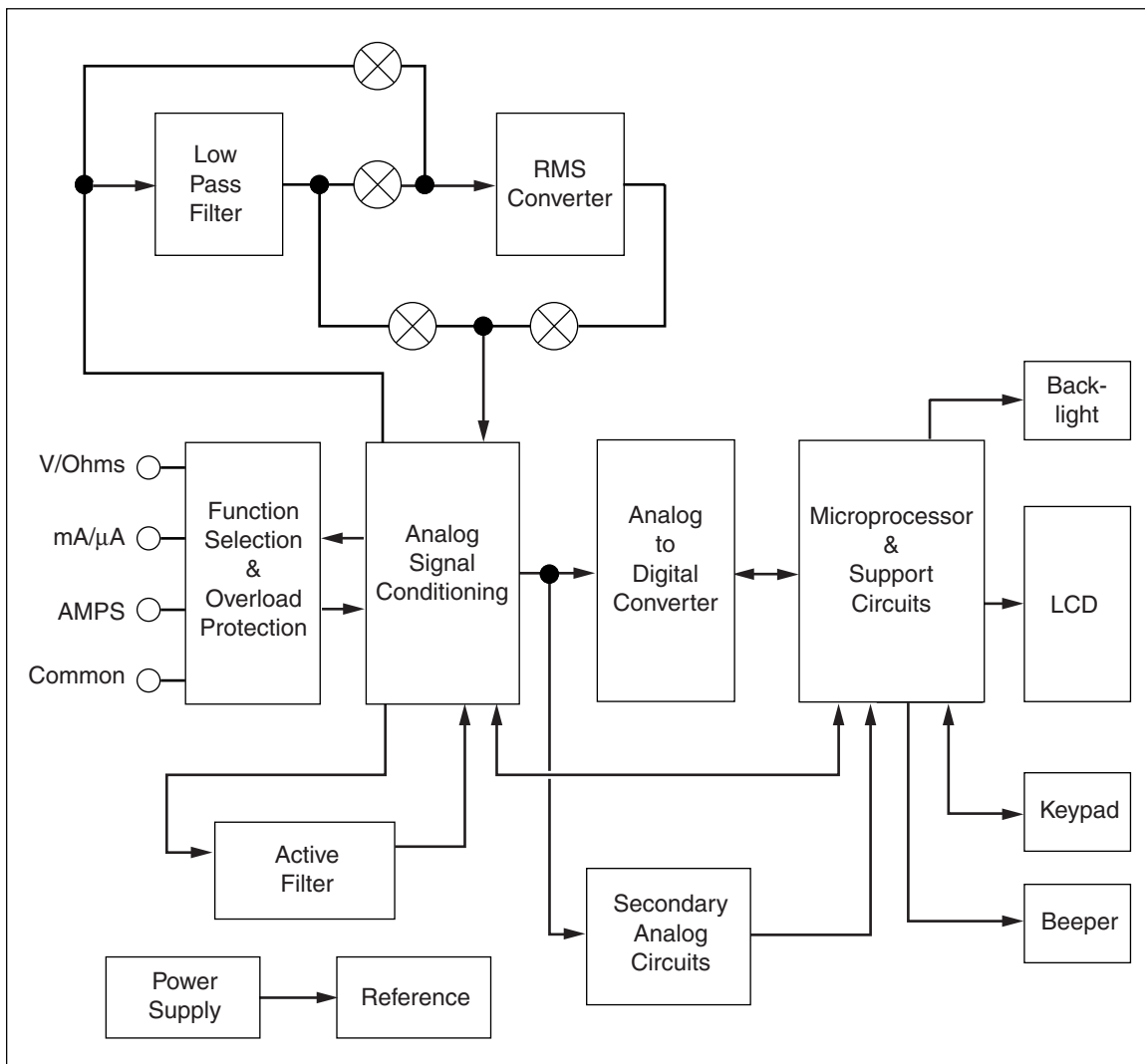

Figure 1. 87 V/AN Block Diagram

ama101f.eps

Power Supply and Voltage Reference

A 9-V alkaline battery supplies power to the Meter and is connected via a cable assembly to J3 on the A1 printed circuit assembly (PCA). Diode CR3 protects the Meter from damage due to accidental polarity reversal at J3.

Q13 is used as a remote power switch that connects the battery to the power supply regulators when the Meter is turned on. When S1 is in the OFF position, Q14 is off to allow the battery voltage to turn off Q13 via R73. When the Meter is turned on, S1 makes a momentary contact to the battery voltage via R80, turning on Q14, which turns on Q13, which connects the battery voltage to R74, which holds Q14 until S1 is returned to the OFF position.

When Q13 is on, battery voltage is applied to regulators U6 and U10, bypass capacitors C12 and C14 and the low battery detect divider resistors R15 & R16. Note that since the power supply levels are referenced to the COMMON input terminal of the Meter, the negative end of the battery is the -2.5 V power supply.

U6 is a 3.3-V regulator that generates the +0.8-V (-2.5 V + 3.3 V) power supply. U10 is a 5.0-V regulator that generates the +2.5-V (-2.5 V + 5.0 V) power supply. U10 is











enabled and disabled via control line V5* from microprocessor U2. C15 bypasses the output of U10.

When U10 is enabled, 5 V is supplied to the voltage reference U8 input. U8 is a 2.5-V reference with a buffered output and accurately holds the COMMON input 2.5 V above the -2.5 V power supply or at 0 V. The triangular ground symbol represents this reference level throughout the Meter schematic. C16, C57, C50 and R109 bypass the output of U8 keeping the voltage between COMMON and the -2.5 V power supply noise free and stable. C50 and R109 form a low Q bypass that is directed at electromagnetic interference (EMI).

Function Selection and Overload Protection

Sections of rotary switch S1 connect the V/Ohms and mA/μA input jacks to the signal conditioning circuit as required for the respective Meter functions. The Meter schematic symbols for each of the sections of S1 have the functions that correspond to the closed positions listed next to them. Table 11 indicates the components that complete normal operation signal path/paths from input jacks to the required signal conditioning circuit/circuits for each Meter function.

Table 11. Input Path Components

Function	Components
 VAC	RT1, R1, R2, C1, Z1(9.997 M), C43, R94
 VDC	RT1, R1, S1(1,3), Z1(9.997 M)
 mV dc	RT1, R1, S1(1,3), Z1(9.997 M), S1(29,5), R85
 mV dc – HiZ	RT1, R1, S1(29,5), R85
 Temperature	RT1, R1, S1(1,2), R3, S1(29,5), R85, S1(1,3) Z1(9.997M)
 Ohms (Below 6 MΩ)	RT1, R1, S1(1,2), R3, Z2, S1(4,5), R85
 Ohms (6 MΩ, 50 MΩ, nS)	RT1, R1, S1(1,2), R3, S1(1,3), Z1(9.99 7M)
 Continuity (below 6 MΩ)	RT1, R1, S1(1,2), R3, Z2, S1(4,5) R85
 Continuity (6 MΩ, 50 MΩ)	RT1, R1, S1(1,2), R3, S1(1,3), Z1(9.997 M)
 Capacitance	RT1, R1, S1(1,2), R3, Z2, S1(4,5) R85
 Diode Test	RT1, R1, S1(1,2), R3, Z2, S1(4,5), R85

The Meter uses diode clamps, a positive temperature coefficient thermistor, metal oxide varistors (MOVs) and fuses for protection when inadvertent overload conditions are applied across the input terminals. Table 12 shows the components that limit and direct overload currents to prevent damage to the Meter.

Table 12. Overload Protection Components

Function	Components Protected	Protection Components
\tilde{V} VAC	U1 pin 3	Z1(9.997 M), U1-3 clamps
	S1(1,2)(1,3)(29,5)(4,5), Z1(9.997 M)	RT1, R1, RV1, RV2, Z2, RV3
\bar{V} VDC	U1 pin 3	Z1(9.997 M), U1-3 clamps
	S1(1,2)(29,5)(4,5), Z1(9.997 M)	RT1, R1, RV1, RV2, Z2, RV3
$m\bar{V}$, \downarrow mV dc, Temperature	U1 pin 36	RT1, R1, CR10, VR1, CR8, CR9, R3, U1-36 clamps
	U1 pin 3	RT1, R1, CR10, VR1, CR8, CR9, Z1(9.997 M), U1-3 clamps
	U1 pin 1	RT1, R1, CR10, VR1, CR8, CR9, R85, U1-1 clamps
	S1(4,5)	Z2, RV3, RV2, RT1, R1, CR10, VR1, CR8, CR9
Ω , \dashv , \parallel Ohms, Capacitance, Continuity	U1 pin 36	RT1, R1, CR10, VR1, CR8, CR9, R3, U1-36 clamps
	U1 pin 3	RT1, R1, CR10, VR1, CR8, CR9, Z1(9.997 M), U1-3 clamps
	U1 pin 1	Z2, R85, U1-1 clamps
	S1(29,5)	RT1, R1, CR10, VR1, CR8, CR9
$\rightarrow+$ Diode Test	U1 pin 36	RT1, R1, CR10, VR1, CR8, CR9, R3, U1-36 clamps
	U1 pin 3	RT1, R1, CR10, VR1, CR8, CR9, R2, C1, Z1(9.997 M), U1-3 clamps
	U1 pin 1	Z2, R85, U1-1 clamps
	S1(1,3)(29,5)	RT1, R1, CR10, VR1, CR8, CR9
Voltage applied to mA/ μ A input jack in any of the above functions or OFF	S1(7,8)(7,6)	F1, CR1, CR2
	U2 pin 3 after F1 opens	R7, CR5
mA/A	R5	F1, CR1, CR2, R6
	U2 pin 3 after F1 opens	R7, CR5
μ A	R4	F1, CR1, CR2
	U2 pin 3 after F1 opens	R7, CR5
Voltage applied to A input jack in any function including OFF	R6	F2 (assuming enough current is available)
	U2 pin 2 after F2 opens	R10, CR6

Internal diodes on each pin of U1 clamp the voltage to a diode drop above or below the power supply levels. Further, U1 power supplies are internally clamped together to prevent overvoltage damage to circuits within U1. U1 pins 1 & 36 have the positive clamp tied to the voltage at CPH (U1 pin 32), which is approximately 5 V above the 2.5-V power supply when the charge pump and current source in U1 are enabled. When an overload voltage is present on the V/Ohms input jack with respect to the COMMON input jack, clamp diodes in U1 conduct enough to drop the offending voltage on resistors that handle the resulting overload current. Additional clamps, CR8, CR9, CR10 and VR1, are used to keep currents from large overload voltages out of U1 pin 36 by safely clamping the voltage at TP6 to approximately +8.9 V and -2.1 V with respect to COMMON. Positive temperature coefficient thermistor, RT1, will aid the safe handling of the overload by increasing in resistance and thereby reducing the overload current being handled by these additional clamps. R1 is a high voltage resistor that drops the overload voltage until RT1 can catch up.

During voltage overload conditions exceeding approximately ± 2 kV at the V/Ohms input jack, the open contacts of S1 need to have the voltage across them kept below the arc-over level. RV1, RV2 & RV3 MOVs will conduct and limit the voltage at TP5 and TP11 to a magnitude of less than 2 kV unless TP5 is connected to TP6 by S1(1,2). The voltage at TP6 will be held by clamps CR8, CR9, CR10 and VR1 as described above with RT1 and the high voltage resistor R1 safely dropping the overload voltage.

During voltage or current overload conditions at the mA/ μ A input jack with the mA/A or μ A Meter function selected, current shunts R4, R5 & R6 and the closed contacts of S1 are protected by F1 opening. CR1 & CR2 limit the voltage at the mA/ μ A input to approximately ± 2.1 V regardless of the Meter function selected, thereby protecting the open or closed contacts of S1 (and the current shunts, if connected) while allowing time for F1 to open.

During voltage or current overload conditions at the A input jack current shunt R6 is protected by F2 opening.

C43 and R94, which are in parallel with Z1 (9.997 M Ω), are used in conjunction with components in the signal conditioning circuit for frequency compensation. C3 reduces input noise in the signal path. R100, R101 & R103 provide a current limited connection to voltages that will minimize the leakage current of CR8, CR9 and CR10, which combines with the input signal creating a temperature-dependent error in the reading.

Inductors L1, L2, L4 & L5 attenuate electromagnetic interference (EMI) and capacitive coupled noise that is picked up by the input circuit and test leads that is passed to the signal conditioning circuit.

The operation of R7, R10, R11, R48, C26, C31, CR5 and CR6 is described in "Secondary Analog Circuits".

Analog Signal Conditioning

U1 provides the switching that is necessary for range selection, the operational amplifiers that are used for buffering and filtering, various current source values and various voltage comparator functions, which are required to transform the input signal to a representation that can be measured and quantified.

VAC

The V/Ohms input is connected, as described in Table 11, to DIV_A (U1 pin 3) and routed by U1 internal switches to the inverting input of an internal operational amplifier. The overall gain to ACAMP_O (U1 pin 22) is set by the total resistance to the inverting input from the V/Ohms input, the selected range resistor in Z1, R105, R12 and R8. U1 works in conjunction with C43 & R94 to compensate the frequency response of this path. The signal at ACAMP_O is, therefore, a scaled representation of the AC input signal

within the band pass specification of the Meter. The signal at ACAMP_O is routed to the Low-Pass Filter and/or the RMS Converter using multiplexer U12. The output of Low-Pass Filter or the RMS Converter is routed back into CONV_IN (U1 pin13), filtered, buffered and passed to FE_O (U1 pin 19) ready for measurement. If the Hz function is selected, the scaled voltage at ACAMP_O is also routed within U1 to comparators that will produce a digital signal at COMP_O (U1 pin 24) ready for frequency measurement.

VDC

The V/Ohms input is connected, as described in Table 11, to DIV_A (U1 pin 3) and routed by U1 internal switches to one of the other resistors in the Z1 network to be divided. The divided voltage is filtered, buffered and passed to FE_O (U1 pin19) ready for measurement. If the operator selects the Hz function, the signal is routed within U1 to comparators that will produce a digital signal at COMP_O (U1 pin 24) ready for frequency or duty cycle measurement.

mVDC

The V/Ohms input is connected, as described in Table 11, to SENSE_HI (U1 pin 1) and routed by U1 internal switches to be filtered, buffered and passed to FE_O (U1 pin19) ready for measurement. The resistor Z1 (9.997 M Ω), is used to provide a 10 M Ω impedance across the Meter V/Ohms to COMMON input jacks by connecting DIV_A (U1 pin 3) to R3 (U1 pin 9), which in turn is connected to COMMON by Z1 (440.4 Ω) and R8. This connection is opened by U1 when the HiZ input power up option is selected. If the operator selects the Hz function, the signal is routed within U1 to comparators that will produce a digital signal at COMP_O (U1 pin 24) ready for frequency or duty cycle measurement.

Temperature

The V/Ohms input is connected the same as in mVDC to FE_O (U1 pin 19) with the exception that U1 provides a gain of 10 to the signal. Another measurement of the temperature of the input terminals where the thermocouple wire transitions to copper is required to calculate the actual temperature sensed by a thermocouple. Since U1 is controlled by the microprocessor, this measurement is done by routing two different values of current from the U1 current source via RJT_I (U1 pin 35) to Q3 and the resulting VBE is routed, buffered and passed to the FE_O (U1 pin 19) ready for measurement. The reference junction temperature is calculated from these measurements. Inductor L2 and capacitor C2 keep noise out of the measurement circuitry. Since thermocouples are easily broken and give incorrect readings, a periodic test of the thermocouple is required. A current from the U1 current source is routed to ISRC (U1 pin36) and on to the thermocouple that is connected from V/Ohms to COMMON. The resulting voltage drop across the thermocouple is connected to the U1 internal comparators and converted to a digital signal at COMP_O (U1 pin 24) ready for evaluation by the microprocessor.

Ohms Below the 6 M Ω Range

The U1 current source is enabled and routed to ISRC (U1 pin 36) and on to the V/Ohms input jack, which is also connected to SENSE_HI (U1 pin 1) via the components indicated in Table 11. SENSE_HI is routed by U1 internal switches, filtered, buffered and passed to FE_O (U1 pin19) ready for measurement. Resistor R51 sets the reference for the 1 mA and 100 μ A U1 current-source currents. Resistor R52 sets the reference for the 10 μ A, 1 μ A and 0.5 μ A U1 current source currents. Capacitors C4 and C5 are used by the U1 current source charge pump to set the available compliance voltage at ISRC to 7.5 V with respect to COMMON. The 0.5- μ A current source is not used for resistor measurements in these ranges. If the operator selects the Hz function, the signal is

routed within U1 to comparators that will produce a digital signal at COMP_O (U1 pin 24) ready for frequency or duty cycle measurement.

Ohms in the 6 M Ω & 50 M Ω Range and Siemens in the 60 nS Range

The U1 current source is enabled and routed to ISRC (U1 pin 36) and on to the V/Ohms input jack, which is also connected to DIV_A (U1 pin 3) via the components indicated in Table 11. DIV_A is routed by U1 internal switches to R0 (U1 pin 5) and on to Z1 (1.106 M Ω) to divide the sensed voltage by 10. The divided voltage is filtered, buffered with a gain of two, and passed to FE_O (U1 pin19) ready for measurement. Only the 1 μ A and 0.5 μ A current sources are used in these ranges. If the operator selects the Hz function, the signal is routed within U1 to comparators that will produce a digital signal at COMP_O (U1 pin 24) ready for frequency or duty cycle measurement.

Continuity in all Ohms and the Siemens Ranges

The same measurement paths discussed above apply with the exception that the filtering is turned off to speed up the circuit response and the signal at FE_O (U1 pin 19) is routed to U1 comparators, which convert it to a digital signal at CONT_O (U1 pin 24) ready for evaluation by the microprocessor.

Capacitance

The U1 current source is enabled and internally routed to COMMON. ISRC (U1 pin 36) is routed to the V/Ohms input, which is also connected to SENSE_HI (U1 pin 1) via the components indicated in Table 11. The voltage signal at SENSE_HI is internally routed in U1 to the comparators converted to a digital signal at COMP_O (U1 pin 24) ready for evaluation by the microprocessor, buffered and passed on to FE_O (U1 pin 19) ready for measurement. The capacitor is discharged to below a value set on the comparator via ISRC (U1 pin 36), which is connected to COMMON or the negative voltage rail depending on how much voltage is on the capacitor being measured. Once the capacitor is discharged sufficiently, current is applied to it in accurately measured packets until the U1 comparator signals that the capacitor under test has been sufficiently charged. By measuring the voltage at discharge and after charge the value of the capacitor is calculated by the microprocessor.

Diode Test

The U1 1-mA current source is enabled and routed to ISRC (U1 pin 36) and on to the V/Ohms input, which is also connected to SENSE_HI (U1 pin 1) via the components indicated in Table 11. SENSE_HI is routed by U1 internal switches to R1 (U1 pin 7) and on to Z1 (110.01 k Ω) & R8 which form 10-to-1 divider with Z2. The divided voltage signal is filtered, buffered with a gain of two and passed to FE_O (U1 pin19) ready for measurement.

mA, μ A and AAC

The mA/ μ A input and the A input are connected to R4 (U1 pin 10) as described in Table 11. The voltage at R4 is proportional to the product of the current being measured and the shunt resistance that is in use. The voltage at R4 is routed by U1 internal switches to the inverting input of an internal operational amplifier. The overall gain to ACAMP_O (U1 pin 22) is set by the total resistance from the shunt in use to the inverting input, either resistor Z1(1.106 M Ω) or Z1(110.01 k Ω), R105, R12 & R8. The signal at ACAMP_O is, therefore, a scaled representation of the AC current input signal. The signal at ACAMP_O is routed to either the Low-Pass Filter or the RMS Converter or both using multiplexer U12. The output of the Low-Pass Filter or the RMS Converter is routed back into CONV_IN (U1 pin13), filtered, buffered with a gain of two and passed to FE_O (U1 pin 19) ready for measurement. If the operator selects the Hz function, the

scaled voltage at ACAMP_O is also routed within U1 to comparators that will produce a digital signal at COMP_O (U1 pin 24) ready for frequency measurement.

mA, μ A and ADC

The mA/ μ A input and the A input are connected to R4 (U1 pin 10) as described in Table 11. The voltage at R4 is proportional to the product of the current being measured and the shunt resistance that is in use. The voltage at R4 is routed by U1 internal switches, filtered, buffered with a gain of 1 or 10 depending upon the range selected and passed to FE_O (U1 pin 19) ready for measurement. If the Hz function is selected, the signal at FE_O is also routed within U1 to comparators that will produce a digital signal at COMP_O (U1 pin 24) ready for frequency or duty-cycle measurement.

The U1 buffer amplifier connected to FE_O (U1 pin 19) is zeroed digitally by the microprocessor. The voltage at ZERO_IN (U1 pin 14) is routed by U1, buffered with the selected gain and passed on to FE_O ready for measurement.

Active Filter

C9, C10, R17 & R18 are used in conjunction with an operational amplifier internal to U1 to form a low-pass active filter. This configuration produces the equivalent of two cascaded filters, each at approximately 6 Hz. R18 is bypassed by switches in U1 when the input impedance of the range voltage divider is above 1 M Ω .

800 Hz Low Pass Filter

R86, R87, R88, C36, C37, C38 & U4 form an 800-Hz low-pass filter (three pole Butterworth) that can be selected in the VAC function. This filter is used to stop high frequency noise such as that encountered in motor drive controllers from passing on to the measurement circuits. The A switch of multiplexer U12 is used to select between either the input or output of this filter as an input to the RMS Converter. The B switch of multiplexer U12 can select the output of this filter for input to CONV_IN (U1 pin 13) and bypass the RMS Converter when the Frequency function or **PEAK MIN MAX** option is selected.

RMS to DC Converter

C6, U7 & C7 form the RMS-to-DC conversion circuit. C33 & C35 are RF-bypass capacitors. C32 & C34 are power-supply bypass capacitors for U7. R29, R30, R32, R33, Q6 & Q7 form the power-control circuit for U7.

The selected AC signal at the A output of U12 is passed to U7 pin 1 via DC-blocking capacitor C6. U7, with the aid of the averaging capacitor C7 on pin 5, produces a DC output at pin 6 that is proportional to the RMS of the input.

U7 is powered on and off as needed for the selected Meter function by the microprocessor controlling the AC* signal. When AC* is driven to a logic high (+0.8 V), Q6 is turned on, turning on Q7, which connects the positive end of the battery (6 V minimum) to the pin 3 of U7, thereby powering it down. When AC* is driven to a logic low (-2.5 V), transistor Q6 is turned off, turning off Q7, which allows U7 pin 3 to be pulled to +0.8 V through R33, thereby allowing Q7 to power on.

Analog to Digital Converter

U3 is a 20-bit $\Sigma\Delta$ analog-to-digital converter (ADC). C21 & C22 are power-supply bypass capacitors. The DC signal at FE_O (U1 pin 19) provides the signal input for U3. The reference for conversion is supplied by U8 as described in 1.3 to the REF and VIN* (compliment of VIN) inputs. Since REF* (compliment of REF) is tied to -2.5 V and both pairs of inputs to U3 are handled differentially, the dynamic range of the VIN is ± 1.25 V around COMMOM. The microprocessor U2 uses three digital lines to communicate with U3. U3 signals the microprocessor U2 that a conversion is completed by pulling the SDO signal line to logic low (-2.5 V), which is coupled through current limiting resistor R31 to DOUT. When U2 is ready for the reading, it pulls ADCS* of U3 to a logic low and clocks the data serially out of SDO with the signal ADSCK applied to SCK. Connecting F0 of U3 to -2.5 V sets the internal clock so that the normal mode rejection ratio (NMRR) of the digital filter will provide adequate rejection of both 50 Hz and 60 Hz.

Secondary Analog Circuits

Several secondary analog circuits are used to provide signals to a 12-bit, 200 kilo samples per second (ksps) (8000 sps is the highest rate used) analog to digital converter (ADC) with eight multiplexed-inputs in U2.

R7, R48 C31 & CR5 form a circuit that determines whether a plug is inserted into the mA/ μ A input jack. The signal MAJACK is held at -2.5 V via R48 if the split-jack J1 is not shorted by a plug. When a plug shorts split-jack J1, current will flow through R7 and the MAJACK signal is pulled to near COMMON via R28 or R4 and/or R5. MAJACK is measured by U2 to determine if the function selected by the rotary switch S1 is in conflict with the Meter inputs. C31 suppresses high frequency noise. Diode CR5 provides protection in case F1 is open. R10, R11, C26 & CR6 provide the same function for the **A** input with the COMMON connection via R6.

R97 & R98 allow the Meter model and possible revision number to be read by the microprocessor U2 as an analog signal over the single signal path MODEL.

R34, R35, R36, R37, C56 & U4 form a buffer and analog level shifter for allowing the ADIN signal to be sampled by the faster U2 ADC. This ADC is used for auto-ranging, for bar graph readings and **PEAK MIN MAX**. R34 and R35 set the DC gain at the output of U4 to 2. Since the dynamic range of ADIN is ± 1.25 , the signal at the U4 output is ± 2.5 V. Since R36 and R37 form a voltage divider referenced to -2.5V, the signal at FASTADIN has a dynamic range of -2.5V to 0 V with respect to COMMON. C56 provides a band-limited response to the higher frequencies contained in signals that are being evaluated for **PEAK MIN MAX**. C39 bypasses U4 power supplies.

S1, R22, R53, R54, R55, R58, R59, R60, R61, R84 & C20 allow the position of the rotary switch S1 to be read by the microprocessor U2 as an analog signal over the signal path SWPOS. U2 reads the position of S1 by pulling the SWPWR signal to logic high (+0.8V) and reading the signal at SWPOS. The voltage divider formed by R61, R60, R59, R58, R55, R54, R53 & R84 creates a signature voltage for each switch position of S1. R22 will pull this voltage down slightly when the divider taps are connected, but will pull the SWPOS voltage to -2.5 V when S1 is between switch positions. C20 suppresses noise.

R15 & R16 form a voltage divider to allow the battery voltage to be monitored via signal LOWBATT. C28 suppresses noise.

Keypad

R40, R43, R68, S3, S4, S5, S6, S7, S8, S9, S10 & S11 form the buttons that allow access to Meter functions that are not selected by rotary switch S1. The microprocessor U2 is connected to 9 switches with three strobe lines PB4, PB5 & PB6 to three switches each. The other end of each switch is pulled to +0.8 V by R40, R43 or R68 and connected to

sense lines PB1, PB2 & PB3 with one switch from each strobe group per sense line. U2 pulls each strobe line to -2.5 V in sequence and monitors the sense lines. U2 can determine which switch is closed, debounce and handle multiple switch closures.

Microprocessor & Support Circuits

U2 is the microprocessor and Y1 is the crystal used for the clock generator that is internal to U2. The 32.768-kHz oscillator is multiplied to above 1 MHz inside U2 when the Meter is not in sleep mode. This low oscillator frequency helps reduce the standby power required by U2 while the Meter is in sleep mode. C17, C18, C19, C25, C27 & C29 are power supply bypass capacitors.

R21 & C8 form the power on reset circuit that holds the RST* signal to U2 at logic low until C8 is charged to logic high on the way to 3.3 V (-2.5 V to +0.8 V).

U14 is an AND gate that allows the signal ODCMP from COMP_O (U1 pin 24) to gate the SMCLK signal from U2 back to the DCMP input of U2 to facilitate the measurement of duty cycle. When U2 sets SMCLK to logic high (+0.8 V), the ODCMP signal is counted by U2 and frequency is measured. When U2 drives SMCLK with an approximately 1-MHz clock, this signal appears at DCMP only when ODCMP is logic high (+0.8 V). The frequency of the signal ODCMP is measured directly while the multiple positive periods are measured referenced to the SMCLK. U2 uses the frequency of ODCMP and the accumulated time that the signal was high to compute both the positive and negative duty cycle.

LCD

U11 is a liquid crystal display (LCD) with four back planes that are multiplexed by U2 with the COM0-3 signals. Only 34 of the possible 40 segment drivers of U2 are connected to U11 and not all combinations of segments and back planes are used.

R20, R25, R26, R27, R41 & RT2 form a temperature-compensated voltage divider used to generate the four voltage levels used by the display multiplexer internal to U2. As the temperature of the Meter is increased, U11 requires less total voltage to maintain the desired contrast ratio. RT1 is a negative temperature coefficient device, so as the temperature increases the total current through R27 increases and the voltage across R20, R25 & R26 decreases, thereby maintaining the display contrast ratio. The opposite occurs as the temperature lowers.

Backlight

DS3, R14, R46, R50, R96, R99, Q4, Q8 & Q17 form the backlight and backlight control circuit. The microprocessor holds the backlight off or can turn it on with two levels of intensity available. When the BKLT and HIBEAM signals from U2 are at logic low (-2.5 V), Q4, Q8 & Q17 are off, allowing no current to flow through DS3. When U2 drives BKLT to logic high (+0.8 V), Q4 & Q8 are turned on. The current through DS3 is set by R50, R96 and Q8, and regulated by Q4, which adjusts the base current of Q8 to keep the voltage drop across R50 & R96 equal to the voltage drop across R46. When U2 drives HIBEAM to logic high (+0.8 V), Q17 is turned on and partially bypasses R96, thereby requiring more current through R50 to keep the voltage across R50, R96 and Q17 equal to the drop across R46 resulting in a brighter backlight.

Beeper

LS1, R19, R44, R47, R108, C11, Q5 & U5 form the beeper and beeper control circuit. When the BPR signal from U2 is at logic low (-2.5 V), Q5 is off, which disconnects the negative power supply connection of U5 disabling the beeper oscillator and drive circuit. When the BPR signal from U2 is at logic high (+0.8 V), Q5 is on, which allows U5 to power up. Pin 2 of piezoelectric beeper LS1 is driven by the parallel combination of two U5 inverters and pin 1 of LS1 is driven by two more U5 inverters to supply enough

current to the beeper and ensure adequate loudness. R108 allows for limiting beeper current if necessary due to future component changes. R44 in parallel with R47 & C11 set the frequency of the beeper oscillator (note that the junction of R44, R47 & C11 operates at voltages beyond the power supply values). The remaining two U5 inverters are used in series to form the non-inverting buffer portion of the oscillator.

Troubleshooting

Refer to the “Theory of Operation” and “Schematics” sections to assist in troubleshooting the Meter.

Restoration Actions

Refer to “Performance Tests”.

Basic Maintenance

Warning

To avoid possible electric shock or personal injury:

- Remove the test leads and any input signals before opening the case or replacing the battery or fuses.
- Repairs or servicing covered in this manual should be performed only by qualified personnel.

Cleaning the Meter

Warning

To avoid possible electric shock, personal injury, or damage to the meter, never allow water inside the case.

Caution

To avoid damaging the Meter, never apply abrasives, solvents, aromatic hydrocarbons, chlorinated solvents, or methanol-based fluids to the Meter.

Periodically wipe the Meter case with Fluke “MeterCleaner” or a damp cloth and mild detergent.

Dirt or moisture in the **A** or **mA** μ **A** input terminals can affect readings and can falsely activate the Input Alert feature without the test leads being inserted. Such contamination may be dislodged by turning the Meter over and, with all test leads removed, gently tapping on the case.

Thoroughly clean the terminals as follows:

1. Turn the Meter off and remove all test leads.
2. Soak a clean swab with isopropyl alcohol and work the swab around in each input terminal to remove contaminates.

Opening the Meter Case

⚠ Caution

To avoid unintended circuit shorting, always place the uncovered Meter assembly on a protective surface. When the case of the Meter is open, circuit connections are exposed.

To open the Meter case, refer to Figure 2 and do the following:

1. Disconnect test leads from any live source, turn the rotary knob to **OFF**, and remove the test leads from the front terminals.
2. Remove the battery door by using a flat-blade screwdriver to turn the battery door screws 1/4-turn counterclockwise.
3. The case bottom is secured to the case top by three screws and two internal snaps (at the LCD end). Using a Phillips-head screwdriver, remove the three screws.

⚠ Caution

To avoid damaging the Meter, the gasket that is sealed to the bottom case, and is between the two case halves, must remain with the case bottom. The case top lifts away from the gasket easily. Do not damage the gasket or attempt to separate the case bottom from the gasket.

4. Hold the Meter display side up.
5. Pushing up from the inside of the battery compartment, disengage the case top from the gasket.
6. Gently unsnap the case top at the display end, see Figure 2.

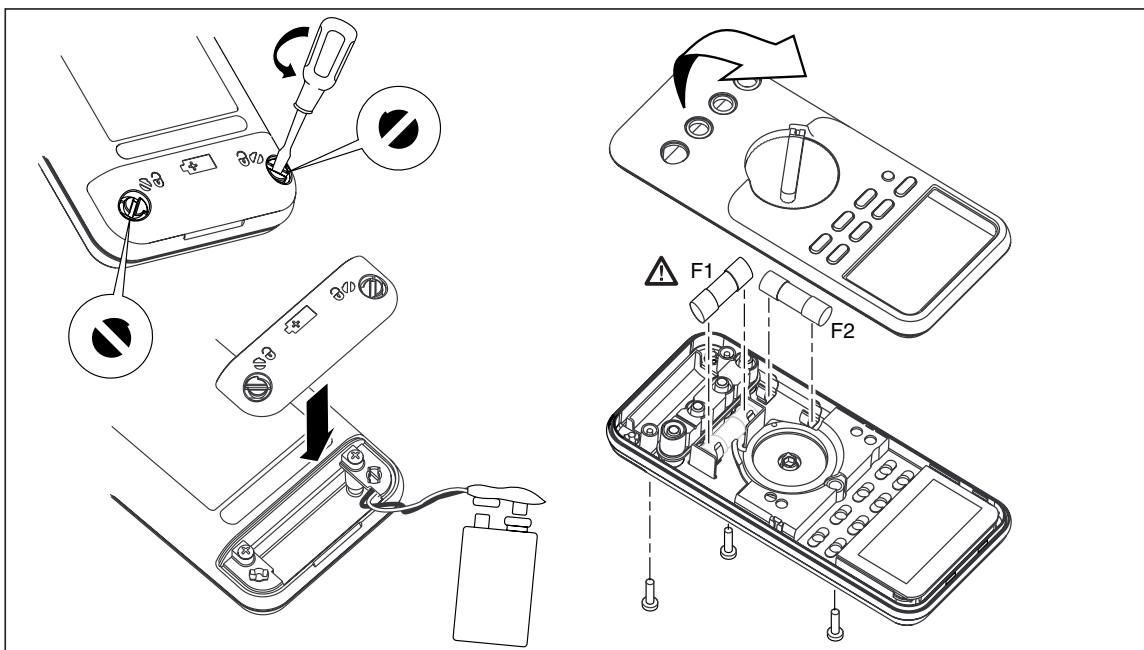

Figure 2. Opening the Meter, Battery and Fuse Replacement

ama12.eps

Accessing the PCA and Replacing the LCD

Once the case has been opened, the A1 Main PCA can easily be removed. The shields disconnect from the PCA as follows:

1. Remove the five Phillips-head screw securing the top and bottom shields to the PCA.
2. Remove the top shield assembly that also houses the LCD and lightpipe for the LCD backlight.
3. To access the LCD, unsnap the LCD mask using a small flat-blade screwdriver. The LCD may now be removed. Refer to Figure 3.

Note

Two elastomeric connectors make electrical contact between the LCD and the PCA. These connectors usually stick to the LCD when it is removed. If the connectors are to be reused, do not handle them, as the electrical contact points might become contaminated. Use tweezers to remove these connectors.

4. To reinstall the connectors, replace the LCD and LCD mask and lay the top shield face down. Install the elastomeric connector strips into the slots on the top shield.
5. Place the PCA onto the top shield so that the screw holes align.
6. Place the bottom shield onto the PCA and secure the assembly with five Phillips-head screws. Ensure that the shields are tightly attached. Properly fitted shields are required for the Meter to perform to specifications.

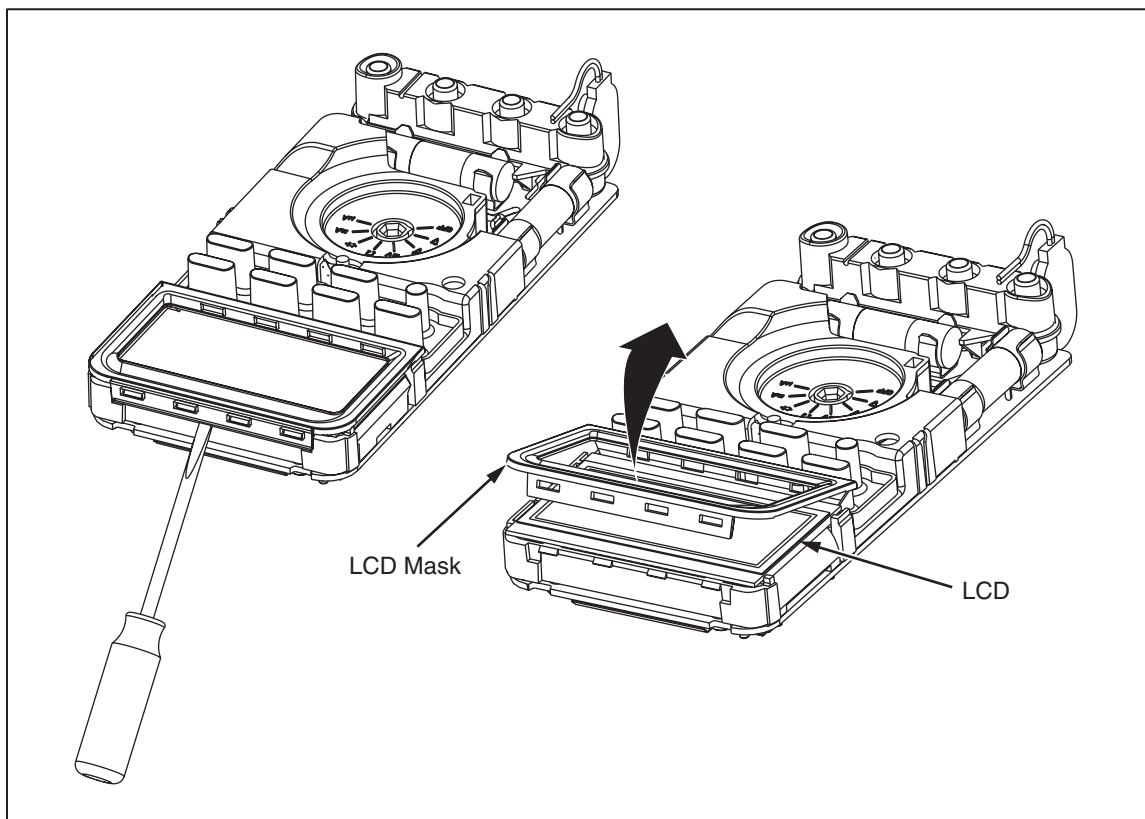

Figure 3. Removing LCD Mask to Access LCD

ama08f.eps

Reassembling the Meter Case

To reassemble the Meter case:

1. Verify that the rotary knob and circuit board switch are in the **OFF** position, and that the gasket remains secured to the bottom case.
2. Place the PCA into the bottom case.
3. Place the case top on the case bottom.
4. To avoid damaging the battery wire, ensure the wire exits the middle of the battery compartment.
5. Properly seat the case gasket and snap the case halves together above the LCD end. See Figure 2.
6. Reinstall the three case screws and the battery door.
7. Secure the battery door by turning the screw 1/4-turn clockwise.
8. Go to “Performance Tests” later in this document, and perform the procedures described.

Replacing the Battery

Replace the battery with a 9-V battery (NEDA A1604, 6F22, or 006P).

Warning

To avoid false readings, which could lead to possible electric shock or personal injury, replace the battery as soon as the battery indicator (🔋) appears. If the display shows “bAt t” the Meter will not function until the battery is replaced.

Replace the battery as follows, refer to Figure 2:

1. Turn the rotary knob to **OFF** and remove the test leads from the terminals.
2. Remove the battery door by using a standard-blade screwdriver to turn the battery door screws one-quarter turn counterclockwise.
3. Remove the old battery and replace it with a new one.
4. Align the battery leads so that they not pinched between the battery door and the case bottom.
5. Secure the door by turning the screws one-quarter turn clockwise.

Testing Fuses and Current Circuitry

If a test lead is plugged into the **mA/μA** or **A** terminal and the rotary knob is turned to a non-current function, the Meter chirps and flashes “L E Ad” if the fuse associated with that current terminal is good. If the Meter does not chirp or flash “L E Ad”, the fuse is bad and must be replaced. Refer to Table 17 for the appropriate replacement fuse.

Before measuring current, test the quality of the appropriate fuse and the current shunt using the following procedure. See Figure 4.

1. Turn the rotary knob to $\Omega \rightarrow$.
2. To test F2, insert a test lead into the $\downarrow V \Omega \rightarrow$ input terminal and touch the probe to the **A** input terminal.

Note

The input receptacles contain split contacts. Be sure to touch the probe to the half of the receptacle nearest the LCD.

3. The display should indicate between $00.0\ \Omega$ and $00.5\ \Omega$. If the display reads OL, replace the fuse and test again. If the display reads another value, further servicing is required.
4. To test F1, move the probe from the **A** input terminal to the **mA/ μ A** input terminal.
5. The display should read between $0.995\ \text{k}\Omega$ and $1.005\ \text{k}\Omega$. If the display reads OL, replace the fuse and test again. If the display reads another value, further servicing is required.

⚠ ⚠ Warning

To avoid electrical shock or personal injury:

- Remove the test leads and any input signals before replacing the battery or fuses.
- Install **ONLY** specified replacement fuses with the amperage, voltage, and speed ratings shown in Table 17.

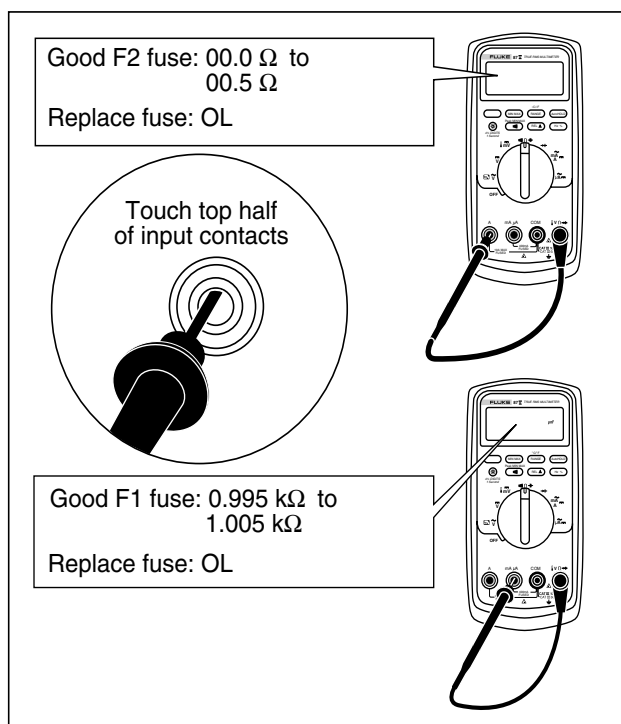

Figure 4. Testing the Current Input Fuses

aom5f.eps

Replacing the Fuses

To replace the fuse(s), perform the following procedure.

1. To open the Meter, refer to “Opening the Meter Case”. See Figure 2.
2. Grasp the fuse in the center with needle nose pliers. Pull straight up on the fuse to remove it from the fuse clips.
3. Install **ONLY** specified replacement fuses with the amperage, voltage, and speed ratings shown in Table 17.
4. To close the Meter, refer to “Reassembling the Meter Case”.

Required Equipment

Required equipment for the performance tests is listed in Table 13. If the recommended models are not available, equipment with equivalent specifications may be used.

Warning

- **To avoid shock or injury, do not perform the verification tests or calibration adjustment procedures described in this manual unless you are qualified to do so.**
- **Repairs or servicing should be performed only by qualified personnel.**

Table 13. Required Equipment

Equipment	Required Characteristics	Recommended Model
Calibrator	AC Voltage Range: 0 - 1000 V ac Accuracy: $\pm 0.12\%$ Frequency Range: 60 - 20000 Hz Accuracy: $\pm 3\%$ DC Voltage Range: 0 - 1000 V dc Accuracy: $\pm 0.012\%$ Current Range: 350 μ A - 2 A Accuracy: AC (60 Hz to 1 kHz): $\pm 0.25\%$ DC: $\pm 0.05\%$ Frequency Source: 19.999 kHz - 199.99 kHz Accuracy: $\pm 0.0025\%$ Amplitude: 150 mV to 6V rms Accuracy: $\pm 5\%$ Range: 1 Ω - 100 M Ω Accuracy: 0.065 %	Fluke 5500A Multi-Product Calibrator or equivalent
TC Adapter Accessory	K-type	Fluke 80 AK
K-type Thermocouple	K-type, mini-plug on both ends	

Performance Tests

The following performance tests verify the complete operability of the Meter and check the accuracy of each Meter function against the Meter's specifications. Performance tests should be performed annually to ensure that the Meter is within accuracy specifications.

Accuracy specifications are valid for a period of one year after calibration adjustment, when measured at an operating temperature of 18 °C to 28 °C and at a maximum of 90 % relative humidity.

To perform the following tests, it is not necessary to open the case. No adjustments are necessary. Make the required connections, apply the designated inputs, and determine if the reading on the Meter display falls within the acceptable range indicated.

Note

If the Meter fails any of these tests, it needs calibration adjustment or repair.

Basic Operability Tests

Refer to the following sections to test the basic operability of the Meter.

Testing the Fuses

Refer to “Testing Fuses (F1 and F2)”.

Testing the Display

Turn the Meter on while holding down (AutoHOLD) to view all segments of the display. Compare the display with the appropriate examples in Figure 5 and Table 14.

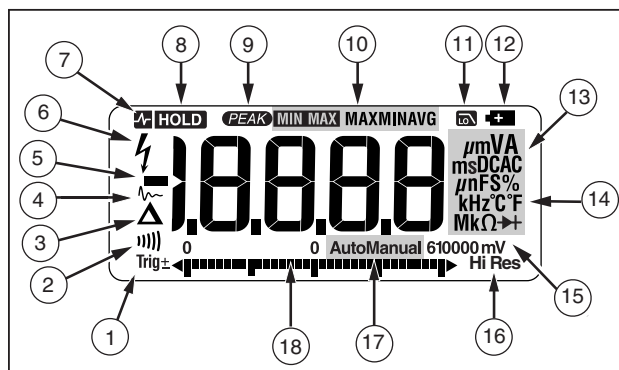



Figure 5. Display Features

aom1_af.eps

Table 14. Display Features



Number	Feature	Indication
①	±	Polarity indicator for the analog bar graph.
	Trig±	Positive or negative slope indicator for Hz/duty cycle triggering.
②		The continuity beeper is on.
③	△	Relative (REL) mode is active.
④	~	Smoothing is active.
⑤	-	Indicates negative readings. In relative mode, this sign indicates that the present input is less than the stored reference.
⑥	⚡	Indicates the presence of a high voltage input. Appears if the input voltage is 30 V or greater (ac or dc). Also appears in low pass filter mode. Also appears in cal, Hz, and duty cycle modes.
⑦	⏸ HOLD	AutoHOLD is active.
⑧	HOLD	Display Hold is active.
⑨	PEAK	Indicates the Meter is in Peak Min Max mode and the response time is 250 μs
⑩	MIN MAX MAX MIN AVG	Indicators for minimum-maximum recording mode.
⑪	LO	Low pass filter mode.

Table 14. Display Features (cont.)

Number	Feature	Indication
⑫		The battery is low. $\Delta\Delta$ Warning: To avoid false readings, which could lead to possible electric shock or personal injury, replace the battery as soon as the battery indicator appears.
⑬	A, μA, mA V, mV μF, nF nS % Ω, MΩ, kΩ Hz, kHz AC DC	Amperes (amps), Microamp, Milliamp Volts, Millivolts Microfarad, Nanofarad Nanosiemens Percent. Used for duty cycle measurements. Ohm, Megohm, Kilohm Hertz, Kilohertz Alternating current, direct current
⑭	$^{\circ}$C, $^{\circ}$F	Degrees Celsius, Degrees Fahrenheit
⑮	610000 mV	Displays selected range
⑯	HiRes	The Meter is in high resolution (Hi Res) mode. HiRes=19,999
⑰	Auto	The Meter is in autorange mode and automatically selects the range with the best resolution.
	Manual	The Meter is in manual range mode.
⑱		The number of segments is relative to the full-scale value of the selected range. In normal operation 0 (zero) is on the left. The polarity indicator at the left of the graph indicates the polarity of the input. The graph does not operate with the capacitance, frequency counter functions, temperature, or peak min max. For more information, see "Bar Graph". The bar graph also has a zoom function, as described under "Zoom Mode".
--	OL	Overload condition is detected.
Error Messages		
bAtt	Replace the battery immediately.	
diSC	In the capacitance function, too much electrical charge is present on the capacitor being tested.	
EEP Err	Invalid EEPROM data. Have Meter serviced.	
CAL Err	Invalid calibration data. Calibrate Meter.	
LEAD	Δ Test lead alert. Displayed when the test leads are in the A or mA/μA terminal and the selected rotary switch position does not correspond to the terminal being used.	

Testing the Pushbuttons

To test the pushbuttons

1. Turn the Meter rotary knob to  \tilde{V} .
2. Press each button and note that the meter responds with a beep for each button press.
3. Press and hold  a second time to exit MIN MAX mode.











Testing Meter Accuracy

Perform the accuracy test steps in Table 15.

Table 15. Accuracy Tests

Step	Test Function	Range	5500A Output	Display Reading
1	\tilde{V} AC Volts	600 mV	330 mV, 60 Hz	327.3 to 332.7
2		600 mV	600 mV, 13 kHz	586.0 to 614.0
3		6 V	3.3 V, 60 Hz	3.275 to 3.325
4		6 V	3.3 V, 20 kHz	3.214 to 3.386
5		60 V	33 V, 60 Hz	32.75 to 33.25
6		60 V	33 V, 20 kHz	32.14 to 33.86
7		600 V	330 V, 60 Hz	327.5 to 332.5
8		600 V	330 V, 2.5 kHz	323.0 to 337.0
9		1000 V	500 V, 60 Hz	494 to 506
10		1000 V	1000 V, 1 kHz	986 to 1014
11	\tilde{V} Hz AC Volts Frequency	600 mV	150 mV, 99.95 kHz	99.93 to 99.97
12		600 mV	150 mV, 199.50 kHz	199.48 to 199.52
13	Sensitivity	6 V	0.7 V, 99.95 kHz	99.93 to 99.97
14		60 V	7 V, 99.95 kHz	99.93 to 99.97
15	$\overline{\tilde{V}}$ Hz Trigger level	6 V	3.4 V, 1 kHz Sq. Wave	999.8 to 1000.2
16	$\overline{\tilde{V}}$ Hz Duty Cycle	6 V	5 V, 1 kHz, DC offset 2.5 V Sq. Wave	49.7 % to 50.3 %
17	$\overline{\overline{V}}$ DC Volts	6V	3.3 V dc	3.297 to 3.303
18		60 V	33 V dc	32.97 to 33.03
19		600 V	330 V dc	329.7 to 330.3
20		1000 V	1000 V dc	998 to 1002
21	$\overline{\overline{mV}}$ DC Volts	600 mV	33 mV dc	32.9 to 33.1
22		600 mV	330 mV dc	329.6 to 330.4
23	Ω Ohms	600 Ω	330 Ω (Use 2 wire Comp) ¹	329.1 to 330.9
24		6 k Ω	3.3 k Ω (Use 2 wire Comp) ¹	3.292 to 3.308
25		60 k Ω	33 k Ω	32.92 to 33.08
26		600 k Ω	330 k Ω	327.9 to 332.1
27		6 M Ω	3.3 M Ω	3.279 to 3.321
28		50 M Ω	30 M Ω	29.67 to 30.33

Table 15. Accuracy Tests (cont.)

Step	Test Function	Range	5500A Output	Display Reading
29	nS Conductance	60 nS	Open input	-0.10 to 0.10
30		60 nS	100 MΩ	9.80 to 10.20
31	 Diode	6 V	3.0 V dc	2.939 to 3.061
32	 AC Amps	6 A	3.0 A, 60 Hz	2.968 to 3.032
33	 DC Amps	6 A	3.0 A	2.990 to 3.010
34	 AC Milliamps	60 mA	33 mA, 60 Hz	32.65 to 33.35
35		400 mA	330 mA, 60 Hz	326.5 to 333.5
36	 DC Milliamp	60 mA	33 mA	32.89 to 33.11
37		400 mA	330 mA	329.1 to 330.9
38	 AC Microamps	600 μA	330 μA, 60 Hz	326.5 to 333.5
39		6000 μA	3300 μA, 60 Hz	3265 to 3335
40	 DC Microamps	600 μA	330 μA	328.9 to 331.1
41		6000 μA	3300 μA	3291 to 3309
42	 Capacitance	10 nf	Open input ²	0.21 to 0.31
43		100 nf	5 nF ⁵	4.7 to 5.3
44		100 μf	9.5 μf	9.2 to 9.8
45	 Low Pass Filter	1000 V	400 V, 400 Hz	372 to 408
46		1000 V	400 V, 800 Hz ⁴	226 to 340 ⁴
47	 Peak Min/Max	6 V	8 Vpp, 2 kHz Sq. Wave, DC offset 2 V	Max = 5.896 to 6.104
48				Min = -1.898 to -2.102
49	 Temperature ³		0 °C	-1.0 to 1.0
50			100 °C	98.0 to 102.0
51	Backlight		Press backlight button	Backlight comes on
52			Press backlight button	Backlight Intensifies
53			Press backlight button	Backlight off

1. Or short test leads and use REL to offset test lead resistance.
2. Remove test leads from unit.
3. To ensure accurate measurement, the Meter and thermocouple adapter must be at the same temperature. After connecting the thermocouple adapter to the Meter allow for reading to stabilize before recording display reading.
4. The Meter accuracy is not specified at this input signal frequency with Low-pass filter selected. The display reading shown, check that the Low-pass filter is active and follows an expected roll-off curve.
5. Use REL to compensate for internal Meter and lead capacitance. The test leads must be disconnected from the calibrator before pushing REL.

Calibration Adjustment



The Meter features closed-case calibration adjustment using known reference sources. The Meter measures the applied reference source, calculates correction factors and stores the correction factors in nonvolatile memory.

The following sections present the features and Meter pushbutton functions that can be used during the Calibration Adjustment Procedure. Perform the Calibration Adjustment Procedure should the Meter fail any performance test listed in Table 15.

Calibration Adjustment Counter

The Meter contains a calibration adjustment counter. The counter is incremented each time a Calibration Adjustment Procedure is completed. The value in the counter can be recorded and used to show that no adjustments have been made during a calibration cycle.

Use the following steps to view the Meter's calibration counter.





1. While holding down , turn the rotary knob from **OFF** to **VAC**. The Meter should display “ **CAL**”.
2. Press  once to see the calibration counter. For example "n001".
3. Turn the rotary knob to **OFF**.









Calibration Adjustment Password

To start the Calibration Adjustment Procedure, the correct 4-button password must be entered. The password can be changed or reset to the default as described in following paragraphs. The default password is “1234”.



Changing the Password

Use the following steps to change the Meter's password:

1. While holding down , turn the rotary knob from **OFF** to **VAC**. The Meter displays “ **CAL**”.
2. Press  once to see the calibration counter.
3. Press  again to start the password entry. The Meter displays "????".
4. The Meter buttons represent the digit indicated below when entering or changing the password:

 = 1  = 2  = 3  = 4
 = 5  = 6  = 7  = 8

Press the 4 buttons to enter the old password. If changing the password for the first time, enter  (1)  (2)  (3)  (4).

5. Press  to change the password. The Meter displays "----" if the old password is correct. If the password is not correct, the Meter emits a double beep, displays "?????" and the password must be entered again. Repeat step 4.
6. Press the 4 buttons of the new password.
7. Press  to store the new password.

Restoring the Default Password

If the calibration password is forgotten, the default password (1234) can be restored using the following steps.

1. While holding down **MIN MAX**, turn the rotary knob from **OFF** to **VAC**. The Meter displays “⚡ CAL”.
2. Remove the Meter's top case. Leave the PCA in the bottom case. (See “Opening the Meter Case”.)

⚠⚠ Warning

To avoid electrical shock or personal injury, remove the test leads and any input signal before removing the Meter's top case.

3. Through an access hole provided in the top shield, short across the keypads on the PCA. See Figure 6. The Meter should beep. The default password is now restored.
4. Replace the Meter's top case and turn the rotary knob to **OFF**. (See “Reassembling the Meter Case”).

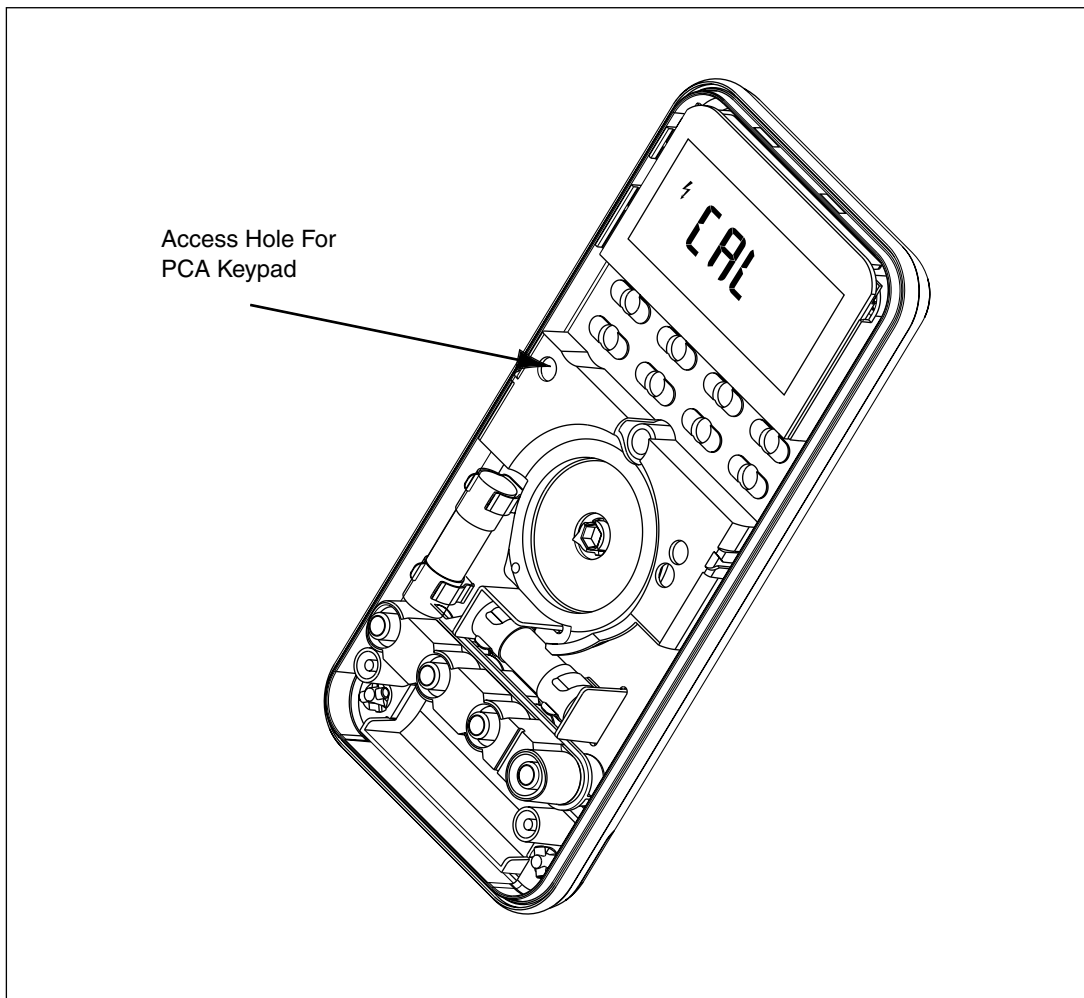





Figure 6. Restoring the Default Password

ama01f.eps





Meter Buttons Used in the Calibration Steps

The Meter buttons behave as follows when performing the Calibration Adjustment Procedure. This may be of help determining why a calibration step is not accepted and for determining the input value without referring to Table 16.

-  Press and hold to show the measured value. The measurement value is not calibrated so it may not match the input value. This is normal.
-  Press and hold to display the required input amplitude.
-  Press and hold to display the frequency of the required input.
-  Press to store the calibration value and advance to the next step. This button is also used to exit calibration mode after the calibration adjustment sequence is complete.

Calibration Adjustment Procedure

Use the following steps to adjust the Meter's calibration. If the Meter is turned off before completion of the adjustment procedure, the calibration constants are not changed.

1. While holding down , turn the rotary knob from **OFF** to **VAC**. The Meter displays “⚡ CAL”.
2. Press  once to see the calibration counter.
3. Press  again to start the password entry. The Meter displays "????".
4. Press 4 buttons to enter the password.
5. Press  to go to the first calibration step. The Meter displays "C-01" if the password is correct. If the password is not correct, the Meter emits a double beep, displays "????" and the password must be entered again. Repeat step 4.
6. Using Table 16, apply the input value listed for each calibration adjustment step. For each step, position the rotary switch and apply the input to the terminals as indicated in the table.
7. After each input value is applied, press  to accept the value and proceed to the next step (C-02 and so forth).

Note

After pressing , wait until the step number advances before changing the calibrator source or turning the Meter rotary knob.

If the Meter rotary knob is not in the correct position, or if the measured value is not within the anticipated range of the input value, the Meter emits a double beep and will not continue to the next step.

Some adjustment steps take longer to execute than others (10 to 15 seconds). For these steps, the Meter will beep when the step is complete. Not all steps have this feature.

8. After the final step, the display shows "End" to indicate that the calibration adjustment is complete. Press  to go to meter mode.

Notes

Set the calibrator to Standby prior to changing the function switch position and or after completing adjustment of each function.

If the calibration adjustment procedure is not completed correctly, the Meter will not operate correctly.



Table 16. Calibration Adjustment Steps

Switch Position (Function)	Input Terminal	Calibration Adjustment Step	Input Value
\tilde{V} (AC Volts)	$V \Omega \rightarrow \rightarrow$	C-01	600.0 mV, 60 Hz
		C-02	600.0 mV, 20 kHz
		C-03	6.000 V, 60 Hz
		C-04	6.000 V, 20 kHz
		C-05	60.00 V, 60 Hz
		C-06	60.00 V, 20 kHz
		C-07	600.0 V, 60 Hz
		C-08	600.0 V, 10 kHz
\bar{V} (DC Volts)		C-09	6.000 V, 0 Hz
		C-10	60.00 V, 0 Hz
$m\bar{V}$ (DC Millivolts)		C-11	600.0 V, 0 Hz
		C-12	600.0 mV, 0 Hz
Ω (Ohms)		C-13	60.00 mV, 0 Hz
		C-14	600.0 Ω
		C-15	6.000 k Ω
		C-16	60.00 k Ω
		C-17	600.0 k Ω
		C-18	6.000 M Ω
		C-19	0.000 Ω
		C-20	50.0 M Ω
$\rightarrow \rightarrow$ (Diode Test)	C-21	3.000 V, 0 Hz	
A, mA (Amps, milliamps)	A	C-22	6.000 A, 60 Hz
		C-23	6.000 A, 0 Hz
	mA / μA	C-24	60.00 mA, 60 Hz
		C-25	400.0 mA, 60 Hz
		C-26	60.00 mA, 0 Hz
μ A (Microamps)	mA / μA	C-27	400.0 mA, 0 Hz
		C-28	600.0 μ A, 60 Hz
		C-29	6000 μ A, 60 Hz
		C-30	600.0 μ A, 0 Hz
		C-31	6000 μ A, 0 Hz

Service and Parts

Replacement parts are shown in Table 17, Table 18, and Figures 7 and 8. To order parts and accessories, refer to “Contacting Fluke”.

Table 17. 87 V/AN Final Assembly

Reference Designator	Description	Part Number	Cage	Manufacturer's Part Number	Qty
A1	PCA Main Assembly	2174143	89536	2174143	1
AC72	Alligator Clip, Black	1670652	89536	1670652	1
AC72	Alligator Clip, Red	1670641	89536	1670641	1
BT1	Battery, 9 V	2139179	83740	522VP	1
BT2	Cable Assy, 9 V Battery Snap	2064217	89536	2064217	1
CR6	Lightpipe	2074057	89536	2074057	1
F1 	Fuse, 0.440 A, 1000 V, FAST	943121	0FB96	DMM-44/100	1
F2 	Fuse, 11 A, 1000 V, FAST	803293	0FB96	DMM-11	1
H2-4	Screw, Case	832246	89536	832246	3
H5-9	Screw, Bottom Shield	448456	89536	448456	5
J1-2	Elastomeric Connector	817460	89536	817460	2
MP2	Shield, Top	2073906	89536	2073906	1
MP4	Shield, Bottom	2074025	89536	2074025	1
MP5	Case Top (PAD XFER) with Window	2073992	89536	2073992	1
MP6	Case Bottom	2073871	89536	2073871	1
MP8	Knob, Switch (PAD XFER)	2100482	89536	2100482	1
MP9	Detent, Knob	822643	89536	822643	1
MP10-11	Foot, Non-Skid	824466	89536	824466	2
MP13	Shock Absorber	828541	89536	828541	1
MP14	O-Ring, Input Receptacle	831933	17506	5-143-N1472-70	1
MP15	Holster w/ Tilt Stand	2074033	89536	2074033	1
MP22	Battery Door	2073938	89536	2073938	1
MP27-MP30	Contact RSOB	1567683	89536	1567683	4
MP31	Mask, LCD (PAD XFER)	2073950	89536	2073950	1
MP41	Housing, RSOB	2073945	89536	2073945	1
MP390-391	Access Door Fastener	948609	89536	948609	2
NA	Tiltstand	2074040	89536	2074040	1
S2	Keypad	2105884	89536	2105884	1
TL75	Test Lead Set	855742	89536	855742	1
TM1 (not shown)	CD ROM, 87 V/AN	2153570	89536	2153570	1
TM2 (not shown)	<i>87 V/AN Users Manual</i>	2153581	89536	2153581	1
TM3 (not shown)	<i>87 V/AN Service Manual</i> (this manual)	2153596	89536	2153596	1
U5	LCD, 4.5 DIGIT, TN, Transflective, Bar Graph, OSPR80	2065213	89536	2065213	1
80BK	Thermocouple Assembly, K-Type, Beaded, Molded Dual Banana Plug, Coiled	1273113	89536	1273113	1

 To ensure safety, use exact replacement only.

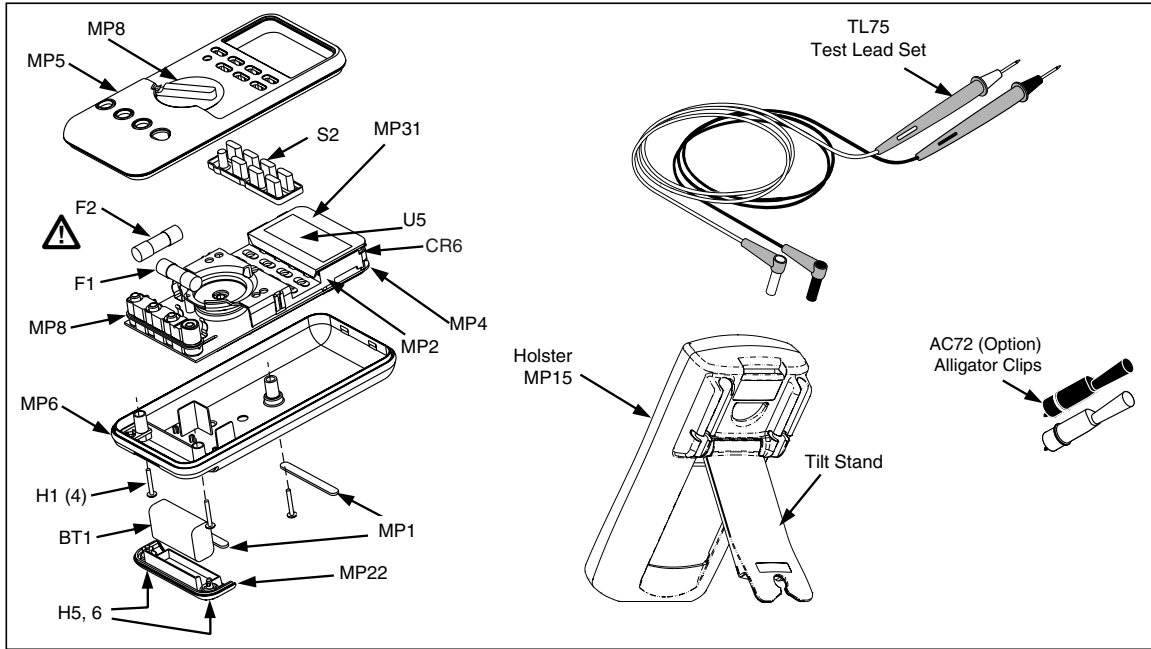

Figure 7. 87 V/AN Final Assembly

axp015.eps

Table 18. A1 Main PCA

Reference Designator	Description	Part Number	Cage	Manufacturer's Part Number	Qty
C1	CAPACITOR,FILM,POLYESTER,0.022UF, +-10%,1000V,10MM LS RADIAL,BULK	2117948	65964	MMK10223K1000A04L4	1
C2 C39 C57	CAPACITOR, SMR,CAP,CER,0.01UF, +-10%,50V,X7R,0603	644838	04222	06035C103KAT2A	3
C3	CAPACITOR, SMR,CAP,CER,180PF, +-5%,100V,C0G,0805	689588	04222	08051A181JAT1A	1
C4-5 C8 C12 C14 C19-21 C25 C28	CAPACITOR,CERAMIC,0.1UF, +-10%,25V,X7R,0805,TAPE	942529	04222	08053C104KAT3A	10
C6	CAPACITOR,ELECTROLYTIC,TANTALUM, 22UF,+-10%,6V,3216,TAPE	2053857	04222	TAJA226K006R	1
C7	CAPACITOR,ELECTROLYTIC,TANTALUM, 33UF,+-20%,16V,6032,0.300 OHM ESR,TAPE	1614265	31433	T495C336_016AS	1
C9-10	CAPACITOR, FILM,POLYPHENYLENE,0.022UF, +-10%,50V,5750,TAPE	802501	65964	SMC5.7 223K50J31 TR12	2
C11	CAPACITOR, SMR,CAP,CER,470PF, +-5%,50V,C0G,1206	943365	04222	12065A471JAT1A	1
C15	CAPACITOR, SMR,CAP,TA,4.7UF, +-20%,16V,3528	745976	04222	TAJB475M016R	1
C16	CAPACITOR,ELECTROLYTIC,TANTALUM, 47UF,+-20%,10V,3528,TAPE	1663963	04222	TAJB476K010R	1
C17	CAPACITOR,CERAMIC,0.1UF, +-20%,16V,X7R,0603,TAPE	1579869	04222	0603YC104MAT2A	1
C18 C22 C27 C29	CAPACITOR, SMR,CAP,TA,10UF, +-20%,10V,3528	603032	04222	TAJB106M010R	4
C26 C31	CAPACITOR, SMR,CAP,CER,0.01UF, +-10%,50V,X7R,1206	747261	04222	12061C103KAT1A	2
C32-35	CAPACITOR, SMR,CAP,CER,1000PF, +-10%,50V,X7R,0603	605342	04222	06035C102KAT2A	4
C36	CAPACITOR,CERAMIC,2700PF, +-5%,50V,C0G,1206,TAPE	688986	04222	12065A272JAT1A	1
C37	CAPACITOR,CERAMIC,390PF, +-5%,50V,C0G,1206,TAPE	887278	04222	12065A391JAT1A	1
C38	CAPACITOR, SMR,CAP,CER,6800PF, +-10%,50V,X7R,0805	604238	04222	08055C682KAT1A	1
C43	CAPACITOR,CERAMIC,1.5PF, +0.1PF,1KVAC/DC,COK,5MMLS,RADIAL, BULK	2138739	89536	2138739	1
C50	CAPACITOR,CERAMIC,100PF, +-5%,100V,C0G,0805,TAPE	601028	04222	08051A101JAT1A	1
C56	CAPACITOR SMR,CAP,CER,100PF, +-10%,50V,C0G,1206	740571	04222	12065A101KAT1A	1
CR1 CR3	DIODE,GF1B SMR,DIODE,SI,100V,1A, DO-214	912451	24444	GF1B	2
CR2	DIODE,SI,PN,DF01S,100V,1A,BRIDGE, 4 PIN SURFACE MOUNT,3530,TAPE	912456	0KTV3	DB104S-T	1
CR5-6 CR8-10	DIODE,SI,PN,BAV199,70V,140MA,3US, DUAL,SERIES,SOT-23,TAPE	605805			5
DS3	LED,WHITE,NICHIA NSCW100,310MCD,20MA,4V,IV RANK S-T,COLOR RANK B1-B2,1208,TAPE	2096202	1B1N5	NSCW100 (RANK S-T,B1-B2)	1
J1	INPUT RCPT ASSY	826214	89536	826214	1
J3	CONNECTOR,HEADER, CONNECTOR, 1 ROW, 2MM CTR, VERTICAL PCB MOUNT, 2 PIN, BULK	2002420	27264	87553-0210	1
L1	INDUCTOR,BEAD,60 OHMS@100MHZ,6ADC,10MOHM,1806,TAPE	944645	32897	BLM41PG600SN1D (T/R)	1
L2 L4	INDUCTOR,BEAD,220 OHMS@100MHZ,200MA,0603,TAPE	1554422	32897	BLM18AG221SN1D	2
Q13	MOSFET,SI,P,IRLML6302,20V,780MA,600 MOHMS,540MW,SOT-23,TAPE	1641929	81483	IRLML6302TR	1

Table 18. A1 Main PCA (cont.)

Reference Designator	Description	Part Number	Cage	Manufacturer's Part Number	Qty
Q3 Q6 Q14	NPN,MMBT3904 SMR,TRANSISTOR,SI,NPN,60V,350MW,SO T-23	742676	89536	742676	3
Q4-5 Q8 Q17	TRANSISTOR,SI,NPN,MMBT5089,30V,50M A,50MHZ,200MW,SOT-23,TAPE	820902	65940	SST5089	4
Q7	TRANSISTOR,SI,PNP,MMBT3906,40V,200 MA,250MHZ,225MW,SOT-23,TAPE	742684	89536	742684	1
R1	RESISTOR,CERMET COMPOSITION,1K, +-10%,1W,-1300+-300PPM,TAPE	1275713	59124	PCF1-102K-T631 <D>	1
R2	RESISTOR, SMR,RES,CERM,1K, +-5%,1W,200PPM,2512	601176	18612	CRCW2512-102JR82	1
R3	RESISTOR,CERMET,2K, +-1%,0.1W,100PPM,0805,TAPE	928742	18612	CRCW-0805-2001F-RT1	1
R4	RESISTOR,METAL FILM,110,+- 0.1%,0.25W,25PPM,1210,TAPE	2064399	59124	RN732ELTD1100B25	1
R5	RESISTOR, SMR,RES,WW,1, +-1%,2W,75PPM,1270	642790	18612	WSR-2,1-OHM,+-1%	1
R6	RESISTOR,WIREWOUND,0.010,+- 2%,1W,100PPM,RADIAL,BULK	2117705	18612	SPU101R01000GD	1
R7 R10	RESISTOR, RES,CERM,1M,+ 5%,1W,200PPM	912589	ODBE5	RG1/2-1M-5%(W/LEAD)	2
R8	RESISTOR,METAL FILM,856,+ 0.5%,0.1W,50PPM,0805,TAPE	2093973	59124	RN732ALTD8560D50	1
R9	RESISTOR, SMR,RES,CERM,1M, +-1%,.125W,100PPM,1206	836387	18612	CRCW-1206-1004F-RT2	1
R11 R48	RESISTOR,CERMET,10M, +-1%,0.1W,400PPM,0805,TAPE	943659	18612	CRCW-0805-1005F-RT2	2
R12	RESISTOR,CERMET,3.01K, +-1%,0.125W,100PPM,0805,TAPE	1591278	18612	CRCW08053011FRT1	1
R14 R99	RESISTOR, SMR,RES,CERM,5.62K, +-1%,0.1W,100PPM,0805	930110	18612	CRCW-0805-5621F-RT1	2
R15	RESISTOR,CERMET,845K, +-1%,0.1W,100PPM,0805,TAPE	1292164	18612	CRCW08058453FRT1	1
R16 R29-30 R32	RESISTOR, SMR,RES,CERM,226K, +-1%,.063W,100PPM,0603	643871	18612	CRCW-0603-2263FRT1	4
R17-18 R33 R73-74 R80	RESISTOR, SMR,RES,CERM,1M, +-1%,.063W,100PPM,0603	643848	18612	CRCW-0603-1004FRT1	6
R19	RESISTOR, SMR,RES,CERM,40.2K, +-1%,.063W,100PPM,0603	689700	18612	CRCW-0603-4022FRT1	1
R20 R25-26 R35-37 R40 R43 R53-55 R58-61 R68 R98	RESISTOR, SMR,RES,CERM,100K, +-1%,.063W,100PPM,0603	643863	18612	CRCW-0603-1003FRT1	17
R21 R63	RESISTOR, SMR,RES,CERM,10K, +-1%,.063W,100PPM,0603	605052	18612	CRCW-0603-1002FRT1	2
R22 R103	RESISTOR, SMR,RES,CERM,1M, +-1%,0.1W,200PPM,0805	928945	18612	CRCW-0805-1004F-RT2	2
R27	RESISTOR, SMR,RES,CERM,4.32K, +-1%,.063W,100PPM,0603	605250	18612	CRCW-0603-4321FRT1	1
R28	RESISTOR, SMR,RES,MF,1K, +-0.1%,0.1W,50PPM,0805	802469	ODBE5	PCF-W0805R-02-1001-B	1
R31	RESISTOR, SMR,RES,CERM,49.9K, +-1%,.063W,100PPM,0603	643921	18612	CRCW-0603-4992FRT1	1
R34 R84	RESISTOR,CERMET,200K, +-1%,0.063W,100PPM,0603,TAPE	1562307	18612	CRCW06032003FRT1	2
R41	RESISTOR, SMR,RES,CERM,21.0K, +-1%,.063W,100PPM,0603	642261	18612	CRCW-0603-2102FRT1	1

Table 18. A1 Main PCA (cont.)

Reference Designator	Description	Part Number	Cage	Manufacturer's Part Number	Qty
R44 R47	RESISTOR, SMR,RES,CERM,475K, +-1%,.125W,100PPM,1206	943530	18612	CRCW-1206-4753F-RT2	2
R46	RESISTOR, SMR,RES,CERM,1K, +-1%,.063W,100PPM,0603	649720	18612	CRCW-0603-1001FRT1	1
R50	RESISTOR, SMR,RES,CERM,12.1,+-1%,0.1W,100PPM,0805	930081	18612	CRCW-0805-12R1F-RT1	1
R51	RESISTOR,METAL FILM,24.9K,+-0.5%,0.063W,50PPM,0603,TAPE	2094011	59124	RN731JLTD2492D50	1
R52	RESISTOR,METAL FILM,249K,+-0.5%,0.063W,50PPM,0603,TAPE	2126890	18612	TNPW0603-2493DT2RT1	1
R85	RESISTOR, SMR,RES,CERM,49.9K, +-1%,0.1W,100PPM,0805	928697	18612	CRCW-0805-4992F-RT1	1
R86	RESISTOR, SMR,RES,CERM,102K, +-1%,.063W,100PPM,0603	605060	18612	CRCW-0603-1023FRT1	1
R87	RESISTOR, SMR,RES,CERM,107K, +-1%,0.1W,100PPM,0805	686748	18612	CRCW-0805-1073F-RT1	1
R88	RESISTOR,CERMET,97.6K, +-1%,0.063W,100PPM,0603,TAPE	2065578	18612	CRCW06039762F-RT1	1
R94	RESISTOR SMR,RES,CERM,499K,+-1%,.125W,100PPM,1206	821678	18612	CRCW-1206-4993F-RT2	1
R96	RESISTOR, SMR,RES,CERM,32.4, +-1%,0.1W,100PPM,0805	641974	18612	CRCW-0805-32R4F-RT1	1
R100-101	RESISTOR, SMR,RES,CERM,499K, +-1%,0.1W,100PPM,0805	944285	18612	CRCW-0805-4993F-RT1	2
R105	RESISTOR, SMR,RES,CERM,2.8K, +-1%,.063W,100PPM,0603	688572	18612	CRCW-0603-2801FRT1	1
R108	RESISTOR,CERMET,JUMPER,0,+0.05 MAX,0.063W,0603,TAPE	604394	18612	CRCW-0603-000-RT1	1
R109	RESISTOR, SMR,RES,CERM,10, +-1%,0.1W,100PPM,0805	928924	18612	CRCW-0805-10R0-RT1	1
RT1	THERMISTOR,POSITIVE,1.1K,+-20%,COATED,RADIAL,TAPE	1277360	58090	YS3961	1
RT2	THERMISTOR, SMR,THERMISTOR,CHIP,NEG,50K,+-5%	807875	18612	NTHS1005N01(50K-5%)	1
RV1-3	VARISTOR, R05R,VARISTOR,910, +-10%,1.0MA	876193	34371	V910LSX1399	3
U1	IC,ASIC,LTC984-1,+2.5V,DMM FUNCTIONS W/O AD OR RMS CONVERTERS,SSOP36,TAPE	2103969	64155	LTC984-1 (SL10327)	1
U2	IC,MICROCONTROLLER,MSP430F448,16 BIT,1.8-3.6V,3.3MHZ,FLASH,PQFP100,TRAY	2155866	01295	MSP430F448IPZ (TRAYS)	1
U3	IC,ADC,LTC2435-1,2.7/5.5V,20-BIT,DIFF,SERIAL,DELTA SIGMA,SSOP16,TAPE	2063400	64155	LTC2435-1CGN	1
U4	IC,OP AMP,OPA2347,2.3 - 5.5V,6MV OFFSET,350KHZ,DUAL,U-PWR,R/R,SO8,TAPE	1618826	01295	OPA2347UA/2K5	1
U5	CMOS 4069 SMR,IC,CMOS,HEX INVERTER,SOIC	838375	07263	CD4069UBCM	1
U6	IC,VOLTAGE REGULATOR, LINEAR, TPS71533,3.3V,50MA,LDO,LOW POWER,SOT-323-5,TAPE	1999667	01295	BQ71533DCKR	1

Table 18. A1 Main PCA (cont.)

Reference Designator	Description	Part Number	Cage	Manufacturer's Part Number	Qty
U7	IC,RMS CONVERTER,AD737J-5,+2.5V,LOW POWER,LOW SUPPLY VOLTAGE,SO8,TAPE	2089072	24355	AD737JR-5	1
U8	IC,VOLTAGE REFERENCE,LT1790,2.5V,0.1%,25PPM/C,60 UA,SOT-23-6,TAPE	1622188	64155	LT1790ACS6-2.5	1
U10	IC,VOLTAGE REGULATOR, LINEAR, TPS77050,5V,50MA,LDO,LOW POWER,SOT-23-5,TAPE	1642135	01295	TPS77050DBVR	1
U12	IC,ANALOG SWITCH,74HCT4053,5V,140 OHMS,TRIPPLE,SPDT,TSSOP16,TAPE	2064876	01295	CD74HCT4053PWR	1
U14	IC,LOGIC,7S08,2.0V-6.0V,SINGLE AND GATE,SC70-5,TAPE	2075176	07263	NC7S08P5X	1
VR1	ZENER,UNCOMP,MMSZ5237B,8.2V,5%, 20MA,500MW,SOD-123,TAPE	1597952	89536	1597952	1
XF1- XF2	FUSE CONTACT	659524	89536	659524	2
XF3 XF4	FUSE CONTACT	707190	89536	707190	2
Y1	CRYSTAL,32.768KHZ,30/105PPM,7PF,CLIP CAN,SMD,TAPE	1627036	89536	1627036	1
Z1	OEIGHTY-4R01T-N,R-NET, MF, POLY, SIP, OEIGHTY HI V DIVIDER	2057204	89536	2057204	1
Z2	76-4R01T-K,R-NET, CERM, SIP, HI V PROTECT	103454	89536	103454	1

Schematic Diagrams

Reference designator drawings and schematic diagrams are provided on the following pages.

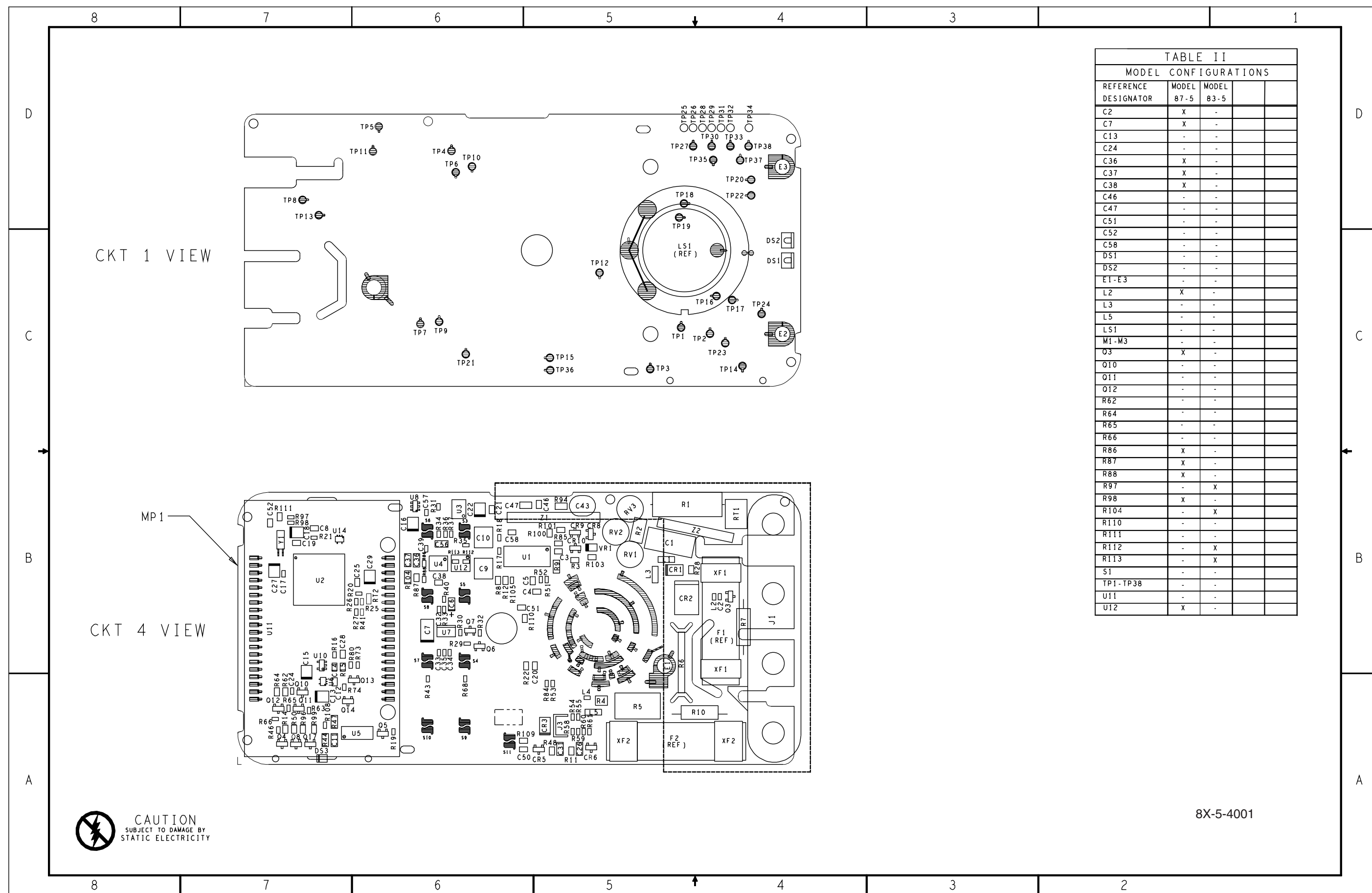

TABLE II			
MODEL CONFIGURATIONS			
REFERENCE DESIGNATOR	MODEL 87-5	MODEL 83-5	
C2	X	-	
C7	X	-	
C13	-	-	
C24	-	-	
C36	X	-	
C37	X	-	
C38	X	-	
C46	-	-	
C47	-	-	
C51	-	-	
C58	-	-	
DS1	-	-	
DS2	-	-	
E1-E3	-	-	
L2	X	-	
L3	-	-	
L5	-	-	
L51	-	-	
M1-M3	-	-	
O3	X	-	
O10	-	-	
O11	-	-	
O12	-	-	
R62	-	-	
R64	-	-	
R65	-	-	
R66	-	-	
R86	X	-	
R87	X	-	
R88	X	-	
R97	-	X	
R98	X	-	
R104	-	X	
R110	-	-	
R111	-	-	
R112	-	X	
R113	-	X	
S1	-	-	
TP1-TP38	-	-	
U11	-	-	
U12	X	-	

8X-5-4001

Figure 8. A1 LED PCA

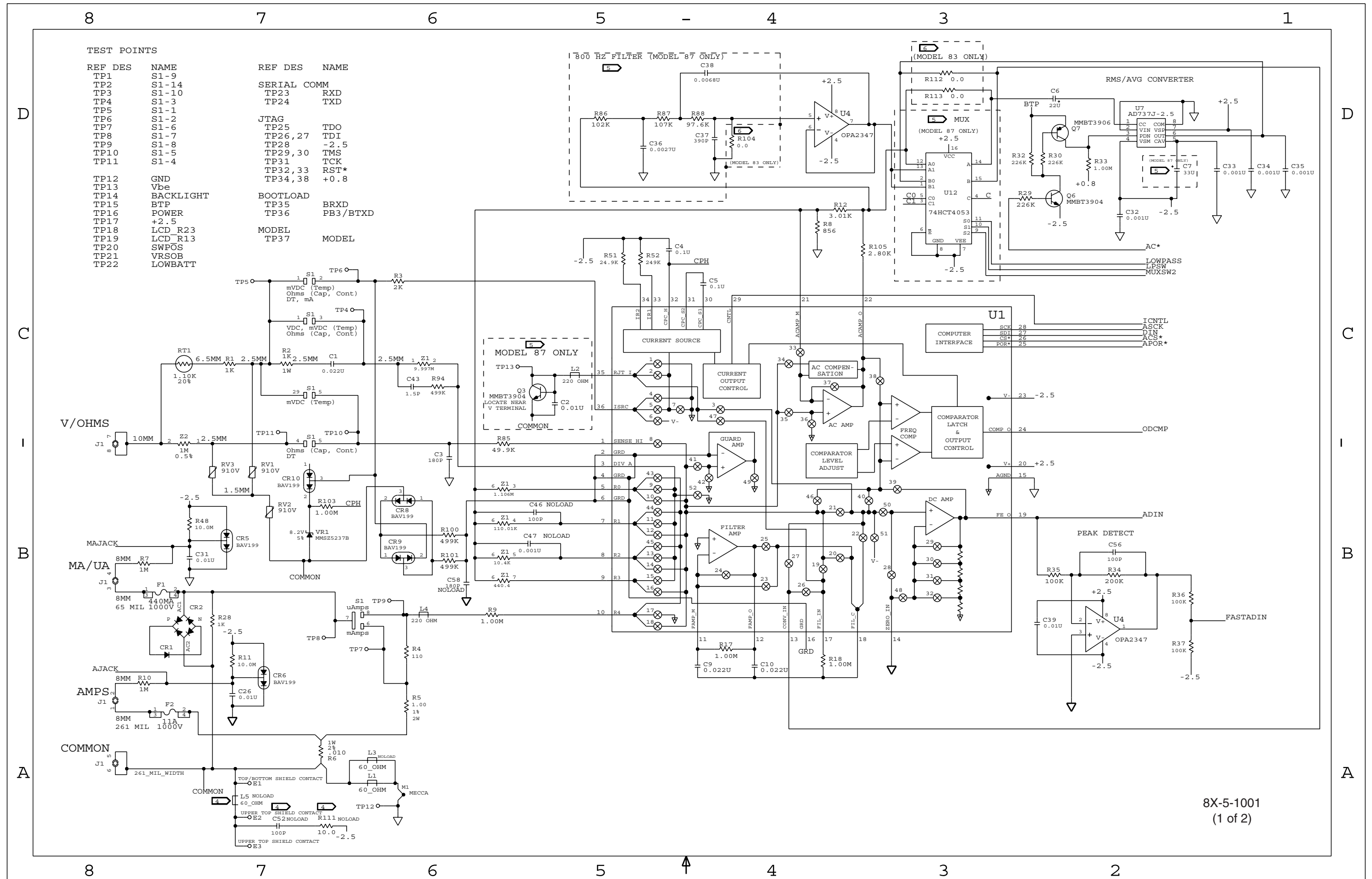

Figure 8. A1 LED PCA (cont)

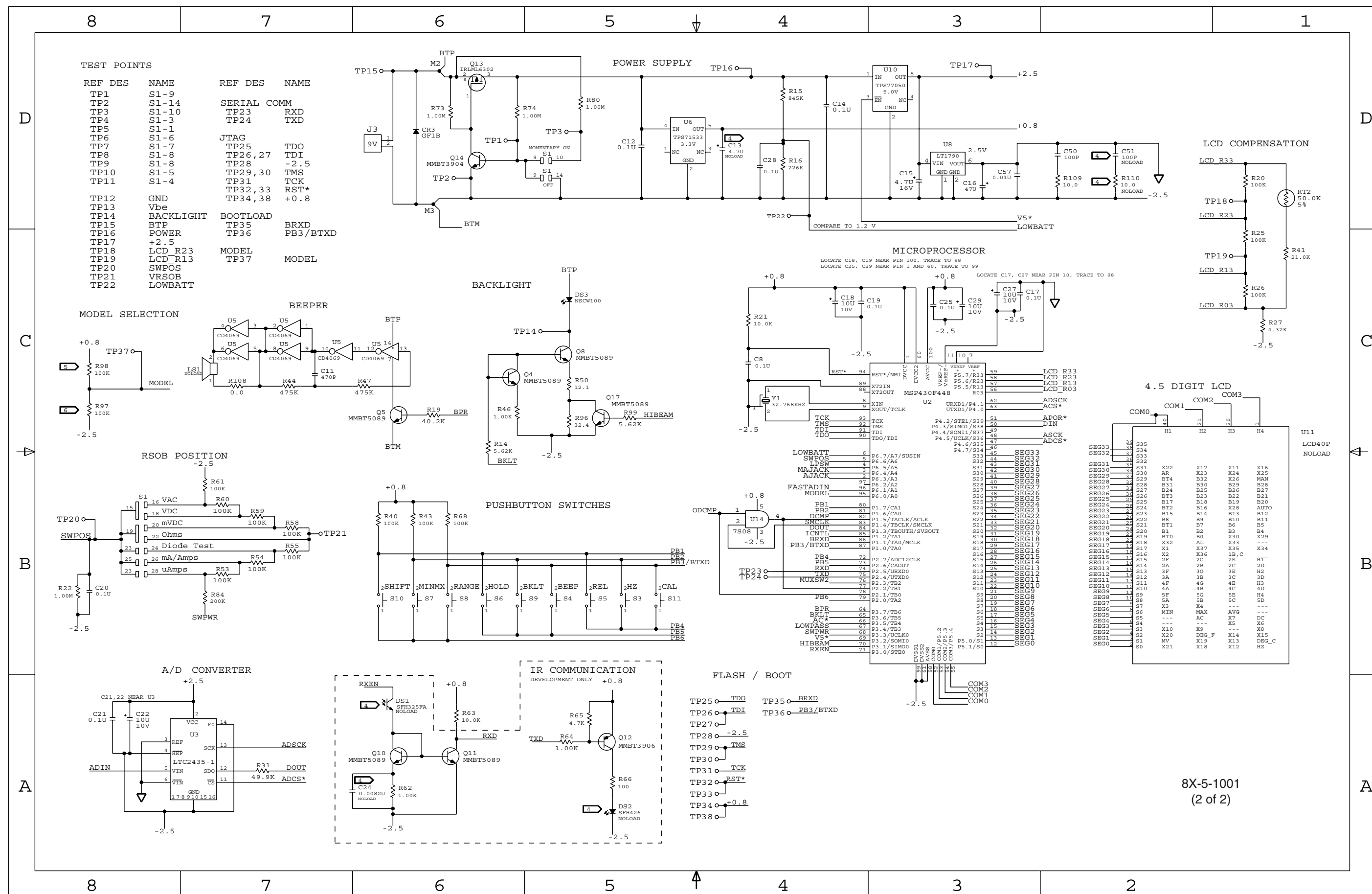

Figure 8. A1 LED PCA (cont)

