

Agilent 8990B Peak Power Analyzer

Programming Guide



Agilent Technologies

Notices

© Agilent Technologies, Inc. 2011–2013

No part of this manual may be reproduced in any form or by any means (including electronic storage and retrieval or translation into a foreign language) without prior agreement and written consent from Agilent Technologies, Inc. as governed by United States and international copyright laws.

Manual Part Number

08990-90009

Edition

Sixth Edition, November 27, 2013

Agilent Technologies, Inc.
5301 Stevens Creek Blvd.
Santa Clara, CA 95051 USA

Warranty

The material contained in this document is provided “as is,” and is subject to being changed, without notice, in future editions. Further, to the maximum extent permitted by applicable law, Agilent disclaims all warranties, either express or implied, with regard to this manual and any information contained herein, including but not limited to the implied warranties of merchantability and fitness for a particular purpose. Agilent shall not be liable for errors or for incidental or consequential damages in connection with the furnishing, use, or performance of this document or of any information contained herein. Should Agilent and the user have a separate written agreement with warranty terms covering the material in this document that conflict with these terms, the warranty terms in the separate agreement shall control.

Technology Licenses

The hardware and/or software described in this document are furnished under a license and may be used or copied only in accordance with the terms of such license.

Restricted Rights Legend

U.S. Government Restricted Rights. Software and technical data rights granted to the federal government include only those rights customarily provided to end user customers. Agilent provides this customary commercial license in Software and technical data pursuant to FAR 12.211 (Technical Data) and 12.212 (Computer Software) and, for the Department of Defense, DFARS 252.227-7015 (Technical Data - Commercial Items) and DFARS 227.7202-3 (Rights in Commercial Computer Software or Computer Software Documentation).

Safety Notices

CAUTION

A **CAUTION** notice denotes a hazard. It calls attention to an operating procedure, practice, or the like that, if not correctly performed or adhered to, could result in damage to the product or loss of important data. Do not proceed beyond a **CAUTION** notice until the indicated conditions are fully understood and met.

WARNING

A **WARNING** notice denotes a hazard. It calls attention to an operating procedure, practice, or the like that, if not correctly performed or adhered to, could result in personal injury or death. Do not proceed beyond a **WARNING** notice until the indicated conditions are fully understood and met.

In This Guide ...

1 8990B Remote Operation

This chapter provides an overview on programming the 8990B.

2 IEEE-488 Command Reference

This chapter describes the IEEE-488 common commands supported by the 8990B.

3 Root Commands

This chapter describes the root commands supported by the 8990B.

4 ACQUIRE Subsystem

This chapter explains how to use the ACQUIRE command subsystem to set the 8990B acquisition mode and parameters.

5 CALIBRATION Subsystem

This chapter explains how to use the CALIBRATION command subsystem to perform internal zeroing and calibration on the peak power sensors connected to respective RF channels.

6 CHANNEL Subsystem

This chapter explains how to use the CHANNEL command subsystem to configure the 8990B channel setup.

7 TIMEBASE Subsystem

This chapter explains how to use the TIMEBASE command subsystem to configure the 8990B timebase setup.

8 TRIGGER Subsystem

This chapter explains how to use the TRIGGER command subsystem to configure the 8990B trigger setup.

9 MEASure Subsystem

This chapter explains how to use the MEASure command subsystem to acquire the 8990B measurement results.

10 MULTIPULse Subsystem

This chapter explains how to use the MULTIPULse command subsystem to acquire the measurement results in the multipulse mode.

11 MARKer Subsystem

This chapter explains how to use the MARKer command subsystem to configure the 8990B marker setup for the trace.

12 FUNCTion Subsystem

This chapter explains how to use the FUNCTion command subsystem to perform mathematical operations on a pair of channels.

13 TRACe Subsystem

This chapter explains how to use the TRACe command subsystem to acquire the waveform trace data and the duration between consecutive data points.

14 LIMIT Subsystem

This chapter explains how to use the LIMIT command subsystem to set the upper and lower limit tests.

15 STATus Subsystem

This chapter explains how to use the STATus command subsystem to examine the status of the 8990B.

16 DISPlay Subsystem

This chapter explains how to use the DISPlay command subsystem to configure the 8990B waveform display.

18 DISK Subsystem

This chapter explains how to use the DISK command subsystem to save and recall/load instrument setups and waveforms.

19 MEMory Subsystem

This chapter explains how to use the MEMory command subsystem to configure the frequency-dependent offset (FDO) tables.

20 WMEMory Subsystem

This chapter explains how to use the WMEMory command subsystem to configure the waveforms in the 8990B memory.

21 SERvice Subsystem

This chapter explains how to use the SERvice command subsystem to perform the 8990B self-tests.

22 SYSTem Subsystem

This chapter explains how to use the SYSTem command subsystem to configure the 8990B system-related settings.

23 Programming Examples

This chapter provides programming examples that help you to remotely program the 8990B.

THIS PAGE HAS BEEN INTENTIONALLY LEFT BLANK.

Contents

- 1 8990B Remote Operation 1**
 - Introduction **2**
 - Introduction to the SCPI Language **3**
 - Remote Interface Connections **13**
 - Status Reporting **17**
 - Using the Operation Complete Commands **31**
 - Summary of Commands **31**

- 2 IEEE-488 Command Reference 33**
 - SCPI Compliance Information **34**
 - *CLS **35**
 - *ESE <NRf> **36**
 - *ESR? **38**
 - *IDN? **39**
 - *OPC **40**
 - *RST **41**
 - *SRE <NRf> **42**
 - *STB? **44**
 - *TST? **45**
 - *WAI **46**

- 3 Root Commands 47**
 - Overview **48**
 - ARS? **49**
 - AUToscale **50**
 - AUToscale:UNDO **51**
 - ECS? **52**
 - ETS <character_data> **53**
 - ETSThreshold <character_data> **55**

RUN 57

SINGle 58

STOP 59

TRS? 60

4 ACQuire Subsystem 61

Overview 63

ACQuire:AVERage[:STATe] <boolean> 65

ACQuire:AVERage:COUNT <numeric_value> 67

ACQuire:AVERage:COUNT:CURRent? 69

ACQuire:CCDF:AVERage? 70

ACQuire:CCDF:COUNT <numeric_value> 71

ACQuire:CCDF:COUNT:CURRent? 73

ACQuire:CCDF:DURation <numeric_value> 74

ACQuire:CCDF:FRAME <numeric_value> 76

ACQuire:CCDF:FRAME:CURRent? 78

ACQuire:CCDF:GAUSSian[:STATe] <boolean> 79

ACQuire:CCDF:MARKer:ASOURce <character_data> 81

ACQuire:CCDF:MARKer:AXPosition <numeric_value> 83

ACQuire:CCDF:MARKer:AYPosition? 85

ACQuire:CCDF:MARKer:BSOURce <character_data> 86

ACQuire:CCDF:MARKer:BXPosition <numeric_value> 88

ACQuire:CCDF:MARKer:BYPosition? 90

ACQuire:CCDF:MARKer:XDELta? 91

ACQuire:CCDF:MARKer:YDELta? 92

ACQuire:CCDF:PAVerage? 93

ACQuire:CCDF:PEAK? 94

ACQuire:CCDF:REFerence[:STATe] <boolean> 95

ACQuire:CCDF:REFerence:SOURce <character_data> 97

ACQuire:CCDF:SCALe <numeric_value> 99

ACQuire:CCDF:SOURce <character_data> 101

ACQuire:CCDF:SWEep <character_data> **103**
ACQuire:CCDF:TABLE? **105**
ACQuire:CCDF:TABLESOURce <character_data> **107**
ACQuire:CCDF:TRACe{1|4}[:STATe] <boolean> **109**
ACQuire:DROp[:STATe] <boolean> **111**
ACQuire:DROp:SOURce CHAN{1|4} **112**
ACQuire:INTerpolate <boolean> **114**
ACQuire:MODE <character_data> **115**
ACQuire:ZOOM:OFFSet <numeric_value> **118**
ACQuire:ZOOM:SCALe <numeric_value> **120**

5 CALibration Subsystem 123

Overview **124**
CALibration[:ALL] **125**
CALibration:CALibrate <character_data> **126**
CALibration:CALibrate:AUTO <boolean> **127**
CALibration:CALibrate:AUTO:INTerval <numeric_value> **129**
CALibration:CALibrate:AUTO:NOTify <boolean> **131**
CALibration:OUTPut <character_data> **132**
CALibration:ZERO <character_data> **134**

6 CHANnel Subsystem 135

Overview **136**
CHANnel{1|4}:BWIDth <character_data> **137**
CHANnel{1|2|3|4}[:DISPlay] <boolean> **139**
CHANnel{1|4}:EXTLoss <numeric_value> **141**
CHANnel{1|4}:FDOffset[:STATe] <boolean> **143**
CHANnel{1|4}:FDOffset:SElect <string> **145**
CHANnel{1|4}:FREQuency <numeric_value> **147**
CHANnel{2|3}:INPut <character_data> **149**
CHANnel{2|3}:OFFSet <numeric_value> **151**

CHANnel{2|3}:PROBe? **153**
CHANnel{2|3}:PROBe:ID? **154**
CHANnel{1|4}:REFErrence <numeric_value> **155**
CHANnel{1|4}:REFErrence:POSItion <character_data> **157**
CHANnel{1|2|3|4}:SCALe <numeric_value> **159**
CHANnel{1|2|3|4}:SRATe? **161**
CHANnel{1|2|3|4}:TIMECOMP <numeric_value> **162**
CHANnel{1|2|3|4}:UNIT <character_data> **164**

7 TIMebase Subsystem 167

Overview **168**
TIMebase:OFFSet <numeric_value> **169**
TIMebase:REFClock <boolean> **171**
TIMebase:SCALe <numeric_value> **173**

8 TRIGger Subsystem 175

Overview **176**
TRIGger:EDGE:SLOPe <character_data> **177**
TRIGger:EVENT:COUNT <numeric_value> **179**
TRIGger:FAST <boolean> **181**
TRIGger:HOLDoff <numeric_value> **183**
TRIGger:HYSTeresis:LEVel <numeric_value> **185**
TRIGger:HYSTeresis:MODE <character_data> **187**
TRIGger:IMPedance <character_data> **189**
TRIGger:LEVel <character_data>,<numeric_value> **191**
TRIGger:MODE <character_data> **193**
TRIGger:OUTput <boolean> **195**
TRIGger:PWIDth <mode>,<time1>,<time2> **197**
TRIGger:SOURce <character_data> **199**
TRIGger:SWEEp <character_data> **201**

9 MEASure Subsystem 203

Overview [205](#)
 MEASure:DR0op? [207](#)
 MEASure:DISPlay <character_data>, CHAN{1 | 2 | 3 | 4}, [NORMal | ZOOM],
 <Boolean> [208](#)
 MEASure:AVERage? CHAN{1 | 2 | 3 | 4}, [NORMal | ZOOM | MULTipulse]
 [, <character_data>] [211](#)
 MEASure:DUTYcycle? CHAN{1 | 2 | 3 | 4}, [NORMal | ZOOM | MULTipulse]
 [, <character_data>] [213](#)
 MEASure:FALLtime? CHAN{1 | 2 | 3 | 4}, [NORMal | ZOOM | MULTipulse]
 [, <character_data>] [215](#)
 MEASure:MINimum? CHAN{1 | 2 | 3 | 4}, [NORMal | ZOOM | MULTipulse]
 [, <character_data>] [217](#)
 MEASure:OFFtime? CHAN{1 | 2 | 3 | 4}, [NORMal | ZOOM | MULTipulse]
 [, <character_data>] [219](#)
 MEASure:OVERshoot? CHAN{1 | 2 | 3 | 4}, [NORMal | ZOOM | MULTipulse]
 [, <character_data>] [221](#)
 MEASure:PAVerage? CHAN{1 | 2 | 3 | 4}, [NORMal | ZOOM | MULTipulse]
 [, <character_data>] [223](#)
 MEASure:PBASe? CHAN{1 | 2 | 3 | 4}, [NORMal | ZOOM | MULTipulse]
 [, <character_data>] [225](#)
 MEASure:PEAK? CHAN{1 | 2 | 3 | 4}, [NORMal | ZOOM | MULTipulse]
 [, <character_data>] [227](#)
 MEASure:PRF? CHAN{1 | 2 | 3 | 4}, [NORMal | ZOOM | MULTipulse]
 [, <character_data>] [229](#)
 MEASure:PRI? CHAN{1 | 2 | 3 | 4}, [NORMal | ZOOM | MULTipulse]
 [, <character_data>] [231](#)
 MEASure:PTOP? CHAN{1 | 2 | 3 | 4}, [NORMal | ZOOM | MULTipulse]
 [, <character_data>] [233](#)
 MEASure:PWIDth? CHAN{1 | 2 | 3 | 4}, [NORMal | ZOOM | MULTipulse]
 [, <character_data>] [235](#)
 MEASure:RISEtime? CHAN{1 | 2 | 3 | 4}, [NORMal | ZOOM | MULTipulse]
 [, <character_data>] [237](#)
 MEASure:THReshold:PDURation CHAN{1 | 2 | 3 | 4}, <numeric_value> [239](#)
 MEASure:THReshold:REFlevel{1 | 2} CHAN{1 | 2 | 3 | 4}, <numeric_value> [241](#)

MEASure:THReshold:VALue CHAN{1|2|3|4}, <numeric_value> [243](#)

10 MULTIPULse Subsystem [245](#)

Overview [246](#)

MULTIPULse:ACQuire:FRAMe [247](#)

MULTIPULse:ACQuire:STATus? [248](#)

MULTIPULse:ACQuire:COUNTer? [249](#)

MULTIPULse:BACKWARD [250](#)

MULTIPULse:HISTOGRAMBIN <numeric_value> [251](#)

MULTIPULse:FORWARD [253](#)

MULTIPULse:FRAMe <numeric_value> [254](#)

MULTIPULse:GOTOFRAME <numeric_value> [256](#)

MULTIPULse:PLAYBACK <character_data> [258](#)

MULTIPULse:SAVE:MEASurement <string>,<character_data> [260](#)

MULTIPULse:TIMEstamp:DATA? [262](#)

MULTIPULse:TIMEstamp:DISPlay <boolean> [263](#)

11 MARKer Subsystem [265](#)

Overview [266](#)

MARKer:ASLope <character_data> [267](#)

MARKer:AXPosition <numeric_value> [269](#)

MARKer:AYPosition <numeric_value> [271](#)

MARKer:BSLope <character_data> [273](#)

MARKer:BXPosition <numeric_value> [275](#)

MARKer:BYPosition <numeric_value> [277](#)

MARKer:ASOURce <character_data> [279](#)

MARKer:BSOURce <character_data> [281](#)

MARKer:LEVel <numeric_value> [283](#)

MARKer:ALEVel <numeric_value> [285](#)

MARKer:BLEVel <numeric_value> [287](#)

MARKer:AYSEARCH <numeric_value> [289](#)

MARKer:BYSEARCH <numeric_value> **291**
MARKer:MODE <character_data> **293**
MARKer:SPACing:PULSe{1|2} <numeric_value> **295**
MARKer:SPACing:SOURce <character_data> **297**
MARKer:YAMPRTATIO? **299**
MARKer:XDELta? **300**
MARKer:YDELta? **301**

12 FUNCTION Subsystem 303

Overview **305**

FUNCTION{1|2}:ADD <character_data>,<character_data>
[,<numeric_value>] **307**
FUNCTION{1|2}:AVERaging <character_data>,<numeric_value> **309**
FUNCTION{1|2}:COMMONmode
<character_data>,<character_data>[,<numeric_value>] **310**
FUNCTION{1|2}:DISPlay <boolean> **312**
FUNCTION{1|2}:DIVide <character_data>,<character_data>
[,<numeric_value>] **313**
FUNCTION{1|2}:INVert <character_data>[,<numeric_value>] **315**
FUNCTION{1|2}:MAGNify <character_data>[,<numeric_value>] **317**
FUNCTION{1|2}:MULtiply <character_data>,<character_data>
[,<numeric_value>] **318**
FUNCTION{1|2}:PAE <character_data>,<character_data>,
<character_data>,<numeric_value>,<numeric_value> **320**
FUNCTION{1|2}:PAE2 <character_data>,<character_data>,
<character_data>,<character_data>,<numeric_value>,
<numeric_value> **324**
FUNCTION{1|2}:REFerence <numeric_value> **328**
FUNCTION{1|2}:REFerence:POSition <character_data> **330**
FUNCTION{1|2}:{SOURce1|SOURce2}
<character_data>[,<numeric_value>] **332**
FUNCTION{1|2}:{VDC|IDC|PGAIN}<character_data>[,<numeric_value>]
334

FUNCTION{1 | 2}:{VDC | IDC | PIN | POUT}
 <character_data>[,<numeric_value>] **337**
 FUNCTION{1 | 2}:SQUare <character_data>[,<numeric_value>] **340**
 FUNCTION{1 | 2}:SQRT <character_data>[,<numeric_value>] **341**
 FUNCTION{1 | 2}:SUBTract <character_data>,<character_data>
 [,<numeric_value>] **342**
 FUNCTION{1 | 2}:SCALE <numeric_value> **344**
 FUNCTION{1 | 2}:TRACe:DATA? **346**
 FUNCTION{1 | 2}:TRACe:PERCent <boolean> **347**

13 TRACe Subsystem 349

Overview **350**
 TRACe:DATA? <character_data>[,HRES] **351**
 TRACe:XINCrement? <character_data> **354**
 TRACe:XSTART? **355**

14 LIMIT Subsystem 357

Overview **358**
 LIMIT:UPper <boolean> **359**
 LIMIT:LOWer <boolean> **360**
 LIMIT:UPper:LEVEL <numeric_value> **361**
 LIMIT:LOWer:LEVEL <numeric_value> **362**

15 STATus Subsystem 363

STATus Subsystem **364**
 Status Register Set Commands **366**
 Device Status Register Set **370**
 Operation Status Register Set **372**
 STATus:OPERation **373**
 STATus:PRESet **374**
 Questionable Status Register Sets **375**
 STATus:QUEStionable **376**

STATus:QUEStionable:CALibration **377**

STATus:QUEStionable:VOLTage **378**

Status Block Diagram **379**

16 DISPLAY Subsystem 381

Overview **382**

DISPlay:CONNect <boolean> **383**

DISPlay:TRACk <boolean> **385**

DISPlay:TRACk:MAX <boolean> **387**

DISPlay:TRACk:MIN <boolean> **389**

DISPlay:CLEar [<character_data>] **391**

XYDISPlay:REFeRence:STATe <boolean> **393**

XYDISPlay:XSOURce <character_data> **395**

XYDISPlay:YSOURce <character_data> **397**

17 XYDISPlay Subsystem 399

Overview **400**

XYDISPlay:REFeRence:STATe <boolean> **401**

XYDISPlay:XSOURce <character_data> **403**

XYDISPlay:YSOURce <character_data> **405**

18 DISK Subsystem 407

Overview **408**

DISK:CWD? **409**

DISK:LOAD <string>[,<character_data>] **410**

DISK:SAVE:IMAGe <string>,<character_data> **412**

DISK:SAVE:SETup <string> **414**

DISK:SAVE:WAVEform <string>,<character_data> **415**

19 MEMory Subsystem 417

MEMory Subsystem **418**

MEMory:TABLE:CLEar **419**

MEMory:TABLE:CLear:NAME <string> **420**
MEMory:TABLE:DELeTe <numeric_value> **421**
MEMory:TABLE:EDIT <numeric_value>,<numeric_value> **422**
MEMory:TABLE:FREQuency? **424**
MEMory:TABLE:INSert <numeric_value>,<numeric_value> **425**
MEMory:TABLE:LIST? **427**
MEMory:TABLE:OFFSet? **428**
MEMory:TABLE:POINts? **429**
MEMory:TABLE:SELEct <string> **430**

20 WMEMory Subsystem 433

Overview **434**
WMEMory{1|2|3|4}:CLear **435**
WMEMory{1|2|3|4}:DISPlay <boolean> **436**
WMEMory{1|2|3|4}:OFFSet <numeric_value> **438**
WMEMory{1|2|3|4}:SAVE <character_data> **440**
WMEMory{1|2|3|4}:SCALe <numeric_value> **442**
WMEMory{1|2|3|4}:UNIT? **444**

21 SERvice Subsystem 445

Overview **446**
SERvice:BIST:TBASe[:STATe] <boolean> **447**
SERvice:CSOURce[:STATe] <boolean> **449**
SERvice:CSOURce:FREQuency <character_data> **450**
SERvice:CSOURce:INTerval <numeric_value> **452**
SERvice:SECure:ERASe **454**

22 SYSTem Subsystem 455

Overview **456**
SYSTem:COMMunicate:LAN:ADDRes <string> **458**
SYSTem:COMMunicate:LAN:DGATeway <string> **460**
SYSTem:COMMunicate:LAN:DHCPEnabled **462**

SYSTem:COMMunicate:LAN:HNAME? **463**
SYSTem:COMMunicate:LAN:MAC? **464**
SYSTem:COMMunicate:LAN:SMASk <string> **465**
SYSTem:DATE <numeric_value>,<numeric_value>,<numeric_value> **467**
SYSTem:ERRor[:NEXT]? **469**
SYSTem:HELP:HEADers? **481**
SYSTem:LOCK <boolean> **482**
SYSTem:PRESet **483**
SYSTem:TIME <numeric_value>,<numeric_value>,<numeric_value> **484**
SYSTem:VERSion? **486**

23 Programming Examples 487

Example 1: Identifying the 8990B In Use **488**
Example 2: Making Pulse Characterization Measurement **489**
Example 3: Making Delay Measurement **492**
Example 4: Making Droop Measurement **495**

THIS PAGE HAS BEEN INTENTIONALLY LEFT BLANK.

List of Figures

- Figure 1-1** Hierarchical structure of SCPI **3**
- Figure 1-2** <character_data> format **6**
- Figure 1-3** <non-decimal numeric> format **8**
- Figure 1-4** <NR1> format **9**
- Figure 1-5** <NR2> format **9**
- Figure 1-6** <NR3> format **10**
- Figure 1-7** <string> format **11**
- Figure 1-8** General status register model **17**
- Figure 1-9** Typical status register bit changes **19**
- Figure 1-10** Status system **22**
- Figure 23-1** Test setup for the pulse characterization measurement **489**
- Figure 23-2** Test setup for delay measurement **492**
- Figure 23-3** Test setup for droop measurement **495**

THIS PAGE HAS BEEN INTENTIONALLY LEFT BLANK.

List of Tables

Table 1-1	Bit definitions – Status Byte register	23
Table 1-2	Bit definitions – Standard Event register	25
Table 1-3	Bit definitions – Questionable Status register	26
Table 1-4	Bit change conditions for the Questionable Status register set	26
Table 1-5	Bit definitions – Operation Status	28
Table 1-6	Bit change conditions for the Operation Status register set	28
Table 1-7	Bit definitions – Device Status register	29
Table 1-8	Bit change conditions for the Device Status register	29
Table 2-1	Bit definitions: Standard Event register	36
Table 2-2	Bit definitions: Standard Event register	38
Table 2-3	Bit definitions: Status Byte register	42
Table 2-4	Bit definitions: Status Byte register	44
Table 15-1	Commands and events affecting the status registers	364

THIS PAGE HAS BEEN INTENTIONALLY LEFT BLANK.



1 8990B Remote Operation

Introduction	2
Introduction to the SCPI Language	3
Mnemonic forms	3
Using a colon (:)	3
Using a semicolon (;)	4
Using a comma (,)	4
Using whitespace	4
Using "?" commands	4
Using "*" commands	5
Syntax conventions	5
Syntax diagram conventions	5
SCPI data types	6
Input message terminators	12
Remote Interface Connections	13
USB	14
LAN	15
Status Reporting	17
General status register model	17
8990B status registers	21
Using the Operation Complete Commands	31
Summary of Commands	31

This chapter provides an overview on programming the 8990B peak power analyzer.



Introduction

This chapter contains the following sections which provide the information on configuring the 8990B remotely:

- [“Introduction to the SCPI Language”](#) on page 3
- [“Remote Interface Connections”](#) on page 13
- [“Status Reporting”](#) on page 17
- [“Using the Operation Complete Commands”](#) on page 31

Introduction to the SCPI Language

SCPI, also known as Standard Commands for Programmable Instruments, defines how you communicate with an instrument from a bus controller. The SCPI language uses a hierarchical structure similar to the file systems used by many bus controllers. The command tree is organized with root-level commands (also called subsystems) positioned at the top, with multiple levels below each root-level command. You must specify the complete path to execute the individual lower-level commands.

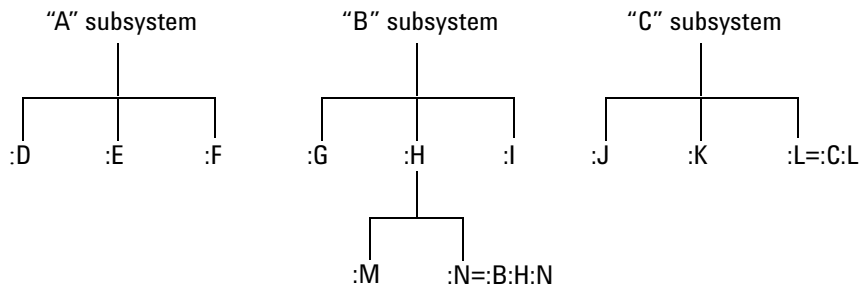

Figure 1-1 Hierarchical structure of SCPI

Mnemonic forms

Each keyword has both a long and a short form. A standard notation is used to differentiate the short-form keyword from the long-form keyword. The long form of the keyword is shown, with the short-form portion shown in upper-case characters, and the rest of the keyword shown in lower-case characters. For example, the short form of AVERage is AVER.

Using a colon (:)

When a colon is the first character of a command keyword, it indicates that the next command mnemonic is a root-level command. When a colon is inserted between two command mnemonics, the colon moves the path down one level in the present path (for the specified root-level command) of the command tree. You *must* separate command mnemonics from each other using a colon. *You can omit the leading colon if the command is the first of a new program line.*

Using a semicolon (;)

Use a semicolon to separate two commands within the same command string. The semicolon does not change the present path specified. For example, the following two statements are equivalent. Note that in the first statement, the first colon is optional but the third is compulsory.

```
:TIM:REFC ON;:TIM:REF RIGH  
:TIM:REFC ON;REF RIGH
```

Using a comma (,)

If a command requires more than one parameter, you must separate adjacent parameters using a comma.

Using whitespace

You *must* use whitespace characters, [tab], or [space] to separate a parameter from a command keyword. Whitespace characters are generally ignored *only* in parameter lists.

Using “?” commands

The bus controller may send commands at any time, but a SCPI instrument may only send responses when *specifically* instructed to do so. Only queries (commands that end with a “?”) instruct the instrument to send a response message. Queries return either measured values or internal instrument settings.

NOTE

If you send two queries without reading the response from the first, then attempt to read the second response, you may receive some data from the first response followed by the complete second response. To avoid this, do not send a query without reading the response. When you cannot avoid this situation, send a Device Clear before sending the second query.

Using "*" commands

Commands starting with a "*" are called common commands. They are required to perform the identical function for *all* instruments that are compliant with the IEEE-488.2 interface standard. The "*" commands are used to control the reset, clear status, identification request, self-test, wait-before-execution, and status operations in the 8990B.

Syntax conventions

Throughout this guide, the following conventions are used for SCPI command syntax:

- Square brackets ([]) indicate optional keywords or parameters.
- Braces ({}) enclose one or more parameters that may be included zero or more times.
- Triangle brackets (<>) indicate that you must substitute a value for the enclosed parameter.
- Bars (|) can be read as "or" and are used to separate alternative parameter options.

Syntax diagram conventions

Throughout this guide, the following conventions are used for SCPI command syntax diagrams:

- Solid lines represent the recommended path.
- Ovals enclose the short form command mnemonics. The command mnemonic must be entered exactly as shown. Ovals are also used to represent discrete parameters and command separators.
- Rectangles enclose the parameters required, and are also used to represent white space.
- Dotted lines indicate an optional path for bypassing secondary keywords.
- Arrows and curved intersections indicate command path direction.

SCPI data types

The SCPI language defines different data formats for use in program messages and response messages. Instruments are flexible listeners and can accept commands and parameters in various formats. However, SCPI instruments are precise talkers. This means that SCPI instruments *always* respond to a particular query in a predefined, rigid format.

<boolean> definition

Throughout this document, <boolean> is used to represent ON|OFF|<NRf>. Boolean parameters have a value of 0 or 1 and are unitless. ON corresponds to 1 and OFF corresponds to 0.

On input, an <NRf> is rounded to an integer. A nonzero result is interpreted as 1.

Queries always return a 1 or 0, never ON or OFF.

<character_data> definition

Throughout this document, <character_data> is used to represent character data, that is, A to Z, a to z, 0 to 9, and _ (underscore). HIGH and R6_5F are examples of character data. The first character must be an alphanumeric, followed by either alphanumeric or underscore characters up to a maximum of 12 characters. The format is defined as shown in the following figure.

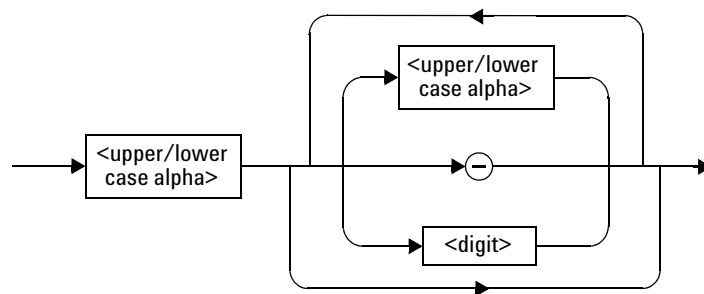

Figure 1-2 <character_data> format

<NAN> definition

Not a number (NAN) is represented as 9.91E37. Not a number is defined in IEEE 754.

<non-decimal numeric> definition

Throughout this document, <non-decimal numeric> is used to represent numeric information in bases other than ten (that is, hexadecimal, octal, and binary). Examples of non-decimal numeric include #HA2F, #ha4e, #Q62, #q15, and #B01011. [Figure 1-3](#) shows the non-decimal numeric standard data structures.

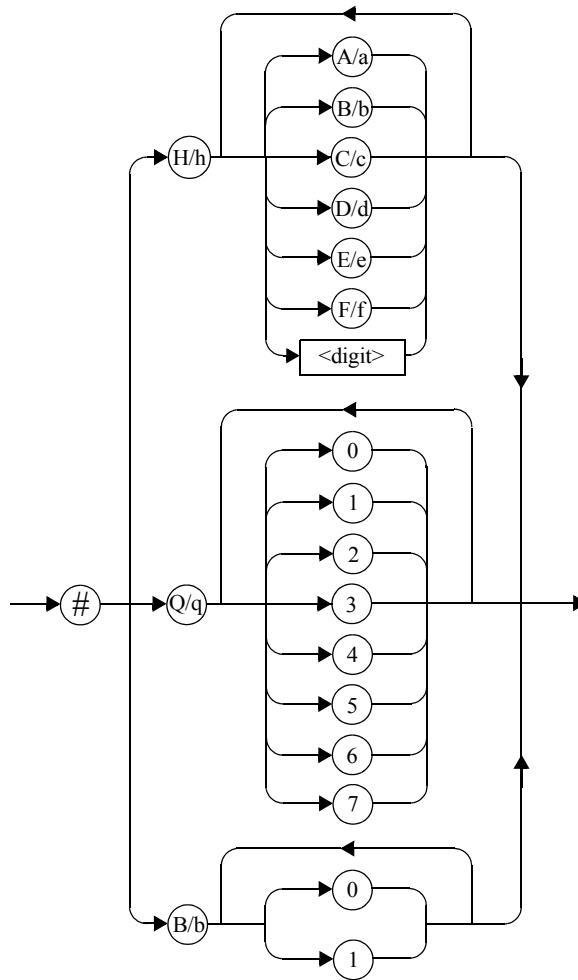

Figure 1-3 <non-decimal numeric> format

<NRf> definition

Throughout this document, <NRf> is used to denote a flexible numeric representation, for example, +200; -56; +9.9E36.

<NR1> definition

Throughout this document, the <NR1> numeric response data is defined as:

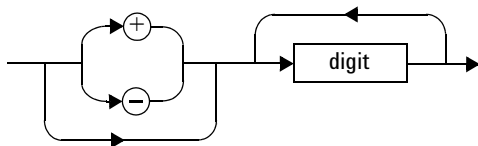

Figure 1-4 <NR1> format

The following shows the examples of <NR1>:

- 146
- +146
- -12345

<NR2> definition

Throughout this document, the <NR2> numeric response data is defined as:

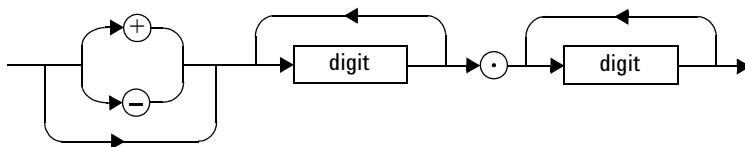

Figure 1-5 <NR2> format

The following shows the examples of <NR2>:

- 12.3
- +1.2345
- -0.123

<NR3> definition

Throughout this document, the <NR3> numeric response data is defined as:

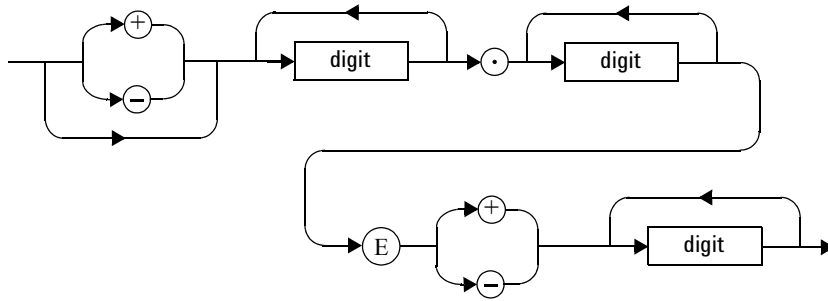

Figure 1-6 <NR3> format

The following shows the examples of <NR3>:

- 1.23E+6
- 123.4E-54
- -1234.567E+90

<numeric_value> definition

Throughout this document, the decimal numeric element is abbreviated to <numeric_value>, for example, <NRf>, MINimum, MAXimum, DEFault, or Not A Number (NaN). You can also send engineering unit suffixes with numeric parameters consisting of G (Giga), MA (Mega), K (kilo), M (milli), U (micro), N (nano), and P (pico). The unit suffixes are not case-sensitive.

<string> definition

Throughout this document, <string> is used to represent 7-bit ASCII characters.

The format is defined as:

Program data**Response data**

Figure 1-7 <string> format

Input message terminators

Program messages sent to a SCPI instrument *must* terminate with a <newline> character. The IEEE.488 EOI (end or identify) signal is interpreted as a <newline> character and may also be used to terminate a message in place of the <newline> character. A <carriage return> followed by a <newline> is also accepted. Many programming languages allow you to specify a message terminator character or EOI state to be automatically sent with each bus transaction. Message termination *always* sets the current path back to the root-level.

Remote Interface Connections

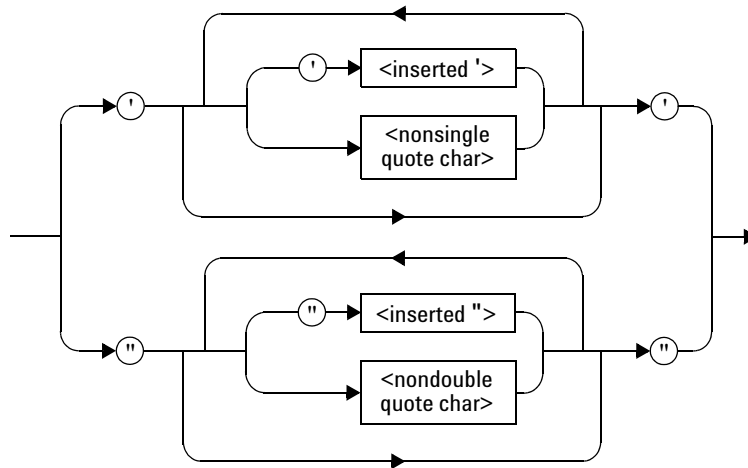
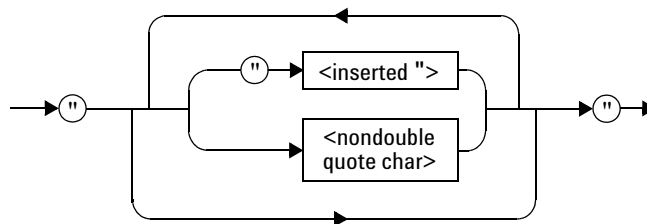
The 8990B can be communicated from the PC via LAN and USB interfaces. This section describes how to establish and verify the connections of these interfaces.

Only one interface should be used at any one time.

To connect the 8990B to your PC, and configure and verify the connection, you can use the *Agilent IO Libraries Suite* or an equivalent.

- To install the Agilent IO Libraries Suite, follow the instructions in the *Agilent IO Libraries Suite CD-ROM* provided with the standard purchase of the 8990B.
- You can also access other information on Agilent IO Libraries at www.agilent.com/find/iolib.

For more information on configuring the remote interface connectivity, refer to the *Agilent IO Libraries Suite Connectivity Guide*. If you have installed the IO Libraries Suite, you can access the connectivity guide from the IO Libraries Control icon. Alternatively, you can access the connectivity guide via the Web at www.agilent.com/find/connectivity.

USB

The USB interface requires no front panel configuration. The USB operation and configuration is supported by the version of VISA and SIDL IO libraries on your PC.

NOTE

Before connecting the USB cable, ensure that the I/O software has been installed on your PC. Refer to “[Remote Interface Connections](#)” on page 13 for information on the Agilent IO Libraries Suite software. If you have installed other I/O software, refer to the documentation that accompanies the software.

- 1 After the I/O software has been installed on your PC, connect the 8990B to your PC using a Type A-to-Type B USB cable.
- 2 The PC will confirm the hardware connection.
- 3 The Found New Hardware Wizard will automatically start and guide you through the configuration of the 8990B as a USB device. Click **Next** to install the software automatically and accept all defaults to complete the installation.

NOTE

If you have installed the Agilent IO Libraries Suite software, you have also installed low-level drivers. Therefore, you do not need to insert the CD when requested by the Found New Hardware Wizard.

- 4 When the Wizard has completed configuring the 8990B, an Assign USB device alias window will appear on your PC. If required, enter an **Alias** name to easily identify the 8990B.
- 5 You can use the Connection Expert in the IO Libraries Suite to check the instrument identification.
- 6 Now, you can use various programming environments to control the 8990B.

LAN

NOTE

Before connecting the LAN cable, ensure that the I/O software has been installed on the PC. Refer to “[Remote Interface Connections](#)” on page 13 for information on the Agilent IO Libraries Suite software. If you have installed other I/O software, refer to the documentation that accompanies the software.

- 1 Using a standard LAN patch cable, connect both the PC and the 8990B to LAN outlets.
- 2 Use the Connection Expert utility of the IO Libraries Suite to add the 8990B and verify the connection.
- 3 You can use various programming environments to control the 8990B.

NOTE

- If the 8990B is not detected automatically on the Connection Expert, you can manually insert a known IP address of the 8990B to detect it. To obtain this IP address, go to the 8990B front panel display and select **Tools > Remote Setup**. Then, on the Connection Expert, go to the Add Address page on the Add LAN Instruments dialog and insert the IP address. You should now be able to detect the 8990B and verify the connection.
 - If you configure an invalid IP address or an IP address that is used by another device or host, an error message is generated. This error can be read by sending the “[SYSTem:ERRor\[:NEXT\]?”](#) query.
-

Once connection has been established, you can configure the 8990B LAN settings remotely through SCPI.

Configuring the LAN remotely

To automatically configure the LAN settings, enable DHCP operation using the “[SYSTem:COMMunicate:LAN:DHCPenabled](#)” command. In this dynamic IP mode, the IP address, subnet mask, and default gateway values are obtained from a DHCP server. Using this dynamic IP mode does not require a detailed knowledge of your network configuration.

1 Power Meter Remote Operation

To individually specify the LAN settings, use the following commands:

- IP address – “`SYSTem:COMMunicate:LAN:ADDRess <string>`”
- Subnet mask – “`SYSTem:COMMunicate:LAN:SMASK <string>`”
- Default gateway – “`SYSTem:COMMunicate:LAN:DGATeway <string>`”

The `string` values for the IP address, subnet mask, and default gateway can range between 0.0.0.0 and 255.255.255.255.

Status Reporting

Status reporting is used to monitor the 8990B to determine when events have occurred. Status reporting is accomplished by configuring and reading status registers.

The 8990B has the following main registers:

- Status Byte Register
- Standard Event Register
- Operation Status Register
- Questionable Status Register
- Device Status Register

There are other registers that exist “behind” the main registers, and are described later in this chapter.

Status Byte and Standard Event registers are read using the IEEE-488 common commands.

Operation, Questionable, and Device Status registers are read using the SCPI STATus command subsystem.

General status register model

The generalized status register model shown below is the building block of the SCPI status system. This model consists of a condition register, a transition filter, an event register, and an enable register. A set of these registers is called a status group.

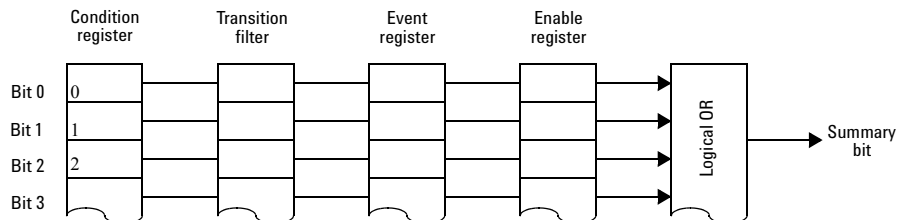

Figure 1-8 General status register model

When a status group is implemented in an instrument, it always contains all of the component registers. However, there is not always a corresponding command to read or write to every register.

Condition register

The condition register continuously monitors the hardware and firmware status of the 8990B. There is no latching or buffering for this register; it is updated in real time. Condition registers are read-only.

Transition filter

The transition filter specifies which type of changes to the bit state in the condition register will set corresponding bits in the event register. Transition filter bits may be set for positive transitions (PTR), negative transitions (NTR), or both. Positive transition will cause the corresponding bit in the event register to be set when the condition bit changes from 0 to 1. Negative transition will cause the corresponding bit in the event register to be set when the condition bit changes from 1 to 0. Setting both positive and negative transitions will cause the corresponding bit in the event register to be set whenever the condition bit changes. Clearing both the positive and negative transition filters disables the corresponding bit in the event register to be set. Transition filters are read-write. They are unaffected by clear status (*CLS) or queries. After STATUS:PRESet, the NTR register is set to 0 and all bits of the PTR register are set to 1.

Event register

The event register latches transition events from the condition register as specified by the transition filter. Bits in the event register are latched and once the bits are set, they will remain set until they are cleared by a query or clear status (*CLS). There is no buffering, therefore, while an event bit is set, subsequent events corresponding to that bit are ignored. Event registers are read-only.

Enable register

The enable register specifies which bits in the event register can generate a summary bit. The instrument logically ANDs corresponding bits in the event and enable registers, and ORs all the resulting bits to obtain a summary bit. Enable registers are read-write. They are not affected by clear status (*CLS) or querying the enable registers. There is always a command to read and write to the enable register of a particular status group.

Example sequence

The figure below illustrates the response of a single bit position in a typical status group for various settings. The changing state of the condition in question is shown at the bottom of the figure. A small binary table shows the state of the chosen bit in each status register at selected times T1 to T5.

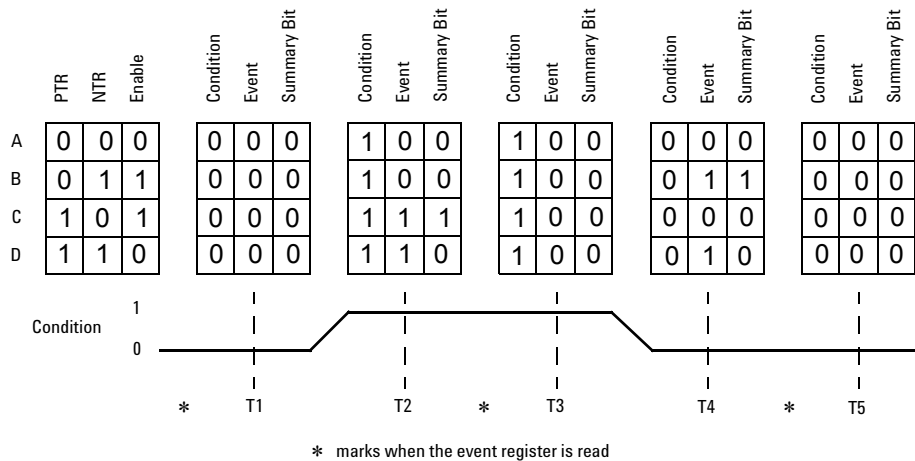

Figure 1-9 Typical status register bit changes

Consider **Case C**, where the positive transition filter is set to 1 and the negative transition filter is set to 0. This configures the 8990B to set the corresponding bit in the event register whenever the condition bit changes from 0 to 1. The enable register is set to 1 to enable the summary bit to be generated each time there is a change in the event register.

At time **T1**, the condition bit is 0. Since there is no changes to the condition bit at this time, no corresponding bit in the event register will be set and the summary bit is 0.

At time **T2**, the condition bit changes from 0 to 1. Since the positive transition filter is set to detect condition bit changes from 0 to 1, the corresponding bit in the event register will be set to 1. The enable register is set to 1, which means that the summary bit will also be set to 1 whenever any bit in the event register is set to 1.

At time **T3**, the condition bit remains 1. The event register is cleared by a query. Hence, the event register bit and summary bit are set to 0.

1 Power Meter Remote Operation

At time **T4**, the condition bit changes from 1 to 0. Since the positive transition filter is set to detect condition bit changes from 0 to 1, the corresponding bit in the event register will be set to 0, signifying no event has been logged. The summary bit is set to 0 as no bit is set in the event register.

At time **T5**, the condition bit remains 0. Since there is no changes to the condition bit at this time, no corresponding bit in the event register will be set and the summary bit is 0.

Consider **Case D**, where the positive and negative transition filters are set to 1. This configures the 8990B to set the corresponding bit in the event register whenever there are changes to the condition bit. The enable register is set to 0 to disable the summary bit to be generated.

At time **T1**, the condition bit is 0. Since there is no changes to the condition bit at this time, no corresponding bit in the event register will be set and the summary bit is 0.

At time **T2**, the condition bit changes from 0 to 1. Since the positive and negative transition filters are set to detect any changes to the condition bit, the corresponding bit in the event register will be set to 1. The enable register is set to 0, which means that the summary bit will not be set.

At time **T3**, the condition bit remains 1. The event register is cleared by a query. Hence, the event register bit and summary bit are set to 0.

At time **T4**, the condition bit changes from 1 to 0. Since the positive and negative transition filters are set to detect any changes to the condition bit, the corresponding bit in the event register will be set to 1, signifying an event has been logged. The summary bit is 0 as the enable register is set to 0.

At time **T5**, the condition bit remains 0. The event register is cleared by a query. Hence, the event register bit and summary bit are set to 0.

8990B status registers

The Status system in the 8990B is shown in [Figure 1-10](#). The Operation Status, Questionable Status, and Device Status groups are 16-bit wide, while the Status Byte and Standard Event groups are 8-bit wide. In all 16-bit groups, the most significant bit (bit 15) is not used and is always set to 0.

1 Power Meter Remote Operation

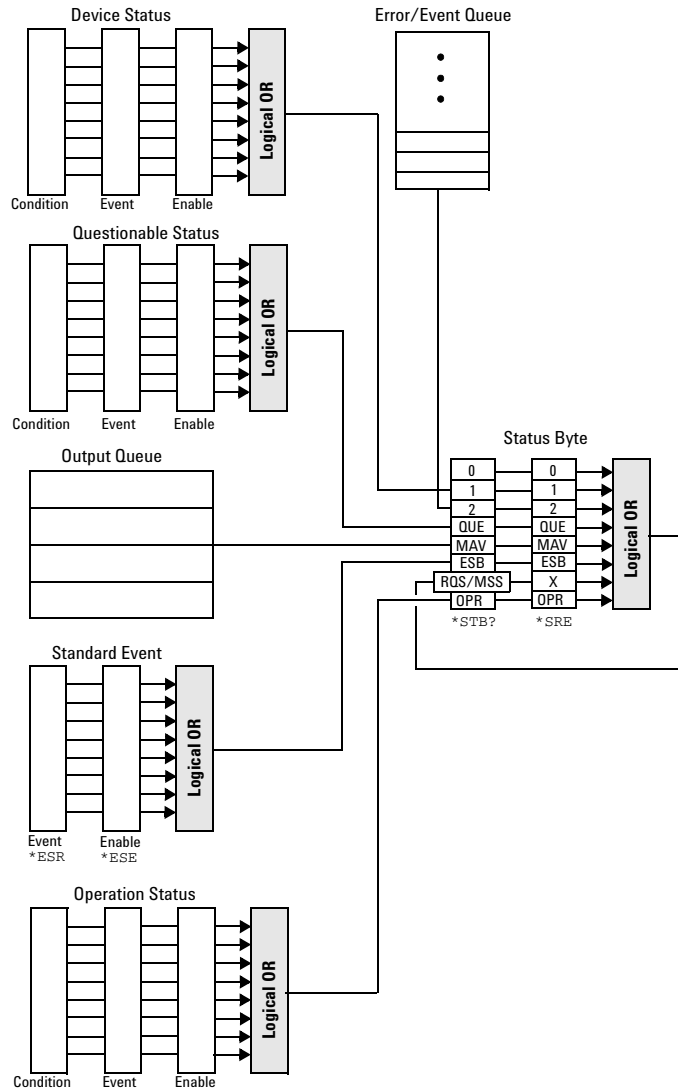

Figure 1-10 Status system

Status Byte summary register

The Status Byte summary register reports conditions from other status registers. Query data waiting in the 8990B output buffer is immediately reported through the “Message Available” bit (bit 4). Clearing an event register clears the corresponding bits in the Status Byte summary register. Reading all messages in the output buffer, including any pending queries, clears the Message Available bit.

Table 1-1 Bit definitions – Status Byte register

Bit	Weight/Decimal value	Definition
0	1	Not used (always set to 0)
1	2	Device Status register summary bit One or more bits are set in the Device Status register (bits must be “enabled” in the enable register)
2	4	Error/Event queue
3	8	Questionable Status register summary bit One or more bits are set in the Questionable Status register (bits must be “enabled” in the enable register)
4	16	Message available Data is available in the 8990B output buffer
5	32	Standard Event register summary bit One or more bits are set in the Standard Event register (bits must be “enabled” in the enable register)
6	64	Request for service The 8990B is requesting for service (serial poll)
7	128	Operation Status register summary bit One or more bits are set in the Operation Status register (bits must be “enabled” in the enable register)

Particular bits in the Status Byte register are cleared when:

- The Standard Event, Questionable Status, Operation Status, and Device Status are queried.
- The error/event queue becomes empty.
- The output queue becomes empty.

The Status Byte enable register (*SRE <NR>, service request enable) is cleared when you:

- cycle the 8990B power.
- execute an *SRE 0 command.

Using *STB? to read the Status Byte

*STB? (status byte query) is similar to a serial poll except that it is processed like any other 8990B command. The *STB? query returns the same result as an IEEE-488 serial poll except that the request service bit (bit 6) is *not* cleared if a serial poll has occurred. The *STB? query is not handled automatically by the IEEE-488 bus interface hardware, and the query is executed only after previous commands have completed. Using the *STB? query does not clear the Status Byte summary register.

Standard Event register

The Standard Event register reports the following types of instrument events: power-on detected, command and syntax errors, command execution errors, self-test errors, query errors, or when an overlapped command completes following an *OPC command. Any or all of these conditions can be reported in the Standard Event summary bit through the enable register. You must write a decimal value using the *ESE <NRf> (event status enable) command to set the enable register mask.

Table 1-2 Bit definitions – Standard Event register

Bit	Weight/Decimal value	Definition
0	1	Operation complete All overlapped commands following an *OPC command have completed
1	2	Not used (always set to 0)
2	4	Query error A query error occurred
3	8	Device-dependent error A device error occurred
4	16	Execution error An execution error occurred
5	32	Command error A command syntax error occurred
6 to 7	–	Not used (always set to 0)

The Standard Event register is cleared when you:

- send a *CLS (clear status) command.
- query the event register using the *ESR? (event status register) command.

The Standard Event enable register is cleared when you:

- cycle the 8990B power.
- execute an *ESE 0 command.

Questionable Status register

The Questionable Status register set provides information on the quality of the 8990B measurement results. Any or all of these conditions can be reported in the questionable data summary bit through the enable register. You must write a value using the `STATUS:QUESTIONABLE:ENABLE` command to set the enable register mask.

The following bits in this register set are used by the 8990B.

Table 1-3 Bit definitions – Questionable Status register

Bit	Weight/Decimal value	Definition
0	1	VOLTage summary
1 to 7	–	Not used
8	256	CALibration summary
9	512	Self-test failure
10 to 15	–	Not used (bit 15 is always 0)

Refer to “[Questionable Status Register Sets](#)” on page 375 for the `STATUS:QUESTIONABLE` commands.

The condition bits are set and cleared under the following conditions:

Table 1-4 Bit change conditions for the Questionable Status register set

Bit	Definition	EVENTs causing bit changes
0	VOLTage summary	This is the summary bit for the Questionable VOLTage register SET: When there is voltage overload on channel 2 or 3 (error –231, “Data questionable;Voltage overloaded”) CLEARED: When there is no voltage overload on channel 2 or 3

Bit	Definition	EVENTs causing bit changes
8	CALibration summary	This is the summary bit for the Questionable CALibration register SET: This may be caused by any CALibration command Error -231, "Data questionable;Calibration error in channel 1" Error -231, "Data questionable;Calibration error in channel 4" CLEARED: When any of the events listed above succeed and no errors are placed on the error queue
9	Self-test failure	SET: When the power-on self-test fails CLEARED: When the power-on self-test passes

Operation Status register

The Operation Status group monitors conditions in the 8990B measurement process.

The following bits in this register set are used by the 8990B:

Table 1-5 Bit definitions – Operation Status

Bit	Weight/Decimal value	Definition
0 to 6	–	Not used
7	128	ARM event occurred
8	256	TRIGger event occurred
9	512	Equivalent-Time Sampling (ETS) operation completed
10 to 15	–	Not used (bit 15 is always 0)

Refer to “[Operation Status Register Set](#)” on page 372 for the STATUS:OPERation commands.

The condition bits are set and cleared under the following conditions:

Table 1-6 Bit change conditions for the Operation Status register set

Bit	Definition	EVENTs causing bit changes
7	ARM event occurred	SET: When the trigger is armed CLEARED: When the trigger is unarmed
8	TRIGger event occurred	SET: When triggering of a waveform occurs CLEARED: When there is no triggering of a waveform
9	ETS operation completed	SET: When the ETS operation has completed CLEARED: When the ETS operation has not completed

Device Status register

The Device Status register contains bits which provide device-dependent information.

The following bits in this register are used by the 8990B:

Table 1-7 Bit definitions – Device Status register

Bit	Weight/Decimal value	Definition
0	1	Not used
1	2	Channel 1 sensor connected
2	4	Channel 4 sensor connected
3	8	Channel 1 sensor error
4	16	Channel 4 sensor error
5 to 15	–	Not used (bit 15 is always 0)

Refer to “[Device Status Register Set](#)” on page 370 for the `STATUS:DEVICE` commands.

The condition bits are set and cleared under the following conditions:

Table 1-8 Bit change conditions for the Device Status register

Bit	Definition	EVENTs causing bit changes
1	Channel 1 sensor connected	SET: When a sensor is connected to the Channel 1 input CLEARED: When no sensor is connected to the Channel 1 input
2	Channel 4 sensor connected	SET: When a sensor is connected to the Channel 4 input CLEARED: When no sensor is connected to the Channel 4 input
3	Channel 1 sensor error	SET: When an error for the sensor connected to the Channel 1 input is detected CLEARED: When no error is detected for the sensor connected to the Channel 1 input

1 Power Meter Remote Operation

Bit	Definition	EVENTs causing bit changes
4	Channel 4 sensor error	SET: When an error for the sensor connected to the Channel 4 input is detected CLEARED: When no error is detected for the sensor connected to the Channel 4 input

Using the Operation Complete Commands

The `*OPC?` query and `*OPC` command allow you to maintain synchronization between the PC and the 8990B. The `*OPC?` query places an ASCII character 1 into the 8990B output queue when all pending 8990B commands have completed. If your program reads this response before continuing program execution, you can ensure synchronization between one or more instruments and the PC.

The `*OPC` command sets bit 0 (Operation Complete) in the Standard Event Status register when all pending 8990B operations have completed.

Procedure

- 1 Send a device clear message to clear the 8990B output buffer.
- 2 Clear the event registers with the `*CLS` (clear status) command.
- 3 Enable Operation Complete using the `*ESE 1` command (Standard Event register).
- 4 Send the `*OPC?` query and enter the result to assure synchronization.
- 5 Send your programming command string, and place the `*OPC` command as the last command.
- 6 Send the `*STB?` (status byte) query to poll the register. This command does not clear the Status Byte summary register.

Summary of Commands

For details of each SCPI command available to program the 8990B, refer to later chapters for more details on each command.

THIS PAGE HAS BEEN INTENTIONALLY LEFT BLANK.



2 IEEE-488 Command Reference

SCPI Compliance Information 34

*CLS 35

*ESE <NRf> 36

*ESR? 38

*IDN? 39

*OPC 40

*RST 41

*SRE <NRf> 42

*STB? 44

*TST? 45

*WAI 46

This chapter contains information on the IEEE-488 common commands supported by the 8990B.



SCPI Compliance Information

This chapter describes the IEEE-488 common commands supported by the 8990B.

The IEEE-488 common command descriptions are listed below in the alphabetical order:

*CLS	Clear Status	page 35
*ESE and *ESE?	Event Status Enable	page 36
*ESR?	Event Status Register	page 38
*IDN?	Identify	page 39
*OPC and *OPC?	Operation Complete	page 40
*RST	Reset	page 41
*SRE and *SRE?	Service Request Enable	page 42
*STB?	Status Byte	page 44
*TST?	Self-test	page 45
*WAI	Wait	page 46

*CLS

The *CLS (Clear Status) command clears the status data structures. The SCPI registers (Questionable Status, Operation Status, and all the other SCPI registers), the Standard Event Status register, the Status Byte, and the Error/Event Queue are all cleared.

Syntax

*CLS →

Example

*CLS

This command clears the status data structures of the 8990B.

***ESE <NRf>**

The *ESE (Event Status Enable) command sets the bits in the Standard Event Enable register. The selected bits are then reported to bit 5 of the Status Byte register. The <NRf> parameter is used to specify which bits will be enabled. The specified decimal value corresponds to the binary-weighted sum of the bits you wish to enable in the register. For example, to enable bit 2 (decimal value = 4), bit 3 (decimal value = 8), and bit 5 (decimal value = 32), the corresponding decimal value would be 44 (4 + 8 + 32).

The following table lists the bit definitions for the Standard Event register:

Table 2-1 Bit definitions: Standard Event register

Bit	Weight/Decimal value	Definition
0	1	Operation complete
1	2	Not used
2	4	Query error
3	8	Device-dependent error
4	16	Execution error
5	32	Command error
6 to 7	–	Not used

Refer to “Standard Event register” on page 25 for more details.

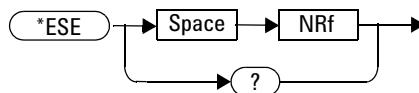
Syntax

Parameter

Type	Description/Default	Range of values
NRf	A decimal value which corresponds to the binary-weighted sum of the bits to enable in the Standard Event register	0 to 255

Example

*ESE 16 *This command enables bit 4 (decimal value = 16) in the enable register.*

Query

*ESE?

This query reads the Standard Event Enable register and returns a decimal value which corresponds to the binary-weighted sum of all bits set in the register. The return format is <NR1> in the range of 0 to 255.

Query example

*ESE? *Returns the bits currently set in the enable register.*

*ESR?

The *ESR? query reads the event register of the Standard Event register group and returns a decimal value which corresponds to the binary-weighted sum of all bits set in the register. The return format is <NR1> in the range of 0 to 255. The bits are cleared by executing this query or *CLS.

The following table lists the bit definitions for the Standard Event register:

Table 2-2 Bit definitions: Standard Event register

Bit	Weight/Decimal value	Definition
0	1	Operation complete
1	2	Not used
2	4	Query error
3	8	Device-dependent error
4	16	Execution error
5	32	Command error
6 to 7	–	Not used

Refer to “Standard Event register” on page 25 for more details.

Syntax



Example

*ESR? *Returns the bits currently set in the event register.*

*IDN?

The *IDN? query reads the 8990B identification string and returns the string in the following format:

```
Agilent Technologies,8990B,<serial number>,<firmware version>
```

where,

- <serial number> uniquely identifies each 8990B, and
- <firmware version> represents the current firmware revision of the 8990B.

Syntax

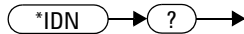

Example

```
*IDN?           Returns the 8990B identification string.
```

*OPC

The *OPC (Operation Complete) command sets the “Operation Complete” bit (bit 0) in the Standard Event register when all pending operations have completed. This command is used to synchronize your application with the 8990B.

Syntax

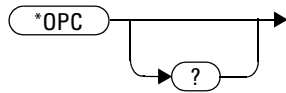

Example

*OPC *This command sets the “Operation Complete” bit.*

Query

*OPC?

This query sends 1 to the output buffer when all pending operations have completed.

Query example

*OPC? *Waits until the completion of the current command and then sends 1 to the output buffer.*

*RST

The *RST (ReSeT) command places the 8990B in a known state. This command also sets the 8990B in the Run mode.

Syntax

*RST →

Example

*RST *This command resets the 8990B to its default settings, and also sets it in the Run mode.*

Remark

This command is similar to “[SYSTEM:PRESet](#)” on page 483.

***SRE <Nrf>**

The *SRE (Service Request Enable) command enables the bits in the Status Byte enable register. The selected enabled bits are summarized in the “Master Status Summary” (MSS) bit (bit 6) of the Status Byte register. If any of the selected bit condition changes from 0 to 1, a Service Request is generated. The <Nrf> parameter is used to specify which bits to enable. The specified decimal value corresponds to the binary-weighted sum of the bits you wish to enable in the register. For example, to enable bit 2 (decimal value = 4) and bit 5 (decimal value = 32), the corresponding decimal value would be 36 (4 + 32).

The following table lists the bit definitions of the Status Byte register:

Table 2-3 Bit definitions: Status Byte register

Bit	Weight/Decimal value	Definition
0	1	Not used
1	2	Device Status register summary
2	4	Error/Event queue
3	8	Questionable Status register summary
4	16	Message available
5	32	Standard Event register summary
6	64	Master Status summary (Request for service)
7	128	Operation Status register summary

Refer to “[Status Byte summary register](#)” on page 23 for more details.

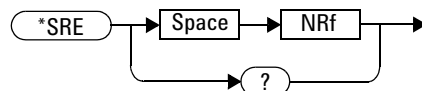
Syntax

Parameter

Type	Description/Default	Range of values
NRf	A decimal value which corresponds to the binary-weighted sum of the bits to enable in the Status Byte register	0 to 255

Example

*SRE 16 *This command enables bit 4 (decimal value = 16) in the enable register.*

Query

*SRE?

This query reads the Status Byte enable register and returns a decimal value that corresponds to the binary-weighted sum of all bits set in the register. The return format is <NR1> in the range of 0 to 255.

Query example

*SRE? *Returns the bits currently set in the enable register.*

***STB?**

The *STB? query reads the condition register of the Status Byte register and returns a decimal value which corresponds to the binary-weighted sum of all bits set in the register. The return format is <NR1> in the range of 0 to 255. This query is similar to a Serial Poll, but it is processed like any other instrument command. This is a read-only register, and the bits are not cleared when you read the register.

NOTE

This query returns the same results as a Serial Poll, but the “Master Status Summary” (MSS) bit (bit 6) is not cleared if a Serial Poll has occurred.

The following table lists the bit definitions of the Status Byte register:

Table 2-4 Bit definitions: Status Byte register

Bit	Weight/Decimal value	Definition
0	1	Not used
1	2	Device Status register summary
2	4	Error/Event queue
3	8	Questionable Status register summary
4	16	Message available
5	32	Standard Event register summary
6	64	Master Status summary (Request for service)
7	128	Operation Status register summary

Refer to “[Status Byte summary register](#)” on page 23 for more details.

Syntax**Example**

*STB? *Returns the bits currently set in the condition register.*

*TST?

The *TST? (TeST) query initiates an internal self-test of the 8990B and returns a pass or fail indication where:

- 0 is returned if all tests pass, or
- 1 is returned if one or more tests fail.

Syntax

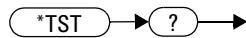

Example

*TST? *Performs a self-test and returns a pass or fail indication.*

*WAI

The *WAI (WAIt) command has no function in the 8990B, but is parsed for compatibility with other instruments.

Syntax

*WAI →



3 Root Commands

Overview	48
ARS?	49
AUToscale	50
AUToscale:UNDO	51
ECS?	52
ETS <character_data>	53
ETSThreshold <character_data>	55
RUN	57
SINGLE	58
STOP	59
TRS?	60

This chapter describes the root commands supported by the 8990B.



Overview

This chapter describes the 8990B root commands which are SCPI commands that are not located under any subsystem.

Below lists the root command descriptions:

ARS?	Arm Event State	page 49
AUToscale	Autoscale	page 50
AUToscale:UNDO	Undo Autoscale	page 51
ECS?	Equivalent-Time Sampling (ETS) Event Completed State	page 52
ETS <character_data>	Equivalent-Time Sampling (ETS) Event State	page 53
ETSThreshold <character_data>	Equivalent-Time Sampling (ETS) Threshold Value	page 55
RUN	Continuous Acquisition	page 57
SINGle	Single Acquisition	page 58
STOP	Stop Acquisition	page 59
TRS?	Trigger Event State	page 60

ARS?

This query enters a 1 or 0 into the output buffer indicating the current state of the arm trigger event of the 8990B.

- 1 is returned when the trigger is armed
- 0 is returned when the trigger is unarmed

Syntax

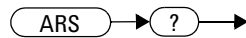

Example

ARS? *Queries the state of the arm trigger event of the 8990B.*

Remark

Executing this query or ***CLS** clears the arm trigger event status. This status bit will not be reset when the Arm Event bit of the “**Operation Status register**” is read using the `STATUS:OPERation[:EVENT]?` query.

AUToscale

This command automatically scales the waveform of all the current channels to the optimized graph display.

Syntax

AUT →

Example

AUT *This command autoscales the waveform display.*

Remarks

- This command, when executed, causes the 8990B to adjust and display the waveforms in the optimum condition by evaluating all the input channels. This command will turn off the channel with no waveform found.
- This command is not compatible in CCDF mode.

AUToscale:UNDO

This command returns the 8990B to the settings that existed before autoscale was executed. This is useful if you have unintentionally executed autoscale or do not like the settings autoscale has selected and want to return to your previous settings.

Syntax



Example

AUT:UNDO *This command returns the 8990B to the settings that existed before autoscale was executed.*

Remark

This command is not compatible in the CCDF mode.

ECS?

This query enters a 1 or 0 into the output buffer indicating the completed state of the Equivalent-Time Sampling (ETS) event.

- 1 is returned when ETS has completed
- 0 is returned when ETS has not completed

Syntax

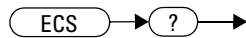

Example

ECS? *Queries whether or not the ETS event has completed.*

Remark

Executing this query or [*CLS](#) clears the ETS event completed status. This status bit will not be reset when the ETS Operation Completed bit of the “[Operation Status register](#)” is read using the `STATUS:OPERation[:EVENT]?` query.

ETS <character_data>

This command sets the state of the Equivalent-Time Sampling (ETS) event.

Syntax

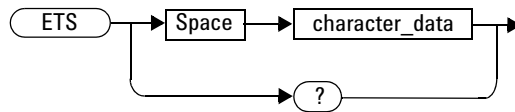

Parameter

Item	Description/Default	Range of values
character_data	Sets the ETS state as: <ul style="list-style-type: none"> AUTO: Sets ETS to automatically turn on when the timescale value is less than the value set at ETSThreshold. OFF: Turns off ETS. 	AUTO OFF

Example

ETS OFF *This command turns off the ETS event.*

Remarks

- Turning on ETS enables the 8990B to capture high-frequency signals with a higher effective sampling rate.
- Video bandwidth is turned off when ETS is enabled.
- The 10 MHz reference signal input is turned off when ETS is enabled. If ETS is enabled while the 10 MHz input is turned on, error 939, “10 MHz setting is only applicable when ETS is off. 10 MHz setting is turned off” will occur.

Reset condition

On reset, ETS is set to AUTO.

Query

ETS?

This query returns the current setting of the ETS state. The response format is <NRf>.

Query example

ETS? *Queries the current ETS state.*

ETSThreshold <character_data>

This command sets the ETS threshold value.

Syntax

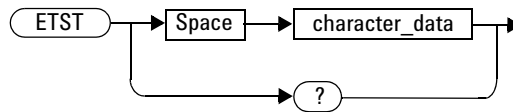

Parameter

Item	Description/Default	Range of values
character_data	Sets the ETS threshold as: <ul style="list-style-type: none"> • ETS500N: Sets ETS threshold to 500 ns. • ETS1U: Sets ETS threshold to 1 μs. • ETS2U: Sets ETS threshold to 2 μs. • ETS5U: Sets ETS threshold to 5 μs. • ETS10U: Sets ETS threshold to 10 μs. 	ETS500N ETS1U ETS2U ETS5U ETS10U

Example

```
ETST ETS500N
```

This command sets the ETS threshold to 500 ns.

Reset condition

On reset, ETS threshold is set to ETS500N.

Query

ETST?

This query returns the current setting of the ETS threshold. The response format is <NRf>.

Query example

ETST? *Queries the current ETS threshold.*

RUN

This command sets the 8990B to start a continuous data acquisition.

Syntax

`RUN` →

Example

`RUN` *This command initiates a continuous data acquisition.*

Remark

To exit the continuous acquisition mode, you need to execute the `STOP` or `SINGLE` command.

SINGle

This command sets the 8990B to make a single data acquisition when the next trigger event occurs.

Syntax

SING →

Example

SINGle *This command initiates a single data acquisition.*

Remark

The 8990B will stop acquiring data after making the single acquisition.

STOP

This command sets the 8990B to stop data acquisition.

Syntax

STOP →

Example

STOP *This command stops the data acquisition.*

Remark

To re-initiate data acquisition, you need to execute the RUN or SINGLE command.

TRS?

This query enters a 1 or 0 into the output buffer indicating the current state of the trigger event of the 8990B.

- 1 is returned if a trigger event occurs
- 0 is returned if there is no trigger event

Syntax



Example

TRS? *Queries the state of the trigger event of the 8990B.*

Remark

Executing this query or ***CLS** clears the trigger event status. This status bit will not be reset when the Trigger Event bit of the “[Operation Status register](#)” is read using the `STATUS:OPERation[:EVENT]? query`.

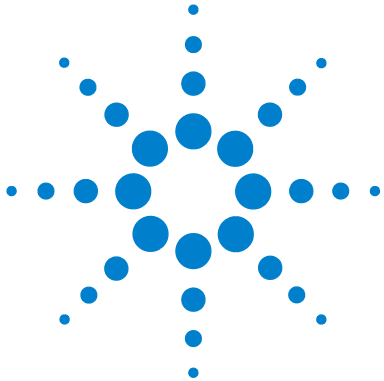

4 ACQuire Subsystem

Overview 63

ACQuire:AVERAge[:STATe] <boolean> 65

ACQuire:AVERAge:COUNT <numeric_value> 67

ACQuire:AVERAge:COUNT:CURRent? 69

ACQuire:CCDF:AVERAge? 70

ACQuire:CCDF:COUNT <numeric_value> 71

ACQuire:CCDF:COUNT:CURRent? 73

ACQuire:CCDF:DURation <numeric_value> 74

ACQuire:CCDF:FRAMe <numeric_value> 76

ACQuire:CCDF:FRAMe:CURRent? 78

ACQuire:CCDF:GAUSSian[:STATe] <boolean> 79

ACQuire:CCDF:MARKer:ASOURce <character_data> 81

ACQuire:CCDF:MARKer:AXPosition <numeric_value> 83

ACQuire:CCDF:MARKer:AYPosition? 85

ACQuire:CCDF:MARKer:BSOURce <character_data> 86

ACQuire:CCDF:MARKer:BXPosition <numeric_value> 88

ACQuire:CCDF:MARKer:BYPosition? 90

ACQuire:CCDF:MARKer:XDELta? 91

ACQuire:CCDF:MARKer:YDELta? 92

ACQuire:CCDF:PAVerage? 93

ACQuire:CCDF:PEAK? 94

ACQuire:CCDF:REFerence[:STATe] <boolean> 95

ACQuire:CCDF:REFerence:SOURce <character_data> 97

ACQuire:CCDF:SCALe <numeric_value> 99

ACQuire:CCDF:SOURce <character_data> 101

ACQuire:CCDF:SWEep <character_data> 103

ACQuire:CCDF:TABLE? 105

ACQuire:CCDF:TABLESOURce <character_data> 107



4 ACQUIRE Subsystem

ACQUIRE:CCDF:TRACE{1 4}[:STATE] <boolean>	109
ACQUIRE:CCDF:TRACE{1 4}[:STATE] <boolean>	109
ACQUIRE:DROOP[:STATE] <boolean>	111
ACQUIRE:DROOP:SOURCE CHAN{1 4}	112
ACQUIRE:INTERPOLATE <boolean>	114
ACQUIRE:MODE <character_data>	115
ACQUIRE:ZOOM:OFFSET <numeric_value>	118
ACQUIRE:ZOOM:SCALE <numeric_value>	120

This chapter explains how the ACQUIRE command subsystem is used to set the 8990B acquisition mode and parameters.

Overview

The ACQuire command subsystem allows you to configure the acquisition settings of the 8990B.

Keyword	Parameter form	Note	Page
ACQuire			
:AVERage			
[:STATe]	<boolean>		page 65
:COUNT	<numeric_value>		page 67
:CURRent?		[query only]	page 69
:CCDF			
:AVERage?	<character_data>	[query only]	page 70
:COUNT	<numeric_value>		page 71
:CURRent?		[query only]	page 69
:DURation	<numeric_value>		page 74
:FRAMe	<numeric_value>		page 76
:CURRent?		[query only]	page 78
:GAUSSian			
[:STATe]	<boolean>		page 79
:MARKer			
:ASOURce	<character_data>		page 81
:AXPosition	<numeric_value>		page 83
:AYPosition?		[query only]	page 85
:BSOURce	<character_data>		page 86
:BXPosition	<numeric_value>		page 88
:BYPosition?		[query only]	page 90
:XDELta?		[query only]	page 91
:YDELta?		[query only]	page 92
:MODE	<character_data>		page 92
:PAverage?	<character_data>	[query only]	page 93
:PEAK?	<character_data>	[query only]	page 94

4 ACQuire Subsystem

Keyword	Parameter form	Note	Page
:REFerence			
[:STATe]	<boolean>		page 95
:SOURce	<character_data>		page 97
:SCALE	<numeric_value>		page 99
:SOURce	<character_data>		page 101
:SWEep	<character_data>		page 103
:TABle?		[query only]	page 105
:TABLESOURce	<character_data>		page 107
:TRACe{1 4}			
[:STATe]	<boolean>		page 109
:DROop			
[:STATe]	<boolean>		page 111
:SOURce CHAN{1 4}			page 112
:INTerpolate	<boolean>		page 114
:MODE	<character_data>		page 115
:ZOOM			
:OFFSet	<numeric_value>		page 118
:SCALE	<numeric_value>		page 120

ACQuire:AVERage[:STATe] <boolean>

This command sets the state of averaging which is used to improve measurement accuracy.

Syntax

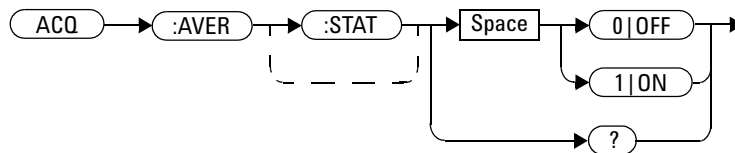

Example

ACQ:AVER 1 *This command enables averaging.*

Remark

The last setting of the averaging filter length will be saved with every averaging state change.

Reset condition

On reset, averaging is disabled.

Query

ACQuire:AVERage[:STATE]?

This query enters a 1 or 0 into the output buffer indicating the state of averaging.

- 1 is returned when averaging is enabled
- 0 is returned when averaging is disabled

Query example

ACQ:AVER? *Queries whether averaging is enabled or disabled.*

ACQuire:AVERage:COUNT <numeric_value>

This command sets the filter length for the averaging operation.

Syntax

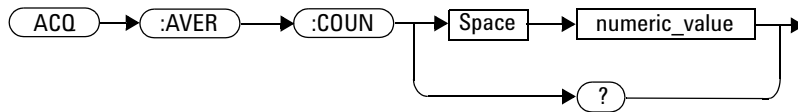

Parameter

Item	Description/Default	Range of values
numeric_value	A numeric value for the averaging filter length: <ul style="list-style-type: none"> • Default value: 2 • Minimum value: 2 • Maximum value: 2048 	2, 4, 8, 16, 32, 64, 128, 256, 512, 1024, or 2048

Example

ACQ:AVER:COUNT 128

This command sets the averaging filter length to 128.

Remarks

- If the averaging state is off, it will be turned on when you set the averaging filter length.
- If you set a value other than the range specified for the filter length, error -222, "Data out of range" will occur.

Reset condition

On reset, the averaging filter length is set to 2.

Query

```
ACQuire:AVERage:COUNT?
```

This query returns the current setting of the averaging filter length. The response format is <NR1>.

Query example

```
ACQ:AVER:COUN?     Queries the averaging filter length setting.
```

ACQuire:AVERage:COUNT:CURRent?

This query returns the filter length of the running averaging operation.

Syntax

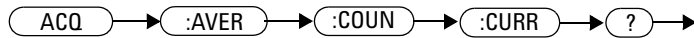

Example

ACQ:AVER:COUNT:CURR? *Queries the running averaging filter length.*

Remark

If the averaging state is off, this query returns a value of 0 and error -221, “Settings conflict; Requires averaging to be enabled” will occur. Refer to “ACQuire:AVERage:COUNT <numeric_value>” on page 67 to enable the averaging.

ACQUIRE:CCDF:AVERAGE?

This query returns the Complementary Cumulative Distribution Function (CCDF) average power value (in dBm) for the selected CCDF source. The CCDF source can be selected at “ACQUIRE:CCDF:SOURCE <character_data>” on page 101.

Syntax



Example

ACQ:CCDF:AVER? *Queries the CCDF average power value for the selected CCDF source.*

Remarks

- This query is only applicable for channels 1 and 4. If you send this query for a channel other than 1 or 4, error 700, “Applicable to channel 1 and 4 only” will occur.
- This query is only applicable in the CCDF acquisition mode. If the acquisition mode is not set to CCDF, error -221, “Settings conflict; Requires CCDF mode to be enabled” will occur. Refer to “ACQUIRE:MODE <character_data>” on page 115 to set the acquisition mode.

ACQuire:CCDF:COUNt <numeric_value>

This command sets the CCDF acquisition length.

NOTE

The CCDF acquisition length can only be set when the CCDF free run sweep mode is enabled (refer to “ACQuire:CCDF:SWEEp <character_data>” on page 103).

Syntax

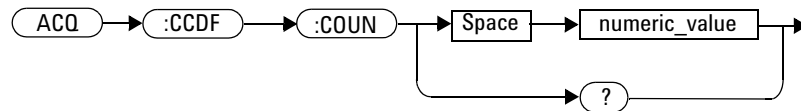

Parameter

Item	Description/Default	Range of values
numeric_value	A numeric value for the CCDF count: <ul style="list-style-type: none"> • Default value: 100M • Minimum value: 100M • Maximum value: 10G The value specified will be truncated to a multiple of 100M.	100M to 10G

Example

ACQ:CCDF:COUN 500MA

This command sets the CCDF acquisition length to 500M.

Remarks

- The acquisition length specified in this command corresponds to the CCDF source selected in “ACQUIRE:CCDF:SOURce <character_data>” on page 101.
- This command is only applicable for channels 1 and 4. If you send this command for a channel other than 1 or 4, error 700, “Applicable to channel 1 and 4 only” will occur.
- This command is only applicable in the CCDF acquisition mode. If the acquisition mode is not set to CCDF, error -221, “Settings conflict; Requires CCDF mode to be enabled” will occur. Refer to “ACQUIRE:MODE <character_data>” on page 115 to set the acquisition mode.
- This command is only applicable when the CCDF sweep is set to the free run mode. If the CCDF sweep mode is not set to free run, error -221, “Settings conflict; Requires CCDF sweep to be in free run mode” will occur.
- If you set an acquisition length value which exceeds its minimum or maximum limit, the value will be clipped to its minimum or maximum value respectively. Error -222, “Data out of range; Value clipped to minimum (#)” or -222, “Data out of range; Value clipped to maximum (#)” will occur.

Reset condition

On reset, the CCDF acquisition length is set to 100M.

Query

```
ACQUIRE:CCDF:COUNT?
```

This query returns the current setting of the CCDF acquisition length. The response format is <NRf>.

Query example

```
ACQ:CCDF:COUN? Queries the CCDF acquisition length setting.
```

ACQuire:CCDF:COUNt:CURRent?

This query returns the CCDF acquisition length of the running CCDF free run sweep.

Syntax

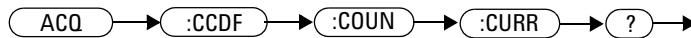

Example

ACQ:CCDF:COUN:CURR?

Queries the acquisition length of the running CCDF free run sweep.

Remarks

- This query is only applicable for channels 1 and 4. If you send this query for a channel other than 1 or 4, error 700, “Applicable to channel 1 and 4 only” will occur.
- This query is only applicable in the CCDF acquisition mode. If the acquisition mode is not set to CCDF, error -221, “Settings conflict; Requires CCDF mode to be enabled” will occur. Refer to “ACQuire:MODE <character_data>” on page 115 to set the acquisition mode.
- This query is only applicable when the CCDF sweep is set to the free run mode. If the CCDF sweep is not set to free run, error -221, “Settings conflict; Requires CCDF sweep to be in free run mode” will occur.

ACQUIRE:CCDF:DURATION <numeric_value>

This command sets the CCDF trigger duration.

Syntax

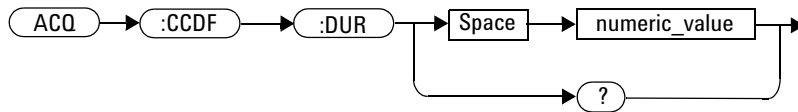

Parameter

Item	Description/Default	Range of values
numeric_value	<p>A numeric value in second for the CCDF trigger duration:</p> <ul style="list-style-type: none"> • Default value: 10 ms • Minimum value: 100 ns • Maximum value: 1 s <p>The value specified will be truncated to a multiple of 10 ns.</p> <p>The range of values above is determined by CCDF trigger duration × CCDF frame and must be ≤ 100 s.</p>	100 ns to 1 s

Example

ACQ:CCDF:DUR 0.01

This command sets the CCDF trigger duration to 0.01 s.

Remarks

- This command is only applicable for channels 1 and 4. If you send this command for a channel other than 1 or 4, error 700, “Applicable to channel 1 and 4 only” will occur.

- This command is only applicable in the CCDF acquisition mode. If the acquisition mode is not set to CCDF, error -221, “Settings conflict; Requires CCDF mode to be enabled” will occur. Refer to “ACQuire:MODE <character_data>” on page 115 to set the acquisition mode.
- If you set a trigger duration value which exceeds its minimum or maximum limit, the value will be clipped to its minimum or maximum value respectively. Error -222, “Data out of range; Value clipped to minimum (#)” or -222, “Data out of range; Value clipped to maximum (#)” will occur.
- This command is only applicable when the CCDF sweep is set to the triggered mode. If the CCDF sweep mode is not set to triggered, error -221, “Settings conflict; Requires CCDF sweep to be in triggered mode” will occur.
- CCDF duration is set based on the trace length of the normal mode when switching from normal to zoom mode. This command is applicable within the range of duration, If the duration is out of range, “Settings conflict; CCDF trigger duration is out of range. It sets to default” will occur.

Reset condition

On reset, the CCDF trigger duration is set to 10 ms.

Query

ACQuire:CCDF:DURation?

This query returns the current setting of the CCDF trigger duration. The response format is <Nrf>.

Query example

ACQ:CCDF:DUR? *Queries the CCDF trigger duration setting.*

ACQUIRE:CCDF:FRAME <numeric_value>

This command sets the CCDF frame.

NOTE

The CCDF frame can only be set when the CCDF triggered sweep mode is enabled (refer to “ACQUIRE:CCDF:SWEEP <character_data>” on page 103).

Syntax

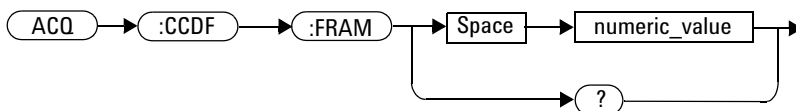

Parameter

Item	Description/Default	Range of values
numeric_value	A numeric value for the CCDF frame: <ul style="list-style-type: none"> • Default value: 1 • Minimum value: 1 • Maximum value: 1G The range of values above is determined by CCDF trigger duration × CCDF frame and must be ≤ 100 s.	1 to 1 G

Example

ACQ:CCDF:FRAME 2K

This command sets the CCDF frame to 2K.

Remarks

- This command is only applicable for channels 1 and 4. If you send this command for a channel other than 1 or 4, error 700, “Applicable to channel 1 and 4 only” will occur.
- This command is only applicable in the CCDF acquisition mode. If the acquisition mode is not set to CCDF, error -221, “Settings conflict; Requires CCDF mode to be enabled” will occur. Refer to “ACQuire:MODE <character_data>” on page 115 to set the acquisition mode.
- This command is only applicable when the CCDF sweep is set to the triggered mode. If the CCDF sweep mode is not set to triggered, error -221, “Settings conflict; Requires CCDF sweep to be in triggered mode” will occur.
- If you set a CCDF frame value which exceeds its minimum or maximum limit, the value will be clipped to its minimum or maximum value respectively. Error -222, “Data out of range; Value clipped to minimum (#)” or -222, “Data out of range; Value clipped to maximum (#)” will occur.

Reset condition

On reset, the CCDF frame is set to 1.

Query

```
ACQuire:CCDF:FRAME?
```

This query returns the current setting of the CCDF frame. The response format is <NRf>.

Query example

```
ACQ:CCDF:FRAM?    Queries the CCDF frame setting.
```

ACQUIRE:CCDF:FRAME:CURRENT?

This query returns the CCDF frame of the running CCDF triggered sweep.

Syntax



Example

ACQ:CCDF:FRAM:CURR?

Queries the frame of the running CCDF triggered sweep.

Remarks

- This query is only applicable for channels 1 and 4. If you send this query for a channel other than 1 or 4, error 700, “Applicable to channel 1 and 4 only” will occur.
- This query is only applicable in the CCDF acquisition mode. If the acquisition mode is not set to CCDF, error -221, “Settings conflict; Requires CCDF mode to be enabled” will occur. Refer to “ACQUIRE:MODE <character_data>” on page 115 to set the acquisition mode.
- This query is only applicable when the CCDF sweep is set to the triggered mode. If the CCDF sweep mode is not set to triggered, error -221, “Settings conflict; Requires CCDF sweep to be in triggered mode” will occur.

ACQuire:CCDF:GAUSSian[:STATe] <boolean>

This command sets the state of the CCDF Gaussian trace.

Syntax

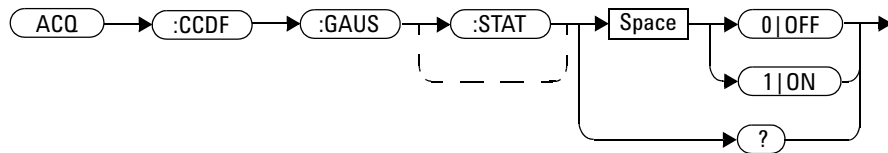

Example

ACQ:CCDF:GAUS 1 *This command turns on the CCDF Gaussian trace.*

Remarks

- This command is only applicable for channels 1 and 4. If you send this command for a channel other than 1 or 4, error 700, “Applicable to channel 1 and 4 only” will occur.
- This command is only applicable in the CCDF acquisition mode. If the acquisition mode is not set to CCDF, error -221, “Settings conflict; Requires CCDF mode to be enabled” will occur. Refer to “ACQuire:MODE <character_data>” on page 115 to set the acquisition mode.

Reset condition

On reset, the CCDF Gaussian trace is turned on.

Query

```
ACQUIRE:CCDF:GAUSSIAN[:STATE]?
```

This query enters a 1 or 0 into the output buffer indicating the state of the CCDF Gaussian trace.

- 1 is returned when the trace is turned on
- 0 is returned when the trace is turned off

Query example

```
ACQ:CCDF:GAUS?      Queries whether the CCDF Gaussian trace is turned  
                                 on or off.
```

ACQuire:CCDF:MARKer:ASOUrce <character_data>

This command sets the CCDF marker A source.

Syntax

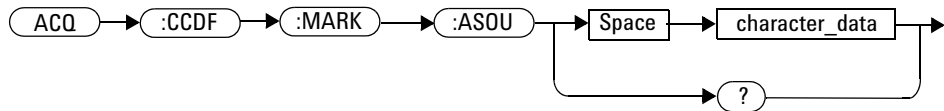

Parameter

Item	Description/Default	Range of values
character_data	Sets the source of marker A as: <ul style="list-style-type: none"> • TRACe1: Places marker A on channel 1 CCDF trace. • TRACe4: Places marker A on channel 4 CCDF trace. • GAUSSian: Places marker A on Gaussian trace. • REFerence: Places marker A on reference trace. • NONE: Disables marker A. 	TRACe1 TRACe4 GAUSSian REFerence NONE

Example

```
ACQ:CCDF:MARK:ASOU TRAC1
```

This command sets marker A on channel 1 CCDF trace.

Remarks

- This command is only applicable for channels 1 and 4. If you send this command for a channel other than 1 or 4, error 700, “Applicable to channel 1 and 4 only” will occur.

- This command is only applicable in the CCDF acquisition mode. If the acquisition mode is not set to CCDF, error -221, “Settings conflict; Requires CCDF mode to be enabled” will occur. Refer to “ACQUIRE:MODE <character_data>” on page 115 to set the acquisition mode.
- This command is only applicable when the CCDF trace from channel 1 or 4 is enabled. If the channel trace is not enabled, error -221, “Settings conflict; Requires CCDF trace # to be enabled” will occur. Refer to “ACQUIRE:CCDF:TRACE{1|4}[:STATE] <boolean>” on page 109 to set the CCDF channel trace.
- This command is only applicable when the CCDF Gaussian trace is enabled. If the Gaussian trace is not enabled, error -221, “Settings conflict; Requires CCDF Gaussian trace to be enabled” will occur. Refer to “ACQUIRE:CCDF:GAUSSIAN[:STATE] <boolean>” on page 79 to set the CCDF Gaussian trace.
- This command is only applicable when the CCDF reference trace is enabled. If the reference trace is not enabled, error -221, “Settings conflict; Requires CCDF Reference trace to be enabled” will occur. Refer to “ACQUIRE:CCDF:REFERENCE[:STATE] <boolean>” on page 95 to set the CCDF reference trace.

Reset condition

On reset, the CCDF marker A source is set to none.

Query

```
ACQUIRE:CCDF:MARKER:ASOURCE?
```

This query returns the current setting of the CCDF marker A source.

Query example

```
ACQ:CCDF:MARK:ASOU?      Queries the CCDF marker A source setting.
```

ACQuire:CCDF:MARKer:AXPosition <numeric_value>

This command sets the X-axis position of CCDF marker A.

Syntax

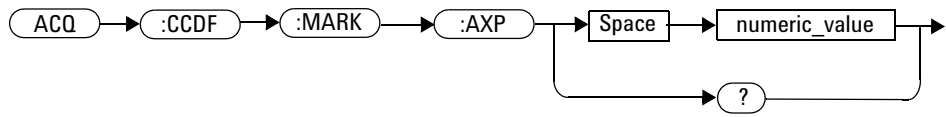

Parameter

Item	Description/Default
numeric_value	A numeric value in dB for the X-axis position

Example

ACQ:CCDF:MARK:AXP 0.1

This command sets the X-axis position of CCDF marker A to 0.1 dB.

Remarks

- This command is only applicable for channels 1 and 4. If you send this command for a channel other than 1 or 4, error 700, “Applicable to channel 1 and 4 only” will occur.
- This command is only applicable in the CCDF acquisition mode. If the acquisition mode is not set to CCDF, error -221, “Settings conflict; Requires CCDF mode to be enabled” will occur. Refer to “ACQUIRE:MODE <character_data>” on page 115 to set the acquisition mode.
- This command is only applicable when the CCDF marker A source is set. If the source is not set, error -221, “Settings conflict; CCDF marker A source not set” will occur. Refer to “ACQUIRE:CCDF:MARKER:ASOURCE <character_data>” on page 81 to set the CCDF marker A source.

Query

```
ACQUIRE:CCDF:MARKER:AXPosition?
```

This query returns the current setting of the CCDF marker A X-axis position. The response format is <NRf>.

Query example

```
ACQ:CCDF:MARK:AXP?
```

Queries the X-axis position setting of CCDF marker A.

ACQuire:CCDF:MARKer:AYPosition?

This query returns the current Y-axis position setting of CCDF marker A. The response format is <NRf> in percentage.

Syntax

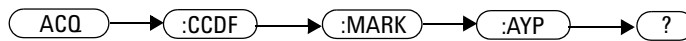

Example

ACQ:CCDF:MARK:AYP?

Queries the Y-axis position setting of CCDF marker A.

Remarks

- This query is only applicable for channels 1 and 4. If you send this query for a channel other than 1 or 4, error 700, “Applicable to channel 1 and 4 only” will occur.
- This query is only applicable in the CCDF acquisition mode. If the acquisition mode is not set to CCDF, error -221, “Settings conflict; Requires CCDF mode to be enabled” will occur. Refer to “ACQuire:MODE <character_data>” on page 115 to set the acquisition mode.
- This query is only applicable when the CCDF marker A source is set. If the source is not set, error -221, “Settings conflict; CCDF marker A source not set” will occur. Refer to “ACQuire:CCDF:MARKer:ASOURCE <character_data>” on page 81 to set the CCDF marker A source.

ACQUIRE:CCDF:MARKer:BSOURce <character_data>

This command sets the CCDF marker B source.

Syntax

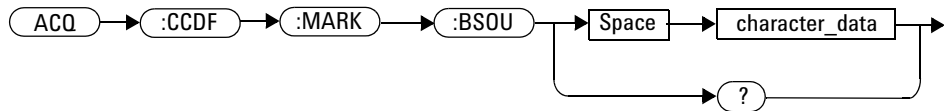

Parameter

Item	Description/Default	Range of values
character_data	Sets the source of marker B as: <ul style="list-style-type: none"> • TRACe1: Places marker A on channel 1 CCDF trace. • TRACe4: Places marker A on channel 4 CCDF trace. • GAUSSian: Places marker A on Gaussian trace. • REFerence: Places marker A on reference trace. • NONE: Disables marker B. 	TRACe1 TRACe4 GAUSSian REFerence NONE

Example

ACQ:CCDF:MARK:BSOU TRAC4

This command sets marker B on channel 4 CCDF trace.

Remarks

- This command is only applicable for channels 1 and 4. If you send this command for a channel other than 1 or 4, error 700, “Applicable to channel 1 and 4 only” will occur.

- This command is only applicable in the CCDF acquisition mode. If the acquisition mode is not set to CCDF, error -221, “Settings conflict; Requires CCDF mode to be enabled” will occur. Refer to “ACQuire:MODE <character_data>” on page 115 to set the acquisition mode.
- This command is only applicable when the CCDF trace from channel 1 or 4 is enabled. If the channel trace is not enabled, error -221, “Settings conflict; Requires CCDF trace # to be enabled” will occur. Refer to “ACQuire:CCDF:TRACe{1|4}[:STATe] <boolean>” on page 109 to set the CCDF channel trace.
- This command is only applicable when the CCDF Gaussian trace is enabled. If the Gaussian trace is not enabled, error -221, “Settings conflict; Requires CCDF Gaussian trace to be enabled” will occur. Refer to “ACQuire:CCDF:GAUSSian[:STATe] <boolean>” on page 79 to set the CCDF Gaussian trace.
- This command is only applicable when the CCDF reference trace is enabled. If the reference trace is not enabled, error -221, “Settings conflict; Requires CCDF reference trace to be enabled” will occur. Refer to “ACQuire:CCDF:REFerence[:STATe] <boolean>” on page 95 to set the CCDF reference trace.

Reset condition

On reset, the CCDF marker B source is set to none.

Query

```
ACQuire:CCDF:MARKer:BSOURce?
```

This query returns the current setting of the CCDF marker B source.

Query example

```
ACQ:CCDF:MARK:BSOU?    Queries the CCDF marker B source setting.
```

ACQuire:CCDF:MARKer:BXPosition <numeric_value>

This command sets the X-axis position of CCDF marker B.

Syntax

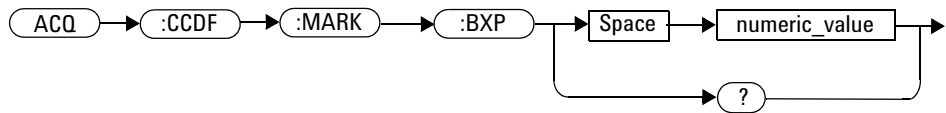

Parameter

Item	Description/Default
numeric_value	A numeric value in dB for the X-axis position

Example

ACQ:CCDF:MARK:BXPosition 0.5 *This command sets the X-axis position of CCDF marker B to 0.5 dB.*

Remarks

- This command is only applicable for channels 1 and 4. If you send this command for a channel other than 1 or 4, error 700, “Applicable to channel 1 and 4 only” will occur.
- This command is only applicable in the CCDF acquisition mode. If the acquisition mode is not set to CCDF, error -221, “Settings conflict; Requires CCDF mode to be enabled” will occur. Refer to “ACQuire:MODE <character_data>” on page 115 to set the acquisition mode.
- This command is only applicable when the CCDF marker B source is set. If the source is not set, error -221, “Settings conflict; CCDF marker B source not set” will occur. Refer to “ACQuire:CCDF:MARKer:BSOURCE <character_data>” on page 86 to set the CCDF marker B source.

Query

ACQuire:CCDF:MARKer:BXPosition?

This query returns the current setting of the CCDF marker B X-axis position. The response format is <NRf>.

Query example

ACQ:CCDF:MARK:BX?

Queries the X-axis position setting of CCDF marker B.

ACQuire:CCDF:MARKer:BYPosition?

This query returns the current Y-axis position setting of CCDF marker B. The response format is <NRf> in percentage.

Syntax

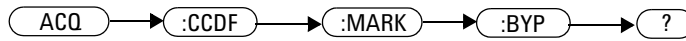

Example

ACQ:CCDF:MARK:BYP?

Queries the Y-axis position setting of CCDF marker B.

Remarks

- This query is only applicable for channels 1 and 4. If you send this query for a channel other than 1 or 4, error 700, “Applicable to channel 1 and 4 only” will occur.
- This query is only applicable in the CCDF acquisition mode. If the acquisition mode is not set to CCDF, error -221, “Settings conflict; Requires CCDF mode to be enabled” will occur. Refer to “ACQuire:MODE <character_data>” on page 115 to set the acquisition mode.
- This query is only applicable when the CCDF marker B source is set. If the source is not set, error -221, “Settings conflict; CCDF marker B source not set” will occur. Refer to “ACQuire:CCDF:MARKer:BSOURCE <character_data>” on page 86 to set the CCDF marker B source.

ACQuire:CCDF:MARKer:XDELta?

This query returns the X-axis delta value between the CCDF A and B markers.

Syntax

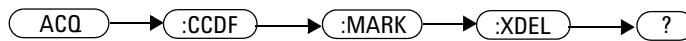

Example

ACQ:CCDF:MARK:XDEL? *Queries the CCDF marker X-axis delta value.*

Remarks

- This query is only applicable for channels 1 and 4. If you send this query for a channel other than 1 or 4, error 700, “Applicable to channel 1 and 4 only” will occur.
- This query is only applicable in the CCDF acquisition mode. If the acquisition mode is not set to CCDF, error -221, “Settings conflict; Requires CCDF mode to be enabled” will occur. Refer to “ACQuire:MODE <character_data>” on page 115 to set the acquisition mode.

ACQuire:CCDF:MARKer:YDELta?

This query returns the Y-axis delta value between the CCDF A and B markers.

Syntax

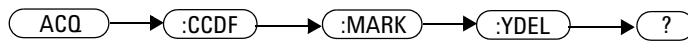

Example

ACQ:CCDF:MARK:YDEL? *Queries the CCDF marker Y-axis delta value.*

Remarks

- This query is only applicable for channels 1 and 4. If you send this query for a channel other than 1 or 4, error 700, “Applicable to channel 1 and 4 only” will occur.
- This query is only applicable in the CCDF acquisition mode. If the acquisition mode is not set to CCDF, error -221, “Settings conflict; Requires CCDF mode to be enabled” will occur. Refer to “ACQuire:MODE <character_data>” on page 115 to set the acquisition mode.

ACQuire:CCDF:PAverage?

This query returns the CCDF peak-to-average power value (in dB) for the selected CCDF source. The CCDF source can be selected at “ACQuire:CCDF:SOURce <character_data>” on page 101.

Syntax

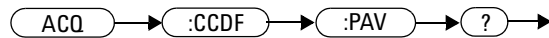

Example

ACQ:CCDF:PAV?

Queries the CCDF peak- to- average power value for the selected CCDF source.

Remarks

- This query is only applicable for channels 1 and 4. If you send this query for a channel other than 1 or 4, error 700, “Applicable to channel 1 and 4 only” will occur.
- This query is only applicable in the CCDF acquisition mode. If the acquisition mode is not set to CCDF, error -221, “Settings conflict; Requires CCDF mode to be enabled” will occur. Refer to “ACQuire:MODE <character_data>” on page 115 to set the acquisition mode.
- This query is only applicable when the CCDF source is set. If the source is not set, error -221, “Settings conflict; CCDF source not set” will occur. Refer to “ACQuire:CCDF:SOURce <character_data>” on page 101 to set the CCDF source.

ACQUIRE:CCDF:PEAK?

This query returns the CCDF peak power value (in dBm) for the selected CCDF source.

Syntax

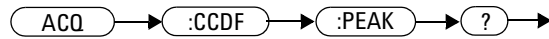

Example

ACQ:CCDF:PEAK? *Queries the CCDF peak power value for selected CCDF source.*

Remarks

- This query is only applicable for channels 1 and 4. If you send this query for a channel other than 1 or 4, error 700, “Applicable to channel 1 and 4 only” will occur.
- This query is only applicable in the CCDF acquisition mode. If the acquisition mode is not set to CCDF, error -221, “Settings conflict; Requires CCDF mode to be enabled” will occur. Refer to “ACQUIRE:MODE <character_data>” on page 115 to set the acquisition mode.
- This query is only applicable when the CCDF source is set. If the source is not set, error -221, “Settings conflict; CCDF source not set” will occur. Refer to “ACQUIRE:CCDF:SOURCE <character_data>” on page 101 to set the CCDF source.

ACQuire:CCDF:REfERENCE[:STATe] <boolean>

This command sets the state of the CCDF reference trace.

Syntax

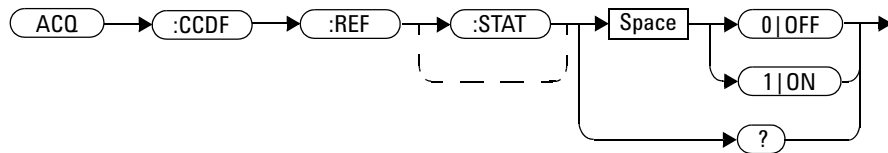

Example

ACQ:CCDF:REF 1 *This command turns on the CCDF reference trace.*

Remarks

- This command is only applicable for channels 1 and 4. If you send this command for a channel other than 1 or 4, error 700, “Applicable to channel 1 and 4 only” will occur.
- This command is only applicable in the CCDF acquisition mode. If the acquisition mode is not set to CCDF, error -221, “Settings conflict; Requires CCDF mode to be enabled” will occur. Refer to “ACQuire:MODE <character_data>” on page 115 to set the acquisition mode.
- This command is only applicable when the CCDF trace from channel 1 or 4 is enabled. If the channel trace is not enabled, error -221, “Settings conflict; Requires CCDF trace # to be enabled” will occur. Refer to “ACQuire:CCDF:TRACe{1|4}[:STATe] <boolean>” on page 109 to set the CCDF channel trace.

Reset condition

On reset, the CCDF reference trace is turned off.

Query

```
ACQuire:CCDF:REFerence[:STATe]?
```

This query enters a 1 or 0 into the output buffer indicating the state of the CCDF reference trace.

- 1 is returned when the trace is turned on
- 0 is returned when the trace is turned off

Query example

```
ACQ:CCDF:REF?
```

Queries whether the CCDF reference trace is turned on or off.

ACQuire:CCDF:REfERENCE:SOURce <character_data>

This command sets the CCDF channel trace as a reference source.

Syntax

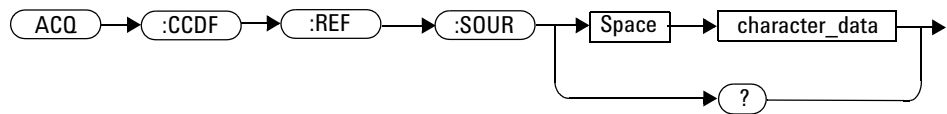

Parameter

Item	Description/Default	Range of values
character_data	Sets the reference source as: <ul style="list-style-type: none"> • TRACe1: Trace from channel 1. • TRACe4: Trace from channel 4. 	TRACe1 TRACe4

Example

ACQ:CCDF:REF:SOUR TRAC1

This command sets the CCDF trace from channel 1 as the reference source.

Remarks

- This command is only applicable for channels 1 and 4. If you send this command for a channel other than 1 or 4, error 700, “Applicable to channel 1 and 4 only” will occur.
- This command is only applicable in the CCDF acquisition mode. If the acquisition mode is not set to CCDF, error -221, “Settings conflict; Requires CCDF mode to be enabled” will occur. Refer to “ACQUIRE:MODE <character_data>” on page 115 to set the acquisition mode.
- This command is only applicable when the CCDF trace from channel 1 or 4 is enabled. If the channel trace is not enabled, error -221, “Settings conflict; Requires CCDF trace # to be enabled” will occur. Refer to “ACQUIRE:CCDF:TRACE{1|4}[:STATE] <boolean>” on page 109 to set the CCDF channel trace.
- This command is only applicable when the reference trace is turned on. If no reference trace is set, error -221, “Settings conflict; Requires CCDF reference trace to be enabled” will occur. Refer to “ACQUIRE:CCDF:REFERENCE[:STATE] <boolean>” on page 95 to set the CCDF reference trace.

Query

ACQUIRE:CCDF:REFERENCE:SOURCE?

This query returns the current setting of the reference source.

Query example

ACQ:CCDF:REF:SOUR?

Queries the reference source setting.

ACQuire:CCDF:SCALe <numeric_value>

This command sets the scale for the CCDF trace display.

Syntax

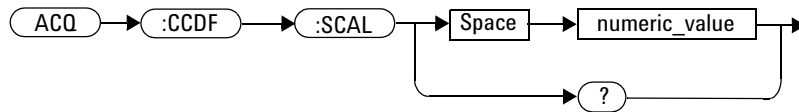

Parameter

Item	Description/Default	Range of values
numeric_value	A numeric value in dB/div for the CCDF trace display scale: <ul style="list-style-type: none"> • Default value: 5 dB/div • Minimum value: 0.5 dB/div • Maximum value: 5 dB/div 	0.5 dB/div to 5 dB/div

Example

ACQ:CCDF:SCAL 0.5

This command sets the CCDF trace display scale to 0.5 dB/div.

Remarks

- This command is only applicable for channels 1 and 4. If you send this command for a channel other than 1 or 4, error 700, “Applicable to channel 1 and 4 only” will occur.
- This command is only applicable in the CCDF acquisition mode. If the acquisition mode is not set to CCDF, error -221, “Settings conflict; Requires CCDF mode to be enabled” will occur. Refer to “ACQUIRE:MODE <character_data>” on page 115 to set the acquisition mode.
- If you set a scale value which exceeds its minimum or maximum limit, the value will be clipped to its minimum or maximum value respectively. Error -222, “Data out of range; Value clipped to minimum (#)” or -222, “Data out of range; Value clipped to maximum (#)” will occur.

Reset condition

On reset, the CCDF trace display scale is set to 5 dB/div.

Query

```
ACQUIRE:CCDF:SCALE?
```

This query returns the current setting of the CCDF trace display scale. The response format is <Nrf>.

Query example

```
ACQ:CCDF:SCAL?      Queries the CCDF trace display scale setting.
```

ACQuire:CCDF:SOURce <character_data>

This command sets the CCDF source as channel 1 or 4.

Syntax

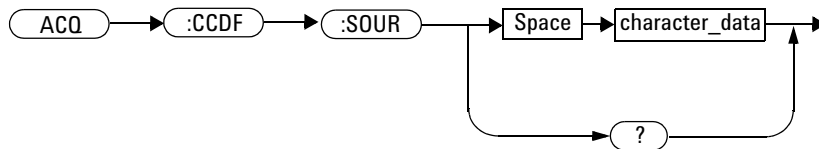

Parameter

Item	Description/Default	Range of values
character_data	Sets the CCDF source as: <ul style="list-style-type: none"> • CHAN1: Sets the source to channel 1. • CHAN4: Sets the source to channel 4. 	CHAN1 CHAN4

Example

ACQ:CCDF:SOUR CHAN1

This command sets the CCDF source as channel 1.

Remarks

- This command is only applicable for channels 1 and 4. If a channel other than channel 1 or 4 is specified, error 700, “Applicable to channel 1 and 4 only” will occur.
- This command is only applicable in the CCDF acquisition mode. If the acquisition mode is not set to CCDF, error -221, “Settings conflict; Requires CCDF mode to be enabled” will occur. Refer to “ACQUIRE:MODE <character_data>” on page 115 to set the acquisition mode.
- This command is only applicable when the selected channel is enabled. If the channel is disabled, error -221, “Settings conflict; Requires channel # to be enabled” will occur.

Reset condition

On reset, the CCDF source is set to the first channel 1 or 4 available.

Query

```
ACQUIRE:CCDF:SOURce?
```

This query returns the current setting of the CCDF source.

Query example

```
ACQ:CCDF:SOUR?      Queries the CCDF source setting.
```

ACQuire:CCDF:SWEep <character_data>

This command sets the CCDF sweep mode.

Syntax

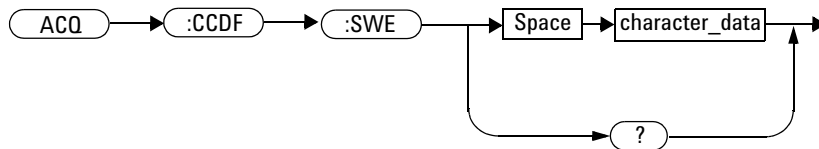

Parameter

Item	Description/Default	Range of values
character_data	Sets the CCDF sweep mode as: <ul style="list-style-type: none"> • FREErun: Sets the sweep to the free run mode. This is the default setting. • TRIGgered: Sets the sweep to the triggered mode. 	FREErun TRIGgered

Example

ACQ:CCDF:SWE FREE

This command sets the CCDF sweep mode to free run.

Remarks

- This command is only applicable for channels 1 and 4. If you send this command for a channel other than 1 or 4, error 700, “Applicable to channel 1 and 4 only” will occur.
- This command is only applicable in the CCDF acquisition mode. If the acquisition mode is not set to CCDF, error -221, “Settings conflict; Requires CCDF mode to be enabled” will occur. Refer to “ACQuire:MODE <character_data>” on page 115 to set the acquisition mode.

Reset condition

On reset, the CCDF sweep mode is set to free run.

Query

```
ACQuire:CCDF:SWEep?
```

This query returns the current setting of the CCDF sweep mode.

Query example

```
ACQ:CCDF:SWE?           Queries the CCDF sweep mode setting.
```

ACQuire:CCDF:TABLE?

This query returns the CCDF statistical table value of the current source selected. The value is returned in the dB unit as an array in the following order:

- Power level (power-to-average power ratio) that contains 10% of the power
- Power level that contains 1% of the power
- Power level that contains 0.1% of the power
- Power level that contains 0.01% of the power
- Power level that contains 0.001% of the power
- Power level that contains 0.0001% of the power

Syntax

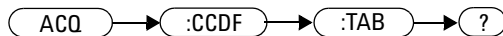

Example

ACQ:CCDF:TAB?

Queries the CCDF statistical table value.

Remarks

- This query is only applicable for channels 1 and 4. If you send this query for a channel other than 1 or 4, error 700, “Applicable to channel 1 and 4 only” will occur.
- This query is only applicable in the CCDF acquisition mode. If the acquisition mode is not set to CCDF, error -221, “Settings conflict; Requires CCDF mode to be enabled” will occur. Refer to “ACQUIRE:MODE <character_data>” on page 115 to set the acquisition mode.
- This command is only applicable when the CCDF source is set. If the source is not set, error -221, “Settings conflict; CCDF source not set” will occur. Refer to “ACQUIRE:CCDF:SOURCE <character_data>” on page 101 to set the CCDF source.

ACQuire:CCDF:TABLESOURce <character_data>

This command sets the CCDF statistical table source as channel 1 or 4.

Syntax



Parameter

Item	Description/Default	Range of values
character_data	Sets the CCDF statistical table source as: <ul style="list-style-type: none"> • CHAN1: Sets the source to channel 1. • CHAN4: Sets the source to channel 4. 	CHAN1 CHAN4

Example

ACQ:CCDF:TABLESOUR CHAN1 *This command sets the CCDF statistical table source as channel 1.*

Remarks

- This command is only applicable for channels 1 and 4. If a channel other than channel 1 or 4 is specified, error 700, “Applicable to channel 1 and 4 only” will occur.
- This command is only applicable in the CCDF acquisition mode. If the acquisition mode is not set to CCDF, error -221, “Settings conflict; Requires CCDF mode to be enabled” will occur. Refer to “ACQUIRE:MODE <character_data>” on page 115 to set the acquisition mode.
- This command is only applicable when the selected channel is enabled. If the channel is disabled, error -221, “Settings conflict; Requires channel # to be enabled” will occur.

Reset condition

On reset, the CCDF source is set to the first channel 1 or 4 available.

Query

```
ACQUIRE:CCDF:TABLESOURCE?
```

This query returns the current setting of the CCDF source.

Query example

```
ACQ:CCDF:TABLESOUR? Queries the CCDF statistical table source setting.
```

ACQuire:CCDF:TRACe{1 | 4}[:STATe] <boolean>

This command sets the state of the CCDF trace from channel 1 or 4.

Syntax

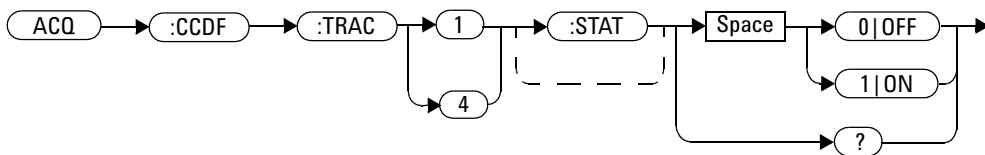

Example

ACQ:CCDF:TRAC1 ON

This command turns on the CCDF trace from channel 1.

Remarks

- This command is only applicable for channels 1 and 4. If you send this command for a channel other than 1 or 4, error 700, “Applicable to channel 1 and 4 only” will occur.
- This command is only applicable in the CCDF acquisition mode. If the acquisition mode is not set to CCDF, error -221, “Settings conflict; Requires CCDF mode to be enabled” will occur. Refer to “ACQuire:MODE <character_data>” on page 115 to set the acquisition mode.

Reset condition

On reset, the CCDF trace from both channels 1 and 4 is turned on.

Query

```
ACQUIRE:CCDF:TRACe{1|4}[:STATe]?
```

This query enters a 1 or 0 into the output buffer indicating the state of the CCDF trace from channel 1 or 4.

- 1 is returned when the trace is turned on
- 0 is returned when the trace is turned off

Query example

```
ACQ:CCDF:TRAC4? Queries whether the CCDF trace from channel 4 is turned on or off.
```

ACQuire:DROop[:STATe] <boolean>

This command sets the state of the droop measurement mode.

Syntax

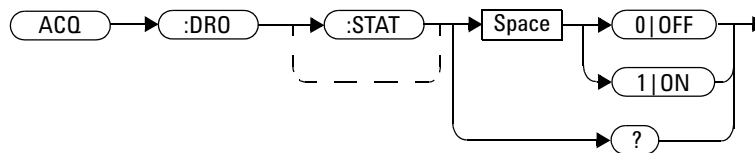

Example

```
ACQ:DRO 1
```

This command turns on the droop measurement mode.

Remark

This command is only applicable when the selected channel is enabled. If the channel is disabled, error -221, “Settings conflict; Requires channel # to be enabled” will occur.

Query

```
ACQuire:DROop[:STATe]?
```

This query enters a 1 or 0 into the output buffer indicating the state of the droop measurement mode.

- 1 is returned when the droop measurement mode is turned on
- 0 is returned when the droop measurement mode is turned off

Query example

```
ACQ:DRO?
```

Queries whether the droop measurement mode is turned on or off.

ACQuire:DROop:SOURce CHAN{1|4}

This command sets the source of either channel 1 or 4 for the droop measurement.

Syntax

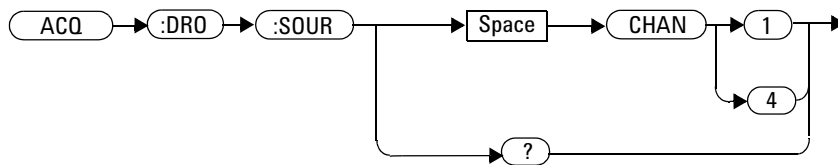

Example

```
ACQ:DRO:SOUR CHAN1
```

This command sets the droop measurement source to channel 1.

Remark

If a channel other than channel 1 or 4 is specified, error 700, “Applicable to channel 1 and 4 only” will occur.

Reset condition

On reset, the droop measurement source is set to the first channel 1 or 4 available.

Query

ACQuire:DROop:SOURce?

This query returns the current setting of the droop measurement source.

Query example

ACQ:DRO:SOUR?

Queries the droop measurement source setting.

ACQuire:INTerpolate <boolean>

This command turns on or off the $\sin(x)/x$ interpolation filter.

Syntax

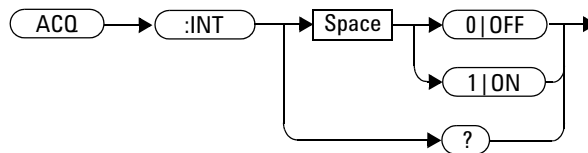

Example

`ACQ:INT ON` *This command turns on the $\sin(x)/x$ interpolation filter.*

Reset condition

On reset, the $\sin(x)/x$ interpolation filter is turned off.

Query

`ACQuire:INTerpolate?`

This query enters a 1 or 0 into the output buffer indicating the state of the $\sin(x)/x$ interpolation filter.

- 1 is returned when the $\sin(x)/x$ interpolation filter is turned on
- 0 is returned when the $\sin(x)/x$ interpolation filter is turned off

Query example

`ACQ:INT?` *Queries whether the $\sin(x)/x$ interpolation filter is turned on or off.*

ACQuire:MODE <character_data>

This command sets the data acquisition mode of the 8990B.

Syntax

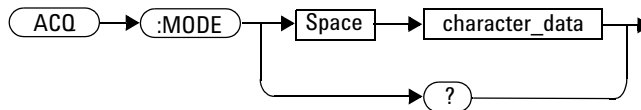

Parameter

Item	Description/Default	Range of values
character_data	Sets the acquisition mode as: <ul style="list-style-type: none"> • NORMAl: Sets to the normal acquisition mode. This is the default setting. • ZOOM: Sets to the zoom acquisition mode, • CCDF: Sets to the Complementary Cumulative Distribution Function (CCDF) acquisition mode. • SPLITSCReen: Sets to the splitscreen mode. • XYDISPlay: Sets to the XY display mode. • MULTIPULse: Sets to the multipulse mode. 	NORMAl ZOOM CCDF SPLITSCReen XYDISPlay MULTIPULse

Example

ACQ:MODE NORM

This command enables the normal acquisition mode.

Reset condition

On reset, the acquisition mode is set to normal.

Query

```
ACQuire:MODE?
```

This query returns the current setting of the acquisition mode.

Query example

```
ACQ:MODE?           Queries the acquisition mode setting.
```

ACQuire:ZOOM:OFFSet <numeric_value>

This command sets the time offset in the zoom mode.

Syntax

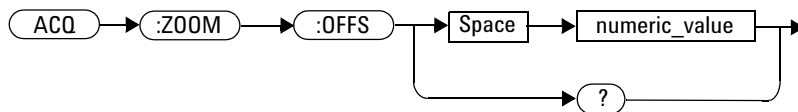

Parameter

Item	Description/Default	Range of values
numeric_value	<p>A numeric value in second for the zoom time offset:</p> <ul style="list-style-type: none"> • Default value: 0 <p>The range of values will change according to the scale you set in the normal graph with "TIMebase:SCALe <numeric_value>". The zoom window can only be offsetted within the range of the graph.</p>	<p>The range of values will change according to the scale you set in the normal graph with "TIMebase:SCALe <numeric_value>".</p>

Example

ACQ:ZOOM:OFFS 1m

This command sets the time offset in the zoom mode to 1 ms.

Remarks

- This command is only applicable in the zoom mode. If this command is sent when the 8990B is not in the zoom mode, error -221, “Settings conflict; Requires zoom mode to be enabled” will occur.
- If you set a time offset value which exceeds its minimum or maximum limit, the value will be clipped to its minimum or maximum value respectively. Error -222, “Data out of range; Value clipped to minimum (#)” or -222, “Data out of range; Value clipped to maximum (#)” will occur.

Reset condition

On reset, the zoom time offset is set to 0.

Query

```
ACQuire:ZOOM:OFFSet?
```

This query returns the current setting of the zoom time offset. The response format is <Nrf>.

Query example

```
ACQ:ZOOM:OFFS?      Queries the zoom time offset setting.
```

ACQuire:ZOOM:SCALe <numeric_value>

This command sets the time scale in the zoom mode.

NOTE

The zoom resolution is up to 30 times of the normal graph timebase scale.

Syntax

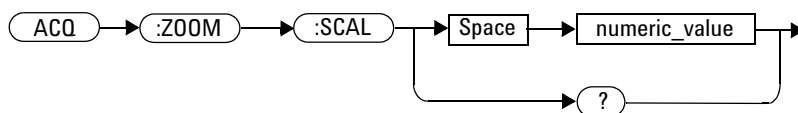

Parameter

Item	Description/Default	Range of values
numeric_value	A numeric value in second for the zoom time scale: <ul style="list-style-type: none"> • Default value: 100 ns The range of values will change according to the graph scale you set in "TIMebase:SCALe <numeric_value>".	The range of values will change according to the graph scale you set in "TIMebase:SCALe <numeric_value>".

Example

ACQ:ZOOM:SCAL 60E-09

This command sets the time scale in the zoom mode to 60 ns.

Remarks

- This command is only applicable in the zoom mode. If this command is sent when the 8990B is not in the zoom mode, error -221, “Settings conflict;Requires zoom mode to be enabled” will occur.
- The minimum and maximum values of the zoom time scale are based on the current Normal mode time scale settings.
- If you set a time scale value which exceeds its minimum or maximum limit, the value will be clipped to its minimum or maximum value respectively. Error -222, “Data out of range;Value clipped to minimum (#)” or -222, “Data out of range;Value clipped to maximum (#)” will occur.

Query

```
ACQuire:ZOOM:SCALE?
```

This query returns the current setting of the zoom time scale. The response format is <NRf>.

Query example

```
ACQ:ZOOM:SCAL? Queries the zoom time scale setting.
```



5 CALibration Subsystem

Overview	124
CALibration[:ALL]	125
CALibration:CALibrate <character_data>	126
CALibration:CALibrate:AUTO <boolean>	127
CALibration:CALibrate:AUTO:INTerval <numeric_value>	129
CALibration:CALibrate:AUTO:NOTify <boolean>	131
CALibration:OUTPut <character_data>	132
CALibration:ZERO <character_data>	134

This chapter explains how the CALibration command subsystem is used to perform internal zeroing and calibration on the peak power sensors connected to respective RF channels.



Overview

The CALibration command subsystem allows you to set the 8990B to perform internal zeroing and calibration on the peak power sensor. The internal zeroing and calibration process is used to combine the peak power sensor and the 8990B to make accurate power measurements.

Keyword	Parameter form	Note	Page
CALibration			
[:ALL]	<character_data>		page 125
:CALibrate	<character_data>		page 126
:AUTO	<boolean>		page 127
:INTerval	<numeric_value>		page 129
:NOTify	<boolean>		page 131
:OUTPut	<character_data>		page 132
:ZERO	<character_data>		page 134

CALibration[:ALL]

This command sets the 8990B to manually perform zeroing and calibration on both channels 1 and 4.

Syntax

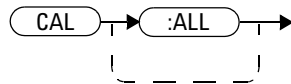

Example

CAL

This command sets the 8990B to perform zeroing and calibration on both channels 1 and 4.

Remark

If channel 1 or 4 is not connected, error -241, “Hardware missing; Sensor not found in channel 1 or channel 4.” will occur.

CALibration:CALibrate <character_data>

This command sets the 8990B to manually perform calibration on channel 1 or 4.

Syntax

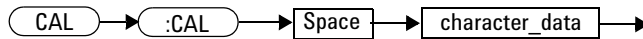

Parameter

Item	Description/Default	Range of values
character_data	Sets the channel calibration as: <ul style="list-style-type: none"> • CHAN1: Sets channel 1 to calibrate. • CHAN4: Sets channel 4 to calibrate. 	CHAN1 CHAN4

Example

CAL:CAL CHAN1 *This command sets the 8990B to perform calibration on channel 1.*

Remark

This command is only applicable for channels 1 and 4. If a channel other than channel 1 or 4 is specified, error 700, “Applicable to channel 1 and 4 only” will occur.

CALibration:CALibrate:AUTO <boolean>

This command sets the state of auto calibration performed on channels 1 and 4. You can set the time interval to run the auto calibration using “CALibration:CALibrate:AUTO:INTerval <numeric_value>” on page 129.

Syntax

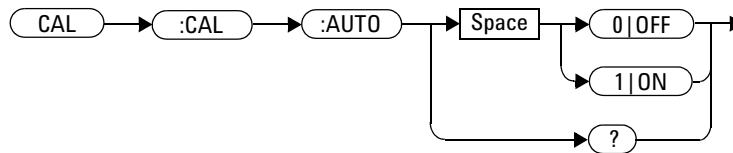

Example

`CAL:CAL:AUTO 1` *This command enables auto calibration on channels 1 and 4.*

Remarks

- For seamless remote operation when auto calibration is enabled, you are advised to incorporate sufficient timeouts (10 secs) in your test program to avoid errors. Alternatively, the *OPC command can be used for status checking before proceeding to the next command.

Reset condition

On reset, auto calibration is enabled.

Query

CALibration:CALibrate:AUTO?

This query enters a 1 or 0 into the output buffer indicating the state of auto calibration on channels 1 and 4.

- 1 is returned when auto calibration is enabled
- 0 is returned when auto calibration is disabled

Query example

CAL:CAL:AUTO?

Queries whether auto calibration on channels 1 and 4 is enabled or disabled.

CALibration:CALibrate:AUTO:INTerval <numeric_value>

This command sets the time interval to run auto calibration on channels 1 and 4.

Syntax

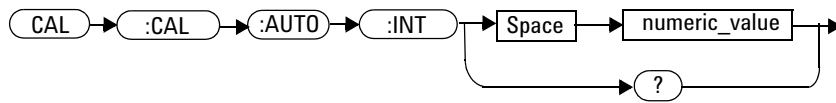

Parameter

Item	Description/Default	Range of values
numeric_value	A numeric value in minute for the time interval: <ul style="list-style-type: none"> • Default value: 10 min • Minimum value: 1 min • Maximum value: 60 min 	1 min to 60 min (decimals will be rounded to the closest integer)

Example

CAL:CAL:AUTO:INT 1

This command sets the auto calibration to run on a 1 min interval.

CAL:CAL:AUTO:INT 9.5

This command rounds up 9.5 to the nearest integer, and auto calibration will run on a 10 min interval.

Reset condition

On reset, the time interval is set to 10 min.

Query

CALibration:CALibrate:AUTO:INTerval?

This query returns the current setting of the time interval for auto calibration on channels 1 and 4. The response format is <NRf>.

Query example

CAL:CAL:AUTO:INT?

Queries the time interval setting for auto calibration on channels 1 and 4.

CALibration:CALibrate:AUTO:NOTify <boolean>

This command sets the state of the display notification for the auto calibration performed on channels 1 and 4.

Syntax

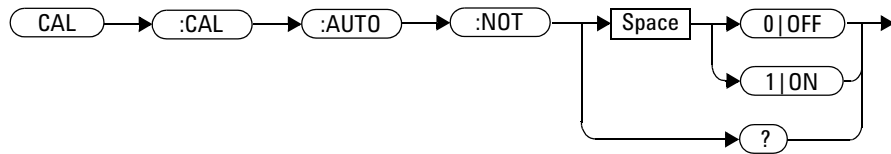

Example

CAL:CAL:AUTO:NOT 1

This command enables the display notification for auto calibration on channels 1 and 4.

Query

CALibration:CALibrate:AUTO:NOTify?

This query enters a 1 or 0 into the output buffer indicating the state of the display notification for auto calibration on channels 1 and 4.

- 1 is returned when the auto calibration display notification is enabled
- 0 is returned when the auto calibration display notification is disabled

Query example

CAL:CAL:AUTO:NOT?

Queries whether display notification for auto calibration on channels 1 and 4 are enabled or disabled.

CALibration:OUTPut <character_data>

This command sets the AC coupling frequency or DC level of the calibrator waveform output through the rear panel Auxiliary Trigger Out connector.

Syntax

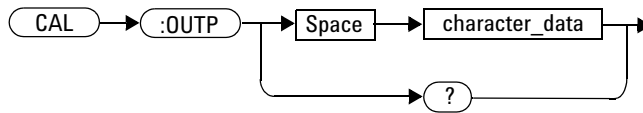

Parameter

Item	Description/Default	Range of values
character_data	Sets the calibration output as: <ul style="list-style-type: none"> AC: Sets the AC coupling frequency. DC, <dc_value>: Sets the DC level, with its value in volts within the range of -2.4 V to +2.4 V. 	AC DC, <dc_value>

Example

CAL:OUTP DC,2.0

This command puts a DC voltage of 2.0 V on the Aux Trig Out connector.

Remark

The AC setting sets the Aux Trig Out to be the probe compensation square wave (approximately 750 Hz).

Query

```
CALibration:OUTPut?
```

This query returns the current setting of the calibration output.

Query example

```
CAL:OUTP?           Queries the calibration output setting.
```

CALibration:ZERO <character_data>

This command sets the 8990B to perform zeroing on channel 1 or 4.

Syntax

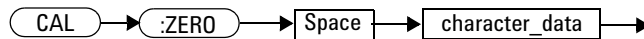

Parameter

Item	Description/Default	Range of values
character_data	Sets the channel for zeroing as: <ul style="list-style-type: none"> • CHAN1: Sets channel 1 to zero. • CHAN4: Sets channel 4 to zero. 	CHAN1 CHAN4

Example

CAL:ZERO CHAN1 *This command sets the 8990B to perform zeroing on channel 1.*

Remarks

- This command is only applicable for channels 1 and 4. If a channel other than channel 1 or 4 is specified, error 700, “Applicable to channel 1 and 4 only” will occur.
- If channel 1 or 4 is not connected, error -241, “Hardware missing; Sensor not found in channel 1 or channel 4.” will occur.



6 CHANnel Subsystem

Overview	136
CHANnel{1 4}:BWIDth <character_data>	137
CHANnel{1 2 3 4}[:DISPlay] <boolean>	139
CHANnel{1 4}:EXTLoss <numeric_value>	141
CHANnel{1 4}:FDOffset[:STATe] <boolean>	143
CHANnel{1 4}:FDOffset:SElect <string>	145
CHANnel{1 4}:FREQuency <numeric_value>	147
CHANnel{2 3}:INPut <character_data>	149
CHANnel{2 3}:OFFSet <numeric_value>	151
CHANnel{2 3}:PROBe?	153
CHANnel{2 3}:PROBe:ID?	154
CHANnel{1 4}:REFerence <numeric_value>	155
CHANnel{1 4}:REFerence:POSition <character_data>	157
CHANnel{1 2 3 4}:SCALe <numeric_value>	159
CHANnel{1 2 3 4}:SRATe?	161
CHANnel{1 2 3 4}:TIMECOMP <numeric_value>	162
CHANnel{1 2 3 4}:UNIT <character_data>	164

This chapter describes how the CHANnel command subsystem is used to configure the 8990B channel setup.



Overview

The CHANnel command subsystem controls the channel settings and vertical (Y-axis) functions of the 8990B.

The channel numbers in the following command list refer to:

- RF channels (for channels 1 and 4), or
- oscilloscope channels (for channels 2 and 3).

Keyword	Parameter form	Note	Page
CHANnel{1 4}			
:BWIDth	<character_data>		page 137
:EXTloss	<numeric_value>		page 141
:FDOffset			
[:STATe]	<boolean>		page 143
:SElect	<string>		page 145
:FREQuency	<numeric_value>		page 147
:REFerence	<numeric_value>		page 155
[:POSition]	<character_data>		page 157
CHANnel{1 2 3 4}			
[:DISPlay]	<boolean>		page 139
:SCALe	<numeric_value>		page 159
:SRATe?		[query only]	page 161
:TIMECOMP	<numeric_value>		page 162
:UNIT	<character_data>		page 164
CHANnel{2 3}			
:INPut	<character_data>		page 149
:OFFSet	<numeric_value>		page 151
:PROBe?		[query only]	page 153
:PROBe			page 153
:ID?		[query only]	page 154

CHANnel{1 | 4}:BWIDth <character_data>

This command sets the video bandwidth of the sensor for channel 1 or 4.

Syntax

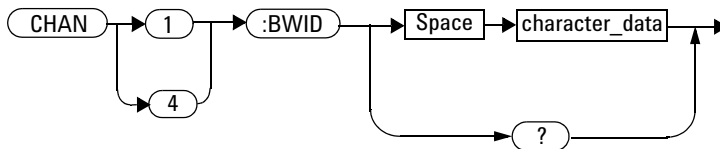

Parameter

Item	Description/Default	Range of values
character_data	Sets the sensor video bandwidth as: <ul style="list-style-type: none"> • OFF: Disables the bandwidth setting. This is the default setting. • LOW: Sets to the low bandwidth. • MEDium: Sets to the medium bandwidth. • HIGH: Sets to the high bandwidth. 	OFF LOW MED HIGH

Example

CHAN1:BWID HIGH

This command sets the sensor video bandwidth to high for channel 1.

Remarks

- This command is only applicable for channels 1 and 4. If a channel other than channel 1 or 4 is specified, error 700, “Applicable to channel 1 and 4 only” will occur.
- This command is only applicable when the ETS mode is disabled. If you send this command when the ETS mode is enabled, error -221, “Settings conflict;Unable to turn on video bandwidth while ETS mode is on” will occur.
- If the video bandwidth is being set to MEDIUM or HIGH when the frequency is less than 500 MHz, error -221, “Settings conflict;Unable to set video bandwidth to MEDIUM or HIGH. Frequency must be higher than 500 MHz” will occur.
- If channel 1 or 4 is not connected, error -241, “Hardware missing; Sensor is not found in channel <channel>.” will occur.

Reset condition

On reset, the sensor video bandwidth setting is disabled.

Query

```
CHANnel{1|4}:BWIDth?
```

This query returns the current setting of the sensor video bandwidth for the specified channel.

Query example

```
CHAN1:BWID?
```

Queries the sensor video bandwidth setting for channel 1.

CHANnel{1 | 2 | 3 | 4}[:DISP] <boolean>

This command sets the state of the display for the specified channel.

Syntax

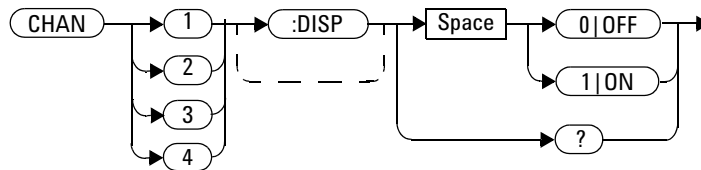

Example

CHAN3 OFF

This command turns off the display for channel 3.

Remarks

- If there is no signal at a particular channel, the display of that channel will be turned off even if its display state is set to on.
- If no sensor is connected to a particular channel, error -241, “Hardware missing;Unable to turn on channel #;no sensor detected” will occur.

Reset condition

On reset, the channel display is turned on.

Query

```
CHANnel{1|2|3|4}[:DISPlay]?
```

This query enters a 1 or 0 into the output buffer indicating the state of the display for the specified channel.

- 1 is returned when the channel display is turned on
- 0 is returned when the channel display is turned off

Query example

```
CHAN1?
```

Queries whether the display is turned on or off for channel 1.

CHANnel{1 | 4}:EXTLoss <numeric_value>

This command sets the external loss of channel 1 or 4 for offset correction.

Syntax

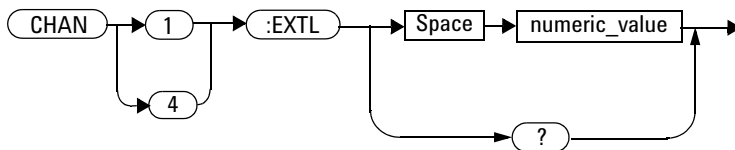

Parameter

Item	Description/Default	Range of values
numeric_value	A numeric value in dB for the external loss: <ul style="list-style-type: none"> • Default value: 0 dB • Minimum value: -100 dB • Maximum value: 100 dB 	-100 dB to 100 dB

Example

CHAN1:EXTL 1

This command sets the external loss to 1 dB for channel 1.

Remarks

- This command is only applicable for channels 1 and 4. If a channel other than channel 1 or 4 is specified, error 700, “Applicable to channel 1 and 4 only” will occur.
- If you set an external loss value which exceeds its minimum or maximum limit, the value will be clipped to its minimum or maximum value respectively. Error -222, “Data out of range; Value clipped to minimum (#)” or -222, “Data out of range; Value clipped to maximum (#)” will occur.
- If channel 1 or 4 is not connected, error -241, “Hardware missing; Sensor is not found in channel <channel>.” will occur.

Reset condition

On reset, the external loss is set to 0 dB.

Query

```
CHANnel{1|4}:EXTLoss?
```

This query returns the current setting of the external loss for the specified channel. The response format is <NRf>.

Query example

```
CHAN4:EXTL?           Queries the external loss setting for channel 4.
```

CHANnel{1 | 4}:FDOffset[:STATe] <boolean>

This command sets the state of the frequency-dependent offset (FDO) table selected in “CHANnel{1|4}:FDOffset:SElect <string>” for the specified channel.

Syntax

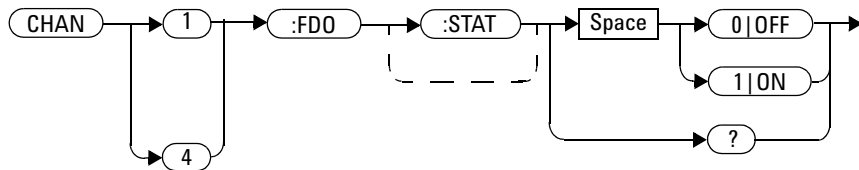

Example

CHAN1:FDO OFF *This command disables the FDO table for channel 1.*

Remarks

- If there is no FDO table selected when sending this command, error -221, “Settings conflict;No FDO table selected” will occur.
- This command is only applicable for channels 1 and 4. If a channel other than channel 1 or 4 is specified, error 700, “Applicable to channel 1 and 4 only” will occur.

Query

```
CHANnel{1|4}:FDOffset[:STATe]?
```

This query enters a 1 or 0 into the output buffer indicating the state of the FDO table for the specified channel.

- 1 is returned when the FDO table is enabled
- 0 is returned when the FDO table is disabled

Query example

```
CHAN1:FDO?           Queries whether the FDO table is enabled or disabled for channel 1.
```

CHANnel{1 | 4}:FDOffset:SElect <string>

This command selects the FDO table for the specified channel.

Syntax

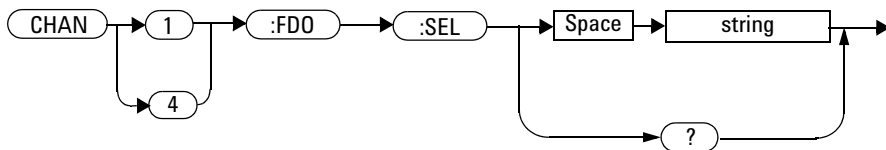

Parameter

Item	Description/Default
string	Sets any of the following FDO table names as a string value (""): <ul style="list-style-type: none"> • CUSTOM_A • CUSTOM_B • CUSTOM_C • CUSTOM_D • CUSTOM_E • CUSTOM_F • CUSTOM_G • CUSTOM_H • CUSTOM_I • CUSTOM_J

Example

```
CHAN1:FDO:SEL "CUSTOM_A"
```

This command assigns the FDO table named "CUSTOM_A" to channel 1.

Remarks

- If an invalid table name is specified, error -224, “Illegal parameter value” will occur.
- This command is only applicable for channels 1 and 4. If a channel other than channel 1 or 4 is specified, error 700, “Applicable to channel 1 and 4 only” will occur.
- If there is no data in the selected FDO table, error -221, “Settings conflict;No FDO data entry available” will occur.

Query

```
CHANnel{1|4}:FDOffset:SElect?
```

This query returns the current setting of the FDO table for the specified channel as a string value. An empty string "" will be returned if no table has been selected.

Query example

```
CHAN1:FDO:SEL? Queries the FDO table assigned to channel 1.
```

CHANnel{1|4}:FREQuency <numeric_value>

This command sets the frequency for channel 1 or 4.

Syntax

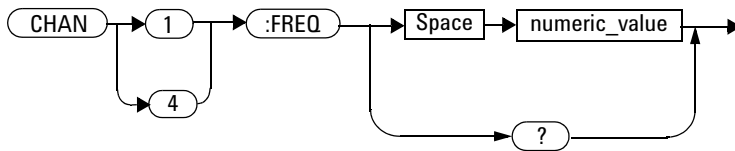

Parameter

Item	Description/Default	Range of values
numeric_value	A numeric value in Hz for frequency: <ul style="list-style-type: none"> • Default value: 1 GHz • Minimum value: 1 kHz • Maximum value: 1000 GHz 	1 kHz to 1000 GHz

Example

CHAN1:FREQ 5000

This command sets the frequency to 5 kHz for channel 1.

Remarks

- This command is only applicable for channels 1 and 4. If a channel other than channel 1 or 4 is specified, error 700, “Applicable to channel 1 and 4 only” will occur.
- If the frequency is set to less than 500 MHz when the video bandwidth is set to medium or high, error -221, “Settings conflict; Frequency less than 500 MHz. Video bandwidth has been set to LOW” will occur.
- If you set a frequency value which exceeds its minimum or maximum limit, the value will be clipped to its minimum or maximum value respectively. Error -222, “Data out of range; Value clipped to minimum (#)” or -222, “Data out of range; Value clipped to maximum (#)” will occur.
- If channel 1 or 4 is not connected, error -241, “Hardware missing; Sensor is not found in channel <channel>.” will occur.

Reset condition

On reset, the frequency is set to 1 GHz.

Query

```
CHANnel{1|4}:FREQuency?
```

This query returns the current setting of the frequency for the specified channel. The response format is <NRf>.

Query example

```
CHAN1:FREQ?           Queries the frequency setting for channel 1.
```

CHANnel{2|3}:INPut <character_data>

This command sets the input coupling and impedance for channel 2 or 3.

Syntax

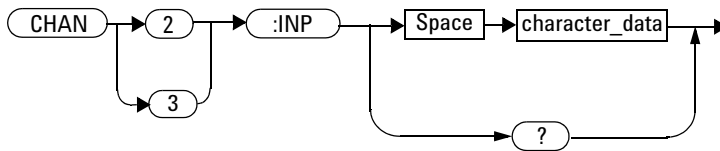

Parameter

Item	Description/Default	Range of values
character_data	Sets the coupling and impedance as: <ul style="list-style-type: none"> • AC: AC coupling, 1 MΩ impedance • DC: DC coupling, 1 MΩ impedance • DC50: DC coupling, 50 Ω impedance. This is the default setting. 	AC DC DC50

Example

```
CHAN2 : INP AC
```

This command sets the input coupling and impedance to AC coupling and 1 M Ω respectively for channel 2.

Remarks

- This command is only applicable for channels 2 and 3. If a channel other than channel 2 or 3 is specified, error 701, “Applicable to channel 2 and 3 only” will occur.
- If channel 1 or 4 is not connected, error -241, “Hardware missing; Sensor is not found in channel <channel>.” will occur.

Reset condition

On reset, the input coupling and impedance settings are set to DC coupling and 50 Ω impedance respectively.

Query

```
CHANnel{2|3}:INPut?
```

This query returns the current settings of the input coupling and impedance for the specified channel.

Query example

```
CHAN2:INP?
```

Queries the input coupling and impedance settings for channel 2.

CHANnel{2|3}:OFFSet <numeric_value>

This command sets the offset for channel 2 or 3.

Syntax

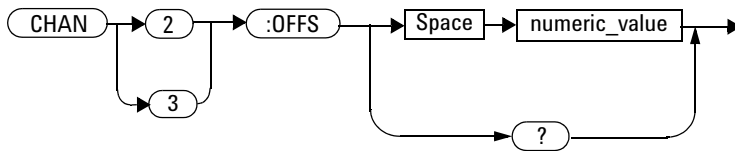

Parameter

Item	Description/Default	Range of values
numeric_value	A numeric value in volts per division for the offset: <ul style="list-style-type: none"> • Default value: 0 • Minimum value: -4 V/div • Maximum value: 4 V/div 	-4 V/div to 4 V/div

Example

CHAN2:OFFS 1.5 *This command sets the offset to 1.5 V/div for channel 2.*

Remarks

- This command is only applicable for channels 2 and 3. If a channel other than channel 2 or 3 is specified, error 701, “Applicable to channel 2 and 3 only” will occur.
- If you set an offset value which exceeds its minimum or maximum limit, the value will be clipped to its minimum or maximum value respectively. Error -222, “Data out of range;Value clipped to minimum (#)” or -222, “Data out of range;Value clipped to maximum (#)” will occur.
- If channel 1 or 4 is not connected, error -241, “Hardware missing; Sensor is not found in channel <channel>.” will occur.

Reset condition

On reset, the offset is set to 0.

Query

```
CHANnel{2|3}:OFFSet?
```

This query returns the current setting of the offset for the specified channel. The response format is <NRf>.

Query example

```
CHAN2:OFFS?           Queries the offset setting for channel 2.
```

CHANnel{2|3}:PROBe?

This query enters a 1 or 0 into the output buffer indicating whether a probe is connected or not for the specified channel:

- 1 is returned if a probe is connected
- 0 is returned if there is no probe connected

Syntax

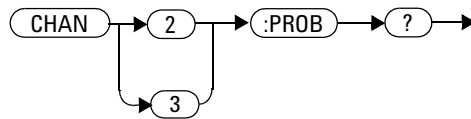

Example

CHAN2 : PROB? *Queries if there is a probe connected for channel 2.*

Remarks

- This command is only applicable for channels 2 and 3. If a channel other than channel 2 or 3 is specified, error 701, “Applicable to channel 2 and 3 only” will occur.
- If channel 1 or 4 is not connected, error -241, “Hardware missing; Sensor is not found in channel <channel>.” will occur.

CHANnel{2 | 3}:PROBe:ID?

This query returns the identification of the probe connected to the specified channel.

Syntax

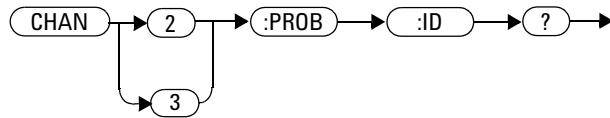

Example

CHAN3 : PROB : ID? *Queries the channel 3 probe identification.*

Remarks

- This command is only applicable for channels 2 and 3. If a channel other than channel 2 or 3 is specified, error 701, “Applicable to channel 2 and 3 only” will occur.
- If channel 1 or 4 is not connected, error -241, “Hardware missing; Sensor is not found in channel <channel>.” will occur.

CHANnel{1 | 4}:REFerence <numeric_value>

This command sets the reference value for channel 1 or 4 for the current reference position.

Syntax

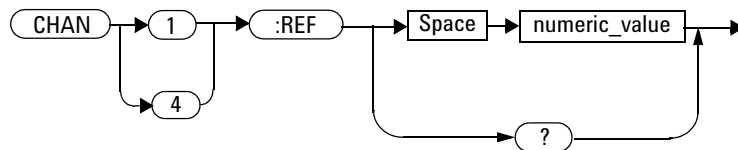

Parameter

Item	Description/Default	Range of values
numeric_value	A numeric value for the channel reference: <ul style="list-style-type: none"> • Default value: 0 • Minimum value: -99 dBm/0 W • Maximum value: 99 dBm/1 W 	-99 dBm to 99 dBm 0 W to 1 W

Example

CHAN1:REF 11.75 *This command sets the top reference to 11.75 dBm.*

Remarks

- This command is only applicable for channels 1 and 4. If a channel other than channel 1 or 4 is specified, error 700, “Applicable to channel 1 and 4 only” will occur.
- If you set a reference value which exceeds its minimum or maximum limit, the value will be clipped to its minimum or maximum value respectively. Error -222, “Data out of range;Value clipped to minimum (#)” or -222, “Data out of range;Value clipped to maximum (#)” will occur.
- If channel 1 or 4 is not connected, error -241, “Hardware missing; Sensor is not found in channel <channel>.” will occur.
- If the channel unit is set to dBm (refer “CHANnel{1|2|3|4}:UNIT <character_data>” on page 164), the suffix for the input value such as 1 u or 10 m will be removed and the system refer this at 1 dBm or 10 dBm respectively. Only when the unit is set to SI style input such as Watt, 1 u will yield 1 micro and 10 m will yield 10 milli respectively.

Reset condition

On reset, the channel reference is set to 0.

Query

```
CHANnel{1|4}:REfERENCE?
```

This query returns the current setting of the reference value for the specified channel. The response format is <NRf>.

Query example

```
CHAN4:REF?           Queries the reference value for channel 4.
```

CHANnel{1 | 4}:REFerence:POSition <character_data>

This command sets the reference position on the display for channel 1 or 4.

Syntax

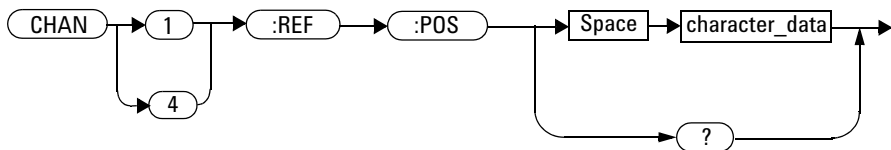

Parameter

Item	Description/Default	Range of values
character_data	Sets the reference position as: <ul style="list-style-type: none"> • TOP: Sets the reference at the top of the display. • BOTTom: Sets the reference at the bottom of the display. • CENTer: Sets the reference at the center of the display. This is the default setting. 	TOP BOTTom CENTer

Example

CHAN1:REF:POS TOP *This command sets the reference position to the top of the display for channel 1.*

Remarks

- This command is only applicable for channels 1 and 4. If a channel other than channel 1 or 4 is specified, error 700, “Applicable to channel 1 and 4 only” will occur.
- If channel 1 or 4 is not connected, error -241, “Hardware missing; Sensor is not found in channel <channel>.” will occur.

Reset condition

On reset, the reference is set to the center of the display.

Query

```
CHANnel{1|4}:REFerence:POSition?
```

This query returns the current settings of the reference position for the specified channel.

Query example

```
CHAN1:REF:POS? Queries the reference position setting for channel 1.
```

CHANnel{1|2|3|4}:SCALe <numeric_value>

This command sets the scale for any of the four channels.

Syntax

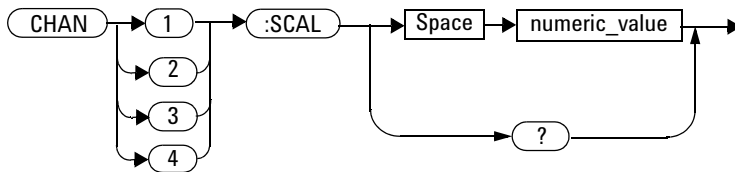

Parameter

Item	Description/Default	Range of values
numeric_value	A numeric value for the scale: <ul style="list-style-type: none"> • Default values: <ul style="list-style-type: none"> • 5 dB/1 mW per division (for channels 1 and 4) • 1 V per division (for channels 2 and 3) • Minimum values: <ul style="list-style-type: none"> • 0.01 dB/1 μW per division (for channels 1 and 4) • 1 mV per division (for channels 2 and 3) • Maximum values: <ul style="list-style-type: none"> • 100 dB/1 kW per division (for channels 1 and 4) • 1 V per division (for channels 2 and 3) 	<ul style="list-style-type: none"> • Channels 1 and 4: <ul style="list-style-type: none"> 0.01 dB/div to 100 dB/div 1 μW/div to 1 kW/div • Channels 2 and 3: <ul style="list-style-type: none"> 1 mV/div to 1 V/div when the input coupling is 50 Ω 1 mV/div to 5 V/div when the input coupling is 1 MΩ

Example

```
CHAN2:SCAL 0.05
```

This command sets the channel 2 scale to 0.05 V/div.

Remarks

- If you set a scale value which exceeds its minimum or maximum limit, the value will be clipped to its minimum or maximum value respectively. Error -222, “Data out of range;Value clipped to minimum (#)” or -222, “Data out of range;Value clipped to maximum (#)” will occur.
- If channel 1 or 4 is not connected, error -241, “Hardware missing; Sensor is not found in channel <channel>.” will occur.

Reset condition

On reset, the scale is set to 5 dB/1 mW per division for channels 1 and 4, and 1 V per division for channels 2 and 3.

Query

```
CHANnel{1|2|3|4}:SCALE?
```

This query returns the current setting of the scale for the specified channel. The response format is <NRF>.

Query example

```
CHAN4:SCAL?           Queries the scale setting for channel 4.
```

CHANnel{1 | 2 | 3 | 4}:SRATe?

This query returns the sampling rate for the specified channel.

Syntax

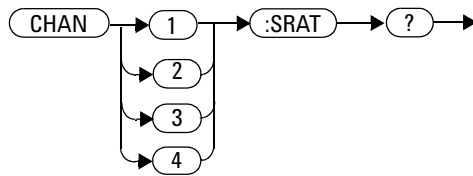

Example

CHAN1 : SRAT?

Queries the channel 1 sampling rate.

Remark

The sampling rate is the same for a channel pair (1 and 4 or 2 and 3).

CHANnel{1 | 2 | 3 | 4}:TIMECOMP <numeric_value>

This command sets the channel time compensation for any of the four channels.

Syntax

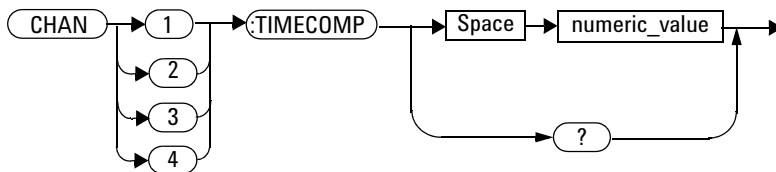

Parameter

Item	Description/Default	Range of values
numeric_value	A numeric value in second for the channel time compensation. <ul style="list-style-type: none"> • Default value: 0 • Minimum values: <ul style="list-style-type: none"> • -1 ms • -1 μs (only applicable when ETS is turned on) • Maximum values: <ul style="list-style-type: none"> • 1 ms • 1 μs (only applicable when ETS is turned on) 	<ul style="list-style-type: none"> • -1 ms to 1 ms • -1 μs to 1 μs (only applicable when ETS is turned on)

Example

CHAN2:TIMECOMP 1 m *This command sets the channel time compensation to 1 ms for channel 2*

Remarks

- If you set a channel time compensation value which exceeds the minimum or maximum limit, the value will be clipped to the minimum or maximum value respectively. Error -222, “Data out of range;Value clipped to minimum (#)” or -222, “Data out of range;Value clipped to maximum (#)” will occur.
- If channel 1 or 4 is not connected, error -241, “Hardware missing; Sensor is not found in channel <channel>.” will occur.

Reset condition

On reset, the channel time compensation is set to zero.

Query

```
CHANnel{1|2|3|4}:TIMECOMP?
```

This query returns the current channel time compensation value. The response format is <Nrf>.

Query example

```
CHAN4:TIMECOMP? Queries the channel time compensation.
```

CHANnel{1 | 2 | 3 | 4}:UNIT <character_data>

This command sets the unit for the specified channel.

Syntax

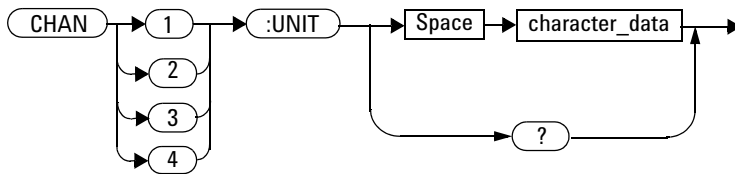

Parameter

Item	Description/Default	Range of values
character_data	Sets the channel unit as: <ul style="list-style-type: none"> • DBM: Sets the unit to dBm. This is the default setting for channels 1 and 4. • WATT: Sets the unit to W. (for channels 1 and 4) • VOLT: Sets the unit to V. This is the default setting for channels 2 and 3. 	DBM WATT VOLT

Example

CHAN1:UNIT WATT *This command sets the channel 1 unit to W.*

Remarks

- The channel scale will be displayed as dB/div if the channel unit is set to dBm, and W/div if the unit is set to W.
- If there is a change to the channel unit, the channel scale will reset to its default value.
- This command is only applicable for channels 1 and 4 to configure the unit as DBM or WATT. If a unit other than DBM and WATT is specified, error -224, “Illegal parameter value” will occur.
- If channel 1 or 4 is not connected, error -241, “Hardware missing; Sensor is not found in channel <channel>.” will occur.

Reset condition

On reset, the channel unit is set to dBm for channels 1 and 4, and V for channels 2 and 3.

Query

```
CHANnel{1|2|3|4}:UNIT?
```

This query returns the current setting of the unit as DBM, WATT, or VOLT for the specified channel.

Query example

```
CHAN2:UNIT?           Queries the unit for channel 2.
```

THIS PAGE HAS BEEN INTENTIONALLY LEFT BLANK.

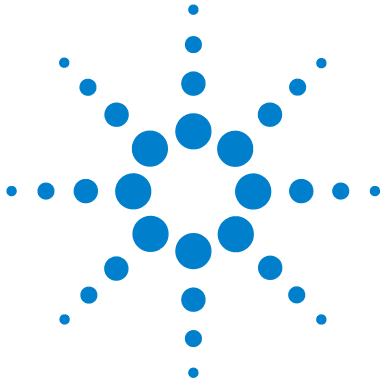

7 TIMebase Subsystem

Overview [168](#)

TIMebase:OFFSet <numeric_value> [169](#)

TIMebase:REFClock <boolean> [171](#)

TIMebase:SCALe <numeric_value> [173](#)

This chapter describes how the TIMebase command subsystem is used to configure the 8990B timebase setup.



Overview

The TIMEbase command subsystem controls the horizontal (X-axis) functions of the 8990B.

Keyword	Parameter form	Note	Page
TIMEbase			
:OFFSet	<numeric_value>		page 169
:REFClock	<boolean>		page 171
:SCALE	<numeric_value>		page 173

TIMebase:OFFSet <numeric_value>

This command sets the time interval between the trigger event and delay reference point.

Syntax

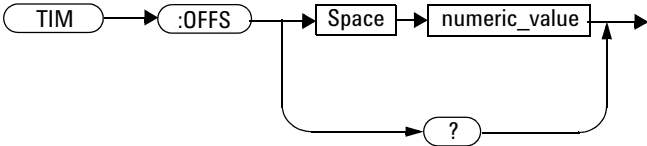

Parameter

Item	Description/Default	Range of values
numeric_value	<p>A numeric value in second for the timebase offset:</p> <ul style="list-style-type: none"> • Default value: 0 s • Minimum value: <ul style="list-style-type: none"> • -1 s • -10 μs (only applicable when ETS is turned on) • Maximum value: <ul style="list-style-type: none"> • 1 s • 10 μs (only applicable when ETS is turned on) <p>The range of values will change according to the zoom scale you set in "ACquire:ZOOM:SCALE <numeric_value>".</p>	<ul style="list-style-type: none"> • -1 s to 1 s • -10 μs to 10 μs (only applicable when ETS is turned on)

Example

TIM:OFFS 0.05 *This command sets the timebase offset to 0.05 s.*

Remark

If you set a timebase offset value which exceeds its minimum or maximum limit, the value will be clipped to its minimum or maximum value respectively. Error -222, “Data out of range;Value clipped to minimum (#)” or -222, “Data out of range;Value clipped to maximum (#)” will occur.

Reset condition

On reset, the timebase offset is set to 0.

Query

`TIMEbase:OFFSet?`

This query returns the current setting of the timebase offset. The response format is `<NRf>`.

Query example

`TIM:OFFS?`

Queries the timebase offset setting.

TIMebase:REFClock <boolean>

This command sets the state of the reference signal of the 10 MHz REF IN BNC input.

Syntax

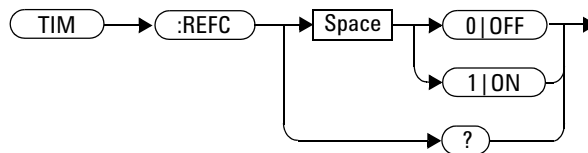

Example

TIM:REFC ON *This command turns on the 10 MHz reference signal input.*

Remarks

- If there is no reference signal at the 10 MHz REF IN BNC input, this command will set the state to OFF even if the state is ON. Also, error 720, “Settings conflict;No reference signal detected on the 10 MHz REF IN BNC input” will occur.
- This command is only applicable when the ETS mode is disabled. If you send this command when the ETS mode is enabled, error 940, “Unable to turn on 10 MHz setting when ETS is on” will occur.

Reset condition

On reset, the 10 MHz reference signal input is turned off.

Query

TIMebase:REFClock?

This query enters a 1 or 0 into the output buffer indicating the state of the 10 MHz reference signal input.

- 1 is returned when the reference signal input is turned on
- 0 is returned when the reference signal input is turned off

Query example

TIM:REFC?

Queries whether the 10 MHz reference signal input is turned on or off.

TIMEbase:SCALE <numeric_value>

This command sets the timebase scale.

Syntax

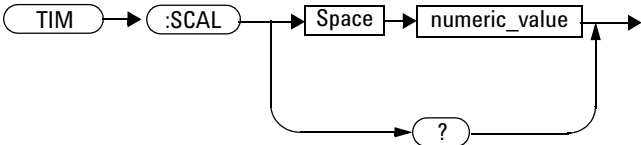

Parameter

Item	Description/Default	Range of values
numeric_value	A numeric value in second per division for the scale: <ul style="list-style-type: none"> • Default value: 1 μs/div • Minimum value: 2 ns/div • Maximum value: 100 ms/div 	2 ns/div to 100 ms/div

Example

```
TIM:SCALE 0.05
```

This command sets the timebase scale to 0.05 s/div.

Remark

If you set a timebase scale value which exceeds its minimum or maximum limit, the value will be clipped to its minimum or maximum value respectively. Error -222, “Data out of range;Value clipped to minimum (#)” or -222, “Data out of range;Value clipped to maximum (#)” will occur.

Reset condition

On reset, the timebase scale is set to 1 μ s/div.

Query

`TIMEbase:SCALe?`

This query returns the current setting of the timebase scale. The response format is `<NRf>`.

Query example

`TIM:SCAL?`

Queries the timebase scale setting.



8 TRIGger Subsystem

Overview	176
TRIGger:EDGE:SLOPe <character_data>	177
TRIGger:EVENT:COUNt <numeric_value>	179
TRIGger:FAST <boolean>	181
TRIGger:HOLDoff <numeric_value>	183
TRIGger:HYSTeresis:LEVel <numeric_value>	185
TRIGger:HYSTeresis:MODE <character_data>	187
TRIGger:IMPedance <character_data>	189
TRIGger:LEVel <character_data>,<numeric_value>	191
TRIGger:MODE <character_data>	193
TRIGger:OUTput <boolean>	195
TRIGger:PWIDth <mode>,<time1>,<time2>	197
TRIGger:SOURce <character_data>	199
TRIGger:SWEep <character_data>	201

This chapter explains how the TRIGger command subsystem is used to configure the 8990B trigger setup.



Overview

The TRIGger command subsystem allows you to set up the 8990B for triggering.

Keyword	Parameter form	Note	Page
TRIGger			
:EDGE			
:SLOPe	<character_data>		page 177
:EVENt			
:COUNT	<numeric_value>		page 179
:FAST	<boolean>		page 181
:HOLDoff	<numeric_value>		page 183
:HYSteresis			
:LEVel	<numeric_value>		page 185
:MODE	<character_data>		page 187
:IMPedance	<character_data>		page 189
:LEVel	<numeric_value>		page 191
:MODE	<character_data>		page 193
:OUTput	<boolean>		page 195
:PWIDth	<mode>, <time1>, <time2>		page 197
:SOURce	<character_data>		page 199
:SWEep	<character_data>		page 201

TRIGger:EDGE:SLOPe <character_data>

This command sets the slope type for the edge trigger.

Syntax

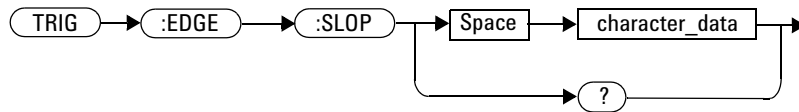

Parameter

Item	Description/Default	Range of values
character_data	Sets the edge trigger slope type as: <ul style="list-style-type: none"> • POSitive: Sets the slope to positive. This is the default setting. • NEGative: Sets the slope to negative. 	POSitive NEGative

Example

```
TRIG:EDGE:SLOP POS
```

This command sets the slope to positive for the edge trigger.

Reset condition

On reset, the edge trigger slope is set to positive.

Query

```
TRIGger:EDGE:SLOPe?
```

This query returns the current setting of the edge trigger slope.

Query example

```
TRIG:EDGE:SLOP?
```

Queries the slope setting for the edge trigger.

TRIGger:EVENT:COUNT <numeric_value>

This command sets the trigger event count.

Syntax

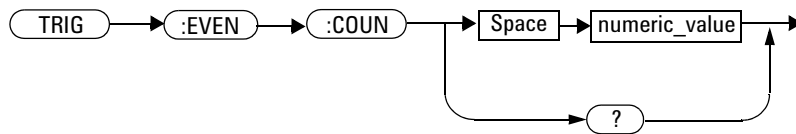

Parameter

Item	Description/Default	Range of values
numeric_value	A numeric value for the trigger event count: <ul style="list-style-type: none"> • Default value: 0 • Minimum value: 0 • Maximum value: 16000000 	0 to 16000000

Example

TRIG:EVENT:COUNT 10 *This command sets the trigger event count to 10.*

Remark

If you set a trigger event count value which exceeds its minimum or maximum limit, the value will be clipped to its minimum or maximum value respectively. Error -222,“Data out of range;Value clipped to minimum (#)” or -222,“Data out of range;Value clipped to maximum (#)” will occur.

Reset condition

On reset, the count is set to 0.

Query

TRIGger:EVENT:COUNT?

This query returns the current setting of the trigger event count. The response format is <Nrf>.

Query example

TRIG:EVEN:COUN?

Queries the trigger event count setting.

TRIGger:FAST <boolean>

This command sets the state of the fast trigger.

Syntax

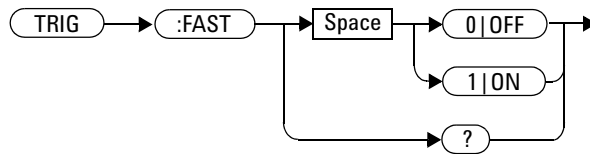

Example

TRIG:FAST ON *This command enables the fast trigger.*

Remarks

- This command is only applicable for the channels 1 and 4 only. If this command is sent for a trigger source other than any of these sources, error -221, “Settings conflict;Fast trigger is only applicable to trigger source for channel 1 and 4. Fast trigger has been disabled” will occur.
- Auto-calibration will be turned off when the fast trigger is enabled.

Reset condition

On reset, the fast trigger is disabled.

Query

TRIGger:FAST?

This query enters a 1 or 0 into the output buffer indicating the state of the fast trigger.

- 1 is returned when the fast trigger is enabled
- 0 is returned when the fast trigger is disabled

Query example

TRIG:FAST? *Queries whether the fast trigger is enabled or disabled.*

TRIGger:HOLDoff <numeric_value>

This command sets the trigger holdoff value.

Syntax

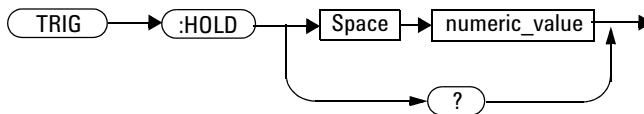

Parameter

Item	Description/Default	Range of values
numeric_value	A numeric value for the trigger holdoff: <ul style="list-style-type: none"> • Default value: 1 μs • Minimum value: 1 μs • Maximum value: 1 s 	1 μ s to 1 s

Example

TRIG:HOLD 0.5 *This command sets the trigger holdoff to 0.5 s.*

Remark

If you set a trigger holdoff value which exceeds its minimum or maximum limit, the value will be clipped to its minimum or maximum value respectively. Error -222, “Data out of range;Value clipped to minimum (#)” or -222, “Data out of range;Value clipped to maximum (#)” will occur.

Reset condition

On reset, the trigger holdoff is set to 1 μ s.

Query

TRIGger:HOLDoff?

This query returns the current setting of the trigger holdoff. The response format is <NRf>.

Query example

TRIG:HOLD?

Queries the trigger holdoff setting.

TRIGger:HYSTeresis:LEVel <numeric_value>

This command sets the trigger hysteresis level for channels 1 and 4.

Syntax

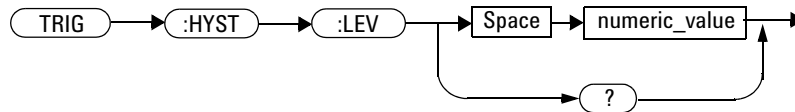

Parameter

Item	Description/Default	Range of values
numeric_value	A numeric value in dBm for the hysteresis level: <ul style="list-style-type: none"> • Default value: 0 dBm • Minimum value: 0 dBm • Maximum value: 3 dBm 	0 to 3 dBm

Example

TRIG:HYST:LEV 1 *This command sets the trigger hysteresis level to 1 dBm.*

Remarks

- This command is only applicable for channels 1 and 4. If you send this command for channels other than 1 and 4, error 705, “Applicable to trigger source for channel 1 and 4 only” will occur.
- If you set a hysteresis level value which exceeds its minimum or maximum limit, the value will be clipped to its minimum or maximum value respectively. Error -222, “Data out of range;Value clipped to minimum (#)” or -222, “Data out of range;Value clipped to maximum (#)” will occur.

Reset condition

On reset, the trigger hysteresis level is set to 0 dBm.

Query

```
TRIGger:HYSTeresis:LEVel?
```

This query returns the current setting of the trigger hysteresis level. The response format is <Nrf>.

Query example

```
TRIG:HYST:LEV? Queries the trigger hysteresis level setting.
```

TRIGger:HYSTeresis:MODE <character_data>

This command sets the trigger hysteresis mode for channels 2 and 3.

Syntax

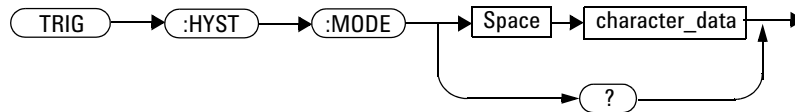

Parameter

Item	Description/Default	Range of values
character_data	Sets the hysteresis mode as: <ul style="list-style-type: none"> • NORMAl: Sets the mode to normal sensitivity. This is the default setting. • NREJect: Sets the mode to noise reject. 	NORMAl NREJect

Example

TRIG:HYST:MODE NORM *This command sets the trigger hysteresis mode to normal sensitivity.*

Remark

This command is only applicable for channels 2 and 3. If you send this command for channels other than 2 and 3, error 706, “Applicable to trigger source for channel 2 and 3 only” will occur.

Reset condition

On reset, the trigger hysteresis mode is set to normal sensitivity.

Query

```
TRIGger:HYSTeresis:MODE?
```

This query returns the current setting of the trigger hysteresis mode.

Query example

```
TRIG:HYST:MODE?     Queries the trigger hysteresis mode setting.
```

TRIGger:IMPedance <character_data>

This command sets the impedance for the auxiliary trigger source input.

Syntax

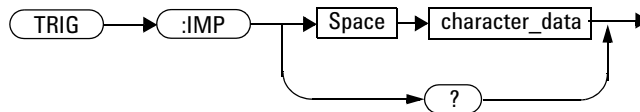

Parameter

Item	Description/Default	Range of values
character_data	Sets the impedance type as: <ul style="list-style-type: none"> • IMP50: Sets the impedance to 50 Ω. This is the default setting. • IMP1M: Sets the impedance to 1 MΩ. 	IMP50 IMP1M

Example

TRIG:IMP IMP50

This command sets the auxiliary trigger source input impedance to 50 Ω

Remark

This command is only applicable for the auxiliary trigger source input. If this command is sent for a trigger source other than auxiliary, error 704, “Applicable to trigger source for auxiliary only” will occur.

Reset condition

On reset, the impedance is set to 50 Ω .

Query

TRIGger:IMPedance?

This query returns the current setting of the auxiliary trigger source input impedance.

Query example

TRIG:IMP?

Queries the auxiliary trigger source input impedance setting.

TRIGger:LEVel <character_data>,<numeric_value>

This command sets the trigger level for the specified channel trigger source.

Syntax

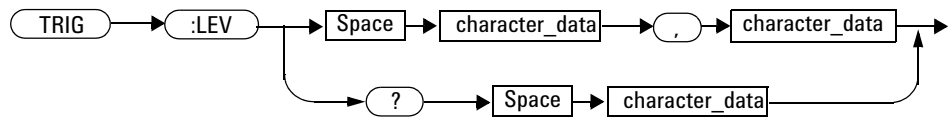

Parameter

Item	Description/Default	Range of values
character_data	Specifies the channel trigger source as: <ul style="list-style-type: none"> • CHAN1: Sets the source to channel 1. • CHAN2: Sets the source to channel 2. • CHAN3: Sets the source to channel 3. • CHAN4: Sets the source to channel 4. 	CHAN1 CHAN2 CHAN3 CHAN4
numeric_value	A numeric value for the trigger level: <ul style="list-style-type: none"> • Default value: <ul style="list-style-type: none"> ◦ 0 dBm/1 mW (for channels 1 and 4) ◦ 0 V (for channels 2 and 3) • Minimum value: <ul style="list-style-type: none"> ◦ -40 dBm/100 nW (for channels 1 and 4) ◦ -4 V (for channels 2 and 3) • Maximum value: <ul style="list-style-type: none"> ◦ 20 dBm/100 mW (for channels 1 and 4) ◦ 4 V (for channels 2 and 3) 	<ul style="list-style-type: none"> • Channels 1 and 4: -40 dBm to 20 dBm 100 nW to 100 mW • Channels 2 and 3: -4 V to 4 V

Example

TRIG:LEV CHAN1,10 *This command sets the channel 1 trigger level to 10 dBm.*

Remarks

- The minimum and maximum values of the trigger level are the boundary minimum and maximum values for each channel. These values will change according to the signal determined by the 8990B.
- If you set a trigger level value which exceeds its minimum or maximum limit, the value will be clipped to its minimum or maximum value respectively. Error -222,“Data out of range;Value clipped to minimum (#)” or -222,“Data out of range;Value clipped to maximum (#)” will occur.

Query

TRIGger:LEVel? <channel>

This query returns the current setting of the trigger level for the specified channel trigger source. The response format is <NRf> in the following units:

- dBm/W (for channels 1 and 4)
- V (for channels 2 and 3).

Query example

TRIG:LEV? CHAN2 *Queries the channel 2 trigger level setting.*

TRIGger:MODE <character_data>

This command sets the trigger mode.

Syntax

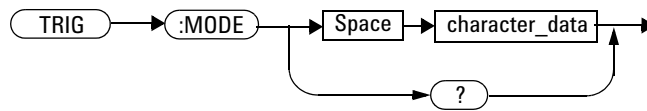

Parameter

Item	Description/Default	Range of values
character_data	Sets the trigger mode as: <ul style="list-style-type: none"> • EDGE: Sets the 8990B to trigger on edge. This is the default setting. • EVENT: Sets the 8990B to trigger on event. • PWIDTh: Sets the 8990B to trigger on pulse width. 	EDGE EVENT PWIDTh

Example

TRIG:MODE EDGE *This command sets the trigger mode to the edge trigger.*

Reset condition

On reset, the trigger mode is set to the edge trigger.

Remark

If the 8990B is set to trigger on event when the ETS mode is enabled, error -221, “Settings conflict;Unable to turn on Trigger on Event while ETS mode is on” will occur.

Query

TRIGger:MODE?

This query returns the current setting of the trigger mode.

Query example

TRIG:MODE?

Queries the trigger mode setting.

TRIGger:OUTput <boolean>

This command sets the state of the output trigger.

Syntax

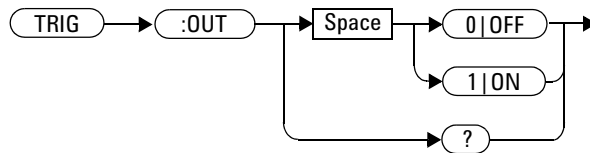

Example

TRIG:OUT ON *This command turns on the output trigger.*

Reset condition

On reset, the output trigger is turned on.

Remark

This command is only applicable for the channel 1, channel 4, and auxiliary trigger sources only. If this command is sent for a trigger source other than any of these sources, error 702, “Applicable to trigger source for channel 1, 4 and auxiliary only” will occur.

Query

TRIGger:OUTput?

This query enters a 1 or 0 into the output buffer indicating the state of the output trigger.

- 1 is returned when the output trigger is turned on
- 0 is returned when the output trigger is turned off

Query example

TRIG:OUT? *Queries whether the output trigger is turned on or off.*

TRIGger:PWIDth <mode>,<time1>,<time2>

This command sets the mode and time for the pulse width trigger.

Syntax

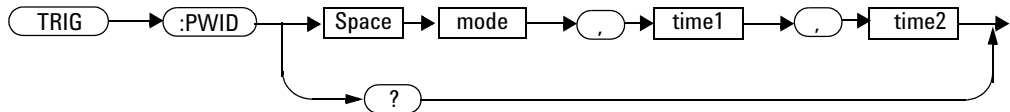

Parameter

Item	Description/Default	Range of values
mode	Specifies the pulse width trigger mode as: <ul style="list-style-type: none"> • LESS: Sets the pulse width mode to less. Only time1 is required. • MORE: Sets the pulse width mode to more. This is the default setting. Only time1 is required. • WITHIN: Sets the pulse width mode to within. Time 1 and time2 are required. • OUTOF: Sets the pulse width mode to out. Time 1 and time2 are required. 	LESS MORE WITHIN OUTOF
time1 time2	A numeric value for the pulse width. Default: 1 μ s	60 ns to 500 ms

Example

```
TRIG:PWID LESS,0.1
```

This command sets the pulse width trigger mode to less at 0.1 s.

Reset condition

On reset, the pulse width trigger mode is set to MORE and the time is set to 1 μ s.

Query

```
TRIGger:PWIDth?
```

This query returns the current mode of the pulse width trigger.

Query example

```
TRIG:PWID?
```

Queries the pulse width trigger mode.

TRIGger:SOURce <character_data>

This command sets the trigger source.

Syntax

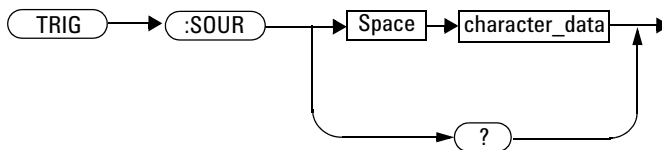

Parameter

Item	Description/Default	Range of values
character_data	Sets the trigger source as: <ul style="list-style-type: none"> • CHAN1: Sets the source to channel 1. • CHAN2: Sets the source to channel 2. • CHAN3: Sets the source to channel 3. • CHAN4: Sets the source to channel 4. • AUX: Sets the source to auxiliary. 	CHAN1 CHAN2 CHAN3 CHAN4 AUX

Example

```
TRIG:SOUR CHAN1
```

This command sets the trigger source to channel 1.

Reset condition

On reset, the trigger source is set to first channel available.

Query

TRIGger:SOURce?

This query returns the current setting of the trigger source.

Query example

TRIG:SOUR?

Queries the trigger source setting.

TRIGger:SWEep <character_data>

This command sets the trigger sweep mode.

Syntax

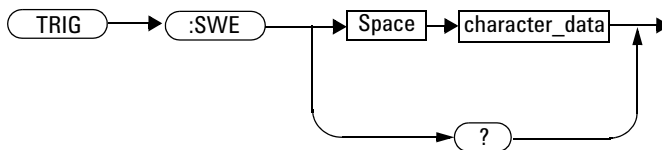

Parameter

Item	Description/Default	Range of values
character_data	Sets the trigger sweep mode as: <ul style="list-style-type: none"> AUTO: Sets to the auto sweep mode. This is the default setting. TRIGgered: Sets to the triggered sweep mode. 	AUTO TRIGgered

Example

TRIG:SWE AUTO

This command sets the trigger sweep to the auto sweep mode.

Remark

When the ETS mode is enabled, the trigger sweep mode must be set to triggered. If set to the auto sweep mode, error -221, “Settings conflict;Unable to set trigger sweep to auto mode, time scale must be at least 5E-07 or higher” will occur.

Reset condition

On reset, the trigger sweep mode is set to auto.

Query

TRIGger:SWEep?

This query returns the current setting of the trigger sweep mode.

Query example

TRIG:SWE?

Queries the trigger sweep mode setting.



9 MEASure Subsystem

Overview	205
MEASure:DR0op?	207
MEASure:DISPlay <character_data>, CHAN{1 2 3 4}, [NORMal ZOOM], <Boolean>	208
MEASure:AVERage? CHAN{1 2 3 4}, [NORMal ZOOM MULTipulse] [<character_data>]	211
MEASure:DUTYcycle? CHAN{1 2 3 4}, [NORMal ZOOM MULTipulse] [<character_data>]	213
MEASure:FALLtime? CHAN{1 2 3 4}, [NORMal ZOOM MULTipulse] [<character_data>]	215
MEASure:MINimum? CHAN{1 2 3 4}, [NORMal ZOOM MULTipulse] [<character_data>]	217
MEASure:OFFtime? CHAN{1 2 3 4}, [NORMal ZOOM MULTipulse] [<character_data>]	219
MEASure:OVERshoot? CHAN{1 2 3 4}, [NORMal ZOOM MULTipulse] [<character_data>]	221
MEASure:PAverage? CHAN{1 2 3 4}, [NORMal ZOOM MULTipulse] [<character_data>]	223
MEASure:PBASe? CHAN{1 2 3 4}, [NORMal ZOOM MULTipulse] [<character_data>]	225
MEASure:PEAK? CHAN{1 2 3 4}, [NORMal ZOOM MULTipulse] [<character_data>]	227
MEASure:PRF? CHAN{1 2 3 4}, [NORMal ZOOM MULTipulse] [<character_data>]	229
MEASure:PRI? CHAN{1 2 3 4}, [NORMal ZOOM MULTipulse] [<character_data>]	231
MEASure:PTOP? CHAN{1 2 3 4}, [NORMal ZOOM MULTipulse] [<character_data>]	233
MEASure:PWIDth? CHAN{1 2 3 4}, [NORMal ZOOM MULTipulse] [<character_data>]	235



MEASure:RISEtime? CHAN{1|2|3|4}, [NORMal|ZOOM|MULTipulse]
[,<character_data>] 237

MEASure:THReshold:PDURation CHAN{1|2|3|4},<numeric_value> 239

MEASure:THReshold:REFlevel{1|2}
CHAN{1|2|3|4},<numeric_value> 241

MEASure:THReshold:VALue CHAN{1|2|3|4}, <numeric_value> 243

This chapter describes how the MEASure command subsystem is used to acquire measurement results for the waveform parameters.

Overview

The MEASure command subsystem allows you to measure the available waveform parameters of the 8990B and retrieve the measurement results.

The channel numbers in the following command list refer to:

- RF channels (for channels 1 and 4), or
- oscilloscope channels (for channels 2 and 3).

Keyword	Parameter form	Note	Page
MEASure			
:DRoop?		[query only]	page 207
:DISPlay	<character_data>, CHAN{1 2 3 4}, [NORMal ZOOM], <Boolean>		page 212
:AVERage? CHAN{1 2 3 4}	, [NORMal ZOOM MULTi pulse] [, <character_data>]	[query only]	page 211
:DUTYcycle? CHAN{1 2 3 4}	, [NORMal ZOOM MULTi pulse] [, <character_data>]	[query only]	page 213
:FALLtime? CHAN{1 2 3 4}	, [NORMal ZOOM MULTi pulse] [, <character_data>]	[query only]	page 215
:MINimum? CHAN{1 2 3 4}	, [NORMal ZOOM MULTi pulse] [, <character_data>]	[query only]	page 217
:OFFtime? CHAN{1 2 3 4}	, [NORMal ZOOM MULTi pulse] [, <character_data>]	[query only]	page 219
:OVERshoot? CHAN{1 2 3 4}	, [NORMal ZOOM MULTi pulse] [, <character_data>]	[query only]	page 221
:PAVerage? CHAN{1 2 3 4}	, [NORMal ZOOM MULTi pulse] [, <character_data>]	[query only]	page 223

Keyword	Parameter form	Note	Page
:PBASe? CHAN{1 2 3 4}	, [NORMal ZOOM MULTi pulse] [, <character_data>]	[query only]	page 225
:PEAK? CHAN{1 2 3 4}	, [NORMal ZOOM MULTi pulse] [, <character_data>]	[query only]	page 227
:PRF? CHAN{1 2 3 4}	, [NORMal ZOOM MULTi pulse] [, <character_data>]	[query only]	page 229
:PRI? CHAN{1 2 3 4}	, [NORMal ZOOM MULTi pulse] [, <character_data>]	[query only]	page 231
:PTOP? CHAN{1 2 3 4}	, [NORMal ZOOM MULTi pulse] [, <character_data>]	[query only]	page 233
:PWIDTH? CHAN{1 2 3 4}	, [NORMal ZOOM MULTi pulse] [, <character_data>]	[query only]	page 235
:RISEtime? CHAN{1 2 3 4}	, [NORMal ZOOM MULTi pulse] [, <character_data>]	[query only]	page 237
:THReshold			
:PDURation CHAN{1 2 3 4}	, <numeric_value>		page 239
:REFlevel{1 2} CHAN{1 2 3 4}	, <numeric_value>		page 241
:VALue CHAN{1 2 3 4}	, <numeric_value>		page 243

MEASure:DR0op?

This query returns the droop measurement result for the selected droop measurement source.

Syntax

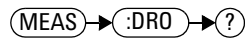

Example

MEAS:DR0?

Queries the droop measurement result for the selected droop measurement source.

Remarks

- If the droop measurement mode is not enabled (“ACQuire:DR0op[:STATe] <boolean>”) when sending this query, error -221, “Settings conflict;Requires droop measurement to be enabled” will occur.
- This query is only applicable for channels 1 and 4. If a channel other than channel 1 or 4 is specified, error 700, “Applicable to channel 1 and 4 only” will occur.
- This query is only applicable in the Normal and Zoom mode. If this query is sent in the CCDF mode, error -221, “Settings conflict;Not Applicable to CCDF” will occur.

MEASure:DISPlay <character_data>, CHAN{1|2|3|4}, [NORMal|ZOOM], <Boolean>

This command displays the measurement result of the selected measurement type for the specified channel.

Syntax

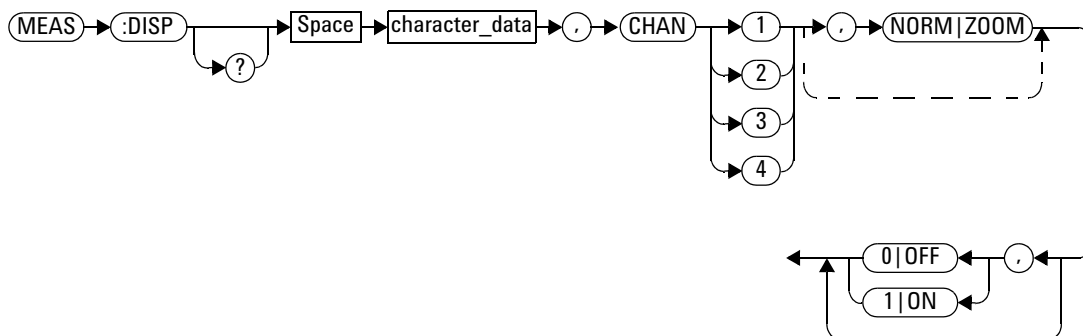

Parameter

Item	Description/Default	Range of values
character_data	Selects the measurement type to be displayed: <ul style="list-style-type: none"> • MINimum: Selects minimum power measurement • PEAK: Selects peak power measurement • AVERage: Selects average power measurement • DUTYcycle: Selects duty cycle measurement • PRI :Selects PRI measurement • PRF: Selects PRF measurement • FALLtime: Selects fall time measurement • RISEtime: Selects rise time measurement • OFFtime: Selects off time measurement • PBASe: Selects pulse base measurement • PTOp: Selects pulse top measurement • PWIDth: Selects pulse width measurement • OVERshoot: Selects overshoot measurement • PAVerage: Selects peak-to-average power measurement 	MINimum PEAK AVERage DUTYcycle PRI PRF FALLtime RISEtime OFFtime PBASe PTOp PWIDth OVERshoot PAVerage

Example

```
MEAS:DISP MIN, CHAN1, 1
```

This command displays the minimum power measurement result for channel 1 in normal mode.

```
MEAS:DISP MIN, CHAN1, ZOOM, 1
```

This command displays the minimum power measurement result for channel 1 in zoom mode.

Remarks

- This query is only applicable in Normal and Zoom mode. If this query is sent in the CCDF mode, error -221, “Settings conflict;Not Applicable to CCDF” will occur.
- If the query is sent as a zoom query, it is only applicable in zoom mode. If this query is sent in the normal mode, error -221, “Settings conflict;Require zoom mode to be enabled” will occur.

Reset condition

On reset, there is no measurement result to be displayed.

Query

```
MEASure:DISPlay? <character_data>, CHAN{1|2|3|4},
[NORMal|ZOOM]
```

This query indicating the state of the measurement display.

- **1** is returned when the measurement result of the selected measurement type for the specified channel is displayed.
- **0** is returned when the measurement result of the selected measurement type for the specified channel is not displayed.

Query example

```
MEAS:DISP? MIN, CHAN1
```

Queries the minimum power measurement result display for channel 1 in normal mode.

```
MEAS:DISP? MIN, CHAN1, ZOOM
```

Queries the minimum power measurement result display for channel 1 in zoom mode.

MEASure:AVERage? CHAN{1|2|3|4}, [NORMal|ZOOM|MULTipulse] [,<character_data>]

This query returns the average power measurement result for the specified channel.

Syntax

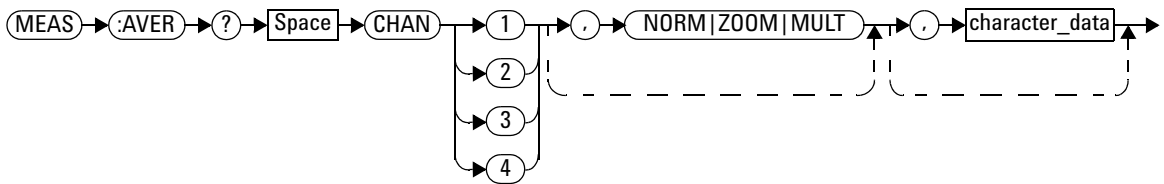

Parameter

Item	Description/Default	Range of values
character_data	<p>This is an optional parameter where it sets the returned measurement value as:</p> <ul style="list-style-type: none"> • MAX: Returns the maximum measurement value. • MIN: Returns the minimum measurement value. • MEAN: Returns the mean measurement value. • CURRent: Returns the recent measurement value. • STDev: Returns the standard deviation value 	MAX MIN MEAN CURRent STDev

Example

MEAS:AVER? CHAN1	<i>Queries the average power measurement result for channel 1 in normal mode.</i>
MEAS:AVER? CHAN1, ZOOM	<i>Queries the average power measurement result for channel 1 in zoom mode.</i>
MEAS:AVER? CHAN1, MULT	<i>Queries the average power measurement result for channel 1 in multipulse mode.</i>

Remark

- Set the acquire mode to normal, zoom, or multipulse mode before using this command. Refer to [“ACQUIRE:MODE <character_data>”](#) on page 115.
- If the query is sent as a normal query, it is also applicable in the zoom mode.
- If the query is sent as a zoom query, it is only applicable in the zoom mode. If this query is sent in other mode, error -221, “Settings conflict;Require zoom mode to be enabled” will occur.
- If the query is sent as a multipulse query, it is only applicable in the multipulse mode. If this query is sent in other mode, error -221, “Settings conflict;Require multipulse mode to be enabled” will occur.
- The multipulse query is only applicable when the multipulse acquisition is completed in the multipulse mode. If this query is sent when the multipulse acquisition is running, error -221, “Stop multipulse frame acquisition to change the setting” will occur.

MEASure:DUTYcycle? CHAN{1 | 2 | 3 | 4}, [NORMal | ZOOM | MULTipulse] [, <character_data>]

This query returns the power duty cycle measurement result for the specified channel.

Syntax

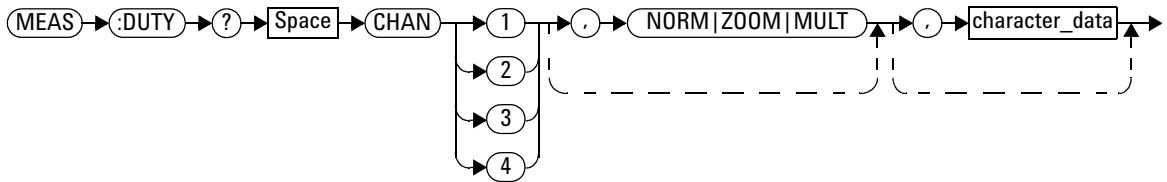

Parameter

Item	Description/Default	Range of values
character_data	<p>This is an optional parameter where it sets the returned measurement value as:</p> <ul style="list-style-type: none"> • MAX: Returns the maximum measurement value. • MIN: Returns the minimum measurement value. • MEAN: Returns the mean measurement value. • CURRent: Returns the recent measurement value. • STDev: Returns the standard deviation value 	MAX MIN MEAN CURRent STDev

Example

MEAS:DUTY? CHAN4	<i>Queries the power duty cycle measurement result for channel 4 in normal mode.</i>
MEAS:DUTY? CHAN4, ZOOM	<i>Queries the power duty cycle measurement result for channel 4 in zoom mode.</i>
MEAS:DUTY? CHAN4, MULT	<i>Queries the power duty cycle measurement result for channel 4 in multipulse mode.</i>

Remarks

- Set the acquire mode to normal, zoom, or multipulse mode before using this command. Refer to “[ACQUIRE:MODE <character_data>](#)” on page 115.
- If the query is sent as a normal query, it is also applicable in the zoom mode.
- If the query is sent as a zoom query, it is only applicable in the zoom mode. If this query is sent in other mode, error -221, “Settings conflict; Require zoom mode to be enabled” will occur.
- If the query is sent as a multipulse query, it is only applicable in the multipulse mode. If this query is sent in other mode, error -221, “Settings conflict; Require multipulse mode to be enabled” will occur.
- The multipulse query is only applicable when the multipulse acquisition is completed in the multipulse mode. If this query is sent when the multipulse acquisition is running, error -221, “Stop multipulse frame acquisition to change the setting” will occur.

MEASure:FALLtime? CHAN{1|2|3|4}, [NORMal|ZOOM|MULTipulse] [,<character_data>]

This query returns the fall time measurement result for the specified channel.

Syntax

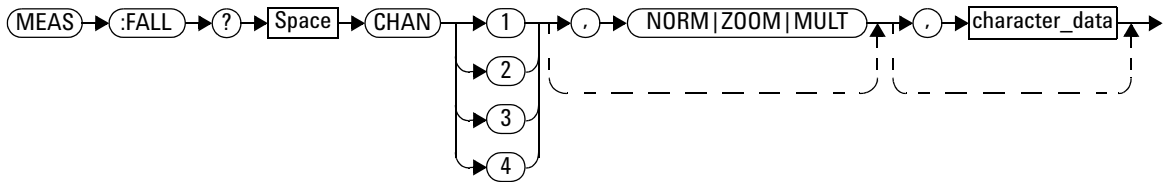

Parameter

Item	Description/Default	Range of values
character_data	<p>This is an optional parameter where it sets the returned measurement value as:</p> <ul style="list-style-type: none"> • MAX: Returns the maximum measurement value. • MIN: Returns the minimum measurement value. • MEAN: Returns the mean measurement value. • CURRent: Returns the recent measurement value. • STDev: Returns the standard deviation value 	MAX MIN MEAN CURRent STDev

Example

MEAS:FALL? CHAN2	<i>Queries the fall time measurement result for channel 2 in normal mode.</i>
MEAS:FALL? CHAN2, ZOOM	<i>Queries the fall time measurement result for channel 2 in zoom mode.</i>
MEAS:FALL? CHAN2, MULT	<i>Queries the fall time measurement result for channel 2 in multipulse mode.</i>

Remarks

- Set the acquire mode to normal, zoom, or multipulse mode before using this command. Refer to “[ACQUIRE:MODE <character_data>](#)” on page 115.
- If the query is sent as a normal query, it is also applicable in the zoom mode.
- If the query is sent as a zoom query, it is only applicable in the zoom mode. If this query is sent in other mode, error -221, “Settings conflict; Require zoom mode to be enabled” will occur.
- If the query is sent as a multipulse query, it is only applicable in the multipulse mode. If this query is sent in other mode, error -221, “Settings conflict; Require multipulse mode to be enabled” will occur.
- The multipulse query is only applicable when the multipulse acquisition is completed in the multipulse mode. If this query is sent when the multipulse acquisition is running, error -221, “Stop multipulse frame acquisition to change the setting” will occur.

MEASure:MINimum? CHAN{1|2|3|4}, [NORMal|ZOOM|MULTipulse] [,<character_data>]

This query returns the minimum power measurement result for the specified channel.

Syntax

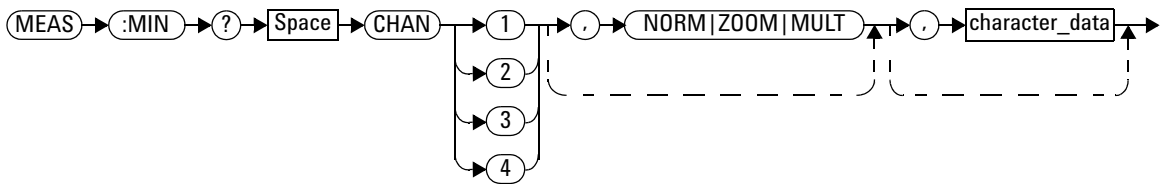

Parameter

Item	Description/Default	Range of values
character_data	<p>This is an optional parameter where it sets the returned measurement value as:</p> <ul style="list-style-type: none"> • MAX: Returns the maximum measurement value. • MIN: Returns the minimum measurement value. • MEAN: Returns the mean measurement value. • CURRent: Returns the recent measurement value. • STDev: Returns the standard deviation value 	MAX MIN MEAN CURRent STDev

Example

MEAS:MIN? CHAN3	<i>Queries the minimum power measurement result for channel 3 in normal mode.</i>
MEAS:MIN? CHAN3, ZOOM	<i>Queries the minimum power measurement result for channel 3 in zoom mode.</i>
MEAS:MIN? CHAN3, MULT	<i>Queries the minimum power measurement result for channel 3 in multipulse mode.</i>

Remarks

- Set the acquire mode to normal, zoom, or multipulse mode before using this command. Refer to “[ACQUIRE:MODE <character_data>](#)” on page 115.
- If the query is sent as a normal query, it is also applicable in the zoom mode.
- If the query is sent as a zoom query, it is only applicable in the zoom mode. If this query is sent in other mode, error -221, “Settings conflict; Require zoom mode to be enabled” will occur.
- If the query is sent as a multipulse query, it is only applicable in the multipulse mode. If this query is sent in other mode, error -221, “Settings conflict; Require multipulse mode to be enabled” will occur.
- The multipulse query is only applicable when the multipulse acquisition is completed in the multipulse mode. If this query is sent when the multipulse acquisition is running, error -221, “Stop multipulse frame acquisition to change the setting” will occur.

MEASure:OFFtime? CHAN{1|2|3|4}, [NORMal|ZOOM|MULTipulse] [,<character_data>]

This query returns the off time measurement result for the specified channel.

Syntax

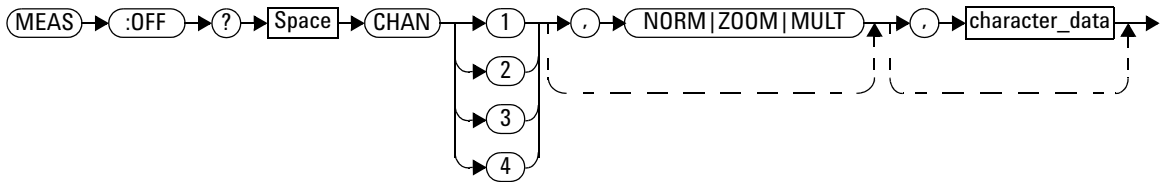

Parameter

Item	Description/Default	Range of values
character_data	<p>This is an optional parameter where it sets the returned measurement value as:</p> <ul style="list-style-type: none"> • MAX: Returns the maximum measurement value. • MIN: Returns the minimum measurement value. • MEAN: Returns the mean measurement value. • CURRent: Returns the recent measurement value. • STDev: Returns the standard deviation value 	MAX MIN MEAN CURRent STDev

Example

MEAS:OFF? CHAN1	<i>Queries the off time measurement result for channel 1 in normal mode.</i>
MEAS:OFF? CHAN1, ZOOM	<i>Queries the off time measurement result for channel 1 in zoom mode.</i>
MEAS:OFF? CHAN1, MULT	<i>Queries the off time measurement result for channel 1 in multipulse mode.</i>

Remarks

- Set the acquire mode to normal, zoom, or multipulse mode before using this command. Refer to “[ACQUIRE:MODE <character_data>](#)” on page 115.
- If the query is sent as a normal query, it is also applicable in the zoom mode.
- If the query is sent as a zoom query, it is only applicable in the zoom mode. If this query is sent in other mode, error -221, “Settings conflict;Require zoom mode to be enabled” will occur.
- If the query is sent as a multipulse query, it is only applicable in the multipulse mode. If this query is sent in other mode, error -221, “Settings conflict;Require multipulse mode to be enabled” will occur.
- The multipulse query is only applicable when the multipulse acquisition is completed in the multipulse mode. If this query is sent when the multipulse acquisition is running, error -221, “Stop multipulse frame acquisition to change the setting” will occur.

MEASure:OVERshoot? CHAN{1|2|3|4}, [NORMal|ZOOM|MULTipulse] [,<character_data>]

This query returns the overshoot measurement result for the specified channel.

Syntax

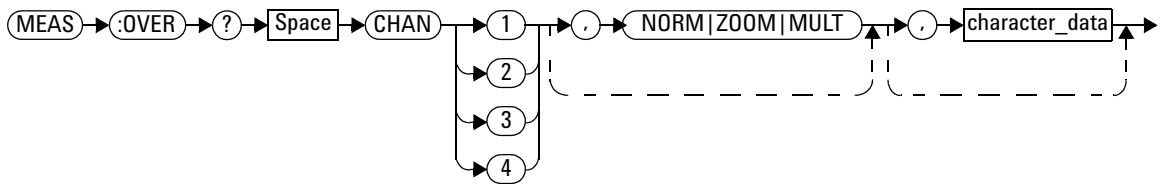

Parameter

Item	Description/Default	Range of values
character_data	<p>This is an optional parameter where it sets the returned measurement value as:</p> <ul style="list-style-type: none"> • MAX: Returns the maximum measurement value. • MIN: Returns the minimum measurement value. • MEAN: Returns the mean measurement value. • CURRent: Returns the recent measurement value. • STDev: Returns the standard deviation value 	MAX MIN MEAN CURRent STDev

Example

MEAS:OVER? CHAN2	<i>Queries the overshoot measurement result for channel 2 in normal mode.</i>
MEAS:OVER? CHAN2, ZOOM	<i>Queries the overshoot measurement result for channel 2 in zoom mode.</i>
MEAS:OVER? CHAN2, MULT	<i>Queries the overshoot measurement result for channel 2 in multipulse mode.</i>

Remarks

- Set the acquire mode to normal, zoom, or multipulse mode before using this command. Refer to “[ACQUIRE:MODE <character_data>](#)” on page 115.
- If the query is sent as a normal query, it is also applicable in the zoom mode.
- If the query is sent as a zoom query, it is only applicable in the zoom mode. If this query is sent in other mode, error -221, “Settings conflict;Require zoom mode to be enabled” will occur.
- If the query is sent as a multipulse query, it is only applicable in the multipulse mode. If this query is sent in other mode, error -221, “Settings conflict;Require multipulse mode to be enabled” will occur.
- The multipulse query is only applicable when the multipulse acquisition is completed in the multipulse mode. If this query is sent when the multipulse acquisition is running, error -221, “Stop multipulse frame acquisition to change the setting” will occur.

MEASure:PAverage? CHAN{1 | 2 | 3 | 4}, [NORMal | ZOOM | MULTipulse] [, <character_data>]

This query returns the peak-to-average power measurement result for the specified channel.

Syntax

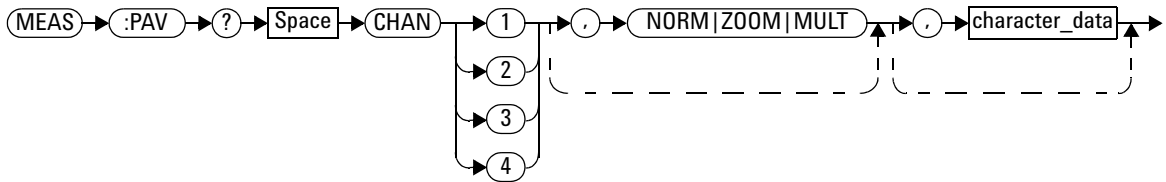

Parameter

Item	Description/Default	Range of values
character_data	<p>This is an optional parameter where it sets the returned measurement value as:</p> <ul style="list-style-type: none"> • MAX: Returns the maximum measurement value. • MIN: Returns the minimum measurement value. • MEAN: Returns the mean measurement value. • CURRent: Returns the recent measurement value. • STDev: Returns the standard deviation value 	MAX MIN MEAN CURRent STDev

Example

MEAS:PAV? CHAN3

Queries the peak- to- average power measurement result for channel 3 in normal mode.

MEAS:PAV? CHAN3, ZOOM

Queries the peak- to- average power measurement result for channel 3 in zoom mode.

MEAS:PAV? CHAN3, MULT

Queries the peak- to- average power measurement result for channel 3 in multipulse mode.

Remarks

- Set the acquire mode to normal, zoom, or multipulse mode before using this command. Refer to “ACQUIRE:MODE <character_data>” on page 115.
- If the query is sent as a normal query, it is also applicable in the zoom mode.
- If the query is sent as a zoom query, it is only applicable in the zoom mode. If this query is sent in other mode, error -221, “Settings conflict;Require zoom mode to be enabled” will occur.
- If the query is sent as a multipulse query, it is only applicable in the multipulse mode. If this query is sent in other mode, error -221, “Settings conflict;Require multipulse mode to be enabled” will occur.
- The multipulse query is only applicable when the multipulse acquisition is completed in the multipulse mode. If this query is sent when the multipulse acquisition is running, error -221, “Stop multipulse frame acquisition to change the setting” will occur.

MEASure:PBASe? CHAN{1 | 2 | 3 | 4}, [NORMal | ZOOM | MULTipulse] [, <character_data>]

This query returns the pulse-base measurement result for the specified channel.

Syntax

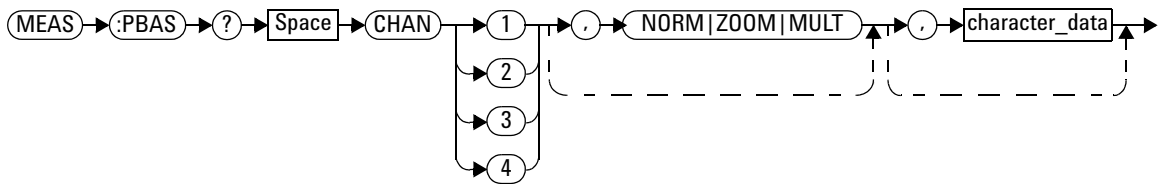

Parameter

Item	Description/Default	Range of values
character_data	<p>This is an optional parameter where it sets the returned measurement value as:</p> <ul style="list-style-type: none"> • MAX: Returns the maximum measurement value. • MIN: Returns the minimum measurement value. • MEAN: Returns the mean measurement value. • CURRent: Returns the recent measurement value. • STDev: Returns the standard deviation value 	MAX MIN MEAN CURRent STDev

Example

MEAS:PBAS? CHAN4	<i>Queries the pulse- base measurement result for channel 4 in normal mode.</i>
MEAS:PBAS? CHAN4, ZOOM	<i>Queries the pulse- base measurement result for channel 4 in zoom mode.</i>
MEAS:PBAS? CHAN4, MULT	<i>Queries the pulse- base measurement result for channel 4 in multipulse mode.</i>

Remarks

- Set the acquire mode to normal, zoom, or multipulse mode before using this command. Refer to “[ACQUIRE:MODE <character_data>](#)” on page 115.
- If the query is sent as a normal query, it is also applicable in the zoom mode.
- If the query is sent as a zoom query, it is only applicable in the zoom mode. If this query is sent in other mode, error -221, “Settings conflict;Require zoom mode to be enabled” will occur.
- If the query is sent as a multipulse query, it is only applicable in the multipulse mode. If this query is sent in other mode, error -221, “Settings conflict;Require multipulse mode to be enabled” will occur.
- The multipulse query is only applicable when the multipulse acquisition is completed in the multipulse mode. If this query is sent when the multipulse acquisition is running, error -221, “Stop multipulse frame acquisition to change the setting” will occur.

MEASure:PEAK? CHAN{1|2|3|4}, [NORMal|ZOOM|MULTipulse] [,<character_data>]

This query returns the peak power measurement result for the specified channel.

Syntax

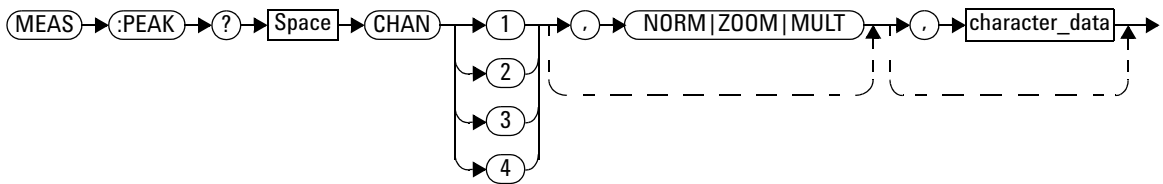

Parameter

Item	Description/Default	Range of values
character_data	This is an optional parameter where it sets the returned measurement value as: <ul style="list-style-type: none"> • MAX: Returns the maximum measurement value. • MIN: Returns the minimum measurement value. • MEAN: Returns the mean measurement value. • CURRent: Returns the recent measurement value. • STDev: Returns the standard deviation value 	MAX MIN MEAN CURRent STDev

Example

MEAS:PEAK? CHAN1	<i>Queries the peak power measurement result for channel 1 in normal mode.</i>
MEAS:PEAK? CHAN1, ZOOM	<i>Queries the peak power measurement result for channel 1 in zoom mode.</i>
MEAS:PEAK? CHAN1, MULT	<i>Queries the peak power measurement result for channel 1 in multipulse mode.</i>

Remarks

- Set the acquire mode to normal, zoom, or multipulse mode before using this command. Refer to “[ACQUIRE:MODE <character_data>](#)” on page 115.
- If the query is sent as a normal query, it is also applicable in the zoom mode.
- If the query is sent as a zoom query, it is only applicable in the zoom mode. If this query is sent in other mode, error -221, “Settings conflict; Require zoom mode to be enabled” will occur.
- If the query is sent as a multipulse query, it is only applicable in the multipulse mode. If this query is sent in other mode, error -221, “Settings conflict; Require multipulse mode to be enabled” will occur.
- The multipulse query is only applicable when the multipulse acquisition is completed in the multipulse mode. If this query is sent when the multipulse acquisition is running, error -221, “Stop multipulse frame acquisition to change the setting” will occur.

MEASure:PRF? CHAN{1|2|3|4}, [NORMal|ZOOM|MULTipulse] [,<character_data>]

This query returns the pulse repetition frequency (PRF) measurement result for the specified channel.

Syntax

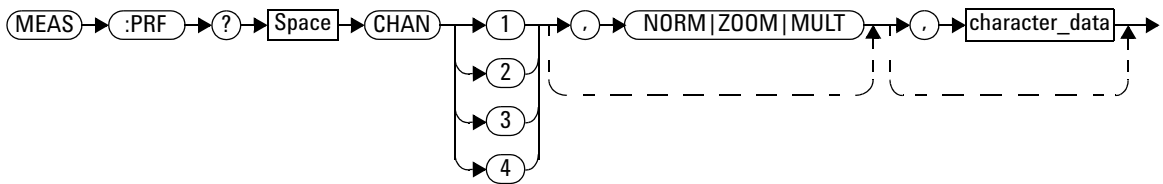

Parameter

Item	Description/Default	Range of values
character_data	<p>This is an optional parameter where it sets the returned measurement value as:</p> <ul style="list-style-type: none"> • MAX: Returns the maximum measurement value. • MIN: Returns the minimum measurement value. • MEAN: Returns the mean measurement value. • CURRent: Returns the recent measurement value. • STDev: Returns the standard deviation value 	MAX MIN MEAN CURRent STDev

Example

MEAS:PRF? CHAN3	<i>Queries the PRF measurement result for channel 3 in normal mode.</i>
MEAS:PRF? CHAN3, ZOOM	<i>Queries the PRF measurement result for channel 3 in zoom mode.</i>
MEAS:PRF? CHAN3, MULT	<i>Queries the PRF measurement result for channel 3 in multipulse mode.</i>

Remarks

- Set the acquire mode to normal, zoom, or multipulse mode before using this command. Refer to “[ACQUIRE:MODE <character_data>](#)” on page 115.
- If the query is sent as a normal query, it is also applicable in the zoom mode.
- If the query is sent as a zoom query, it is only applicable in the zoom mode. If this query is sent in other mode, error -221, “Settings conflict; Require zoom mode to be enabled” will occur.
- If the query is sent as a multipulse query, it is only applicable in the multipulse mode. If this query is sent in other mode, error -221, “Settings conflict; Require multipulse mode to be enabled” will occur.
- The multipulse query is only applicable when the multipulse acquisition is completed in the multipulse mode. If this query is sent when the multipulse acquisition is running, error -221, “Stop multipulse frame acquisition to change the setting” will occur.

MEASure:PRI? CHAN{1 | 2 | 3 | 4}, [NORMal | ZOOM | MULTipulse] [,<character_data>]

This query returns the pulse repetition interval (PRI) measurement result for the specified channel.

Syntax

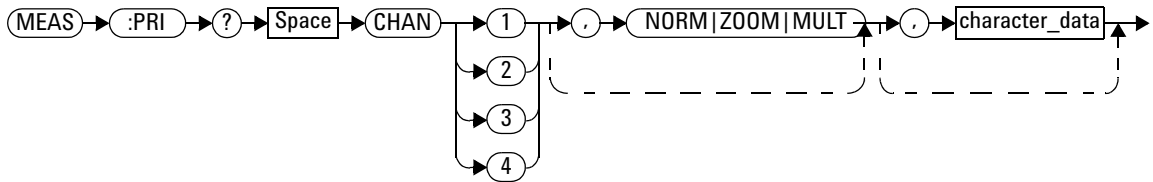

Parameter

Item	Description/Default	Range of values
character_data	<p>This is an optional parameter where it sets the returned measurement value as:</p> <ul style="list-style-type: none"> • MAX: Returns the maximum measurement value. • MIN: Returns the minimum measurement value. • MEAN: Returns the mean measurement value. • CURRent: Returns the recent measurement value. • STDev: Returns the standard deviation value 	MAX MIN MEAN CURRent STDev

Example

MEAS:PRI? CHAN2	<i>Queries the PRI measurement result for channel 2 in normal mode.</i>
MEAS:PRI? CHAN2, ZOOM	<i>Queries the PRI measurement result for channel 2 in zoom mode.</i>
MEAS:PRI? CHAN2, MULT	<i>Queries the PRI measurement result for channel 2 in multipulse mode.</i>

Remarks

- Set the acquire mode to normal, zoom, or multipulse mode before using this command. Refer to “[ACQUIRE:MODE <character_data>](#)” on page 115.
- If the query is sent as a normal query, it is also applicable in the zoom mode.
- If the query is sent as a zoom query, it is only applicable in the zoom mode. If this query is sent in other mode, error -221, “Settings conflict;Require zoom mode to be enabled” will occur.
- If the query is sent as a multipulse query, it is only applicable in the multipulse mode. If this query is sent in other mode, error -221, “Settings conflict;Require multipulse mode to be enabled” will occur.
- The multipulse query is only applicable when the multipulse acquisition is completed in the multipulse mode. If this query is sent when the multipulse acquisition is running, error -221, “Stop multipulse frame acquisition to change the setting” will occur.

MEASure:PTOP? CHAN{1 | 2 | 3 | 4}, [NORMal | ZOOM | MULTipulse] [,<character_data>]

This query returns the pulse-top measurement result for the specified channel.

Syntax

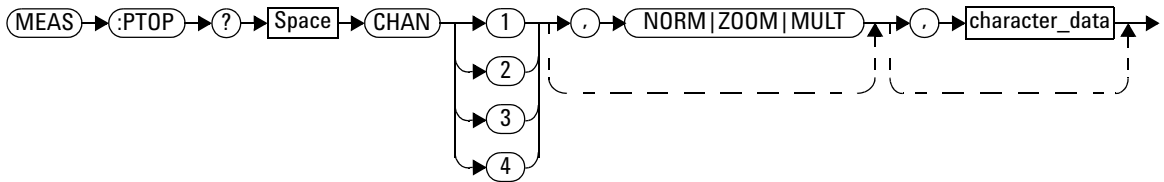

Parameter

Item	Description/Default	Range of values
character_data	<p>This is an optional parameter where it sets the returned measurement value as:</p> <ul style="list-style-type: none"> • MAX: Returns the maximum measurement value. • MIN: Returns the minimum measurement value. • MEAN: Returns the mean measurement value. • CURRent: Returns the recent measurement value. • STDev: Returns the standard deviation value 	<p>MAX MIN MEAN CURRent STDev</p>

Example

MEAS:PTOP? CHAN4	<i>Queries the pulse- top measurement result for channel 4 in normal mode.</i>
MEAS:PTOP? CHAN4, ZOOM	<i>Queries the pulse- top measurement result for channel 4 in zoom mode.</i>
MEAS:PTOP? CHAN4, MULT	<i>Queries the pulse- top measurement result for channel 4 in multipulse mode.</i>

Remarks

- Set the acquire mode to normal, zoom, or multipulse mode before using this command. Refer to “[ACQUIRE:MODE <character_data>](#)” on page 115.
- If the query is sent as a normal query, it is also applicable in the zoom mode.
- If the query is sent as a zoom query, it is only applicable in the zoom mode. If this query is sent in other mode, error -221, “Settings conflict;Require zoom mode to be enabled” will occur.
- If the query is sent as a multipulse query, it is only applicable in the multipulse mode. If this query is sent in other mode, error -221, “Settings conflict;Require multipulse mode to be enabled” will occur.
- The multipulse query is only applicable when the multipulse acquisition is completed in the multipulse mode. If this query is sent when the multipulse acquisition is running, error -221, “Stop multipulse frame acquisition to change the setting” will occur.

MEASure:PWIDth? CHAN{1 | 2 | 3 | 4}, [NORMal | ZOOM | MULTipulse] [, <character_data>]

This query returns the pulse width measurement result for the specified channel.

Syntax

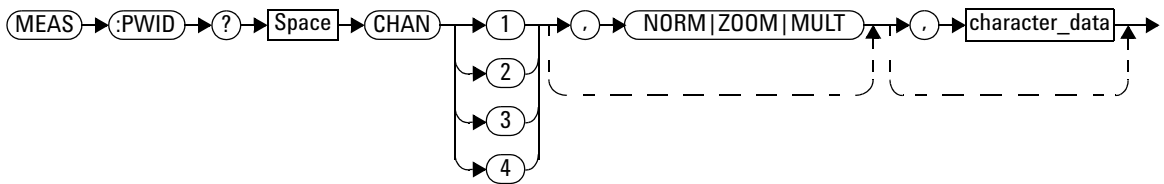

Parameter

Item	Description/Default	Range of values
character_data	<p>This is an optional parameter where it sets the returned measurement value as:</p> <ul style="list-style-type: none"> • MAX: Returns the maximum measurement value. • MIN: Returns the minimum measurement value. • MEAN: Returns the mean measurement value. • CURRent: Returns the recent measurement value. • STDev: Returns the standard deviation value 	MAX MIN MEAN CURRent STDev

Example

MEAS:PWID? CHAN1	<i>Queries the pulse width measurement result for channel 1 in normal mode.</i>
MEAS:PWID? CHAN1, ZOOM	<i>Queries the pulse width measurement result for channel 1 in zoom mode.</i>
MEAS:PWID? CHAN1, MULT	<i>Queries the pulse width measurement result for channel 1 in multipulse mode.</i>

Remarks

- Set the acquire mode to normal, zoom, or multipulse mode before using this command. Refer to “[ACQUIRE:MODE <character_data>](#)” on page 115.
- If the query is sent as a normal query, it is also applicable in the zoom mode.
- If the query is sent as a zoom query, it is only applicable in the zoom mode. If this query is sent in other mode, error -221, “Settings conflict;Require zoom mode to be enabled” will occur.
- If the query is sent as a multipulse query, it is only applicable in the multipulse mode. If this query is sent in other mode, error -221, “Settings conflict;Require multipulse mode to be enabled” will occur.
- The multipulse query is only applicable when the multipulse acquisition is completed in the multipulse mode. If this query is sent when the multipulse acquisition is running, error -221, “Stop multipulse frame acquisition to change the setting” will occur.

MEASure:RISEtime? CHAN{1|2|3|4}, [NORMal|ZOOM|MULTipulse] [,<character_data>]

This query returns the rise time measurement result for the specified channel.

Syntax

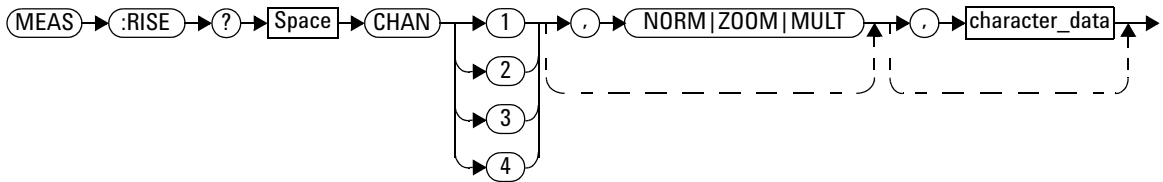

Parameter

Item	Description/Default	Range of values
character_data	<p>This is an optional parameter where it sets the returned measurement value as:</p> <ul style="list-style-type: none"> • MAX: Returns the maximum measurement value. • MIN: Returns the minimum measurement value. • MEAN: Returns the mean measurement value. • CURRent: Returns the recent measurement value. • STDev: Returns the standard deviation value 	MAX MIN MEAN CURRent STDev

Example

MEAS:RISE? CHAN2	<i>Queries the rise time measurement result for channel 2 in normal mode.</i>
MEAS:RISE? CHAN2, ZOOM	<i>Queries the rise time measurement result for channel 2 in zoom mode.</i>
MEAS:RISE? CHAN2, MULT	<i>Queries the rise time measurement result for channel 2 in multipulse mode.</i>

Remarks

- Set the acquire mode to normal, zoom, or multipulse mode before using this command. Refer to “[ACQUIRE:MODE <character_data>](#)” on page 115.
- If the query is sent as a normal query, it is also applicable in the zoom mode.
- If the query is sent as a zoom query, it is only applicable in the zoom mode. If this query is sent in other mode, error -221, “Settings conflict;Require zoom mode to be enabled” will occur.
- If the query is sent as a multipulse query, it is only applicable in the multipulse mode. If this query is sent in other mode, error -221, “Settings conflict;Require multipulse mode to be enabled” will occur.
- The multipulse query is only applicable when the multipulse acquisition is completed in the multipulse mode. If this query is sent when the multipulse acquisition is running, error -221, “Stop multipulse frame acquisition to change the setting” will occur.

MEASure:THReshold:PDURation CHAN{1|2|3|4},<numeric_value>

This command sets the pulse duration level for any of the four channels.

Syntax

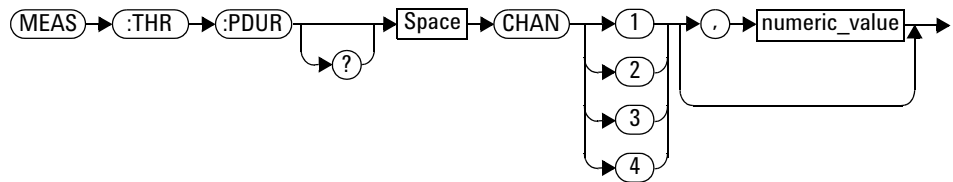

Parameter

Item	Description/Default	Range of values
numeric_value	A numeric value in % for the pulse duration level: <ul style="list-style-type: none"> • Default value: 50% • Minimum value: 0% • Maximum value: 100% 	0 to 100%

Example

```
MEAS:THR:PDUR CHAN1,60
```

This command sets the pulse duration level to 60% for channel 1.

Remark

If you set a pulse duration level value which exceeds its minimum or maximum limit, the value will be clipped to its minimum or maximum value respectively. Error -222, “Data out of range;Value clipped to minimum (#)” or -222, “Data out of range;Value clipped to maximum (#)” will occur.

Reset condition

On reset, the pulse duration level is set to 50%.

Query

```
MEASure:THReshold:PDURation? CHAN{1|2|3|4}
```

This query returns the current setting of the pulse duration level for the specified channel. The response format is <NRf>.

Query example

```
MEAS:THR:PDUR? CHAN1
```

Queries the pulse duration level setting for channel 1.

MEASure:THReshold:REFlevel{1 | 2} CHAN{1 | 2 | 3 | 4},<numeric_value>

This command sets the trace reference level for any of the four channels. Reference level 1 represents the lower boundary, while level 2 represents the upper boundary.

NOTE

- The minimum value for Marker A level and Marker B level is clipped to reference level 1 when the marker source is set to one of the four channels.
- The maximum value for Marker A level and Marker B level is clipped to reference level 2 when the marker source is set to one of the four channels.

Syntax

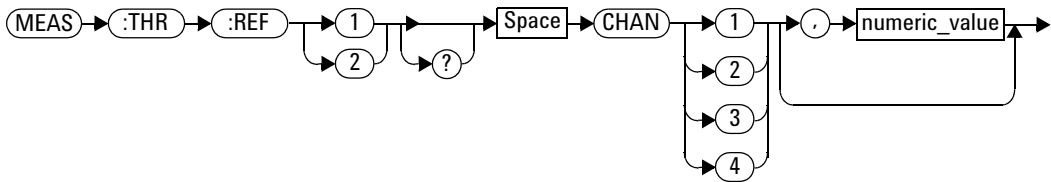

Parameter

Item	Description/Default	Range of values
numeric_value	A numeric value in % for the trace reference level: <ul style="list-style-type: none"> • Default value: <ul style="list-style-type: none"> • 10% (for reference level 1) • 90% (for reference level 2) • Minimum value: 0% • Maximum value: 100% • Reference level 1 <ul style="list-style-type: none"> • Maximum value: < reference level 2 • Reference level 2 <ul style="list-style-type: none"> • Minimum value: > reference level 1 	0 to 100%

Example

```
MEAS:THR:REF1 CHAN1,20
```

This command sets the trace reference level 1 to 20% for channel 1.

Remark

If you set a reference level value which exceeds its minimum or maximum limit, the value will be clipped to its minimum or maximum value respectively. Error -222,“Data out of range;Value clipped to minimum (#)” or -222,“Data out of range;Value clipped to maximum (#)” will occur.

Reset condition

On reset, the trace reference level is set to 10% for reference level 1, and 90% for reference level 2.

Query

```
MEASure:THReshold:REFlevel{1|2}? CHAN{1|2|3|4}
```

This query returns the current setting of the trace reference level for the specified channel. The response format is <NRf>.

Query example

```
MEAS:THR:REF1? CHAN4
```

Queries the trace reference level 1 setting for channel 4.

MEASure:THReshold:VALue CHAN{1|2|3|4}, <numeric_value>

This command sets the threshold value for any of the four channels.

Syntax

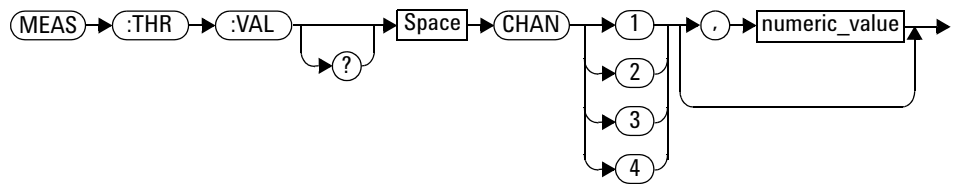

Parameter

Item	Description/Default	Range of values
numeric_value	A numeric value in % to set the measurement threshold: <ul style="list-style-type: none"> • Default value: 0% • Minimum value: 0% • Maximum value: 100% 	0% to 100%

Example

```
MEAS:THR:VAL CHAN1,60
```

This command sets the threshold value to 60% for channel 1.

Remark

If you set a measurement threshold value which exceeds its minimum or maximum limit, the value will be clipped to its minimum or maximum value respectively. Error -222, “Data out of range;Value clipped to minimum (#)” or -222, “Data out of range;Value clipped to maximum (#)” will occur.

Reset condition

On reset, the pulse duration level is set to 0%.

Query

```
MEASure:THReshold:VALue? CHAN{1|2|3|4}
```

This query returns the current setting of the threshold value for the specified channel. The response format is <NRf>.

Query example

```
MEAS:THR:VAL? CHAN1
```

Queries the threshold setting for channel 1.



10 MULTIPULse Subsystem

Overview	246
MULTIPULse:ACQuire:FRAMe	247
MULTIPULse:ACQuire:STATus?	248
MULTIPULse:ACQuire:COUNTer?	249
MULTIPULse:BACKWARD	250
MULTIPULse:HISTOGRAMBIN <numeric_value>	251
MULTIPULse:FORWARD	253
MULTIPULse:FRAMe <numeric_value>	254
MULTIPULse:GOTOFRAME <numeric_value>	256
MULTIPULse:PLAYBACK <character_data>	258
MULTIPULse:SAVE:MEASurement <string>,<character_data>	260
MULTIPULse:TIMEstamp:DATA?	262
MULTIPULse:TIMEstamp:DISPlay <boolean>	263

This chapter describes how the MULTIPULse command subsystem is used to acquire measurement results in the multipulse mode.



Overview

The MULTIPULse command subsystem allows you to set the multipulse mode parameters.

Keyword	Parameter form	Note	Page
MULTIPULse			
:ACQuire			
:FRAMe			page 247
:STATus?		[query only]	page 248
:COUNTer?		[query only]	page 249
:BACKWARD			page 250
:HISTOGRAMBIN	<numeric_value>		page 251
:FORWARD			page 253
:FRAMe	<numeric_value>		page 254
:GOTOFRAME	<numeric_value>		page 256
:PLAYBACK	<numeric_value>		page 258
:SAVE:MEASurement	<string>, <character_data>		page 260
:TIMEstamp:DATA?		[query only]	page 262
:TIMEstamp:DISPlay	<boolean>		page 263

MULTIPULse:ACQUIRE:FRAME

This command acquires the frames in the multipulse mode.

Syntax

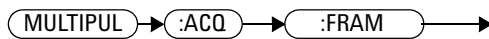

Example

```
MULTIPUL:ACQ:FRAME
```

This command acquires the frames in the multipulse mode.

Remark

This command is only applicable in the multipulse mode. If this query is sent in other modes, error -221, "Settings conflict; Required multipulse mode to set this setting." will occur.

MULTIPULse:ACQuire:STATus?

This query enters a 1 or 0 into the output buffer indicating the state of the multipulse acquisition.

- **1** is returned when the multipulse acquisition is completed.
- **0** is returned when the multipulse acquisition is still acquiring.

Syntax



Example

`MULTIPUL:ACQ:STAT?` *Queries the multipulse completion status.*

Remark

This command is only applicable in the multipulse mode. If this query is sent in other modes, error -221, “Settings conflict; Required multipulse mode to query this data” will occur.

MULTIPULse:ACQuire:COUNTer?

This query returns the multipulse acquisition number.

Syntax

MULTIPUL → :ACQ → :COUNT → ?

Example

MULTIPUL:ACQ:COUNT? *Queries the multipulse acquisition number.*

Remark

This command is only applicable in the multipulse mode. If this query is sent in other modes, error -221, “Settings conflict; Required multipulse mode to query this data” will occur.

MULTIPULse:BACKWARD

This command sets the multipulse backward by one frame.

Syntax

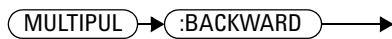

Example

`MULTIPUL:BACKWARD` *This command sets the multipulse backward by one frame.*

Remark

This command is only applicable in the multipulse mode. If this query is sent in other modes, error -221, “Settings conflict; Required multipulse mode to set this setting.” will occur.

MULTIPULse:HISTOGRAMBIN <numeric_value>

This command sets the multipulse histogram bin size.

Syntax

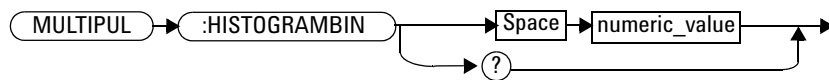

Parameter

Item	Description/Default	Range of values
numeric_value	A numeric value for the histogram bin size: <ul style="list-style-type: none"> • Default value: 10 • Minimum value: 5 • Maximum value: 20 	5 to 20

Example

MULTIPUL:HISTOGRAMBIN 7 *This command sets the multipulse histogram bin size to 7.*

Remark

This command is only applicable in the multipulse mode. If this query is sent in other modes, error -221, “Settings conflict; Required multipulse mode to set this setting.” will occur.

Reset condition

On reset, the multipulse histogram bin size is set to 10.

Query

```
MULTIPULse:HISTOGRAMBIN?
```

This query returns the current multipulse histogram bin size.

Query example

```
MULTIPUL:HISTOGRAMBIN?
```

Queries the current multipulse histogram bin size.

MULTIPULse:FORWARD

This command sets the multipulse forward by one frame.

Syntax

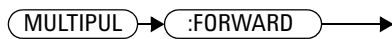

Example

`MULTIPUL:FORWARD` *This command sets the multipulse forward by one frame.*

Remark

This command is only applicable in the multipulse mode. If this query is sent in other modes, error -221, “Settings conflict; Required multipulse mode to set this setting.” will occur.

MULTIPULse:FRAMe <numeric_value>

This command sets the multipulse frame size.

Syntax

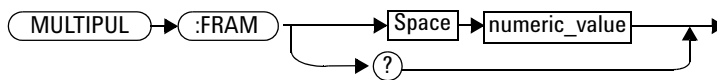

Parameter

Item	Description/Default	Range of values
numeric_value	A numeric value for the multipulse frame size: <ul style="list-style-type: none"> • Default value: 1 • Minimum value: 1 • Maximum value: 512 	1 to 512

Example

`MULTIPUL:FRAM 20` *This command sets the multipulse frame size to 20.*

Remark

This command is only applicable in the multipulse mode. If this query is sent in other modes, error -221, “Settings conflict; Required multipulse mode to set this setting.” will occur.

Reset condition

On reset, the multipulse frame size is set to 1.

Query

```
MULTIPULse:FRAMe?
```

This query returns the current multipulse frame size.

Query example

```
MULTIPUL:FRAM?
```

Queries the current multipulse frame size.

MULTIPULse:GOTOFRAME <numeric_value>

This command displays the selected multipulse frame size.

Syntax

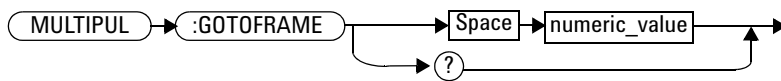

Parameter

Item	Description/Default	Range of values
numeric_value	A numeric value for the multipulse frame size: <ul style="list-style-type: none"> • Default value: 1 • Minimum value: 1 • Maximum value: Available frame size. 	1 to available frame size

Example

```
MULTIPUL:GOTOFRAME 20
```

This command displays frame 20 of the multipulse.

Remark

This command is only applicable in the multipulse mode. If this query is sent in other modes, error -221, "Settings conflict; Required multipulse mode to set this setting." will occur.

Reset condition

On reset, the selected multipulse frame size is set to 1.

Query

```
MULTIPULse:GOTOFRAME?
```

This query returns the current selected multipulse frame size.

Query example

```
MULTIPUL:GOTOFRAME?
```

Queries the current selected multipulse frame size.

MULTIPULse:PLAYBACK <character_data>

This command playbacks the multipulse state.

Syntax

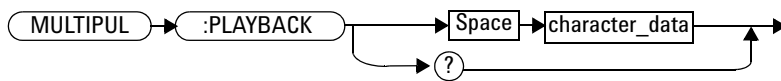

Parameter

Item	Description/Default	Range of values
character_data	Sets the multipulse playback status as: <ul style="list-style-type: none"> • START: Starts the playback. • STOP: Stops the playback. This is the default setting. 	START STOP

Example

```
MULTIPUL:PLAYBACK START
```

This command starts the multipulse playback.

Remark

This command is only applicable in the multipulse mode. If this query is sent in other modes, error -221, "Settings conflict; Required multipulse mode to set this setting." will occur.

Reset condition

On reset, the multipulse playback status is set to STOP.

Query

MULTIPULse:PLAYBACK?

This query returns the current multipulse playback status.

Query example

MULTIPUL:PLAYBACK?

Queries the current multipulse playback status.

MULTIPULse:SAVE:MEASurement <string>,<character_data>

This command saves the multipulse measurement of the selected channel to a .csv file.

Syntax

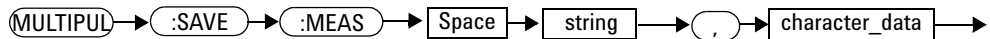

Parameter

Item	Description/Default	Range of values
string	Sets the file name to save to as a string value (""): <ul style="list-style-type: none"> The file name can be specified as a full path, for example, "c:\multipulse\xyz", or only the file name, "xyz". Any existing file with the same name will be overwritten automatically. The default file directory is the working directory where the 8990B software resides. The file extension is .csv. 	—
character_data	Sets the channel of the waveform as: <ul style="list-style-type: none"> CHAN1: Sets to channel 1. CHAN4: Sets to channel 4. 	CHAN1 CHAN4

Example

```
MULTIPUL:SAVE:MEAS "c:\multipulse\
test",CHAN4
```

This command saves the channel 4 multipulse measurement to c:\multipulse\test.csv.

Remark

- This command is only applicable for channels 1 and 4 in the multipulse acquisition mode.
- If an invalid file name is specified, error -257,“File name error” will occur. This error may also occur due to missing directory. Ensure that the directory exists.

MULTIPULse:TIMEstamp:DATA?

This query returns the multipulse time stamp data.

Syntax



Example

MULTIPUL:TIME:DATA? *Queries the multipulse time stamp data.*

Remark

This command is only applicable in the multipulse mode. If this query is sent in other modes, error -221, “Settings conflict; Required multipulse mode to query this data” will occur.

MULTIPULse:TIMEstamp:DISPlay <boolean>

This command enables or disables the multipulse time stamp.

Syntax

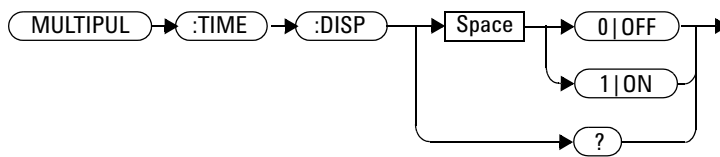

Example

MULTIPUL:TIME:DISP ON

This command displays the multipulse time stamp.

Remark

This command is only applicable in the multipulse mode. If this query is sent in other modes, error -221, “Settings conflict; Required multipulse mode to set this setting.” will occur.

Query

MULTPULse:TIMEstamp:DISPlay?

This query enters a 1 or 0 into the output buffer indicating the state of the multipulse time stamp.

- **1** is returned when the multipulse time stamp is enabled.
- **0** is returned when the multipulse time stamp is disabled.

Query example

MULTPUL:TIME:DISP?

Queries whether the multipulse time stamp is enabled or disabled.

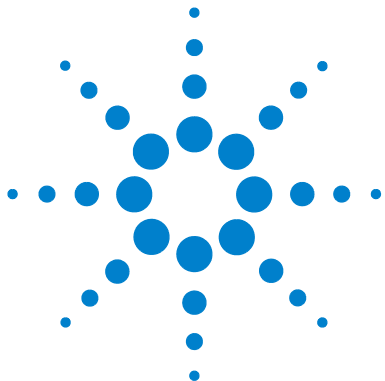

11 MARKer Subsystem

Overview	266
MARKer:ASLope <character_data>	267
MARKer:AXPosition <numeric_value>	269
MARKer:AYPosition <numeric_value>	271
MARKer:BSLope <character_data>	273
MARKer:BXPosition <numeric_value>	275
MARKer:BYPosition <numeric_value>	277
MARKer:ASOURce <character_data>	279
MARKer:BSOURce <character_data>	281
MARKer:LEVel <numeric_value>	283
MARKer:ALEVel <numeric_value>	285
MARKer:BLEVel <numeric_value>	287
MARKer:AYSEARCH <numeric_value>	289
MARKer:BYSEARCH <numeric_value>	291
MARKer:MODE <character_data>	293
MARKer:SPACing:PULSe{1 2} <numeric_value>	295
MARKer:SPACing:SOURce <character_data>	297
MARKer:YAMPRTATIO?	299
MARKer:XDELta?	300
MARKer:YDELta?	301

This chapter describes how the `MARKer` command subsystem is used to configure the marker setup for the trace.



Overview

The MARKer command subsystem controls the horizontal (X-axis) and vertical (Y-axis) marker functions of the trace.

Keyword	Parameter form	Note	Page
MARKer			
:ASLope	<character_data>		page 267
:AXPosition	<numeric_value>		page 269
:AYPosition	<numeric_value>		page 271
:BSLope	<character_data>		page 273
:BXPosition	<numeric_value>		page 275
:BYPosition	<numeric_value>		page 277
:ASOUrce	<character_data>		page 279
:BSOUrce	<character_data>		page 281
:ALEVel	<numeric_value>		page 285
:BLEVel	<numeric_value>		page 287
:AYSEARCH	<numeric_value>		page 289
:BYSEARCH	<numeric_value>		page 291
:MODE	<character_data>		page 293
:SPACing			
:PULSe{1 2}	<numeric_value>		page 295
:SOUrce	<character_data>		page 297
:YAMPRATIO?		[query only]	page 299
:XDELta?		[query only]	page 300
:YDELta?		[query only]	page 301

MARKer:ASLope <character_data>

This command sets the slope type of marker A.

NOTE

Prior to sending this command, you need to set the marker measurement mode to DELay or SPACing (refer to “MARKer:MODE <character_data>” on page 293).

Syntax

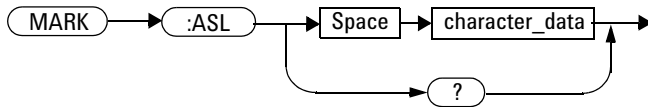

Parameter

Item	Description/Default	Range of values
character_data	Sets the marker A slope type as: <ul style="list-style-type: none"> • POSitive: Sets the slope to positive. This is the default setting. • NEGative: Sets the slope to negative. 	POSitive NEGative

Example

MARK:ASL POS

This command sets the marker A slope to positive.

Reset condition

On reset, the marker A slope is set to positive.

Query

MARKer:ASLope?

This query returns the current setting of the marker A slope.

Query example

MARK:ASL?

Queries the marker A slope setting.

MARKer:AXPosition <numeric_value>

This command sets the X-axis position of marker A.

NOTE

Prior to sending this command, you need to set the marker measurement mode to `MANual` (refer to “`MARKer:MODE <character_data>`” on page 293).

Syntax

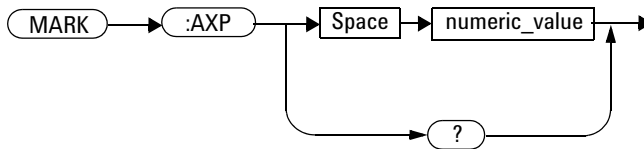

Parameter

Item	Description/Default
numeric_value	A numeric value in second for the X-axis position

Example

```
MARK:AXP 0.1
```

This command sets the X-axis position of marker A to 0.1 s.

Reset condition

On reset, marker A is disabled.

Query

MARKer:AXPosition?

This query returns the current setting of the marker A X-axis position.
The response format is <NRf>.

Query example

MARK:AXP?

Queries the X- axis position setting of marker A.

MARKer:AYPosition <numeric_value>

This command sets the Y-axis position of marker A in the free float mode. The MARKer:AYPosition command will place the marker A horizontal line over the input value, and the marker A vertical line will disappear. The query command will return the Y-axis position of the marker A.

To search for the corresponding points based on the input Y, use the marker searching feature (refer to “MARKer:AYSEARCH <numeric_value>” on page 289).

NOTE

Prior to sending this command, you need to set the marker measurement mode to FLOat (refer to “MARKer:MODE <character_data>” on page 293).

Syntax

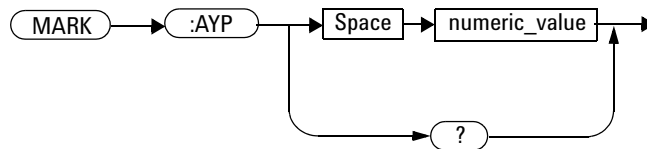

Parameter

Item	Description/Default
numeric_value	A numeric value for the Y-axis position

Example

MARK:AYP 0.1

This command sets the Y-axis position of marker A to 0.1.

Reset condition

On reset, marker A is disabled.

Query

MARKer:AYPosition?

This query returns the current setting of the marker A Y-axis position. The response format is <NRf> in the following units:

- dBm/W (for channels 1 and 4)
- V (for channels 2 and 3)

Query example

MARK:AYP?

Queries the Y-axis position setting of marker A.

MARKer:BSLope <character_data>

This command sets the slope type of marker B.

NOTE

Prior to sending this command, you need to set the marker measurement mode to DELay or SPACing (refer to “MARKer:MODE <character_data>” on page 293).

Syntax

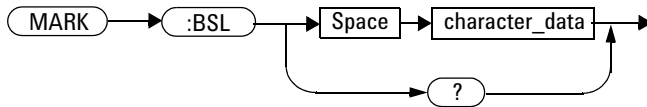

Parameter

Item	Description/Default	Range of values
character_data	Sets the marker B slope type as: <ul style="list-style-type: none"> • POSitive: Sets the slope to positive. This is the default setting. • NEGative: Sets the slope to negative. 	POSitive NEGative

Example

MARK:BSL POS

This command sets the marker B slope to positive.

Reset condition

On reset, the marker B slope is set to positive.

Query

MARKer:BSLope?

This query returns the current setting of the marker B slope.

Query example

MARK:BSL?

Queries the marker B slope setting.

MARKer:BXPosition <numeric_value>

This command sets the X-axis position of marker B.

NOTE

Prior to sending this command, you need to set the marker measurement mode to MANual (refer to “MARKer:MODE <character_data>” on page 293).

Syntax

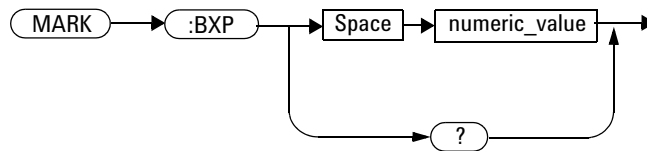

Parameter

Item	Description/Default
numeric_value	A numeric value in second for the X-axis position

Example

MARK: BXP 0.5

This command sets the X-axis position of marker B to 0.5 s.

Reset condition

On reset, marker B is disabled.

Query

MARKer:BXPosition?

This query returns the current setting of the marker B X-axis position.
The response format is <NRf>.

Query example

MARK: BXP?

Queries the X- axis position setting of marker B.

MARKer:BYPosition <numeric_value>

This command sets the Y-axis position of marker B in the free float mode. The MARKer:BYPosition command will place the marker B horizontal line over the input value, and the marker B vertical line will disappear. The query command will return the Y-axis position of the marker B.

To search for the corresponding points based on the input Y, use the marker searching feature (refer to “MARKer:BYSEARCH <numeric_value>” on page 291).

NOTE

Prior to sending this command, you need to set the marker measurement mode to FLOat (refer to “MARKer:MODE <character_data>” on page 293).

Syntax

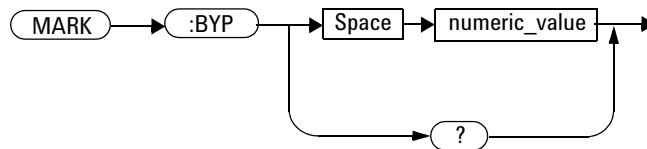

Parameter

Item	Description/Default
numeric_value	A numeric value for the Y-axis position

Example

MARK:BYP 0.1

This command sets the Y-axis position of marker B to 0.1.

Reset condition

On reset, marker B is disabled.

Query

MARKer:BYPosition?

This query returns the current setting of the marker B Y-axis position. The response format is <NRf> in the following units:

- dBm/W (for channels 1 and 4)
- V (for channels 2 and 3)

Query example

MARK:BYP?

Queries the Y-axis position setting of marker B.

MARKer:ASOUrce <character_data>

This command sets the source of marker A.

NOTE

Prior to sending this command, you need to set the marker measurement mode to MANual, DELay, or SPACing (refer to “MARKer:MODE <character_data>” on page 293).

Syntax

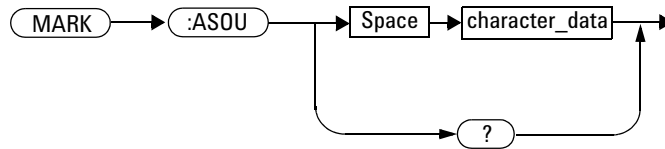

Parameter

Item	Description/Default	Range of values
character_data	Sets the marker A source as: <ul style="list-style-type: none"> • NONE: Disables the source. • CHAN1: Sets the source to channel 1. • CHAN2: Sets the source to channel 2. • CHAN3: Sets the source to channel 3. • CHAN4: Sets the source to channel 4. • WMEM1: Sets the source to waveform memory slot 1. • WMEM2: Sets the source to waveform memory slot 2. • WMEM3: Sets the source to waveform memory slot 3. • WMEM4: Sets the source to waveform memory slot 4. • FUNC1: Sets the source to waveform math function 1. • FUNC2: Sets the source to waveform math function 2. 	NONE ^[1] CHAN1 CHAN2 CHAN3 CHAN4 WMEM1 ^[1] WMEM2 ^[1] WMEM3 ^[1] WMEM4 ^[1] FUNC1 ^[1] FUNC2 ^[1]

[1] These parameters are not applicable when the marker measurement mode is set to DELay or SPACing.

Example

```
MARK:ASOU CHAN2
```

This command sets the marker A source to channel 2.

Remarks

- If a disabled channel is specified as the marker A source, error -221, "Settings conflict; Requires channel # to be enabled" will occur.
- If the marker measurement mode is set to DELay and the marker A source is the same as the marker B source, error 943, "Markers A and B are positioned on the same waveform" will occur.

Reset condition

On reset, marker A is disabled.

Query

```
MARKer:ASOUrce?
```

This query returns the current setting of the marker A source.

Query example

```
MARK:ASOU?
```

Queries the marker A source.

MARKer:BSOUrce <character_data>

This command sets the source of marker B.

NOTE

Prior to sending this command, you need to set the marker measurement mode to MANual, DELay, or SPACing (refer to “MARKer:MODE <character_data>” on page 293).

Syntax

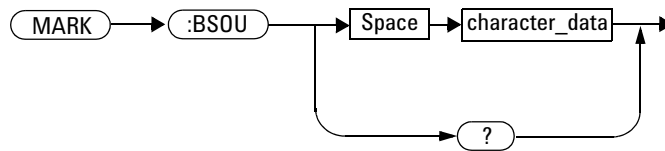

Parameter

Item	Description/Default	Range of values
character_data	<p>Sets the marker B source as:</p> <ul style="list-style-type: none"> • NONE: Disables the source. • CHAN1: Sets the source to channel 1. • CHAN2: Sets the source to channel 2. • CHAN3: Sets the source to channel 3. • CHAN4: Sets the source to channel 4. • WMEM1: Sets the source to waveform memory slot 1. • WMEM2: Sets the source to waveform memory slot 2. • WMEM3: Sets the source to waveform memory slot 3. • WMEM4: Sets the source to waveform memory slot 4. • FUNC1: Sets the source to waveform math function 1. • FUNC2: Sets the source to waveform math function 2. 	NONE ^[1] CHAN1 CHAN2 CHAN3 CHAN4 WMEM1 ^[1] WMEM2 ^[1] WMEM3 ^[1] WMEM4 ^[1] FUNC1 ^[1] FUNC2 ^[1]

[1] These parameters are not applicable when the marker measurement mode is set to DELay or SPACing.

Example

```
MARK:BSOU CHAN1
```

This command sets the marker B source to channel 1.

Remarks

- If a disabled channel is specified as the marker B source, error -221, “Settings conflict; Requires channel # to be enabled” will occur.
- If the marker measurement mode is set to DELay and the marker B source is the same as the marker A source, error 943, “Markers A and B are positioned on the same waveform” will occur.

Reset condition

On reset, marker B is disabled.

Query

```
MARKer:BSOUrce?
```

This query returns the current setting of the marker B source.

Query example

```
MARK:BSOU?
```

Queries the marker B source.

MARKer:LEVel <numeric_value>

This command sets the marker measurement level.

NOTE

- Prior to sending this command, you need to set the marker measurement mode to DELay or SPACing (refer to “MARKer:MODE <character_data>” on page 293).
- This command sets the marker level for both marker A and marker B.

Syntax

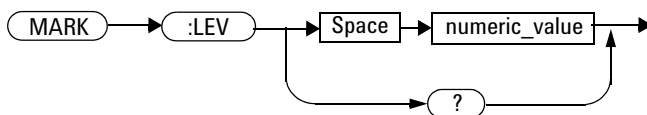

Parameter

Item	Description/Default	Range of values
numeric_value	<p>A numeric value in % for the marker measurement level:</p> <ul style="list-style-type: none"> • Default value: 50% • Minimum value: Reference level 1 (refer to “MEASure:THReshold:REFlevel{1 2} CHAN{1 2 3 4},<numeric_value>” on page 241, channel-dependent) • Maximum value: Reference level 2 (refer to “MEASure:THReshold:REFlevel{1 2} CHAN{1 2 3 4},<numeric_value>” on page 241, channel-dependent) 	Reference level 1 to reference level 2

Example

MARK:LEV 55 *This command sets the marker measurement level to 55%.*

Remark

If this query is sent when marker A and marker B have different measurement levels, error -400, “Query error;Unable to query marker level. Marker A and Marker B have different level. Refer to Programming Guide for further information.” will occur. You may use “MARKer:ALEvel <numeric_value>” or “MARKer:BLEvel <numeric_value>” to query the measurement level.

Reset condition

On reset, the marker measurement level is set to 50%.

Query

MARKer:LEVel?

This query returns the current setting of the marker measurement level. The response format is <NRf>.

Query example

MARK:LEV? *Queries the marker measurement level setting.*

MARKer:ALEVel <numeric_value>

This command sets the marker A measurement level.

NOTE

Prior to sending this command, you need to set the marker measurement mode to DELay or SPACing (refer to “MARKer:MODE <character_data>” on page 293).

Syntax

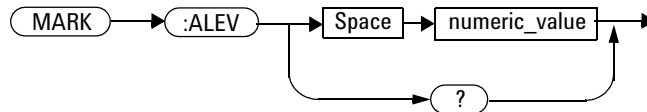

Parameter

Item	Description/Default	Range of values
numeric_value	A numeric value in % for the marker A measurement level: <ul style="list-style-type: none"> • Default value: 50% • Minimum value: Reference level 1 (refer to “MEASure:THReshold:REFlevel{1 2} CHAN{1 2 3 4},<numeric_value>” on page 241) • Maximum value: Reference level 2 (refer to “MEASure:THReshold:REFlevel{1 2} CHAN{1 2 3 4},<numeric_value>” on page 241) 	Reference level 1 to reference level 2

Example

MARK:ALEV 55 *This command sets the marker A measurement level to 55%.*

Reset condition

On reset, the marker A measurement level is set to 50%.

Query

MARKer:ALEVel?

This query returns the current setting of the marker A measurement level. The response format is <NRf>.

Query example

MARK:ALEV? *Queries the marker A measurement level setting.*

MARKer:BLEVel <numeric_value>

This command sets the marker B measurement level.

NOTE

Prior to sending this command, you need to set the marker measurement mode to DELay or SPACing (refer to “MARKer:MODE <character_data>” on page 293).

Syntax

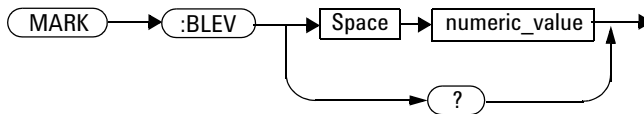

Parameter

Item	Description/Default	Range of values
numeric_value	<p>A numeric value in % for the marker B measurement level:</p> <ul style="list-style-type: none"> • Default value: 50% • Minimum value: Reference level 1 (refer to “MEASure:THReshold:REFlevel{1 2}CHAN{1 2 3 4},<numeric_value>” on page 241) • Maximum value: Reference level 2 (refer to “MEASure:THReshold:REFlevel{1 2}CHAN{1 2 3 4},<numeric_value>” on page 241) 	Reference level 1 to reference level 2

Example

MARK:BLEV 55 *This command sets the marker B measurement level to 55%.*

Reset condition

On reset, the marker B measurement level is set to 50%.

Query

MARKer:BLEV?

This query returns the current setting of the marker B measurement level. The response format is <NRf>.

Query example

MARK:BLEV? *Queries the marker B measurement level setting.*

MARKer:AYSEARCH <numeric_value>

This command sets the Y-axis input position of marker A.

Syntax

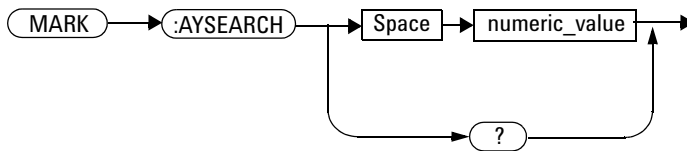

Parameter

Item	Description/Default
numeric_value	A numeric value for the Y-axis input position

Example

MARK:AYSEARCH 0.5 *This command sets the Y-axis position of marker A to 0.5.*

Query

MARKer:AYSEARCH?

This query returns a list of float values, which is the X-axis position of the Marker A Y-axis input position.

Query example

MARK:AYSEARCH?

Queries the X- axis position of the marker A Y- axis input position.

MARKer:BYSEARCH <numeric_value>

This command sets the Y-axis input position of marker B.

Syntax

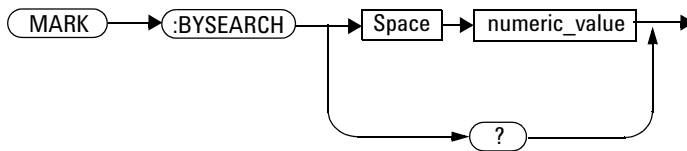

Parameter

Item	Description/Default
numeric_value	A numeric value for the Y-axis input position

Example

`MARK:BYSEARCH 0.5` *This command sets the Y-axis position of marker B to 0.5.*

Query

`MARKer:BYSEARCH?`

This query returns a list of float values, which is the X-axis position of the Marker B Y-axis input position.

Query example

MARK:BYSEARCH?

Queries the X- axis position of the marker B Y- axis input position.

MARKer:MODE <character_data>

This command sets the marker measurement mode.

Syntax

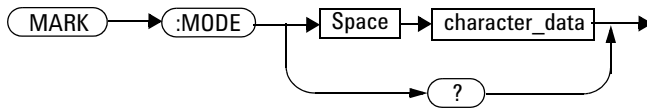

Parameter

Item	Description/Default	Range of values
character_data	Sets the marker measurement mode as: <ul style="list-style-type: none"> • OFF: Disables marker measurement. This is the default setting. • MANual: Enables manual placement of the marker. • DELay: Enables marker delay measurement between two traces. • SPACing: Enables marker spacing measurement between two pulses. • FLOAt: Enables free float placement of the marker. 	OFF MANual DELay SPACing FLOAt

Example

MARK:MODE MAN

This command sets the marker measurement mode to manual.

Reset condition

On reset, the marker measurement mode is set to OFF.

Query

MARKer:MODE?

This query returns the current setting of the marker measurement mode.

Query example

MARK:MODE?

Queries the marker measurement mode setting.

MARKer:SPACing:PULSe{1 | 2} <numeric_value>

This command sets the marker pulse spacing for spacing measurement. PULSe1 represents the lower pulse spacing while PULSe2 represents the upper pulse spacing.

Syntax

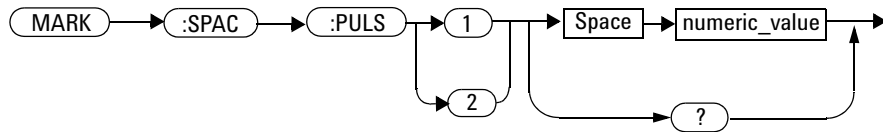

Parameter

Item	Description/Default	Range of values
numeric_value	A numeric value for the lower and upper pulse spacing: <ul style="list-style-type: none"> • Default values: <ul style="list-style-type: none"> • Lower pulse spacing (PULSe1): 1 (represents the 1st pulse) • Upper pulse spacing (PULSe2): 1 (represents the 1st pulse) • Minimum value: 1 (represents the 1st pulse) • Maximum value: 50 (represents the 50th pulse) 	1 to 50

Example

```

MARK:SPAC:PULS1 10
MARK:SPAC:PULS2 20
  
```

These commands set the marker pulse spacing for spacing measurement in between the 10th pulse and the 20th pulse.

Remarks

- This command is only applicable for the marker spacing measurement. If this command is sent for a marker measurement mode other than spacing, error -221, “Settings conflict; Requires to switch to pulse spacing marker measurement” will occur.
- If you set a pulse spacing value which exceeds its minimum or maximum limit, the value will be clipped to its minimum or maximum value respectively. Error -222, “Data out of range; Value clipped to minimum (#)” or -222, “Data out of range; Value clipped to maximum (#)” will occur.

Reset condition

On reset, the lower and upper pulse spacings are set to the 1st pulse and 2nd pulse respectively.

Query

```
MARKer:SPACing:PULSe{1|2}?
```

This query returns the current setting of the lower or upper marker pulse spacing. The response format is <NR1>.

Query example

```
MARK:SPAC:PULS1?
```

Queries the lower marker pulse spacing.

MARKer:SPACing:SOURce <character_data>

This command sets the marker source for spacing measurement on the same channel.

NOTE

- Prior to sending this command, you need to set the marker measurement mode to DELay or SPACing (refer to “MARKer:MODE <character_data>” on page 293).
- Alternatively, you can also use “MARKer:ASOURce <character_data>” or “MARKer:BSOURce <character_data>” to set the interchannel pulse spacing measurement.

Syntax

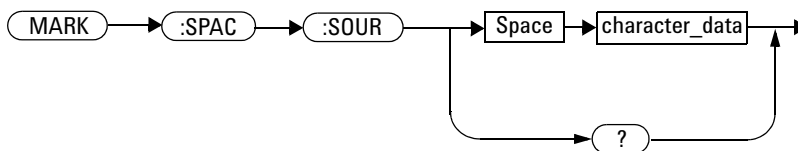

Parameter

Item	Description/Default	Range of values
character_data	Sets the marker source as: <ul style="list-style-type: none"> • CHAN1: Sets the source to channel 1. • CHAN2: Sets the source to channel 2. • CHAN3: Sets the source to channel 3. • CHAN4: Sets the source to channel 4. 	CHAN1 CHAN2 CHAN3 CHAN4

Example

MARK:SPAC:SOUR CHAN1 *This command sets the marker source for spacing measurement to channel 1.*

Remarks

- If a disabled channel is specified as the marker source, error -221,“Settings conflict;Requires channel # to be enabled” will occur.
- This command is only applicable for the marker spacing measurement. If this command is sent for a marker measurement mode other than spacing, error -221,“Settings conflict;Requires to switch to pulse spacing marker measurement” will occur.

Reset condition

On reset, the marker measurement mode is set to OFF.

Query

MARKer:SPACing:SOURce?

This query returns the current setting of the marker source for spacing measurement.

Query example

MARK:SPAC:SOUR? *Queries the marker source for spacing measurement.*

MARKer:YAMPRTATIO?

This query returns the amplitude ratio value.

Syntax



Example

MARK:YAMPRTATIO? *Queries the amplitude ratio value.*

MARKer:XDELta?

This query returns the X-axis delta value between the A and B markers.

Syntax

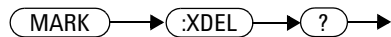

Example

MARK :XDEL? *Queries the marker X- axis delta value.*

MARKer:YDELta?

This query returns the Y-axis delta value between the A and B markers.

Syntax

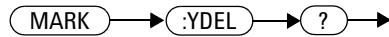

Example

MARK:YDEL?

Queries the marker Y-axis delta value.

THIS PAGE HAS BEEN INTENTIONALLY LEFT BLANK.



12 FUNCTION Subsystem

Overview 305

FUNCTION{1|2}:ADD <character_data>,<character_data>
[,<numeric_value>] 307

FUNCTION{1|2}:AVERaging <character_data>,<numeric_value> 309

FUNCTION{1|2}:COMMONmode
<character_data>,<character_data>,<numeric_value>] 310

FUNCTION{1|2}:DISPlay <boolean> 312

FUNCTION{1|2}:DIVide <character_data>,<character_data>
[,<numeric_value>] 313

FUNCTION{1|2}:INVert <character_data>[,<numeric_value>] 315

FUNCTION{1|2}:MAGNify <character_data>[,<numeric_value>] 317

FUNCTION{1|2}:MULtiply <character_data>,<character_data>
[,<numeric_value>] 318

FUNCTION{1|2}:PAE <character_data>,<character_data>,
<character_data>,<numeric_value>,<numeric_value> 320

FUNCTION{1|2}:PAE2 <character_data>,<character_data>,
<character_data>,<character_data>,<numeric_value>,
<numeric_value> 324

FUNCTION{1|2}:REFeRence <numeric_value> 328

FUNCTION{1|2}:REFeRence:POStion <character_data> 330

FUNCTION{1|2}:{SOURce1 | SOURce2}
<character_data>[,<numeric_value>] 332

FUNCTION{1|2}:{VDC | IDC | PGAIN}
<character_data>[,<numeric_value>] 334

FUNCTION{1|2}:{VDC | IDC | PIN | POUT}
<character_data>[,<numeric_value>] 337

FUNCTION{1|2}:SQUare <character_data>[,<numeric_value>] 340

FUNCTION{1|2}:SQRT <character_data>[,<numeric_value>] 341

FUNCTION{1|2}:SUBTRact <character_data>,<character_data>
[,<numeric_value>] 342



12 FUNCTION Subsystem

FUNCTION{1|2}:SCALE <numeric_value> 344

FUNCTION{1|2}:TRACE:DATA? 346

FUNCTION{1|2}:TRACE:PERCent <boolean> 347

This chapter explains how the FUNCTION command subsystem is used to perform mathematical operations on a pair of channels.

Overview

The FUNction command subsystem allows you to perform math operations (addition, subtraction, and division) on a selected pair of channels.

Keyword	Parameter form	Note	Page
FUNction{1 2}			
:ADD	<character_data>, <character_data> [, <numeric_value>]		page 307
:AVERaging	<character_data>, <numeric_value>		page 309
:COMMonmode	<character_data>, <character_data> [, <numeric_value>]		page 310
:DISPlay	<boolean>		page 312
:DIVide	<character_data>, <character_data> [, <numeric_value>]		page 313
:INVert	<character_data>[, <numeric_value>]		page 315
:MAGNify	<character_data>[, <numeric_value>]		page 317
:MULTiply	<character_data>, <character_data> [, <numeric_value>]		page 318
:PAE	<character_data>, <character_data>, <character_data>, <numeric_value>, <numeric_value>		page 320
:PAE2	<character_data>, <character_data>, <character_data>, <character_data>, <numeric_value>, <numeric_value>		page 324
:REFerence	<numeric_value>		page 328
:REFerence:POSit ion	<character_data>		page 330
:{SOURce1 SOURce 2}	<character_data>, [numeric_value]		page 332
:{VDC IDC PGAIN}	<character_data>, [numeric_value]		page 334
:{VDC IDC PIN PO UT}	<character_data>, [numeric_value]		page 337
:SQUare	<character_data>[, <numeric_value>]		page 340
:SQRT	<character_data>[, <numeric_value>]		page 341

12 FUNCtion Subsystem

Keyword	Parameter form	Note	Page
:SUBtract	<character_data>, <character_data> [, <numeric_value>]		page 342
:SCALE	<numeric_value>		page 344
:TRACe:DATA?		[query only]	page 346
:TRACe:PERCent	<Boolean>		page 347

FUNcTion{1 | 2}:ADD <character_data>,<character_data> [,<numeric_value>]

This command performs the addition operation on the specified channel pair. FUNcTion1 represents the first addition operation while FUNcTion2 represents the second addition operation.

NOTE

- The result of the addition will be displayed as an additional trace on the screen.
- If the source(s) input is in the log scale, it will be converted to the linear scale to perform the add math operation. The resultant trace is then converted back to dBm.
- If the trace length between the channels is not equal, the waveform math operation will find the shortest trace between the sources and shrink other traces to an equal length.
- If the number of trace points is not equal, the waveform math operation will add trace points by using the PCHIP method.

Syntax

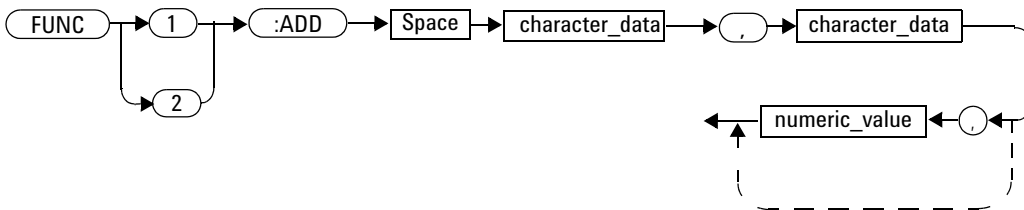

Parameter

Item	Description/Default	Range of values
character_data	Sets the source as: <ul style="list-style-type: none"> • CHANnel<n> • WMEMory<n> • CONStant where n = 1, 2, 3, or 4	CHANnel<n> WMEMory<n> CONStant
numeric_value	A numeric value as constant. <ul style="list-style-type: none"> • Default: 1 • Minimum: 100 μ • Maximum 10 k 	100 μ to 10 k

Example

`FUNC1:ADD CHAN1,CHAN4` *This command adds the values of channel 1 and channel 4.*

Remark

This command is only applicable for channel pair 1 and 4 or 2 and 3. If an invalid channel pair is specified, error 703, “Applicable in pair of channel 1 and 4 or 2 and 3” will occur.

FUNCTION{1 | 2}:AVERaging <character_data>,<numeric_value>

This command sets the source and count number for averaging. The averaging operation acquires the selected count number of the waveform and performs averaging.

Syntax

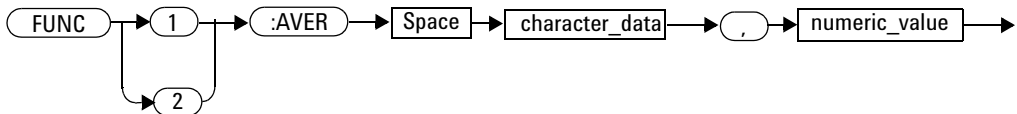

Parameter

Item	Description/Default	Range of values
character_data	Sets the source as: <ul style="list-style-type: none"> • CHANnel<n> • WMEMory<n> where n = 1, 2, 3, or 4	CHANnel<n> WMEMory<n>
numeric_value	A numeric value for the count number	

Example

```
FUNC1:AVER CHAN1,1
```

This command sets the source to CHAN1 and the count number to 1 for the averaging operation.

FUNCtion{1 | 2}:COMMOnmode <character_data>,<character_data>[,<numeric_value>]

This command sets the source for the common mode operation. The common mode operation adds two sources and divides the resultant by two. It is done point by point.

NOTE

- If the source(s) input is in the log scale, it will be converted to the linear scale to perform the common mode math operation. The resultant trace is then converted back to dBm.
- If the trace length between the channels is not equal, the waveform math operation will find the shortest trace between the channels and shrink other traces to an equal length.
- If the number of trace points is not equal, the waveform math operation will add trace points by using the PCHIP method.

Syntax

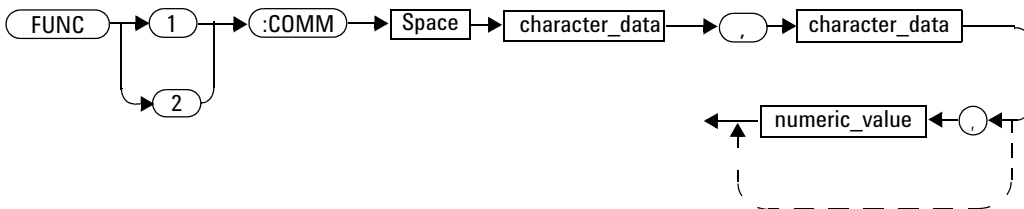

Parameter

Item	Description/Default	Range of values
character_data	Sets the source as: <ul style="list-style-type: none"> • CHANnel<n> • WMEMory<n> • CONStant where n = 1, 2, 3, or 4	CHANnel<n> WMEMory<n> CONStant
numeric_value	A numeric value as constant. <ul style="list-style-type: none"> • Default: 1 • Minimum: 100 μ • Maximum 10 k 	100 μ to 10 k

Example

`FUNC1:COMM CHAN1,WMEM1` *This command sets the source for the common mode operation to channel 1 and waveform memory 1.*

Remark

For the resultant trace that has unit other than dB, W, or V, the unit will be set to UDF (undefined).

FUNCTION{1 | 2}:DISPlay <boolean>

This command enables or disables the specified function trace to be displayed on the screen. FUNCTION1 represents function trace 1 while FUNCTION2 represents function trace 2.

Syntax

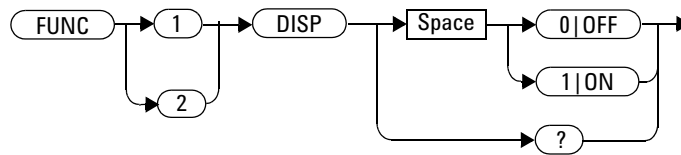

Example

FUNC1:DISP ON *This command turns on function trace 1.*

Query

FUNCTION{1 | 2}:DISPlay?

This query enters a 1 or 0 into the output buffer indicating the state of the function trace display.

- 1 is returned when the function trace is turned on
- 0 is returned when the function trace is turned off

Query example

FUNC1:DISP? *Queries whether function trace 1 is turned on or off.*

FUNCTION{1 | 2}:DIVide <character_data>,<character_data> [,<numeric_value>]

This command performs the division operation on the specified channel pair. FUNCTION1 represents the first division operation while FUNCTION2 represents the second division operation.

NOTE

- The result of the division will be displayed as an additional trace on the screen.
- If the source(s) input is in the log scale, it will be converted to the linear scale to perform the divide math operation. The resultant trace is then converted back to dB.
- If the trace length between the channels is not equal, the waveform math operation will find the shortest trace between the sources and shrink the other trace to an equal length.
- If the number of trace points is not equal, the waveform math operation will add trace points by using the PCHIP method.

Syntax

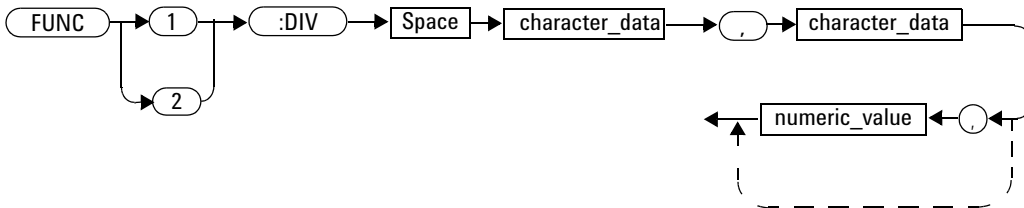

Parameter

Item	Description/Default	Range of values
character_data	Sets the source as: <ul style="list-style-type: none"> • CHANnel<n> • WMEMory<n> • CONStant where n = 1, 2, 3, or 4	CHANnel<n> WMEMory<n> CONStant
numeric_value	A numeric value as constant. <ul style="list-style-type: none"> • Default: 1 • Minimum: 100 μ • Maximum 10 k 	100 μ to 10 k

Example

`FUNC1:DIV CHAN2,CHAN3` *This command divides the values of channel 2 with the values of channel 3.*

Remark

This command is only applicable for channel pair 1 and 4 or 2 and 3. If an invalid channel pair is specified, error 703, “Applicable in pair of channel 1 and 4 or 2 and 3” will occur.

FUNCTION{1 | 2}:INVert <character_data>[,<numeric_value>]

This command sets the source for the invert operation. The invert operation inverts the sign of the trace point. It is done point by point.

Syntax

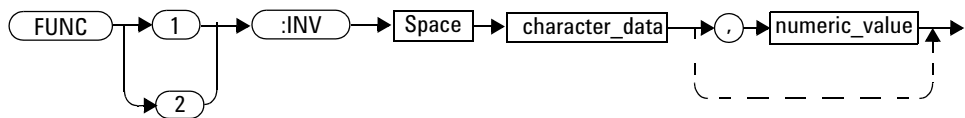

Parameter

Item	Description/Default	Range of values
character_data	Sets the source as: <ul style="list-style-type: none"> • CHANnel<n> • WMEMory<n> • CONSTant where n = 1, 2, 3, or 4	CHANnel<n> WMEMory<n> CONSTant
numeric_value	A numeric value as constant. <ul style="list-style-type: none"> • Default: 1 • Minimum: 100 μ • Maximum 10 k 	100 μ to 10 k

Example

```
FUNC1:INV CHAN1
```

This command sets the source for the invert operation to channel 1.

Remark

For the resultant trace that has unit other than dB, W, or V, the unit will be set to UDF (undefined).

FUNCTION{1 | 2}:MAGNify <character_data>[,<numeric_value>]

This command sets the source for the magnify operation. The magnify operation magnifies or reduces the source waveform vertically. This operation is performed on an acquired waveform. Therefore, the resolution is the same as the original acquisition no matter how large the waveform is magnified.

Syntax

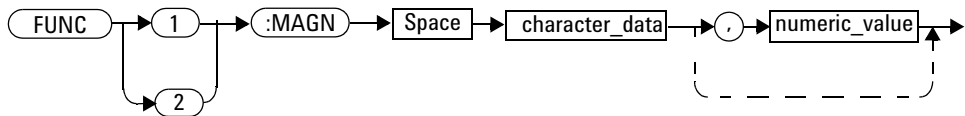

Parameter

Item	Description/Default	Range of values
character_data	Sets the source as: <ul style="list-style-type: none"> • CHANnel<n> • WMEMory<n> • CONStant where n = 1, 2, 3, or 4	CHANnel<n> WMEMory<n> CONStant
numeric_value	A numeric value as constant. <ul style="list-style-type: none"> • Default: 1 • Minimum: 100 μ • Maximum 10 k 	100 μ to 10 k

Example

FUNC1 :MAGN CHAN1

This command sets the source for the magnify operation to channel 1.

FUNCTION{1 | 2}:MULTIPLY <character_data>, <character_data> [, <numeric_value>]

This command sets the source for the multiply operation. The multiply operation multiplies two sources point by point.

NOTE

- If the source(s) input is in the log scale, it will be converted to the linear scale to perform the multiply math operation. The resultant trace will have the undefined (UDF) unit.
- If the trace length between the channels is not equal, the waveform math operation will find the shortest trace between the channels and shrink other traces to an equal length.
- If the number of trace points is not equal, the waveform math operation will add trace points by using the PCHIP method.

Syntax

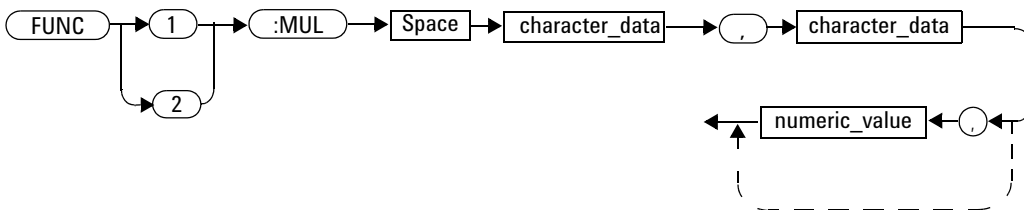

Parameter

Item	Description/Default	Range of values
character_data	Sets the source as: <ul style="list-style-type: none"> • CHANnel<n> • WMEMory<n> • CONSTant where n = 1, 2, 3, or 4	CHANnel<n> WMEMory<n> CONSTant
numeric_value	A numeric value as constant. <ul style="list-style-type: none"> • Default: 1 • Minimum: 100 μ • Maximum 10 k 	100 μ to 10 k

Example

`FUNC1:MUL CHAN1,WMEM1` *This command sets the source for the multiply operation to channel 1 and waveform memory 1.*

Remark

For the resultant trace that has unit other than dB, W, or V, the unit will be set to UDF (undefined).

FUNCTION{1 | 2}:PAE <character_data>,<character_data>,<character_data>,<numeric_value>,<numeric_value>

This command performs the PAE operation on the specified channel. FUNCTION1 represents the first PAE operation while FUNCTION2 represents the second PAE operation.

$$\frac{P_{GAIN}}{P_{DC}} = \frac{P_{GAIN}}{V_{DC} \times I_{DC}} = \frac{3rd\ character_data}{(1st\ numeric_value)(1st\ character_data) \times (2nd\ numeric_value)(2nd\ character_data)}$$

Syntax

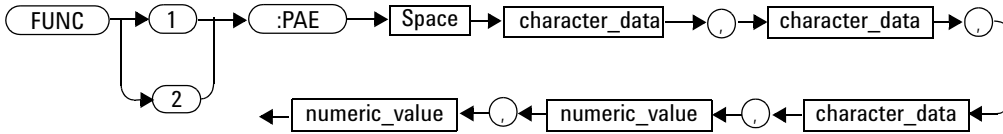

NOTE

- From the Waveform Math dialog, you can toggle the **X** button to select between multiplication symbol (x) or division symbol (/) as the symbol type.. The multiplication symbol (x) is the default setting. If the multiplication symbol (x) is used, the constant value sent through SCPI will be updated in the text box accordingly. If the division symbol (/) is used, the constant value sent through SCPI will be displayed as 1/(constant value) in the text box.
 - If the amplifier gain is more than 30 dB, the nominator can be set to a single RF input channel.
 - The power-added efficiency result is an absolute and non-negative value.
 - The denominator PDC must be a real and non-zero value.
 - The dBm and power conversion formula is $10 \times \log (\text{power}/1 \text{ mW})$
 - If the trace lengths among the channels are not equal, the waveform math operation will find the shortest trace among the sources and shrink the other traces to an equal length.
 - If the number of trace points is not equal, the waveform math operation will add trace points by using the PCHIP method.
 - If the source(s) input is in the log scale, it will be converted to the linear scale to perform the power-added efficiency measurement.
-

Parameter

Item	Description/Default	Range of values
character_data	<p>Sets IDC as:</p> <ul style="list-style-type: none"> • CHANnel<n> where n = 2 or 3 • WMEMory<n> where n = 1, 2, 3, or 4 (only for linear waveform) • CONStant • CH2MCH3: Sets to the resultant trace of channel 2 subtract channel 3.^[1] • CH3MCH2: Sets to the resultant trace of channel 3 subtract channel 2.^[1] <p>Sets VDC as:</p> <ul style="list-style-type: none"> • CHANnel<n> where n = 2 or 3 • WMEMory<n> where n = 1, 2, 3, or 4 (only for linear waveform) • CONStant <p>Sets PGAIN as:</p> <ul style="list-style-type: none"> • CHANnel<n> where n = 1 or 4 • WMEMory<n> where n = 1, 2, 3, or 4 (only for linear waveform) • CONStant 	CHANnel<n> WMEMory<n> CONStant ^[2] CH2MCH3 CH3MCH2
numeric_value	<p>A numeric value as constant.</p> <ul style="list-style-type: none"> • Default: 1 • Minimum: 100 μ • Maximum 10 k 	100 μ to 10 k

[1] CH2MCH3 and CH3MCH2 parameters are only applicable for the IDC source.

[2] For VDC and IDC, if the constant is set as a source, the value can be set by replacing the <numeric_data> slot. For PGAIN, the value can be appended after the 5 required parameters.

First character_data is set to V_{DC} source.

First numeric_value is set to V_{DC} constant.

Second character_data is set to I_{DC} source.

Second numeric_value is set to I_{DC} constant.

Third character_data is set to P_{GAIN} .

Example

`FUNC1:PAE CHAN2,CHAN3,CHAN4,1,5`

This command performs the PAE operation by setting VDC to channel 2, VDC constant to 1, IDC to channel 3, IDC constant to 5, and PGAIN to channel 4..

`FUNC1:PAE CONS,CONS,CHAN4,2,5`

This command performs the PAE operation by setting VDC constant to 2, IDC constant to 5, and PGAIN to channel 4..

FUNCTION{1 | 2}:PAE2 <character_data>,<character_data>, <character_data>,<character_data>,<numeric_value>, <numeric_value>

This command performs the PAE2 operation on the specified channel. FUNCTION1 represents the first PAE2 operation while FUNCTION2 represents the second PAE2 operation.

$$\frac{P_{\text{GAIN}}}{P_{\text{DC}}} = \frac{P_{\text{OUT}} - P_{\text{IN}}}{V_{\text{DC}} \times I_{\text{DC}}} = \frac{3\text{rd character_data} - 4\text{th character_data}}{(1\text{st numeric_value})(1\text{st character_data}) \times (2\text{nd numeric_value})(2\text{nd character_data})}$$

Syntax

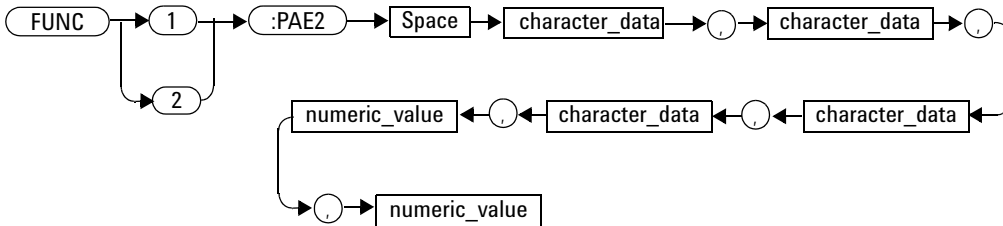

NOTE

- From the Waveform Math dialog, you can toggle the **X** button to select between multiplication symbol (x) or division symbol (/) as the symbol type.. The multiplication symbol (x) is the default setting. If the multiplication symbol (x) is used, the constant value sent through SCPI will be updated in the text box accordingly. If the division symbol (/) is used, the constant value sent through SCPI will be displayed as 1/(constant value) in the text box.
- If the amplifier gain is more than 30 dB, the nominator can be set to a single RF input channel.
- The power-added efficiency result is an absolute and non-negative value.
- The denominator PDC must be a real and non-zero value.
- The dBm and power conversion formula is $10 \times \log (\text{power}/1 \text{ mW})$
- If the trace lengths among the channels are not equal, the waveform math operation will find the shortest trace among the sources and shrink the other traces to an equal length.
- If the number of trace points is not equal, the waveform math operation will add trace points by using the PCHIP method.

If the source(s) input is in the log scale, it will be converted to the linear scale to perform the power-added efficiency measurement.

Parameter

Item	Description/Default	Range of values
character_data	<p>Sets IDC as:</p> <ul style="list-style-type: none"> • CHANnel<n> where n = 2 or 3 • WMEMory<n> where n = 1, 2, 3, or 4 (only for linear waveform) • CONStant • CH2MCH3: Sets to the resultant trace of channel 2 subtract channel 3.^[1] • CH3MCH2: Sets to the resultant trace of channel 3 subtract channel 2.^[1] <p>Sets VDC as:</p> <ul style="list-style-type: none"> • CHANnel<n> where n = 2 or 3 • WMEMory<n> where n = 1, 2, 3, or 4 (only for linear waveform) • CONStant <p>Sets POUT as:</p> <ul style="list-style-type: none"> • CHANnel<n> where n = 1 or 4 • WMEMory<n> where n = 1, 2, 3, or 4 (only for linear waveform) • CONStant <p>Sets PIN as:</p> <ul style="list-style-type: none"> • CHANnel<n> where n = 1 or 4 • WMEMory<n> where n = 1, 2, 3, or 4 (only for linear waveform) • CONStant 	CHANnel<n> WMEMory<n> CONStant CH2MCH3 CH3MCH2
numeric_value	<p>A numeric value as constant.</p> <ul style="list-style-type: none"> • Default: 1 • Minimum: 100 μ • Maximum 10 k 	100 μ to 10 k

[1] CH2MCH3 and CH3MCH2 parameters are only applicable for the IDC source.

First character_data is set to V_{DC} source.

First numeric_value is set to V_{DC} constant.

Second character_data is set to I_{DC} source.

Second numeric_value is set to I_{DC} constant.

Third character_data is set to P_{OUT} .

Fourth character_data is set to P_{IN} .

Example

`FUNC1:PAE2 CHAN3,CHAN2,CHAN1,CHAN4,2,6` *This command performs the PAE2 operation by setting VDC to channel 3, VDC constant to 3, IDC to channel 2, IDC constant to 6, POUT to channel 1, and PIN to channel 4.*

`FUNC1:PAE2 CONS,CONS,CHAN4,CHAN1,2,3` *This command performs the PAE2 operation by setting VDC constant to 2, IDC constant to 3, POUT to channel 4, and PIN to channel 1.*

FUNCTION{1 | 2}:REFERENCE <numeric_value>

This command sets the reference level for the function trace.

Syntax

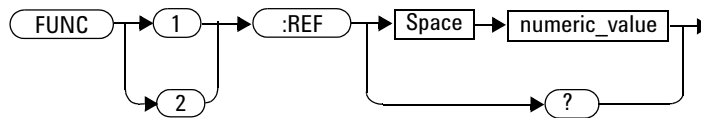

Parameter

Item	Description/Default	Range of values
numeric_value	A numeric value for the reference level Default: 0	For trace unit in W: 0 to 1000 For trace with unit other than W: -1000 to 1000

Example

```
FUNC1:REF 10
```

This command sets the function 1 reference level to 10.

Reset condition

On reset, the reference level is set to 0.

Query

```
FUNCTION{1|2}:REFERENCE?
```

This query returns the current reference level. The response format is <NRF>.

Query example

```
FUNC1:REF?
```

Queries the reference level for function 1.

FUNCTION{1 | 2}:REFERENCE:POSITION <character_data>

This command sets the reference type for the function trace.

Syntax

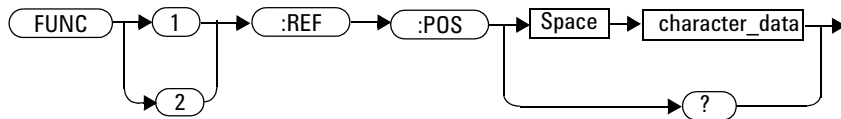

Parameter

Item	Description/Default	Range of values
character_data	Sets the reference type as: <ul style="list-style-type: none"> • TOP: Sets the reference type to top • BOTTom: Sets the reference type to bottom • CENTre: Sets the reference type to centre. This is the default setting. 	TOP BOTTom CENTre

Example

```
FUNC1:REF:POS BOTT
```

This command sets the function trace reference type to bottom.

Reset condition

On reset, the reference type is set to CENTre.

Query

```
FUNCTION{1|2}:REFERENCE:POSITION?
```

This query returns the current reference type.

Query example

```
FUNC1:REF:POS? Queries the reference type for function 1.
```

FUNCtion{1 | 2}:{SOURce1 | SOURce2} <character_data>[,<numeric_value>]

This command sets the source for each of the source term. This is an alternative SCPI command to change the source without using SCPI commands with operand.

NOTE

- Prior to sending this command, you need to set the math function to ADD, AVERaging, COMMONmode, DIVide, INVert, MAGNify, MULTiply, SQUare, SQRT, or SUBTract. Refer to the respective commands as listed in “Overview” on page 305.
- <numeric_value> for this command is an optional parameter, which is used for setting SOURce1 or SOURce2 as CONSTANT.

Syntax

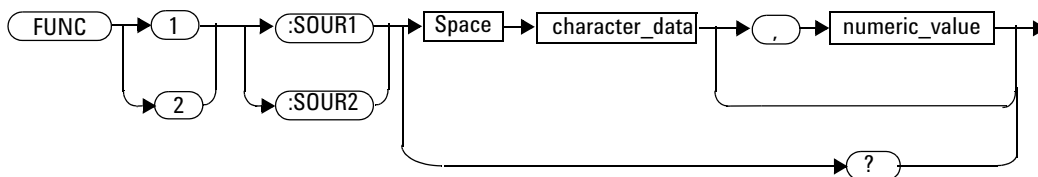

Parameter

Item	Description/Default	Range of values
character_data	Sets the source as: <ul style="list-style-type: none"> • CHANnel<n> • WMEMory<n> • CONStant where n = 1, 2, 3, or 4	CHANnel<n> WMEMory<n> CONStant ^[1]
numeric_value	This numeric value is an optional parameter	

[1] This is not applicable for averaging.

Example

FUNC1:SOUR1 CHAN1

This command sets the source to CHAN1 for the source 1.

FUNC1:SOUR1 CONS,5

This command sets the source to CONSTANT with the value at 5 for the source 1.

Query

FUNCTION{1|2}:{SOURCE1|SOURCE2}?

This query returns the current source for the desired source term.

Query example

FUNC1:SOUR1?

Queries the current source for function 1 source 1.

FUNCTION{1 | 2}:{VDC | IDC | PGAIN} <character_data>[,<numeric_value>]

This command sets the source for each of the source term. This is an alternative SCPI command to change the source without using SCPI commands with operand.

NOTE

- Prior to sending this command, you need to set the math function to operation to PAE. Refer to “FUNCTION{1 | 2}:PAE <character_data>,<character_data>,<character_data>,<numeric_value>,<numeric_value>” on page 320.
- VDC is voltage supplied, IDC is current supplied, and PGAIN is the power gain for PAE.
- <numeric_value> for this command is an optional parameter, which is used for setting VDC, IDC, or PGAIN as CONSTANT.

Syntax

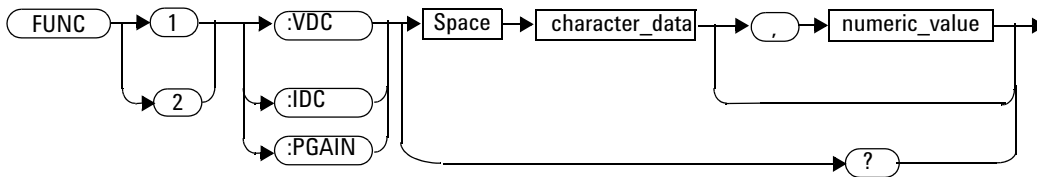

Parameter

Item	Description/Default	Range of values
character_data	Sets VDC or IDC as: <ul style="list-style-type: none"> • CHANnel<n> • WMEMory<n> • CONStant • CH2MCH3: Sets to the resultant trace of channel 2 subtract channel 3.^[1] • CH3MCH2: Sets to the resultant trace of channel 3 subtract channel 2.^[1] where n = 2 or 3 Sets PGAIN as: <ul style="list-style-type: none"> • CHANnel<n> • WMEMory<n> • CONStant where n = 1 or 4	CHANnel<n> WMEMory<n> CONStant CH2MCH3 CH3MCH2
numeric_value	This numeric value is an optional parameter	

[1] CH2MCH3 and CH3MCH2 parameters are only applicable for the IDC source.

Example

```
FUNC1:IDC CH2MCH3
```

This command sets the current IDC to the resultant trace of channel 2 subtract channel 3.

```
FUNC1:PGAIN CHAN1
```

This command sets the power gain PGAIN to channel 1.

Query

```
FUNCTION{1|2}:{VDC|IDC|PGAIN}?
```

This query returns the current source for the desired source term.

Query example

FUNC1:VDC? *Queries the current source for function 1 VDC.*

FUNCTION{1 | 2}:{VDC | IDC | PIN | POUT} <character_data>[,<numeric_value>]

This command sets the source for each of the source term. This is an alternative SCPI command to change the source without using SCPI commands with operand.

NOTE

- Prior to sending this command, you need to set the math function to operation to PAE2. Refer to “FUNCTION{1 | 2}:PAE2 <character_data>,<character_data>,<character_data>,<character_data>,<numeric_value>,<numeric_value>” on page 324.
- VDC is voltage supplied, IDC is current supplied, PIN is the power input for PAE2, and POUT is the power output for PAE2.
- <numeric_value> for this command is an optional parameter, which is used for setting VDC, IDC, PIN, or POUT as CONSTANT.

Syntax

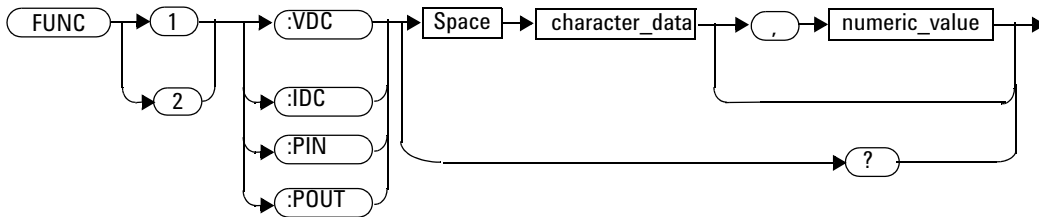

Parameter

Item	Description/Default	Range of values
character_data	Sets VDC or IDC as: <ul style="list-style-type: none"> • CHANnel<n> • WMEMory<n> • CONStant • CH2MCH3: Sets to the resultant trace of channel 2 subtract channel 3.^[1] • CH3MCH2: Sets to the resultant trace of channel 3 subtract channel 2.^[1] where n = 2 or 3 Sets PIN or POUT as: <ul style="list-style-type: none"> • CHANnel<n> • WMEMory<n> • CONStant where n = 1 or 4	CHANnel<n> WMEMory<n> CONStant CH2MCH3 CH3MCH2
numeric_value	This numeric value is an optional parameter	

[1] CH2MCH3 and CH3MCH2 parameters are only applicable for the IDC source.

Example

```
FUNC1:IDC CH2MCH3
```

This command sets the current IDC to the resultant trace of channel 2 subtract channel 3.

```
FUNC1:PIN CHAN1
```

This command sets the power input PIN to channel 1.

Query

```
FUNCTION{1|2}:{VDC|IDC|PIN|POUT}?
```

This query returns the current source for the desired source term.

Query example

FUNC1 : IDC? *Queries the current source for function 1 IDC.*

FUNCTION{1 | 2}:SQUare <character_data>[,<numeric_value>]

This command sets the source for the square operation. The square operation squares each trace point of the source trace point.

Syntax

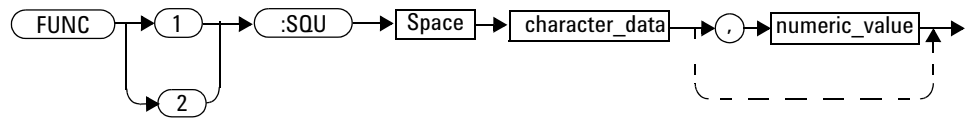

Parameter

Item	Description/Default	Range of values
character_data	Sets the source as: <ul style="list-style-type: none"> • CHANnel<n> • WMEMory<n> • CONStant where n = 1, 2, 3, or 4	CHANnel<n> WMEMory<n> CONStant
numeric_value	A numeric value as constant. <ul style="list-style-type: none"> • Default: 1 • Minimum: 100 μ • Maximum 10 k 	100 μ to 10 k

Example

```
FUNC1:SQU CHAN1
```

This command sets the source for the square operation to channel 1.

Remark

For the resultant trace that has unit other than dB, W, or V, the unit will be set to UDF (undefined).

FUNction{1 | 2}:SQRT <character_data>[,<numeric_value>]

This command sets the source for the square root operation. The square root operation square roots each trace point of the source trace point. The square root operation will clip trace points with negative values to zero.

Syntax

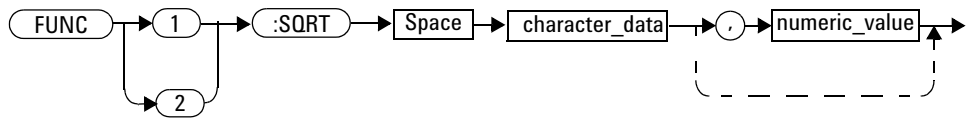

Parameter

Item	Description/Default	Range of values
character_data	Sets the source as: <ul style="list-style-type: none"> • CHANnel<n> • WMEMory<n> • CONSTant where n = 1, 2, 3, or 4	CHANnel<n> WMEMory<n> CONSTant
numeric_value	A numeric value as constant. <ul style="list-style-type: none"> • Default: 1 • Minimum: 100 μ • Maximum 10 k 	100 μ to 10 k

Example

`FUNC1:SQRT CHAN1`

This command sets the source for the square root operation to channel 1.

Remark

For the resultant trace that has unit other than dB, W, or V, the unit will be set to UDF (undefined).

FUNCTION{1 | 2}:SUBTRACT <character_data>, <character_data> [, <numeric_value>]

This command performs the subtraction operation on the specified channel pair. FUNCTION1 represents the first subtraction operation while FUNCTION2 represents the second subtraction operation.

NOTE

- The result of the subtraction will be displayed as an additional trace on the screen.
- If the source(s) input is in the log scale, it will be converted to the linear scale to perform the subtract math operation. The resultant trace is then converted back to dBm.
- If the trace length between the channels is not equal, the waveform math operation will find the shortest trace between the sources and shrink other traces to an equal length.
- If the number of trace points is not equal, the waveform math operation will add trace points by using the PCHIP method.

Syntax

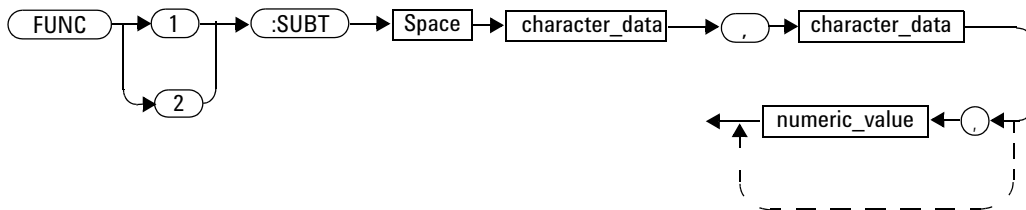

Parameter

Item	Description/Default	Range of values
character_data	Sets the source as: <ul style="list-style-type: none"> • CHANnel<n> • WMEMory<n> • CONStant where n = 1, 2, 3, or 4	CHANnel<n> WMEMory<n> CONStant
numeric_value	A numeric value as constant. <ul style="list-style-type: none"> • Default: 1 • Minimum: 100 μ • Maximum 10 k 	100 μ to 10 k

Example

`FUNC1 : SUBT CHAN2 , CHAN3` *This command subtracts the values of channel 3 from the values of channel 2.*

Remark

This command is only applicable for channel pair 1 and 4 or 2 and 3. If an invalid channel pair is specified, error 703, “Applicable in pair of channel 1 and 4 or 2 and 3” will occur.

FUNCtion{1 | 2}:SCALE <numeric_value>

This command sets the scale for any of the two functions.

Syntax

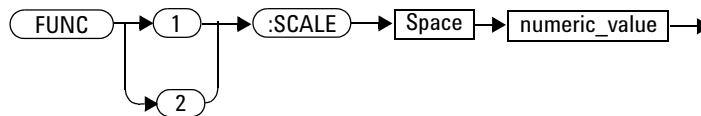

Parameter

Item	Description/Default	Range of values
numeric_value	A numeric value as constant. <ul style="list-style-type: none"> • Default: 1 • Maximum: <ul style="list-style-type: none"> • 100 dB per division (for trace unit dBm) • 10 k per division (for other trace unit) • Minimum: <ul style="list-style-type: none"> • 0.01 dB per division (for trace unit dBm) • 1 n per division (for other trace unit) 	For trace unit in dBm: 0.01 dB/div to 100 dB/div For trace with unit other than dBm: 1 n/div to 10 k/div

Example

```
FUNC1:SCALE 10
```

This command sets the function 1 scale to 10/div.

Remark

If you set a scale value which exceeds its minimum or maximum limit, the value will be clipped to its minimum or maximum value respectively.

Reset condition

On reset, the scale is set to 1.00 dB/div.

Query

```
FUNC{1|2}:SCALE?
```

This query returns the current setting of the scale for the specified function. The response format is <NRf>.

Query example

```
FUNC1:SCALE?
```

Queries the scale setting for function 1.

FUNCtion{1 | 2}:TRACe:DATA?

This query returns the current trace data of the specified source. The data is returned as a definite-length binary block of floating point numbers.

Syntax

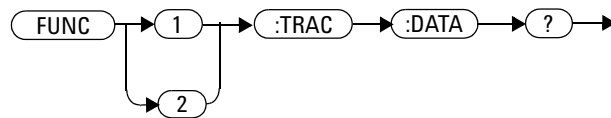

Example

`FUNC1:TRAC:DATA?` *Queries the current trace data for function 1.*

FUNCTION{1 | 2}:TRACe:PERCent <boolean>

This command enables or disables the trace display in percentage.

Syntax

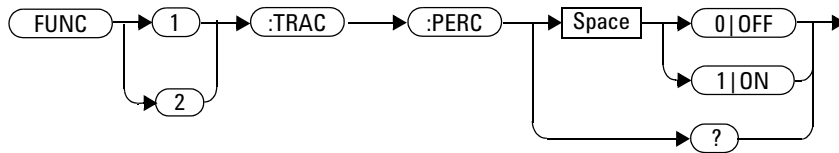

Example

`FUNC1:TRAC:PERC ON` *This command displays the function trace 1 in percentage.*

Remark

This command is only applicable for the PAE or PAE2 operation.

Reset condition

On reset, the trace is not displayed in percentage.

Query

```
FUNCTION{1|2}:TRACE:PERCENT?
```

This query returns a 1 or 0 into the output buffer indicating whether the function trace is displayed in percentage.

- 1 is returned when the function trace is set to percentage
- 0 is returned when the function trace is not set to percentage

Query example

```
FUNC1:TRAC:PERC?
```

Queries whether function trace 1 is set to percentage.



13 TRACe Subsystem

Overview [350](#)

TRACe:DATA? <character_data>[,HRES] [351](#)

TRACe:XINCrement? <character_data> [354](#)

TRACe:XSTART? [355](#)

This chapter describes how the TRACe command subsystem is used to acquire the waveform trace data and the duration between consecutive data points.



Overview

The TRACe command subsystem is used to obtain the trace data and the duration between consecutive data points of the 8990B.

Keyword	Parameter form	Note	Page
TRACe			
:DATA?	<character_data> [,HRES]	[query only]	page 351
:XINcrement?	<character_data>	[query only]	page 354
:XSTART		[query only]	page 355

TRACe:DATA? <character_data>[,HRES]

This query returns the current trace data of the specified source. The data is returned as a definite-length binary block of floating point numbers.

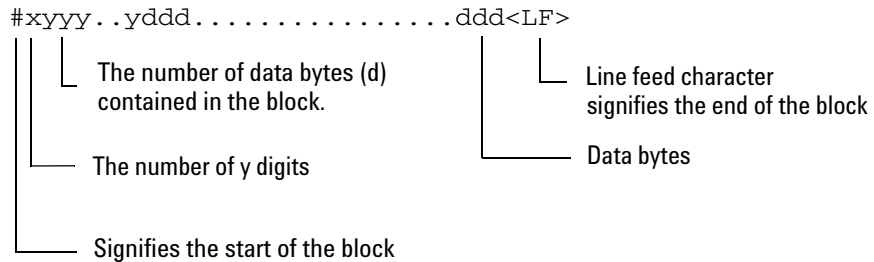

Example: if there are 12435 data bytes, y = 12435 and x = 5

Each point in the trace is represented as an IEEE-754 32-bit floating point number, made up of four bytes in the data block. The MS byte is transmitted first. Each complete block is terminated by a line feed.

[,HRES] is an optional parameter which returns high-resolution data when specified.

NOTE

- [,HRES] is only applicable for channels 1 and 4.
- When the acquisition is stopped or paused, using the [,HRES] parameter is not able to return any trace data.
- This command is only applicable for timebase scale below 2 ms.

Syntax

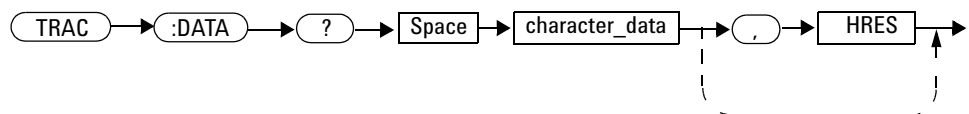

Parameter

Item	Description/Default	Range of values
character_data	Sets the source as: <ul style="list-style-type: none"> • CHAN1: Sets the channel 1 trace. • CHAN2: Sets the channel 2 trace. • CHAN3: Sets the channel 3 trace. • CHAN4: Sets the channel 4 trace. • CCDF1: Sets the channel 1 CCDF trace. • CCDF4: Sets the channel 4 CCDF trace. • CREference: Sets the CCDF reference trace. • CGAUssian: Sets the CCDF Gaussian trace. 	CHAN1 CHAN2 CHAN3 CHAN4 CCDF1 CCDF4 CREference CGAUssian

Example

```
TRAC:DATA? CHAN1
```

Queries the current trace data of channel 1.

Remarks

- For the channel source, this query is only applicable when the channel is enabled. If the channel is disabled, error -221, “Settings conflict; Requires channel # to be enabled” will occur.
- For the CCDF source, this query is only applicable when the CCDF acquisition mode is enabled. If the CCDF acquisition mode is not enabled, error -221, “Settings conflict; Requires CCDF mode to be enabled” will occur. Refer to “[ACQUIRE:MODE <character_data>](#)” on page 115 to set the CCDF acquisition mode.
- For the CCDF Gaussian source, this query is only applicable when the CCDF Gaussian trace is enabled. If the Gaussian trace is not enabled, error -221, “Settings conflict; Requires CCDF Gaussian trace to be enabled” will occur. Refer to “[ACQUIRE:CCDF:GAUSSIAN\[:STATe\] <boolean>](#)” on page 79 to set the CCDF Gaussian trace.

- For the CCDF reference source, this query is only applicable when the CCDF reference trace is enabled. If the reference trace is not enabled, error -221, “Settings conflict;Requires CCDF reference trace to be enabled” will occur. Refer to “[ACQUIRE:CCDF:REFERENCE\[:STATE\] <boolean>](#)” on page 95 to set the CCDF reference trace.
- For the channel source, this query is only applicable when the normal acquisition mode is enabled. If the normal acquisition mode is not enabled, error -221, “Setting conflict;Not Applicable to CCDF.” will occur. Refer to “[ACQUIRE:MODE <character_data>](#)” on page 115 to set the normal acquisition mode.

TRACe:XINCrement? <character_data>

This query returns the duration between consecutive data points for the specified source.

Syntax

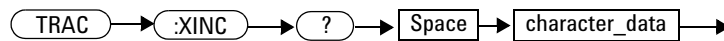

Parameter

Item	Description/Default	Range of values
character_data	Sets the source as: <ul style="list-style-type: none"> • CHAN1: Sets the channel 1 trace. • CHAN2: Sets the channel 2 trace. • CHAN3: Sets the channel 3 trace. • CHAN4: Sets the channel 4 trace. 	CHAN1 CHAN2 CHAN3 CHAN4

Example

TRAC:XINC? CHAN1

Queries the duration between consecutive data points for channel 1.

TRACe:XSTART?

This query returns the trace X start value.

Syntax



Example

TRAC:XSTART?

Queries the trace X start value.

THIS PAGE HAS BEEN INTENTIONALLY LEFT BLANK.

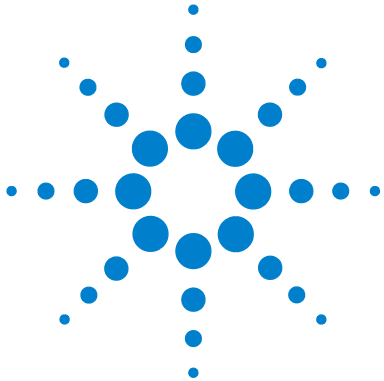

14 LIMIT Subsystem

Overview [358](#)

LIMIT:UPper <boolean> [359](#)

LIMIT:LOWer <boolean> [360](#)

LIMIT:UPper:LEVEL <numeric_value> [361](#)

LIMIT:LOWer:LEVEL <numeric_value> [362](#)

This chapter describes how the LIMIT command subsystem is used to set the upper and lower limit tests.



Overview

The LIMIT command subsystem is used to set the upper and lower limit test levels.

Keyword	Parameter form	Note	Page
LIMIT			
:UPper	<boolean>		page 359
:LOWer	<boolean>		page 360
:UPper:LEVEL	<numeric_value>		page 361
:LOWer:LEVEL	<numeric_value>		page 362

LIMIT:UPper <boolean>

This command enables or disables the upper limit test.

NOTE

The limit test is applied on the trigger source only. Refer to “TRIGger:SOURce <character_data>” on page 199.

Syntax

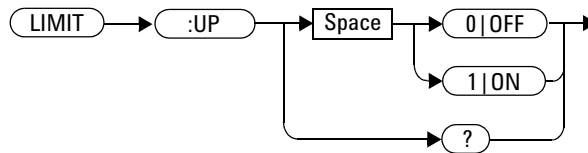

Example

LIMIT:UP ON *This command enables the upper limit test.*

Query

LIMIT:UPper?

This query enters a 1 or 0 into the output buffer indicating the state of the upper limit test.

- 1 is returned when the upper limit test is enabled
- 0 is returned when the upper limit test is disabled

Query example

LIMIT:UP? *Queries whether the upper limit test is enabled or disabled.*

LIMIT:LOWer <boolean>

This command enables or disables the lower limit test.

NOTE

The limit test is applied on the trigger source only. Refer to “TRIGger:SOURce <character_data>” on page 199.

Syntax

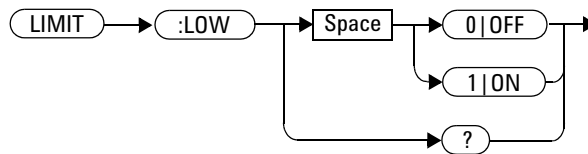

Example

LIMIT:LOW ON *This command enables the lower limit test.*

Query

LIMIT:LOWer?

This query enters a 1 or 0 into the output buffer indicating the state of the lower limit test.

- 1 is returned when the lower limit test is enabled
- 0 is returned when the lower limit test is disabled

Query example

LIMIT:LOW? *Queries whether the lower limit test is enabled or disabled.*

LIMIT:UPper:LEVEL <numeric_value>

This command sets the input level for the limit test. When the waveform exceeds the upper limit level, it will be displayed in the Limit Test tab in the measurement view panel or it can be recorded in a .csv file.

Syntax

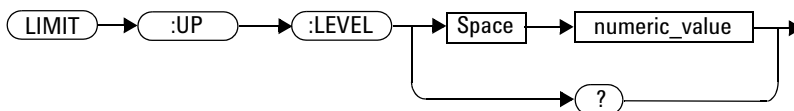

Parameter

Item	Description/Default	Range of values
numeric_value	A numeric value for the input level. The range of values depends on the trigger source.	The range of values depends on the trigger source.

Example

LIMIT:UPper:LEVEL 1 *This command sets the upper limit level to 1.*

Query

LIMIT:UPper:LEVEL?

This query returns the current level of the upper limit test. The response format is <NRf>.

Query example

LIMIT:UP:LEVEL? *Queries the upper limit level.*

LIMIT:LOWer:LEVEL <numeric_value>

This command sets the input level for the limit test. When the waveform exceeds the lower limit level, it will be displayed in the Limit Test tab in the measurement view panel or it can be recorded in a .csv file.

Syntax

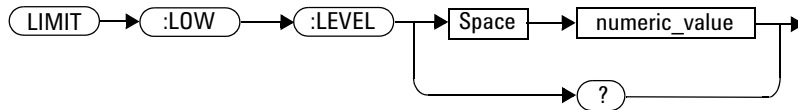

Parameter

Item	Description/Default	Range of values
numeric_value	A numeric value for the input level. The range of values depends on the trigger source.	The range of values depends on the trigger source.

Example

LIMIT:LOWer:LEVEL 1 *This command sets the lower limit level to 1.*

Query

LIMIT:LOWer:LEVEL?

This query returns the current level of the lower limit test. The response format is <NRf>.

Query example

LIMIT:LOW:LEVEL? *Queries the upper limit level.*



15 STATus Subsystem

STATus Subsystem	364
Status Register Set Commands	366
Device Status Register Set	370
Operation Status Register Set	372
STATus:OPERation	373
STATus:PRESet	374
Questionable Status Register Sets	375
STATus:QUEStionable	376
STATus:QUEStionable:CALibration	377
STATus:QUEStionable:VOLTage	378
Status Block Diagram	379

This chapter explains how the `STATus` command subsystem enables you to examine the status of the 8990B by monitoring the “Device Status Register”, “Operation Status Register”, and “Questionable Status Register”.



STATus Subsystem

NOTE

Refer to “**Status Block Diagram**” at the end of this chapter to view the relationship between various registers in the 8990B SCPI status system.

The STATus command subsystem enables you to examine the status of the 8990B by monitoring the following status registers:

- Device status register
- Operation status register
- Questionable status register

The contents of these and other registers in the 8990B are determined by one or more status registers.

The following table summarizes the effects of various commands and events on the status registers:

Table 15-1 Commands and events affecting the status registers

Status register	*RST	*CLS	Power on	STATus: PRESet
SCPI Transition Filters (NTR and PTR registers)	none	none	preset	preset
SCPI Enable Registers	none	none	preset	preset
SCPI Event Registers	none	clear	clear	none
SCPI Error/Event Queue Enable	none	none	preset	preset
SCPI Error/Event Queue	none	clear	clear	none
IEEE-488.2 Registers ESE SRE	none	none	clear	none
IEEE-488.2 Registers ESR STB	none	clear	clear	none

The contents of the status registers are examined using the following status register set commands:

```
:CONDition?
:ENABle <NRf>|<non-decimal numeric>
[:EVENT]?
:NTRansition <NRf>|<non-decimal numeric>
:PTRansition <NRf>|<non-decimal numeric>
```

Each of these can be used to examine any of the following status registers:

```
STATus:DEVIce (page 370)
STATus:OPERation (page 373)
STATus:QUESTionable (page 376)
STATus:QUESTionable:CALibration (page 377)
STATus:QUESTionable:VOLTagE (page 377)
```

Examples

Using the `:CONDition?` query to examine the `STATus:DEVIce` register:

```
STATus:DEVIce:CONDition?
```

Using the `:NTRansition` command to examine the `STATus:QUESTionable:CALibration` register:

```
STATus:QUESTionable:CALibration:NTRansition
```

Status Register Set Commands

This section describes the five status register set commands. Each can be used to examine all of the status registers listed on [page 365](#).

To apply a command to a specific register, prefix the command with the name of the appropriate register. For example, to apply the `:ENABle` command to the `STATus:QUEStionable` register, use the following command:

```
STATus:QUEStionable:ENABle
```

The status register set commands detailed in this section are:

Keyword	Parameter form	Note	Page
<code>:CONDition?</code>		[query only]	page 366
<code>:ENABle</code>	<code><NRf> <non-decimal numeric></code>		page 367
<code>[:EVENT]?</code>		[query only]	page 367
<code>:NTRansition</code>	<code><NRf> <non-decimal numeric></code>		page 368
<code>:PTRansition</code>	<code><NRf> <non-decimal numeric></code>		page 369

:CONDition?

This query returns a 16-bit decimal-weighted number representing the bits set in the Condition register of the SCPI register set you require to control. The return format is `<NR1>` in the range of 0 to 32767 ($2^{15}-1$). The contents of the Condition register remain unchanged after they are read.

Syntax

```
.. → (:COND) → (?) →
```

[:EVENTt]?

This query returns a 16-bit decimal-weighted number representing the bits set in the Event register of the SCPI register set you require to control. The return format is <NR1> in the range of 0 to 32767 ($2^{15}-1$). This query clears all bits in the register to 0.

NOTE

[: EVENTt] ? is the default command if the STATus commands are not accompanied by any of the status register set commands (:COND?, :ENAB, :NTR, and :PTR).

Syntax

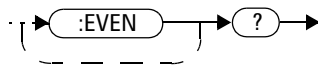

:ENABLE <NRf> | <non-decimal numeric>

This command sets the Enable register of a particular SCPI register set you require to control. The parameter value, when rounded to an integer and expressed in base 2 has its first 15 bits written into the Enable register of the specific SCPI register set. The last bit (bit 15) is always set to 0.

Syntax

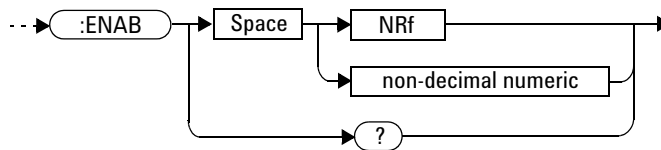

Parameter

Item	Description	Range of values
NRf	The value used to set the Enable register	0 to $2^{15}-1$
non-decimal numeric		

Query

:ENABle?

This query returns a 15-bit decimal-weighted number representing the contents of the Enable register of the SCPI register set being queried. The return format is <NR1> in the range of 0 to 32767 ($2^{15}-1$).

:NTRansition <NRf> | <non-decimal numeric>

This command sets the Negative Transition register of the SCPI register set you require to control. The parameter value, when rounded to an integer and expressed in base 2 has its first 15 bits written into the Negative Transition register of the specific SCPI register set. The last bit (bit 15) is always set to 0.

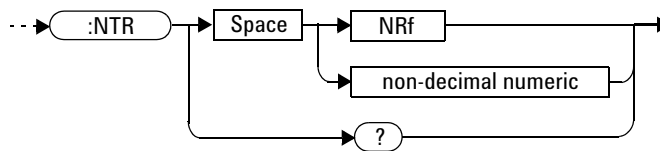
Syntax**Parameter**

Item	Description	Range of values
NRf	The value used to set the NTR register	0 to $2^{15}-1$
non-decimal numeric		

Query

:NTRansition?

This query returns a 15-bit decimal-weighted number representing the contents of the Negative Transition register of the SCPI register set being queried. The return format is <NR1> in the range of 0 to 32767 ($2^{15}-1$).

:PTRansition <NRf> | <non-decimal numeric>

This command is used to set the Positive Transition register of the SCPI register set you require to control. The first 15 bits of the input parameter are written into the Positive Transition register of the specific SCPI register set. The last bit (bit 15) is always set to 0.

Syntax

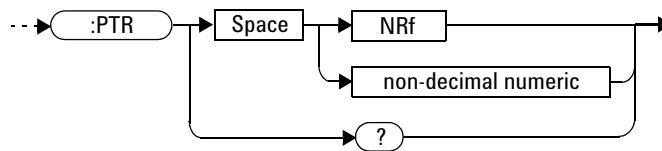

Parameter

Item	Description	Range of values
NRf	The value used to set the PTR register	0 to $2^{15}-1$
non-decimal numeric		

Query

:PTRansition?

This query returns a 15-bit decimal-weighted number representing the contents of the Positive Transition register of the SCPI register set being queried. The return format is <NR1> in the range of 0 to 32767 ($2^{15}-1$).

Device Status Register Set

The device status register set contains the information which provides the device status information. The contents of the individual registers of this register set can be accessed by appending the commands listed in “[Status Register Set Commands](#)”.

The following descriptions detail the SCPI register you require to control and some examples on the register set commands.

The one device status register set is:

STATus:DEvice

The following bits in this register are used by the 8990B:

Bit	Weight/Decimal value	Definition
0	1	Not used
1	2	Channel 1 sensor connected
2	4	Channel 4 sensor connected
3	8	Channel 1 sensor error
4	16	Channel 4 sensor error
5 to 15	–	Not used (bit 15 is always 0)

The channel 1 sensor connected bit (bit 1) or the channel 4 sensor connected bit (bit 2), when queried by STATus:DEvice:CONDition?, is set to:

- 1, when a peak power sensor is connected.
- 0, when no peak power sensor is connected.

The channel 1 sensor connected bit (bit 1) or the channel 4 sensor connected bit (bit 2), when queried by STATus:DEvice[:EVENT]?, indicates whether a peak power sensor has been connected or disconnected depending on the state of the corresponding bits of STATus:DEvice:NTRansition and STATus:DEvice:PTRansition.

If the corresponding bit in:

- `STATus:DEVIce:NTRansition` is 1, then bit 1 is set when a sensor is disconnected.
- `STATus:DEVIce:PTRansition` is 1, then bit 1 is set when a sensor is connected.

The channel 1 sensor error bit (bit 3) or the channel 4 sensor error bit (bit 4), when queried by `STATus:DEVIce:CONDition?`, is set to:

- 1, when an error is detected.
- 0, when no error is detected.

The channel 1 sensor error bit (bit 3) or the channel 4 sensor error bit (bit 4), when queried by `STATus:DEVIce[:EVENT]?`, indicates whether there is an error or not depending on the state of the corresponding bits of `STATus:DEVIce:NTRansition` and `STATus:DEVIce:PTRansition`. If the corresponding bit in:

- `STATus:DEVIce:NTRansition` is 1, then 1 is set when no error is detected.
- `STATus:DEVIce:PTRansition` is 1, then 1 is set when an error is detected.

NOTE

Querying `STATus:DEVIce[:EVENT]?` clears the Device Status Event register.

Operation Status Register Set

The `STATUS:OPERation` register set contains information which is part of the 8990B normal operation. The contents of the individual registers of this register set can be accessed by appending the commands listed in “[Status Register Set Commands](#)”.

Further information on this register set is provided on the following page.

STATus:OPERation

The operation status register set contains conditions which are a part of the 8990B operation as a whole.

The following bits in the register set are used by the 8990B:

Bit	Weight/Decimal value	Definition
0 to 6	–	Not used
7	128	ARM event occurred
8	256	TRIGger event occurred
9	512	Equivalent-Time Sampling (ETS) operation completed
10 to 15	–	Not used (bit 15 is always 0)

Bit 7 is set when the trigger is armed and cleared when the trigger is unarmed.

Bit 8 is set when triggering of a waveform occurs and cleared when there is no waveform triggering.

Bit 9 is set when the ETS operation has completed and cleared when the ETS operation has not completed.

Syntax



STATus:PRESet

This command sets a number of the status registers to their preset values as shown below; all other registers are unaffected. Bit 15 is always 0.

Register	Filter/Enable	PRESet value
OPERation	ENABle	all zeros
	PTR	all ones
	NTR	all zeros
QUEStionable	ENABle	all zeros
	PTR	all ones
	NTR	all zeros
All others	ENABle	all ones
	PTR	all ones
	NTR	all zeros

Syntax

STAT → :PRES →

Questionable Status Register Sets

The questionable status register sets contain information which gives an indication of the quality of data produced by the 8990B. The contents of the individual registers in these register sets can be accessed by appending the commands listed in “[Status Register Set Commands](#)”.

The four questionable status register sets are:

```
STATus:QUEStionable
```

```
STATus:QUEStionable:CALibration
```

```
STATus:QUEStionable:VOLTage
```

STATUS:QUESTIONABLE

The questionable status register set contains bits that indicate the quality of various aspects of signals processed by the 8990B.

The following bits in the register set are used by the 8990B:

Bit	Weight/Decimal value	Definition
0	1	VOLTage summary
1 to 7	–	Not used
8	256	CALibration summary
9	512	Self-test failure
10 to 15	–	Not used (bit 15 is always 0)

Bit 0 is set by the logical OR outputs of the STATUS:QUESTIONABLE:VOLTage register.

Bit 8 is set by the logical OR outputs of the STATUS:QUESTIONABLE:CALibration register.

Bit 9 is set if the power-on self-test fails, and cleared if it passes.

Syntax



STATus:QUEStionable:CALibration

The questionable status calibration summary register contains bits which give an indication of the quality of data produced by the 8990B due to its calibration status.

The following bits in the register are used by the 8990B:

Bit	Weight/Decimal value	Definition
0	1	Not used
1	2	Channel 1 CALibration summary
2 to 3	–	Not used
4	16	Channel 4 CALibration summary
5 to 15	–	Not used (bit 15 is always 0)

Bit 1 is set when error -231, “Data questionable; Calibration error in channel 1” occurs. It is cleared when this error condition succeeds and no errors are placed on the error queue.

Bit 4 is set when error -231, “Data questionable; Calibration error in channel 4” occurs. It is cleared when this error condition succeeds and no errors are placed on the error queue.

Syntax



STATUS:QUESTIONABLE:VOLTage

The questionable status voltage summary register contains bits that indicate the quality of voltage data being acquired by the 8990B.

The following bits in the register are used by the 8990B:

Bit	Weight/Decimal value	Definition
0 to 1	–	Not used
2	4	Channel 2 VOLTage overload
3	8	Channel 3 VOLTage overload
4 to 15	–	Not used (bit 15 is always 0)

Bit 2 and bit 3 are set when error –231, “Data questionable; Voltage overloaded” occurs.

These bits are cleared when there is no voltage overload on channels 2 and 3.

Syntax



Status Block Diagram

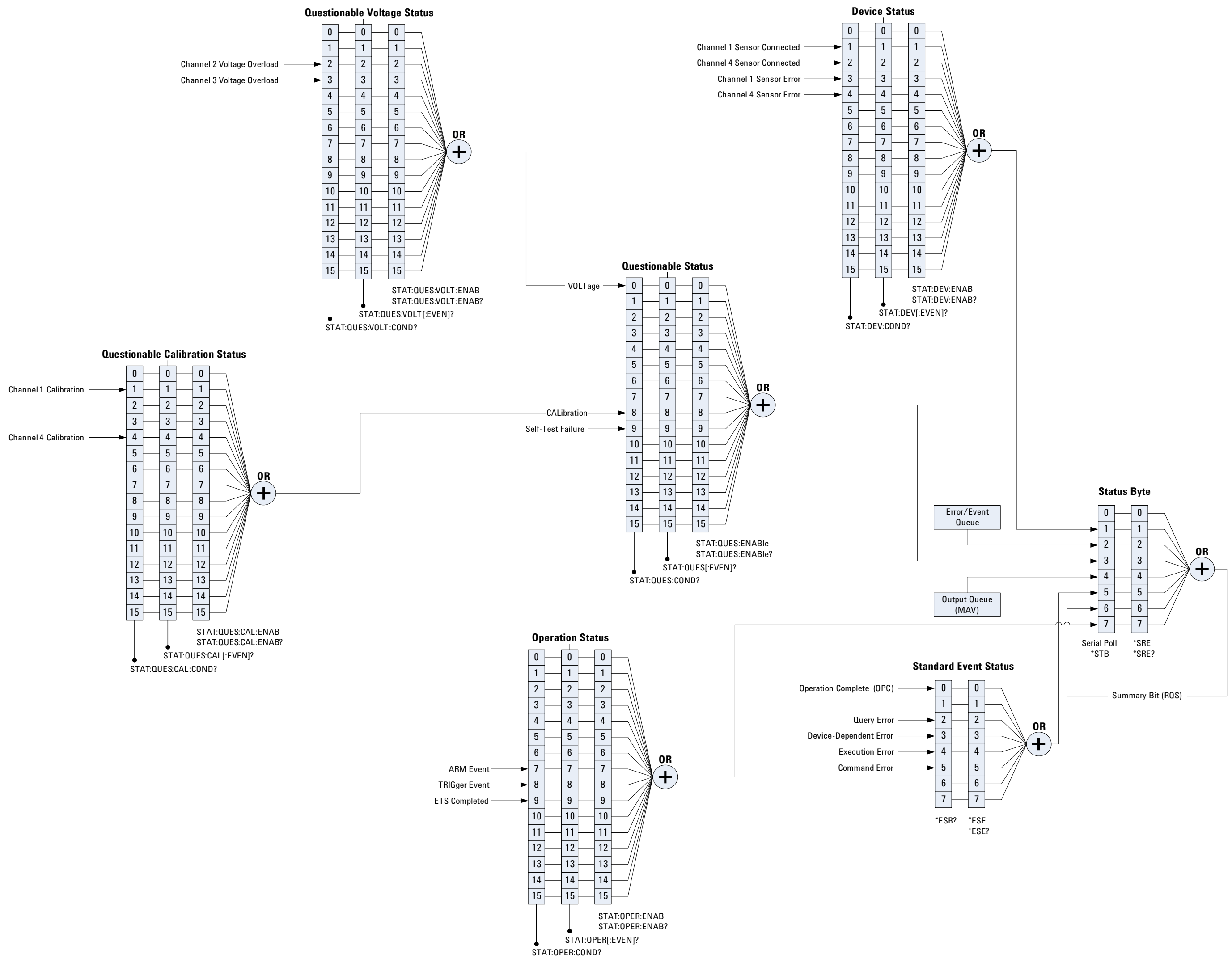

THIS PAGE HAS BEEN INTENTIONALLY LEFT BLANK.



16 DISPlay Subsystem

Overview	382
DISPlay:CONNect <boolean>	383
DISPlay:TRACk <boolean>	385
DISPlay:TRACk:MAX <boolean>	387
DISPlay:TRACk:MIN <boolean>	389
DISPlay:CLEAr [<character_data>]	391

This chapter describes how the DISPlay command subsystem is used to configure the 8990B waveform display.



Overview

The DISPlay command subsystem controls the display of the 8990B waveforms.

Keyword	Parameter form	Note	Page
DISPlay			
:CONNect	<boolean>		page 383
:TRACk	<boolean>		page 385
:MAX	<boolean>		page 387
:MIN	<boolean>		page 389
:CLEAr	[<character_data>]		page 391

DISPlay:CONNect <boolean>

This command sets the state of the vectors display mode which draws a line between consecutive waveform data points when enabled. If the vectors mode is disabled, the waveform data is displayed as dots.

Syntax

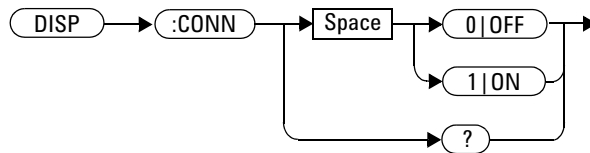

Example

DISP:CONN OFF *This command disables the vectors mode and displays the waveform data as dots.*

Reset condition

On reset, the vectors display mode is enabled.

Query

DISPlay:CONNect?

This query enters a 1 or 0 into the output buffer indicating the state of the vectors display mode.

- 1 is returned when vectors is turned on
- 0 is returned when vectors is turned off

Query example

DISP:CONN?

Queries whether the vectors display mode is turned on or off.

DISPlay:TRACk <boolean>

This command enables or disables the waveform data to be displayed as a region containing minimum and maximum traces. If disabled, the waveform data is displayed as a normal trace.

Syntax

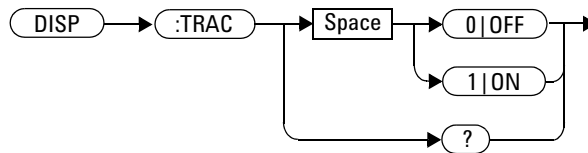

Example

DISP:TRAC 1 *This command enables the waveform data to be displayed as a region containing minimum and maximum traces.*

Reset condition

On reset, the waveform data is displayed as a normal trace.

Query

DISPlay:TRACk?

This query enters a 1 or 0 into the output buffer indicating the state of the maximum and minimum traces tracking region display.

- 1 is returned when the tracking region is enabled
- 0 is returned when the tracking region is disabled

Query example

DISP:TRAC?

Queries whether the tracking region for maximum and minimum traces is turned on or off.

DISPlay:TRACk:MAX <boolean>

This command enables or disables the maximum trace tracking line for the waveform data.

Syntax

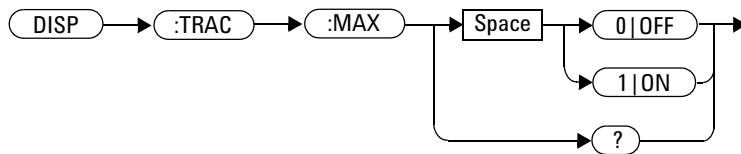

Example

DISP:TRAC:MAX ON

This command displays the maximum trace tracking line.

Reset condition

On reset, the maximum trace tracking line is disabled.

Query

DISPlay:TRACk:MAX?

This query enters a 1 or 0 into the output buffer indicating the state of the maximum trace tracking line for the waveform data.

- 1 is returned when the maximum tracking line is enabled
- 0 is returned when the maximum tracking line is disabled

Query example

DISP:TRAC:MAX?

Queries whether the maximum trace tracking line is enabled or disabled.

DISPlay:TRACk:MIN <boolean>

This command enables or disables the minimum trace tracking line for the waveform data.

Syntax

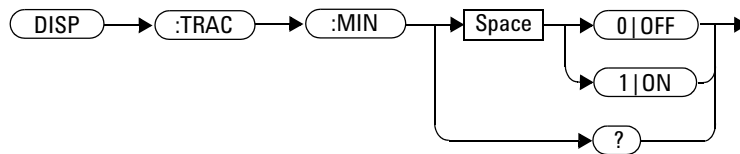

Example

DISP:TRAC:MIN ON

This command displays the minimum trace tracking line.

Reset condition

On reset, the minimum trace tracking line is disabled.

Query

DISPlay:TRACk:MIN?

This query enters a 1 or 0 into the output buffer indicating the state of the minimum trace tracking line for the waveform data.

- 1 is returned when the minimum tracking line is enabled
- 0 is returned when the minimum tracking line is disabled

Query example

DISP:TRAC:MIN?

Queries whether the minimum trace tracking line is enabled or disabled.

DISPlay:CLEar [<character_data>]

This command clears the current screen display of the 8990B.

Syntax

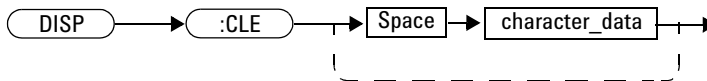

Parameter

Item	Description/Default	Range of values
character_data	<p>This is an optional parameter where it sets the clear display function as:</p> <ul style="list-style-type: none"> • SCReen: Clears and resets the current screen display. This is the default setting. • ALL: Clears the current screen and measurement data display. • MEASuretab: Clears the measurement data only. 	SCReen ALL MEASuretab

Example

DISP:CLE *This command clears the current screen display.*

Remarks

- When the 8990B is running in the continuous acquisition mode, this command clears the current waveform and redraws it.
- This command also clears the measurement data, marker information, droop measurement data, and waveform averaging if the MEASuretab parameter is not specified.

Reset condition

On reset, the clear display function is set to SCReen.

XYDISPlay:REFeRence:STATe <boolean>

This command enables or disables the XY reference trace.

Syntax

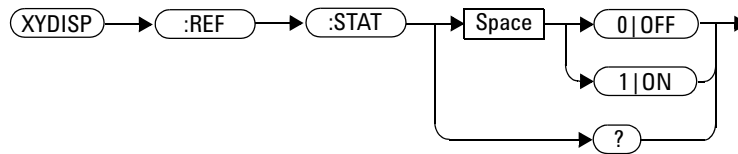

Example

`XYDISPlay:REFeRence:STAT ON` *This command displays the XY reference trace.*

Reset condition

On reset, the XY reference trace is disabled.

Query

`XYDISPlay:REFeRence:STATe?`

This query enters a 1 or 0 into the output buffer indicating the state of the XY reference trace.

- 1 is returned when the XY reference trace is enabled.
- 0 is returned when the XY reference trace is disabled.

Query example

`XYDISP:REF:STAT?`

Queries whether the XY reference trace is enabled or disabled.

XYDISPlay:XSOURce <character_data>

This command sets the X-axis source for the XY Display mode. The X-axis scale depends on the X-axis source.

Syntax

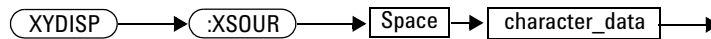

Parameter

Item	Description/Default	Range of values
character_data	Sets the XY Display X-axis source as: <ul style="list-style-type: none"> • CHANnel<n> • WMEMory<n> • FUNCTion{1 2} where n = 1, 2, 3, or 7	CHANnel<n> WMEMory<n> FUNCTion{1 2}

Example

XYDISP:XSOUR CHAN2 *This command sets the X-axis source for the XY Display mode to channel 2.*

Reset condition

On reset, the X-axis source for the XY Display mode is set to CHAN1.

Query

`XYDISPlay:XSOURce?`

This query returns the current setting of the X-axis source for the XY Display mode.

Query example

`XYDISP:XSOUR?` *Queries the XY Display mode X- axis source.*

XYDISPlay:YSOURce <character_data>

This command sets the Y-axis source for the XY Display mode. The Y-axis scale depends on the Y-axis source.

Syntax



Parameter

Item	Description/Default	Range of values
character_data	Sets the XY Display Y-axis source as: <ul style="list-style-type: none"> • CHANnel<n> • WMEMory<n> • FUNCTion{1 2} where n = 1, 2, 3, or 7	CHANnel<n> WMEMory<n> FUNCTion{1 2}

Example

XYDISP:YSOUR CHAN2 *This command sets the Y-axis source for the XY Display mode to channel 2.*

Reset condition

On reset, the Y-axis source for the XY Display mode is set to CHAN1.

Query

`XYDISPlay:YSOURce?`

This query returns the current setting of the Y-axis source for the XY Display mode.

Query example

`XYDISP:YSOUR?` *Queries the XY Display mode Y- axis source.*



17 XYDISPlay Subsystem

Overview 400

XYDISPlay:REFeRence:STATe <boolean> 401

XYDISPlay:XSOURce <character_data> 403

XYDISPlay:YSOURce <character_data> 405

This chapter describes how the XYDISPlay command subsystem is used to configure the XY display mode.



Overview

The XYDISPlay command subsystem controls the XY display mode.

Keyword	Parameter form	Note	Page
XYDISPlay			
:REFerence:STATe	<boolean>		page 401
:XSOURce	<character_data>		page 403
:YSOURce	<character_data>		page 405

XYDISPlay:REfERENCE:STATe <boolean>

This command enables or disables the XY reference trace.

Syntax

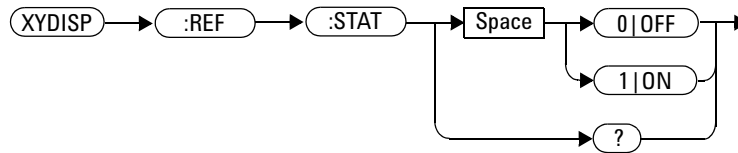

Example

`XYDISP:REF:STAT ON` *This command displays the XY reference trace.*

Remark

This command is only applicable in the XYDISPlay acquisition mode. If the acquisition mode is not set to XYDISPlay, error -221, “Settings conflict; Requires XY display mode to be enabled” will occur. Refer to “ACQUIRE:MODE <character_data>” on page 115 to set the acquisition mode.

Reset condition

On reset, the XY reference trace is disabled.

Query

XYDISPlay:REFerence:STATe?

This query enters a 1 or 0 into the output buffer indicating the state of the XY reference trace.

- 1 is returned when the XY reference trace is enabled.
- 0 is returned when the XY reference trace is disabled.

Query example

XYDISP:REF:STAT?

Queries whether the XY reference trace is enabled or disabled.

XYDISPlay:XSOURce <character_data>

This command sets the X-axis source for the XY Display mode. The X-axis scale depends on the X-axis source.

Syntax

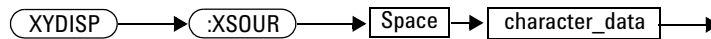

Parameter

Item	Description/Default	Range of values
character_data	Sets the XY Display X-axis source as: <ul style="list-style-type: none"> • CHANnel<n> • WMEMory<n> • FUNction{1 2} where n = 1, 2, 3, or 7	CHANnel<n> WMEMory<n> FUNction{1 2}

Example

XYDISP:XSOUR CHAN2 *This command sets the X-axis source for the XY Display mode to channel 2.*

Remark

This command is only applicable in the XYDISPlay acquisition mode. If the acquisition mode is not set to XYDISPlay, error -221, “Settings conflict; Requires XY display mode to be enabled” will occur. Refer to “ACQuire:MODE <character_data>” on page 115 to set the acquisition mode.

Reset condition

On reset, the X-axis source for the XY Display mode is set to CHAN1.

Query

XYDISPlay:XSOURce?

This query returns the current setting of the X-axis source for the XY Display mode.

Query example

XYDISP:XSOUR? *Queries the XY Display mode X- axis source.*

XYDISPlay:YSOURce <character_data>

This command sets the Y-axis source for the XY Display mode. The Y-axis scale depends on the Y-axis source.

Syntax

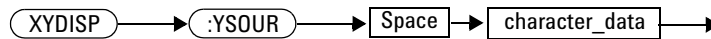

Parameter

Item	Description/Default	Range of values
character_data	Sets the XY Display Y-axis source as: <ul style="list-style-type: none"> • CHANnel<n> • WMEMory<n> • FUNction{1 2} where n = 1, 2, 3, or 7	CHANnel<n> WMEMory<n> FUNction{1 2}

Example

XYDISP:YSOUR CHAN2 *This command sets the Y-axis source for the XY Display mode to channel 2.*

Remark

This command is only applicable in the XYDISPlay acquisition mode. If the acquisition mode is not set to XYDISPlay, error -221, “Settings conflict; Requires XY display mode to be enabled” will occur. Refer to “ACQuire:MODE <character_data>” on page 115 to set the acquisition mode.

Reset condition

On reset, the Y-axis source for the XY Display mode is set to CHAN1.

Query

XYDISPlay:YSOURce?

This query returns the current setting of the Y-axis source for the XY Display mode.

Query example

XYDISP:YSOUR? *Queries the XY Display mode Y- axis source.*



18 DISK Subsystem

Overview	408
DISK:CWD?	409
DISK:LOAD <string>[,<character_data>]	410
DISK:SAVE:IMAGe <string>,<character_data>	412
DISK:SAVE:SETup <string>	414
DISK:SAVE:WAVEform <string>,<character_data>	415

This chapter explains how the DISK command subsystem is used to save and recall/load instrument setups and waveforms.



Overview

The DISK command subsystem allows you to perform file maintenance for the 8990B setups and waveforms. You can choose to save the current display, instrument setup, and channel waveform to a file, or to load any saved setup or waveform from a file.

Keyword	Parameter form	Note	Page
DISK			
:CWD?		[query only]	page 409
:LOAD	<string>		page 410
:SAVE			
:IMAGe	<string>, <character_data>		page 412
:SETup	<string>		page 414
:WAVEform	<string>, <character_data>		page 415

DISK:CWD?

This query returns the current working directory of the 8990B software. The directory is returned as a string.

Syntax

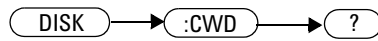

Example

DISK:CWD? *Queries the 8990B current working directory.*

DISK:LOAD <string>[,<character_data>]

This command loads/recalls a saved instrument setup or waveform from the specified file into the 8990B memory slot.

Syntax

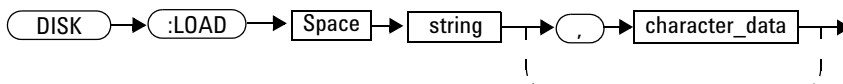

Parameters

Item	Description/Default	Range of values
string	Sets the file name to recall from as a string value (""): <ul style="list-style-type: none"> • The setup file name can be specified as a full path, for example, "c:\wave\xyz.xml". • The waveform file name can be specified as a full path, for example, "c:\wave\xyz.csv", or only the file name, "xyz.csv". • The default file directory is the working directory where the 8990B software resides. 	–
character_data ^[1]	Assigns the memory slot to load the file into as: <ul style="list-style-type: none"> • WMEM1: To load the file into memory slot 1. • WMEM2: To load the file into memory slot 2. • WMEM3: To load the file into memory slot 3. • WMEM4: To load the file into memory slot 4. <p>This is an optional parameter. If no memory slot is specified, NONE will be used.</p>	WMEM1 WMEM2 WMEM3 WMEM4 NONE ^[2]

[1] This parameter is only applicable for loading a saved waveform from the specified file into the 8990B memory slot.

[2] Memory slot 1 will be assigned when NONE is used.

Example

```
DISK:LOAD "c:\wave\wfm1.csv",WMEM1
```

This command loads the saved waveform into memory slot 1.

Remarks

- The instrument setup data is recalled from a file with a .xml extension.
- The waveform data is recalled from a file with a .csv extension.
- If an invalid file name is specified, error -256, "File name not found" will occur. This error may also occur due to missing directory. Ensure that the directory exists.

DISK:SAVE:IMAGe <string>,<character_data>

This command saves the current 8990B display to an image file.

Syntax

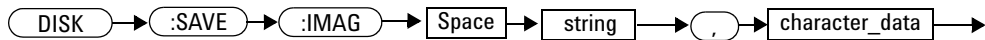

Parameter

Item	Description/Default	Range of values
string	Sets the file name to save to as a string value (""): <ul style="list-style-type: none"> • The file name can be specified as a full path, for example, "c:\wave\xyz", or only the file name, "xyz". Any existing file with the same name will be overwritten automatically. • The default file directory is the working directory where the 8990B software resides. 	–
character_data	Sets the file format as: <ul style="list-style-type: none"> • BMP: To save as a .bmp file. • GIF: To save as a .gif file, • JPEG: To save as a .jpg file, • TIFF: To save as a .tif file. • PNG: To save as a .png file. 	BMP GIF JPEG TIFF PNG

Example

DISK:SAVE:IMAG "c:\wave\pic1",BMP

This command saves the current display to c:\wave\pic1.bmp.

Remark

If an invalid file name is specified, error -257, "File name error" will occur. This error may also occur due to missing directory. Ensure that the directory exists.

DISK:SAVE:SETup <string>

This command saves the current 8990B setup to a .xml file.

Syntax

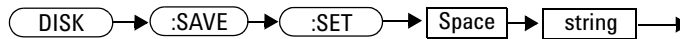

Parameter

Item	Description/Default
string	Sets the file name to save to as a string value (""): <ul style="list-style-type: none"> • The file name can be specified as a full path, for example, "c:\wave\xyz", or only the file name, "xyz". Any existing file with the same name will be overwritten automatically. • The default file directory is the working directory where the 8990B software resides. • The file extension is .xml.

Example

```
DISK:SAVE:SET "c:\wave\setupDevice1"
```

This command saves the current 8990B setup to c:\wave\setupDevice1.xml.

Remark

If an invalid file name is specified, error -257, "File name error" will occur. This error may also occur due to missing directory. Ensure that the directory exists.

DISK:SAVE:WAVEform <string>,<character_data>

This command saves the current 8990B waveform of the selected channel or memory slot to a .csv file.

Syntax

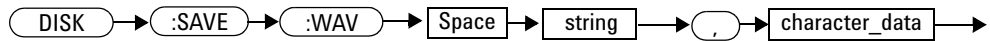

Parameter

Item	Description/Default	Range of values
string	Sets the file name to save to as a string value (""): <ul style="list-style-type: none"> The file name can be specified as a full path, for example, "c:\wave\xyz", or only the file name, "xyz". Any existing file with the same name will be overwritten automatically. The default file directory is the working directory where the 8990B software resides. The file extension is .csv. 	–
character_data	Sets the channel of the waveform as: <ul style="list-style-type: none"> CHAN1: Sets to channel 1. CHAN2: Sets to channel 2. CHAN3: Sets to channel 3. CHAN4: Sets to channel 4. Or, sets the memory slot of the waveform as: <ul style="list-style-type: none"> WMEM1: Sets to memory slot 1. WMEM2: Sets to memory slot 2. WMEM3: Sets to memory slot 3. WMEM4: Sets to memory slot 4. <ul style="list-style-type: none"> FUNC1: Sets the source to waveform math function 1. FUNC2: Sets the source to waveform math function 2. 	CHAN1 CHAN2 CHAN3 CHAN4 WMEM1 WMEM2 WMEM3 WMEM4 FUNC1 FUNC2

Example

DISK:SAVE:WAV "c:\wave\test",CHAN2

This command saves the channel 2 waveform to c:\wave\test.csv.

Remark

If an invalid file name is specified, error –257,“File name error” will occur. This error may also occur due to missing directory. Ensure that the directory exists.



19 MEMory Subsystem

MEMory Subsystem	418
MEMory:TABLE:CLEar	419
MEMory:TABLE:CLEar:NAME <string>	420
MEMory:TABLE:DELeTe <numeric_value>	421
MEMory:TABLE:EDIT <numeric_value>,<numeric_value>	422
MEMory:TABLE:FREQuency?	424
MEMory:TABLE:INSerT <numeric_value>,<numeric_value>	425
MEMory:TABLE:LIST?	427
MEMory:TABLE:OFFSet?	428
MEMory:TABLE:POINts?	429
MEMory:TABLE:SElect <string>	430

This chapter explains how the MEMory command subsystem is used to configure the frequency-dependent offset (FDO) tables.



MEMory Subsystem

The MEMory command subsystem is used to create, edit, and view FDO tables. The 8990B is capable of storing 10 FDO tables of 80 frequency points each. Stored tables remain in the 8990B memory during power down.

Keyword	Parameter form	Note	Page
MEMory			
:TABLE			
:CLEar			page 419
:NAME	<string>		page 420
:DELeTe	<numeric_value>		page 421
:EDIT	<numeric_value>, <numeric_value>		page 421
:FREQuency?		[query only]	page 424
:INSert	<numeric_value>, <numeric_value>		page 425
:LIST?		[query only]	page 427
:OFFSet?		[query only]	page 428
:POINTs?		[query only]	page 429
:SElect	<string>		page 430

MEMory:TABLE:CLEar

This command clears the contents of the FDO table selected in “MEMory:TABLE:SElect <string>” on page 430.

NOTE

The FDO table contents cleared using this command are non-recoverable.

Syntax

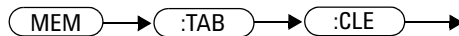

Example

MEM:TABLE:CLE

This command clears the contents of the selected FDO table.

Remark

If no FDO table has been selected when sending this command, error -221, “Settings conflict;No FDO table selected” will occur.

MEMory:TABLE:CLEar:NAME <string>

This command clears the contents of an existing FDO table.

NOTE

The FDO table contents cleared using this command are non-recoverable.

Syntax

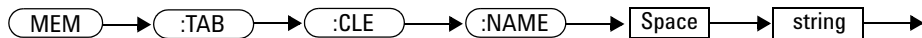

Parameter

Item	Description/Default	Range of values
string	Sets an existing table name as a case-sensitive string value, with a maximum of 12 characters.	A to Z (uppercase) a to z (lowercase) 0 to 9 _ (underscore)

Example

MEM:TABLE:CLE:NAME "CUSTOM_D" *This command clears the contents of the "CUSTOM_D" FDO table.*

Remark

If an invalid table name is specified, error -224, "Illegal parameter value" will occur.

MEMory:TABLE:DELeTe <numeric_value>

This command deletes a frequency and offset pair from the FDO table selected in “MEMory:TABLE:SElect <string>” on page 430.

Syntax

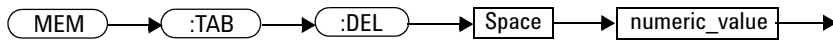

Parameter

Item	Description/Default
numeric_value	A numeric value in Hz for frequency. The value specified will be truncated to a multiple of 1000.

Example

MEM:TABLE:DEL 1000 *This command deletes the 1000 Hz frequency with its offset from the FDO table.*

Remarks

- If no FDO table has been selected when sending this command, error -221, “Settings conflict;No FDO table selected” will occur.
- If the frequency specified does not exist, error -224, “Illegal parameter value” will occur.

MEMory:TABLE:EDIT <numeric_value>,<numeric_value>

This command modifies the offset value of an existing frequency and offset pair in the FDO table selected in “MEMory:TABLE:SElect <string>” on page 430.

Syntax



Parameter

Item	Description/Default	Range of values
numeric_value	<p>Numeric values for the frequency and offset pair:</p> <ul style="list-style-type: none"> • Minimum values: <ul style="list-style-type: none"> • Frequency: 1 kHz • Offset: 1% • Maximum values: <ul style="list-style-type: none"> • Frequency: 1 THz • Offset: 150% <p>The first <numeric_value> represents the frequency while the second <numeric_value> represents the offset. The frequency value specified will be truncated to a multiple of 1000.</p>	1 kHz frequency, 1% offset to 1 THz frequency, 150% offset

Example

```
MEM:TABLE:EDIT 1000,30
```

This command changes the offset to 30% for the 1 kHz frequency in the selected FDO table.

Remarks

- If no FDO table has been selected when sending this command, error -221,“Settings conflict;No FDO table selected” will occur.
- The frequency value specified must exist in the selected FDO table. If the frequency value does not exist, error -224,“Illegal parameter value” will occur.
- If you set an offset value which exceeds its minimum or maximum limit, error -222,“Data out of range” will occur.

MEMory:TABLE:FREQuency?

This query returns the list of frequency values of the FDO table selected in “MEMory:TABLE:SElect <string>” on page 430. The frequency values are returned in the Hz unit in the ascending order.

Syntax

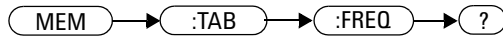

Example

MEM: TAB: FREQ?

Queries the list of frequency values of the selected FDO table.

Remark

If no FDO table has been selected when sending this query, error -221, “Settings conflict; No FDO table selected” will occur.

MEMory:TABLE:INSert <numeric_value>,<numeric_value>

This command inserts a new pair of frequency and offset into the FDO table selected in “MEMory:TABLE:SElect <string>” on page 430.

Syntax

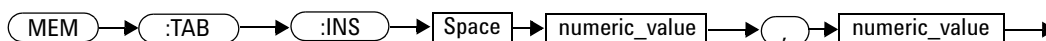

Parameter

Item	Description/Default	Range of values
numeric_value	Numeric values for the frequency and offset pair: <ul style="list-style-type: none"> • Minimum values: <ul style="list-style-type: none"> • Frequency: 1 kHz • Offset: 1% • Maximum values: <ul style="list-style-type: none"> • Frequency: 1 THz • Offset: 150% <p>The first <numeric_value> represents the frequency while the second <numeric_value> represents the offset. The frequency value specified will be truncated to a multiple of 1000.</p>	1 kHz frequency, 1% offset to 1 THz frequency, 150% offset

Example

```
MEM:TABLE:INS 1000,20
```

This command inserts a 1 kHz frequency with an offset of 20% for the selected FDO table.

Remarks

- If no FDO table has been selected when sending this command, error -221,“Settings conflict;No FDO table selected” will occur.
- If a frequency value is specified which is a duplicate of an existing frequency value, error -221,“Settings conflict;Duplicated frequency input” will occur.
- If you set an offset value which exceeds its minimum or maximum limit, error -222,“Data out of range” will occur.
- If the selected FDO table has more than 80 frequency points, error 946,“Selected FDO table has reached the limit of 80 frequency points” will occur.

MEMory:TABLE:LIST?

This query returns a list of all the available FDO tables in the 8990B as a string array.

Syntax

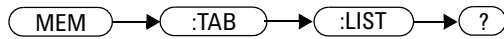

Example

MEM:TABLE:LIST?

Queries the list of all available FDO tables.

MEMory:TABLE:OFFSet?

This query returns the list of offset values of the FDO table selected in “MEMory:TABLE:SElect <string>” on page 430. The offset values are returned in the % unit.

Syntax

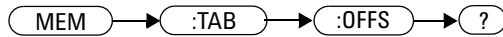

Example

```
MEM: TAB: OFFS?
```

Queries the list of offset values of the selected FDO table.

Remark

If no FDO table has been selected when sending this query, error -221, “Settings conflict; No FDO table selected” will occur.

MEMory:TABLE:POINts?

This query returns the number of points representing all frequency and offset pairs in the FDO table selected in “MEMory:TABLE:SElect <string>” on page 430.

Syntax

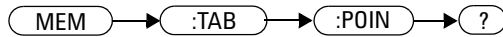

Example

MEM: TAB: POIN?

Queries the number of points for the selected FDO table.

Remark

If no FDO table has been selected when sending this query, error -221, “Settings conflict; No FDO table selected” will occur.

MEMory:TABLE:SElect <string>

This command selects and activates an FDO table. The FDO table must be activated before any operation can be performed on it.

Syntax

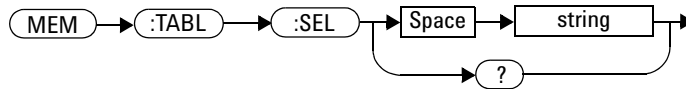

Parameter

Item	Description/Default
string	Sets any of the following FDO table names as a string value (""): <ul style="list-style-type: none"> • CUSTOM_A • CUSTOM_B • CUSTOM_C • CUSTOM_D • CUSTOM_E • CUSTOM_F • CUSTOM_G • CUSTOM_H • CUSTOM_I • CUSTOM_J

Example

```
MEM:TABLE:SElect "CUSTOM_A"
```

This command selects an FDO table named "CUSTOM_A".

Remark

The table name specified must exist in the list of FDO tables. If the table name does not exist, error -224, "Illegal parameter value" will occur.

Query

```
MEMory:TABLE:SElect?
```

This query returns the name of the currently selected FDO table as a string value.

Query example

```
MEM:TAB:SEL?      Queries the name of the current FDO table.
```

THIS PAGE HAS BEEN INTENTIONALLY LEFT BLANK.



20 WMEemory Subsystem

Overview	434
WMEemory{1 2 3 4}:CLEar	435
WMEemory{1 2 3 4}:DISPlay <boolean>	436
WMEemory{1 2 3 4}:OFFSet <numeric_value>	438
WMEemory{1 2 3 4}:SAVE <character_data>	440
WMEemory{1 2 3 4}:SCALE <numeric_value>	442
WMEemory{1 2 3 4}:UNIT?	444

This chapter describes how the `WMEemory` command subsystem is used to configure the waveforms in the 8990B memory.



Overview

The WMemory command subsystem allows you to configure the display, offset, and scale of the waveform in a 8990B memory slot as well as save a waveform into the selected memory slot. This command subsystem also enables you to clear a waveform memory slot or query the waveform unit of the selected memory slot.

In this command subsystem, the {1|2|3|4} following WMemory represents the respective memory slot of the 8990B.

Keyword	Parameter form	Note	Page
WMemory{1 2 3 4}			
:CLear			page 435
:DISPlay	<boolean>		page 436
:OFFSet	<numeric_value>		page 438
:SAVE	<character_data>		page 440
:SCALE	<numeric_value>		page 442
:UNIT?		[query only]	page 444

WMEMemory{1 | 2 | 3 | 4}:CLEar

This command clears the waveform data of the specified memory slot.

Syntax

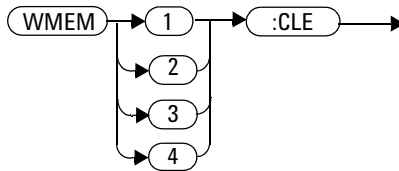

Example

`WMEM1 :CLE` *This command clears the waveform data of memory slot 1.*

WMemory{1 | 2 | 3 | 4}:DISPlay <boolean>

This command turns on or off the waveform trace display of the specified memory slot.

Syntax

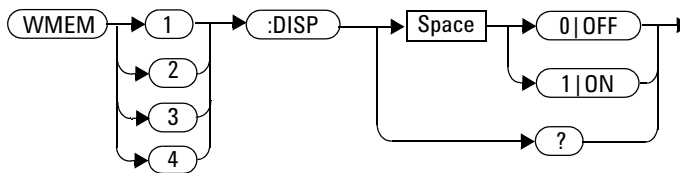

Example

`WMEM2:DISP ON` *This command turns on the waveform trace display of memory slot 2.*

Remark

If no waveform data exists in the selected memory slot, error -221, "Settings conflict;No data in waveform memory slot" will occur.

Query

`WMemory{1 | 2 | 3 | 4}:DISPlay?`

This query enters a 1 or 0 into the output buffer indicating the state of the waveform trace display of the specified memory slot.

- 1 is returned when the waveform trace display is turned on
- 0 is returned when the waveform trace display is turned off

Query example

WMEM3:DISP?

Queries whether the waveform trace display of memory slot 3 is turned on or off.

WMEMory{1|2|3|4}:OFFSet <numeric_value>

This command sets the waveform offset of the specified memory slot.

Syntax

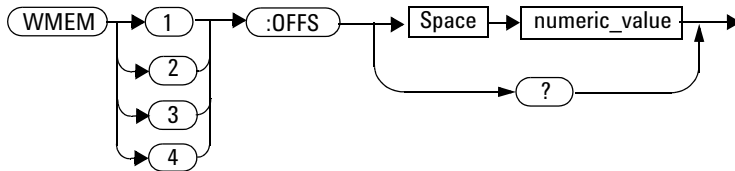

Parameter

Item	Description/Default	Range of values
numeric_value	A numeric value for the waveform offset: <ul style="list-style-type: none"> • Default value: 0 • Minimum value: <ul style="list-style-type: none"> • -99 dB/div or 100 pW/div (for waveforms of channels 1 and 4) • -4 V/div (for waveforms of channels 2 and 3) • Maximum value: <ul style="list-style-type: none"> • 99 dB/div or 1W/div (for waveforms of channels 1 and 4) • 4 V/div (for waveforms of channels 2 and 3) 	<ul style="list-style-type: none"> • Waveforms of channels 1 and 4: <ul style="list-style-type: none"> • -99 dB/div to 99 dB/div • 100 pW/div to 1 W/div • Waveforms of channels 2 and 3: <ul style="list-style-type: none"> • -4 V/div to 4 V/div

Example

```
WMEM1:OFFS 0.1
```

This command sets the waveform offset of memory slot 1 to 0.1 dB/div.

Remarks

- The unit for the offset specified must correspond to the existing unit in the selected memory slot.
- If no waveform data exists in the selected memory slot, error -221, “Settings conflict;No data in waveform memory slot” will occur.
- If you set an offset value which exceeds its minimum or maximum limit, error -222, “Data out of range” will occur.

Query

WMEMory{1|2|3|4}:OFFSet?

This query returns the current setting of the waveform offset of the specified memory slot. The response format is <NRf> in the following units:

- dB/div or W/div (for waveforms of channels 1 and 4)
- V/div (for waveforms of channels 2 and 3).

Query example

WMEM4:OFFS? *Queries the waveform offset setting of memory slot 4.*

WMemory{1 | 2 | 3 | 4}:SAVE <character_data>

This command saves the waveform of a channel source or memory slot into the specified memory slot.

Syntax

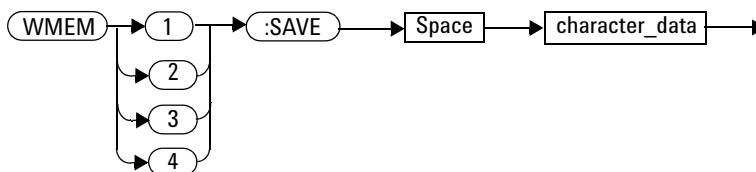

Parameter

Item	Description/Default	Range of values
character_data	Sets the channel source as: <ul style="list-style-type: none"> • CHAN1: Sets to channel 1. • CHAN2: Sets to channel 2. • CHAN3: Sets to channel 3. • CHAN4: Sets to channel 4. Or, sets the waveform memory slot as: <ul style="list-style-type: none"> • WMEM1: Sets to memory slot 1. • WMEM2: Sets to memory slot 2. • WMEM3: Sets to memory slot 3. • WMEM4: Sets to memory slot 4. 	CHAN1 CHAN2 CHAN3 CHAN4 WMEM1 WMEM2 WMEM3 WMEM4

Example

WMEM1:SAVE CHAN2 *This command saves the channel 2 waveform into memory slot 1.*

Remarks

- Sending this command will overwrite any existing waveform in the selected memory slot.
- If there is no waveform data in the source memory slot, error -221,“Settings conflict;No data in waveform memory slot” occurs.
- If a disabled channel is specified as the waveform channel source, error -221,“Settings conflict;Requires channel # to be enabled” occurs.

WMemory{1|2|3|4}:SCALE <numeric_value>

This command sets the waveform scale of the specified memory slot.

Syntax

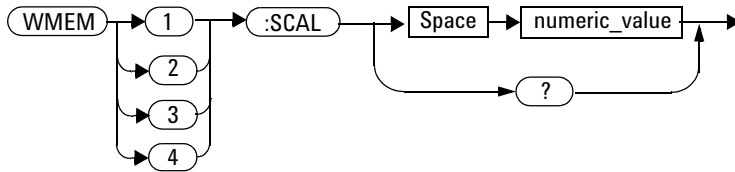

Parameter

Item	Description/Default	Range of values
numeric_value	A numeric value for the waveform scale: <ul style="list-style-type: none"> • Default value: <ul style="list-style-type: none"> • 5 dB/div or 1 mW/div (for waveforms of channels 1 and 4) • 1 V/div (for waveforms of channels 2 and 3) • Minimum value: <ul style="list-style-type: none"> • 0.01 dB/div or 1 μW/div (for waveforms of channels 1 and 4) • 1 mV/div (for waveforms of channels 2 and 3) • Maximum value: <ul style="list-style-type: none"> • 100 dB/div or 1 kW/div (for waveforms of channels 1 and 4) • 1 V/div (for waveforms of channels 2 and 3) 	<ul style="list-style-type: none"> • Waveforms of channels 1 and 4: 0.01 dB/div to 100 dB/div 1 μW/div to 1 kW/div • Waveforms of channels 2 and 3: 1 mV/div to 1 V/div

Example

WMEM1 : SCALE 5

This command sets the waveform scale of memory slot 1 to 5 dB/div.

Remarks

- The unit for the scale specified must correspond to the existing unit in the selected memory slot.
- If no waveform data exists in the selected memory slot, error -221, “Settings conflict;No data in waveform memory slot” will occur.
- If you set a scale value which exceeds its minimum or maximum limit, the value will be clipped to its minimum or maximum value respectively. Error -222, “Data out of range;Value clipped to minimum (#)” or -222, “Data out of range;Value clipped to maximum (#)” will occur.

Query

```
WMEMemory{1|2|3|4}:SCALE?
```

This query returns the current setting of the waveform scale of the specified memory slot. The response format is <NRf> in the following units:

- dB/div or W/div (for waveforms of channels 1 and 4)
- V/div (for waveforms of channels 2 and 3).

Query example

```
WMEM2:SCALE?    Queries the waveform scale setting of memory slot 2.
```

WMEMory{1 | 2 | 3 | 4}:UNIT?

This query returns the waveform unit of the specified memory slot as DBM, WATT, or VOLT.

Syntax

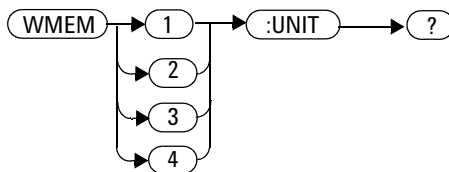

Example

```
WMEM3:UNIT?
```

Queries the waveform unit of memory slot 3.

Remark

If no waveform data exists in the selected memory slot, error -221, “Settings conflict;No data in waveform memory slot” will occur.



21 SERVice Subsystem

Overview [446](#)

SERVice:BIST:TBASe[:STATe] <boolean> [447](#)

SERVice:CSOUrce[:STATe] <boolean> [449](#)

SERVice:CSOUrce:FREQuency <character_data> [450](#)

SERVice:CSOUrce:INTerval <numeric_value> [452](#)

SERVice:SECure:ERASe [454](#)

This chapter describes how the `SERVice` command subsystem is used to configure the reference check source and perform data secure erase.



Overview

The SERVICE command subsystem controls the reference check source configuration and secure erase operation of the 8990B.

Keyword	Parameter form	Note	Page
SERVICE			
:BISt			
:TBASe			
:STATe	<boolean>		page 447
:CSOUrce			
[:STATe]	<boolean>		page 449
:FREQUency	<character_data>		page 450
:INTerVal	<numeric_value>		page 452
:SECure			
:ERASe			page 454

SERVice:BIST:TBASe[:STATe] <boolean>

This command enables or disables a 10 MHz timebase signal to be sent to the rear panel 10 MHz Ref Out connector for testing purposes.

Syntax

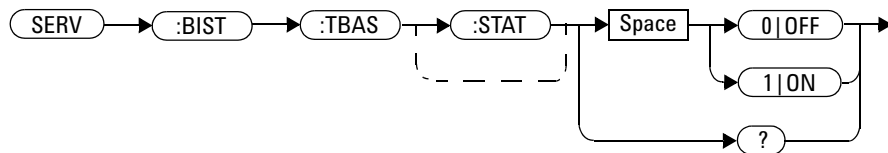

Example

`SERV:BIST:TBAS:STAT ON` *This command sends a 10 MHz timebase signal to the 10 MHz Ref Out connector.*

Reset condition

On reset, the 10 MHz timebase signal is disabled.

Query

`SERVice:BIST:TBASe:STATe?`

This query enters a 1 or 0 into the output buffer indicating the state of the 10 MHz timebase testing.

- 1 is returned when the signal is enabled
- 0 is returned when the signal is disabled

Query example

`SERV:BIST:TBAS:STAT?`

Queries whether the 10 MHz timebase signal is enabled or disabled.

SERVice:CSOUrce[:STATe] <boolean>

This command sets the state of the reference check source.

Syntax

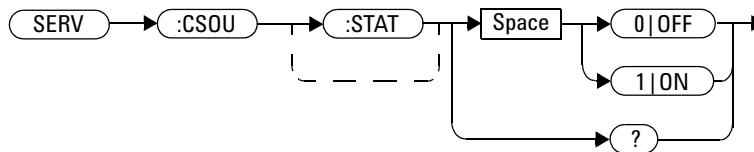

Example

SERV:CSOU ON *This command turns on the reference check source.*

Reset condition

On reset, the reference check source is turned off.

Query

SERVice:CSOUrce[:STATe]?

This query enters a 1 or 0 into the output buffer indicating the state of the reference check source.

- 1 is returned when the check source is turned on
- 0 is returned when the check source is turned off

Query example

SERV:CSOU? *Queries whether the reference check source is turned on or off.*

SERVICE:CSOURCE:FREQUENCY <character_data>

This command sets the frequency of the reference check source.

Syntax

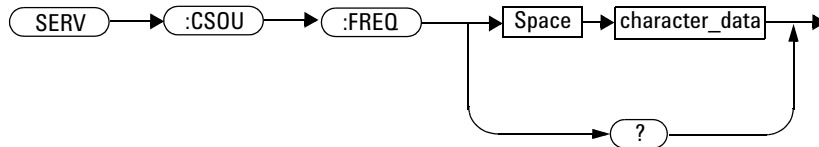

Parameter

Item	Description/Default	Range of values
character_data	Sets the check source frequency as: <ul style="list-style-type: none"> CS1K: Sets the frequency to 1 kHz. This is the default setting. CS50M: Sets the frequency to 50 MHz. CS1_05G: Sets the frequency to 1.05 GHz. 	CS1K CS50M CS1_05G

Example

```
SERV:CSOU:FREQ CS1K
```

This command sets the reference check source frequency to 1 kHz.

Reset condition

On reset, the reference check source frequency is set to 1 kHz.

Query

SERvice:CSOUrce:FREQuency?

This query returns the current setting of the reference check source frequency.

Query example

SERV:CSOU:FREQ? *Queries the reference check source frequency setting.*

SERVICE:CSOURCE:INTERVAL <numeric_value>

This command sets the time interval for the reference check source.

Syntax

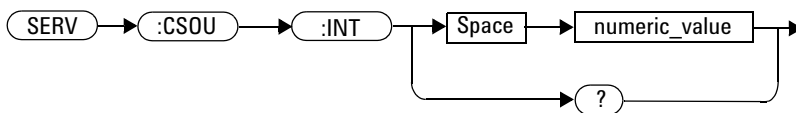

Parameter

Item	Description/Default	Range of values
numeric_value	A numeric value in minute for the check source interval: <ul style="list-style-type: none"> • Default value: 10 min • Minimum value: 1 min • Maximum value: 60 min 	1 min to 60 min

Example

SERVICE:CSOURCE:INTERVAL 20

This command sets the reference check source interval to 20 min.

Remark

If you set a check source interval value which exceeds its minimum or maximum limit, the value will be clipped to its minimum or maximum value respectively. Error -222,“Data out of range;Value clipped to minimum (#)” or -222,“Data out of range;Value clipped to maximum (#)” will occur.

Reset condition

On reset, the reference check source interval is set to 10 min.

Query

```
SERvice:CSOURCE:INTERVAL?
```

This query returns the current setting of the reference check source interval. The response format is <NR1>.

Query example

```
SERV:CSOU:INT?      Queries the reference check source interval setting.
```

SERVice:SECure:ERASe

This command erases all data stored in the 8990B memory.

Syntax

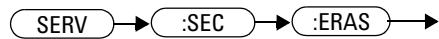

Example

SERV:SEC:ERAS

This command erases the 8990B memory.

Remark

The memory erase operation will take a few minutes to complete.



22 SYSTem Subsystem

Overview	456
SYSTem:COMMunicate:LAN:ADDRess <string>	458
SYSTem:COMMunicate:LAN:DGATeway <string>	460
SYSTem:COMMunicate:LAN:DHCPenabled	462
SYSTem:COMMunicate:LAN:HNAME?	463
SYSTem:COMMunicate:LAN:MAC?	464
SYSTem:COMMunicate:LAN:SMASK <string>	465
SYSTem:DATE	
<numeric_value>,<numeric_value>,<numeric_value>	467
SYSTem:ERRor[:NEXT]?	469
SYSTem:HELP:HEADers?	481
SYSTem:LOCK <boolean>	482
SYSTem:PRESet	483
SYSTem:TIME	
<numeric_value>,<numeric_value>,<numeric_value>	484
SYSTem:VERSion?	486

This chapter explains how to use the SYSTem command subsystem to configure the system-related settings of the 8990B.



Overview

The SYSTem command subsystem is used to perform system-related configurations such as:

- Configuring the LAN settings
- Setting the system date and time
- Returning error numbers and messages from the 8990B
- Presetting the 8990B to its default settings
- Querying the SCPI commands available in the 8990B
- Setting the state of the front panel touch screen feature
- Querying the SCPI version

Keyword	Parameter form	Note	Page
SYSTem			
:COMMunicate			
:LAN			
:ADDRess	<string>		page 458
:DGATeway	<string>		page 460
:DHCPenabled			page 462
:HNAME?		[query only]	page 463
:MAC?		[query only]	page 464
:SMASK	<string>		page 465
:DATE	<numeric_value>, <numeric_value>, <numeric_value>		page 467
:ERRor			
[:NEXT]?		[query only]	page 469
:HELP			
:HEADers?		[query only]	page 481
:LOCK	<boolean>		page 482
:PRESet			page 483

Keyword	Parameter form	Note	Page
:TIME	<numeric_value>, <numeric_value>, <numeric_value>		page 484
:VERSiOn?		[query only]	page 486

SYSTem:COMMunicate:LAN:ADDRess <string>

This command assigns a static IP address for the 8990B.

Syntax

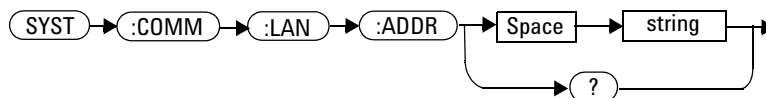

Parameter

Item	Description	Range of values
string	Numeric character values for the address. Up to 15 characters, formatted as A.B.C.D where each A, B, C, and D = 0 to 255	0 to 255 (no embedded spaces)

Example

SYST:COMM:LAN:ADDR "10.0.0.2"

This command sets the IP address to 10.0.0.2.

Remark

Sending this command will automatically disable the DHCP and switch to static IP.

Query

SYSTem:COMMunicate:LAN:ADDRess?

This query returns the current setting of the IP address.

Query example

SYST:COMM:LAN:ADDR? *Queries the IP address setting.*

SYSTem:COMMunicate:LAN:DGATeway <string>

This command assigns a default gateway address for the 8990B.

Syntax

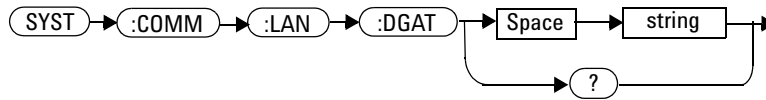

Parameter

Item	Description	Range of values
string	Numeric character values for the address. Up to 15 characters, formatted as A.B.C.D where each A, B, C, and D = 0 to 255	0 to 255 (no embedded spaces)

Example

SYST:COMM:LAN:DGAT "10.0.0.2" *This command sets the default gateway address to 10.0.0.2.*

Remark

Sending this command will automatically disable the DHCP and switch to static default gateway.

Query

SYSTem:COMMunicate:LAN:DGATeway?

This query returns the current setting of the default gateway address.

Query example

SYST:COMM:LAN:DGAT? *Queries the default gateway address setting.*

SYSTem:COMMunicate:LAN:DHCPenabled

This command enables the Dynamic Host Configuration Protocol (DHCP) for the 8990B. When DHCP is enabled, the 8990B will try to obtain an IP address from a DHCP server. If a DHCP server is found, it will assign a dynamic IP address, subnet mask, and default gateway to the 8990B.

Syntax

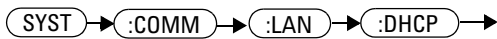

Example

SYST:COMM:LAN:DHCP *This command enables DHCP.*

Remark

DHCP can be disabled by sending “SYSTem:COMMunicate:LAN:ADDRESS <string>” on page 458.

SYSTem:COMMunicate:LAN:HNAME?

This query returns the current setting of the 8990B LAN host name in the string format.

Syntax



Example

SYST:COMM:LAN:HNAME?

Queries the host name setting.

SYSTem:COMMunicate:LAN:MAC?

This query returns the current setting of the 8990B LAN Media Access Control (MAC) address in the string format.

Syntax



Example

SYST:COMM:LAN:MAC?

Queries the MAC address setting.

SYSTem:COMMunicate:LAN:SMASk <string>

This command assigns a static subnet mask address for the 8990B.

Syntax

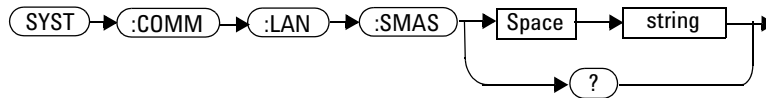

Parameter

Item	Description	Range of values
string	Numeric character values for the address. Up to 15 characters, formatted as A.B.C.D where each A, B, C, and D = 0 to 255	0 to 255 (no embedded spaces)

Example

SYST:COMM:LAN:SMAS "255.255.255.0" *This command sets the subnet mask to 255.255.255.0.*

Remark

Sending this command will automatically disable the DHCP and switch to static subnet mask.

Query

SYSTEM:COMMunicate:LAN:SMASK?

This query returns the current setting of the subnet mask.

Query example

SYST:COMM:LAN:SMAS?

Queries the subnet mask setting.

SYSTEM:DATE

<numeric_value>,<numeric_value>,<numeric_value>

This command sets the date of the 8990B realtime clock in the year (yyyy), month (mm), and day (dd) format.

Syntax

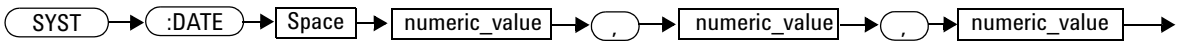

Parameter

Item	Description/Default
numeric_value	Sets the date as: <ul style="list-style-type: none"> • <i>yyyy</i>: A 4-digit integer representing the year. The value is within the range of 1980 to 2099. • <i>mm</i>: An integer from 1 to 12 representing the month • <i>dd</i>: An integer from 1 to 31 representing the day

Example

SYSTEM:DATE 2011,1,29 *This command sets the current system date to January 29, 2011.*

Remarks

- If an invalid date is specified, error -224,“Illegal parameter value” will occur.
- If the specified date is not within the acceptable range, error -710,“Invalid data format” will occur.
- If additional parameters are inserted, error -108,“Parameter not allowed” will occur.
- If there are missing parameters, error -109,“Missing parameter” will occur.
- If the parameter contains suffix, error -138,“Suffix not allowed” will occur.

Query

SYSTem:DATE?

This query returns the current setting of the system date. The response format is <NR1>.

Query example

SYST:DATE?

Queries the current system date.

SYSTem:ERRor[:NEXT]?

This query returns the next error number and its corresponding error message from the error queue. When an error is generated by the 8990B, it stores an error number and its corresponding message in the error queue. One error is removed from the error queue each time this query is sent. The errors are cleared in the first-in first-out (FIFO) order, where the oldest errors are cleared first. When the error queue is empty, subsequent SYSTem:ERRor? queries will return 0, “No error”.

Syntax

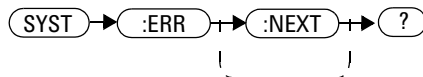

Example

SYST:ERR? *Queries the oldest error message stored in the 8990B error queue.*

Remark

To clear all errors from the error queue, send the *CLS command.

Reset condition

On reset, the error queue is unaffected.

Error list

0	No error The error queue is completely empty. Every error or event in the queue has been read or the queue has been purposely cleared by power-on, *CLS, and so forth.
-100	Command error Generic syntax error
-101	Invalid character An invalid character was found in the command string. You may have inserted a character such as #, \$, or % in the command header or within a parameter. Example: MARK:AXP 30#
-102	Syntax error An invalid syntax was found in the command string Example: AUTO
-103	Invalid separator An invalid separator was found in the command string. You may have used a comma instead of a colon, semicolon, or blank space; or you may have used a blank space instead of a comma. Example: ACQ:AVER:COUN,128
-105	GET not allowed A Group Execute Trigger (GET) is not allowed within a command string
-108	Parameter not allowed Additional parameters were received. You must remove the additional parameters for this command. Example: SYST:DATE 1981,2,1,1
-109	Missing parameter Fewer parameters were received than expected for the command. You may have omitted one or more parameters that are required for this command. Example: CHAN1:BWID

-110	<p>Command header error An error was detected in the header</p>
-111	<p>Header separator error A character that was not a valid header separator was found in the command string</p>
-112	<p>Program mnemonic too long A command header was received which contained more than the maximum 12 characters allowed Example: SYSTemCOMMunicateLANDGATeway "10.0.0.2"</p>
-113	<p>Undefined header A command was received that is not valid for the 8990B. You may have misspelled the command, it may not be a valid command, or you may have selected the wrong interface. If you are using the short form of the command, remember that it may contain up to four letters. Example: CHAN2:OFF 50</p>
-114	<p>Header suffix out of range The value of the numeric suffix is invalid</p>
-120	<p>Numeric data error Generic numeric data error</p>
-121	<p>Invalid character in number An invalid character was found in the number specified for a parameter value Example: MARK: BXP 20\$</p>
-123	<p>Exponent too large A numeric parameter was found whose exponent was larger than 32000 Example: CHAN1:FREQ 1E34000</p>
-124	<p>Too many digits A numeric parameter was found whose mantissa contained more than 255 digits, excluding leading zeros</p>

-128	Numeric data not allowed A numeric value was received within a command which does not accept a numeric value Example: CHAN1:REF 50
-130	Suffix error Generic suffix error
-131	Invalid suffix A suffix was incorrectly specified for a numeric parameter. You may have misspelled the suffix. Example: CHAN2:INP LFRJ1
-134	Suffix too long A suffix used contained more than 12 characters Example: CHAN2:INP LFR20000000000000
-138	Suffix not allowed A suffix was received following a numeric parameter which does not accept a suffix Example: CHAN2:OFFS 50Hz
-140	Character data error Generic character data error
-141	Invalid character data Either the character data element contains an invalid character, or the element is not valid
-144	Character data too long The character data element contains more than 12 characters
-148	Character data not allowed A discrete parameter was received but a character string or a numeric parameter was expected. Check the list of parameters to verify that you have used a valid parameter type. Example: MARK:MODE OFF_0
-150	String data error Generic string data error

-151	<p>Invalid string data</p> <p>An invalid string was received. Check to see if you have enclosed the character string in single or double quotes.</p> <p>Example; SYST:COMM:LAN:ADDR "10.0.0.2"</p>
-158	<p>String data not allowed</p> <p>A character string was received but is not allowed for the command. Check the list of parameters to verify that you have used a valid parameter type.</p> <p>Example: SYST:LOCK 'ON'</p>
-160	<p>Block data error</p> <p>Generic block data error</p>
-161	<p>Invalid block data</p> <p>A block data element was expected but was invalid for some reason</p>
-168	<p>Block data not allowed</p> <p>A legal block data element was encountered but not allowed by the 8990B at this point</p>
-170	<p>Expression error</p> <p>Generic expression error</p>
-171	<p>Invalid expression data</p> <p>The expression data element was invalid</p>
-178	<p>Expression data not allowed</p> <p>A legal expression data was encountered but not allowed by the 8990B at this point</p> <p>Example: MARK:LEV (5+5)</p>
-200	<p>Execution error</p> <p>Generic syntax error</p>
-210	<p>Trigger error</p> <p>An error occurred during triggering</p>
-211	<p>Trigger ignored</p> <p>A triggering signal was received but the trigger was ignored</p>

-220	Parameter error A data element related error occurred
-221	Settings conflict;Requires channel # to be enabled The channel selected is not enabled
-221	Settings conflict;Requires averaging to be enabled The averaging mode is not enabled
-221	Settings conflict;Requires CCDF mode to be enabled The data acquisition mode is not set to CCDF
-221	Settings conflict;Requires zoom mode to be enabled The data acquisition mode is not set to zoom
-221	Settings conflict;Requires droop measurement to be enabled The droop measurement is not enabled
-221	Settings conflict;Requires to switch to manual marker mode The marker measurement mode is not set to manual
-221	Settings conflict;Requires to switch to pulse spacing marker measurement The marker measurement mode is not set to pulse spacing
-221	Settings conflict;Requires CCDF sweep to be in free run mode The CCDF sweep mode is not set to free run
-221	Settings conflict;Requires CCDF sweep to be in triggered mode The CCDF sweep mode is not set to triggered
-221	Settings conflict;Requires CCDF trace # to be enabled The CCDF trace from the channel selected is not enabled
-221	Settings conflict;Requires CCDF Gaussian trace to be enabled The CCDF Gaussian trace is not enabled

-221	Settings conflict;Requires CCDF reference trace to be enabled The CCDF reference trace is not enabled
-221	Settings conflict;CCDF marker # source not set The source of CCDF marker A or B is not set
-221	Settings conflict;CCDF source not set The CCDF source is not set
-221	Settings conflict;Settings conflict;Fast trigger is only applicable to trigger source for channel 1 and 4. Fast trigger has been disabled The fast trigger is enabled when the trigger source is set to channel 2, 3, or auxiliary
-221	Settings conflict;Unable to turn on video bandwidth while ETS mode is on The video bandwidth is being turned on when the ETS mode is enabled
-221	Settings conflict;Unable to set video bandwidth to MEDIUM or HIGH. Frequency must be higher than 500 MHz The video bandwidth is being set to medium or high when the frequency is less than 500 MHz
-221	Settings conflict;Video bandwidth must be off when ETS is on. Video bandwidth is turned off ETS is being turned on when the video bandwidth is enabled
-221	Settings conflict;Frequency less than 500 MHz. Video bandwidth has been set to LOW The frequency is set to less than 500 MHz when the video bandwidth is set to medium or high
-221	Settings conflict;Unable to turn on Trigger on Event while ETS mode is on The 8990B is set to trigger on event when the ETS mode is enabled
-221	Settings conflict;Trigger sweep must be in triggered mode while ETS is on. Trigger sweep is set to triggered mode The trigger sweep mode is set to auto when the ETS mode is enabled

-221	Settings conflict;Unable to set trigger sweep to auto mode, time scale must be at least {0} or higher The trigger sweep mode is set to auto when the time scale is too low
-221	Settings conflict;No FDO data entry available There is no data in the selected FDO table
-221	Settings conflict;No FDO table selected There was no FDO table selected when sending an FDO table-related command
-221	Settings conflict;Duplicated frequency input The frequency value specified for the FDO table is a duplicate of an existing frequency value
-221	Settings conflict;No data in waveform memory slot There is no waveform data in the selected 8990B memory slot
-221	Settings conflict;Unable to set the trigger source. Command ignored An error occurred when setting the trigger source
-222	Data out of range A numeric parameter value is outside the valid range for the command Example: CHAN1:EXT 500
-222	Data out of range;Value clipped to minimum (#) A numeric parameter value is lower than the minimum value allowed
-222	Data out of range;Value clipped to maximum (#) A numeric parameter value is higher than the maximum value allowed
-223	Too much data A data element was received that contains more data than the 8990B can handle
-224	Illegal parameter value A discrete parameter was received which was not a valid choice for the command. You may have used an invalid parameter choice. Example: CHAN1:REF MIDD

-225	Out of memory The 8990B has insufficient memory to perform the requested operation
-231	Data questionable;Calibration error 8990B calibration and zeroing has failed
-231	Data questionable;Voltage overloaded The voltage input to the channel exceeds the maximum range of the probe
-231	Data questionable;Calibration error in channel 1 An error has occurred during calibration for channel 1
-231	Data questionable;Calibration error in channel 4 An error has occurred during calibration for channel 4
-232	Invalid format The data format or structure is inappropriate
-233	Invalid version The version of the data format is incorrect
-240	Hardware error The command could not be executed due to a hardware problem
-241	Hardware missing;Unable to turn on channel #;no sensor detected The 8990B is unable to execute the command because no sensor is connected to the respective channel
-250	Mass storage error Generic error relating to mass storage
-251	Missing mass storage The mass storage is not available
-255	Directory full The specified directory is full

-256	File name not found The selected file was not found
-257	File name error The file name is invalid
-260	Expression execution error An expression program data element related error occurred
-291	Out of memory error The memory is not sufficient to implement the command
-300	Device specific error This is the generic device-dependent error for devices that cannot detect more specific errors. This code indicates that only a Device-Dependent Error as defined in the IEEE-488.2, 11.5.1.1.6 has occurred.
-310	System error The 8990B operation has not completed properly, possibly due to an abnormal hardware or firmware condition
-311	Memory error An error was detected in the 8990B memory
-330	Self-test failed The 8990B self-test has failed
-340	Calibration failed The 8990B calibration has failed
-350	Error queue overflow The error queue is full and another error has occurred which could not be recorded
-400	Query error Generic error query

-410	<p>Query interrupted A condition causing an interrupted query error occurred</p>
-420	<p>Query unterminated A condition causing an unterminated query error occurred</p>
-430	<p>Query deadlocked A condition causing a deadlocked query error occurred</p>
-440	<p>Query unterminated after indefinite response A query was received in the same program message after a query indicating an indefinite response was executed</p>
-710	<p>Invalid data format The data format is invalid</p>
700	<p>Applicable to channel 1 and 4 only A channel other than channel 1 or 4 has been specified for a command applicable for channels 1 and 4 only; or a command applicable for channels 1 and 4 only has been sent for a channel other than channel 1 or 4</p>
701	<p>Applicable to channel 2 and 3 only A channel other than channel 2 or 3 has been specified for a command applicable for channels 2 and 3 only; or a command applicable for channels 2 and 3 only has been sent for a channel other than channel 2 or 3</p>
702	<p>Applicable to trigger source for channel 1, 4 and auxiliary only A command applicable for the channel 1, 4, or auxiliary trigger source only has been sent when the trigger source was not set to any of these sources</p>
703	<p>Applicable in pair of channel 1 and 4 or 2 and 3 An incorrect channel pair has been specified</p>
704	<p>Applicable to trigger source for auxiliary only A command applicable for the auxiliary trigger source only has been sent when the trigger source was not set to auxiliary</p>

705	<p>Applicable to trigger source for channel 1 and 4 only</p> <p>A command applicable for the channel 1 or 4 trigger source only has been sent when the trigger source was not set to any of these sources</p>
706	<p>Applicable to trigger source for channel 2 and 3 only</p> <p>A command applicable for the channel 2 or 3 trigger source only has been sent when the trigger source was not set to any of these sources</p>
720	<p>No reference signal detected on the 10 MHz REF IN BNC input</p> <p>There is no reference signal at the 10 MHz REF IN BNC input</p>
780	<p>System is busy, command unterminated</p> <p>The system is busy processing the command</p>
939	<p>10 MHz setting is only applicable when ETS is off. 10 MHz setting is turned off</p> <p>The ETS mode is set when the 10 MHz reference signal input is enabled</p>
940	<p>Unable to turn on 10 MHz setting when ETS is on</p> <p>The 10 MHz reference signal input is being turned on when the ETS mode is enabled</p>
943	<p>Markers A and B are positioned on the same waveform</p> <p>Markers A and B have to be placed on two separate waveforms to measure the time difference between them</p>
946	<p>Selected FDO table has reached the limit of 80 frequency points</p> <p>Select another FDO table or delete some frequency points</p>
977	<p>Detected channel 1 frequency changed. Power level is questionable. Please zero and cal channel 1.</p>
978	<p>Detected channel 4 frequency changed. Power level is questionable. Please zero and cal channel 4.</p>

SYSTem:HELP:HEADers?

This query returns the SCPI commands available on the 8990B in the IEEE block format. Each command returned is separated by a new-line character (0x0A). At the end of each command before the new-line character, the following string characters may be present:

- /nquery/ – for the SCPI command only
- /qonly/ – for the SCPI query only
- <empty> – for both the SCPI command and the query

An example of the return data is as follows:

```
#41024<<x0A>>:AUToscale/nquery/<<x0A>>:AVERage ...
```

Syntax

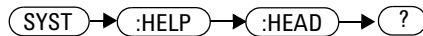

Example

```
SYST:HELP:HEAD?
```

Queries the SCPI commands available on the 8990B.

Remark

The output representation of the IEEE block format may vary depending on the device and software used.

SYSTem:LOCK <boolean>

This command enables or disables the front panel touch screen.

Syntax

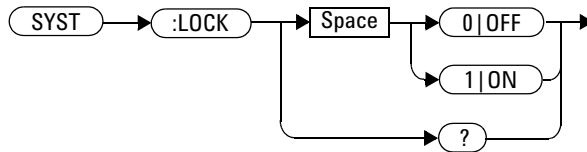

Example

SYST:LOCK 1 *This command disables the front panel touch screen.*

Reset condition

On reset, the front panel touch screen is enabled.

Query

SYSTem:LOCK?

This query enters a 1 or 0 into the output buffer indicating whether the front panel touch screen is enabled or disabled.

- 1 is returned when the front panel touch screen is enabled.
- 0 is returned when the front panel touch screen is disabled.

Query example

SYST:LOCK? *Queries the status of the front panel touch screen.*

SYSTem:PRESet

This command is used to preset the 8990B to its default settings.

Syntax

SYST → :PRES →

Example

SYST:PRESet *This command presets the 8990B to the default settings.*

SYSTem:TIME

<numeric_value>,<numeric_value>,<numeric_value>

This command sets the 8990B 24-hour realtime clock in the hour (hh), minute (mm), and second (ss) format.

Syntax

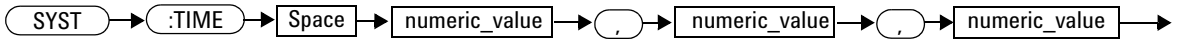

Parameter

Item	Description/Default
numeric_value	Sets the time as: <ul style="list-style-type: none"> • hh: An integer from 0 to 23 representing the hour • mm: An integer from 0 to 59 representing the minute • ss: An integer from 0 to 59 representing the second

Example

SYSTem:TIME 12,1,0

This command sets the current system time to 12:01:00.

Remarks

- If an invalid time is specified, error -224,“Illegal parameter value” will occur.
- If the specified time is not within the acceptable range, error -710,“Invalid data format” will occur.
- If additional parameters are inserted, error -108,“Parameter not allowed” will occur.
- If there are missing parameters, error -109,“Missing parameter” will occur.
- If the parameter contains suffix, error -138,“Suffix not allowed” will occur.

Query

SYSTem:TIME?

This query returns the current setting of the system time. The response format is <NR1>.

Query example

SYST:TIME?

Queries the current system time.

SYSTem:VERSion?

This query returns the version of SCPI used in the 8990B. The response is in the form of XXXX.Y, where XXXX is the year and Y is the version number.

Syntax

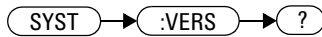

Example

SYST:VERS? *Queries which version of SCPI is used in the 8990B.*



23 Programming Examples

- Example 1: Identifying the 8990B In Use [488](#)
- Example 2: Making Pulse Characterization Measurement [489](#)
- Example 3: Making Delay Measurement [492](#)
- Example 4: Making Droop Measurement [495](#)

This chapter provides programming sequence examples to remotely control the 8990B using SCPI commands.



Example 1: Identifying the 8990B In Use

The following example shows how to verify whether you are communicating with the right 8990B. Refer to “[Error list](#)” on page 470 for more information on the error messages.

NOTE

“->” indicates the commands that you send to the 8990B.

```
-> *IDN? //Queries the instrument identification and checks
         whether you are communicating with the right 8990B.
-> SYST:ERR? //Checks the 8990B system error queue.
```

Example 2: Making Pulse Characterization Measurement

The following command sequences provide the example to perform the pulse characterization measurement.

NOTE

"->" indicates the commands that you send to the 8990B.

This measurement example requires the following test setup:



Figure 23-1 Test setup for the pulse characterization measurement

E4438C signal generator configuration

```
-> SYST:PRES //Presets the E4438C to its default settings.
Wait 1 sec for operation to complete.
-> *CLS //Clears the error queue.
-> FREQ 1GHZ //Sets the frequency to 1 GHz.
-> POW 0DBM //Sets the output power level to 0 dBm.
-> PULM:INT:PER 1000uS //Sets the pulse period to 1000 μs.
-> PULM:INT:PWID 200uS //Sets the pulse width to 200 μs.
```

23 Programming Examples

```
-> PULM:STAT ON           //Turns on the pulse signal.
-> OUTP:MOD ON            //Turns on the modulation signal.
-> OUTP ON                //Turns on the RF output power.
```

8990B configuration

```
-> SYST:PRES             //Presets the 8990B to its default settings.
-> *OPC?                 //Waits until the completion of the current command
                        //and then sends 1 to the output buffer.
-> *CLS                  //Clears the status data structures.
-> *IDN?                 //Queries the 8990B identification string.
-> CHAN1:FREQ 1G         //Sets the channel 1 frequency to 1 GHz.
-> AUT                   //Autoscales the waveform display.
-> *OPC?                 //Waits until the completion of the current command
                        //and then sends 1 to the output buffer.
-> TRIG:SOUR CHAN1      //Sets the trigger source to channel 1.
-> TIM:SCAL 0.0002      //Sets the timebase scale to 0.2 ms/div.
```

Wait 1 sec for operation to complete.

```
-> MEAS:MIN? CHAN1      //Queries the minimum power measurement result for
                        //channel 1.
-> MEAS:PEAK? CHAN1    //Queries the peak power measurement result for
                        //channel 1.
-> MEAS:AVER? CHAN1    //Queries the average power measurement result for
                        //channel 1.
-> MEAS:PAV? CHAN1     //Queries the peak-to-average power measurement
                        //result for channel 1.
-> MEAS:DUTY? CHAN1    //Queries the power duty cycle measurement result for
                        //channel 1.
-> MEAS:PRI? CHAN1     //Queries the pulse repetition interval (PRI)
                        //measurement result for channel 1.
-> MEAS:PRF? CHAN1    //Queries the pulse repetition frequency (PRF)
                        //measurement result for channel 1.
-> MEAS:OFF? CHAN1    //Queries the off time measurement result for
                        //channel 1.
```



```

-> MEAS:PBAS? CHAN1 //Queries the pulse-base measurement result for
channel 1.
-> MEAS:PTOP? CHAN1 //Queries the pulse-top measurement result for
channel 1.
-> MEAS:PWID? CHAN1 //Queries the pulse width measurement result for
channel 1.
-> MEAS:OVER? CHAN1 //Queries the overshoot measurement result for
channel 1.
-> TIM:SCAL 50u //Sets the timebase scale to 50  $\mu$ s/div.
Wait 1 sec for operation to complete.
-> TRIG:EDGE:SLOP POS //Sets the slope to positive for the edge trigger.
-> MEAS:RISE? CHAN1 //Queries the rise time measurement result for
channel 1.
-> TRIG:EDGE:SLOP NEG //Sets the slope to negative for the edge trigger.
-> MEAS:FALL? CHAN1 //Queries the fall time measurement result for
channel 1.

```

Example 3: Making Delay Measurement

The following command sequences provide the example to measure delay.

NOTE

"->" indicates the commands that you send to the 8990B.

This measurement example requires the following test setup:

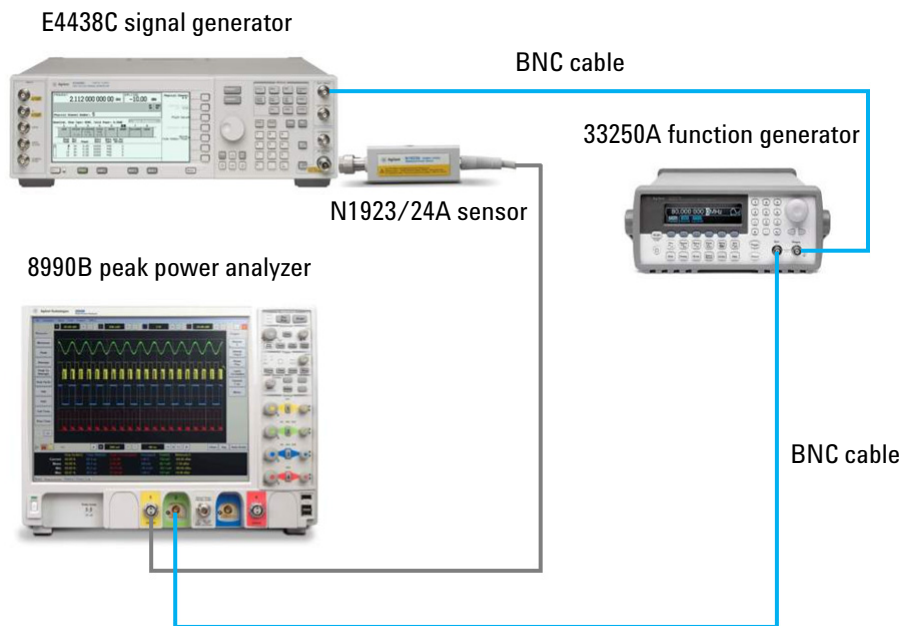

Figure 23-2 Test setup for delay measurement

E4438C signal generator configuration

```

-> SYST:PRES //Presets the E4438C to its default settings.
Wait 1 sec for operation to complete.
-> *CLS //Clears the error queue.
-> FREQ 1GHZ //Sets the frequency to 1 GHz.
-> POW 0DBM //Sets the output power level to 0 dBm.
-> PULM:SOUR EXT1 //Sets the pulse modulation source to external.
-> PULM:STAT ON //Turns on the pulse signal.
-> OUTP:MOD ON //Turns on the modulation signal.
-> OUTP ON //Turns on the RF output power.

```

33250A function generator configuration

```

-> *RST //Resets the 33250A to its default settings.
Wait 1 sec for operation to complete.
-> *CLS //Clears the error queue.
-> OUTP:POL NORM //Sets the waveform polarity to the normal mode.
-> FUNC PULS //Sets the output function to pulse.
-> PULS:PER 1m //Sets the pulse period to 1 ms.
-> PULS:WIDT 100u //Sets the pulse width to 100  $\mu$ s.
-> VOLT 1 //Sets the output amplitude to 1 Vpp.
-> OUTP ON //Turns on the RF output.

```

8990B configuration

```

-> SYST:PRES //Presets the 8990B to its default settings.
-> *OPC? //Waits until the completion of the current command
         and then sends 1 to the output buffer.
-> *CLS //Clears the status data structures.
-> *IDN? //Queries the 8990B identification string.
-> CHAN1:FREQ 1G //Sets the channel 1 frequency to 1 GHz.
-> AUT //Autoscales the waveform display.

```

23 Programming Examples

```
-> *OPC? //Waits until the completion of the current command  
and then sends 1 to the output buffer.
```

```
-> TIM:SCAL 1u //Sets the timebase scale to 1  $\mu$ s/div.
```

```
-> CHAN1:SCAL 20 //Sets the channel 1 scale to 20 dB/div.
```

Wait 1 sec for operation to complete.

```
-> CHAN2:SCAL 0.5 //Sets the channel 2 scale to 0.5 V/div.
```

Wait 1 sec for operation to complete.

```
-> MARK:MODE DEL //Sets the marker measurement mode to delay.
```

```
-> MARK:DEL:ASOU CHAN2 //Sets the marker A source for delay measurement to  
channel 2.
```

```
-> MARK:DEL:BSOU CHAN1 //Sets the marker B source for delay measurement to  
channel 1.
```

Wait 3 secs for operation to complete.

```
-> MARK:XDEL? //Queries the X-axis delta value between the A and B  
markers.
```

Example 4: Making Droop Measurement

The following command sequences provide the example to measure droop.

NOTE

"->" indicates the commands that you send to the 8990B.

This measurement example requires the following test setup:

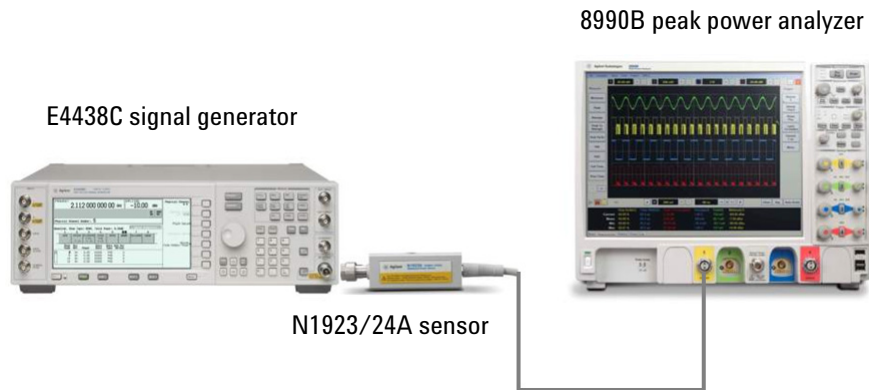

Figure 23-3 Test setup for droop measurement

E4438C signal generator configuration

```
-> SYST:PRES //Presets the E4438C to its default settings.
Wait 1 sec for operation to complete.
-> *CLS //Clears the error queue.
-> FREQ 1GHZ //Sets the frequency to 1 GHz.
-> POW 0DBM //Sets the output power level to 0 dBm.
-> PULM:INT:PER 10uS //Sets the pulse period to 10 μs.
-> PULM:INT:PWID 4uS //Sets the pulse width to 4 μs.
-> PULM:STAT ON //Turns on the pulse signal.
```

23 Programming Examples

```
-> OUTP:MOD ON //Turns on the modulation signal.
-> OUTP ON //Turns on the RF output power.
```

8990B configuration

```
-> SYST:PRES //Presets the 8990B to its default settings.
-> *OPC? //Waits until the completion of the current command
and then sends 1 to the output buffer.
-> *CLS //Clears the status data structures.
-> *IDN? //Queries the 8990B identification string.
-> CHAN1:FREQ 1G //Sets the channel 1 frequency to 1 GHz.
-> AUT //Autoscales the waveform display.
-> *OPC? //Waits until the completion of the current command
and then sends 1 to the output buffer.
-> TIM:SCAL 1u //Sets the timebase scale to 1  $\mu$ s/div.
```

Wait 1 sec for operation to complete.

```
-> CHAN1:SCAL 20 //Sets the channel 1 scale to 20 dB/div.
-> ACQ:DRO 1 //Turns on the droop measurement mode.
-> ACQ:DRO:SOUR CHAN1 //Sets the droop measurement source to channel 1.
```

Wait 1 sec for operation to complete.

```
-> MEAS:DRO? //Queries the droop measurement result for channel 1.
```

www.agilent.com

Contact us

To obtain service, warranty, or technical assistance, contact us at the following phone or fax numbers:

United States:

(tel) (800) 829 4444 (fax) 800 829 4433

Canada:

(tel) (877) 894 4414 (fax) 800 746 4866

China:

(tel) 800 810 0189 (fax) 800 820 2816

Europe:

(tel) 31 20 547 2111

Japan:

(tel) 0120 (421) 345 (fax) 0120 421 678

Korea:

(tel) 080 769 0800 (fax) (080) 769 0900

Latin America:

(tel) 305 269 7500

Taiwan:

(tel) 0800 047 866 (fax) 0800 286 331

Other Asia Pacific Countries:

(tel) (65) 6375 8100 (fax) (65) 6755 0042

Or visit Agilent World Wide Web at:

www.agilent.com/find/assist

Product specifications and descriptions in this document are subject to change without notice. Always refer to the Agilent Web site for the latest revision.

© Agilent Technologies, Inc. 2011–2013

Sixth Edition, November 27, 2013

08990-90009



Agilent Technologies