

Keysight 86205A/B & 86207A 50 Ω & 75 Ω Bridges

300 kHz to 3 GHz (50 Ω)
300 kHz to 6 GHz (50 Ω)
300 kHz to 3 GHz (75 Ω)

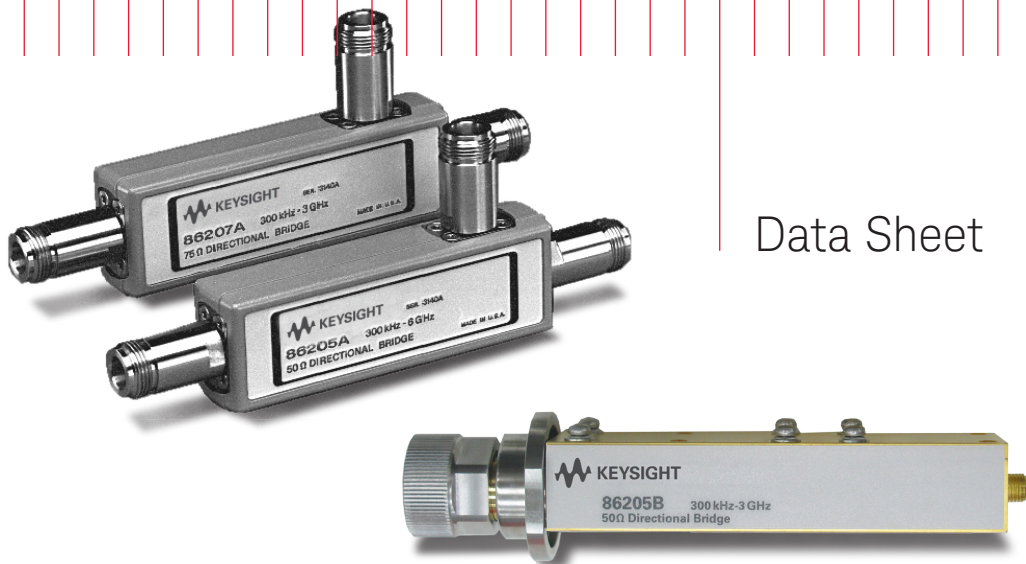

[Data Sheet](#)



Introduction

The Keysight Technologies, Inc. 86205A/B and 86207A high directivity RF bridges offer unparalleled performance in a variety of general purpose applications. They are ideal for accurate reflection measurements and signal-leveling applications. They combine the directivity and broad-band frequency range of directional bridges and the low insertion loss and flat coupling factor of directional couplers.

40 dB directivity

Excellent directivity allows you to measure high return loss devices and good port match lets you measure low return loss devices. This is especially important when making reflection measurements with scalar network analyzers, vector network analyzers and spectrum analyzers.

Wide frequency range

The bridges have an exceptionally wide RF frequency range: 300 kHz to 3/6 GHz for the 50 Ω 86205A/B and 300 kHz to 3 GHz for the 75 Ω 86207A. They are ideal accessories when used with the E5061/71 family of the ENA series network analyzers.

Low insertion loss

These bridges offer low insertion loss, (nominally 1.5 dB), which is significantly less than the typical 6 to 8 dB normally associated with RF bridges. Low insertion loss means more power to the device under test. This is required for the measurement of high-power solid state amplifiers and traveling wave tube amplifiers.

Flat coupling factor

The frequency response of the coupled arm for these bridges is very flat, within ± 0.2 dB of the nominal value of 16 dB. This is important in applications such as external power leveling where a power meter or diode detector is used to remotely level the output power from an RF source and when measuring power level dependent devices such as the LO input to a mixer or the RF input to an amplifier during compression testing.

Specifications

Specifications describe the instrument's warranted performance over the temperature range of 0 °C to 55 °C. Supplemental characteristics are intended to provide information useful in applying the instrument by giving supplemental, but not warranted performance parameters. These are denoted as "typical."

86205A

Frequency range	300 kHz to 6 GHz
Impedance	50 Ohms (nominal)
Directivity (25 °C, ±5 °C)	30 dB, 0.3 MHz to 5 MHz 40 dB, 5 MHz to 2 GHz 30 dB, 2 GHz to 3 GHz (typical) 20 dB, 3 GHz to 5 GHz (typical) 16 dB, 5 GHz to 6 GHz

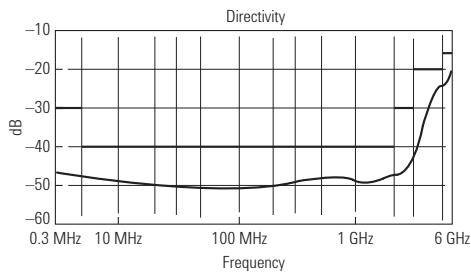

Port match	23 dB, 0.3 MHz to 2.0 GHz (1.15 SWR) 20 dB, 2.0 GHz to 3 GHz (1.22 SWR) (typical) 18 dB, 3 GHz to 5 GHz (1.29 SWR) (typical) 16 dB, 5 GHz to 6 GHz (1.38 SWR)
------------	--

Supplemental characteristics

Insertion loss	1.5 dB, +0.1 dB/GHz
Insertion loss deviation	±0.2 dB
Coupling factor	(< 3 GHz) 16.0 dB, +0.15 dB/GHz (> 3 GHz) 16.5 dB, -0.20 dB/GHz
Coupling factor deviation	(< 3 GHz) ±0.2 dB, (> 3 GHz) ±0.4 dB
Maximum input power	25 dBm
Maximum DC, volts (through arm)	30 VDC
Maximum DC, volts (coupled arm)	0 VDC
Maximum DC, amps (through arm)	1 amp
Below 1 MHz directivity and port match will be slightly degraded above 200 ma bias current.	
Connectors	Type-N (female)
Dimensions	160 W x 93 H x 23 mm D (6.3 W x 3.7 H x 1 in D)
Weight	Net 0.57 kg (1.3 lbs), shipping 1.80 kg (4.0 lbs)

86205B

Frequency range	300 kHz to 3 GHz
Impedance	50 Ohms (nominal)
Directivity (25 °C, ±5 °C)	38 dB, 0.3 MHz to 1.3 GHz 33 dB, 1.3 GHz to 3 GHz

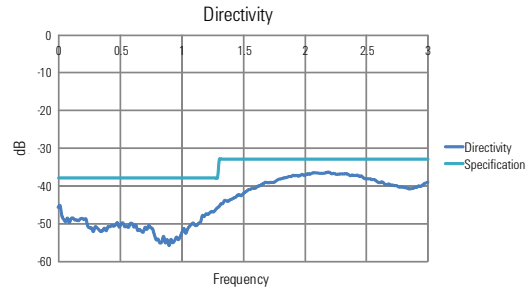

Port match	14 dB, 0.3 MHz to 3 GHz, (1.50 SWR)
------------	-------------------------------------

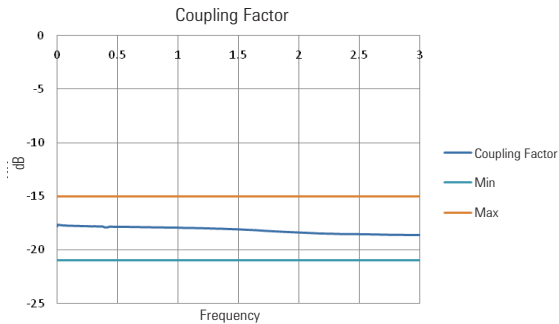
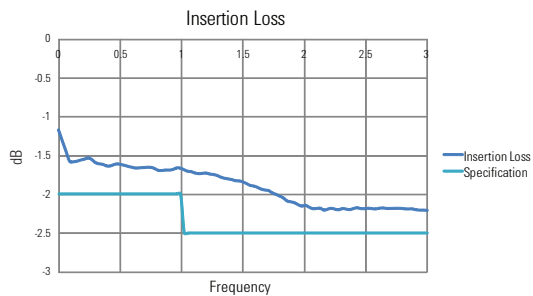

Supplemental characteristics

Insertion loss	2.0 dB, 0.3 MHz to 1 GHz 2.5 dB, 1 GHz to 3 GHz
Coupling factor	-21 to -15 dB, 0.3 MHz to 3 GHz 18 dB, 0.3 MHz to 3 GHz
Coupling factor deviation	+3 dB
Connectors	3.5 mm (f), APC-7
Dimension	133.2 W x 18.2 H x 31.5 mm D (5.2 W x 0.7 H x 1.2 in D)
Weight	Net 0.31 kg (0.68 lbs), Shipping 0.64 kg (1.41 lbs)

86207A

Frequency range 300 kHz to 3 GHz
Impedance 75 Ohms (nominal)
Directivity (25 °C, ±5 °C)
 30 dB, 0.3 MHz to 5 MHz
 40 dB, 5 MHz to 1.3 GHz
 35 dB, 1.3 GHz to 2 GHz
 (typical) 30 dB, 2 GHz to 3 GHz

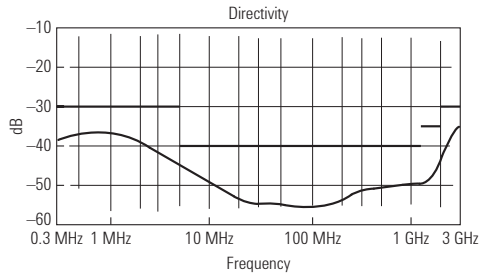

Port match 20 dB, 0.3 GHz to 1.3 GHz (1.22 SWR)
 (typical) 18 dB, 1.3 GHz to 2 GHz (1.29 SWR)
 (typical) 18 dB, 2 GHz to 3 GHz (1.29 SWR)

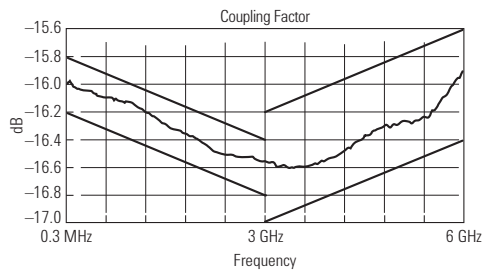
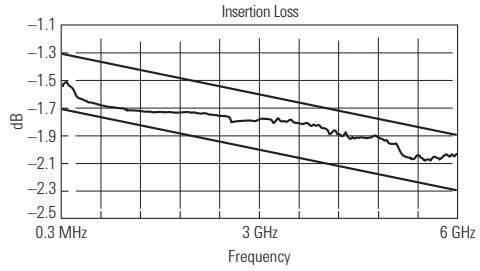

Models

- 86205A RF bridge (50 Ω)
- 86205B RF bridge (50 Ω)
- 86207A RF bridge (75 Ω)

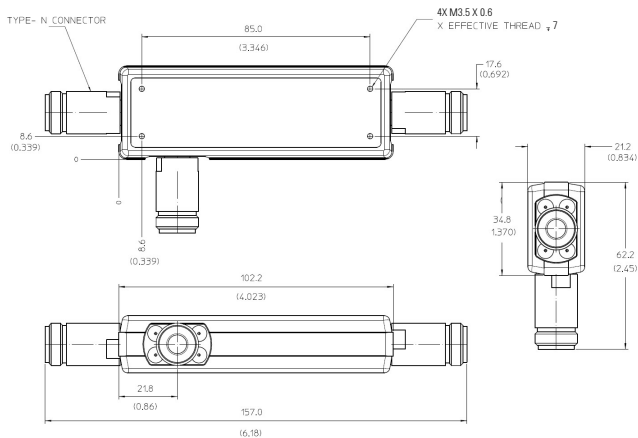

Figure 1. Mechanical dimension for 86205/7A

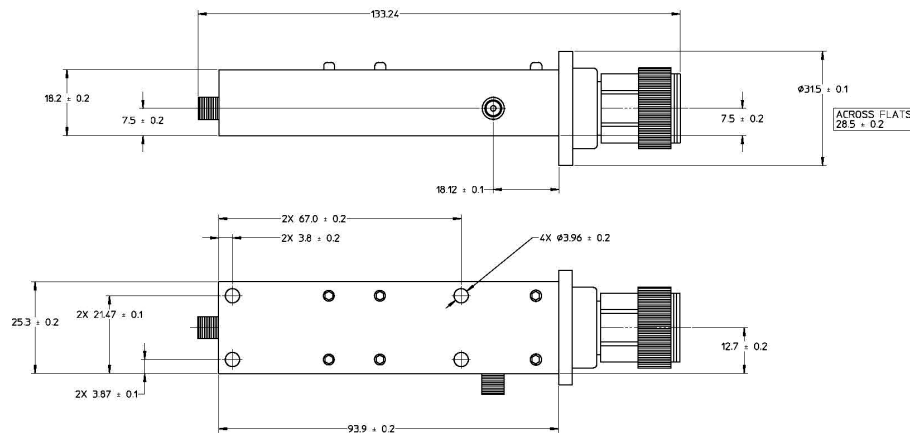

Figure 2. Mechanical dimension for 86205B

myKeysight

myKeysight

www.keysight.com/find/mykeysight

A personalized view into the information most relevant to you.

www.axiestandard.org



Three-Year Warranty

www.keysight.com/find/ThreeYearWarranty

Keysight's commitment to superior product quality and lower total cost of ownership. The only test and measurement company with three-year warranty standard on all instruments, worldwide.



Keysight Assurance Plans

www.keysight.com/find/AssurancePlans

Up to five years of protection and no budgetary surprises to ensure your instruments are operating to specification so you can rely on accurate measurements.



www.keysight.com/quality

Keysight Electronic Measurement Group

DEKRA Certified ISO 9001:2008

Quality Management System

Keysight Channel Partners

www.keysight.com/find/channelpartners

Get the best of both worlds: Keysight's measurement expertise and product breadth, combined with channel partner convenience.

www.keysight.com/find/mta

For more information on Keysight Technologies' products, applications or services, please contact your local Keysight office. The complete list is available at: www.keysight.com/find/contactus

Americas

Canada	(877) 894 4414
Brazil	55 11 3351 7010
Mexico	001 800 254 2440
United States	(800) 829 4444

Asia Pacific

Australia	1 800 629 485
China	800 810 0189
Hong Kong	800 938 693
India	1 800 112 929
Japan	0120 (421) 345
Korea	080 769 0800
Malaysia	1 800 888 848
Singapore	1 800 375 8100
Taiwan	0800 047 866
Other AP Countries	(65) 6375 8100

Europe & Middle East

Austria	0800 001122
Belgium	0800 58580
Finland	0800 523252
France	0805 980333
Germany	0800 6270999
Ireland	1800 832700
Israel	1 809 343051
Italy	800 599100
Luxembourg	+32 800 58580
Netherlands	0800 0233200
Russia	8800 5009286
Spain	0800 000154
Sweden	0200 882255
Switzerland	0800 805353
	Opt. 1 (DE)
	Opt. 2 (FR)
	Opt. 3 (IT)
United Kingdom	0800 0260637

For other unlisted countries:
www.keysight.com/find/contactus
 (BP-05-29-14)