

Errata

Title & Document Type: Extending the 8640B to DC

Manual Part Number: 5952-8125

Revision Date: unknown

HP References in this Manual

This manual may contain references to HP or Hewlett-Packard. Please note that Hewlett-Packard's former test and measurement, semiconductor products and chemical analysis businesses are now part of Agilent Technologies. We have made no changes to this manual copy. The HP XXXX referred to in this document is now the Agilent XXXX. For example, model number HP8648A is now model number Agilent 8648A.

About this Manual

We've added this manual to the Agilent website in an effort to help you support your product. This manual provides the best information we could find. It may be incomplete or contain dated information, and the scan quality may not be ideal. If we find a better copy in the future, we will add it to the Agilent website.

Support for Your Product

Agilent no longer sells or supports this product. You will find any other available product information on the Agilent Test & Measurement website:

www.tm.agilent.com

Search for the model number of this product, and the resulting product page will guide you to any available information. Our service centers may be able to perform calibration if no repair parts are needed, but no other support from Agilent is available.

Measurements with SIGNAL GENERATORS



Extending the 8640B Frequency DOWN TO DC

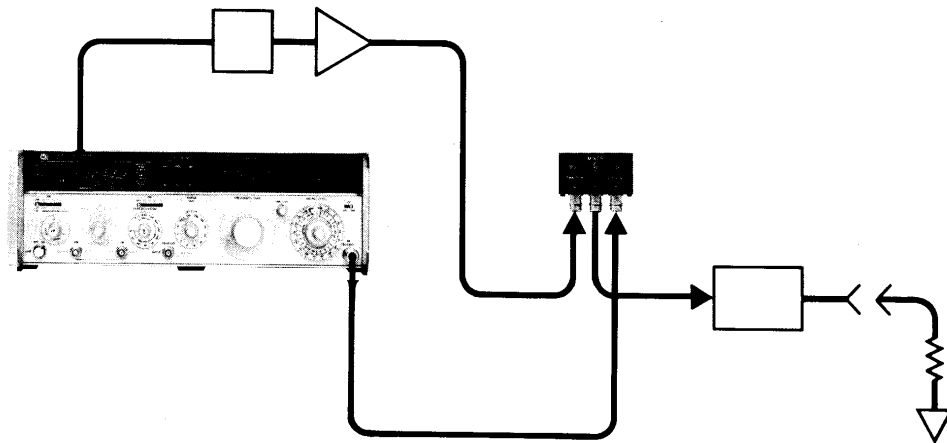

INTRODUCTION

The 8640B Signal Generator is specified to operate over the frequency range of 0.5 to 512 MHz. With over-range the achievable output frequencies are from 0.45 to 550 MHz. In some applications it is desirable to extend this frequency coverage either up or down. For those who need to go higher a doubler is usually used, such as the 11690A External Doubler or the Option 002 Internal Doubler, which extends the 8640 upper frequency to 1100 MHz. For those who need to go lower than 450 kHz, the solutions are not so readily available. The purpose of this note is to address this problem of generating modulated signals below 450 kHz with the 8640B.

TWO POSSIBLE METHODS

The two most obvious methods of generating lower frequencies from the 8640B are:

1. Division
2. Heterodyne down conversion

The **division method** involves dividing the RF output frequency by some integer n , and then filtering the output appropriately to reduce the harmonic content.

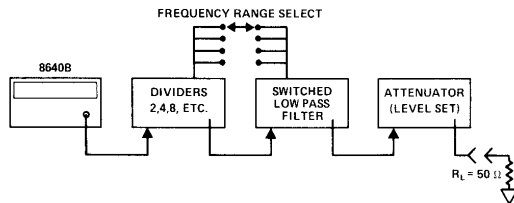

Figure 1. Division Method

The division method is the extension of the 8640 basic block diagram, which uses a fundamental oscillator at 256 to 512 MHz, followed by a series of binary dividers and switchable low pass filters.

This process is optimum for the generation of spectrally pure signals (low noise and spurious), but unfortunately has some undesirable limitations at lower frequencies. Some limitations are: (1) each division by two also reduces the frequency tuning range by two; (2) each division by two also reduces the FM deviation capability by two; and (3) without significant internal modification the division method provides no direct control of AM depth or output level.

The **heterodyne method** involves mixing the RF output at some higher frequency, down to the dc to 500 kHz range, and filtering any higher frequency components to leave only the desired difference frequency. This approach has some very attractive features: (1) the dc to 500 kHz range can be covered in one continuously tuned band; (2) the modulation capability of a higher frequency carrier can be directly translated to the lower frequency range; (3) fully calibrated modulation is retained and (4) the approach can be implemented with off-the-shelf components for the most part.

BLOCK DIAGRAM

The suggested method is to amplify the 5.0 MHz crystal time base reference signal, available on the rear panel of the 8640B, for use as the local oscillator signal for a balanced mixer. This signal was intended to be used as a reference for another counter or 8640B. If the signal is amplified from its level of approximately 100 mV_{rms} (into 50 Ω), to a level of 500 mV_{rms} (+7 dBm), it can be used as the local oscillator drive for a balanced

mixer like the HP 10514A. The RF output from the 8640B front panel provides a signal between 5.0 MHz and 5.5 MHz, which is mixed with the 5 MHz reference signal and generates the sum and difference frequencies (i.e., 0 to 0.5 MHz and 10.0 to 10.5 MHz). The double balance response of the mixer suppresses the 5.0 MHz LO and the 5.0 to 5.5 MHz RF input signal. The upper sideband signal (or sum) and the remaining LO and RF signals can be reduced by a simple low pass filter, leaving only the desired 0 to 0.5 MHz signal.

PERFORMANCE CHARACTERISTICS

This system has several features which enhance its usability.

1. Calibrated Frequency Readout

Since the counter crystal reference was used as the LO, and since the output is the lower sideband (or difference frequency), the counter display is still accurate. The frequency display in the counter expand $\times 100$ mode reads the down-converted signal directly in MHz (or in hertz if the decimal point is ignored) because the leading "5" digit overflows the display. The other counter display modes ($\times 10$, $\times 1$), may still be used but the "5" in the most significant digit must be ignored, (e.g. 5.26250 MHz in the display is an output of 0.26250 MHz from the down converter).

The internal phase lock loop in the generator still works, and the down-converted signal retains a stability of $<.03$ Hz/hr drift rate when locked.

2. Calibrated Modulation

Since the heterodyne method is a direct frequency and amplitude translation, both amplitude and frequency modulation components are also directly translated. This means that the meter on the front panel reads AM and FM levels directly and is calibrated.

Further, because the primary modulation is taking place on a high frequency carrier, 5.0 to 5.5 MHz, the modulation capability is quite good with this approach.

AM	Depth ≤50%	Depth ≤90%
3 dB Bandwidth	dc to 40 kHz	dc to 25 kHz
Distortion (1 kHz Rate)	<1%	<3%

FM	Deviation ≤5 kHz	Deviation ≤40 kHz
3 dB Bandwidth	dc to 250 kHz	dc to 250 kHz
Distortion (1 kHz Rate)	<1%	<3%

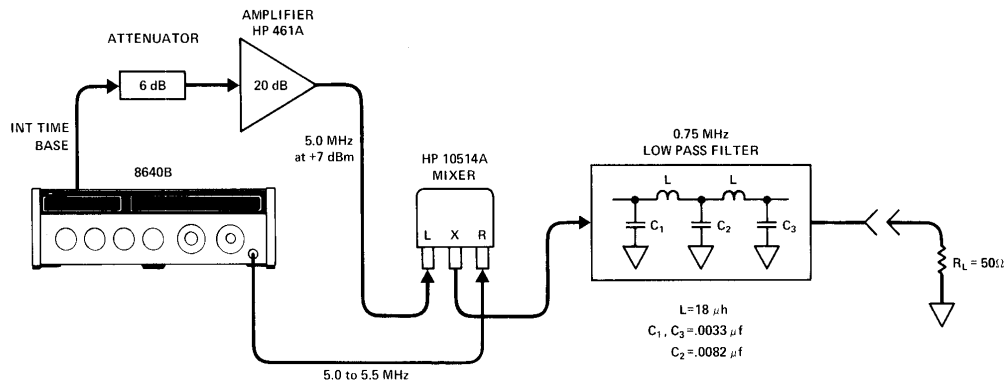

Figure 2. Heterodyne Method Block Diagram

3. Calibratable Output Level

Though the amplitude translation is linear, there is a fixed insertion loss in the mixer and filter which total approximately 6 dB. If this value is measured, and then subtracted from the metered level reading, the actual RF level out of the converter can be determined. As this factor will be quite close to 6 dB, a rule of thumb would be to divide the meter voltage reading by two.

4. Spurious

In a mixer type of frequency translation, there are two types of spurious or undesired signals which can be present. The first type is LO related and appears in the output spectrum at the LO frequency and its harmonics. In our system these spurious signals are at 5 MHz, 10 MHz, 15 MHz, etc. Their level in the desired output spectrum is determined by two factors: A) the mixer balance which suppresses these signals (typically 40 to 60 dB for a 10514A type mixer) and B) the low pass filter, which can be designed to further suppress these signals to practically any level desired. The low pass filter shown in the example is quite simple, and yet yields greater than 70 dB additional rejection at 5 MHz and higher frequencies.

The second type of spurious signal, which can theoretically be present, is related to the RF signal (5 to 5.5 MHz) either harmonically or as intermixing products of the form $\pm M \times F_{LO} \pm N \times F_{RF}$ (M and N integers). These signals are also suppressed by the mixer balance and are for the most part also filtered by the low pass. There are some combinations of M and N, however, which yield signals which fall within the dc to 500 kHz range and thus within the filter bandwidth. These signals, therefore, are not filtered out and represent the greatest drawback for most heterodyne systems.

Fortunately, as M and N get larger the level of the

intermixing spurious gets smaller, and thus by selecting the LO and RF frequencies far away from the highest desired frequency ($\frac{5 \text{ MHz}}{500 \text{ kHz}} = 10$), these problem spurious can be made insignificantly small. In the example of Figure 2, actual tests demonstrated spurious levels down more than 100 dB from the desired signal. As the RF level is reduced, the spurious products associated with it are also reduced.

5. Output Range

The mixer will track the RF output level down below -145 dBm , but in order not to overdrive the mixer it is necessary to limit the upper RF signal level to -7 dBm ($100 \text{ mV}_{\text{rms}}$). With a 6 dB insertion loss the maximum available power at the output of the low pass filter is -13 dBm ($50 \text{ mV}_{\text{rms}}$). If this level is not sufficient, an additional amplifier can be used at the output.

6. Typical Performance

Figures 3 through 6 are examples of the type of performance which can be achieved with this approach.

SUMMARY

The heterodyne down conversion technique is a common method of frequency translation. Its application to the 8640B is both simple and versatile to execute. Through this approach, the stability, accuracy and modulation capability of the 8640B can be extended down essentially to dc. This provides useful signals for automobile radio IF testing at 262.5 kHz, plus the capability for testing throughout the audio range.

Hewlett-Packard assumes no responsibility for the use of any circuits described herein and makes no representation or warranties, expressed or implied, that such circuits are free from patent infringement.

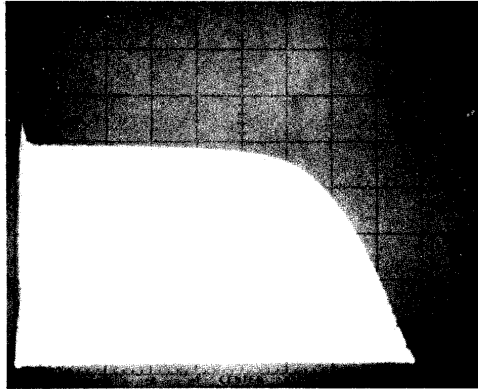

Figure 3. FREQUENCY RESPONSE
 Vert: 2 dB/DIV
 Horiz: 0.1 MHz/DIV
 Horiz: Sweep (dc to 1 MHz)
 RF Level: -20 dBm (0 dB Ref)
 Shows: 6 dB Insertion Loss
 Flatness ≈ 0.5 dB dc to 0.5 MHz
 Filter Cutoff 0.75 MHz

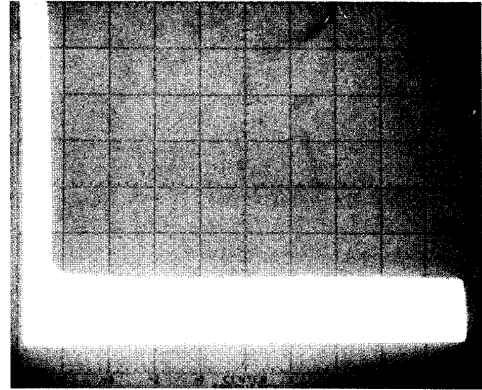

Figure 4. SPURIOUS SEARCH
 Vert: 10 dB/DIV
 Horiz: 1.0 MHz/DIV
 RF Level: -20 dBm
 Desired signal swept 0 to 0.5 MHz
 Shows: No visible spurious within 60 dB of carrier level

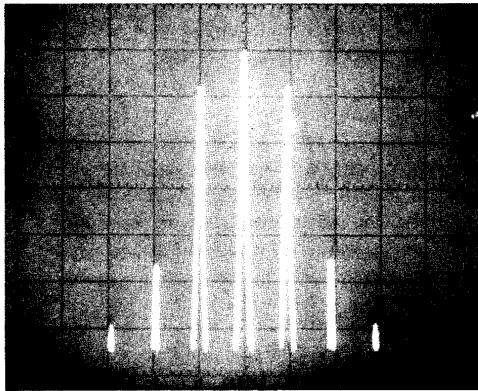

Figure 5. AM MODULATION (Typical)
 Vert: 10 dB/DIV
 Horiz: 1 kHz/DIV
 CF: 262.5 kHz
 AM Depth: 90%
 Rate: 1 kHz
 Shows: Distortion $\approx 2\%$ at 90% AM Depth

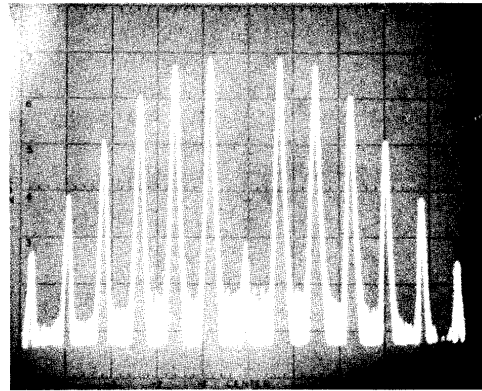

Figure 6. FM MODULATION (Typical)
 Vert: 10 dB/DIV
 Horiz: 20 kHz/DIV
 CF: 262.5 kHz
 Dev: 80 kHz peak to peak
 Rate: 16.6 kHz
 Shows: 40 dB Bessel Null and excellent response

For more information, call your local HP Sales Office or East (301) 948-6370 • Midwest (312) 677-0400 • South (404) 434-4000 • West (213) 877-1282. Or, write: Hewlett-Packard, 1501 Page Mill Road, Palo Alto, California 94304. In Europe, Post Office Box 349, CH-1217 Meyrin 1, Geneva, Switzerland. In Japan, Yokogawa-Hewlett-Packard, 1-59-1, Yoyogi, Shibuya-Ku, Tokyo, 151.