

# LIGHTWAVE CATALOG

General Photonic Test

# 2014

## VOLUME I



*Anticipate — Accelerate — Achieve*



**Agilent Technologies**

## Agilent in Photonic Test & Measurement 2014



Highest definition video content, social networking and online gaming become easily available anytime and everywhere on mobile devices, tablets, computers, and entertainment devices.

Data traffic continues to increase dramatically, between and within data centers and in telecommunication networks including the mobile backhaul, driving cloud-based services and virtualization and also deployment programs for fiber to the home and LTE.

The opportunity is two-fold, addressing the line-side and the client-side of the high-speed communication network:

- The new era of data-center infrastructure, enabling cloud computing, big data storage and analytics, is driving the development of higher data rates standards. Coherent transmission is chosen as the key technology for 100G, 400G and 1Tb communication lines for metro or long-haul equipment at the line-side.

- With the enormous surge in data-center traffic, servers and storage designs must support much higher bandwidths on their backplane and networking ports. Data rates of 25 Gb/s and more on multiple lanes over PC boards, cable or optical interconnects are required by most of the latest industry standards, such as 100GbE, CEI and Fiber Channel. This development increases the importance of optical components and modules in data centers and the client side - increasing the business opportunities in the optical communications industry.

Agilent is the only T&M vendor which offers solutions along the entire value chain of the communication network from components through data centers to telecom, addressing the latest technologies like silicon photonics and coherent transmission.

Over the last decades we've worked closely with you to keep up with evolving standards. Our experts have been actively contributing in many standardization committees, which helps us anticipate the next design challenges. Agilent Technologies' J-BERT is the industry test standard in BER test solutions. Based on this foundation we have now developed a new generation of BER test solutions, the M8000 Series. It is highly integrated but at the same time also scalable. It offers investment protection as your test needs grow from single channel to multi-channel, supporting different standards and signal types.

Please take a look into Volume III of the Agilent Lightwave Catalog 2014 to find out about the J-BERT M8020A, the first in a series of BER test solutions offering 16 and 32 Gb/s and to see how the new generation of test tool helps you to master your design and test challenges.

Agilent's test solutions for communications and photonic applications advance future trends by helping you accelerate products to market. Our manufacturing test solutions are designed to support you in achieving your gross margin targets.

I'm proud to present all the products - which support your test needs and business goals - in the new Agilent Lightwave Catalog 2014.

**Volume I covers** "General Photonic Instruments" to characterize single-mode and multimode fiber-optic components.

**Volume II covers** "Optical-Electrical, Polarization and Complex Modulation Analysis" for the transmission networks.

**Volume III covers** "Bit Error Ratio & Waveform Analysis" for data center and cloud environment.



**Juergen Beck**  
Vice President and General Manager  
Digital Photonic Test Division

### Get greater reliability—standard

Since more than 30 years, Agilent offers high-performance solutions to support you in building the high-speed communication network. Your experience and feedback helped us to continuously improve the product performance and quality, while significantly reducing the cost, especially when it comes to manufacturing of optical components.



Your needs and my confidence into our quality let me now offer our products with a 3-year warranty that's standard on all instruments, worldwide. This combination of reliability and coverage brings you three key benefits: increased confidence in instrument uptime, reduced cost of ownership and greater convenience. It's just one more way our solutions help you achieve your business goals. When you choose Agilent, you get greater reliability—standard.

### Juergen Beck

Vice President and General Manager  
Digital Photonic Test Division

## Volume 1: General Photonic Test

Introduction by Juergen Beck	2
Table of Content	3
Applications: Swept-Wavelength Optical Measurement Solutions	4
Applications: Optical Transient Measurements	5
Applications: Wavelength and polarization dependent characterization of optical-to-electrical components	6
All-states method for PDL and PER	7
8163B, 8164B and 77-Series of Optical Instruments	8
81600B Tunable Laser Modules	10
81960A, 8194xA, 8198xA and 81950A Compact Tunable Laser Sources	12
N7711A and N7714A Tunable Laser Source	15
81663A DFB Laser Modules	17
8165xA Fabry-Perot Laser Modules	18
N7744A and N7745A Optical Multiport Power Meter	19
N7747A and N7748A High Sensitivity Optical Power Meter	20
8163xA/B and 8162xB Optical Power Meters	21
81610A and 81613A Return Loss Modules	25
8157xA High-Power Optical Attenuators	26
N775xA and N776xA Multi-Channel Optical Attenuators	28
81595B, N7731A and N7734A Optical Switch	30
Polarization Controllers and Analyzers	31
86120B/C and 86122C Multi-Wavelength Meters	33
Accessories	35

## Product Selection Guide

Tunable Laser Source Selection Table	37
Optical Power Meter Selection Table	38
Product vs. Measurement Parameter Selection Table	39

## Applications: Swept-Wavelength Optical Measurement Solutions

[www.agilent.com/find/oct](http://www.agilent.com/find/oct)

### Swept-wavelength measurement solutions

Tunable laser instruments are used for spectral measurements of optical components and materials. The wavelength dependence is rapidly determined with selectable and very high wavelength resolution. The measurement systems can be flexibly configured to match the requirements of the application. Here we suggest some examples.

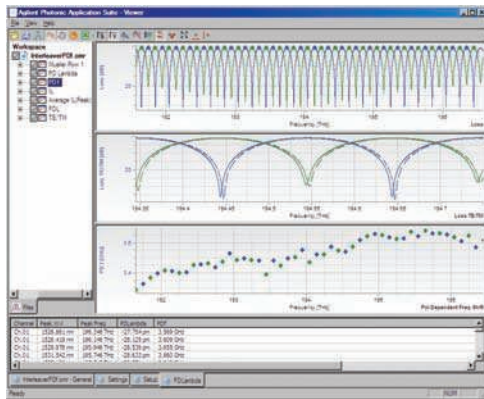

### Insertion loss measurement (IL)

Combining one or more optical power meters with the tunable laser source (TLS) permits measurement of optical power vs. wavelength. Often this is used to find the ratio of power at the input of a component to the output power, commonly called insertion loss and expressed in dB. While the TLS tunes the wavelength over the chosen range, the power meters periodically sample the power for the desired number of measurement points. These samples are synchronized with the TLS sweep by a trigger signal for accurate association with the corresponding wavelength. Use of multiple power meters allows simultaneous measurement of outputs from multiport components like multiplexers, splitters and wavelength switches. A setup can combine the 81600B, 81960A, 81940A or 81980A TLS with power meters from the 816x-series modules or the multiport N7744A and N7745A and the free N7700A IL software. Easy programming of these "lambda scan" routines uses the free 816x Plug&Play driver and can be enhanced with the N4150A Photonic Foundation Library (PFL) of measurement functions. Reflection spectra (return loss) can also be measured, by connecting the 81610A return loss module after the TLS.

### Performance considerations

High wavelength accuracy and repeatability, particularly during fast wavelength scans, is assured with the built-in wavelength monitoring in these laser sources. These "lambda-logging" data are synchronized with the measurement triggers to the power meters. And if even higher absolute wavelength accuracy is needed, an offset calibration against a gas cell reference can be used, as conveniently supported by the PFL. InGaAs power detectors are best for such measurements due to the small variation in responsivity over the single-mode fiber wavelength range (1260 to 1630 nm) and high sensitivity and dynamic range. The N7744A and N7745A power meters are especially well adapted to these swept-wavelength measurements with fast sampling rates and high signal bandwidth that allow high-resolution measurements at high sweep speeds without distortion of the measurement trace. Faster data transfer raises throughput dramatically, especially at high port counts.

When insertion loss is low at some wavelengths and very high at others (high dynamic), like in DWDM components, it is very important that the broadband spontaneous emission from the TLS is very low. This avoids light transmitted in the passband of the component when the TLS wavelength is outside this band. The 81600B TLS provides light with very low source spontaneous emission (SSE), especially for components with more than 40-50 dB dynamic. The dynamic range of the power meters is then important too. Sometimes this is extended by measuring with multiple power ranges and "stitching" the traces to capture both the strongest and weakest signal. This stitching is provided by the 816x P&P as well.

### Polarization dependent loss (PDL)

Optical signals are generally polarized and the variation in insertion loss with polarization must be determined. This involves determining the maximum and minimum IL vs. polarization for all desired wavelengths, and all combinations of linear and circular polarization. Fortunately this can be done by measuring swept-wavelength IL at a set of four (or optionally six) polarizations, from which any other IL can be calculated. This is known as the Mueller Matrix method. The setup includes a polarization controller after the TLS, that sets the polarization of the light into the device under test. The 8169A polarization controller does this by sequentially setting each polarization for separate TLS sweeps, support by the PFL software. And now the N7786B rapidly switches polarization and monitors the SOP and power so PDL can even be measured in one wavelength sweep. This innovative method and calculations such as resolution of TE/TM spectra and determination of polarization dependent wavelength are provided in the N7700A PDL software routine.

### Dispersion (PMD and CD)

At high data rates, like 10 Gb/s and faster, the variations in time required for parts of the signal to pass through the network causes data pulses to broaden. The way this timing, group delay (GD), varies is called dispersion. The dependence of GD on polarization is called polarization mode dispersion (PMD) and described by differential group delay (DGD) spectra, the difference between the GD for the fastest and slowest polarizations in the component. This too can be measured with swept wavelength at a set of polarizations, but also requires a polarization analyzer as a receiver. This method is called Jones Matrix Eigenanalysis and is supported by the N7788B component analyzer together with a TLS. This system measures single-channel DGD, PDL, IL and other advanced parameters does this with a single wavelength sweep for optimum stability and speed, using the N7700A Polarization Navigator. Finally the chromatic dispersion (CD) is the variation of GD itself vs. wavelength and is an important property of optical fiber and especially wavelength-selective components. Measuring this accurately and with sufficient wavelength resolution is achieved with the modulation phase shift (MPS) method, where the TLS signal is amplitude modulated and the variation in phase shift vs. wavelength of the signal through the component is determined. The 86038B Photonic Dispersion and Loss Analyzer uses an enhanced polarization-dependent implementation of MPS with adjustable frequency between 10 MHz and 2.5 GHz to optimize the wavelength resolution and accuracy. This setup then provides spectra for GD, CD, DGD, PDL, IL and other parameters.

### Making transient optical power measurements with the N77-Series multiport optical power meter

Measuring optical power level changes, to determine fiberoptic switching times or to observe transient fluctuations from fiber movement or network reconfiguration, goes beyond the design of most fiberoptic power meters. These instruments are generally designed for calibrated determination of optical power levels that are constant or change in synchronization with other instruments. The typical sample rates like 10 kHz, data capacity of perhaps 100,000 samples, and data transfer speed to the controller are often insufficient for general time-dependent measurements. Instead alternative setups, like a fast optical-to-electrical converter combined with an oscilloscope, have been used and described in standards. These often sacrifice optical power calibration, involve additional integration effort, and are likely implemented with an over-dimensioned scope bandwidth.

The N7744A 4-port and N7745A 8-port optical power meters now offer the performance to make these measurements with a small self-contained programmable instrument that is used together with a controller computer. These power meters accurately log optical power at selectable sample rates up to 1 MHz, store up to 2 million samples per port, allow fast data transfer via USB or LAN and support simultaneous measurement and data transfer for continuous power monitoring without interruption.

Now the new N7747A and N7748A high sensitivity power meters can be used in the same way, with the difference that the lower bandwidth reduces the sampling rate to 10 K/s, but with lower noise and for weaker signals.

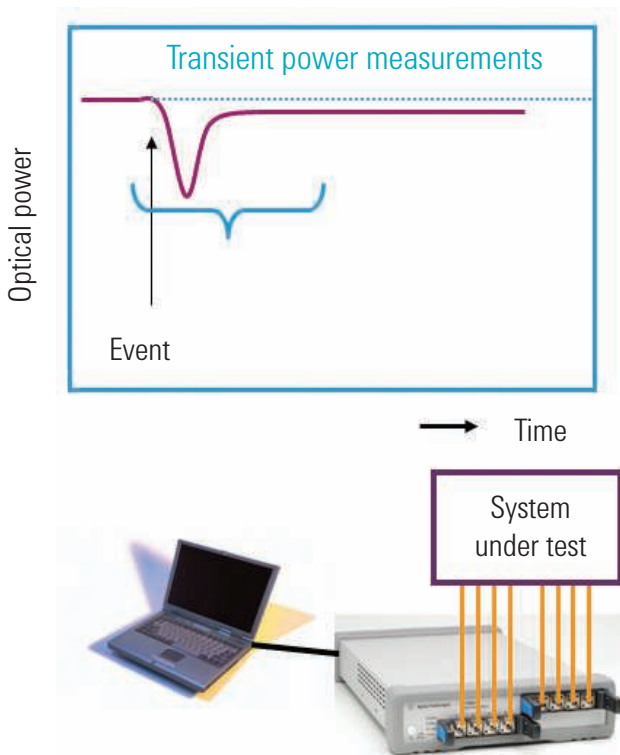

### Logging functionality basics

The measurement of time-dependent signals is realized with the easy-to-use logging function of the optical power meters. The logging function is set up by choosing the number of logging samples,  $N$ , and the averaging time of each sample,  $t$ . The logging measurement is then started with a programming command or an electrical trigger. The instrument can be configured to make the complete logging measurement of  $N$  samples or individual samples when triggered. For logging time-dependence, the measurement will usually be configured for logging all samples without pause over a total time  $Nt$ .

For completeness, note that the instruments also have a stability function that performs similarly, but with a programmable dwell time between samples. This is used for measuring longer term changes in optical power, as for source stability tests, and is not discussed here further.

The N7744A and N7745A multiport power meters, MPPM, can perform this logging simultaneously on optical signals from up to 8 fibers. The averaging time can be chosen between 1  $\mu$ s and 10 s, and up to 1 million samples can be taken. During the logging, a wide dynamic range can be recorded, exceeding 60 dB for averaging times of 100  $\mu$ s or more, and the power range maximum can be chosen between  $-30$  dBm and  $+10$  dBm in 10 dB steps. The MPPM can also be configured to begin a new logging measurement of  $N$  samples as soon as the previous measurement finishes. The existing results can be uploaded to the controller computer during the new measurement. This set of functionality provides two methods for making transient measurements, which we label here as triggered logging and continuous logging methods.

**Triggered logging** is used to measure a fixed number of samples, starting from a time chosen by software or an electrical signal to synchronize with the event to be measured. This is most useful when the timing of the event to be measured is also controlled, as for setting a switch or shutter, changing an attenuator, or blocking an input signal to an amplifier or ROADM (reconfigurable add/drop multiplexer). Since 1 million samples can be stored per port, a single logging measurement is usually sufficient. The multiple ports of the instrument make it easy to watch, for example, all output ports of a switch during reconfiguration. Measurements like described in the IEC standard 61300-3-21 for switching time and bounce time or transient characterization of optical amplifiers can be accomplished with this method.

**Continuous logging** is especially useful for recording events with unpredictable timing as well as for keeping a very large number of samples. A typical application would be the measurement described in IEC 61300-3-28 for transient loss, where the power from fibers is monitored for change due to mechanical disturbances. This method can be programmed using the same logging function mentioned above, with the extension that the complete logging sequence is repeated multiple times. For such real-time processing while data is being gathered, multi-threaded programming is useful to avoid interruption of the data stream, as now available in Agilent VEE 9.0 and higher.

For a more detailed description refer to: Application Note 5990-3710EN: Making Transient Optical Power Measurements with the N7744A and N7745A Multiport Optical Power Meter.

# Applications: Wavelength and polarization dependent characterization of optical-to-electrical components

[www.agilent.com/find/n7700](http://www.agilent.com/find/n7700)



There is an increasing number of fiberoptic components that integrate photodiodes with passive optical functionality and with electronic circuits. Important examples are:

- Integrated coherent receivers (ICR)
- DPSK receivers, and
- Optical channel monitors

These all have optical input ports and electrical or RF output ports. The photodiodes produce photocurrent from the optical signal after it has passed the passive sections, such as polarizer, splitter, or interferometer. Thus the responsivity of the photodiodes to the input signal, measured in mA/mW, in dependence of wavelength and polarization is a fundamental performance measure of the component.

Measurement of such devices can be made in the same way as mentioned on Page 4 for PDL, by replacing the optical power meter with an instrument for logging photocurrent. The N7700A-100 IL/PDL engine software supports this setup.

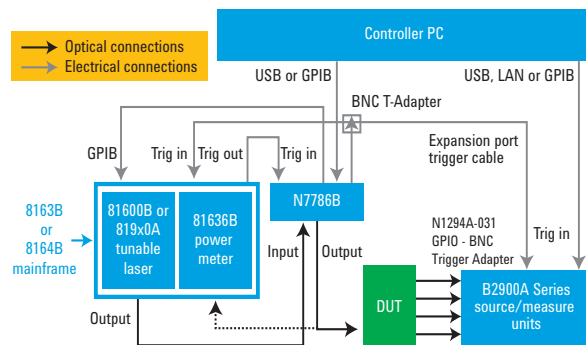

Figure 1: Setup example for measuring optoelectrical devices with the B2900A.

From the swept-wavelength measurement of the input optical power and the output diode current, the responsivity spectra are calculated as the average vs. state of polarization.

The maximum and minimum responsivity vs. SOP are also determined, which is especially useful for polarizing components like ICR for polarization multiplexed signals. The polarization dependence is also displayed as PDL and the TE/TM traces are also calculated, as for optical-optical measurements.

For balanced-detection components, the common-mode rejection ratio (CMRR) of detector pairs is also determined.

**The N7700A-100 software** also has added functionality for measuring high PER with an additional measurement step that continuously scans a large number of SOP at a set of fixed-wavelength points. The user can choose the number of points to balance measurement time vs resolution. Good accuracy to well beyond 20dB can be obtained.

For devices like ICR, where the photocurrent is converted to an RF output signal, the "CW" photocurrent can typically be accessed from the pins for applying bias voltage.

For higher flexibility in the polarity and isolation of the biasing, the B2900A-series source measure units can also be used for detection, as shown here.



Figure 2: B2900A-series source measure unit

Support for these instrument is added to the N7700A-100 IL/PDL engine with Version 1.5. Further details can be found in the brochure for the N7700A Photonic Application Suite, 5990-3751EN.

## Applications: All-states method for PDL and PER

www.agilent.com/find/pol

### All-states method for PDL and PER

The all-states PDL method for measuring polarization dependent loss by scanning the polarization of light input to the DUT over a large sampling of all possible states is a good way to measure components with little wavelength dependence, so that the wavelength can be fixed during the scanning. Fiberoptic couplers, splitters and isolators are typical components to test this way. Tests of polarization beam splitters and other devices designed for high PER also benefit from this method, because it samples the states with high polarization extinction.

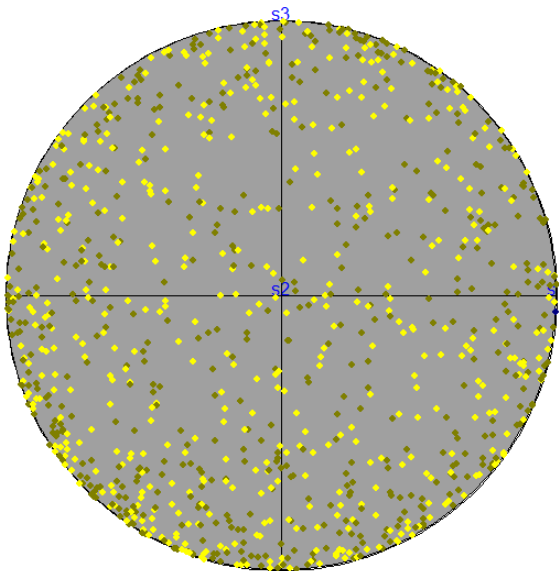

Figure 3: Random sampling of SOP, represented on the Poincaré sphere.

Conventionally, this method has been realized by monitoring output optical power while scanning the input polarization, so that the accuracy is limited by the polarization dependence of the instrumentation, particularly the polarization controller. This was generally addressed by using mechanical movement of fiber loops, which can give very low polarization dependence of the power level, but has limited speed.

Faster accurate measurements now use the Agilent N7785B synchronous scrambler, which can be programmed for repeatable stepping through a sequence of polarization states at high speed while producing synchronization triggers. This can be used to shorten total measurement time, allow optimized detector averaging times, and normalize the results to remove the polarization dependence of the setup from the results.

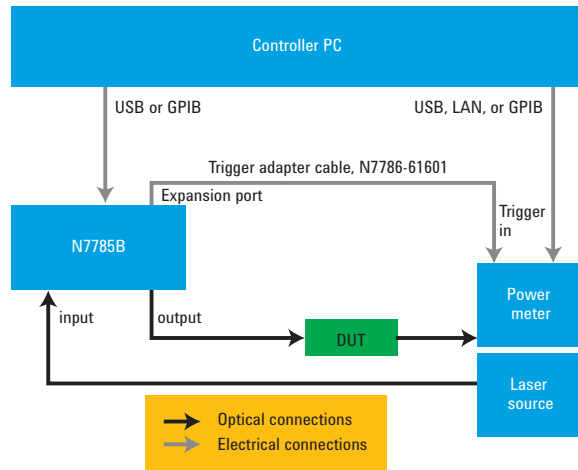

Figure 4: A typical setup for synchronized all-states measurement.

For measuring PDL values up to 1 dB, about 100 samples are sufficient for the minimum/maximum ratio to come within 10% of the full PDL value. So a good measurement is achieved in less than 50 ms using 100  $\mu$ s averaging time. For measuring PDL values significantly below 0.1 dB, the noise is a limitation and longer averaging time is needed. Using 10 ms averaging time with a stable setup has been seen to give repeatability corresponding to less than 0.005 dB over times of 10 minutes or more. The 10 ms averaging time also supports use of the coherence control function of the laser sources, if needed to avoid interference effects due to reflections in the setup. Again for these values, good measurements are obtained with sequence lengths of about 100.

The range of high extinction ratio measurements amounts to how well the lowest transmission value is determined. When using a random pattern of SOP, this is improved by using many samples and having minimum SOP variation during the averaging time of the sample. This latter condition is an advantage of the polarization switching vs. continuous scanning. To assure measurements above 30 dB PER, a minimum of 20 k samples is recommended. For example using 100  $\mu$ s averaging time, the 20 k sequence requires 8 s.

For further details, refer to Application Note 5990-9973EN: All-states measurement method for PDL and PER with a synchronous polarization scrambler.

# Agilent 8163B, 8164B and 77-Series of Optical Instruments

[www.agilent.com/find/oct](http://www.agilent.com/find/oct)

## Modular and multi-channel platform for optical components and optical networks

### Flexible

Free combination of instruments for the best fit to each application

### Scalable

The right form factor for each setup in R&D and manufacturing for single-port and multipoint applications

### Efficient

Plug&Play drivers and the Photonic Application Suite software from Agilent provide a variety of application functions for increased measurement performance

### Fast

Modules and controllers optimized for high test speed and data throughput

### Ergonomic

Comfortable color, high contrast displays for enhanced stand-alone benchtop usability

This family of optical test instruments and modules covers all kind of fiberoptic test capability from tunable and fixed sources via signal and path control to a broad range of optical power measurement modules and instruments. Different form factors and performance classes allow an easy adaptation to any test need and support both manual use and remote control via LAN, GPIB and USB. A common remote language lets you control all test module categories with the same set of commands.



### The Agilent 8163B – Modular stimulus-response solutions with excellent performance

The two-slots Agilent 8163B lightwave multimeter is one of the basic measurement tools in the fiber optics industry. Its modularity and compact format makes it flexible enough to meet changing measurement needs, whether measuring optical power and loss with laser and power meter modules or using attenuator and switch as signal conditioning.

### The Agilent 8164B - The platform for testing optical components



The Agilent 8164B lightwave measurement system supports a wide range of tunable laser modules together with capacity for up to 8 power meters in one box, for high resolution spectral testing of passive components. Its LAN and GPIB ports provide connectivity for remote control that can be utilized for system automation, supported with Agilent's software suite. For easy standalone operation of the 8164B, the large display and comfortable controls make this a great benchtop tool.

The Agilent 8163B and 8164B mainframes and optical modules have commonly used built-in applications for quick manual testing without programming:

- Passive component test (PACT) — measure spectral insertion loss with a tunable laser module and one or more power meter module
- Return loss/loss — measure the return loss and insertion loss of your devices with the 81613A return loss module and a power meter module (8163B only)
- Stability — check the long term power stability a power meter module or power head
- Logging — perform statistical analysis on the power readings

### The Agilent 77-Series of multichannel power meters, attenuators and tunable sources

The characterization of multipoint optical devices or parallel testing of optical devices demands a new set of optical test equipment, which provides cost-effectiveness, high speed measurement throughput and parallel data acquisition and data aggregation. Agilent's 77-Series expands the optical test and measurement family to address this kind of test demand. The instruments are controlled via a Graphical User Interface (GUI) on your PC or laptop computer, which eliminates the cost of multiple instrument displays, controls and the related electronics. The GUI let's you monitor and control the multiple channels at a glance and gives a quick status information. Powerful full functionality is available by remote control via USB, LAN or GPIB. Now supported by Agilent Command Expert.





## The N7700A Photonic application suite

- **Display and overlay of traces from multiple channels and multiple measurement files**
- **Scale switching between wavelength and frequency**
- **Display of tabular analysis**
- **Smoothing, markers and zooming**
- **File loading, saving and data export**
- **Direct launching of Excel and Matlab with data**

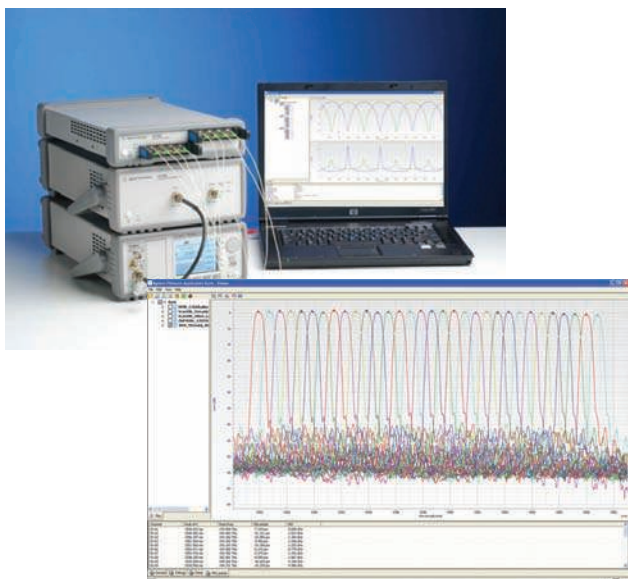

The N7700A Photonic Application Suite is a modular software platform for fast, easy and advanced characterization and analysis of optical components and signals. This suite is widely distributed with instruments and from the Agilent website and can be installed on PCs to control instruments and to process and analyze measurement data.

The freely-distributed main package of the N7700A Photonic Application Suite provides a powerful File Viewer program that allows viewing and analyzing measurement data. It has been designed for sharing measurement results throughout entire development teams or manufacturing groups.

The File Viewer uses the same N77xx Windows-based graphical user interface that is used in the measurement engine packages. The controls for this interface can also be built into customized programs for automated data display.

For performing measurement tasks, an increasing range of application packages are available. Some basic ones are available free for use with the instruments. Licenses can be purchased for more advanced packages. All packages can be downloaded and used immediately for a 14 day trial period and 60-day evaluation licenses can also be generated automatically from the Agilent web site for extended consideration.

## Insertion loss

The Insertion Loss measurement package performs very accurate swept-wavelength insertion loss measurements using one of Agilent's tunable laser sources along with optical power meters. No license required.

## Fast IL/PDL measurement

The Fast IL/PDL measurement package makes rapid and very accurate measurements of spectral insertion loss and polarization dependent loss (PDL) characteristics of multiport optical components. The new single sweep Mueller Matrix method provides speed and immunity from vibrations and noise. Measurements including multiple lasers for wider wavelength coverage and return loss module are now also supported. In addition to the measured IL and PDL traces, the Mueller Matrix data can be exported and analyzed to provide the polarization resolved IL traces for the device axes (TE/TM). Measurement of optical-to-electrical devices is also supported.

License available for purchase as N7700A-100.

## Filter analysis

The Filter Analysis package provides extended post-processing of measurements from the IL/PDL and IL measurement packages for analysis of narrow-band components like filters and multiplexers. Analysis parameters include peak and center wavelength, wavelength offset from ITU grid, IL at ITU wavelength and center wavelength, bandwidth and channel isolation from adjacent and non-adjacent channels. From the TE & TM traces of the IL/PDL engine, the polarization dependent frequency shift (PDF or PDA) of channels in filters, interleavers or phase demodulators can also be determined. A convenient peak search function is also included. License available for purchase as N7700A-101.

## Fast spectral loss measurement

This package measures insertion loss and power spectra at enhanced repetition rate and is a valuable tool for tuning and calibrating devices with near real-time feedback. Especially powerful in combination with the 81960A tunable laser using bidirectional sweeps, repetition rates of 1 to 3 scans per second can be attained, depending on the sweep range.

## Polarization navigator

The Polarization Navigator package provides all the tools needed for your work with N778x polarization analysis and control instruments: measurement of Stokes parameters and degree of polarization (DOP); representation on the Poincaré sphere or time dependent long term monitoring, spike analysis, etc. Various functions for control, switching and scrambling the polarization of optical signals are also provided. No license required for use with N778x instruments.

## N4150A Agilent photonic foundation library

The N4150A Agilent Photonic Foundation Library is well known as the established software for photonic engineers. This library is also integrated with the N7700A Photonic Application Suite and programs using this library can also use the new automation controls for display. License available for purchase as N7700A-200.

# Agilent 81600B Tunable Laser Modules

www.agilent.com/find/tls

- **Complete wavelength coverage from 1260 to 1640 nm**
- **Low SSE output for high dynamic range**
- **Built-in wavelength meter for high wavelength accuracy**
- **Sweep speeds up to 80 nm/s to reduce test times**
- **No compromise of measurement accuracy for sweep speed**



## Tuning range from 1260 to 1640 nm

Agilent offers a family of tunable laser sources to cover the wavelength range of 1260 to 1640 nm. Whether you are measuring Dense Wavelength Division Multiplexing (DWDM) devices or a WDM device, such as an LX4 component for 10 Gigabit Ethernet, Agilent has a laser to fit your testing needs.

## It sweeps as precisely as it steps

As manufacturing yields become more demanding it is critical for your test instruments to have optimal performance for any measurement condition. The 81600B offers several sweep speeds up to 80 nm/s without compromising measurement accuracy. In contrast to other lasers, the 81600B sweeps with the same precision as it steps; without the use of an external wavelength-tracking filter. No compromise on sweep speed.

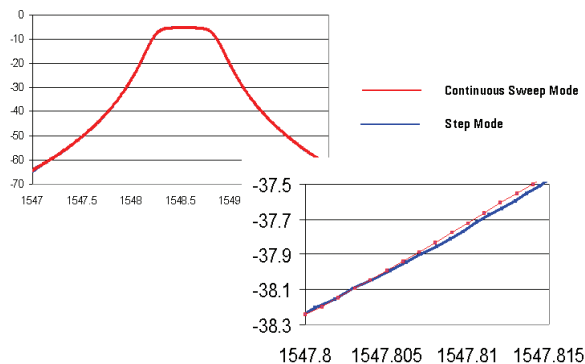

No compromise on sweep speed

## Reduce cost of test

For DWDM components, high wavelength accuracy and dynamic range are most important. For CWDM components, a wide wavelength range, high power stability, dynamic range and low cost targets are key. Agilent's state-of-the-art tunable lasers meet the demanding requirements of high tech optical manufacturing facilities with fast sweep speed, high wavelength accuracy and power stability. This will reduce your test time while increasing your throughput, hence, reducing the cost of test in manufacturing to give you the competitive advantage.

## Advantage of using suppressed laser noise (low SSE)

Source Spontaneous Emission (SSE), the sum of all spontaneous emissions inside the laser diode of the tunable laser, is broadband light output in addition to the monochromatic laser line. This emission limits the noise floor of the tunable laser, which, in turn, limits the dynamic range of your measurements. The Agilent tunable laser source offers a high signal to source spontaneous emission ratio. For you, this means more dynamic range to enable your measurements to completely characterize DWDM devices with high channel isolation.

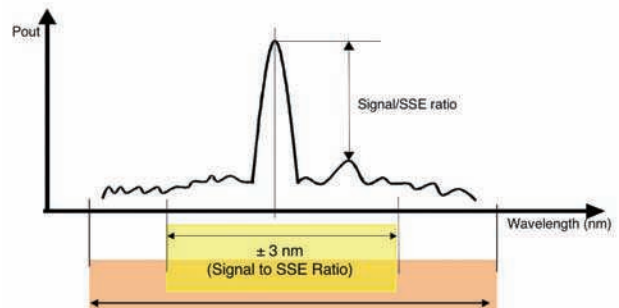

## Agilent laser noise definition

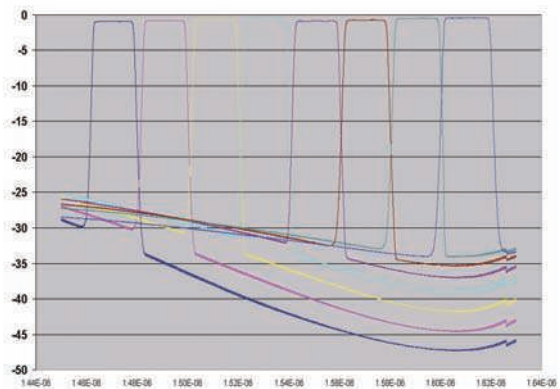

Output 2: High power

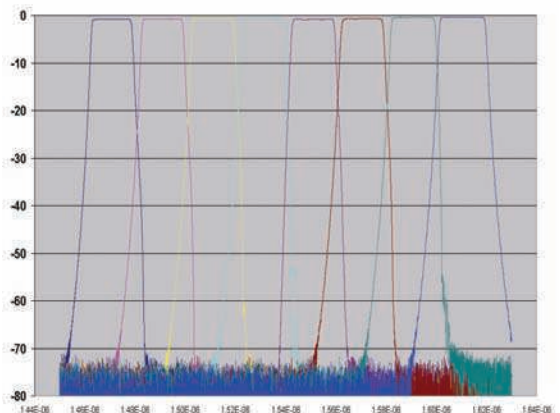

Output 1: Low SSE

# Agilent 81600B Tunable Laser Modules (cont.)

www.agilent.com/find/tls

81600B Option	#132/#142	#130/#140/#150/#160	#200/#201
Output power, peak (typ)	≥ +9/+8.5 dBm	Output 1: ≥ -4/-4.5/-1/-2 dBm Output 2: ≥ +5/+5.5/+7/+7 dBm	Output 1: ≥ +3 dBm Output 2: ≥ +9 dBm
Signal to SSE ratio	≥ 45/42 dB/nm	Output 1: ≥ 63/63/65/64 dB/nm Output 2: ≥ 42/42/45/45 dB/nm	Output 1: ≥ 70 dB/nm Output 2: ≥ 48 dB/nm
Signal to total SSE ratio	≥ 28 dB	Output 1: > 58/60/60/59 dB Output 2: ≥ 26/28/30/27dB (typ)	Output 1: ≥ 65 dB Output 2: ≥ 30 dB (typ)
Wavelength stability (typ)		≤ ±1 pm (24h)	
Power repeatability		±0.003 dB	
RIN	-145 dB/Hz typ.	-140 dB/Hz typ.	-145 dB/Hz (1520 to 1610 nm)
Wavelength repeatability		±0.8 pm, typ ± 0.5 pm	

Parameter	Common to all 81600B options			
	Stepped mode	Continuous sweep mode (typ.)		
		at 5 nm/s	at 40 nm/s	at 80 nm/s
Abs. wavelength accuracy	±10 pm, Typ. ±3.6 pm	±4.0 pm	±4.6 pm	±6.1 pm
Rel. wavelength accuracy	±5 pm, Typ. ±2 pm	±2.4 pm	±2.8 pm	±4.0 pm
Wavelength repeatability	±0.8 pm Typ. ±0.5 pm	±0.3 pm	±0.4 pm	±0.7 pm
Dynamic power reproducibility		±0.005 dB	±0.01 dB	±0.015 dB
Dynamic relative power flatness		±0.01 dB	±0.02 dB	±0.04 dB
Wavelength resolution			0.1 pm, 12.5 MHz at 1550 nm	
Maximum sweep speed			80 nm/s	
Linewidth (coherence control off)			100 kHz	
Power stability			±0.01 dB, 1 hour Typ. ±0.03 dB, 24 hour	
Power linearity			Output 1: ±0.1 dB Output 2: ±0.1 dB (±0.3 dB in attenuation mode)	
Power flatness versus wavelength			Output 1: ±0.25 dB, typ. ±0.1 dB Output 2: ±0.3 dB, typ ±0.15 dB	

Agilent 81600B tunable laser module selection table

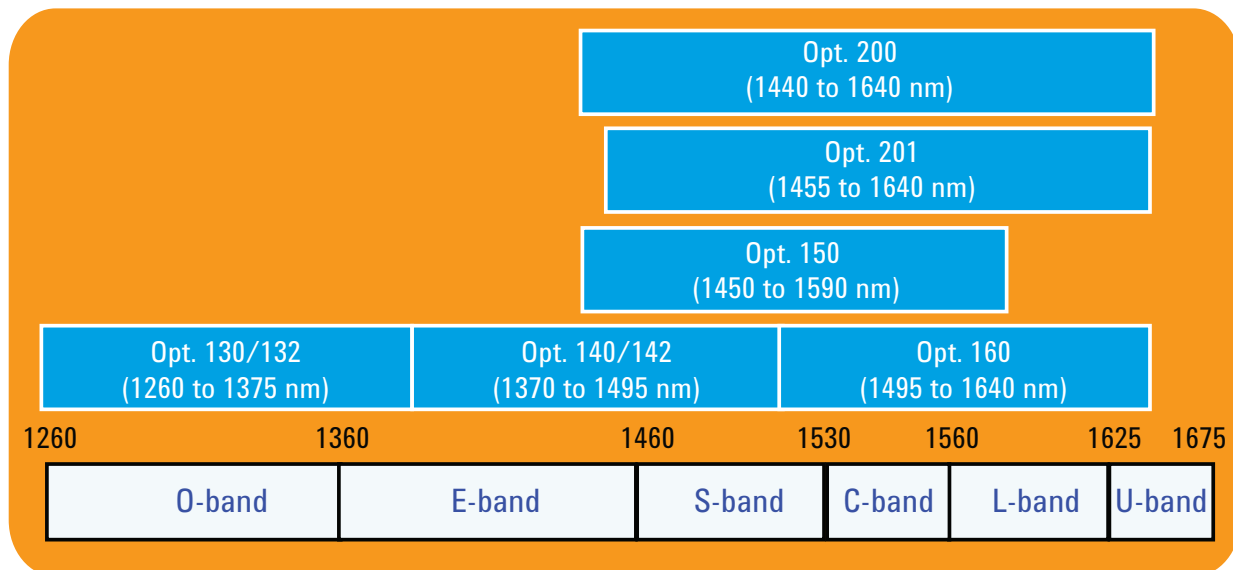

## Agilent 81960A, 8194xA, 8198xA and 81950A Compact Tunable Laser Sources

[www.agilent.com/find/tls](http://www.agilent.com/find/tls)

- **Modular design for multichannel platform**
- **Up to 125 nm coverage in one module**
- **Better than 2 Hz repetition rate in fast swept mode**
- **Device characterization at high power levels up to +14 dBm**
- **SBS suppression feature enables high launch power**
- **Excellent power and wavelength repeatability**



### High power compact tunable lasers for S-, C- and L-band

The Agilent 819xxA Series of compact tunable laser sources enables optical device characterization at high power levels and measurement of nonlinear effects. Each of the 819xxA lasers enhances the testing of systems, all types of optical amplifiers and other active components, as well as passive optical components.

As single-slot plug-in modules for the Agilent Technologies 8163A/B, 8164A/B, and 8166A/B mainframes, Agilent's compact tunable laser sources are a flexible and cost effective stimulus for single channel and DWDM test applications.

Agilent's 8198xA, 81960A and 8194xA compact tunable laser sources provide high output power up to +13 dBm.

The 81980A and 81989A modules cover a 110 nm wavelength range in the S- and C-band, the 81940A and 81949A modules operate over 110 nm in the C- and L-band, and the 81960A scans even 125 nm including the C- and L-band.

### New: Fast swept spectral loss measurement

The Agilent 81960A sets a new mark in tunable laser performance with faster sweep speeds and repetition rates combined with the dynamic accuracy specifications needed for DWDM component measurements.

Dynamically specified sweeps in both directions enhance the repetition rate even further for real-time use in adjustment and calibration procedures. Rocket-fast and accurate, the 81960A helps you hit your development and production targets.

### An ideal stimulus for DWDM system loading

The Agilent Technologies 81950A system-loading source is step-tunable for setting channel frequencies within the C- or L-band. With high output power up to +15 dBm, narrow linewidth of 100 kHz, gridless and grid-defined wavelength setting, and offset fine-tuning capability, the 81950A is a universal source for realistic loading of the latest transmission systems.

### Continuous sweep mode with wavelength logging

The 81940A, 81960A and 81980A can be operated in the continuous sweep mode with dynamic wavelength logging to make measurements during the wavelength sweep. This functionality forms the basis for fast wavelength-dependent measurements of passive and detecting optical components. Spectral measurements with tunable lasers provide high dynamic range and highest wavelength resolution.

### Built-in wavelength meter for active wavelength control

The 81940A, 81960A and 81980A feature a built-in wavelength meter with a closed feedback loop for enhanced wavelength accuracy. In continuous sweep mode, the meter allows dynamic wavelength logging to make accurate measurements during the sweep.

### Dynamic power control for excellent reproducibility

The integrated dynamic power control loop ensures a high reproducibility in power level. Highly repeatable measurements reduce errors when comparing the results of several wavelength sweeps. As the 81940A, 81960A and 81980A feature mode-hop-free tunability over their entire tuning range with continuous output power, they achieve highly accurate measurements over wavelength.

### Coherence control avoids interference-induced power fluctuations

In 8194xA, 81960A and 8198xA modules, a high-frequency modulation function is used to increase the effective linewidth to avoid power fluctuations due to coherent interference effects. The modulation pattern is optimized for stable power measurements, even in the presence of reflections.

# Agilent 81960A, 8194xA, 8198xA and 81950A Compact Tunable Laser Sources

[www.agilent.com/find/tls](http://www.agilent.com/find/tls)



Compact tunable laser source with dual power meter in one box

## Accurate DWDM component measurements at full scan rate

The 81960A module adds the new and unique capability to sweep in both directions, and sports increased sweep speeds and acceleration. Its dramatically improved and fully specified dynamic accuracy enables DWDM component measurements and adjustments at high repetition rate, and boosts the characterization of single and multichannel components. The laser is especially well supported by the swept-wavelength measurement engines in the N7700A software suite and can be programmed directly.

The most specially adapted application for this laser is high repetition-rate scanning for real-time updates, enabled by the Agilent N7700A-102 fast-sweep insertion loss engine. It synchronizes the laser with the N7744A or N7745A power meters to produce power and loss spectra in a convenient GUI display, and accelerates the uploading of the logged wavelength monitor data.

The wavelength resolution and 50 to 60 dB dynamic range achieved surpass comparable measurements by an Optical Spectrum Analyzer (OSA), with repetition rates better than 2 Hz for add-drop filter adjustment and calibration.

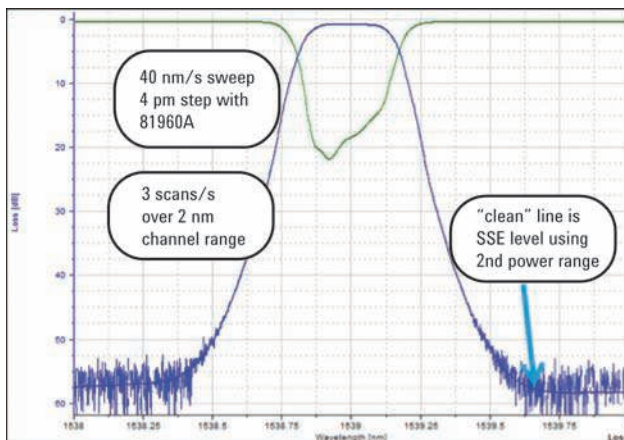

Dynamic range is > 55 dB with 25  $\mu$ s averaging time, sufficient to perform a 55 dB isolation test of a 50 GHz filter at 40 nm/s.

The high performance in continuous sweeps also matches this laser well to the single-sweep PDL and IL N7700A-100 measurement engine. The enhanced dynamic wavelength accuracy will satisfy the test needs for many DWDM components at an optimized performance/price balance. The source to spontaneous noise ratio, SSE, while not as high as the 81600B series, is also sufficient to qualify the isolation of many filter devices. The higher sweep speeds save time measuring broadband devices not needing such high wavelength resolution.

These same advantages apply to use with the N7788B component analyzer for measuring PMD and DGD in addition to PDL and IL. The relative wavelength accuracy during the sweeps is especially important for accurate DGD measurements using the JME method, since the result depends on the derivatives with respect to wavelength. The high speed is great for measuring isolators, PMF and other broadband components.

The powerful lambda scan functions of the 816x Plug&Play driver for customized programs, and the N7700A IL engine which provides a GUI interface to these functions also support power and IL measurements together with any of the Agilent power meters. And the performance of swept-wavelength measurements in the N4150A PFL, including fast repetitive sweeps are also supported with this newest member of the Agilent swept tunable lasers.

## Device characterization at high power levels

The high optical output power of the 819xxA tunable lasers enhances test stations for optical amplifier, active components and broadband passive optical components. It helps overcome losses in test setups or in the device under test itself. Thus, engineers can test optical amplifiers such as EDFAs, Raman amplifiers, SOAs and EDWAs to their limits. These tunable lasers provide the high power required to speed the development of innovative devices by enabling the test and measurement of nonlinear effects.

## Internal modulation

The internal modulation feature of 81940A, 81960A, 81980A, 81949A and 81989A enables an efficient and simple time-domain extinction (TDE) method for Erbium-based optical amplifier test. It also supports the transient testing of optical amplifiers by simulating channel add and drop events.

## SBS Suppression feature enables high launch power

The new SBS-suppression feature prevents the reflection of light induced by Stimulated Brillouin Scattering (SBS). It enables the launch of the high power into long fibers without intensity modulation.

# Agilent 81960A, 8194xA, 8198xA and 81950A Compact Tunable Laser Sources

www.agilent.com/find/tls

	81980A, 81940A	81960A	81950A Tunable System Source
Wavelength range	1465 to 1575 nm (81980A) 1520 to 1630 nm (81940A)	1505 to 1630 nm	1527.60 to 1565.50 nm (196.25 to 191.50 THz, 81950A-210) 1570.01 to 1608.76 nm (190.95 to 186.35 THz, 81950A-201)
Wavelength resolution	1 pm, 125 MHz at 1550 nm	0.1 pm, 12.5 MHz at 1550 nm	Typ. 100 MHz, 0.8 pm at 1550 nm
Mode-hop free tuning range	Full wavelength range	Full wavelength range	
Maximum tuning speed	50 nm/s	200 nm/s	< 30 s (incl. power stabilization)
Fine tuning range / resolution			typ. $\pm 6$ GHz / typ. 1 MHz
Absolute wavelength accuracy <sup>1</sup>	$\pm 20$ pm, typ. $\pm 5$ pm	$\pm 10$ pm, typ. $\pm 5$ pm	$\pm 22$ pm ( $\pm 2.5$ GHz)
Relative wavelength accuracy	$\pm 10$ pm, typ. $\pm 5$ pm	$\pm 7$ pm, typ. $\pm 3$ pm	$\pm 12$ pm ( $\pm 1.5$ GHz)
Wavelength repeatability	$\pm 2.5$ pm, typ. $\pm 1$ pm	$\pm 2.5$ pm, typ. $\pm 1.5$ pm	Typ. $\pm 2.5$ pm ( $\pm 0.3$ GHz) <sup>3</sup>
Wavelength stability (typ.) <sup>3</sup>	$\leq \pm 25$ pm over 24 hours	$\leq \pm 0.5$ pm over 1 min $\leq \pm 2.5$ pm over 15 min	$\leq \pm 2.5$ pm ( $\pm 0.3$ GHz) over 24 hours
Linewidth, coherence control off	Typ. 100 kHz	Typ. 100 kHz	Typ. 100 kHz, SBS suppression off
Effective linewidth (typ., coherence control on) <sup>2</sup>	> 50 MHz (1525 to 1575 nm, 81980A) > 50 MHz (1570 to 1620 nm, 81940A)	> 50 MHz (at max. constant output power)	
Maximum output power (continuous power during tuning)	> +14.5 dBm peak $\geq +13$ dBm (1525 to 1575 nm, 81980A) $\geq +13$ dBm (1570 to 1620 nm, 81940A) $\geq +10$ dBm (1465 to 1575 nm, 81980A) $\geq +10$ dBm (1520 to 1630 nm, 81940A)	$\geq +14$ dBm peak, typ. $\geq +13$ dBm (1570 to 1620 nm) $\geq +10$ dBm (1505 to 1630 nm)	$\geq +13.5$ dBm (typ. $\geq +15$ dBm)
Power range (nominal)	+6 dBm to maximum output power	+6 dBm to maximum output power	8 dB off maximum output power
Power linearity	Typ. $\pm 0.1$ dB	$\pm 0.15$ dB (1505 nm, 1575 nm, 1630 nm)	
Power stability <sup>3</sup>	$\pm 0.01$ dB over 1 hour Typ. $\pm 0.03$ dB over 24 hours	$\pm 0.01$ dB over 1 hour Typ. $\pm 0.03$ dB over 24 hours	Typ. $\pm 0.03$ dB over 24 hours
Power flatness versus wavelength	$\pm 0.3$ dB, typ. $\pm 0.15$ dB	$\pm 0.2$ dB (1570 nm to 1620 nm, +13 dBm) $\pm 0.3$ dB (full wavelength range)	Typ. $\pm 0.2$ dB (full wavelength range)
Power repeatability (typ.)	$\pm 0.01$ dB	$\pm 0.01$ dB	$\pm 0.08$ dB <sup>3</sup>
Continuous sweep mode, both directions <sup>5</sup>	n/a	5 nm/s	50 nm/s
Absolute wavelength accuracy (typ.)	n/a	$\pm 5$ pm	$\pm 8$ pm
Wavelength repeatability (typ.) <sup>6</sup>	n/a	$\pm 0.8$ pm	$\pm 2$ pm
Dynamic power reproducibility (typ.) <sup>6</sup>	n/a	$\pm 0.01$ dB	$\pm 0.04$ dB
Power repeatability (typ.)	$\geq 50$ dB	$\geq 50$ dB	50 dB
Signal to source spontaneous emission ratio <sup>4</sup>	$\geq 45$ dB/nm <sup>2</sup> 48 dB/nm (1525 to 1575 nm, 81980A) <sup>2</sup> 48 dB/nm (1570 to 1620 nm, 81940A) <sup>2</sup>	$\geq 45$ dB/nm (+10 dBm) $\geq 50$ dB/nm (1525 to 1620 nm, +12 dBm)	Typ. 50 dB/1 nm <sup>2</sup>
Signal to total source spontaneous emission ratio (typ.) <sup>2</sup>	$\geq 25$ dB $\geq 30$ dB (1525 to 1575 nm, 81980A) $\geq 30$ dB (1570 to 1620 nm, 81940A)	$\geq 25$ dB (+10 dBm) $\geq 30$ dB (1525 to 1620 nm, +12 dBm)	
Relative intensity noise (RIN) (typ.) <sup>2</sup>	-145 dB/Hz	-145 dB/Hz (0.1 GHz to 6 GHz)	-145 dB/Hz (10 MHz to 40 GHz)
Dimensions (H x W x D)	75 mm x 32 mm x 335 mm	75 mm x 32 mm x 335 mm	75 mm x 32 mm x 335 mm

[1] At day of calibration.

[2] At maximum output power as specified per wavelength range.

[3] At constant temperature  $\pm 0.5$  K.

[4] Value for 1 nm resolution bandwidth.

[5] For sweep range 1510 to 1625 nm. For 200 nm/s, sweep range is 1528 to 1608 nm.

[6] Repeatability within the same direction. At 200 nm/s, the specification value is double for sweeps from long to short wavelength

## Ordering information

81960A-162 Fast-Swept Compact Tunable Laser, 1505 to 1630 nm, step and fast sweep mode

81940A Compact Tunable Laser Source L-band, 1520 to 1630 nm, step and sweep mode

81980A Compact Tunable Laser Source C-band, 1465 to 1575 nm, step and sweep mode

81950A-210 Tunable System Source C-band, 1465 to 1575 nm, step mode

81950A-201 Tunable System Source L-band, 1520 to 1630 nm, step mode

a) All tunable lasers must be ordered with one connector option.

b) # 071 for PMF, straight output (not available for 81960A).

c) # 072 for PMF, angled output.

d) One Agilent 81000xl-series connector interface is required.

# Agilent N7711A and N7714A Tunable Laser Source

www.agilent.com/find/tls

## N7711A, N7714A Tunable laser sources

- Compact instrument format with one or four ports per unit on one-half rack-unit width and one-unit height
- Flexible configuration of four-port model between C- and L-band channels (N7714A)
- Adjustable to any wavelength grid (ITU-T 100 GHz, 50 GHz, 25 GHz, and arbitrary grids), or use gridless wavelength setting
- Narrow linewidth less than 100 kHz and offset-grid tuning greater than  $\pm 6$  GHz ideally suited for coherent mixing applications and new complex modulation formats
- Up to +15 dBm output power, with 8 dB power adjustment range
- Polarization maintaining fiber output

The new Agilent N7711A and N7714A tunable lasers are single-port and four-port sources, available with C-band or L-band wavelength coverage. The narrow linewidth and offset grid fine-tuning capability of the N7711A and N7714A make them ideal sources for realistic loading of the latest transmission systems.



N7711A one-port Tunable Laser Source



N7714A four-port Tunable Laser Source

The N7711A and N7714A tunable laser sources are step-tunable within any frequency grid in the C-band (1527.60 to 1565.50 nm; 196.25 to 191.50 THz) or L-band (1570.01 to 1608.76 nm; 190.95 to 186.35 THz). Their output power of up to +15 dBm and a linewidth under 100 kHz are ideal to emulate state-of-the-art DWDM transmitters. SBS suppression can be activated on demand to avoid stimulated Brillouin scattering.

## Tuning modes that fit every application

Each individual laser in the N7711A and N7714A features the same tuning modes as the 81950A: in channel setting mode, the source wavelength, (or frequency, respectively) is determined by the chosen channel index, zero frequency and grid spacing; ITU-T standard grids are possible as well as custom grids. In wavelength setting mode the laser operates gridless and is tunable to any wavelength point within its range, just like any other Agilent tunable lasers. In both modes, each laser channel operates independently and can be fine-tuned by  $\pm 6$  GHz with output power active.

## The 77-Viewer: An easy-to-use graphical user interface

The 77's Window's based graphical user interface offers flexible and extensive control of the instrument.

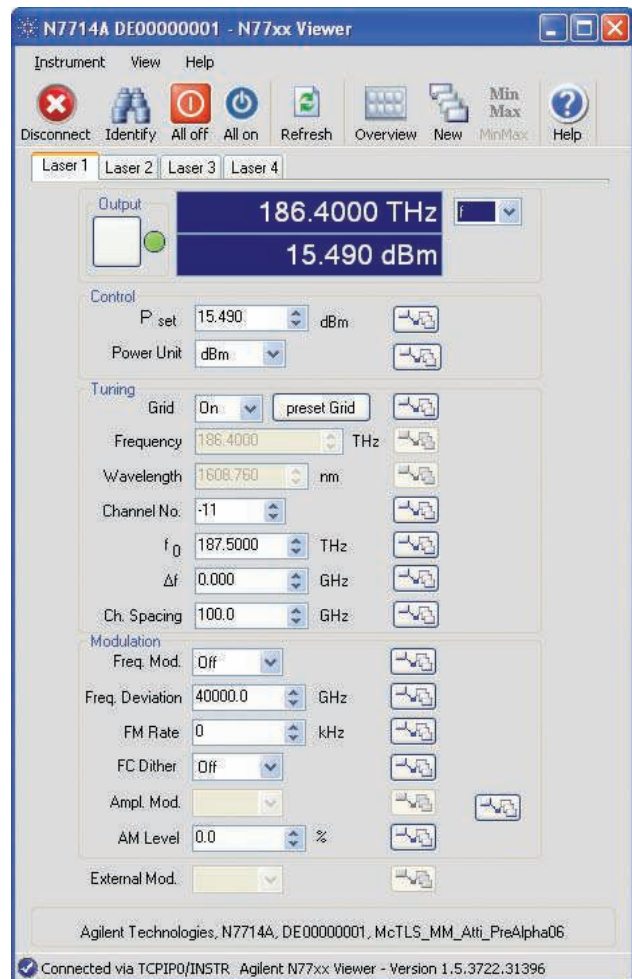

# Agilent N7711A and N7714A Tunable Laser Source

www.agilent.com/find/tls

## Technical Specifications N7711A and N7714A (Specifications apply to wavelengths on the 50 GHz ITU-T grid, after warm up.)

Wavelength	Options #210, #222, #240	Options #201, #222, #204
Wavelength range	1527.60 to 1565.50 nm (196.25 to 191.50 THz)	1570.01 to 1608.76 nm (190.95 to 186.35 THz)
Fine tuning range	Typ. ±6 GHz	
Fine tuning resolution	Typ. 1 MHz	
Absolute wavelength accuracy	±22 pm (±2.5 GHz)	
Relative wavelength accuracy	±12 pm (±1.5 GHz)	
Wavelength repeatability	Typ. ±2.5 pm (±0.3 GHz)	
Wavelength stability	Typ. ±2.5 pm (±0.3 GHz), 24 hours	
Tuning time including power stabilization	Typ. < 30 s	
<b>Optical power</b>		
Maximum output power	≥ +13.5 dBm Typ. ≥ +15 dBm	
Power stability	Typ. ±0.03 dB over 24 hours	
Power flatness	Typ. ±0.2 dB (full wavelength range)	
Power repeatability	typ. ±0.08 dB	
<b>Spectral</b>		
Linewidth	Typ. < 100 kHz (SBS suppression off)	
Side mode suppression ratio (SMSR)	Typ. 50 dB	
Source spontaneous emission (SSE)	Typ. 50 dB/ 1 nm Typ. 60 dB/ 0.1 nm	
Relative intensity noise (RIN)	Typ. -145 dB/Hz (10 MHz to 40 GHz)	

## Non-warranted Performance Characteristics N7711A and N7714A

Grid spacing	100, 50, 25 GHz, arbitrary grid, or gridless
<b>Output power</b>	
Power attenuation range	8 dB
Power setting resolution	0.1 dB
Residual output power (shutter closed)	≤ -45 dBm
<b>Stimulated Brillouin scattering</b>	
SBS suppression FM p-p modulation range	0 to 1 GHz
SBS suppression dither frequency	20.8 kHz



# Agilent 81663A DFB Laser Modules

www.agilent.com/find/oct

The Agilent 81663A high power DFB laser source modules are best suited for multiple fixed-wavelength test applications, like PON component test.

- Center wavelengths: 1310 nm, 1490 nm, 1510 nm, 1550 nm, 1625 nm
- Fine tuning capability  $\pm 500$  pm
- Excellent power and wavelengths stability
- Up to 20 mW output power

The Agilent 81663A modules offer +13 dBm output power to overcome power penalties given in today's test setups. Their excellent power and wavelength stability is key for accurate testing of IL and PDL at PON wavelengths.

## Applications

- PON component IL & PDL test
- PON Stimulus-response measurement



Agilent 81663A Option	#131	#149	#151	#155	#162
-----------------------	------	------	------	------	------

## Specifications apply to maximum power setting

Type	CW DFB laser with built-in isolator				
Center wavelength <sup>[1][2]</sup>	1310 nm $\pm 5$ nm	1490 nm $\pm 3$ nm	1510 nm $\pm 3$ nm	1550 nm $\pm 3$ nm	1625 nm $\pm 3$ nm
Tuning range	Typ. > $\pm 500$ pm				
• Display resolution	10 pm				
• Repeatability <sup>[4]</sup>	$\pm 5$ pm (typ. $\pm 2$ pm)				
• Stability (15 min.) <sup>[3][4]</sup>	$\pm 5$ pm (typ. $\pm 2$ pm)				
• Stability (24 h) <sup>[3][4]</sup>	Typ. $\pm 5$ pm				
Fiber type	Panda PMF 9 / 125 mm				
Output connector <sup>[6]</sup>	Compatible to angled contact APC, ASC, DIN47256/4108				
Power					
• Max. output <sup>[5]</sup>	Typ. > +13 dBm (20 mW)				
• CW stability (15 min) <sup>[4]</sup>	Typ. $\pm 0.003$ dB				
• CW stability (24 h) <sup>[3][4]</sup>	Typ. $\pm 0.01$ dB				
Side mode suppression ratio (SMSR) <sup>[5]</sup>	Typ. 50 dB				
Polarization extinction ratio (PER)	Typ. > 20 dB				
Dimensions (H x W x D)	75 mm x 32 mm x 335 mm (2.8" x 1.3" x 13.2")				
Weight	0.5 kg				
Recalibration period	2 year				
Operating temperature	15 to 35 °C				
Warm-up time <sup>[3]</sup>	60 min				

[1] Center wavelength is shown on display as default.

[2] Via GPIB tuning resolution < 10 pm.

[3] If previously stored at the same temperature 20 min.

[4] Controlled environment DT =  $\pm 1$  °C.

[5] At maximum power setting and default wavelength at the end of a 2 m SM patchcord.

[6] Connector interface not included.

# Agilent 8165xA Fabry-Perot Laser Modules

www.agilent.com/find/oct

- **SMF with 1310, 1550 or 1310/1550 nm and MMF with 850 nm**
- **20 mW output power**
- **Excellent CW power stability of  $< \pm 0.005$  dB (15 min.)**
- **Stable test of patchcords, couplers and connectors**



The Agilent Fabry-Perot laser sources are available as single or dual wavelength sources, are insensitive to back reflections, and are stabilized for short and long term applications.

## Flexible application fit

Agilent 8165xA Fabry-Perot laser sources are a family of plug-in modules for Agilent's lightwave solution platform and offer ideal power and loss characterization of optical components and fibers with wavelengths at 850 nm, 1310 nm and 1550 nm, mainly used in optical telecommunication including today's fiber to the home (FTTH) and short reach applications such as Fibre Channel and Gigabit Ethernet.

## Ideal solution for IL, RL and PDL tests

Combination of Agilent's Fabry-Perot laser source and wide variety of power meters (or optical heads) provides the basic setup for insertion loss (IL) characterization. Simple front panel operation together with a power meter immediately show results of IL. Agilent's 8161xA return loss module can utilize an external laser source such as a Fabry-Perot laser to set up a return loss (RL) test. Adding the Agilent 8169A or N7785B polarization controller enables testing of the polarization properties of optical components.

## 850 nm source

For 850 nm, the special 81655A Option E03 is also offered with 50/125  $\mu$ m multimode output.

High power modules, +13 dBm	Agilent 81655A	Agilent 81656A	Agilent 81657A
Type		Fabry-Perot laser	
Center wavelength <sup>[1]</sup>	1310 nm $\pm$ 15 nm	1550 nm $\pm$ 15 nm	1310/1550 nm $\pm$ 15 nm
Fiber type		Single-mode 9/125 mm	
Spectral bandwidth (rms) <sup>[1] [2]</sup>	$< 5.5$ nm (high power)	$< 7.5$ nm (high power)	$< 5.5$ nm/ 7.5 nm (high power)
Output power		$> + 13$ dBm (20 mW) (high power)	
CW power stability <sup>[3] [4]</sup>		$< \pm 0.005$ dB	
Short term (15 min.)		Typ. $< \pm 0.003$ dB with coherence control active	
Long term (24 h)		typ. $\pm 0.03$ dB	
To back reflection (RL <sup>3</sup> 14 dB)		typ $\pm 0.003$ dB	
Dimensions (H x W x D)		75 mm x 32 mm x 335 mm (2.8" x 1.3" x 13.2")	
Weight		0.5 kg	
Recalibration period		2 years	
Operating temperature		0 °C to 45 °C	
Humidity		Non condensing	
Warm-up time		60 minutes <sup>[3]</sup>	

[1] Central wavelength is shown on display.

[2] rms: root mean square.

[3] Warm-up time 20 min, if previously stored at the same temperature.

[4] Controlled environment (T =  $\pm 1$  °C).

## Supplementary performance characteristics:

### Internal digital modulation mode:

270 Hz, 330 Hz, 1 kHz, 2 kHz and free selection 200 Hz to 10 kHz.  
All output signals are pulse shaped, duty cycle 50 %.  
Internal coherence control for linewidth broadening.

### Output attenuation:

The output power of all source modules can be attenuated from 0 to 6 dB in steps of 0.1 dB.

# Agilent N7744A and N7745A Optical Multiport Power Meter

www.agilent.com/find/mppm

- Patented 4-port optical connector interface for FC, SC, LC, MU and bare-fiber
- Storage of up to 1 million power values per channel for high speed measurement data acquisition and transfer
- Short minimum averaging time of 1  $\mu$ s for high time resolution and transient power measurements
- LAN, USB and GPIB programming interfaces
- High dynamic range with high bandwidth for accurate high-speed spectra
- Code compatibility to Agilent's Lightwave Measurement System platform



Agilent N7745A Multiport Power Meter with Quad-Adapter Connector Interfaces N7740ZI, N7740FI, N7740BI, N7740KI (left to right)

## Up to eight power meter channels in a small package

Agilent's new N7744A and N7745A optical power meters with four or eight power-sensor channels provide manufacturing customers with increased throughput and operational efficiency to meet today's challenges in manufacturing.

## Designed for optical multiport applications

Designed for characterizing optical multiport components, these optical power meters offer industry-leading solutions for device connectivity, high-speed measurement data acquisition and fast data transfer for postprocessing. The multiport power meter enables fast measurement solutions for all multiport devices; for example multiplexers, PON splitters, wavelength selective switches (WSS) and ROADMs, as well as compact setups for simultaneous testing of multiple single-port devices. These power meters are easily integrated with a tunable laser using the N7700A software to make fast IL and PDL measurements.

## Continuous data logging

Each channel can log up to 1 M samples and has an additional 1 M buffer. Sampling can be set between 1  $\mu$ s and 10 s. The buffer allows data upload during measurements for uninterrupted transient power measurement and monitoring.

## A reliable four-port optical connection with a new one-click quad-adapter

With this new power meter comes the unprecedented N7740xl fiber connectivity concept, which is a quadruple adapter with a snap-on quick-locking mechanism. The device to be tested can be connected to the quad-adapters in a comfortable ergonomic working position, even while the instrument is measuring another device. Then the quad-adapters can quickly be snapped on, to provide repeatable high-precision connections. Use of the quad-adapters simplifies aligning connector keys, especially for rack-mounted instruments and makes it easier to connect ports in the desired order, helping to avoid errors and connector damage. This quad-adapter fits also into Agilent's standard bare fiber connectivity solutions 81000Bx.

## Agilent N7744A, N7745A

Sensor element	InGaAs
Wavelength range	1250 to 1650 nm
Specification wavelength range	1250 to 1625 nm (if not stated differently)
Power range	-80 to +10 dBm
Maximum safe power	+16 dBm
Data logging capability	1 million measurement points per port
Averaging time	1 $\mu$ s to 10 s
Applicable fiber type	Standard SM and MM $\leq$ 62.5 $\mu$ m core size, NA $\leq$ 0.24
Uncertainty at reference conditions	$\pm$ 2.5%
Total uncertainty	$\pm$ 4.5%
Relative port to port uncertainty	typ. $\pm$ 0.05 dB
Linearity at (23 $\pm$ 5°C) over operating temperature	$\pm$ 0.02 dB $\pm$ 3 pW $\pm$ 0.04 dB $\pm$ 5 pW
Polarization dependent responsivity	< $\pm$ 0.015 dB (1520 to 1580 nm) Typ. < $\pm$ 0.01 dB (1250 to 1580 nm)
Noise peak-to-peak (dark)	< 7 pW (1 s averaging time, 300 s observation time)
Return loss	> 50 dB (1520 to 1580 nm) typ. > 57 dB (1280 to 1580 nm)
Operating temperature	+5 to +40 °C
Operating humidity	15% to 95%, non-condensing
Storage conditions	-40 °C to +70 °C
Warm-up time	20 min.
Dimensions (H x W x D)	372 mm x 212 mm x 43 mm
Weight	3 kg (6 lb)

## N7747A and N7748A High Sensitivity Optical Power Meter

www.agilent.com/find/jet

With the N7747A and N7748A, the highest optical performance is now offered in the N77 platform for compact automated instrumentation. The high optical performance encompasses the highest sensitivity available with  $-110$  dBm and correspondingly low noise and high stability to accurately measure and monitor weak signals and small signal changes. This is supported by high relative power accuracy with low polarization dependence and low spectral ripple. The high sensitivity together with 9 power ranges at 10 dB spacing provides highest dynamic range with excellent linearity.

These instruments combine the proven optical performance of the 81634B sensor modules with the large memory, fast data transfer and small footprint of the N77 series platform. Eight high-sensitivity optical power meters now fit in a single rack unit. Optical connections are made with the interchangeable 81000xl connector interface system so the instrument can be easily adapted to different fiber connector types. Each optical port has 2 buffers of memory, each able to log up to 1 M samples. With the ability to upload one buffer while the other is recording measurements, this permits continuous monitoring over extended times with sensitivity to small transients. Details for programming this logging are given in the application note 5990-3710. The functionality is the same used in the N7744A and N7745A except that the high-sensitivity models use lower bandwidth to match the low-noise performance.

Like the 81634B and the 8162\*B optical power heads, the N7747A and N7748A include an analog output for each optical channel. This provides a 0 to 2 V signal proportional to the optical power, scaled by the selected power range and allows analog monitoring of signals with up to 5 kHz bandwidth.

The instruments have USB, LAN and GPIB interfaces for control with the SCPI command set also used for the 816x, N7744A and N7745A optical power meters. The updated versions of the N77xx Viewer user interface program and the 816x VXI Plug&Play driver can also be used.



### N7747A and N7748A

Sensor element	InGaAs
Wavelength range	800 to 1700 nm
Power range	$-110$ to $+10$ dBm
Maximum safe input power	$+16$ dBm
Applicable fiber type	Standard SM and MM, $\leq 100$ $\mu$ m core size, NA $\leq 0.3$
Uncertainty at reference conditions <sup>1</sup>	$\pm 2.5\%$
Total uncertainty <sup>2,3</sup>	$\pm 4.5\%$
Polarization dependent responsivity <sup>4</sup>	$< \pm 0.005$ dB
Spectral ripple (due to interference) <sup>5</sup>	$< \pm 0.005$ dB
Linearity <sup>3,6</sup>	$< \pm 0.015$ dB (at $23 \pm 5$ °C) $< \pm 0.05$ dB (in operating temperature range) $< \pm 0.005$ dB (fixed power range, within 10 dB of range max.)
Noise (peak to peak, dark) <sup>7</sup>	$< 0.2$ pW (1200 to 1630 nm)
Drift	
Return loss	$> 55$ dB
Analog output	0 to 2 V in to open, 600 ohm typ. output impedance, max input voltage $\pm 10$ V
Frequency response (3 dB cutoff, also for analog output)	5.0 kHz ( $+10$ dBm to $-20$ dBm range) 4.0 kHz ( $-30$ dBm to $-40$ dBm range) 0.3 kHz ( $-40$ dBm to $-70$ dBm range)
Averaging time	10 $\mu$ s to 10 s
Data logging capability	2 buffers/port, each with 1 Mio. measurement point capacity

$-110$   
dBm

1. Reference conditions:

Power level 10  $\mu$ W ( $-20$  dBm), continuous wave (CW), Fiber 50  $\mu$ m graded-index, NA = 0.2, Ambient temperature  $23 \pm 5$  °C, On day of calibration (add  $\pm 0.3\%$  for aging over one year, add  $\pm 0.6\%$  over two years), Spectral width of source  $< 10$  nm (FWHM), Wavelength setting at power sensor must correspond to source wavelength  $\pm 0.4$  nm.

2. Operating conditions:

Fiber  $\leq 50$   $\mu$ m, NA  $\leq 0.2$ , connectors with 2.5 mm ferrule with flat face (fiber tip offset not more than 0.3 mm from 2.5 mm cross-section) with straight or angled polish, within one year after calibration, add 0.3% for second year, operating temperature range as specified humidity: none condensing.

3. Excluding noise and drift.

4. All states of polarization at constant wavelength (1550  $\pm 30$  nm) and constant power, straight connector, T =  $23 \pm 5$  °C. For angled connector ( $8^\circ$ ) add  $\pm 0.01$  dB typ.

5. Test conditions: wavelength 1550  $\pm 30$  nm, fixed state of polarization, constant power, temperature  $23 \pm 5$  °C, linewidth of source  $\geq 100$  MHz, angled connector  $8^\circ$ .

6. CW,  $-90$  to  $+10$  dBm, 1000 to 1630 nm.

7. Averaging time 1 s, T =  $23 \pm 5$  °C,  $\Delta T \pm 1$  °C, observation time 300 s.

# Agilent 8163xA/B and 8162xB Optical Power Meters

www.agilent.com/find/oct

- Complete wavelength range, 450 to 1800 nm
- Low uncertainty of  $\leq \pm 0.8\%$  at reference conditions
- Low PDL of  $\leq \pm 0.005$  dB, for polarization sensitive tests
- High single-sweep dynamic range of 55 dB
- High power measurements of up to +40 dBm
- Support of high channel count testing with dual power sensor
- Support of bare-fiber and open-beam applications with a 5 mm detector
- Synchronous measurements with a laser source or external modulation



## Wide variety of optical power sensors and optical heads

The superiority of Agilent's stimulus-response test solutions guarantee performance. Agilent has been an industry leader in optical instrumentation since the early 1980s - excellence in laser sources, reliable power sensor modules and large detector optical heads.

The power measurement instruments are available in two formats: self-contained power sensor modules for front-panel optical fiber connection and external power measurement heads for flexible connection positioning, which are connected to the mainframe using the 81618A or 81619A (dual) interface modules. The external beams with a large 5 mm detector are also useful in many free-space optical configurations.

The flexible connector interface system allows the same instrument to be used with many different types of optical connector.



81628B InGaAs head with integrating sphere

## Passive component test

For multi-channel devices, such as, CWDM and AWG, for R&D or the manufacturing environment, accurate measurements at a minimum cost are in demand. The modular design provides the user with the flexibility to add power meters or mainframes for high channel count or high dynamic range applications. Testing of free space optics, such as, thin film filter (TFF) and waveguide alignment, are easily supported with the optical head. Its 5 mm detector and long, moveable reach provides the user with easy handling.

## Active component test

High power amplifiers and sources are developed today in order to transmit signals over longer distances and to support a high loss environment for complex systems. High power measurements of +40 dBm, can be accomplished without an attenuator, which could add to the measurement uncertainty.

## Optical component test in the visible wavelength range

For measuring visible and near-infrared light, like used in POS (polymer optical fiber) networks, visible LED's or infrared remote control sources, the new 81623B Option E01 external power head is an ideal solution. It covers the wavelength range from 450 to 1020 nm.

## Research and calibration

Low measurement uncertainty of  $\leq \pm 2.5\%$  and low PDL of  $\leq \pm 0.005$  dB are a couple of the key features found in the Agilent power sensors. All of Agilent's power meter products are NIST and PTB traceable to guarantee precise optical power measurements. All metrology labs are ISO 17025 certified to meet general requirements for the competence of testing and calibration laboratories.

The instruments can log up to 20 k points with sampling times down to 100  $\mu$ s, or even 100 k points at 25  $\mu$ s with the 81636B. These samples can be triggered by the tunable laser for swept-wavelength spectral measurements. Built-in routines are also included for measuring maximum and minimum power, stability over extended time, and offset from an initial measurement value. Results can be displayed in mW, dBm, or dB change.

## Selection criteria for optical power meters (see also page 38)

### Optical power sensors

- 81635A: Dual-channel sensor, lowest price
- 81634B: Most accurate sensor, highest sensitivity
- 81636B: Fast power sensor, 100 k points, 25  $\mu$ s averaging, higher dynamic range during logging
- 81630B: Highest power sensor

### Optical power heads

- 81623B: Ge head, general purpose, also specified for 850 nm
- 81624B: InGaAs head, highest accuracy
- 81626B: InGaAs head, high power with high relative accuracy
- 81628B: InGaAs head with integrating sphere, highest power and a accuracy at high power

# Agilent 8163xA/B and 8162xB Optical Power Meters

www.agilent.com/find/oct

## Agilent 81636B continued

Return loss	> 40 dB
Noise (peak to peak)	< 20 pW (1260 to 1630 nm)
Averaging time (minimal)	25 $\mu$ s
<b>Dynamic range at manual range mode</b>	
at +10 dBm-range	Typ. > 55 dB
at 0 dBm-range	Typ. > 55 dB
at -10 dBm-range	Typ. > 52 dB
at -20 dBm-range	Typ. > 45 dB
<b>Noise at manual range mode (peak to peak)</b>	
	CW -60 to +10 dBm, 1260 to 1630 nm
at +10 dBm-range	< 50 nW
at 0 dBm-range	< 5 nW
at -10 dBm-range	< 1 nW
at -20 dBm-range	< 500 pW
Analog output	Included
Dimensions (H x W x D)	75 mm x 32 mm x 335 mm (2.8" x 1.3" x 13.2")
Weight	0.5 kg
Recommended recalibration period	2 years
Operating temperature	+10 °C to +40 °C
Humidity	Non-condensing
Warm-up time	20 min

	Agilent 81623B	Agilent 81623B Cal Opt C85	Agilent 81623B Cal Opt C01	Agilent 81623B #E01 (special Si Detector)
Applicable fiber type standard open beam	SM and MM max 100 $\mu$ m core size, NA 0.3; Parallel beam max $\phi$ 4 mm			
Sensor element	Ge, $\phi$ 5 mm		Si, $\phi$ 5mm	
Wavelength range	750 to 1800 nm		450 to 1020 nm	
Power range	-80 to +10 dBm		-90 to +10 dBm	
Uncertainty at reference conditions	$\pm 2.2\%$ (1000 to 1650 nm)	$\pm 2.2\%$ (1000 to 1650 nm)	$\pm 1.7\%$ (1000 to 1650 nm)	$\pm 2.2\%$ (600 to 1020 nm) <sup>[1]</sup>
	$\pm 3.0\%$ typ (800 to 1000 nm)	$\pm 2.5\%$ (800 to 1000 nm)	$\pm 3.0\%$ (800 to 1000nm)	
Total uncertainty	$\pm 3.5\% \pm 100$ pW (1000 to 1650 nm)	$\pm 3.5\% \pm 100$ pW (1000 to 1650 nm)	$\pm 3.0\% \pm 100$ pW (1000 to 1650 nm)	typ. $\pm 4\% \pm 0.5$ pW (600 to 1020 nm) <sup>[2]</sup>
	$\pm 4.0\%$ typ. $\pm 250$ pW (800 to 1000 nm)	$\pm 3.7\% \pm 250$ pW (800 to 1000 nm)	$\pm 4.0\%$ typ. $\pm 250$ pW (800 to 1000 nm)	
Relative uncertainty				
– Due to polarization	< $\pm 0.01$ dB (typ. < $\pm 0.005$ dB)			
– Spectral ripple (due to interference)	< $\pm 0.006$ dB (typ. < $\pm 0.003$ dB)			
Linearity (power)	(CW -60 to +10 dBm)			
– At 23°C $\pm 5$ °C	< $\pm 0.025$ dB			
– At operating temp. range	< $\pm 0.05$ dB			
Return loss	> 50 dB, typ. > 55 dB			
Noise (peak to peak)	< 100 pW (1200 to 1630 nm)		Typ. < 0.5 pW (700 to 900 nm)	
	< 400 pW (800 to 1200 nm)			
Averaging time (minimal)	100 $\mu$ s			
Analog output	Included			
Maximum safe input power	+16 dBm			
Dimensions (H x W x D)	57 mm x 66 mm x 156 mm			
Weight	0.5 kg		0.5 kg	
Recommended recalibration period	2 years		2 years	
Operating temperature	0 to 40 °C		0 to 40 °C	
Humidity	Non-condensing			
Warm-up time	40 min		20 min	

[1] Reference conditions:

- Power level 10 W (-20 dBm), continuous wave (CW)
- Parallel beam, 3 mm spot diameter on the center of the detector
- Ambient temperature 23 °C  $\pm 5$  °C
- On day of calibration (add  $\pm 0.3\%$  for aging over one year, add  $\pm 0.6\%$  over two years)
- Spectral width of source < 10 nm (FWHM)
- Wavelength setting at power sensor must correspond to source wavelength  $\pm 0.4$  nm

[2] Operating conditions:

- Parallel beam, 3 mm spot diameter on the center of the detector or connectorized fiber with NA  $\leq 0.2$  (straight connector)
- Averaging time 1s
- For NA > 0.2: add 1%
- Within one year after calibration, add 0.3% for second year
- Spectral width of source < 10 nm (FWHM)
- Wavelength setting at power sensor must correspond to source wavelength  $\pm 0.4$  nm

# Agilent 8163xA/B and 8162xB Optical Power Meters

www.agilent.com/find/oct

	Agilent 81635A	Agilent 81634B	Agilent 81630B
Sensor element	InGaAs (dual)	InGaAs	InGaAs
Wavelength range	800 to 1650 nm	800 to 1700 nm	970 to 1650 nm
Power range	-80 to +10 dBm	-110 to +10 dBm	-70 to +28 dBm
Applicable fiber type	Standard SM and MM up to 62.5 $\mu$ m core size, NA $\leq$ 0.24	Standard SM and MM up to 100 $\mu$ m core size, NA $\leq$ 0.3	Standard SM and MM up to 100 $\mu$ m core size, NA $\leq$ 0.3
Uncertainty (accuracy) at reference conditions	Typ. $< \pm 3\%$ (1200 to 1630 nm)	$\pm 3.5\%$ (800 to 1200 nm) (1000 to 1630 nm)	$\pm 2.5\% \pm 3.0\%$ for 1255 to 1630 nm at 980 nm $\pm 3.5\%$ (add $\pm 0.5\%$ per nm if 980 nm is not the center wavelength) at 1060 nm $\pm 4.0\%$ (add $\pm 0.6\%$ per nm if 1060 nm is not the center wavelength)
Total uncertainty $\pm 5\% \pm 20$ pW (1200 to 1630 nm)	Typ. $\pm 5.5\% \pm 200$ pW (800 to 1200 nm) (1000 to 1630 nm)	$\pm 4.5\% \pm 0.5$ pW	$\pm 5\% \pm 1.2$ nW (1255 to 1630 nm) at 980 nm $\pm 5.5\% \pm 1.2$ nW (add $\pm 0.5\%$ per nm if 980 nm is not the center wavelength) at 1060 nm $\pm 6.0\% \pm 1.2$ nW (add $\pm 0.6\%$ per nm if 1060 nm is not the center wavelength)
Relative uncertainty			
- due to polarization	Typ. $< \pm 0.015$ dB	$< \pm 0.005$ dB	$< \pm 0.01$ dB
- spectral ripple (due to interference)	Typ. $< \pm 0.015$ dB	$< \pm 0.005$ dB	$< \pm 0.005$ dB
Linearity (power)	CW -60 to +10 dBm	CW -90 to +10 dBm	CW -50 to +28 dBm (970 to 1630 nm)
- at 23°C $\pm 5^\circ$ C	Typ. $< \pm 0.02$ dB (800 to 1200 nm) $< \pm 0.02$ dB (1200 to 1630 nm)	$< \pm 0.015$ dB (1000 to 1630 nm)	$\leq \pm 0.05$ dB
- at operating temp. range	Typ. $< \pm 0.06$ dB (800 to 1200 nm) $< \pm 0.06$ dB (1200 to 1630 nm)	$< \pm 0.05$ dB (1000 to 1630 nm)	$\leq \pm 0.15$ dB
Return loss	$> 40$ dB	$> 55$ dB	$> 55$ dB
Noise (peak to peak)	Typ. $< 200$ pW (800 to 1200 nm) $< 20$ pW (1200 to 1630 nm)	$< 0.2$ pW (1200 to 1630 nm)	$< 1.2$ nW (1255 to 1630 nm)
Averaging time (minimal)	100 $\mu$ s	100 $\mu$ s	100 $\mu$ s
Analog output	None	Included	Included
Maximum safe input power	$> +16$ dBm	+16 dBm	28.5 dBm
Dimensions (H x W x D)	75 mm x 32 mm x 335 mm (2.8" x 1.3" x 13.2")	75 mm x 32 mm x 335 mm (2.8" x 1.3" x 13.2")	75 mm x 32 mm x 335 mm (2.8" x 1.3" x 13.2")
Weight	0.5 kg	0.5 kg	0.6 kg
Recommended recalibration period	2 years	2 years	2 years
Operating temperature	+10 $^\circ$ C to +40 $^\circ$ C	0 $^\circ$ C to +45 $^\circ$ C	0 $^\circ$ C to +35 $^\circ$ C
Humidity	Non-condensing	Non-condensing	Non-condensing
Warm-up time	20 min	20 min	20 min

-110 dBm

Agilent 81636B	
Sensor element	InGaAs
Wavelength range	1250 to 1640 nm
Power range	-80 to +10 dBm
Applicable fiber type	Standard SM and MM up to 62.5 $\mu$ m core size, NA $\leq$ 0.24
Uncertainty (accuracy) at reference conditions	$\pm 3\%$ (1260 to 1630 nm)
Total uncertainty	$\pm 5\% \pm 20$ pW (1260 to 1630 nm)
Relative uncertainty	
- Due to polarization	Typ. $\pm 0.015$ dB
- Spectral ripple (due to interference)	Typ. $\pm 0.015$ dB
Linearity (power)	CW -60 to +10 dBm, (1260 to 1630 nm)
- At 23°C $\pm 5^\circ$ C	$< \pm 0.02$ dB
- At operating temperature range	$< \pm 0.06$ dB

# Agilent 8163xA/B and 8162xB Optical Power Meters

www.agilent.com/find/oct

	Agilent 81624B		Agilent 81626B	
Sensor element	InGaAs, ø 5 mm		InGaAs, ø 5 mm	
Wavelength range	800 to 1700 nm		850 to 1650 nm	
Power range	-90 to +10 dBm		-70 to +27 dBm (1250 to 1650 nm) -70 to +23 dBm (850 to 1650 nm)	
Applicable fiber type	Standard SM and MM max 100 µm core size, NA ≤ 0.3		Standard SM and MM max 100 µm core size, NA ≤ 0.3	
Open beam	Parallel beam max ø 4 mm		Parallel beam max ø 4 mm	
Uncertainty at reference conditions	± 2.2 % (1000 to 1630 nm)	± 1.5 % (970 to 1630 nm)	± 3.0 % (950 to 1630 nm)	± 2.5 % (950 to 1630 nm)
Total uncertainty	± 3.5% ± 5 pW (1000 to 1630 nm)	± 2.8% ± 5 pW (970 to 1630 nm)	± 5.0% ± 500 pW (950 to 1630 nm)	± 4.5% ± 500 pW, (1250 to 1630 nm, max 27 dBm)
Relative uncertainty				
– Due to polarization	≤ ± 0.005 dB (typ. ± 0.002 dB)		≤ ± 0.005 dB (typ. ± 0.002 dB)	
– Spectral ripple (due to interference)	≤ ± 0.005 dB (typ. ≤ ± 0.002 dB)		≤ ± 0.005 dB (typ. < ± 0.002 dB)	
Linearity (power)	CW -70 to +10 dBm, 1000 to 1630 nm		CW -50 to +27 dBm, 950 to 1630 nm	
– At 23 ± 5 °C	< ± 0.02 dB		< ± 0.04 dB	
– At operat. temp. range	< ± 0.05 dB		< ± 0.15 dB	
Return loss typ.	60 dB		> 45 dB	> 47 dB
Noise (peak to peak)	< 5 pW		< 500 pW	
Averaging time (min.)	100 µs		100 µs	
Analog output	Included		Included	
Maximum safe input power	+16 dBm	+23.5 dBm (850 to 1250 nm) / +27.5 dBm (1250 to 1650 nm)		
Dimensions (H x W x D)	57 mm x 66 mm x 156 mm		57 mm x 66 mm x 156 mm	
Weight	0.5 kg		0.5 kg	
Recommended recalibration period	2 years		2 years	
Operating temperature	0 to 40 °C		0 °C to +35 °C	
Humidity	Non-condensing		Non-condensing	
Warm-up time	40 min		40 min	

Agilent 81628B with Integrating Sphere			
Sensor element	InGaAs		
Wavelength range	800 to 1700 nm		
Power range	-60 to +40 dBm (800 to 1700 nm), For operation higher than 34 dBm <sup>1</sup>		
Damage power	40.5 dBm		
Applicable fiber type / open beam	Single mode NA ≤ 0.2, Multimode NA ≤ 0.4 / ø ≤ 3 mm center of sphere		
Uncertainty at reference conditions	± 3.0 % (970 to 1630 nm)		
Total uncertainty	(970 to 1630 nm)		
≤ 10 dBm	± 4.0% ± 5 nW		
> 10 to ≤ 20 dBm	± 4.5%		
> 20 to ≤ 38 dBm	± 5%		
Relative uncertainty			
– Due to polarization	Typ. ≤ ± 0.006 dB		
– Due to speckle noise at source linewidth:			
0.1 to 100 pm	Typ. < ± 0.02 dB		
> 100 pm	Typ. < ± 0.002 dB		
Linearity (power)	(CW -40 to +38 dBm), (970 to 1630 nm)		
≤ 10 dBm	≤ ± 0.03 dB		
> 10 to ≤ 20 dBm	≤ ± 0.06 dB		
> 20 to ≤ 37 dBm	≤ ± 0.09 dB		
> 37 to ≤ 38 dBm	≤ ± 0.10 dB		
	At 23 °C ± 5 °C, for operating temperature range add ± 0.03 dB		
Return loss	Typ. > 75 dB	Noise (peak to peak)	< 5 nW
Averaging time (minimal)	100 µs	Analog output	Included
Dimensions (H x W x D)	55 mm x 80 mm x 250 mm	Operating temperature	0 to +40 °C
Weight	0.9 kg (without heat sink)	Humidity	Non-condensing
Recommended recalibration period	2 years	Warm-up time	40 min

<sup>1)</sup> For optical power higher than 34 dBm the attached heat sink MUST be used! For continuous optical power or average optical power higher than 38 dBm the connector adapters will get warmer than permitted according to the safety standard IEC 61010-1. The 81628B Optical Head can handle optical power up to 40 dBm, however, operation above 38 dBm is at the operator's own risk. Agilent Technologies Deutschland GmbH will not be liable for any damage caused by an operation above 38 dBm.



# Agilent 81610A and 81613A Return Loss Modules

www.agilent.com/find/oct

- **Single module for return loss (RL) test**
- **High dynamic range of 75 dB**
- **Built-in Fabry-Perot laser source for 1310 and 1550 nm**
- **Use any external laser source, including tunable laser for swept RL applications**
- **Three easy calibration steps for enhanced accuracy**



## Plug&Play for RL measurement

Portability and cost effective; a single mainframe, single module and single connection to the device under test are all you need to make a return loss (RL) measurement. Agilent's RL test solution solves the complex operation of calibration and is able to exclude measurement uncertainties due to coupler/filter usage in your design. In addition, a built-in FP laser at 1310 and 1550 nm enables basic component tests.

## Meeting manufacturing needs

The need for IL and RL for optical component tests is fulfilled with the RL module when used with an optical power meter - preferably an optical head due to its flexibility. On-board application software supports step-by-step operation with instructions.

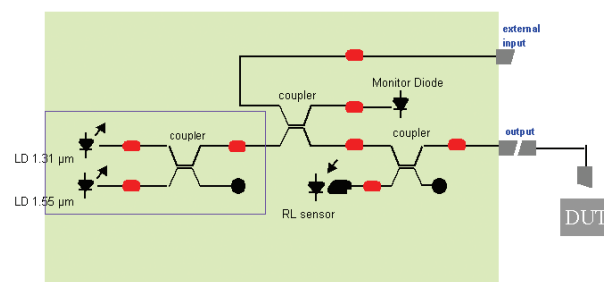

Return Loss Module, Optical Assembly

## Swept RL measurement with tunable laser source

Today's passive component devices are not only characterized at a single wavelength, but over a wide wavelength range using a tunable laser source. The swept wavelength measurement concept is applicable for RL measurements using an Agilent tunable laser source (TLS) in synchronous operation of the two modules. The N7700A-100 PDL software supports use of the return loss modules as well.

	81610A		81613A	
Source	External input only		Fabry-Perot laser (internal)	
Output power	—		Typ. -4 dBm	
Center wavelength	—		1310 nm/1550 nm ± 20 nm typ.	
Sensor element	InGaAs		InGaAs	
Fiber type	Standard single-mode 9 / 125 μm		Standard single-mode 9/125 μm	
External input	Max input power: 10 dBm Min input power: 0 dBm Damage input power: 16 dBm		—	
Wavelength range for external input	1250 to 1640 nm		—	
Dynamic range	70 dB		75 dB	
Relative uncertainty of return loss (RL)	With broadband source	With Agilent FP sources	User calibration	Plug&play
RL ≤ 55 dB	< ± 0.25 dB	Typ. < ± 0.5 dB	< ± 0.5 dB (typ. < ± 0.3 dB)	typ. < ± 0.6 dB
RL ≤ 60 dB	< ± 0.3 dB	Typ. < ± 1.0 dB	< ± 0.6 dB (typ. < ± 0.4 dB)	typ. < ± 1.5 dB
RL ≤ 65 dB	< ± 0.65 dB	Typ. < ± 2.0 dB	< ± 0.8 dB (typ. < ± 0.5 dB)	—
RL ≤ 70 dB	< ± 1.7 dB	—	< ± 1.9 dB (typ. < ± 0.8 dB)	—
RL ≤ 75 dB	—	—	typ. < ± 2.0 dB	—
Total uncertainty add	± 0.2 dB add	typ. ± 0.2 dB	Add ± 0.2 dB	Add typ. ± 0.2 dB
Dimensions (H x W x D)	75 mm x 32 mm x 335 mm (2.8" x 1.3" x 13.2")		75 mm x 32 mm x 335 mm (2.8" x 1.3" x 13.2")	
Weight	0.6 kg		0.6 kg	
Recommended recalibration period	2 years		2 years	
Operating temperature	10 to 40 °C		10 to 40 °C	
Humidity	Non-condensing		Non-condensing	
Warm-up time	20 minutes		20 minutes	

# Agilent 8157xA High-Power Optical Attenuators

www.agilent.com/find/voa

- **Low insertion loss of 0.7 dB**
- **Excellent wavelength flatness**
- **Coverage in both single mode and multi mode fiber**
- **High attenuation resolution of 0.001 dB**
- **Active power control option**



## Modular design, fit for various component and network solutions

Agilent's 8157xA variable optical attenuators are a family of plug-in modules for Agilent's lightwave solution platform 8163A/B, 8164A/B and 8166A/B. The attenuator modules 81570A, 81571A and 81578A occupy one slot, while modules 81576A and 81577A occupy two slots. With 17 slots, the Agilent 8166A/B lightwave multichannel system can host up to 17 single slot modules or up to 8 dual slot modules.

## Variable optical attenuators

The Agilent 81570A, 81571A and 81578A are small, cost effective attenuator modules with high resolution. They feature excellent wavelength flatness and can handle high input power levels. Various calibration features allow the user to set a reference power. Both the attenuation and the power level, relative to the reference power, can then be set and displayed in the user interface. An integrated shutter, which can be used for protection purposes, or to simulate channel drops, is available.

## Attenuators for high optical input power

The Agilent modules feature excellent wavelength flatness and can handle high input power levels of 2 mW. Combined with their low insertion loss, they are ideal for optical amplifier tests, such as characterization of EDFAs and of Raman amplifiers, as well as for other multi-wavelength applications, such as DWDM transmission system test.

## Attenuators with power control

Agilent's 81576A and 81577A attenuators feature power control functionality that allows you to set the output power level of the attenuator. The attenuator module firmware uses the feedback signal from a photo diode after a monitor tap, both integrated in the module, to set the desired power level at the output of the module. When the power control mode is enabled, the module automatically corrects power changes at the input to maintain the output level set by the user. After an initial calibration for the uncertainties at connector interfaces, absolute power levels can be set with high accuracy. The absolute accuracy of these power levels depends on the accuracy of the reference power meter used for calibration.

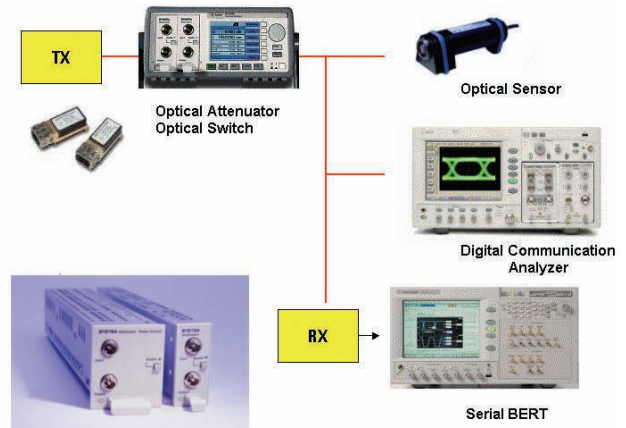

Transceiver and Receiver Test

## Wavelength flatness

The Agilent optical attenuator modules feature excellent wavelength flatness and can handle high input power levels. Combined with their low insertion loss, they are ideal for optical amplifier tests, such as characterization of EDFAs and of Raman amplifiers, as well as for other multi-wavelength applications, such as DWDM transmission system test. One unique feature is a Plug&Play software function which enhances calibration capacity by setting the integral power of a DWDM signal with a known spectrum.

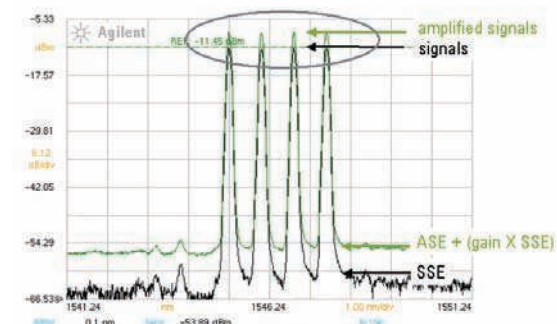

Wavelength flatness preserves multichannel signal flatness for EDFA test.

## Modal fidelity for multimode fiber systems

Signals in multimode fibers are distributed over a range of mode groups that can have different loss and delay in a link. For dependable multimode transceiver testing, the instrument used to set the power level should not change this modal distribution. The bulk-optic filter and collimated beam path of Agilent multimode attenuators are the best way to assure homogeneous attenuation of all input modes.

# Agilent 8157xA High-Power Optical Attenuators

www.agilent.com/find/oct

	8157xA		81578A-050	81578A-062
Connectivity	Straight (81570A) / Angled (81571A) Flexible connector interface		Straight (81576A) / Angled (81577A) Flexible connector interface	
Fibre type	9/125 µm SMF28		50/125 µm MMF	62.5/125 µm MMF
Wavelength range	1200 to 1700 nm		1250 to 1650 nm	700 to 1400 nm
Attenuation range	0 to 60 dB		0 to 60 dB	
Resolution	0.001 dB		0.001 dB	
		Attenuation setting	Power setting	
Repeatability <sup>[1]</sup>	± 0.01 dB	± 0.01 dB	± 0.015 dB <sup>[2]</sup>	± 0.015 dB <sup>[13, 15]</sup>
Accuracy (uncertainty) <sup>[1,3]</sup>	± 0.1 dB <sup>[4,5]</sup>	± 0.1 dB <sup>[4, 5]</sup>	N/A	Typ. ± 0.15 dB (800 to 1350 nm) ± 0.2 dB (at 850 nm ± 15 nm, 1310 nm ± 15 nm) <sup>[13, 14]</sup>
Settling time (typ.) <sup>[23]</sup>	Typ. 100 ms	100 ms	300 ms	Typ. 100 ms
Transition speed (typ.)	0.1 to 12 dB/s		Typ. 0.1 to 12 dB/s	
Relative power meter uncertainty <sup>[16,17]</sup>	N/A	± 0.03 dB ± 200 pW <sup>[16]</sup>		
Attenuation flatness <sup>[1,5,7,9]</sup>	< ± 0.07 dB (typ.) ± 0.05 dB for 1520 to 1620 nm typ. ± 0.10 dB for 1420 to 1640 nm		N/A	
Spectral ripple (typ.) <sup>[8]</sup>	± 0.003 dB		N/A	
Insertion loss <sup>[3,5]</sup>	Typ. 0.7 dB excluding connectors < 1.6 dB (typ. 1.0 dB) including connectors <sup>[10, 13]</sup>	Typ. 0.9 dB (excluding connectors) < 1.8 dB (typ. 1.2 dB) connectors including <sup>[10,12]</sup>	Typ. 1.0 dB (NA = 0.1) Typ. 1.3 dB (NA = 0.2) 2.0 dB (NA = 0.2) <sup>[13, 15]</sup>	Typ. 1.0 dB (NA = 0.1) Typ. 1.3 dB (NA = 0.2) 2.0 dB (NA = 0.2) <sup>[13, 15]</sup> Typ. 3.0 dB (NA = 0.27)
Insertion-loss flatness (typ.) <sup>[1,12,5]</sup>	± 0.1 dB for 1420 to 1615nm		N/A	
Polarization-dependent loss <sup>[3,10,12]</sup>	< 0.08 dBpp (Typ. 0.03 dBpp)	< 0.10 dBpp (typ. 0.05 dBpp)		N/A
Return loss (typ.)	45 dB (81570A) / 57 dB (81571A) <sup>[10,12]</sup>	45 dB (81576A) / 57 dB (81577A) <sup>[10,12]</sup>		Typ. 27 dB <sup>[13, 15]</sup>
Maximum input power <sup>[14]</sup>	+33 dBm		+27 dBm	
Shutter isolation (typ.)	100 dB		Typ. 100 dB	
Dimensions (H x W x D)	75 mm x 32 mm x 335 mm (2.8" x 1.3" x 13.2")	75 mm x 64 mm x 335 mm (2.8" x 2.6" x 13.2")		75 mm x 32 mm x 335 mm (2.8" x 1.3" x 13.2")
Weight	0.9 kg		1.3 kg	0.9 kg
Recommended recalibration period			2 years	
Operating temperature			10 to 45 °C	
Humidity			Non-condensing	
Warm-up time			30 minutes	

[1] At constant temperature.

[2] Output power > -40 dBm, input power < +27 dBm. For input power > +27 dBm add typ. ± 0.01 dB.

[3] Temperature within 23 ± 5 °C.

[4] Input power < +30 dBm; 1550 nm ± 15 nm; typ. for 1250 nm < λ < 1650 nm.

[5] For unpolarized light

[6] Stepsize < 1 dB; for full range: typ. 6 s.

[7] Relative to reference at 0 dB attenuation.

[8] Linewidth of source ≥ 100 MHz.

[9] For λdisp set to 1550 nm and attenuation ≤ 20 dB; for higher attenuation add 0.01 dB per additional dB for 1520 to 1620 nm and 0.02 dB/dB for 1450 to 1640 nm.

[10] For 1550 nm ± 15 nm.

[11] Add typ. 0.1 dB for 1310 nm ± 15 nm.

[12] Measured with Agilent reference connectors.

[13] Effective spectral source bandwidth > 5 nm

[14] For input mode conditions NA = 0.2; for additional ΔNA = 0.01, add ± 0.01 dB typ.

[15] At 850 ± 15 nm or 1310 ± 15 nm

## Ordering information

For the most up-to-date information on Agilent optical attenuators, please contact your Agilent Technologies sales representative or visit our web site at: www.agilent.com/find/lightwave

## Connector interface

All modules require two connector interfaces, 81000xl series (physical contact).

# Agilent N775xA and N776xA Multi-Channel Optical Attenuators

www.agilent.com/find/voa

## N775xA and N776xA Optical attenuators

- 0.05 dB relative power setting accuracy
- Settling time: 20 ms attenuation, 100 ms power, 200 ms multimode
- Miniature bulk optics for best multimode transfer distribution
- 0.1 to 1000 dB/s or for multimode to 0.1 to 80 and 1000 dB/s attenuation transition speed (selectable)
- +23 dBm max. input power
- $\leq 1.2$  dB insertion loss
- 45 dB single-mode attenuation range (typ.)
- 35 dB multimode attenuation range
- -50 to +20 dBm power setting range
- Fully compatible with setups and programs developed using the Agilent 8157x modular attenuators
- Two instrument configurations can be stored and recalled

The Agilent N775xA and N776xA series compact multichannel attenuators and power meters are a new class of remote controlled fiber optic instruments for optical transceiver and network integration test. All attenuators include an internal power monitor for each channel to reduce the complexity of closed-loop setups like those needed for very accurate BER testing or eye mask analysis by allowing power to be set directly rather than needing to set an attenuation value. All attenuators feature both attenuation mode and power control mode: In attenuation mode, the calibrated value of attenuation in dB can be set. The rate of attenuation change during setting can be adjusted between 0.1 and 80 dB/s or set to 1000 for multimode and adjusted from 0.1 to 1000 dB/s for single mode. In power control mode, the instrument uses its integrated power monitor to set the desired power level at the output of the module. It automatically corrects for input power changes so that the output power level is maintained. Absolute power levels can be set with high accuracy after an initial offset calibration.

## Modal fidelity for multimode fiber systems

Signals in multimode fibers are distributed over a range of mode groups that can have different loss and delay in a link. For dependable multimode transceiver testing, the instrument used to set the power level should not change this modal distribution. The bulk-optic filter and collimated beam path of Agilent multimode attenuators are the best way to assure homogeneous attenuation of all input modes.

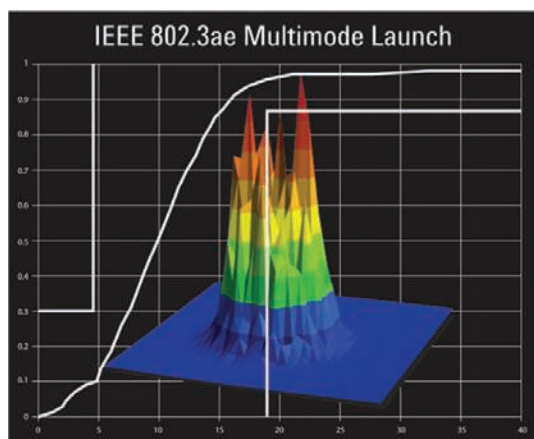

N776xA multi-channel optical attenuators with internal power control



1-channel variable attenuator N7761A



2-channel N7762A SMF attenuator or N7766A MMF attenuator



4-channel N7764A SMF attenuator or N7768A MMF attenuator

N775xA multi-channel optical attenuators with internal power control and external power meter channels.

The 2 integrated power meters in the N7751A and N7752A allow convenient measurement of optical power from different stages of the test setup and provide a very convenient and automatic way to calibrate the attenuator power reading to the power actually present at another point, such as the input to the receiver under sensitivity test. This calibration can thus correct for insertion loss due to switches and other components between the attenuator and the point of interest.



1-channel attenuator with two power meter channels N7751A



2-channel attenuator with two power meter channels N7752A

# Agilent N775xA and N776xA Multi-Channel Optical Attenuators

www.agilent.com/find/voa

N7751A, N7752A, N7761A, N7762A, N7764A			N7766A and N7768A	
Connectivity	FC/APC angled (Option -022) or FC/PC straight (Option -021) contact connector interface		FC/PC straight contact connector interface	
Fiber type	9/125 $\mu$ m SMF 28		50 $\mu$ m (Option 050) or 62.5 $\mu$ m (Option 062) or 80 $\mu$ m (Opt. 080) core MMF	
Wavelength range	1260 to 1640 nm		800 to 1370 nm	
Attenuation range	0 to 40 dB (45 dB typ.)		0 to 35 dB	
	<b>Attenuation setting mode</b>	<b>Power setting mode</b>	<b>Attenuation setting mode</b>	<b>Power setting mode</b>
Range	0 to 40 dB	-50 to +20 dBm	0 to 35 dB	-35 to +20 dBm
Resolution	0.01 dB	0.01 dB	0.03 dB	0.03 dB
Repeatability*	Typ. $\pm$ 0.05 dB for attenuation 0 to 30 dB Typ. $\pm$ 0.10 dB for attenuation 30 to 40 dB	$\pm$ 0.025 dB	$\pm$ 0.05 dB	$\pm$ 0.05 dB
Accuracy (uncertainty)*	Typ. $\pm$ 0.10 dB for attenuation 0 to 10 dB Typ. $\pm$ 0.15 dB for attenuation 10 to 20 dB Typ. $\pm$ 0.40 dB for attenuation 20 to 40 dB		Typ. $\pm$ 0.40 dB	
Relative accuracy (uncertainty)*		$\pm$ 0.05 dB $\pm$ 300 pW		$\pm$ 0.1 dB $\pm$ 300 pW
Polarization dependent loss*	Typ. $\leq$ 0.15 dBpp for attenuation 0 to 10 dB Typ. $\leq$ 0.25 dBpp for attenuation 10 to 20 dB Typ. $\leq$ 0.5 dBpp for attenuation 20 to 40 dB	$\leq$ 0.15 dBpp		
Settling time*	Typ. 20 ms*	Typ. 100 ms*	Typ. 200 ms	Typ. 200 ms
Insertion loss*	Typ. $\leq$ 1.2 dB (excluding connectors) $\leq$ 2.2 dB (including connectors)*		Typ. $\leq$ 1.0 dB (excluding connectors) $\leq$ 2.0 dB (including connectors)*	
Attenuation transition speed	Selectable from 0.1 to 1000 dB/s		Selectable from 0.1 to 80 or at > 500	
Relative uncertainty of monitor power meter*	$\pm$ 0.05 $\pm$ 300 pW		$\pm$ 0.1 $\pm$ 300 pW	
Averaging time of monitor power meter*	2 ms to 1 s		2 ms to 1 s	
Return loss*	Typ. 45 dB		Typ. 25 dB	
Maximum safe input power*	+23 dBm		+23 dBm	
Optical path blocking	Typ. 45 dB		Typ. 60 dB	

## N7751A and N7752A

Sensor element	InGaAs
Wavelength range	1260 to 1640 nm
Specification wavelength range	(1310 $\pm$ 15) nm, (1490 $\pm$ 10) nm, (1550 $\pm$ 15) nm
Power range	-80 to +10 dBm
Maximum safe power	+16 dBm
Averaging time	2 ms to 1 s
Applicable fiber type	Standard SM and MM $\leq$ 62.5 $\mu$ m core size, NA $\leq$ 0.24
Uncertainty at reference conditions*	$\pm$ 2.5%
Total uncertainty*	$\pm$ 4.5%
Linearity* at (23 $\pm$ 5) $^{\circ}$ C	$\pm$ 0.02 dB
Linearity* over operating temperature	$\pm$ 0.04 dB
Polarization dependent responsivity (PDR)	Typ. $<$ $\pm$ 0.01 dB (1260 to 1580 nm)
Spectral ripple (due to interference)*	Typ. $<$ $\pm$ 0.01 dB
Drift (dark)*	$\pm$ 9 pW
Noise pp (dark) <sup>3</sup> , (1 s averaging time, 300 s observation time)	$<$ 7 pW*
Return loss*	Typ. $>$ 57 dB

\* For the most up-to-date information on Agilent optical attenuators, please contact your Agilent Technologies sales representative or visit our web site at: [www.agilent.com/find/lightwave](http://www.agilent.com/find/lightwave)

# Agilent 81595B, N7731A and N7734A Optical Switch

www.agilent.com/find/oct

- **Excellent repeatability, specified over 10,000 random cycles**
- **Low insertion loss and polarization dependence**
- **Single-mode or multimode**
- **Single 1x4, dual 1x4 and single 1x13**



## Switching reduces uncertainty from connections and eases test automation

These instruments and modules are used for automatic routing of optical signals for testing devices like transceivers, amplifiers, and passive components. Optical switches optimize the investment in automated test equipment by improving repeatability and throughput and supporting parallel measurements of multiport and multiple devices.

The low IL and PDL and high repeatability assure minimum impact of the switch on measurement accuracy.

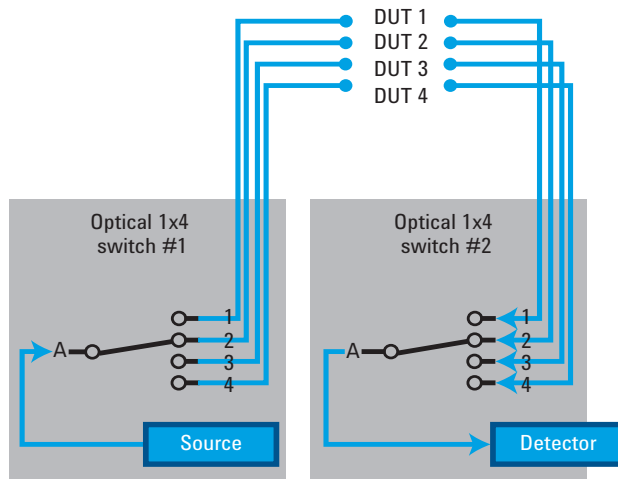

Switching can be performed from the button on the module, from the mainframe interface and via GPIB control. The compact form and high performance allow combining switches for multistage setups, like five 1x4 modules.

## Modal fidelity for multimode fiber systems

Signals in multimode fibers are distributed over a range of mode groups that can have different loss and delay in a link. For dependable multimode transceiver testing, the instrument used to set the power level should not change this modal distribution. The Agilent multimode switches are designed with very short collimated paths between fiber, so signals propagate in practically the same distribution as through uninterrupted multimode fiber.

## Modular optical switch specifications

81595B		
Switch type	1x4	
Fiber interface	# 009 single mode	# 062 multimode
Fiber type	9/125 $\mu$ m SMF	62.5/125 $\mu$ m MMF
Connectivity	FC/APC angled, narrow key	FC/PC straight
Wavelength range	1270 to 1670 nm	700 to 1400 nm
Repeatability <sup>2</sup>	$\pm$ 0.03 dB	$\pm$ 0.03 dB
Insertion loss	< 1.25 dB	< 1.0 dB
Polarization dependent loss	typ. 0.07 dB <sub>pp</sub>	N/A
Return loss	typ. 55 dB	typ. 20 dB
Crosstalk	typ. -70 dB	typ. -70 dB
Switching time	< 10 ms	
Lifetime	> 10 million cycles	
Maximum input power	+20 dBm	

N7731A		
Switch type	Dual 1x4	
Fiber interface	# 009 single mode	# 062 multimode
Fiber type	9/125 $\mu$ m SMF	62.5/125 $\mu$ m MMF
Connectivity	FC/APC angled, narrow key	FC/PC straight
Wavelength range	1250 to 1650 nm	600 to 1700 nm
Repeatability <sup>2</sup>	$\pm$ 0.01 dB, $\pm$ 0.004 dB typ.	$\pm$ 0.01 dB <sup>1</sup> , $\pm$ 0.004 dB typ.
Insertion loss	< 2.0 dB, < 1.5 dB typ.	< 1.0 dB <sup>1</sup> , < 0.5 dB typ.
Polarization dependent loss	Typ. 0.07 dB <sub>pp</sub>	NA
Return loss	Typ. 55 dB	Typ. 35 dB
Crosstalk	Typ. -65 dB	Typ. -65 dB <sup>4</sup>
Switching time	< 20 ms	
Lifetime	> 1 billion cycles	
Maximum input power	+23 dBm	

N7734A		
Switch type	1x13	
Fiber interface	# 009 single mode	# 062 multimode
Fiber type	9/125 $\mu$ m SMF	62.5/125 $\mu$ m MMF
Connectivity	FC/APC angled, narrow key	FC/PC straight
Wavelength range	1250 to 1650 nm	600 to 1700 nm
Repeatability <sup>2</sup>	$\pm$ 0.01 dB, $\pm$ 0.004 dB typ.	$\pm$ 0.01 dB <sup>1</sup> , $\pm$ 0.004 dB typ.
Insertion loss	< 2.5 dB, < 2.2 dB typ.	< 1.2 dB, < 0.7 dB typ.
Polarization dependent loss	Typ. 0.12 dB <sub>pp</sub>	NA
Return loss	Typ. 55 dB	Typ. 30 dB
Crosstalk	Typ. -60 dB	Typ. -55 dB
Switching time	< 20 ms	
Lifetime	> 1 billion cycles	
Maximum input power	+23 dBm	

Now 1x13 available

Test & measurement capabilities for analyzing polarization properties of optical signals are indispensable in today's optical R&D-labs and manufacturing floors. The Agilent N778x Polarization Analysis and Control series offers high speed instruments for high performance characterization and verification of optical components and sub-systems.

### Agilent N7781B Polarization analyzer



The Agilent N7781B is a compact high-speed polarization analyzer which provides comprehensive capabilities for analyzing polarization properties of optical signals. This includes representation of the State of Polarization (SOP) on the Poincaré Sphere (Stokes Parameter). The on-board algorithms together with the on-board calibration data ensure highly accurate operation across a broad wavelength range.

Due to its real time measurement capability (1 MSamples/s) the instrument is well suited for analyzing disturbed and fluctuating signals as well as for control applications requiring real time feedback of polarization information.

### Agilent N7782B PER analyzer



Agilent's N7782B series of PER analyzers has been designed for high speed and highly accurate testing of the polarization extinction ratio (PER) in PM fibers. The polarimetric measurement principle guarantees reliable measurements of PER values of up to 50 dB.

The real time measurement capability in combination with automation interfaces makes this unit ideally suited for integration in manufacturing systems, for example pig-tailing stations for laser diodes and planar waveguide components. Analog interfaces are provided for integration of the system in control loop applications.

### N7785B Synchronous scrambler



The N7785B Synchronous Scrambler provides fast SOP switching in response to internal or external triggering. This supports optical network simulations that often require switching of the signal SOP in a random way within a few microseconds, such as in recirculating loop tests. The SOP is switched rapidly, and then held for a predefined time until it again switches to a new SOP. The output SOP is controlled but not determined by the N7785B and will be changed if the input SOP changes. The output SOP can be adjusted to a desired external condition, such as maximizing the signal through a polarizer.

Application routines in the Polarization Navigator software can be used for random scrambling and continuous scrambling (where the state of polarization moves smoothly about the Poincaré sphere, similar to a flipper-style scrambler) over a wide range of speeds.

### N7784B Polarization controller



The N7784B Polarization Controller provides alignment and fast stabilization of SOP into polarization maintaining fiber (PMF) or with respect to an external condition by adding an analog feedback and polarizer path to the basic N7785B configuration.

For alignment into PMF, the input signal is first routed through the fast switching controller with single-mode fiber (SMF) and is available at an intermediate front panel output. An external jumper fiber is used to route the signal into the polarizer path consisting of a polarizing beam splitter with one output monitored by a photodetector. The other output is coupled to the front panel output with PMF. The signal from the photodetector is used to actively align and stabilize the input signal into the PMF output that could then be connected to a modulator or other polarization dependent device.

## Polarization Controllers and Analyzers

[www.agilent.com/find/pol](http://www.agilent.com/find/pol)

Similarly, the signal can be used directly from the intermediate output and a user-configured setup can provide the feedback for optimizing the desired SOP from the instrument.

### N7786B Polarization synthesizer



The N7786B Polarization Synthesizer includes internal SOP monitoring and feedback via a tap coupler to determinately set and hold any chosen states or sequences of polarization. This allows generation of sequences with chosen relative SOP orientation. This is often used for component analysis based on Mueller Matrix or Jones Matrix analysis. The uniquely fast switching supports the new single-sweep spectral PDL measurements with the N7700A software, which eliminates sensitivity to environmental stability and minimizes measurement time. Analysis of these results into transmission spectra of the primary device axes (like TE and TM) is also achieved in this way. The real-time monitoring and logging of output SOP permits accurate calculation including the wavelength dependence of the SOP.

### Agilent N7788B Optical component analyzer



Agilent Technologies pushes the limits of component measurements with the N7788B Component Analyzer. Its proprietary technology is comparable with the well-known Jones-Matrix-Eigenanalysis (JME) which is the standard method for measuring Polarization Mode Dispersion (PMD) or differential group delay (DGD) of optical devices.

Compared to the JME, Agilent's new single scan technology offers a range of advantages:

#### A complete set of parameters:

- DGD/PMD/PDL/2nd order PMD
- Power/Loss
- TE/TM-Loss
- Principal States of Polarization (PSPs)
- Jones and Mueller Matrices

For measuring these parameters, the N7788B is used together with an Agilent continuous-sweep tunable laser like the 81600B or 81960A, and control is provided with the Polarization Navigator package of the N7700A Photonic Application Suite.

The N7788B also provide the full polarization analysis functionality of the N7781B.

The image shows the cover of the 'Lightwave Catalog 2014 Volume II' by Agilent Technologies. The cover features a blue background with a white central area containing the title 'LIGHTWAVE CATALOG' and '2014 VOLUME II'. Below the title is a '3 YEAR WARRANTY' badge and a row of small images of various optical instruments. The Agilent logo and tagline 'Anticipate...Accelerate...Achieve' are at the bottom.

Find detailed product description, features and benefits in the

**Agilent**  
**Lightwave Catalog 2014 Volume II**  
Optical-Electrical/Polarization/Complex Modulation Analysis



## Agilent 86120B/C and 86122C Multi-Wavelength Meters

www.agilent.com/find/mwm

- **New, redesigned 86122C replaces 86122B to provide even greater lifetime, ongoing support and manufacturability**
- **Characterize WDM spectra during R&D and manufacturing**
- **Wavelength accuracy  $< \pm 0.3$  pm with 0.5 s update rate**
- **Simultaneously measure wavelengths and powers of up to 1000 channels**
- **Automatic optical signal-to-noise ratio measurements**
- **Automated measurement routines and data logging**

As the demand for access to more information increases, the need for greater capacity on transmission systems drives component manufacturers and network equipment manufacturers to push their capabilities to new limits. The use of tunable transmitters and ROADMs in networks makes accurate and fast measurements of wavelength more critical than ever. With Agilent multi-wavelength meters, you will be able to address these demands with confidence.



### The Performance You Need – When You Need It

The Agilent family of multi-wavelength meters is just that – a family. Each model uses compatible SCPI remote commands. You pay for only the performance you need, when you need it. If your requirements become more demanding in the future, you can substitute another Agilent multi-wavelength meter, avoiding unnecessary cost and time developing new code for your test system. With the 86122C, you can upgrade to a unit with the best performance available. Agilent multi-wavelength meters allow you to optimize test costs while protecting your investments.

### Simultaneously measure up to 1000 wavelengths and powers

The Agilent 86120B, 86120C and 86122C multi-wavelength meters, like other, Michelson interferometer-based wavelength meters, allow you to measure the average wavelength of the input signal. In addition, the Agilent multi-wavelength meters – with advanced digital processing – accurately and easily differentiate and measure up to 1000 (200 and 100 for the 86120C and 86120B, respectively) discrete wavelengths.

Agilent multi-wavelength meters simultaneously measure the individual powers of discrete wavelengths, offering the following measurement capabilities:

- 1 to 1000 wavelengths and powers
- Average wavelength and total power
- Up to  $\pm 0.2$  ppm wavelength accuracy
- Up to 5 GHz wavelength resolution

- Calibrated for evaluation in air or vacuum
- Wavelength units in nm, THz, or wave number ( $\text{cm}^{-1}$ )
- Amplitude units in dBm, mW, or  $\mu\text{W}$
- OSNR and averaged OSNR for WDM SONET/SDH systems
- Rugged design to withstand strong shocks and vibrations

### WDM transmission systems

Combining measurement performance with reliability, the Agilent multi-wavelength meters allow easy and accurate verification of optical carrier performance in transmission systems by measuring wavelength, power and optical signal-to-noise ratios during design and manufacturing test. The 86122C multi-wavelength meter is optimized for measuring ultra-dense channel spacing with an absolute wavelength accuracy of up to  $\pm 0.2$  ppm ( $\pm 0.3$  pm referenced to 1550 nm). With a resolution of  $< 5$  GHz, it is an ideal solution for the design and manufacturing of next-generation optical networks. With a rugged and portable package, the 86120B and 86120C multi-wavelength meters are ideal for optical network commissioning and monitoring applications. With the 86120C resolution of  $< 10$  GHz ( $< 20$  GHz for the 86120B) and absolute wavelength accuracy of  $\pm 2$  ppm or  $\pm 3$  pm at 1550 nm ( $\pm 3$  ppm,  $\pm 5$  pm at 1550 nm for the 86120B), you can confidently verify system performance of DWDM systems with channels spaced at  $< 50$  GHz.

### Sources

The superior wavelength and amplitude measurement capabilities of the Agilent 86120B, 86120C and 86122C multi-wavelength meters enable maximum performance of your components. You can measure DFB, FP, iTLA or multiple DFB laser wavelengths and amplitudes during burn-in, environmental evaluation, mode mapping, final test and incoming inspection. Calculate center wavelengths of broader linewidth sources, such as LED's or Bragg-Gratings filtered ASE responses, or modulated sources, using the user-selectable broadband algorithm.

### Features and advanced measurement applications:

- Relative Wavelength and Amplitude Measurements
- Built-in Data Logging
- Drift: Current and Min/Max values
- Optical Signal-To-Noise Ratio
- Fabry-Perot Laser Characterization (available on 86120C and 86122C)
- Coherence length (available on 86120B only)
- Broadband signal mode for high-rate modulated signals.

### Instrument drivers

Instrument drivers compatible with LabView, Visual Basic, C++, and LabWindows are available for the Agilent 86120B, 86120C, and 86122C multi-wavelength meters. These drivers enable remote program development by offering building blocks that allow you to customize your measurements. The new 86122C is equipped with two front-side USB ports. A driver update ensures maximum backward compatibility to the 86122A and 86122B.

# Agilent 86120B/C and 86122C Multi-Wavelength Meters

www.agilent.com/find/mwm

## Specifications

Specifications describe the instrument's warranted performance and apply after the instrument's temperature has been stabilized for 15 minutes (86120B, 86120C in Normal Update mode), unless otherwise noted. Each laser line is assumed to have a linewidth (including modulation sidebands) of less than: 10 GHz for the 86120B, 5 GHz for the 86120C, 2.5 GHz for the 86122C. Supplementary performance characteristics provide information about non-warranted instrument performance in the form of nominal values, and are printed in italic typeface.

		86120B	86120C	86122C
<b>Maximum number of laser lines input</b>		100	200	1000
<b>Wavelength</b>	Range	700 to 1650 nm (182 to 428 THz)	1270 to 1650 nm (182 to 236 THz)	1270 to 1650 nm (182 to 236 THz)
	Absolute accuracy	± 3 ppm (± 0.005 nm at 1550 nm, ± 0.004 nm at 1310 nm) for laser lines separated by ≥ 30 GHz	± 2 ppm (± 0.003 nm at 1550 nm and 1310 nm) for laser lines separated by ≥ 15 GHz	± 0.2 ppm (± 0.3 pm at 1550 nm and 1310 nm); for laser lines separated by ≥ 10 GHz
<i>Differential accuracy minimum resolvable separation (equal power lines input)</i>		± 2 ppm 20 GHz (0.16 nm at 1550 nm, 0.11 nm at 1300 nm)	± 1 ppm 10 GHz (0.08 nm at 1550 nm, 0.06 nm at 1300 nm)	± 0.15 ppm 5 GHz (0.04 nm at 1550 nm; 0.03 nm at 1310 nm)
Display resolution		0.001 nm, normal update mode; 0.01 nm, fast update mode	0.001 nm, normal update mode; 0.01 nm, fast update mode	0.0001 nm
Units		nm (vacuum or standard air), cm <sup>-1</sup> , THz	nm (vacuum or standard air), cm <sup>-1</sup> , THz	nm (vacuum or standard air), cm <sup>-1</sup> , THz
<b>Power</b>	Calibration accuracy	± 0.5 dB (at ± 30 nm from 780, 1310, and 1550 nm)	± 0.5 dB (at ± 30 nm from 1310 and 1550 nm)	± 0.5 dB (at ± 30 nm from 1310 and 1550 nm)
	<i>Flatness, 30 nm from any wavelength</i>	± 0.2 dB, 1200 to 1600 nm ± 0.5 dB, 700 to 1650 nm	± 0.2 dB, 1270 to 1600 nm ± 0.5 dB, 1270 to 1650 nm	± 0.2 dB, 1270 to 1600 nm ± 0.5 dB, 1270 to 1650 nm
Linearity, lines above -30 dBm		± 0.3 dB, 1200 to 1600 nm	± 0.3 dB, 1270 to 1600 nm	± 0.3 dB, 1270 to 1600 nm
Polarization dependence		± 0.5 dB, 1200 to 1600 nm ± 1.0 dB, 700 to 1650 nm	± 0.5 dB, 1270 to 1600 nm ± 1.0 dB, 1600 to 1650 nm	± 0.5 dB, 1270 to 1600 nm ± 1.0 dB, 1600 to 1650 nm
Units		dBm, mW, μW	dBm, mW, μW	dBm, mW, μW
<b>Sensitivity</b>	Single line input	-20 dBm, 700 to 900 nm -25 dBm, 800 to 1200 nm -40 dBm, 1200 to 1600 nm -30 dBm, 1600 to 1650 nm	-40 dBm, 1270 to 1600 nm -30 dBm, 1600 to 1650 nm	-32 dBm, 1270 to 1600 nm -22 dBm, 1600 to 1650 nm
	<i>Multiple lines input</i>	30 dB below total input power, but not less than single line		
<b>Selectivity</b>		25 dB spacing ≥ 100 GHz 10 dB spacing ≥ 30 GHz	25 dB spacing ≥ 50 GHz 10 dB spacing ≥ 15 GHz	25 dB spacing ≥ 90 GHz 10 dB spacing ≥ 10 GHz
	<b>Measurement cycle time</b>	1.0 s	1.0 s	0.5 s
<b>Input power</b>	Maximum displayed level	+10 dBm (sum of all lines input)		
	Maximum safe input level	+18 dBm (sum of all lines input)		
<b>Built-in automatic measurement applications</b>				
<i>Signal-to-noise ratio, 100 averages, at 1550 nm, 0.1 nm noise bandwidth, lines above -25 dBm</i>		> 35 dB, channel spacing ≥ 200 GHz	> 35 dB, channel spacing ≥ 100 GHz > 27 dB, channel spacing ≥ 50 GHz	> 35 dB, channel spacing ≥ 100 GHz > 27 dB, channel spacing ≥ 50 GHz
Drift		Maximum, Minimum, total drift (max-min) wavelengths and powers over time		
<i>Fabry-Perot characterization</i>		N/A N/A	<i>Mean wavelength, peak wavelength, mode spacing full-width half maximum, peak amplitude, total power, sigma</i>	
<i>Coherence length</i>		<i>Fabry-Perot lasers</i> 1 mm to 200 mm coherence length Accuracy to within ± 5%, 0.75 cycle time	n/a	n/a
<b>Reliability</b>	Warranty	3 years standard warranty	3 years standard warranty	5 years standard warranty
	Recommended re-calibration period	2 years	2 years	2 years
<b>Laser classification</b>		FDA Laser Class I according to 21 CFR 1040.10; IEC Laser Class 1 according to IEC 60825-1/2007		
<b>Dimensions HxWxD</b>		140 mm x 340 mm x 465 mm (5.5 in x 13.4 in x 18.3 in)		138 mm x 425 mm x 520 mm (5.4 in x 16.7 in x 20.5 in)
<b>Weight</b>		9 kg (19 lb)		14.5 kg (32 lb)

<sup>1</sup> For lines separated by less than the specified amount, wavelength accuracy is reduced.

## Threaded head adapter

(Threaded adapter for 8152x Optical Heads, 8162x Optical Heads with 81624DD and 81628B Optical Heads)



81000FA	81000KA	81000PA	81000VA	81003LA
FC/PC	SC	E-2000	ST	LC/F3000
FC/APC				

## Optical head adapter

These adapters are to be used with Agilent optical heads only. The connector adapters are needed to attach connectorized fibers.

Optical head adapters – with integral D-shape attachment for 8162xx optical head (except 81628B – see threaded version)



81001FA	81001KA	81001PA	81001LA	81001MA
FC/PC	SC	E-2000	LC/F3000	MU

## 81003TD - MPO/MTP connector adapter

Optical head adapter with integral D-shape attachment for 8162xx optical head (except 81628B) for connection of ribbon cables with MT/MPO connectors. The adapter has connector guide pins and should be used with female cable connectors.



## 81001ZA - Blank adapter

Plug-in D-shape adapter for 8162x Optical Heads To be customized by customer.

Doesn't match to 8152x and High Power Optical Heads



## 81624DD - D-shape adapter

To connect threaded adapters to 8162x D-shape receptable. Included with new heads except 81628B. Remove for using head with D-shaped adapters.

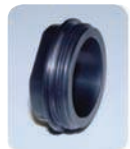

## Bare fiber adapters and interfaces

The Agilent Bare Fiber Connectivity Solutions enable the easy and repeatable adaptation of optical components to Agilent's standard optical heads (all 8152x and 8162x series) and sensor modules 81630B, 81634B.



### 81000BC

Bare fiber connectivity set for 81623B, 81624B and 81626B (1 x head adapter, 1 x 0-400 um holder, 1 x 400-900 um holder, 1 x gauge)

### 81000BI

Bare fiber connectivity Set for 81630B and 81634B (1 x sensor adapter, 1 x 0-400 um holder, 1 x 400-900 um holder, 1 x gauge)

### 81000BT

Bare FC set for 8152x and 8162x optical heads and threaded interface

### 81004BH

Bare fiber holder Set (10 x 0-400 um holder)

### 81009BH

Bare fiber holder Set (10 x 400-900 um holder)

### 81004BM / 9BM

Bare fiber holder Set (4 x 0-400 um or 0-900 um holder)

## N7740KI - SC

4-port SC connector for the multiport power meter series N7744A and N7745A.



## N7740FI - FC

4-port FC connector for the multiport power meter series N7744A and N7745A.



## N7740BI - Bare fiber adapter

Fiber holders not included; please add 81004BM or 81009BM



## N7740ZI - Zeroing adapter



## N7740LI - LC

4-port LC connector for the multiport power meter series N7744A and N7745A.

## N7740MI - MU

4-port MU connector for the multiport power meter series N7744A and N7745A.

### 81000HI - E-2000 Connector interface

For **physical** contact connections

Recommended for angled and straight connector interfaces. Use with sources. Not for sensors.

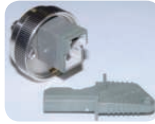

### 81000PI - E-2000 Connector interface

For **non-physical** contact connections

Recommended for angled and straight connector interfaces. Use with sensors.

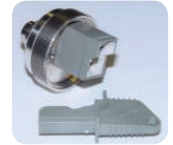

### 81000LI - LC/F3000 Connector interface

For **physical** contact connections

Recommended for angled and straight connector interfaces. Use with sources.



### 81002LI - LC/F3000 Connector interface

For **non-physical** contact connections

Recommended for angled and straight connector interfaces. Use with sensors.



### 81000FI - FC/PC Connector interface

N-keying (key slot = 2.20 mm nominal)

For physical and non-physical contact connections

Recommended for angled and straight connector interfaces



### 81000NI - FC/APC Connector interface

R-keying (key slot = 2.00 mm nominal)

For physical and non-physical contact connections

Recommended for angled and straight connector interfaces



### 81000MI - MU Connector interface

For **physical** contact connections

Recommended for angled and straight connector interfaces. Use with sources.



### 81002MI - MU Connector interface

For **non-physical** contact connections

Recommended for angled and straight connector interfaces. Use with sensors.

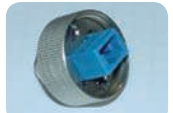

### 81000KI - SC Connector interface

For physical and non-physical contact connections

Recommended for angled and straight connector interfaces

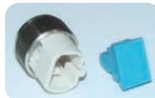

### 81000VI - ST Connector interface

For physical and non-physical contact connections

Recommended for angled and straight connector interfaces



### 81000SI - DIN 4108/47256 Connector interface

For physical and non-physical contact connections

Recommended for angled and straight connector interfaces



### 81000BR - HMS-10 Reference reflector

- Return loss = 0.18 dB ± 0.1 dB (96% ± 2%) typ.
- Wavelength range: 1200 to 1600 nm

A gold-plated HMS-10 connector for use in measuring return loss of optical connectors. It allows you to establish a precise reference for reflection measurements. Return loss is 0.18 dB ± 0.1dB (96% ± 2%)



### 81000UM - Universal feedthrough adapter

To adapt 81000BR or HMS-10 connectors to any other appropriate connector. In combination with an Agilent 81000xI connector interface, this adapter allows you to mate an HMS-10 connector to another HMS-10, FC/PC/SPC, APC, DIN, ST, E-2000, or SC connector.

It can also be used to mate an Agilent 81000BR reference reflector to a connector under test. The Agilent 81000UM is a through adapter only. It can not be used at the fiber interfaces of the modules.



### 81000RI - High return loss interface

- Return loss = 36 dB typ.
- To adapt straight connectors to Power Sensor modules





## Optical Power Meter Selection Table

[www.agilent.com/find/oct](http://www.agilent.com/find/oct)

Power meter heads	81623B	81623B C01/C85	81623B E01	81624B	81624B C01	81626B	81626B C01	81628B
Sensor element	Ge, ø 5 mm	Ge, ø 5 mm	Si, ø 5mm	InGaAs, ø 5mm	InGaAs, ø 5mm	InGaAs, ø 5mm	InGaAs, ø 5mm	Sphere
Wavelength range [nm]	750 to 1800	750 to 1800	450 to 1020	800 to 1700	800 to 1700	850 to 1650	850 to 1650	800 to 1700
Power range [dBm]	-80 to +10	-80 to +10	-90 to +10	-90 to +10	-90 to +10	-70 to +27	-70 to +27	-60 to +40
Uncertainty at ref. cond.	±2.2%	±1.7% / ±2.2%	±2.2%	±2.2%	±1.5 %	±3.0 %	±2.5 %	±3.0 %
Rel. uncertainty due to polarization (typ.)	< ±0.005 dB	< ±0.005 dB	< ±0.005 dB	±0.002 dB	±0.002 dB	±0.002 dB	±0.002 dB	≤ ±0.006 dB
Rel. uncertainty spectral ripple (typ.)	< ±0.003 dB	< ±0.003 dB	< ±0.003 dB	≤ ±0.002 dB	≤ ±0.002 dB	≤ ±0.002 dB	≤ ±0.002 dB	≤ ±0.02 dB
Return loss (typ.)	> 55 dB	> 55 dB	> 56 dB	60 dB	60 dB	> 45 dB	> 47 dB	> 75 dB
Averaging time (minimal)	100 µs	100 µs	100 µs	100 µs	100 µs	100 µs	100 µs	100 µs
Analog output	Yes	Yes	Yes	Yes	Yes	Yes	Yes	Yes

Power meter modules	81630B	81634B	81635A	81636B	N7744A	N7745A	N7747A	N7748A
Sensor element	InGaAs	InGaAs	InGaAs	InGaAs	InGaAs	InGaAs	InGaAs	InGaAs
No. of channels	1	1	2	1	4	8	2	4
Core diameter	Up to 100 µm	Up to 100 µm	Up to 62.5 µm	Up to 62.5 µm	≤ 62.5 µm	≤ 62.5 µm	Up to 100 µm	Up to 100 µm
Wavelength range [nm]	970 to 1650	800 to 1700	800 to 1650	1250 to 1640	1250 to 1650	1250 to 1650	1250 to 1650	1250 to 1650
Power range [dBm]	-70 to +28	-110 to +10	-80 to +10	-80 to +10	-80 to +10	-80 to +10	-110 to +10	-10 to +10
Uncertainty at ref. cond.	± 3.0%	± 2.5%	± 3.5%	± 3.0%	± 2.5%	± 2.5%	± 2.5%	± 2.5%
Rel. uncertainty due to polarization (dB)	< ± 0.01	< ± 0.005	Typ. < ± 0.015	Typ. ± 0.015	Typ. < ± 0.01 dB	Typ. < ± 0.01 dB	< ± 0.005	< ± 0.005
Rel. uncertainty spectral ripple (dB)	< ± 0.005	< ± 0.005	Typ. < ± 0.015	Typ. ± 0.015	Typ. < ± 0.01 dB	Typ. < ± 0.01 dB	< ± 0.005	< ± 0.005
Memory/channel (samples)	20 k	20 k	20 k	100 k	2 x 1 M	2 x 1 M	2 x 1 M	2 x 1 M
Averaging time (minimal)	100 µs	100 µs	100 µs	25 µs	1 µs	1 µs	100 µs	100 µs
Analog output	Yes	Yes	No	Yes	No	No	Yes	Yes

# Product/Measurement Matrix

www.agilent.com/find/lightwave

Product vs. Measurement parameter		Tunable laser sources	DFB laser sources	Optical power meters	Return loss modules	High-power optical attenuators	Modular optical switches	Polarization controllers	Polarisation solutions	Multi-wavelength meters	Photonic dispersion & Loss analyzer	Lightwave component analyzer	Optical modulation analyzer	Oscilloscope	Reference transmitter & Receiver	Arbitrary waveform generator	Precision source/Measure unit (SMU)	J-BERT N4903B/ M8020A	Serial BERT 32 and 17 Gb/s	Multi-channel BERT 12.5 Gb/s	Serial BERT system 40 Gb/s	ParBERT	Manufacturing serial BERT	Serial BERT	Optical receiver stress test solution	Infiniium DCA-J oscilloscope	Pulse pattern noise generators		
		Volume I										Volume II																	
		12	17	19	25	26	30	31	31	33	21	23	27	33	34	36	38	14	16	20	21	27	28	29	30	31	38		
Basic optical component test	Insertion loss	✓	✓	✓					✓		✓																✓		
	Return loss				✓						✓																		
	Spectral IL	✓		✓					✓		✓																		
	Wavelength									✓			✓																
	EDFA test	✓	✓	✓	✓	✓	✓	✓	✓																				
	Polarization state			✓							✓																		
	Chromatic dispersion										✓																		
	Polarization dependent loss	✓		✓					✓	✓		✓																	
	Polarization extinction ratio									✓																			
	Polarization mode dispersion								✓		✓																		
Coherent component test	Electro-optical S-parameter											✓	✓				✓												
	Gain imbalance/IQ offset											✓	✓				✓												
	Channel skew											✓	✓				✓												
	CMRR											✓	✓				✓												
	Quadrature error											✓	✓				✓												
Magnitude error/Phase error											✓	✓				✓													
Optical transceiver test	Modulation signal															✓				✓							✓		
	Pulse response													✓			✓	✓	✓	✓	✓	✓	✓	✓	✓	✓	✓	✓	
	Extinction ratio													✓	✓											✓	✓		
	Optical modulation amplitude													✓	✓											✓	✓		
	Vertical eye closure penalty														✓	✓										✓	✓		
	Transmitter dispersion penalty																	✓	✓							✓	✓		
	Eye-diagram/Mask													✓	✓			✓	✓							✓	✓		
	Jitter analysis													✓	✓			✓	✓							✓	✓		
	Jitter tolerance													✓	✓			✓	✓							✓	✓		
	Bit error ratio													✓	✓			✓	✓							✓	✓		
	Receiver sensitivity													✓	✓			✓	✓							✓	✓		
	Stressed receiver sensitivity													✓	✓			✓	✓							✓	✓		



### myAgilent

[www.agilent.com/find/myagilent](http://www.agilent.com/find/myagilent)

A personalized view into the information most relevant to you.



### [www.axiestandard.org](http://www.axiestandard.org)

AdvancedTCA® Extensions for Instrumentation and Test (AXIe) is an open standard that extends the AdvancedTCA for general purpose and semiconductor test. Agilent is a founding member of the AXIe consortium.



### [www.lxistandard.org](http://www.lxistandard.org)

LAN eXtensions for Instruments puts the power of Ethernet and the Web inside your test systems. Agilent is a founding member of the LXI consortium.



### Three-Year Warranty

[www.agilent.com/find/ThreeYearWarranty](http://www.agilent.com/find/ThreeYearWarranty)

Beyond product specification, changing the ownership experience. Agilent is the only test and measurement company that offers three-year warranty on all instruments, worldwide.



### Agilent Assurance Plans

[www.agilent.com/find/AssurancePlans](http://www.agilent.com/find/AssurancePlans)

Five years of protection and no budgetary surprises to ensure your instruments are operating to specifications and you can continually rely on accurate measurements.



### [www.agilent.com/quality](http://www.agilent.com/quality)

Agilent Electronic Measurement Group  
DEKRA Certified ISO 9001:2008  
Quality Management System

### Agilent Channel Partners

[www.agilent.com/find/channelpartners](http://www.agilent.com/find/channelpartners)

Get the best of both worlds: Agilent's measurement expertise and product breadth, combined with channel partner convenience.

## Related Literature:

### Lightwave Catalog Volume 2:

Optical-Electrical / Polarization /  
Complex Modulation 5989-6754EN

### Lightwave Catalog Volume 3:

Bit Error Ratio and Waveform Analysis  
5991-1802EN

[www.agilent.com](http://www.agilent.com)

[www.agilent.com/find/lightwave](http://www.agilent.com/find/lightwave)

For more information on Agilent Technologies' products, applications or services, please contact your local Agilent office. The complete list is available at:

[www.agilent.com/find/contactus](http://www.agilent.com/find/contactus)

## Americas

Canada	(877) 894 4414
Brazil	(11) 4197 3600
Mexico	01800 5064 800
United States	(800) 829 4444

## Asia Pacific

Australia	1 800 629 485
China	800 810 0189
Hong Kong	800 938 693
India	1 800 112 929
Japan	0120 (421) 345
Korea	080 769 0800
Malaysia	1 800 888 848
Singapore	1 800 375 8100
Taiwan	0800 047 866
Other AP Countries	(65) 375 8100

## Europe & Middle East

Belgium	32 (0) 2 404 93 40
Denmark	45 45 80 12 15
Finland	358 (0) 10 855 2100
France	0825 010 700*
	*0.125 €/minute
Germany	49 (0) 7031 464 6333
Ireland	1890 924 204
Israel	972-3-9288-504/544
Italy	39 02 92 60 8484
Netherlands	31 (0) 20 547 2111
Spain	34 (91) 631 3300
Sweden	0200-88 22 55
United Kingdom	44 (0) 118 927 6201

For other unlisted countries:

[www.agilent.com/find/contactus](http://www.agilent.com/find/contactus)

Product specifications and descriptions in this document subject to change without notice.

© Agilent Technologies, Inc. 2014  
Published in USA, March 24, 2014  
5989-6753EN



**Agilent Technologies**