

# Agilent M9392A PXI Vector Signal Analyzer

50 MHz to 26.5 GHz

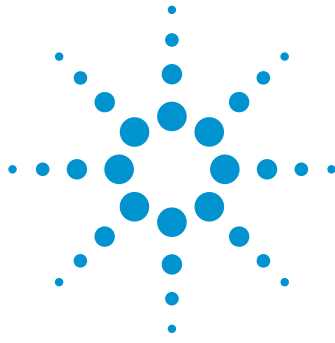

Data Sheet



*Challenge the Boundaries of Test  
Agilent Modular Products*

*Anticipate — Accelerate — Achieve*



**Agilent Technologies**

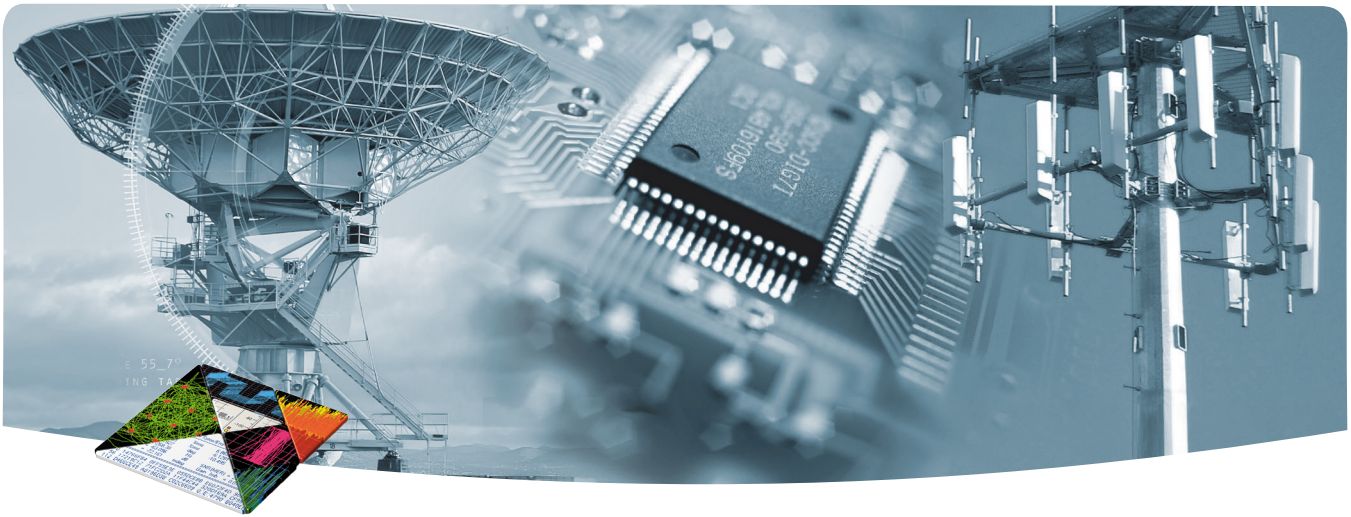

## OVERVIEW

### Introduction

Agilent's goal is to help you achieve the measurements you need today and enable new capabilities not previously available. The M9392A PXI Vector Signal Analyzer when combined with the M9018A PXIe 18-slot Chassis and 89600 VSA software, delivers a complete microwave vector signal analyzer solution enabling analysis of multichannel, communications, radar, and avionics signals from 50 MHz to 26.5 GHz with 250 MHz of instantaneous bandwidth.

### Product description

The Agilent M9392A<sup>1</sup> is a PXI Vector Signal Analyzer system with frequency coverage from 50 MHz to 26.5 GHz with up to 250 MHz of instantaneous bandwidth and up to 100 MHz streamed analog bandwidth. Achieve multichannel analysis capability by combining two PXI vector signal analyzers in one chassis.

The digital down-conversion (DDC) algorithm in the FPGA of the M9202A IF digitizer improves analog performance, such as spurious free dynamic range, signal-to-noise ratio and reduces data upload time. With the M9202A PXI Express backplane connection, the M9392A supports continuous data streaming to disk.

### Applications

- Aerospace and defense
- Wireless communications
- Radar and wideband signal capture

<sup>1</sup> The system consists of the M9202A PXIe IF Digitizer, M9302A PXI Local Oscillator, M9360A PXI Attenuator/Preselector, and the M9361A and M9351A PXI Downconverter modules.

### Features

- Frequency range: 50 MHz to 26.5 GHz
- Bandwidth: 250 MHz,  $\geq 2.75$  GHz
- Maximum streamed analog bandwidth:
  - 50 MHz
  - 100 MHz (optional)
- Real-time digital down conversion algorithm
- Multichannel analysis
- 12-bit, 2 GS/s digitizer
- DANL (bypass path)
  - 158 dBm/Hz,  $\leq 9.5$  GHz, (nominal)
  - 147 dBm/Hz,  $> 9.5$  GHz, (nominal)
- Chassis slot compatibility: cPCI (J1), PXI-1, PXIe Hybrid
- PXI form factor
- Size: 7 or 8 slots-wide multiple modules

### Customer values

- Real-time, wideband RF and microwave data streaming
- Complete vector signal analyzer solution with instantaneous bandwidth in a open-system standard
- Measure distortion products of a wide variety of signals
- Data decimation for analog performance and data upload time improvement
- Detect and identify sources of interference and measure 80+80 MHz 802.11ac devices
- High throughput of digitized data
- Multiple programmatic interfaces enable easy integration into existing test environments and reduced development time
- Included drivers, soft front panels and programming examples in Visual Studio (VB.NET, C#, C/C++), VEE, LabVIEW, LabWindows/CVI, MATLAB
- Conforms to Modular Open Systems Approach (MOSA)

# EASY SETUP ... TEST ... AND MAINTENANCE

## Hardware platform

### Compliance

The M9392A is PXI compliant, using either a cPCI(J1), PXI-1, or PXIe Hybrid slot. Designed to benefit from fast data interfaces, the products can be integrated with other test and automation modules in cPCI(J1), PXI-1, or PXIe Hybrid chassis slots. The PXI format offers high performance in a small, rugged package. It is an ideal deployment platform for many automated test systems. A wide array of complementary PXI products are currently available. Products include multimeters, waveform generators, local oscillators, digitizers, and switch multiplexers.

## Software platform

### IO libraries

Agilent IO Libraries Suite offers FAST and EASY connection to instruments and the newest version extends that capability to include modular instruments.

The Agilent IO Libraries Suite helps you display ALL of the modules in your system, whether they are PXI, PXIe, or PCIe. From here you can view information about the installed software or start the module's soft front panel. Launch the module's soft front panel directly from Agilent Connection Expert. Find the right driver from Agilent Connection Expert.

### Drivers

Agilent provides instrument drivers that work with your choice of software that saves time and preserves software and hardware investments. Agilent modular instruments come with IVI-COM, IVI-C, LabVIEW and MATLAB software drivers that work in the most popular T&M development environments including, Visual Studio (VB.NET, C#, C/C++), VEE, LabVIEW, LabWindows/CVI, and MATLAB.

With the multiple drivers included and minimum software adjustments, any Agilent PXI module can be swapped out, replaced, or upgraded with the latest PXI module.

## Easy software integration

Included are application code examples for Visual Studio (VB.NET, C#, C/C++), VEE, LabVIEW, LabWindows/CVI, and MATLAB, which provide set up and basic acquisition functionality. These application code examples are easily modified to quickly integrate the module into your measurement system.

## Software applications

Agilent soft front panels provide easy to use instrument communications. The graphical user interface guides developers through module setup. Users can quickly configure the instrument parameters. More sophisticated functions are available through the instrument's numerous programmatic interfaces. The modular products support interfaces for Visual Studio, MATLAB, and LabVIEW. The interfaces are implemented using the IVI standard supporting both IVI-COM and IVI-C.

The M9392A soft front panel monitors and controls the PXI Vector Signal Analyzer with the following functions:

- Setting input frequency, power, bandwidth and time span
- Setting trigger functions
- Displaying markers
- Formatting frequency and time displays
- Monitoring hardware status
- Streaming data to file

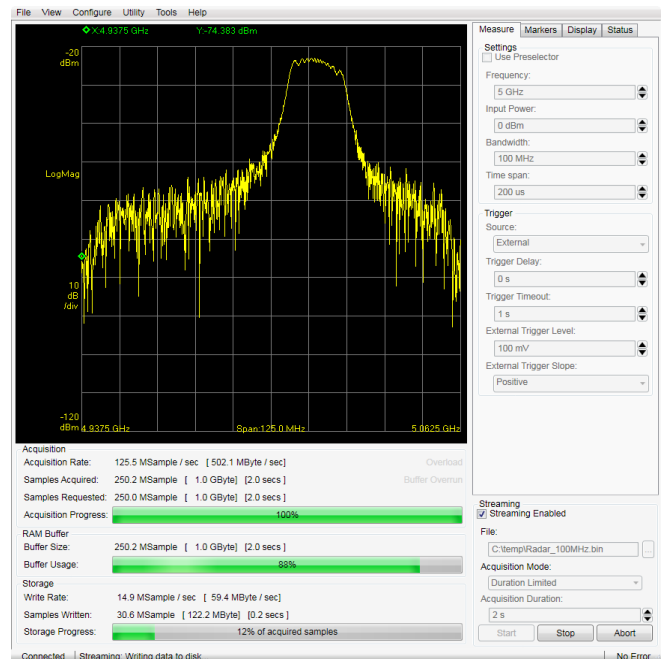

Figure 1. Agilent M9392A PXI Vector Signal Analyzer, display of the status menu with streaming enabled.

## Calibration intervals

The modular products are factory calibrated and shipped with an ISO-9002, NIST-traceable calibration certificate. A one year calibration cycle is recommended.

# TECHNICAL SPECIFICATIONS AND CHARACTERISTICS

## Definitions for specifications

**Specifications** describe the warranted performance of calibrated instruments that have been stored for a minimum of 2 hours within the operating temperature range of 0 to 50°C, unless otherwise stated, and after a 45 minute warm-up period. Data represented in this document are specifications unless otherwise noted.

**Characteristics** describe product performance that is useful in the application of the product, but that is not covered by the product warranty. Characteristics are often referred to as *Typical* or *Nominal* values. Characteristic are represented in italics.

- **Typical** describes characteristic performance, which 80% of instruments are expected to meet when operated over a 20 to 30 °C temperature range. Typical performance is not warranted.
- **Nominal** describes representative performance that is useful in the application of the product when operated over a 20 to 30 °C temperature range. Nominal performance is not warranted.

Note: All graphs contain measured data from several units at room temperature unless otherwise noted

Frequency and time specifications	
Description	Specifications and characteristics
<b>Maximum frequency</b>	26.5 GHz
<b>Minimum frequency</b>	
With downconverter M9361A	2.75 GHz (under range to 2.25 GHz) <sup>1</sup>
With downconverters M9351A and M9361A	50 MHz
<b>Frequency band</b>	<b>Harmonic mixing mode</b>
50 MHz to 2.9 GHz	1
2.25 GHz to 9.5 GHz	1
9.5 GHz to 26.5 GHz	3
<b>Direct receiver mode (with M9351A)</b>	
Bypasses downconverter chain and routes signal directly to digitizer	
Maximum frequency	625 MHz <sup>2</sup>
Minimum frequency	50 MHz
<b>Frequency reference</b>	
Internal frequency reference	
Ref out frequency	<i>10 MHz, (nominal)</i>
Amplitude	<i>0 dBm ± 3 dB, (nominal)</i>
Aging (after 30 days of operation)	± 1.0 ppm/year
Frequency temperature stability	± 0.5 ppm
External frequency reference input	
Ref In lock frequency range	10 MHz ± 3 ppm
Ref In level range	0 ± 4 dBm
<b>Frequency span</b>	
Minimum	1 kHz <sup>3</sup>
Maximum	
Frequency band (50 MHz to 2.9 GHz)	40 MHz
Frequency band (2.25 GHz to 26.5 GHz)	250 MHz (bypass YTF path)
Frequency band (2.75 GHz to 26.5 GHz)	40 MHz (YTF enabled )

1. All specifications and characteristics, using bypass path, apply to the under range frequencies 2.25 GHz to 2.75 GHz except as noted.

2. 400 MHz bandwidth maximum with 350 MHz center frequency.

3. Approximates minimum bandwidth derived from using all available DDC stages.

# TECHNICAL SPECIFICATIONS AND CHARACTERISTICS

Frequency and time specifications	
Description	Specifications and characteristics
<b>Sweep time and triggering</b>	
Internal storage	512 MB
Sweep (trace) point range	3 to 128E6 complex pairs
Time span range setting (sample rate dependent)	10 ns to 10 s
Sweep trigger modes	Free run External trigger <sup>1,2</sup> Video trigger <sup>2</sup>
<b>Analysis bandwidth</b>	
<i>(Analysis bandwidth is the instantaneous bandwidth available around a center frequency over which the input signal can be digitized for further analysis or processing in the time, frequency, or modulation domain)</i>	
Maximum	
Frequency band (50 MHz to 2.9 GHz)	40 MHz
Frequency band (2.25 GHz to 26.5 GHz)	250 MHz (bypass YTF path)
Frequency band (2.75 GHz to 26.5 GHz)	40 MHz (YTF enabled )
<b>Streamed analog bandwidth <sup>3</sup></b>	
Maximum	
Frequency band (50 MHz to 2.9 GHz)	40 MHz
Frequency band (2.25 GHz to 26.5 GHz)	50 MHz, 100 MHz (optional) (bypass YTF path)
Frequency band (2.75 GHz to 26.5 GHz)	40 MHz (YTF enabled)
Minimum	
All frequency bands	1.5 kHz
<b>Measurement speed</b>	
Center frequency tune and transfer (bypass path, tune < 100 MHz, no band crossing)	8 ms, (nominal)
Measurement accuracy	
Description	Characteristic performance (nominal)
<b>Residual EVM</b>	< -40 dB at 80 MHz BW, 5.8 GHz, 256 QAM (nominal)

1. Range -1 to +1 V

2. With trigger delay

3. Controller must be able to consume data at a rate  $\geq 500$  MB/s

# TECHNICAL SPECIFICATIONS AND CHARACTERISTICS

Amplitude accuracy and range specifications	
Description	Specifications and characteristics
<b>Amplitude range</b>	
Measurement range	<i>Displayed average noise level (DANL) to +30 dBm (maximum safe input level)</i>
Input Attenuator Range	0 to 70 dB in 10 dB steps
<b>Maximum safe input level</b>	
Average total power (at RF IN port )	+30 dBm (1W)
<b>Frequency response</b> (see figure 2)	

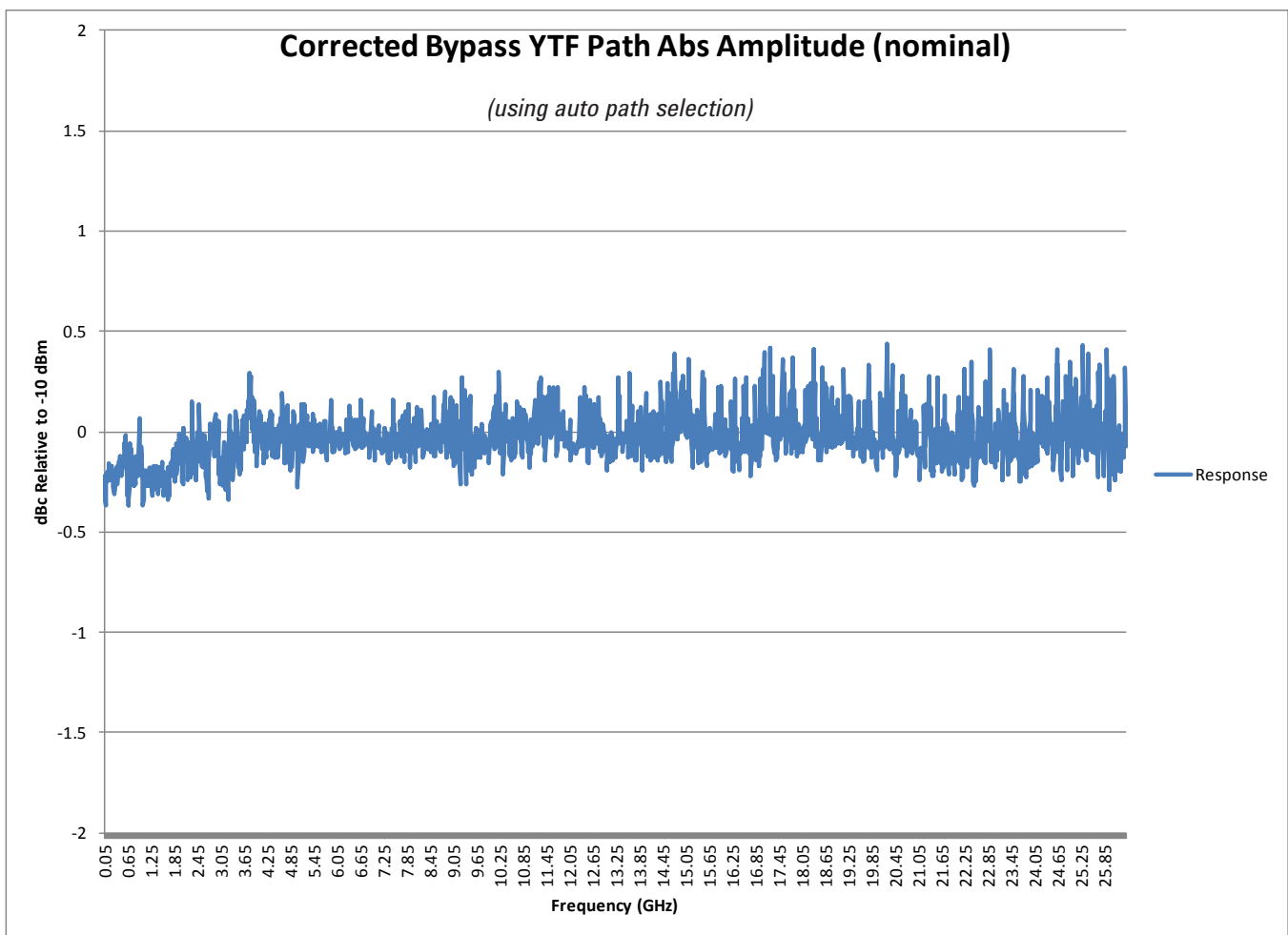

Figure 2. Frequency response graph after performing field calibration

# TECHNICAL SPECIFICATIONS AND CHARACTERISTICS

Amplitude accuracy and range specifications	
Description	Characteristic performance (nominal)
<b>Absolute amplitude accuracy at -10 dBm (bypass YTF path)</b>	
Corrected <sup>1</sup>	
50 MHz to 2.75 GHz	$\pm 0.6 \text{ dB}$
2.25 GHz to 2.75 GHz (BW >40 MHz)	$\pm 0.5 \text{ dB}$
> 2.75 GHz to 26.5 GHz	$\pm 0.5 \text{ dB}$
Uncorrected <sup>2</sup>	
50 MHz to 26.5 GHz	$\pm 2 \text{ dB}^5$
2.25 GHz to 2.75 GHz (BW >40 MHz)	$\pm 2.5 \text{ dB}$
<b>Absolute amplitude accuracy at -10 dBm (YTF path)</b>	
Corrected <sup>1</sup>	
2.75 GHz to 26.5 GHz	$\pm 0.75 \text{ dB}$
Uncorrected <sup>2</sup>	
2.75 GHz to 26.5 GHz	$\pm 2 \text{ dB}$
<b>Displayed average noise level (DANL)</b>	
Bypass YTF path	
50 MHz to 9.5 GHz	-158 dBm/Hz
>9.5 GHz to 26.5 GHz	-147 dBm/Hz
YTF preselected path	
2.75 GHz to 9.5 GHz	-156 dBm/Hz
> 9.5 GHz to 26.5 GHz	-142 dBm/Hz
<b>Input voltage standing wave ratio (VSWR) (<math>\geq 10 \text{ dB}</math> input Attenuation)</b>	
50 MHz to 2.9 GHz	-18 dB
> 2.9 GHz to 26.5 GHz	-10 dB
<b>Residuals/images/ spurious responses</b>	
Residuals	$< -90 \text{ dBm}^3$
Input related spurious 50 MHz to 2.75 GHz <sup>4</sup>	$< 100 \text{ kHz offset from carrier: } -75 \text{ dBc}$ $< 10 \text{ MHz offset from carrier: } -48 \text{ dBc}$
Input related spurious 2.75 GHz to 26.5 GHz	$< 100 \text{ kHz offset from carrier: } -60 \text{ dBc}$ $< 10 \text{ MHz offset from carrier: } -64 \text{ dBc}$
IP3 (Two -40 dBm RF input tones, 1 MHz apart, referenced to RF IN on M9360A)	-10 dBm, min
<b>Phase noise (at 10 GHz, 10 kHz offset)</b>	-115 dBc/Hz, (nominal)

1. Field calibration performed and applied

2. Without field calibration

3. For frequency spans < 10 MHz and reference level (Rng) set to -15 dBm, in frequency range 50 MHz - 2.75 GHz.

For frequency spans < 50 MHz and reference level (Rng) set to -15 dBm in, frequency range 2.75 - 26.5 GHz.

4. Excluding LO feedthrough at 2.5 GHz

5. Using auto path selection

# TECHNICAL SPECIFICATIONS AND CHARACTERISTICS

## Amplitude accuracy and range characteristics

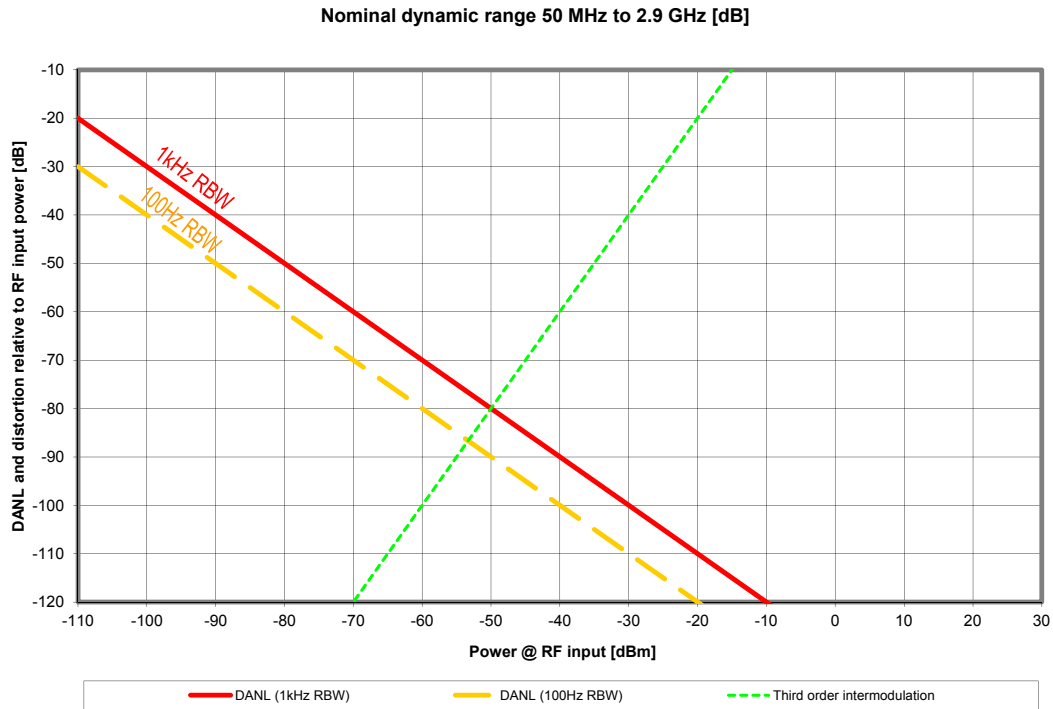

Phase Matrix, Inc.

COMPANY PROPRIETARY

5990-6050\_Figure\_3.xls 9/1/2011

Figure 3. Nominal Dynamic Range Plot 50 MHz to 2.9 GHz

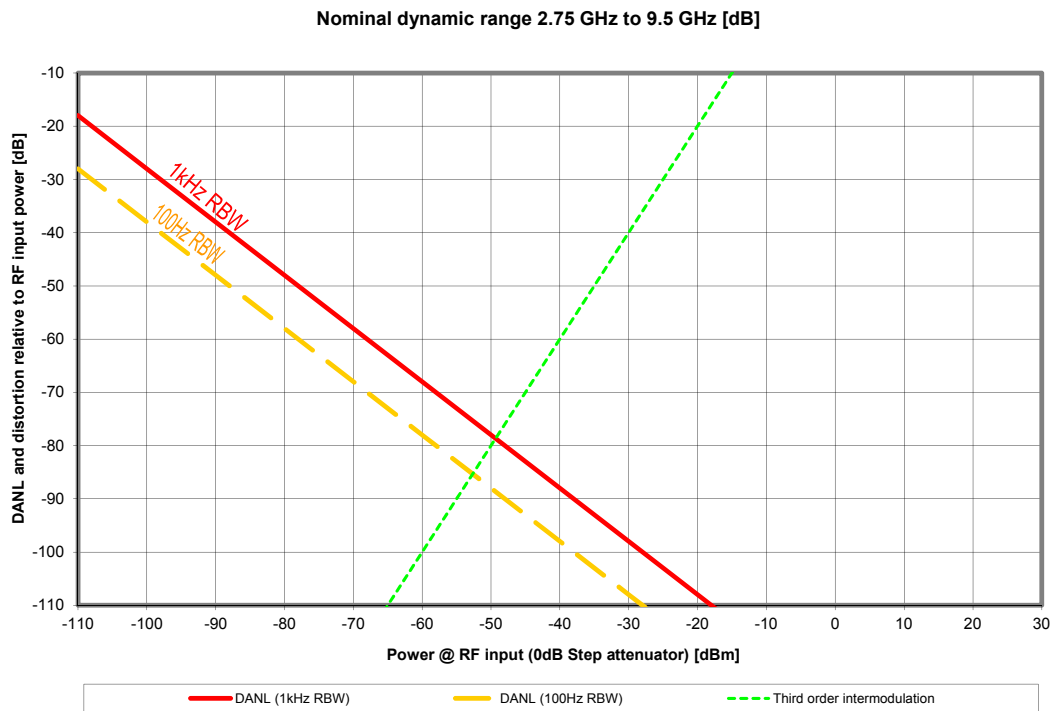

Phase Matrix, Inc.

COMPANY PROPRIETARY

5990-6050\_Figure\_4.xls 9/1/2011

Figure 4. Nominal Dynamic Range Plot 2.75 GHz to 9.5 GHz



# TECHNICAL SPECIFICATIONS AND CHARACTERISTICS

## Amplitude accuracy and range characteristics

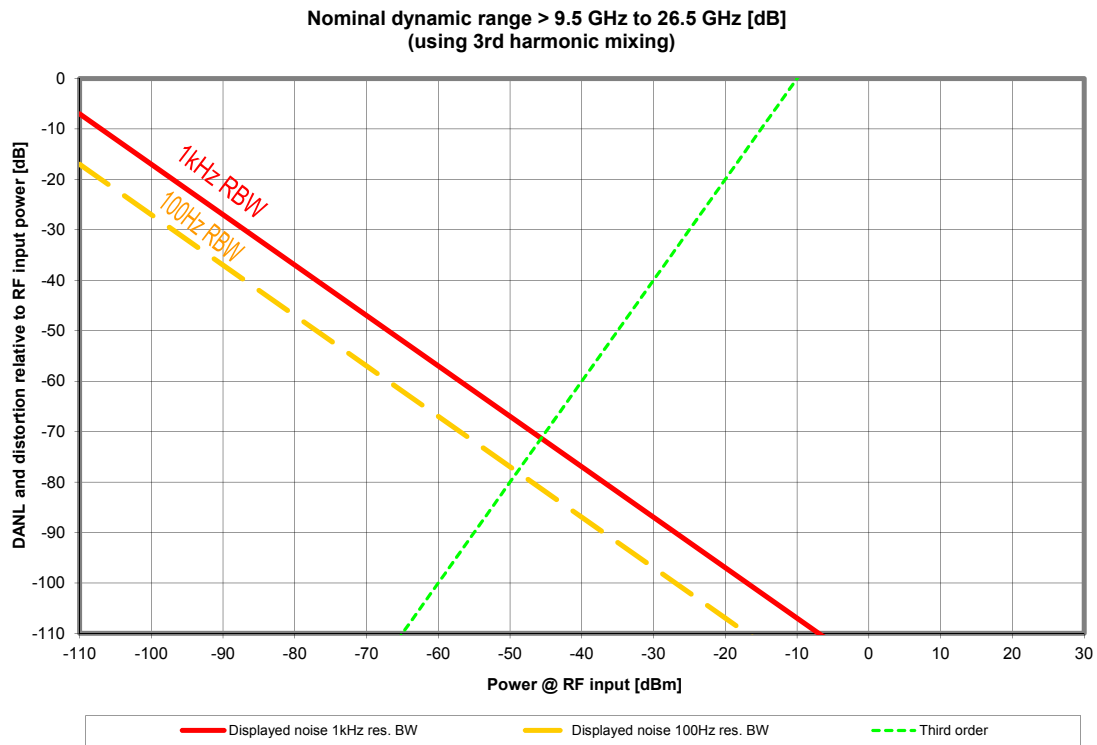

Phase Matrix, Inc.

COMPANY PROPRIETARY

5990-6050\_Figure\_5.xls 9/1/2011

Figure 5. Nominal Dynamic Range Plot > 9.5 GHz to 26.5 GHz

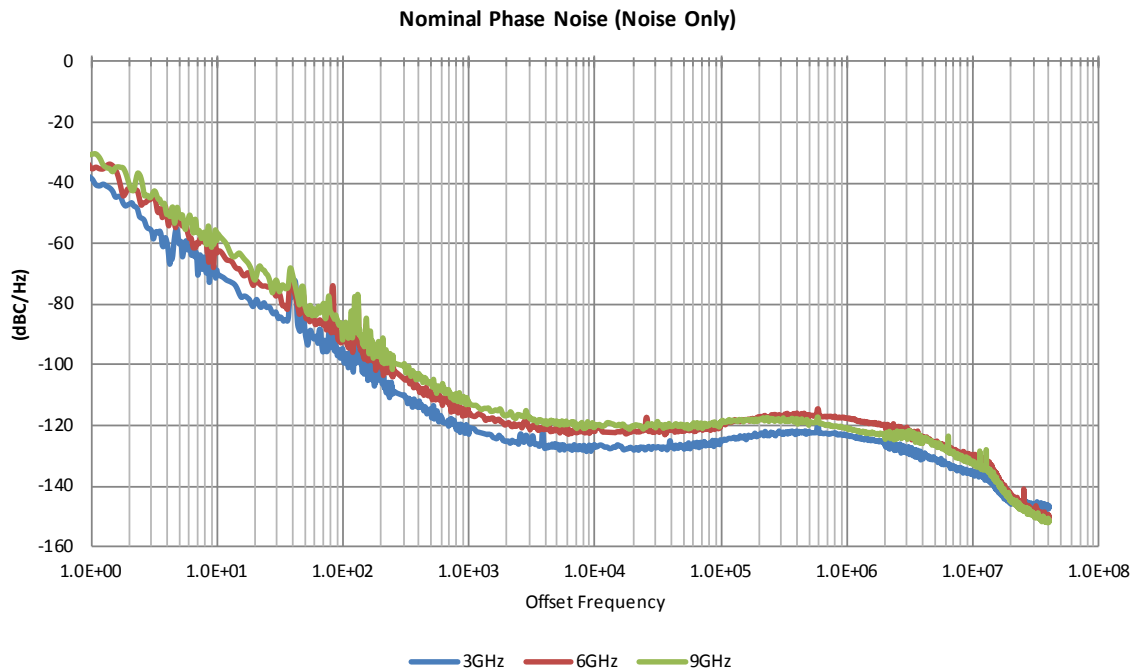

Figure 6. Nominal Phase Noise

# TECHNICAL SPECIFICATIONS AND CHARACTERISTICS

Environmental and physical specifications		
Temperature	Operating Non-operating	0 °C to 50 °C -40 °C to +55 °C
Connectors	RF IN	APC 3.5 (precision type)
EMC		Complies with European EMC Directive 2004/108/EC <ul style="list-style-type: none"> <li>• IEC/EN 61326-2-1</li> <li>• CISPR Pub 11 Group 1, class A</li> <li>• AS/NZS CISPR 11</li> <li>• ICES/NMB-001</li> </ul> This ISM device complies with Canadian ICES-001. Cet appareil ISM est conforme a la norme NMB-001 du Canada.
Warm-up time		45 minutes, minimum
<b>Power dissipation</b>		
Total power		92.5 W, max
Weight	Vector signal analyzer modules only	8.5 lbs/3.9kg

System requirements			
Operating systems	Windows XP, Service Pack 3 or later (32-bit) <sup>1</sup>	Windows Vista, SP1 and SP2 (32-bit and 64-bit), Business, Ultimate, Enterprise, Home Basic, and Home Premium <sup>1</sup>	Windows 7 (32-bit and 64-bit) Starter, Home Basic, Home Premium, Professional, Ultimate, Enterprise
Processor speed	600 MHz or higher required 800 MHz recommended	1 GHz 32-bit (x86), 1 GHz 64-bit (x64), no support for Itanium 64	1 GHz 32-bit (x86), 1 GHz 64-bit (x64), no support for Itanium 64
Available memory	256 MB minimum (1 GB or greater recommended)	1 GB minimum	1 GB minimum <sup>2</sup>
Available disk space <sup>3</sup>	1.5 GB available hard disk space, includes: <ul style="list-style-type: none"> <li>• 1 GB available for Microsoft .NET Framework 3.5 SP1 <sup>4</sup></li> <li>• 100 MB for Agilent IO Libraries Suite</li> </ul>	1.5 GB available hard disk space, includes: <ul style="list-style-type: none"> <li>• 1 GB available for Microsoft .NET Framework 3.5 SP1 <sup>4</sup></li> <li>• 100 MB for Agilent IO Libraries Suite</li> </ul>	1.5 GB available hard disk space, includes: <ul style="list-style-type: none"> <li>• 1 GB available for Microsoft .NET Framework 3.5 SP1 <sup>4</sup></li> <li>• 100 MB for Agilent IO Libraries Suite</li> </ul>
Video	Super VGA (800x600) 256 colors or more	Support for DirectX 9 graphics with 128 MB graphics memory recommended (Super VGA graphics is supported)	Support for DirectX 9 graphics with 128 MB graphics memory recommended (Super VGA graphics is supported)
Browser	Microsoft Internet Explorer 6.0 or greater	Microsoft Internet Explorer 7 or greater	Microsoft Internet Explorer 7 or greater

1. Not supported when using streaming options (M9202A-V05 or M9202A-V10)

2. 4 GB minimum required for streaming capability (M9202A-V05 and M9202A-V10)

3. Because of the installation procedure, less memory may be required for operation than is required for installation

4. .NET Framework Runtime Components are installed by default with Windows Vista and Windows 7. Therefore, you may not need this amount of available disk space

# CONFIGURATION AND ORDERING INFORMATION

## Ordering information

Model	Description
✓ M9392A <sup>1</sup>	PXI vector signal analyzer: 50 MHz to 26.5 GHz with 50 MHz streaming
✓ M9202A <sup>2</sup>	PXIe IF Digitizer: 12-bit, 2 GS/s (with options CO1, F02, M05, DDC, V05)
□ M9202A-V10	100 MHz BW streaming
✓ M9302A <sup>2</sup>	PXI local oscillator: 3 GHz to 10 GHz
✓ M9360A <sup>2</sup>	PXI Attenuator/preselector: 100 kHz to 26.5 GHz
✓ M9361A <sup>2</sup>	PXI downconverter: 2.75 GHz to 26.5 GHz
✓ M9351A	PXI downconverter: 50 MHz to 2.9 GHz

✓ *Recommended configuration*

1. For the M9392A to work properly, at least one PXI chassis and one PXI controller type must be available.
2. Included with purchase of M9392A

## Accessories

Software, example programs, and product information on a CD (included)

Cables (included)

## Software

Model	Description
Supported operating systems	Microsoft Windows XP (32-bit), Microsoft Windows Vista (32/64-bit), Microsoft Windows 7 (32/64-bit)
Standard compliant drivers	IVI-COM, IVI-C, LabVIEW, MATLAB
Supported application development environments (ADE)	Visual Studio (VB.NET, C#, C/C++), VEE, LabVIEW, LabWindows/CVI, MATLAB
Agilent IO Libraries	Includes: VISA Libraries, Agilent Connection Expert, IO Monitor

## Warranty and calibration

Warranty and calibration are provided at the module level.

### Advantage services: Calibration and warranty

Agilent Advantage Services is committed to your success throughout your equipment's lifetime.

### Warranty

Included 3-year warranty (return to Agilent), standard

R-51B-001-5Z 5-year return to Agilent warranty assurance plan

### Express warranty<sup>3</sup>

R-51B-001-3X Express warranty - 3 years

R-51B-001-5X Express warranty - 5 years

3. Not available in all countries.

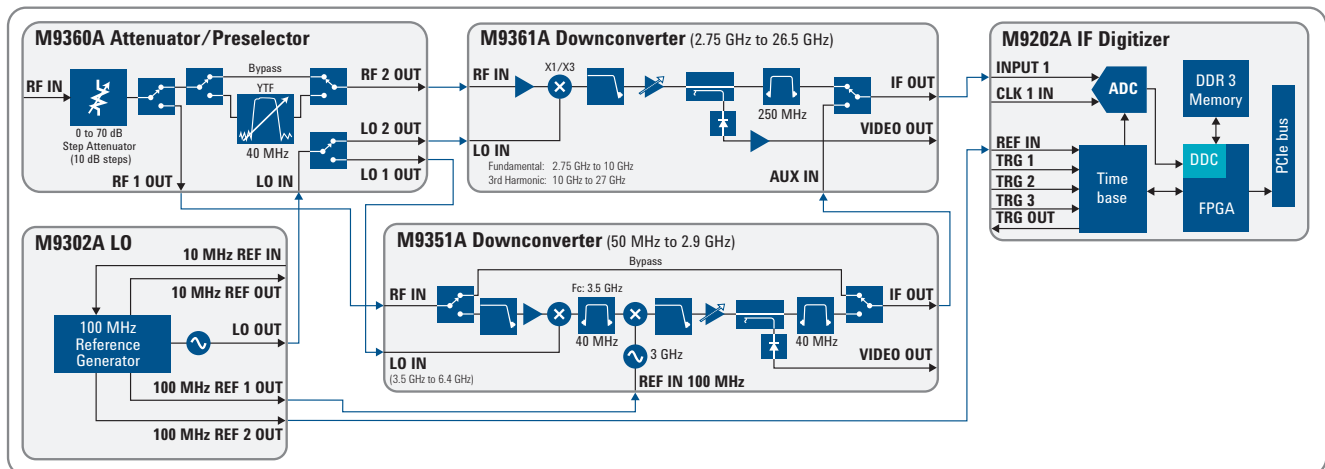

Figure 7. M9392A PXI Vector Sector Analyzer simplified diagram



## The modular tangram

The four-sided geometric symbol that appears in this document is called a tangram. The goal of this seven-piece puzzle is to create identifiable shapes—from simple to complex. As with a tangram, the possibilities may seem infinite as you begin to create a new test system. With a set of clearly defined elements—hardware, software—Agilent can help you create the system you need, from simple to complex.



## Challenge the Boundaries of Test Agilent Modular Products



**myAgilent**  
[www.agilent.com/find/myagilent](http://www.agilent.com/find/myagilent)



[www.pxisa.org](http://www.pxisa.org)



**Three-Year Warranty**  
[www.agilent.com/find/ThreeYearWarranty](http://www.agilent.com/find/ThreeYearWarranty)



**Agilent Assurance Plans**  
[www.agilent.com/find/AssurancePlans](http://www.agilent.com/find/AssurancePlans)



[www.agilent.com/quality](http://www.agilent.com/quality)



**Agilent SolutionPartners**  
[www.agilent.com/find/solutionpartners](http://www.agilent.com/find/solutionpartners)

[www.agilent.com](http://www.agilent.com)

[www.agilent.com/find/modular](http://www.agilent.com/find/modular)

[www.agilent.com/find/m9392a](http://www.agilent.com/find/m9392a)

For more information on Agilent Technologies' products, applications or services, please contact your local Agilent office. The complete list is available at: [www.agilent.com/find/contactus](http://www.agilent.com/find/contactus)

### Americas

Canada	(877) 894 4414
Brazil	(11) 4197 3600
Mexico	01800 5064 800
United States	(800) 829 4444

### Asia Pacific

Australia	1 800 629 485
China	800 810 0189
Hong Kong	800 938 693
India	1 800 112 929
Japan	0120 (421) 345
Korea	080 769 0800
Malaysia	1 800 888 848
Singapore	1 800 375 8100
Taiwan	0800 047 866
Other AP Countries	(65) 375 8100

### Europe & Middle East

Belgium	32 (0) 2 404 93 40
Denmark	45 45 80 12 15
Finland	358 (0) 10 855 2100
France	0825 010 700* *0.125 €/minute
Germany	49 (0) 7031 464 6333
Ireland	1890 924 204
Israel	972-3-9288-504/544
Italy	39 02 92 60 8484
Netherlands	31 (0) 20 547 2111
Spain	34 (91) 631 3300
Sweden	0200-88 22 55
United Kingdom	44 (0) 118 927 6201

For other unlisted countries: [www.agilent.com/find/contactus](http://www.agilent.com/find/contactus)

(BP-11-07-13)

Product specifications and descriptions in this document subject to change without notice.

PICMG and the PICMG logo, CompactPCI and the CompactPCI logo, AdvancedTCA and the AdvancedTCA logo are US registered trademarks of the PCI Industrial Computers Manufacturers Group. "PCIe" and "PCI EXPRESS" are registered trademarks and/or service marks of PCI-SIG.

© Agilent Technologies, Inc. 2011–2013  
Published in USA, December 6, 2013  
5990-6050EN



**Agilent Technologies**