



## Leverage the Genius Inside

Wrap your OEM products around Agilent's high-speed digitizer technology

*Anticipate — Accelerate — Achieve*



**Agilent Technologies**

# Leverage the Genius Inside



Every new product takes shape in a different way, but all share a common issue: Tradeoffs must be made in the pursuit of metrics such as time-to-market, competitive pricing and profit margin. The pursuit of those goals often involves another important choice: Design in-house or buy off-the-shelf.

As you weigh the choices, consider Agilent. We're known for test and measurement equipment that offers industry-leading performance, accuracy and reliability. Those same attributes are built into Agilent high-speed digitizers that can be designed into your end-user products. Whether you choose to do the integration on your own or with our help, we can help you create a cost-effective solution that minimizes project risk and accelerates your time-to-market. Work with us—and leverage the genius embedded inside our products.

## Reduce the risks—today and tomorrow

Whether you're the product architect or project manager, our technology can enhance the products you're creating. When you choose our high-speed digitizer technologies, your projects can benefit in five important ways:

- Faster time to market
- Smaller size and lower power consumption
- Better measurement fidelity and signal integrity
- Higher measurement throughput
- Lower total cost of ownership (TCO)

The net result is a lower cost of integration that comes from reduced development time, greater reuse of designs and the advantages of open architectures, including future upgradeability. This forward-looking approach will help you shape future solutions faster, too.

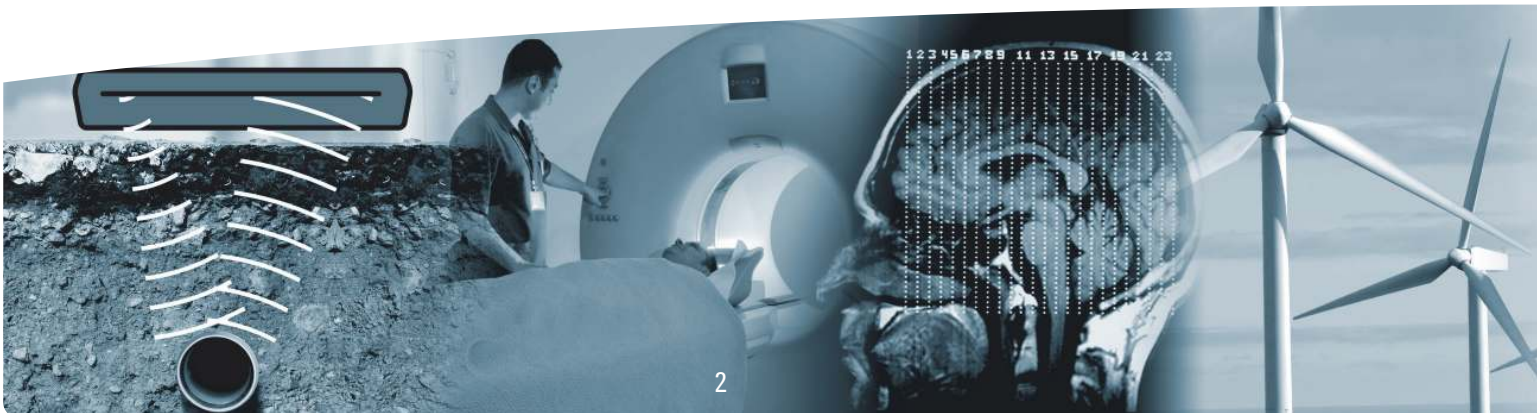

# Wrap your Products around our Technologies

To support the needs of original equipment manufacturers (OEMs), we offer a range of hardware products, software elements and, for specific customer needs, development toolkits and services. We illustrate our offering as a set of three nested spheres.

Agilent-proprietary technologies—and know-how—are at the core. These unique elements include data-converter chipsets, analog front-end technology and digital data-handling devices. Together, these field-programmable gate arrays (FPGA), with commercial off-the-shelf (COTS) technologies, provide three key advantages:

- Provide easy access to low-power, high-fidelity data acquisition
- Ensure maximum data throughput to the host processor
- Reduce measurement time and cost

These components are available only as embedded parts of our high-speed digitizer products, which comprise the second sphere. These boards and modules include analog-to-digital converters (ADC). Key capabilities include onboard real-time processing, memory storage and data streaming.

The third layer is your product, which can be wrapped around the two inner spheres. This is often the fastest way to create a working prototype or get your initial end-user product to market.



*1. Agilent  
core technology*



*2. Agilent embedded  
ADC board*

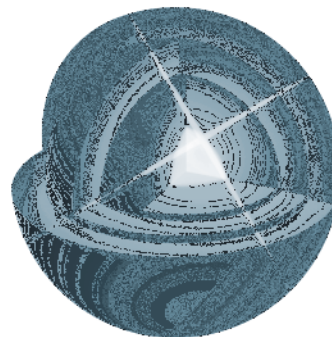

*3. OEM Product*

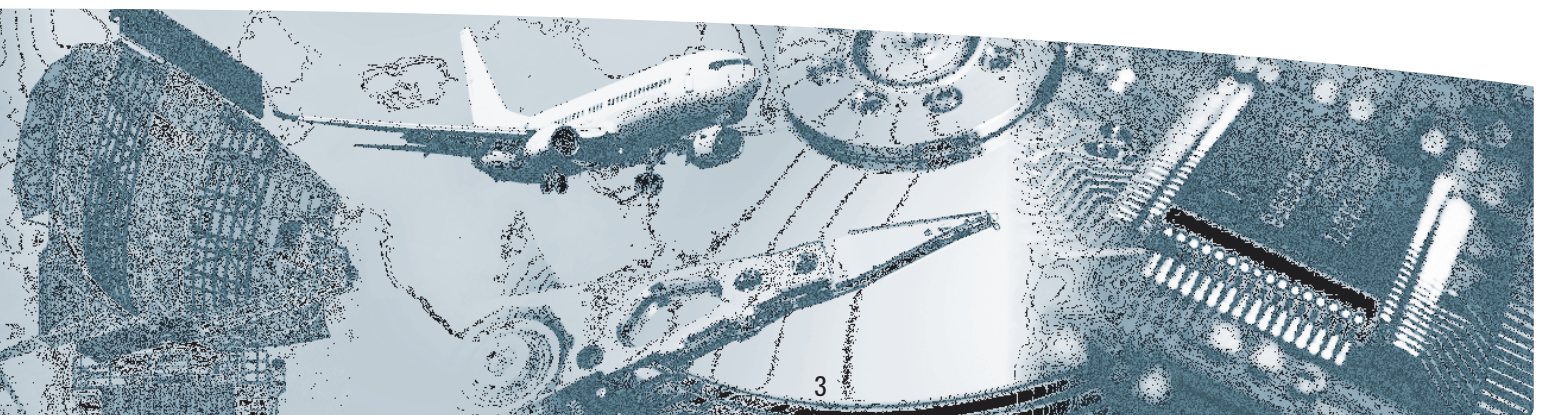

# Build on our toolkits and software

On the software side, we support Linux and Windows operating systems. We also offer software designed for multichannel data acquisition and FPGA development kit enabling you to integrate your algorithm within our technology.

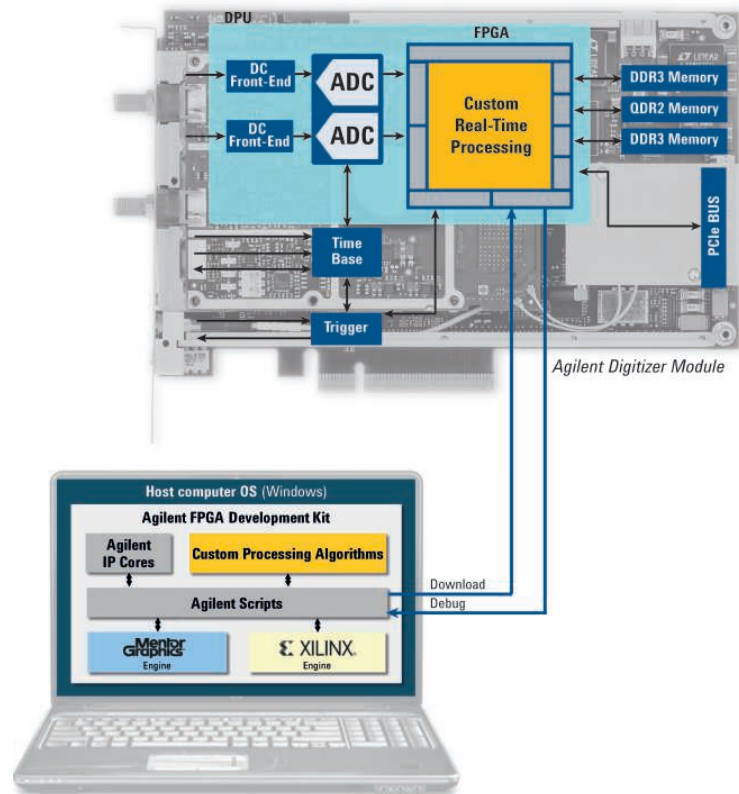

## Let us help create your solution

If you need hands-on development support, we're ready to help with your design starting from concept, prototype to manufacture. We have experience supporting designs for applications in ultrasound, laser, lidar, radar, RF antennas and beyond.

Who better than Agilent to adapt our technologies, products and software to suit your application?

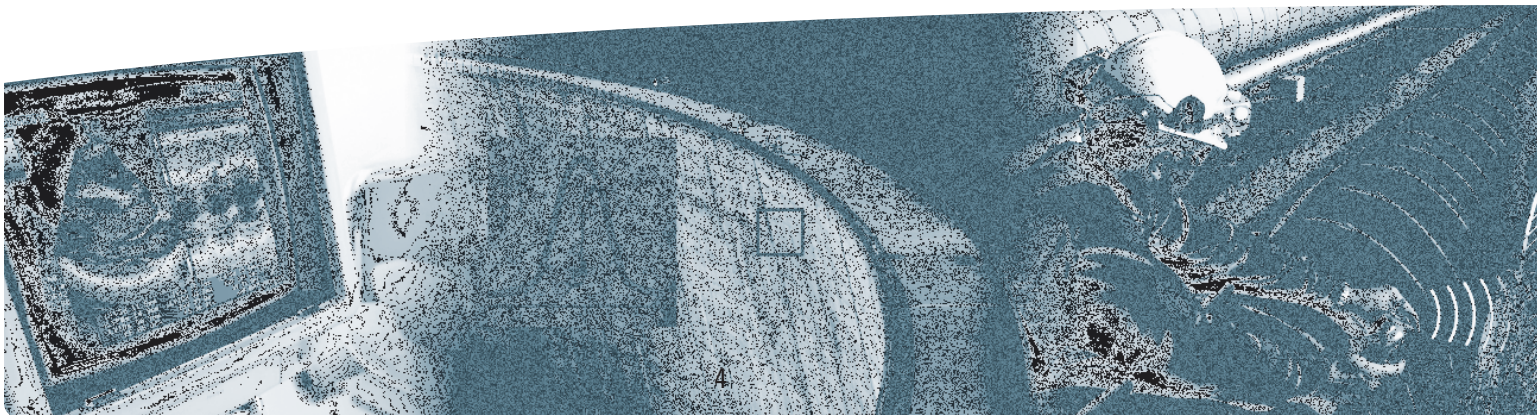

# Deploy our Product Families

At the product level, we offer a range of modular solutions for data conversion. These cover a wide range of specifications and capabilities:

- Sampling rates of 500 MS/s and up to 8 GS/s
- Resolution of 8, 10, 12 or 14 bits
- Wide bandwidths up to 3 GHz
- Small to large acquisition memories
- High throughput
- On-board real-time processing
- From single to multi-channels solutions

Some modules also feature real-time processing and data streaming. To ensure maximum flexibility, we support industry-standard form factors and interfaces such as PCIe/PCI, PXIe/PXI-H and AXIe.

## Get the Right Mix of Features and Performance

Our technology spans a range of features and performance points that can be tuned to meet challenging measurement needs in commercial, industrial, aerospace and defense applications. Examples include medical imaging, ultrasound, radar, lidar, time-of-flight (TOF) imaging, high-energy physics, non-destructive testing and environmental monitoring.

Unlike a typical R&D project, our commitment is to deliver the digitizer that has exactly what you need—nothing more, nothing less.

Our deliverable to you will be a finely tuned device at a price point that fits within your business needs. Your final result will be an OEM product that meets the needs for your application.



PCI  
EXPRESS

PXIExpress™

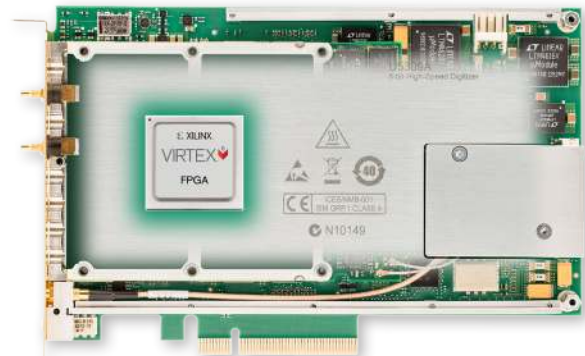

AXIe

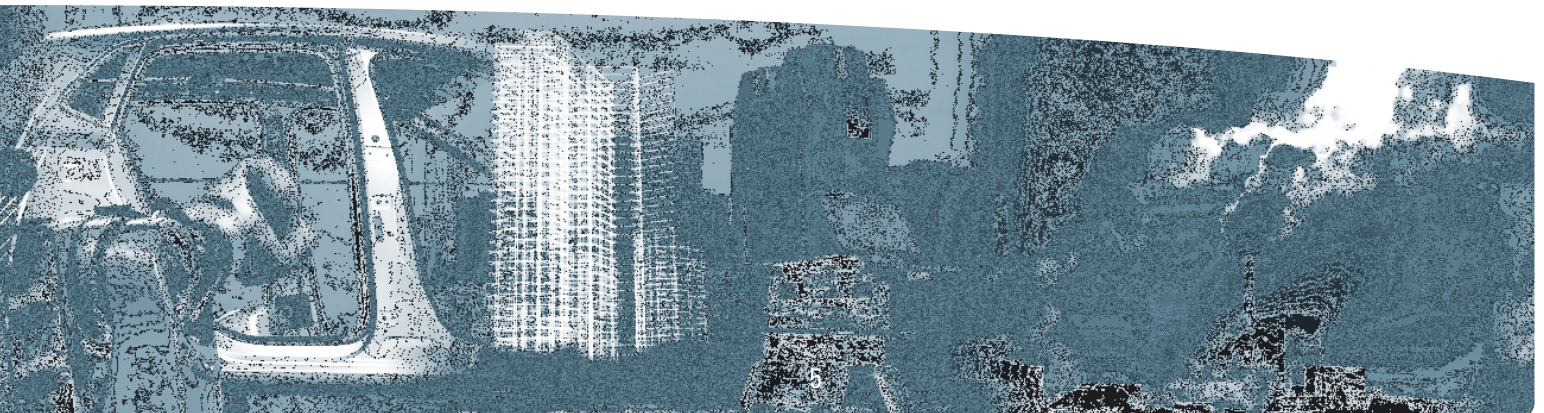

# Leverage the Genius Embedded Inside

Tremendous levels of customization are possible. This flexibility is based on four key elements:

- Base boards
- Mezzanine boards
- Firmware
- Software

Regardless of form factor, the base cards share a common technology foundation. Mezzanines contain front-end signal conditioning and the ADC, and they share a common footprint with the base cards.

The field-programmable gate array (FPGA) at the hearth of the data processing unit (DPU), share common base designs, enabling easy porting of both firmware and software between different solutions. Firmware can support specific requirements such as fast Fourier transform (FFT), digital downconversion (DDC), finite impulse response (FIR) filtering, intermediate frequency (IF) digitization, data decimation and pulse integration.

## Incorporate Advanced Technologies

Agilent high-speed digitizers embody our technical know-how and incorporate a variety of advanced technologies. These are implemented as FPGAs, ADC chipsets, analog front ends, digital data-handling devices, and COTS chips.

Our proprietary ADC chipsets are designed to optimize high-speed performance. They also help ensure excellent signal fidelity in a wide range of applications.

To further enhance signal fidelity, we've developed excellent analog front-end technology. This provides the signal conditioning, amplification and interleaving functions essential to data acquisition at gigasample-per-second rates.

Accurate multi-channel acquisition and cross-channel measurements depend on digital data-handling components. These provide the vital clock and synchronization signals that make it possible to capture and memorize acquired data with maximum data throughput.

Specialized FPGAs make low-power, high-fidelity data acquisition more accessible. They also accelerate data throughput to the host processor, further reducing measurement time and cost.

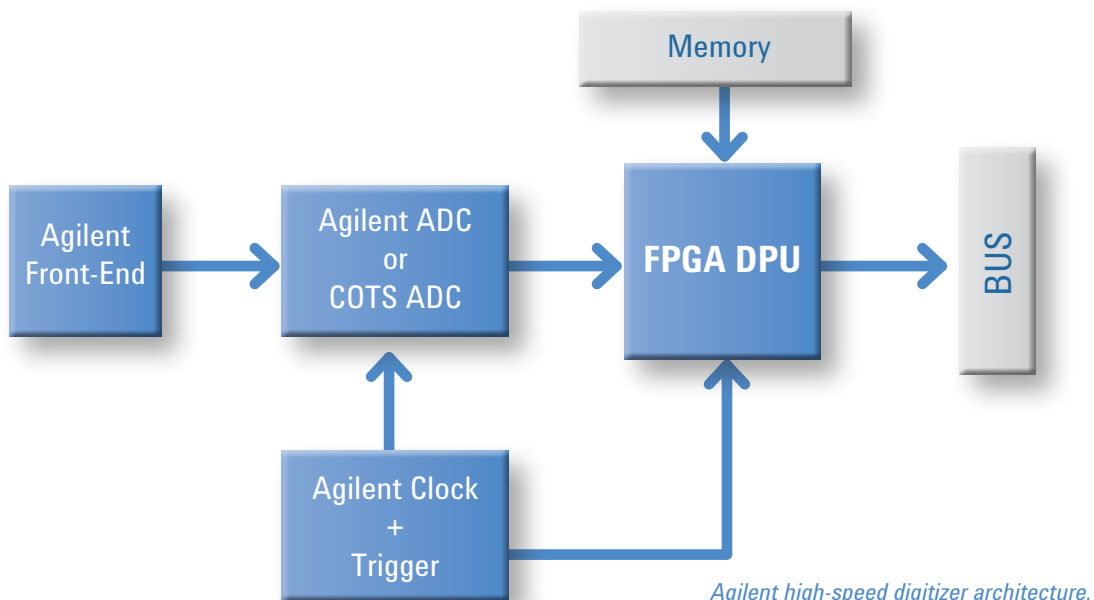

# Put our Expertise to Work for You

Our driving philosophy should be clear: We want to put excellent data converter technologies in the hands of an ever wider number of users. For OEMs, we want to ensure that your end users are quickly and easily capturing, storing, measuring and analyzing signals with the highest fidelity.

Behind the scenes, our core team has a tremendous amount of expertise in data conversion and ADC design. For example, our engineering staff includes hardware designers and software developers with decades of cumulative experience in a vast range of applications.

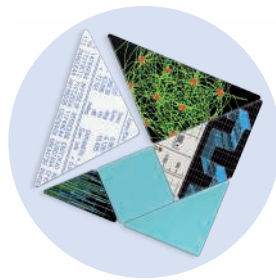
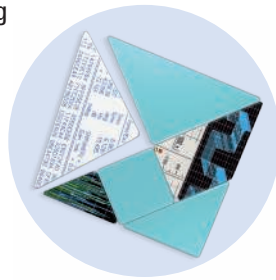
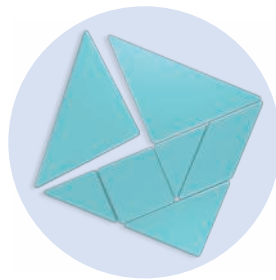

## Contact us

Don't hesitate to contact us via mail at [digitizers@agilent.com](mailto:digitizers@agilent.com) to request more information or ask a product expert for the best and most cost-effective solution.

For detailed information about our technology, please visit us on the Web at [www.agilent.com/find/embedded-digitizers](http://www.agilent.com/find/embedded-digitizers)

## High-speed ADC technology blog

You can also stay in touch with the evolution of high-speed digitizer technology and applications on our blog: <http://high-speed-digitizer.tm.agilent.com>





## The Modular Tangram

The four-sided geometric symbol that appears in this document is called a tangram. The goal of this seven-piece puzzle is to create identifiable shapes—from simple to complex. As with a tangram, the possibilities may seem infinite as you begin to create a new test system. With a set of clearly defined elements—hardware, software—Agilent can help you create the system you need, from simple to complex.



*Challenge the Boundaries*

*Agilent Modular Products*



[www.agilent.com](http://www.agilent.com)

[www.agilent.com/find/embedded-digitizers](http://www.agilent.com/find/embedded-digitizers)

For more information on Agilent Technologies' products, applications or services, please contact your local Agilent office. The complete list is available at: [www.agilent.com/find/contactus](http://www.agilent.com/find/contactus)

### Americas

Canada	(877) 894 4414
Brazil	(11) 4197 3600
Mexico	01800 5064 800
United States	(800) 829 4444

### Asia Pacific

Australia	1 800 629 485
China	800 810 0189
Hong Kong	800 938 693
India	1 800 112 929
Japan	0120 (421) 345
Korea	080 769 0800
Malaysia	1 800 888 848
Singapore	1 800 375 8100
Taiwan	0800 047 866
Other AP Countries	(65) 375 8100

### Europe & Middle East

Belgium	32 (0) 2 404 93 40
Denmark	45 45 80 12 15
Finland	358 (0) 10 855 2100
France	0825 010 700*
	*0.125 €/minute
Germany	49 (0) 7031 464 6333
Ireland	1890 924 204
Israel	972-3-9288-504/544
Italy	39 02 92 60 8484
Netherlands	31 (0) 20 547 2111
Spain	34 (91) 631 3300
Sweden	0200-88 22 55
United Kingdom	44 (0) 118 927 6201

For other unlisted countries: [www.agilent.com/find/contactus](http://www.agilent.com/find/contactus)

(BP-10-02-13)

Product specifications and descriptions in this document subject to change without notice.

PICMG and the PICMG logo, CompactPCI and the CompactPCI logo, AdvancedTCA and the AdvancedTCA logo are US registered trademarks of the PCI Industrial Computers Manufacturers Group. "PCIe" and "PCI EXPRESS" are registered trademarks and/or service marks of PCI-SIG.

© Agilent Technologies, Inc. 2013-2014

Published in USA, January 30, 2014

5990-7626EN



**Agilent Technologies**