

OPERATING AND SERVICE MANUAL

MODEL 6433B

DC POWER SUPPLY

MANUFACTURING CODE 6A

January, 1966

TABLE OF CONTENTS

Section	Title	Page
I	GENERAL INFORMATION	1-1
	1-1. Description	1-1
	1-2. General	1-1
	1-4. Overload Protection	1-1
	1-7. Cooling	1-1
	1-9. Monitoring	1-1
	1-11. Output Terminals	1-1
	1-13. Instrument Identification	1-2
II	INSTALLATION	2-1
	2-1. Initial Inspection	2-1
	2-2. General	2-1
	2-4. Mechanical Check	2-1
	2-6. Electrical Check	2-1
	2-8. Installation Data	2-1
	2-9. General	2-1
	2-11. Location	2-1
	2-13. Power Requirements	2-2
	2-15. Power Cable	2-2
	2-18. Repackaging for Shipment.	2-2
III	OPERATING INSTRUCTIONS.	3-1
	3-1. Controls and Indicators	3-1
	3-3. Operation	3-1
	3-4. General	3-1
	3-6. Normal	3-1
	3-10. Connecting Load.	3-2
	3-14. Remote Sensing	3-2
	3-17. Remote Programming	3-3
	3-26. Parallel	3-5
	3-30. Series	3-5
	3-35. Auto-Tracking	3-6
	3-38. Operating Considerations.	3-7
	3-39. Pulse Loading	3-7
	3-41. Output Capacitance	3-7
	3-44. Negative Voltage Loading	3-7
	3-46. Negative Current Loading	3-7

TABLE OF CONTENTS (cont.)

Section	Title	Page
IV	PRINCIPLES OF OPERATION4-1
	4-1. Block Diagram Description4-1
	4-9. Circuit Description4-2
	4-10. AC Input4-2
	4-12. DC Output4-2
	4-14. Voltage Input4-2
	4-20. Current Input4-3
	4-24. Gating Circuit4-4
	4-27. Turn-On Circuit4-4
	4-29. SCR Regulator Control4-4
	4-37. SCR Regulator4-6
	4-42. Bias and Reference Circuit4-6
V	MAINTENANCE5-1
	5-1. General5-1
	5-3. Measurement Techniques5-1
	5-7. Performance Check5-2
	5-8. General5-2
	5-10. Rated Output and Meter Accuracy5-2
	5-13. Line Regulation5-3
	5-16. Load Regulation5-4
	5-19. Ripple and Noise5-4
	5-21. Transient Recovery Time5-5
	5-23. Additional Specification Check5-6
	5-24. Temperature Coefficient5-6
	5-27. Output Stability5-6
	5-30. Remote Programming5-7
	5-33. Output Impedance5-9
	5-35. Output Inductance5-9
	5-37. Cover Removal5-10
	5-39. Troubleshooting5-10
	5-40. General5-10
	5-42. Trouble Analysis5-10
	5-49. Repair and Replacement5-12
	5-51. Adjustments and Calibrations5-14
	5-52. General5-14
	5-54. Meter Zero5-14
	5-56. Voltmeter Tracking5-14
	5-58. Ammeter Tracking5-14
	5-60. Constant Voltage Programming Current5-15
	5-62. Zero Voltage Output5-15
	5-64. Constant Current Programming Current5-15

TABLE OF CONTENTS (cont.)

Section	Title	Page
5-66.	Zero Current Output5-16
5-68.	Bias and Reference Line Regulation5-16
5-70.	Line Imbalance5-17
5-72.	Constant Current Load Regulation5-18
VI	REPLACEABLE PARTS6-1
6-1.	Introduction6-1
6-4.	Ordering Information.6-1

MODEL 6433B

REVISION:

Please note the following changes in the instruction manual:

1. Wherever 6433A appears, change it to 6433B.
2. Eliminate the 10A fuse and holder in the ACC side of the line.
3. Change voltage rating from 32 volts to 36 volts.
4. Change T1 from 643391 to 643391B.
5. Change C13 and C17 from 47,000 μ f 40VDC to 40,000 μ f 50VDC Mfg. Part # D42343.
6. Change R21 from 160 ohm 2W to 43 ohm 2W.
7. Remove C12 from AC lead -- move to ACC (anode of CR18).
8. Change Q1, 2, 3, 4, 6, 8, 9 from 2N3390 to 2N3391 Corporate Part # 1854-0071.

Table 1-1. Specifications

INPUT:	105-125 vac, 57 to 63 cps, single phase, 7 amperes, 450 watts max.
RATED OUTPUT:	Constant Voltage: 0 to 32 vdc. Constant Current: 0 to 10 amperes dc
LINE REGULATION:	Constant Voltage: Less than 18 mv for 105-125 vac input change. Constant Current: Less than 100ma for 105-125 vac input change.
LOAD REGULATION:	Constant Voltage: Less than 36 mv for 0 to 10ampere load change. Constant Current: Less than 100 ma for 0 to 32vdc load change.
RIPPLE AND NOISE:	32 mvrms
OPERATING TEMPERATURE RANGE:	0°C to 50°C
STORAGE TEMPERATURE RANGE:	-20°C to 71°C
TEMPERATURE COEFFICIENT:	Constant Voltage: 0.05% plus 8 mv per degree centigrade. Constant Current: 30 ma per degree centigrade.
OUTPUT STABILITY: (after 30-minute warm-up)	Constant Voltage: 0.15% plus 24mv for 8 hours at constant temperature. Constant Current: 100ma for 8 hours at constant temperature.
REMOTE PROGRAMMING:	Constant Voltage: 200 ohms per volt $\pm 1\%$ Constant Current: 25ohms per ampere $\pm 10\%$
TYPICAL OUTPUT IMPEDANCE:	Less than 0.01 ohm from dc to 0.5 cps Less than 0.5 ohm from 0.5 cps to 100 cps Less than 0.2 ohm from 100 cps to 1kc Less than 1.0 ohm from 1kc to 100 kc
OUTPUT INDUCTANCE:	1.0 microhenry

Table 1-1. Specifications (cont.)

TRANSIENT RECOVERY TIME:

In constant voltage operation, less than 300 milliseconds is required for output voltage recovery to within 200 millivolts of the nominal output voltage following a load change equal to one half the maximum current rating of the power supply. Nominal output voltage is defined as the mean between the no-load and full-load voltages. The transient amplitude is less than 0.5 volt per ampere for any load change between 20% and 100% of rated output current. (Excluding the initial spike of approximately 100 microseconds duration which is significant only for load rise times faster than 0.5 ampere per microsecond.)

SIZE AND WEIGHT:

Height	Width	Depth	Weight
3-1/2 in.	19 in.	17-1/2 in.	33 lb.

FINISH:

Light gray front panel with dark gray case.



Figure 1-1. Model 6433A DC Power Supply

SECTION I

GENERAL INFORMATION

1-1. DESCRIPTION

1-2. GENERAL

1-3. The H-Lab Model 6433ADC Power Supply (fig. 1-1) is a completely solid-state, compact, well-regulated, constant voltage/constant current dc power supply suitable for either bench or relay rack operation. A three-wire five-foot power cord is provided. The output is continuously variable between 0 and 32vdc, and between 0 and 10 amperes. Detailed specifications are given in table 1-1.

1-4. OVERLOAD PROTECTION

1-5. A crossover feature protects both power supply and load in constant voltage operation. Automatic crossover circuitry switches the power supply from constant voltage to constant current operation if the output current exceeds a preset limit. This crossover circuitry also protects the load from overvoltage during constant current operation by automatically switching the power supply into constant voltage operation. The user can adjust the crossover point via the front panel controls (para. 3-8 and 3-9).

1-6. The power supply is protected from reverse voltage (positive voltage applied to negative terminal) by a diode that shunts current across the output terminals when this condition exists. The ac input is fused. A double-pole on/off switch opens both power leads in the off position.

1-7. COOLING

1-8. Convection cooling is used. No fan is required. The power supply has no moving parts (except meter movement).

1-9. MONITORING

1-10. Two front-panel meters are provided for monitoring output voltage and current. The voltmeter has a 0 to 40 volt range and the ammeter has a 0 to 12 ampere range. Each meter has a 2% accuracy at full scale.

1-11. OUTPUT TERMINALS

1-12. Output power is available via a terminal strip on the rear panel. The rear panel terminal strip also enables the power supply to be connected for different modes of operation (para. 3-3). The output terminals are isolated from the chassis

and either the positive or the negative terminal may be connected to the chassis via a separate ground terminal located adjacent to the output terminals. The power supply is insulated to permit operation up to 300 vdc off ground.

1-13. INSTRUMENT IDENTIFICATION

1-14. Harrison Laboratories power supplies are identified by a three-part designation. The first part is the model number; the second part is the serial number; and the third part is the manufacturing code letter. This manual applies to all Model 6433A power supplies with the same manufacturing code letter given in the title page. Change sheets will be supplied with the manual to make it apply to Model 6433A power supplies with different manufacturing code letters.

SECTION II
INSTALLATION

2-1. INITIAL INSPECTION

2-2. GENERAL

2-3. Before shipment, the power supply was inspected and found free of mechanical and electrical defects. If damage to the shipping carton is evident, ask that the carrier's agent be present when the power supply is unpacked. As soon as the power supply is unpacked, inspect it for any damage that may have occurred in transit. Also check the cushioning material for signs of severe stress (may be indication of internal damage). Save all packing materials until the inspection is completed. If damage is found, proceed as instructed in the Claim for Damage in Shipment notice on the back of the front cover of this manual.

2-4. MECHANICAL CHECK

2-5. Check that there are no broken knobs or connectors, that the external surface is not scratched or dented, that the meter faces are not damaged, and that all controls move freely. Any external damage may be an indication of internal damage.

2-6. ELECTRICAL CHECK

2-7. Check that the straps on the terminal strip at the rear of the power supply are secure and that the strapping pattern is in accord with figure 3-2. Check the electrical performance of the power supply as soon as possible after receipt. A performance check that is suitable for incoming inspection is given in paragraphs 5-7 through 5-22.

2-8. INSTALLATION DATA

2-9. GENERAL

2-10. The power supply is shipped ready for bench or relay rack (19 inch) operation.

2-11. LOCATION

2-12. Because the power supply is cooled by convection, there must be enough space along the sides and rear of the power supply to permit free flow of cooling air. The power supply should be located in an area where the ambient temperature does not exceed 50°C.

2-13. POWER REQUIREMENTS

2-14. The power supply is operated from a 105 to 125 volt (115 volts nominal), 57 to 63 cps, single phase power source. At 115 volts, 60 cps, the full load requirement is 450 watts at 6.5 amperes.

2-15. POWER CABLE

2-16. To protect operating personnel, the National Electrical Manufacturers Association (NEMA) recommends that the instrument panel and cabinet be grounded. This instrument is equipped with a three-conductor power cable. The third conductor is the ground conductor and when the cable is plugged into an appropriate receptacle, the instrument is grounded. The offset pin on the power cable three-prong connector is the ground connection.

2-17. To preserve the protection feature when operating the instrument from a two-contact outlet, use a three-prong to two-prong adaptor and connect the green lead on the adaptor to ground.

2-18. REPACKAGING FOR SHIPMENT

2-19. To insure safe shipment of the instrument, it is recommended that the package designed for the instrument be used. The original packaging material is reusable. If it is not available, contact your Hewlett-Packard field office for packing materials and information. A packing carton part number is included in the parts list.

2-20. Attach a tag to the instrument which specifies the owner, model number, full serial number, and service required, or a brief description of the trouble.

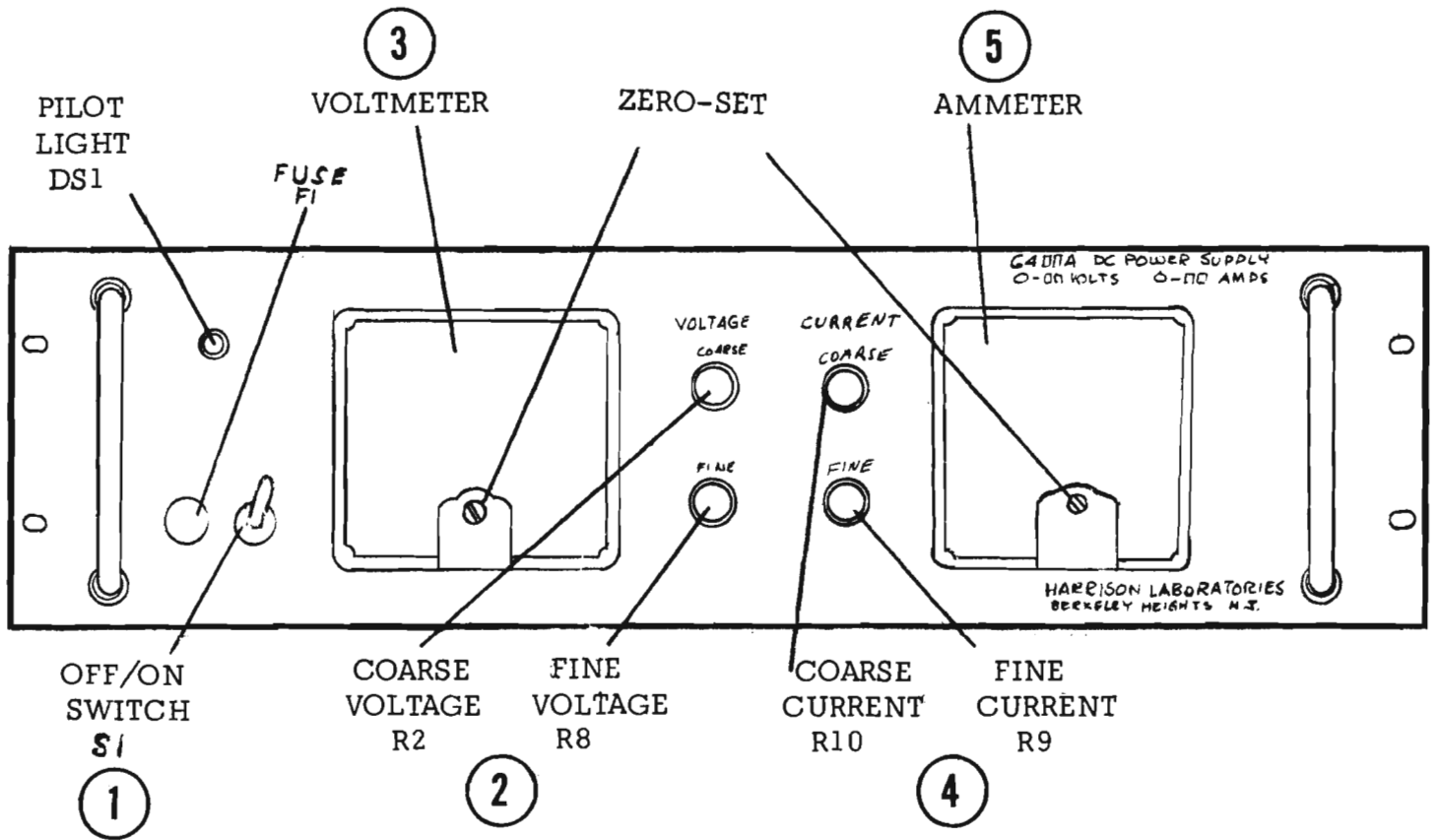

1. TURN ON POWER SUPPLY
2. ADJUST OUTPUT VOLTAGE
3. OBSERVE VOLTMETER
4. SHORT OUTPUT TERMINALS (AT REAR OF POWER SUPPLY) AND ADJUST OUTPUT CURRENT LIMIT
5. OBSERVE AMMETER
6. REMOVE SHORT AND CONNECT LOAD TO OUTPUT TERMINALS

Figure 3-1. Controls and Indicators

SECTION III

OPERATING INSTRUCTIONS

3-1. CONTROLS AND INDICATORS

3-2. The controls and indicators are illustrated in figure 3-1.

3-3. OPERATION

3-4. GENERAL

3-5. The power supply is designed so that its mode of operation can be selected by making strapping connections between particular terminals on the terminal strip at the rear of the power supply. The terminal designations are stenciled in white on the power supply and are adjacent to their respective terminals. The strapping patterns illustrated in this section show neither terminal grounded. The operator can ground either terminal or operate the power supply up to 300 vdc off ground (floating).

3-6. NORMAL

3-7. GENERAL. The power supply is normally shipped with its rear terminal strapping connections arranged for constant voltage/constant current, local sensing, local programming, single unit mode of operation. This strapping pattern is illustrated in figure 3-2. The operator selects either a constant voltage or a constant current output using the front panel controls (local programming, no strapping changes are necessary).

3-8. CONSTANT VOLTAGE. To select a constant voltage output, proceed as follows:

a. Turn-on power supply and adjust VOLTAGE controls for desired output voltage (output terminals open).

b. Short output terminals and adjust CURRENT controls for maximum output current allowable (current limit), as determined by load conditions. If a load change causes the current limit to be exceeded, the power supply will automatically cross-over to constant current output at the preset current limit and the output voltage will drop proportionately. In setting the current limit, allowance must be made for high peak currents which can cause unwanted cross-over (refer to para. 3-40).

3-9. CONSTANT CURRENT. To select a constant current output, proceed as follows:

a. Short output terminals and adjust CURRENT controls for desired output current.

b. Open output terminals and adjust VOLTAGE controls for maximum output voltage allowable (voltage limit), as determined by load conditions. If a load change causes the voltage limit to be exceeded, the power supply will automatically crossover to constant voltage output at the preset voltage limit and the output current will drop proportionately. In setting the voltage limit, allowance must be made for high peak voltages which can cause unwanted crossover. (Refer to para. 3-40.)

3-10. CONNECTING LOAD

3-11. Two pairs of output terminals are provided on the terminal strip at the left rear side (facing rear) of the power supply. Either pair of terminals or both may be used. The terminals are marked + and -. A separate ground terminal is located adjacent to the output terminals. The positive or negative output terminal may be grounded, or neither grounded (floating operation; permitted to 300 vdc off ground).

3-12. Each load should be connected to the power supply output terminals using separate pairs of connecting wires. This will minimize mutual coupling effects between loads and will retain full advantage of the low output impedance of the power supply. Each pair of connecting wires should be as short as possible and twisted or shielded to reduce noise pickup. (If shield is used, connect one end to power supply ground terminal and leave the other end unconnected.)

3-13. If load considerations require that the output power distribution terminals be remotely located from the power supply, then the power supply output terminals should be connected to the remote distribution terminals via a pair of twisted or shielded wires and each load separately connected to the remote distribution terminals. For this case, remote sensing should be used (para. 3-14).

NOTE

It is recommended that the voltage drop in the connecting wires not exceed 2 volts. If a larger drop must be tolerated, please consult a Hewlett-Packard field representative.

3-14. REMOTE SENSING

3-15. Remote sensing is used to ameliorate the degradation of regulation which will occur at the load when the voltage drop in the connecting wires is appreciable. The use of remote distribution terminals (para. 3-13) is an example where remote sensing may be required. Due to the voltage drop in the load leads, it may be necessary to slightly increase the current limit in constant voltage operation.

CAUTION

Turn-off power supply before rearranging strapping pattern at the power supply rear terminal strip. If the -S terminal is opened while the power supply is on, the output voltage and current may exceed their maximum ratings and result in damage to the load. The power supply will not be damaged.

3-16. Proceed as follows:

a. Turn-off power supply and arrange rear terminal strapping pattern as shown in figure 3-3. The sensing wires will carry less than 10 ma and need not be as heavy as the load wires. It is recommended that sensing and load wires be twisted and shielded. (If shield is used, connect one end to power supply negative terminal and leave the other end unconnected.)

CAUTION

Observe polarity when connecting the sensing leads to the load.

b. In order to maintain low ac output impedance, a capacitor with a minimum rating of 20,000 μ fd and 25 vdcw should be connected across the load using short leads. This capacitor must have high-frequency characteristics as good or better than C17 has (see parts list).

c. Turn-on power supply.

3-17. REMOTE PROGRAMMING

3-18. GENERAL. The constant voltage and constant current outputs may be programmed (controlled) from a remote location. The front-panel controls are disabled in the following instructions. Changes in the rear terminal strapping arrangement are necessary. The wires connecting the programming terminals of the power supply to the remote programming device should be twisted or shielded to reduce noise pick-up. (if shield is used, connect one end to power supply ground terminal and leave the other end unconnected.) Remote sensing (para. 3-14) may be used simultaneously with remote programming. However, the strapping patterns shown in figures 3-4, 3-5, and 3-6 employ only local sensing and do not show the load connections.

CAUTION

Turn-off power supply before rearranging strapping pattern at the power supply rear terminal strip. If the current programming terminals are opened while the power supply is on, the output current will exceed its maximum rating and may result in damage to the load. The power supply will not be damaged. The constant voltage programming terminals have a zener diode connected internally across them to limit the programming voltage and thus prevent excessive output voltage.

3-19. **CONSTANT VOLTAGE.** In the constant voltage mode of operation, either a resistance or voltage source can be used for remote programming. For resistance programming, the programming coefficient (fixed by the programming current) is 200 ohms per volt (output voltage increases 1 volt for each 200 ohms in series with programming terminals). The programming current is adjusted to within 1% of 5 ma at the factory. If greater programming accuracy is required, change R39 (shunt). The programming resistance should be a stable, low noise, low-temperature (less than 30 ppm per °C) resistor with a power rating at least 10 times its actual dissipation.

3-20. The output voltage of the power supply should be 0 +20 mv, -100 mv when the programming resistance is zero ohms. This tolerance can be improved by changing R6. For further information on improving this tolerance, refer to paragraph 5-63 and to H-Lab Tech Letter #1.

3-21. If the resistance programming device is controlled by a switch, make-before-break contacts should be used in order to avoid momentary opening of the programming terminals. To connect the remote programming resistance, arrange rear terminal strapping pattern as shown in figure 3-4. The front-panel VOLTAGE controls are disabled when the strap between A6 and A7 is removed.

3-22. If a voltage source is used as the remote programming device, the output voltage of the power supply will vary in a 1 to 1 ratio with the programming voltage. The load on the voltage source will not exceed 25 microamperes. To connect the programming voltage, arrange rear terminal strapping pattern as shown in figure 3-5.

3-23. **CONSTANT CURRENT.** In constant current operation, resistance programming is used. The resistance programming coefficient (fixed by the programming current) is 25ohms per ampere (output current increases 1 ampere for each 25 ohms in series with programming terminals). The programming current is adjusted to within approximately 10% of 4 ma at the factory. If greater programming accuracy is required, change R41 (shunt). The programming resistance should be a stable, low noise, low-temperature (less than 30 ppm per °C) resistor with a power rating at least 10 times its actual dissipation.

3-24. The output current of the power supply should be 0 ± 50 ma, -100 ma when the programming resistance is zero ohms. This tolerance can be improved by changing R20. For further information on improving this tolerance, refer to paragraph 5-67 and to H-Lab Tech Letter #1.

3-25. If the resistance programming device is controlled by a switch, make-before-break contacts should be used to avoid momentary opening of the programming terminals. To connect the remote programming resistance, arrange rear terminal strapping as shown in figure 3-6. The front-panel CURRENT controls are disabled when the strap between A1 and A2 is removed.

3-26. PARALLEL

3-27. GENERAL. Two or more power supplies can be connected in parallel to obtain a total output current greater than that available from one power supply. The total output current is the sum of the output currents of the individual power supplies. Each power supply can be turned-on or off separately. Remote sensing (para. 3-14) and programming (para. 3-17) can be used; however, the strapping patterns shown in figures 3-7 and 3-8 employ only local sensing and programming.

3-28. NORMAL. The strapping pattern for normal parallel operation of two power supplies is shown in figure 3-7. The output current controls of each power supply can be separately set. The output voltage controls of one power supply (master) should be set to the desired output voltage; the other power supply (slave) should be set for a slightly larger output voltage. The master will act as a constant voltage source; the slave will act as a constant current source, dropping its output voltage to equal the master's.

3-29. AUTO-PARALLEL. The strapping patterns for auto-parallel operation of two and three power supplies are shown in figures 3-8A and B, respectively. Auto-parallel operation permits equal current sharing under all load conditions, and allows complete control of output current from one master power supply. The output current of each slave is approximately equal to the master's. Because the output current controls of each slave is operative, they should be set to maximum to avoid having the slave revert to constant current operation; this would occur if the master output current setting exceeded the slave's.

3-30. SERIES

3-31. GENERAL. Two or more power supplies can be connected in series to obtain a total output voltage higher than that available from one power supply. The total output voltage is the sum of the output voltages of the individual power supplies. A single load can be connected across the series-connected power supplies or a separate load can be connected across each power supply. The power supply has a reverse polarity diode connected internally across the output terminals to protect the power supply against reverse polarity voltage if the load is short-circuited or if one power supply is turned off while its series partners are on.

3-32. The output current controls of each power supply are operative and the current limit is equal to the lowest control setting. If any output current controls are set too low with respect to the total output voltage, the series power supplies will automatically crossover to constant current operation and the output voltage will drop. Remote sensing (para. 3-14) and programming (para. 3-17) can be used; however, the strapping patterns shown in figures 3-9 and 3-10 employ only local sensing and programming.

3-33. NORMAL. The strapping pattern for normal series operation of two power supplies is shown in figure 3-9. The output voltage controls of each power supply must be adjusted to obtain the total output voltage.

3-34. AUTO-SERIES. The strapping patterns for auto-series operation of two and three power supplies are shown in figures 3-10A and B, respectively. Auto-series operation permits control of the output voltage of several power supplies (slaves) from one master power supply. The master must be the most negative power supply of the series. To obtain positive and negative voltages, the + terminal of the master may be grounded. For a given position of the slave output voltage controls, the total output voltage is determined by the master output voltage controls. The output voltage controls of a slave determines the percentage of the total output voltage that the slave will contribute. Turn-on and turn-off of the series is controlled by the master. In order to maintain the temperature coefficient and stability specifications of the power supply, the external resistors shown in figures 3-10A and B, should be stable, low-noise, low-temperature (less than 30 ppm per °C) resistors. The value of these resistors is determined by multiplying the output voltage of the applicable slave by the programming coefficient (200 ohms/volt).

3-35. AUTO-TRACKING

3-36. The strapping patterns for auto-tracking operation of two and three power supplies are shown in figures 3-11A and B, respectively. Automatic tracking operation permits the output voltages of two or more power supplies to be referenced to a common buss; one of the power supplies (master) controls the magnitude of the output voltage of the others (slaves) for a given position of the slave output voltage controls. The master must be the most negative power supply in the group. The output voltage of a slave is a percentage of the master output voltage. The output voltage controls of a slave determines this percentage. Turn-on and turn-off of the power supplies is controlled by the master. Remote sensing (para. 3-14) and programming (para. 3-17) can be used; however, the strapping patterns shown in figure 3-4 employ only local sensing and programming.

3-37. The value of the external resistors shown in figure 3-11 is determined by dividing the voltage difference between the master and the applicable slave by the programming current (nominally 5 ma; refer to para. 3-19). Finer adjustment of the slave output voltage can be accomplished using the slave output voltage controls. In order to maintain the temperature coefficient and stability specifications of the power supply, the external resistors should be stable, low-noise, low-temperature (less than 30 ppm per °C) resistors.

3-38. OPERATING CONSIDERATIONS

3-39. PULSE LOADING

3-40. The power supply will automatically cross over from constant voltage to constant current operation, or the reverse, in response to an increase (over the preset limit) in the output current or voltage, respectively. Although the preset limit may be set higher than the average output current or voltage, high peak currents or voltages (as occur in pulse loading) may exceed the preset limit and cause crossover to occur. To avoid this unwanted crossover, the preset limit must be set for the peak requirement and not the average.

3-41. OUTPUT CAPACITANCE

3-42. There are capacitors (internal) across the output terminals of the power supply. These capacitors help to supply high-current pulses of short duration during constant voltage operation. Any capacitance added externally will improve the pulse current capability, but will decrease the safety provided by the constant current circuit. A high-current pulse may damage load components before the average output current is large enough to cause the constant current circuit to operate.

3-43. The effects of the output capacitors during constant current operation are as follows:

- a. The output impedance of the power supply decreases with increasing frequency.
- b. The rise time of the output voltage is increased.
- c. A large surge current causing a high power dissipation in the load occurs when the load impedance is reduced rapidly.

3-44. NEGATIVE VOLTAGE LOADING

3-45. A diode is connected across the output terminals. Under normal operating conditions, the diode is reverse biased (anode connected to negative terminal). If a negative voltage is applied to the output terminals (positive voltage applied to negative terminal), the diode will conduct, shunting current across the output terminals and limiting the voltage to the forward voltage drop of the diode. This diode protects the filter and output electrolytic capacitors.

3-46. NEGATIVE CURRENT LOADING

3-47. Certain types of loads may cause current to flow into the power supply in the direction opposite to the output current. If the reverse current exceeds 0.1 ampere, preloading will be necessary. For example; if the load delivers 1 ampere to the power supply with the power supply output voltage at 18 vdc, a resistor equal to

18 ohms (18v/1a) should be connected across the output terminals. Thus, the 18 ohm resistor shunts the reverse current across the power supply. For more information on preloading, refer to paragraph C4 in the H-Lab Application Manual.

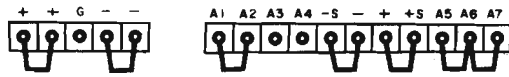

FIGURE 3-2. NORMAL STRAPPING PATTERN

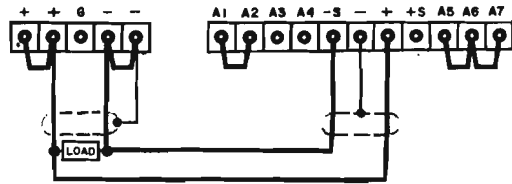

FIGURE 3-3. REMOTE SENSING STRAPPING PATTERN

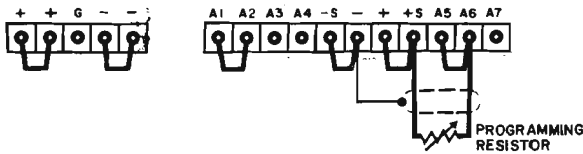

FIGURE 3-4. REMOTE RESISTANCE PROGRAMMING (CONSTANT VOLTAGE) STRAPPING PATTERN

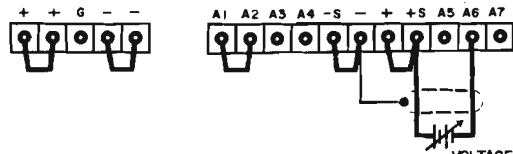

FIGURE 3-5. REMOTE VOLTAGE PROGRAMMING (CONSTANT VOLTAGE) STRAPPING PATTERN

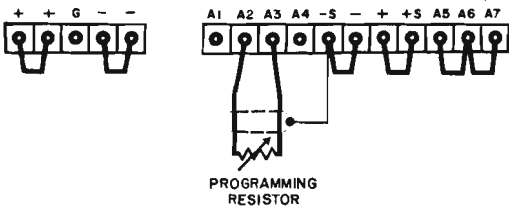

FIGURE 3-6. REMOTE RESISTANCE PROGRAMMING (CONSTANT CURRENT) STRAPPING PATTERN

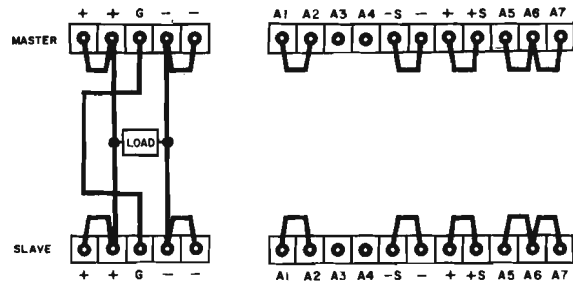
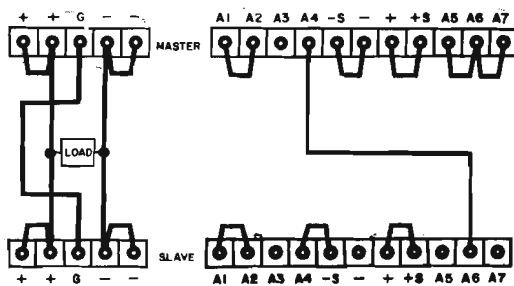
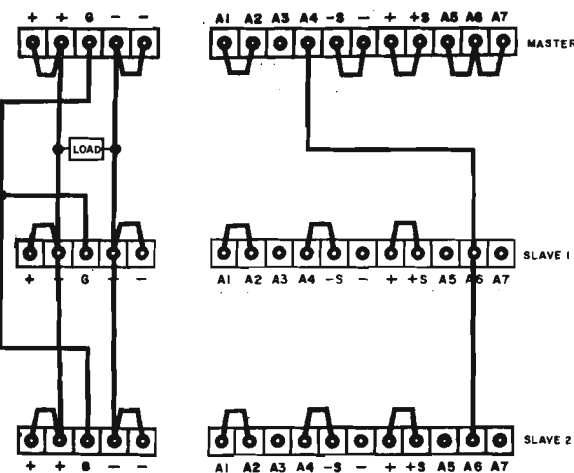

FIGURE 3-7. NORMAL PARALLEL STRAPPING PATTERN



A. TWO POWER SUPPLIES



B. THREE POWER SUPPLIES

FIGURE 3-8. AUTO-PARALLEL STRAPPING PATTERN

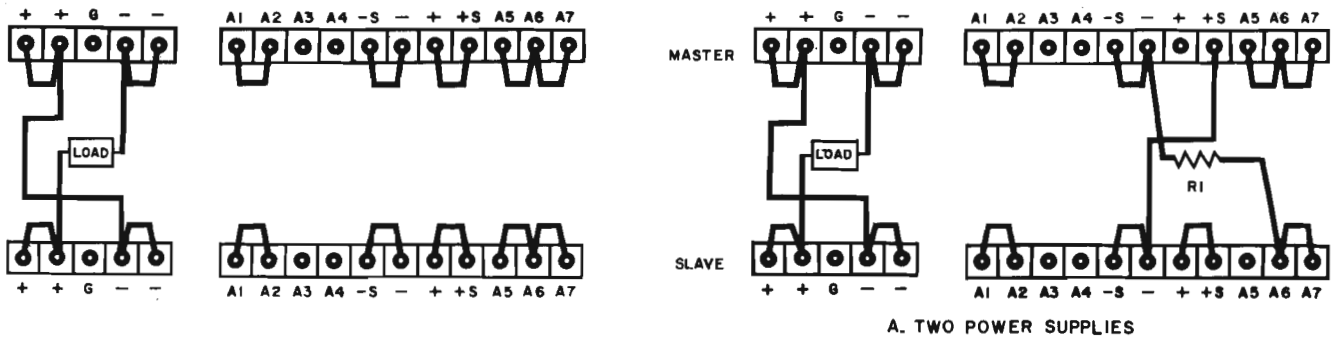

FIGURE 3-9. NORMAL SERIES STRAPPING PATTERN

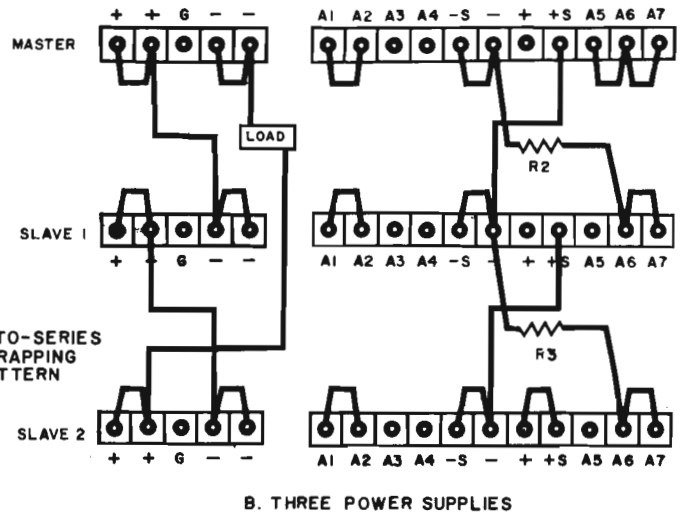

FIGURE 3-10. AUTO-SERIES STRAPPING PATTERN

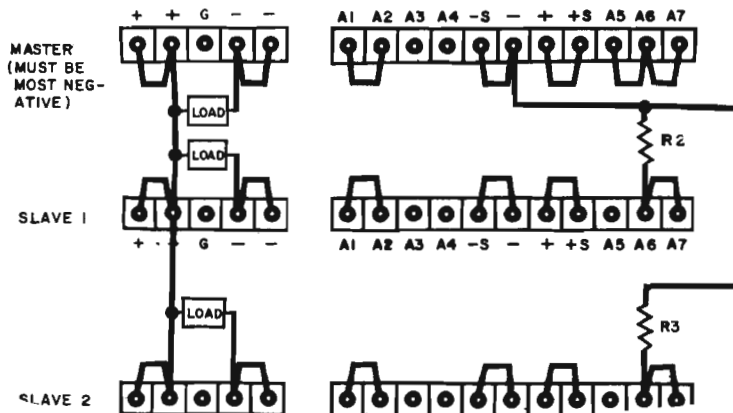
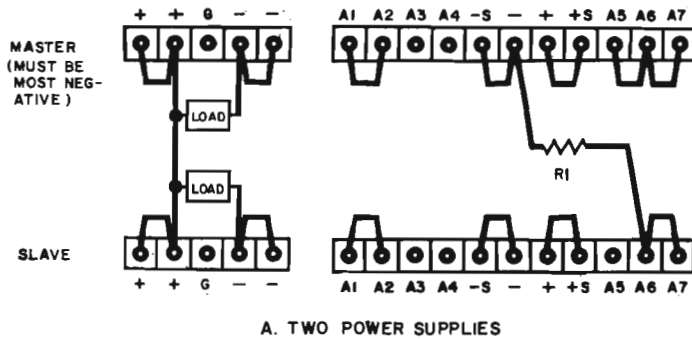

FIGURE 3-12. AUTO-TRACKING STRAPPING PATTERN

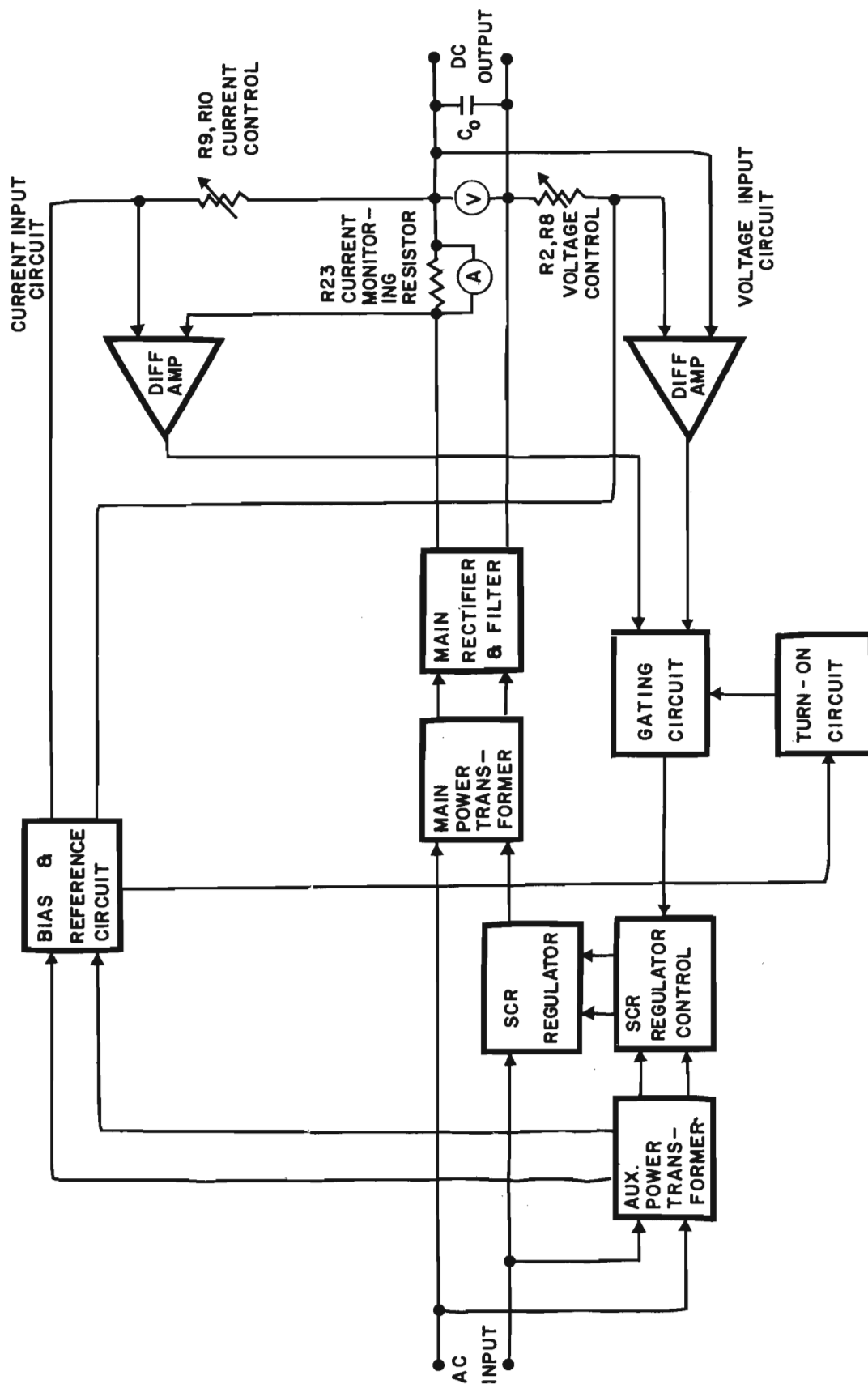

FIGURE 4-1. BLOCK DIAGRAM

SECTION IV

PRINCIPLES OF OPERATION

4-1. BLOCK DIAGRAM DESCRIPTION (See figure 4-1.)

4-2. The main power transformer isolates the ac input from the power supply and reduces it to the voltage level required. Rectification and filtering produces a smoothed dc output across the - and + terminals. A large capacitor (C_0) is connected across the - and + terminals for low ac output impedance and to help supply large pulse currents. An SCR regulator controls the ac input to provide good regulation of the dc output. The auxiliary power transformer powers the SCR regulator control circuit and the bias and reference circuit which produces dc bias and reference voltages for the power supply.

4-3. The SCR regulator is controlled by the SCR regulator control circuit which operates in response to signals developed by the voltage or current input circuit. A gating circuit assures that only one input circuit is used at a time.

4-4. The voltage and current input circuits operate in a similar manner. Each circuit has a differential amplifier that amplifies an error voltage that is proportional to the difference between the actual output and the programmed output. The programmed output is determined by the resistance of the programming resistors (voltage and current controls). Each programming resistor has a constant current through it which is maintained by the bias and reference circuit.

4-5. The voltage input circuit differential amplifier detects the error voltage that is proportional to the difference between the voltage across its programming resistors (R2-R8) and the dc output voltage. The error voltage is amplified and passed through the gating circuit to the SCR regulator control which triggers the SCR regulator. The SCR regulator increases or decreases the ac input voltage to the main power transformer as required to maintain a constant load voltage that is equal to the programmed voltage. In constant voltage operation, the gating circuit is biased to inhibit the input from the current input circuit.

4-6. The current input circuit differential amplifier detects the error voltage that is proportional to the difference between the voltage across its programming resistors (R9-R10) and the voltage across current monitoring resistor R23. The voltage across R23 is proportional to the load current. The SCR regulator responds to the amplified error voltage by increasing or decreasing the ac input current to the main power transformers as required to maintain a constant load current. In constant current operation, the gating circuit is biased to inhibit the input from the voltage input circuit.

4-7. To prevent overvoltage and excessive surge current when the power supply is turned-on, the turn-on circuit establishes initial conditions in the gating circuit. The turn-on circuit is activated by the bias and reference circuit when the power supply is turned-off.

4-8. A voltmeter is connected across the - and + terminals to monitor the output voltage. An ammeter is connected across current monitoring resistor R23 to monitor the output current (proportional to voltage across R23).

4-9. CIRCUIT DESCRIPTION (See figure 4-2 at back of manual.)

4-10. AC INPUT

4-11. The 105-125 vac, 57-63 cps, single phase input is applied to transformer T2 and to the series combination of transformer T1 and SCR's CR17 and CR18 which are in parallel opposition. The SCR's are used to regulate the dc output by controlling the average value of the ac input to transformer T1. Capacitors C11 and C12 smooth transients to prevent the SCR's from being triggered by a rapidly changing voltage from anode to cathode. Resistor R21 damps oscillations that may occur due to resonance of C12 and the leakage inductance of T1. The leakage inductance of T1 limits the peak input current.

4-12. DC OUTPUT

4-13. The output of the secondary of transformer T1 is full-wave rectified by bridge rectifier CR19 through CR22 and filtered by pi-section filter C13, C17, and L1. Resistor R29 damps the parallel resonance of L1 and C17. The dc output is regulated to a constant value by the SCR's in the ac input line. Capacitor C17 is the output capacitor. Diode CR23 is connected across the filtered dc output to protect the power supply from reverse voltage applied to the output terminals. Resistor R23 is the current monitoring resistor; the full load current flows through it. Resistors R25 and R27 are used to calibrate the voltmeter and ammeter, respectively.

4-14. VOLTAGE INPUT

4-15. GENERAL. The voltage input circuit is basically a differential amplifier (Q1-Q2) that detects any voltage difference between the programmed output voltage and the actual output voltage. The differential amplifier output voltage varies in proportion to the power supply output voltage variation.

4-16. Q2 INPUT. Voltage divider R6-R47 maintains a slightly negative base bias to ensure that the output voltage can be programmed to zero. The output of Q2 is emitter-coupled (resistor R4) to Q1.

4-17. Q1 INPUT. There are three inputs to the base of Q1; one determined by the programmed voltage (voltage controls R2-R8), the second determined by the collector voltage of Q1 (negative feedback), and the third is from the positive side of the main rectifier. The collector current of Q1 is determined by the difference between its base and emitter inputs. This difference is an error voltage that is proportional to the difference between the programmed output voltage and the actual output voltage. The negative feedback from collector to base (C4, and R17-R18 in parallel) improves the stability of the voltage-regulating feedback loop.

4-18. The input from the positive side of the main rectifier (C1 and R1) improves loop stability by making the differential amplifier insensitive to output voltage variations of four cps or greater. Below four cps this input is negligible. This input is necessary because the phase shift of the pi-section output filter begins to become excessive over four cps. Resistors R1 and R5 are arranged so that the four cps input is isolated from the negative feedback input; and so that necessary impedance levels are obtained looking out from the base of Q1. The collector output of Q1 is coupled to the gating circuit.

4-19. CLAMPING. In order to protect the differential amplifier, the base of Q1 is clamped with respect to -S by diodes CR1 and CR2 to prevent excessive base voltage in either direction. Diode CR1 clamps the base to approximately -0.7 vdc; CR2 and the base-emitter junction of Q1 clamp the base to approximately +1.4 vdc. Zener diode VR1 clamps the programming terminals to prevent an excessive error signal that would cause excessive output voltage. This would occur, for example, if the programming terminals were opened accidentally. To prevent overshoot when the power supply switches from constant current to constant voltage, diodes CR9 and CR10 clamp the collector of Q1. Resistor R30 provides a small bleed current for CR10.

4-20. CURRENT INPUT

4-21. GENERAL. The current input circuit is basically a differential amplifier (Q8-Q9) that detects any current difference between the programmed output current (proportional to voltage across current controls) and the actual output current (proportional to voltage across current monitoring resistor R23). The differential amplifier output voltage varies in proportion to the output current variation.

4-22. Q8-Q9 INPUT. The input to the differential amplifier (across bases of Q8-Q9) is the voltage difference across current controls R9-R10 and current monitoring resistor R23. Because the programming current is constant in constant current operation, the voltage input to the differential amplifier varies as the load current through R23 (error voltage). Capacitors C6 and C24 and resistor R22 provide gain roll-off at high frequencies. Diode CR26 clamps the voltage (0.7 vdc) across the emitter-base junction of Q9 and R20. This clamping action prevents excessive reverse base voltage in Q9 when very large load current is drawn (output terminals shorted). To prevent overshoot when the power supply switches from constant voltage to constant current operation, diodes CR10 and CR12 clamp the collector of Q8.

4-23. Q8-Q9 OUTPUT. Resistor R13 is the collector load for Q8. The collector output of Q8 is coupled to the gating circuit. Voltage divider R20-R46 biases the base of Q9 and maintains a slightly negative base bias to ensure that the output current can be programmed to zero. Resistor R44 provides positive feedback to improve load regulation during constant current operation.

4-24. GATING CIRCUIT

4-25. Transistor Q4 draws current from the SCR control circuit (capacitor C25). The magnitude of this current is determined by either the voltage or current input circuit. For constant voltage operation, diode CR7 is forward biased to permit the voltage input circuit to drive Q4; diode CR8 is reverse biased to inhibit the input from the current input circuit. For constant current operation, the reverse occurs.

4-26. To prevent transients in the dc output when the power supply is turned-on, the turn-on of Q4 is delayed by capacitor C2 which charges through R12, R15 and CR5. When C2 charges sufficiently to reverse bias CR5, all the current through R15 flows to the base of Q4 to turn it on. This base current is controlled by the voltage or current input circuits via CR7 or CR8, respectively. For example, during constant voltage operation the collector voltage of Q1 (voltage input) forward biases CR7 (CR8 reverse biased by Q8), the current through CR7 will vary as Q1 collector voltage varies and thus vary Q4 base current; therefore, the collector current of Q4 is controlled by the voltage input. In a similar manner, the current input circuit controls the collector current of Q4 during constant current operation.

4-27. TURN-ON CIRCUIT

4-28. Transistor Q3 provides a path for rapidly discharging C2 (in gating circuit) when the power supply is turned-off. This assures that C2 is discharged if the power supply is turned-on shortly after turn-off. The purpose of having C2 discharged each time the power supply is turned-on is to maintain the same time delay in the turn-on of the gating circuit (refer to para. 4-26).

4-29. SCR REGULATOR CONTROL (See waveshapes on figure 4-2.)

4-30. GENERAL. The SCR regulator control is basically a blocking oscillator (Q7 and T3) that applies pulses to the SCR regulator in response to error signals detected by the voltage or current input circuit. When transistor Q7 conducts, the pulse developed in winding 1-2 of transformer T3 is coupled to the base of Q7 (positive feedback) and to the SCR regulator (CR17 and CR18). Capacitor C27 charges in opposition to the feedback voltage and cuts off Q7. The charge time of C27 determines the pulse duration in the collector of Q7 (approximately 20 microseconds). The 35-vdc bias supplies current through R52, CR46, and CR44 to discharge C27 after Q7 stops conducting.

4-31. GATE INPUT. Throughout the operation of the blocking oscillator, capacitor C25 supplies most of the collector current for Q4 in the gating circuit (refer to para. 4-25). The amount of current pulled from C25 by Q4 is determined by the input (from the voltage or current input circuit) to the gating circuit. As a result of this current flow from C25, the voltage across C25 increases negatively with respect to the 6.0-vdc bias and has a waveshape that approximates a linear ramp. Thus, the slope of this ramp is determined by the voltage or current input circuit. Due to the time delay in the feedback loop, the slope of the ramp is constant for a half cycle of the ac input. The voltage on C25 is the emitter bias (forward bias when negative) for Q7 and therefore helps determine the point at which Q7 conducts.

4-32. AC INPUT. The ac input to transformer T2 is stepped-down and full-wave rectified by bridge rectifier CR39 through CR43. The output of the bridge rectifier is a negative-going pulsating dc (120 cps). Voltage divider R50-R51 supplies a portion of this pulsating dc through C27 to the base of Q7; thus, the base is reverse biased.

4-33. FIRING. A point is reached during each cycle of the 120-cps pulsating dc (each half cycle of the 60-cps ac input) when the reverse bias on the base and the forward bias (capacitor C25) on the emitter of Q7 are equal, and therefore Q7 has zero bias. As the ramp voltage across C25 goes more negative than the base voltage, the base-emitter junction of Q7 begins to become forward biased. When the emitter is more negative than the base by approximately 0.5 volts, Q7 conducts. The firing point of Q7 is therefore determined by both the dc output error and the line voltage change. Because Q7 saturates when it conducts, the collector voltage approximates a rectangular wave with a negative going pulse width of approximately 20 microseconds (determined by C27 and R51). The conduction of Q7 charges C25 in the positive direction (clamped by CR49). When Q7 stops conducting, the ramp across C25 begins again. However, Q7 is held cut-off by the charge on C27.

4-34. INITIAL CONDITIONS. At the beginning of each cycle of the 120-cps pulsating dc, certain initial conditions must be established on capacitors C25 and C27. When the negative-going pulsating dc is at the end of its cycle (C27 negatively charged earlier in the cycle by the feedback voltage), CR44 and CR45 become forward biased and current flows from the 35-vdc bias through R52, CR46, and CR44 to discharge C27 to approximately zero volts and through R52, CR46, and CR45 to charge C25 to approximately 0.7 volts (clamped by CR49). This discharge and charge occurs rapidly, so that it is completed before the next cycle begins and Q7 can conduct again. Diode CR47 provides another path for the current through CR44 so that the voltage to which C27 discharges remains predictable. As the negative-going pulsating dc increases in the next cycle, CR44 and CR45 become reverse biased.

4-35. BRIDGE RECTIFIER. At the zero cross-over region of the voltage waveform on secondary winding 3-4 of transformer T2, the voltage is insufficient to forward bias the rectifiers in the bridge. In order to maintain definition between the end of one cycle of the rectified output and the beginning of the next cycle, diode CR41 provides approximately 0.7 volts at the rectified output. The current for CR41 is supplied through CR46. As the voltage across the secondary winding moves away from the zero cross-over region, CR41 becomes reverse biased.

4-36. TRANSIENTS, DECOUPLING AND PROTECTION. Transients in the pulsating dc are reduced by R56 and C28. The base of Q7 is decoupled by C3. The voltage spike in the collector of Q7, induced by secondary winding 1-2 of transformer T3 when Q7 cuts-off, is clamped by CR48. The collector is decoupled by R53 and C26.

4-37. SCR REGULATOR

4-38. GENERAL. The SCR regulator (CR17 and CR18) controls the ac input voltage and current to main power transformer T1 in response to the voltage and current error signals. In constant voltage operation, the ac input voltage to T1 is adjusted so that the output voltage remains constant with changing loads. In constant current operation, the ac input current to T1 is adjusted so that the output current remains constant with changing loads and the output voltage is allowed to vary.

4-39. GATING. Each half cycle of the ac input, either CR17 or CR18 is forward biased. The pulse induced in secondary windings 5-6 and 7-8 of T3 by the SCR control, turns on the SCR that is forward biased when the pulse occurs. The other SCR is not affected by the gate pulse because it is reverse biased. A gate pulse occurs each half cycle of the ac input, unless the output is open. The timing of the gate pulse with respect to the ac input is determined by the error in the dc output via the loop action.

4-40. AC INPUT CONTROL. When an SCR is gated on, it conducts until its anode-to-cathode voltage goes to approximately zero. Thus, the earlier an SCR is gated on, the greater the portion of the ac input that will be applied to T1. Because of the leakage inductance of T1, the conduction of an SCR may extend into the next half cycle. The conduction period may be shortened at high output by the voltage across capacitor C13 through C16 being reflected back into the primary. By controlling the ac input to T1 each half cycle, the average value of the voltage or current at the output of bridge rectifier CR19 through CR21 is adjusted so that dc output voltage or current is maintained constant.

4-41. PROTECTION. Diodes CR50 and CR51 prevent anode induced reverse gate currents from being fed back to the control circuit. Resistors R54 and R55 limit current in the SCR gates.

4-42. BIAS AND REFERENCE CIRCUIT

4-43. GENERAL. The bias and reference circuit supplies three voltages (+35, +6.0, and -19.5 vdc) for internal power supply operation, and maintains the programming currents constant. The +35 vdc is not regulated. The -19.5 vdc, +6.0 vdc, and the programming currents are regulated.

4-44. +35 AND +6.0 VDC. The output of secondary winding 5-6 of transformer T2 is full-wave rectified by CR30 and CR31. Capacitors C20 and C21 each charge to the peak rectified voltage (voltage doubling). The +6.0 vdc (with respect to -S) is maintained by diodes CR6 and CR14 and by zener diode VR4. The +35 vdc includes the +6.0 vdc and the voltage across C21. The +6.0 vdc and the negative voltage across C20 provide the unregulated input to the -19.5 vdc regulator.

4-45. -19.5 VDC. For the -19.5 vdc, transistor Q10 is the error detector/amplifier. Zener diode VR3 and diode CR27 provide a reference voltage at the emitter of Q10. Voltage divider R35-R36 supplies an error voltage to the base of

Q10 which amplifies and applies it to the base of series regulator Q11. The base drive of Q11 adjusts the voltage across Q11 as required to compensate for the error in the -19.5 vdc. Resistor R37 sets the optimum current through temperature-compensated zener diode VR3. Resistor R45 improves the line regulation. Resistor R56 reduces power dissipation in Q11. Capacitor C22 stabilizes the loop.

4-46. PROGRAMMING CURRENTS. Each programming current is held constant in a similar manner. The voltage across emitter resistors R38 and R40 is held constant by VR3, CR27, and the base-emitter drop of each transistor. Thus, the emitter current in each transistor is constant and therefore the collector currents are nearly constant. The collector currents of Q5 and Q6 are the constant voltage and constant current programming currents, respectively. Resistors R39 and R41 are used for trimming. Resistors R42 and R43 are collector loads. Diode CR28 clamps the collector of Q5 to protect against excessive positive voltage (breakdown) which might occur if the voltage controls are reduced to zero rapidly (positive dc output voltage would appear at collector).

Table 5-1. Test Equipment

Type	Required Characteristics	Use	Recommended Model
Differential Voltmeter	Sensitivity: 1 mv full scale (min.) Input impedance: 10 megohms	Measure regulation and dc voltages; calibrate meters	HP 741A (See note 1)
AC Voltmeter	Accuracy: 2% Sensitivity: 1 mv full scale (min.)	Measure ac voltages and ripple	HP 403B
Variable Voltage Transformer	Range: 90-130 volts Equipped with voltmeter accurate within 1 volt	Vary and measure ac input voltage	-----
Oscilloscope	Sensitivity: 5mv/cm (min.) Differential input	Measure ripple and transient response	HP 130C
Battery	32 vdc	Measure transient response	-----
Switch	10 -ampere capacity	Transient response; Constant current load regulation;	-----
Resistor	3.2 ohm, $\pm 5\%$, 320 w	Load resistor	Rex Rheostat (See note 2)
Resistor	5 milliohms, 10 amperes, 4 terminals	Current monitoring	Any 50 mv, 10 ampere meter shunt
Resistor	1,000 ohms, $\pm 1\%$, 2 w non-inductive	Measure impedance	-----
Resistor	300 ohms, $\pm 5\%$, 10 w	Measure impedance	-----
Capacitor	500 μ fd, 50 vdcw	Measure impedance	-----
Oscillator	Range: 1 cps to 100 kc Accuracy: 2% Output: 10 vrms	Measure impedance	HP 202C

Table 5-1. Test Equipment (cont.)

Type	Required Characteristics	Use	Recommended Model
Controlled-temperature oven	Range: 0-50°C	Measure temperature stability	-----
Resistance box	Range: 0- 6,400 ohms Accuracy: 0.1% plus 1 ohm Make-before-break contacts	Measure programming coefficients	H-Lab 6931A

NOTE 1

A satisfactory substitute for a differential voltmeter is to arrange a reference voltage source and null detector as shown in figure 5-1. The reference voltage source is adjusted so that the voltage difference between the supply being measured and the reference voltage will have the required resolution for the measurement being made. The voltage difference will be a function of the null detector that is used. For measurements at the base of transistor Q4, a null detector with input impedance of 10 megohms or greater is required. Otherwise, satisfactory null detectors are: HP 405AR digital voltmeter, HP412A dc voltmeter, HP 419A null detector, a dc coupled oscilloscope utilizing differential input, or a 50 mv meter movement with a 100 division scale. A 2 mv change in voltage will result in a meter deflection of four divisions.

CAUTION

Care must be exercised when using an electronic null detector in which one input terminal is grounded to avoid ground loops and circulating currents.

NOTE 2

To obtain 3.2 ohms, connect rheostat across output terminals, turn front-panel CURRENT controls fully clockwise (maximum), adjust front-panel VOLTAGE controls for 32 vdc and adjust rheostat until output current is 10 amperes.

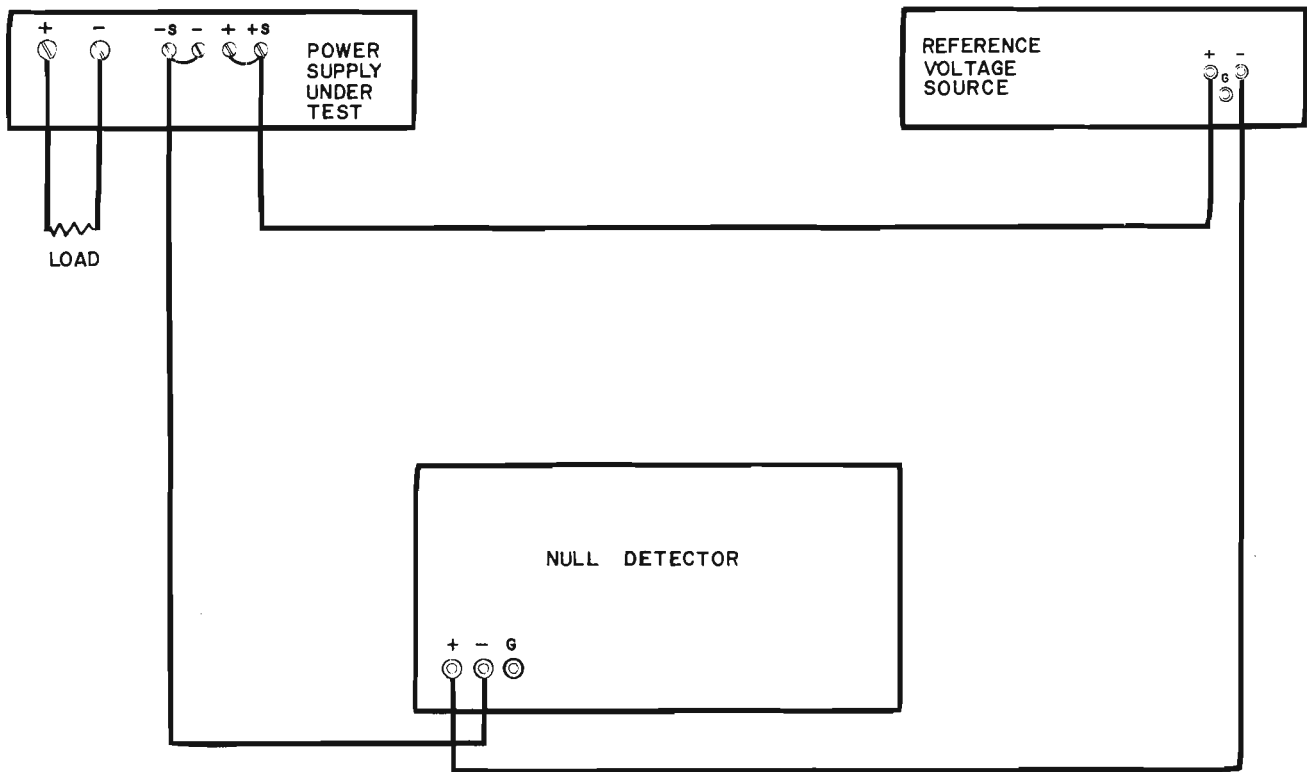

FIGURE 5-1. DIFFERENTIAL VOLTMETER SUBSTITUTE, TEST SETUP

SECTION V
MAINTENANCE

5-1. GENERAL

5-2. Table 5-1 lists the type of test equipment, its required characteristics, its use, and a recommended model for performing the instructions given in this section. Upon receipt of the power supply, the performance check (para. 5-7) should be made. This check is suitable for incoming inspection. Additional specification checks are given in paragraphs 5-24 through 5-36. If a fault is detected in the power supply while making the performance check or during normal operation, proceed to the troubleshooting procedures (para. 5-39). After troubleshooting and repair (para. 5-50), perform any necessary adjustments and calibrations (para. 5-51). Before returning the power supply to normal operation, repeat the performance check to ensure that the fault has been properly corrected and that no other faults exist. Before doing any maintenance checks, turn-on power supply, allow a half-hour warm-up, and read the measurement techniques (para. 5-3).

5-3. MEASUREMENT TECHNIQUES

5-4. A measurement made across the load includes the effect of the impedance of the leads connecting the load; these leads can have an impedance several orders of magnitude greater than the output impedance of the power supply. When measuring the output voltage of the power supply, use the -S and +S terminals.

5-5. For output current measurements, the current monitoring resistor should be a four-terminal resistor. The four terminals are connected as shown in figure 5-2.

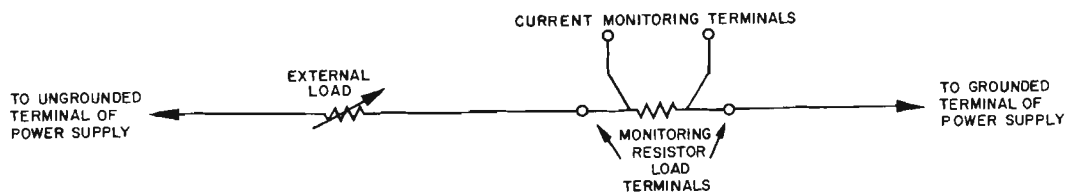

Figure 5-2. Output Current Measurement Technique

5-6. When using an oscilloscope, ground one terminal of the power supply and ground the case at the same ground point. Make certain that the case is not also grounded by some other means (power line). Connect both oscilloscope input leads to the power supply ground terminal and check that the oscilloscope is not exhibiting a ripple or transient due to ground loops, pick-up, or other means.

5-7. PERFORMANCE CHECK

5-8. GENERAL

5-9. The performance check is made using a 115-volt, 60-cps, single-phase input power source. The performance check is normally made at a constant ambient room temperature. The temperature range specification can be verified by doing the performance check at a controlled temperature of 0°C and at a controlled temperature of 50°C. If the correct result is not obtained for a particular check, do not adjust any controls; proceed to troubleshooting (para. 5-39).

5-10. RATED OUTPUT AND METER ACCURACY

5-11. CONSTANT VOLTAGE. Proceed as follows:

- a. Connect the 3.2-ohm load resistor across the output terminals and the differential voltmeter across the -S and +S terminals.
- b. Turn front-panel CURRENT controls fully clockwise (maximum).
- c. Turn front-panel VOLTAGE controls until front-panel voltmeter indicates 32.0 vdc.
- d. The differential voltmeter should indicate 32.0 ± 0.64 vdc.

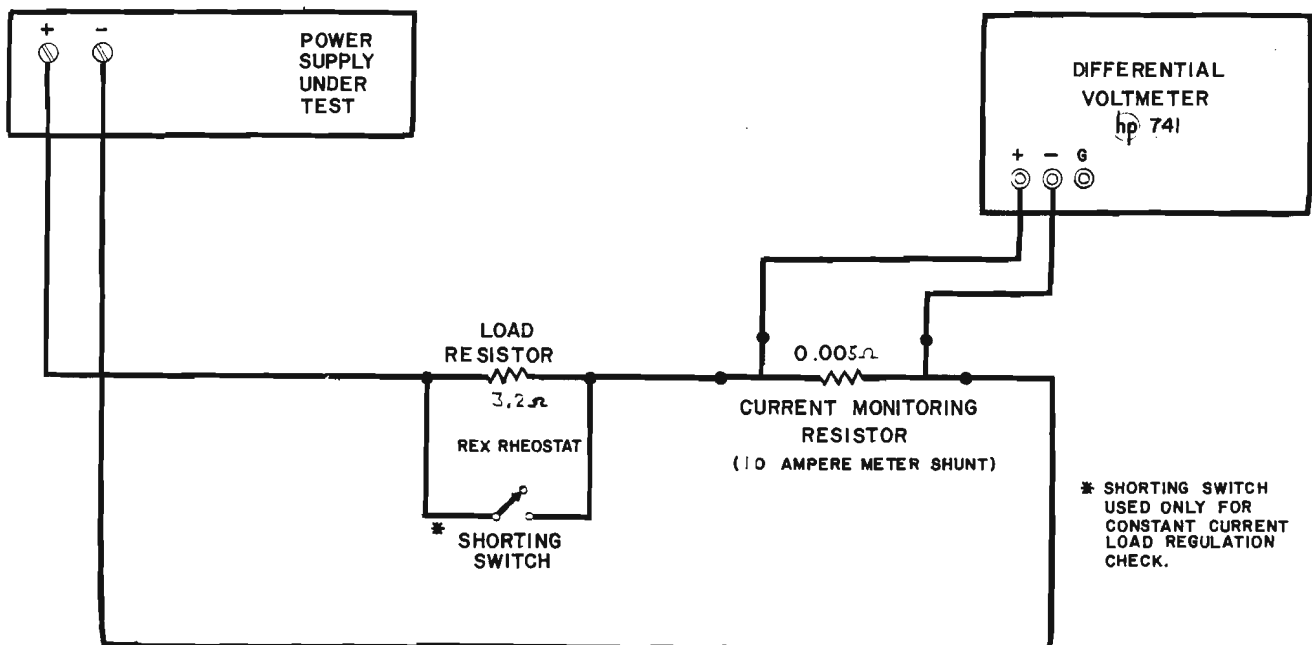

FIGURE 5-3. CONSTANT CURRENT TEST-SETUP

5-12. CONSTANT CURRENT. Proceed as follows:

- a. Connect test setup shown in figure 5-3.
- b. Turn front-panel VOLTAGE controls fully clockwise (maximum).
- c. Turn front-panel CURRENT controls until front-panel ammeter indicates 10 amperes.
- d. The differential voltmeter should indicate 50 ± 1.0 mvdc.

5-13. LINE REGULATION

5-14. CONSTANT VOLTAGE. Proceed as follows:

- a. Connect the 3.2-ohm load resistor across the output terminals and the differential voltmeter across the -S and +S terminals.
- b. Turn front-panel CURRENT controls fully clockwise (maximum).
- c. Connect the variable voltage transformer between the input power source and the power supply power input. Adjust the variable voltage transformer to 105 vac.
- d. Turn front-panel VOLTAGE controls until the differential voltmeter indicates 32.0 vdc.
- e. Adjust the variable voltage transformer to 125 vac.
- f. Differential voltmeter indication should change by less than 10 mvdc.

5-15. CONSTANT CURRENT. Proceed as follows:

- a. Connect test setup shown in figure 5-3.
- b. Turn front-panel VOLTAGE controls fully clockwise (maximum).
- c. Connect the variable voltage transformer between the input power source and the power supply power input. Adjust the variable voltage transformer to 105 vac.
- d. Turn front-panel CURRENT controls until front-panel ammeter indicates 10 amperes.
- e. Record voltage indicated on differential voltmeter
- f. Adjust the variable voltage transformer to 125 vac.
- g. Differential voltmeter indication should change by less than 0.5 mvdc.

5-16. LOAD REGULATION

5-17. CONSTANT VOLTAGE. Proceed as follows:

- a. Connect the 3.2-ohm load resistor across the output terminals and the differential voltmeter across the -S and +S terminals.
- b. Turn front-panel CURRENT controls fully clockwise (maximum).
- c. Turn the front-panel VOLTAGE controls until front-panel ammeter indicates 10 amperes.
- d. Record voltage indicated on differential voltmeter.
- e. Disconnect load resistor.
- f. Differential voltmeter indication should change by less than 20 mvdc.

5-18. CONSTANT CURRENT. Proceed as follows:

- a. Connect test setup shown in figure 5-3.
- b. Turn front-panel VOLTAGE controls fully clockwise (maximum).
- c. Turn front-panel CURRENT controls until front-panel ammeter indicates 10 amperes.
- d. Record voltage indicated on differential voltmeter.
- e. Close the shorting switch.
- f. Differential voltmeter indication should change by less than 0.5 mvdc.

5-19. RIPPLE AND NOISE

5-20. Proceed as follows:

- a. Connect the 3.2-ohm load resistor across the output terminals and the ac voltmeter across the -S and +S terminals.
- b. Turn front-panel CURRENT controls fully clockwise (maximum).
- c. Connect the variable voltage transformer between the input power source and the power supply power input. Adjust the variable voltage transformer to 125 vac.
- d. Turn front-panel VOLTAGE controls until front-panel ammeter indicates 10 amperes.
- e. The ac voltmeter should indicate less than 32 mvrms.

5-21. TRANSIENT RECOVERY TIME

5-22. Proceed as follows:

- a. Connect test setup shown in figure 5-4.
- b. Turn front-panel CURRENT controls fully clockwise (maximum).
- c. Turn front-panel VOLTAGE controls until front-panel ammeter indicates 10 amperes.
- d. Open and close the switch several times and observe the oscilloscope display.
- e. Oscilloscope display should be as shown in figure 5-5.

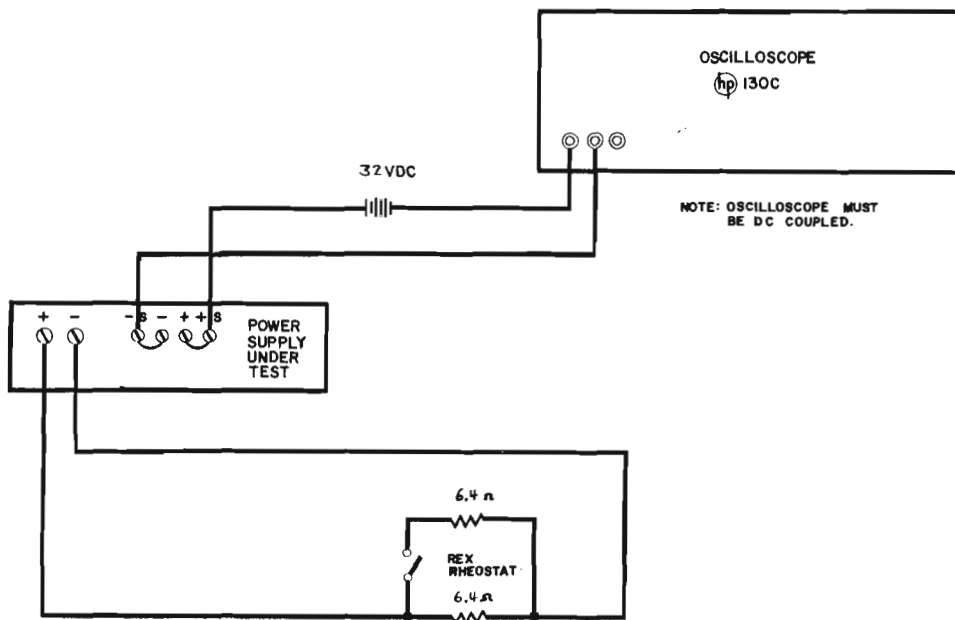

FIGURE 5-4 TRANSIENT RECOVERY TIME, TEST SETUP

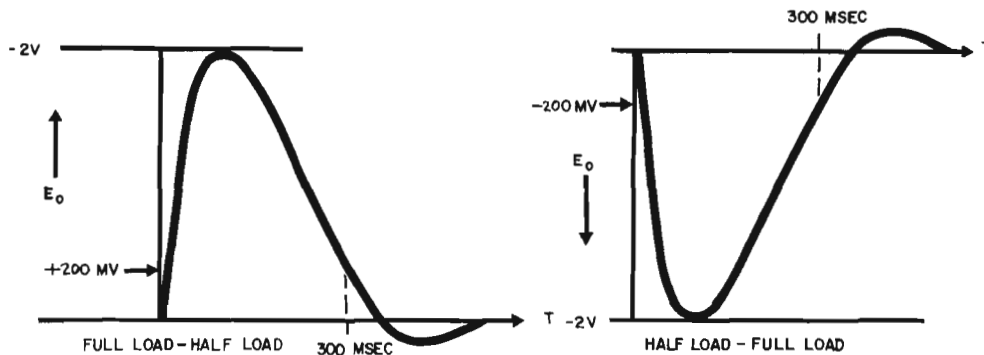

FIGURE 5-5. TRANSIENT RECOVERY TIME, WAVEFORM

5-23. ADDITIONAL SPECIFICATION CHECK

5-24. TEMPERATURE COEFFICIENT

5-25. CONSTANT VOLTAGE. Proceed as follows:

a. Connect the 3.2-ohm load resistor across the output terminals and the differential voltmeter across the -S and +S terminals.

b. Turn front-panel CURRENT controls fully clockwise (maximum).

c. Turn front-panel VOLTAGE controls until the differential voltmeter indicates 32 vdc.

d. Insert the power supply into the controlled-temperature oven (differential voltmeter and load remain outside oven). Set the temperature to 30°C and allow a half-hour warm-up.

e. Record the differential voltmeter indication.

f. Raise the temperature to 40°C and allow a half-hour warm-up.

g. Differential voltmeter indication should change by less than 240 mvdc from indication recorded in step e.

5-26. CONSTANT CURRENT. Proceed as follows:

a. Connect test setup shown in figure 5-3.

b. Turn front-panel VOLTAGE controls fully clockwise (maximum).

c. Turn front-panel CURRENT controls until the differential voltmeter indicates 50 mvdc.

d. Insert the power supply into the controlled-temperature oven (differential voltmeter and load remain outside oven). Set the temperature to 30°C and allow a half-hour warm-up.

e. Record the differential voltmeter indication.

f. Raise the temperature to 40°C and allow a half-hour warm-up.

g. Differential voltmeter indication should change by less than 1.5 mvdc from indication recorded in step e.

5-27. OUTPUT STABILITY

5-28. CONSTANT VOLTAGE. Proceed as follows:

- a. Connect the 3.2-ohm load resistor across the output terminals and the differential voltmeter across the -S and +S terminals.
- b. Turn front-panel CURRENT controls fully clockwise (maximum).
- c. Turn front-panel VOLTAGE controls until the differential voltmeter indicates 32 vdc.
- d. allow a half-hour warm-up and then record the differential voltmeter indication.
- e. After eight hours, the differential voltmeter indication should change by less than 72 mvdc from indication recorded in step d.

5-29. CONSTANT CURRENT. Proceed as follows:

- a. Connect test setup shown in figure 5-3.
- b. Turn front-panel VOLTAGE controls fully clockwise (maximum).
- c. Turn front-panel CURRENT controls until the differential voltmeter indicates 50 mvdc.
- d. Allow a half-hour warm-up and then record the differential voltmeter indication.
- e. After eight hours, the differential voltmeter indication should change by less than 0.5 mvdc.

5-30. REMOTE PROGRAMMING

5-31. CONSTANT VOLTAGE. Proceed as follows:

- a. Turn-off power supply and arrange rear terminal strapping pattern for constant voltage remote programming as shown in figure 3-4; use the resistance box (set to 2,000 ohms) for the remote programming resistance. (Refer to para. 3-17 through 3-21.)
- b. Connect the 3.2-ohm load resistor across the output terminals and the differential voltmeter across the -S and +S terminals.
- c. Turn front-panel CURRENT controls fully clockwise (maximum).
- d. Turn-on power supply, allow a half-hour warm-up and then record the differential voltmeter indication.
- e. Increase the remote programming resistance in 200-ohm steps to 3,000 ohms; record the differential voltmeter indication at each step. The voltage indication should increase 1.0 ± 0.01 vdc at each step.

f. Set the remote programming resistance to 5,400 ohms and repeat step e until the remote programming resistance reaches 6,400 ohms.

g. Turn-off power supply and reconnect normal strapping pattern (figure 3-2).

5-32. CONSTANT CURRENT. Proceed as follows:

a. Turn-off power supply and arrange rear terminal strapping pattern for constant current remote resistance programming as shown in figure 3-6: use the resistance box (set to 75 ohms) for the remote programming resistance. (Refer to para. 3-18 and 3-23 through 3-25.)

b. Connect test setup shown in figure 5-3.

c. Turn front-panel VOLTAGE controls fully clockwise (maximum).

d. Turn-on power supply, allow a half-hour warm-up and then record the differential voltmeter indication.

e. Increase the remote programming resistance in 25-ohm steps to 125 ohms; record the differential voltmeter indication at each step. The voltage indication should increase 5.0 ± 0.5 mVdc, at each step.

f. Set the remote programming resistance to 200 ohms and repeat step e until the remote programming resistance reaches 250 ohms.

g. Turn-off power supply and reconnect normal strapping pattern (figure 3-2).

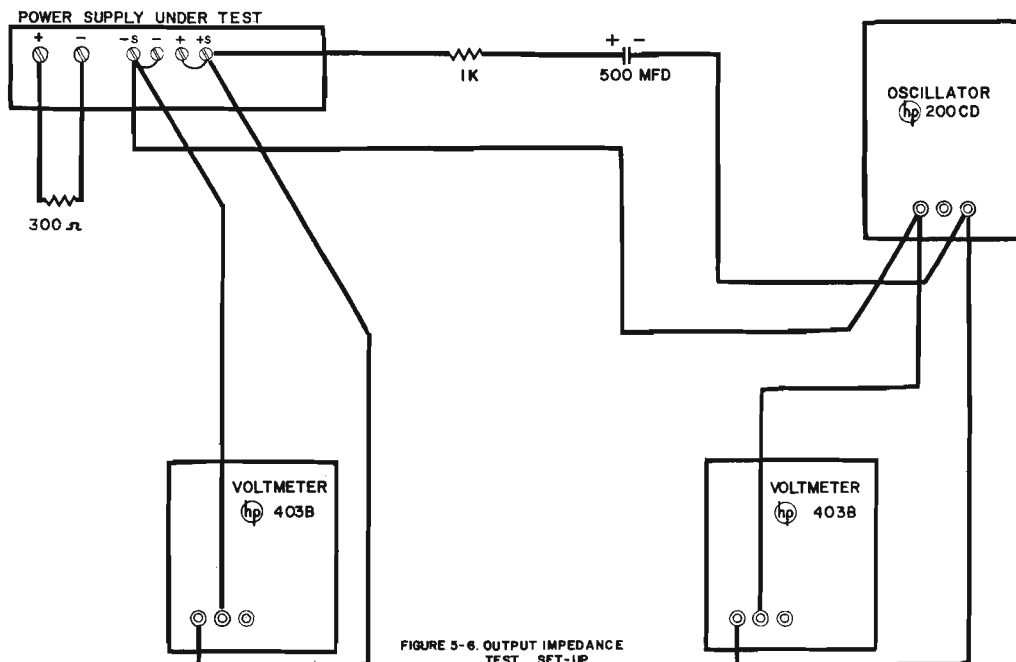

FIGURE 5-6. OUTPUT IMPEDANCE TEST SET-UP

5-33. OUTPUT IMPEDANCE

5-34. Proceed as follows:

- a. Connect test setup shown in figure 5-6.
- b. Turn front-panel CURRENT controls fully clockwise (maximum).
- c. Turn front-panel VOLTAGE controls until front-panel voltmeter indicates 16 vdc.
- d. Adjust the oscillator for a 10-vrms (E_{in}), 0.5-cps output.
- e. Calculate and record the output impedance using the following formula:

$$Z_{out} = E_O R / (E_{in} - E_O)$$

$R = 1,000$ ohms; E_O measured across power supply -S and +S terminals using ac voltmeter; E_{in} measured across oscillator output terminals using the ac voltmeter.

f. Using the formula given in step e, calculate and record the output impedance for oscillator frequencies of 100 cps, 1 kc, and 100 kc.

g. The output impedance calculated and recorded in steps e and f should fall into the following ranges:

- (1) dc to 0.5 cps; less than 0.01 ohm
- (2) 0.5 cps to 100 cps; less than 0.5 ohm
- (3) 100 cps to 1 kc; less than 0.2 ohm
- (4) 1 kc to 100 kc; less than 1.0 ohm

5-35. OUTPUT INDUCTANCE

5-36. Proceed as follows:

- a. Repeat steps a through c of para. 5-34.
- b. Adjust the oscillator for a 10-vrms (E_{in}), 10-kc output.
- c. Calculate and record the output inductance using the following formula:

$$L = X_L / 2\pi f$$

X_1 is the output impedance (Z_{out}) calculated in steps e and f of paragraph 5-34; f is the frequency of the oscillator (determines which Z_{out} is used).

NOTE

The equation assumes that $X_1 \gg R_{out}$ and therefore $X_1 = Z_{out}$.

d. Using the formula given in step c, calculate and record the output inductance for oscillator frequencies of 50 kc and 100 kc at 10 vrms.

e. The output inductance calculated in steps c and d should not exceed 1.0 microhenry.

5-37. COVER REMOVAL

5-38. The top and bottom covers are removed by removing both sets of six attaching screws.

5-39. TROUBLESHOOTING

5-40. GENERAL

5-41. If a fault in the power supply is suspected, remove the covers (para. 5-38) and visually inspect for broken connections, burned components, etc. If the fault is not detected visually, proceed to trouble analysis (para. 5-42). If the fault is detected visually or via trouble analysis, correct it and then do the performance check (para. 5-7). If a part is replaced, refer to repair and replacement (para 5-50) and to adjustments and calibrations (para. 5-51).

5-42. TROUBLE ANALYSIS

5-43. GENERAL. Before attempting trouble analysis, a good understanding of the principles of operation should be acquired by reading Section IV of this manual. Once the principles of operation are understood, logical application of this knowledge in conjunction with significant waveforms (on figure 4-2) and with normal voltage information (table 5-2) should suffice to isolate a fault to a part or small group of parts. As additional aids, the following are given:

a. Procedure for checking the bias and reference circuit. (Refer to para. 5-45.) Trouble in this circuit could show up in many ways because it supplies internal operating voltages for the power supply and the programming currents.

b. Procedures for checking the voltage feedback loop for the two most common troubles; high or low output voltage (para. 5-46 or 5-47, respectively).

c. Paragraph 5-48 which discusses common troubles.

5-44. A defective part should be replaced (refer to the parts list in Section VI). Test points called out in the procedures are identified on the schematic diagram (figure 4-2).

5-45. BIAS AND REFERENCE CIRCUIT. Proceed as follows:

a. Make an ohmmeter check to be certain that neither the positive nor negative terminal is grounded.

b. Turn front-panel VOLTAGE and CURRENT controls fully clockwise (maximum).

c. Turn-on power supply (no load connected).

d. Using the ac voltmeter, check voltage across secondary winding 5-6 of transformer T2. If voltage indication is not 23 ± 1.5 vrms, transformer T2 may be defective.

e. Using the differential voltmeter, proceed as instructed in table 5-3.

5-46. HIGH OUTPUT VOLTAGE. Proceed as follows:

a. Turn front-panel CURRENT controls fully clockwise (maximum).

b. Turn front-panel VOLTAGE controls to mid-position.

c. Turn-on power supply (no load connected).

d. Using the ac voltmeter, check voltage across test points ACC and 45. If voltage indication is less than 1.0 vdc, CR17 or CR18 may be shorted.

e. Using the differential voltmeter, check voltage across test points 33 and 36. If voltage is not 0.8 ± 0.12 vdc, check T2, CR39 through CR43, R50, and R51.

f. Using the differential voltmeter, proceed as instructed in table 5-4.

5-47. LOW OUTPUT VOLTAGE. Proceed as follows:

a. Turn front-panel CURRENT controls fully clockwise (maximum).

b. Disconnect anode or cathode of diode CR8.

c. Turn-on power supply (no load connected).

d. Turn front-panel VOLTAGE controls clockwise and observe the front-panel voltmeter to see if the 32 vdc output can be obtained. If it can, the probable cause of the low output voltage is one or more of the following:

- (1) CR8 shorted.
- (2) Q8 shorted.
- (3) Q9 open.
- (4) Q6 open.
- (5) R40, R43 open.

e. If the 32vdc output cannot be obtained in step d, reconnect diode CR8 and turn the front-panel VOLTAGE controls to mid-position.

f. Using the oscilloscope, check the following:

(1) Waveform across test points 31 (positive lead) and 33 (waveform on figure 4-2). If peak negative voltage is less than 15 volts, Q7, R53, CR48, C25, C26, or transformer T3 may be defective.

(2) Ripple waveform across test points 18 (positive lead) and 48 (waveform shown on figure 4-2). If waveform is correct (except for amplitude), proceed to step (3). If waveform is incorrect, proceed as follows:

(a) If the ripple waveform is half-wave (60 cps) instead of full-wave (120 cps), either SCR (CR17 or CR18) may be open or the applicable gate circuit for the SCR may be defective. To check the gate circuit, disconnect R54 or R55 (as applicable) and make an ohmmeter check from the open end of the resistor to test point ACC or 45 (as applicable). If the resistance is greater than 55 ohms, the gate circuit is defective.

(b) If the ripple waveform indicates that neither SCR has fired, CR17 or CR18 may be shorted.

(c) If there is no ripple waveform, both CR17 and CR18 may be open or T1 may be defective.

g. Using the differential voltmeter, proceed as instructed in table 5-5.

5-48. COMMON TROUBLES. Table 5-6 gives the symptoms, checks, and probable causes for common troubles. The checks should be made using a 115-volt, 60-cps, single-phase power input and the test equipment listed in table 5-1.

5-49. REPAIR AND REPLACEMENT

5-50. Before servicing etched circuit boards, refer to figure 5-7. After replacing a semiconductor device, refer to table 5-7 for checks and adjustments that may be necessary. If a check indicates a trouble, refer to paragraph 5-39. If an adjustment is necessary, refer to paragraph 5-51.

SERVICING ETCHED CIRCUIT BOARDS

Excessive heat or pressure can lift the copper strip from the board. Avoid damage by using a low power soldering iron (50 watts maximum) and following these instructions. Copper that lifts off the board should be cemented in place with a quick drying acetate base cement having good electrical insulating properties.

A break in the copper should be repaired by soldering a short length of tinned copper wire across the break.

Use only high quality rosin core solder when repairing etched circuit boards. NEVER USE PASTE FLUX. After soldering, clean off any excess flux and coat the repaired area with a high quality electrical varnish or lacquer.

When replacing components with multiple mounting pins such as tube sockets, electrolytic capacitors, and potentiometers, it will be necessary to lift each pin slightly, working around the components several times until it is free.

WARNING: If the specific instructions outlined in the steps below regarding etched circuit boards without eyelets are not followed, extensive damage to the etched circuit board will result.

1. Apply heat sparingly to lead of component to be replaced. If lead of component passes through an eyelet in the circuit board, apply heat on component side of board. If lead of component does not pass through an eyelet, apply heat to conductor side of board.

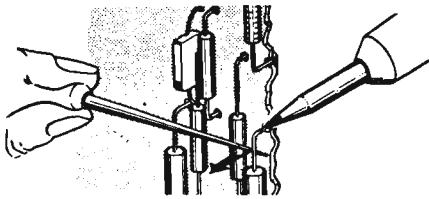

2. Reheat solder in vacant eyelet and quickly insert a small awl to clean inside of hole. If hole does not have an eyelet, insert awl or a #57 drill from conductor side of board.

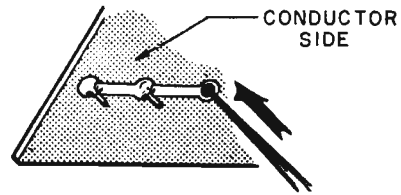

3. Bend clean tinned leads on new part and carefully insert through eyelets or holes in board.

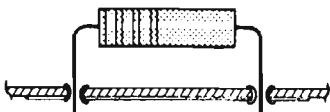

4. Hold part against board (avoid overheating) and solder leads. Apply heat to component leads on correct side of board as explained in step 1.

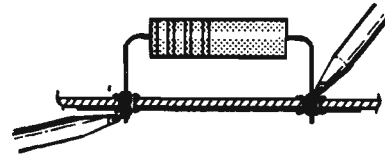

In the event that either the circuit board has been damaged or the conventional method is impractical, use method shown below. This is especially applicable for circuit boards without eyelets.

1. Clip lead as shown below.

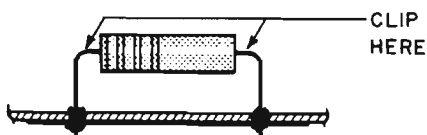

2. Bend protruding leads upward. Bend lead of new component around protruding lead. Apply solder using a pair of long nose pliers as a heat sink.

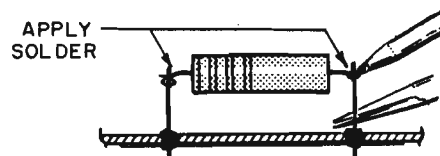

This procedure is used in the field only as an alternate means of repair. It is not used within the factory.

Figure 5-7. Servicing Etched Circuit Boards

5-51. ADJUSTMENTS AND CALIBRATIONS

5-52. GENERAL

5-53. Adjustments and calibrations may be required after performance testing (para. 5-7), additional specification testing (para. 5-23), troubleshooting (para. 5-39), or repair and replacement (para. 5-50). Test points called out in the procedures are identified on the schematic diagram (figure 4-2). If an adjustment or calibration cannot be performed, troubleshooting is required. Table 5-8 summarizes the adjustments and calibrations. The adjustments and calibrations are performed using a 115-volt, 60-cps, single-phase power input to the power supply.

5-54. METER ZERO

5-55. Proceed as follows:

- a. Turn-off power supply and allow 2 minutes for all capacitors to discharge.
- b. Rotate voltmeter zero-set screw (figure 3-1) clockwise until the meter pointer is to the right of zero and moving to the left towards zero. Stop when pointer is on zero. If the pointer overshoots zero, continue rotating clockwise and repeat this step.
- c. When the pointer is exactly on zero, rotate the zero-set screw counter-clockwise approximately 15 degrees to free the screw from the meter suspension. If pointer moves, repeat steps a through c.
- d. Repeat steps a through c for the ammeter.

5-56. VOLTMETER TRACKING

5-57. Proceed as follows:

- a. Connect the differential voltmeter across the -S and +S terminals.
- b. Turn front-panel VOLTAGE controls until the differential voltmeter indicates 32 vdc.
- c. Adjust R25 until the front-panel voltmeter indicates 32 vdc.

5-58. AMMETER TRACKING

5-59. Proceed as follows:

- a. Connect test setup shown in figure 5-3.
- b. Turn front-panel VOLTAGE controls fully clockwise (maximum).

c. Turn front-panel CURRENT controls until the differential voltmeter indicates 50 mvdc.

d. Adjust R27 until the front-panel ammeter indicates 10 amperes.

5-60. CONSTANT VOLTAGE PROGRAMMING CURRENT

5-61. Proceed as follows:

a. Connect a 6,400-ohm, 0.1%, 1/2 w resistor between terminals +S and A6 on the rear terminal strip of the power supply.

b. Disconnect the jumper between terminals A6 and A7.

c. Connect the resistance box in place of R39 (shunt).

d. Connect the differential voltmeter between the +S and -S terminals.

e. Adjust the resistance box until the differential voltmeter indicates 32 ± 0.16 vdc.

f. Choose resistor R39 (shunt) equal to the resistance required in step e.

5-62. ZERO VOLTAGE OUTPUT

5-63. Proceed as follows:

a. Connect a jumper between the +S and A7 terminals on the rear terminal strip of the power supply.

b. Connect the differential voltmeter between the +S and -S terminals.

c. Connect the resistance box in place of R6.

d. Adjust the resistance box so that the voltage indicated by the differential voltmeter is between zero and ± 10 mvdc.

e. Choose resistor R6 equal to the resistance value required in step d.

5-64. CONSTANT CURRENT PROGRAMMING CURRENT

5-65. Proceed as follows:

a. Connect test setup shown in figure 5-3.

b. Connect a 250 -ohm, 0.1%, 1/2w resistor between terminals A2 and A3 on the rear terminal strip of the power supply.

c. Disconnect the jumper between terminals A1 and A2.

- d. Connect the resistance box in place of R41 (shunt)
- e. Adjust the resistance box until the differential voltmeter indicates 50 ± 5.0 mvdc.
- f. Choose resistor R41 (shunt) equal to the resistance value required in step e.

5-66. ZERO CURRENT OUTPUT

5-67. Proceed as follows:

- a. Connect test setup shown in figure 5-3.
- b. Connect a jumper between the A1 and A3 terminals on the rear terminal strip of the power supply.
- c. Connect the resistance box in place of R20.
- d. Adjust the resistance box until the voltage indicated by the differential voltmeter is between zero and 0.1 mvdc.
- e. Choose resistor R20 equal to the resistance value required in step d.

NOTE

If the resistance value required is less than 7,000 ohms or greater than 17,000 ohms, change R46. Replace the original R20.

5-68. BIAS AND REFERENCE LINE REGULATION

5-69. Proceed as follows:

- a. Connect the variable voltage transformer between the input power source and the power supply power input. Adjust the variable voltage transformer to 105 vac.
- b. Connect the differential voltmeter between the +S and -S terminals.
- c. Connect the resistance box in place of R45.
- d. Turn front-panel VOLTAGE controls until the differential voltmeter indicates 32 vdc.
- e. Adjust the variable voltage transformer to 125 vac.

f. Adjust the resistance box until the voltage indicated by the differential voltmeter is within 18 mvdc of 32 vdc.

g. Choose resistor R45 equal to the resistance value required in step f.

NOTE

If the resistance value required is less than 20,000 ohms, troubleshooting is required. Replace the original R45.

5-70. LINE IMBALANCE

5-71. Proceed as follows:

a. Connect the 3.2-ohm load resistor across the output terminals.

b. Turn front-panel CURRENT controls fully clockwise (maximum).

c. Connect the variable voltage transformer between the input power source and the power supply power input. Adjust the variable voltage transformer to 125 vac.

d. Turn front-panel VOLTAGE controls until front-panel ammeter indicates 10 amperes.

e. Connect the oscilloscope across test points 18 and 48. Use internal sync.

f. Connect the resistance box in place of R17.

g. Adjust the resistance box until the oscilloscope display is similar to the waveform for test points 18-48 shown on figure 4-2.

h. Choose resistor R17 equal to the resistance value required in step f.

NOTE

If the resistance value required is less than 5,000 ohms, troubleshooting is required. Replace the original R17.

5-72. CONSTANT CURRENT LOAD REGULATION

5-73. Proceed as follows:

- a. Perform steps a through e of para. 5-18.
- b. Place a 10-megohm resistor in place of R44.
- c. Adjust the variable voltage transformer to 125 vac.
- d. Close the shorting switch.

e. Differential voltmeter indication should change by less than 0.5 mvdc. If voltage change is greater than 0.5 mvdc, reduce the 10-megohm resistor to 9 megohms, set the variable voltage transformer to 105 vac, open the shorting switch, record the differential voltmeter indication, and repeat steps c and d. Repeat this process, reducing the 10-megohm resistor in 1-megohm steps until the voltmeter change is less than 0.5 mvdc. Changes smaller than 1-megohm may be required to obtain the optimum resistance value for R44. Choose resistor R44 equal to the optimum resistance value required.

NOTE

If the resistance value required is less than 1 megohm, troubleshooting is required. Replace the original R44.

Table 5-2. Normal Voltage

From (+)	to (-)	Voltage	Typical Peak-to-Peak Values
-S	51	19.5 ±1.0 vdc	0.05 v
33	27	34.1 ±1.7 vdc	1.0 v
33	-S	6.0 ±0.3 vdc	0.1 v
40	33	33.0 ±1.7 vdc	0.6 v
24	51	10.3 ±0.6 vdc	---
22	51	9.7 ±0.5 vdc	---
21	51	9.7 ±0.5 vdc	---
23	22	7.1 ±0.7 vdc	---
20	21	3.1 ±0.3 vdc	---
39	38	0.81 ±0.1 vdc	---
51	27	6.6 ±2.0 vdc	1.0 v
33	12	3.7 ±0.6 vdc	---
26	27	0.59 ±0.1 vdc	---
-S	25	10.0 ±0.5 vdc	---
18	48	33.5 ±0.5 vdc	1.5 v
14	19	0.72 ±0.1 vdc	---
-S	A6	0.04 ±0.1 vdc	---
-S	8	0.45 ±0.07 vdc	---
10	-S	0.06 ±0.1 vdc	---
19	-S	0.82 ±0.1 vdc	---
15	19	1.14 ±0.2 vdc	---
33	16	1.0 ±0.5 vdc	---
40	32	7.0 ±1.1 vdc	---
33	36	0.8 ±0.1 vdc	---
41	42	46.0 ±2.3 vpp	---
28	33	66.0 ±3.3 vpp	---
33	38	14.0 ±1.4 vdc	---

NOTE

These measurements were made with a 115-volt, 60-cps, single-phase power input; the front-panel CURRENT controls fully clockwise (maximum); the front-panel VOLTAGE controls set for 32 vdc output; and the 3.2-ohm load resistor across the output terminals (10 amperes). Differential voltmeter HP 741A was used for all measurements.

Table 5-3. Bias and Reference Circuit Troubleshooting

Step	Meter Common	Meter Positive	Normal Indication	If Indication is not Normal, Check the Following Parts
1	33	40	33 \pm 1.7 vdc	CR31, C21
2	-S	33	6.2 \pm 0.3 vdc	CR6, CR14, VR4
3	27	33	34.1 \pm 1.7 vdc	CR30, C20
4	51	-S	19.5 \pm 1.0 vdc	Q10, Q11
5	51	24	10.3 \pm 0.6 vdc	CR27, VR3
6	51	22	9.7 \pm 0.5 vdc	R40, R43, Q6
7	51	21	9.7 \pm 0.5 vdc	R38, R42, Q5

Table 5-4. High Output Voltage Troubleshooting

Step	Meter Common	Meter Positive	Response	Probable Cause
1	Emitter of Q4	29	<0.5 vdc	a. Q4 shorted b. R16 shorted c. R15 shorted
2	14	17	>0.85 vdc	CR7 open
3	14	33	<2 vdc	a. Q1 open b. Q2 shorted c. CR1 shorted d. R2-R8 open

Table 5-5. Low Output Voltage Troubleshooting

Step	Meter Common	Meter Positive	Response	Probable Cause
1	Emitter of Q4	29	>5 vdc	a. Q4 open b. R16 open c. R15 open
2	14	17	<0.4 vdc	CR7 shorted
3	14	33	>6 vdc	a. Q1 shorted b. Q2 open c. R2-R8 shorted

Table 5-6. Common Troubles

Symptom	Checks and Probable Causes
Fuse blows when power supply is turned on.	Power supply has internal short. Disconnect Collector of Q7, turn-on power supply and check voltages (refer to table 5-2 or figure 4-2). If fuse blows with Q7 disconnected, check CR17, CR18, and T3.
Poor line regulation (constant voltage)	<ul style="list-style-type: none"> a. Check bias and reference circuit (para. 5-45). Refer to paragraph 5-69 for adjustment. b. Check line input to SCR regulator control circuit (T2, CR39 through CR43, R50, R51).
Poor load regulation (constant voltage)	<ul style="list-style-type: none"> a. Check bias and reference circuit (para. 5-45). b. Power supply going into current limit. Check constant current input circuit. c. Constant voltage loop oscillates. Check adjustment of R17 (para. 5-71).
Poor line and load regulation (constant current)	<ul style="list-style-type: none"> a. Check bias and reference circuit (para. 5-45). Refer to paragraph 5-69 for adjustment. b. Power supply going into voltage limit. Check constant voltage input circuit. c. Constant current loop oscillates. Check adjustment of R44 (para. 5-73).
High ripple	<ul style="list-style-type: none"> a. Check operating setup for ground loops. b. If output is floating (ungrounded) connect 1-μf capacitor between output and ground (unless particular application prohibits this). c. Check pi-section output filter C13, C17, and L1. d. Line imbalance. Check adjustment of R17 (para. 5-70).
Poor stability (constant voltage)	<ul style="list-style-type: none"> a. Check bias and reference circuit line regulation. (Refer to para. 5-69). b. Noisy programming resistors (R2-R8). c. CR1 or CR2 leaky. d. R1, R5, R40, R41, or R43 noisy or drifting. e. Q1 or Q2 defective.
Poor stability (constant current)	<ul style="list-style-type: none"> a. Check bias and reference circuit line regulation. (Refer to para. 5-69). b. Noisy programming resistors (R9-R10). c. R20, R23, R38, R39, or R42 noisy or drifting. d. Q8 defective.

Table 5-6. Common Troubles (cont.)

Symptom	Checks and Probable Causes
Oscillates (constant voltage)	Check R18, C1, C4, and adjustment of R17 (para. 5-71).
Oscillates (constant current)	Check C6, C24, R22, and adjustment of R20 (para. 5-66) and adjustment of R44 (para. 5-72).
Output voltage does not go to zero.	Check R6 and R47. (Refer to para. 5-63.)
Output current does not go to zero.	Check R20 and R46. (Refer to para. 5-67.)

Table 5-7. Checks and Adjustments after Replacement of Semiconductor Devices

Circuit Reference	Function	Check	Adjust
Q1, Q2	Constant voltage differential amplifier	Constant voltage line and load regulation; transient recovery time; zero voltage output	R6, R17
Q3	Turn-on circuit	Excessive transients at turn-on	-----
Q4	Gating Circuit	Constant voltage/constant current line and load regulation	-----
Q5	Constant voltage programming current regulator	Constant voltage programming coefficient	R38-R39
Q6	Constant Current programming current regulator	Constant current programming coefficient	R40-R41
Q7	SCR regulator control	Waveforms (shown in figure 4-2)	R51
Q8, Q9	Constant current differential amplifier	Constant current line and load regulation; zero current output	R20, R44
Q10	Bias and reference error detector/amplifier	Bias and reference circuit line regulation	R45
Q11	Bias and reference series regulator	Bias and reference circuit line regulation	R45
CR1, CR2, CR28	Constant voltage protection	Constant voltage load regulation	-----
CR6, CR9, CR10, CR11, CR12, CR14, CR27, CR46	Forward bias regulators	Voltage across each diode (0.6 to 0.85 vdc)	-----

Table 5-7. Checks and Adjustments after Replacement of Semiconductor Devices
(cont.)

Circuit Reference	Function	Check	Adjust
CR17, CR18	SCR regulator	Constant voltage load regulation	-----
CR19, CR20 CR21, CR22	Bridge rectifier	Voltage across bridge at full output (32 vdc)	-----
CR23	Output Protection	Output voltage	-----
CR26	Constant current protection	Constant current line and load regulation	-----
CR30, CR31	Full-wave rectifier	Rectifier output (67 vdc)	-----
CR39, CR40 CR41, CR42 CR43	Bridge rectifier	Voltage across bridge (20-25 peak, full wave)	-----
CR5, CR7, CR8, CR44, CR45, CR47, CR48, CR49, CR50, CR51,	Diode switches	-----	-----
VR1	Constant voltage programming protection	Full output voltage and zero output voltage obtainable via VOLTAGE controls; voltage regulation at 32 vdc output	-----
VR3	Voltage reference	Bias and reference circuit line regulation	R45
VR4	Voltage reference	6.0 vdc line regulation	-----

Table 5-8. Adjustment and Calibration Summary

Adjustment or Calibration	Paragraph Reference	Control Device
Meter Zero	5-55	Meter Spring
Voltmeter Tracking	5-57	R25
Ammeter Tracking	5-59	R27
Constant Voltage Programming Current	5-61	R39
Zero Voltage Output	5-63	R6
Constant Current Programming Current	5-65	R41
Zero Current Output	5-67	R20
Bias and Reference Line Regulation	5-69	R45
Line Imbalance	5-71	R17
Constant Current Load Regulation	5-73	R44

SECTION VI
REPLACEABLE PARTS

6-1 INTRODUCTION

6-2 This section contains information for ordering replacement parts.

6-3 Table 6-1 lists parts in the alpha-numerical order of the circuit designators and provides the following information:

- A. Description (See list of abbreviations below).
- B. Total quantity used in the instrument.
- C. Manufacturer's part number.
- D. Manufacturer.
- E. The Manufacturer's code number as listed in the Federal Supply Code for Manufacturers H4-1.
- F. The H-P Part Number.
- G. The recommended spare parts quantity for complete maintenance during one year of isolated service. (Column A).

6-4 ORDERING INFORMATION

6-5 To order replacement parts, address order or inquiry either to your authorized Harrison Laboratories sales representative or to Customer Service, Harrison Laboratories, 100 Locust Avenue, Berkeley Heights, New Jersey.

6-6 Specify the following information for each part:

- A. Model and complete serial number of instrument.
- B. Circuit reference designator.
- C. Description.

6-7 To order a part not listed in Table 6-1, give a complete description of the part and include its function and location.

Reference Designators

A	= assembly	K	= relay	T	= transformer
B	= motor	L	= inductor	V	= vacuum tube, neon bulb, photocell, etc.
C	= capacitor	M	= meter	X	= socket
CR	= diode	P	= plug	XF	= fuseholder
DS	= device signaling (lamp)	Q	= transistor	XDS	= lampholder
E	= misc. electronic part	R	= resistor	Z	= network
F	= fuse	RT	= thermistor		
J	= jack	S	= switch		

ABBREVIATIONS

a	= amperes	K	= kilo = 1000
c	= carbon	obd	= order by description
cer	= ceramic	p	= peak
coef	= coefficient	pc	= printed circuit board
com	= common	pf	= picofarads = 10^{-12} farads
comp	= composition	pp	= peak-to-peak
conn	= connection	ppm	= parts per million
crt	= cathode-ray tube	pos	= position (s)
dep	= deposited	poly	= polystyrene
elect	= electrolytic	pot	= potentiometer
encap	= encapsulated	prv	= peak reverse voltage
f	= farads	rect	= rectifier
fxd	= fixed	rot	= rotary
GE	= germanium	rms	= root-mean-square
grd	= ground (ed)	s-b	= slow-blow
h	= henries	sect	= section (s)
Hg	= mercury	Si	= silicon
impq	= impregnated	sil	= silver
ins	= insulation (ed)	sl	= slide
lin	= linear taper	td	= time delay
log	= logarithmic taper	TiO ₂	= titanium dioxide
m	= milli = 10^{-3}	tog	= toggle
M	= megohms	tol	= tolerance
ma	= milliamperes	trim	= trimmer
μ	= micro = 10^{-6}	twt	= traveling wave tube
mfr	= manufacturer	var	= variable
mtg	= mounting	w/	= with
my	= mylar	W	= watts
NC	= normally closed	ww	= wirewound
Ne	= neon	w/o	= without
NO	= normally open	cmo	= cabinet mount only
nsr	= not separately replaceable		

MANUFACTURERS

AB	Allen-Bradley	Kulka	Kulka Electric
B	Bendix Corporation	Mot.	Motorola, Inc.
Beede	Beede Elec. Instr. Co., Inc.	RCA	Radio Corporation of America
Buss	Bussman Mfg. Company	Reliance	Reliance Mica Corporation
Carling	Carling Electric Company		Mica
CTS	CTS Corporation	Semcor	Semcor Corporation
Elco	Elco Corporation	Sloan	Sloan Company
GE	General Electric Company	Sprague	Sprague Electric
GI	General Instrument Company	Superior	Superior Electric
HH	Hardwick-Hindle Company	Sylv	Sylvania Electric
Hoff	Hoffman Electric Company	TI	Texas Instruments
		WL	Ward Leonard Electric

Circuit Reference Number	Description	Quantity	Mfr. Part # or Type	Mfr.	Mfr. Code*	H-P Part #	A
C1, 4, 5, 6, 26	fxd elect 5µf 65 VDC	5	D33689	Sprague	56289		10
C2	fxd elect 100µf 6 VDC	1	30D 107G 006 DB4	Sprague	56289		2
C3	fxd film .0022µf 200 VDC	1	192P22292	Sprague	56289	0160-0154	2
C7, 8, 9, 14, 15, 16, 18, 19, 23	Not Assigned	-					
C10, 12	fxd paper 0.1µf 400 VDC	2	160P10494	Sprague	56289	0160-0013	4
C11	fxd paper 1µf 200 VDC	1	161P10502	Sprague	56289		2
C13, 17	fxd elect 47000µf 40 VDC	2	D39067	Sprague	56289		4
C20, 21	fxd elect 430µf 40 VDC	2	D36260	Sprague	56289		4
C22, 25	fxd elect 1µf 35 VDC	2	150D 105X9036A2S	Sprague	56289	0180-0291	4
C24	fxd elect 10µf 25 VDC	1	30D 106G 025 BB4	Sprague	56289		2
C27	fxd film .082µf 200 VDC	1	192P82392	Sprague	56289	0160-0167	2
C28	fxd film .22µf 80 VDC	1	192P2249R8	Sprague	56289		2
CR1, 2, 5, 7, 8, 11, 26, 28, 39, 40, 41, 42, 43, 44, 45, 48	Diode Silicon	16	1N485B	Sylv	93332	1901-0033	30
CR3, 4, 13, 15, 16, 24, 25, 29, 32, 33, 34, 35, 36, 37, 38	Not Assigned	-					
CR6, 9, 10, 12, 14, 27, 46, 47, 49, 50, 51	Rectifier Silicon 200 ma 10 PRV	11	111S1	Sylv	93332		22
CR17, 18	SCR 7A 200 PRV <i>Sub 203940</i>	2	C20B	GE	03508		4
CR19, 20, 21, 22	Rectifier Silicon 20A 50 PRV	4	A 40 F	GE	03508		8

101-1-58

Circuit Reference Number	Description	Quantity	Mfr. Part # or Type	Mfr.	Mfr. Code*	H-P Part #
CR23	Rectifier Silicon 12A 100 PRV	1	1N1200A	RCA	02735	
CR30, 31	Rectifier Silicon 500 ma 200 PRV	2	1N3253	RCA	02735	1901-0026
DS1	Indicator Light, Neon	1	32RL2211T	Leecraft	95263	
F1, 2	Fuse 10A @ 250V 3 AB	2	314010	Littelfuse	75915	
L1	Filter Choke	1	642793	H-Lab	09182	
Q1,2,3,4,5,6,8,9	S.S. NPN Silicon	8	2N3390	GE	03508	
Q7, 11	S.S. NPN Silicon	2	2N3417	GE	03508	
Q10	S.S. PNP Silicon	1	SM9085	TI	01295	
R1	fxd film 20K ±1% 1/8 watt	1		IRC	07716	0757-0449
R2	var ww 8K Ω ±5%	1	100213-3	H-Lab	09182	
R3, 13	fxd film 43K Ω ±1% 1/8 watt	2		IRC	07716	
R4, 19	fxd film 100K Ω ±1% 1/8 watt	2		IRC	07716	0757-0465
R5, 20	fxd film 12K Ω ±1% 1/8 watt	2		IRC	07716	
R6, 35, 36	fxd film 3K Ω ±1% 1/8 watt	3		IRC	07716	0757-1093
R7	fxd comp 22 Ω ±5% 1/2 watt	1	EB2205	AB	01121	0686-2205
R8	var ww 200 Ω ±5%	1	100213-10	H-Lab	09182	
R9	var ww 10 Ω ±5%	1	100213-11	H-Lab	09182	
R10	var ww 300 Ω ±5%	1	100213-2	H-Lab	09182	
R11	fxd comp 3K Ω ±5% 1 watt	1	GB3025	AB	01121	0689-3025
R12, 15	fxd comp 680K Ω ±5% 1/2 watt	2	EB6845	AB	01121	0686-6845
R14	Not Assigned	-				
R16	fxd comp 1K Ω ±5% 1/2 watt	1	EB1025	AB	01121	0686-1025
R17, 39, 41, 44	fxd comp Selected ±5% 1/2 watt	4		AB	01121	
R18, 34, 53	fxd comp 10K Ω ±5% 1/2 watt	3	EB1035	AB	01121	0686-1035
R21	fxd film 160 Ω ±5% 2 watt	1	Type C42S	Corning	16299	
R22	fxd comp 20K Ω ±5% 1/2 watt	1	EB2035	AB	01121	0686-2035

6
4
1
4

Circuit Reference Number	Description	Quantity	Mfr. Part # or Type	Mfr.	Mfr. Code*	H-P Part #
R23	fxd ww 0.1 Ω \pm 5% 40 watt 20 ppm	1	2BR37	HH	73978	
R24	fxd film 36.5K Ω \pm 1% 1/4 watt	1		IRC	07716	0757-0765
R25	var ww 5K Ω (modify)	1	Type 110-F4	CTS	11236	
R26, 37, 43	fxd film 1K Ω \pm 1% 1/4 watt	3		IRC	07716	0757-0338
R27	var ww 250 Ω (modify)	1	Type 110-F4	CTS	11236	
R28	fxd ww 300 Ω \pm 5% 10 watt	1	Type 10XM	WL	63743	
R29	fxd ww 1 Ω \pm 5%	1	Type BWH	IRC	07716	
R30, 50	fxd comp 3K Ω \pm 5% 1/2 watt	2	EB3025	AB	01121	0686-3025
R31	fxd comp 33K Ω \pm 5% 1/2 watt	1	EB3335	AB	01121	0686-3335
R32, 49	Strap	-				
R33	fxd comp 2K Ω \pm 5% 1/2 watt	1	EB2025	AB	01121	0686-2025
R38	fxd film 2K Ω \pm 1% 1/4 watt	1		IRC	07716	0757-0739
R40	fxd film 2.74K Ω \pm 1% 1/4 watt	1		IRC	07716	0757-0742
R42	fxd film 1.33K Ω \pm 1% 1/4 watt	1		IRC	07716	
R45	fxd comp 51K Ω \pm 5% 1/2 watt	1	EB1565	AB	01121	0686-1565
R46	fxd comp 15 meg Ω \pm 5% 1/2 watt	1	EB1565	AB	01121	0686-1565
R47	fxd comp 1 meg Ω \pm 5% 1/2 watt	1	EB1055	AB	01121	0686-1055
R48	fxd comp 43K Ω \pm 5% 1/2 watt	1	EB4335	AB	01121	0686-4335
R51	fxd comp 180 Ω \pm 5% 1/2 watt	1	EB1815	AB	01121	0686-1815
R52	fxd film 3K Ω \pm 5% 2 watt	1	Type C42S	Corning	16299	
R54, 55	fxd comp 47 Ω \pm 5% 1/2 watt	2	EB4705	AB	01121	0686-4705
R56	fxd comp 39 Ω \pm 5% 1/2 watt	1	EB3905	AB	01121	0686-3905
S1	Switch D. P. S. T.	1	12TS15-2	Micro	91929	
T1	Power Transformer	1	643391	H-Lab	09182	
T2	Bias Transformer	1	643392	H-Lab	09182	
T3	Pulse Transformer	1	642895	H-Lab	09182	
VR1	Zener 42.2V \pm 5%	1		Cont. Device	07910	1902-3323
VR2	Strap	-				
VR3	Zener 9.4V \pm 5%	1	1N2163	Semcor	06751	1902-0762
VR4	Zener 4.22V \pm 5%	1		Cont. Device	07910	1902-3070

Circuit Reference Number	Description	Quantity	Mfr. Part # or Type	Mfr.	Mfr. Code*	H-P Part #	A
	Barrier Strip (Output)	1	602-Y-3	Kulka	75382		2
	Barrier Strip (Sensing)	1	10100-11	H-Lab	09182		2
	Jumper	5	422-13-11-013	Cinch	71785		10
	Meter Panel 1 ma 50 ohms (Front panel)	2	649	H-Lab	09182		2
	Meter Face 0-40 Volts (Meter)	1	10042	H-Lab	09182		1
	Meter Face (meter) 0-12 Amps	1	100138	H-Lab	09182		1
	Fuse Holder (Front Panel)	2	342014	Littelfuse	75915	1400-0048	2
	Knob 5/8 diameter 1/4 Insert Pointer	4		H-Lab	09182	0370-0084	4
	Line Cord 6' 18-3 (16-30)	1	KH-4629	Beldon	70903		2
	Slate Grey Stranded Plug PH151						
	Type SJT Jacket Strip 2" Conductor						
	Strip 1/2" Tinned						
	Strain Relief	1	SR-6P-1	Heyman	28520		2
	Fastener (Capacitor)	1	C684-1024-4	Tinnerman	89032		2
	Rubber Bumper Black Durom Hard 55/60	4	3066	Stockwell	87575		4

A = Recommended Spares For One Year Per Ten Units.

* = As Listed in Federal Supply Code for Manufacturers'.

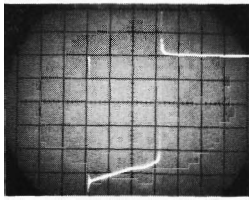

A. Test Points 31-33
5 μ sec/cm, 5v/cm

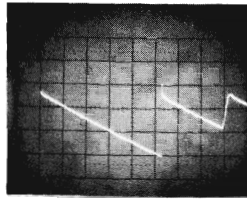

B. Test Points 29-33
1 ms/cm, 1v/cm

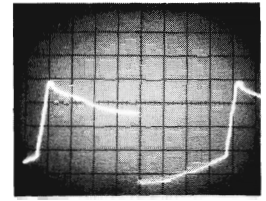

C. Test Points 37-33
1ms/cm, 1v/cm

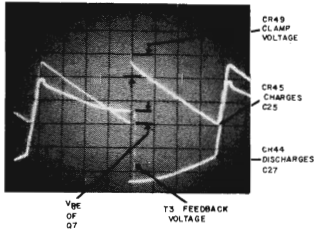

D. Waveforms B and C superimposed

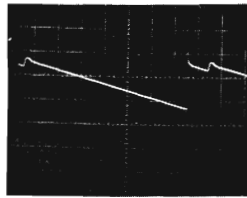

E. Same as B, except smaller load used (2v, 3a)



F. Same as C, except Q7 fires later due to smaller load (2v, 3a)

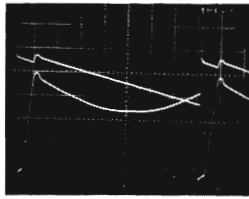

G. Waveforms E and F superimposed

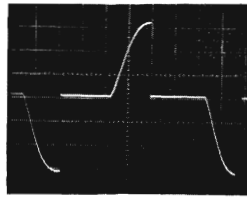

H. Test Points 45-ACC
2ms/cm, 50v/cm

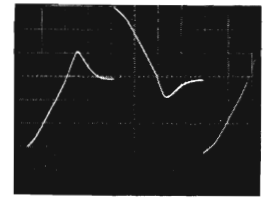

I. Test Points 45-AC
2ms/cm, 50v/cm

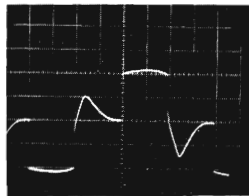

J. Test Points 47-46
2 ms/cm, 10v/cm

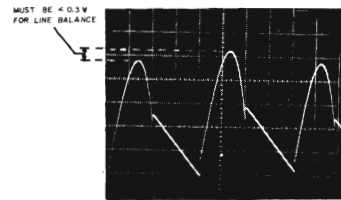

K. Test Points 48-18
2 ms/cm, 0.2v/cm

All waveforms were taken with 115-volt, 60-cps, single-phase input and 32vdc, 10 ampere load (except E and F as indicated). Waveforms H and I require the oscilloscope to be ungrounded. If it is not desirable to unground the oscilloscope, use a 1-kva isolation transformer between the input power source and the power supply power input.

WARNING

If the oscilloscope is ungrounded, injury can occur if personnel touch the oscilloscope case and other equipment simultaneously.

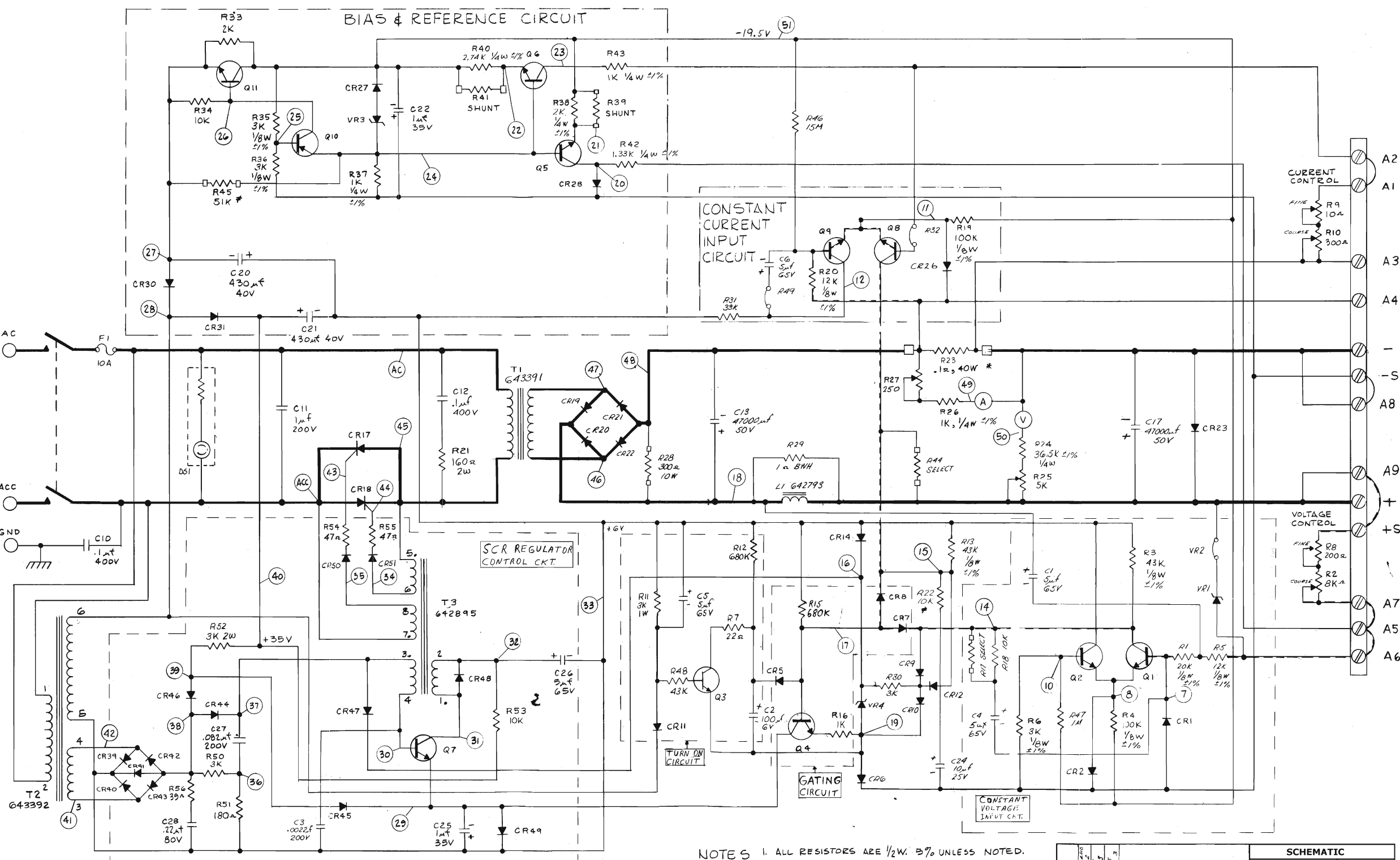

NOTES 1. ALL RESISTORS ARE 1/2W. 5% UNLESS NOTED.

2. * DENOTES 20 PPM WIRE TEMP. COEFF.

3. REAR TERMINALS SHOWN IN NORMAL STRAPPING.

4. INPUT VOLTAGES MEASURED AT 115V. NO LOAD.

5. --- DENOTES VOLTAGE SIGNAL.

6. - - - - DENOTES CURRENT SIGNAL.

7. # SELECTED FOR OPTIMUM PERFORMANCE

PATENT APPLIED FOR ON THIS CIRCUIT. LICENSE TO USE MUST BE OBTAINED IN WRITING FROM HARRISON LABORATORIES DIV OF HEWLETT PACKARD

JOB NO		SCHEMATIC	
643391		0-32V / 0-10A	
REV. 6-5-65		HARRISON	
REV. 6-5-65		Berkeley Heights, N.J.	
REV. 6-5-65		Div of Hewlett-Packard	
REV. 7-9-65			
REV. 8-11			



The information contained in this booklet is intended for the operation and maintenance of Harrison equipment and is not to be reproduced without written consent of:

Harrison Division of Hewlett-Packard Company

AA4DF Scans Are Reproduced With Permission, Courtesy Of Agilent Technologies, Inc.

PATENT NOTICE

Patents have been applied for on circuits used in this power supply. Buyer is not licensed to reproduce drawings or to utilize the circuit without written permission from Harrison Division of Hewlett-Packard Company.

CLAIM FOR DAMAGE IN SHIPMENT

This equipment should be tested as soon as it is received. If it fails to operate properly or is damaged in any way, a claim should be filed with the carrier. A full report of the damage should be obtained by the claim agent, and this report should be forwarded to us. We will then advise you of the disposition which is to be made of the equipment and arrange for repair or replacement.

HARRISON DIVISION OF HEWLETT-PACKARD COMPANY

100 LOCUST AVENUE • BERKELEY HEIGHTS, NEW JERSEY 07922 • 464-1234 • AREA CODE 201 • TWX 201-464-2117