



Agilent E4412A and E4413A Power Sensors

Operating and Service Guide



Agilent Technologies

Notices

© Agilent Technologies, Inc. 1999–2012

No part of this manual may be reproduced in any form or by any means (including electronic storage and retrieval or translation into a foreign language) without prior agreement and written consent from Agilent Technologies, Inc. as governed by United States and international copyright laws.

Manual Part Number

E4412-90013

Edition

Fourth Edition, December 14, 2012

Agilent Technologies, Inc.
5301 Stevens Creek Blvd.
Santa Clara, CA 95052 USA

Warranty

The material contained in this document is provided “as is,” and is subject to being changed, without notice, in future editions. Further, to the maximum extent permitted by applicable law, Agilent disclaims all warranties, either express or implied, with regard to this manual and any information contained herein, including but not limited to the implied warranties of merchantability and fitness for a particular purpose. Agilent shall not be liable for errors or for incidental or consequential damages in connection with the furnishing, use, or performance of this document or of any information contained herein. Should Agilent and the user have a separate written agreement with warranty terms covering the material in this document that conflict with these terms, the warranty terms in the separate agreement shall control.

Technology Licenses

The hardware and/or software described in this document are furnished under a license and may be used or copied only in accordance with the terms of such license.

Restricted Rights Legend

U.S. Government Restricted Rights. Software and technical data rights granted to the federal government include only those rights customarily provided to end user customers. Agilent provides this customary commercial license in Software and technical data pursuant to FAR 12.211 (Technical Data) and 12.212 (Computer Software) and, for the Department of Defense, DFARS 252.227-7015 (Technical Data - Commercial Items) and DFARS 227.7202-3 (Rights in Commercial Computer Software or Computer Software Documentation).

Safety Notices

CAUTION

A **CAUTION** notice denotes a hazard. It calls attention to an operating procedure, practice, or the like that, if not correctly performed or adhered to, could result in damage to the product or loss of important data. Do not proceed beyond a **CAUTION** notice until the indicated conditions are fully understood and met.

WARNING

A **WARNING** notice denotes a hazard. It calls attention to an operating procedure, practice, or the like that, if not correctly performed or adhered to, could result in personal injury or death. Do not proceed beyond a **WARNING** notice until the indicated conditions are fully understood and met.

Certification

Agilent Technologies certifies that this product met its published specifications at the time of shipment. Agilent further certifies that its calibration measurements are traceable to the United States National Institute of Standard and Technology (formerly National Bureau of Standards), to the extent allowed by that organization's calibration facility, and to the calibration facilities of other International Standards Organization members.

General Warranty

The material contained in this document is provided "as is," and is subject to being changed, without notice, in future editions. Further, to the maximum extent permitted by applicable law, Agilent disclaims all warranties, either express or implied with regard to this manual and any information contained herein, including but not limited to the implied warranties of merchantability and fitness for a particular purpose. Agilent shall not be liable for errors or for incidental or consequential damages in connection with the furnishing, use, or performance of this document or any information contained herein. Should Agilent and the user have a separate written agreement with warranty terms covering the material in this document that conflict with these terms, the warranty terms in the separate agreement shall control. Duration and conditions of warranty for this product may be superseded when the product is integrated into (becomes a part of) other Agilent products. During the warranty period, Agilent will, at its option, either repair or replace products which prove to be defective. The warranty period begins on the date of delivery or on the date of installation if installed by Agilent.

Warranty Service

For warranty service or repair, this product must be returned to a service facility designated by Agilent. For products returned to Agilent for warranty service, the Buyer shall prepay shipping charges to Agilent and Agilent shall pay shipping charges to return the product to the Buyer. However, the Buyer shall pay all shipping charges, duties, and taxes for products returned to Agilent from another country.

Limitation of Warranty

The foregoing warranty shall not apply to defects resulting from improper or inadequate maintenance by the Buyer, Buyer-supplied products or interfacing, unauthorized modification or misuse, operation outside of the environmental specifications for the product, or improper site preparation or maintenance.

The design and implementation of any circuit on this product is the sole responsibility of the Buyer. Agilent does not warrant the Buyer's circuitry or malfunctions of Agilent products that result from the Buyer's circuitry. In addition, Agilent does not warrant any damage that occurs as a result of the Buyer's circuit or any defects that result from Buyer-supplied products.

To the extent allowed by local law, Agilent makes no other warranty, expressed or implied, whether written or oral with respect to this product and specifically disclaims any implied warranty or condition of merchantability, fitness for a particular purpose or satisfactory quality.

Exclusive Remedies

To the extent allowed by local law, the remedies provided herein are the Buyer's sole and exclusive remedies. Agilent shall not be liable for any direct, indirect, special, incidental, or consequential damages (including lost profit or data), whether based on warranty, contract, tort, or any other legal theory.

Restricted Rights Legend

The Software and Documentation have been developed entirely at private expense. They are delivered and licensed as “commercial computer software” as defined in DFARS 252.227-7013 (Oct 1988), DFARS 252.211-7015 (May 1991), or DFARS 252.227-7014 (Jun 1995), as a “commercial item” as defined in FAR 2.101(a), or as “restricted computer software” as defined in FAR 52.227-19 (Jun 1987) (or any equivalent agency regulation or contract clause), whichever is applicable. You have only those rights provided for such Software and Documentation by the applicable FAR or DFARS clause or the Agilent standard software agreement for the product involved.

Technology Licenses

The hardware and/or software described in this document are furnished under a license and may be used or copied only in accordance with the terms of such license.

Safety Summary

The following general safety precautions must be observed during all phases of operation of this instrument. Failure to comply with these precautions or with specific warnings elsewhere in this manual violates safety standards of design, manufacture, and intended use of the instrument. Agilent Technologies, Inc. assumes no liability for the customer's failure to comply with these requirements.

Safety Notices

WARNING

A **WARNING** notice denotes a hazard. It calls attention to an operating procedure, practice, or the like that, if not correctly performed or adhered to, could result in personal injury or loss of life. Do not proceed beyond a **WARNING** notice until the indicated conditions are fully understood and met.

CAUTION

A **CAUTION** notice denotes a hazard. It calls attention to an operating procedure, practice, or the like that, if not correctly performed or adhered to, could result in damage to the product or loss of important data. Do not proceed beyond a **CAUTION** notice until the indicated conditions are fully understood and met.

Safety Symbols

The following symbol on the instrument and in the documentation indicates precautions that must be taken to maintain safe operation of the instrument.



Caution, risk of danger.

The Instruction Documentation Symbol. The product is marked with this symbol when it is necessary for the user to refer to the instructions in the supplied documentation.



This symbol indicates that a device, or part of a device, may be susceptible to electrostatic discharges (ESD) which can result in damage to the product.

Observe ESD precautions given on the product, or its user documentation, when handling equipment bearing this mark.



Alternating current (AC).



Direct current (DC).



Both direct and alternating current.



Three-phase alternating current.

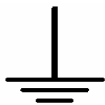

Earth (ground) TERMINAL.



PROTECTIVE CONDUCTOR TERMINAL.

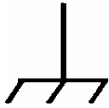

Frame or chassis TERMINAL.



Equipotentiality.



On (Supply).

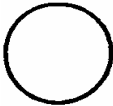

Off (Supply).

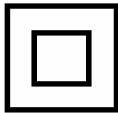

Equipment protected throughout by DOUBLE INSULATION or REINFORCED INSULATION.



Caution, risk of electric shock.



Caution, hot surface.



In position of bi-stable push control.

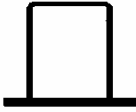

Out position of bi-stable push control.

Regulatory Markings



The CE mark shows that the product complies with all the relevant European legal Directives (if accompanied by a year, it signifies when the design was proven).



The C-tick mark is a registered trademark of the Spectrum management Agency of Australia. This signifies compliance with the Australian EMC Framework regulations under the terms of the Radio Communications Act of 1992.



This product complies with the WEEE Directive (2002/96/EC) marking equipment. The affixed product label indicates that you must not discard this electrical/electronic product in domestic household waste.

ICES/NMB - 001

This ISM device complies with the Canadian ICES-001,
Cet appareil ISM est conforme à la norme NMB-001 du Canada.

General Safety Information

The following general safety precautions must be observed during all phases of operation, service, and repair of this instrument. Failure to comply with these precautions or with specific warnings elsewhere in this manual violates safety standards of design, manufacture, and intended use of the instrument. Agilent Technologies assumes no liability for the customer's failure to comply with these requirements.

WARNING

BEFORE CONNECTING THE POWER SENSOR TO OTHER INSTRUMENTS ensure that all instruments are connected to the protective (earth) ground. Any interruption of the protective earth grounding will cause a potential shock hazard that could result in personal injury.

CAUTION

- Use the device with the cables provided
 - Repair or service that is not covered in this manual should only be performed by qualified personnels.
-

CAUTION

- This product is designed for use in Installation category II and Pollution Degree 2.
 - This instrument has been designed and tested in accordance with IEC Publication 248, Safety Requirements for Electronic Measuring Apparatus, and has been supplied in a safe condition. The instruction documentation contains information and warnings which must be followed by the user to ensure safe operation and to maintain the instrument in a safe condition.
 - Notice for germany: Noise Declaration $L_{pA} < 70$ dBm am Arbeitsplatz (operator position) mormaler Betrieb (normal position) nach DIN 45635 T.19 (per ISO 7779).
-

In This Guide ...

- 1 Operation and Service Guide** This chapter contains information about initial inspection, performance tests, specifications, operations, troubleshooting and service of the Agilent E4412A and E4413A power sensors.
- 2 Appendix** This Appendix contains specifications that applies to E4412A and E4413A sensors (formerly EXCP-E18A and ECP-E26A, respectively) with a serial prefix below US3848/MYxxxxxxx/SGxxxxxxx.

Table of Contents

1 Operation and Service Guide

General Information	3
Warranty	3
Instruments Covered by Manual	3
Description	3
Specifications	4
Calibration Factor (CF) and Reflection Coefficient (Rho)	8
Installation	11
Interconnections	11
Recommended Calibration Interval	11
Storage and Shipment	12
Operation	12
Power Meter Calibrations	14
Operating Instructions	14
Performance Test	15
Standing Wave Ratio (SWR) and Reflection Coefficient (Rho) Performance Test	15
Replaceable Parts	17
Service	20
Principles of Operation	20
Troubleshooting	21
Repair of Defective Sensor	21
Cleaning	21
Disassembly Procedure	22
Reassembly Procedure	23
Agilent Sales and Service Offices	24

A Appendix

List of Figures

- Figure 1 E4412A and E4413A Power Sensors (Formerly ECP-E18A and EXCP-E26A, respectively) 2
- Figure 2 Relative Mode Power Measurement Linearity with Power Meter/Sensor at 25 °C (Typical) 7
- Figure 3 E4413A power sensor with adapter 14
- Figure 4 Illustrated Parts Break down 18
- Figure 5 Removing Power Sensor Shell 22

List of Tables

Table 1	E4412A and E4413A Specifications	5
Table 2	E4412A Calibration Factor Uncertainty at 1 mW (0 dBm)	9
Table 3	E4413A Calibration Factor Uncertainty at 1 mW (0 dBm)	10
Table 4	Power Sensor SWR and Reflection Coefficient for the E4412Aa	15
Table 5	Power Sensor SWR and Reflection Coefficient for the E4413Aa	16
Table 6	Replaceable Parts	19
Table 7	Agilent Sales and Service Offices	24
Table A-1	E4412A and E4413A Specifications (Serial Prefixes Below US3848/MYxxxxxxx/SGxxxxxxx)	26
Table A-2	E4412A Calibration Factor Uncertainty at 1 mW (0 dBm) (Serial Prefixes Below US3848/MYxxxxxxx/SGxxxxxxx)	28
Table A-3	E4413A Calibration factor Uncertainty at 1 mW (0 dBm) (Serial Prefixes Below US3848/MYxxxxxxx/SGxxxxxxx)	29



1 Operation and Service Guide

General Information	3
Performance Test	15
Replaceable Parts	17
Service	20

This chapter contains information about initial inspection, performance tests, specifications, operations, troubleshooting and service of the Agilent E4412A and E4413A power sensors.





Figure 1 E4412A and E4413A Power Sensors (Formerly ECP-E18A and EXCP-E26A, respectively)

General Information

Warranty

The power sensors are warranted and certified as indicated on the inside cover of this manual.

Instruments Covered by Manual

These instruments have a two-part serial number: the prefix (two letters and the first four numbers), and the suffix (the last four numbers). The two letters identify the country in which the unit was manufactured. The four numbers of the prefix are a code identifying the date of the last major design change incorporated in your Agilent Technologies product. The four-digit suffix is a sequential number and, coupled with the prefix, provides a unique identification for each unit produced. The contents of this manual apply directly to all serial numbers unless otherwise indicated.

Description

The E4412A and E4413A power sensors are diode power sensors. They are intended for measurement of CW microwave power levels in a wide dynamic range from -70 dBm to +20 dBm (100 pW to 100 mW). The E4412A measures at frequencies from 10 MHz to 18.0 GHz. The E4413A measures at frequencies from 50 MHz to 26.5 GHz. These are high-speed power sensors, and do not incorporate narrow-bandwidth averaging used in average-power sensors. Signals with digital, pulse, or other forms of amplitude modulation may introduce measurement errors. Multi-tone signals (containing multiple frequency components), or signals with significant harmonic content (> -45 dBc) may introduce measurement errors at high power levels. (Specifications for the power sensors are in [Table 1](#)).

These power sensors measure CW power, displayed on a compatible power meter in logarithmic (dBm or dB) or linear (Watts or %) measurement units. The E4413A is shipped with a 3.5-mm to Type-N adapter, part number 08485-60005.

NOTE

The E4412A and E4413A power sensors are compatible **ONLY** with the newer E44XX-Series power meters. They are **NOT** compatible with the earlier 430-Series, E1416A, or 70100A power meters.

NOTE

The E4412A and E4413A power sensors are extremely static-sensitive. Do not open the power sensor unless you and the power sensor are at a static-free workstation.

Specifications

The specifications listed in [Table 1](#) are the performance standards or limits against which the power sensor may be tested. These specifications are valid **ONLY** after proper calibration of the power meter. Refer to the *Calibration Procedure Using Agilent E-Series Power Sensors* in the E4418A or the *Agilent E4419A Power Meter User's Guide*.

Table 1 E4412A and E4413A Specifications

	Limit		Comments
Frequency Range	E4412A: 10 MHz to 18 GHz E4413A: 50 MHz to 26.5 GHz		
Power Range	-70 dBm to +20 dBm (100 pW to 100 mW)		
Impedance	50 ohm		nominal
Connector Type	E4412A: Type-N (male) E4413A: 3.5 mm (male)		
Maximum Standing Wave Ratio (SWR) and Reflection Coefficient (Rho)^b	SWR	Rho	Return Loss (dB)
E4412A			
10 MHz to <30 MHz	1.22	0.099	20.08
30 MHz to <2 GHz	1.15	0.070	23.13
2 GHz to <6 GHz	1.17	0.078	22.12
6 GHz to <11 GHz	1.20	0.091	20.82
11 GHz to <18 GHz	1.27	0.119	18.42
E4413A			
50 MHz to <100 MHz	1.21	0.095	20.45
100 MHz to <8 GHz	1.19	0.087	21.23
8 GHz to <18 GHz	1.21	0.095	20.45
18 GHz to 26.5 GHz	1.26	0.115	18.79
Maximum Power	200 mW peak (+23 dBm) 200 mW average (+23 dBm)		
AC Coupled Input	max: 20 VDC		
Zero Set	±50 pW		

	Limit		Comments
Power Linearity^{ab}	25 ± 5°C	0 to 55°C	(After calibration at 0 dBm at ambient temperature)
100 pW to 10 mW	±3%	±7%	-70 dBm to +10 dBm
10 mW to 100 mW	±4.5%	±10%	+10 dBm to +20 dBm
Operating Temperature	0 to 55°C		
Net Weight			
E4412A	0.47 kg (1.04 lb)		
E4413A	0.45 kg (1.00 lb)		
Dimensions			
E4412A	Length: 130 mm (5.1 in)		Same for both models Same for both models
E4413A	Length: 102 mm (4.0 in)		
	Width: 38 mm (1.5 in)		
	Height: 30 mm (1.2 in)		

a. Limits are in percent of power in Watts. See [Figure 2](#) for relative power measurement.

b. Specifications apply to instruments with serial prefix US3848/MYxxxxxxx/SGxxxxxxx and above. For earlier instruments, refer to Appendix A.

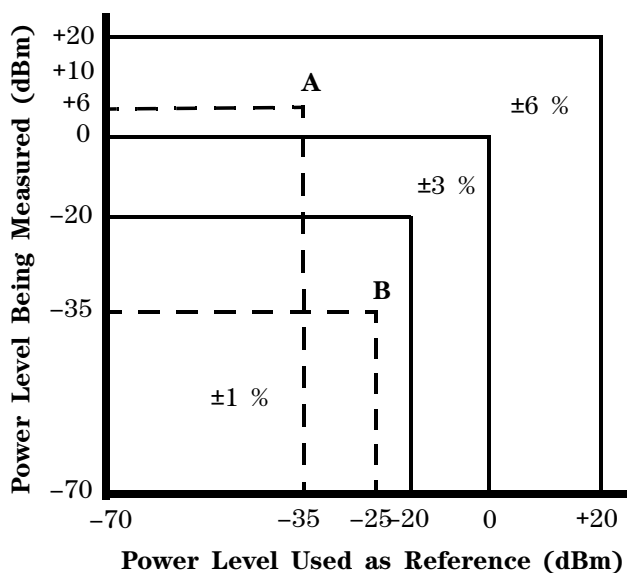

Figure 2 Relative Mode Power Measurement Linearity with Power Meter/Sensor at 25 °C (Typical)

The chart in [Figure 2](#) shows the typical uncertainty in making relative power measurements with the E44XX-Series power meter in the Rel (relative) mode. In a relative measurement, two power levels are compared using a single sensor. The typical measurement uncertainty can be found by drawing a vertical line at a power level used as a reference, and a horizontal line at the power being measured. The region where these two lines intersect shows the typical uncertainty. This assumes that the reference power and the measured power are at the same frequency, and neglects errors due to zero set, zero drift, and noise. It also assumes no change in mismatch when measuring the “Power level used as reference” and the “Power level being measured”. This chart illustrates that the best relative power measurement accuracy is obtained when the reference and the measured power levels are equal to, or less than, -20 dBm. Care in choosing the power levels can yield improved measurement accuracy. Example A illustrates a relative gain (amplifier measurement) and example B illustrates a relative loss (insertion loss measurement).

EXAMPLE A (Amplifier Gain Measurement):

Input power (reference) = -35 dBm; power measured = +6 dBm' so the relative gain is +41 dB. the chart indicates a typical error of ±6 %, which corresponds to +0.25 dB/-0.27 dB uncertainty in the gain measurement.

EXAMPLE B (Insertion Loss Measurement):

Reference power = -25 dBm; power measured = -35 dBm, for the case of an insertion loss of 10 dB. the chart indicates a typical error of ±1 %, which corresponds to ±0.04 dBm uncertainty in the measurement.

Calibration Factor (CF) and Reflection Coefficient (Rho)

Calibration factor and reflection coefficient data are given at 1 GHz increments on a data sheet included with the power sensor. This data is unique to each sensor. If you have more than one sensor, match the serial number on the data sheet with the serial number on the power sensor you are using. The CF corrects for the frequency response of the sensor. The power meter automatically reads the CF data stored in the sensor and uses it to make the corrections.

Reflection Coefficient (Rho, or ρ) relates to SWR according to the following formula:

$$SWR = (1+\rho)/(1-\rho)$$

Typical uncertainties of the CF data are listed in [Table 2](#) for the E4412A power sensor, and in [Table 3](#) for the E4413A power sensor. The uncertainty analysis for the calibration of the sensors was done in accordance with the ISO/TAG4 Guide. The uncertainty data reported on the calibration certificate is the expanded uncertainty with 95% confidence level and a coverage factor of 2.

Additionally, at frequencies other than the reference frequency, for measurements above 0 dBm include 0.5 %/dB high power calibration factor uncertainty.

Table 2 E4412A Calibration Factor Uncertainty at 1 mW (0 dBm)

Frequency	Uncertainty (%) ^a
10 MHz	1.8
30 MHz	1.8
50 MHz	Reference
100 MHz	1.8
1.0 GHz	1.8
2.0 GHz	2.4
4.0 GHz	2.4
6.0 GHz	2.4
8.0 GHz	2.4
10.0 GHz	2.4
11.0 GHz	2.4
12.0 GHz	2.4
14.0 GHz	2.4
16.0 GHz	2.6
18.0 GHz	2.6

a. Specifications apply to instruments with serial prefix US3848/MYxxxxxxx/SGxxxxxxx and above. For earlier instruments, refer to Appendix A.

Table 3 E4413A Calibration Factor Uncertainty at 1 mW (0 dBm)

Frequency	Uncertainty (%) ^a
50 MHz	Reference
100 MHz	1.8
1.0 GHz	1.8
2.0 GHz	2.4
4.0 GHz	2.4
6.0 GHz	2.4
8.0 GHz	2.4
10.0 GHz	2.6
11.0 GHz	2.6
12.0 GHz	2.8
14.0 GHz	2.8
16.0 GHz	2.8
17.0 GHz	2.8
18.0 GHz	2.8
19.0 GHz	3.0
20.0 GHz	3.0
22.0 GHz	3.0
24.0 GHz	3.0
26.0 GHz	3.0
26.5GHz	3.0

a. Specifications apply to instruments with serial prefix US3848/MYxxxxxxx/SGxxxxxxx and above. For earlier instruments, refer to Appendix A.

Installation

Initial Inspection

Inspect the shipping container for damage. If the shipping container or packaging material is damaged, it should be kept until the contents of the shipment have been checked mechanically and electrically. If there is mechanical damage or if the instrument does not pass the performance tests, notify the nearest Agilent Technologies office. Keep the damaged shipping materials (if any) for inspection by the carrier and a Agilent Technologies representative.

Interconnections

Connect one end of the 11730A sensor cable to the E4412A or E4413A power sensor and connect the other end of the cable to the power meter's channel input. Allow a few seconds for the power meter to download the power sensor's calibration table before making a measurement.

Measurement connector (connects to DUT)

E4412A: Type-N (male)

E4413A: 3.5-mm (male)

A torque wrench should be used to tighten these connectors. Use a 3/4-inch open-end wrench and torque to 12 in-lb (135 Ncm) for the Type-N connector. Use a 20-mm open-end wrench and torque to 8 in-lb (90 Ncm) for the 3.5-mm connector.

Recommended Calibration Interval

Agilent Technologies recommends a one-year calibration cycle for the E4412A and E4413A power sensors.

Storage and Shipment

Environment

The instruments should be stored in a clean, dry environment. The following limitations apply to both storage and shipment:

Temperature	–55 to +75 °C
Relative Humidity	<95 % at 40 °C
Altitude	<15,240 metres (50,000 feet)

Original Packaging

Containers and materials identical to those used in factory packaging are available through Agilent Technologies offices. If the instrument is being returned to Agilent Technologies for servicing, attach a tag indicating the type of service required, return address, model number, and serial number.

Also, mark the container FRAGILE to assure careful handling. In any correspondence, refer to the instrument by model number and serial number.

Operation

Operating Environment

The operating environment for the power sensor should be within the following limits:

Temperature	0 to 55 °C
Relative Humidity	<95 %
Altitude	<4,530 metres (15,000 feet)

Operation Precautions

WARNING

BEFORE CONNECTING THE POWER SENSOR TO OTHER INSTRUMENTS, ensure that all instruments are connected to the protective (earth) ground. Any interruption of the protective earth grounding will cause a potential shock hazard that could result in personal injury and cause damage to the power sensor.

If the following energy and power levels are exceeded, the power meter system may be damaged.

- a Maximum Average Power: 200 mW (+23 dBm)
- b Maximum Peak Power: 200 mW (+23 dBm)

Maximum torque at the connector should not exceed 12 in-lb (135 Ncm) for the Type-N connector, or 8 in-lb (90 Ncm) for the 3.5-mm connector to avoid damage to the connector.

Connect the power sensor by turning only the hex nut portion of the connector. Damage can occur if torque is applied to the power sensor body.

The connector plastic insulator bead deteriorates when contacted by acetone, trichloroethylene, carbon tetrachloride, benzene, etc. Refer to Application Note 326, Principals of Microwave Connector Care (5954-1566) or Microwave Connector Care (08510-90064) for proper cleaning methods.

Performance Test

Standing Wave Ratio (SWR) and Reflection Coefficient (Rho) Performance Test

This section does not establish preset SWR test procedures since there are several test methods and different equipment available for testing the SWR or reflection coefficient. Therefore, the actual accuracy of the test equipment must be accounted for when measuring against instrument specifications to determine a pass or fail condition. The test system used must not exceed the system Rho uncertainties shown in [Table 4](#) when testing the E4412A, or in [Table 5](#) when testing the E4413A

Table 4 Power Sensor SWR and Reflection Coefficient for the E4412A^a

Frequency	System Rho Uncertainty	Actual Measurement	Maximum Rho
10 MHz to < 30 MHz	± 0.010		0.099
30 MHz to < 2 GHz	± 0.010		0.070
2 GHz to < 6 GHz	± 0.010		0.078
6 GHz to < 11 GHz	± 0.010		0.091
11 GHz to 18 GHz	± 0.010		0.119

a. Specifications apply to instruments with serial prefix US3848/MYxxxxxxx/SGxxxxxxx and above. For earlier instruments, refer to Appendix A.

Table 5 Power Sensor SWR and Reflection Coefficient for the E4413A^a

Frequency	System Rho Uncertainty	Actual Measurement	Maximum Rho
50 MHz to < 100 MHz	± 0.010		0.095
100 MHz to < 8GHz	± 0.010		0.087
8 GHz to < 18MHz	± 0.010		0.095
18 GHz to < 26.5 GHz	± 0.015		0.115

a.Specifications apply to instruments with serial prefix US3848/MYxxxxxxx/SGxxxxxxx and above. For earlier instruments, refer to Appendix A

Replaceable Parts

Table 6 is a list of replaceable parts. [Figure 4](#) is the illustrated parts breakdown (IPB) that identifies all of the replaceable parts. To order a part, quote the Agilent Technologies part number, specify the quantity required, and address the order to the nearest Agilent Technologies office.

NOTE

Within the USA, it is better to order directly from the Agilent Parts Center in Roseville, California. Ask your nearest Agilent office for information and forms for the “Direct Mail Order System.” Also your nearest Agilent office can supply toll free telephone numbers for ordering parts and supplies.

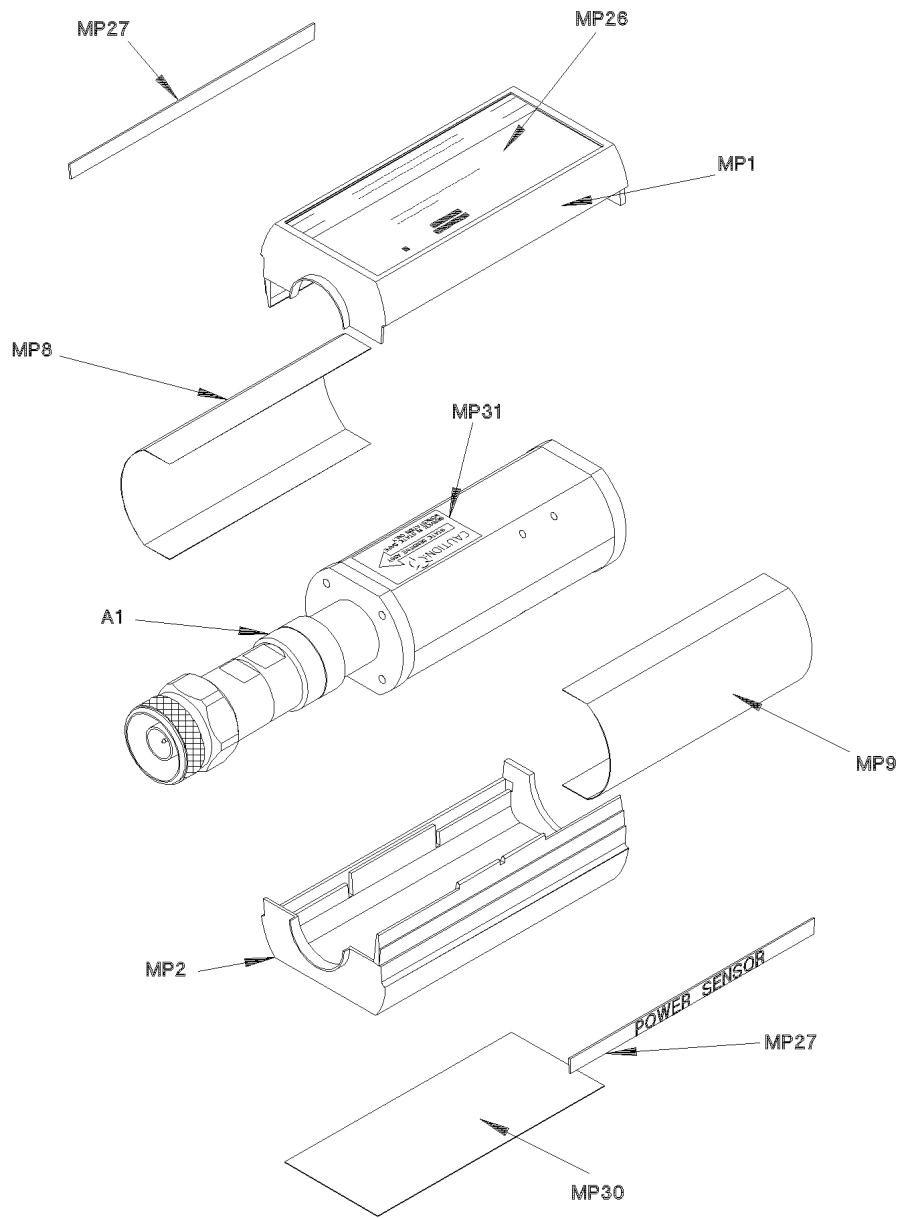

Figure 4 Illustrated Parts Break down

Table 6 Replaceable Parts

Reference Designation	Part Number	Qty	Description
A1/A2 E4412A	E4412-60006	1	SENSOR MODULE (E4412A)
A1/A2 E4412A	E4412-69006	1	RESTORED SENSOR MODULE (E4412A)
A1/A2 E4413A	E4413-60003	1	SENSOR MODULE (E4413A)
A1/A2 E4413A	E4413-69003	1	RESTORED SENSOR MODULE (E4413A)
	08485-60005	1	ADAPTOR, 3.5-mm to Type-N
			CHASSIS PARTS
MP1	5041-9160	1	SHELL PLASTIC
MP2	5041-9160	1	SHELL PLASTIC
MP3	08481-20011	1	CHASSIS
MP4	08481-20011	1	CHASSIS
MP8	08481-00002	1	SHIELD
MP9	08481-00002	1	SHIELD
MP26	E4412-80002	1	LABEL, ID E4412A
MP26	E4413-80002	1	LABEL, ID E4413A
MP27	7121-7389	1	LABEL, POWER SENSOR
MP30	7121-7388	1	LABEL, CAL/ESD
MP31	00346-80011	1	LABEL, CAUTION

Service

Service instructions consist of principles of operation, troubleshooting, and repairs.

Principles of Operation

The A1 Bulkhead assembly provides a 50 ohm load to the RF signal applied to the power sensor. A diode assembly in the bulkhead rectifies the applied RF to produce a dc voltage which varies with the RF power across the 50 ohm load. Thus the voltage varies with the RF power dissipated in the load. With maximum specified RF power (100 mW) the dc voltage is approximately 1V.

The low-level dc voltage from the bulkhead assembly must be amplified before it can be transferred on standard cables to the power meter. The amplification is provided by an input amplifier assembly which consists of a chopper (sampling gate) and an input amplifier. The chopper circuit converts the dc voltage to an ac voltage. To do this, the chopper uses two field effect transistors (FETs), A2Q1 and A2Q2, controlled by a 440 Hz square wave generated by the power meter. The amplitude of the sampling gate output (drain of A2Q1, source of A2Q2) is a 440 Hz square wave which varies with the RF power input. The 440 Hz ac output is applied to the input amplifier A2Q3 which provides the input to the first amplifier stage in the power meter.

The E44XX-Series power meter automatically detects when an E44XX Series power sensor is connected and downloads the correction data from the sensor's EEPROM. This configures the power meter to operate over the +20 dBm to -70 dBm power range with that particular sensor's unique correction data applied.

Troubleshooting

Troubleshooting information is intended to first isolate the power sensor, the cable, or the power meter as the defective component. When the power sensor is isolated, a “Restored Sensor Module” must be used for repair. See [Table 6](#).

If error message **241** or **310** is indicated on the power meter, suspect failed power sensor. If no error message is displayed, but a problem occurs when making a measurement, try replacing the cable from the power meter to the power sensor. If the problem still exists, try using a different power sensor to determine if the problem is in the power meter or in the power sensor.

CAUTION

Electrostatic discharge will render the power sensor inoperative. Do not, under any circumstances, open the power sensor unless you and the power sensor are in a static free environment.

Repair of Defective Sensor

There are no serviceable parts inside the E44XX-Series sensors. If the sensor is defective, replace the entire “module” with the appropriate “Restored sensor Module.” See [Table 6](#).

Cleaning

Cleaning Solutions

Keeping in mind its flammable nature; a solution of pure isopropyl or ethyl alcohol can be used to clean the connector.

Connector Cleaning

CAUTION

The RF connector beads deteriorate when contacted by hydrocarbon compounds such as acetone, trichloroethylene, carbon tetrachloride, and benzene.

CAUTION

Clean the connector only at a static free workstation. Electrostatic discharge to the center pin of the connector will render the power sensor inoperative.

Clean the connector face using a cotton swab dipped in isopropyl alcohol. If the swab is too big use a round wooden toothpick wrapped in a lint free cotton cloth dipped in isopropyl alcohol. Refer to Agilent Application Note 326, Principals of Microwave Connector Care (5954-1566) or Microwave Connector Care (08510-90064) for proper cleaning methods.

Disassembly Procedure

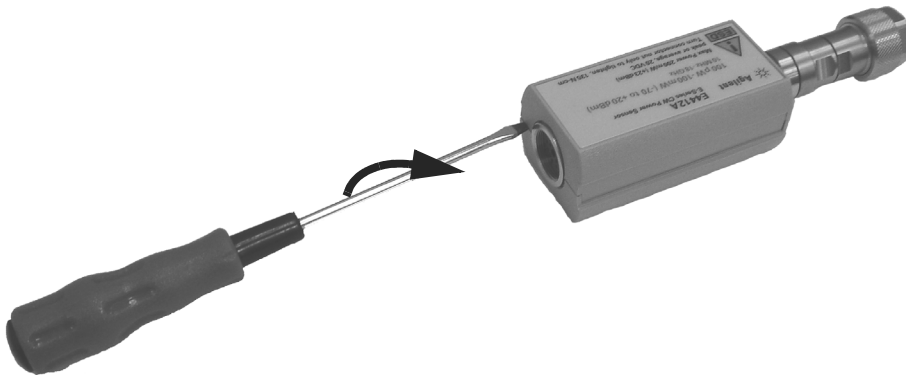

Figure 5 Removing Power Sensor Shell

CAUTION

Disassemble the power sensor only in a static free workstation. Electrostatic discharge will render the power sensor inoperative.

Disassemble the power sensor by performing the following steps:

- 1 At the rear of the power sensor, insert the blade of a screwdriver between the plastic shells (Figure 5). To prevent damage to the plastic shells use a screwdriver blade as wide as the slot between the two shells.
- 2 Pry alternately at both sides of the connector J1 until the plastic shells are apart. Remove the shells and the magnetic shields.

Reassembly Procedure

- 1 Replace the magnetic shields and the plastic shells as shown in Figure 5. Snap the plastic shells together.

Agilent Sales and Service Offices

Table 7 Agilent Sales and Service Offices

United States:	
(tel) 800 829 4444	(fax) 800 829 4433

Canada:	
(tel) 877 894 4414	(fax) 800 746 4866

China:	
(tel) 800 810 0189	(fax) 800 820 2816

Europe:	
(tel) 31 20 547 2111	

Japan:	
(tel) 0120 (421) 345	(fax) 0120 421 678

Korea:	
(tel) (080) 769 0800	(fax) (080) 769 0900

Latin America:	
(tel) (305) 269 7500	

Taiwan:	
(tel) 0800 047 866	(fax) 0800 286 331

Other Asia Pacific Countries:	
(tel) (65) 6375 8100	(fax) (65) 6755 004

or visit Agilent worldwide Web at: www.agilent.com/find/assist



A Appendix

E4412A and E4413A Specifications (Serial Prefixes Below
US3848/MYxxxxxxx/SGxxxxxxx) [26](#)

E4412A Calibration Factor Uncertainty at 1 mW (0 dBm) (Serial Prefixes
Below US3848/MYxxxxxxx/SGxxxxxxx) [28](#)

E4413A Calibration factor Uncertainty at 1 mW (0 dBm) (Serial Prefixes
Below US3848/MYxxxxxxx/SGxxxxxxx) [29](#)

The following specifications apply to E4412A and E4413A sensors (formerly EXCP-E18A and ECP-E26A, respectively) with a serial prefix below US3848/MYxxxxxxx/SGxxxxxxx.



Table A-1 E4412A and E4413A Specifications (Serial Prefixes Below US3848/MYxxxxxxxx/SGxxxxxxxx)

	Limit		Comments
Frequency Range	E4412A: 10 MHz to 18 GHz E4413A: 50 MHz to 26.5 GHz		
Power Range	-70 dBm to +20 dBm (100 pW to 100 mW)		
Impedance	50 ohm		nominal
Connector Type	E4412A: Type-N (male) E4413A: 3.5 mm (male)		
Maximum Standing Wave Ratio (SWR) and Reflection Coefficient (Rho)	SWR	Rho	Return Loss (dB)
E4412A			
10 MHz to <30 MHz	1.34	0.145	16.8
30 MHz to <10 GHz	1.22	0.100	20.0
10 GHz to <18 GHz	1.27	0.120	18.4
E4413A			
50 MHz to <2 GHz	1.25	0.110	19.2
2 GHz to <18 GHz	1.21	0.095	20.5
18 GHz to <26.5 GHz	1.26	0.115	18.8
Maximum Power	200 mW peak (+23 dBm) 200 mW average (+23 dBm)		
Zero Set	±50 pW		
Power Linearity^a	25 ± 5°C	0 to 55°C	(After calibration at 0 dBm at ambient temperature)
100 pW to 10 mW	±4%	±8%	-70 dBm to +10 dBm
10 mW to 100 mW	±5.5%	±11%	+10 dBm to +20 dBm

	Limit	Comments
Operating Temperature	0 to 55°C	
Net Weight E4412A E4413A	0.47 kg (1.04 lb) 0.45 kg (1.00 lb)	
Dimensions E4412A E4413A	Length: 130 mm (5.1 in) Length: 102 mm (4.0 in) Width: 38 mm (1.5 in) Height: 30 mm (1.2 in)	Same for both models Same for both models

a. Limits are in percent of power in Watts. See [Figure 2](#) for relative power measurement.

Table A-2 E4412A Calibration Factor Uncertainty at 1 mW (0 dBm) (Serial Prefixes Below US3848/MYxxxxxxxx/SGxxxxxxxx)

Frequency	Uncertainty (%)
10 MHz	2.7
30 MHz	2.7
50 MHz	Reference
100 MHz	2.7
1.0 GHz	2.7
2.0 GHz	3.1
4.0 GHz	3.1
6.0 GHz	3.1
8.0 GHz	3.1
10.0 GHz	3.1
11.0 GHz	3.1
12.0 GHz	3.3
14.0 GHz	3.3
16.0 GHz	3.3
18.0 GHz	3.3

Table A-3 E4413A Calibration factor Uncertainty at 1 mW (0 dBm) (Serial Prefixes Below US3848/MYxxxxxxx/SGxxxxxxx)

Frequency	Uncertainty (%)
50 MHz	Reference
100 MHz	2.7
1.0 GHz	2.7
2.0 GHz	3.1
4.0 GHz	3.1
6.0 GHz	3.1
8.0 GHz	3.1
10.0 GHz	3.1
12.0 GHz	3.3
14.0 GHz	3.3
16.0 GHz	3.3
17.0 GHz	3.3
18.0 GHz	3.5
20.0 GHz	3.5
22.0 GHz	3.5
24.0 GHz	3.5
26.0 GHz	3.5
26.5 GHz	3.5

www.agilent.com

Contact us

To obtain service, warranty, or technical support assistance, contact us at the following phone numbers:

United States:

(tel) 800 829 4444 (fax) 800 829 4433

Canada:

(tel) 877 894 4414 (fax) 800 746 4866

China:

(tel) 800 810 0189 (fax) 800 820 2816

Europe:

(tel) 31 20 547 2111

Japan:

(tel) 0120 (421) 345 (fax) 0120 421 678

Korea:

(tel) (080) 769 0800 (fax) (080) 769 0900

Latin America:

(tel) (305) 269 7500

Taiwan:

(tel) 0800 047 866 (fax) 0800 286 331

Other Asia Pacific Countries:

(tel) (65) 6375 8100 (fax) (65) 6755 0042

Or visit Agilent World Wide Web at:

www.agilent.com/find/assist

Product specifications and descriptions in this document are subject to change without notice. Always refer to Agilent Web site for the latest revision.

© Agilent Technologies, Inc. 1999–2012

Fourth Edition, December 14, 2012
E4412-90013



Agilent Technologies