

*Keysight MOI for HDMI 1.4b Ethernet and Audio Return Channel (HEAC)  
Cable Assembly Test*

Revision 1.02

20-Oct 2014

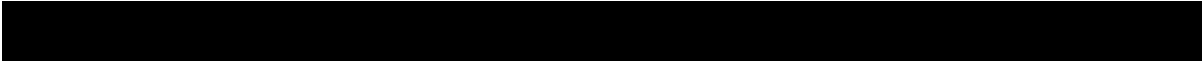

**Keysight Method of Implementation (MOI) for HDMI  
1.4b Ethernet and Audio Return Channel (HEAC) Cable  
Assembly Test Using Keysight E5071C ENA Option TDR**

**Keysight MOI for HDMI 1.4b Ethernet and Audio Return Channel (HEAC)  
Cable Assembly Test**

**Table of Contents**

1. Modification Record.....	4
2. Purpose .....	4
3. References .....	4
4. Resource Requirements .....	5
5. Test Procedure .....	6
5.1. Outline of Test Procedure .....	6
5.2. Instrument Setup.....	7
5.2.1. Recalling State File.....	7
5.2.2. Running VBA macro program.....	8
5.3. Screen Area and Cable Connection .....	10
5.4. Calibration and Adjustment .....	13
5.4.1. Time Domain Calibration .....	13
5.4.2. Measure DUT Length .....	15
5.4.3. Rise time adjustment .....	16
5.4.4. Frequency Domain Calibration .....	18
5.4.5. Perform Auto Port Extension.....	18
5.5. Measurement and Data Analysis .....	19
5.5.1. Intra-Pair Skew .....	19
5.5.2. Differential Attenuation .....	21
5.5.3. Differential Impedance .....	22
5.5.4. Common Mode Impedance .....	24
6. Appendix .....	25
6.1. Manual Setup for Time Domain Measurement .....	25
6.1.1. Starting Setup .....	25
6.1.2. Intra-Pair Skew .....	25
6.1.3. Differential Impedance .....	27
6.2. Manual Setup for Frequency Domain Measurement.....	31

***Keysight MOI for HDMI 1.4b Ethernet and Audio Return Channel (HEAC)  
Cable Assembly Test***

6.2.1. Channel and Trace Settings .....	31
6.2.2. Attenuation .....	31
6.3. Limit Test Settings .....	32
6.3.1. Turning On/Off Fail Sign .....	32
6.3.2. Setting the Warning Beeper .....	32
6.3.3. Defining the Limit Line .....	32

***Keysight MOI for HDMI 1.4b Ethernet and Audio Return Channel (HEAC)  
Cable Assembly Test***

## **1. Modification Record**

<b>Revision</b>	<b>Comments</b>	<b>Issue Date</b>
1.00	Initial release	Oct 10, 2014
1.02	Fixed a few typos	Oct 20, 2014

## **2. Purpose**

This document is intended to provide the measurement procedures for High-Definition Multimedia Interface (HDMI) Ethernet and Audio Return Channel (HEAC) cable assemblies with Keysight E5071C ENA Option TDR. The procedures are designed to perform tests equivalent to the methodologies defined in the HDMI Compliance Test Specification (CTS) Version 1.4b.

## **3. References**

High-Definition Multimedia Interface Specification Version 1.4b

High-Definition Multimedia Interface Compliance Test Specification Version 1.4b

# ***Keysight MOI for HDMI 1.4b Ethernet and Audio Return Channel (HEAC) Cable Assembly Test***

## **4. Resource Requirements**

1. E5071C ENA Series Network Analyzer with Enhanced Time Domain Analysis Option

*Note: Ensure that*

*- Test set option is any one of 440/445/460/465/480/485/4D5/4K5*

*- E5071C firmware revision A.11.31 or above is installed.*

*- E5071C-TDR application software revision A.01.56 or above is installed.*

2. Electronic Calibration Module N4431B (for 440/445/460/465/480/485) or N4433A (for 4D5/4K5)
3. 3.5 mm cables 8 GHz bandwidth or equivalent x4
4. Certified HDMI receptacle fixtures (ex. Keysight N1080B-H05) x2
5. Female to female adaptors to connect fixture and test cables (if necessary) x4

# ***Keysight MOI for HDMI 1.4b Ethernet and Audio Return Channel (HEAC) Cable Assembly Test***

## **5. Test Procedure**

### **5.1. Outline of Test Procedure**

#### **1. Instrument Setup**

#### **2. Calibration and Adjustment**

- Time domain calibration with the setup wizard in TDR application software
- Frequency domain calibration with the VBA macro program

#### **3. Measurements and Data Analysis**

##### **Time Domain Measurements**

- Intra-pair Skew Test
- Differential Impedance Test
- Common Mode Impedance Test

##### **Frequency Domain Measurements**

- Differential Attenuation Test

*Note: Hard Keys (Keys located on the Front panel of E5071C) are displayed in **Blue color and Bold**. (Example: **Avg, Analysis**)*

*Note: Soft keys (Keys on the screen) are displayed in **Bold**. (Example: **S11, Real, Transform**)*

*Note: Buttons (in the TDR or VBA) are displayed in **Green color and Bold**. (Example: **Trace, Rise Time**)*

*Note: Tabs (in the TDR) are displayed in **Brown color and Bold**. (Example: **Setup, Trace Control**)*

# Keysight MOI for HDMI 1.4b Ethernet and Audio Return Channel (HEAC) Cable Assembly Test

## 5.2. Instrument Setup

This section describes procedures for recalling the state file and VBA macro that support the instrument setup. Download “HEAC cable assembly test package” from

[http://www.keysight.com/find/ena-tdr\\_hdmi-cabcon](http://www.keysight.com/find/ena-tdr_hdmi-cabcon).

Extract the zip file and transfer the extracted files to the instrument with a USB flash memory.

### 5.2.1. Recalling State File

1. If TDR setup wizard appears, click **Close** button on the wizard.
2. Open **Setup** tab (item1).
3. Click **More Function** (item2).
4. Click **Advanced Mode** (item3).

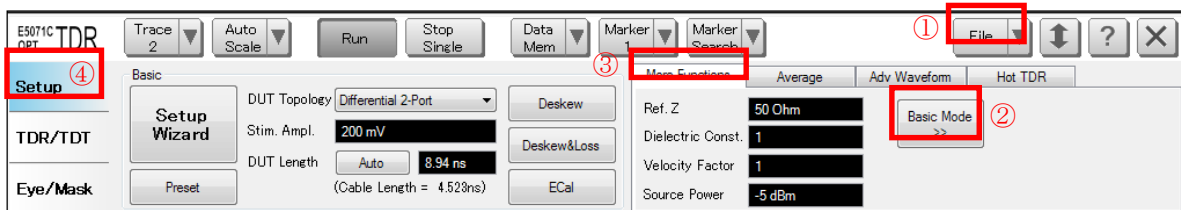

5. A dialog box appears requesting for confirmation. Then click **Yes**. (Clear the check box for “Use Advanced Calibration Methods”)

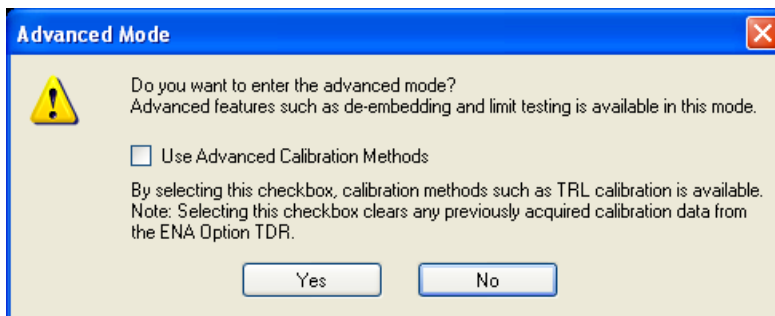

6. Click **File** (item4) and select **Recall State** to open the Recall State dialog box.
7. Specify a folder and a file name, and click **Open**.

For manual measurement setup, refer to **Error! Reference source not found. Error! Reference source not found.**

# Keysight MOI for HDMI 1.4b Ethernet and Audio Return Channel (HEAC) Cable Assembly Test

## 5.2.2. Running VBA macro program

### 1. Installing the VBA macro program

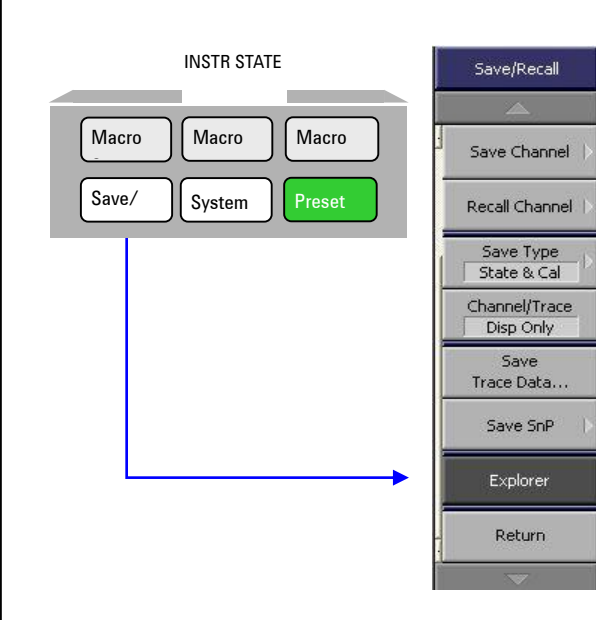

Obtain the VBA macro program from Keysight and install it on the E5071C.

- Press **Save/Recall** on the front panel, then press the **Explorer** soft key.
- Using **Explorer**, copy the file to the “D:¥VBA” folder.



## *Keysight MOI for HDMI 1.4b Ethernet and Audio Return Channel (HEAC) Cable Assembly Test*

### 2. Running the VBA macro program

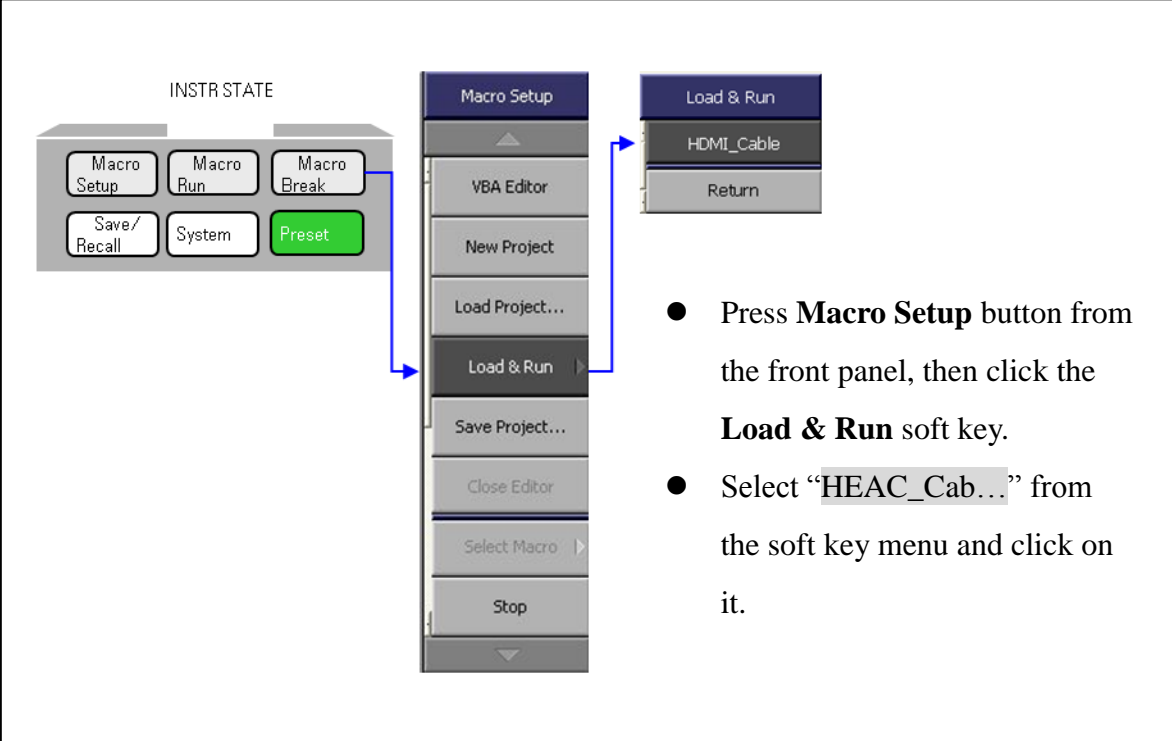

The diagram illustrates the process of running a VBA macro program. It shows the INSTR STATE panel with buttons for Macro Setup, Macro Run, Macro Break, Save/Recall, System, and Preset. A blue arrow points from the Macro Setup button to the Macro Setup menu. Another blue arrow points from the Load & Run menu item to the Load & Run soft key menu, which shows the selected macro 'HEAC\_Cable' and a 'Return' button.

- Press **Macro Setup** button from the front panel, then click the **Load & Run** soft key.
- Select “HEAC\_Cab...” from the soft key menu and click on it.

# Keysight MOI for HDMI 1.4b Ethernet and Audio Return Channel (HEAC) Cable Assembly Test

## 5.3. Screen Area and Cable Connection

This section explains the screen area of ENA Option TDR and the test cable connections. ENA Option TDR screen area consists of two channels as shown in Figure 5-1. Channel1 dedicated to time domain measurements is controlled by the TDR application software located at the bottom of the screen, and Channel2 dedicated to frequency domain measurements is controlled by the VBA macro program located at the upper right of the screen.

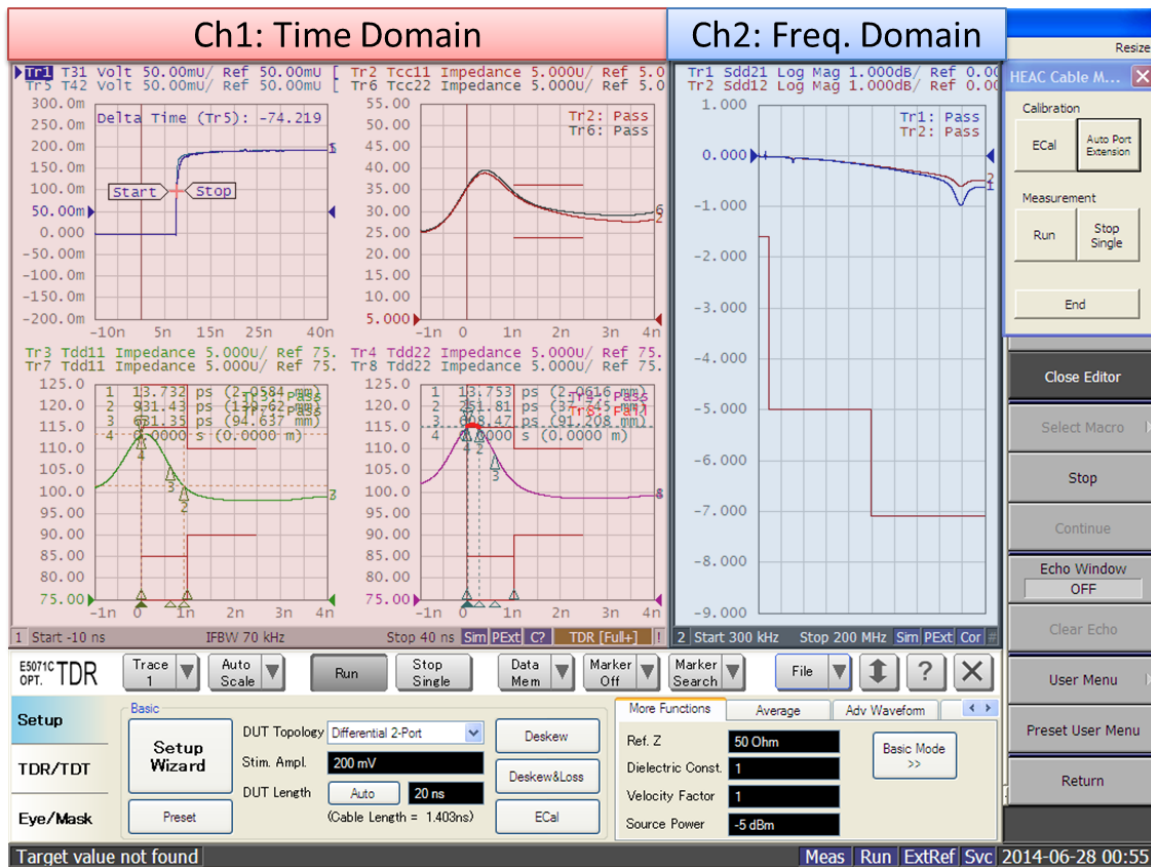
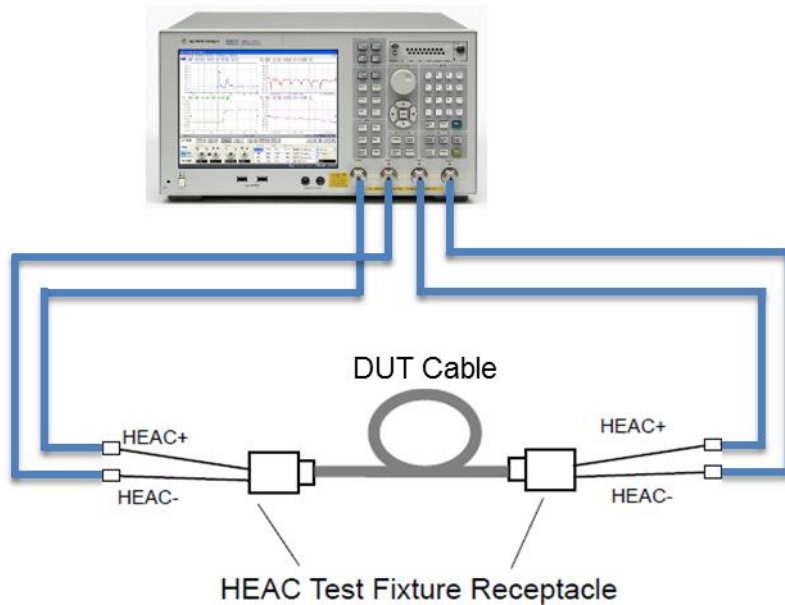

Figure 5-1 Screen area of ENA Option TDR

## ***Keysight MOI for HDMI 1.4b Ethernet and Audio Return Channel (HEAC) Cable Assembly Test***

The cables and fixtures are connected to the instrument as shown in Figure 5-2, but do not connect fixtures and Cable DUT yet.



**Figure 5-2 Measurement setup example**

Table 5-1 and Figure 5-3 show the cable connections and corresponding measurement areas on the screen, respectively. The measurement items of the same background color can be measured with the same cable connections.

**Table 5-1 Cable and Fixture Connection**

ENA Port Number	Port1	Port2	Port3	Port4
Fixture PIN Number	A HEAC+	A HEAC-	B HEAC+	B HEAC-

*Note: A and B represent each one of the test fixtures.*

**Keysight MOI for HDMI 1.4b Ethernet and Audio Return Channel (HEAC)  
Cable Assembly Test**

Ch1: Time Domain		Ch2: Freq. Domain
Intra-pair skew <ul style="list-style-type: none"> <li>• Tr1: T31</li> <li>• Tr5: T42</li> </ul>	Common Mode Impedance <ul style="list-style-type: none"> <li>• Tr2: Tcc11</li> <li>• Tr6: Tcc22</li> </ul>	Differential Attenuation <ul style="list-style-type: none"> <li>• Tr1: Sdd21</li> <li>• Tr2: Sdd12</li> </ul>
Differential Impedance (A) <ul style="list-style-type: none"> <li>• Tr3: Tdd11</li> <li>• Tr7: Tdd11</li> </ul>	Differential Impedance (B) <ul style="list-style-type: none"> <li>• Tr4: Tdd22</li> <li>• Tr8: Tdd22</li> </ul>	

**Figure 5-3 Measurement areas when Channel 1 is in TDR/TDT mode.**

# Keysight MOI for HDMI 1.4b Ethernet and Audio Return Channel (HEAC) Cable Assembly Test

## 5.4. Calibration and Adjustment

### 5.4.1. Time Domain Calibration

1. Connect the cables and ECal module to the E5071C.
2. Press **Channel Next** key to select Channel1.
3. Open **Setup** tab (item1).
4. Click **ECal** (item2) to launch the Full Calibration (ECal) and Fixture Compensation wizard.

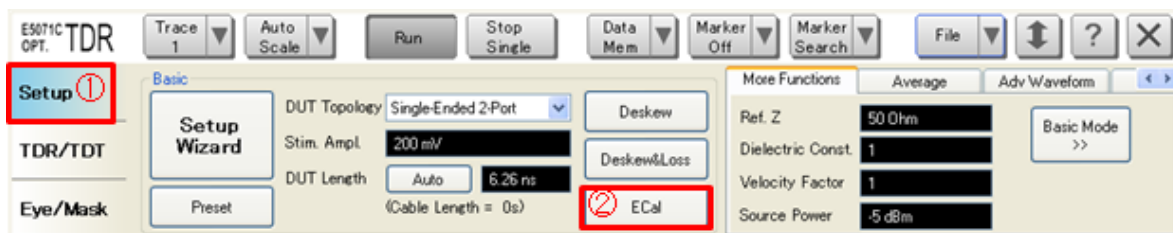

5. Connect all cables to the ECal module.
6. Click **Calibrate** (item3), then it will start the full calibration. Wait until the check-mark appears on the right of Calibrate button.
7. Click **Next** (item4).

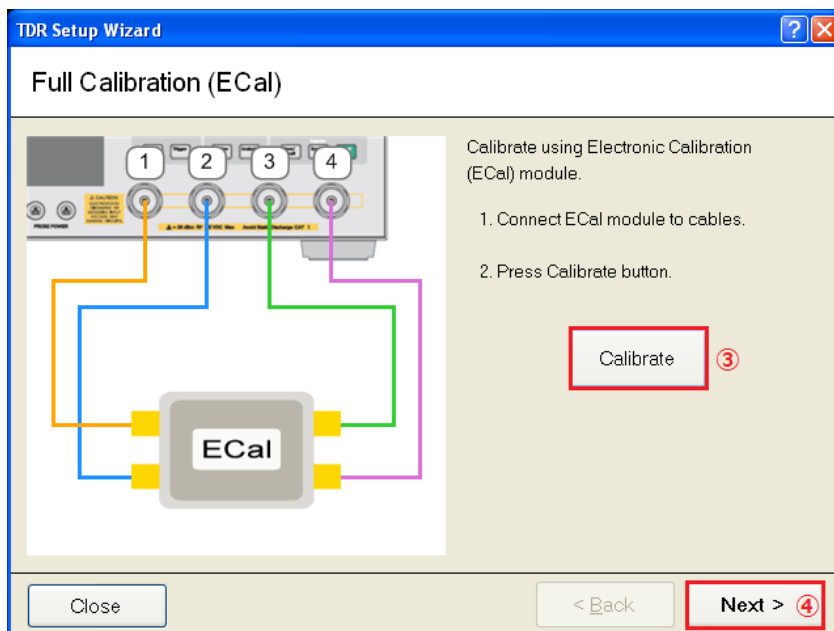

## ***Keysight MOI for HDMI 1.4b Ethernet and Audio Return Channel (HEAC) Cable Assembly Test***

8. Connect all cables to the test fixtures in accordance with the table below.

ENA Port Number	Port1	Port2	Port3	Port4
Fixture PIN Number	A HEAC+	A HEAC-	B HEAC+	B HEAC-

*Note: A and B represent each one of the test fixtures.*

9. Click **Fixture Comp** (item5), then it will start the fixture compensation. Wait until the check-mark appears on the right of Fixture Comp button.
10. Click **Finish** (item6).

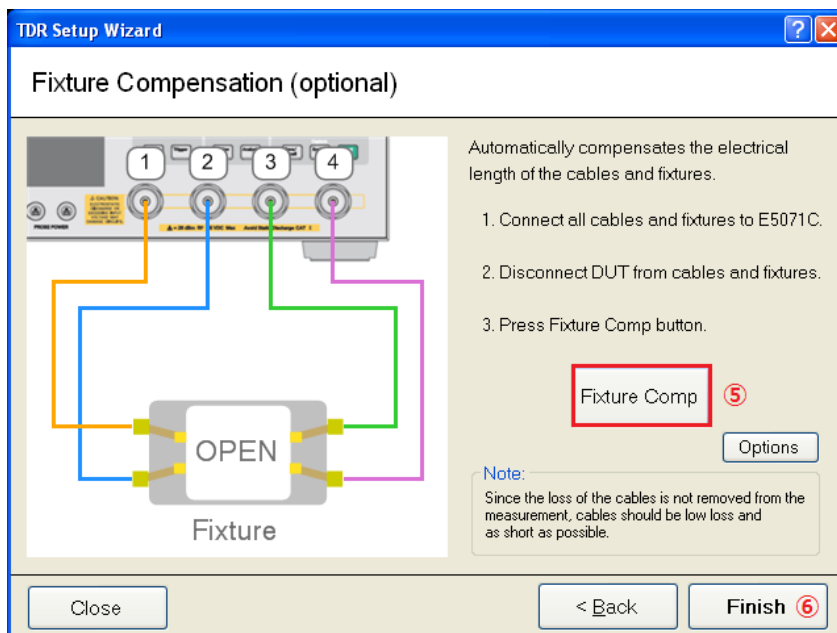

# Keysight MOI for HDMI 1.4b Ethernet and Audio Return Channel (HEAC) Cable Assembly Test

## 5.4.2. Measure DUT Length

1. Click **Auto** (item1) to measure the DUT Length.

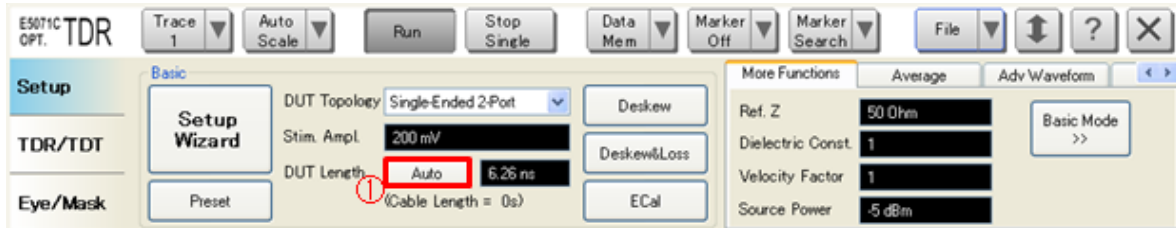

2. Connect the DUT.
3. Click **Measure** (item2), then it will measure the DUT length. Wait until the checkmark appears on the right of Measure button.
4. Click **Finish** (item3).

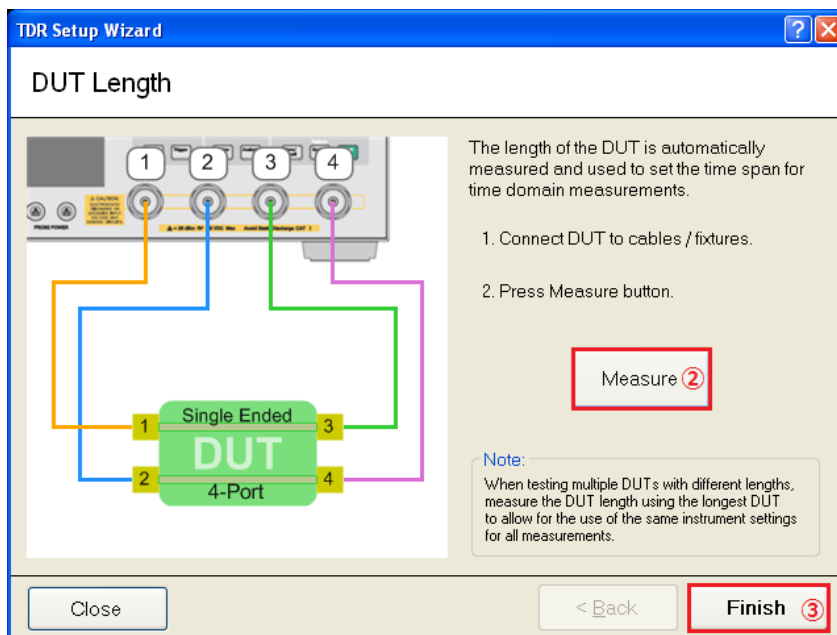

5. If the value of the DUT Length is smaller than 20 ns, enter 20 ns for enabling to set the rise time to 1 ns at the fixture open end in the next step.

## Keysight MOI for HDMI 1.4b Ethernet and Audio Return Channel (HEAC) Cable Assembly Test

### 5.4.3. Rise time adjustment

1. Disconnect DUT.
2. Select Trace3.
3. Click **TDR/TDT** tab and click **Parameters**. Change the format to **Volt**.

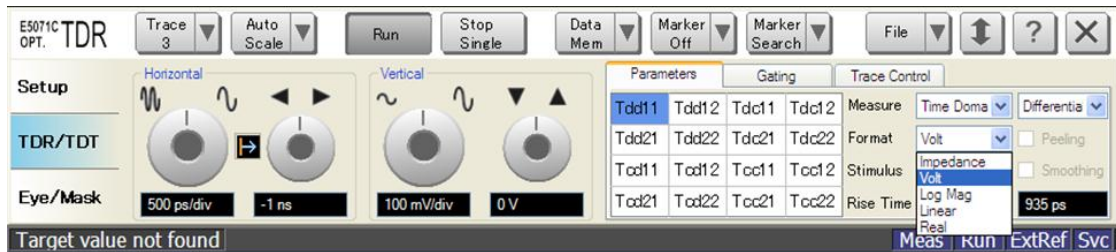

4. Click Marker Search and select Rise Time (10-90%).

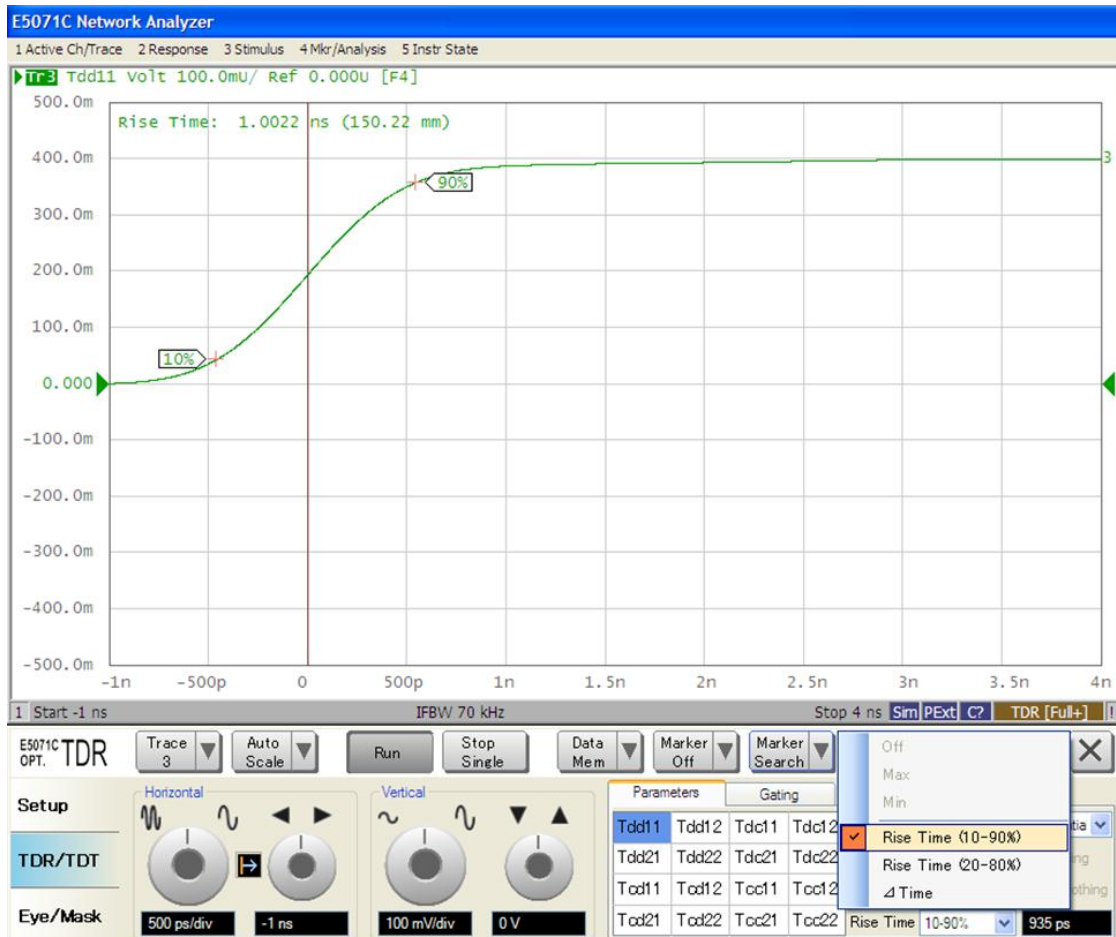

5. Set effective rise time at the open end of the test fixture to 1 ns.
6. Turn off the rise time marker, and revert the format to **Impedance**.



***Keysight MOI for HDMI 1.4b Ethernet and Audio Return Channel (HEAC)  
Cable Assembly Test***

7. Set same rise time value to Trace2, Trace4, Trace6, Trace7, and Trace8.

## Keysight MOI for HDMI 1.4b Ethernet and Audio Return Channel (HEAC) Cable Assembly Test

### 5.4.4. Frequency Domain Calibration

1. Connect all cables to the ECal module.
2. Click **ECal** to perform the Full Calibration (ECal).

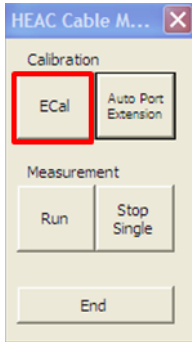

### 5.4.5. Perform Auto Port Extension

1. Connect the test fixtures as follows. Make the fixture ends open.

ENA Port Number	Port1	Port2	Port3	Port4
Fixture PIN Number	A HEAC+	A HEAC-	B HEAC+	B HEAC-

*Note: A and B represent each one of the test fixtures.*

2. Click **Auto Port Extension** to perform the Auto Port Extension.

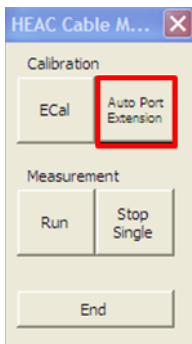

## ***Keysight MOI for HDMI 1.4b Ethernet and Audio Return Channel (HEAC) Cable Assembly Test***

### 5.5.Measurement and Data Analysis

#### 5.5.1. Intra-Pair Skew

1. Press **Channel Next** key to select Channel1.
2. Press **Channel Max** key to enlarge Channel1.
3. Open **TDR/TDT** tab.
4. Connect the test fixtures as follows.

<b>ENA Port Number</b>	<b>Port1</b>	<b>Port2</b>	<b>Port3</b>	<b>Port4</b>
<b>Fixture PIN Number</b>	A HEAC+	A HEAC-	B HEAC+	B HEAC-

*Note: A and B represent each one of the test fixtures.*

5. Connect the DUT (HDMI cable) to the test fixture.
6. Click **Stop Single** for Time Domain measurement.
7. Select **Trace1**.
8. Click **Auto Scale** and **X** to show the overall step response.
9. Apply the same horizontal scale settings to Trace5.
10. Click **Stop Single** for Time Domain measurement.

## Keysight MOI for HDMI 1.4b Ethernet and Audio Return Channel (HEAC) Cable Assembly Test

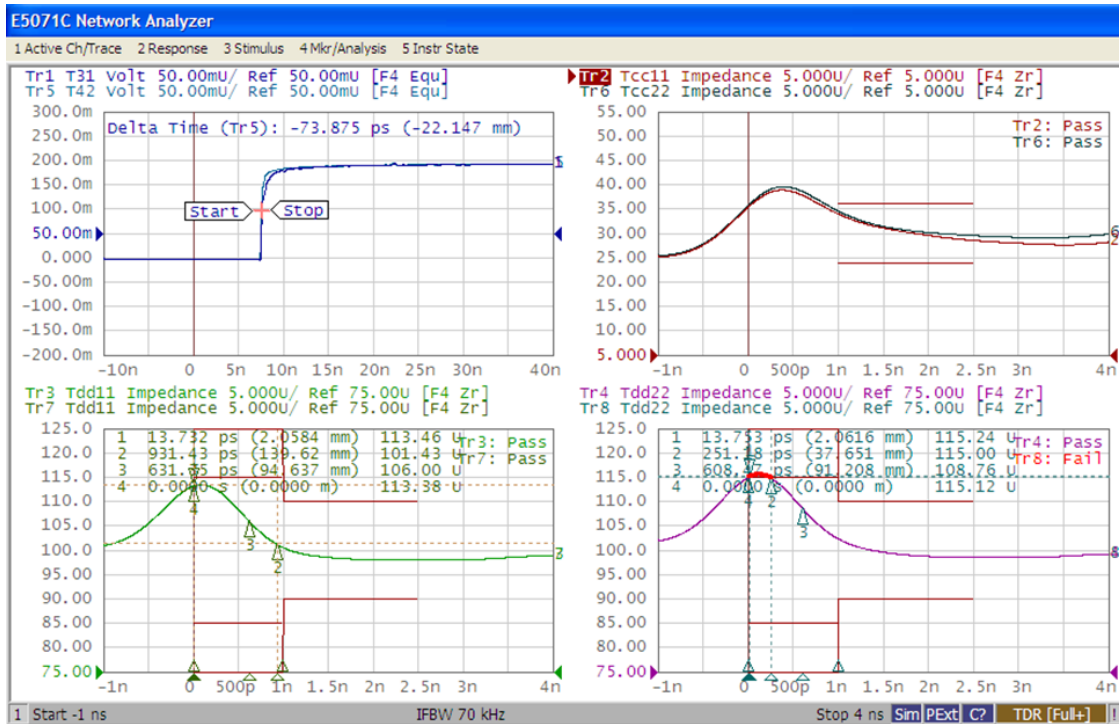

**Figure 5-4 Time Domain Measurement Example**

### Data Analysis

Read the delta time between Trace1 and Trace5 (top-left in Figure 5-4). Check if the value is within the limit: If the delta time  $\leq 111$  ps, then pass. Otherwise fail.

# Keysight MOI for HDMI 1.4b Ethernet and Audio Return Channel (HEAC) Cable Assembly Test

## 5.5.2. Differential Attenuation

### Measurement

1. Press **Channel Next** key to activate Channel2.
2. Press **Channel Max** key to enlarge Channel2.
3. Connect the test fixtures as follows. Unused fixture pins should be terminated.

ENA Port Number	Port1	Port2	Port3	Port4
Fixture PIN Number	A HEAC+	A HEAC-	B HEAC+	B HEAC-

*Note: A and B represent each one of the test fixtures.*

4. Connect the DUT (HDMI) cable to the test fixture.
5. Click **Stop Single** for Frequency Domain measurement.

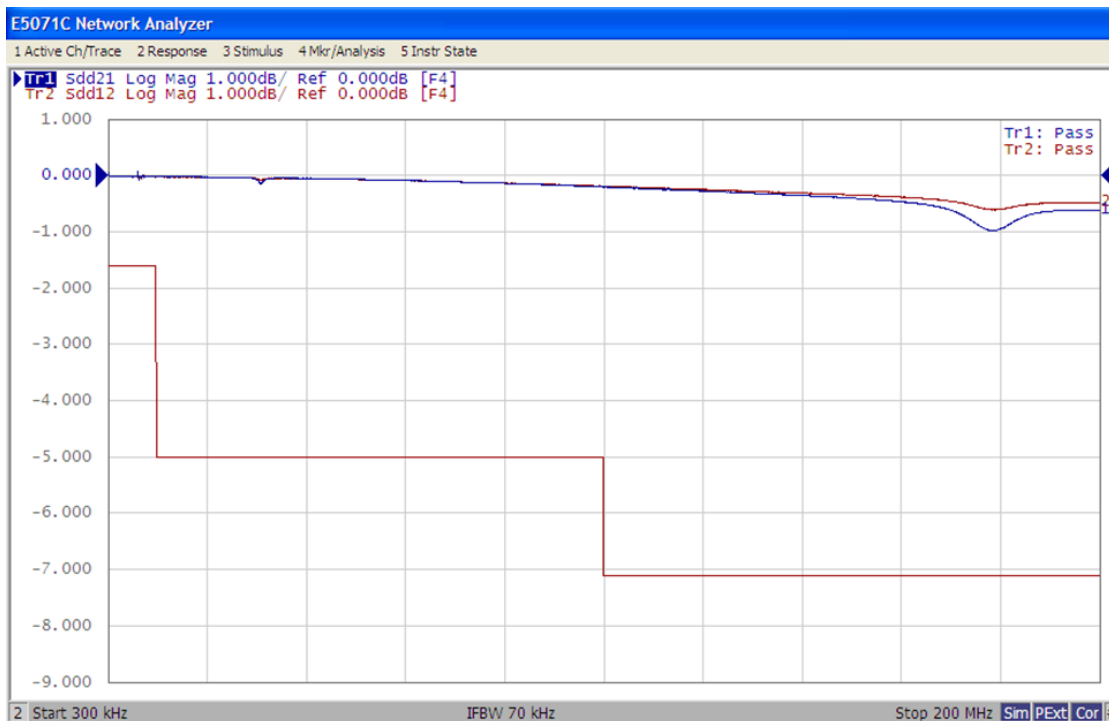

**Figure 5-5 Differential Attenuation Measurement Example**

### Data Analysis

Read Pass/Fail sign on Trace1 and Trace2 (Figure 5-5).

## **Keysight MOI for HDMI 1.4b Ethernet and Audio Return Channel (HEAC) Cable Assembly Test**

### 5.5.3. Differential Impedance

#### Measurement

1. Press **Channel Next** key to select Channel1.
2. Press **Channel Max** key to enlarge Channel1.
3. Open **TDR/TDT** tab.
4. Connect the test fixtures as follows. Unused fixture pins should be terminated.

ENA Port Number	Port1	Port2	Port3	Port4
Fixture PIN Number	A HEAC+	A HEAC-	B HEAC+	B HEAC-

*Note: A and B represent each one of the test fixtures.*

5. Connect the DUT (HDMI) cable to the test fixture.
6. Click **Stop Single** for Time Domain measurement.

#### Data Analysis

The result must meet following criteria.

- *Connection point and transition area (up to 1 ns): within  $100 \Omega \pm 15\%$ \**

*\* A single excursion is permitted out to a max/min of  $100 \Omega \pm 25\%$  and of a duration less than 250ps.*

- *Cable area (1 ns – 2.5 ns): within  $100 \Omega \pm 10\%$ .*

1. Read Pass/Fail sign on Trace3 and Trace7, and find an overall result from the following table:

Trace3 (Trace4)	Trace7 (Trace8)	Overall Result
Pass	Pass	Pass
Pass	Fail	Check the duration of violation
Fail	Fail	Fail

2. If Trace3 is pass and Trace7 is fail (bottom-left in Figure 5-4), confirm if the excursion is only one time and the duration of violation is within 250 psec.

Duration of violation = (Marker2 – Marker1) or (Marker4 – Marker3).

## Keysight MOI for HDMI 1.4b Ethernet and Audio Return Channel (HEAC) Cable Assembly Test

- Repeat the same test with Trace4 and Trace8 (bottom-right in Figure 5-4).

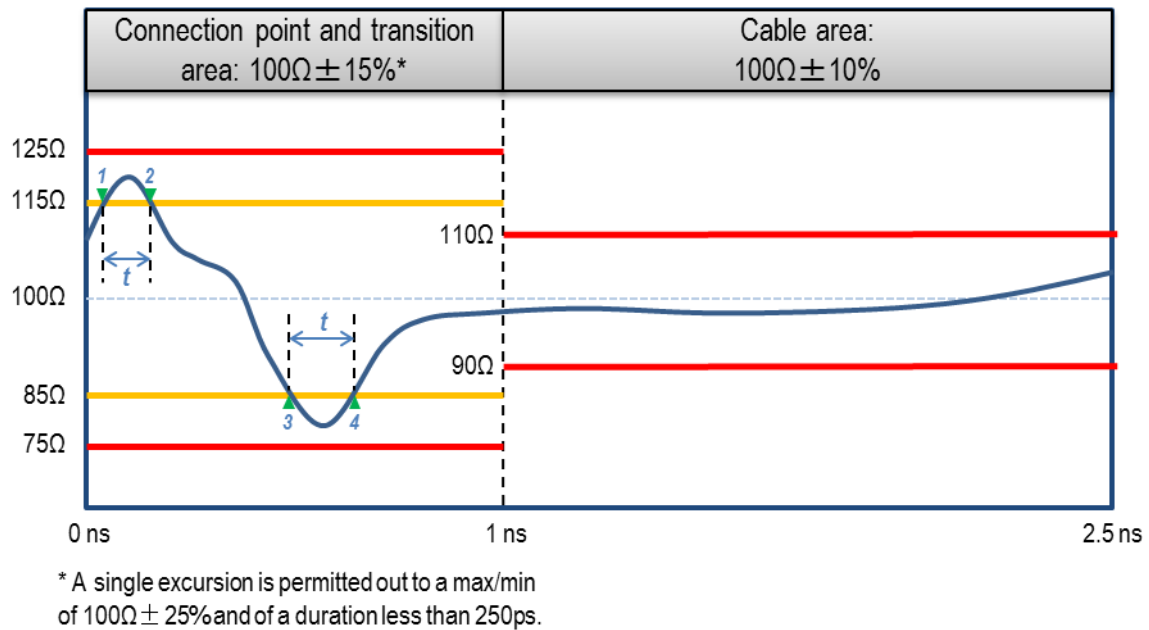

**Figure 5-6 Connection point and transition are and Cable area limits for Differential Impedance**

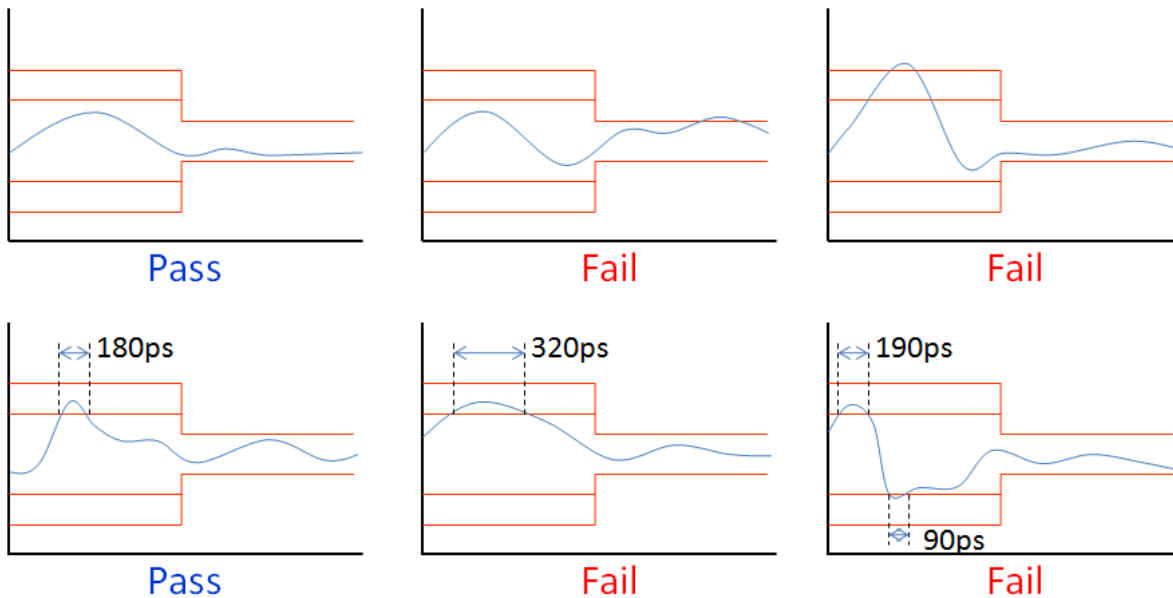

**Figure 5-7 Example for Impedance Judgment**

## ***Keysight MOI for HDMI 1.4b Ethernet and Audio Return Channel (HEAC) Cable Assembly Test***

### 5.5.4. Common Mode Impedance

#### Measurement

1. Press **Channel Next** key to select Channel1.
2. Press **Channel Max** key to enlarge Channel1.
3. Open **TDR/TDT** tab.
4. Connect the test fixtures as follows. Unused fixture pins should be terminated.

<b>ENA Port Number</b>	<b>Port1</b>	<b>Port2</b>	<b>Port3</b>	<b>Port4</b>
<b>Fixture PIN Number</b>	A HEAC+	A HEAC-	B HEAC+	B HEAC-

*Note: A and B represent each one of the test fixtures.*

5. Connect the DUT (HDMI) cable to the test fixture.
6. Click **Stop Single** for Time Domain measurement.

#### Data Analysis

The result must meet following criteria.

- Cable area (1 ns – 2.5 ns): within  $30 \Omega \pm 20\%$ .

Read Pass/Fail sign on Trace2 and Trace6 (top-right in Figure 5-4).



# Keysight MOI for HDMI 1.4b Ethernet and Audio Return Channel (HEAC) Cable Assembly Test

## 6. Appendix

### 6.1. Manual Setup for Time Domain Measurement

#### 6.1.1. Starting Setup

1. If TDR setup wizard was appeared, click **Close** button in the TDR setup wizard.
2. Open **Setup** tab (item1).
3. Click **Preset** (item2).
4. A dialog box appears requesting for confirmation. Then click **OK**.
5. Set **DUT Topology** (item3) to “Differential 2-port”.
6. Set **DUT Length** to 20 ns.
7. Open **More Functions** tab (item4).
8. Click **Advanced Mode** (item5).



9. A dialog box appears requesting for confirmation. Then click **Yes**. (Clear the check box for “Use Advanced Calibration Methods”)

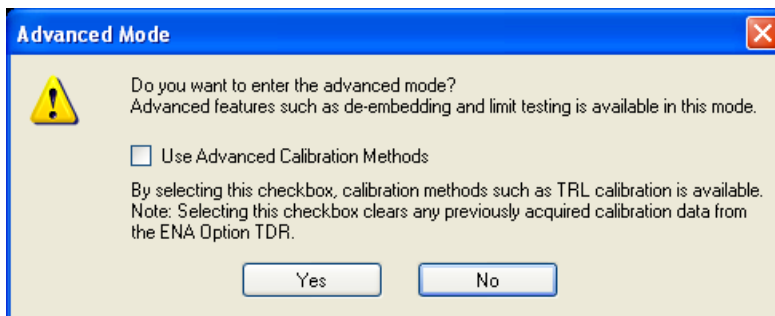

#### 6.1.2. Intra-Pair Skew

##### 6.1.2.1. Measurement Setup

1. Open **TDR/TDT** tab.
2. Select **Trace1**.
3. Open **Parameters** tab.

## ***Keysight MOI for HDMI 1.4b Ethernet and Audio Return Channel (HEAC) Cable Assembly Test***

4. Set **Measure** to “Time Domain” and “Single-Ended”.
5. Set **Format** to Volt.
6. Click **T31** in the table.
7. Click the box below the left knob under Horizontal.
8. Input 5 nsec/div with the Entry dialog box.
9. Click the box below the right knob under Horizontal.
10. Input -10 sec with the Entry dialog box.
11. Click the box below the left knob under Vertical.
12. Input 50 mV/div with the Entry dialog box
13. Click the box below the right knob under Vertical.
14. Input 50 mV with the Entry dialog box
15. Open **Trace Control** tab.
16. Clear **Time** and **Marker** check box under Coupling.
17. Click **Trace Settings Copy** button. Then Trace Settings Copy dialog box appears.
18. Select **Trace1** in the From list.
19. Select **Trace5** in the To list.
20. Click **Copy**.
21. Click **Close**.
22. Select **Trace5**.
23. Open **Parameters** tab.
24. Click **T42** in the table.
25. Select **Trace1**.
26. Click **Marker Search** and select **Δ Time**. Then Delta Time dialog box appears.
27. Check the **Δ Time** check box.
28. Select Trace5 (T42) for **Target (Stop)**.
29. Input **Position (%)** to 50.
30. Click **OK**.

## *Keysight MOI for HDMI 1.4b Ethernet and Audio Return Channel (HEAC) Cable Assembly Test*

### 6.1.2.2. Crosstalk Compensation

1. Select **Trace1**.
2. Press **Display** > **Equation Editor...** > Enter an equation “**Intra+= S31-S32**”.
3. Check **Equation Enabled** check box.
4. Click **Apply**.
5. Click **Close**.
6. Select **Trace5**.
7. Press **Display** > **Equation Editor...** > Enter an equation “**Intra-= S42-S41**”.
8. Check **Equation Enabled** check box.
9. Click **Apply**.
10. Click **Close**.

### 6.1.3. Differential Impedance

1. Open **TDR/TDT** tab.
2. Open **Parameters** tab.
3. Select **Trace3**.
4. Set **Format** to Impedance.
5. Set **Rise Time** to 1 nsec (10-90%).
6. Click **Tdd11** in the table.
7. Click the box below the left knob under Horizontal.
8. Input 500 psec/div with the Entry dialog box.
9. Click the box below the right knob under Horizontal.
10. Input -1 nsec with the Entry dialog box.
11. Click the box below the left knob under Vertical.
12. Input 5 Ohm/div with the Entry dialog box
13. Click the box below the right knob under Vertical.
14. Input 75 Ohm with the Entry dialog box.
15. Open **Trace Control** tab.

## *Keysight MOI for HDMI 1.4b Ethernet and Audio Return Channel (HEAC) Cable Assembly Test*

16. Click **Trace Settings Copy** button. Then Trace Settings Copy dialog box appears.
17. Select **Trace3** in the From list.
18. Select **Trace4, Trace7** and **Trace8** in the To list.
19. Click **Copy**.
20. Click **Close**.
21. Open **Parameters** tab.
22. Select **Trace4**.
23. Click **Tdd22** in the table.
24. Select **Trace8**.
25. Click **Tdd22** in the table.
26. Select **Trace7**.
27. Press **Marker Search > Search Range**, and set **Start** to 0 and **Stop** to 1n.
28. Click **Search Range** to turn it **ON**.
29. Click **Couple** to turn it **OFF**.
30. Click **Return**.
31. Click **Maker** menu and select **1**.
32. Press **Marker Search > Target**, and set **Target Value** to 115.<sup>1</sup>
33. Click **Target Transition > Positive**.
34. Click **Return**.
35. Click **Tracking** to turn it **ON**.
36. Click **Maker** menu and select **2**.
37. Press **Marker Search > Target**, and set **Target Value** to 115.<sup>1</sup>
38. Click **Target Transition > Negative**.
39. Click **Return**.
40. Click **Tracking** to turn it **ON**.
41. Click **Maker** menu and select **3**.

---

<sup>1</sup> Ignore the message “Target value not found” displayed at the bottom-left of screen..

***Keysight MOI for HDMI 1.4b Ethernet and Audio Return Channel (HEAC)  
Cable Assembly Test***

42. Press **Marker Search** > **Target**, and set **Target Value** to 85.<sup>1</sup>
43. Click **Target Transition** > **Negative**.
44. Click **Return**.
45. Click **Tracking** to turn it **ON**.
46. Click **Maker** menu and select **4**.
47. Press **Marker Search** > **Target**, and set **Target Value** to 85.<sup>1</sup>
48. Click **Target Transition** > **Positive**.
49. Click **Return**.
50. Click **Tracking** to turn it **ON**.
51. Select **Trace8**.
52. Press **Marker Search** > **Search Range**, and set **Start** to 0 and **Stop** to 1n.
53. Click **Search Range** to turn it **ON**.
54. Click **Couple** to turn it **OFF**.
55. Click **Return**.
56. Click **Maker** menu and select **1**.
57. Press **Marker Search** > **Target**, and set **Target Value** to 115.<sup>1</sup>
58. Click **Target Transition** > **Positive**.
59. Click **Return**.
60. Click **Tracking** to turn it **ON**.
61. Click **Maker** menu and select **2**.
62. Press **Marker Search** > **Target**, and set **Target Value** to 115.<sup>1</sup>
63. Click **Target Transition** > **Negative**.
64. Click **Return**.
65. Click **Tracking** to turn it **ON**.
66. Click **Maker** menu and select **3**.
67. Press **Marker Search** > **Target**, and set **Target Value** to 85.<sup>1</sup>
68. Click **Target Transition** > **Negative**.
69. Click **Return**.

## *Keysight MOI for HDMI 1.4b Ethernet and Audio Return Channel (HEAC) Cable Assembly Test*

70. Click **Tracking** to turn it **ON**.
71. Click **Maker** menu and select **4**.
72. Press **Marker Search** > **Target**, and set **Target Value** to 85.<sup>1</sup>
73. Click **Target Transition** > **Positive**.
74. Click **Return**.
75. Click **Tracking** to turn it **ON**.

### 6.1.4. Common Mode Impedance

1. Open **TDR/TDT** tab.
2. Open **Parameters** tab.
3. Select **Trace2**.
4. Set **Format** to Impedance.
5. Set **Rise Time** to 1 nsec (10-90%).
6. Click **Tcc11** in the table.
7. Click the box below the left knob under Horizontal.
8. Input 500 psec/div with the Entry dialog box.
9. Click the box below the right knob under Horizontal.
10. Input -1 nsec with the Entry dialog box.
11. Click the box below the left knob under Vertical.
12. Input 5 Ohm/div with the Entry dialog box
13. Click the box below the right knob under Vertical.
14. Input 5 Ohm with the Entry dialog box.
15. Open **Trace Control** tab.
16. Click **Trace Settings Copy** button. Then Trace Settings Copy dialog box appears.
17. Select **Trace2** in the From list.
18. Select **Trace6** in the To list.
19. Click **Copy**.
20. Click **Close**.

## *Keysight MOI for HDMI 1.4b Ethernet and Audio Return Channel (HEAC) Cable Assembly Test*

21. Open **Parameters** tab.
22. Select **Trace6**.
23. Click **Tcc22** in the table.

### 6.2. Manual Setup for Frequency Domain Measurement

#### 6.2.1. Channel and Trace Settings

1. Press **Display**.
2. Click **Allocate Channels** > .
3. Press **Channel Next**.
4. Click **Num of Traces** > **2**.

#### 6.2.2. Differential Attenuation

1. Press **Trace Next** to select Trace1.
2. Press **Sweep Setup** > **Sweep Type** > **Lin Freq**.
3. Set **Points** to 1601.
4. Press **Start** > Set start value to 300 kHz.
5. Press **Stop** > Set stop value to 200 MHz.
6. Press **Avg** > Set **IF Bandwidth** to 70 kHz.
7. Press **Analysis** > **Fixture Simulator** > **Fixture Simulator** to turn it **ON**.
8. Click **Topology** > **Device** > **Bal-Bal**.
9. Click **Port1 (bal)** > **1-2**.
10. Click **Port2 (bal)** > **3-4**.
11. Click **Return**.
12. Click **BalUn ON All Traces**.
13. Click **Measurement** > **Sdd21**.
14. Press **Format** > **Log Mag**.
15. Press **Scale**.
16. Set **Scale/Div** to 1 dB/div.

## ***Keysight MOI for HDMI 1.4b Ethernet and Audio Return Channel (HEAC) Cable Assembly Test***

17. Set **Reference position** to 9 Div.
18. Press **Trace Next** to select Trace2.
19. Press **Meas** and select **Sdd12**.
20. Press **Scale**.
21. Set **Scale/Div** to 1 dB/div.
22. Set **Reference position** to 9 Div.

### 6.3. Limit Test Settings

The E5071C-TDR provides a capability of setting limit lines to perform pass/fail test on each measurement.

#### 6.3.1. Turning On/Off Fail Sign

If this option is turned on, a fail sign appears when one or more measurement items violate the limit lines. It is useful to check overall test result.

1. Press **Analysis** > **Limit Test** > **Fail Sign** to switch the fail sign ON/OFF.

#### 6.3.2. Setting the Warning Beeper

If this option is turned on, a beep is generated when one or more measurement items violate the limit lines.

1. Press **System** > **Misc Setup** > **Beeper** > **Beep Warning** to switch the warning beeper ON/OFF.

#### 6.3.3. Defining the Limit Line

Set limit lines to perform pass/fail tests on the following measurement items.

- Differential Impedance (Trace3, 4, 7, 8 in Ch1)
- Common Mode Impedance (Trace2, 6 in Ch1)
- Differential Attenuation (Trace1, 2 in Ch2)

*Note: If using the VBA, appropriate limit lines are automatically selected for Attenuation and Phase in accordance with the DUT cable type.*



## ***Keysight MOI for HDMI 1.4b Ethernet and Audio Return Channel (HEAC) Cable Assembly Test***

1. Press **Channel Next** key and **Trace Next** key to activate the trace on which limit lines should be set.
2. Press **Analysis** > **Limit Test** > **Edit Limit Line** to display the limit table shown below (Initially, no segments are entered in the limit table). Using the limit table, create/edit a segment.

	Type	Begin Stimulus	End Stimulus	Begin Response	End Response
1	MAX	0 s	600 ps	105 u	105 u
2	MIN	0 s	600 ps	75 u	75 u
3					

3. Enter the limit line data following the tables below.
4. Click **Return**.
5. Click **Limit Line** and turn it **ON**.
6. Click **Limit Test** and turn it **ON**.
7. Repeat 1 to 6 for each Measurement items.

**Keysight MOI for HDMI 1.4b Ethernet and Audio Return Channel (HEAC)  
Cable Assembly Test**

**Differential Impedance**

- (Trace3, 4 in Ch1)

Type	Begin Stimulus	End Stimulus	Begin Response	End Response
Max	0 s	1 ns	125 Ohm	125 Ohm
Max	1 ns	2.5 ns	110 Ohm	110 Ohm
Min	0 s	1 ns	75 Ohm	75 Ohm
Min	1 ns	2.5 ns	90 Ohm	90 Ohm

- (Trace7, 8 in Ch1)

Type	Begin Stimulus	End Stimulus	Begin Response	End Response
Max	0 s	1 ns	115 Ohm	115 Ohm
Min	0 s	1 ns	85 Ohm	85 Ohm

**Common Mode Impedance**

- (Trace2, 6 in Ch1)

Type	Begin Stimulus	End Stimulus	Begin Response	End Response
Max	1 ns	2.5 ns	36 Ohm	36 Ohm
Min	1 ns	2.5 ns	24 Ohm	24 Ohm

**Differential Attenuation**

- (Trace1, 2 in Ch2)

Type	Begin Stimulus	End Stimulus	Begin Response	End Response
Min	300 kHz	10 MHz	-1.6 dB	-1.6 dB
Min	10 MHz	100 MHz	-5.0 dB	-5.0 dB
Min	100 MHz	200 MHz	-7.1 dB	-7.1 dB