

Keysight Technologies N5393C PCI Express® 3.0 (Gen3) Software for Infiniium Oscilloscopes

Data Sheet

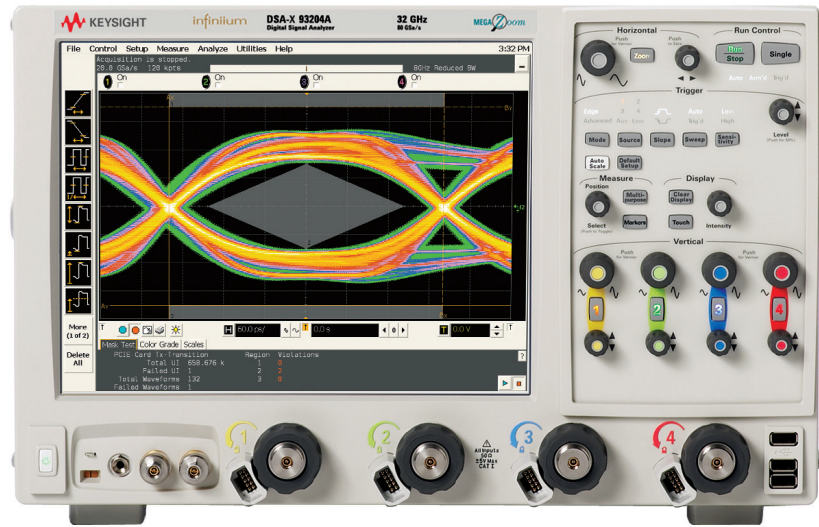

Table of Contents

Features	4
Benefits	5
Easy Test Definition	6
PCI Express 3.0	7
Configurability and Guided Connections	8
Reports with Margin Analysis	9
Extensibility	11
Automation	12
Switch Matrix	13
Receiver Stressed Eye Calibration	14
Reference Clock Measurements	16
Powerful Debugging Aids	17
Measurement Requirements	20
Recommended Test Accessories	21
Oscilloscope Compatibility	22
Test Performed	23
Ordering Information	24

Verify and debug your PCI Express® designs more easily

Keysight Technologies, Inc. N5393C PCI Express electrical performance validation and compliance software provides you with a fast and easy way to verify and debug your PCI Express 3.0, 2.0, and 1.1/1.0a designs for both silicon validation (as per the PCIe® BASE specification) as well as for add-in cards and motherboard systems (as per the PCIe CEM specification).

The PCI Express electrical test software allows you to automatically execute PCI Express electrical transmitter tests, and it displays the results in a flexible report format. In addition to the measurement data, the report provides a margin analysis that shows how closely your device passed or failed each test.

The N5393C PCI Express electrical test software utilizes the prescribed test methods and algorithms as required by the PCI Express Card Electromechanical (CEM) specifications for all current PCI Express Standards. This produces results that are not only consistent with the PCI-SIG®'s own SigTest utility, but also provides you with a fast and easy means of executing complex two-port motherboard tests and single port add-in card test with total automation.

In addition to transmitter testing, the N5393C PCI Express electrical test software also provides an optional receiver test calibration test suite, which allows you to setup your N4903B JBERT bit error ratio tester for performing PCI Express 3.0 jitter tolerance testing under the PCIe 3.0 BASE specification.

The PCI Express electrical performance validation and compliance software performs a wide range of electrical tests as per the PCI Express PCI Express 2.0 and 1.1/1.0a. electrical specifications for add-in cards and motherboard systems as documented in Section 4 of the base specification and Section 4 of the card electromechanical specification.

Tests for PCI Express 3.0 (based on section 4.3.3.10 and 4.3.3.13) are also included to help you test your products against for the next generation of this powerful I/O technology.

In addition to full swing (800 mV) testing, the N5393C also supports testing for low-power, half-swing devices (400 mV) as per the PCI Express Architecture Mobile Graphics Low-Power Addendum to the PCI Express Base Specification Revision 1.0.

Features

The N5393C PCI Express electrical test software offers several features to simplify the validation of PCI Express designs:

- PCIe 3.0 measurements for uncorrelated TJ, DJ, and PWJ, pseudo package loss, and preset de-emphasis and preshoot.
- Automated 1.6 M Unit Interval (or greater) testing for highest accuracy when embedding PCIe reference channel and package model losses
- Results consistent with PCI-SIG SigTest software utility
- Support for de-embedding of test fixtures and cables*
- Test setup wizard for ease-of-use
- Wide range of electrical transmitter and reference clock tests
- PCI-SIG SigTest clock recovery algorithm
- Optional integrated receiver test calibration suite for automated calibration (BASE spec) of your N4903B JBERT**
- Automated scope measurement setup
- Test results report generation
- Pass/fail margin analysis
- Reference clock phase jitter analysis
- Two-port (explicit clock and data) supported for motherboard signal quality testing
- Support for both full-swing and low-power, half-swing devices.

With the PCI Express electrical test software, you can use the same oscilloscope you use for everyday debugging to perform automated testing and margin analysis based on the PCI-SIG-specified tests.

PCI Express compliance testing

To pass signal quality testing at a PCI-SIG-sponsored compliance workshop, your product must successfully pass “Gold Suite” testing, based on the PCI-SIG SigTest application. The SigTest application tests your device against the minimum signal-quality performance requirements for PCI. If you are developing receivers and transmitters for add-in boards and system motherboards, the N5393C PCI Express electrical test software helps you execute the SigTest tests and additional oscilloscope already completed tests. See the list of tests in Table 3 on page 16 (for 1.1 test coverage).

While SigTest tests provide a good overview of PCI Express electrical signal quality, they address only a small subset of the electrical compliance measurements specified in the PCI-SIG specification. The SigTest application also provides minimal reporting capability with pass/fail indication and measurement values, and has limited debugging capabilities to decipher eye mask violations or excessive jitter.

For PCI Express 3.0 measurements, the N5393C software automatically calculates uncorrelated total jitter, uncorrelated deterministic jitter, uncorrelated PWJ necessary for validating new PCIe 3.0 compliant chipsets. For versions of devices compliant with PCI Express 2.0 or earlier, random jitter is also reported for completeness and a voltage margin “eye” diagram is included in the final HTML report. DJ and TJ values are specified in the PCIe 2.0 specification and are required for compliance verification.



Figure 1. PCI Express 2.0 supports data rates up to 5.0 GT/s as shown above (~3.5 dB de-emphasis)

* Requires the purchase of the optional Keysight N5465A InfiniSim Waveform Transformation Toolset for Infiniium Oscilloscopes

** Requires the purchase of N5393C opt. 004 software license. Receiver test hardware and fixtures not included and must be purchased separately

Benefits

N5393C benefits

The N5393C PCI Express electrical test software saves you time by setting the stage for automatic execution of PCI Express electrical tests, including JBERT jitter stress calibration (optional). Part of the difficulty of performing electrical tests for PCI Express is hooking up the oscilloscope, loading the proper setup files, and then analyzing the measured results by comparing them to limits published in the specification. The PCI Express electrical test software does much of this work for you. In addition, if you discover a problem with your device, robust debug tools are available to aid in root-cause analysis. These debug tools are provided by the Keysight E2688A high-speed serial data analysis software, which you must install on your oscilloscope to use the PCI Express electrical test software.

The N5393C also now has an integrated interface for controlling the N4565A InfiniiSim Waveform Transformation Toolset for de-embedding of test fixtures. Introduced with PCIe 2.0, de-embedding of test fixtures utilizes S-parameters as input to create a de-embed model that helps to restore high frequency signal content that is often lost or significantly attenuated by test fixtures and cables. This can help to recover significant jitter margin normally lost to fixtures used in a test setup.

The N5393C can be purchased with an optional test suite for performing the calibration of your Keysight JBERT (B) bit error ratio tester for stressed eye receiver testing for PCIe 3.0 silicon. This helps ensure consistent run-to-run setup of the instrumentation, saving you time and

providing consistent and accurate receive test results.

The N5393C PCI Express electrical test software offers many more electrical tests than the SigTest application. Unlike the SigTest application, the N5393C PCI Express electrical test software automatically configures the oscilloscope for each test, and it provides an informative results report that includes margin analysis indicating how close your product is to passing or failing a particular test assertion. Table 1 shows a side-by-side comparison of the capabilities of the SigTest application and the Keysight N5393C PCI Express electrical test software. A list of the measurements made by the PCI Express electrical test software can be found in Table 3, (Table 3 contains comparison of SigTest vs. Keysight).

Capability	Keysight N5393C	PCI-SIG SigTest
Support for PCIe 3.0	BASE Spec	N/A
Integrated de-embedding support	Yes (N5465A Required)	No
Number of measurement assertions	16+	4
Support for PCIe 1.0a, 1.1, 2.0	Yes	Yes
Reference clock tests	10 (1.1)	0*
Automated oscilloscope setup for each measurement	Yes, guided	No, single setup
Measurement results	Pass/fail with margin analysis	Pass/fail with measured value
CEM based measurement methodology	Yes	Yes
Clock recovery method	PCI-SIG SigTest or 1st/2nd order PLL	PCI-SIG SigTest
Brick wall filter (2.0 testing)	Yes	Yes
Custom HTML report generation	Yes	No
Support for low power device	Yes	No
Selectable number of tests performed	Yes	No
Multi-trial run support	Yes	No
Debug mode for "what if" analysis	Yes	No
Compliance test boards supported	CBB1, CBB2, CLB1, CLB2	CBB1, CBB2, CLB1, CLB2

*PCI-Sig offers a separate utility (Clock_Jitter) for analyzing reference clock phase jitter.

Table 1. Comparison of capabilities of the Keysight PCI Express electrical test software and the PCI-SIG SigTest application.

Easy Test Definition

The N5393C PCI Express electrical test software extends the ease-of-use advantages of Keysight's Infiniium 90000 or 90000 X-Series oscilloscopes to testing PCI Express designs. The Keysight automated test engine walks you quickly through the steps required to define the tests, set up the tests, perform the tests, and view the test results. You can select a category of tests all at once, or specify individual tests. You can save tests and configurations as project files and recall them later for quick testing and review of previous test results. Straightforward menus let you perform tests with a minimum of mouse clicks.

The Keysight N5393C allows you to easily specify the test standard you want to use to test the compliance of your device. This makes test setup easy as only the appropriate tests for the test point you pick are shown on later test selection pages.

Pick the standard you want to test against

Choose the test point or specific signal you want to test

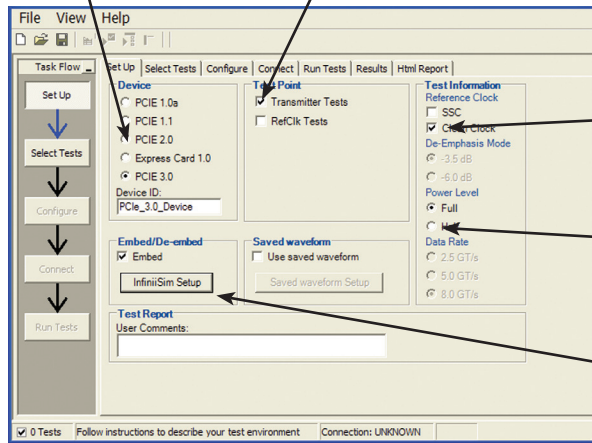

Test with SSC enabled or with a clean clock (for compliance)

Choose half swing if testing low power devices

De-embd test fixtures with the optional N5465A InfiniiSim waveform transformation toolset

Figure 2. The Keysight N5393C allows you to easily specify the test standard you want to use to test the compliance of your device. This makes test setup easy as only the appropriate tests for the test point you pick are shown on later test selection pages.

Easy to follow task flow for configuring and running tests

Select one test or a group of tests with a single mouse click

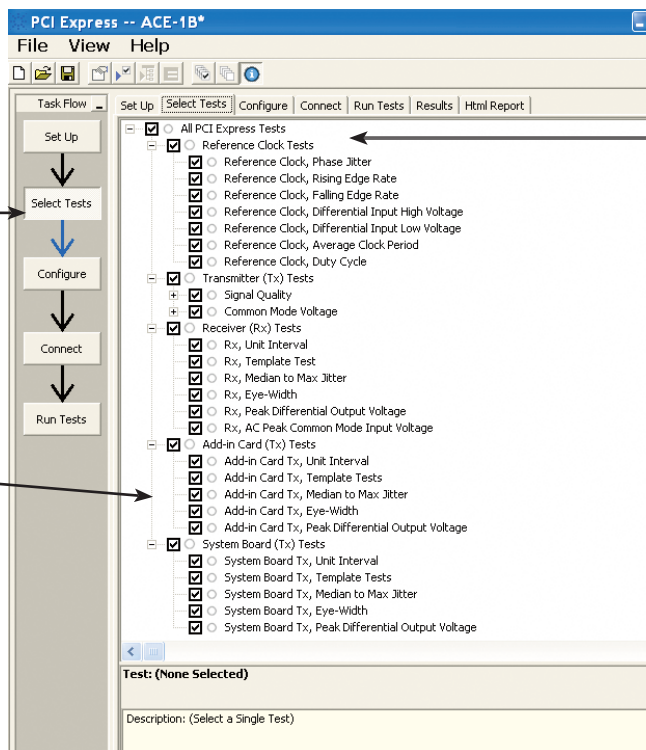

Test your reference clock for phase jitter to help ensure clean high data rate transmissions

Figure 3. The Keysight automated test engine guides you quickly through selecting tests, configuring tests, setting up the connection, running the tests, and viewing the results. Individual tests or groups of tests are easily selected with a mouse click.

PCI Express 3.0

The N5393C includes support for testing PCI Express 3.0 devices. The tests supported include new jitter, voltage, de-emphasis, preshoot, pseudo S21 loss and others defined by the PCI Express 3.0 BASE specification. In addition, with the addition of the optional N5465A InfiniiSim Waveform Transformation Toolset, the N5393C also integrated de-embedding of test channel and cable losses with user supplied S parameters for fixtures and connectors. De-embedding is used to recover jitter losses due to the attenuation of high frequency elements caused by the test channel.

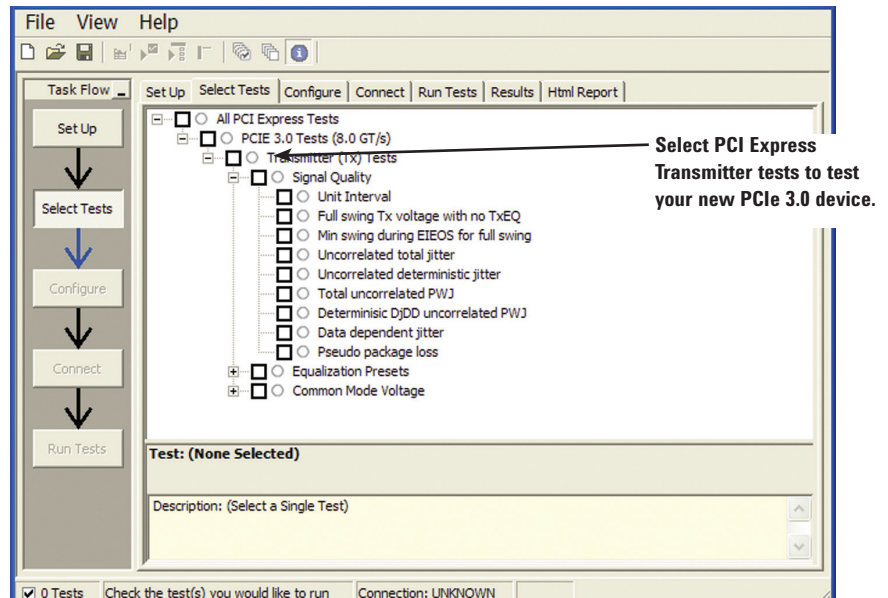

Figure 4. PCI Express 3.0 transmitter tests

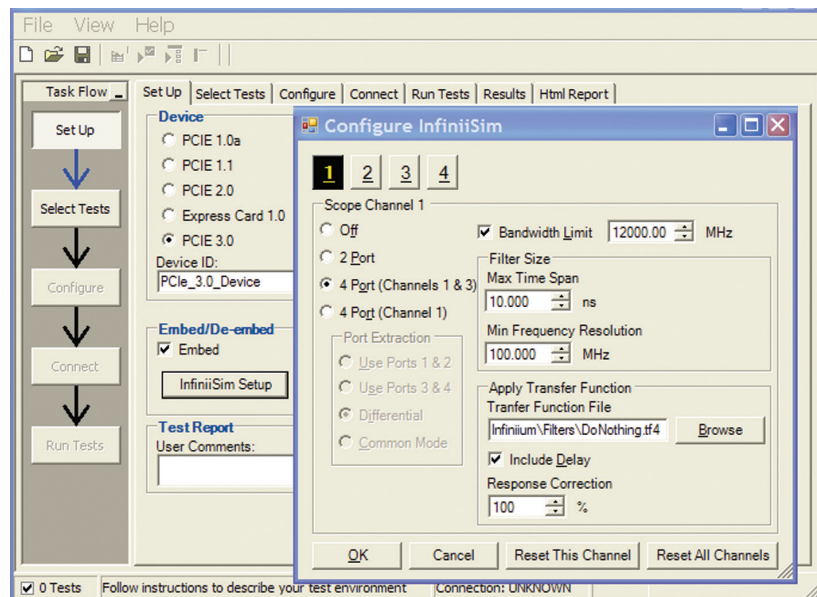

Figure 5. The N5393C integrates de-embedding capability when coupled with the optional N5465A InfiniiSim waveform transformation toolset

Configurability and Guided Connections

The N5393C PCI Express electrical test software provides flexibility in your test setup. It guides you to make connection changes with hookup diagrams when the tests you select require it. All PCI Express electrical compliance tests you perform are based on the official PCI-SIG approved set of test fixtures. The compliance fixtures include the Compliance Base Board (CBB2) for add-in card testing, and the Compliance Load Board (CLB2) for motherboard or system testing. Connection to the compliance test fixtures is selectable between SMA/SMP cables or Keysight InfiniiMax active differential probes.

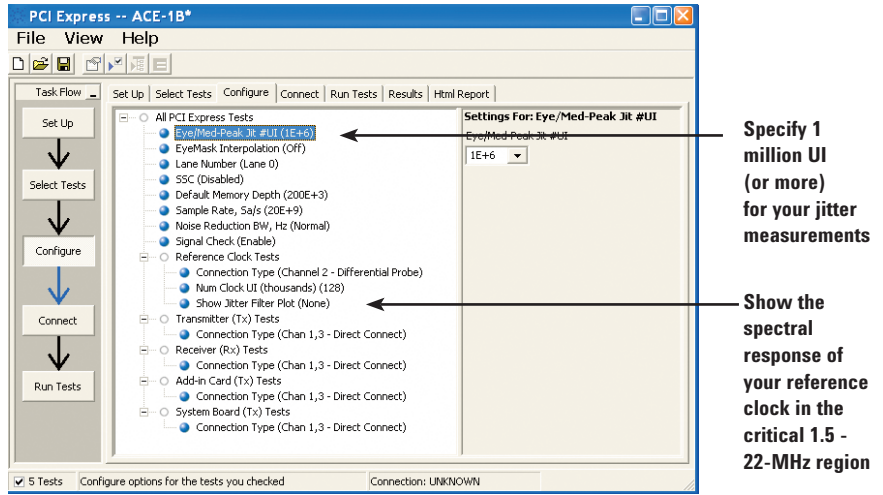

Figure 6. In configuring the tests, you specify the device to test, its configuration, and how the oscilloscope is connected.

If more than one test setup connection is required, you will be notified here

You are prompted to make the appropriate connections for the set of tests

Toggle circuit to switch between Gen1 (2.5 GBit/s) and Gen2 (50 GBit/s)

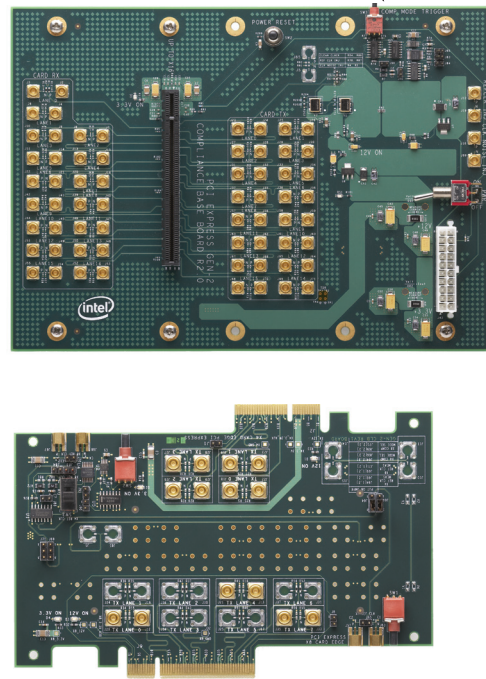
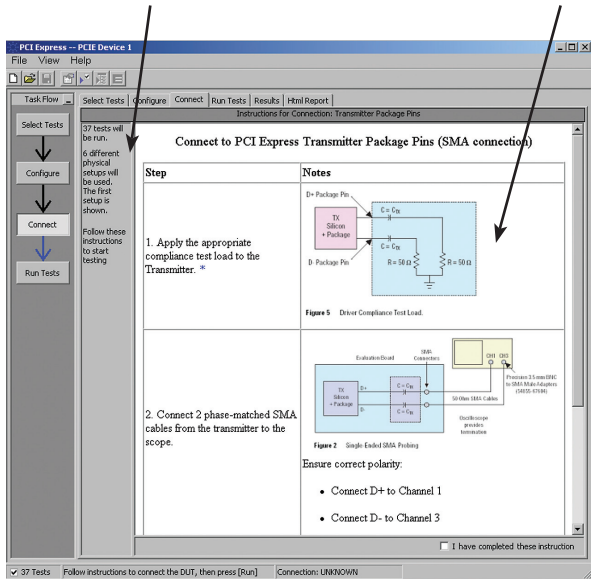

Figure 7. When you make multiple tests where the connections must be changed, you are prompted with connection diagrams and/or photographs.

Figure 8. The PCI-SIG Compliance Base Board (CBB2) for Gen2 add-in card testing, and the Compliance Load Board (CLB2) for Gen2 motherboard or host system testing.

Reports with Margin Analysis

In addition to providing you with measurement results, the N5393C PCI Express electrical test software provides a report format that shows you not only where your product passes or fails, but also reports how close you are to the limits specified for a particular test assertion. You can select the margin test report parameter, which means you can specify the level at which warnings are issued to alert you to electrical tests where your product is operating close to the official test limit defined by the PCI Express 2.0, 1.0a or 1.1 specifications.

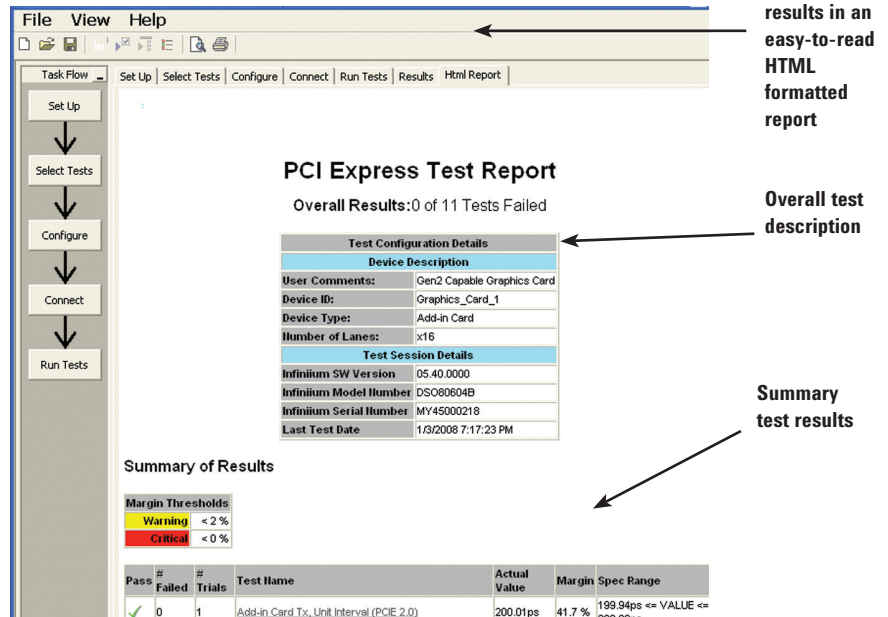

Figure 9. The PCI Express electrical test software results report documents your test, indicates the pass/fail status, the test specification range, the measured values, and shows how much margin you have.

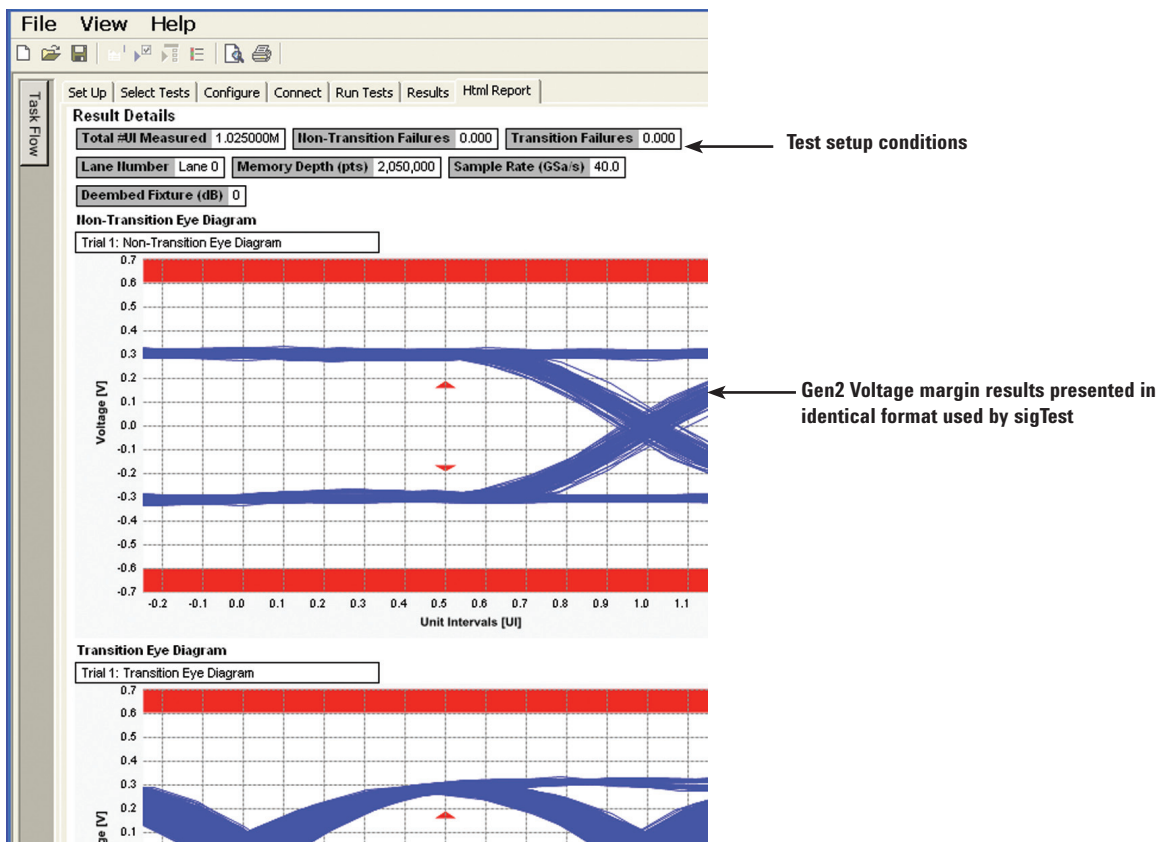

Figure 10. The HTML report provides additional details including test setup conditions, graphical results, and test limits (where appropriate).

Reports with Margin Analysis, (continued)

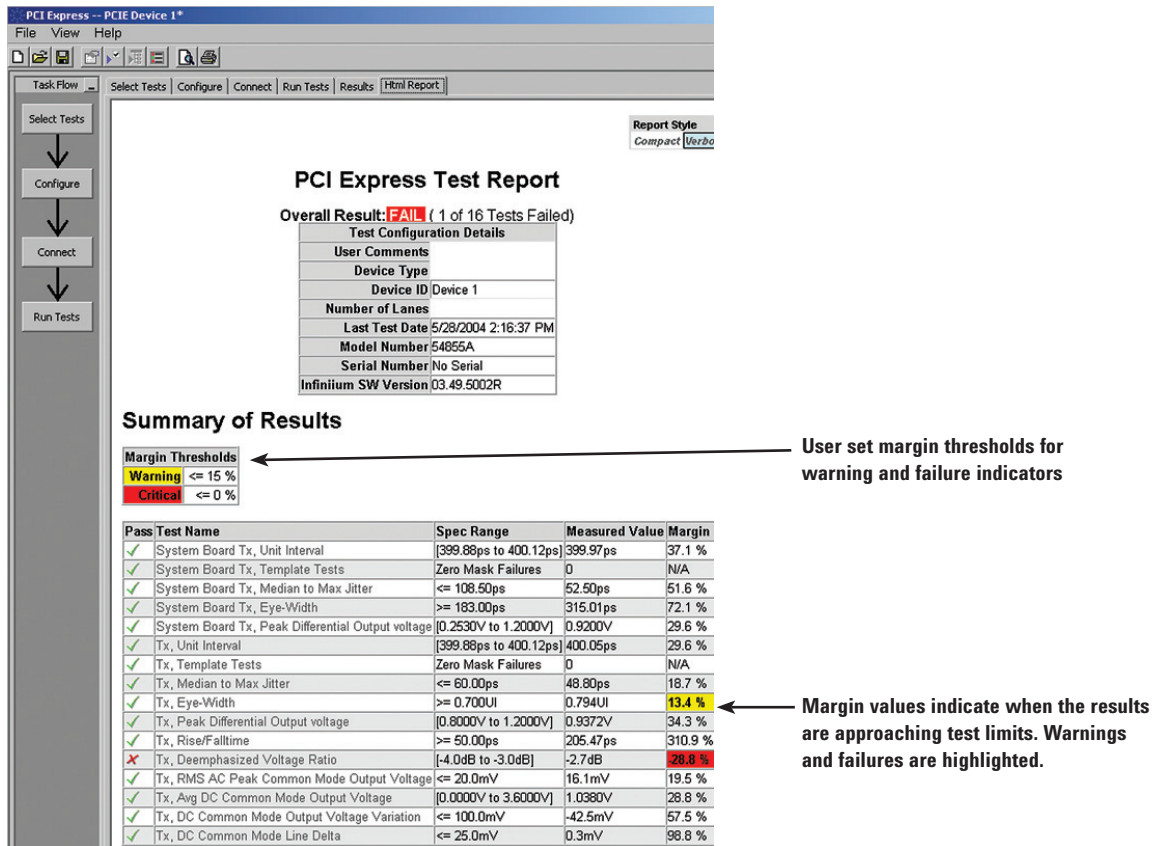

Figure 11. How close you are to passing or failing a test is indicated as a % in the margin field. A result highlighted in yellow or red indicates that the margin threshold level for a warning or failure was detected.

Extensibility

You may add additional custom tests or steps to your application using the N5467A User Defined Application (UDA) development tool (www.keysight.com/find/uda). Use UDA to develop functional “Add-Ins” that you can plug into your application.

Add-ins may be designed as:

- Complete custom tests (with configuration variables and connection prompts)
- Any custom steps such as pre or post processing scripts, external instrument control and your own device control

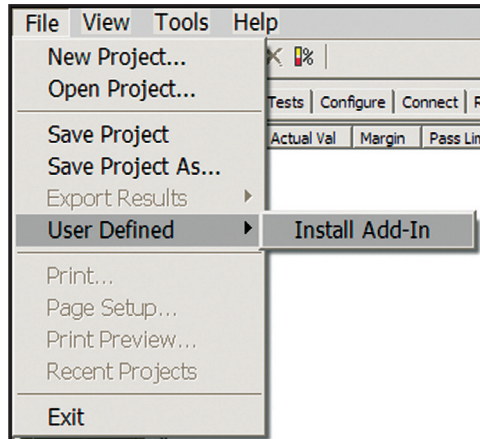

Figure 12. Importing a UDA Add-In into your test application.

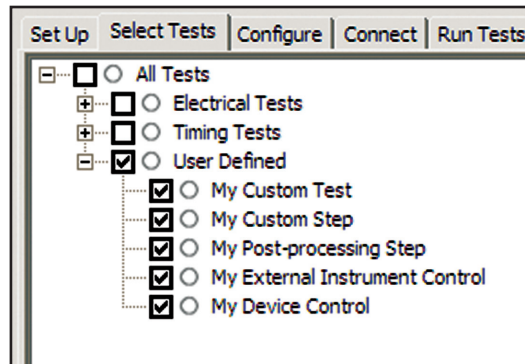

Figure 13. UDA Add-In tests and utilities in your test application.

Automation

You can completely automate execution of your application's tests and Add-Ins from a separate PC using the included N5452A Remote Interface feature (download free toolkit from www.keysight.com/find/scope-apps-sw). You can even create and execute automation scripts right inside the application using a convenient built-in client.

The commands required for each task may be created using a command wizard or from "remote hints" accessible throughout the user interface.

Using automation, you can accelerate complex testing scenarios and even automate manual tasks such as:

- Opening projects, executing tests and saving results
- Executing tests repeatedly while changing configurations
- Sending commands to external instruments
- Executing tests out of order

Combine the power of built-in automation and extensibility to transform your application into a complete test suite executive:

- Interact with your device controller to place it into desired states or test modes before test execution.
- Configure additional instruments used in your test suite such as a pattern generator and probe switch matrix.
- Export data generated by your tests and post-process it using your favorite environment, such as MATLAB, Python, LabVIEW, C, C++, Visual Basic etc.
- Sequence or repeat the tests and "Add-In" custom steps execution in any order for complete test coverage of the test plan.

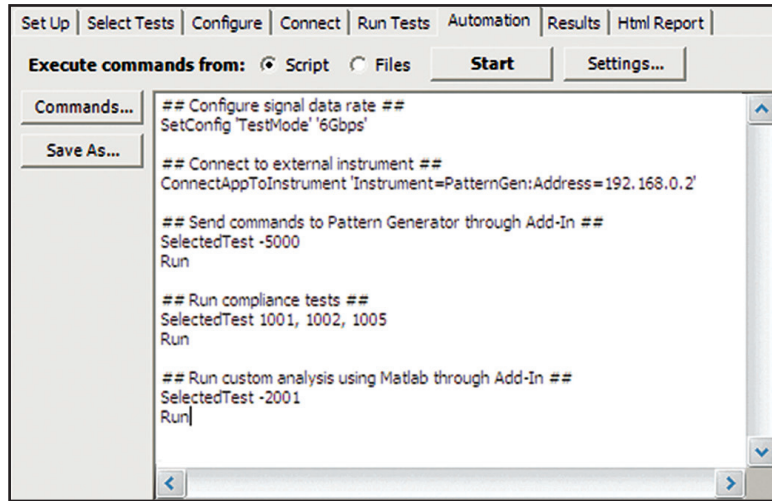

Figure 14. Remote Programming script in the Automation tab.

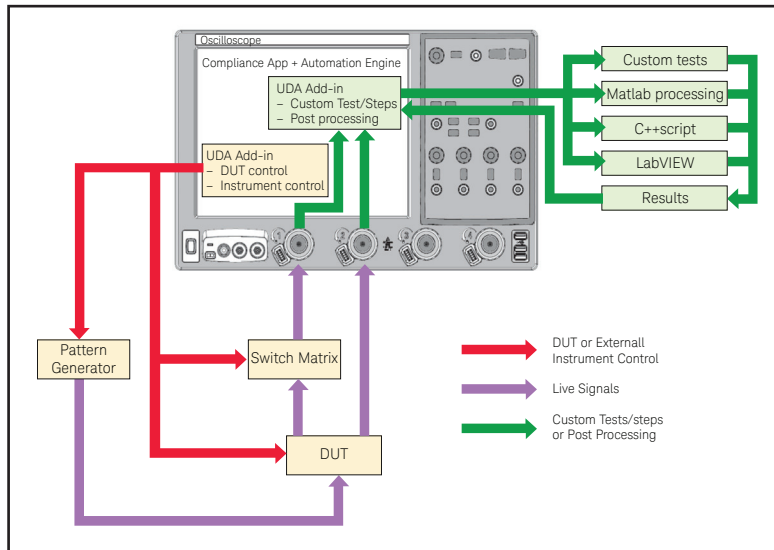

Figure 15. Combine the power of built-in automation and extensibility to transform your application into a complete test suite executive.

Switch Matrix

The Keysight N5393C Option 7FP switch matrix software tool for the PCI Express compliance application, used together with switch matrix hardware, enables fully automated testing for this multi-lane digital bus interface. The benefits of this automated switching solution include:

- Eliminate reconnections, which saves time and reduces errors through automating test setup for each lane of a multi-lane bus.
- Maintain accuracy with the use of unique N2809A PrecisionProbe or N5465A InfiniiSim features to compensate for switch path losses and skew.
- Customize testing by using remote programming interface and the N5467A user-defined application tool for device control, instrument control and test customization.

More information of the switching solution and configuration, visit www.keysight.com/find/switching and the Keysight application note with the publication number 5991-2375EN.



Figure 16. Automated testing for multi-lane digital bus interface through switching solution

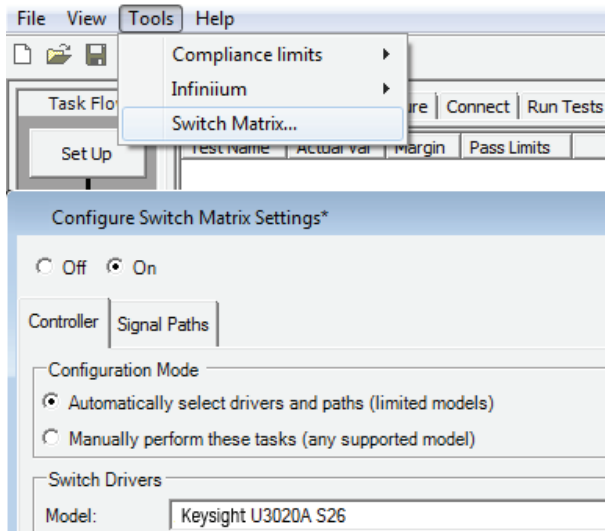

Figure 17. Switch matrix software feature enabled in the compliance application

Receiver Stressed Eye Calibration

The PCI Express 3.0 BASE specification outlines the requirements for a PCIe 3.0 compliant receiver equalizer. The capabilities defined employ a reference equalizer that consists of a CTLE (continuous time linear equalizer) and a single tap DFE (decision feedback equalizer).

In order to ensure that your devices receiver equalizer is at least as capable as the reference equalizer defined in the PCIe 3.0 BASE specification, it is necessary to execute a stressed eye receiver test. The signal that must be presented to the receiver must represent a worst case condition yet still be a valid and compliant PCIe 3.0 signal.

To achieve this calibrated worst case signal, it is necessary to carefully construct a significantly small amplitude signal that contains a prescribed amount of certain specified impairments. These impairments include sinusoidal jitter, random jitter, and channel induced intersymbol interference (ISI). In addition, it is necessary to add common mode and differential mode noise simultaneously to the jitter cocktail in order to emulate system crosstalk.

The N5393C option 004 along with your N4903B JBERT bit error ratio tester and required accessories, such as an 81150A Pulse Function Arbitrary Noise Generator, N4916B De-emphasis Signal Converter, and N4915A-014 PCI Express 3.0 calibration channels.

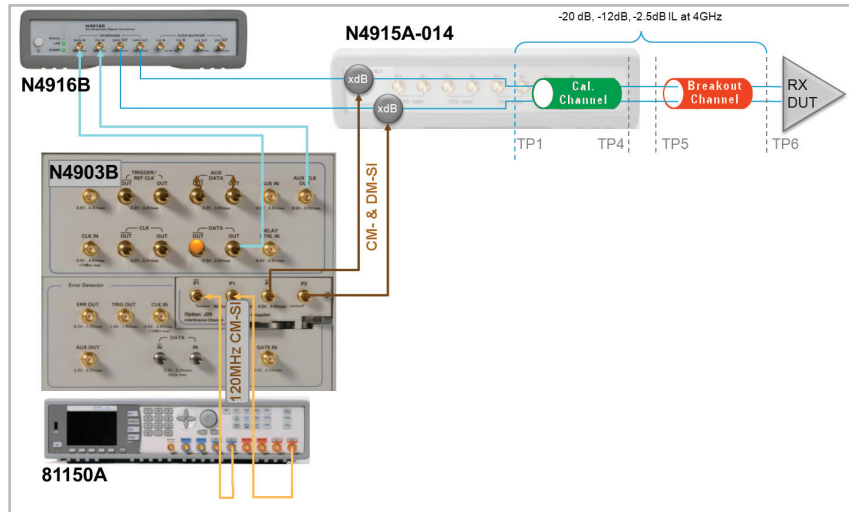

Figure 18. N4903B JBERT Setup for PCIe 3.0 Receiver Stress Testing.

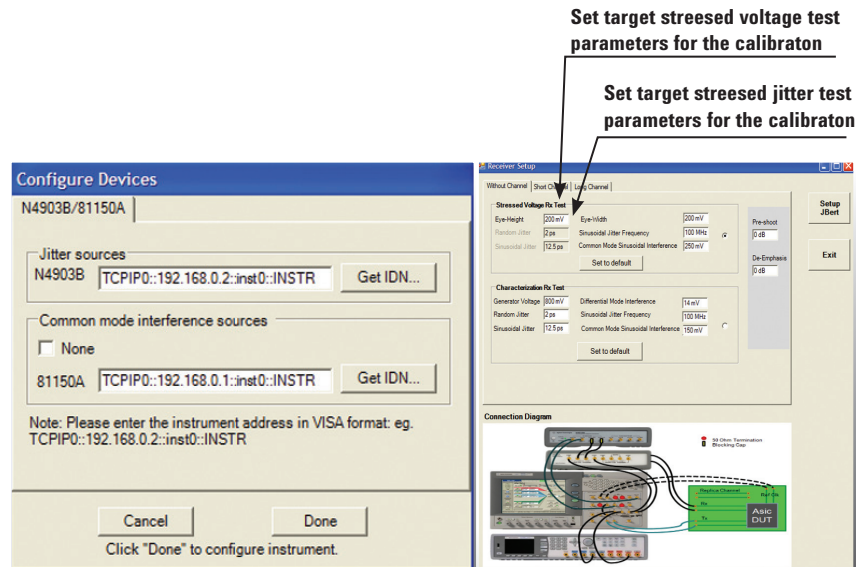

Figure 19. Setting up instrument control of the N4903B and 81150A from the N5393C PCIe application.

Receiver Stressed Eye Calibration (continued)

The N5393C utilizes the PCI SIG’s own Seasim simulation software to determine the target signal impairments and communicates those parameters to the instruments configured as part of the receiver test setup. The Keysight DSA90000 series oscilloscope is used to capture traces from the JBERT system setup, and that information is used by Seasim to set the calibration values of the bit error ratio tester setup.

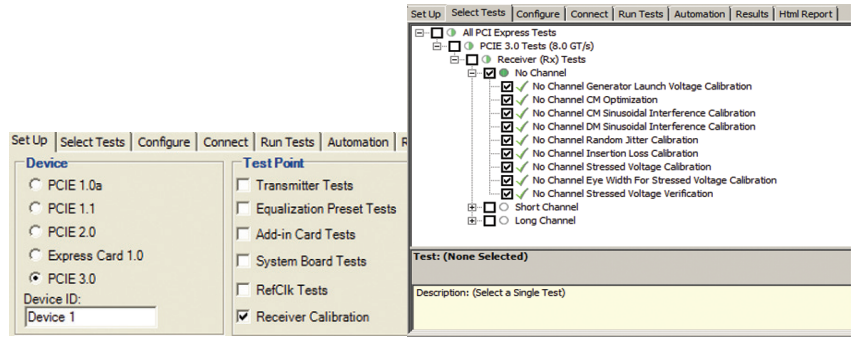

Figure 20. Configuring the type of receiver test calibration to perform.

The N5393C utilizes the PCI SIG’s own Seasim simulation software to determine the target signal impairments and communicates those parameters to the instruments configured as part of the receiver test setup. The Keysight DSA90000 series oscilloscope is used to capture traces from the JBERT system setup, and that information is used by Seasim to set the calibration values of the bit error ratio tester setup.

The N5393C option 004 is provided to help automate the most rigorous step in receive testing, the calibration step. Once the equipment is calibrated, the actual receiver stress test can be performed manually or by using additional automation tools provided by Keysight and its partners. The N539C opt. 004 covers automates only the calibration step. You can also reference the Keysight application note on PCIe 3.0 BASE spec receiver testing at <http://literature.cdn.keysight.com/litweb/pdf/5990-6599EN.pdf> for additional information.

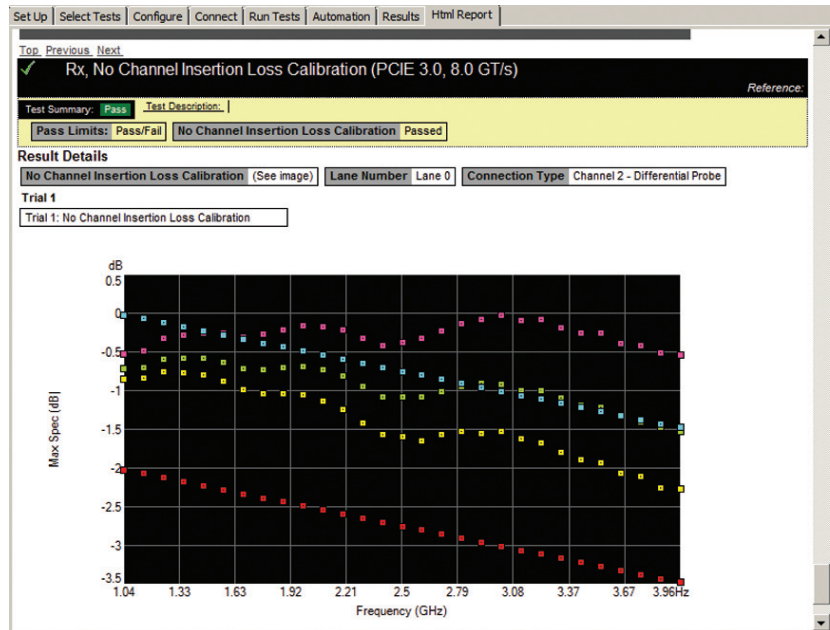

Figure 21. In the HTML test report the N5393C generates the appropriate graphical summary for each calibration parameter it configures. This gives you a traceable reference for how the tool setup and the calibration can save time when de-bugging the RX test setup.

Reference Clock Measurements

The PCI Express 1.0a specification failed to specify the input bandwidth the reference clock receiver or phase jitter of the reference clock itself. This is important because jitter that lies within the loop bandwidth the receiver PLL for the reference clock will transfer onto the high speed data lines. This hole in the PCI Express specification was corrected in the 1.1 update.

The N5393C includes powerful reference clock evaluation tools including phase jitter. The PCIe 1.1 specification calls for a very specific phase jitter filter that focuses the measurement on the jitter that lies between 1.5 and 22-MHz. The filter also amplifies the jitter 3dB (peaking) within this region. The Keysight N5393C includes proprietary filtering software (patent pending) that exactly implements the filters specified in the PCI Express specification. The N5393C also includes reference clock tests based on the PCIe 2.0 and 3.0 specification.

Utilizing Keysight's InfiniiMax 1169A high performance differential probes, or direct cabled connections, you can measure your reference clock using the PCI-SIG's Compliance Load Board or custom test fixture.

Reference clock tests

- Phase jitter
- Rising edge rate
- Falling edge rate
- Differential input high voltage
- Differential input low voltage
- Average clock period
- Duty cycle

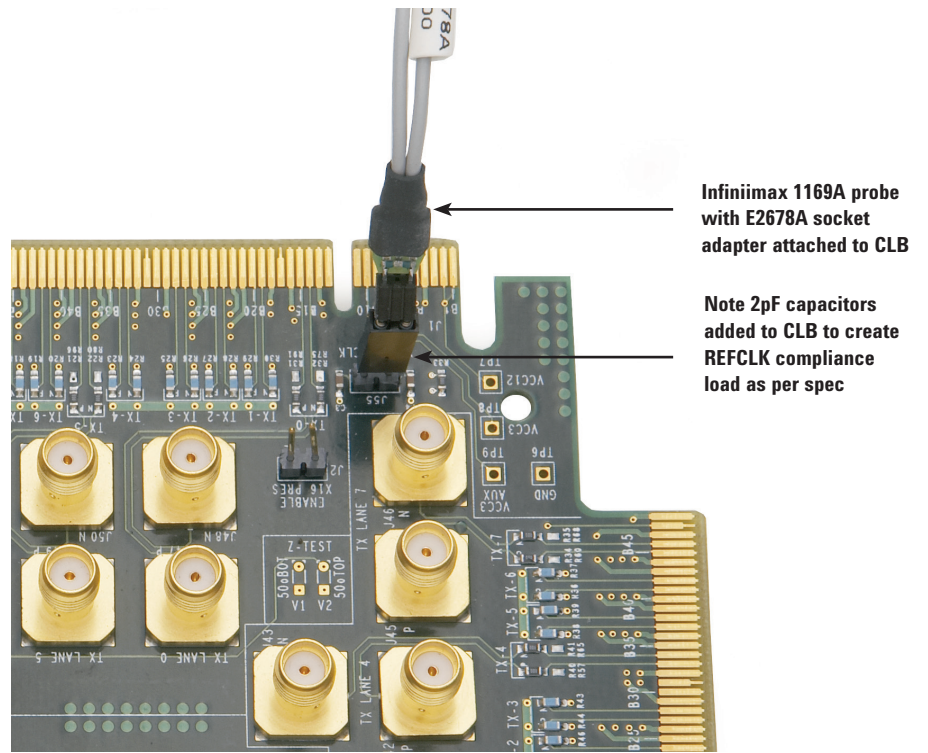

Figure 22. The N5393C software includes important tests for the reference clock of your PCI Express system. This signal can be probed using the Keysight InfiniiMax 1169A probes in conjunction with the PCI-SIG's compliance load board.

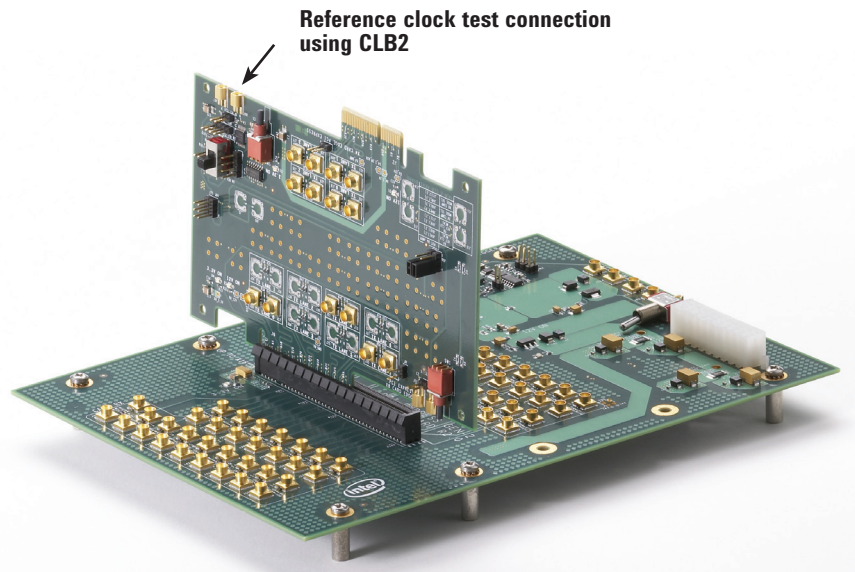

Figure 23. This shows the CLB2 inserted into the CBB2 test fixture, representing the setup required to test add-in cards

Powerful Debugging Aids

If your device fails a test, you need to determine how it failed. To use N5393C PCI Express electrical test software, you must install Keysight E2688A high-speed serial data analysis software, which provides you with several powerful debugging tools. The 8b/10b decoding feature lets you

identify data-dependent errors that result in eye mask violations caused by inter-symbol interference (ISI). You can perform 8b/10b decoding to capture and display serial data synchronized with the analog view of a serial data stream (For PCIe 1.x and 2.x).

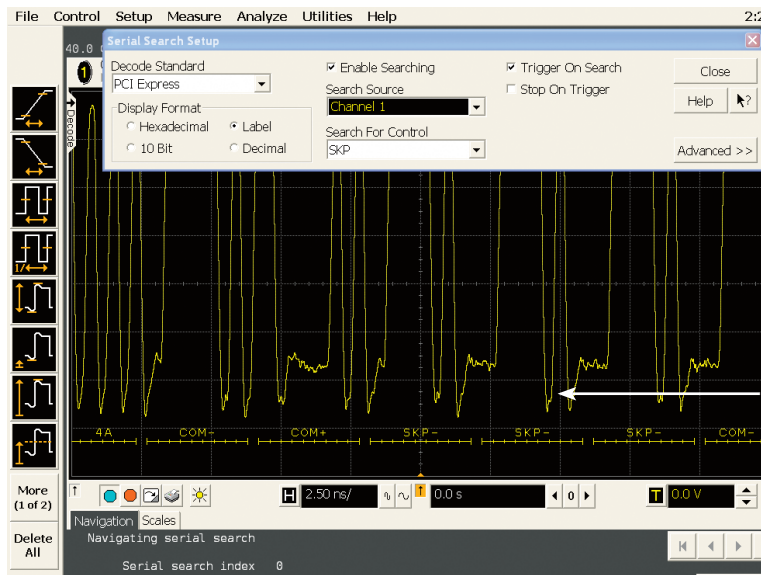

Figure 24. The 8b/10b decoded symbol information is shown below the appropriate portion of a PCI Express signal using the E2688A software.

Powerful Debugging Aids (continued)

Using the E2688A Serial Data Analysis tool you can test for illegal characters in your compliance pattern. You can also use the mask test feature to identify the specific digital patterns that caused a specific failure in the eye diagram when testing under the 1.1 specification (using a first order PLL).

For 2.0 testing you can use a first or second order PLL for clock recovery and apply a TIE brick wall filter (included with the E2688A Series Data Analysis package) to achieve a proper clock filtering.



Problems with early silicon still persist with new PCI Express devices. Make sure yours isn't one of them. SKP characters are not allowed in the compliance pattern.

Figure 25. Check for illegal characters in the compliance pattern (such as SKP's) using the E2688A Serial Data Analysis tool.

Powerful Debugging Aids (continued)

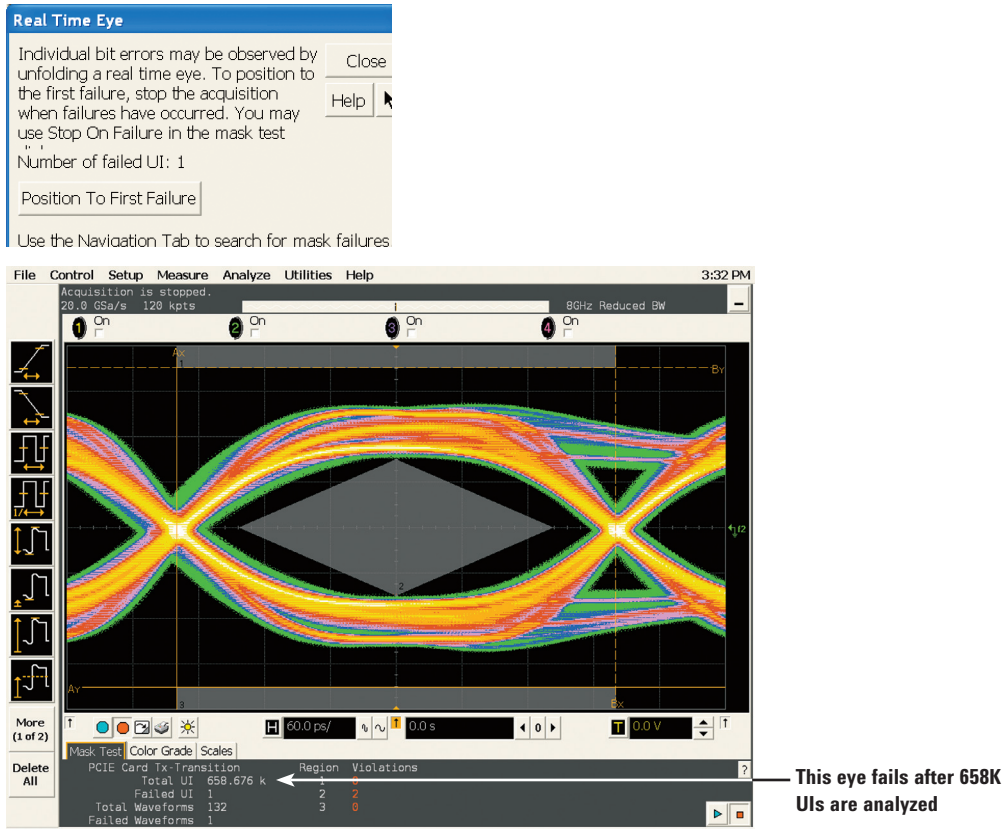

Figure 26.



Figure 27. The E2688A allows you to show the specific waveform that caused an eye diagram failure.

Measurements Requirements

The N5393C PCI Express electrical performance validation and compliance software requires the E2688A high-speed serial data analysis software, one of the PCI-SIG approved compliance test fixtures (CBB or CLB), and at least two SMA cables or InfiniiMax active differential probes. The N5393C optionally requires the N5465A InfiniiSim waveform transformation toolset to enable to de-embedding or de-convolving of test fixture and cable losses based on user supplied S-parameter descriptions

of these structures. Some of the measurements cannot be made with the PCI-SIG compliance test fixtures and may require you to build or acquire a custom test board, assembly, or other test fixture.

To purchase the PCI Express compliance test fixtures, consult the PCI-SIG Web site and select the PCI-SIG specification order form link at: www.pcisig.com/specifications/ordering_information

Compliance test fixture	Description
CBB	PCI Express Compliance Base Board for testing PCI Express add-in cards
CLB	PCI Express Compliance Load Board for testing PCI Express platforms
CBB2	Gen 2 PCI Express Compliance Base Board for testing PCI Express add-in cards
CLB2	Gen2 PCI Express Compliance Load Board for testing PCI Express platforms
CBB3	Gen 3 PCI Express Compliance Base Board for testing PCI Express add-in cards
CLB3	Gen3 PCI Express Compliance Load Board for testing PCI Express platforms

Recommended Test Accessories

To complete your test setup, Keysight provides a wide range of cables, adapters, terminations, etc.

Note:
While the PCI-SIG does supply Gen2 test fixtures for motherboard and add-in card testing, you will need to obtain SMP cables, adapters and terminators from a vendor of your choice as the SIG does not supply them.

Add-in card testing	
Model number	Description
	PCI-SIG Compliance Base Board (order from www.pcisig.com/specifications/ordering_information)
15442A	Two SMA cables
	One PC power supply
	One power supply load for regulation
1810-0118	Six 50 Ω terminators
System motherboard testing	
	PCI-SIG Compliance Base Board (order from www.pcisig.com/specifications/ordering_information)
15442A	Two SMA cables
1134A or 1169A	InfiniiMax probe with socketed (E2678A) probe adapter
250-1741	Two right angle SMA adapters (f - m)
1810-0118	Six 50 Ω terminators
Semiconductor device testing	
	Customer supplied custom test fixtures with SMAs
15442A	Two SMA cables
1169A	One InfiniiMax probe with differential solder connection (E2677A)
Optional (for all types of testing)	
11667B	Power splitter, DC to 26.5 GHz, 3.5 mm (f) connectors
11636B	Power divider, DC to 26.5 GHz, 3.5 mm (f) connectors
1250-1159	Three SMA (m - m) adapters
8493B	Coaxial attenuator (3, 6, 10, 20 or 30 dB), DC to 18 GHz, SMA connector
	Matched cable pair, two 90cm (36 inch) SMA (m - m) cables propagation delay within 25 ps
1810-0118	SMA (m) 50 Ω termination

Table 2. Recommended test accessories

Oscilloscope Compatibility

The N5393C PCI Express electrical performance validation and compliance software is compatible with Keysight DSO/DSA 90000 Series oscilloscopes with operating system software revision A.03.23 or higher.

To use it, you must also install Keysight E2688A high-speed serial data analysis software. For oscilloscopes with earlier software revisions, free upgrade software of the oscilloscope firmware is available at: www.keysight.com/find/infiniium_software

Data Rate	Recommended oscilloscope	Bandwidth of recommended oscilloscope	
2.5 Gb/s	DSO/DSAX91604A	16 GHz	
	DSO/DSAX92004A	20 GHz	
	DSO/DSAX92504A	25 GHz	
	DSO/DSAX92804A	28 GHz	
	DSO/DSAX93204A	33 GHz	
	DSO/DSAX92004Q	20 GHz	
	DSO/DSAX92504Q	25 GHz	
	DSO/DSAX93304Q	33 GHz	
	DSO91304A	13 GHz	
	DSO91204A	12 GHz	
	DSO90804A	8 GHz	
	DSO90604A	6 GHz	
	5.0 Gb/s	DSO/DSAX91604A	16 GHz
DSO/DSAX92004A		20 GHz	
DSO/DSAX92504A		25 GHz	
DSO/DSAX92804A		28 GHz	
DSO/DSAX93204A		33 GHz	
DSO/DSAX92004Q		20 GHz	
DSO/DSAX92504Q		25 GHz	
DSO/DSAX93304Q		33 GHz	
DSO91304A*		13 GHz	
DSO91204A		12 GHz	
8.0 Gb/s		DSO/DSAX91604A	16 GHz
		DSO/DSAX92004A	20 GHz
		DSO/DSAX92504A	25 GHz
	DSO/DSAX92804A	28 GHz	
	DSO/DSAX93204A	33 GHz	
	DSO/DSAX92004Q	20 GHz	
	DSO/DSAX92504Q	25 GHz	
	DSO/DSAX93304Q	33 GHz	
	DSO91304A*	13 GHz	
	DSO91204A	12 GHz	

*DSA model equivalents are also compatible

Tests Performed

The N5393C PCI Express electrical performance validation and compliance software performs the following tests as per the PCI Express 1.0a and 1.1 electrical specifications for add-in cards and motherboard systems as documented in Section 4 of the base specification (“PHY”) and Section 4 of the card electromechanical specification (“EM”). For reference, the tests performed by the SigTest application are also noted.

For Gen2 testing coverage, the PCI-SIG decided not to create checklist, as was done for Gen1. For test coverage refer to section 4.7.2. Table 4-8 of the PCI Express 2.0 Card Electromechanical Specification.

For PCI Express 3.0, test coverage includes items listed on table 4-18 under section 4.3.3 of the PCI Express 3.0 Base Specification.

Assertion no.	Description	N5393C	SigTest
Transmitter tests			
PHY.3.1#26	DC common mode voltage	Y	N
PHY.3.2#1	De-emphasis on multiple bits same polarity in succession	Y	N
PHY.3.2#2	Transition bit voltage	Y	N
PHY.3.3#1	Transmitter eye diagram	Y	N
PHY.3.3#2	Unit interval without SSC variations	Y	N
PHY.3.3#3	Minimum D+/D- output rise/fall time	Y	N
PHY.3.3#4	Jitter median to max deviation	Y	N
PHY.3.3#5	Maximum RMS AC common mode voltage	Y	N
PHY.3.3#9	Minimum eye width	Y	N
Receiver tests			
PHY.3.4#1	Minimum receiver eye diagram	Y*	N
PHY.3.4#2	AC peak common mode input voltage	Y*	N
PHY.3.4#6	Jitter median to max deviation input	Y*	N
System board (connector) tests			
EM.4#4	Minimum jitter	Y	Y
EM.4#20	Transmitter path eye diagram	Y	Y
Reference clock (connector) tests			
PHY.3.3#2	Phase jitter	Y	N/A*
PHY.3.3#1	Rising edge rate	Y	N/A
PHY.3.3#1	Falling edge rate	Y	N/A
PHY.3.3#4	Differential input high voltage	Y	N/A
PHY.3.3#4	Differential input low voltage	Y	N/A
PHY.3.3#9	Average clock period	Y	N/A
PHY.3.2#2	Duty cycle	Y	N/A
Add-in card (connector) tests			
EM.4#13	Minimum jitter	Y	Y
EM.4#19	Transmitter path eye diagram	Y	Y

Note:

* Receiver tests provided by the N5393C listed under the PCIe 1.x or 2.0 test tabs do not validate the receiver’s tolerance or ability to correctly receive data. They validate the signal at the receiver against specified tolerances

Ordering Information

You can order the N5393C as an option to your oscilloscope hardware purchase or as a separate software product. Oscilloscope option 044 supports testing for PCI Express 3.0, 2.0, and 1.1/1.0a devices. To purchase a new license for the PCI Express electrical performance validation and compliance software with an Infiniium 90000 or 90000 X-Series oscilloscope please order the following:

Model number	Description
Option 044	PCI Express 3.0 Electrical Test software for Infiniium 90000 X, 90000, Series oscilloscopes
Option 003	High Speed serial Data Analysis Software for Infiniium 90000 X, 90000
Option 13 and Option 14	InfiniiSim Waveform Transformation Toolset for de-embedding (recommended)
Option 001	PrecisionProbe for oscilloscope probe and cable correction (recommended)

To add the PCI Express Electrical Performance Validation and Compliance software to an existing Infiniium Series oscilloscope, please order the following:

Model number	Description
N5393C Option 003	PCI Express 3.0 Electrical Test Software for Infiniium 90000 X, 90000 Series Oscilloscope
E2688A	PCI Express 3.0 Electrical Test Software for Infiniium 90000 X, 90000 Series Oscilloscope
N5465A	InfiniiSim waveform transformation toolset (recommended)
N2809A	PrecisionProbe for oscilloscope probe and cable correction

To add the receiver test automation for PCI Express 3.0 to a new or existing Infiniium Series oscilloscope, please order the following (*Note: that Option 003, E2688A, and E5465A also required*):

Model number	Description
N5393C Option 004	Receiver test calibration for PCI Express 3.0 for Infiniium 90000 X, 90000 Series Oscilloscope

Upgrade to N5393C from the N5393B. To upgrade your existing version of the N5393B or N5393C Option 002 to the N5393C, order the following:

Model number	Description
N5393C Option 001	Upgrade to N5393C PCI Express 3.0 Electrical Test Software from N5393B or N5393C option 002 PCI Express Electrical test software for Infiniium 90000 X, 90000 Series Oscilloscopes

PCI Express 1.x and 2.x Only

The N5393C Option 002 supports only PCI Express 1.x and 2.x testing. This product can be upgraded later to support PCIe 3.0 if needed. To purchase a new license for an existing or new scope that supports only PCI Express 1.x and 2.x, please order the following.

Model number	Description
N5393C Option 002	PCI Express 2.0 Electrical Test software for Infiniium 90000 X, 90000 Series oscilloscopes
E2688A	High Speed serial Data Analysis Software for Infiniium 90000 X, 90000 Series oscilloscopes
N5465A	InfiniiSim Waveform Transformation Toolset for de-embedding (recommended)

To add the switch matrix software option for the PCI Express compliance software, please order the following (note: the PCIe 1.x, 2.x or 3.0 option is required).

Model number	Description
N5393C Option 7FP	PCI Express switch matrix software option for Infiniium 90000A, 90000 X or 90000 Q Series oscilloscopes (Option 705 on new oscilloscope or N5435A-705 for server-based license). For full configuration, please go to www.keysight.com/find/switching

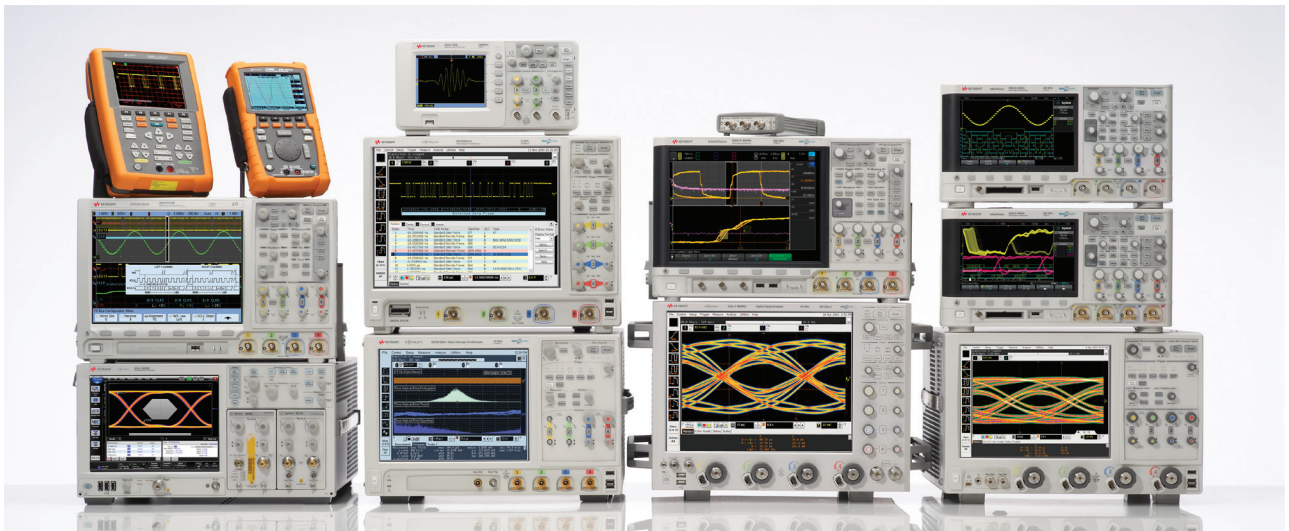

Keysight Oscilloscopes

Multiple form factors from 20 MHz to > 90 GHz | Industry leading specs | Powerful applications



myKeysight

www.keysight.com/find/mykeysight

A personalized view into the information most relevant to you.

www.keysight.com/go/quality

Keysight Technologies, Inc.

DEKRA Certified ISO 9001:2008

Quality Management System



PCI-SIG®, PCIe® and the PCI Express® are US registered trademarks and/or service marks of PCI-SIG.

www.keysight.com/find/N5393B

For more information on Keysight Technologies' products, applications or services, please contact your local Keysight office. The complete list is available at: www.keysight.com/find/contactus

Americas

Canada	(877) 894 4414
Brazil	55 11 3351 7010
Mexico	001 800 254 2440
United States	(800) 829 4444

Asia Pacific

Australia	1 800 629 485
China	800 810 0189
Hong Kong	800 938 693
India	1 800 112 929
Japan	0120 (421) 345
Korea	080 769 0800
Malaysia	1 800 888 848
Singapore	1 800 375 8100
Taiwan	0800 047 866
Other AP Countries	(65) 6375 8100

Europe & Middle East

Austria	0800 001122
Belgium	0800 58580
Finland	0800 523252
France	0805 980333
Germany	0800 6270999
Ireland	1800 832700
Israel	1 809 343051
Italy	800 599100
Luxembourg	+32 800 58580
Netherlands	0800 0233200
Russia	8800 5009286
Spain	800 000154
Sweden	0200 882255
Switzerland	0800 805353
	Opt. 1 (DE)
	Opt. 2 (FR)
	Opt. 3 (IT)
United Kingdom	0800 0260637

For other unlisted countries:
www.keysight.com/find/contactus
(BP-09-23-14)

