

HP 4142B Modular DC Source/Monitor
Operation Manual

SERIAL NUMBERS

This manual applies directly to instruments with serial numbers 2946J- and above. With changes described in Appendix A, this manual also applies to instruments with serial numbers 2716J- and 2839J-.



HP Part No. 04142-90001
Microfiche Part No. 04142-90051
Printed in Japan November 1989

E1189

CERTIFICATION

Hewlett-Packard Company certifies that this product met its published specifications at the time of shipment from the factory. Hewlett-Packard further certifies that its calibration measurements are traceable to the United States National Institute of Standards and Technology (formerly National Bureau of Standards), to the extent allowed by that organization's calibration facility, or to the calibration facilities of other International Standards Organization members.

WARRANTY

This Hewlett-Packard instrument product is warranted against defects in material and workmanship for a period of one year from the date of shipment. During the warranty period, Hewlett-Packard Company will, at its option, either repair or replace products which prove to be defective.

For warranty service or repair, this product must be returned to a service facility designated by HP. Buyer shall prepay shipping charges to HP and HP shall pay shipping charges to return the product to Buyer. However, Buyer shall pay all shipping charges, duties, and taxes for products returned to HP from another country.

HP warrants that its software and firmware designated by HP for use with an instrument will execute its programming instruction when properly installed on that instrument. HP does not warrant that the operation of the instrument, or software, or firmware will be uninterrupted or error free.

LIMITATION OF WARRANTY

The foregoing warranty shall not apply to defects resulting from improper or inadequate maintenance by Buyer, Buyer-supplied software or interfacing, unauthorized modification or misuse, operation outside of the environment specifications for the product, or improper site preparation or maintenance.

NO OTHER WARRANTY IS EXPRESSED OR IMPLIED. HP SPECIFICALLY DISCLAIMS THE IMPLIED WARRANTIES OF MERCHANTABILITY AND FITNESS FOR A PARTICULAR PURPOSE.

EXCLUSIVE REMEDIES

THE REMEDIES PROVIDED HEREIN ARE BUYER'S SOLE AND EXCLUSIVE REMEDIES. HP SHALL NOT BE LIABLE FOR ANY DIRECT, INDIRECT, SPECIAL, INCIDENTAL, OR CONSEQUENTIAL DAMAGES, WHETHER BASED ON CONTRACT, TORT, OR ANY OTHER LEGAL THEORY.

ASSISTANCE

Product maintenance agreements and other customer assistance agreements are available for Hewlett-Packard products.

For any assistance, contact your nearest Hewlett-Packard Sales and Service Office. Address are provided at the back of this manual.

Herstellerbescheinigung

Hiermit wird bescheinigt, daß das Gerät HP 4142B Modular DC Source/Monitor in Übereinstimmung mit den Bestimmungen von Postverfügung 1046/84 funkentstört ist.

Der Deutschen Bundespost wurde das Inverkehrbringen dieses Gerätes angezeigt und die Berechtigung zur Überprüfung der Serie auf Einhaltung der Bestimmungen eingeräumt.

Anm: Werden Meß- und Testgeräte mit ungeschirmten Kabeln und/oder in offenen Meßaufbauten verwendet, so ist vom Betreiber sicherzustellen, daß die Funk-Entstörbestimmungen unter Betriebsbedingungen an seiner Grundstücksgrenze eingehalten werden.

Manufacturer's Declaration

This is to certify that this product, the HP 4142B Modular DC Source/Monitor, meets the radio frequency interference requirements of directive 1046/84. The German Bundespost has been notified that this equipment was put into circulation and was granted the right to check the product type for compliance with these requirements.

Note: If test and measurement equipment is operated with unshielded cables and/or used for measurements on open setups, the user must insure that under these operating conditions, the radio frequency interference limits are met at the border of his premises.

SAFETY SUMMARY

The following general safety precautions must be observed during all phases of operation, service, and repair of this instrument. Failure to comply with these precautions or with specific **WARNINGS** given elsewhere in this manual violates safety standards of design, manufacture, and intended use of the instrument. **The Hewlett-Packard Company assumes no liability for the customer's failure to comply with these requirements.**

GROUND THE INSTRUMENT

To minimize shock hazards, the instrument chassis and cabinet must be connected to an electrical ground. The instrument is equipped with a three-conductor AC power cable. The power cable must be plugged into an approved three-contact electrical outlet or used with a three-contact to two-contact adapter with the grounding wire (**green**) firmly connected to an electrical ground (safety ground) at the power outlet. The power jack and the mating plug of the power cable meet International Electrotechnical Commission (IEC) safety standards.

DO NOT OPERATE IN AN EXPLOSIVE ATMOSPHERE

Do not operate the instrument in the presence of flammable gasses or fumes. Operation of any electrical instrument in such an environment constitutes a safety hazard.

KEEP AWAY FROM LIVE CIRCUITS

Operating personnel must not remove instrument covers. Component replacement and internal adjustments must be made by qualified maintenance personnel. Do not replace components with power cable connected. Under certain conditions, dangerous voltages may exist even with the power cable removed. To avoid injuries, always disconnect power and discharge circuits before touching them.

DO NOT SERVICE OR ADJUST ALONE

Do not attempt internal service or adjustment unless another person, capable of rendering first aid and resuscitation, is present.

DO NOT SUBSTITUTE PARTS OR MODIFY INSTRUMENT

Because of the danger of introducing additional hazards, do not substitute parts or perform unauthorized modifications to the instrument. Return the instrument to a Hewlett-Packard Sales and Service Office for service and repair to ensure the safety features are maintained.

DANGEROUS PROCEDURE WARNINGS

WARNINGS, such as the example below, precede potentially dangerous procedures throughout this manual. Instructions contained in the warnings must be followed.

WARNING

DANGEROUS VOLTAGES, CAPABLE OF CAUSING DEATH, ARE PRESENT IN THIS INSTRUMENT. USE EXTREME CAUTION WHEN HANDLING, TESTING, AND ADJUSTING THIS INSTRUMENT.

SAFETY SYMBOLS

General Definitions of Safety Symbols Used On Equipment or In Manuals.



Instruction manual symbol: the product will be marked with this symbol when it is necessary for the user to refer to the instruction manual in order to protect against damage to the instrument.



Indicates dangerous voltage (terminals fed from the interior by voltage exceeding 1000 volts must be so marked).

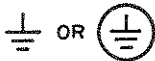

Protective conductor terminal. For protection against electrical shock in case of a fault. Used with wiring terminals to indicate the terminal which must be connected to ground before operating equipment.



Low-noise or noiseless, clean ground (earth) terminal. Used for a signal common, as well as providing protection against electrical shock in case of fault. A terminal marked with this symbol must be connected to ground in the manner described in the installation (Operating) manual, and before operating the equipment.

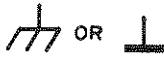

Frame or chassis terminal. A connection to the frame (chassis) of the equipment which normally includes all exposed metal structures.



Alternating current (power line).



Direct current (power line).



Alternating or direct current (power line).



A **WARNING** denotes a hazard. It calls attention to a procedure, practice, condition or the like, which, if not correctly performed or adhered to, could result in injury or death to personnel.



A **CAUTION** sign denotes a hazard. It calls attention to a procedure, practice, condition or the like, which, if not correctly performed or adhered to, could result damage to or destruction of part or all of the product.

NOTE

A **NOTE** denotes important information. It calls attention to a procedure, practice, condition or the like, which is essential to highlight.

PREFACE

This manual contains installation information, and operating and programming information for the HP 4142B. The manual consists of the following chapters and appendixes:

Chapter 1 Installation

Contains initial inspection and installation information necessary to know before applying ac power.

Chapter 2 Getting Started

Shows product overview, how to send commands to the HP 4142B, how to force and measure voltage and current, and how to retrieve measurement data. This chapter will help you quickly learn to operate the HP 4142B.

Chapter 3 Test Device Connections

Shows how to connect the test device to the HP 4142B.

Chapter 4 Measurement Modes

Describes the types of measurements, such as spot, sweep, and pulsed measurements.

Chapter 5 Measurement Functions

Describes the functions that can be used in measurements, such as ranging, compliance, measurement averaging, automatic sweep abort function, and program memory.

Chapter 6 Miscellaneous Functions

Describes the functions that are not directly related to the measurements, such as the front and rear panels, query commands, and the functions at power-on.

Appendix A Manual Changes

Contains the information needed to use this manual with an HP 4142B that was manufactured before the printing date of this manual.

Appendix B Specifications

Contains the specification and reference data of the HP 4142B.

Appendix C Accessories and Options

Contains the accessories and options lists.

This manual does not contain detailed descriptions of each HP 4142B command, measurement data output format, and error messages. Refer to the *HP-IB Command Reference Manual* for more detailed information on these topics.

NOTES



CONTENTS

CHAPTER 1 INSTALLATION

Introduction	1-1
Initial Inspection	1-1
Installing the HP 4142B	1-2
Installing the Blank Panel	1-2
Installing the Front Panel	1-2
Line Power Requirements	1-2
Line Voltage and Fuse Selection	1-3
Setting the Line Frequency FILTER Switch	1-3
Power Cables	1-4
Grounding Requirements	1-5
Changing the HP-IB Address	1-5
Connecting the HP-IB Cable	1-5
Mounting the HP 4142B	1-6
Operating Environment	1-7
Installing and Removing Plug-in Units	1-8
Storage and Shipment	1-9
Environment	1-9
Original Packaging	1-9
Other Packaging	1-9
Repair Service	1-10
Serial Number	1-10

CHAPTER 2 GETTING STARTED

Introduction	2-1
Product Introduction	2-1
HP 4142B	2-1
Ground Unit (GNDU)	2-3
HP 41420A HPSMU and HP 41421B MPSMU	2-4
HP 41422A HCU	2-7
HP 41424A VS/VMU	2-9
HP 41425A AFU	2-11
Measurement Modes	2-12
Total Power Limitation of Plug-in Units	2-14
Panel Overview	2-15
Before Applying Power	2-17
Applying Power	2-18
Sending the HP-IB Command	2-19
Output/Input Statement	2-19
Sending an HP-IB Command	2-19
Getting Data from the HP 4142B	2-19
If an Error Occurs	2-20
Reading the Error Register	2-20
Resetting the HP 4142B	2-21
Sending a Command to the Unit	2-21
Channel Numbers (ch#)	2-21

Forcing and Measuring	2-22
Setting the Output Switch of the Unit to ON	2-22
Setting the Output Switch of the Unit to OFF	2-22
Forcing Constant Voltage	2-23
Forcing Constant Current	2-23
Setting the Output to 0 V	2-23
Performing the Measurement	2-24
Performing the Staircase Sweep Measurement	2-25
Specifying the Measurement Range	2-26
Measurement Program Flow	2-27
Waiting for Time	2-28
Performing Self-Calibration	2-28
Performing Self-Test	2-28

CHAPTER 3 TEST DEVICE CONNECTIONS

Introduction	3-1
Before Connecting Test Devices	3-1
Enclose the Test Device with a Shielding Box	3-1
Connect the INTLK Terminal	3-1
Shorting Circuit Common and Chassis Ground Terminals	3-2
Connecting the Test Devices	3-3
GNDU Connections	3-3
HPSMU and MPSMU Connections	3-5
HCU Connections	3-9
VS/VMU Connections	3-13
Using the Connection Accessories	3-14
Using Connector Plate Part Number 04142-60021	3-14
Using Connector Plate Part Number 04142-60031	3-15
Using the HP 16088A Test Fixture	3-16
Using the HP 16058A Test Fixture	3-18
Advanced Connection Information	3-20
For High Current Measurements (Kelvin Connection)	3-20
For Low Current Measurements (Using the GUARD Terminal)	3-22
If the Test Device is Externally Grounded (Floating Measurement)	3-23
If the Test Device has Negative Resistance	3-25
Preventing Oscillation from the Test Device	3-26

CHAPTER 4 MEASUREMENT MODES

Introduction	4-1
Spot Measurements	4-1
Commands and Parameters	4-3
Information	4-3
Spot Measurement Sample Program	4-4
Staircase Sweep Measurements	4-6
Commands and Parameters	4-10
Information	4-11
Staircase Sweep Measurement Sample Program	4-11
1ch Pulsed Spot Measurements	4-15
Information	4-18
Commands and Parameters	4-18
1ch Pulsed Spot Measurement Sample Program	4-19

Pulsed Sweep Measurements	4-21
Commands and Parameters	4-25
Information	4-26
Pulsed Sweep Measurement Sample Program	4-26
Staircase Sweep with Pulsed Bias Measurements	4-29
Commands and Parameters	4-33
Information	4-34
Staircase Sweep with Pulsed Bias Measurement Sample Program	4-34
Analog Search Measurements	4-37
Search Operation Modes	4-40
Search Measurement Modes	4-42
Commands and Parameters	4-43
AFU Monitor Port	4-44
Information	4-45
Analog Search Measurement Sample Program	4-45
2ch Pulsed Spot Measurements	4-48
Commands and Parameters	4-52
Information	4-53
2ch Pulsed Spot Measurement Sample Program	4-53
Pulsed Sweep with Pulsed Bias Measurements	4-55
Commands and Parameters	4-60
Information	4-61
Pulsed Sweep with Pulsed Bias Measurement Sample Program	4-61
High Speed Spot Measurements	4-65
Commands and Parameters	4-66
Information	4-66
High Speed Spot Measurement Sample Program	4-67

CHAPTER 5 MEASUREMENT FUNCTIONS

Introduction	5-1
Output Ranging Mode	5-1
Allowable Ranging Mode	5-1
Auto Ranging	5-2
Limited Auto Ranging	5-3
Measurement Ranging Mode	5-4
Allowable Ranging Mode	5-4
Auto Ranging	5-5
Limited Auto Ranging	5-5
Compliance Range	5-6
Fixed Range	5-7
Compliance/Limiter	5-8
V/I Compliance	5-8
Power Compliance	5-16
Limiter	5-17
Averaging	5-18
Filter	5-20
Automatic Sweep Abort Function	5-21
Output After Sweep	5-21
Measurement Data Memory	5-22
Program Memory	5-23
Using Program Memory	5-26
Program Memory Sample Program	5-27

Using the HP 4142B with External Instruments	5-29
Trigger Output and Input Function	5-29
Triggering an External Instrument	5-29
Externally Triggered HP 4142B Measurements	5-30
Waiting for Trigger Signal from TRIGGER INPUT Terminal	5-30
Waiting for Time or Trigger	5-32
Waiting for Command Execution Completion	5-32

CHAPTER 6 MISCELLANEOUS FUNCTIONS

Introduction	6-1
Front and Rear Panels	6-1
Front Panel	6-1
Rear Panel	6-6
Query Commands	6-7
HP-IB Capability	6-8
Status Byte	6-9
Status	6-9
Commands	6-10
Status Byte Sample Program	6-11
Self-Calibration	6-16
Auto-Calibration	6-16
Self-Test	6-17
Initial Settings	6-18

APPENDIXES

Appendix A, Manual Changes	A-1
Appendix B, Specifications	B-1
Appendix C, Accessories and Options	C-1

CHAPTER 1

INSTALLATION

CONTENTS

Introduction	1-1
Initial Inspection	1-1
Installing the HP 4142B	1-2
Installing the Blank Panel	1-2
Installing the Front Panel	1-2
Line Power Requirements	1-2
Line Voltage and Fuse Selection	1-3
Setting the Line Frequency FILTER Switch	1-3
Power Cables	1-4
Grounding Requirements	1-5
Changing the HP-IB Address	1-5
Connecting the HP-IB Cable	1-5
Mounting the HP 4142B	1-6
Operating Environment	1-7
Installing and Removing Plug-in Units	1-8
Storage and Shipment	1-9
Environment	1-9
Original Packaging	1-9
Other Packaging	1-9
Repair Service	1-10
Serial Number	1-10

NOTES



INTRODUCTION

This chapter provides HP 4142B installation information. Included is information on initial inspection and damage claims, installing your HP 4142B, installing and removing plug-in units, storage and shipment, and repair service.

INITIAL INSPECTION

Each HP 4142B is carefully inspected before it leaves the factory. Upon receipt and before unpacking the HP 4142B, inspect the shipping container for damage. If there is any evidence of damage or mishandling, retain all packing materials and notify both the shipping carrier and the nearest Hewlett-Packard office.

When you unpack the HP 4142B, verify that the following accessories are included.

- Operation Manual (this manual)
- HP-IB Command Reference Manual
- Power Cable

If the shipment is incomplete, or if the contents show any sign of mechanical damage or other defects (scratches, dents, broken switches, etc.), notify the nearest Hewlett-Packard office (see the list at the back of this manual). HP arranges for repair or replacement without waiting for the claim settlement.

When you unpack the HP 4142B, retain all packing materials for future use. If it becomes necessary to reship the HP 4142B, repack it in the original packing materials and shipping carton.

INSTALLING THE HP 4142B

Installing the Blank Panel

CAUTION

To prevent thermal damage to HP 4142B units, be sure that Blank Panels (part number 04142-60012) are installed in all unused slots.

Installing the Front Panel

The front panel of the HP 4142B is packed separately from the mainframe. Before you connect a power cable to the HP 4142B, attach the front panel to the mainframe as instructed in the following procedure.

1. Connect the flat cable connector of the front panel to the mainframe unit connector.
2. Insert the metal flanges on the upper right and left sides of the front panel into their corresponding slots on the mainframe. With a slotted screwdriver, tighten the two screws in the lower left and right corners of the front panel.

Line Power Requirements

The HP 4142B requires a 48 to 66 Hz, single phase power source of 100, 120, or 220 VAC $\pm 10\%$, or 240 VAC $-10\% + 5\%$. Maximum power consumption is 750 VA (Volt-Amps).

WARNING

IF THE HP 4142B IS TO BE ENERGIZED VIA AN EXTERNAL AUTO TRANSFORMER FOR VOLTAGE REDUCTION, BE SURE THE COMMON TERMINAL IS CONNECTED TO THE NEUTRAL POLE OF THE POWER SOURCE.

Line Voltage and Fuse Selection

CAUTION

Before connecting the HP 4142B to an ac power source, verify that the **LINE VOLTAGE SELECTOR** switch is set to the correct line voltage. Be sure the correct fuse is installed for the selected line voltage.

Setting the Line Voltage Switches:

Disconnect the HP 4142B line power cable before changing the ac line voltage selection switches. With a small flatblade screwdriver, move the **LINE VOLTAGE SELECTOR** switch to the 100V/120V or the 220V/240V position in accordance with the ac line voltage of your area.

Installing the Line Power Fuse:

To install a fuse, make sure the HP 4142B power cable is disconnected. With a small flatblade screwdriver, turn the fuse holder cap counterclockwise until it pops out. The correct fuse type for each line voltage is shown in the following table. Insert one end of the correct fuse into the fuse cap.

Line Voltage Fuse

Line Voltage	Fuse Rating	Part No.
100V/200V	8 A Normal Blow	2110-0342
220V/240V	4 A Normal Blow	2110-0055

CAUTION

Use only replacement fuses of the correct current rating and of the specified type. Do not use mended fuses, and do not short circuit the fuse holder.

Insert the fuse/cap assembly into the fuse holder. Push in on the fuse cap with the screwdriver and rotate it clockwise.

The HP 4142B is shipped from the factory with the **LINE VOLTAGE SELECTOR** switch set to the line voltage used in the geographic area to which the HP 4142B is shipped, and with the corresponding fuse installed.

Setting the Line Frequency FILTER Switch

To minimize the effects of line frequency noise during measurements, set the **FILTER** switch on the HP 4142B rear panel to the ac line frequency.

Power Cables

The following figure shows the power plugs used in various countries, and provides available power cable/plug information. Also included is ordering information. If you need assistance in determining the power cable you need, contact the nearest Hewlett-Packard office.

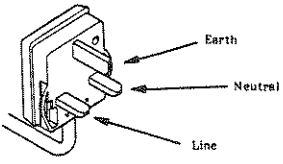
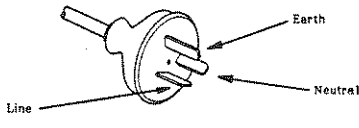
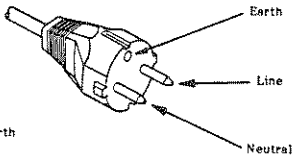
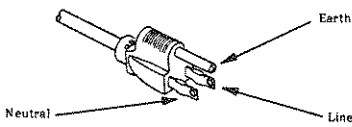
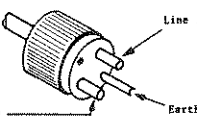
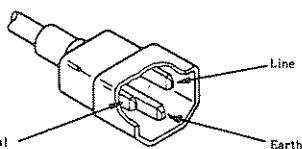
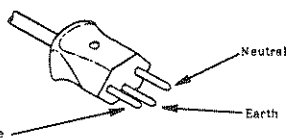
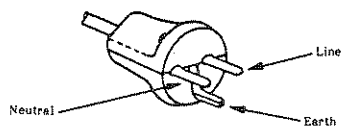
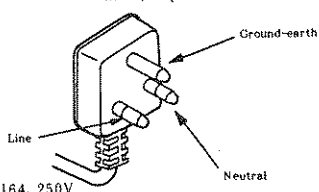
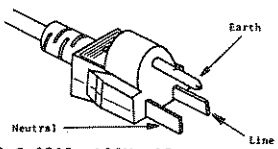
<p>OPTION 906 United Kingdom</p>  <p>Plug: BS 1363A, 250V Cable: HP 8120-1351</p>	<p>OPTION 901 Australia/New Zealand</p>  <p>Plug: NZSS 198/AS C112, 250V Cable: HP 8120-1369</p>
<p>OPTION 902 European Continent</p>  <p>Plug: CEE-VII, 250V Cable: HP 8120-1689</p>	<p>OPTION 903 U.S./Canada</p>  <p>Plug: NEMA 5-15P, 125V, 15A Cable: HP 8120-1378</p>
<p>OPTION 904 U.S./Canada</p>  <p>Plug: NEMA 6-15P, 250V, 15A Cable: HP 8120-0698</p>	<p>OPTION 905* Any country</p>  <p>Plug: CEE 22-VI, 250V Cable: HP 8120-1396</p>
<p>OPTION 908 Switzerland</p>  <p>Plug: SEV 1011.1959-24507 Type 12, 250V Cable: HP 8120-2104</p>	<p>OPTION 912 Denmark</p>  <p>Plug: DHCR 107, 220V Cable: HP 8120-2956</p>
<p>OPTION 917 India/Republic of S.Africa</p>  <p>Plug: SABS 164, 250V Cable: HP 8120-4211</p>	<p>OPTION 918 Japan</p>  <p>Plug: JIS C 8303, 125V, 15A Cable: HP 8120-4753</p>
<p>NOTE: Each option number includes a 'family' of cords and connectors of various materials and plug body configurations (straight, 90° etc.).</p> <p>* Plug option 905 is frequently used for interconnecting system components and peripherals.</p>	

Power Cables

Grounding Requirements

The HP 4142B is equipped with a three-conductor ac power cable. When plugged into the appropriate power line outlet, the cable grounds the HP 4142B cabinet, thereby protecting the user from possible shock hazards. To preserve this protection feature, the power cable must be connected to an approved three-contact electrical outlet that has its ground conductor connected to an electrical ground (safety ground).

If operating the HP 4142B from a two-contact outlet, use a three-prong to two-prong adapter, and connect the green grounding tab of the adapter to power line ground.

The HP 4142B power jack and the supplied power cable meet International Electrotechnical Commission (IEC) safety standards.

WARNING

FOR PROTECTION FROM ELECTRICAL SHOCK, THE POWER CABLE GROUND MUST NOT BE DEFEATED.

Changing the HP-IB Address

Every device on the HP-IB bus must have a unique address. If you need to change the HP-IB address of the HP 4142B, make sure the HP 4142B is turned off. With a small flatblade screwdriver, set the **HP-IB ADDRESS Switch** on the rear panel to the new address (0 to 30). The new HP-IB address is only recognized at power on.

The HP 4142B leaves the factory with the HP-IB address set to 17.

Connecting the HP-IB Cable

To connect the HP 4142B with a computer or peripheral device via HP-IB (IEEE Std. 488), connect an HP-IB cable between the HP-IB connector on the HP 4142B rear panel and the HP-IB connector on the peripheral device.

A total of 15 devices can be connected on the same HP-IB bus. The length of the HP-IB cables must not exceed 20 meters (65 feet) total, or 2 meters (6.5 feet) per device, whichever is less.

Mounting the HP 4142B

The HP 4142B comes equipped with four feet which allow it to be used as a bench instrument. There are also two retractable stands mounted on the bottom cover so you can tilt the HP 4142B. To use the stands, pull each one away from the bottom cover until it locks into position.

The HP 4142B can be rack-mounted into a cabinet. Use Option 907 to install front handles on your HP 4142B. If you're going to mount your HP 4142B into a rack, remove the retractable stands and install either Option 908 or 909. The following figure provides front handle and rack-mount flange installation information.



Install the HP 4142B horizontally within $\pm 20^\circ$ when you turn on and use the HP 4142B.

Option	Description	Kit Part Number
907	Handle Kit	5062-3991
908	Rack Flange Kit	5062-3979
909	Rack Flange & Handle Kit	5062-3985

Before installing the desired option, remove the adhesive-backed trim strips (1) from the right and left front sides of the HP 4142B.

HANDLE INSTALLATION (Option 907):

Attach the front handles (3) to the right and left front sides of the HP 4142B with the screws provided. Attach the trim (4) to the handles.

NOTE

To install either Option 908 or 909, remove the feet from the bottom cover by lifting the bar at the inner side of each foot and sliding the foot towards the bar.

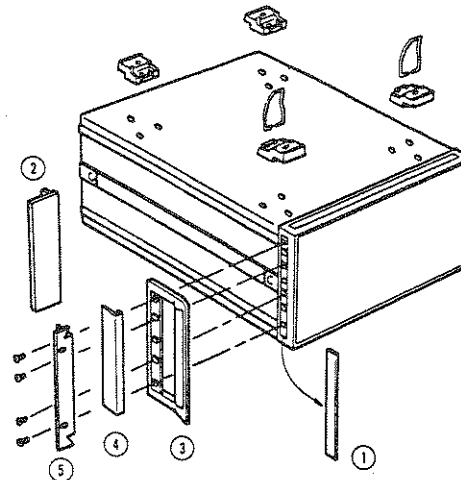

RACK FLANGE INSTALLATION (Option 908): Attach the rack-mount flanges (2) to the right and left front sides of the HP 4142B with the screws provided.

HANDLE & RACK FLANGE INSTALLATION (Option 909): Attach the front handles (3) and the rack-mount flanges (5) to the right and left front sides of the HP 4142B with the screws provided.

Front Handle and Rack-Mount Flange Installation

Operating Environment

To maintain the proper operating environment, operate your HP 4142B within the following limits:

- Temperature: 5 °C to 40 °C.
- Humidity: 5% to 80% RH.

Protect the HP 4142B from temperature extremes to prevent condensation from forming inside the HP 4142B.

INSTALLING AND REMOVING PLUG-IN UNITS

All HP 4142B plug-in units can be easily installed and removed. Each plug-in unit can be installed in any slot between slot #1 and #8, and all units can be retrofitted. The following procedure explains plug-in unit installation and removal.

1. Set the **POWER ON/OFF** switch or **LINE ON/OFF** switch to **OFF**.

CAUTION

To prevent damage to HP 4142B units, be sure to turn your HP 4142B **OFF** and wait at least **10 seconds** before you remove or install units.

2. With a slotted screwdriver, loosen the two screws located in the lower left and right corners of the front panel. Swing the front panel slightly upward, then down, until it comes loose. Disconnect the flat cable that connects the front panel to the mainframe from the mainframe unit connector.

3. **Installing units:**

Align the unit with the upper and lower slot guide rails. Push the unit into the slot until you feel the unit seat firmly into its mainframe connector. Turn the upper and lower quick-disconnect screws clockwise until they lock.

Removing units:

Turn the upper and lower quick-disconnect screws 90° counterclockwise to unlock the unit. Gently pull the unit free from its mainframe connector and remove the unit.

CAUTION

To prevent thermal damage to HP 4142B units, be sure that **Blank Panels** (part number 04142-60012) are installed in all unused slots.

4. Reconnect the front panel flat cable to the mainframe connector, and reinstall the front panel.

STORAGE AND SHIPMENT

Environment

The HP 4142B should be stored or shipped in environments within the following limits:

Temperature: -40 °C to 70 °C.

Humidity: Up to 90% RH at 65 °C.

Protect the HP 4142B from temperature extremes to prevent condensation from forming inside the HP 4142B.

Original Packaging

When you unpack the HP 4142B, retain all packing material for future use. If it becomes necessary to reship the HP 4142B, repack it in the original packing material and shipping carton. Containers and material identical to those used in factory packaging are available from Hewlett-Packard.

Other Packaging

If you choose to package the HP 4142B in commercially available material, observe the following general instructions.

1. Wrap the HP 4142B in heavy paper or plastic.
2. Use a strong shipping container. A double-walled carton made of 159 kg (350 lb.) test material is adequate.
3. Use enough shock absorbing material, a 76 to 102 mm (3 to 4 in) layer, around all sides of the HP 4142B to provide a firm cushion and to prevent movement inside the container. Protect the front panel with cardboard.
4. Seal the shipping container securely and mark it FRAGILE to ensure careful handling.
5. In any correspondence with HP, refer to the instrument by model and serial number.

REPAIR SERVICE

You can have the HP 4142B repaired at an HP service center whether it is under warranty or not. Contact the nearest HP Sales Office for shipping instructions prior to returning the instrument. A list of Sales and Service Offices is located in the back of this manual.

Serial Number

Hewlett-Packard uses a two-serial-number system to identify the HP 4142B and each HP 4142B plug-in unit. The HP 4142B (mainframe) serial number is stamped on the serial number plate attached to the rear panel of the HP 4142B. The individual serial number of each unit is stamped on the serial number plate attached to the side panel of each unit. The HP 4142B serial number identifies the mainframe; unit serial numbers identify each individual unit. In any correspondence with Hewlett-Packard, be sure to include the serial numbers of both the HP 4142B and the unit.

CHAPTER 2

GETTING STARTED

CONTENTS

Introduction	2-1
Product Introduction	2-1
HP 4142B	2-1
Ground Unit (GNDU)	2-3
HP 41420A HPSMU and HP 41421B MPSMU	2-4
HP 41422A HCU	2-7
HP 41424A VS/VMU	2-9
HP 41425A AFU	2-11
Measurement Modes	2-12
Total Power Limitation of Plug-in Units	2-14
Panel Overview	2-15
Before Applying Power	2-17
Applying Power	2-18
Sending the HP-IB Command	2-19
Output/Input Statement	2-19
Sending an HP-IB Command	2-19
Getting Data from the HP 4142B	2-19
If an Error Occurs	2-20
Reading the Error Register	2-20
Resetting the HP 4142B	2-21
Sending a Command to the Unit	2-21
Channel Numbers (ch#)	2-21
Forcing and Measuring	2-22
Setting the Output Switch of the Unit to ON	2-22
Setting the Output Switch of the Unit to OFF	2-22
Forcing Constant Voltage	2-23
Forcing Constant Current	2-23
Setting the Output to 0 V	2-23
Performing the Measurement	2-24
Performing the Staircase Sweep Measurement	2-25
Specifying the Measurement Range	2-26
Measurement Program Flow	2-27
Waiting for Time	2-28
Performing Self-Calibration	2-28
Performing Self-Test	2-28

NOTES



INTRODUCTION

This chapter teaches you the fundamentals of operating your HP 4142B and how to make measurements. Included are discussions on basic function, and operating and measurement procedures.

PRODUCT INTRODUCTION

HP 4142B

The HP 4142B is a high performance DC parametric measurement instrument with plug-in unit architecture designed for:

- Wide Measurement Range (10 A, 200 V)
- High Resolution (20 fA, 4 μ V)
- High Speed (Force I or V: 4 ms, Measure I or V: 4 ms)
- High Accuracy (V: 0.05%, I: 0.2%)

All HP 4142B operations--measurement set up and execution, and measurement data receipt--are computer-controlled via the Hewlett-Packard Interface Bus (HP-IB). Up to 1023 measurement data (4095 for binary data format) can be stored in internal memory.

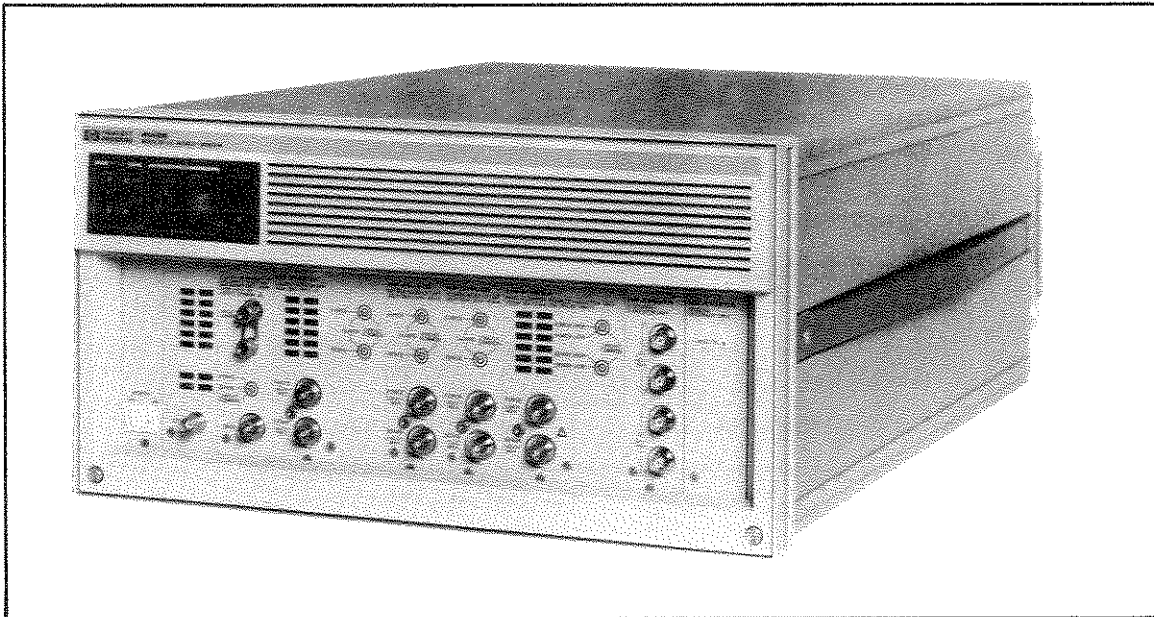

HP 4142B Modular DC Source/Monitor

As a measurement unit, the following five types of plug-in units are available, in addition to a built-in, 0 V source Ground Unit (GNDU). The plug-in units can be built-in to up to eight slots.

- HP 41420A Source/Monitor Unit, 40 μ V-200V/20fA-1A (High Power SMU, HPSMU). Occupies 2 slots.
- HP 41421B Source/Monitor Unit, 40 μ V-100V/20fA-100mA (Medium Power SMU, MPSMU). Occupies 1 slot.
- HP 41422A High Current Source/Monitor Unit, 40 μ V-10V/20nA-10A (HCU). Occupies 2 slots.
- HP 41424A Voltage Source/ Voltage Monitor Unit (VS/VMU). Occupies 1 slot.
- HP 41425A Analog Feedback Unit (AFU). Occupies 1 slot. No more than one HP 41425A per mainframe.

The following figure shows the output and measurement range of plug-in units.

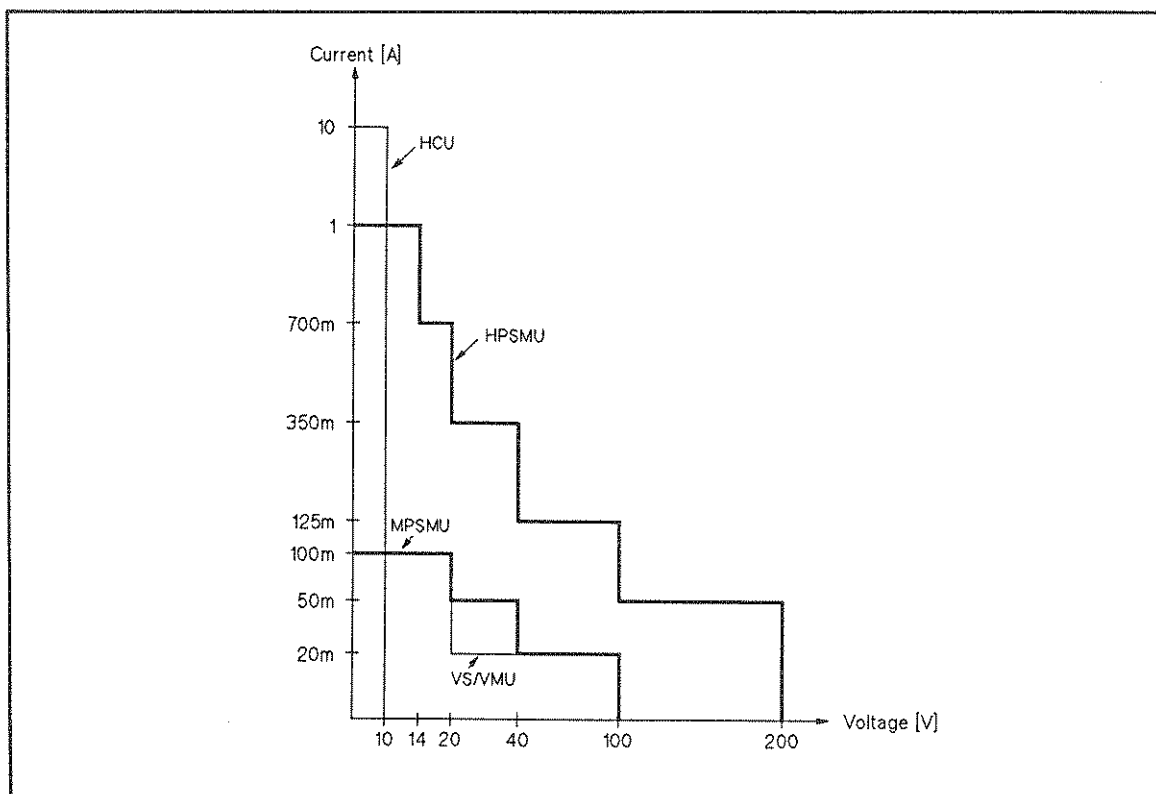

Output and Measurement Range of Plug-in Units

Ground Unit (GNDU)

The Ground Unit (GNDU) is a 0 V constant source that provides a measurement ground reference, and can sink up to ± 1.6 A. The following figure shows a simplified GNDU circuit diagram.

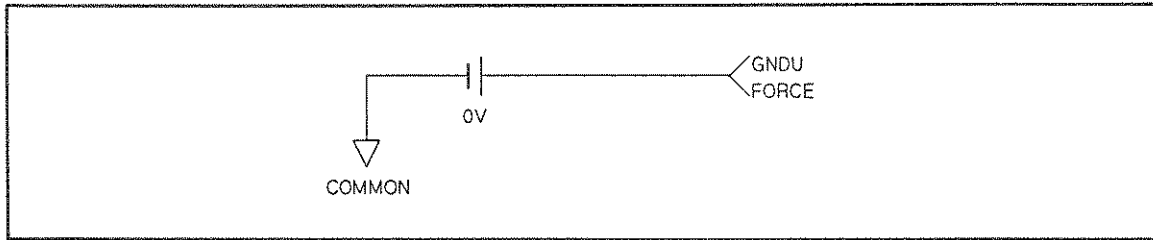

Simplified GNDU Circuit Diagram

HP 41420A HPSMU and HP 41421B MPSMU

The HP 41420A Source/Monitor Unit (High Power SMU: HPSMU) can force and measure up to ± 200 V or ± 1 A (maximum power: 14 W).

The HP 41421B Source/Monitor Unit (Medium Power SMU: MPSMU) can force and measure up to ± 100 V or ± 100 mA (maximum power: 2 W).

Each SMU functions in either of the following two modes:

- V source (constant or pulse) and I monitor
- I source (constant or pulse) and V monitor

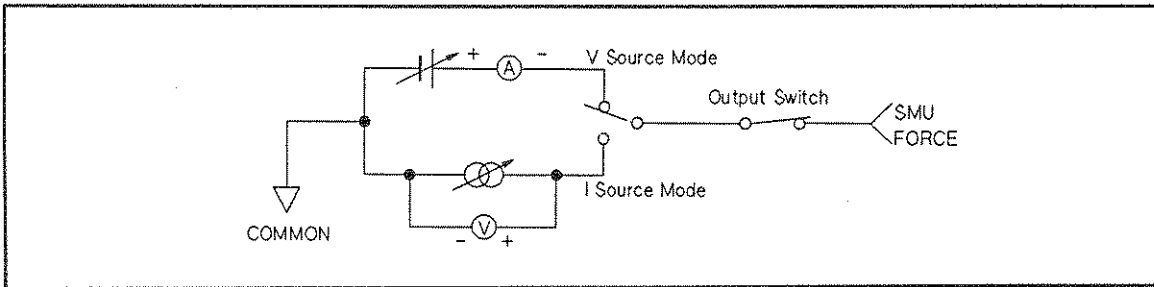

Simplified SMU Circuit Diagram

In High speed spot measurements and Analog search measurements (described later), the SMU functions in the following two modes in addition to the above two modes:

- V source (constant only) and V monitor
- I source (constant only) and I monitor

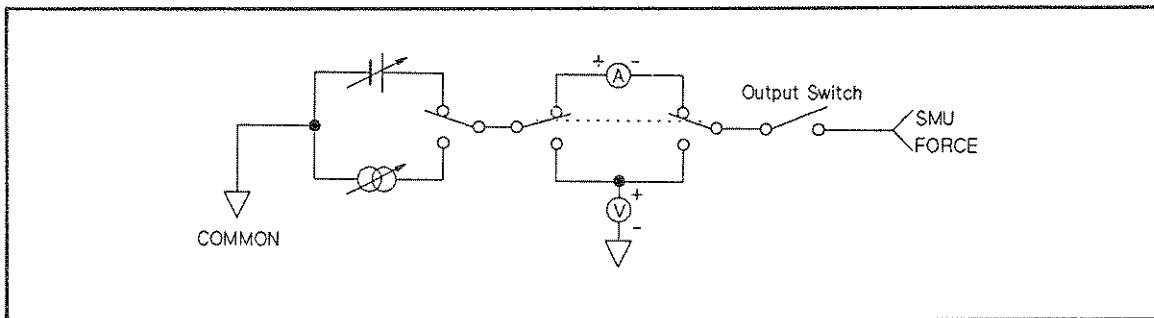

SMU Circuit Diagram

The following figure and table list HPSMU/MPSMU output and measurement ranges.

HPSMU/MPSMU Output and Measurement Ranges

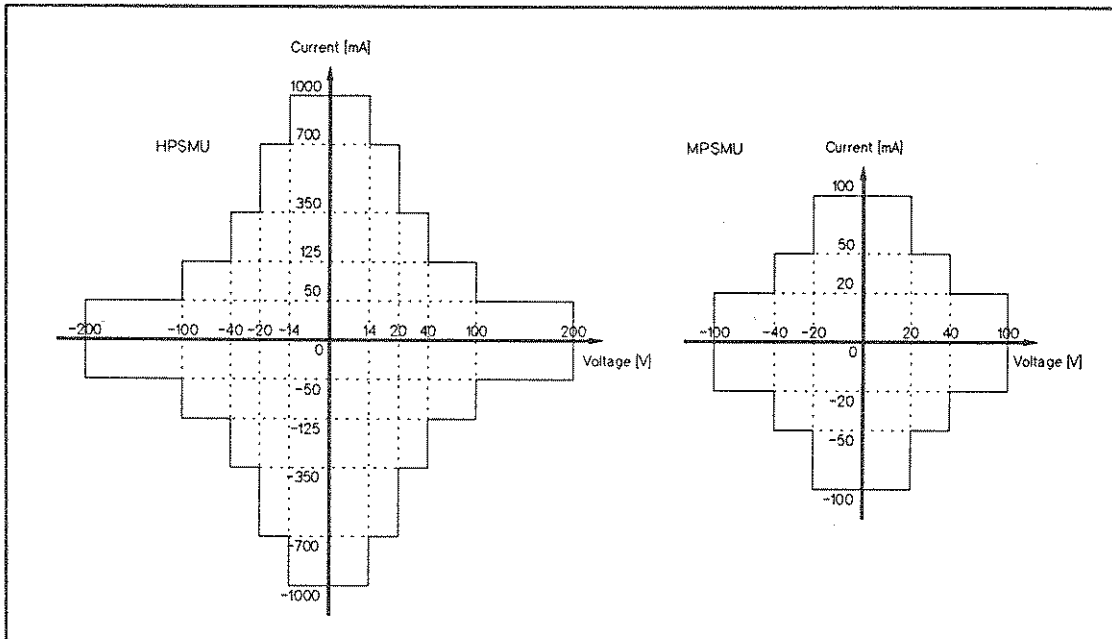

Range	Output/Measurement Value	Resolution ¹ Output/Meas.	Maximum Output	
			HPSMU	MPSMU
2 V	$0 \leq V \leq 2 V$	100 μ V/40 μ V	$\pm 1 A$	$\pm 100 mA$
20 V	$0 \leq V \leq 14 V$ $14 V < V \leq 20 V$	1mV/400 μ V 1mV/400 μ V	$\pm 1 A$ $\pm 700 mA$	$\pm 100 mA$ $\pm 100 mA$
40 V	$0 \leq V \leq 40 V$	2mV/800 μ V	$\pm 350 mA$	$\pm 50 mA$
100 V	$0 \leq V \leq 100 V$	5mV/2mV	$\pm 125 mA$	$\pm 20 mA$
200 V	$0 \leq V \leq 200 V$	10mV/4mV	$\pm 50 mA$	---
1 nA ²	$0 \leq \leq 1.15 nA$	50fA/20fA	$\pm 200 V$	$\pm 100 V$
10 nA ³	$0 \leq \leq 11.5 nA$	500fA/200fA	$\pm 200 V$ ⁴	$\pm 100 V$ ⁴
100 nA ³	$0 \leq \leq 115 nA$	5pA/2pA	$\pm 200 V$ ⁴	$\pm 100 V$ ⁴
1 μ A ³	$0 \leq \leq 1.15 \mu A$	50pA/20pA	$\pm 200 V$ ⁴	$\pm 100 V$ ⁴
10 μ A ³	$0 \leq \leq 11.5 \mu A$	500pA/200pA	$\pm 200 V$ ⁴	$\pm 100 V$ ⁴
100 μ A	$0 \leq \leq 115 \mu A$	5nA/2nA	$\pm 200 V$	$\pm 100 V$
1 mA	$0 \leq \leq 1.15 mA$	50nA/20nA	$\pm 200 V$	$\pm 100 V$
10 mA	$0 \leq \leq 11.5 mA$	500nA/200nA	$\pm 200 V$	$\pm 100 V$
100 mA	$0 \leq \leq 20 mA$ $20 mA < \leq 50 mA$	5 μ A/2 μ A 5 μ A/2 μ A	$\pm 200 V$ $\pm 200 V$	$\pm 100 V$ $\pm 40 V$
	$50 mA < \leq 115 mA$ ⁵	5 μ A/2 μ A	$\pm 100 V$	$\pm 20 V$
1 A	$0 \leq \leq 50 mA$ $50 mA < \leq 125 mA$ $125 mA < \leq 350 mA$ $350 mA < \leq 700 mA$ $700 mA < \leq 1 A$	50 μ A/20 μ A 50 μ A/20 μ A 50 μ A/20 μ A 50 μ A/20 μ A 50 μ A/20 μ A	$\pm 200 V$ $\pm 100 V$ $\pm 40 V$ $\pm 20 V$ $\pm 14 V$	--- --- --- --- ---

¹ Output Resolution: 1/20000, Measurement Resolution: 1/50000

² The 1 nA range cannot force and measure pulse current.

³ When the pulse voltage output is in the 20 V through 200 V range, 10 nA through 10 μ A measurement ranges cannot be used.

⁴ When the pulse current output is in the 100 nA through 10 μ A range, the maximum voltage is 2 V.

⁵ For MPSMU, 100 mA

Pulse parameters are:

Pulse width: 1 ms to 50 ms

Pulse period: 10 ms to 500 ms

Maximum pulse duty (pulse width/ pulse period): 50%

Each SMU includes a compliance feature that limits output voltage or current to prevent damage to your device. When the SMU forces voltage, you can specify I compliance. When the SMU forces current, you can specify V compliance. You can specify V or I compliance with the same resolution as the output voltage or current within the maximum output.

HP 41422A HCU

HP 41422A High Current Source/Monitor Unit (HCU) can force and measure up to 10 A and 10 V, and functions in either of the following two modes:

- Pulsed V source and I monitor
- Pulsed I source and V monitor

The HCU can force pulsed voltage or pulsed current, but cannot force constant voltage or constant current. When the HCU does not force a pulse value, the HCU functions as 0 V source. (Maximum current: 0.1% of the current range value. 10 mA maximum at the 10 A range.)

The following figure shows a simplified HCU circuit diagram. Although the HCU is a floating source/monitor, the LOW line of the HCU must be connected to the GNDU and fixed to 0 V. Therefore, HCU circuit (including GNDU) is equivalent to the SMU circuit.

You cannot connect an SMU or VS in place of the GNDU.

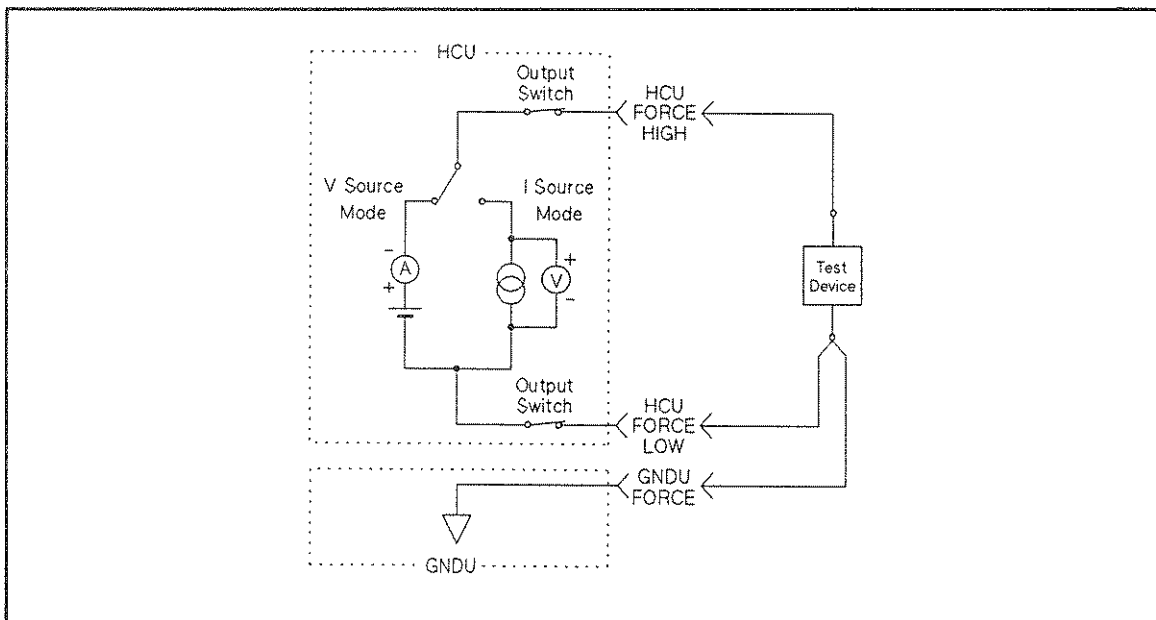

Simplified HCU Circuit Diagram

The following table shows the HCU output and measurement ranges. The HCU is a unipolar source, that is, voltage and current output are limited to the same polarity.

HCU Output/Measurement Ranges

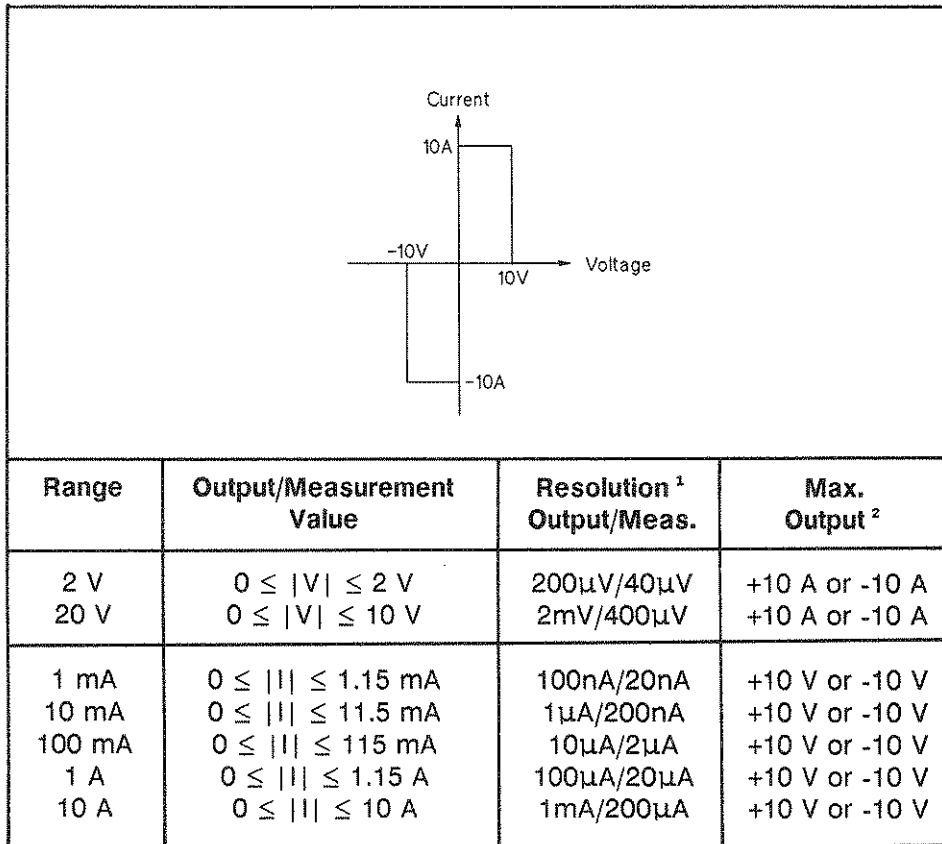

¹ V/I Output Resolution: 1/10000, V/I Measurement Resolution: 1/50000

² The polarity of maximum output is positive if the output value is positive, and negative if the output value is negative.

Pulse parameters are:

Pulse width: 100 μ s to 1 ms

Pulse period: 10 ms to 500 ms

Maximum pulse duty (pulse width/ pulse period):

10% (if output current or I compliance is 1 A or less.)

1% (if output current or I compliance is more than 1 A.)

An HCU includes a compliance feature that limits output voltage or current to prevent damage to your device (same as the HPSMU/MPSMUs).

HP 41424A VS/VMU

The HP 41424A V Source/V Monitor Unit (VS/VMU) provides:

- V source (constant or pulse) and I monitor (VS), 2ch
- V monitor (VM), 2ch for grounded measurement, or 1ch for differential measurement

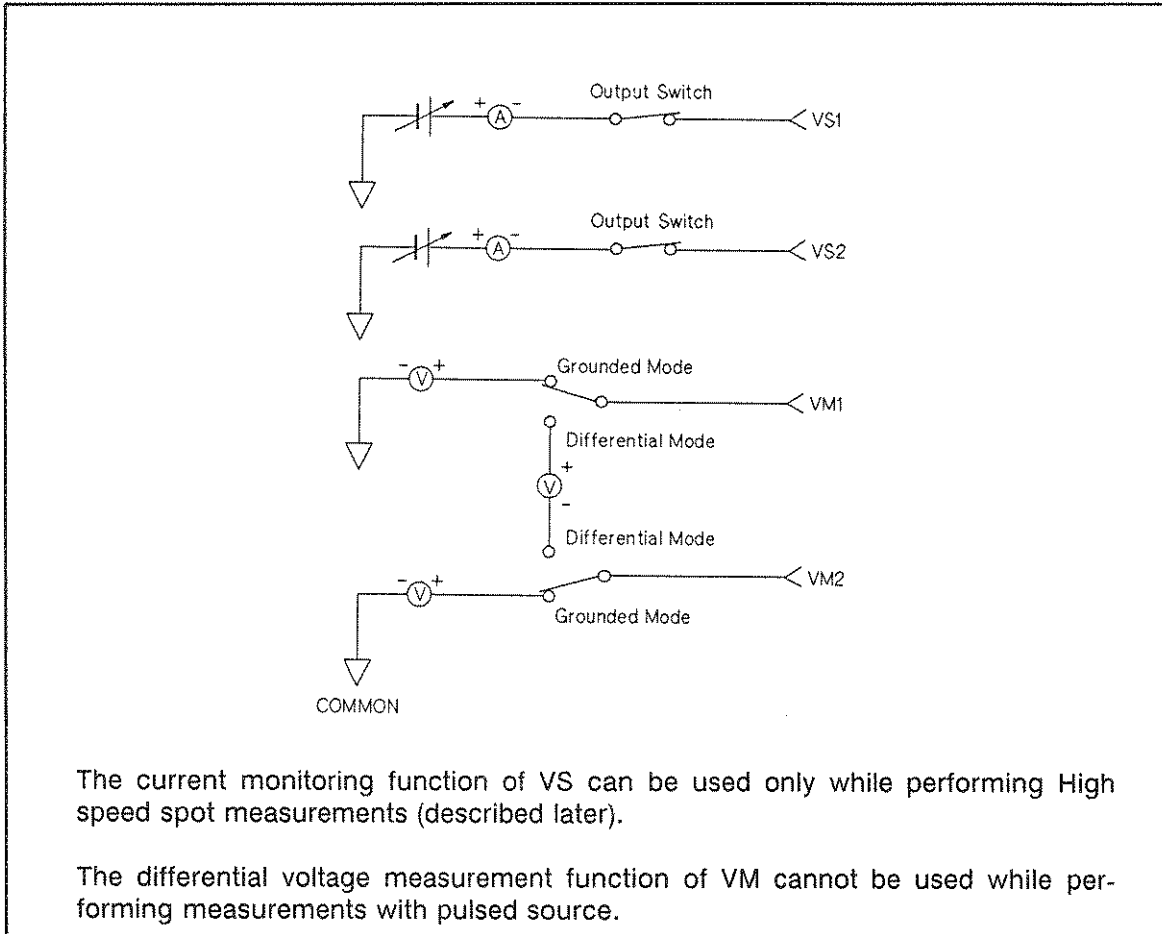

Simplified VS/VMU Circuit Diagram

VS can force up to 40 V, and VM can measure up to 40 V. The following tables show the V output range and I measurement range of VS, and the V measurement range of VM.

VS Output and Measurement Ranges

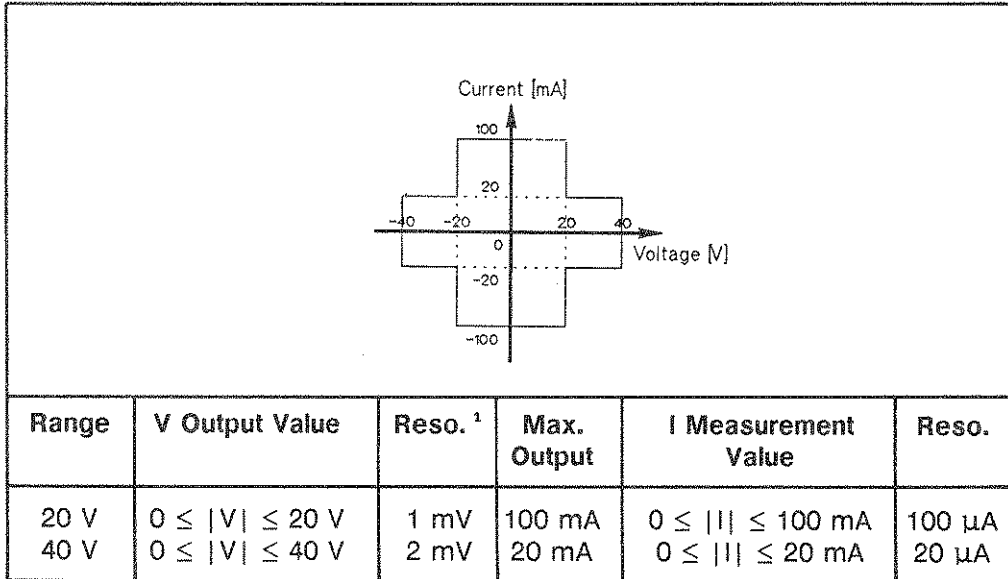

¹ V Output Resolution: 1/20000, I Measurement Resolution: 1/1000

VM Measurement Ranges

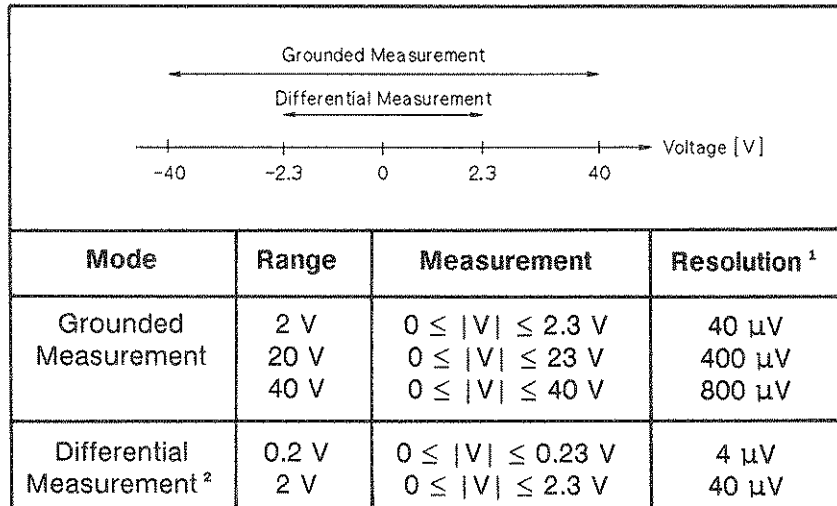

¹ V Measurement Resolution: 1/50000

² Each voltage of differential input must be within $\pm 40 \text{ V}$.

Pulse parameters are the same as the SMU:

Pulse width: 1 ms to 50 ms

Pulse period: 10 ms to 500 ms

Maximum pulse duty (Pulse width/ Pulse period): 50%

The VS has a current limiter. The limiter value is automatically determined by the output voltage range. If the output range is 20 V, then the current limit is 100 mA. If the output range is 40 V, then the current limit is 20 mA.

HP 41425A AFU

The HP 41425A Analog Feedback Unit (AFU) controls the output voltage of one SMU (HPSMU or MPSMU, called the search SMU), and set the monitor value of another SMU (HPSMU or MPSMU, called the sense SMU) to the specified value. The monitor value is current if the sense SMU is set to V source, and it is voltage if the sense SMU is set to I source. The SMUs specified for use are automatically connected internally to the AFU. The following figure shows a simplified AFU operational diagram.

The major applications of the AFU are:

- Bipolar transistor hFE measurement at the specified collector voltage and collector current.
- MOSFET V_{th} measurement at the specified drain voltage and drain current.

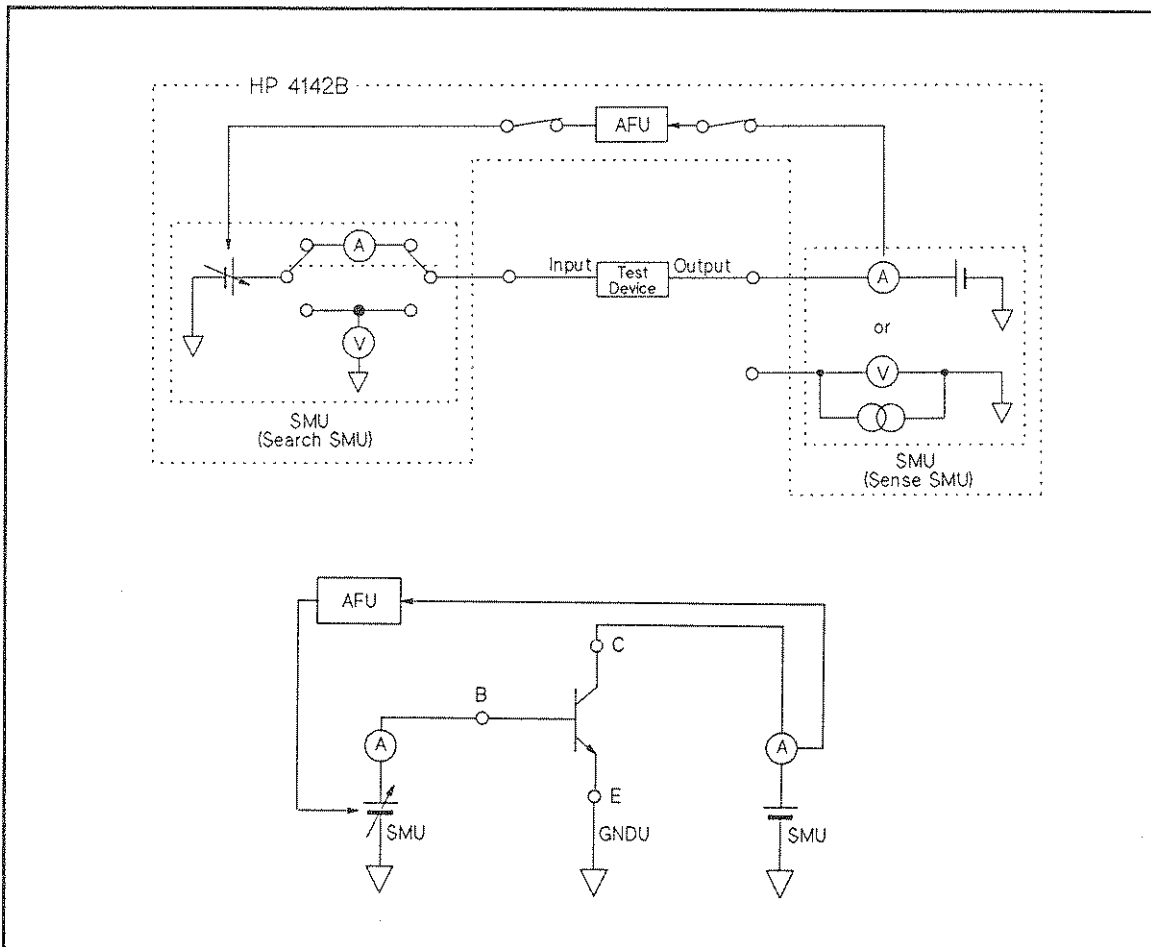











Simplified AFU Operational Diagram

Measurement Modes

By using the measurement units, you can perform the following nine types of measurements. The output waveform and available units are shown for each measurement mode in the following figure. The explanation number below corresponds to the No. in the figure.

- 1) Spot measurements
Up to 16 sources force constant voltages and currents, and up to 8 monitors measure the outputs.
- 2) Staircase sweep measurements
One source sweeps constant V or I, while up to 8 monitors measure the outputs.
Or two sources sweep constant voltages or currents at the same time, while up to 8 monitors measure the outputs.
- 3) 1ch pulsed spot measurements
One source forces pulsed V or I, and one monitor measures the output.
- 4) Pulsed sweep measurements
One source sweeps pulsed V or I, while one monitor measures the output.
- 5) Staircase sweep with pulsed bias measurements
One source sweeps constant V or I, and another source forces pulsed V or I with synchronized sweep output, while one monitor measures the output.
- 6) Analog search measurement
Searches for a specified current or voltage on one SMU by controlling the voltage output of another SMU.
The AFU is required.
- 7) 2ch pulsed spot measurements
Two sources force pulsed outputs at the same time, and one monitor measures the output.
At least one pulsed source must be an HCU.
- 8) Pulsed sweep with pulsed bias measurement
One source sweeps pulsed V or I, and another source forces pulsed V or I with synchronized sweep pulsed output, while one monitor measures the output.
At least one pulsed source must be an HCU.
- 9) High speed spot measurement
Up to 16 sources force constant voltages and currents, and one monitor measures the outputs. You can perform the measurement with fewer commands than spot measurement.

Available Units in Each Measurement Mode

No.	Output Waveform	Source			Monitor					AFU
		SMU (M/I)	HCU (M/I)	VS (M)	SMU (M/I)	HCU (M/I)	VS (I)	VM		
								(V ¹)	(VD ²)	
1		●		●	●			●	●	
2		●		●	●			●	●	
		●		●	●			●	●	
3		●	●	●	●	●		●		
4		●	●	●	●	●		●		
5		●		●	●	●		●		
		●	●	●	●	●		●		
6		●			●					●
		●			●					
7		●	●		●	●		●		
		●	●		●	●		●		
8		● ³	●		●	●		●		
		● ³	●		●	●		●		
9		●		●	●		●	●	●	

¹ Grounded measurement mode

² Differential measurement mode

³ At least one pulsed source must be an HCU.

Total Power Limitation of Plug-in Units

Total SMU, HCU, and VS power consumption must not exceed 32 W. If you do not have an HPSMU, an HCU, or more than six VS/VMUs, total power consumption can not reach 32 W. Your HP 4142B is not limited by the total power of the units. Power consumption depends on the output settings for voltage and current, and is calculated as follows. Note that when the output switch of the unit is set to OFF, the power of that unit is 0 W.

Unit	Power ¹
SMU	2 V, 20 V range ² : $20(I_{set}^3)$ [W] 40 V range: $40(I_{set})$ [W] 100 V range: $100(I_{set})$ [W] 200 V range: $200(I_{set})$ [W]
HCU	$20(I_{set})(\text{pulse duty}^4)+10$ [W]
VS	20 V range: 2.2 [W] 40 V range: 0.88 [W]

¹ Output switch set to OFF: 0 W

The power of each unit is rounded down to the nearest hundredth. For example, if the calculation result is 1.057 W, then power = 1.05 W. If 0.002 W, then power = 0 W.

² If the SMU is the I source mode, voltage range is the lowest range that includes the voltage compliance value. For example, if you set the voltage compliance to 5 V, voltage range is 20 V.

³ I_{set} is the specified output current value at I source mode, and is the specified current compliance value at V source mode.

⁴ The pulse duty is defined: $(\text{pulse duty}) = (\text{pulse width} / \text{pulse period})$.

Maximum value of power consumption for these units is as follows.

HPSMU: 20 W
 MPSMU: 2 W
 HCU: 12 W
 VS/VMU: 4.4 W

For example, if you have two HPSMUs, total maximum power consumption is 40 W (20 W + 20 W) and exceeds 32 W. You cannot force the maximum output of each unit at the same time. The maximum current of the two units is limited to 1.6 A (32W/20V).

PANEL OVERVIEW

The following figures point out important locations on the HP 4142B. The name of each part is referenced in this manual.

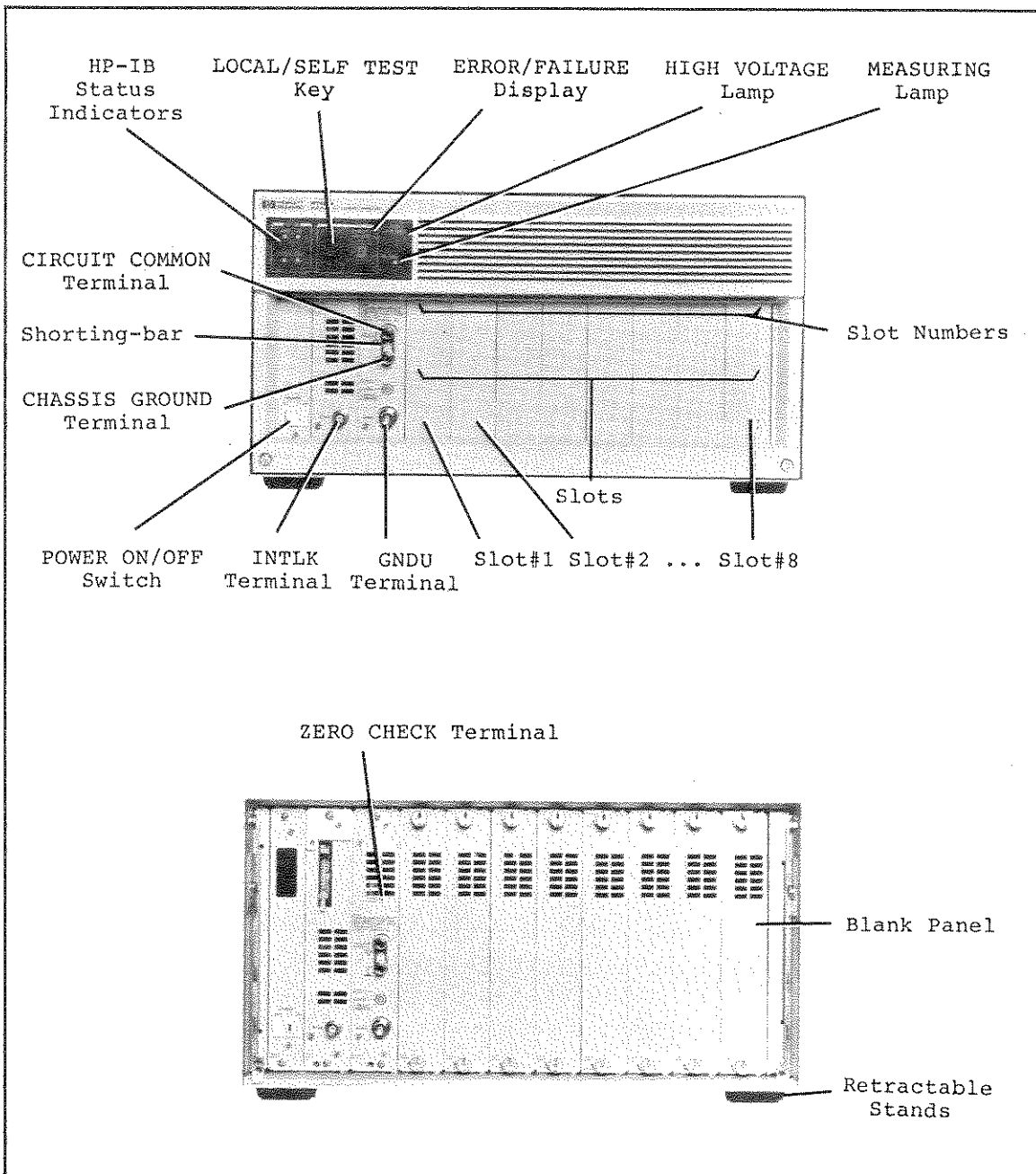

HP 4142B Panel Overview (1 of 2)

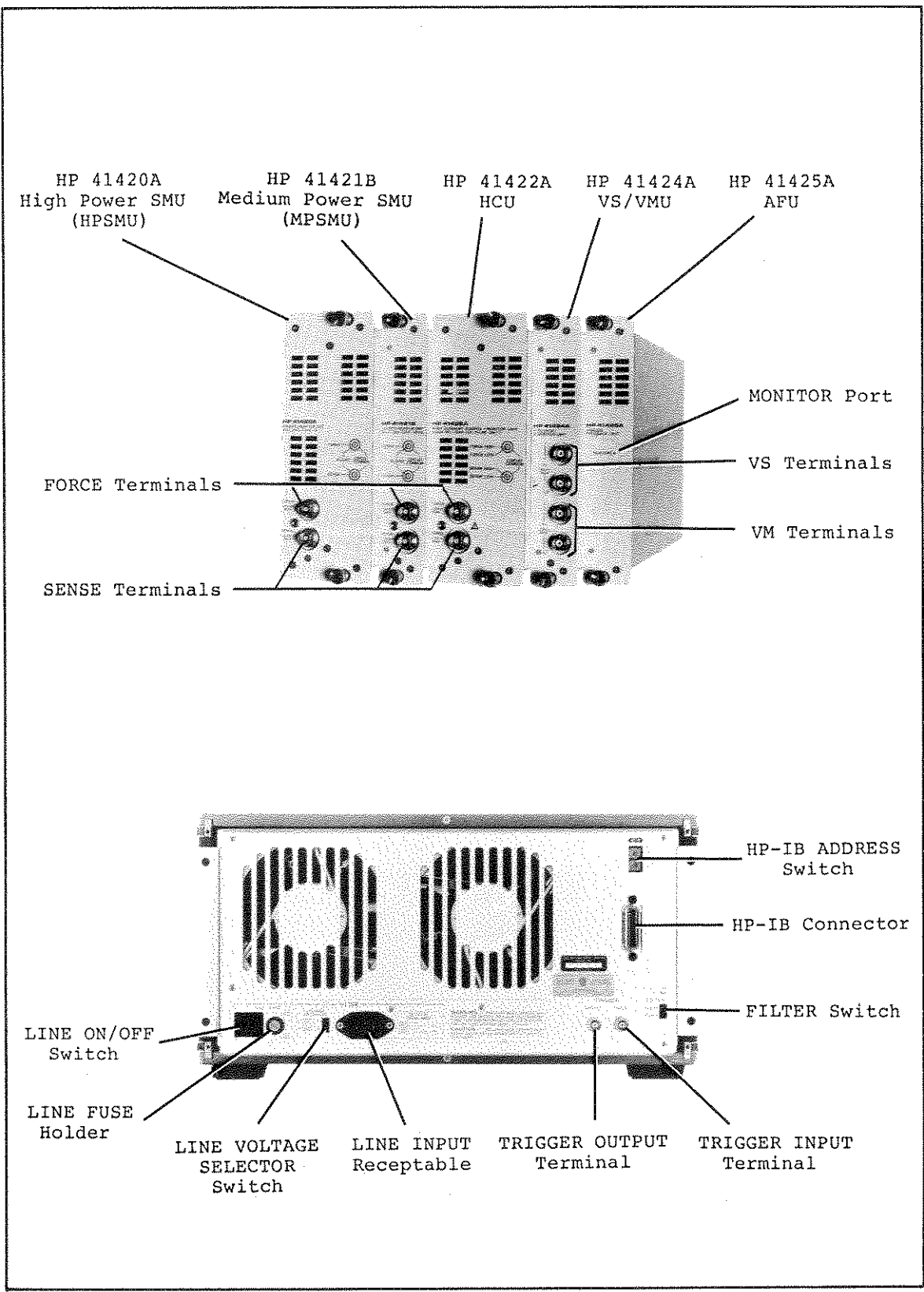

HP 4142B Panel Overview (2 of 2)

BEFORE APPLYING POWER

Before you apply power, confirm the following:

- The HP 4142B is installed horizontally, $\pm 20^\circ$ maximum.
- Line voltage is within the specified tolerance.
- The **LINE VOLTAGE SELECTOR** switch is set correctly.
- The correct fuse is installed.
- The line frequency **FILTER** switch is set correctly.
- Blank panels (part number 04142-60012) are installed in all unused slots.
- Front panel is correctly installed on the HP 4142B.
- **HP-IB ADDRESS Switch** on the rear panel is set to the desired value between 0 to 30 (it is set to 17 when shipped from the factory). The new HP-IB address is recognized only at power on.

If you have any questions above, refer to Chapter 1.

APPLYING POWER

To turn on the HP 4142B, perform the following procedure.

1. Set the front panel **POWER ON/OFF** switch to **ON**.
2. Set the rear panel **LINE ON/OFF** switch to **ON**.

All front panel indicators light momentarily, **C** (performing the Self-Test or Self-Calibration) is displayed in the **ERROR/FAILURE** display, and Self-Test and Self-Calibration starts. The Self-Test and Self-Calibration takes about 30 seconds.

Self-Test: This test verifies that the HP 4142B is operating but does not verify that the output and measurement will be accurate.

Self-Calibration: This improves short-term accuracy for output and measurement functions, but is not a substitute for periodic calibration (adjustment) of the HP 4142B.

When Self-Test and Self-Calibration are finished, the **LOCAL/SELF TEST** key indicator light goes out and a **0** (No error) is displayed in the **ERROR/FAILURE** display.

3. Confirm that **ERROR/FAILURE** display indicates **0** (No error). If anything other than **0** is displayed, see Chapter 6, "Front Panel" for details.

NOTE

To simplify turning the HP 4142B on or off, keep the **POWER ON/OFF Switch** setting to **ON** at all times, and turn it on or off with the **LINE ON/OFF Switch**.

Line power is applied to the HP 4142B if the rear panel **LINE ON/OFF** switch is set to **ON**, even if the front panel **POWER ON/OFF** switch is set to **OFF**. To completely power down the HP 4142B, set the rear panel **LINE ON/OFF** switch to **OFF**, regardless of the **POWER ON/OFF Switch** setting.

To satisfy the specifications of the HP 4142B, allow the HP 4142B to warm-up for a minimum of 40 minutes before you begin performing measurements.

SENDING THE HP-IB COMMAND

Output/Input Statement

The statements used to operate the HP 4142B depend on the computer and its language. In particular, you need to know the statements the computer uses to output and input information. For example, the output statement for the HP 9000 Series 200/300 BASIC language is **OUTPUT**. The input statement is **ENTER**.

Read your computer manuals to find out which statements you need to use. The examples in this manual use HP 9000 Series 200/300 BASIC language. To use the examples, load the binary (BIN) files: HPIB, IO, GRAPH, and ERR.

Sending an HP-IB Command

To send the HP 4142B an HP-IB command, combine the output statement of the computer with the HP-IB select code, the HP 4142B address, and finally, the HP 4142B HP-IB command. For example, to make the HP 4142B perform Self-Calibration, send:

```
OUTPUT 717;"CA"
```

Notice that the **REM** and **LSTN** indicators of the front panel are illuminated. This means the HP 4142B is in the remote mode and has been addressed to listen (received a command).

Each HP-IB command syntax is described in the *HP-IB Command Reference Manual*.

Getting Data from the HP 4142B

The HP 4142B is capable of sending measurement data and responses to query commands. As an example, have the HP 4142B generate a response to a query command by sending:

```
OUTPUT 717;"*IDN?"
```

The HP 4142B sends the response to its output buffer. The output buffer is a register that holds a query response or measurement data until it is read by the computer. Use the input statement of the computer to get the response from the output buffer. For example, the following program reads the response (HEWLETT PACKARD, 4142B, 0, *ROM__version__number*) and prints it.

```
10 DIM A$(30)
20 ENTER 717;A$
30 DISP A$
40 END
```

The output format of response data to each query command and measurement data are described in the *HP-IB Command Reference Manual*.

IF AN ERROR OCCURS

The HP 4142B indicates errors in the following manner.

1. The HP 4142B displays an **A, E, F, H, P,** or **1 to 8** in the **ERROR/FAILURE** display, which indicates the following error conditions. For more information, see Chapter 6, "Front Panel."
 - E:** Syntax error or out of the parameter range.
 - F:** Incorrect input command sequence.
 - H:** Overvoltage or overcurrent occurred. Output switches of all units are disconnected to prevent the HP 4142B damage.
 - 1 to 8, A, P:** Self-Test failed.
 - (C:** Performing the Self-Test or Self-Calibration)
2. The HP 4142B sets Bit 5 of the status byte to one. If you remove the mask of that bit, the HP 4142B asserts the SRQ. Use this function when you handle the error in your programs. For more information, see Chapter 6, "Status Byte."

If an error occurs, you can get the error message. Refer to the next paragraph, "Reading the Error Register."

NOTE

In case of momentary power loss, overvoltage, or overcurrent, the HP 4142B may automatically turn off, keeping **LINE ON/OFF** and **POWER ON/OFF** switches **ON**, to prevent damage. If this occurs, set **LINE ON/OFF** switch to **OFF** and wait for more than 10 seconds, then set the switch to **ON**. The HP 4142B will function properly.

Reading the Error Register

Whenever an error occurs, a record of errors is stored in the error register as the error code. To read the error record, send the **ERR?** command to transfer the error codes from the error register to the output data buffer as shown below.

```
10 DIM A$(23)
20 OUTPUT 717;"ERR?"
30 ENTER 717;A$
40 PRINT A$
50 END
```

The first four error codes are printed in the order of their occurrence. For example:

```
120, 100, 0, 0
```

For error code descriptions, see *HP-IB Command Reference Manual*, "Error Messages." If no error occurs, the error register returns "0, 0, 0, 0."

When you execute the **ERR?** command, the error register and **ERROR/FAILURE** display are initialized (set to "0, 0, 0, 0" and 0).

RESETTING THE HP 4142B

Many times during operation, you may wish to return to the power-on initial settings. The *RST or the HP BASIC CLEAR command returns you to the initial settings. To reset the HP 4142B (HP 4142B mainframe and all plug-in units), send:

OUTPUT 717;"*RST"

or

CLEAR 717

For initial settings information, see Chapter 6, "Initial Settings".

SENDING A COMMAND TO THE UNIT

Channel Numbers (*Ch#*) are used to identify the plug-in units installed in the HP 4142B. To control each unit, you must specify the channel number of the unit. For example, to make *ch#5* of the unit perform Self-Calibration, send:

OUTPUT 717;"CA5"

Channel Numbers (Ch#)

Channel numbers are determined by the slot number that the unit is installed as follows. The slot number is displayed on the front panel.

HP 41420A HPSMU

HP 41422A HCU:

Ch# is the slot number that is the greater of the two slots occupied by the unit.

Example: In slot#1 and slot#2, *Ch#* is 2.

HP 41421B MPSMU:

Ch# is the slot number in which the MPSMU is installed.

Example: In slot#3, *Ch#* is 3.

HP 41424A VS/VMU:

1) VS1 and VM1:

Ch# is $1n$ or n , where n is the slot number in which the VS/VMU is installed.

Example: In slot#8, *Ch#* is 18 or 8.

2) VS2 and VM2:

Ch# is $2n$, where n is the slot number in which the VS/VMU is installed.

Example: In slot#8, *Ch#* is 28.

3) Differential Voltmeter using VM1 and VM2:

Ch# is n , $1n$, or $2n$, where n is the slot number in which the VS/VMU is installed.

Example: In slot#8, *Ch#* is 8, 18, or 28.

FORCING AND MEASURING

This paragraph explains the operation of measurements using a bipolar transistor as a test device.

Connect the units to the test device as follows. Refer to Chapter 3 for information on how to connect.

Emitter: GNDU
Base: SMU (HPSMU or MPSMU)
Collector: SMU (HPSMU or MPSMU)

Setting the Output Switch of the Unit to ON

Before you make the SMUs/HCU/VSS force or measure voltage/current, you must set the internal output switch of the unit to ON.

Even if a physical connection by a cable exists, these units are not electrically connected to a test device, because the output switches are set to OFF at power-on. To set the output switches to ON, and to connect the units to the test device electrically, send **CN** command. The syntax is:

```
CN [ch#] [,ch#] [,ch#] [,ch#] [,ch#] [,ch#] [,ch#] [,ch#]
```

Where the brackets [] mean optional parameter. If you connect three units of ch#2, ch#3, and ch#8:

```
OUTPUT 717;"CN";2,3,8
```

If you connect all units:

```
OUTPUT 717;"CN"
```

When the output switch is set to ON, 0 V is forced to the test device.

For VMs, GNDU and AFU, you do not need this operation because these units do not have output switches.

Setting the Output Switch of the Unit to OFF

To set the output switches to OFF, and to disconnect the units from the test device, send **CL** command. The syntax is:

```
CL [ch#] [,ch#] [,ch#] [,ch#] [,ch#] [,ch#] [,ch#] [,ch#]
```

If you disconnect three units of ch#2, ch#3, and ch#8:

```
OUTPUT 717;"CL";2,3,8
```

If you disconnect all units:

```
OUTPUT 717;"CL"
```

Forcing Constant Voltage

The **DV** command forces the specified constant voltage. Constant voltage can be forced from SMUs or VSs. The syntax of **DV** command is:

For SMUs:

DV ch#, output range, output voltage, I compliance

For VSs:

DV ch#, output range, output voltage

If you force 1 V from the SMU of ch#2 with Auto ranging (*output range = 0*), and set the current compliance to 10 mA:

```
OUTPUT 717;"CN";2
OUTPUT 717;"DV";2,0,1,10E-3
```

Forcing Constant Current

The **DI** command forces the specified constant current. Constant current can be forced from SMUs. The syntax of **DI** command is:

DI ch#, output range, output current, V compliance

If you force 10 μ A from the SMU of ch#3 with Auto ranging (*output range = 0*), and set the voltage compliance to 2 V:

```
OUTPUT 717;"CN";3
OUTPUT 717;"DI";3,0,10E-6,2
```

The current polarity is positive if current flows from the HP 4142B, and negative if it flows into the HP 4142B.

If you use an SMU as no output (open) or a voltage monitor only, set current output to 0 A.

Setting the Output to 0 V

To stop forcing voltage and current, send the **DZ** command. The **DZ** command sets the specified unit(s) output to 0 V. You can send this command more easily than the **DV** command. The **DZ** command syntax is:

DZ [ch#] [,ch#] [,ch#] [,ch#] [,ch#] [,ch#] [,ch#] [,ch#]

If you specify three units of ch#2, ch#3, and ch#8:

```
OUTPUT 717;"DZ";2,3,8
```

If you specify all units:

```
OUTPUT 717;"DZ"
```

Performing the Measurement

To specify the measurement mode and measurement channel, send the **MM** command. The syntax is:

```
MM measurement mode, ch# [ch#] [ch#] [ch#] [ch#] [ch#] [ch#] [ch#]
```

When the measurement unit is an SMU or HCU, an SMU/HCU set to V source mode performs an I measurement--even if output value is 0 V, and an SMU/HCU set to I source mode performs a V measurement--even if output value is 0 A.

Measurements are performed in the order in which you specify them with the **MM** command.

Send the measurement trigger command **XE** to start a measurement. Measurement results are stored in the HP 4142B output data buffer in ASCII format. Transfer measurement data to your computer using the **ENTER** statement.

The following program forces collector voltage (1 V) and base current (10 μ A) and measures the collector current with the spot measurement (*measurement mode* = 1).

```
10 Base=3      I Base: ch#3, Collector: ch#2, Emitter: GNDU
20 Collector=2
30 Ib=10E-6
40 Vc=1
50 OUTPUT 717;"*RST"
60 OUTPUT 717;"CN";Base,Collector
70 OUTPUT 717;"DV";Collector,0,Vc,10E-3
80 OUTPUT 717;"DI";Base,0,Ib,2
90 OUTPUT 717;"MM";1,Collector
100 OUTPUT 717;"XE"
110 OUTPUT 717;"DZ";Base,Collector
120 OUTPUT 717;"CL";Base,Collector
130 ENTER 717;A$
140 PRINT A$
150 END
```

The measurement data *A\$* is printed as shown below:

```
NBI+02.1808E-03
```

The first three characters (NBI) are the measurement data status, which indicates measurement condition. The remainder (+02.1808E-3) is the measurement value, 2.1808 mA. For more information about the measurement data format, see the *HP-IB Command Reference Manual*.

NOTE

The HP 4142B output data buffer can store up to 1023 measurement data (4095 for binary data format). See "Measurement Data Memory" in Chapter 5 for more information. The data buffer sends measurement data in the order in which it was stored. Therefore, if you transfer the measurement data after you perform the measurement twice, the first measurement data is transferred from the HP 4142B first. Use the **BC** command to clear the output data buffer. The output data buffer is also cleared when you turn the HP 4142B on and when you execute an ***RST** command.

Performing the Staircase Sweep Measurement

You can perform staircase sweep measurements easily by using the sweep command **WV** (for voltage sweep) or **WI** (for current sweep). The following is the syntax for each:

*WV ch#, sweep mode, output range, start voltage, stop voltage,
number of steps [, I compliance]*

*WI ch#, sweep mode, output range, start current, stop current,
number of steps [, V compliance]*

The following program forces collector voltage (0 to 1 V, 21 steps, linear sweep (*sweep mode = 1*)) and base current (10 μ A) and measures the collector current with the staircase sweep measurement (*measurement mode = 2*).

```
10 Base=3      ! Base: ch#3, Collector: ch#2, Emitter: GNDU
20 Collector=2
30 Ib=10E-6
40 Vcstart=0
50 Vcstop=1
60 No_step=21
70 DIM A$[400]
80 OUTPUT 717;"*RST"
90 OUTPUT 717;"CN";Base,Collector
100 OUTPUT 717;"WV";Collector,1,0,Vcstart,Vcstop,No_step,10E-3
110 OUTPUT 717;"DI";Base,0,Ib,2
120 OUTPUT 717;"MM";2,Collector
130 OUTPUT 717;"XE"
140 OUTPUT 717;"DZ";Base,Collector
150 OUTPUT 717;"CL";Base,Collector
160 ENTER 717;A$
170 PRINT A$
180 END
```

The measurement data *A\$* is printed as shown below:

```
NBI-09.9696E-06,NBI+08.5332E-06,NBI+0.12334E-03,NBI+0.61556E-03,
NBI+01.4284E-03,NBI+01.9058E-03,NBI+02.0858E-03,NBI+02.1426E-03,
NBI+02.1612E-03,NBI+02.1648E-03,NBI+02.1672E-03,NBI+02.1680E-03,
NBI+02.1700E-03,NBI+02.1722E-03,NBI+02.1728E-03,NBI+02.1744E-03,
NBI+02.1756E-03,NBI+02.1764E-03,NBI+02.1778E-03,NBI+02.1780E-03,
NBI+02.1808E-03
```

For the above program, measurement data is displayed after all steps of measurements are complete. If you want to display the measurement data immediately after each step of measurements, change program lines 140 through 180 to the following:

```

140 FOR Step=1 TO No_step
150   ENTER 717 USING "#,3A,12D,X";I$,I
160   PRINT I$,I
170 NEXT Step
180 ENTER 717 USING "#,X"
190 OUTPUT 717;"DZ";Base,Collector
200 OUTPUT 717;"CL";Base,Collector
210 END

```

The measurement data I and $I\$$ is printed as shown below:

```

NBI -9.9636E-6
NBI 8.5332E-06
NBI .00012334
NBI .00061556
NBI .0014284
NBI .0019058
:      :
:      :
NBI .002178
NBI .0021808

```

Specifying the Measurement Range

If you specify a measurement ranging mode or range, specify that before sending the measurement trigger command **XE**. The measurement range of each unit can be specified as follows:

SMU/HCU Current Measurement Range:

RI sets $Ch\#$ and I measurement range. Default I measurement range at power on is Auto.

SMU/HCU Voltage Measurement Range:

Set automatically, depending on the V compliance setting, to the lowest range that includes the value of V compliance. For example, if you set the V compliance of the SMU to 5 V, the 20 V measurement range is set.

VM (voltage) Measurement Range:

RV sets $Ch\#$ and V measurement range. Default V measurement range at power on is Auto.

See "Measurement Ranging Mode" in Chapter 5 for details.

Measurement Program Flow

The following figure shows the basic measurement program flow. The HP-IB commands for each step are listed in parentheses.

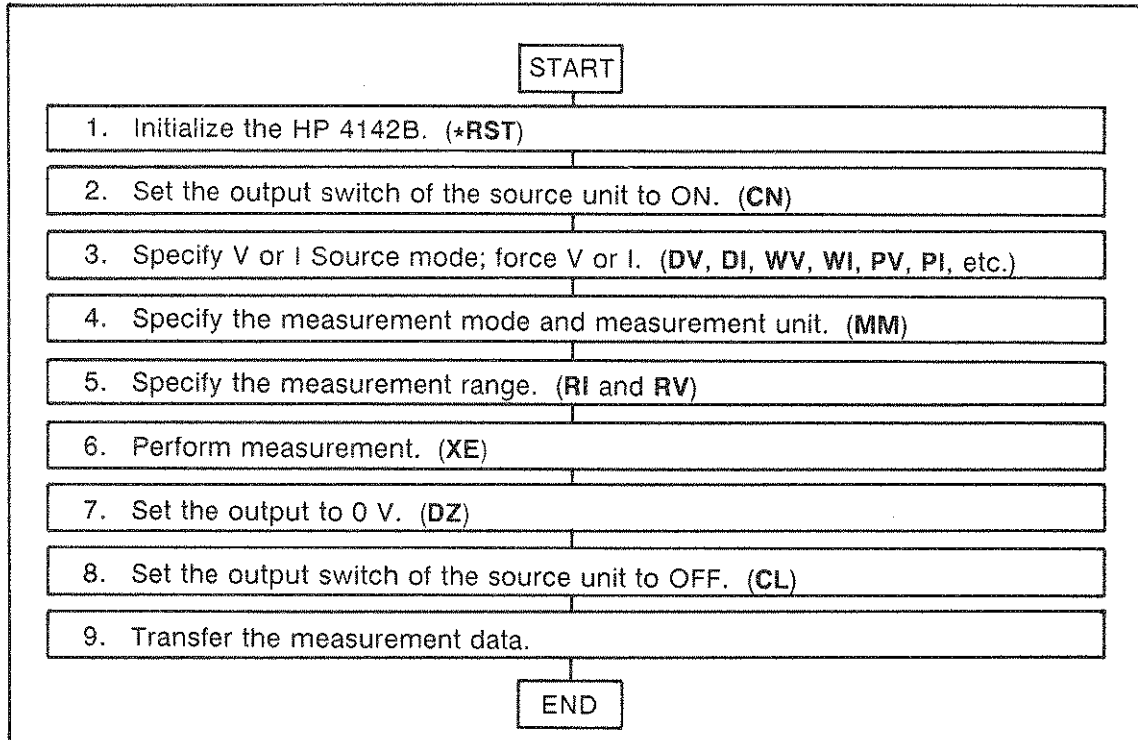

Basic Measurement Program Flow

In flow number 3 of above figure, the main commands for specifying measurement conditions for Sweep, Pulsed, and Analog Search measurement are listed below.

- Staircase Sweep measurements (1ch sweep): **WV** and **WI**
- Staircase Sweep measurements (2ch sweep): **WV**, **WI**, **WSV**, and **WSI**
- 1ch Pulsed Spot measurements: **PV** and **PI**
- Pulsed Sweep measurements: **PWV** and **PWI**
- Staircase Sweep with Pulsed Bias measurements: **WV**, **WI**, **PV**, and **PI**
- Analog Search measurements: **ASV**, **AVI**, and **AIV**
- 2ch Pulsed Spot measurements: **PV**, **PI**, **PDV**, and **PDI**
- Pulsed Sweep with Pulsed Bias measurements: **PWV**, **PWI**, **PDV**, and **PDI**

WAITING FOR TIME

You can pause command execution until the specified *wait time* has elapsed. The command is **PA**, and the syntax is:

PA *wait time*

The *wait time* setting area is from 0 to 99.9999 s (100 μ s resolution).

If you wait for 1 ms between output and measurement, send as follows:

```
:
80  OUTPUT 717;"MM";1;Collector
90  OUTPUT 717;"DI";Base,0,Ib,2      ! Current output
100 OUTPUT 717;"PA";1E-3
110 OUTPUT 717;"XE"                  ! Measurement Trigger
:
```

PERFORMING SELF-CALIBRATION

Self-Calibration improves short-term accuracy for output and measurement functions. To perform Self-Calibration, send:

```
OUTPUT 717;"CA"
```

or press the **LOCAL/SELF TEST** key.

After a minimum 40 minute warm-up period and before you begin to use your HP 4142B, perform Self-Calibration. Self-Calibration should be performed every 30 minutes or if the ambient temperature changes by more than 3 °C (6 °F).

PERFORMING SELF-TEST

Self-Test verifies that the HP 4142B is operating. To perform the Self-Test, press the **LOCAL/SELF TEST** key. If no errors occur, **0** is displayed in the **ERROR/FAILURE** display.

If you perform Self-Test by the program, send:

```
10  OUTPUT 717;"*TST?"
20  ENTER 717;A$
30  PRINT A$
40  END
```

If no error occurs, *A\$* is 0.

If you keep the HP 4142B turned on more than 1 day, we recommend that you perform Self-Test one time per one day.

When the HP 4142B performs Self-Test, the HP 4142B also performs Self-Calibration.

CHAPTER 3

TEST DEVICE CONNECTIONS

CONTENTS

Introduction	3-1
Before Connecting Test Devices	3-1
Enclose the Test Device with a Shielding Box	3-1
Connect the INTLK Terminal	3-1
Shorting Circuit Common and Chassis Ground Terminals	3-2
Connecting the Test Devices	3-3
GNDU Connections	3-3
HPSMU and MPSMU Connections	3-5
HCU Connections	3-9
VS/VMU Connections	3-13
Using the Connection Accessories	3-14
Using Connector Plate Part Number 04142-60021	3-14
Using Connector Plate Part Number 04142-60031	3-15
Using the HP 16088A Test Fixture	3-16
Using the HP 16058A Test Fixture	3-18
Advanced Connection Information	3-20
For High Current Measurements (Kelvin Connection)	3-20
For Low Current Measurements (Using the GUARD Terminal)	3-22
If the Test Device is Externally Grounded (Floating Measurement)	3-23
If the Test Device has Negative Resistance	3-25
Preventing Oscillation from the Test Device	3-26

NOTES

INTRODUCTION

This chapter explains test device connection considerations and methods, and provides procedures to obtain optimum measurement results.

Be sure to observe all **WARNINGS**, **CAUTIONS**, and **NOTES** to ensure your safety and to maintain the integrity of the HP 4142B.

BEFORE CONNECTING TEST DEVICES

Before you connect the test devices to the source or monitor unit, perform the following steps.

Enclose the Test Device with a Shielding Box

When you perform measurements, enclose the test device (wafer prober or user-fabricated test fixture) with a box to prevent the operator from receiving an electric shock from the output voltage or current of the HP 4142B. Use a grounded shielding box to minimize the effects of environmental noise and ambient light. To ground the shielding box, connect it to the chassis ground of the HP 4142B by using the **CHASSIS GROUND** (\perp) terminal or the outer conductor of the INTLK terminal.

Connect the INTLK Terminal

To prevent an operator from receiving an electric shock from the high voltage (more than ± 42 V), connect the INTLK (interlock) terminal to a switch that turns on when the shielding box access door is closed, and that turns off when the shielding box access door is opened.

The HPSMU output can be as high as ± 200 V and the MPSMU output can be as high as ± 100 V. If the door is opened (INTLK terminal is open), the output is limited to ± 42 V. When a unit output is more than ± 42 V and if the door is opened, the HP 4142B immediately drops all output down to 0 V. Conversely, if the door is closed (INTLK terminal is shorted, that is, the INTLK center conductor is set to the chassis ground), the SMU output can be more than ± 42 V.

To ground the shielding box, connect it to the outer conductor (chassis ground) of the INTLK terminal.

WARNING

SHORTING THE INTLK TERMINAL ENABLES SMU OUTPUT TO EXCEED ± 42 V. DANGEROUS VOLTAGES MAY BE PRESENT AT FORCE, SENSE AND GUARD LINES OF THE SMU OUTPUT CONNECTORS WHEN THE INTLK TERMINAL IS SHORTED.

Shorting Circuit Common and Chassis Ground Terminals

Short the **CIRCUIT COMMON** (∇) and **CHASSIS GROUND** (\perp) terminals together with the shorting-bar installed on the **CHASSIS GROUND** terminal.

WARNING

A POTENTIAL SHOCK HAZARD EXISTS IF THE CIRCUIT COMMON (∇) TERMINAL IS NOT TIED TO CHASSIS GROUND (\perp) (SHORTING-BAR DISCONNECTED FOR FLOATING MEASUREMENTS). DO NOT TOUCH ANY FRONT PANEL CONNECTORS OF THE HP 4142B AT ANY TIME WHILE A FLOATING MEASUREMENT IS IN PROGRESS.

If you disconnect the shorting-bar, see "If the Test Device is Externally Grounded (Floating Measurement)" in this chapter.

CONNECTING THE TEST DEVICES

The following paragraphs discuss test device connection considerations and methods, and provide procedures for obtaining optimum measurement results.

GNDU Connections

GNDU can be connected to test devices using kelvin connections. The following figure shows and describes several GNDU/test device connection methods: one for kelvin connections, and one for non-kelvin connections.

WARNING

DO NOT USE TRIAXIAL CABLE PART NUMBERS 16058-61603 OR 04145-61622 TO CONNECT GNDU TO A TEST DEVICE. THE GNDU CAN SINK UP TO 1.6 A, AND THE MAXIMUM CURRENT RATING OF THESE CABLES IS 1 A.

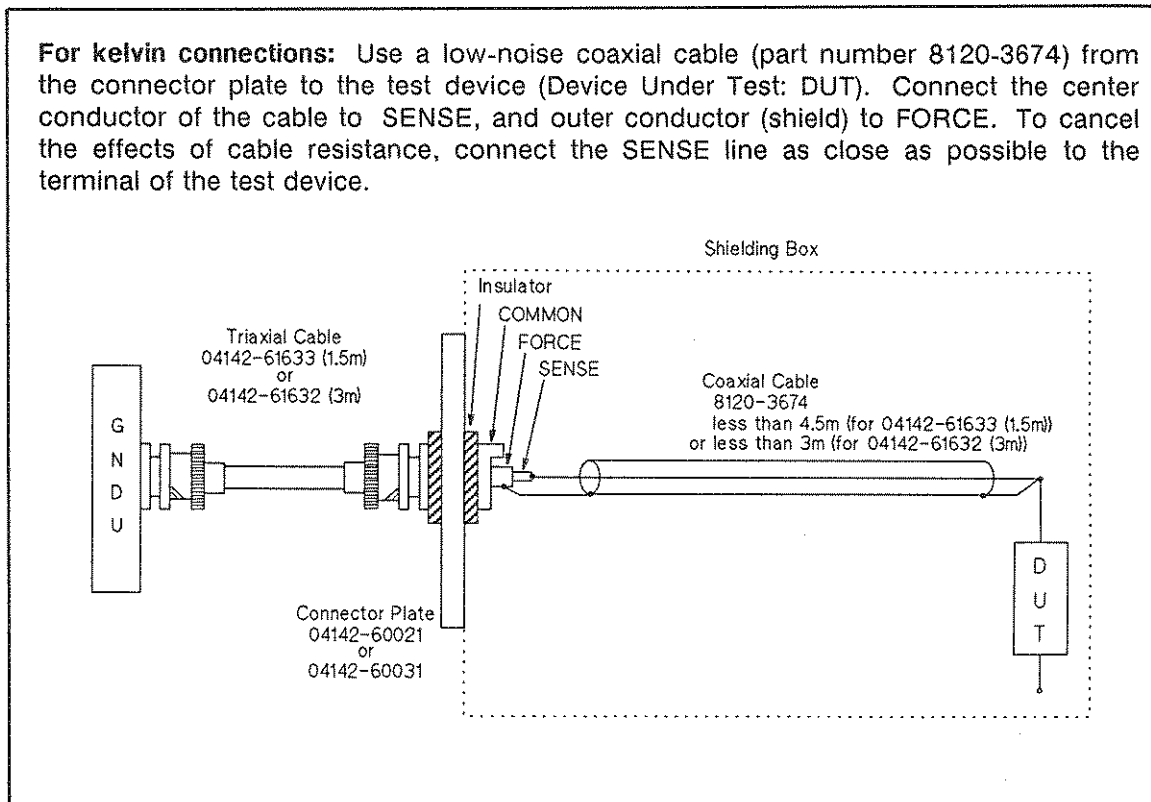

GNDU Example Connections (1 of 2)

For non-kelvin connections: Short SENSE and FORCE at the connector plate as shown. Use AWG 24 single-strand insulated wire (part number 8150-0447) from the connector plate to the test device (DUT). Measurement results include the residual resistance of the connection wire.

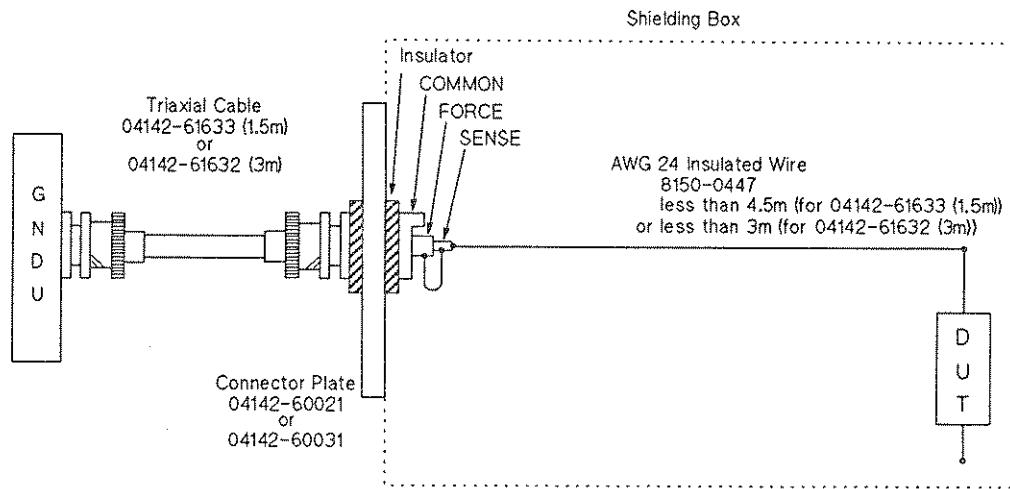

NOTE

To easily connect GNDU for a measurement in which the accuracy is not important, connect only FORCE to the test device (DUT), without shorting SENSE and FORCE.

GNDU Example Connections (2 of 2)

HPSMU and MPSMU Connections

The HPSMU and MPSMU can be connected to test devices using kelvin connections. For highly accurate current forcing and measurements while minimizing leakage, the FORCE and SENSE terminals are surrounded by a GUARD terminal that has the same potential as the output. The following figure shows and describes several SMU/test device connections.

WARNING

VOLTAGES UP TO ± 200 V (± 100 V FOR MPSMU) MAY BE PRESENT AT THE FORCE, SENSE, AND GUARD TERMINALS. DO NOT TOUCH THESE TERMINALS IF THE FRONT PANEL HIGH VOLTAGE LAMP IS LIT.

NOTE THAT SMU GUARD TERMINAL POTENTIAL IS EQUAL TO THE OUTPUT.

TO PREVENT POTENTIAL SHOCK HAZARDS WHEN INTERCONNECTING THE HP 4142B TO OTHER DEVICES (E.G., A WAFER PROBER OR USER-FABRICATED TEST FIXTURE), DO NOT EXPOSE THE SMU OUTPUT LINES.

CAUTION

NEVER connect the GUARD terminal of any SMU to any output, including CIRCUIT COMMON ($\dot{\vee}$), CHASSIS GROUND (\perp), or the GUARD terminal of any other SMU. Doing so will result in SMU damage.

For kelvin connections: Use a low-noise coaxial cable (part number 8120-3674) from the connector plate to the test device. Connect the center conductor of one of the cables to FORCE, the center conductor of the other cable to SENSE, and the outer conductors (shields) of both cables to GUARD. To cancel the effects of cable resistance, connect the SENSE line as close as possible to the terminal of the test device. To prevent oscillations when making dc measurements, do not use cables longer than 1.5 m (for using 04142-61632 3 m cable) or 2.5 m (for using 04142-61633 1.5 m cable). For highly accurate current forcing and measurements while minimizing leakage, surround all FORCE and SENSE lines on the SMU by a GUARD as far as possible.

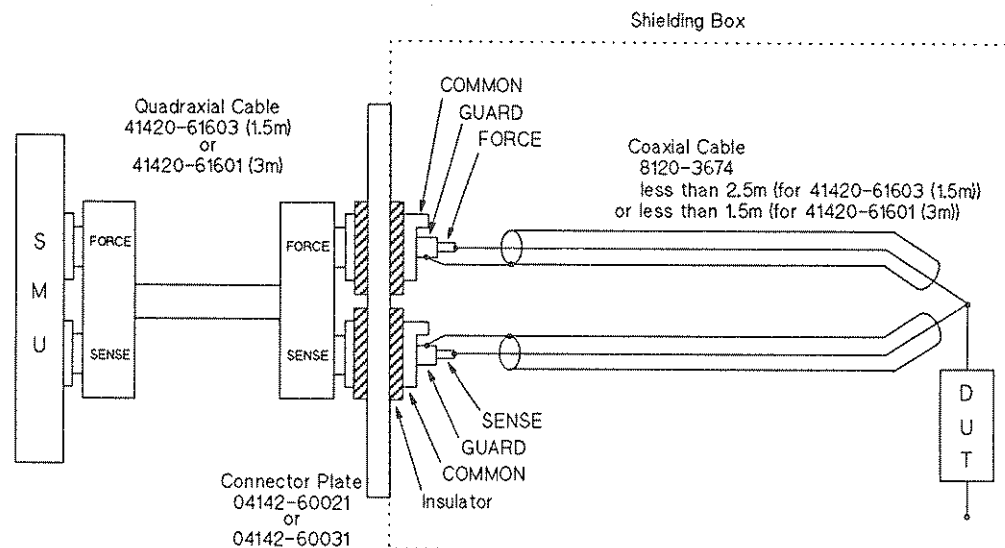

NOTE

One quadraxial cable can be replaced by two triaxial cables. If you use the 1.5 m triaxial cable (part number 16058-61603), make the length of the coaxial cable less than 1.5 m. If you use the 3 m triaxial cable (part number 04145-61622), make the length of the coaxial cable less than 35 cm.

SMU Example Connections (1 of 3)

For non-kelvin connections: The total connection cable length can be increased to 6 m by shorting SENSE and FORCE at the connector plate, as shown below. Measurement results include residual resistance from the connection wire. To enable highly accurate current forcing and measurements while minimizing leakage, surround all FORCE lines on the SMU by a GUARD as far as possible.

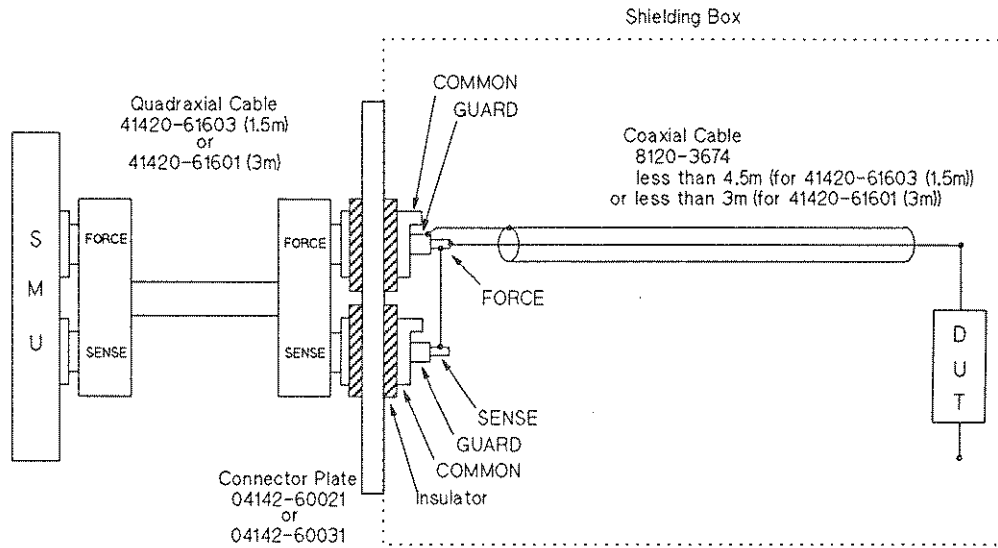

NOTE

One quadaxial cable can be replaced two triaxial cables. If you use the 1.5 m triaxial cable (part number 16058-61603), make the coaxial cable length less than 3 m. If you use the 3 m triaxial cable (part number 04145-61622), make the coaxial cable length less than 70 cm.

SMU Example Connections (2 of 3)

For non-kelvin connections: When current flow is minimum, i.e., the connection cable residual resistance is unimportant, the following connection method can be used. To use this method, be sure to connect a triax cover (part number 1250-1708) to the SENSE terminal of the SMU to provide shielding. For highly accurate current forcing and measurements while minimizing leakage, surround the FORCE line of the SMU with a GUARD as far as possible.

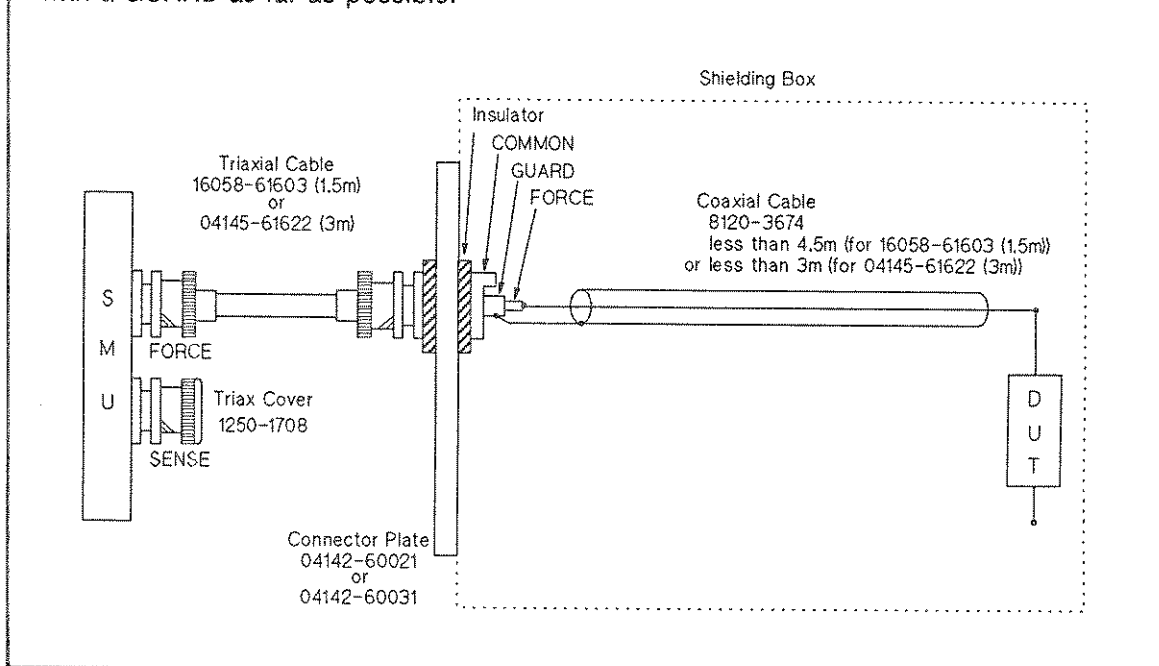

SMU Example Connections (3 of 3)

Connecting the SMU by another method

If you connect the SMU by a method that is not shown in the above figure, please note the following.

To prevent SMU oscillation, make the guard capacitance of the wiring cable less than 500 pF. The guard capacitance is the total cable capacitance between the FORCE and GUARD lines and between the SENSE and GUARD lines. Refer to the following guard capacitance data. For quadraxial cables, the following data is total guard capacitance.

41420-61603	1.5 m Quadraxial Cable: 150 pF
41420-61601	3 m Quadraxial Cable: 300 pF
16058-61603	1.5 m Triaxial Cable: 120 pF
04145-61622	3 m Triaxial Cable: 240 pF
8120-3674	Coaxial Cable: 77 pF/m

Do not use the GNDU cables (04142-61632 and 04142-61633) because guard capacitance is too large.

HCU Connections

The HCU can be connected to test devices using kelvin connections. The following figure shows several HCU/ connections.

NOTE

You can not use the HCU as a normal floating source. Whenever you use the HCU, connect GNDU to the FORCE LOW line of the HCU, and fix FORCE LOW to 0 V. Do not connect the SMU or VS instead of the GNDU because the SMU or VS will not operate correctly.

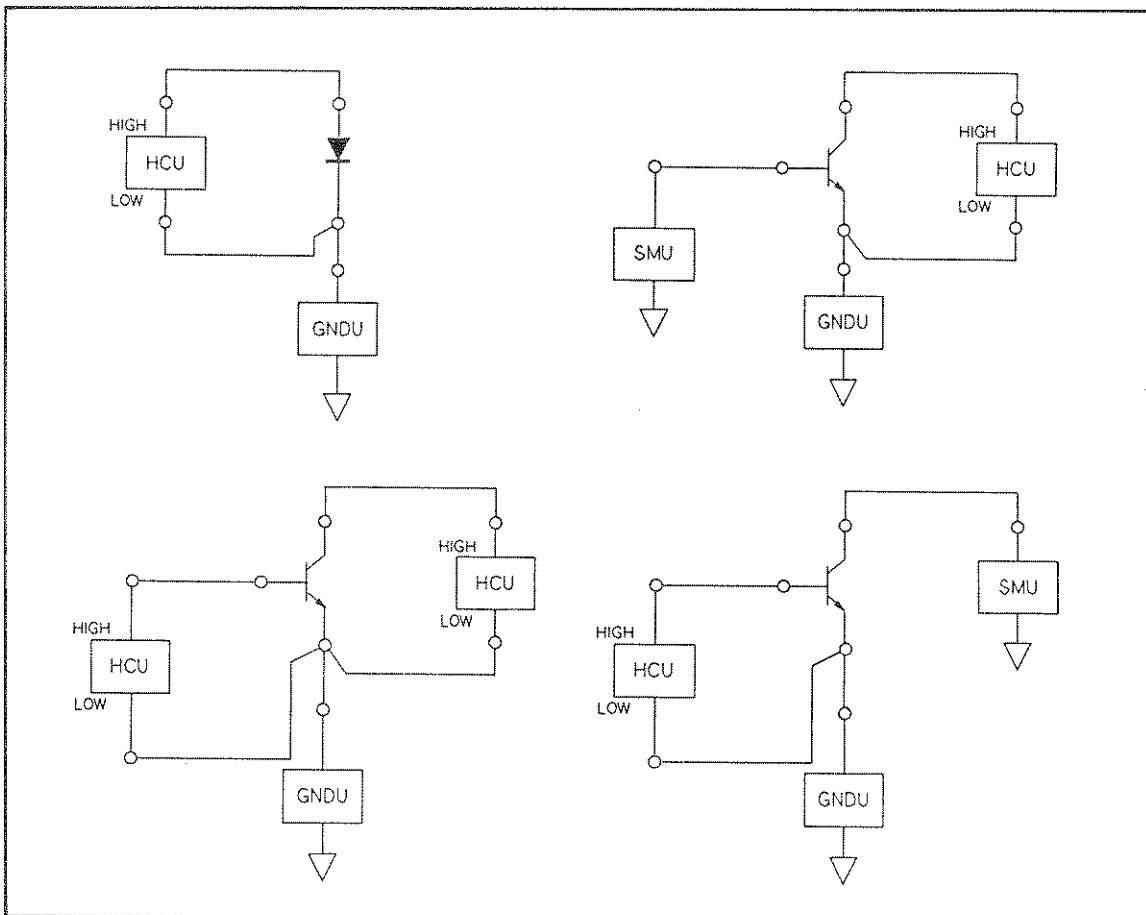

HCU Example Connection (1 of 2)

For the FORCE line connection, use an AWG 16 (1.29 mm in diameter) single-strand insulated wire (part number 8150-2605) from the connector plate to the test device. Make the wire length less than 1 m if you use 3 m wire (41422-61601), and less than 2.5 m if you use 1.5 m wire (41422-61602). Twist the FORCE HIGH and FORCE LOW lines together to prevent the increase of settling time and the occurrence of overshoot and noise from wire inductance. If the wire length is too short to twist the wires, tie the two wires together with string, as shown in the figure below.

For the SENSE line connection, use an AWG 24 (0.511 mm diameter) single-strand insulated wire (part number 8150-0447) from the connector plate to the test device. Make the length of the wire less than 3 m. Twist the SENSE HIGH and SENSE LOW lines together or tie the two wires together with string. To cancel the effects of residual resistance from the wire, connect the SENSE HIGH and SENSE LOW lines as close as possible to the test device.

Connect the FORCE and SENSE lines of GNDU to the same terminal of the test device (DUT) in which you connected the FORCE LOW and SENSE LOW lines of the HCU.

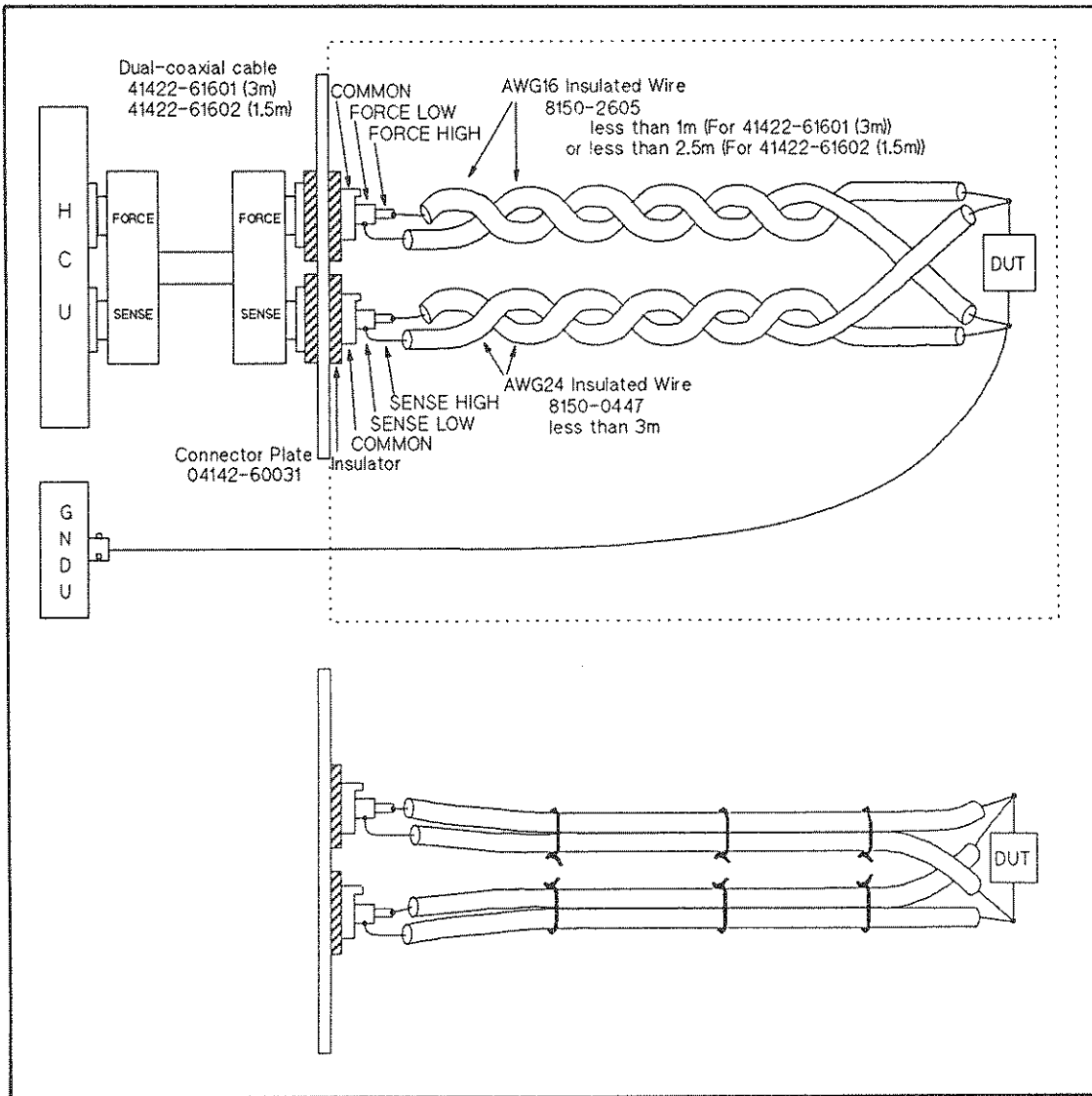

HCU Example Connection (2 of 2)

Connecting the HCU by another method

If you connect the HCU by a method that is not shown in the above figure, note the following.

- FORCE Wiring Resistance

The wiring resistance between the HCU FORCE HIGH terminal and the test device, and the wiring resistance between the HCU FORCE LOW terminal and the test device must be less than 150 m Ω , respectively. Refer to the following FORCE wiring resistance data. When you use the HP 16088A Test Fixture, do not use a 3 m dual-coaxial cable (part number 41422-61602) because the wiring resistance exceeds 150 m Ω .

41422-61601 3 m Dual-coaxial Cable

110 m Ω

41422-61602 1.5m Dual-coaxial Cable

65 m Ω

8150-2605 AWG16 (1.290 mm in diameter) insulated wire

14 m Ω /m

8150-2890 AWG18 (1.024 mm in diameter) insulated wire

22 m Ω /m

8150-0005 AWG22 (0.634 mm in diameter) insulated wire

56 m Ω /m

8150-0447 AWG24 (0.511 mm in diameter) insulated wire

89 m Ω /m

Contact resistance between the Dual-coaxial cable (41422-61601 or 41422-61602) and connector plate (41422-60031)

5 m to 10 m Ω

HP 16088A Test Fixture (from HCU connector of the the HP 16088A rear panel to the test device, for using the 16088-60007 to -60009 Socket boards)

75 m Ω

If the wiring resistance exceeds 150 m Ω , the usable output area of the HCU is limited. The limitation depends on the wiring resistance value. The following figure shows the output limitation when the wiring resistance of FORCE HIGH line R is same as that of FORCE LOW line.

If the wiring resistance value R is 0.5 ohm, maximum output current is limited to 8 A and output voltage is limited to 5 V (at 8 A) and 7 V (at 5 A). You cannot use the HCU outside of this limitation. If you specify a value that exceeds the limitation, the HCU output is not the specified value, and the actual output voltage or current value includes a large error.

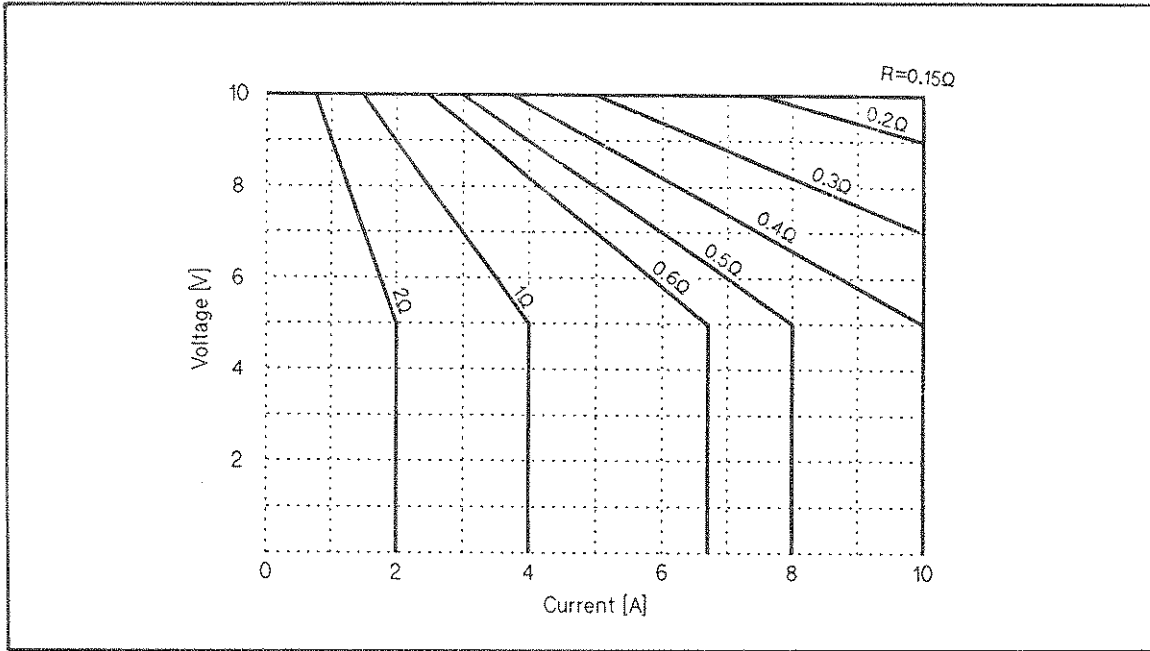

Output Limitation by Wiring Resistance

Apply the larger wiring resistance value of the FORCE HIGH and LOW lines in the above figure, if both values are different. To calculate the exact output limitation, use the following equations.

- 1) $V \leq 13 - (R1+R2)I$
- 2) $I \leq 4/R1$
- 3) $I \leq 4/R2$
- 4) $I \leq 10$
- 5) $V \leq 10$

where:

- V: Voltage across the test device. If the HCU forces voltage, it is the specified voltage value.
- I: Current through the test device. If the HCU forces current, it is the specified current value.
- R1: Wiring resistance of FORCE LOW
- R2: Wiring resistance of FORCE HIGH

Equation 1 is the limitation of maximum voltage between FORCE HIGH and FORCE LOW at the front output connectors, which is 13 V. Equation 2 and 3 are the limitations of maximum voltage between FORCE HIGH and SENSE HIGH or between FORCE LOW and SENSE HIGH at the front output connectors, which is 4 V. Equation 4 and 5 are the limitations of the maximum voltage and current of HCU across the test device.

- FORCE Wiring Inductance

To prevent slow pulsed output settling, output overshoot, and noise, make the wiring inductance of the FORCE line less than 300 nH. The FORCE wiring inductance is the wiring inductance from the FORCE HIGH terminal of the HCU to the FORCE LOW terminal of the HCU, when both lines are shorted at the test device. Refer to the following FORCE wiring inductance.

41422-61601 3 m Dual-coaxial Cable: 200 nH

41422-61602 1.5 m Dual-coaxial Cable: 100 nH

Twist the FORCE HIGH and FORCE LOW lines from the connector plate to the test device so that wiring inductance decreases.

VS/VMU Connections

The following figure shows an example of a connection between VS1, VS2, VM1, or VM2 and a test device. Use AWG 24 single-strand insulated wire (part number 8150-0447) to connect the connector plate and the test device.

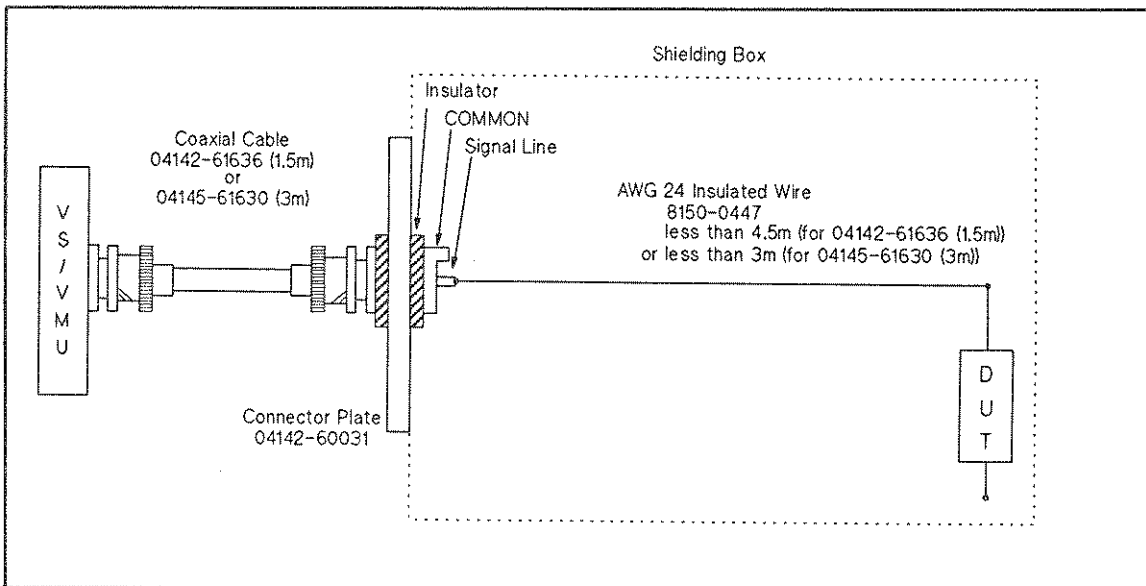

VS/VMU Example Connection

USING THE CONNECTION ACCESSORIES

Using Connector Plate Part Number 04142-60021

Connector Plate part number 04142-60021, one of the available accessories for the HP 4142B, interconnects 4 (for kelvin) to 8 (for non-kelvin) SMUs, GNDU and INTLK to test devices and a switch for INTLK via a shielding box. The following figure shows the connector assignments and connector plate dimensions.

The plate is electrically connected to the outer conductor of the INTLK connector, and is insulated from the outer conductors of the SMU and GNDU connectors for floating measurements.

To install the connector plate, drill holes to mount the connector plate onto the shielding-box, install the connector plate on the shielding-box, and ensure that there is good electrical contact between the connector plate and the shielding box.

NOTE

This connector plate cannot connect the HCU cable (41422-61601 or 41422-61602) because the location of the screw is different from the SMU cable (41420-61601 or 41420-61603).

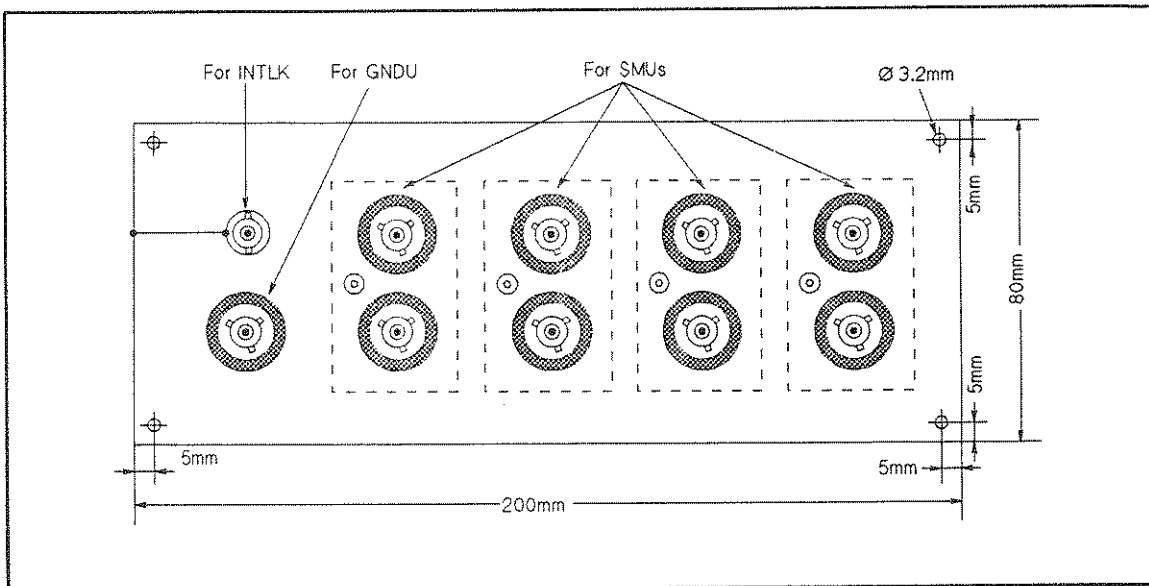

Connector Plate Part Number 04142-60021

Using Connector Plate Part Number 04142-60031

Connector Plate part number 04142-60031, one of the available accessories for the HP 4142B, interconnects two HCU, VS/VMU, GNDU, INTLK, and two AUXs (two coaxial connectors) to test devices and a switch for INTLK via a shielding box. The following figure shows the connector assignment and connector plate dimensions.

The plate is electrically connected to the outer conductor of the INTLK connector, and is insulated from the outer conductors of other connectors for floating measurements.

To install the connector plate, drill holes to mount the connector plate onto the shielding-box, and install the connector plate on the shielding-box. Ensure that there is good electrical contact between the connector plate and the shielding box.

NOTE

The connector plate cannot connect the SMU cable (41420-61601 or 41420-61603) because the location of the screw is different from the HCU cable (41422-61601 or 41422-61602).

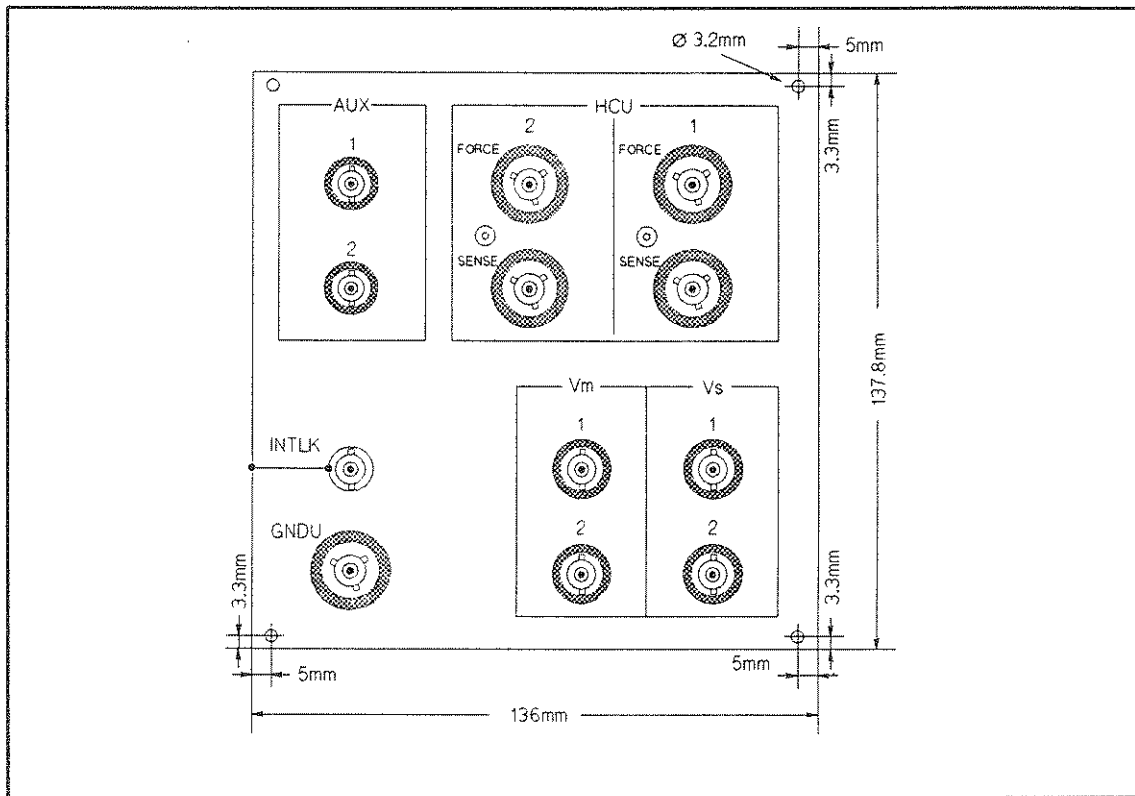

Connector Plate Part Number 04142-60031

Using the HP 16088A Test Fixture

The HP 16088A Test Fixture connects packaged test devices, such as transistors and ICs, to between four (for kelvin) and eight (for non-kelvin) SMUs, 2 HCU's, 2 VS's, 2 VM's, GNDU, and 2 AUX's. Eleven interchangeable DUT Socket Boards are available. The following figure shows the connector assignments of the HP 16088A.

You can use the following cables to connect the HP 4142B and HP 16088A.

For GNDU:

04142-61633 1.5 m Triaxial Cable
04142-61632 3 m Triaxial Cable

For SMUs:

41420-61603 1.5 m Quadaxial Cable
41420-61601 3 m Quadaxial Cable
16058-61603 1.5 m Triaxial Cable
04145-61622 3 m Triaxial Cable

For HCU's:

41422-61602 1.5 m Dual-coaxial Cable

For VS's, VM's, INTLK, or AUX's:

04142-61636 1.5 m Coaxial Cable
04145-61630 3 m Coaxial Cable

NOTE

When you connect the HCU and the HP 16088A Test Fixture, use 1.5 m Dual-coaxial cable, part number 41422-61602. Do not use 3 m Dual-coaxial cable, part number 41422-61601, because the wiring resistance of the FORCE line exceeds 150 m Ω .

You can also connect the VS's and VM's of the HP 4142B to the **AUX1** and **AUX2** coaxial terminals of the HP 16088A.

Because circuit common (∇) and chassis ground (\perp) are connected inside the HP 16088A Test Fixture, floating measurements cannot be performed with the HP 16088A.

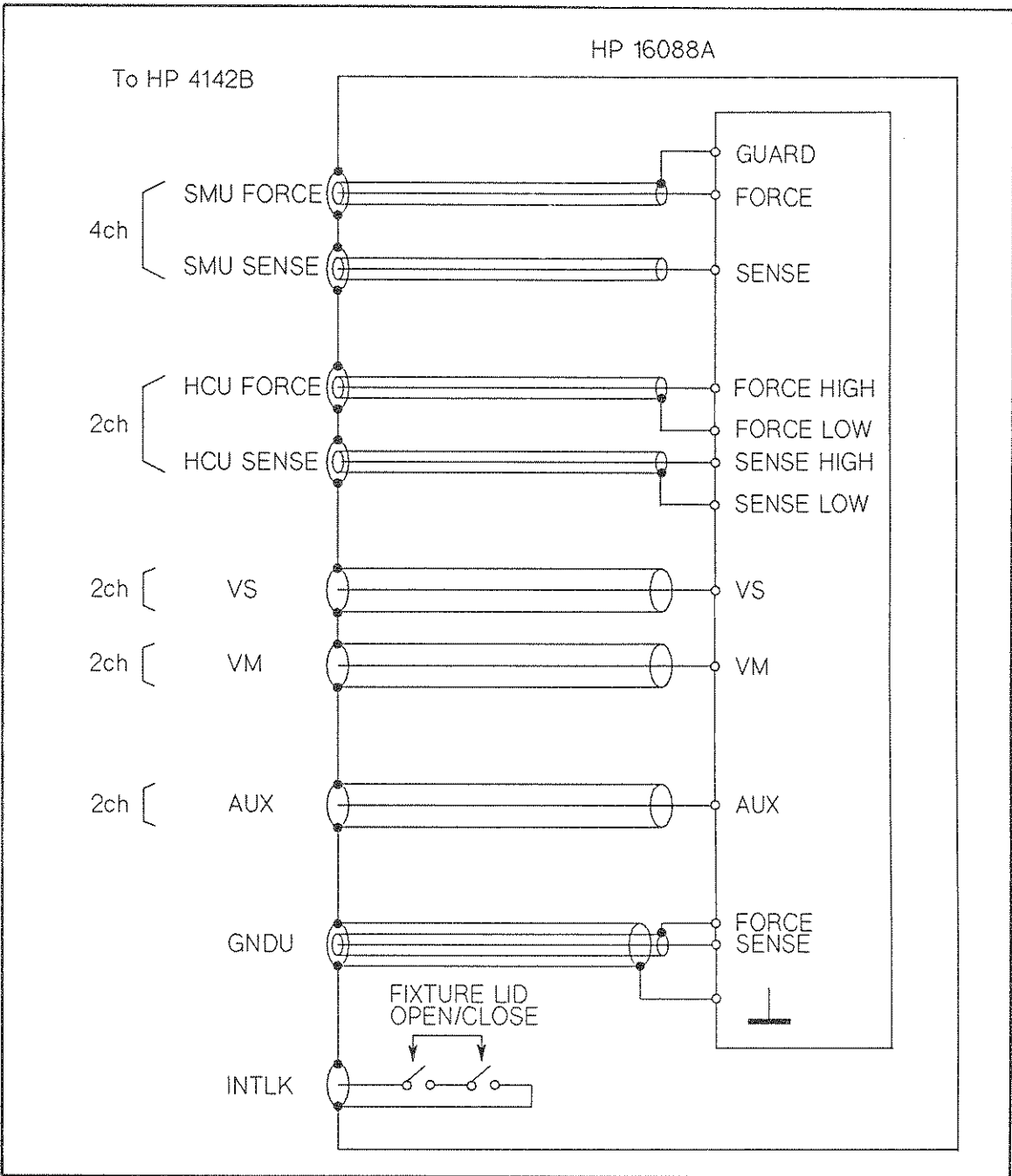

16088A Circuit Diagram

Using the HP 16058A Test Fixture

The HP 16058A Test Fixture connects packaged test devices, such as transistors and ICs, to the SMUs, VSs, and VMs of the HP 4142B. Eight interchangeable DUT Socket Boards are furnished with the HP 16058A. The following figure shows the interconnections between the HP 4142B and the HP 16058A.

NOTE

To use the GNDU with the HP 16058A, connect the GNDU to the desired HP 16058A SMU triaxial terminal, and connect the corresponding SMU **GD** (FORCE) or **GD** and **SMU** (SENSE) terminals to test device.

You can also connect the VSs and VMs of the HP 4142B to the **HIGH** and **LOW** coaxial terminals of the HP 16058A.

Because circuit common (ψ) and chassis ground (\perp) are connected inside the HP 16058A Test Fixture, floating measurements cannot be performed with the HP 16058A.

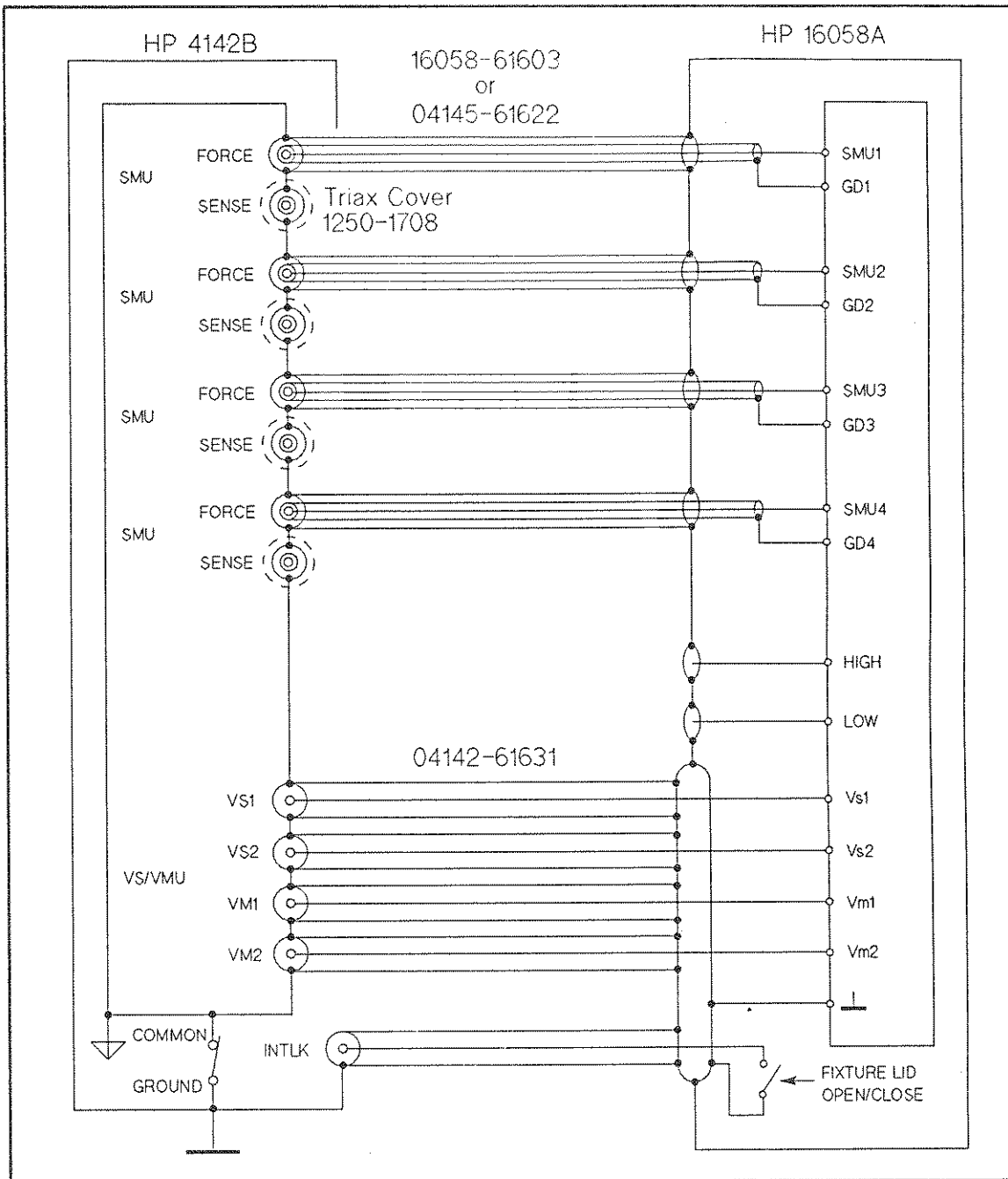

HP 4142B/16058A Interconnections Example

ADVANCED CONNECTION INFORMATION

For High Current Measurements (Kelvin Connection)

If you perform high-current measurements using the GNDU, SMU or HCU, use the SENSE terminal for the kelvin connection, as shown in one of the following sections in this chapter: "GNDU Connections," "HPSMU and MPSMU Connections," and "HCU Connections."

The wiring between the source unit and the test device has residual resistance from the cable and contact residual resistance from the connector. For example, if you do not use the kelvin connection and you force 1 A through a cable that has a residual resistance of 100 m Ω , as shown in the following figure, the voltage drop is 100 mV. This voltage (Verror) is included in the measurement result, and the measurement result (Vmeas) becomes:

$$V_{\text{meas}} = V_{\text{dut}} + V_{\text{error}} \quad \text{where } V_{\text{dut}} \text{ is the voltage at device terminal.}$$

To eliminate the effect of residual resistance (Verror) from the FORCE line, connect the SENSE terminal as close as possible to the test device terminal. This way, V monitor is directly connected to the test device.

Because the input impedance of V monitor is high, current does not flow into the SENSE line. Therefore, measurement error does not occur if the SENSE line has a residual resistance of 10 Ω or less.

The kelvin connection is effective even when voltage is forced, because the voltage drop by wiring residual resistance is fed back to the voltage source through the SENSE line, thereby ensuring the specified voltage output at the sense point where the FORCE and SENSE lines intersect.

Because the input impedance of SENSE line is high, current does not flow into the SENSE line. Therefore, output error does not occur if the SENSE line has a residual resistance of 10 Ω or less.

I source /V monitor Mode

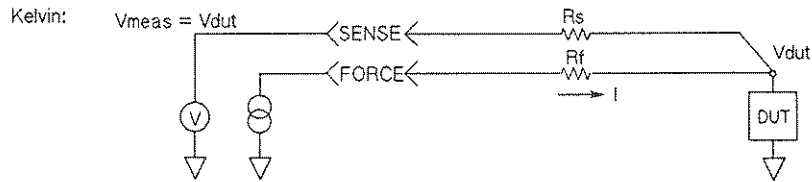
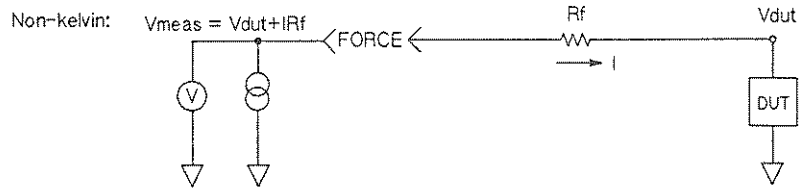

V source /I monitor Mode

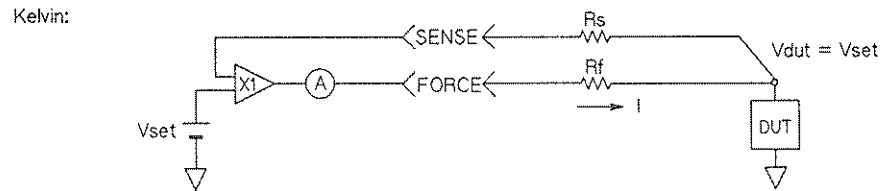
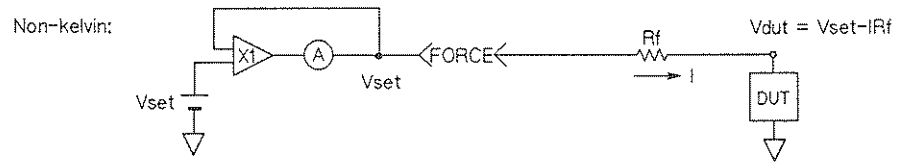

Kelvin Connection and Non-kelvin Connection Comparisons

For Low Current Measurements (Using the GUARD Terminal)

If you perform low-current measurements using an SMU, surround all FORCE and SENSE lines with the potential of GUARD as far as possible, as shown in the following figure, to minimize leakage current from the FORCE and SENSE lines. The potential of the Guard terminal is the same as FORCE and SENSE terminal voltage (the maximum difference is 1 mV).

By using GUARD, there is no potential difference between the FORCE or SENSE lines and GUARD line. Therefore, the leakage current from the FORCE and SENSE lines can not flow. The leakage current from GUARD does not affect the measurement result because it does not flow into the SMU ammeter (I monitor).

WARNING

SMU GUARD TERMINAL POTENTIAL IS EQUAL TO THE OUTPUT. DO NOT TOUCH THE SMU OUTPUT CONNECTORS DURING VOLTAGE OR CURRENT OUTPUT.

CAUTION

NEVER connect the GUARD terminal of any SMU to any other output, including CIRCUIT COMMON (∇), CHASSIS GROUND (\perp), or the GUARD terminal of any other SMU. Doing so results in damage to the SMU.

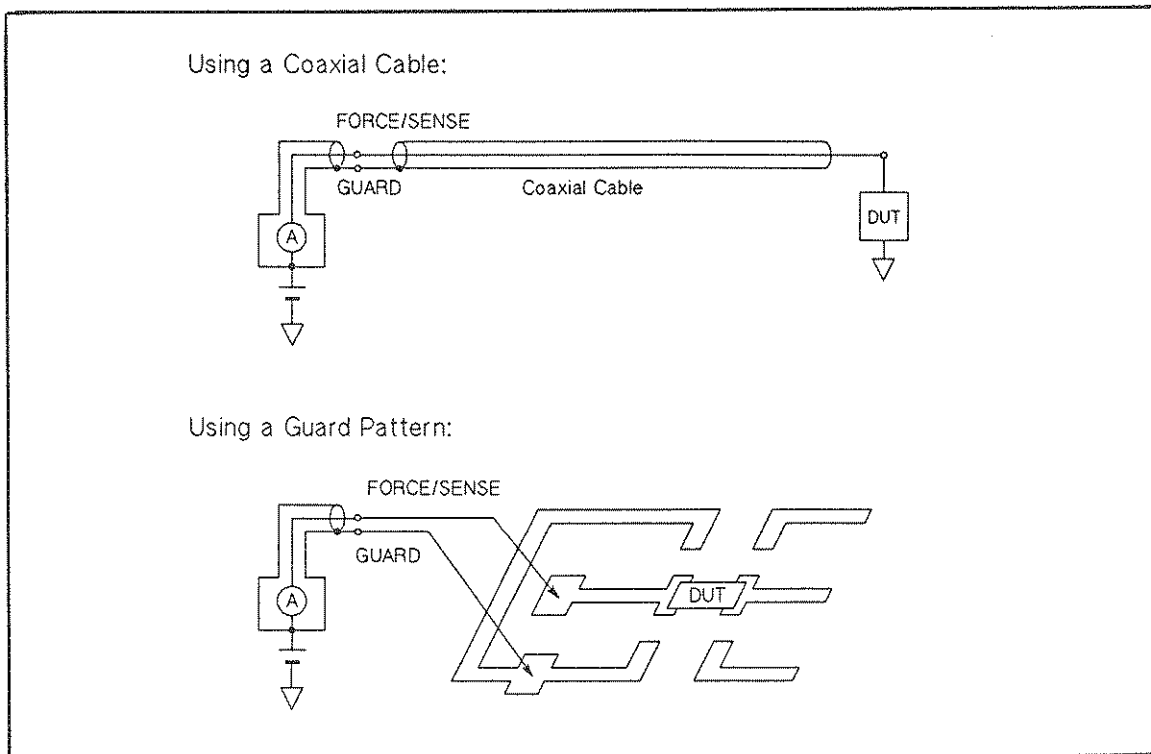

Example of GUARD Use

If the Test Device is Externally Grounded (Floating Measurement)

When the test device is grounded by the prober or is forced by the external V or I sources, the noise of ground loops may affect measurement results. To prevent this, perform the floating measurement as shown in the following procedure.

- 1) Disconnect the **CIRCUIT COMMON** (∇) terminal and **CHASSIS GROUND** (\perp) terminal by removing the shorting-bar.
- 2) Connect the external ground to the **CIRCUIT COMMON** terminal. To do this, use the **CIRCUIT COMMON** terminals of the source and monitor units (GNDU, SMUs, HCU, VSs, and VMs) on the connector plate, as shown in the following figure.

The **CIRCUIT COMMON** terminal is connected to the outer conductors of the GNDU, SMU, HCU, VS, and VM connectors. The **CHASSIS GROUND** terminal is tied to the HP 4142B chassis. With the above procedure, the HP 4142B (GNDU, SMUs, HCU, VSs and VMs) forces and measures voltage or current referenced to external ground.

WARNING

A POTENTIAL SHOCK HAZARD EXISTS IF THE CIRCUIT COMMON (∇) TERMINAL IS NOT TIED TO CHASSIS GROUND (\perp) (SHORTING-BAR DISCONNECTED FOR FLOATING MEASUREMENTS). DO NOT TOUCH ANY OF THE HP 4142B FRONT PANEL CONNECTORS AT ANY TIME WHILE A FLOATING MEASUREMENT IS IN PROGRESS.

DO NOT FLOAT THE CIRCUIT COMMON TERMINAL AT VOLTAGES GREATER THAN ± 42 V REFERENCED TO CHASSIS GROUND. FAILURE TO HEED THIS WARNING MAY RESULT IN DAMAGE TO YOUR HP 4142B.

NOTE

Because circuit common (∇) and chassis ground (\perp) are connected inside the HP 16088A and HP 16058A Test Fixtures, floating measurements cannot be performed with the HP 16088 or 16058A, even if the **CIRCUIT COMMON** (∇) and **CHASSIS GROUND** (\perp) terminals of the HP 4142B are not connected (shorting-bar removed).

If the **CIRCUIT COMMON** terminal is open without connecting the **CIRCUIT COMMON** terminal to the **CHASSIS GROUND** terminal or the external ground, the noise can affect the accuracy of the measurements.

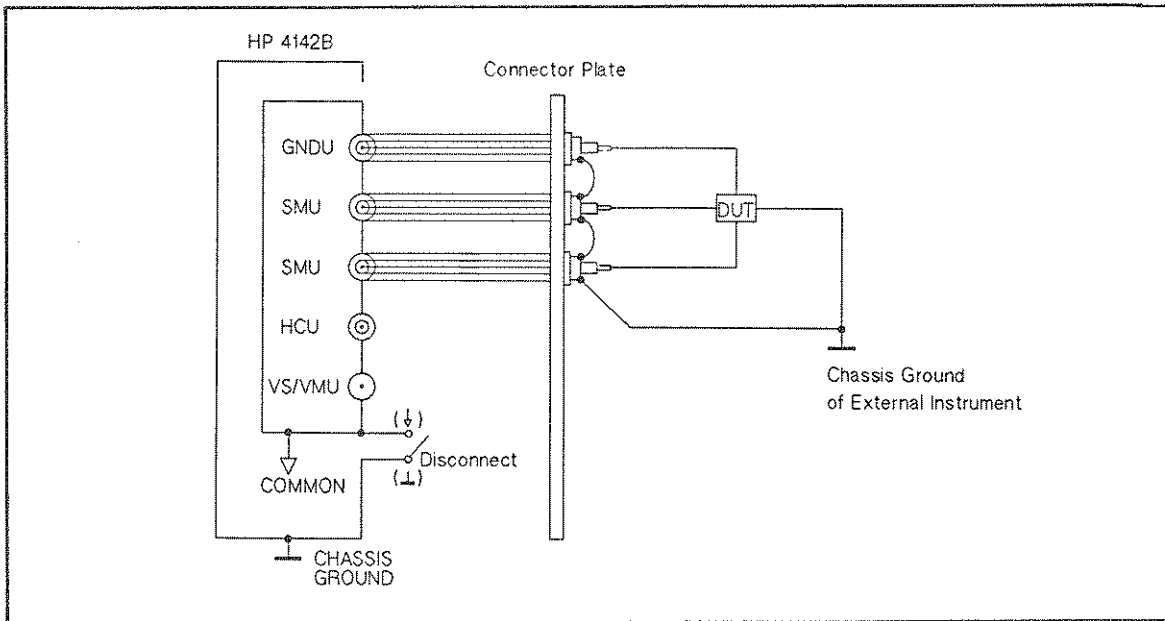

Floating Measurement Example

If the Test Device has Negative Resistance

If the test device has negative resistance characteristics (tunnel diodes or unijunction transistors), a source unit may oscillate at frequencies of 300 kHz or less because the source unit operates as a negative feedback amplifier.

The HPSMUs or the MPSMUs can detect this oscillation. An "X" is indicated in data status of measurement data if the HPSMU or MPSMU detects oscillation.

The following figure shows several examples of measurements made on negative devices.

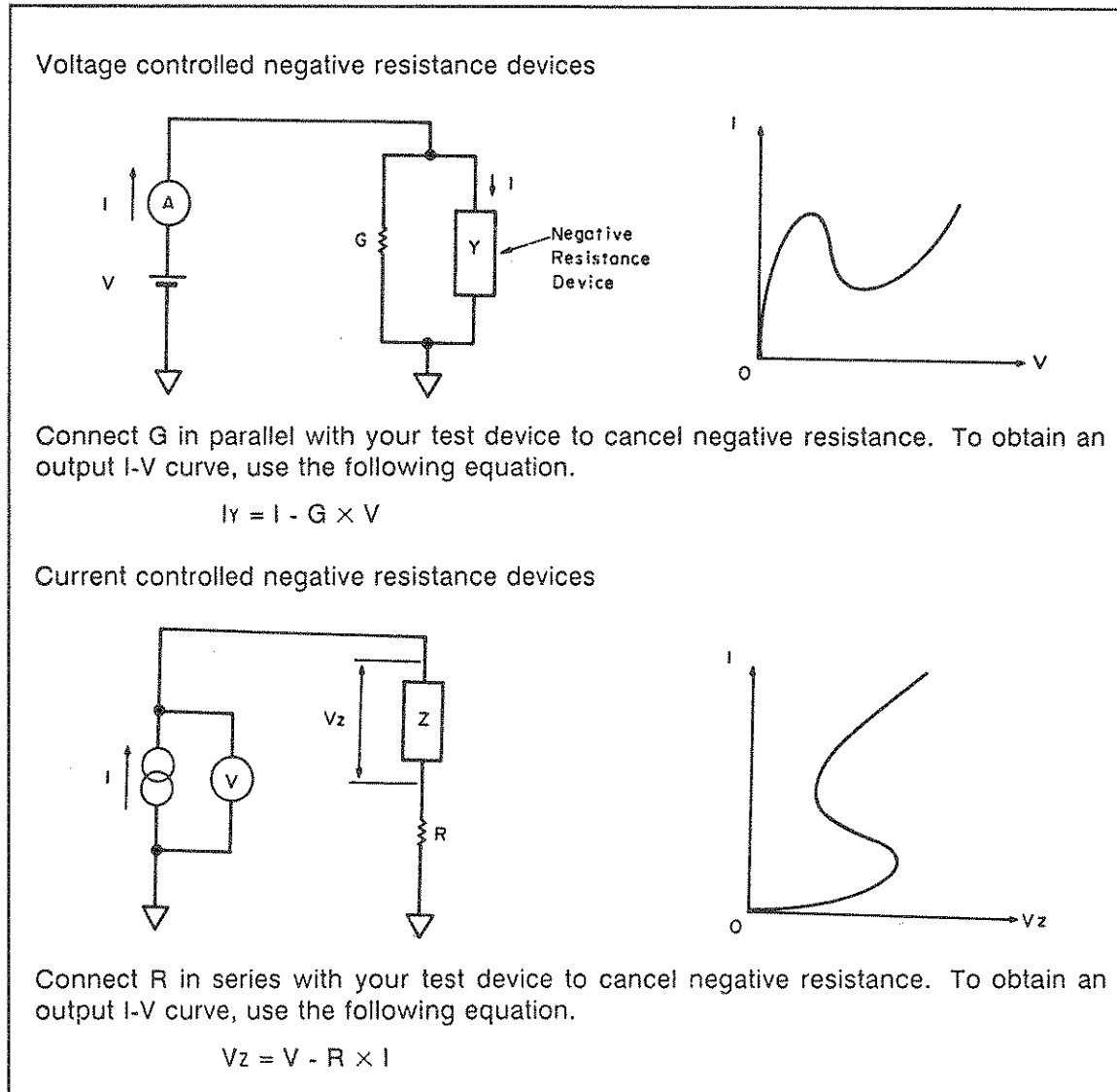

Negative Resistance Measurements

Preventing Oscillation from the Test Device

The test device itself may oscillate at high frequencies (more than 3 MHz) due to stray capacitances and residual inductances of connection cables, probe card, and test fixture. Bipolar transistors, which have a high h_{fe} (forward current transfer ratio) and a wide frequency range, and Field Effect Transistors (FETs), which have a high g_m (transconductance) and a wide frequency range, are especially likely to oscillate, and produce measurement results similar to those shown in the following figure.

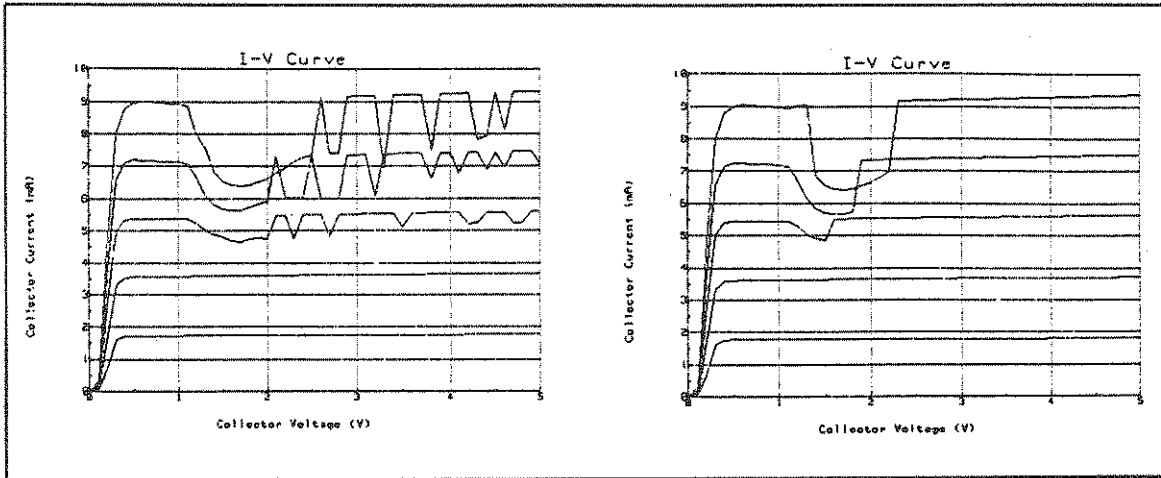

Example of an Oscillating Test Device Output I-V Curves

To prevent test device oscillation, install a ferrite bead (part number 9170-0029) to the test device leads as shown in the following figure.

Install the ferrite bead as close as possible to the test device. You may need to install more than one bead or change to a bead with a different diameter to prevent oscillation. Installing the ferrite bead to the base lead of bipolar transistors and to the gate lead of FETs is generally most effective to stop oscillation.

To minimize leakage current, do not short the ferrite beads to the case of the device, to other leads, or to the ferrite beads of other lines.

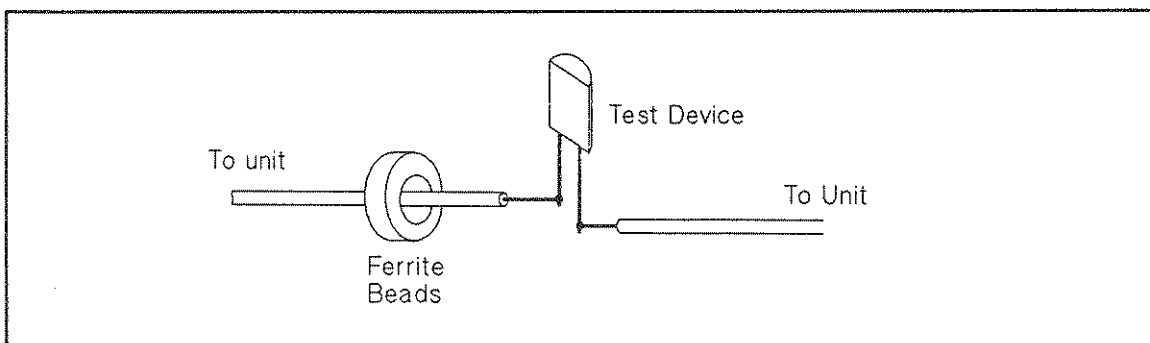

Preventing Test Device Oscillation

NOTE

Below are more suggestions to stop oscillation:

- Shorten the length of the connection cable.
- Enclose the test device with a shielding box.
- For the SMU, surround the FORCE and SENSE lines by GUARD.

This type of oscillation (more than 3 MHz) does not come from the source and monitor units. It comes from a combination of the test device and stray parameters around the test device. Oscillation of 5 MHz or more cannot be detected by the SMU.

NOTES

CHAPTER 4

MEASUREMENT MODES

CONTENTS

Introduction	4-1
Spot Measurements	4-1
Commands and Parameters	4-3
Information	4-3
Spot Measurement Sample Program	4-4
Staircase Sweep Measurements	4-6
Commands and Parameters	4-10
Information	4-11
Staircase Sweep Measurement Sample Program	4-11
1ch Pulsed Spot Measurements	4-15
Commands and Parameters	4-18
Information	4-18
1ch Pulsed Spot Measurement Sample Program	4-19
Pulsed Sweep Measurements	4-21
Commands and Parameters	4-25
Information	4-26
Pulsed Sweep Measurement Sample Program	4-26
Staircase Sweep with Pulsed Bias Measurements	4-29
Commands and Parameters	4-33
Information	4-34
Staircase Sweep with Pulsed Bias Measurement Sample Program	4-34
Analog Search Measurements	4-37
Search Operation Modes	4-40
Search Measurement Modes	4-42
Commands and Parameters	4-43
AFU Monitor Port	4-44
Information	4-45
Analog Search Measurement Sample Program	4-45
2ch Pulsed Spot Measurements	4-48
Commands and Parameters	4-52
Information	4-53
2ch Pulsed Spot Measurement Sample Program	4-53
Pulsed Sweep with Pulsed Bias Measurements	4-55
Commands and Parameters	4-60
Information	4-61
Pulsed Sweep with Pulsed Bias Measurement Sample Program	4-61
High Speed Spot Measurements	4-65
Commands and Parameters	4-66
Information	4-66
High Speed Spot Measurement Sample Program	4-67

NOTES

INTRODUCTION

This chapter explains all nine measurement modes of the HP 4142B. Included in the description of each measurement mode are measurement method, allowable units, allowable number of source and measurement channels, HP-IB commands, and a sample program.

SPOT MEASUREMENTS

Spot measurements are performed as follows: up to 16 sources force constant voltages and currents and up to 8 monitors measure the outputs. The **DV** and **DI** commands set *output voltage* and *output current*. When using an SMU as a voltage monitor, set the *output current* of the unit to 0 A using the **DI** command. The following table and figure show HP 4142B spot measurement specifics, and an example spot measurement using two channels, respectively.

Spot Measurement Specifics

Output Mode	No. of Source Ch.	Source Mode	Source Setup Command	Allowable Units	Allowable Monitor Mode	Meas. Setup Command	No. of Meas. Ch.
Constant	0 ¹ to 16	V	DV	HPSMU MPSMU	I	MM	1 to 8
		I	DI	HPSMU MPSMU	V		
No Output	---	---	---	VM	V DIF. V	MM VM	

¹ When using a VM to make an measurement only.

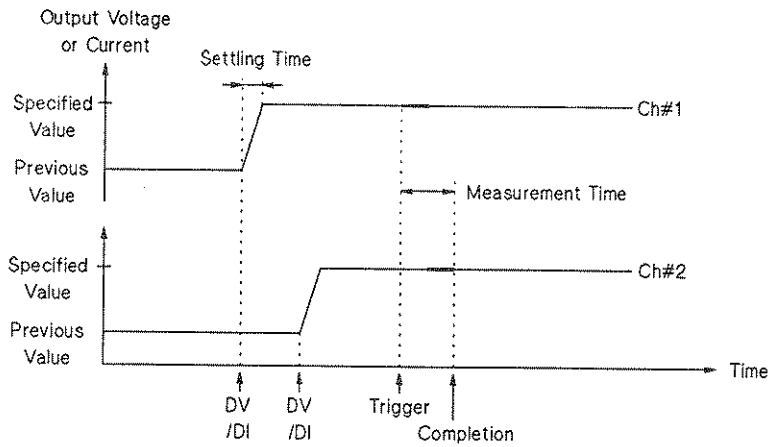

- 1) When the HP 4142B receives a DV or DI command, the source unit forces the *output voltage or current*.
- 2) When the HP 4142B receives a trigger, the measurement starts. When using more than one channel, measurements are performed in the order specified in the MM command. If the trigger is received during the settling time of the source unit, the measurement is performed after the settling time.
- 3) After the measurement is complete, the source unit continues to force the *output voltage or current*.

Spot Measurement Using Two Channels

Commands and Parameters

The following table lists the commands and parameters for spot measurements.

Spot Measurement Commands and Parameters

Function	Command ¹	Parameters ¹
Constant V Source	DV	<i>ch#, output range, output voltage, [I compliance], [compliance polarity mode]</i>
Constant I Source	DI	<i>ch#, output range, output current, [V compliance], [compliance polarity mode]</i>
Measurement	MM	<i>measurement mode, ch#</i>
	[RI]	<i>ch#, I measurement range</i>
	[RV]	<i>ch#, V measurement range</i>
	[VM]	<i>ch#, VM operation mode</i>
	[AV]	<i>number, [averaging mode]</i>
Trigger	XE	-----

¹ Brackets ([]) denote optional commands and parameters.

Information

Measurement Data Output Format is explained in the *HP 4142B HP-IB Command Reference Manual*.

Output and Measurement Ranging Mode and Averaging are explained in chapter 5.

Spot Measurement Sample Program

The following is a sample program that measures collector saturation voltage (Vce(sat)) and base saturation voltage (Vbe(sat)) of a 2N3904 bipolar transistor by using the spot measurement function. A description of key program lines follows the program list.

Measurement Conditions

DUT Terminal	Unit	Output	Measurement
Base	SMU Ch#3	Ib = 1 mA	Vbe
Collector	SMU Ch#2	Ic = 10 mA	Vce
Emitter	GNDU	Ve = 0 V	---

Program List

```

10  ! Vce(sat) and Vbe(sat) Measurement using Spot Function
20  !
30  INTEGER B_ch, C_ch
40  DIM A$[31]
50  ASSIGN @Hp4142 TO 717
60  OUTPUT @Hp4142;"*RST"
70  !
80  B_ch=3           ! Emitter   : GNDU
90  C_ch=2           ! Base     : Ch#3
100 Ib=1.E-3        ! Collector: Ch#2
110 Ic=1.E-2
120 !
130 OUTPUT @Hp4142;"CN";B_ch, C_ch
140 OUTPUT @Hp4142;"DI";B_ch, 0, Ib, 2
150 OUTPUT @Hp4142;"DI";C_ch, 0, Ic, 2
160 OUTPUT @Hp4142;"MM";1, C_ch, B_ch
170 OUTPUT @Hp4142;"XE"
180 OUTPUT @Hp4142;"CL"
190 !
200 ENTER @Hp4142;A$
210 PRINT "Vce(sat)= ";A$[4, 15];"[V]"
220 PRINT "Vbe(sat)= ";A$[20, 31];"[V]"
230 END

```

Result

```

Vce(sat)= +0.06764E+00[V]
Vbe(sat)= +0.74692E+00[V]

```





Description

40	Defines the string variable, <i>AS</i> , for storing measurement data.
60	Initializes the HP 4142B.
130	Sets the SMU output switches to ON.
140	Forces 1 mA to the base.
150	Forces 10 mA to the collector
160	Sets the spot measurement mode and the measurement channels.
170	Sends a trigger to start the measurement.
180	Sets the SMU output switches to OFF.
200	Enters the measurement data into the string variable, <i>AS</i> .
210-220	Displays the measurement results.

STAIRCASE SWEEP MEASUREMENTS

Staircase sweep measurements are performed as follows: one source sweeps constant voltage or current, while up to 8 monitors measure the output for each sweep step. Or two sources sweep constant voltages or currents at the same time, while up to 8 monitors measure the outputs for each sweep step. Measurement data for each sweep step is stored in the output data buffer. The following table lists the staircase sweep measurement modes and provides an illustration of each.

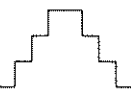
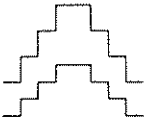
Staircase Sweep Measurement Modes

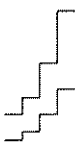
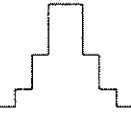
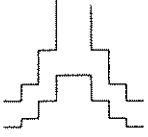
Sweep Mode	Output Waveform	
	1 Channel Sweep	2 Channel Synchronous Sweep ¹
Linear Single Staircase Sweep		
Linear Double Staircase Sweep		
Log Single Staircase Sweep		
Log Double Staircase Sweep		

¹ To perform sweep measurements using two sweep source channels, both source channels must be set to the same source mode (V source or I source).

The following table and figure show HP 4142B staircase sweep measurement specifics, and an example of a linear single staircase sweep measurement, respectively.

Staircase Sweep Measurement Specifics

Output Mode	No. of Source Ch.	Source Mode	Source Setup Command	Allowable Units	Allowable Monitor Mode	Meas. Setup Command	No. of Meas. Ch.
Staircase Sweep	1 to 2 ¹	V	1ch: WV 2ch: WV WSV	HPSMU MPSMU	I	MM	1 to 8
				VS	---		
Constant	0 to 15	I	1ch: WI 2ch: WI WSI	HPSMU MPSMU	V		
				VS	---		
Constant	0 to 15	V	DV	HPSMU MPSMU	I		
				VS	---		
Constant	0 to 15	I	DI	HPSMU MPSMU	V		
				VS	---		
No Output	---	---	---	VM	V DIF. V	MM VM	

¹ To perform sweep measurements using two sweep source channels, both source channels must be set to the same source mode (V source or I source).

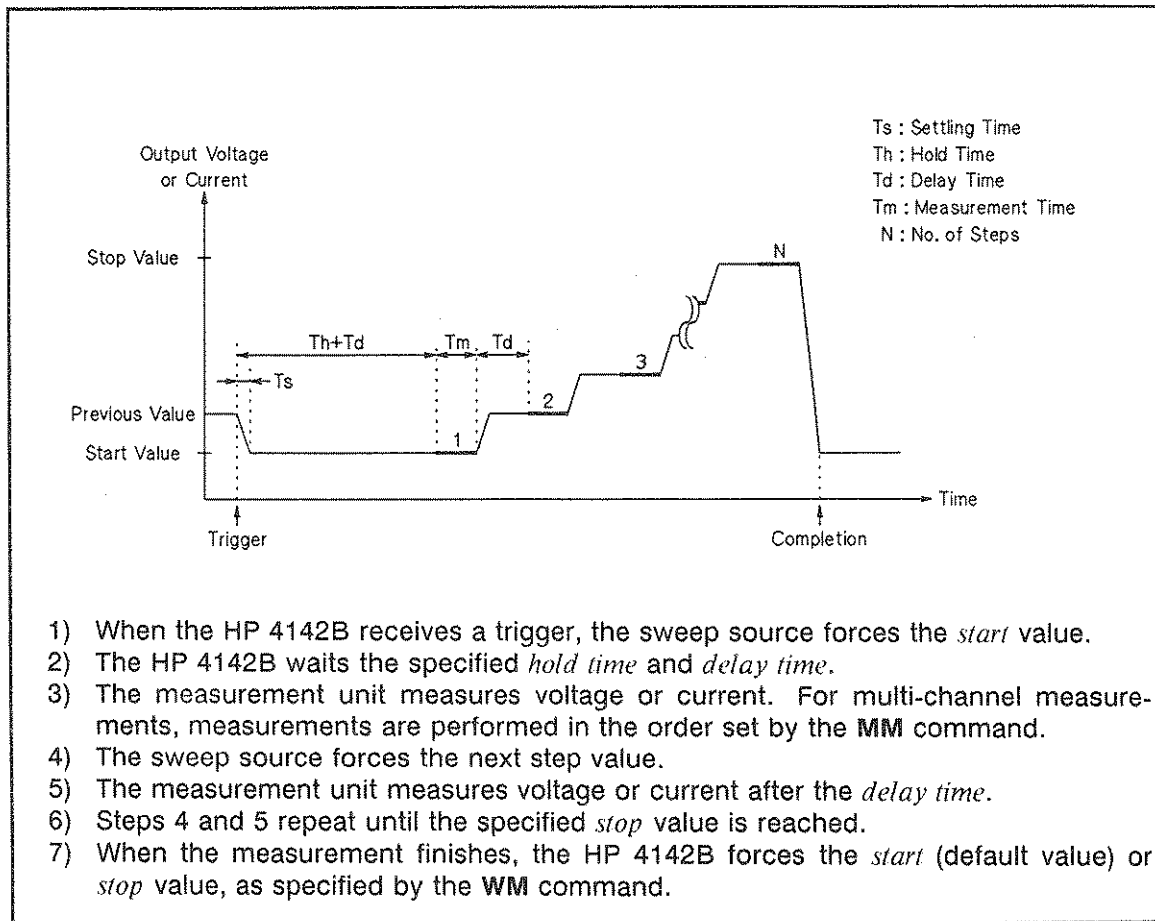

Linear Single Staircase Sweep Measurement

If you specify a *hold time* or *delay time* that is less than the settling time of the source unit, *hold time* or *delay time* is set to equal the settling time.

For linear staircase sweep, output values are calculated using the following equation.

$$k\text{th output value} = \text{start value} + (k-1)(\text{step value})$$

$$\text{where step value} = (\text{stop value} - \text{start value}) / (\text{number of steps} - 1)$$

For log staircase sweep, output values are calculated using the following equation. *Start* and *stop* values must have the same polarity, and must not be zero.

$$k\text{th output value} = (\text{start value})(\text{step value})^{(k-1)}$$

$$\text{where step value} = \text{EXP}[\{\ln(\text{stop value}/\text{start value})\} / (\text{number of steps} - 1)]$$

The following figure shows an example of a linear double staircase sweep measurement. The sweep source output is swept from the *start* value to the *stop* value, then from the *stop* value to the *start* value. The number of sweep steps is determined by the *number of steps* specified between the *start* and *stop* values. The measurement sequence is the same as a single staircase sweep. You can use the **WM** command to set the value (*start* or *stop* value) that is forced after the measurement is complete.

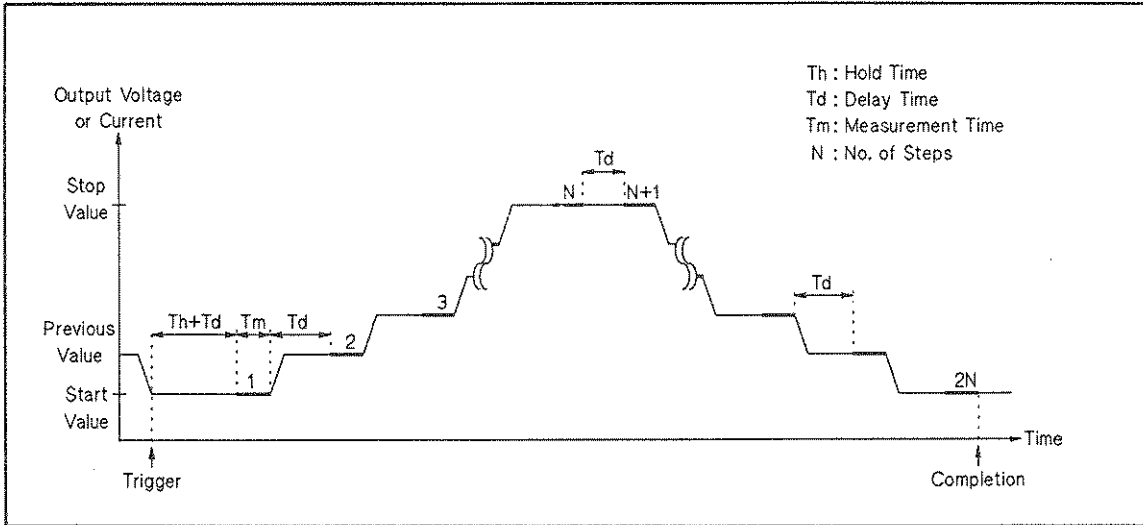

Linear Double Staircase Sweep Measurement

Commands and Parameters

The following table lists the commands and parameters for staircase sweep measurements. To perform a synchronous sweep measurement, set the main sweep source using the **WV** or **WI** commands, and set the synchronous sweep source using the **WSV** or **WSI** commands. Both sweep sources must be set to the same source mode (V source or I source).

Staircase Sweep Measurement Commands and Parameters

Function	Command ¹	Parameters ¹
Sweep V Source	WV	<i>ch#, sweep mode, output range, start voltage, stop voltage, number of steps, [I compliance], [power compliance]</i>
Sweep I Source	WI	<i>ch#, sweep mode, output range, start current, stop current, number of steps, [V compliance], [power compliance]</i>
Synchronous Sweep V Source	WSV	<i>ch#, output range, start voltage, stop voltage, [I compliance], [power compliance]</i>
Synchronous Sweep I Source	WSI	<i>ch#, output range, start current, stop current, [V compliance], [power compliance]</i>
Sweep Conditions	[WT]	<i>hold time, delay time</i>
	[WM]	<i>automatic sweep abort function, [output after sweep]</i>
Constant Source	DV	<i>ch#, output range, output voltage, [I compliance], [compliance polarity mode]</i>
	DI	<i>ch#, output range, output current, [V compliance], [compliance polarity mode]</i>
Measurement	MM	<i>measurement mode, ch#</i>
	[RI]	<i>ch#, I measurement range</i>
	[RV]	<i>ch#, V measurement range</i>
	[VM]	<i>ch#, VM operation mode</i>
	[AV]	<i>number, [averaging mode]</i>
Trigger	XE	-----
Abort	AB	-----

¹ Brackets ([]) denote optional commands and parameters.

Information

Measurement Data Output Format is explained in the *HP 4142B HP-IB Command Reference Manual*.

Output and Measurement Ranging Mode, Averaging, Automatic Sweep Abort Function, and Power Compliance are explained in chapter 5.

Staircase Sweep Measurement Sample Program

The following is a sample program that measures static collector characteristics of a 2N3904 npn bipolar transistor by using the HP 4142B staircase sweep measurement function. This program sweeps the collector voltage while holding the base current constant, then changes the base current as a second variable. The program executes the real-time sweep measurement that plots the measurement result whenever the measurement at each sweep step is performed. A description of key program lines follows the program list, along with an example graphics display of measurement results.

This sample program minimizes range changes to optimize measurement speed.

Measurement Conditions

DUT Terminal	Unit	Output	Measurement
Base	SMU Ch#3	Ib = 10 μ , 20 μ , 30 μ A	---
Collector	SMU Ch#2	Vc = 0 to 1 V, 101 steps	Ic
Emitter	GNDU	Ve = 0 V	---

Program List

```
10 ! Ic-Vce Measurement using Staircase Sweep Function
20 !
30 OPTION BASE 1
40 INTEGER B_ch, C_ch, Vc_no_step, Ib_no_step, Var1, Var2
50 REAL Vc(101)
60 ASSIGN @Hp4142 TO 717
70 OUTPUT @Hp4142;"*RST"
80 OUTPUT @Hp4142;"FMT";S
90 !
100 B_ch=3           ! Emitter : GNDU
110 C_ch=2           ! Base   : Ch#3
120 Vc_start=0
130 Vc_stop=1
140 Vc_no_step=101
150 Ic_comp=.01
160 Ib_start=1.E-5
170 Ib_step=1.E-5
180 Ib_no_step=3
190 !
```

```

200 Vc_step=(Vc_stop-Vc_start)/(Vc_no_step-1)
210 FOR Var1=1 TO Vc_no_step
220   Vc(Var1)=Vc_start+(Var1-1)*Vc_step
230 NEXT Var1
240 CALL lcvc_graph(Vc_start, Vc_stop, 0, 1.E-2)
250 !
260 OUTPUT @Hp4142;"CN";B_ch, C_ch
270 OUTPUT @Hp4142;"WV";C_ch, 1, 0, Vc_start, Vc_stop, Vc_no_step,
lc_comp
280 OUTPUT @Hp4142;"MM";2, C_ch
290 OUTPUT @Hp4142;"RI";C_ch, 18
300 FOR Var2=1 TO Ib_no_step
310   Ib=Ib_start+(Var2-1)*Ib_step
320   OUTPUT @Hp4142;"DI";B_ch, 0, Ib, 2
330   OUTPUT @Hp4142;"XE"
340   !
350   FOR Var1=1 TO Vc_no_step
360     ENTER @Hp4142 USING "#, 3X, 2D, X";lc
370     PLOT Vc(Var1), Ic
380   NEXT Var1
390   PENUP
400 NEXT Var2
410 OUTPUT @Hp4142;"CL"
420 END
430 !
440 SUB lcvc_graph(X_axis_min, X_axis_max, Y_axis_min, Y_axis_max)
450 !
460   GINIT
470   GRAPHICS ON
480   CONTROL CRT, 12;1
490   PRINT CHR$(12)
500   !
510   Xmax=100*MAX(1, RATIO)
520   Ymax=100*MAX(1,1/RATIO)
530   !
540   LORG 6
550   MOVE Xmax/2, Ymax
560   LABEL "COLLECTOR CHARACTERISTICS"
570   DEG
580   LDIR 90
590   CSIZE 4.5
600   MOVE 0, Ymax/2
610   LABEL "Ic(A)"
620   LORG 4
630   LDIR 0
640   MOVE Xmax/2, 0
650   LABEL "Vce(V)"
660   !
670   VIEWPORT .16*Xmax, .91*Xmax, .15*Ymax, .9*Ymax
680   !
690   FRAME
700   WINDOW X_axis_min, X_axis_max, Y_axis_min, Y_axis_max
710   AXES(X_axis_max-X_axis_min)/10,(Y_axis_max-Y_axis_min)/10,
X_axis_min, Y_axis_min
720   CLIP OFF
730   CSIZE 4, .5
740   LORG 6

```

```

750   FOR I=X_axis_min TO X_axis_max STEP (X_axis_max-X_axis_min)/2
760     MOVE I, Y_axis_min
770     LABEL I
780   NEXT I
790   CSIZE 3.8, .5
800   LORG 8
810   FOR I=Y_axis_min TO Y_axis_max STEP (Y_axis_max-Y_axis_min)/2
820     MOVE X_axis_min, I
830     LABEL USING "#, MD.DE";I
840   NEXT I
850   CLIP ON
860   !
870   SUBEND

```

Result

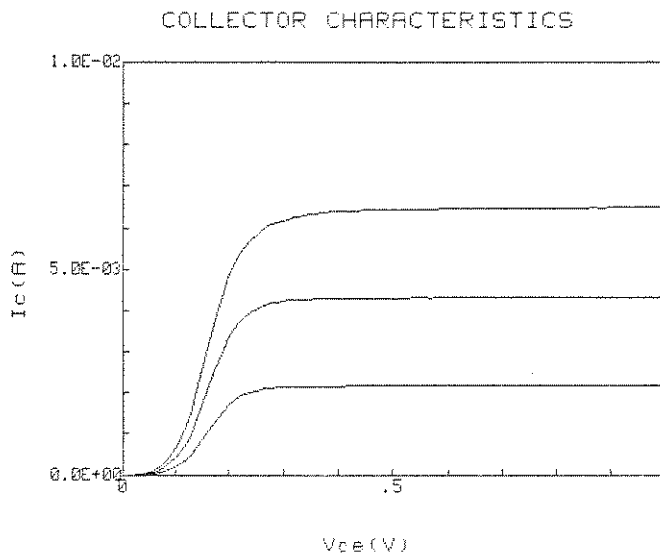

Description

30-50 Defines the variables.
70 Initializes the HP 4142B.
80 Sets the data output format to ASCII with header and comma (,) as a terminator.
100-180 Assigns the constants.
200-230 Calculates collector voltage value for each step, and stores these values in an array variable.
240 Calls subprogram to display graphics frame.
260 Sets the SMU output switches to ON.
270 Sets the *ch#2* SMU voltage sweep parameters.
280 Sets the measurement mode to staircase sweep function.
290 Sets the measurement range to 10 mA.
310-320 Sets the *ch#3* SMU current output parameters as a second sweep source.
330 Sends a trigger to start a voltage sweep measurement.

350-390 Enters the measurement data into the variable I_c , and displays measurement data in the graphics frame.
400 Sets the source base current to the next value.
410 Sets the SMU output switches to OFF.
440-870 Subprogram for displaying graphics frame.

1CH PULSED SPOT MEASUREMENTS

1 Channel Pulsed spot measurements are performed as follows: one source forces pulsed voltage or current, and one monitor measures the output. The following table lists HP 4142B pulsed spot measurement specifics. The following two figures show an example of a typical pulsed spot measurement (when *pulse period* is not specified), and an example of a repeated pulsed spot measurement (when *pulse period* is specified), respectively.

Pulsed Spot Measurement Specifics

Output Mode	No. of Source Ch.	Source Mode	Source Setup Command	Allowable Units	Allowable Monitor Mode	Meas. Setup Command	No. of Meas. Ch.
Pulse	1	V	PV	HPSMU MPSMU HCU	I	MM	1
				VS	---		
		I	PI	HPSMU MPSMU HCU	V		
Constant	0 to 15	V	DV	HPSMU MPSMU	I		
				VS	---		
		I	DI	HPSMU MPSMU	V		
No Output	---	---	---	VM	V ¹		

¹ Differential voltage measurements cannot be performed for pulsed measurements.

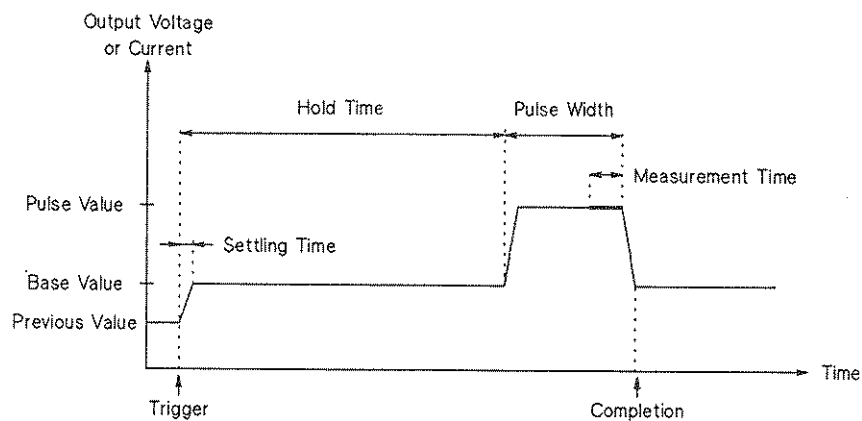

- 1) When the HP 4142B receives a trigger, the pulse source forces the *base* value.
- 2) The HP 4142B waits for the specified *hold time*. If the *hold time* is less than the settling time of the source unit, *hold time* is set equal to the settling time.
- 3) The pulse source forces the *pulse* value.
- 4) The measurement unit measures V or I before the end of pulse.
- 5) The pulse source forces the *base* value.

Pulsed Spot Measurement

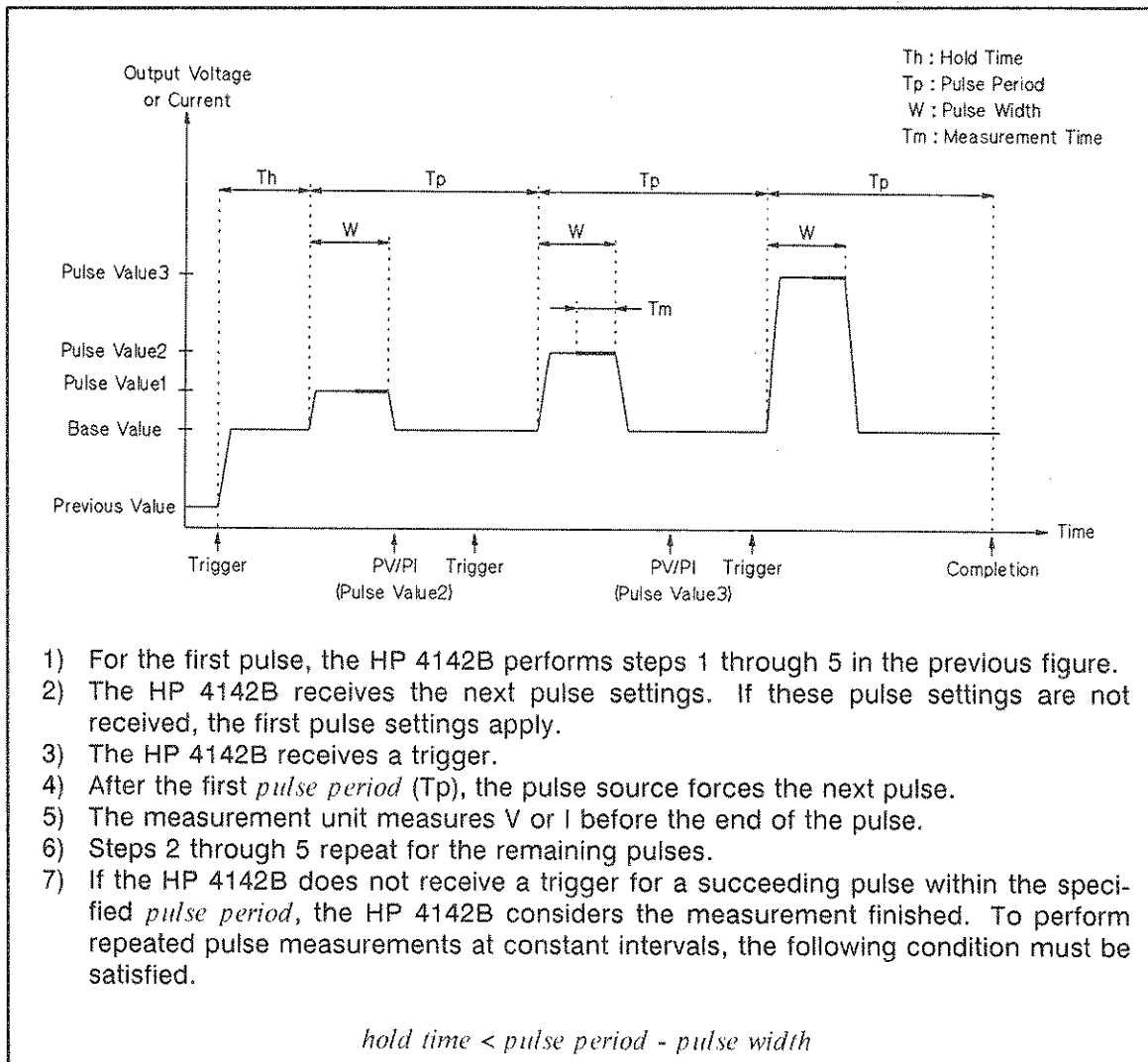

Repeated Pulsed Spot Measurement

NOTE

When using an SMU as a pulse source, set the Filter to OFF (Filters set to ON at power on) with the FL command.

The HP 4142B can receive and execute commands during the *base value* output of pulsed spot measurements with *pulse period*, but other types of measurements cannot be performed until the pulsed spot measurement is complete.

For SMU current pulses, the *pulse current* and *base current* values must have the same polarity.

For HCU voltage pulses, the base voltage can be specified only as 0 V. For HCU current pulses, during HCU base value output, the HCU output is 0 V and no current.

Commands and Parameters

The following table lists the commands and parameters for 1ch pulsed spot measurements. To specify a voltage pulse source, use the **PV** command. To specify a current pulse source, use the **PI** command.

1ch Pulsed Spot Measurement Commands and Parameters

Function	Command ¹	Parameters ¹
Pulsed Source ²	PV	<i>ch#, output range, base voltage, pulse voltage, [I compliance]</i>
	PI	<i>ch#, output range, base current, pulse current, [V compliance]</i>
	[FL]	<i>filter, [ch#]</i>
Pulse Conditions	[PT]	<i>hold time, pulse width, [pulse period]</i>
Constant Source	DV	<i>ch#, output range, output voltage, [I compliance], [compliance polarity mode]</i>
	DI	<i>ch#, output range, output current, [V compliance], [compliance polarity mode]</i>
Measurement	MM	<i>measurement mode, [ch#]</i>
	[RI]	<i>ch#, I measurement range</i>
	[RV]	<i>ch#, V measurement range</i>
Trigger	XE	----
Abort	AB	----

¹ Brackets ([]) denote optional commands and parameters.

² When using SMUs, set Filter to OFF.

Information

Measurement Data Output Format is explained in the *HP 4142B HP-IB Command Reference Manual*.

Output and Measurement Ranging Mode and Filter are explained in chapter 5.

1ch Pulsed Spot Measurement Sample Program

The following is the sample program for measuring the collector saturation voltage (Vce(sat)) of a 2N3904 npn bipolar transistor by using the 1ch pulsed spot measurement function. A description of key program lines follows the program list.

Measurement Conditions

DUT Terminal	Unit	Output	Measurement
Base	SMU Ch#3	Ib = 5 mA	---
Collector	SMU Ch#2	Ic = 50 mA	Vce
Emitter	GNDU	Ve = 0 V	---

Program List

```

10  ! Vce(sat) Measurement using 1ch Pulsed Spot Function
20  !
30  INTEGER B_ch, C_ch
40  DIM A$[15]
50  ASSIGN @Hp4142 TO 717
60  OUTPUT @Hp4142;"*RST"
70  !
80  B_ch=3           Emitter      : GNDU
90  C_ch=2           ! Base       : Ch#3
                   ! Collector   : Ch#2
100 Ib=5.E-3
110 Ic=5.E-2
120 !
130 OUTPUT @Hp4142;"CN";B_ch, C_ch
140 OUTPUT @Hp4142;"FL";0, B_ch
150 OUTPUT @Hp4142;"PI";B_ch, 0, 0, Ib, 2
160 OUTPUT @Hp4142;"PT";0, 1.E-3
170 OUTPUT @Hp4142;"DI";C_ch, 0, Ic, 2
180 OUTPUT @Hp4142;"MM";3, C_ch
190 OUTPUT @Hp4142;"XE"
200 OUTPUT @Hp4142;"CL"
210 !
220 ENTER @Hp4142;A$
230 PRINT "Vce(sat)= ";A$[4, 15]
240 END

```

Result

Vce(sat)= +0.10800E+00

Description

60	Initializes the HP 4142B.
80-110	Assigns the constants.
130	Sets the SMU output switches to ON.
140	Sets the SMU Filter to OFF.
150	Sets the <i>ch#3</i> SMU current pulse parameters.
160	Sets the output pulse waveform.
170	Forces 50 mA to the collector.
180	Sets the measurement mode to 1ch pulsed spot function.
190	Sends a trigger to start the measurement.
200	Sets the SMU output switches to OFF.
220	Enters the measurement data into the string variable, <i>A\$</i> .
230	Displays the measurement results.

PULSED SWEEP MEASUREMENTS

Pulsed sweep measurements are performed as follows: one source sweeps pulsed voltage or current, while one monitor measures the output for each sweep step. Measurement data for each pulse sweep step is stored in the output data buffer. The following two tables list the pulsed sweep measurement modes and provide an illustration of each, and list the HP 4142B pulsed sweep measurement specifics, respectively.

Pulsed Sweep Measurement Modes

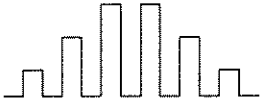
Sweep Mode	Output Waveform
Single Pulsed Sweep	
Double Pulsed Sweep	

Pulsed Sweep Measurement Specifics

Output Mode	No. of Source Ch.	Source Mode	Source Setup Command	Allowable Units	Allowable Monitor Mode	Meas. Setup Command	No. of Meas. Ch.
Pulsed Sweep	1	V	PWV	HPSMU MPSMU HCU	I	MM	1
				VS	---		
		I	PWI	HPSMU MPSMU HCU	V		
Constant	0 to 15	V	DV	HPSMU MPSMU	I		
				VS	---		
		I	DI	HPSMU MPSMU	V		
No Output	---	---	---	VM	V ¹		

¹ Differential voltage measurements cannot be performed for pulsed measurements.

The following figure shows an example of a pulsed single sweep measurement.

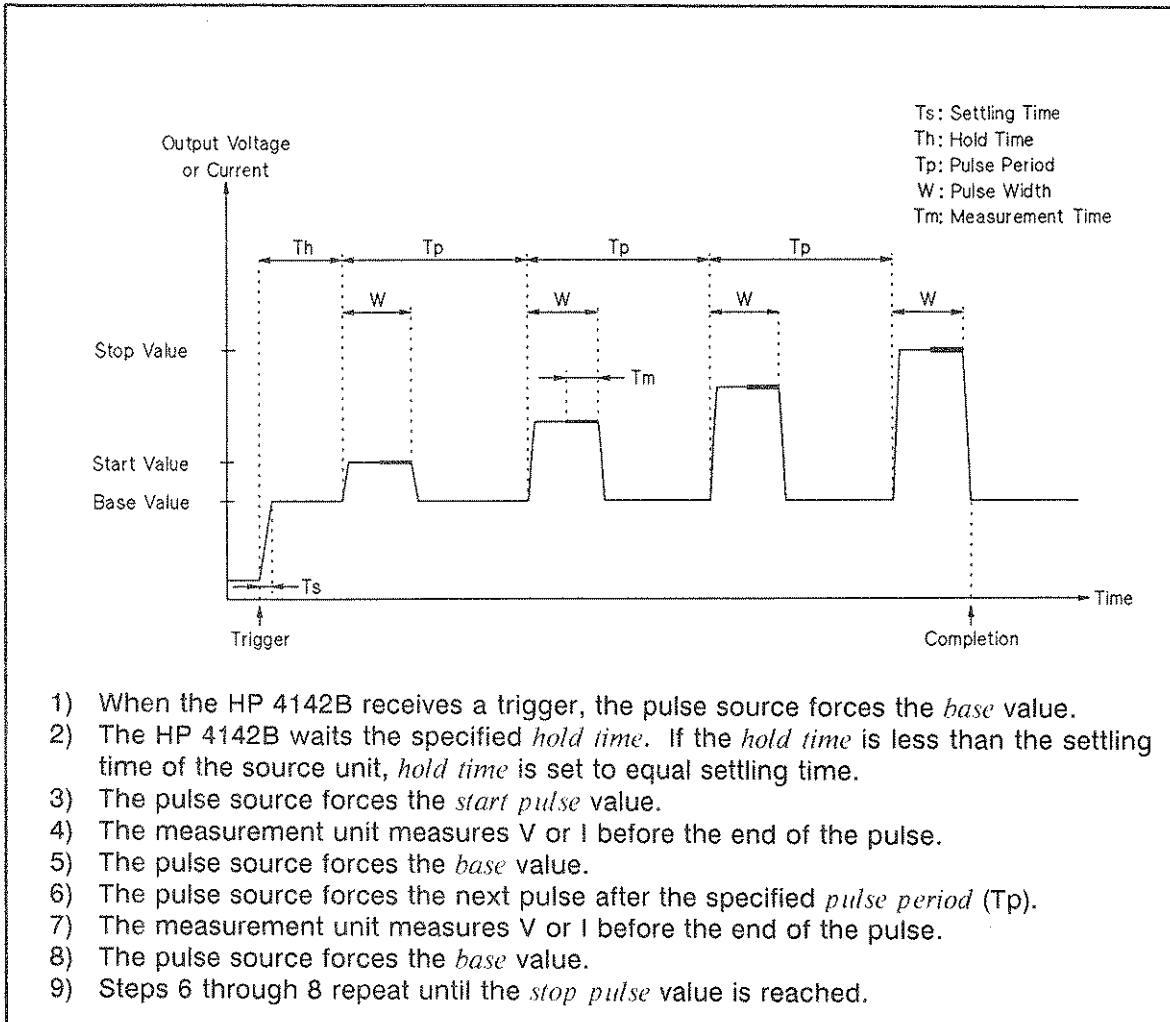

Pulsed Single Sweep Measurement

The k th pulse value is calculated using the following equation.

$$k\text{th pulse value} = \text{start pulse value} + (k-1)(\text{step value})$$

where $\text{step value} = (\text{stop pulse value} - \text{start pulse value}) / (\text{number of steps} - 1)$

The following figure shows an example of a pulsed double sweep measurement. Pulse sweep source output is swept from *start pulse* to *stop pulse* value, then from *stop pulse* to *start pulse*, as shown. The measurement sequence is the same as a pulsed single sweep measurement.

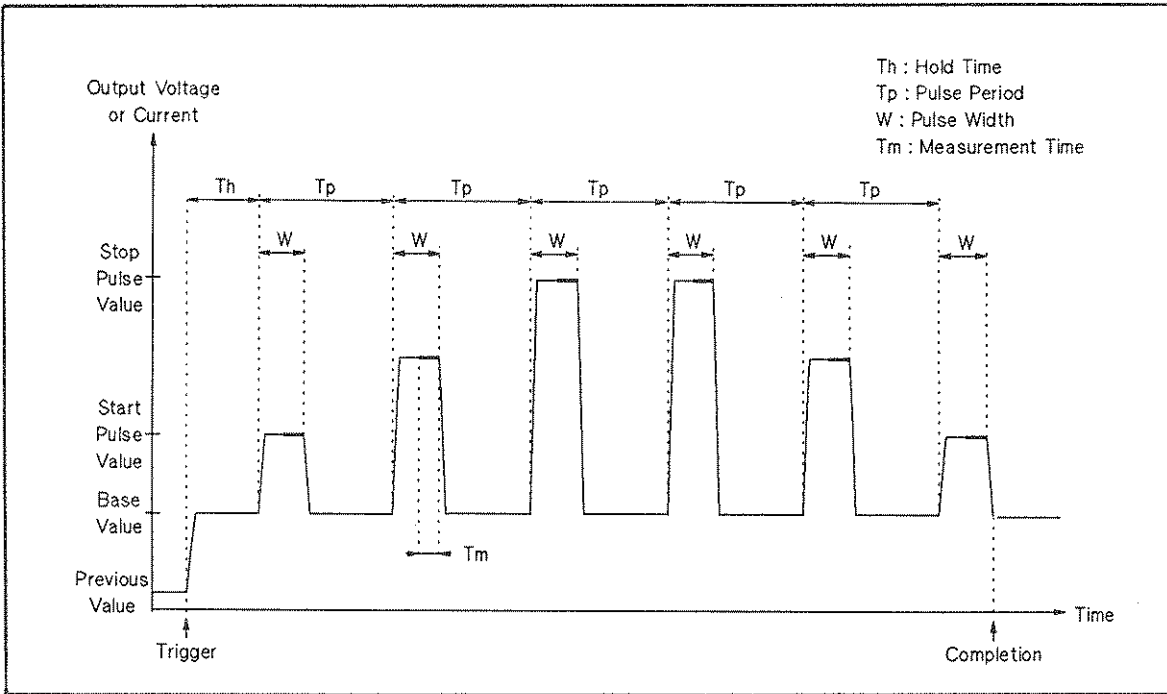

Pulsed Double Sweep Measurement

NOTE

When using an SMU as a pulse source, set the Filter to OFF (SMU Filters set to ON at power-on) by using FL command.

If you set *start pulse value* = *stop pulse value*, all pulses are the same height.

For current pulse sweep measurements, *base*, *start pulse*, and *stop pulse* values must have the same polarity.

For HCU voltage pulses, the base voltage can be specified only as 0 V. For HCU current pulses, while the HCU output is a base value, the HCU output is 0 V and no current.

Commands and Parameters

The following table lists the commands and parameters for pulsed sweep measurements. To specify a voltage pulse sweep source, use the **PWV** command. To specify a current pulse sweep source, use the **PWI** command.

Pulsed Sweep Measurement Commands and Parameters

Function	Command ¹	Parameters ¹
Pulsed Sweep Source ²	PWV	<i>ch#, sweep mode, output range, base voltage, start pulse voltage, stop pulse voltage, number of steps, [I compliance]</i>
	PWI	<i>ch#, sweep mode, output range, base current, start pulse current, stop pulse current, number of steps, [V compliance]</i>
	[FL]	<i>filter, [ch#]</i>
Pulse Conditions	[PT]	<i>hold time, pulse width, [pulse period]</i>
Sweep Conditions	[WM]	<i>automatic sweep abort function</i>
Constant Source	DV	<i>ch#, output range, output voltage, [I compliance], [compliance polarity mode]</i>
	DI	<i>ch#, output range, output current, [V compliance], [compliance polarity mode]</i>
Measurement	MM	<i>measurement mode, ch#</i>
	[RI]	<i>ch#, I measurement range</i>
	[RV]	<i>ch#, V measurement range</i>
Trigger	XE	-----
Abort	AB	-----

¹ Brackets ([]) denote optional commands and parameters.

² To use an SMU as a pulsed sweep source, set the Filter to OFF.

Information

Measurement Data Output Format is explained in the *HP 4142B HP-IB Command Reference Manual*.

Output and Measurement Ranging Mode, Automatic Sweep Abort Function, and Filter are explained in chapter 5.

Pulsed Sweep Measurement Sample Program

The following is a sample program that measures the forward characteristics of a pn junction diode by using the pulsed sweep measurement function. A description of key program lines follows the program list.

Measurement Conditions

DUT Terminal	Unit	Output	Measurement
Cathode Anode	SMU Ch#2 GNDU	Vf = 0 to 0.9 V 0 V	If ---

Program List

```
10 ! Diode If-Vf Measurement using Pulsed Sweep Function
20 !
30 INTEGER A_ch, No_step, Var1
40 ASSIGN @Hp4142 TO 717
50 OUTPUT @Hp4142;"*RST"
60 OUTPUT @Hp4142;"FMT";5
70 !                                     ! Cathode : GNDU
80 A_ch=2                               ! Anode   : Ch#2
90 Pv_start=0
100 Pv_stop=.9
110 No_step=91
120 If_comp=.1
130 !
140 CALL Ifvf_graph(Pv_start, 1, 0, If_comp)
150 Pv_step=(Pv_stop-Pv_start)/(No_step-1)
160 !
170 OUTPUT @Hp4142;"CN";A_ch
180 OUTPUT @Hp4142;"FL";0, A_ch
190 OUTPUT @Hp4142;"PWV";A_ch, 1, 0, 0, Pv_start, Pv_stop, No_step,
If_comp
200 OUTPUT @Hp4142;"PT";0, 1.E-3, 1.E-2
210 OUTPUT @Hp4142;"MM";4, A_ch
220 OUTPUT @Hp4142;"RI";A_ch, -19
230 OUTPUT @Hp4142;"XE"
240 OUTPUT @Hp4142;"CL"
250 !
```



```

260 FOR Var1=1 TO No_step
270   ENTER @HP4142 USING "#, 3X, 12D, X";If
280   Vf=Pv_start+(Var1-1)*Pv_step
290   PLOT Vf, If
300 NEXT Var1
310 PENUP
320 END
330 !
340 SUB Ifvf_graph(X_axis_min, X_axis_max, Y_axis_min, Y_axis_max)
350   !
360   GINIT
370   GRAPHICS ON
380   CONTROL CRT, 12;1
390   PRINT CHR$(12)
400   !
410   Xmax=100*MAX(1, RATIO)
420   Ymax=100*MAX(1, 1/RATIO)
430   !
440   LORG 6
450   MOVE Xmax/2, Ymax
460   LABEL "If-Vf Curve"
470   DEG
480   LDIR 90
490   CSIZE 4.5
500   MOVE 0, Ymax/2
510   LABEL "If(A)"
520   LORG 4
530   LDIR 0
540   MOVE Xmax/2, 0
550   LABEL "Vf(V)"
560   !
570   VIEWPORT .16*Xmax, .91*Xmax, .15*Ymax, .9*Ymax
580   !
590   FRAME
600   WINDOW X_axis_min, X_axis_max, Y_axis_min, Y_axis_max
610   AXES(X_axis_max-X_axis_min)/10.,(Y_axis_max-Y_axis_min)/10.,
X_axis_min, Y_axis_min
620   CLIP OFF
630   CSIZE 4, .5
640   LORG 6
650   FOR I=X_axis_min TO X_axis_max STEP (X_axis_max-X_axis_min)/2
660     MOVE I, Y_axis_min
670     LABEL I
680   NEXT I
690   CSIZE 3.8, .5
700   LORG 8
710   FOR I=Y_axis_min TO Y_axis_max STEP (Y_axis_max-Y_axis_min)/2
720     MOVE X_axis_min, I
730     LABEL USING "#, MD.DE";I
740   NEXT I
750   CLIP ON
760   !
770 SUBEND

```

Result

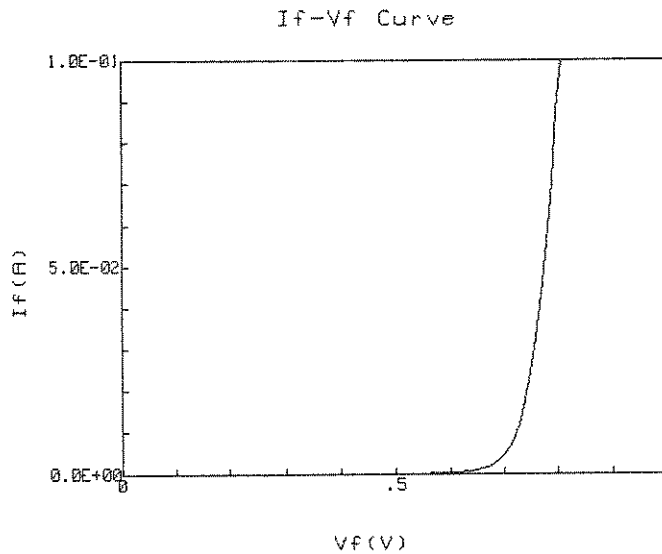

Description

- 30 Defines the variables.
- 50 Initializes the HP 4142B.
- 60 Sets the data output format to ASCII with header and comma (,) as a terminator.
- 80-120 Assigns the constants.
- 140 Calls subprogram to display graphics frame.
- 150 Calculates the pulse sweep step value.
- 170 Sets the SMU output switch to ON.
- 180 Sets the SMU Filter to OFF.
- 190 Sets the *ch#2* SMU voltage pulse sweep parameters.
- 200 Sets the output pulse sweep waveform.
- 210 Sets the measurement mode to pulsed sweep function.
- 220 Sets the current measurement range to 100 mA.
- 230 Sends a trigger to start measurement.
- 240 Sets the SMU output switch to OFF.
- 260-310 Enters the measurement data into variable *If*, and displays measurement data in the graphics frame.
- 340-770 Subprogram for displaying graphics frame.

STAIRCASE SWEEP WITH PULSED BIAS MEASUREMENTS

Staircase sweep with pulsed bias measurements are performed as follows: one source sweeps constant voltage or current, another source forces pulsed voltage or current with synchronized sweep output, while one monitor measures the output for each sweep step. Measurement data for each sweep step is stored in the output data buffer. The following two tables list the staircase sweep with pulsed bias measurement modes and provides an illustration of each, and HP 4142B staircase sweep with pulsed bias measurement specifics, respectively.

Staircase Sweep with Pulsed Bias Measurement Modes

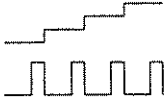
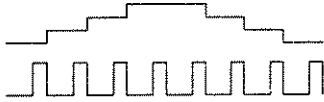
Sweep Mode	Output Waveform
Linear Single Staircase Sweep with Pulsed Bias	 The waveform shows a staircase-like signal that increases in steps over time. Below it is a pulsed signal consisting of a series of rectangular pulses, where each pulse is synchronized with a step in the staircase signal.
Linear Double Staircase Sweep with Pulsed Bias	 The waveform shows a double staircase signal that increases to a peak and then decreases in steps. Below it is a pulsed signal consisting of a series of rectangular pulses, where each pulse is synchronized with a step in the double staircase signal.

Staircase Sweep with Pulsed Bias Measurement Specifics

Output Mode	No. of Source Ch.	Source Mode	Source Setup Command	Allowable Units	Allowable Monitor Mode	Meas. Setup Command	No. of Meas. Ch.
Staircase Sweep	1	V	WV	HPSMU MPSMU	I	MM	1
				VS	---		
		I	WI	HPSMU MPSMU	V		
Pulse	1	V	PV	HPSMU MPSMU HCU	I		
				VS	---		
		I	PI	HPSMU MPSMU HCU	V		
Constant	0 to 14	V	DV	HPSMU MPSMU	I		
				VS	---		
		I	DI	HPSMU MPSMU	V		
No Output	---	---	---	VM	V ¹		

¹ Differential voltage measurements cannot be performed for pulsed measurements.

The following figure shows an example of a single staircase sweep with pulsed bias measurement.

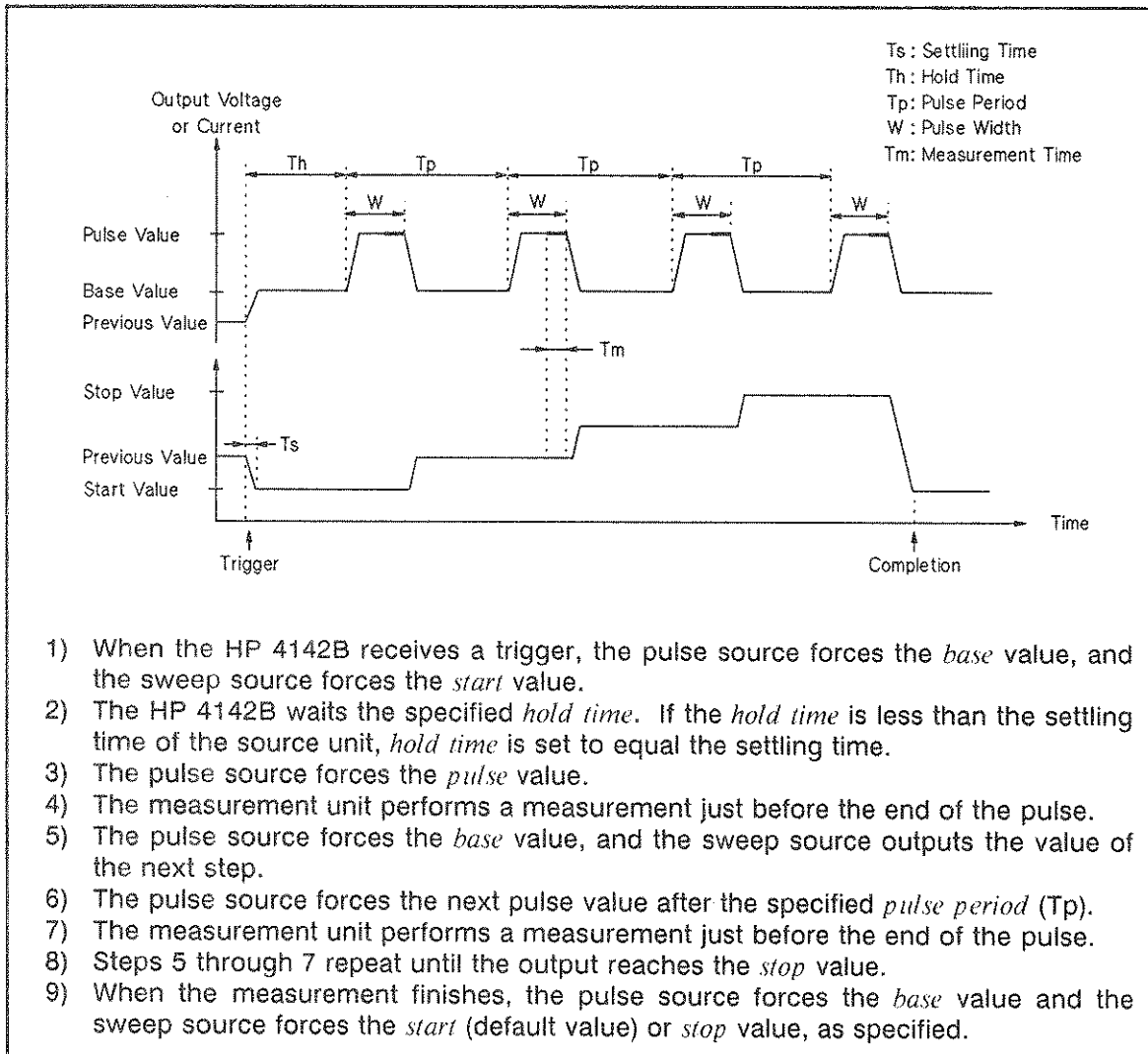

Single Staircase Sweep with Pulsed Bias Measurement

The following figure shows an example of a double staircase sweep with pulsed bias measurement. Sweep source output is swept from *start* to *stop* value, then from *stop* to *start* value, as shown. The measurement sequence is the same as a single staircase sweep measurement.

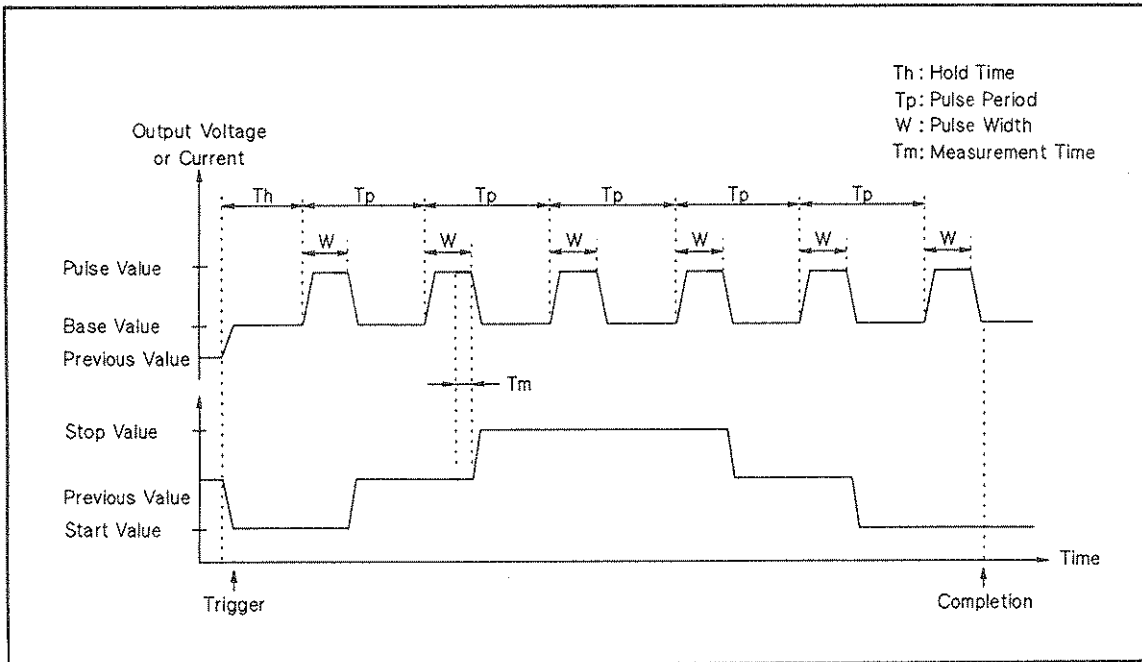

Double Staircase Sweep with Pulsed Bias Measurement

NOTE

When using an SMU as a pulse source, set the Filter to OFF (Filters set to ON at power-on) with the FL command.

For SMU current pulses, the *pulse current* and *base current* values must have the same polarity.

For HCU voltage pulses, the base voltage can be specified only as 0 V. For HCU current pulses, while the HCU output is a base value, the HCU output is 0 V and no current.

Commands and Parameters

The following table lists the commands and parameters for staircase sweep with pulsed bias measurements. To specify the staircase sweep source, use the **WV** or **WI** command. To specify the pulse source, use the **PV** or **PI** command.

Staircase Sweep with Pulsed Bias Measurement Commands and Parameters

Function	Command ¹	Parameters ¹
Voltage Sweep Source	WV	<i>ch#, sweep mode, output range, start voltage, stop voltage, number of steps, [I compliance]</i>
Current Sweep Source	WI	<i>ch#, sweep mode, output range, start current, stop current, number of steps, [V compliance]</i>
Sweep Conditions	[WM]	<i>automatic sweep abort function, [output after sweep]</i>
Pulse Source ²	PV	<i>ch#, output range, base voltage, pulse voltage, [I compliance]</i>
	PI	<i>ch#, output range, base current, pulse current, [V compliance]</i>
	[FL]	<i>filter, [ch#]</i>
Pulse Conditions	[PT]	<i>hold time, pulse width, [pulse period]</i>
Constant Source	DV	<i>ch#, output range, output voltage, [I compliance], [compliance polarity mode]</i>
	DI	<i>ch#, output range, output current, [V compliance], [compliance polarity mode]</i>
Measurement	MM	<i>measurement mode, [ch#]</i>
	[RI]	<i>ch#, I measurement range</i>
	[RV]	<i>ch#, V measurement range</i>
Trigger	XE	-----
Abort	AB	-----

¹ Brackets ([]) denote optional commands and parameters.

² When using SMUs, set Filter to OFF.

Information

Measurement Data Output Format is explained in the *HP 4142B HP-IB Command Reference Manual*.

Output and Measurement Ranging Modes, Automatic Sweep Abort Function, and Filter are explained in chapter 5.

Staircase Sweep with Pulsed Bias Measurement Sample Program

The following is a sample program that measures the static collector characteristics of a 2N3904 bipolar transistor by using the HP 4142B staircase sweep with pulsed bias measurement function. A description of key program lines follows the program list.

Measurement Conditions

DUT Terminal	Unit	Output	Measurement
Base	SMU Ch#3	Ib = 200 μ , 300 μ , 400 μ A	---
Collector	SMU Ch#2	Vc = 0 to 20 V, 101 steps	Ic
Emitter	GNDU	Ve = 0 V	---

Program List

```
10 ! Ic-Vce Measurement using Sweep with Pulsed Bias Function
20 !
30 OPTION BASE 1
40 INTEGER B_ch, C_ch, Vc_no_step, Ib_no_step, Var1, Var2
50 REAL Vc(101)
60 ASSIGN @Hp4142 TO 717
70 OUTPUT @Hp4142;"*RST"
80 OUTPUT @Hp4142;"FMT";5
90 !
100 B_ch=3 ! Emitter : GNDU
110 C_ch=2 ! Base : Ch#3
120 Vc_start=0 ! Collector : Ch#2
130 Vc_stop=20
140 Vc_no_step=101
150 Ic_comp=.1
160 Ib_start=2.E-4
170 Ib_step=1.E-4
180 Ib_no_step=3
190 !
200 Vc_step=(Vc_stop-Vc_start)/(Vc_no_step-1)
210 FOR Var1=1 TO Vc_no_step
220 Vc(Var1)=Vc_start+(Var1-1)*Vc_step
230 NEXT Var1
240 CALL Icvc_graph(Vc_start, Vc_stop, 0, Ic_comp)
250 !
260 OUTPUT @Hp4142;"CN";B_ch, C_ch
270 OUTPUT @Hp4142;"WV";C_ch, 1, 0, Vc_start, Vc_stop, Vc_no_step,
Ic_comp
280 OUTPUT @Hp4142;"FL";0, B_ch
```



```

290 OUTPUT @Hp4142;"PT";0, 1.E-3, 5.0E-2
300 OUTPUT @Hp4142;"MM";5, C_ch
310 OUTPUT @Hp4142;"RI";C_ch, -19
320 FOR Var2=1 TO lb_no_step
330     lb=lb_start+lb_step*(Var2-1)
340     OUTPUT @Hp4142;"PI";B_ch, 0, 0, lb, 2
350     OUTPUT @Hp4142;"XE"
360     !
370     FOR Var1=1 TO Vc_no_step
380         ENTER @Hp4142 USING "#, 3X, 12D, X";lc
390         PLOT Vc(Var1), lc
400     NEXT Var1
410     PENUP
420 NEXT Var2
430 OUTPUT @Hp4142;"CL"
440 END
450 !
460 SUB lcvc_graph(X_axis_min, X_axis_max, Y_axis_min, Y_axis_max)
470     !
480     GINIT
490     GRAPHICS ON
500     CONTROL CRT, 12;1
510     PRINT CHR$(12)
520     !
530     Xmax=100*MAX(1, RATIO)
540     Ymax=100*MAX(1, 1/RATIO)
550     !
560     LORG 6
570     MOVE Xmax/2, Ymax
580     LABEL "COLLECTOR CHARACTERISTICS"
590     DEG
600     LDIR 90
610     CSIZE 4.5
620     MOVE 0, Ymax/2
630     LABEL "Ic(A)"
640     LORG 4
650     LDIR 0
660     MOVE Xmax/2, 0
670     LABEL "Vce(V)"
680     !
690     VIEWPORT .16*Xmax, .91*Xmax, .15*Ymax, .9*Ymax
700     !
710     FRAME
720     WINDOW X_axis_min, X_axis_max, Y_axis_min, Y_axis_max
730     AXES(X_axis_max-X_axis_min)/10,(Y_axis_max-Y_axis_min)/10,
X_axis_min, Y_axis_min
740     CLIP OFF
750     CSIZE 4, .5
760     LORG 6
770     FOR I=X_axis_min TO X_axis_max STEP (X_axis_max-X_axis_min)/2
780         MOVE I, Y_axis_min
790         LABEL I
800     NEXT I
810     CSIZE 3.8, .5
820     LORG 8
830     FOR I=Y_axis_min TO Y_axis_max STEP (Y_axis_max-Y_axis_min)/2
840         MOVE X_axis_min, I

```

```

850     LABEL USING "#, MD.DE";!
860     NEXT I
870     CLIP ON
880     !
890     SUBEND

```

Result

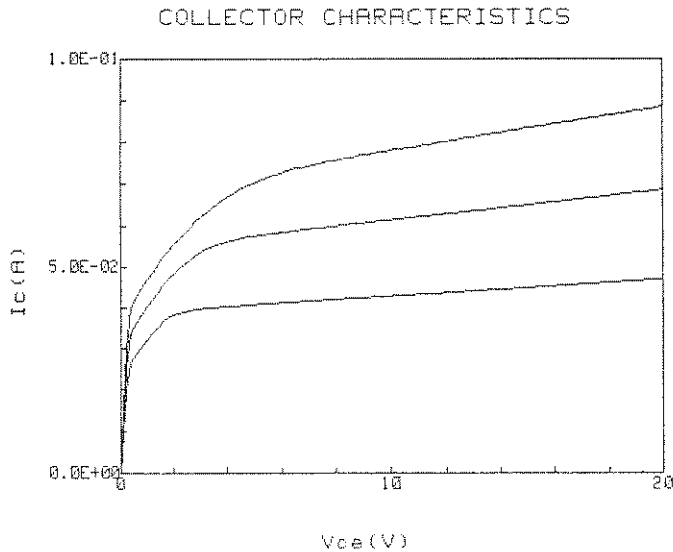

Description

30-50	Defines the variables.
70	Initializes the HP 4142B.
80	Sets the data output format to ASCII with header and comma as a terminator.
100-180	Assigns the constants.
200-230	Calculates collector voltage value for each step, and stores these values in an array variable.
240	Calls subprogram to display graphics frame.
260	Sets the SMU output switches to ON.
270	Sets the <i>ch#2</i> SMU voltage sweep parameters.
280	Sets the SMU filter to OFF.
290	Sets the output pulse waveform.
300	Sets the measurement mode to staircase sweep with pulsed bias function.
310	Sets the current measurement range to 100 mA.
320-340	Sets the <i>ch#3</i> SMU current pulsed source parameters.
350	Sends a trigger to start a voltage sweep measurement.
370-410	Enters the measurement data into variable <i>Ic</i> , and displays measurement data in the graphics frame.
420	Sets the base current to the next value.
430	Sets the SMU output switches to OFF.
460-890	Subprogram for displaying graphics frame.

ANALOG SEARCH MEASUREMENTS

Analog search measurements are performed with the Analog Feedback Unit (AFU) and two SMUs. The AFU provides precision control between the specified SMUs via a feedback loop to obtain a previously specified *target* value. The SMUs specified for use are automatically connected internally to the AFU. The following figure shows the basic analog search measurement circuit.

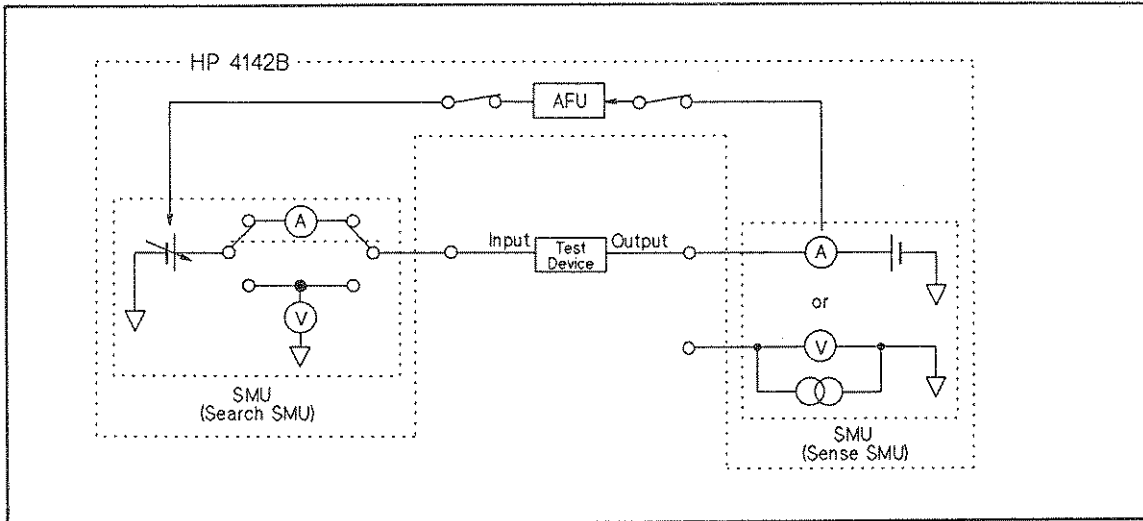

Basic Analog Search Measurement Circuit

One SMU (the search SMU) connects to the input of a test device, and sources voltage. The other SMU (the sense SMU) connects to the output of the test device, and monitors the output voltage (I source mode) or current (V source mode), depending on the specified *target* value. An error amplifier in the AFU detects the difference between the monitored test device output and the *target* value. The AFU then sends a control voltage, in proportion to the difference value, to the search SMU. This control voltage adjusts the voltage output from the search SMU to the test device, thereby adjusting test device output. This feedback process continues until the monitored test device output equals the *target* value and the specified measurements are complete.

The following figure shows the basic analog search measurement timing sequence and provides a brief description of the sequence of events.

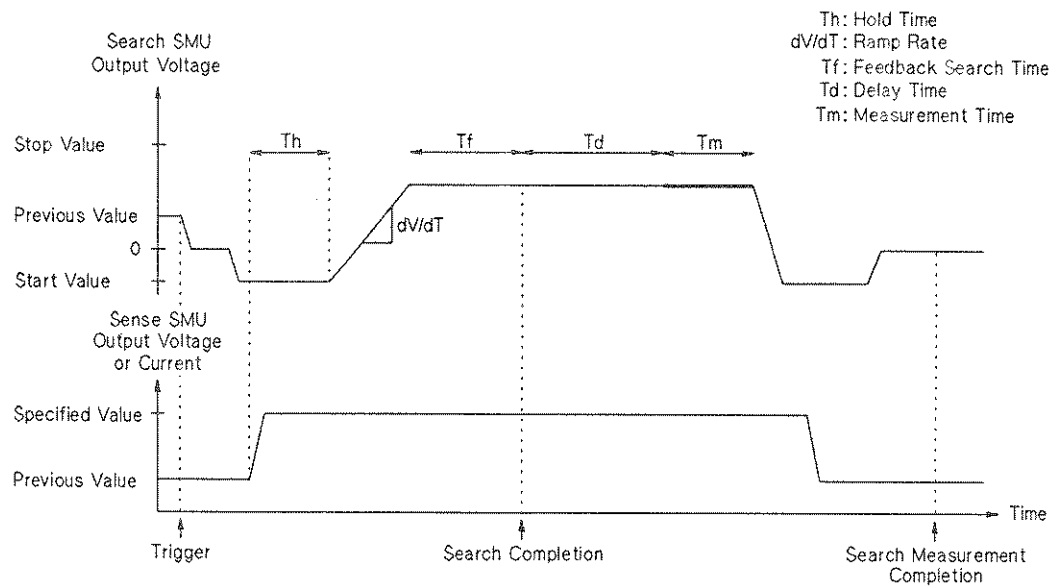

- 1) When the HP 4142B receives a trigger, the search SMU forces 0 V. The search and sense SMUs are then automatically connected to the AFU.
- 2) The AFU forces the *search start* value via the search SMU.
- 3) The sense SMU forces the *output* value specified in the AIV or AVI command. If the output range, *output*, and *compliance* values are the same as before the trigger, this step is not performed.
- 4) After the sense SMU starts to force the *output* value, the HP 4142B waits the *hold time*.
- 5) The AFU forces the ramp voltage with the specified *ramp rate* via the search SMU to start the search.
- 6) The AFU converges the output of test device (DUT) to the specified *target* value. For feedback searches, negative or positive feedback begins when DUT output is approximately equal to the *target* value, and continues until measurements are performed. After feedback begins, the HP 4142B waits the feedback search time T_f , and the *delay time* T_d , before performing the measurements. T_f is either the *feedback integration time* or 100 μ s, whichever is longer, and is valid for feedback searches only. The time constant in which the AFU converges the output is directly proportional to the *feedback integration time*. If the *feedback integration time* is set larger, the time constant becomes larger. For ramp searches, the HP 4142B waits the *delay time* T_d after the search is complete, then performs the measurements.
- 7) The HP 4142B performs the measurements according to the *search measurement mode*.
- 8) The search SMU forces 0 V, and the sense SMU forces the same value as before the trigger. The search and sense SMUs are then automatically disconnected from the AFU.

Analog Search Measurement Sequence

The following table lists HP 4142B analog search measurement specifics.

Analog Search Measurement Specifics

Output Mode	No. of Source Ch.	Source Mode	Source Setup Command	Allowable Units	Allowable Monitor Mode	Meas. Setup Command	No. of Meas. Ch.
Search	1	V	ASV	HPSMU MPSMU	V, I	MM ASM	1
Sense	1	V	AVI	HPSMU MPSMU	I		0 to 1
		I	AIV	HPSMU MPSMU	V		
Constant	0 ¹ to 10	V	DV	HPSMU MPSMU VS	---	---	---
		I	DI	HPSMU MPSMU	---	---	---

Search Operation Modes

The AFU can perform four types of search operations: two feedback-type searches, and two ramp-wave-type searches. Feedback search operations are for performing highly accurate search measurements, where measurement speed is not as important. Ramp wave search operations are for performing high speed search measurements, where measurement accuracy is not as important.

These four search operation modes are described in the following paragraphs. Each paragraph number corresponds to the *search operation mode* number you must specify in your measurement program. The following table lists the four search operation modes and shows the basic input and output waveforms for each mode.

(1) Negative Feedback Search:

Use this search mode for measuring DUTs in which the inputs and outputs are directly related, i.e., a positive-going input causes a positive-going output, and a negative-going input causes a negative-going output.

As the measurement begins, the AFU forces a ramp voltage via the search SMU, and compares the *target* and DUT output values. When the *target* and DUT output values are nearly the same, a negative feedback search begins. If DUT output is greater than the *target* value, AFU output decreases, and vice versa. Feedback continues until the *target* value is reached, then the specified measurements are performed.

(2) Positive Feedback Search:

Use this search mode for measuring DUTs in which the inputs and outputs are inversely related, i.e., a positive-going input causes a negative-going output, and a negative-going input causes a positive-going output.

As the measurement begins, the AFU forces a ramp voltage via the search SMU, and compares the *target* and DUT output values. When the *target* and DUT output values are nearly the same, a positive feedback search begins. If DUT output is less than the *target* value, AFU output decreases, and vice versa. Feedback continues until the *target* value is reached, then the specified measurements are performed.







(3) Ramp Wave Search (search until DUT output > target):

The AFU forces ramp voltage to the DUT input via the search SMU. Immediately after the DUT output is greater than the *target* value, the AFU keeps the DUT input voltage constant, then performs the specified measurements.

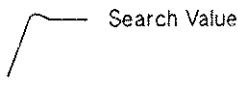
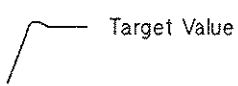
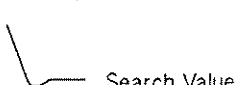
(4) Ramp wave search (search until DUT output < target):

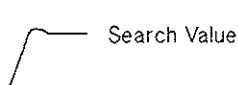
The AFU forces ramp voltage to the DUT input via the search SMU. Immediately after the DUT output becomes less than the *target* value, the AFU keeps the DUT input voltage constant, then performs the specified measurements.

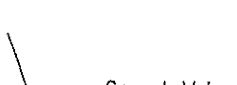
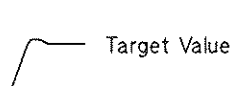
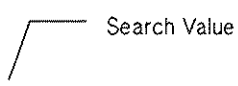
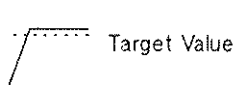
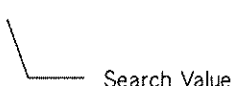
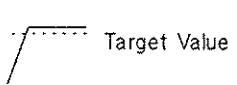
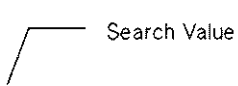
Search Operation Modes

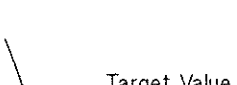
Search Operation Mode	DUT Input and Output Waveform	
	$(search\ start\ voltage) < (search\ stop\ voltage)$	$(search\ start\ voltage) > (search\ stop\ voltage)$
Negative Feedback Search	Input Waveform:  Search Value Output Waveform:  Target Value	Input Waveform:  Search Value Output Waveform:  Target Value
Positive Feedback Search	Input Waveform:  Search Value Output Waveform:  Target Value	Input Waveform:  Search Value Output Waveform:  Target Value
Ramp Wave Search (search until DUT output > target)	Input Waveform:  Search Value Output Waveform:  Target Value	Input Waveform:  Search Value Output Waveform:  Target Value
Ramp Wave Search (search until DUT output < target)	Input Waveform:  Search Value Output Waveform:  Target Value	Input Waveform:  Search Value Output Waveform:  Target Value

Search Measurement Modes

After the *target* value is reached, the HP 4142B performs the measurements in accordance with the measurement mode you specified. The following table lists the four measurement modes.

Search Measurement Modes

Search Measurement Mode#	Number of Measurement Channels	V or I Measurement	
		Search SMU (DUT Input)	Sense SMU (DUT Output)
1	1	V	-
2	1	I	-
3	2	V	V (if <i>target</i> value is V)
			I (if <i>target</i> value is I)
4	2	I	V (if <i>target</i> value is V)
			I (if <i>target</i> value is I)

Commands and Parameters

The following table lists the commands and parameters for analog search measurements. The search SMU is set by the **ASV** command. The sense SMU is set by **AIV** (if *target* value is voltage) or by **AVI** (if *target* value is current).

Analog Search Measurement Commands and Parameters

Function	Command ¹	Parameters ¹
Search SMU	ASV	<i>ch#</i> , <i>search start voltage</i> , <i>search stop voltage</i> , [<i>ramp rate</i>], [<i>I compliance</i>]
V Sense SMU	AIV	<i>ch#</i> , <i>output current</i> , <i>target voltage</i> , [<i>V compliance</i>]
I Sense SMU	AVI	<i>ch#</i> , <i>output voltage</i> , <i>target current</i> , [<i>I compliance</i>]
Search Conditions	[ASM]	<i>search operation mode</i> , <i>search measurement mode</i> , [<i>feedback integration time</i>]
	[AT]	<i>hold time</i> , <i>delay time</i>
Constant Source	DV	<i>ch#</i> , <i>output range</i> , <i>output voltage</i> , [<i>I compliance</i>], [<i>compliance polarity mode</i>]
	DI	<i>ch#</i> , <i>output range</i> , <i>output current</i> , [<i>V compliance</i>], [<i>compliance polarity mode</i>]
Measurement ²	MM	<i>measurement mode</i>
	AV	<i>number</i> , [<i>averaging mode</i>]
Trigger	XE	---
Abort	AB	---

¹ Brackets ([]) denote optional commands and parameters.

² Measurement channels are specified by the *search measurement mode* parameter of the **ASM** command.

NOTE

When measuring hFE or Vth, suitable *ramp rate*, *feedback integration time*, and *delay time* values can be obtained by using the Control Software parameter calculation subprograms, **Para_hfe** and **Para_vth**.

AFU MONITOR Port

The AFU **MONITOR** port allows you to monitor DUT output, as monitored by the sense SMU, by providing a voltage proportional to DUT output. Maximum AFU **MONITOR** port voltage is ± 8 V, as calculated using the following equations.

(1) If the target value is voltage:

$$\text{AFU MONITOR Port V} = \text{DUT Output V} / (\text{Sense SMU V Measurement Range}) (-8\text{V})$$

where the sense SMU V measurement range is the lowest range that includes *V compliance*.

(2) If the target value is current:

$$\text{AFU MONITOR Port V} = \text{DUT Output I} / (\text{Sense SMU I Measurement Range}) (8\text{V})$$

where sense SMU I measurement range is the lowest range that includes *I compliance*.

You can also observe DUT waveform patterns at the AFU **MONITOR** port using an oscilloscope to determine the validity of several analog search measurement parameters. The following table lists four waveform pattern symptoms and their related parameter(s). If you observe any of the waveform patterns listed in the following table, check the corresponding parameter(s).

AFU MONITOR Port Waveforms and Related Parameters

Waveform Pattern	Parameter To Check
If waveform does not settle before search starts	<i>hold time</i>
Excessive waveform overshoot at beginning of feedback search	<i>ramp rate</i>
Excessive waveform oscillation when a measurement is performed	<i>feedback integration time</i>
If waveform does not settle when a measurement is performed	<i>ramp rate,</i> <i>feedback integration time,</i> <i>delay time</i>

NOTE

If the sense current monitor range of the sense SMU is set to less than 10 μA range, no overshoot may be observed at the MONITOR port due to measurement circuit delay, even if overshoot occurs. Therefore, even if no overshoot is observed, do not set the *feedback integration time* too short or the *ramp rate* too high. The measurement circuit delay does not affect the measurement because it is corrected by the internal circuit of the AFU.

Information

Measurement Data Output Format is explained in the *HP 4142B HP-IB Command Reference Manual*.

Output and Measurement Ranging Mode, and Averaging are explained in chapter 5.

Analog Search Measurement Sample Program

The following figure shows a sample program that measures the hFE of a 2N3904 bipolar transistor by using the analog search measurement function. The base terminal is connected to the search SMU, and the collector terminal is connected to the sense SMU. The AFU senses the collector current via the sense SMU, and uses negative feedback to control the base voltage via the search SMU. A description of key program lines follows the program list.

Measurement Conditions

DUT Terminal	Unit	Output	Measurement
Base Collector Emitter	SMU Ch#3 SMU Ch#2 GNDU	$V_b = 0$ to 1 V $V_c = 1$ V, $I_c = 1$ mA $V_e = 0$ V	I_b I_c ---

The diagram shows a 2N3904 bipolar transistor with terminals B (Base), C (Collector), and E (Emitter). The base terminal is connected to a current source labeled 'Ch#3 SMU' through an ammeter 'A'. The collector terminal is connected to a current source labeled 'Ch#2 SMU' through another ammeter 'A'. The emitter terminal is connected to a ground point labeled 'GNDU'. An AFU (Automatic Feedback Unit) is connected to the collector circuit and provides feedback to the base circuit.

Program List

```
10 ! hFE Measurement using Analog Search Function
20 !
30 INTEGER B_ch, C_ch
40 DIM A$(31)
50 ASSIGN @Hp4142 TO 717
60 CLEAR @Hp4142
70 !
80 B_ch=3 ! Emitter : GNDU
90 C_ch=2 ! Base : Ch#3
100 Vb_start=0 ! Collector : Ch#2
110 Vb_stop=1
120 Vb_rate=200
130 Ib_comp=1.15E-4
140 Vc=1
150 Ic_target=1.E-3
160 Ic_comp=1.15E-3
170 Integ_time=4.5E-4
180 Delay_time=1.E-4
190 !
200 OUTPUT @Hp4142;"CN";B_ch, C_ch
210 OUTPUT @Hp4142;"ASV";B_ch, Vb_start, Vb_stop, Vb_rate, Ib_comp
220 OUTPUT @Hp4142;"AVI";C_ch, Vc, Ic_target, Ic_comp
230 OUTPUT @Hp4142;"ASM";1, 4, Integ_time
240 OUTPUT @Hp4142;"AT";0, Delay_time
250 OUTPUT @Hp4142;"MM";6
260 OUTPUT @Hp4142;"XE"
270 OUTPUT @Hp4142;"CL"
280 !
290 ENTER @Hp4142;A$
300 Ib=VAL(A$(4, 15))
310 Ic_meas=VAL(A$(20, 31))
320 PRINT "Ib= ";Ib*1.E+6;"[uA]"
330 PRINT "Ic= ";Ic_meas*1.E+3;"[mA]"
340 Hfe=Ic_meas/Ib
350 PRINT "hFE= ";PROUND(Hfe, -2)
360 END
```

Result

```
Ib= 4.492 [uA]
Ic= .99628 [mA]
hFE= 221.79
```

Description

40	Defines the string variable <i>AS</i> for storing measurement data.
60	Initializes the HP 4142B.
100-180	Assigns the constants.
200	Sets the SMU output switches to ON.
210	Sets the parameters for the search SMU.
220	Sets the parameters for the sense SMU.
230-240	Sets the parameters for the search operation and the measurement after search.
250	Sets the measurement mode to analog search measurement function.
260	Sends a trigger to start measurement.
270	Sets the SMU output switches to OFF.
290	Enters the measurement data into string variable <i>AS</i> .
300-350	Displays the base current, collector current, and hFE.

2CH PULSED SPOT MEASUREMENTS

2 Channel Pulsed spot measurements are performed as follows: two sources force pulsed outputs at the same time, and one monitor measures the output. The following table lists 2 channel pulsed spot measurement specifics. The following two figures show an example of a typical 2 channel pulsed spot measurement (when *pulse period* is not specified), and an example of a repeated pulsed spot measurement (when *pulse period* is specified), respectively.

2ch Pulsed Spot Measurement Specifics

Output Mode	No. of Source Ch.	Source Mode	Source Setup Command	Allowable Units	Allowable Monitor Mode	Meas. Setup Command	No. of Meas. Ch.
Pulse	2	V	PDV ¹ PV ¹	HPSMU ² MPSMU ² HCU ²	I	MM	1
		I	PDI ¹ PI ¹	HPSMU ² MPSMU ² HCU ²	V		
Constant	0 to 10	V	DV	HPSMU MPSMU	I		
				VS	---		
		I	DI	HPSMU MPSMU	V		
No Output	---	---	---	VM	V ³		

¹ Select one command from (PDV and PDI), and one command from (PV and PI).

² One of two pulsed sources must be an HCU.

³ Differential voltage measurements cannot be performed for pulsed measurements.

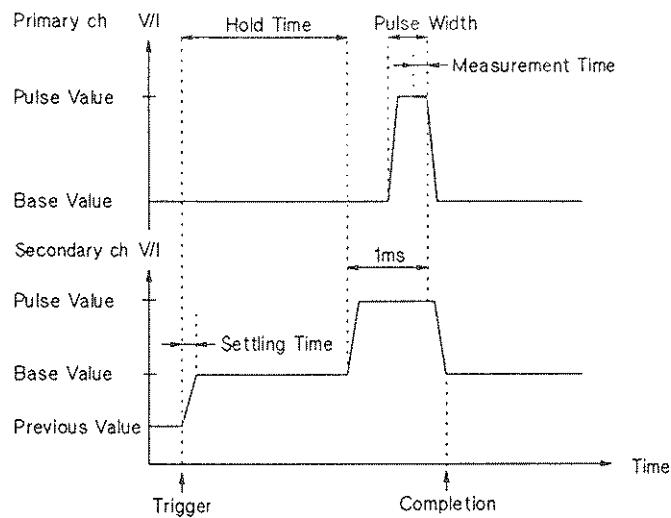

- 1) When the HP 4142B receives a trigger, the primary pulsed source forces the *base* value, and the secondary pulsed source forces the *base* value.
The primary pulsed source is automatically set to the HCU (if you use two HCUs for both pulsed sources, the primary pulsed source is specified by **PDM** command), and forces a pulse with the specified *pulse width*. The pulse width of the secondary pulsed source is set to about 1 ms, regardless of the specified *pulse width*.
- 2) After the secondary pulsed source starts to force the *base* value, the HP 4142B waits for the specified *hold time*. If the *hold time* is less than the settling time of the source unit, *hold time* is set to equal the settling time.
- 3) The secondary pulsed source forces the *pulse* value.
- 4) The primary pulsed source forces the *pulse* value.
- 5) The monitor unit measures V or I before the end of pulse.
- 6) The primary pulsed source forces the *base* value, and the secondary pulsed source forces the *base* value.

2ch Pulsed Spot Measurement Output Waveform

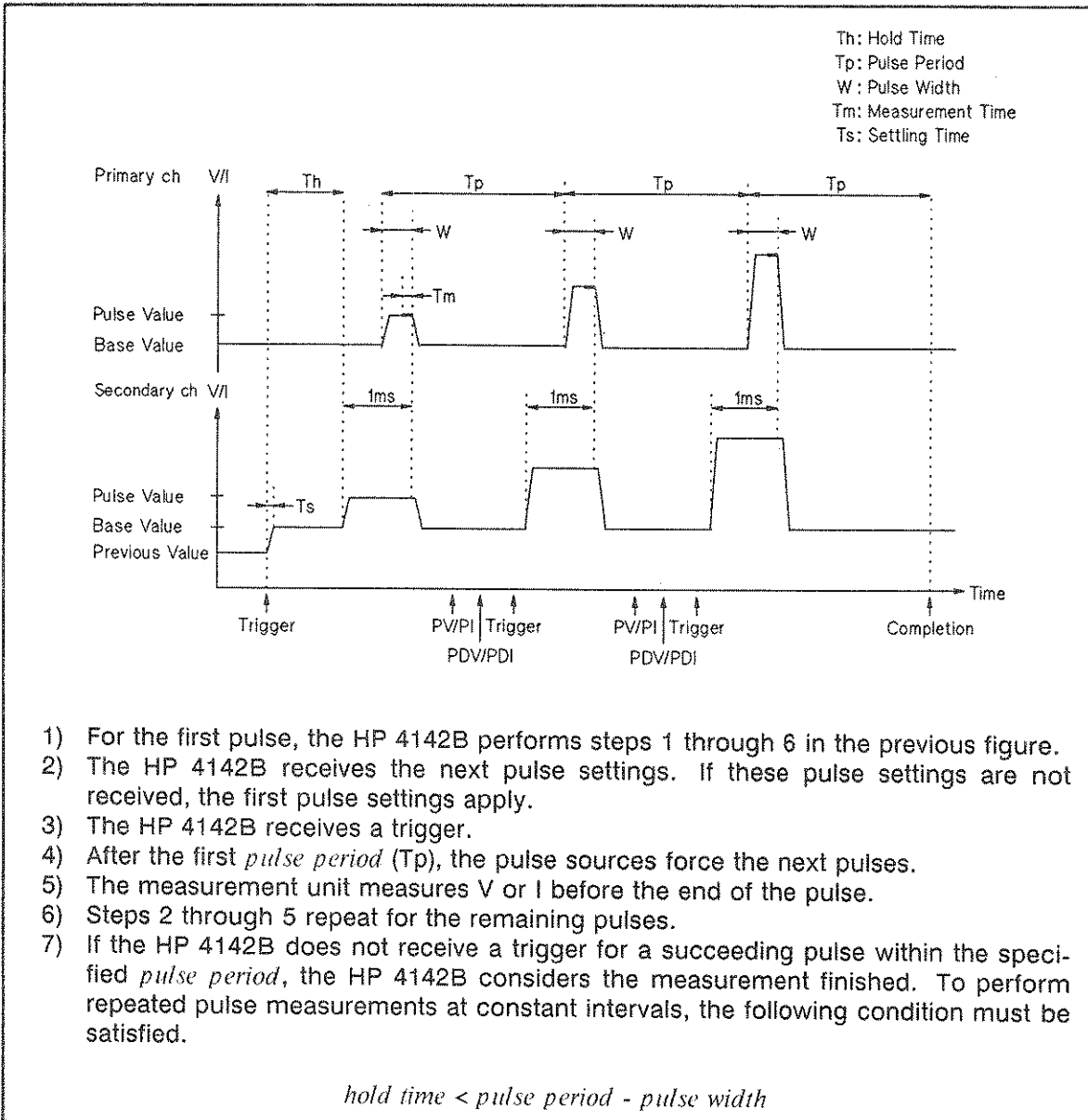

Repeated 2 ch Pulsed Spot Measurement

NOTE

When using an SMU as a pulse source, set the Filter to OFF (Filters set to ON at power-on) by using the **FL** command.

The HP 4142B can receive and execute commands during *base* value output in pulsed spot measurements that *pulse period* specified, but other types of measurements cannot be performed until the pulsed spot measurement is complete.

For SMU current pulses, the *pulse current* and *base current* values must have the same polarity.

For HCU voltage pulses, the base voltage can be specified only as 0 V. For HCU current pulses, while the HCU output is a base value, the HCU output is 0 V and no current.

Commands and Parameters

The following table lists the commands and parameters for 2 channel pulsed spot measurements. To specify one pulsed source, use the **PDV** or **PDI** command. To specify another pulsed source, use the **PV** or **PI** command.

2ch Pulsed Spot Measurement Commands and Parameters

Function	Command ¹	Parameters ¹
Pulsed Sources ²	PDV	<i>ch#, output range, base voltage, pulse voltage, [I compliance]</i>
	PV	<i>ch#, output range, base voltage, pulse voltage, [I compliance]</i>
	PDI	<i>ch#, output range, base current, pulse current, [V compliance]</i>
	PI	<i>ch#, output range, base current, pulse current, [V compliance]</i>
	[FL]	<i>filter, [ch#]</i>
Pulse Conditions	PT	<i>hold time, pulse width, [pulse period]</i>
	[PDM]	<i>primary pulse ch#</i>
Constant Source	DV	<i>ch#, output range, output voltage, [I compliance], [compliance polarity mode]</i>
	DI	<i>ch#, output range, output current, [V compliance], [compliance polarity mode]</i>
Measurement	MM	<i>measurement mode, [ch#]</i>
	[RI]	<i>ch#, I measurement range</i>
	[RV]	<i>ch#, V measurement range</i>
Trigger	XE	-----
Abort	AB	-----

¹ Brackets ([]) denote optional commands and parameters.

² When using SMUs, set Filter to OFF.

Information

Measurement Data Output Format is explained in the *HP 4142B HP-IB Command Reference Manual*.

Output and Measurement Ranging Mode, and Filter are explained in chapter 5.

2ch Pulsed Spot Measurement Sample Program

The following is a sample program that measures the collector saturation voltage ($V_{ce(sat)}$) of a 2SC3281 npn bipolar transistor by using the 2ch pulsed spot measurement function of the HP 4142B. A description of key program lines follows the program list.

Measurement Conditions

DUT Terminal	Unit	Output	Measurement
Base	HPSMU Ch#2	Ib = 1 A	---
Collector	HCU Ch#5	Ic = 10 A	Vce
Emitter	GNDU	Ve = 0 V	---

Program List

```
10 ! Vce(sat) Measurement using 2ch Pulsed Spot Function
20 !
30 INTEGER B_ch, C_ch
40 DIM Status$(3)
50 ASSIGN @Hp4142 TO 717
60 OUTPUT @Hp4142;"*RST"
70 !
80 B_ch=2                               Emitter      : GNDU
90 C_ch=5                               ! Base       : HPSMU Ch#2
100 Ib=1                                ! Collector  : HCU Ch#5
110 Ic=10
120 !
130 OUTPUT @Hp4142;"CN";B_ch, C_ch
140 OUTPUT @Hp4142;"FL";0, B_ch
150 OUTPUT @Hp4142;"PI";B_ch, 0, 0, Ib, 2
160 OUTPUT @Hp4142;"PDI";C_ch, 0, 0, Ic, 5
170 OUTPUT @Hp4142;"PT";0, 1.E-4
180 OUTPUT @Hp4142;"MM";7, C_ch
190 OUTPUT @Hp4142;"XE"
200 OUTPUT @Hp4142;"CL"
210 !
220 ENTER @Hp4142 USING "#, 3A, 12D, 2X";Status$,Vce
230 PRINT "Vce(sat)= ";Vce;"V", "(Data status: ";Status$;)"
240 END
```

Result

Vce(sat)= .4336 V (Data status: NEV)

Description

60	Initializes the HP 4142B.
80-110	Assigns the constants.
130	Sets the output switches to ON.
140	Sets the SMU Filter to OFF.
150	Sets the <i>ch#2</i> HPSMU current pulse parameters.
160	Sets the <i>ch#5</i> HCU current pulse parameters.
170	Sets the output pulse waveform.
180	Sets the measurement mode to 2ch pulsed spot function.
190	Sends a trigger to start the measurement.
200	Sets the output switches to OFF.
220	Enters the measurement data.
230	Displays the measurement results.

PULSED SWEEP WITH PULSED BIAS MEASUREMENTS

Pulsed sweep with pulsed bias measurements are performed as follows: one source sweeps pulsed voltage or current, and another source forces pulsed voltage or current with synchronized sweep pulsed output, while one monitor measures the output for each sweep step. Measurement data for each sweep step is stored in the output data buffer. The following two tables list the pulsed sweep with pulsed bias measurement modes and provide an illustration of each, and HP 4142B pulsed sweep with pulsed bias measurement specifics, respectively.

Pulsed Sweep with Pulsed Bias Measurement Modes

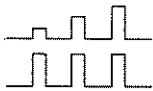
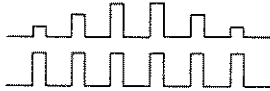
Sweep Mode	Output Waveform
Linear Single Pulsed Sweep with Pulsed Bias	
Linear Double Pulsed Sweep with Pulsed Bias	

Pulsed Sweep with Pulsed Bias Measurement Specifics

Output Mode	No. of Source Ch.	Source Mode	Source Setup Command	Allowable Units	Allowable Monitor Mode	Meas. Setup Command	No. of Meas. Ch.
Pulsed Sweep	1	V	PWV	HPSMU ¹ MPSMU ¹ HCU ¹	I	MM	1
		I	PWI	HPSMU ¹ MPSMU ¹ HCU ¹	V		
Pulsed Bias	1	V	PDV	HPSMU ¹ MPSMU ¹ HCU ¹	I		
		I	PDI	HPSMU ¹ MPSMU ¹ HCU ¹	V		
Constant	0 to 10	V	DV	HPSMU MPSMU	I		
				VS	---		
		I	DI	HPSMU MPSMU	V		
No Output	---	---	---	VM	V ²		

¹ One of the two pulsed sources must be an HCU.

² Differential voltage measurements cannot be performed for pulsed measurements.

The pulse period of one pulsed source (primary pulsed source) is set to the specified *pulsed width*, and the other pulsed source (secondary pulsed source) is set to about 1 ms. The following figure shows an example of a single pulsed sweep with pulsed bias measurement. Figure (a) shows the pulsed sweep source as the primary pulsed source, and the pulsed bias source as the secondary pulsed source. Figure (b) shows the pulsed sweep source as the secondary pulsed source, and the pulsed bias source as the primary pulsed source.

The primary pulsed source is automatically set to the HCU (if you use two HCUs for both pulsed sources, the primary pulsed source is specified by the **PDM** command). The secondary pulsed source is set to the other pulsed source.

(a) When pulsed sweep source is the primary pulsed source:

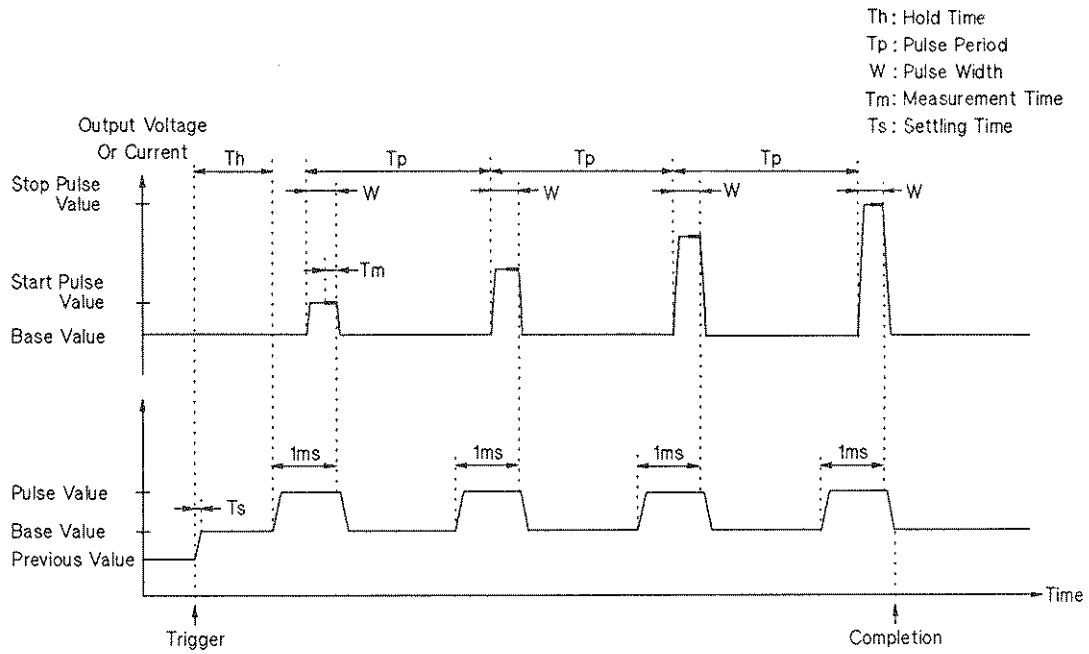

(b) When pulsed bias source is the primary pulsed source:

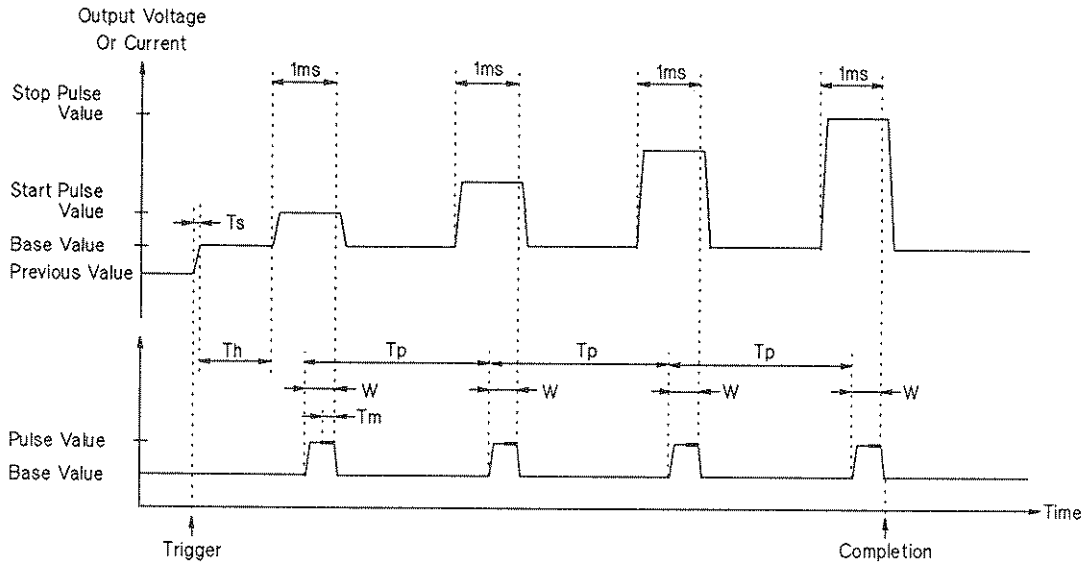

Pulsed Sweep with Pulsed Bias Measurement Output Waveform (1 of 2)

- 1) When the HP 4142B receives a trigger, the pulsed sweep source forces the *base* value, and the pulsed bias source forces the *base* value.
- 2) After the pulsed bias source starts to force the *base* value, the HP 4142B waits for the specified *hold time*. If the *hold time* is less than the settling time of the source unit, *hold time* is set to equal the settling time.
- 3) The secondary pulsed source forces the pulse, and the primary pulsed source forces the pulse.
- 4) The monitor unit measures V or I before the end of pulse.
- 5) The primary pulsed source forces the *base* value, and the secondary pulsed source forces the *base* value.
- 6) The secondary pulsed source forces the next pulse.
- 7) The primary pulsed source forces the next pulse after the specified *pulse period* (T_p).
- 8) The monitor unit measures V or I before the end of pulse.
- 9) Steps 5 through 8 repeat until the output reaches the *stop pulse* value. When the measurement finishes, both pulsed sources force the *base* value.

Pulsed Sweep with Pulsed Bias Measurement Output Waveform (2 of 2)

The following figure shows an example of a double pulsed sweep with pulsed bias measurement. Sweep source output is swept from *start* value to *stop* value, then from *stop* value to *start* value, as shown. The measurement sequence is the same as a single staircase sweep measurement.

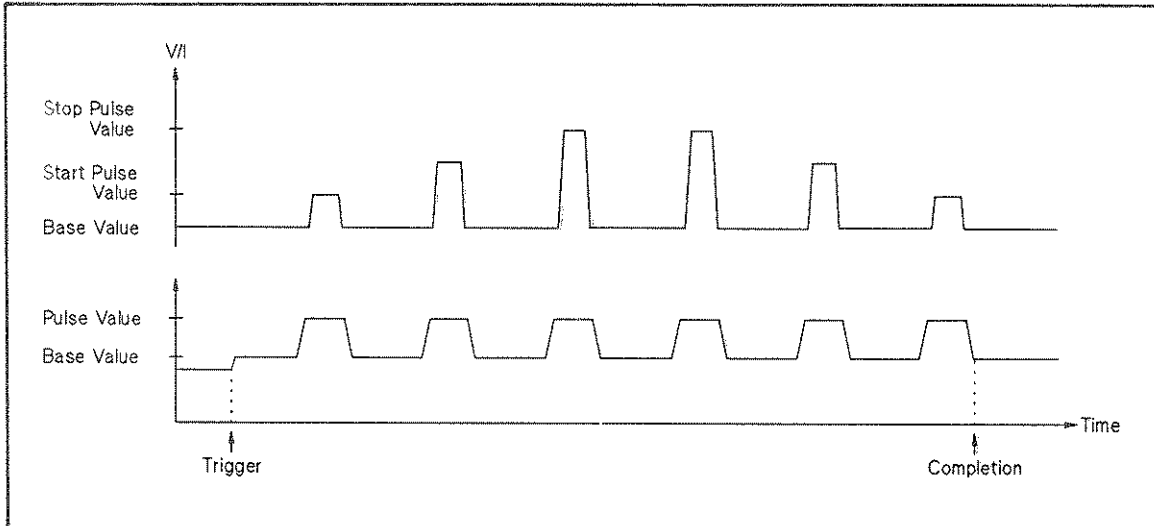

Pulsed Double Sweep Measurement

NOTE

When using an SMU as a pulse source, set the Filter to OFF (Filters set to ON at power-on) by using the FL command.

If you set *start pulse value* = *stop pulse value*, all pulses are the same height.

For current pulse sweep source, *base*, *start pulse*, and *stop pulse* values must have the same polarity. For current bias source, *base current* and *pulse current* must have the same polarity.

For HCU voltage pulses, the base voltage can be specified only as 0 V. For HCU current pulses, while the HCU output is a base value, the HCU output is 0 V and no current.

Commands and Parameters

The following table lists the commands and parameters for pulsed sweep with pulsed bias measurements. To specify the pulsed sweep source, use the **PWV** or **PWI** command. To specify the pulsed bias source, use the **PDV** or **PDI** command.

Pulsed Sweep with Pulsed Bias Measurement Commands and Parameters

Function	Command ¹	Parameters ¹
Pulsed Sweep Source ²	PWV	<i>ch#, sweep mode, output range, base voltage, start pulse voltage, stop pulse voltage, number of steps, [I compliance]</i>
	PWI	<i>ch#, sweep mode, output range, base current, start pulse current, stop pulse current, number of steps, [V compliance]</i>
Pulsed Source ²	PDV	<i>ch#, output range, base voltage, pulse voltage, [I compliance]</i>
	PDI	<i>ch#, output range, base current, pulse current, [V compliance]</i>
Pulse Enable ²	[FL]	<i>filter, [ch#]</i>
Pulse Conditions	PT	<i>hold time, pulse width, [pulse period]</i>
	[PDM]	<i>primary pulse ch#</i>
Sweep Conditions	[WM]	<i>automatic sweep abort function</i>
Constant Source	DV	<i>ch#, output range, output voltage, [I compliance], [compliance polarity mode]</i>
	DI	<i>ch#, output range, output current, [V compliance], [compliance polarity mode]</i>
Measurement	MM	<i>measurement mode, [ch#]</i>
	[RI]	<i>ch#, I measurement range</i>
	[RV]	<i>ch#, V measurement range</i>
Trigger	XE	----
Abort	AB	----

¹ Brackets ([]) denote optional commands and parameters.

² When using SMUs, set the SMU Filter to OFF.

Information

Measurement Data Output Format is explained in the *HP 4142B HP-IB Command Reference Manual*.

Output and Measurement Ranging Mode, Automatic Sweep Abort Function, and Filter are explained in chapter 5.

Pulsed Sweep with Pulsed Bias Measurement Sample Program

The following is a sample program that measures the static collector characteristics of a 2SC3281 bipolar transistor by using the pulsed sweep with pulsed bias measurement function of the HP 4142B. A description of key program lines follows the program list.

Measurement Conditions

DUT Terminal	Unit	Output	Measurement
Base	HPSMU Ch#2	Ib = 50 m,100 m,150 mA	---
Collector	HCU Ch#5	Vc = 0.1 to 10 V, 100 steps	Ic
Emitter	GNDU	Ve = 0 V	---

Program List

```
10  ! Ic-Vce Measurement using Pulsed Sweep with Pulsed Bias Function
20  !
30  OPTION BASE 1
40  INTEGER B_ch, C_ch, Vc_no_step, Ib_no_step, Var1, Var2
50  REAL Vc(100), Ic(3, 100)
60  COM Error$(100)[3], Error1(100), Error2(100), Error3(100), No_error
70  ASSIGN @Hp4142 TO 717
80  OUTPUT @Hp4142;"*RST"
90  OUTPUT @Hp4142;"FMT";5
100 !
110 B_ch=2           ! Emitter      : GNDU
120 C_ch=5           ! Base       : HPSMU (Ch#2)
130 Vc_start=.1      ! Collector  : HCU (Ch#5)
140 Vc_stop=10
150 Vc_no_step=100
160 Ic_comp=10
170 Ib_start=5.0E-2
180 Ib_step=5.0E-2
190 Ib_no_step=3
200 !
210 Vc_step=(Vc_stop-Vc_start)/(Vc_no_step-1)
220 FOR Var1=1 TO Vc_no_step
230   Vc(Var1)=Vc_start+(Var1-1)*Vc_step
240 NEXT Var1
250 CALL Icvc_graph(0, Vc_stop, 0, Ic_comp)
260 !
```

```

270 OUTPUT @Hp4142;"CN";B_ch, C_ch
280 OUTPUT @Hp4142;"PWV";C_ch, 1, 0, 0, Vc_start, Vc_stop, Vc_no_step,
lc_comp
290 OUTPUT @Hp4142;"FL";0, B_ch
300 OUTPUT @Hp4142;"PT";0, 2.E-4, 2.0E-2
310 OUTPUT @Hp4142;"MM";8, C_ch
320 !
330 No_error=0
340 FOR Var2=1 TO lb_no_step
350 lb=lb_start+lb_step*(Var2-1)
360 OUTPUT @Hp4142;"PDI";B_ch, 0, 0, lb, 2
370 OUTPUT @Hp4142;"XE"
380 !
390 FOR Var1=1 TO Vc_no_step
400 ENTER @Hp4142 USING "#, 3A, 12D, X";Status$, lc(Var2, Var1)
410 PLOT Vc(Var1), lc(Var2, Var1)
420 IF Status$[1;1]<>"N" THEN
430 No_error=No_error+1
440 Error$(No_error)=Status$
450 Error1(No_error)=lb
460 Error2(No_error)=Vc(Var1)
470 Error3(No_error)=lc(Var2, Var1)
480 DISP "MEASUREMENT ERROR", Error$(No_error), Er-
ror1(No_error), Error2(No_error), Error3(No_error)
490 END IF
500 NEXT Var1
510 PENUP
520 NEXT Var2
530 OUTPUT @Hp4142;"CL"
540 END
550 !
560 SUB lcvc_graph(X_axis_min, X_axis_max, Y_axis_min, Y_axis_max)
570 !
580 GINIT
590 GRAPHICS ON
600 CONTROL CRT, 12;1
610 PRINT CHR$(12)
620 !
630 Xmax=100*MAX(1, RATIO)
640 Ymax=100*MAX(1, 1/RATIO)
650 !
660 LORG 6
670 MOVE Xmax/2, Ymax
680 LABEL "COLLECTOR CHARACTERISTICS"
690 DEG
700 LDIR 90
710 CSIZE 4.5
720 MOVE 0, Ymax/2
730 LABEL "Ic(A)"
740 LORG 4
750 LDIR 0
760 MOVE Xmax/2, 0
770 LABEL "Vce(V)"
780 !
790 VIEWPORT .16*Xmax, .91*Xmax, .15*Ymax, .9*Ymax
800 !
810 FRAME

```

```

820 WINDOW X_axis_min, X_axis_max, Y_axis_min, Y_axis_max
830 AXES(X_axis_max-X_axis_min)/10,(Y_axis_max-Y_axis_min)/10,
X_axis_min, Y_axis_min
840 CLIP OFF
850 CSIZE 4, .5
860 LORG 6
870 FOR I=X_axis_min TO X_axis_max STEP (X_axis_max-X_axis_min)/2
880 MOVE I, Y_axis_min
890 LABEL I
900 NEXT I
910 CSIZE 3.8, .5
920 LORG 8
930 FOR I=Y_axis_min TO Y_axis_max STEP (Y_axis_max-Y_axis_min)/2
940 MOVE X_axis_min, I
950 LABEL USING "#, MD.DE";I
960 NEXT I
970 CLIP ON
980 !
990 SUBEND
1000 SUB Error_disp
1010 COM Error$(*), Error1(*), Error2(*), Error3(*), No_error
1020 PRINT "STATUS", "Ib", "Vc", "Ic"
1030 FOR I=1 TO No_error
1040 PRINT Error$(I), Error1(I), Error2(I), Error3(I)
1050 NEXT I
1060 SUBEND

```

Result

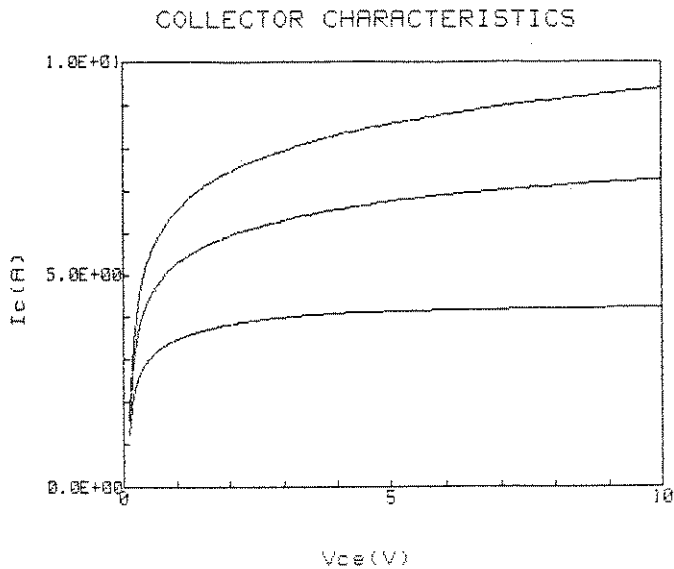

Description

30-60	Defines the variables.
80	Initializes the HP 4142B.
90	Sets the data output format to ASCII with header and comma as a terminator.
110-190	Assigns the constants.
210-240	Calculates collector voltage value for each step, and stores these values in an array variable.
250	Calls subprogram to display graphics frame.
270	Sets the output switches to ON.
280	Sets the <i>ch#5</i> HCU pulsed voltage sweep parameters.
290	Sets the SMU filter to OFF.
300	Sets the output pulse waveform.
310	Sets the measurement mode to pulsed sweep with pulsed bias function.
340-360	Sets the <i>ch#2</i> SMU current pulsed source parameters.
370	Forces a trigger to start a voltage swept measurement.
400-410	Enters the measurement data into variable <i>I_c</i> , and displays measurement data in the graphics frame.
420-490	Displays any measurement errors that may occur.
520	Sets the base current to the next value.
530	Sets the SMUs output switches to OFF.
560-990	Subprogram for displaying graphics frame.
1000-1060	Subprogram for displaying measurement errors.

HIGH SPEED SPOT MEASUREMENTS

You can make high speed spot measurements by using the TV or TI commands. These commands make a V or I measurement independently of the source mode setting (V or I). Measurements are faster because trigger, *measurement mode*, *measurement ch#*, and *measurement range* are all combined into one command. However, you are limited to one measurement channel. The TV command (for V measurements) is used instead of the MM, RV, and XE commands. The TI command (for I measurements) is used instead of the MM, RI, and XE commands. The following two tables list measurement functions that can only be performed using the high speed spot measurement function, and high speed spot measurement specifics, respectively.

High Speed Spot Measurement Special Functions

Measurement Function	Equivalent Circuit
VS current measurement	
Voltage measurement by SMU set to V source mode	
Current measurement by SMU set to I source mode	

High Speed Spot Measurement Specifics

Output Mode	No. of Source Ch.	Source Mode	Source Setup Command	Allowable Units	Allowable Monitor Mode	Meas. Setup Command	No. of Meas. Ch.
Constant	0 ¹ to 16	V	DV	HPSMU MPSMU	V, I	V: TV I: TI	1
				VS	I	TI	
		I	DI	HPSMU MPSMU	V, I	V: TV I: TI	
No Output	---	---	---	VM	V DIF. V	TV VM	

¹ When using a VM to make a measurement only.

Commands and Parameters

The following table lists high speed spot measurement commands and parameters.

High Speed Spot Measurement Commands and Parameters

Function	Command ¹	Parameters ¹
Constant Source	DV	<i>ch#, output range, output voltage, [I compliance], [compliance polarity mode]</i>
	DI	<i>ch#, output range, output current, [V compliance], [compliance polarity mode]</i>
Measurement and Trigger	TV	<i>ch#, [V measurement range]</i>
	TI	<i>ch#, [I measurement range]</i>
Measurement	[VM]	<i>ch#, VM operation mode</i>
	[AV]	<i>number, [averaging mode]</i>

¹ Brackets ([]) denote optional commands and parameters. Optional parameters and optional command parameters have default values.

Information

Measurement Data Output Format is explained in the *HP 4142B HP-IB Command Reference Manual*.

Output and Measurement Ranging Mode and Averaging are explained in chapter 5.

High Speed Spot Measurement Sample Program

The following is a sample program that measures collector current for two collector-to-emitter voltage values using the high speed spot measurement function. Saturation I_c - V_{ce} values are then used to calculate Early Voltage. A description of key program lines follows the program list.

Measurement Conditions

DUT Terminal	Unit	Output	Measurement
Base	SMU Ch#3	$I_b = 20 \mu A$	---
Collector	SMU Ch#2	$V_c = 2, 6 V$	I_c
Emitter	GNDU	$V_e = 0 V$	---

Program List

```

10  ! Early Voltage Measurement using High Speed Spot Function
20  !
30  INTEGER B_ch, C_ch
40  DIM Ic1$(15), Ic2$(15)
50  ASSIGN @Hp4142 TO 717
60  OUTPUT Hp4142;"*RST"
70  !
80  B_ch=3                               Emitter      : GNDU
90  C_ch=2                               ! Base       : Ch#3
100 Ib=2.E-5                             ! Collector  : Ch#2
110 Vc1=2
120 Vc2=6
130 !
140 OUTPUT @Hp4142;"CN";B_ch, C_ch
150 OUTPUT @Hp4142;"DI";B_ch, 0, Ib, 2
160 OUTPUT @Hp4142;"DV";C_ch, 0, Vc1, 1.E-2
170 OUTPUT @Hp4142;"TI";C_ch
180 ENTER @Hp4142;Ic1$
190 OUTPUT @Hp4142;"DV";C_ch, 0, Vc2
200 OUTPUT @Hp4142;"TI";C_ch
210 ENTER @Hp4142;Ic2$
220 OUTPUT @Hp4142;"CL"
230 !
240 Ic1=VAL(Ic1$(4, 15))
250 Ic2=VAL(Ic2$(4, 15))
260 Va=(Vc1*Ic2-Ic1*Vc2)/(Ic2-Ic1)
270 PRINT "Early Voltage= ";PROUND(Va, -2);"[V]"
280 END

```

Result

Early Voltage= -155.44[V]

Description

60	Initializes the HP 4142B.
100-120	Assigns the constants.
140	Sets the SMUs output switches to ON.
150	Forces 20 μ A to the base.
160	Forces 2 V to the collector.
170	Measures the collector current.
180	Enters the measurement data into string variable <i>Ic1S</i> .
190	Forces 6 V to the collector.
200	Measures the collector current.
210	Enters the measurement data into string variable <i>Ic2S</i> .
220	Sets the SMUs output switches to OFF.
240-250	Converts the string expression into a numeric value to obtain the collector current values.
260	Calculates the Early Voltage value.
270	Displays the result.

CHAPTER 5

MEASUREMENT FUNCTIONS

CONTENTS

Introduction	5-1
Output Ranging Mode	5-1
Allowable Ranging Mode	5-1
Auto Ranging	5-2
Limited Auto Ranging	5-3
Measurement Ranging Mode	5-4
Allowable Ranging Mode	5-4
Auto Ranging	5-5
Limited Auto Ranging	5-5
Compliance Range	5-6
Fixed Range	5-7
Compliance/Limiter	5-8
V/I Compliance	5-8
Power Compliance	5-16
Limiter	5-17
Averaging	5-18
Filter	5-20
Automatic Sweep Abort Function	5-21
Output After Sweep	5-21
Measurement Data Memory	5-22
Program Memory	5-23
Using Program Memory	5-26
Program Memory Sample Program	5-27
Using the HP 4142B with External Instruments	5-29
Trigger Output and Input Function	5-29
Triggering an External Instrument	5-29
Externally Triggered HP 4142B Measurements	5-30
Waiting for Trigger Signal from TRIGGER INPUT Terminal	5-30
Waiting for Time or Trigger	5-32
Waiting for Command Execution Completion	5-32

NOTES

INTRODUCTION

This chapter explains the functions that can be used in measurements, such as ranging, compliance, measurement averaging, automatic sweep about function and program memory.

OUTPUT RANGING MODE

Allowable Ranging Mode

The following table lists the allowable output ranging mode for each source.

Allowable Output Ranging Mode

Output Mode	Output Setup Command	Auto Ranging	Limited Auto Ranging
Constant V/I Source	DV/DI	YES	YES
Staircase Sweep V/I Source	WV/WI, WSV/WSI	YES	YES
Pulsed V/I Source	PV/PI, PDV/PDI	YES	YES
Pulsed Sweep V/I Source	PWV/PWI	YES	YES
Search	ASV	YES	---
V/I Sense (Constant I/V Source)	AVI/AIV	YES	---

Auto Ranging

For Auto ranging, the output of the source unit is forced at the lowest range that includes the Range Determination Value shown in the following table.

Range Determination Value	
Output Setup Command	Range Determination Value ¹
DV	<i>output voltage</i>
DI	<i>output current</i>
WV	$\text{MAX}(\text{start voltage}, \text{stop voltage})^2 \text{ }^3$
WSV	$\text{MAX}(\text{start voltage}, \text{stop voltage})^2 \text{ }^3$
WI (For linear sweep)	$\text{MAX}(\text{start current}, \text{stop current})^2$
WI (For log sweep)	each step output current ⁴
WSI (For linear sweep)	$\text{MAX}(\text{start current}, \text{stop current})^2$
WSI (For log sweep)	each step output current ⁴
PV	$\text{MAX}(\text{base voltage}, \text{pulse voltage})$
PI	$\text{MAX}(\text{base current}, \text{pulse current})$
PWV	$\text{MAX}(\text{base voltage}, \text{start pulse voltage}, \text{stop pulse voltage})^2$
PWI	$\text{MAX}(\text{base current}, \text{start pulse current}, \text{stop pulse current})^2$
ASV	$\text{MAX}(\text{search start voltage}, \text{search stop voltage}, (\text{search stop voltage} - \text{search start voltage}))^2$
AVI	<i>output voltage</i>
AIV	<i>output current</i>

¹ Each parameter value means an absolute value.

² During a sweep, the output range does not change.

³ However, if you specify *power compliance* for the SMU of the staircase sweep V source, and the I compliance value at some step (smaller value of *(power compliance)/ (step output voltage)* and *I compliance*) is greater than the maximum current for the V output range selected by the Auto ranging or Limited Auto ranging, then the V output range at this step is changed according to the output voltage, as follows. SMU output is momentarily set to 0 V if V range changing occurs.

⁴ During a log I sweep, the output range changes so that each step current is forced at the lowest range that includes the step current.

Unit	Step Voltage	Output Range
SMU	$0 \text{ V} \leq V \leq 20 \text{ V}$	20 V
	$20 \text{ V} < V \leq 40 \text{ V}$	40 V
	$40 \text{ V} < V \leq 100 \text{ V}$	100 V

The following table lists the lowest output range that includes the Range Determination Value, that is, the range set by Auto ranging.

Output Range Set by Auto Ranging

Unit	Range Determination Value	Output Range
HPSMU MPSMU	$0 \leq V \leq 2 \text{ V}$ $2 \text{ V} < V \leq 20 \text{ V}$ $20 \text{ V} < V \leq 40 \text{ V}$ $40 \text{ V} < V \leq 100 \text{ V}$ $100 \text{ V} < V \leq 200 \text{ V}$	2 V 20 V 40 V 100 V 200 V
HCU	$0 \leq V \leq 2 \text{ V}$ $2 \text{ V} < V \leq 10 \text{ V}$	2 V 20 V
VS	$0 \leq V \leq 20 \text{ V}$ $20 \text{ V} < V \leq 40 \text{ V}$	20 V 40 V
HPSMU MPSMU	$0 \leq I \leq 1.15 \text{ nA}$ $1.15 \text{ nA} < I \leq 11.5 \text{ nA}$ $11.5 \text{ nA} < I \leq 115 \text{ nA}$ $115 \text{ nA} < I \leq 1.15 \text{ }\mu\text{A}$ $1.15 \text{ }\mu\text{A} < I \leq 11.5 \text{ }\mu\text{A}$ $11.5 \text{ }\mu\text{A} < I \leq 115 \text{ }\mu\text{A}$ $115 \text{ }\mu\text{A} < I \leq 1.15 \text{ mA}$ $1.15 \text{ mA} < I \leq 11.5 \text{ mA}$ $11.5 \text{ mA} < I \leq 115 \text{ mA}$ $115 \text{ mA} < I \leq 1 \text{ A}$	1 nA 10 nA 100 nA 1 μA 10 μA 100 μA 1 mA 10 mA 100 mA 1 A
HCU	$0 \leq I \leq 1.15 \text{ mA}$ $1.15 \text{ mA} < I \leq 11.5 \text{ mA}$ $11.5 \text{ mA} < I \leq 115 \text{ mA}$ $115 \text{ mA} < I \leq 1.15 \text{ A}$ $1.15 \text{ A} < I \leq 10 \text{ A}$	1 mA 10 mA 100 mA 1 A 10 A

Limited Auto Ranging

For Limited Auto ranging, the output of the source unit is forced at the specified range, if this range includes the Range Determination Value described in "Auto Ranging." If not, the output is forced at the same range as Auto ranging.

MEASUREMENT RANGING MODE

Allowable Ranging Mode

The following table lists the allowable V measurement ranging mode for each monitor unit.

Unit	V/I Meas.	Allowable Ranging Mode ¹ (Ranging Mode Setup Command)		
		Constant V/I Meas.	Pulsed V/I Meas.	Search Meas.
HPSMU MPSMU	V Meas.	Comp ²	Comp	Comp ²
HCU	I Meas.	Auto, Ltd, Fix, Comp ² (RI, TI)	Comp, Fix (RI, TI)	Comp
VM	V Meas.	Auto, Fix (RV, TV)	Fix (RV, TV)	---
VS	I Meas.	³	---	---

¹ Auto: Auto ranging, Ltd: Limited Auto ranging, Comp: Compliance range, Fix: Fixed range

Constant Meas.: For Spot, Staircase sweep, or High speed spot measurements.

Pulse Used Meas.: 1ch pulsed spot, 2ch pulsed spot, Pulsed sweep, Pulsed sweep with pulsed bias, or staircase sweep with pulsed bias measurements.

Search Meas.: Analog search measurements

² If the unit is the V source and V monitor, or I source and I monitor, the measurement range is set to the same as output range, regardless of the shown ranging mode.

³ If VS output range is set to 20 V, VS I measurement range is automatically set to the 100 mA range. If VS output range is set to 40 V, VS I measurement range is automatically set to the 20 mA range. VS I measurement is only available for High speed spot measurements.

Auto Ranging

The monitor unit measures at the range that provides the highest resolution. The range changes to the next higher range if the measurement value is greater than 114% of the present range. The range changes to the next lower range if the measurement value is less than 10% of the present range.

The following table lists the auto ranging measurement area for each range.

Auto Ranging Measurement Area

Unit	Range	Meas. Area	Auto Ranging Meas. Area
VM (Grounded measurement)	2 V	0 to ± 2.3 V	$0 \text{ V} \leq V \leq 2.28 \text{ V}$
	20 V	0 to ± 23 V	$2 \text{ V} \leq V \leq 22.8 \text{ V}$
	40 V	0 to ± 40 V	$4 \text{ V} \leq V \leq 40 \text{ V}$
VM (Differential measurement)	0.2 V	0 to ± 0.23 V	$0 \leq V \leq 0.228 \text{ V}$
	2 V	0 to ± 2.3 V	$0.2 \text{ V} \leq V \leq 2.3 \text{ V}$
HPSMU MPSMU	1 nA	0 to 1.15 nA	$0 \text{ A} \leq I \leq 1.14 \text{ nA}$
	10 nA	0 to 11.5 nA	$1 \text{ nA} \leq I \leq 11.4 \text{ nA}$
	100 nA	0 to 115 nA	$10 \text{ nA} \leq I \leq 114 \text{ nA}$
	1 μ A	0 to 1.15 μ A	$100 \text{ nA} \leq I \leq 1.14 \mu\text{A}$
	10 μ A	0 to 11.5 μ A	$1 \mu\text{A} \leq I \leq 11.4 \mu\text{A}$
	100 μ A	0 to 115 μ A	$10 \mu\text{A} \leq I \leq 114 \mu\text{A}$
	1 mA	0 to 1.15 mA	$100 \mu\text{A} \leq I \leq 1.14 \text{ mA}$
	10 mA	0 to 11.5 mA	$1 \text{ mA} \leq I \leq 11.4 \text{ mA}$
	100 mA	0 to 115 mA ¹	$10 \text{ mA} \leq I \leq 114 \text{ mA}^1$
	1 A	0 to 1 A	$100 \text{ mA} \leq I \leq 1 \text{ A}$

¹ For MPSMU, 100 mA

Limited Auto Ranging

The monitor unit measures at the range that provides the highest resolution in the specified range and higher. The range changes to the next higher range if the measurement value is greater than 114% of the present range. The range changes to the next lower range if the present range is higher than the specified range and the measurement value is less than 10% of the present range. If you do not need to measure at the lower range, specify the higher range at this ranging mode. You can reduce the measurement time of Auto Ranging with Limited Auto Ranging because the number of range changes decreases.

However, if the specified range is greater than the lowest range that includes *I compliance*, the measurement range is not set by Limited Auto ranging and is set to Compliance range (see next paragraph, "Compliance Range"). Therefore, if you specify the 1 A Limited Auto ranging for HPSMU, and the 100 mA Limited Auto ranging for MPSMU, then the measurement range is always set to Compliance range regardless of *I compliance*.

Compliance Range

For V measurement, the monitor unit measures at the lowest range that includes *V compliance*. If you also specify *power compliance* for the SMU, the SMU measures at the lowest range that includes *V compliance*, or $(\text{power compliance})/(\text{step output current})$, whichever range is lower.

For I measurement, the monitor unit measures at the lowest range that includes *I compliance*. If you also specify *power compliance* for the SMU, the SMU measures at the lowest range that includes *I compliance*, or $(\text{power compliance})/(\text{step output voltage})$, whichever range is lower.

Compliance range performs measurements fastest because the ranging is performed when you set the compliance and the range does not change for each measurement.

The following table lists the measurement range for Compliance range.

NOTE

If you specify the 1 A Limited Auto ranging or 1 A fixed range for the HPSMU, and the 100 mA Limited Auto ranging or 100 mA fixed range for the MPSMU, then the measurement range is set to Compliance range.

Measurement Range for Compliance Range

Unit	<i>V compliance</i> <i>I compliance</i>	Measurement Range
HPSMU MPSMU	$0 \text{ V} \leq V \leq 2 \text{ V}$ $2 \text{ V} < V \leq 20 \text{ V}$ $20 \text{ V} < V \leq 40 \text{ V}$ $40 \text{ V} < V \leq 100 \text{ V}$ $100 \text{ V} < V \leq 200 \text{ V}$	2 V 20 V 40 V 100 V 200 V
HCU	$0 \text{ V} \leq V \leq 2 \text{ V}$ $2 \text{ V} < V \leq 10 \text{ V}$	2 V 20 V
HPSMU MPSMU	$0 \leq I \leq 1.15 \text{ nA}$ $1.15 \text{ nA} < I \leq 11.5 \text{ nA}$ $11.5 \text{ nA} < I \leq 115 \text{ nA}$ $115 \text{ nA} < I \leq 1.15 \text{ }\mu\text{A}$ $1.15 \text{ }\mu\text{A} < I \leq 11.5 \text{ }\mu\text{A}$ $11.5 \text{ }\mu\text{A} < I \leq 115 \text{ }\mu\text{A}$ $115 \text{ }\mu\text{A} < I \leq 1.15 \text{ mA}$ $1.15 \text{ mA} < I \leq 11.5 \text{ mA}$ $11.5 \text{ mA} < I \leq 115 \text{ mA}$ $115 \text{ mA} < I \leq 1 \text{ A}$	1 nA 10 nA 100 nA 1 μA 10 μA 100 μA 1 mA 10 mA 100 mA 1 A
HCU	$0 \leq I \leq 1.15 \text{ mA}$ $1.15 \text{ mA} < I \leq 11.5 \text{ mA}$ $11.5 \text{ mA} < I \leq 115 \text{ mA}$ $115 \text{ mA} < I \leq 1.15 \text{ A}$ $1.15 \text{ A} < I \leq 10 \text{ A}$	1 mA 10 mA 100 mA 1 A 10 A

Fixed Range

The monitor unit measures at the specified range only.

However, the I measurement range is set to the Compliance range if the specified range is greater than the lowest range that includes I compliance. For example, if you specify the 1 A range for HPSMU and the 100 mA range for MPSMU, then the measurement range is always set to the Compliance range, regardless of *I compliance*.

If the measurement value exceeds the specified measurement range, the measurement data is dummy data (199.999E+99).

COMPLIANCE/LIMITER

V/I Compliance

Allowable Units:

HPSMU, MPSMU, HCU

To prevent damage to the test device due to overcurrent or overvoltage, you can set the HPSMU, MPSMU, and HCU to I or V compliance. I and V compliance are limiters that can be set with the same resolution and accuracy as output current or output voltage. When using a unit in the V source mode, specify *I compliance*. When using a unit in the I source mode, specify *V compliance*. The following tables list the compliance area and compliance resolution, respectively.

If an output reaches *I* or *V compliance*, that unit acts as a constant I or V source, respectively, and output is maintained at the specified compliance level.

To check whether a source unit reaches *I* or *V compliance* during a measurement, check the measurement data status byte. Refer to the *HP-IB Command Reference Manual* for more details.

When setting compliance, observe the following precautions:

- Do not set *I compliance* too low.
The lower that *I compliance* is, the longer it takes for the settling time.
- Do not set *V compliance* too high, even if you think that damaging high voltage can not occur. A unit will reach *V compliance* if it cannot force the specified current by the following current limitations:
 - 1) Test device.
 - 2) Compliance/limiter of another unit.
 - 3) Limitation of maximum current at the I measurement range of another unit, if the I measurement range is lower than the compliance range. However, this limitation is momentary because the I measurement range automatically changes to the compliance range immediately after this limitation occurs.
- The V measurement range (that is, V measurement resolution) of the SMU or HCU is determined by *V compliance*, and set to the Compliance range.

V/I compliance Setting Area

Unit	Output Range	V/I compliance
HPSMU	2 V 20 V ($0 \leq V \leq 14$ V) 20 V ($14 < V \leq 20$ V) 40 V 100 V 200 V	1 pA ¹ to 1 A 1 pA ² to 1 A 1 pA ² to 700 mA 1 pA ² to 350 mA 1 pA ² to 125 mA 1 pA ² to 50 mA
	1 nA ³ 10 nA to 10 μ A 100 μ A to 10 mA 100 mA ($0 \leq I \leq 50$ mA) 100 mA (50 mA $\leq I \leq 115$ mA) 1 A ($0 \leq I \leq 50$ mA) 1 A (50 mA $< I \leq 125$ mA) 1 A (125 mA $< I \leq 350$ mA) 1 A (350 mA $< I \leq 700$ mA) 1 A (700 mA $< I \leq 1$ A)	0 to 200 V 0 to 200 V ⁴ 0 to 200 V 0 to 200 V 0 to 100 V 0 to 200 V 0 to 100 V 0 to 40 V 0 to 20 V 0 to 14 V
MPSMU	2 V 20 V 40 V 100 V	1 pA ¹ to 100 mA 1 pA ² to 100 mA 1 pA ² to 50 mA 1 pA ² to 20 mA
	1 nA ³ 10 nA to 10 μ A 100 μ A to 10 mA 100 mA ($0 \leq I \leq 20$ mA) 100 mA (20 mA $< I \leq 50$ mA) 100 mA (50 mA $\leq I \leq 100$ mA)	0 to 100 V 0 to 100 V ⁴ 0 to 100 V 0 to 100 V 0 to 40 V 0 to 20 V
HCU	2 V to 20 V	1 μ A to 10 A
	1 mA to 10 A	0 to 10 V

¹ 2 nA when performing pulsed measurements.

² 20 μ A when performing pulsed measurements.

³ 1 nA range not available when performing pulsed measurements.

⁴ 2 V when performing pulsed measurements.

V/I compliance Resolution

Unit	<i>V/I compliance</i>	Resolution
HPSMU MPSPMU	$0 < V \leq 2 \text{ V}$ $2 \text{ V} < V \leq 20 \text{ V}$ $20 \text{ V} < V \leq 40 \text{ V}$ $40 \text{ V} < V \leq 100 \text{ V}$ $100 \text{ V} < V \leq 200 \text{ V}$	100 μV 1 mV 2 mV 5 mV 10 mV
	$1 \text{ pA} \leq I \leq 1.15 \text{ nA}$ $1.15 \text{ nA} < I \leq 11.5 \text{ nA}$ $11.5 \text{ nA} < I \leq 115 \text{ nA}$ $115 \text{ nA} < I \leq 1.15 \text{ }\mu\text{A}$ $1.15 \text{ }\mu\text{A} < I \leq 11.5 \text{ }\mu\text{A}$ $11.5 \text{ }\mu\text{A} < I \leq 115 \text{ }\mu\text{A}$ $115 \text{ }\mu\text{A} < I \leq 1.15 \text{ mA}$ $1.15 \text{ mA} < I \leq 11.5 \text{ mA}$ $11.5 \text{ mA} < I \leq 115 \text{ mA}$ $115 \text{ mA} < I \leq 1 \text{ A}$	50 fA 500 fA 5 pA 50 pA 500 pA 5 nA 50 nA 500 nA 5 μA 50 μA
HCU	$0 < V \leq 2 \text{ V}$ $2 \text{ V} < V \leq 10 \text{ V}$	200 μV 2 mV
	$1 \text{ }\mu\text{A} < I \leq 1.15 \text{ mA}$ $1.15 \text{ mA} < I \leq 11.5 \text{ mA}$ $11.5 \text{ mA} < I \leq 115 \text{ mA}$ $115 \text{ mA} < I \leq 1 \text{ A}$	100 nA 1 μA 10 μA 100 μA

NOTE

For HCU, the specified *V* or *I compliance* is set only during pulse value output. While the HCU forces a base value, the output is fixed to 0 V and the *I compliance* is fixed to 0.1% of the range value of *I* range, regardless of the pulsed *V* or *I* source. The *I* range is the lowest range that includes the *I compliance* for pulsed *V* source, or is the *I* output range for the pulsed *I* source.

When the *V* or *I compliance* range is set to the unit, the *V* or *I* measurement range is set to the lowest range that includes the compliance. The *I* measurement range, however, changes during the measurement according to the specified ranging mode, if you do not specify compliance range.

Polarity of Compliance

The HP 4142B automatically sets *I compliance* polarity to the same polarity as the output voltage, regardless of the specified *I compliance* polarity.

The HP 4142B automatically sets *V compliance* polarity to the same polarity as the output current, regardless of the specified *V compliance* polarity.

The following figure shows the compliance and output area.

NOTE

The only time V/I compliance automatic polarity setting mode is not valid is when you set *compliance polarity mode* to MANUAL using the DV or DI command. See the following paragraph, "Manual Setting of Compliance Polarity."

For I compliance, current with the opposite polarity of *I compliance* is limited also. For HPSMU and MPSMU, this opposite polarity value is greater than $|I_{compliance}|$ by an amount that is 2% to 10% of the range value in the lowest range that includes *I compliance*. For HCU, the opposite polarity value is 0.1% of the range value for *I* range (maximum value is 10 mA at 10 A range). *I* range is the lowest range that includes *I compliance* for pulsed V source, or is the I output range for pulsed I source.

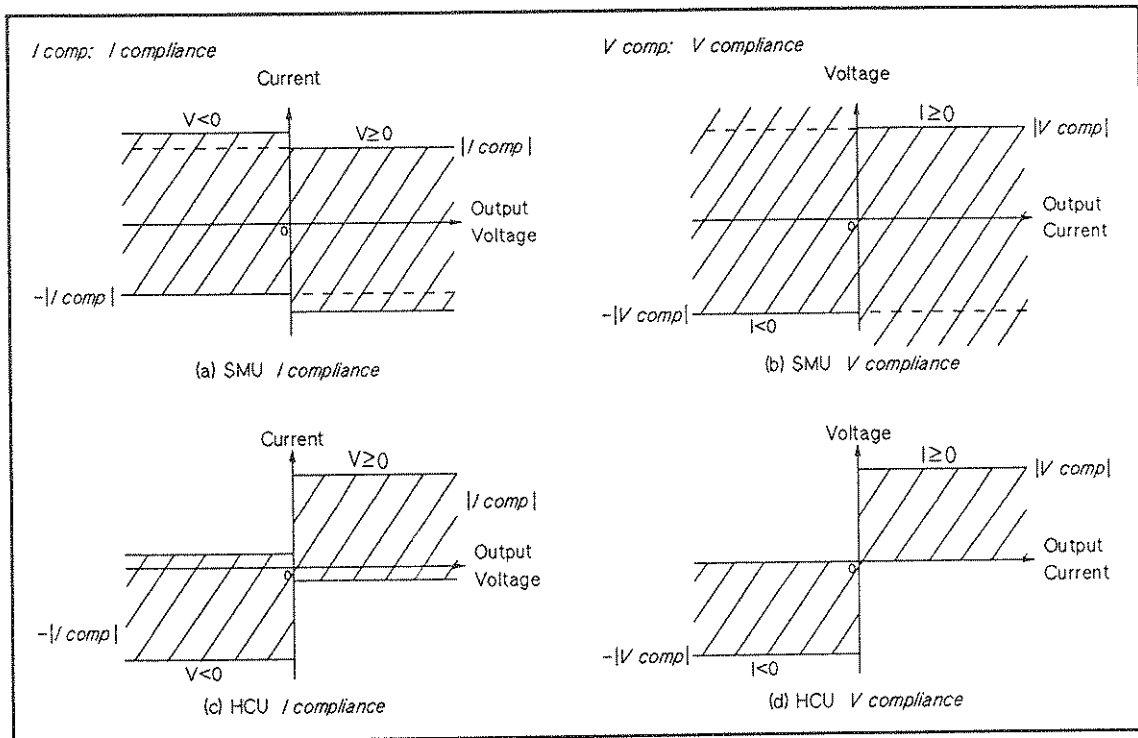

Output Area

The following table lists the compliance polarity for each command.

Compliance Polarity

Source	Setup Command	Compliance Polarity ¹
Constant	DV DI	Same as <i>output voltage</i> ² Same as <i>output current</i> ²
Staircase sweep	WV, WSV WI, WSI	Same as each step voltage Same as each step current
Pulse	PV, PDV PI, PDI	Same as <i>pulse voltage</i> Same as <i>pulse current and base current</i>
Pulsed sweep	PWV	SMU: Same as <i>start pulse voltage</i> HCU: Same as each step pulse voltage
	PWI	SMU: Same as <i>start pulse current and base current</i> HCU: Same as each step pulse current
Search	ASV	Same as <i>search stop voltage</i>
Sense	AVI AIV	Same as <i>output voltage</i> Same as <i>output current</i>

¹ If the parameter value(s) = 0, the compliance polarity is positive for the SMU, and the same as the previous polarity for the HCU.

² If you set *compliance polarity mode* to MANUAL, the I compliance polarity you specified is used, regardless of the polarity of the parameter. See the following paragraph, "Manual Setting of Compliance Polarity."

Manual Setting of Compliance Polarity

When you execute the DI or DV command for the HPSMU or the MPSMU, you can set compliance to the polarity of a specified V or I compliance, regardless of the output voltage polarity. Set the compliance polarity mode to MANUAL. The following figure shows the MANUAL mode compliance and output areas.

In figure (c), V compliance ≥ 0 . If the specified *output current* < 0 , then V compliance is the minimum allowed positive voltage. Negative voltages are not allowed. If the specified *output current* ≥ 0 , then V compliance is the maximum allowed positive voltage. Negative voltages are not limited. In figure (d), V compliance < 0 . If the specified *output current* < 0 , then V compliance is the maximum allowed negative voltage. Positive voltage is not limited. If the specified *output current* ≥ 0 , then V compliance is the minimum allowed negative voltage. Positive voltages are not allowed.

The following figure shows a measurement example using MANUAL mode.

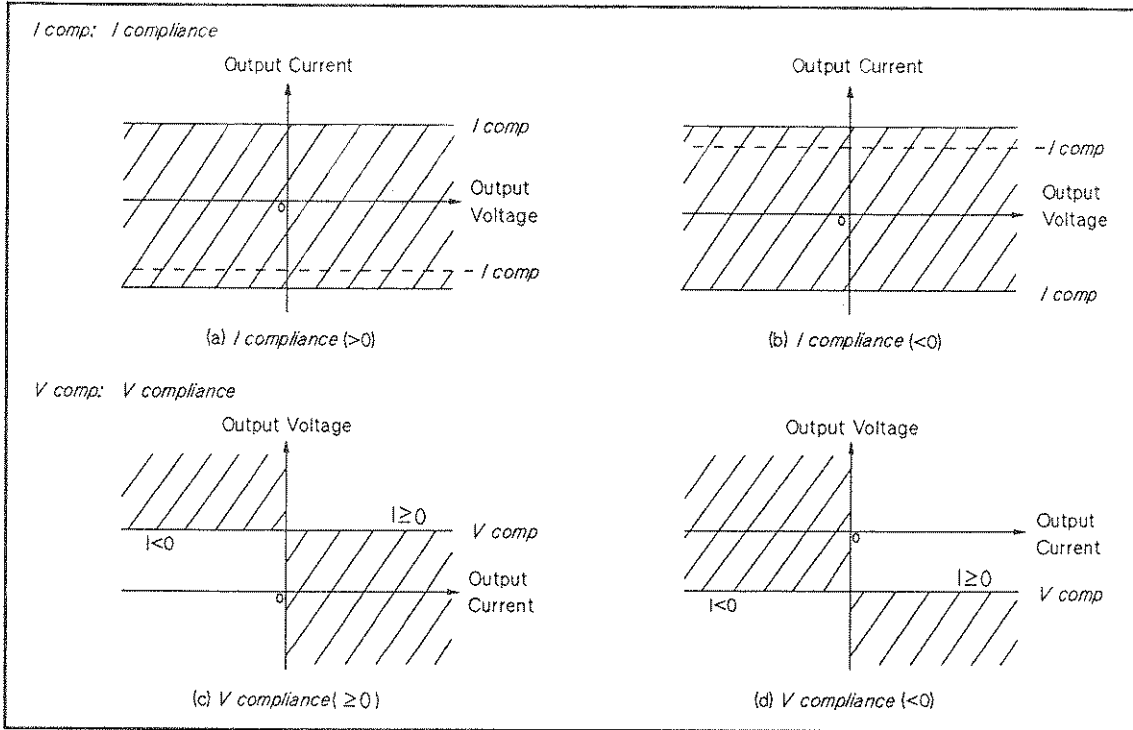

SMU Output Area for Manual Mode Compliance

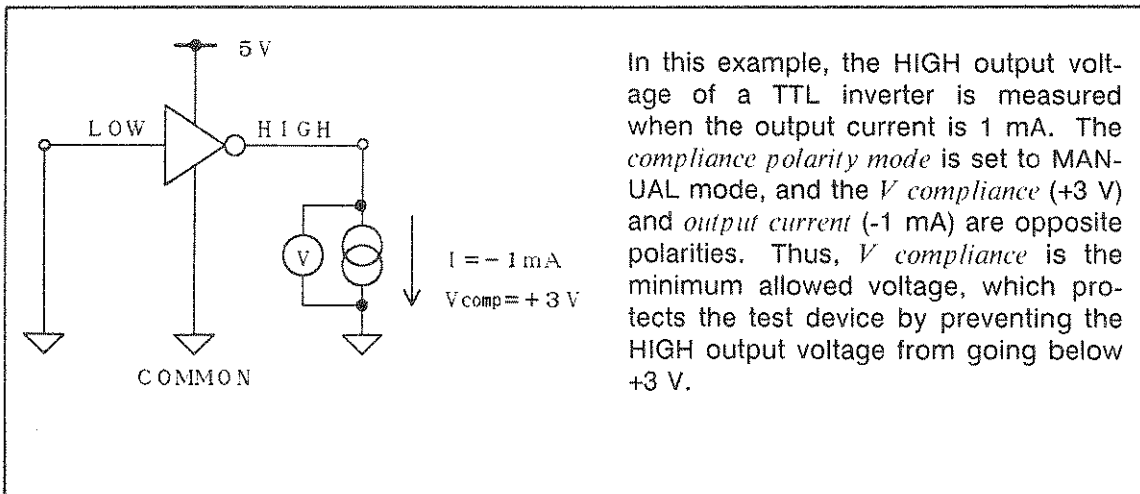

Compliance Polarity MANUAL Mode V Measurement Example

MANUAL MODE V COMPLIANCE CONSIDERATIONS

If you set the *compliance polarity mode* of the **DI** command to **MANUAL**, set *V compliance* (V_{comp}) as follows. If *V compliance* is not set as follows, the SMU output may be an undesired opposite polarity current (I_{rev}), instead of the desired *output current* (I_{set}).

- 1) If the specified I_{set} is positive or zero, set V_{comp} more positive than V_{rev} .
- 2) If the specified I_{set} is negative, set V_{comp} less positive than V_{rev} .

V_{rev} is the voltage that occurs at the SMU output terminal when I_{rev} is forced to a test device. $|I_{rev}| = |I_{set}| + |\Delta I|$, where ΔI is 2% to 10% range value of I output range.

The following figure shows the allowable *V compliance* values when the test device (DUT) is a resistor.

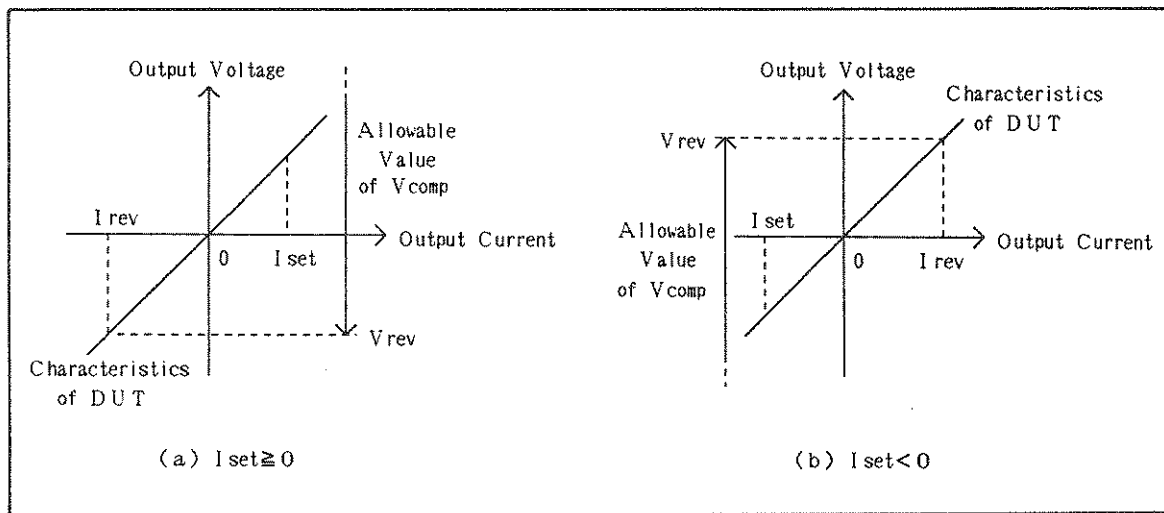

Allowable *V compliance* Values

In the I source mode, the I - V characteristics curve of an SMU is determined by the specified I_{set} and V_{comp} , and consists of the I_{set} , V_{comp} , and I_{rev} lines as shown in the following figure. SMU output depends on the intersection of the I - V characteristic curves of the SMU and the DUT. An SMU forces I_{set} , V_{comp} , or I_{rev} depending on the intersection. To achieve the desired SMU output, specify V_{comp} as shown in the above figure.

The following second figure shows how changing V_{comp} affects the SMU output when the specified I_{set} is greater than 0, and the DUT is a resistor:

- (1) If $V_{comp} > V_{rev}$, and the intersection is on the I_{set} line, as shown in figure (a), the SMU forces I_{set} .
- (2) If $V_{comp} > V_{rev}$, and the intersection is on the V_{comp} line, as shown in figure (b), the SMU forces V_{comp} .
- (3) If $V_{comp} < V_{rev}$, and the intersection is on the I_{rev} line, as shown in figure (c), the SMU forces undesirable current I_{rev} .

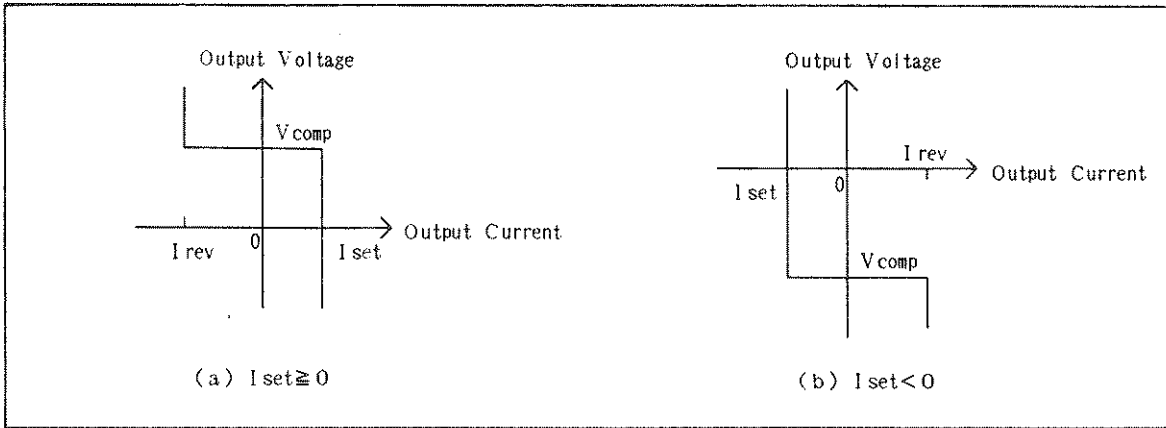

SMU I-V Characteristics Curve

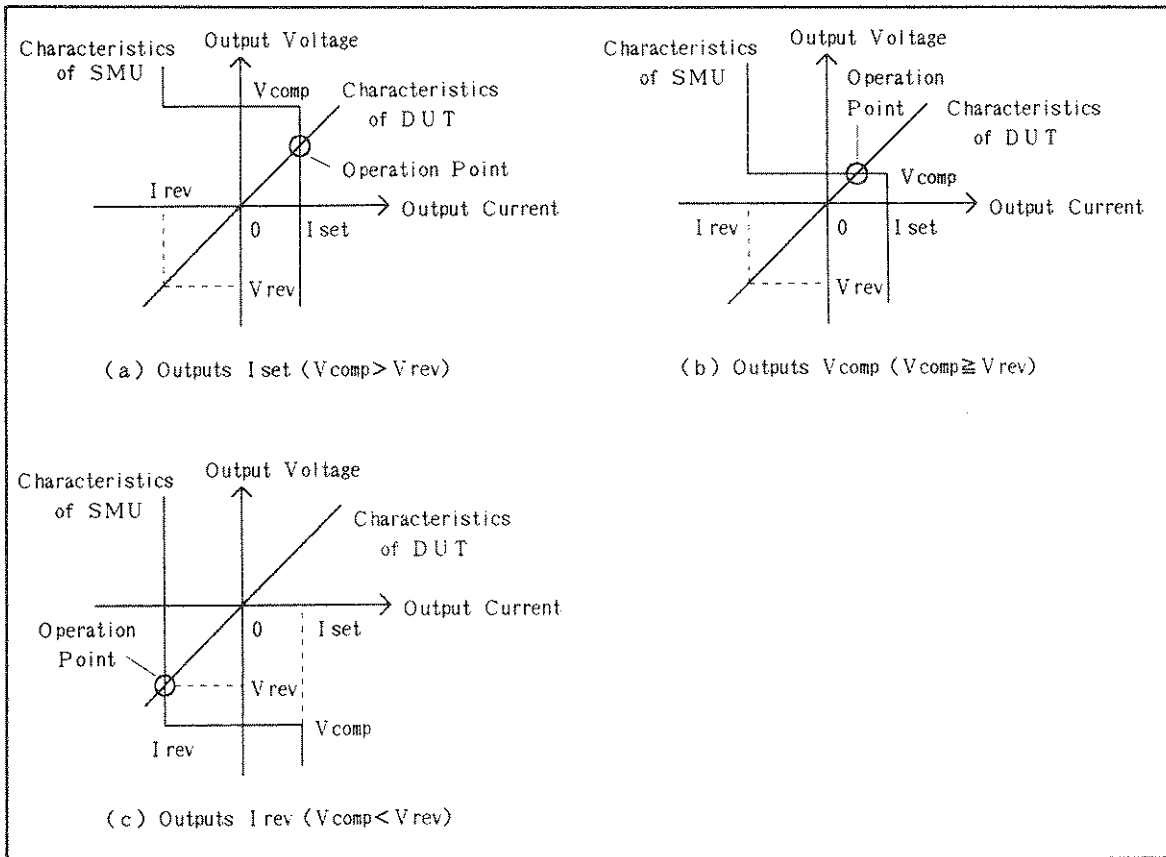

V compliance and SMU Operation

Power Compliance

Allowable Unit:

HPSMU, MPSMU

Allowable Measurement Mode:

Staircase sweep measurements

When using an SMU as a staircase sweep source, you can specify *power compliance* in addition to *V compliance* or *I compliance*.

If you specify *I compliance* and *power compliance* when using an SMU as a staircase sweep V source, the HP 4142B changes the I compliance at every voltage step. The I compliance is set to the smaller value of *I compliance* and $(\text{power compliance})/(\text{step voltage})$, as shown in the following figure (a).

If you specify *V compliance* and *power compliance* when using an SMU as a staircase sweep I source, the HP 4142B changes the V compliance at every current step. The V compliance is set to the smaller value of *V compliance* and $(\text{power compliance})/(\text{step current})$ as shown in figure (b).

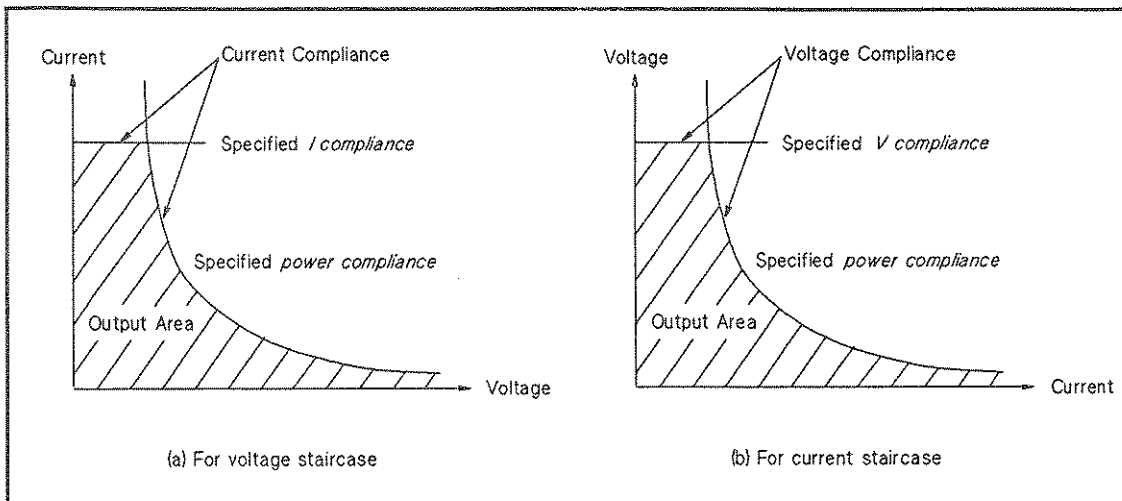

Staircase Sweep Source Power Compliance

If you specify *power compliance* and the staircase sweep source output reaches compliance during a sweep, the sweep stops, the specified *start* value is forced, and an **F** is displayed in the **ERROR/FAILURE** display. Dummy data (199.999E+99) is returned for measurement points not reached.

If the $(\text{power compliance})/(\text{step value at a step})$ is greater than the maximum SMU output, compliance is set to the maximum SMU output.

If you specify *power compliance*, SMUs can be swept at their maximum output limits because the HP 4142B changes the V range during a V sweep. The following figure shows an example of the difference in SMU output when *power compliance* is set and when *power compliance* is not set.

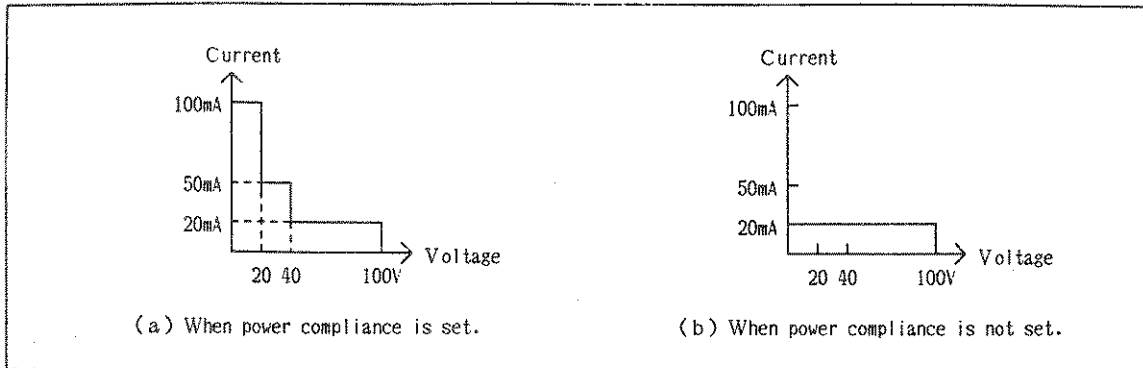

SMU Sweep I Source Output

NOTE

If you specify *power compliance*, the measurement time increases slightly because the HP 4142B adjusts V or I compliance for every sweep step to accommodate *power compliance*.

The SMU output is momentarily set to 0 V if V range changing occurs during a staircase sweep.

Limiter

Allowable Unit:

VS

The VS can be set to I limiter. The limiter value is automatically determined by the V output range. If output range = 20 V, then I limit = 100 mA. If the output range = 40 V, then I limit = 20 mA.

AVERAGING

Allowable Unit:

HPSMU, MPSMU, HCU, and VM

Allowable Measurement Mode:

Spot / Staircase sweep / Analog search / High speed spot measurements

To minimize the possibility of reduced HP 4142B measurement accuracy due to line frequency noise or other environmental noise, use the **AV** command to perform averaging. The averaging function of the HP 4142B arithmetically averages the results of two or more samples (A/D conversions). The **AV** command provides three averaging modes--AUTO, MANUAL, or POWER LINE CYCLE--as described in the following paragraphs.

AUTO Mode:

In the AUTO mode, the actual number of samples taken and averaged for a measurement is determined by the following expression:

$$\text{number of samples} = (\text{required minimum samples})(\text{averaging number})$$

where *averaging number* is the value specified in the **AV** command, and the required minimum sample is the minimum number of samples required to assure an accurate HP 4142B measurement. If you specify 1 for the *averaging number*, the HP 4142B performs the required minimum samples. For V measurements, the required minimum samples is 1. For SMU I measurements, the required minimum samples depends on the V output range and I measurement range as listed in the following table. The initial settings for averaging are *averaging number* = 1, *averaging mode* = AUTO.

Measurement times increase approximately 240 μ s for each additional sample.

Required Minimum Samples for SMU I Measurements

		V Output Range ¹		
		2 V, 20 V, 40 V	100 V	200 V
I Meas. Range	1 nA to 10 μ A	4	10	25
	100 μ A to 1 A	1	1	1

¹ If the SMU is in I source mode, the V output range is the lowest range that includes *V compliance*.

MANUAL Mode:

In the MANUAL mode, the number of samples taken and averaged for a measurement is determined by the following expression.

$$\text{number of samples} = \text{averaging number}$$

Where *averaging number* is the value specified in the **AV** command. If you specify 1 for the *averaging number*, only 1 sample is taken for the measurement. To assure an accurate HP 4142B measurement, the *averaging number* you specify should be greater than or equal to the required minimum samples defined by the AUTO mode.

In the AUTO or MANUAL mode, measurement times increase approximately 240 μs for each additional sample.

POWER LINE CYCLE (PLC) Mode:

In the PLC mode, 32 samples are taken for each line frequency period (50 Hz: 20 ms, 60 Hz: 16.67 ms) specified in the **AV** command. To set to this mode, specify the *averaging number* with a negative number. Number of power line cycles is determined by the following expression:

$$\text{number of power line cycles} = - (\text{averaging number})$$

For example, if 3 periods are specified, 96 samples are taken and averaged for the measurement.

Before the measurements, make sure the **FILTER** switch on the rear panel is set to the correct line frequency.

NOTE

During sweep measurements, averaging settings can be changed using the **AV** command.

FILTER

Allowable Unit:

HPSMU and MPSMU

Each SMU provides a low-pass filter (LPF) at the digital-to-analog converter (DAC) output. When the DAC output changes, a spike occurs. DAC output changes when the output value, compliance value, or output range changes. If the filter is ON, the spike is reduced to 1/30 of its unfiltered value. Output overshoot becomes 0.03% (typically) of the maximum value in the range. However, the SMU settling time may be longer. If the filter is ON, the SMU settling time is 200 μ s to 500 ms. If the filter is OFF, the SMU settling time is 10 μ s to 500 ms. The settling time of each depends on output value, output range, and compliance. The initial setting of the filter is ON, and can be set to ON or OFF using the FL command.

When an SMU filter is ON, the output wait time is set to the SMU settling time (200 μ s to 500 ms). When an SMU filter is OFF, the output wait time is set to the SMU settling time if the SMU settling time (10 μ s to 500 ms) is 5 ms or less. If the SMU settling time is greater than 5 ms, the output wait time is set to 5 ms. When an SMU filter is set to OFF, wait for the settling time of the SMU before making a measurement. Setting multi-channel output is usually much faster when SMU filters are OFF because the maximum wait time between output settings is 5 ms versus 500 ms when the SMU filter is on.

NOTE

- When an SMU filter is set to OFF, the DAC output settling time is 1/40 of the filter ON value. However, the actual settling time at the output terminal is limited by the slew rate, and thus is greater than the DAC output settling time. The slew rate depends on the test device, output range, and compliance value. The filter OFF output terminal settling time is still less than the filter ON value. For example, if the two following conditions apply, the filter OFF value is less than 50% of the filter ON value.

Voltage difference:	less than 50 V
I Compliance:	greater than 1 mA

If above conditions do not apply, the filter OFF value will be 50% to 100% of the filter ON value.

- When using an SMU as a pulse source, set the filter of that SMU to OFF (to enable pulse output). SMU filter initial setting is ON.

AUTOMATIC SWEEP ABORT FUNCTION

Allowable Measurement Mode:

Staircase sweep / Staircase sweep with pulsed bias / Pulsed sweep / Pulsed sweep with pulsed bias measurements

To reduce sweep time and to prevent damage to the test device during sweep measurements, the *automatic sweep abort function* parameter of the **WM** command aborts a sweep if any of the following conditions occur:

- 1) If SMU or HCU output reaches compliance.
- 2) If VS output reaches I limit.
- 3) If a measurement value exceeds the specified measurement range.
- 4) If an SMU oscillates.

If a sweep aborts, the staircase sweep source forces the specified *start value*, the pulsed source and pulsed sweep source force the specified *base* value. An **F** is displayed in the **ERROR/FAILURE** display, and dummy data (199.999E+99) is returned for measurement points not reached.

NOTE

For staircase sweep measurements: if you set *power compliance* and the output of the SMU that you set *power compliance* reaches *power compliance*, *V compliance*, or *I compliance*, the HP 4142B automatically stops the measurement, even if you do not specify *automatic sweep abort function*.

If the HP 4142B receives an abort (**AB**) command, only the measurement data obtained before the sweep was aborted is stored in the output data buffer (dummy data is not stored).

OUTPUT AFTER SWEEP

Allowable Measurement Mode:

Staircase sweep / Staircase sweep with pulsed bias measurements

After staircase sweep or staircase sweep with pulsed bias measurements, you can set the output of staircase sweep source to either *start* value or *stop* value by the *output after sweep* of the **WM** command.

However, if the sweep is stopped by *power compliance*, *automatic sweep abort function*, or **AB** command, the *start* value is forced regardless of the *output after sweep* setting.

MEASUREMENT DATA MEMORY

When the HP 4142B performs a measurement, measurement data are stored in the internal output data buffer. Output data buffer size is 16383 bytes. The maximum number of data that can be stored in the output data buffer depends on the data format specified by the **FMT** command as follows.

- ASCII data with header (15 bytes) and "CR/LF^EOI" terminator (2 bytes):
(default)
 - Spot measurement: Max. 963 data
 - Sweep measurement: Max. 1023 data
- ASCII data without header (12 bytes) and "," terminator (1 byte):
 - Spot measurement: Max. 1023 data
 - Sweep measurement: Max. 1023 data
- ASCII data without header (12 bytes) and "CR/LF^EOI" terminator (2 bytes):
 - Spot measurement: Max. 1170 data
 - Sweep measurement: Max. 1260 data
- BINARY data (4 bytes) and "CR/LF^EOI" terminator (2 bytes):
 - Spot measurement: Max. 2730 data
 - Sweep measurement: Max. 4095 data
- BINARY data (4 bytes) and "^EOI" terminator (0 byte):
 - Spot measurement: Max. 4095 data
 - Sweep measurement: Max. 4095 data

For more information about measurement data format, see the *HP-IB Command Reference Manual*.

The data buffer sends measurement data in the order in which it was stored. Therefore, if you transfer the measurement data after you perform the measurement twice, first measurement data is transferred from the HP 4142B first. If there is an output data buffer overflow, new measurement data is not stored and existing measurement data is maintained. Clear the output data buffer with the **BC** command. You can also clear it with the **FMT**, ***RST**, Device Clear, or by turning the HP 4142B off.

PROGRAM MEMORY

HP-IB commands can be stored locally in the internal program memory of the HP 4142B. Program memory size is 5000 bytes, enabling you to store approximately 500 commands. The commands stored in program memory can be grouped into as many as 99 programs. Because the programs are stored locally in the HP 4142B instead of in the controller, the following steps are eliminated, thus increasing execution speed.

- 1) Command transmission:
Transmission of commands from the controller to the HP 4142B.
- 2) Command validation:
Checking the syntax and content of transmitted commands.
- 3) Internal code conversion:
Conversion of commands to the internal code of the HP 4142B.

For example, **DV** command execution time can be reduced by about 1 ms if the **DV** command is stored in internal program memory. Also, if frequently used command strings are stored in internal program memory, bus/controller activity is reduced to a minimum.

The following table lists the HP-IB commands that can be stored in program memory, and the number of bytes required for each command.

HP-IB Commands Allowed in Internal Program Memory (1 of 2)

HP-IB Command	Optional Parameters	No. of Bytes ¹
AIV	0	12
	1	14
ASM	0	4
	1	6
ASV	0	10
	1	12
	2	16
AT	---	6
AV	0,1	6
AVI	0	12
	1	14
BC	---	2
CL	0,2,4,6,8	2+n
	1,3,5,7	2+(n+1)
CN	0,2,4,6,8	2+n
	1,3,5,7	2+(n+1)
DI	0	8
	1	12
DO	0,2,4,6	4+n
	1,3,5,7	4+(n-1)
DV	0	8
	1	12
DZ	0,2,4,6,8	2+n
	1,3,5,7	2+(n+1)
FL	1,3,5,7	4+(n-1)
	0,2,4,6,8	4+n
FMT	0,1	4
IN	0,2,4,6,8	2+n
	1,3,5,7	2+(n+1)
MM	1,3,5,7	4+(n-1)
	0,2,4,6,8	4+n
OS	---	2
PA	0,1	6
PDM	0	2
	1	4
PDI	0	10
	1	14
PDV	0	10
	1	14

¹ Where *n* is the number of optional parameters used in the command.

HP-IB Commands Allowed in Internal Program Memory (2 of 2)

HP-IB Command	Optional Parameters	No. of Bytes ¹
PI	0	10
	1	14
PT	0,1	8
PV	0	10
	1	14
PWI	0	14
	1	18
PWV	0	14
	1	18
RI	---	6
RU	---	4
RV	---	6
RZ	0,2,4,6,8	$2+n$
	1,3,5,7	$2+(n+1)$
TI	0,1	6
TM	---	4
TV	0,1	6
VM	---	4
WI	0	14
	1	18
	2	20
WM	0,1	4
WS	0,1	4
WSI	0	14
	1	18
	2	20
WSV	0	14
	1	18
	2	20
WT	---	6
WV	0	14
	1	18
	2	20
XE	---	2
*SRE	---	4

¹ Where n is the number of optional parameters used in the command.

Using Program Memory

The following paragraphs describe how to store, execute, list, and scratch programs using the program memory function. See *HP-IB Command Reference Manual* for details on each command.

Storing Programs

Use the **ST** and **END** commands to store a program. The **ST** command indicates the start of the program and assigns its program number (*program#* is an integer from 1 to 99). Following the **ST** command, enter the desired HP-IB commands in the order you want them executed. Use the **END** command to indicate the end of a program. The HP 4142B continues to store HP-IB commands until the **END** command is received or until a memory overflow.

NOTE

If program memory overflows while storing a program, an F displays on the **ERROR/FAILURE** Display.

Executing Programs

To execute a stored program, use the **RU** or **DO** command with the *program#*.

- 1) Use the **RU** command with *start program#* and *stop program#* to execute a series of programs. For example, if **RU1,5** is sent to the HP 4142B, *program#1* through *program#5* executes in sequence.
- 2) Use the **DO** command to execute programs in a specified order. For example, if **DO2,5,4** is sent to the HP 4142B, these programs execute in this order: *program#2*, *program#5*, and *program#4*. You can specify up to eight programs for each **DO** command.

Listing Programs

Use the **LST?** command with the *program#* to place a program list in the output buffer. You can then read the program list using the controller.

Scratching (Deleting) Programs

Use the **SCR** command with a *program#* to scratch a program from program memory. If you do not specify a *program#* with the **SCR** command, all programs in program memory are scratched. If you store a new program using the same *program#* as an existing program, the old program is scratched and the new program is stored.

NOTE

Program memory is cleared only by the **SCR** command and when the HP 4142B is turned OFF. ***RST** and Device Clear (HP BASIC **CLEAR**) commands do not clear program memory.

Program Memory Sample Program

The following is a sample program for using the program memory function. A description of key program lines follows the program list.

Program List

```
10  ! SAMPLE PROGRAM FOR PROGRAM MEMORY
20  !
30  OPTION BASE 1
40  INTEGER B_ch, C_ch
50  DIM A$(7)[15], Exit$(1)
60  ASSIGN @Hp4142 TO 717
70  OUTPUT @Hp4142;"*RST"
80  !                               Emitter   : GNDU
90  B_ch=3                          ! Base    : Ch#3
100 C_ch=2                          ! Collector : Ch#2
110 !
120 OUTPUT @Hp4142;"ST";1
130 OUTPUT @Hp4142;"DV";B_ch, 0, -3, 1.E-7      ! Vb=-3V
140 OUTPUT @Hp4142;"DV";C_ch, 0, 30, 1.E-7     ! Vc=30V
150 OUTPUT @Hp4142;"TI";C_ch, 0                ! Icev Measurement
160 OUTPUT @Hp4142;"TI";B_ch, 0                ! Ibev Measurement
170 OUTPUT @Hp4142;"END"
180 !
190 OUTPUT @Hp4142;"ST";2
200 OUTPUT @Hp4142;"DI";C_ch, 0, 1.E-2, 2      ! Ic=10mA
210 OUTPUT @Hp4142;"DI";B_ch, 0, 1.E-3, 2     ! Ib=1mA
220 OUTPUT @Hp4142;"TV";C_ch                  ! Vce(sat) Measurement
230 OUTPUT @Hp4142;"TV";B_ch                  ! Vbe(sat) Measurement
240 OUTPUT @Hp4142;"END"
250 !
260 OUTPUT @Hp4142;"ST";3                    ! Early Voltage
Measurement
270 OUTPUT @Hp4142;"DI";B_ch, 0, 2.E-5, 2     ! Ib=20uA
280 OUTPUT @Hp4142;"DV";C_ch, 0, 2, 1.E-2     ! Vc1=2V
290 OUTPUT @Hp4142;"TI";C_ch                  ! Ic1 Measurement
300 OUTPUT @Hp4142;"DV";C_ch, 0, 6           ! Vc2=6V
310 OUTPUT @Hp4142;"TI";C_ch                  ! Ic2 Measurement
320 OUTPUT @Hp4142;"END"
330 !
340 OUTPUT @Hp4142;"ST";4
350 OUTPUT @Hp4142;"DI";B_ch, 12, 0, 2        ! Ib=0A
360 OUTPUT @Hp4142;"DI";C_ch, 0, 1.E-3, 70    ! Ic=1mA
370 OUTPUT @Hp4142;"TV";C_ch                  ! BVceo Measurement
380 OUTPUT @Hp4142;"END"
390 !
400 OUTPUT @Hp4142;"ST";5
410 OUTPUT @Hp4142;"DZ"
420 OUTPUT @Hp4142;"END"
430 !
```

```

440 OUTPUT @Hp4142;"CN";B_ch, C_ch
450 LOOP
460 OUTPUT @Hp4142;"RU";1, 5
470 ENTER @Hp4142 USING "#, 15A, 2X";A$(*)
480 PRINT "Icev=           ";A$(1)[4, 15]
490 PRINT "Ibev=           ";A$(2)[4, 15]
500 PRINT "Vce(sat)=       ";A$(3)[4, 15]
510 PRINT "Vbe(sat)=       ";A$(4)[4, 15]
520 Ic1=VAL(A$(5)[4, 15])
530 Ic2=VAL(A$(6)[4, 15])
540 Vc1=2
550 Vc2=6
560 Va=(Vc1*Ic2-Ic1*Vc2)/(Ic2-Ic1)
570 PRINT "Early Voltage=     "PROUND(Va, -2)
580 PRINT "BVceo=           "A$(7)[4, 15]
590 PRINT
600 !
610 INPUT "Set the next device and hit ""Return"" key to continue, or enter
""E"" to stop", Exit$
620 EXIT IF Exit$="E"
630 END LOOP
640 !
650 OUTPUT @Hp4142;"CL"
660 BEEP
670 END

```

Result

```

Icev=           +000.272E-09
Ibev=           -0.07796E-09
Vce(sat)=       +0.06760E+00
Vbe(sat)=       +0.74656E+00
Early Voltage=  -160
BVceo=         +058.368E+00

```

Description

```

120-170 Stores program#1 in HP 4142B memory.
190-240 Stores program#2 in HP 4142B memory.
260-320 Stores program#3 in HP 4142B memory.
340-380 Stores program#4 in HP 4142B memory.
400-420 Stores program#5 in HP 4142B memory.
440     Sets the output switches to ON.
460     Executes the the five programs.
470     Enters measurement data into the string array variable, A$.
480-590 Displays the measurement results.
610-620 Decides whether to exit or continue.
650     Sets the output switches to OFF.

```

USING THE HP 4142B WITH EXTERNAL INSTRUMENTS

The HP 4142B can perform measurements synchronized with external instruments, such as C meters, precision voltmeters/ammeters, probers, and handlers, via the rear panel **TRIGGER INPUT** and **TRIGGER OUTPUT** terminals. The following paragraphs describe how to synchronize external instruments with the HP 4142B to perform measurements.

Trigger Output and Input Function

You can trigger external instruments from the HP 4142B via the **TRIGGER OUTPUT** terminal. You can initiate HP 4142B operation via the **TRIGGER INPUT** terminal, as described in the following paragraphs. The following figure shows the connection of the HP 4142B and an external instrument. The figure also shows the trigger output waveform from the **TRIGGER OUTPUT** terminal, and the trigger input waveform conditions. For trigger input, the HP 4142B is triggered by a negative-going (HIGH to LOW) TTL level trigger.

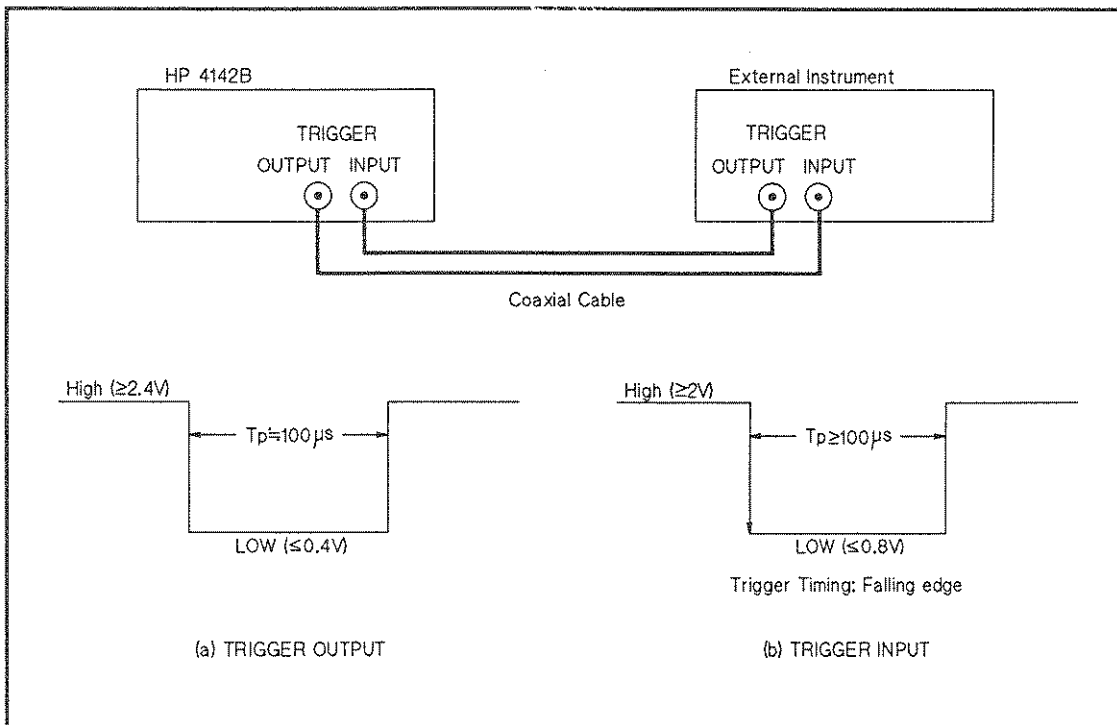

Trigger Output and Input

Triggering an External Instrument

To trigger an external instrument from the HP 4142B, execute the **OS** command. When the HP 4142B receives the **OS** command, the HP 4142B sends a trigger signal from **TRIGGER OUTPUT** terminal.

Externally Triggered HP 4142B Measurements

To externally trigger the HP 4142B to perform only measurements, set the *trigger mode* parameter of the **TM** command to 3. The HP 4142B performs a measurement when it receives a negative-going (HIGH to LOW) TTL level trigger.

To pause program execution until the HP 4142B receives a trigger and completes measurements, include an **ENTER** statement of the HP BASIC in your measurement program. The **ENTER** statement pauses program execution until measurement data is entered into the measurement data buffer. Then, the **ENTER** statement reads the data, and program execution continues.

When an externally triggered HP 4142B measurement is complete, the HP 4142B automatically sends a trigger signal from the **TRIGGER OUTPUT** terminal.

Waiting for Trigger Signal from TRIGGER INPUT Terminal

The **WAIT** state (**WS**) command waits for a negative-going (HIGH to LOW) TTL level trigger signal via the **TRIGGER INPUT** terminal.

You can cause the execution of the commands following the **WS** (for example, V/I sourcing or measurement commands) to wait until an external instrument completes its operation and triggers the HP 4142B.

WS signals the HP 4142B CPU to check the software **TRIGGER** flag to determine whether an external trigger has been received (**TRIGGER** flag **SET**) or not (**TRIGGER** flag **RESET**). The **TRIGGER** flag is **SET** when the HP 4142B receives an external trigger. The **TRIGGER** flag is **RESET** when any of the following occur:

- If ***RST** or Device Clear executes.
- If **TM3** executes.
- If **TM** *trigger mode* is changed from 3 to another mode.
- If **OS** executes.
- After a **WS** **WAIT** state completes.
- If the trigger signal via the **TRIGGER INPUT** terminal triggers the measurements.

WS provides two **WAIT** states--*waiting mode* parameters 1 and 2--as follows:

WS1 (default):

If the **TRIGGER** flag is **SET** when **WS1** is executed, the HP 4142B continues operation without waiting. If the **TRIGGER** flag is **RESET**, HP 4142B operation waits until an external trigger is received before continuing operation.

WS2:

When **WS2** executes, the HP 4142B operation waits--regardless of whether the **TRIGGER** flag is **SET** or **RESET**--and continues operation when the next external trigger is received.

Include the **WS** command in your measurement program immediately following the **OS** command. When **OS** executes, the HP 4142B triggers an external instrument to perform its operation. When the external instrument completes an operation, it triggers the HP 4142B, which is set to a WAIT state by **WS**, to perform its operation. Using **OS** and **WS** together, therefore, ensures that the HP 4142B and external instrument operations do not overlap.

If you want to end a WAIT state, execute the **AB** or ***RST** command. If you first send any other commands while the HP 4142B is in the WAIT state, the WAIT state ending commands are not effective because the command input buffer is full. In this case, use the Device Clear (**CLEAR** command in HP BASIC) to end the WAIT state.

NOTE

An external trigger can end a WAIT state independent of the *trigger mode* set by the **TM** command. To reduce programming complexity when using the **WS** command, set the **TM** command *trigger mode* to 1, 2, or 4. In **TM3**, WAIT state programming is complex because an external trigger signal can cause either of the following to occur:

Case 1--The HP 4142B is in a WAIT state when the external trigger is received.
The HP 4142B ends the WAIT state.

Case 2--The HP 4142B is not in a WAIT state when the external trigger is received.
The HP 4142B performs the measurement.

Waiting for Time or Trigger

Use the **PA** command to pause command execution or internal memory program execution. The pause lasts until the specified *wait time* has elapsed, or until a trigger is received (**XE** command, and **MM** command, HP BASIC **CLEAR** command, or the external trigger signal from **TRIGGER INPUT** terminal specified by the **TM** command). The trigger only releases the wait status and does not perform the measurements. The *wait time* setting area is from 0 to 99.9999s (100 μ s resolution).

If you send the **PA** command without a *wait time* parameter, you can pause until a trigger is received.

Waiting for Command Execution Completion

Use the ***OPC?** query command to wait for the completion of the previous command execution before sending a command to the external instrument. This command tells the HP 4142B to return a 1 to the HP 4142B query buffer. The measurement program then reads the contents of the query buffer (via the **ENTER** statement). A 1 in the query buffer indicates that the HP 4142B has executed the ***OPC?** command, that is, the HP 4142B has completed the previous command execution. In effect, the ***OPC?** command serves to delay external instrument operation until the HP 4142B has completed its operation.

For example, refer to the following program segment and assume that you're forcing current from the HP 4142B, and measuring voltage via an external voltmeter, such as the HP 3457A. By including the ***OPC?** command immediately after the I forcing (**DI**) command, then by reading the contents of the query buffer with the **ENTER** statement, the measurement program waits until the query buffer is set to 1 before performing a measurement with the HP 3457A.

```
OUTPUT 717;"DI";1,0,1.0E-10,1
OUTPUT 717;"*OPC?"
ENTER 717; AS
OUTPUT Hpib;"DCV"
```

(Hpib: HP-IB address of the HP 3457A)

(**DCV** command: V measurement command of the HP 3457A)

NOTE

If you do not include the ***OPC?** command in your measurement program(s) to confirm HP 4142B operation completion, an external instrument may initiate operation prematurely.

CHAPTER 6

MISCELLANEOUS FUNCTIONS

CONTENTS

Introduction	6-1
Front and Rear Panels	6-1
Front Panel	6-1
Rear Panel	6-6
Query Commands	6-7
HP-IB Capability	6-8
Status Byte	6-9
Status	6-9
Commands	6-10
Status Byte Sample Program	6-11
Self-Calibration	6-16
Auto-Calibration	6-16
Self-Test	6-17
Initial Settings	6-18

NOTES

INTRODUCTION

This chapter explains the functions that are not directly related to measurement. Included is information about front and rear panels, query commands, and the functions at power-on.

FRONT AND REAR PANELS

The following describes each key, indicator, and connector on the HP 4142B. See "Panel Overview" in chapter 2 for location on the panel of each item.

Front Panel

INTLK Terminal:

Used in conjunction with the INTERLOCK function of the HP 4142B. The HPSMU output can be as high as ± 200 V, and the MPSMU output can be as high as ± 100 V. The voltages are also present at the **GUARD** conductors of the SMU output terminals. If the INTLK terminal is open, i.e., not shorted, SMU output is limited to ± 42 V. Conversely, if you short the INTLK terminal (with a shorting switch or 0Ω termination), SMU output is enabled to the maximum output voltage of the unit.

For optimum measurement results when using the HP 4142B with a wafer prober or user-fabricated test fixture, use a grounded shielding box to minimize the effects of environmental noise and ambient light. Connect the INTLK terminal of the HP 4142B to a switch on the shielding box access door, so that when the door is open, voltage is limited to ± 42 V.

WARNING

SHORTING THE INTLK TERMINAL ENABLES SMU OUTPUT TO EXCEED ± 42 V. DANGEROUS VOLTAGES MAY BE PRESENT AT SMU OUTPUT CONNECTORS (CENTER CONDUCTORS AND INNER SHIELDS) WHEN THE INTLK TERMINAL IS SHORTED.

CIRCUIT COMMON (∇) - CHASSIS GROUND (\perp) Terminals:

Used when making floating or grounded measurements. These terminals are shorted together for grounded measurements, and disconnected from each other (shorting-bar removed) for floating measurements. The **CIRCUIT COMMON (∇)** terminal is connected to the outer conductors of the GNDU, SMU, HCU, VM, and VS connectors. The **CHASSIS GROUND (\perp)** terminal is tied to the HP 4142B chassis. If **CIRCUIT COMMON** is disconnected from **CHASSIS GROUND** and tied to external ground, the HP 4142B forces or measures voltage or current referenced to the external ground potential. For more information, see Chapter 3, "If the Test Device is Externally Grounded (Floating Measurements)."

WARNING

A POTENTIAL SHOCK HAZARD EXISTS IF THE CIRCUIT COMMON (∇) TERMINAL IS NOT TIED TO CHASSIS GROUND (\perp) (SHORTING-BAR DISCONNECTED FOR FLOATING MEASUREMENTS). DO NOT TOUCH ANY OF THE HP 4142B FRONT PANEL CONNECTORS AT ANY TIME WHILE A FLOATING MEASUREMENT IS IN PROGRESS.

DO NOT FLOAT THE CIRCUIT COMMON TERMINAL AT VOLTAGES GREATER THAN ± 42 V REFERENCED TO CHASSIS GROUND. FAILURE TO HEED THIS WARNING MAY RESULT IN DAMAGE TO YOUR HP 4142B.

HIGH VOLTAGE Lamp:

Indicates that the HP 4142B output is $> \pm 42$ V.

WARNING

DO NOT TOUCH THE SMU OUTPUT CONNECTORS WHEN THE HIGH VOLTAGE LAMP IS LIT. THIS LAMP INDICATES THAT DANGEROUS VOLTAGES OF UP TO ± 200 V MAY BE PRESENT AT THESE CONNECTORS.

Blank Panel:

For unused slots.

CAUTION

To prevent thermal damage to HP 4142B units, be sure that Blank Panels (part number 04142-60012) are installed in all unused slots.

ERROR/FAILURE Display:

The front panel **ERROR/FAILURE** Display indicates the status of the HP 4142B by displaying one of the following: **0** to **8**, **A**, **C**, **E**, **F**, **H**, or **P**. See the descriptions below.

- 0**: Displayed during normal operating conditions: The HP 4142B or specified plug-in unit(s) passed Self-Test or Self-Calibration.
- C**: The HP 4142B or specified plug-in unit(s) are now performing Self-Test or Self-Calibration.
- E**: The HP 4142B received an undefined command; all succeeding commands did not execute. Check for correct command syntax and out-of-range parameters.
- F**: Command execution not allowed due to present HP 4142B settings; normally caused by an incorrect input command sequence.

If **F** is displayed during a sweep measurement, one of the following occurred:

- 1) Measurement aborted: SMU reached *power compliance*.
- 2) Measurement aborted by *automatic sweep abort function*.
- 3) Output data buffer measurement data overflow.

- H**: All SMU, HCU, and VS outputs are disabled and output switches are disconnected to prevent SMU/HCU/VS damage due to an overvoltage or overcurrent, or a momentary power loss. Check for incorrect settings and check ac power. Reconnect the output switches by using the **CN** command.

1 to 8, A, P:

The HP 4142B failed. If a plug-in unit failed, **1** to **8** indicates the slot # of the failed unit. **A** indicates a failure in the HP 4142B analog-to-digital conversion (ADC) section; **P** indicates a failure in the HP 4142B central processing unit (CPU). If more than one failure occurs, the **ERROR/FAILURE** display indicates the last failure detected during Self-Test or Self-Calibration. Self-Test and Self-Calibration are performed in the following order.

- 1) CPU
- 2) ADC
- 3) All plug-in units by slot # (ascending), except the AFU.
- 4) AFU

To determine whether a multiple failure occurred, execute the ***TST?** command. This command performs the Self-Test again and displays test results on the controller.

If a plug-in unit fails, remove the failed unit from slot and use a known-good unit to perform your measurement. Contact the nearest Hewlett-Packard Sales and Service office for assistance.

If an **A**, **E**, **F**, **H**, **P**, or **1** to **8** is displayed, details about errors (error codes) are stored in the error register. Refer to *HP-IB Command Reference Manual* for error code descriptions.

The **ERROR/FAILURE** Display and error register are initialized (set to **0** and "0, 0, 0, 0", respectively) when the ***RST**, **ERR?**, or Device Clear (HPBASIC **CLEAR** statement) is executed. The error register is also initialized when **CA** or ***TST?** command execution begins.

POWER ON/OFF Switch:

Secondary ac Line switch. Used in conjunction with the rear panel **LINE ON/OFF** switch. Both switches must be set to **ON** to operate the HP 4142B. To simplify turning the HP 4142B on or off, keep the **POWER ON/OFF** switch setting **ON** at all times, and use the **LINE ON/OFF** switch only.

Line power is applied to the HP 4142B if the rear panel **LINE ON/OFF** switch is set to **ON**, even if the front panel **POWER ON/OFF** switch is set to **OFF**. To completely power down the HP 4142B, set the rear panel **LINE ON/OFF** switch to **OFF**, regardless of the **POWER ON/OFF** switch setting.

If you install or remove a plug-in unit, either set the **POWER ON/OFF** switch to **OFF** or set the **LINE ON/OFF** switch to **OFF**, depending on which is most accessible.

LOCAL/SELF TEST Key:

If the HP 4142B is in remote control, this key sets the HP 4142B to local control. If the HP 4142B is in local control, this key starts the HP 4142B Self-Test/Self-Calibration. If the HP 4142B is set to local lockout, this key is disabled.

MEASURING Lamp:

Indicates that the HP 4142B is performing a measurement.

HP-IB Status Indicators:

These LEDs indicate HP 4142B SRQ, LISTEN, TALK, and REMOTE HP-IB status. See "Status Byte" in this chapter for more information on SRQ.

GNDU Terminal:

Triaxial GNDU output terminal. The GNDU terminal output is Circuit Common voltage (0 V). The GNDU maintains 0 V output while sinking up to ± 1.6 A.

ZERO CHECK Terminal:

Circuit Common reference terminal for checking HP 4142B output voltage.

SLOTS:

For plug-in units. The slot number is 1 to 8 from left to right. The slot numbers indicate the number of slot for each plug-in unit.

FORCE and SENSE Terminals of the HP 41420A HPSMU:

Maximum output and input is 200V/1A.

WARNING

VOLTAGES UP TO ± 200 V MAY BE PRESENT AT THE FORCE, SENSE, AND GUARD TERMINALS. DO NOT TOUCH THESE TERMINALS IF THE FRONT PANEL HIGH VOLTAGE LAMP IS LIT.

FORCE and SENSE Terminals of the HP 41421B MPSMU:

Maximum output and input is 100V/100mA.

WARNING

VOLTAGES UP TO ± 100 V MAY BE PRESENT AT THE FORCE, SENSE, AND GUARD TERMINALS. DO NOT TOUCH THESE TERMINALS IF THE FRONT PANEL HIGH VOLTAGE LAMP IS LIT.

FORCE and SENSE Terminals of the HP 41422A HCU:

Maximum output and input is 10V/10A.

HP 41424A VS Terminal:

Maximum output is 40V/100mA.

HP 41424A VM Terminal:

Maximum input is 40 V.

MONITOR Port of the HP 41425A AFU:

See chapter 4, "Analog Search Measurements"

Rear Panel

LINE ON/OFF Switch:

Main ac line switch. Used in conjunction with the front panel **POWER ON/OFF** switch. Both switches must be set to **ON** to operate the HP 4142B. Note that line power is applied to the HP 4142B if this switch is set to **ON**, even if the front panel **POWER ON/OFF** switch is set to **OFF**.

HP-IB ADDRESS Switch:

For setting the HP-IB address (0 to 30) of the HP 4142B. The new HP-IB address is recognized only at power on.

HP-IB Connector:

24-pin connector for connecting the HP 4142B to HP-IB.

FILTER Switch:

For setting measurement integration time to minimize the effects of line-frequency noise. Set to the ac line frequency.

TRIGGER INPUT Terminal:

For triggering the HP 4142B. The HP 4142B is triggered (a measurement is performed) when a negative-going TTL level pulse (from HIGH--5 V to LOW--0 V) is applied. Trigger signals must be ≥ 100 μ s. See chapter 5, "Using the HP 4142B with External Instruments" for more information.

TRIGGER OUTPUT Terminal:

Sends a HIGH (5 V) TTL level signal. When the HP 4142B receives a trigger output command (**OS**), this terminal sends a LOW (0 V) TTL level pulse for approximately 100 μ s. See chapter 5, "Using the HP 4142B with External Instruments" for more information.

LINE Input Receptacle:

For connecting the HP 4142B ac line cord.

LINE VOLTAGE SELECTOR Switch:

For setting the ac line voltage (100 V, 120 V, 220 V, or 240 V). See Chapter 1 for more information on power requirements.

LINE FUSE Holder:

The HP 4142B line fuse is installed in this holder. See chapter 1 for more information on the line fuse.

QUERY COMMANDS

Query commands request HP 4142B operation status data, and return status results to the query buffer. This query data can then be read by the controller. The following table lists the query commands and output data associated with each command. Refer to the *HP-IB Command Reference Manual* for details about query command syntax and output data syntax.

The HP 4142B provides two separate buffers for query data and measurement data. When you perform a data buffer read, the query buffer is always checked first. If there is no query data, a read is performed on the measurement data buffer. Only query data for the most recent query command is stored in the query buffer. The query buffer is cleared by the **BC**, **FMT**, ***RST**, or Device Clear (HP BASIC CLEAR) command.

Query Commands

Command	Query Command Output Data
ERR?	The first four error codes.
*IDN?	Model number (HP 4142B) and ROM version.
LOP?	Plug-in unit operation status.
*LRN?	Plug-in unit output and measurement settings.
LST?	Contents of program memory.
NUB?	Number of measurement data stored in data buffer.
*OPC?	After *OPC? executes, a "1" is placed in the query buffer.
*SRE?	Mask condition of the status byte.
*STB?	Contents of the status byte.
*TST?	Self-Test results.
UNT?	Model # and hardware version of installed plug-in units.
WNU?	Number of steps in sweep measurement.

NOTE

***OPC?** facilitates the synchronizing of HP 4142B and external instrument operations. See "Waiting for Command Execution Completion" in this chapter for details.

Query command output data is always stored in the query buffer in ASCII format regardless of the measurement data output format.

HP-IB CAPABILITY

The following table lists the HP-IB capabilities and functions of the HP 4142B. These functions provide the means for an instrument to receive, process, and transmit, commands, data, and status over the HP-IB bus.

HP-IB Interface Capability

Interface Function	Code	Description
Source Handshake	SH1	Complete capability
Acceptor Handshake	AH1	Complete capability
Talker	T6	Basic Talker: YES Serial Poll: YES Talk Only Mode: NO Unaddress if MLA (my listen address): YES
Listener	L4	Basic Listener: YES Unaddress if MTA (my talk address): YES Listen Only Mode: NO
Service Request	SR1	Complete capability
Remote/Local	RL1	Complete capability (with local lockout)
Parallel Poll	PP0	No capability
Device Clear	DC1	Complete capability
Device Trigger	DT1	Complete capability
Controller Function	C0	No capability
Driver Electronics	E1	Open Collector

The HP 4142B responds to the following HP BASIC statements:

- **ABORT** (IFC)
- **CLEAR** (DCL or SDC, same as *RST command)
- **LOCAL** (GTL)
- **LOCAL LOCKOUT** (LLO)
- **REMOTE**
- **SPOLL** (Serial Poll)
- **TRIGGER** (GET, same as XE command)

Status Byte Sample Program

The following is a sample program that uses Bit 3 (Interlock Open) and Bit 5 (Error) of the status byte, and a sample program that uses Bit 4 (Set Ready). A description of key program lines follows each program list.

Program List 1

```
10 ! BVceo Measurement using High Speed Spot Function
20 !
30 DIM A$(15), Err$(23)
40 ASSIGN @Hp4142 to 717
50 OUTPUT @Hp4142;"*RST"
60 !
70 B_ch=3 ! Emitter : GNDU
80 C_ch=2 ! Base : Ch#3
90 Ib=0 ! Collector : Ch#2
100 Ic=1.E-3
110 Vc_comp=70
120 !
130 ON INTR 7 GOTO Service
140 ENABLE INTR 7;2
150 OUTPUT @Hp4142;"*SRE";40
160 !
170 OUTPUT @Hp4142;"CN";B_ch, C_ch
180 OUTPUT @Hp4142;"DI";B_ch, 12, Ib, 2
190 OUTPUT @Hp4142;"DI";C_ch, 0, Ic, Vc_comp
200 OUTPUT @Hp4142;"TV";C_ch
210 OUTPUT @Hp4142;"CL"
220 !
230 ENTER @Hp4142;A$
240 PRINT "Bvceo= ";A$(4, 15);"[V]"
250 DISABLE INTR 7
260 STOP
270 !
280 Service: !
290 OUTPUT @Hp4142;"CL"
300 Status_byte=SPOLL(@Hp4142)
310 IF BIT(Status_byte, 3)=1 THEN
320 DISP "NOT INTERLOCKED"
330 ELSE
340 OUTPUT @Hp4142;"ERR?"
350 ENTER @Hp4142;Err$
360 DISP "ERROR ";Err$
370 END IF
380 BEEP
390 END
```

Description 1

130	When an SRQ interrupt is received, go to line labeled "Service."
140	Enables the interrupt.
150	Removes masks from Bit3 and Bit5.
170	Sets the SMU output switches to ON.
180-200	Forces current and performs measurement.
210	Sets the SMUs output switches to OFF.
230-240	Enters and displays measurement data.
250	Disables the interrupt.
260	Stops the program.
290	Sets the SMU output switches to OFF.
300	Enters value of the status byte.
310-370	Displays the message.

STATUS BYTE

Status byte bits are turned off or on (0 or 1) to represent HP 4142B operation status. When you execute a Serial Poll (HPBASIC **SPOLL**) command, the controller reads the contents of the status byte, and responds accordingly. When an unmasked status bit is set to "1", the HP 4142B sends an SRQ to the controller, causing the controller to perform an interrupt service routine.

Status

The following table lists status byte contents.

Status Byte Contents

Bit 7 (128)	Bit 6 (64)	Bit 5 (32)	Bit 4 (16)	Bit 3 (8)	Bit 2 (4)	Bit 1 (2)	Bit 0 (1)
Shut Down	RQS	Error	Set Ready	Inter- lock Open	not used	Wait	Data Ready

(): Decimal Value. Use this value when specifying a bit in a command.

A brief description of each bit follows:

- Bit 0: Data Ready
This bit is set to "1" when measurement data or Query command response data is stored in the output data buffer. It is reset to "0" when all the stored data has been transferred to the controller, or when the HP 4142B receives a *RST, BC, FMT, or Device Clear (HP BASIC CLEAR) command.
- Bit 1: Wait
This bit is set to "1" by the PA or WS command. It is reset to "0" when the waiting condition is complete, or when the HP 4142B receives a *RST or Device Clear command.
- Bit 2: not used
This bit is always set to "0".
- Bit 3: Interlock Open
This bit is set to "1" if either of the following occurs when the INTLK terminal is not terminated (open).
1) The HP 4142B outputs a voltage that exceeds ± 42 V.
2) *V compliance* greater than ± 42 V is specified.
This bit is reset to "0" when the HP 4142B receives a Serial Poll, *RST, or Device Clear command.

- Bit 4: Set Ready
This bit is reset to "0" when any of the following occur, and set to "1" when the corresponding operation is complete.
- 1) HP-IB command is received.
 - 2) The **SELF-TEST Key** on the front panel is pushed.
 - 3) A trigger signal is received at the **TRIGGER INPUT Terminal**.
- Bit 5: ERROR
This bit is set to "1" when an error causes 1 to 8, A, E, F, H, or P to be displayed in the **ERROR/FAILURE** Display. It is reset to "0" when the HP 4142B receives a Serial Poll, *RST, ERR?, CA, *TST?, or Device Clear command. The **ERROR/FAILURE** Display is cleared to 0 by all these commands except the Serial Poll command.
- Bit 6: RQS (Request Service)
This bit is set to "1" whenever any other unmasked bit is set to "1". This causes the HP 4142B to send an SRQ to the controller. It is reset to "0" when the HP 4142B receives a Serial Poll, *RST, or Device Clear command. This bit is the only non-maskable status bit.
- Bit 7: Shut Down
This bit is set to "1" when an error causes H to be displayed in the **ERROR/FAILURE** Display. It is reset to "0" when the HP 4142B receives a Serial Poll, *RST, or Device Clear command. The **ERROR/FAILURE** Display is cleared to 0 by all these commands except the Serial Poll command.

NOTE

If Bit 3, Bit 5, or Bit 7 are masked, they are not reset to 0 by a Serial Poll command. Also, if these bits are masked, set to "1", then unmasked, a Serial Poll command does not reset them to "0".

After a masked bit is set to "1", removing the mask does not set Bit 6 to "1". That is, the HP 4142B does not send an SRQ to the controller. Therefore, if you remove a mask from a bit, it is usually best to do it at the beginning of the program.

Commands

The commands related to the status byte are listed below.

- (1) *STB?
This command sends the contents of the status byte to the controller. The status byte is not cleared by this command.
- (2) *SRE
This command removes the mask from the specified bits. All bits except Bit 6 are masked in the initial setting. If parameter is 0, this command masks all bits.
- (3) *SRE?
This command outputs data about which bits of the status byte are masked.

Program List 2

```

10  ! Ic-Vce Measurement using Sweep with Pulsed Bias Function
20  !
30  OPTION BASE!
40  INTEGER B_ch, C_ch, Vc_no_step, Ib_no_step, Var1, Var2
50  INTEGER Data_no, Plot_no, X
60  DIM A$(3)[1615]
70  REAL Vc(101)
80  ASSIGN @Hp4142 TO 717
90  OUTPUT @Hp4142; "*RST"
100 !
110 B_ch=3
120 C_ch=2
130 Vc_start=0
140 Vc_stop=20
150 Vc_no_step=101
160 Ic_comp=.1
170 Ib_start=2.E-4
180 Ib_step=1.E-4
190 Ib_no_step=3
200 !
210 OUTPUT @Hp4142;"CN";B_ch, C_ch
220 OUTPUT @Hp4142;"WV";C_ch, 1, 0, Vc_start, Vc_stop, Vc_no
    _step, Ic_comp
230 OUTPUT @Hp4142;"FL";0, B_ch
240 OUTPUT @Hp4142;"PT";0, 1.E-3, 5.E-2
250 OUTPUT @Hp4142;"MM";5, C_ch
260 OUTPUT @Hp4142;"RI";C_ch, -19
270 !
280 Data_no=1
290 ON INTR 7 GOSUB Service
300 ENABLE INTR 7;2
310 OUTPUT @Hp4142;"PI";B_ch, 0, 0, Ib_start, 2
320 OUTPUT @Hp4142;"*SRE16;XE"
330 !
340 CALL Icvc_graph(Vc_start, Vc_stop, 0, Ic_comp)
350 Vc_step=(Vc_stop-Vc_start)/(Vc_no_step-1)
360 FOR Var1=1 TO Vc_no_step
370     Vc(Var1)=Vc_start+(Var1-1)*Vc_step
380 NEXT Var1
390 !
400 Plot_no=1
410 FOR Plot_no=1 TO Ib_no_step
420     LOOP
430     EXIT IF Plot_no<Data_no
440     END LOOP
450     FOR Var1=1 TO Vc_no_step
460         Ic=VAL(A$(Plot_no)[16*(Var1-1)+4;12])
470         PLOT Vc(Var1), Ic
480     NEXT Var1
490     PENUP
500 NEXT Plot_no
510 !
520 OUTPUT @Hp4142;"CL"
530 STOP
540 !

```

```

550 Service: !
560 Status_byte=SPOLL(@Hp4142)
570 OUTPUT @Hp4142;"*SRE0"
580 !
590 ENTER @Hp4142;A$(Data_no)
600 !
610 Data_no=Data_no+1
620 IF Data_no<=lb_no_step THEN
630     lb=lb_start+(Data_no-1)*lb_step
640     ENABLE INTR 7;2
650     OUTPUT @Hp4142;"PI";B_ch, 0, 0, lb
660     OUTPUT @Hp4142;"*SRE16;XE"
670 END IF
680 RETURN
690 !
700 END
710 !
720 SUB lcvc_graph(X_axis_min, X_axis_max, Y_axis_min, Y_axis_max)
730     !
740     GINIT
750     GRAPHICS ON
760     CONTROL CRT, 12;1
770     PRINT CHR$(12)
780     !
790     Xmax=100*MAX(1, RATIO)
800     Ymax=100*MAX(1, 1/RATIO)
810     !
820     LORG 6
830     MOVE Xmax/2, Ymax
840     LABEL "COLLECTOR CHARACTERISTICS"
850     DEG
860     LDIR 90
870     CSIZE 4.5
880     MOVE 0, Ymax/2
890     LABEL "Ic(A)"
900     LORG 4
910     LDIR 0
920     MOVE Xmax/2, 0
930     LABEL "Vce(V)"
940     !
950     VIEWPORT .16*Xmax, .91*Xmax, .15*Ymax, .9*Ymax
960     !
970     FRAME
980     WINDOW X_axis_min, X_axis_max, Y_axis_min, Y_axis_max
990     AXES(X_axis_max-X_axis_min)/10,(Y_axis_max-Y_axis_min)/10,
X_axis_min, Y_axis_min
1000     CLIP OFF
1010     CSIZE 4, .5
1020     LORG 6
1030     FOR I=X_axis_min TO X_axis_max STEP (X_axis_max-X_axis_min)/2
1040         MOVE I, Y_axis_min
1050         LABEL I
1060     NEXT I

```

```

1070 CSIZE 3.8, .5
1080 LORG 8
1090 FOR I=Y_axis_min TO Y_axis_max STEP (Y_axis_max-Y_axis_min)/2
1100     MOVE X_axis_min, I
1110     LABEL USING "#, MD.DE";I
1120 NEXT I
1130 CLIP ON
1140 I
1150 SUBEND

```

Description 2

110-260 Sets up the conditions for staircase sweep with pulsed bias measurements.

280 Sets sweep data # to 1.

290 When SRQ interrupt is received, go to "Service" subroutine. In this program, the SRQ is received after measurements are performed.

300 Enables the interrupt.

310 Sets up and forces the first Base current.

320 Removes mask from Bit 4 and performs measurements.

340 Calls subprogram to display a graphics frame.

350-380 Calculates Collector voltage for each step, and stores these values in an array variable.

400 Sets sweep data plot# to 1.

410-500 Plots the sweep data. Loops between line 420 and line 440 until sweep data is ready for plotting.

530 Stops the program.

560 Clears the SRQ (resets Bit 6).

570 Disables the SRQ (masks all bits).

590 Enters the measurement data.

610 Increments the sweep data#.

620-670 If not final Base current, sets up next base current, outputs base current, enables interrupt, removes mask from Bit 4, and performs measurement.

680 Returns to main program.

720-1150 Subprogram to display a graphics frame.

SELF-CALIBRATION

To minimize output drift and measurement fluctuations caused primarily by changes in the ambient temperature, the HP 4142B provides a Self-Calibration function. Self-Calibration is performed automatically when you turn your HP 4142B on. After a minimum 40 minute warm-up period and before you begin to use your HP 4142B, perform Self-Calibration again by pressing the **LOCAL/SELF TEST** key, or by executing the **CA** command. Self-Calibration should be performed every 30 minutes, or if the ambient temperature changes by more than 3°C (6°F).

Auto-Calibration

The Auto-Calibration function of the HP 4142B automatically performs Self-Calibration at 30 minute intervals after the output switches of all plug-in units have been set to OFF for 30 minutes. Use the **CM** command to enable or disable the Auto-Calibration function. Auto-Calibration is enabled when you turn the HP 4142B on.

SELF-TEST

The HP 4142B has a Self-Test function that automatically checks its basic operation when you turn your HP 4142B on.

You can also initiate the Self-Test at any time by pressing the **LOCAL/SELF TEST** key, or by executing the ***TST?** command.

When the HP 4142B starts Self-Test, a **C** is displayed in the **ERROR/FAILURE** display and the **LOCAL/SELF TEST** key indicator lights. When Self-Test is finished, the **LOCAL/SELF TEST** key indicator light goes out and a **0** (No error) is displayed.

If a **1** to **8**, **A**, **P** is displayed, the HP 4142B failed Self Test. If a plug-in unit failed, **1** to **8** indicates the slot # of the failed unit. **A** indicates a failure in the HP 4142B analog-to-digital conversion (ADC) section; **P** indicates a failure in the HP 4142B central processing unit (CPU). If more than one failure occurs, the **ERROR/FAILURE** display indicates the last failure detected during Self-Test or Self-Calibration. Self-Test and Self-Calibration are performed in the following order:

- 1) CPU
- 2) ADC
- 3) All plug-in units by slot # (ascending), except the AFU.
- 4) AFU

To determine whether a multiple failure occurred, execute the ***TST?** command. This command performs the Self-Test again and displays the test results on the controller. If Self-Test is performed by pressing the **LOCAL/SELF TEST** key, the test results are not returned.

If a plug-in unit fails, remove the failed unit from the slot and use a known-good unit to perform your measurement. Contact the nearest Hewlett-Packard Sales and Service office for assistance.

When the HP 4142B performs Self-Test, the HP 4142B also performs Self-Calibration.

NOTE

Units that fail Self-Test are disabled except ***TST?** command, and can only be enabled by the **RCV** command. However, the **RCV** command should be used only for servicing the HP 4142B. DO NOT use this command during normal operation.

INITIAL SETTINGS

The HP 4142B is initialized at power ON, or when an *RST or Device Clear (HP BASIC CLEAR) command executes. The following table lists the initial settings of the HP 4142B.

Initial Settings (1 of 3)

Setting Item	Initial Setting		Command
SMU/HCU/VS output	open		CN and CL
SMU/HCU/VS output switch	OFF		CN and CL
SMU filter	ON		FL
VM operation mode	grounded measurement		VM
	spot staircase sweep analog search	Auto	RI
I measurement range of SMU/HCU	1ch pulsed spot pulsed sweep sweep with pulsed bias 2ch pulsed spot pulsed sweep with p_bias	¹	
V measurement range of VM	spot staircase sweep	Auto	RV
	1ch pulsed spot pulsed sweep sweep with pulsed bias	40V	
automatic sweep abort function	OFF		WM
output after sweep of staircase sweep source	start value		WM

¹ Compliance range

Initial Settings (2 of 3)

Setting Item	Initial Setting	Command
hold time	staircase sweep	WT
	1ch pulsed spot pulsed sweep sweep with pulse bias 2ch pulsed spot pulsed sweep with p_bias	0s PT
	analog search	AT
delay time	staircase sweep	0s WT
	analog search	AT
pulse width	0.001 s	PT
pulse period	0.01 s	PT
primary pulse channel	unit specified by PDV/PDI	PDM
search operation mode	negative feedback search	ASM
search measurement mode	search SMU V measurement	ASM
feedback integration time	0.005 s	ASM
trigger	XE, TV, TI, or GET ¹	TM
averaging mode	Auto	AV
averaging number	1	AV
auto calibration	ON	CM
measurement data output format	ASCII (with header and CR/LF)	FMT
output data buffer	cleared	BC
program memory	cleared ²	SCR
status byte	all bits masked except Bit 6	*SRE
ERROR/FAILURE display	displays 0	---
error code register	cleared	ERR?

¹ GET is the HP-IB bus trigger command. For HP BASIC, use the **TRIGGER** command.

² Only at power ON. Program memory is not cleared by an *RST or Device Clear (HP BASIC CLEAR) command.

Initial Settings (3 of 3)

Setting Item	Initial Setting	Command
sweep source parameters	cleared	WV, WSV WI, WSI
pulse source parameters	cleared	PV, PI PDV, PDI
pulse sweep source parameters	cleared	PWV, PWI
search SMU parameters	cleared	ASV
sense SMU parameters	cleared	AVI, AIV

APPENDIXES

CONTENTS

Appendix A, Manual Changes	A-1
Appendix B, Specifications	B-1
Appendix C, Accessories and Options	C-1

NOTES

APPENDIX A

MANUAL CHANGES

HP 4142Bs may vary slightly, depending on the Serial Number and the version of the ROM-based firmware. The information in this manual applies directly to an HP 4142B with the serial number prefix listed on the title page of this manual. This appendix contains information for customizing this manual, so that all the information pertains to the HP 4142B that you are using.

To customize this manual for your HP 4142B, refer to the following table, and make all of the manual changes corresponding to the serial number of your HP 4142B and version of the ROM-based firmware.

To see the version of your HP 4142B ROM-based firmware, send:

```
10  OUTPUT 717;"*IDN?"
20  ENTER 717;A, B, Version
30  DISP Version
40  END
```

Manual Changes by Serial Number

Serial Prefix or Number	ROM Version	Make Manual Changes
2839Jxxxxx and below	2.52 and below	1
	Above 2.52	No changes

• Change 1

Throughout this manual, delete any descriptions referring to the HP 41422A HCU, and to the 40 V, 100 V, and 200 V range of the Search SMU in the Analog feedback measurements.

You cannot use your HP 4142B with the HP 41422A HCU, and cannot use the 40 V, 100 V, and 200 V range of the Search SMU in Analog feedback Measurements.

NOTES

APPENDIX B

SPECIFICATIONS

The following two tables list complete HP 4142B specifications and supplemental performance characteristics. The specifications are the performance standards or limits against which the HP 4142B is tested. When the HP 4142B is shipped from the factory, it meets the specifications. The characteristics are not specifications but are typical characteristics included as additional information for the operator.

GENERAL INFORMATION

Basic Function:

Performs high speed DC parameter measurements.

Plug-in Units:

The HP 4142B provides eight plug-in unit slots, and any combination of units can be specified.* The five types of plug-in units available, and their slot requirements, are listed below.

HP 41420A Source/Monitor Unit (SMU), 40 μ V-200V/20fA-1A: 2 slots

HP 41421B Source/Monitor Unit (SMU), 40 μ V-100V/20fA-100mA: 1 slot

HP 41422A High Current Source/Monitor Unit (HCU),
40 μ V-10V/20nA-10A: 2 slots

HP 41424A Voltage Source/Voltage Monitor Unit (VS/VMU): 1 slot

HP 41425A Analog Feedback Unit (AFU)*: 1 slot

* Only one AFU can be installed per HP 4142B.

Maximum Power Consumption:

Total SMU, HCU and VS/VMU power consumption must not exceed 32W. Power consumption for these units is calculated as follows.

SMUs (HP 41420A and HP 41421B):

V Source Mode:

Voltage Range	Power
2V	20Ic
20V	20Ic
40V	40Ic
100V	100Ic
200V	200Ic

where Ic is the current compliance setting.

I Source Mode:

Voltage Compliance	Power
$V_c \leq 20$	20I _o
$20 < V_c \leq 40$	40I _o
$40 < V_c \leq 100$	100I _o
$100 < V_c \leq 200$	200I _o

where Vc is the voltage compliance setting; I_o is output current.

Output switch set to OFF: 0W

Maximum Power Consumption (continued):

HCU (HP 41422A):

V Source Mode:

$$\text{Power} = 10 + 20I_c(\text{pulse width/pulse period})$$

where I_c is the current compliance setting.

I Source Mode:

$$\text{Power} = 10 + 20I_o(\text{pulse width/pulse period})$$

where I_o is the output current.

Output switch set to OFF: 0 W

VS/VMU (HP 41424A):

Voltage Range	Power
20 V	2.2 W
40 V	0.88 W

Output switch set to OFF: 0 W

AFU (HP 41425A): 0 W

Furnished Unit:

Ground Unit (GNDU), 0 V Output, Maximum Sink Current: 1.6 A

Measurement Modes:

Spot, Staircase Sweep, 1 ch Pulsed Spot, 2ch Pulsed Spot, Pulsed Sweep, Staircase Sweep with Pulsed Bias, Pulsed Sweep with Pulsed Bias, and Analog Search Measurements

Measurement and Output Accuracy Conditions:

Measurement and output accuracies are specified at the front panel connector terminals, referenced to the ZERO CHECK terminal (except for the HCU) under the following conditions:

1. $23^\circ \pm 5^\circ\text{C}$ --accuracies double from $5^\circ - 17^\circ\text{C}$, and $29^\circ - 40^\circ\text{C}$.
2. After a minimum 40 minute warm-up period.
3. After performing Self-calibration.
4. Averaging mode: AUTO; Averaging number: 1
5. SMU Filter: ON (For SMUs)
6. Kelvin connection (For SMU, HCU, and GNDU voltage accuracy)

Accuracies for the HCU are specified between the high and low sense terminals on the front panel of the HCU.

HP 4142B Modular DC Source/Monitor

Ground Unit (GNDU): 1 channel (Kelvin connection)

Maximum Sink Current: 1.6A

Output Voltage: 0V \pm 500 μ V

Maximum Voltage Between Common and Ground: \leq 42V

Plug-in Unit Control Functions:

Spot Measurement Mode: Outputs and measures voltage and current.

Staircase Sweep Measurement Mode: Outputs and measures sweep voltage and current. One channel can sweep current or voltage while up to 8 channels can measure current or voltage. A second channel can be slaved to the first channel (dual synchronous sweep). Linear or log sweeps can be performed.

Number of Steps: 2 - 1001

Hold Time: 0 - 655.35s, 10ms resolution.

Delay Time: 0 - 65.535s, 1ms resolution.

1ch Pulsed Spot Measurement Mode: Outputs and measures V and I pulses.

Pulse Width: 1ms to 50ms, 100 μ s steps (SMU or VS).

100 μ s to 1ms, 100 μ s steps (HCU).

Pulse Period: 10ms to 500ms, 100 μ s steps.

2ch Pulsed Spot Measurement Mode: Outputs and measures V and I pulses in synchronization with a pulse of another channel.

Pulse Width: 100 μ s to 800 μ s, 100 μ s steps

pulse width of another channel is set to about 1ms.

Pulse Period: same as 1ch Pulsed Spot

Pulsed Sweep Measurement Mode: Outputs and measures V and I sweep pulses.

Number of Steps and Hold Time: same as Staircase Sweep Measurement Mode.

Pulse Width and Pulse Period: same as 1ch Pulsed Spot Measurement Mode.

Staircase Sweep with Pulse Bias Measurement Mode: Outputs sweep V or I and performs measurements in synchronization with a periodic pulse of another channel.

Number of Steps and Hold Time: same as Staircase Sweep Measurement Mode.

Pulse Width and Pulse Period: same as 1ch Pulsed Spot Measurement Mode.

Pulsed Sweep with Pulsed Bias Measurement Mode: Outputs pulsed sweep V or I and performs measurements in synchronization with a periodic pulse of another channel.

Number of Steps and Hold Time: same as Staircase Sweep Measurement Mode.

Pulse Width and Pulse Period: same as 1ch Pulsed Spot Measurement Mode.

Analog Search Measurement Mode: Performs measurements using the HP 41425A

Analog Feedback Unit.

HP 4142B Modular DC Source/Monitor (continued)

Pulse Measurement Restrictions (for SMU):

Current Output Range¹: 10nA to 1A

Maximum Voltage for 10nA to 10 μ A Range¹: 2V

Current Measurement Range:

10nA to 1A Range (when voltage output range is 2V)

100 μ A to 1A Range (when voltage output range is 20V to 200V)

Current Limit (Compliance) Minimum Setting Value¹:

2nA (when voltage output range is 2V)

20 μ A (when voltage output range is 20V to 200V)

SMU filter: OFF

Averaging Function: Not available

¹ Not applicable if an SMU is set to constant source and does not perform measurements.

Pulse Measurement Restrictions (for HCU):

Maximum Pulse Duty: 1% (when current range is 10A)

10% (when current range is 1mA to 1A)

Memory Function:

Data Memory: Measurement results can be stored. Maximum number of data are 4095 (binary) or 1023 (ASCII).

Program Memory: Program code can be stored.

Input/Output Functions:

External Trigger Input: TTL-level Negative Logic; pulse width must be > 100 μ s. For continuing a paused program when using the HP 4142B's internal program memory.

External Trigger Output: TTL-level Negative Logic; pulse width is approximately 100 μ s. For controlling peripherals when using the HP 4142B's internal program memory.

HP-IB Function: The HP 4142B may be interfaced to any HP-IB capable computer or instrument.

HP-IB Interface: SH1, AH1, T6, L4, SR1, RL1, PP0, DC1, DT1, C0, E1.

Specifications (5 of 15)

HP 41420A Source/Monitor Unit (SMU) 40 μ V-200V/20fA-1A

Measures current when operating as a voltage source; measures voltage when operating as a current source. Kelvin connections can be used. The HP 41420A's source and measurement ranges, resolution, and accuracy specifications are listed in the following table.

Voltage Range	Setting Resolution	Measurement Resolution	Accuracy	Maximum ¹ Current
$\pm 2V$	100 μ V	40 μ V	$\pm 0.05\% \pm 1mV$	1A
$\pm 20V$	1mV	400 μ V	$\pm 0.05\% \pm 10mV$	1A ($ V_o \leq 14V$)
				700mA ($14V < V_o $)
$\pm 40V$	2mV	800 μ V	$\pm 0.05\% \pm 20mV$	350mA
$\pm 100V$	5mV	2mV	$\pm 0.05\% \pm 50mV$	125mA
$\pm 200V$	10mV	4mV	$\pm 0.05\% \pm 100mV$	50mA

Current Range	Setting Resolution	Measurement Resolution	Accuracy ^{1, 2}	Maximum Voltage
$\pm 1nA$	50fA	20fA	$\pm 1\% \pm (0.1 + 0.2V_o/100)\% \pm 5pA$	200V
$\pm 10nA$	500fA	200fA		
$\pm 100nA$	5pA	2pA	$\pm 0.5\% \pm (0.1 + 0.2V_o/100)\%$	
$\pm 1\mu A$	50pA	20pA		
$\pm 10\mu A$	500pA	200pA	$\pm 0.2\% \pm (0.1 + 0.2V_o/100)\%$	
$\pm 100\mu A$	5nA	2nA		
$\pm 1mA$	50nA	20nA		
$\pm 10mA$	500nA	200nA		

¹ V_o is output voltage.

² $\pm n\%$ of specified output or measurement value, $\pm n\%$ of range value.

Specifications (6 of 15)

HP 41420A Source/Monitor Unit (SMU) 40 μ V-200V/20fA-1A (continued)

Current Range	Setting Resolution	Measurement Resolution	Accuracy ^{1, 2}	Maximum ³ Voltage
$\pm 100\text{mA}$	$5\mu\text{A}$	$2\mu\text{A}$	$\pm 0.2\% \pm (0.1 + 0.2V_o/100)\%$	200V ($ I_o \leq 50\text{mA}$)
				100V ($50\text{mA} < I_o $)
$\pm 1\text{A}$	$50\mu\text{A}$	$20\mu\text{A}$	$\pm 0.5\% \pm (0.1 + 0.2(V_o/100))\%$	200V ($ I_o \leq 50\text{mA}$)
				100V(50mA < $ I_o \leq 125\text{mA}$)
				40V(125mA < $ I_o \leq 350\text{mA}$)
				20V(350mA < $ I_o \leq 700\text{mA}$)
				14V ($700\text{mA} < I_o $)

¹ $\pm n\%$ of specified output or measurement value, $\pm n\%$ of range value.

² V_o is output voltage.

³ I_o is output current.

Current Over-Range:

15% of Range (0% at 1A range)

Current/Voltage Limiting (Compliance):

Limit Setting Range:

Current Limit: 1pA to maximum current for each voltage range.

Voltage Limit: 0V to maximum voltage for each current range.

Limit Setting Accuracy: same as V/I Setting Accuracy.

Current Limit Setting Accuracy for Opposite Polarity:

1nA to 10nA Range: V/I setting accuracy $\pm 10\%$ of range

100nA to 1A Range: V/I setting accuracy $\pm 2\%$ of range.

Specifications (7 of 15)

HP 41421B Source/Monitor Unit (SMU) 40 μ V-100V/20fA-100mA

Measures current when operating as a voltage source; measures voltage when operating as a current source. The following table lists the HP 41421B's source and measurement ranges, resolution, and accuracy specifications.

Voltage Range	Setting Resolution	Measurement Resolution	Accuracy	Maximum Current
$\pm 2V$	100 μ V	40 μ V	$\pm 0.05\% \pm 1mV$	100mA
$\pm 20V$	1mV	400 μ V	$\pm 0.05\% \pm 10mV$	
$\pm 40V$	2mV	800 μ V	$\pm 0.05\% \pm 20mV$	50mA
$\pm 100V$	5mV	2mV	$\pm 0.05\% \pm 50mV$	20mA

Current Range	Setting Resolution	Measurement Resolution	Accuracy ^{1, 2}	Maximum ³ Voltage
$\pm 1nA$	50fA	20fA	$\pm 1\% \pm (0.1 + 0.2V_o/100)\% \pm 5pA$	100V
$\pm 10nA$	500fA	200fA		
$\pm 100nA$	5pA	2pA		
$\pm 1\mu A$	50pA	20pA	$\pm 0.5\% \pm (0.1 + 0.2V_o/100)\%$	
$\pm 10\mu A$	500pA	200pA		
$\pm 100\mu A$	5nA	2nA		
$\pm 1mA$	50nA	20nA		
$\pm 10mA$	500nA	200nA	$\pm 0.2\% \pm (0.1 + 0.2V_o/100)\%$	
$\pm 100mA$	5 μ A	2 μ A		40V(20mA < $ I_o \leq 50mA$)
			20V ($50mA \leq I_o $)	

¹ $\pm n\%$ of specified output or measurement value, $\pm n\%$ of range value.

² V_o is output voltage.

³ I_o is output current.

Specifications (8 of 15)

HP 41421B Source/Monitor Unit (SMU) 40 μ V-100V/20fA-100mA (continued)

Current Over-Range:

15% of Range (0% at 100mA Range)

Current/Voltage Limiting (Compliance):

Limit Setting Range:

Current Limit: 1pA to maximum current for each voltage range.

Voltage Limit: 0V to maximum voltage for each current range.

Limit Setting Accuracy: same as V/I Setting Accuracy.

Current Limit Setting Accuracy for Opposite Polarity:

1nA to 10nA Range: V/I setting accuracy $\pm 10\%$ of range

100nA to 100mA Range: V/I setting accuracy $\pm 2\%$ of range.

Specifications (9 of 15)

HP 41422A High Current Source/Monitor Unit (HCU)

Measures current when operating as a pulsed voltage source; measures voltage when operating as a pulsed current source. Kelvin connections should be used and low terminals of the HCU should be connected the GNDU. The HP 41422A's source and measurement ranges, resolution, and accuracy specifications are listed in the following table.

Voltage Range	Maximum Voltage	Setting Resolution	Measurement Resolution	Accuracy ¹	Maximum ³ Current
±2V	2V	200μV	40μV	±0.5%±10mV	10A
±20V	10V	2mV	400μV	±0.5%±100mV	

Current Range	Setting Resolution	Measurement Resolution	Accuracy ^{1, 2}	Maximum ³ Voltage
±1mA	100nA	20nA	±0.5%±(0.2+0.2Vo/20)%	10V
±10mA	1μA	200nA		
±100mA	10μA	2μA		
±1A	100μA	20μA	±1%±(0.2+0.2Vo/20)%	
±10A	1mA	200μA	±2%±(0.2+0.2Vo/20)%	

¹ ±n% of specified output or measurement value, ±n% of range value.

² Vo is output voltage.

³ Polarity of the current and voltage must be same (see below).

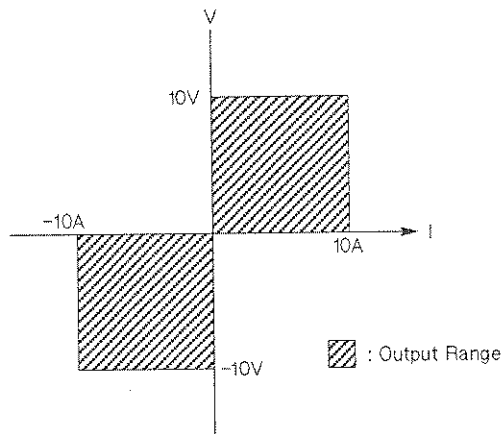

Specifications (10 of 15)

HP 41422A High Current Source/Monitor Unit (HCU)

Current Over-Range:

15% of Range (0% at 10A Range)

Current/Voltage Limiting (Compliance):

Limit Setting Range:

Current Limit: 1 μ A to maximum current for each voltage range.

Voltage Limit: 0V to maximum voltage for each current range.

Limit Setting Accuracy: same as V/I Setting Accuracy.

Specifications (11 of 15)

HP 41424A Voltage Source/Voltage Measurement Unit (VS/VMU)

Provides two voltage source (VS) channels that can monitor current, and two voltage monitor (VM) channels. When used as a differential voltmeter, the two voltage monitor channels (VM1 and VM2) are used together as one channel. The HP 41424A's ranges, resolutions, and accuracies are listed in the following table.

Voltage Source:

Voltage Range	Setting Resolution	Accuracy	Maximum Current
20V	1mV	$\pm 0.1\% \pm 10\text{mV}$	100mA
40V	2mV	$\pm 0.1\% \pm 20\text{mV}$	20mA

VS Current Measurement:

Current Range	Measurement Resolution	Accuracy
20mA	20 μA	$\pm 3\% \pm 200\mu\text{A}$
100mA	100 μA	$\pm 3\% \pm 1\text{mA}$

Voltage Monitor:

Voltage Range	Measurement Resolution	Accuracy
2V	40 μV	$\pm 0.05\% \pm 1\text{mV}$
20V	400 μV	$\pm 0.05\% \pm 10\text{mV}$
40V	800 μV	$\pm 0.05\% \pm 20\text{mV}$

Differential Voltmeter:

Voltage Range	Measurement Resolution	Accuracy ¹	Max. Common Voltage
0.2V	4 μV	$\pm 0.2\% \pm 2.5 \times 10^{-6} V_{in} \pm 0.4\text{mV}$	40V
2V	40 μV	$\pm 0.1\% \pm 25 \times 10^{-6} V_{in} \pm 2\text{mV}$	

¹ V_{in} is the input voltage of VM2.

VM Over-Range:

15% of Range (0% at 40V Range)

HP 41425A Analog Feedback Unit (AFU)

Converges current or voltage on one SMU (Sense SMU) to a specified target value by controlling the output voltage of another SMU (Search SMU).

Maximum Target Voltage:

HP 41420A: 180V

HP 41421B: 90V

Maximum Target Current:

HP 41420A: 900mA

HP 41421B: 90mA

Target Value Setting Resolution:

Same as sense SMU measurement range setting resolution

Target Value Setting Over-Range:

Current: 0%

Voltage: -10%

Target Value Convergence Accuracy: (Sense SMU measurement accuracy)

$\pm(0.1\%$ of Setting Value) $\pm(0.1\%$ of sense SMU measurement range)

Search Voltage Range:

2V,20V,40V,100V, and 200V (HP 41420A only)

Search Start Voltage Accuracy:

(0.5% of Setting) $\pm(0.5\%$ of Voltage Range)

Search Stop Voltage Accuracy:

3% of Voltage Range

Specifications (13 of 15)

HP 41425A Analog Feedback Unit (continued)

Ramp Rate Ranges and Resolution:

Search Voltage Range			
2V		20V	
Ramp Rate	Resolution	Ramp Rate	Resolution
0.5 - 5V/s	0.05V/s	5.5 - 50V/s	0.5V/s
5.5 - 50V/s	0.5V/s	55 - 500V/s	5V/s
55 - 500V/s	5V/s	550 - 5kV/s	50V/s
550 - 5kV/s	50V/s	5.5k - 50kV/s	500V/s

Search Voltage Range (continued)			
40V		100V	
Ramp Rate	Resolution	Ramp Rate	resolution
10 - 50V/s	1V/s	25 - 50V/s	2.5V/s
55 - 100V/s	5V/s	55 - 250V/s	5V/s
110 - 500V/s	10V/s	275 - 500V/s	25V/s
550 - 1kV/s	50V/s	550 - 2.5kV/s	50V/s
1.1k - 5kV/s	100V/s	2.75k - 5kV/s	250V/s
5.5k - 10kV/s	500V/s	5.5k - 25kV/s	500V/s
11k - 50kV/s	1000V/s	27.5k - 50kV/s	2500V/s
55k - 100kV/s	5000V/s	55k - 100kV/s	5000V/s

Search Voltage Range (continued)	
200V	
Ramp Rate	Resolution
55 - 500V/s	5V/s
550 - 5kV/s	50V/s
5.5k - 50kV/s	500V/s
55k - 100kV/s	5000V/s

Specifications (14 of 15)

HP 41425A Analog Feedback Unit (continued)

Feedback Integration Time Ranges and Resolution:

Search Voltage Range			
2V		20V	
Integ. Time	Resolution	Integ. Time	Resolution
50 μ - 450 μ s	50 μ s	5 μ - 45 μ s	5 μ s
500 μ - 4.5ms	500 μ s	50 μ - 450 μ s	50 μ s
5m - 45ms	5ms	500 μ - 4.5ms	500 μ s
50m - 450ms	50ms	5m - 45ms	5ms

Search Voltage Range (continued)			
40V		100V	
Integ. Time	Resolution	Integ. Time	Resolution
2.5 μ - 4.5 μ s	0.5 μ s	1.0 μ - 4.5 μ s	0.5 μ s
5 μ - 45 μ s	5 μ s	5 μ - 45 μ s	5 μ s
50 μ - 450 μ s	50 μ s	50 μ - 450 μ s	50 μ s
500 μ - 4.5ms	500 μ s	500 μ - 4.5ms	500 μ s
5m - 25ms	5ms	5m - 10ms	5ms

Search Voltage Range (continued)	
200V	
Integ. Time	Resolution
0.5 μ - 4.5 μ s	0.5 μ s
5 μ - 45 μ s	5 μ s
50 μ - 450 μ s	50 μ s
500 μ - 4.5ms	500 μ s
5m	-

GENERAL SPECIFICATIONS

Self-Test Function:

At power on, the HP 4142B automatically verifies its own operational status. Self-test can be performed at any time via HP-IB.

Maximum Installation Inclination Angle:

±20° from horizontal (during operation)

Warm-up Time:

Allow the HP 4142B to warm-up for at least 40 minutes before performing measurements.

Operating Temperature Range:

5°C to 40°C

Operating Humidity Range:

5% to 80%RH

Storage Temperature Range:

-40°C to 70°C

Storage Humidity Range:

≤90%RH at 65°C

Power Requirements:

100/120/220V±10%; 240V-10%+5%, 48-66Hz (maximum 750VA)

Dimensions (in mm):

426W by 235H by 676D (approximately)

Weights (approximate):

HP 4142B Mainframe: 23kg	HP 41422A: 2.2kg
HP 41420A: 3kg	HP 41424A: 2kg
HP 41421B: 2kg	HP 41425A: 2kg

Safety Considerations:

The HP 4142B complies with UL-1244, CSA bulletin 556B, and IEC-348 safety standards, and is shipped from the factory in a safe condition.

Supplemental Performance Characteristics (1 of 4)

The following supplemental performance characteristics are not guaranteed specifications but are typical characteristics included as additional operation information.

HP 4142B Modular DC Source/Monitor

Ground Unit (GNDU):

Capacitance Load: $\leq 10\mu\text{F}$

Cable Impedance: $\leq 1\Omega$ (Force side), $\leq 10\Omega$ (Sense side)

Plug-in Unit Control Functions:

Hold Time Setting Accuracy: $0.5\% + 1\text{ms}$

Delay Time Setting Accuracy: $0.5\% + 1\text{ms}$

Pulse Width Accuracy: $0.5\% + 100\mu\text{s}$ (SMU or VS)

$0.5\% + 20\mu\text{s}$ (HCU)

Pulse Period Accuracy: $0.5\% + 100\mu\text{s}$

where the pulse width is defined as below;

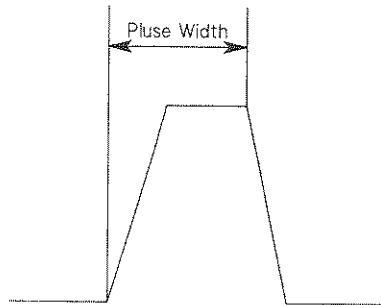

Memory Function:

Program Memory: Can store approximately 500 program steps; up to 99 separate programs. Programs can be executed individually.

HP 41420A and 41421B SMUs

Capacitance Load: $\leq 1000\text{pF}$

Guard Capacitance: $\leq 900\text{pF}$

Shield Capacitance: $\leq 5000\text{pF}$

NOTE

When connecting cables or test devices with capacitance values greater than the allowable Capacitance Load, Guard, and Shield capacitance values, SMUs may oscillate.

Supplemental Performance Characteristics (2 of 4)

HP 41420A and 41421B SMUs (continued)

Cable Impedance:

Force side: $\leq 0.7\Omega$ (when forcing 1A), $\leq 10\Omega$ (when forcing 100mA)
Sense side: $\leq 10\Omega$

NOTE

If cable impedance is greater than the allowable value when performing a measurement and using a Kelvin connection, measurement results may be invalid.

Voltage Measurement Input Resistance: $\geq 10^7 \Omega$

Guard Voltage Offset: $\pm 1\text{mV}$

Noise Characteristics: (typical, with SMU Filter ON)

Voltage Source Noise: 0.01% of Range (rms)
Current Source Noise: 0.1% of Range (rms)
Voltage Monitor Noise: 0.02% of Range (p-p value)
Current Monitor Noise: 0.2% of Range (p-p value)

Voltage/Current Output Overshoot:

0.03% of Range (typical, with SMU Filter ON)

Maximum Slew Rate: 0.2V/ μs (with SMU Filter ON)

Range Switching Transient Noise: (typically, with SMU Filter ON)

Voltage Range Switching: 250mV
Current Range Switching: 10mV

Residual Impedance when not using Kelvin connection: 0.2 Ω (typical)

Measurement Time:

Force (Current or Voltage): Approximately 3.5ms
Measurement (Current or Voltage): Approximately 4ms
(When using an HP 9000 Series 300 Model 310 computer. Including data transfer time when set to the 20V and 100mA ranges.)

Supplemental Performance Characteristics (3 of 4)

HP 41422A HCU

Current Limit Setting for Opposite Polarity: 0.1% of current range

Capacitance Load: ≤ 3.5 nF

Inductance Load: ≤ 1 μ H

Cable Resistance:

Force side: ≤ 150 m Ω (High and low when forcing 10 V and 10 A, respectively. See below for details.)

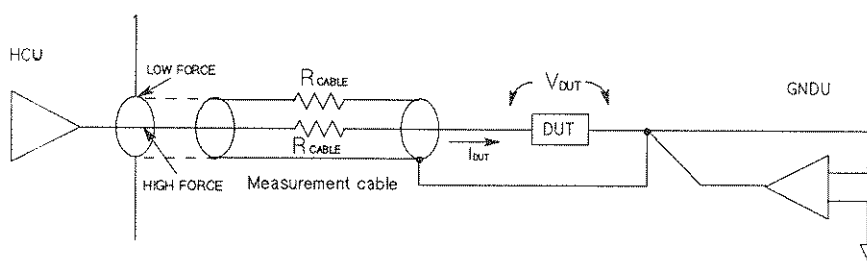

$$\left\{ \begin{array}{l} R_{CABLE} \leq \frac{13 - V_{DUT}}{2 * I_{DUT}} \\ R_{CABLE} \leq \frac{4}{I_{DUT}} \\ I_{DUT} \leq 10 \\ V_{DUT} \leq 10 \end{array} \right.$$

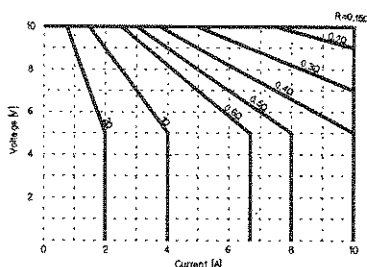

Cable resistance should be satisfied above conditions.

Sense side: ≤ 10 Ω (high and low, respectively)

NOTE

If the cable resistance is greater than the allowable value when performing a measurement and using a kelvin connection, the measurement results may be invalid.

Noise Characteristics: (typical)

- Voltage Source Noise: 0.01% of Range (rms)
- Current Source Noise: 0.1% of Range (rms)
- Voltage Monitor Noise: 0.02% of Range (p-p value)
- Current Monitor Noise: 0.2% of Range (p-p value)

Maximum slew rate: 0.3V/ μ s (typical)

Supplemental Performance Characteristics (4 of 4)

HP 41424A VS/VMU

Voltage Source:

Output Impedance: 0.2Ω (typical)
Capacitance Load: $\leq 10\mu\text{F}$
Slew Rate: $0.2\text{V}/\mu\text{s}$
Current Limit Accuracy: +20% of Limit
Noise: (typically) 0.005% of Range (rms)

Voltage Monitor:

Input Impedance: $\geq 100\text{M}\Omega$
Leakage Current: $\leq 2\text{nA}$ (when measuring 0V)
Noise: 0.01% of Range (p - p value)
Differential Voltage Monitor Noise: 0.02% of Range (p - p value)

Measurement Time: (same as SMU measurement times, except for ranging)

Voltage Force: Approximately 3.5ms (at 20V Range)
Voltage Monitor: Approximately 4ms (at 20V Range)
Differential Voltage Monitor: Approximately 5.5ms (at 2V Range)

HP 41425A AFU

Ramp Rate Setting Accuracy:

0.5 to 5V/s: 30% of setting $\pm 0.5\text{V/s}$
5.5 to 50V/s: 30% of setting $\pm 5\text{V/s}$
55 to 500V/s: 30% of setting $\pm 50\text{V/s}$
550 to 5kV/s: 30% of setting $\pm 500\text{V/s}$
5.5k to 50kV/s: 30% of setting $\pm 5\text{kV/s}$

Feedback Integration Time Setting Accuracy: 30% of setting**Ramp Voltage Stop Delay Time:** $5\mu\text{s}$ (typical)**Measurement Time:**

Approximately 12ms* for detecting MOSFET threshold voltage (V_{th}) when the specified drain current is $1\mu\text{A}$, under optimum measurement setting conditions.

* From the time a measurement is triggered, until measurement results are stored in the output data buffer.

General Characteristics

Auto Calibration:

Automatically calibrates for offset errors (all units) every 30 minutes,.

Allowable Temperature Drift after Calibration: $\pm 3^\circ\text{C}$ ($\pm 6^\circ\text{F}$)

APPENDIX C

ACCESSORIES AND OPTIONS

ACCESSORIES

The following table shows the available accessories for the HP 4142B.

HP 4142B Available Accessories

Description	Model or Part Number
Interactive Measurement and Analysis (IMA) Software	HP 16276A/L
Test Fixture	HP 16088A
Connector Plate (for GNDU, SMUs and INTLK)	04142-60021
Connector Plate (for GNDU, HCU, VS/VMU and INTLK)	04142-60031
Triaxial Cable (3 m for GNDU)	04142-61632
Triaxial Cable (1.5 m for GNDU)	04142-61633
Quadraxial Cable (3 m for SMU)	41420-61601
Quadraxial Cable (1.5 m for SMU)	41420-61603
Triaxial Cable (1.5 m for SMU)	16058-61603
Triaxial Cable (3 m for SMU)	04145-61622
Triax Cover (for SMU)	1250-1708
Dual-coaxial Cable (3 m for HCU)	41422-61601
Dual-coaxial Cable (1.5 m for HCU)	41422-61602
Coaxial Cable (1.5 m for VS/VMU, or INTLK)	04142-61636
Coaxial Cable (3 m for VS/VMU, or INTLK)	04145-61630
Adaptor Cable (for INTLK/VS/VMU - HP 16058A)	04142-61631

HP 16276A/L Interactive Measurement Analysis (IMA) Software

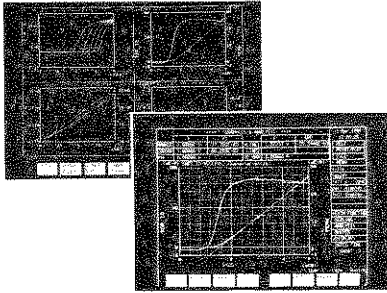

This software turns the HP 4142B into a fully automatic semiconductor dc parameter analyzer by providing an interactive, softpanel user interface. Without having to program, you can quickly make measurements in several different applications.

Besides the softpanel operation, you can easily perform automated measurements and analysis using the Analysis Instruction Set (AIS), which is a subprogram library.

This software operates on HP BASIC.

HP 16088A Test Fixture

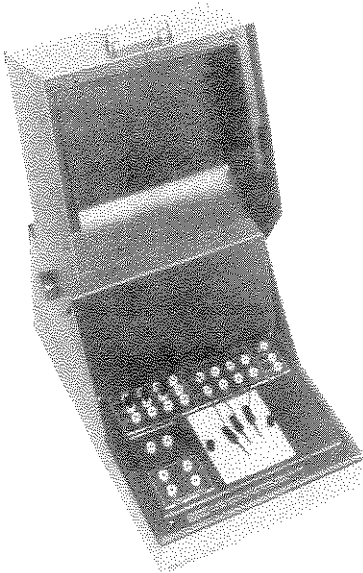

Shielded test fixture for packaged test devices. Equipped with the following two interchangeable socket boards for test device:

- 16058-60004 Blank Teflon Board
- 16088-60010 Universal Socket Board

The following socket boards are available (not furnished with HP 16088A):

- 16088-60001 4-pin TO-package Socket Board
- 16088-60002 28-pin Dual-in-line Socket Board
- 16088-60003 18-pin Dual-in-line Socket Board
- 16088-60004 8-pin TO-package Socket Board
- 16088-60005 10-pin TO-package Socket Board
- 16088-60006 12-pin TO-package Socket Board
- 16088-60007 TO-3/TO-66 Socket Board (kelvin connection)
- 16088-60008 3-pin In-line Socket Board (kelvin connection)
- 16088-60009 Axial Lead Socket Board (kelvin connection)

This fixture can be connected the following units:

- SMU: 4 (for kelvin) to 8 (for non-kelvin) channels
- HCU: 2 channels
- VS or VM: 4 channels
- GNDU: 1 channel
- INTLK: 1 channel
- AUX: 2 channels

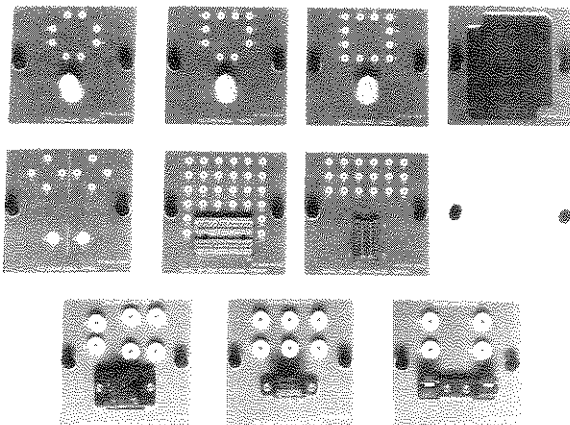

Socket Boards

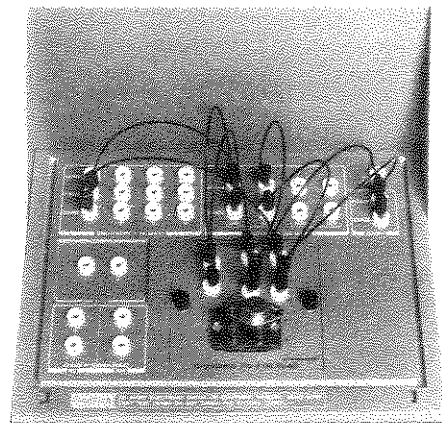

Interconnections Example

HP 16088A

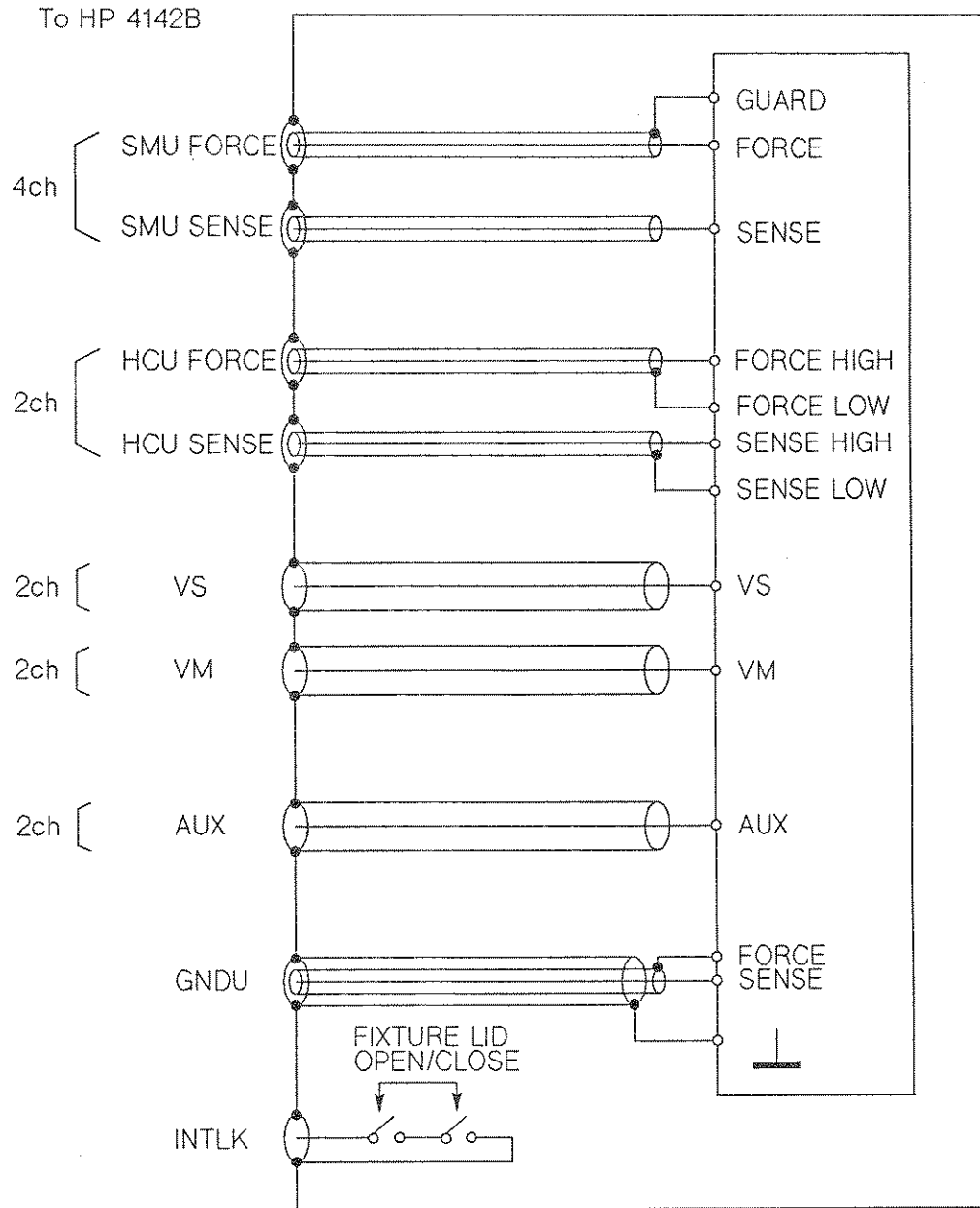

HP 16088A Circuit Diagram

04142-60021 Connector Plate

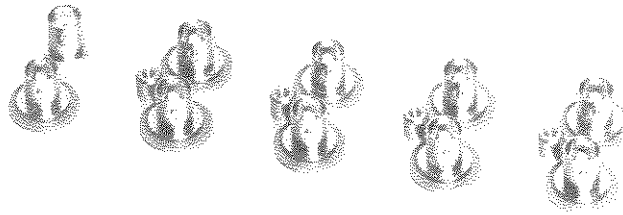

Front View

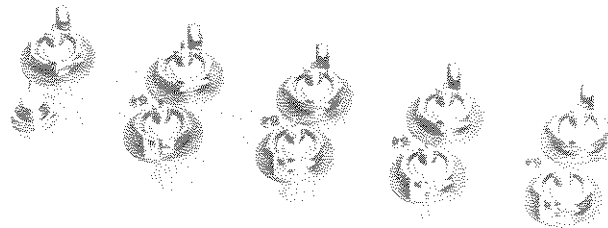

Rear View

For interfacing the HP 4142B with a wafer prober. The connector assignments are:

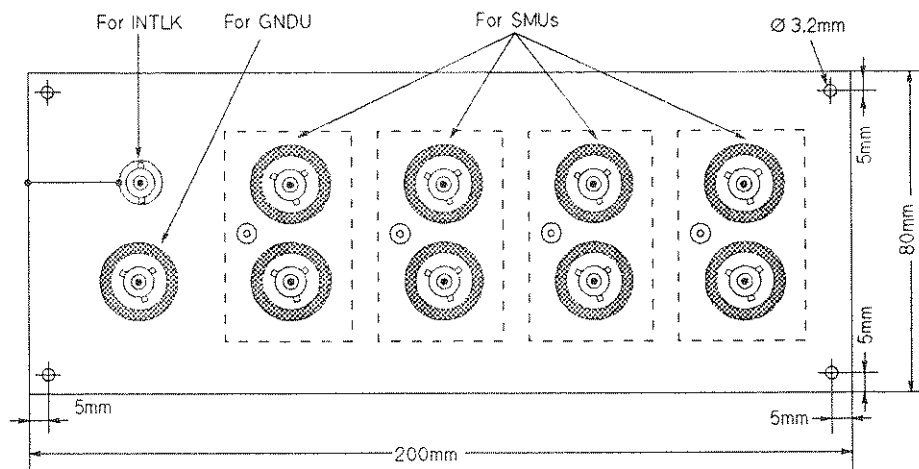

04142-60031 Connector Plate

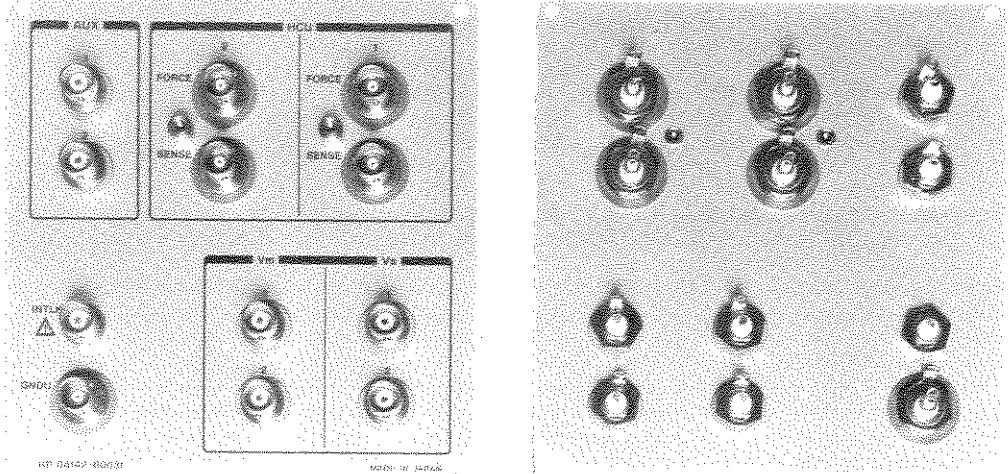

Front View

Rear View

For interfacing the HP 4142B with a wafer prober. The connector assignments are:

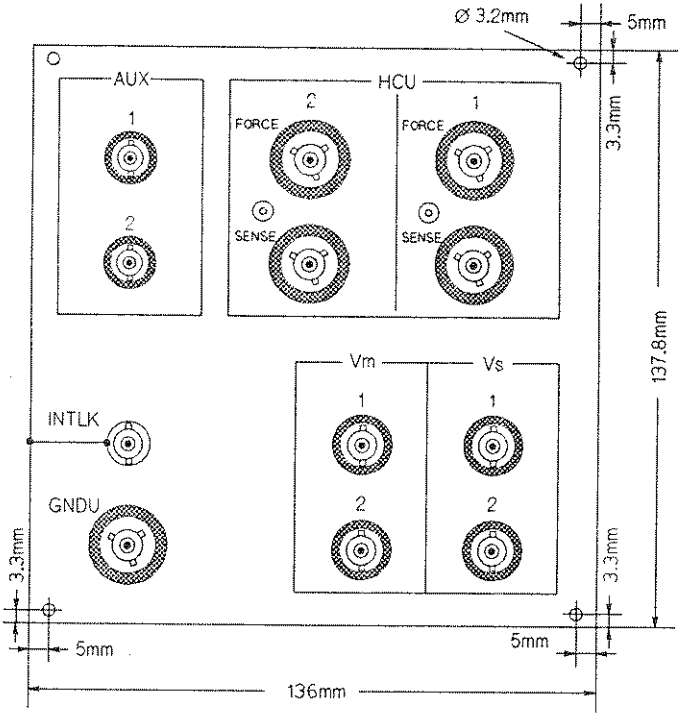

04142-61632 GNDU Triaxial Cable (3 m)

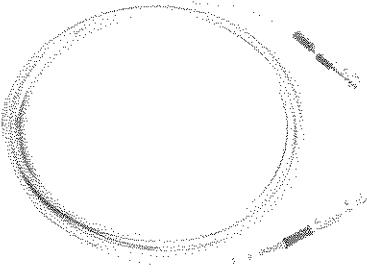

For connecting the HP 4142B GNDU. Reference data is:

Capacitance between FORCE and COMMON lines:
1100 pF

Resistance of FORCE line: 150 m Ω

Capacitance between FORCE and SENSE lines:
700 pF

04142-61633 GNDU Triaxial Cable (1.5 m)

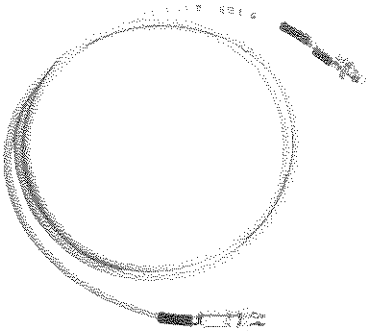

For connecting the HP 4142B GNDU. Reference data is:

Capacitance between FORCE and COMMON lines:
550 pF

Resistance of FORCE line: 80 m Ω

Capacitance between FORCE and SENSE lines:
350 pF

41420-61601 SMU Quadaxial Cable (3 m)

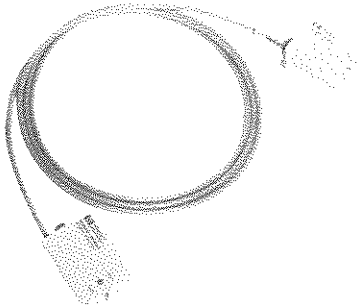

For connecting the HPSMU or MPSMU. Reference data is:

Capacitance between GUARD and FORCE lines
(guard capacitance): 300 pF

Capacitance between GUARD and COMMON
lines: 2400 pF

Resistance of FORCE line: 300 m Ω

41420-61603 SMU Quadaxial Cable (1.5 m)

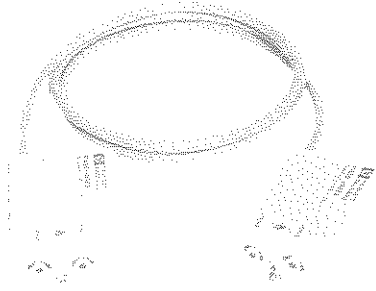

For connecting the HPSMU or MPSMU. Reference data is:

Capacitance between GUARD and FORCE lines (guard capacitance): 150 pF

Capacitance between GUARD and COMMON lines: 1200 pF

Resistance of FORCE line: 150 m Ω

16058-61603 SMU Triaxial Cable (1.5 m)

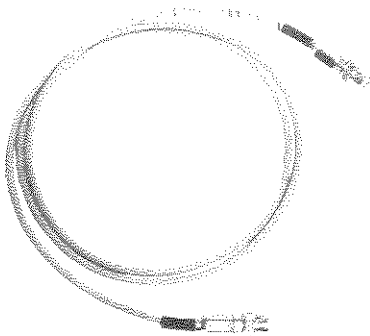

For connecting the HPSMU or MPSMU. Reference data is:

Capacitance between GUARD and FORCE (or SENSE) lines (guard capacitance): 120 pF

Capacitance between GUARD and COMMON lines: 900 pF

Resistance of FORCE line: 160 m Ω

Maximum current: 1 A

04145-61622 SMU Triaxial Cable (3 m)

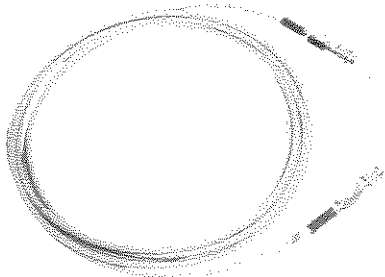

For connecting the HPSMU or MPSMU. Reference data is:

Capacitance between GUARD and FORCE (or SENSE) lines (guard capacitance): 240 pF

Capacitance between GUARD and COMMON lines: 1800 pF

Resistance of FORCE line: 320 m Ω

Maximum current: 1 A

1250-1708 Triax Cover

For shielding the HPSMU or MPSMU SENSE terminal.



41422-61601 HCU Dual-coaxial Cable (3 m)

For connecting the HCU. Reference data is:

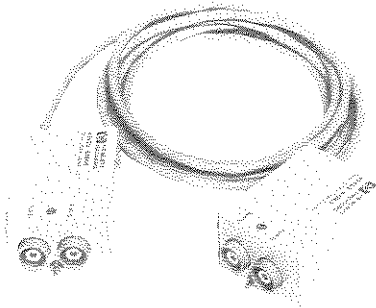

Capacitance between FORCE HIGH and FORCE LOW lines: 3000 pF
Capacitance between SENSE HIGH and SENSE LOW lines: 350 pF
Inductance between FORCE HIGH and FORCE LOW lines: 200 nH
Resistance of FORCE HIGH line: 70 m Ω
Resistance of FORCE LOW line: 110 m Ω

41422-61602 HCU Dual-coaxial Cable (1.5 m)

For connecting the HCU. Reference data is:

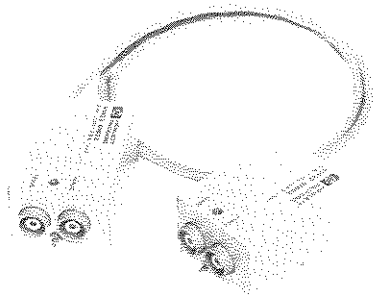

Capacitance between FORCE HIGH and FORCE LOW lines: 1500 pF
Capacitance between SENSE HIGH and SENSE LOW lines: 200 pF
Inductance between FORCE HIGH and FORCE LOW lines: 100 nH
Resistance of FORCE HIGH line: 40 m Ω
Resistance of FORCE LOW line: 65 m Ω

04145-61630 Coaxial Cable (3 m)

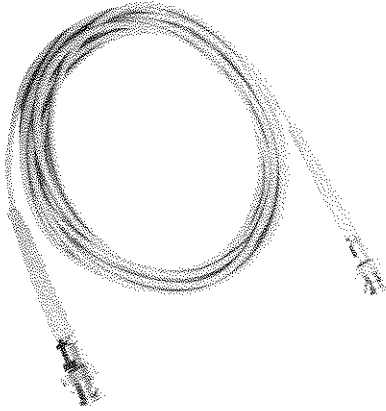

For connecting the VS, VM, or INTLK. Reference data is:

Capacitance: 330 pF
Resistance of center line: 400 mΩ

04142-61636 Coaxial Cable (1.5 m)

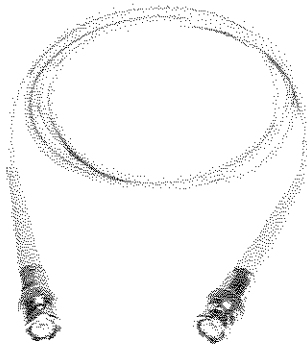

For connecting the VS, VM, or INTLK. Reference data is:

Capacitance: 160 pF
Resistance of center line: 220 mΩ

04142-61631 Adaptor Cable (1.5 m)

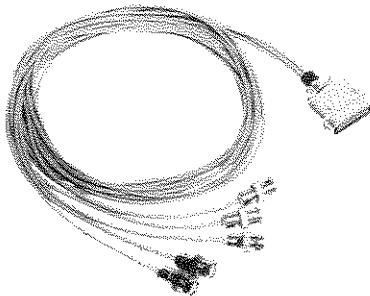

For connecting the VS/VMU and INTLK to the HP 16058A Test Fixture.

OPTIONS

The following tables list the options available for the HP 4142B.

HP 4142B Options Available (1 of 2)

Option Number	Description	Model or Part Number
001	INTLK/VS/VMU - HP16058A Adapter Cable (1.5 m)	04142-61631
002	GNDU and INTLK cables (3 m) and Connector Plate	---
	Triaxial Cable (3 m for GNDU)	04142-61632
	Coaxial Cable (3 m for INTLK or VS/VMU)	04145-61630
	Connector Plate (for GNDU, SMUs and INTLK)	04142-60021
003	GNDU and INTLK Cables (1.5 m)	---
	Triaxial Cable (1.5 m for GNDU)	04142-61633
	Coaxial Cable (1.5 m for INTLK or VS/VMU)	04142-61636
022	Connector Plate (for GNDU, HCU, VS/VMU, and INTLK)	04142-60031
050	Line frequency filter switch is set to 50 Hz.	---
060	Line frequency filter switch is set to 60 Hz.	---
100	Line voltage switch setting and fuse for 100V/120V.	---
220	Line voltage switch setting and fuse for 220V/240V.	---
400	HP 41420A SMU (occupies 2 slots)	HP 41420A
401	SMU Cable (1.5 m) and Triax Cover	---
	Triaxial Cable (1.5 m for SMU)	16058-61603
	Triax Cover (for SMU)	1250-1708
402	Quadraxial Cable (3 m for SMU)	41420-61601
403	Quadraxial Cable (1.5 m for SMU)	41420-61603
410	HP 41421B SMU (1 slot)	HP 41421B
411	SMU Cable (1.5 m) and Triax Cover	---
	Triaxial Cable (1.5 m for SMU)	16058-61603
	Triax Cover (for SMU)	1250-1708
412	Quadraxial Cable (3 m for SMU)	41420-61601
413	Quadraxial Cable (1.5 m for SMU)	41420-61603
420	HP 41422A HCU (occupies 2 slots)	HP 41422A
422	Dual-coaxial Cable (3 m for HCU)	41422-61601
423	Dual-coaxial Cable (1.5 m for HCU)	41422-61602

HP 4142B Options Available (2 of 2)

Option Number	Description	Model or Part Number
440	HP 41424A VS/VMU (1 slot)	HP 41424A
442	Four Coaxial Cables (3 m for VS/VMU or INTLK)	¹
443	Four Coaxial Cables (1.5 m for VS/VMU or INTLK)	²
450	HP 41425A AFU (1 slot--1 per 4142B)	HP 41425A
560	Interactive Measurement and Analysis (IMA) Software	HP 16276A/L
561	License-to-Use the HP 16276A	HP 16276L
907	Front Handle Kit	5062-3991
908	Rack Flange Kit	5062-3979
909	Front Handle and Rack Flange Kits	5062-3985
910	Extra Manuals (English) Operation Manual HP-IB Command Reference Manual Control Software Programming Manual	
J10	Extra Manuals (Japanese) Operation Manual (Japanese) HP-IB Command Reference Manual (Japanese) Control Software Programming Manual (English)	
W03	90 day On-site Service	

¹ Four 04145-61630s

² Four 04142-61636s

Options Available for the HP 4142B Plug-in Units

Model and Option	Description / Part Number
HP 41420A Option 401	Same as HP 4142B Option 401
Option 402	Same as HP 4142B Option 402
Option 403	Same as HP 4142B Option 403
Option W03	90 day On-site Service
HP 41421B Option 411	Same as HP 4142B Option 411
Option 412	Same as HP 4142B Option 412
Option 413	Same as HP 4142B Option 413
Option W03	90 day On-site Service
HP 41422A Option 422	Same as HP 4142B Option 422
Option 423	Same as HP 4142B Option 423
Option W03	90 day On-site Service
HP 41424A Option 442	Same as HP 4142B Option 442
Option 443	Same as HP 4142B Option 443
Option W03	90 day On-site Service
HP 41425A Option W03	90 day On-site Service