

Operating and Programming Manual
HP 8530A Receiver



HP Part No. 8530-90010
Printed in USA February 1994

Edition 2

Errata

Title & Document Type: 8530A Receiver Operating and Programming Manual

Manual Part Number: 08530-90010

Revision Date: February 1, 1994

HP References in this Manual

This manual may contain references to HP or Hewlett-Packard. Please note that Hewlett-Packard's former test and measurement, semiconductor products and chemical analysis businesses are now part of Agilent Technologies. We have made no changes to this manual copy. The HP XXXX referred to in this document is now the Agilent XXXX. For example, model number HP8648A is now model number Agilent 8648A.

About this Manual

We've added this manual to the Agilent website in an effort to help you support your product. This manual provides the best information we could find. It may be incomplete or contain dated information, and the scan quality may not be ideal. If we find a better copy in the future, we will add it to the Agilent website.

Support for Your Product

Agilent no longer sells or supports this product. You will find any other available product information on the Agilent Test & Measurement website:

www.tm.agilent.com

Search for the model number of this product, and the resulting product page will guide you to any available information. Our service centers may be able to perform calibration if no repair parts are needed, but no other support from Agilent is available.

Legal Information

Legal notices are posted in the beginning of the *HP 8530A User's Guide*.

Printing History

New editions of this manual will incorporate all material updated since the previous editions. The manual printing date and part number indicate its current edition. The printing date changes when a new edition is printed. (Minor corrections and updates which are incorporated at reprint do not cause the date to change.) The manual part number changes when extensive technical changes are incorporated.

The following versions of this manual have been produced:

Edition	Date	Firmware Revision
Edition 1	June 1992	A.01.40
Edition 2	October 1993	A.01.60

Manual Applicability

This manual applies to HP 8530A Receivers having an HP 85102R IF detector with serial number prefix 3237A or higher, running firmware revision A.01.60.

Safety Considerations

General

This product and related documentation must be reviewed for familiarization with safety markings and instructions before operation. This product has been designed and tested in accordance with international standards.

Safety Symbols



Instruction manual symbol: the product will be marked with this symbol when it is necessary for the user to refer to the instruction manual for warnings or cautions.



Indicates hazardous voltages.



Indicates earth (ground) terminal.

Warning	The WARNING sign denotes a hazard. It calls attention to a procedure, practice, or the like, which, if not correctly performed or adhered to, could result in personal injury. Do not proceed beyond a WARNING sign until the indicated conditions are fully understood and met.
----------------	---

Caution	The CAUTION sign denotes a hazard. It calls attention to an operating procedure, practice, or the like, which, if not correctly performed or adhered to, could result in damage to the product or loss of important data. Do not proceed beyond a CAUTION sign until the indicated conditions are fully understood and met.
----------------	---

Safety Earth Ground

This is a Safety Class I product (provided with a protective earthing terminal). An uninterruptible safety earth ground must be provided from the main power source to the product input wiring terminals, power cord, or supplied power cord set. Whenever it is likely that the protection has been impaired, the product must be made inoperative and secured against any unintended operation.

Before Applying Power

Verify that the product is configured to match the available main power source as described in the input power configuration instructions provided in this manual.

If this product is to be powered by an autotransformer, make sure the common terminal is connected to the neutral (grounded) side of the AC power supply.

Servicing

Any servicing, adjustment, maintenance, or repair of this product must be performed by qualified personnel.

Capacitors inside this product could still be charged even when disconnected from their power source.

To avoid a fire hazard, only fuses with the required current rating and of the specified type (normal blow, time delay, etc.) are to be used for replacement.

Typeface Conventions

Bold

Bold type is used to introduce a new term. Terms that are highlighted in this way are defined in the glossary.

Italics

Italic type is used for emphasis, and for the titles of manuals and other publications. It is also used when describing a computer *variable*. For example: “Type: LOAD BIN *filename* (Return)”

Computer

Computer type is used to depict on-screen prompts and messages.

Front Panel Keys

Front panel keys are shown in enclosed boxes. Numbers you must enter into the data keypad are shown in normal print, they are not enclosed in boxes.

Soft Keys

Softkeys are the keys on the right-hand side of the display. The function of these keys changes depending on the displayed menu.

Warranty

Certification

Hewlett-Packard Company certifies that this product met its published specifications at the time of shipment from the factory. Hewlett-Packard further certifies that its calibration measurements are traceable to the United States National Institute of Standards and Technology (NIST, formerly NBS), to the extent allowed by the Institute's calibration facility, and to the calibration facilities of other International Standards Organization members.

Warranty

This Hewlett-Packard instrument product is warranted against defects in material and workmanship for a period of one year from date of delivery. During the warranty period, Hewlett-Packard Company will, at its option, either repair or replace products which prove to be defective.

For warranty service or repair, this product must be returned to a service facility designated by HP. Buyer shall prepay shipping charges to HP and HP shall pay shipping charges to return the product to Buyer. However, Buyer shall pay all shipping charges, duties, and taxes for products returned to HP from another country.

HP warrants that its software and firmware designated by HP for use with an instrument will execute its programming instructions when properly installed on that instrument. HP does not warrant that the operation of the instrument, or software, or firmware will be uninterrupted or error free.

LIMITATION OF WARRANTY

The foregoing warranty shall not apply to defects resulting from improper or inadequate maintenance by Buyer, Buyer-supplied software or interfacing, unauthorized modification or misuse, operation outside of the environmental specifications for the product, or improper site preparation or maintenance.

NO OTHER WARRANTY IS EXPRESSED OR IMPLIED. HP SPECIFICALLY DISCLAIMS THE IMPLIED WARRANTIES OF MERCHANTABILITY AND FITNESS FOR A PARTICULAR PURPOSE.

EXCLUSIVE REMEDIES

THE REMEDIES PROVIDED HEREIN ARE BUYER'S SOLE AND EXCLUSIVE REMEDIES. HP SHALL NOT BE LIABLE FOR ANY DIRECT, INDIRECT, SPECIAL, INCIDENTAL, OR CONSEQUENTIAL DAMAGES, WHETHER BASED ON CONTRACT, TORT, OR ANY OTHER LEGAL THEORY.

Assistance

Product maintenance agreements and other customer assistance agreements are available for Hewlett-Packard products. For any assistance, contact your nearest Hewlett-Packard Sales and Service Office.

Contents

1. General Information

Chapter Contents	1-1
Operating and Safety Precautions	1-1
Operating	1-1
Service	1-1
HP 8530A Description	1-2
Measurement Features	1-4
Design Background of the HP 8530A	1-4
Major Features	1-4
Angle Domain	1-4
Frequency Domain	1-5
Time Domain	1-5
Calibration	1-6
Four Measurement Inputs	1-6
Selectable Input Ratios	1-6
Flexible Triggering	1-6
Measure Parameter 1, 2, 3 or 4 in Any Combination	1-7
Save/Recall Registers	1-7
Measure Performance Relative to the Peak of the Main Lobe	1-7
Remote Programming	1-7
Data Presentation Features	1-7
Display Formats	1-7
Multiple Measurements Can be Shown Simultaneously	1-7
Trace Memory and Trace Math	1-7
Markers Display Precise Values for Any Point on Display Traces	1-8
External Video Monitor	1-8
Optional Network Analysis	1-8
Input/Output Features	1-8
Printing and Plotting Features	1-8
Peripheral Instruments	1-8
Built In Disc Drive	1-8
How the HP 8530A Receiver Differs from Similar Products	1-9
Options	1-10
Option 005 - Positioner Encoder Compatibility	1-10
Option 010 - Time Domain Operation	1-10
Option 011 - Add HP 8510C Firmware Operating System	1-10
Option 908 - Rack Mount Kit (for instruments without handles)	1-10
Option 913 - Rack Mount Kit (for instruments with handles)	1-10
Option 910 - Additional Manual Set	1-10
Option W31 - Extended Service (On-Site, where Available)	1-10
Equipment Supplied	1-11
Accessories and Supplies	1-12
HP-IB Extenders (HP 37204A) and Related Cables	1-12
Standard Coax HP-IB Extender	1-12
Option 013 Optical Fiber HP-IB Extender	1-12
HP 85043A System Cabinet	1-12

Connector Savers	1-12
Connector Cleaning Supplies	1-13
Touch Up Paint	1-13
Specifications	1-14
Environmental Characteristics	1-14
Temperature, Humidity, Altitude, RFI	1-14
Electrical Requirements	1-14
Size and Weight	1-14
Allowable HP-IB Cable Lengths	1-15
Allowable System Bus Cable Lengths	1-15
Compatible Instruments	1-15
Compatible LO Sources	1-15
HP 8350 Plug-Ins	1-15
HP 8360 Family Sources	1-16
Fast measurement speed and Quick Step mode	1-16
Compatible RF Sources	1-17
Fast Measurement Speeds and Quick Step Mode	1-17
Compatible Frequency Converters	1-18
HP 85310A Distributed Frequency Converter	1-18
HP x85325A Millimeter Wave Subsystem	1-18
HP 8511A/B Frequency Converter (Test Set)	1-18
Compatible Printers	1-18
Compatible Plotters	1-19
Compatible External Monitors	1-19

2. System Overview

Chapter Contents	2-1
Principles of Operation	2-2
Description of HP 8530A Internal Processes	2-2
Analog Section	2-3
Digital Section	2-3
Analog Signal Process Stages	2-4
Digital Data Process Stages	2-5
About the Main Microprocessor	2-5
Internal Data Flow	2-6
Raw Data Stages	2-6
Error Correction	2-7
Convert Parameter	2-7
Time Domain Operations	2-7
Corrected Data Array	2-7
Memory Arrays	2-7
Trace Math	2-7
Format and Smoothing	2-8
Formatted Data Array	2-8
Scaling and Display	2-8
Channel Coupling	2-8
Automatic Recall of Instrument Settings	2-9
The Added Benefit of the SAVE/RECALL feature	2-10
Factory Preset State	2-11
HARDWARE STATE	2-12

3. Front and Rear Panel

Chapter Contents	3-1
Front Panel Display Features	3-2
Display Annotation Areas	3-2
Channel/Parameter Identification Area	3-2
Stimulus Values Area	3-2
Active Entry Area	3-3
Title Area	3-3
System Messages Area	3-3
One-Character Special Display Annotations	3-3
Softkey Menu and Marker List Display Area	3-4
Using Softkey Menus	3-4
How to Tell when a Function is Selected	3-4
Mutually-Exclusive functions	3-4
Other Softkey Protocol and Details	3-4
Front Panel Features	3-5
Channel Selection	3-5
Basic Measurement Functions	3-7
ENTRY Block	3-8
Changing Values Using the Numeric Keypad	3-8
Other Keys in the Entry Block	3-9
MENUS Block	3-9
INSTRUMENT STATE Block	3-10
AUXILIARY MENUS Block	3-10
MEASUREMENT RESTART Key	3-11
HP-IB Mode/Diagnostic Indicator	3-11
Built-In Disc Drive	3-11
Recessed TEST button	3-11
Rear Panel Features	3-12
Top Box Rear Panel	3-12
RS-232 #1 and RS-232 #2	3-12
EXTERNAL DISPLAY	3-13
IF/DISPLAY INTERCONNECT	3-13
SYSTEM INTERCONNECT (System Bus Connector)	3-13
HP-IB Connector (HP-IB Bus)	3-14
Line Voltage Selector	3-14
Line Voltage Fuse	3-14
Bottom Box Rear Panel	3-14
IF/DISPLAY INTERCONNECT	3-14
AUX1, AUX2, RECEIVER READY BNCs	3-14
ENCODER INTERCONNECT	3-14
EVENT TRIGGER BNC	3-14
TEST SET INTERCONNECT	3-14
SWEEP IN 0-10V BNC	3-14
L.O. PHASELOCK OUT BNC	3-14
STOP SWP BNC (Stop Sweep)	3-15
TRIGGER IN BNC	3-15
10 MHz IN BNC	3-15
20 MHz OUT BNC	3-15
PULSE OUT (OPT 008) BNC	3-15
ANALOG $\pm 10V$ BNC	3-15
Line Voltage Selector (Bottom Box)	3-15
Line Voltage Fuse (Bottom Box)	3-15

4. Active Channel Block	
Introduction	4-1
The Two Channels	4-1
Independent Channel Settings	4-1
Internal Data Flow	4-1
5. Menus Block	
Chapter Contents	5-1
Calibration	5-3
Section Contents	5-3
Information Pertaining to All Calibration Types	5-3
What is Calibration?	5-3
Calibration Requirements	5-4
Use the Same Equipment Setup in the Measurement	5-4
Settings You Can Change after Performing a Calibration	5-4
Setting Changes that Require Special Consideration	5-5
Changing Parameter	5-5
Changing Stimulus Values	5-5
Settings that should not be changed	5-5
Selecting a Different Frequency Range	5-5
Selecting a Greater Number of Points	5-5
Using Averaging	5-6
If you are using averaging	5-6
Specific Calibration Procedures	5-8
Antenna Calibration	5-9
Important Terms	5-9
Angle Domain and Frequency Domain Calibrations	5-9
Using a Frequency Domain Calibration in Angle Domain.	5-9
Standard Gain Antenna Definitions	5-11
Performing an Antenna Calibration	5-11
Frequency Domain Calibration	5-11
Angle Domain Calibration	5-15
Important Note On Antenna Measurements	5-17
Things to Try	5-17
RCS Calibration	5-18
RCS Calibration Description	5-18
Important Information about Gating During the Calibration	5-18
RCS Calibration Overview	5-19
RCS Calibration Procedure	5-20
Updating the Background	5-23
Network Analyzer Calibrations	5-24
What is Network Analyzer Calibration?	5-24
Standards	5-24
Calibration Kits	5-24
Loading a Cal Kit Definition	5-25
Important Definitions	5-25
Types of Network Analyzer Calibration	5-25
Calibration Overview	5-26
Response Calibration	5-27
Response Calibration Procedure	5-28
Error Correction Now Goes ON	5-29
Response and Isolation Calibration	5-29
Response & Isolation Procedure	5-30
Error Correction Now Goes ON	5-31
1-Port Calibration	5-32

Standards Required for a 1-Port Calibration	5-32
Performing a 1-Port Calibration	5-33
Error Correction Now Goes ON	5-34
Supplementary Calibration Subjects	5-35
Storing and Loading Calibration Data (to/from disc)	5-35
Storing the Cal Set to Disc	5-35
Storing a Single Cal Set to a File	5-35
Replacing an Existing File	5-35
Storing Multiple Cal Sets to a File	5-36
Loading Cal Sets from Disc	5-36
Loading a File Containing a Single Cal Set	5-36
Loading a File Containing Multiple Cal Sets	5-36
Turning ON an Existing Cal Set	5-37
Exiting and Resuming a Calibration Procedure	5-37
Limitations	5-37
Proper Connector Torque	5-37
Principles and Care of Calibration Standards	5-38
Calibration Standards Require Careful Handling	5-38
Proper Inspection, Cleaning, and Connection	5-38
Principles of Operation	5-38
Quality of the Standards Affects Accuracy	5-38
Standard Models Differ Depending on Connector Type	5-38
Specifications, Modifying a Cal Kit	5-39
Common Problems	5-39
Verifying Calibration Data	5-39
Modifying Network Analyzer Calibration Kit Definitions	5-40
Modifying a Network Analyzer Cal Set	5-42
Reduce Number of Points After Calibration	5-42
Effects in Step Sweep Mode	5-42
Effects in Ramp Sweep Mode	5-42
Defining a Frequency Subset	5-43
Create and Save the Frequency Subset	5-43
Effects in Ramp Sweep Mode	5-44
Adjusting Trim Sweep	5-45
Trim Sweep Procedure	5-45
Creating a Standard Gain Antenna Definition	5-46
Introduction	5-46
Important Terms	5-46
The Supplied Cal Definition	5-46
Required Hardware	5-46
Creating an Antenna Definition	5-47
Choosing the Number of Frequency Points to Define	5-47
Covering a Wide Frequency Range	5-47
Determine Required Stimulus Values	5-47
Choosing the Number of Points	5-47
Determining the Frequency Increment	5-47
Determining Gain Values at Each Frequency Increment (Graph Format)	5-48
If Using Data in Table Format	5-49
Even Frequency Increments	5-49
Required ASCII File Format	5-50
In-Depth Description of a Cal Definition	5-51
Saving the Cal Definition File	5-52
Loading the Cal Definition into the HP 8530A	5-52
Creating a Cal Definition with Multiple Antenna Definitions	5-53
Details on the Supplied Antenna Definitions	5-54

Domain	5-55
Frequency Domain	5-55
Time Domain (Time Band Pass)	5-56
Angle Domain	5-56
Specify Time and Specify Gate	5-56
Display	5-57
Section Contents	5-57
DISPLAY Key Functions	5-57
Displaying More than One Trace	5-58
Adjusting the Display	5-58
Changing CRT Intensity	5-58
Changing Background Intensity	5-58
Changing Display Colors	5-59
How to Modify Colors	5-60
Using an External Monitor	5-61
How to Tell if a Monitor will be Compatible	5-61
Installing an External Monitor	5-62
Monitors that Use Separate Horizontal and Vertical Sync	5-63
HP 8530A Settings	5-63
Monitor Settings	5-63
Monitors that Use One Sync Connector	5-64
HP 8530A Settings	5-64
Monitor Settings	5-64
Monitors with No Sync Connectors	5-65
HP 8530A Settings	5-65
Monitor Settings	5-65
Monitors that Support All Sync Types	5-66
HP 8530A Settings	5-66
Monitor Settings	5-66
When external video configuration settings change	5-67
Using Trace Memory	5-67
Storing a Trace in Memory	5-67
Displaying the Memory Trace	5-67
Settings that can, and cannot be changed	5-68
Displaying Data and Memory at the Same Time	5-68
Settings that can, and cannot be changed	5-68
Selecting Default Memory	5-68
Volatile and non-volatile trace memories	5-69
Operational life of non-volatile memory	5-69
Using Trace Math	5-70
Changing the Default Trace Math Function	5-70
Performing a Trace Math Operation	5-71
Comparing Channel 1 Data with Channel 2 Data	5-71
Measurement Markers	5-73
Section Contents	5-73
Marker Functions	5-73
Using Standard Markers	5-73
Select the Active Marker	5-74
Marker Units	5-75
Continuous and Discrete Markers	5-75
Marker List Displays	5-76
Example of the Default Mode (“Four Param 1 Marker” mode)	5-76
Four Param 1 Marker Mode	5-76
Four Param 5 Marker Mode	5-77
Marker List On/Off	5-77

Delta Mode Markers	5-78
Marker Search Modes	5-79
Search Right and Search Left	5-80
Δ Mode Operation	5-81
Example of Delta Marker Use	5-81
Beamwidth and Bandwidth Functions	5-83

6. Stimulus Functions

Chapter Contents	6-1
Introduction to Stimulus Functions	6-2
Angle Domain Stimulus Controls	6-3
Setting Measurement Angles	6-3
Setting Measurement Frequency	6-3
Setting Increment Angle	6-4
Selecting Sweep Mode (single or swept angle)	6-4
HP 85370A Position Encoder Operation	6-5
Introduction	6-5
Position Encoder Softkeys	6-5
Configuration Functions	6-6
Single and Dual Synchro	6-6
Selecting single and dual synchro mode for any axis	6-6
Angle Display Modes	6-6
Operational Functions	6-7
Axis Controls	6-7
Boresight Angle	6-7
Offset Functions	6-7
Details about Save Offset	6-8
Offsets are axis independent	6-8
Adding incremental offsets	6-8
Encoder Settings and Save/Recall Registers	6-8
Details about Save Offset	6-8
Offsets are axis-independent	6-8
Adding incremental offsets	6-8
Using offset functions	6-8
Frequency/Time Domain Stimulus Control	6-9
Setting Frequency Values	6-9
When to Use START/STOP versus CENTER/SPAN	6-10
Selecting Frequencies Using Markers	6-10
Selecting the Number of Points to Measure	6-10
Source Sweep Modes	6-12
Selecting a Sweep Mode	6-13
Entering Ramp, Step, and Single Point Stimulus Values	6-13
Speed of Ramp, and Step Modes (in HP 8511 systems)	6-13
Frequency List Mode	6-14
Creating a Frequency List	6-15
Entering the First Segment	6-15
Add Segments	6-15
Editing the Frequency List	6-16
Changing a Segment	6-16
Deleting a Segment	6-16
Adding a Segment	6-16
Duplicate Points	6-17
Frequency List Save and Recall	6-17
Selecting All Segments or a Single Segment	6-17
Exit Frequency List	6-18

Sweep Time	6-18
Distortion Caused by Excessively-Fast Sweep Time	6-18
Example: Effects of Sweep Time	6-19
Sweep Execution, Hold/Single/Number of Groups/Continual	6-20
Why use Number of Groups?	6-21
Coupled/Uncoupled Channels	6-21
How to tell if a function is coupled	6-21
Setting Stimulus Power	6-21
Setting Source Output Power	6-22
Using Power Slope	6-22
Trigger Modes	6-23
The Three Triggering Modes	6-23
External and HP-IB Triggering Controls	6-24
How these Functions Work when One Parameter is Being Measured	6-24
How these Functions Work when Multiple Parameters are Being Measured	6-25
EXAMPLE 1	6-25
EXAMPLE 2	6-25
EXAMPLE 3:	6-26
7. Parameter Functions	
Chapter Contents	7-1
Basic Parameters	7-2
Parameter Menu	7-2
Service Parameters	7-2
Power Accuracy of Service Parameter Measurements	7-3
Redefining Parameters	7-3
Descriptions of Each Definition Type	7-4
Redefine Basic Parameters	7-4
Changing the Display Title	7-5
8. Format Functions	
Introduction	8-1
Display Format Keys	8-1
Format Menu Softkeys	8-2
Important Information Regarding Polar Format	8-2
Polar in the Angle Domain	8-2
Polar in Frequency Domain	8-2
Format Examples	8-3
Cartesian Log Format	8-3
Polar Log Format	8-4
Cartesian Log Format, Two Parameter Overlay	8-5
Log Format, Dual Channel Split	8-6
Frequency and Time Domain Data Shown Simultaneously	8-7
9. Response Functions	
Chapter Contents	9-1
Changing Display Scale and Reference	9-2
Setting Scale and Reference Values Automatically	9-2
Changing Display Scale Manually	9-2
Changing the Position of the Reference Line Manually	9-2
Changing the Value of the Reference Line Manually	9-2
The Effect of Factory Preset on Display Settings	9-2
Response Menu	9-3
Normalizing Data	9-4
Magnitude Slope and Magnitude Offset	9-4

Phase Offset	9-4
40 dB and 60 dB Pattern	9-5
Trace Averaging and Smoothing	9-5
Averaging	9-5
Averaging details	9-5
Notification when averaging is finished	9-5
Averaging factor recommendations	9-6
Smoothing	9-6
Delay Features	9-7
Electrical Delay	9-7
Using Electrical Delay	9-7
Delay Options	9-7
Coaxial Delay	9-7
Waveguide Delay	9-8
Table Delay	9-8
Selecting Velocity Factor	9-8
Auto Delay	9-8
10. Entry Block Controls	
Changing Values Using the Numeric Keypad	10-2
Other Keys in the Entry Block	10-2
11. Instrument State Block	
Chapter Contents	11-1
LOCAL	11-2
LOCAL Softkey Menus	11-2
SAVE and RECALL	11-4
Storing Instrument States to Disc	11-4
USER PRESET	11-4
12. Viewing Data	
Chapter Contents	12-1
Viewing Multiple Parameters and Channels	12-1
How Many Parameters does the Receiver Measure?	12-1
Selecting the Number of Parameters or Channels to Display	12-1
Viewing Data from Disc	12-2
13. Introduction to Time Domain RCS and Antenna Measurements	
Chapter Contents	13-1
Introduction	13-1
Using Front Panel Controls in Time Domain Mode	13-1
Time Domain General Theory	13-2
Time Domain Radar Cross Section Measurements	13-3
Viewing a Time Domain RCS Measurement	13-3
Interpreting The Time Domain RCS Response	13-4
RCS Down-Range Resolution	13-5
RCS Waveforms	13-6
User-Defined Waveforms	13-6
Time Domain Digital Resolution	13-7
RCS Alias-Free Range	13-8
Aliasing	13-8
How to Increase Alias-Free Range	13-8
How to Distinguish an Aliased Response from a Real Response	13-8
Measurement Errors and Calibration	13-9
Time Domain Noise Floor Reduction	13-9

Effects of RCS Calibration on Time Domain Responses	13-9
Isolation Error Term (Range Clutter)	13-9
Frequency Response Error Term	13-9
Horizontal Axis: Target Zone Shift	13-10
Vertical Axis: Clutter Removal and Reference Level Shift	13-10
Target Shadowing and Target Scattering	13-11
RCS Measurement Concepts	13-11
Masking	13-11
Reverberations	13-11
Range Gating	13-12
Gating Example	13-12
Select Gate Shape	13-13
Gating During RCS Calibration	13-15
Setting the Gate for a Gated RCS Calibration	13-15
Do Not Use Gating When	13-15
Using Gating During Subsequent Measurements	13-16
Effects of Gating on Background Calibrations	13-16
Time Domain Antenna Impedance Measurements	13-17
Procedure	13-17
Interpreting the Time Band Pass Reflection Response Horizontal Axis.	13-18
Interpreting the Time Band Pass Reflection Response Vertical Axis.	13-18
Time Domain Antenna Impedance Resolution	13-19
Antenna Impedance Alias-Free Range and Aliasing	13-19
Effects of 1-Port Calibration on Antenna Impedance Time Domain Responses	13-19
Effects of 1-Port Calibration	13-20
Antenna Impedance Time Domain Concepts	13-20
Masking in Impedance Measurements	13-20
Gating in Impedance Measurements.	13-20
Time Domain Antenna Transmission Measurements	13-21
Time Domain Characterization of Antenna Range Multipath	13-21
Antenna Impulse Response	13-21
Antenna Transmission Alias-Free Range and Aliasing	13-22
Effects of Antenna Calibration	13-22
Gating	13-23
Errors Caused by the Gating Process	13-23
14. SAVE and RECALL	
Saving and Recalling Instrument States	14-1
Storing Instrument States to Disc	14-1
USER PRESET	14-1
FACTORY PRESET	14-1
Factory Preset State	14-1
15. Disc Drive Operation	
Chapter Contents	15-1
Features	15-1
Compatible Disc Types, Disc Storage Capacity	15-2
DOS Subdirectories	15-2
Disc Menu	15-2
ASCII and Binary File Types	15-3
Changing between DOS and LIF Discs	15-3
Initializing Discs	15-3
Storing Disc Files	15-4
Loading Disc Files	15-6
Loading a File	15-7

Viewing a Directory of Files	15-7
Deleting Disc Files	15-8
Un-deleting Disc Files	15-8
Using an External Disc Drive	15-8
Compatible Disc Drives	15-8
Disc Unit Number and Disc Volume	15-8
Connections and Configuration Settings	15-8
Initializing a Hard Disc	15-9
Guide to Saving Data	15-10
Sharing a System	15-11
Saving Everything	15-11
Viewing or Plotting Old Data	15-11
CITIfile Reference	15-12
Disc Files	15-13
What is in a CITIfile	15-14
The Header	15-15
CITIfile Title Line	15-15
Device-Specific Information	15-15
Domain Information (independent variable declaration)	15-15
Type of Measurement Data (dependent variable declaration)	15-15
Stimulus Information	15-15
In Angle Domain	15-15
In Frequency Domain	15-16
CW Frequency (Angle Domain Only)	15-16
Date and Time	15-16
Data	15-16
Determining the Type of Measurement that Created the Data	15-16
CITIfile Packages	15-17
Multiple Data Lists in a Single Package	15-17
CITIfile Keyword Reference	15-18
HP 8530-Specific (#NA) Definitions	15-20
Data Grouping	15-20
HP 8530 Receiver Keywords	15-20
Error Array Numbering	15-23
CITIfile Examples	15-24
A Display Memory File	15-24
Data File Examples	15-25
Data File Example 1: Frequency Domain, Step or Ramp Mode	15-25
Data File Example 2: Frequency Domain, Frequency List Mode	15-26
Data File Example 3: Angle Domain	15-27
A Three-Term Cal Set File	15-28
A "DATA" Measurement Data File with Four Parameter Display On	15-29

16. Copy (Printing and Plotting)

Chapter Contents	16-1
Compatible Printers and Plotters	16-1
Installation Considerations	16-2
Supported Interfaces	16-2
Connecting an HP-IB Printer or Plotter	16-2
Connecting an RS-232 Printer or Plotter	16-2
Selecting the HP-IB (System Bus) or RS-232 Ports	16-2
RS-232 Print/Plot Buffers	16-2
Adding Your Own Annotations to the Screen	16-3
Using a Printer	16-4
Printing Features	16-4

What is Printed	16-4
Installing a Printer	16-4
Selecting the Output Port	16-4
Printer and HP 8530A Configuration	16-5
Using a Laser Printer	16-6
Configuring the Laser Printer	16-6
Standard Configuration	16-6
Other Laser Printer Settings	16-6
Configuring the Receiver	16-6
Selecting Printer Resolution	16-6
High Speed Configuration	16-7
Why it is Faster?	16-7
My printer has Built-In HP-GL, Do I still Need the Cartridge?	16-7
Ordering the Cartridge	16-7
Printer memory required	16-8
Setting up the Printer	16-8
Other Laser Printer Settings	16-8
Configuring the Receiver	16-8
Switching Between a Real Plotter and an HP-GL-emulating Laser Printer	16-9
Using an HP DeskJet, DeskJet Plus, or DeskJet 500 Printer	16-10
Serial Setup	16-10
Serial DIP switch settings	16-10
Prepare the Printer for Use	16-10
Configuring the Receiver	16-10
Selecting Printer Resolution	16-10
Additional Steps Required for the HP DeskJet 500C	16-10
Using an HP QuietJet, QuietJet Plus, PaintJet, or PaintJet XL Printer	16-11
Serial Setup	16-11
Serial DIP switch settings	16-11
HP-IB Setup	16-11
HP-IB address DIP switch settings	16-11
Prepare the Printer for Use	16-12
Configuring the Receiver	16-12
Selecting Printer Resolution (HP QuietJet and QuietJet Plus printers)	16-12
Selecting Printer Resolution (HP PaintJet and PaintJet XL printers)	16-12
Printing In Color	16-12
Using an HP ThinkJet Printer	16-13
Serial Setup	16-13
Serial DIP switch settings	16-13
HP-IB Setup	16-13
HP-IB address DIP switch settings	16-13
Prepare the Printer for Use	16-13
Configuring the Receiver	16-13
Selecting Printer Resolution	16-13
Using Non-HP Printers	16-14
Serial Setup	16-14
Serial DIP switch settings	16-14
HP-IB Setup	16-14
HP-IB address DIP switch settings	16-14
Before Printing	16-14
Printing	16-15
Landscape and Portrait Printing	16-15
Printing One Snapshot per Page (Portrait or Landscape)	16-16
Printing Two Snapshots per Page	16-16
Printing Tabular Measurement Data	16-17

Changing the format of the tabular data	16-17
Printing Instrument Settings and System Configuration	16-19
Using a Plotter	16-22
Plotting Features	16-22
What is Plotted	16-22
Installing a Plotter	16-22
Selecting the Output Port	16-22
Special instructions for connecting the HP 7550	16-22
HP 7550B and 7550 Plus Plotters	16-23
Plotting Options	16-23
Plotting Options	16-23
Selecting Pen Color	16-23
Plotting	16-25
Plotting One Snapshot per Page	16-25
Plotting Individual Display Components	16-25
Plotting a Selected Quadrant (four snapshots per page)	16-26

17. Using System Functions

Chapter Contents	17-1
System Menus	17-2
Controls that Affect the Receiver	17-3
Phaselock Controls	17-3
Lock Type	17-3
Step Type	17-3
Normal Step	17-4
Quick Step Mode	17-4
Lock Speed	17-4
Warning Beeper	17-5
IF Calibration and Correction	17-5
IF Calibration Controls	17-5
Display Functions	17-6
Creating a Title	17-6
Deleting a Title	17-6
Adjusting the Date/Time Clock	17-6
Security Features	17-7
Controls that Affect I/O	17-8
HP-IB Addresses	17-8
HP-IB Configure	17-9
Edit Multiple Source	17-9
Remote Switch Recall	17-9
Power Leveling	17-9
Frequency Converter Type	17-10
Controlling Multiple Sources	17-11
Using the Multiple Source Menu	17-12
How to Enter the Example Configuration	17-13
Now save the configuration	17-14
Millimeter Wave Mixers	17-14
Uses for the SOURCE 1 and RECEIVER Formulas	17-14
SOURCE 1 Formula Use	17-15
RECEIVER Formula Use	17-15
Why these settings are used	17-16
Service Functions	17-17
Test Menu	17-17
Disc Commands	17-18
System Bus Softkeys	17-18

IF Gain	17-19
Why Use Manual control	17-19
Why the problem occurs	17-19
How to Use Manual IF Gain Controls Properly	17-21
Automated Measurement Issues	17-22
Peek and Poke	17-22
Purpose of Peek and Poke	17-22
18. HP-IB Programming	
What is in this Chapter	18-1
What You Can Do with Remote Programming	18-1
HP-IB Command Information	18-2
Order of Programming Commands	18-2
Syntax Requirements	18-2
Mnemonics	18-2
Numeric entries and units	18-2
“Next Menu” commands are unnecessary	18-3
Timing Considerations	18-3
Overview of Computer-Controlled Measurements	18-4
Setting up the System	18-4
Connect the External Computer	18-4
Address Settings	18-4
Set Up the Measurement Using HP-IB Commands	18-4
Transferring Data Out of the Receiver	18-5
Sending Data to the Computer	18-5
What Types of Data Are Available from the HP 8530A?	18-5
Raw Data	18-6
Corrected Data Array	18-6
Formatted Data Array	18-7
If in Frequency or Time Domain	18-7
If in Angle Domain	18-7
Data Always Comes from the Active Channel	18-8
Available Data Transfer Formats	18-8
How Much Data Is Transferred?	18-9
Preparing the Computer to Transmit or Receive Data	18-9
Setting up the I/O Path	18-9
The size of the preamble, size block, and data blocks	18-9
Setting Up Variables	18-10
Dynamic Array Allocation	18-10
Performing the Actual Transfer	18-10
Using the Data	18-12
Preprocessing Form 1 Data	18-12
Using Real,Imaginary Format for Vector Math	18-12
Converting Real,Imaginary Data to Magnitude and Phase Data	18-12
Transferring Data Into the Receiver	18-13
Raw, Corrected, Formatted Arrays	18-13
Trace Memories	18-14
Form 4 Input	18-14
Commonly-Used Queries	18-15
Marker Value	18-15
Active Function Value	18-15
Query System State	18-15
System Status	18-15
Where to Find Other Query Commands	18-15
Local Operation	18-16

Program Debugging Aids	18-16
Programming Examples	18-17
Example 1: Input Syntax Familiarization	18-17
Example 2: Active Function Output	18-18
Example 3: Marker Data Output	18-18
Example 4: Marker Operation	18-20
Example 5: Display Modes	18-20
Example 6: Using = MARKER	18-21
Example 7: Trace Data Output and Input	18-21
Example 8: FORM 1 Data Conversion	18-21
Example 9: Using the Disc Drive	18-21
Using the Internal Disc	18-21
File Name Prefixes	18-22
Printing Your Own Messages on the Receiver Display	18-22
Example 10: Plots Using Copy	18-22
Example 11: Trace List to Printer	18-23
Example 12: Print/Plot to Receiver System Bus (using	18-23
General Input/Output	18-23
Passing Commands Through the Receiver Devices on the System Bus	18-23
How to send pass through commands	18-23
How pass through works	18-24
Pass-Thru of Text to a Printer	18-25
Output to Plotter	18-25
User Display Graphics	18-25
Example 13: Plot User Graphics HP-GL	18-25
Example 14: Plot to User Display Using BASIC HP-GL	18-26
Vector Diagrams	18-26
Text	18-27
Select Pen Colors	18-27
Using the Internal Disc to Store the User Display	18-27
Summary of User Graphics Statements	18-27
Summary of User Display Instructions	18-28
Example 15: Redefine Parameter	18-28
Example 16: Read and Output Caution/Tell Message	18-28
Example 17: Read and Output Status Bytes	18-29
Read Status Bytes	18-29
Setting the Service Request Mask	18-30
Example 18: Output Key Code	18-30
Example 19: HP-IB Triggered Data Acquisition	18-30
Example 20: Wait Required	18-30
Example 21: Wait Not Required.	18-30
Example 22: Frequency List	18-31
Example 23: Using the Receiver's Learn String	18-31
Example 24: Input Floating Point or ASCII Trace Data	18-32
Example 25: Table Delay Operations	18-32
Example 26: FAST (CW,AD,D) Data Acquisition	18-32
Example 27: Fast IF Multiplexing Operation	18-32
General HP-IB Programming	18-32
Interface Functions	18-33
Response to HP-IB Universal Commands	18-33
Response to HP-IB Addressed Commands	18-33
Example Program Listing	18-35

19. Operator's Check and Routine Maintenance	
Operator's Check	19-1
Routine Maintenance	19-3
Maintain Proper Air Flow	19-3
Connector Care	19-3
Recommended Practices	19-3
How to Inspect Connectors for Wear	19-4
How to Clean Connectors	19-4
Connector Cleaning Supplies	19-4
Clean the Glass Filter (and display as Required)	19-4
Cleaning the display	19-5
Degauss (Demagnetize) the Display	19-6
20. In Case of Difficulty	
Chapter Contents	20-1
Common Operation Problems	20-2
Receiver will not Sweep	20-2
Check the Selected Sweep Mode	20-2
Check the System Phase Lock Setting	20-2
IF Signal Level Problems	20-3
On Systems Using the HP 85309A Frequency Converter	20-3
On Systems Using the HP 8511A/B Frequency Converter	20-3
Possible Solutions	20-3
LO Signal Level Problems (applies to the HP 85309A only)	20-4
LO Signal Is Too Low	20-4
HP 85309A "LO POWER OUT OF RANGE" light is ON During Measurement	20-4
Rotary Joint Problems	20-5
Common Error Messages	20-6
A	20-6
"ABORTED ENCODER TRIGGERED SWEEP"	20-6
"ADDITIONAL STANDARDS NEEDED"	20-6
In Antenna Calibration	20-6
In Network Analyzer Calibration	20-6
C	20-6
"CALIBRATION RESET"	20-6
"CORRECTION MAY BE INVALID"	20-6
E	20-7
"ENCODER NOT FOUND"	20-7
"ENCODER OFFSET ANGLE ALREADY SAVED"	20-7
F	20-7
"FREQUENCY CONVERTER IS TOO HOT!"	20-7
I	20-7
"IF OVERLOAD"	20-7
N	20-8
"NO IF FOUND"	20-8
O	20-8
"OPTION #005 NOT INSTALLED"	20-8
"OVERSPEED ERROR - BACKUP"	20-8
P	20-9
"PHASE-LOCK LOST"	20-9
Phase Lock Problems when using Hardware Gating	20-9
S	20-9
"SOURCE (1 or 2) FAILURE - RF UNLOCKED"	20-9
"SWEEP SYNC ERROR"	20-9
"SYSTEM BUS ADDRESS ERROR"	20-9

T	20-11
“TEST SET IS TOO HOT!”	20-11
U	20-11
“UNABLE TO RAMP THIS DUAL SOURCE SETUP”	20-11
V	20-11
“VTO FAILURE”	20-11
If Using the HP 8511A/B	20-11
If Using the HP 85309A	20-11
Hardware Problems	20-12
HP 8530A Locks Up	20-12
If Your System Uses the HP 8511A/B	20-12
If Your System Uses the HP 85309A	20-12
An Instrument will not Respond to Computer Control	20-12
If the instrument operates manually	20-12
If the instrument does not operate manually	20-13
A System Bus Instrument will not Respond	20-13
If the instrument operates manually	20-13
If the instrument does not operate manually	20-14
HP 85309A (LO/IF Unit) Problems	20-14
LO/IF Unit Does Not Turn ON	20-14
The LO POWER OUT OF RANGE Light is ON	20-14

Glossary

Index

Figures

1-1. Antenna Measurement Setup Using an HP 8511A	1-2
1-2. Antenna Measurement Setup Using an HP 85310A	1-3
1-3. Angle Domain	1-4
1-4. Frequency Domain	1-5
1-5. Time Domain	1-5
2-1. Simplified System Block Diagram	2-3
2-2. HP 8530A Measurement Data Flow Diagram	2-4
2-3. Phase Lock Reference	2-5
2-4. Independent Data Processing in Each Channel	2-6
3-1. Annotation Areas for Single Parameter display mode	3-2
3-2. HP 8530A Front Panel	3-5
3-3. Channel Selection Keys	3-5
3-4. Rear Panel Features	3-12
4-1. Channel Selection Keys	4-1
5-1. Cal and Cal Type Menus	5-7
5-2. Menus Associated with RCS Calibration	5-19
5-3. Dimensions Required by Different Target Types	5-22
5-4. Calibration Setup for Response Cal	5-27
5-5. Transmission and Reflection Response Error Models	5-28
5-6. Calibration Setup for Isolation Cal	5-29
5-7. Transmission/Reflection Response and Isolation Error Model	5-30
5-8. Calibration Setup for 1 Port Cal	5-32
5-9. 1-Port Error Model	5-32
5-10. 1-Port Cal Menu	5-33
5-11. LOADS Frequency Ranges	5-33
5-12. Reduced Number of Points After Calibration	5-42
5-13. Modify Cal Set, Frequency Subset Menu	5-43
5-14. Defining a Frequency Subset	5-44
5-15. Typical Standard Gain Antenna Performance Graph	5-48
5-16. Typical Standard Gain Antenna Performance Graph	5-50
5-17. Domain Menu	5-55
5-18. Frequency Domain	5-55
5-19. Time Domain	5-56
5-20. Angle Domain	5-56
5-21. Display and Display Mode Menus	5-57
5-22. Adjust Display Menu	5-59
5-23. External Video Menu	5-62
5-24. Monitor with Two Sync Connectors (Separate H,V Sync)	5-63
5-25. Monitor with one Sync Connector (Composite Sync)	5-64
5-26. Monitor with No Sync Connectors (Sync on Green)	5-65
5-27. Monitor Supporting All Sync Types	5-66
5-28. Display of Memory, Data and Memory	5-68
5-29. Select Default Trace Memory	5-69
5-30. Select Default Trace Math	5-71
5-31. MARKER Key and Marker Menus	5-73
5-32. Markers on Trace	5-74

5-33. Default Marker Data Display (Four Param 1 Marker mode)	5-76
5-34. Four Param 5 Marker mode	5-77
5-35. Marker and Δ Mode Menus	5-78
5-36. Δ Mode Markers on Trace	5-79
5-37. Marker Search Modes	5-80
5-38. Δ Mode Marker to Target	5-81
6-1. STIMULUS Function Block	6-2
6-2. Stimulus Menu (in Angle Domain)	6-3
6-3. Position Encoder (option 005) Softkeys	6-5
6-4. Stimulus Menu (in Frequency or Time Domain)	6-9
6-5. Number of Points Menu	6-11
6-6. Narrow Band Responses Shown with 51 Points (left) and 401 Points (right)	6-11
6-7. Frequency List Menu Structure	6-14
6-8. Enter the First Segment	6-15
6-9. Frequency List, Display of Single Segment	6-17
6-10. Effects of Sweep Time	6-19
6-11. Stimulus More Menu	6-20
6-12. Source Power Menu	6-21
6-13. Trigger Mode Menu	6-23
6-14. Custom External Triggering Flowchart (one parameter)	6-25
6-15. Custom External Triggering Flowchart (four parameters)	6-27
7-1. Parameter Function Block	7-1
7-2. Parameter Menu	7-2
7-3. Typical SERVICE 1, a1 Measurement	7-3
7-4. Redefine Parameter menu Structure	7-5
8-1. Format Function Block and Format Menu	8-1
8-2. Differences in Angle and Frequency Domain Polar Formats	8-2
8-3. Cartesian Log Format for a Single Parameter	8-3
8-4. Polar Log Format for a Single Parameter	8-4
8-5. Dual Channel Overlay Display	8-5
8-6. Dual Channel Split Display	8-6
8-7. Frequency and Time Domain Display	8-7
9-1. Response Function Block	9-1
9-2. Response Menu Structure	9-3
9-3. Results of Averaging	9-6
9-4. Smoothing Operation	9-6
9-5. Results of Smoothing	9-7
11-1. Instrument State Block Keys	11-1
11-2. LOCAL Key Menus	11-1
13-1. Typical RCS Measurement Configuration	13-3
13-2. Frequency Domain Response versus Time Domain Response	13-4
13-3. Typical RCS Time Domain Response	13-5
13-4. Typical Aliased Response	13-7
13-5. RCS Isolation and Response Error Model	13-9
13-6. Time Domain RCS Response Before and After Calibration	13-11
13-7. Typical Gate Shape	13-12
13-8. The Effects of Gating in Time and Frequency Domains	13-13
13-9. Gate Characteristics	13-14
13-10. Time Domain Antenna Impedance Measurement Setup	13-17
13-11. Typical Frequency and Time Domain Response of an Antenna	13-18
13-12. Antenna Impedance 1-Port Error Model	13-19
13-13. Responses in a Typical RCS Range	13-22
15-1. Disc Menu, Data Type Select Menu, Setup Disc Menu, and Initialize Disc Menu	15-2
16-1. Define Print Menu	16-5
16-2. HP QuietJet and PaintJet (Family) Printer Serial Switch Settings	16-11

16-3. HP QuietJet and PaintJet (Family) Printer HP-IB Switch Settings	16-12
16-4. HP ThinkJet printer HP-IB Switch Settings	16-13
16-5. Landscape Printer Orientation	16-15
16-6. Portrait Printer Orientation	16-16
16-7. Define List Menu	16-18
16-8. System/Operating Parameters Menu	16-19
16-9. Define Plot and Plot to Plotter Menu Structure	16-26
17-1. Main System Menu and Part of the Display Functions Menu	17-2
17-2. System Phaselock Menu	17-3
17-3. Date/Time Functions Menu	17-6
17-4. System Power Leveling Menu	17-10
17-5. Actual LO Frequency Required by a Harmonic Mixer	17-11
17-6. Edit Multiple Source Menu	17-12
17-7. Source 2 Modified for 3rd Harmonic Mixer System	17-12
17-8. Finished Multiple Source Configuration for LO Source and 3rd Harmonic Mixers	17-14
17-9. Module Testing Example	17-15
17-10. Finished Multiple Source Configuration for Hypothetical Module	17-16
17-11. Service Functions Menu	17-17
17-12. Simplified Block Diagram of the HP 8530A Receiver	17-20
17-13. Gain Stages in the IF section	17-21
18-1. Data Processing Stages in the Receiver	18-6
18-2. Pass Through Flow	18-24
18-3. PA Vector Scaling	18-26
18-4. Text Character Cell	18-27
19-1. Typical Preset State Display	19-1
19-2. Typical Preset State Display	19-2
19-3. Removing the Glass Filter	19-5
19-4. Motion for Degaussing the Display	19-6

Tables

1-1. HP 8530A Equipment Supplied	1-11
1-2. Touch Up Paint	1-13
1-3. Environmental Conditions	1-14
1-4. Required options for HP 85360 LO sources	1-16
1-5. Compatible Sources for Fast Measurement Speeds	1-17
1-6. External Monitors	1-19
2-1. Memory Numbers for Each Parameter on Each Channel	2-7
2-2. Instrument Factory Preset Conditions	2-11
3-1. Numeric Value Terminator Key Usage	3-8
5-1. Proper Connector Torque	5-14
5-2. Proper Connector Torque	5-16
5-3. Proper Connector Torque	5-37
5-4. Example Standard Gain Antenna Performance Table	5-49
5-5. Antenna Definitions in the Supplied Cal Definition	5-54
5-6. Default Settings for Display Elements	5-60
5-7. Memory Numbers for Each Parameter on Each Channel	5-67
5-8. Marker Units	5-75
7-1. Standard PARAMETER Definitions	7-3
10-1. Numeric Value Terminator Key Usage	10-2
13-1. Approximate Impulse Width Formulas for Different Window Types (Time Domain Waveforms).	13-6
13-2. Gate Shape Characteristics Using Different Window Settings	13-14
13-3. Useful Time Band Pass Formats	13-18
13-4. Gating Uncertainty	13-23
14-1. Instrument Factory Preset Conditions	14-2
15-1. Disc Storage Capacities	15-2
15-2. Information You Can Store To Disc, and How it is Saved	15-3
15-3. File Types and Prefixes	15-7
15-4. File Name Prefixes	15-13
15-5. CITIfile Keyword Reference	15-18
15-6. Network Analyzer/Receiver Statements	15-21
15-7. Names of Error Coefficient Arrays for Different Calibration Types	15-23
16-1. Serial Printer Settings for Other Printers	16-14
16-2. Typical Initialized System Parameters Listing	16-20
16-3. Typical Operating Parameters Displays (first page)	16-21
16-4. Typical Operating Parameters Displays (second page)	16-21
16-5. Default Pen Numbers	16-24
17-1. Test Menu	17-18
18-1. Marker Units	18-19

General Information

Chapter Contents

This chapter describes the following:

- Operating and Safety Precautions
- HP 8530A Description
 - Design Intent of the HP 8530A
 - Measurement Features
 - Angle Domain
 - Frequency Domain
 - Time Domain
 - Calibration
 - *Other Features*
 - Input/Output Features
 - Printing and Plotting Features
 - Peripheral Instruments
 - Built-In Disc Drive
- How the HP 8530A Differs from Similar Products
- Options
- Equipment Supplied
- Accessories and Supplies
- Specifications
- Environmental Characteristics
- Compatible Instruments
- Compatible Printers and Plotters
- Compatible External Monitors

Operating and Safety Precautions

Operating

ESD (electrostatic discharge) can damage the microcircuits in the HP 8530A. Such damage is most likely to occur as cables are connected or disconnected. To avoid ESD damage, wear a grounding strap or ground yourself by touching any grounded instrument chassis before touching input connectors. Do not touch the center contacts of the connectors.

Service

There are no user-serviceable parts in the HP 8530A. Service should be performed by qualified personnel only.

General Information

HP 8530A Description

The HP 8530A is a high-performance receiver that has been designed specifically for antenna and radar cross section (RCS) measurements. The HP 8530A allows you to make angle-scan and frequency-scan measurements of antennas, or make RCS measurements using the optional Time Domain feature.

Very fast measurement speeds are possible with the HP 8530A. By using a computer controller, the receiver can measure up to 5,000 data points per second. The receiver has very high sensitivity and dynamic range. The HP 8530A provides a large amount of measurement flexibility, providing the features you need for many different types of measurements.

The HP 8530A must be used with a frequency down converter. The following HP down converters are supported:

- HP 8511A/B frequency converter
- HP 85310A distributed frequency converter
- HP 85325 millimeter wave subsystems (the HP 85325A and HP 85309A, used together, make a complete frequency converter system).

Note The HP 85309A is a four channel frequency converter, and is part of the HP 85310A Distributed Frequency Converter system.

These products down-convert microwave (or millimeter-wave) signals to 20 MHz test and reference signals that are measured by the HP 8530A. Figure 1-1 and Figure 1-2 show the basic block diagram of typical antenna measurement systems.

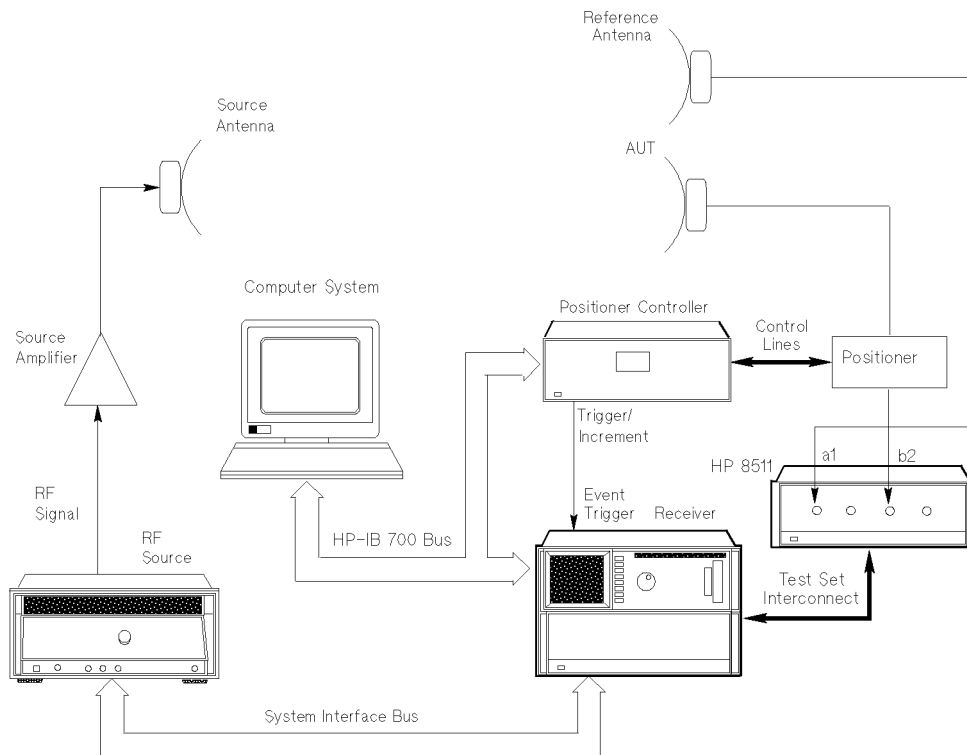

Figure 1-1. Antenna Measurement Setup Using an HP 8511A

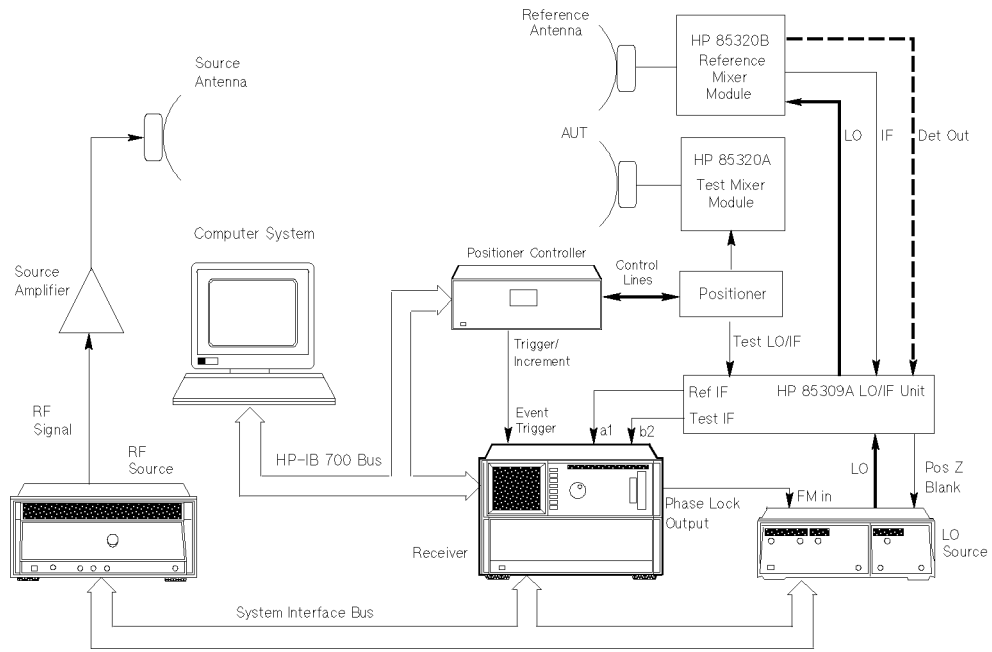

Figure 1-2. Antenna Measurement Setup Using an HP 85310A

Measurement Features

This section discusses the capabilities of the HP 8530A.

Design Background of the HP 8530A

The HP 8530A was designed to be a dedicated antenna/RCS receiver, and its hardware and firmware have been optimized for that use. Before the advent of the HP 8530A, many Antenna/RCS customers had been using the receiver portion of an HP 8510 system for their measurements. The HP 8510 had originally been designed for metrology-quality testing of microwave components, and consisted of the “HP 8510” receiver, and a network analyzer test set. In the network analysis market, the HP 8510 receiver provided benchmark sensitivity, dynamic range, accuracy, and speed. Antenna/RCS customers found that these qualities made the HP 8510 an excellent receiver for automated (computer controlled) testing of antennas and for RCS applications.

To provide more performance for antenna and RCS users, Hewlett Packard designed the HP 8530A. This dedicated receiver is optimized for faster speeds, contains special antenna and optional RCS features, and provides *manual measurement capabilities* using “Angle Domain.” Hewlett-Packard also created upgrade kits so owners of existing HP 8510A/B/C receivers could easily upgrade to the HP 8530A.

Major Features

The major *operational* features of the HP 8530A are listed below:

Angle Domain

Allows you to make angle scan measurements at a single frequency. In Angle Domain mode, the x-axis of the display is angular degrees. External triggering is used (HP-IB or TTL) in this mode. You can measure a single angle, or a range of angles.

Angle Domain

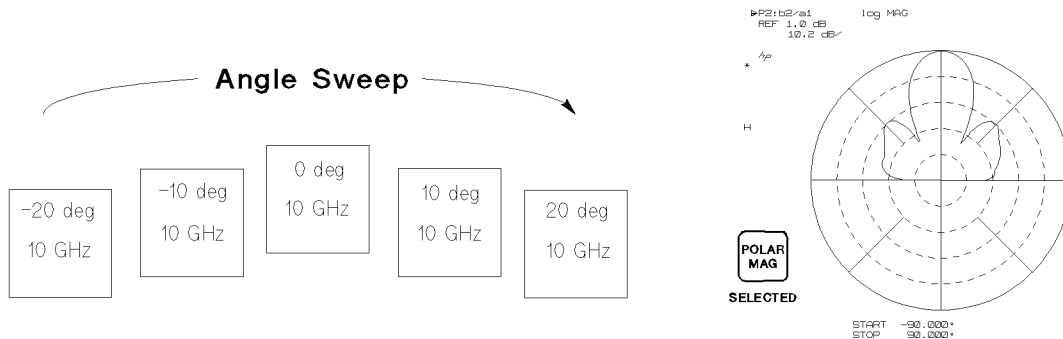

Figure 1-3. Angle Domain

Frequency Domain

Allows you to measure antenna magnitude and phase performance across a band of frequencies. Frequency Domain measurements must be made at a single *angle*. In Frequency Domain mode, the x-axis of the display is frequency. Internal triggering (free run trigger mode) is commonly used when measuring frequency, but external triggering can be used as well. You can measure a single frequency, or choose from Ramp, Step, or Frequency List sweep modes.

Frequency Domain

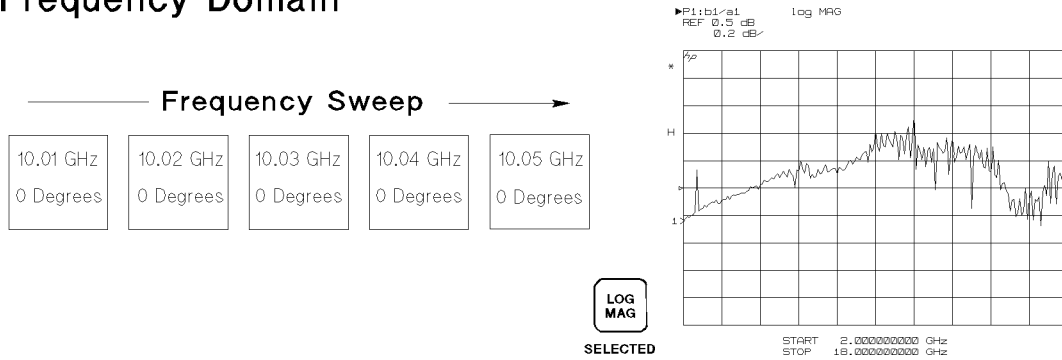

Figure 1-4. Frequency Domain

Time Domain

This optional feature allows you to make RCS measurements or see the time domain response of an antenna (time is shown on the display x-axis). One use of time domain is when measuring multi-path range reflections. Internal triggering is usually used in this mode.

Time domain data is mathematically calculated from Frequency Domain data. This is done using the “chirp-Z” inverse Fourier transform. Therefore, the first step in time domain measurements is to make a measurement in the Frequency Domain.

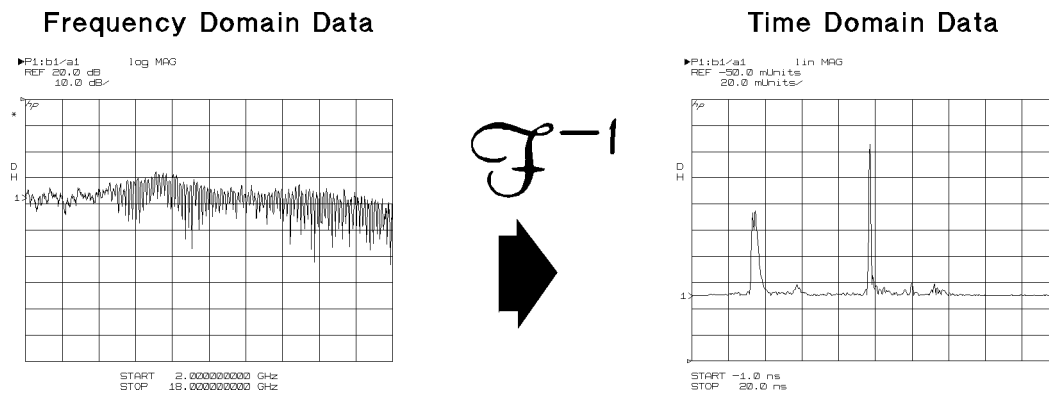

Figure 1-5. Time Domain

HP 8530A Features

Calibration

Antenna calibration provides accurate gain and frequency response measurements by calibrating your range against a standard gain antenna. Also, the isolation calibration feature reduces measurement errors caused by signal crosstalk.

RCS Response and Isolation calibration is also supplied. This calibration reduces range errors using a calibration sphere of known radar cross section. The response portion of the calibration measures the reflections of the calibration sphere. The isolation portion measures the empty antenna chamber to characterize and compensate for clutter. Four reflection standards are supported.

A “network analyzer” calibration is also provided. This calibration is used if you want to make network analyzer-type measurements. For example, assume you want to measure the impedance of an antenna input (or output). You would perform the network analyzer calibration so you could make very accurate measurements. In this example a directional coupler is required to measure the reflected signals.

Four Measurement Inputs

The receiver has four inputs for receiving signals (a1, a2, b1 and b2). You must connect a reference signal to a1 or a2. Then, any other inputs can be used as test signal inputs. For example, assume you connect the reference signal into a1. You could then use a2, b1, and b2 to measure test signals. The “PARAM” keys, described below, select which inputs to ratio for your measurement.

Selectable Input Ratios

PARAM 1, **PARAM 2**, **PARAM 3**, and **PARAM 4**, select a specific pair of inputs to ratio and measure. (“PARAM” is short for “parameter.”) For example, **PARAM 1** mathematically divides (ratios) input b1 data by a1 data. You can redefine the PARAM keys so they ratio any two inputs you desire. You can also measure a single input without ratioing. By default, the four parameters ratio the following inputs:

PARAM 1	b1/a1
PARAM 2	b2/a1
PARAM 3	a2/a1
PARAM 4	b1/a1

Notice that the default ratio for Param 1 and Param 4 are the same. You can redefine the ratios for Param 1, 2, 3 or 4 using the softkeys under PARAMETER **MENU** **REDEFINE PARAMETER**.

Flexible Triggering

The HP 8530A provides three ways of triggering measurements:

Free Run	When you select “Free Run” the receiver does not require any triggering. This is useful when making frequency measurements.
External Triggering	Allows you to trigger measurements using a TTL increment signal produced by a positioner controller. This allows the receiver to take data when the positioner is aligned with each measurement angle.
HP-IB Triggering	Allows a computer to trigger a measurement by issuing a GET command over the HP-IB bus.

Measure Parameter 1, 2, 3 or 4 in Any Combination

You can measure from 1 to 4 ratioed or non-ratioed parameters on any given trigger (HP-IB or External).

Save/Recall Registers

The receiver has eight Save/Recall registers. Each can save current measurement settings for instant recall at a later time. Register-8 is the “User Preset” register. Settings saved under register-8 become active whenever you turn the receiver ON, or when you press **USER PRESET**.

Measure Performance Relative to the Peak of the Main Lobe

The Normalize Trace function sets the peak of the main lobe (the data point of highest amplitude) to 0 dB. You can then use markers to view trace magnitude values relative to this reference point. When data is saved, printed, plotted, or transferred to a computer, magnitude values will be relative to the peak. This feature is under the RESPONSE **MENU** key.

Remote Programming

The HP 8530A can be controlled remotely from any computer that can communicate using HP-IB. All front panel features are supported, plus many functions which are only available via HP-IB. You can query the analyzer to determine current modes of operation and current instrument or system status.

Data Presentation Features

The HP 8530A can show measurement results on its display. It can display:

- Antenna patterns
- Frequency response measurements
- Time domain
- Radar Cross Section (RCS) frequency and time domain measurements
- Return Loss or SWR

The HP 8530A allows you to print or plot measurement results.

Display Formats

You can select logarithmic or linear magnitude display formats (Cartesian or polar), or phase display format (Cartesian only). You can display one, two, three, or four parameters simultaneously on the screen.

Multiple Measurements Can be Shown Simultaneously

The HP 8530A allows you to view up to four parameters at once, in split or overlay presentation. Alternatively, you can display one parameter from each of the independent measurement channels (more on channels is explained later).

Trace Memory and Trace Math

The trace memory feature is similar to the storage feature in a storage oscilloscope. You can store the current data trace to memory, then compare it to subsequent measurement traces. Trace math features allow you to perform vector addition, subtraction, multiplication, and division. These operations are performed using the current data trace and the memory trace. Each parameter has independent trace memory/math operation. In addition, trace math in Channel 1 is independent from trace math in Channel 2.

HP 8530A Features

Markers Display Precise Values for Any Point on Display Traces

Five measurement markers give detailed information about any point on the measurement trace. Delta markers allow you to show the difference in amplitude, phase, angle, or time between any two points on the trace.

External Video Monitor

The HP 8530A can display results on an external multisync monitor. Refer to “Compatible Instruments” for details.

Optional Network Analysis

Option 011 adds high-performance vector network analysis features (HP 8510C operation). This allows you to measure the transmission and reflection properties of microwave devices in frequency or optional time domains. Advanced calibration features provide optimum accuracy in S-Parameter network measurements.

Input/Output Features

The HP 8530A can control other instruments, and has many input/output capabilities using HP-IB, System Bus, RS-232, external monitor interface, and TTL rear panel connectors.

Printing and Plotting Features

The HP 8530A can output data to a wide range of HP-IB or RS-232 printers or plotters. Laser printers are also supported.

Peripheral Instruments

The HP 8530A can control RF and LO signal sources, frequency converters, and RF switches. Refer to “Compatible Instruments” for details.

Built In Disc Drive

The built in high-capacity disc drive allows you to save measurement data, data from memory, instrument configuration setups, save/recall registers, calibration data, or user-created graphics. Both DOS and LIF disc formats are supported, and both disc types are automatically recognized. DOS format is compatible with MS-DOS® based computers, such as IBM PCs and compatibles. LIF format is compatible with Hewlett-Packard computers, such as the HP 9000 Series 300 workstation family. The drive accepts high-capacity 1.44 MB discs. (Disc capacity is different when using LIF format.)

How the HP 8530A Receiver Differs from Similar Products

The HP 8530A receiver is similar to the HP 8510C network analyzer. The main differences are these:

- The HP 8530A can measure up to 5,000 points per second using a new 100,000-point data buffer.
- The HP 8530A has a new domain called ANGLE DOMAIN. This is a new measurement type that measures antenna performance with respect to *angle*. Actual antenna patterns are shown on the screen, and markers read out in angular values. You can display results in Cartesian format or show polar antenna patterns on the screen.
- External triggering is very flexible, allowing you to trigger on an external TTL signal, or by HP-IB command. In addition, you can choose which parameters (input ratios) will be measured on successive triggers. The HP 8530A has a data acquisition handshake line that tells external hardware when the HP 8530A is ready for another trigger.
- The HP 8530A can track increment triggers from the positioner controller, and take data at exactly the right time.
- The HP 8530A provides antenna (gain) and RCS calibration types.
- The HP 8530A has (optional) time domain band pass mode, but not time domain low pass. (The low pass mode requires that the measured device be able to pass signals down to DC. This is not possible with antennas, so low pass mode is not appropriate.)
- A calibration created for a specific parameter ((PARAM 1) for example) can be recalled for any of the other parameter keys ((PARAM 2), (PARAM 3), or (PARAM 4)). Refer to the calibration chapter for details.

Options

Option 005 - Positioner Encoder Compatibility

Option 005 adds the necessary hardware so the HP 8530A will operate with the HP 85370A Position Encoder. If the receiver *does not* already have a rear panel ENCODER INTERCONNECT connector, it must be returned to the factory so the rear panel can be changed.

Option 010 - Time Domain Operation

Adds Time Domain operation. The receiver converts data from the frequency domain to the time domain (using inverse Fourier transform). The time domain response shows the measured parameter value versus time. The windowing feature can modify the frequency domain data to reduce side-lobe levels in the time domain response. You can isolate individual time domain responses using the gating functions.

Option 011 - Add HP 8510C Firmware Operating System

Option 011 receivers can run HP 8510C firmware, and a copy of this firmware is supplied. You can only run one operating system (OS) at a time, either HP 8530A or HP 8510C. To change between HP 8530A and 8510C operation, you must load the appropriate operating system from disc.

When using the receiver as an HP 8510C, refer to the supplied HP 8510C manuals for operating information.

Option 908 - Rack Mount Kit (for instruments without handles)

This HP 8530A rack mount kit allows you to mount the receiver to a standard 19 inch rack. The rack flanges in this kit *are not compatible* with front handles. To obtain this item after receiving the HP 8530A, order part number 5062-3977 and 5062-3978.

Option 913 - Rack Mount Kit (for instruments with handles)

This HP 8530A rack mount kit allows you to mount the receiver to a standard 19 inch rack. The rack flanges in this kit *are compatible* with front handles. To obtain this item after receiving the HP 8530A, order part number 5062-4071 and 5062-4072.

Option 910 - Additional Manual Set

This provides an additional manual Set. To obtain this item after receiving the HP 8530A, order part number 08530-90001.

Option W31 - Extended Service (On-Site, where Available)

Converts the standard warranty to three years of on-site repair service (where available). The warranty period begins at the time of product delivery. This warranty option does not include annual calibration.

Equipment Supplied

The following equipment is included in the HP 8530A system:

Table 1-1. HP 8530A Equipment Supplied

Description	Qty	Part Number
Cables		
IF Display Interconnect	1	08510-60101
RS-232 Cables	2	HP 24542G
External Video Cable	1	HP D1191A
BNC Cables (1 meter)	2	8120-2582
HP-IB Cable (1 meter)	1	8120-3445
Software		
HP 8530 Operating System Disc	1	08530-80005
Antenna/RCS Calibration Disc	1	08530-10001
HP 8510 Operating System Disc ¹	1	85101-80098
HP 8510 Specs and Performance ver. Disc ²	1	08510-10033
HP 8510C Software Toolkit Disc ¹	1	85103-10002
HP 8530A Software Toolkit Disc	1	08530-10002
HP 85102 Adjustments Disc ¹	1	08510-10024
Calibration Data Disc ¹	1	08510-10034
CMP program kit ³	1	85101-60040
Documentation		
HP 8530A manual set	1	08530-90001
HP 8510C manual set ¹	1	08510-90275
Other Items		
Alcohol Cleaning Fluid, bottle	1	8500-5344
Swabs, package	1	08530-90001

1 Only included with option 011.

2 Runs on HP 9000 Series 200/300 workstations (calculates and verifies specifications). Only supplied with option 011.

3 The CMP (circuit modeling program) is only useful if your instrument is equipped with option 010, time domain. This disc is only supplied with option 011.

Accessories and Supplies

HP-IB Extenders (HP 37204A) and Related Cables

One extender is required at the receiver, plus one additional extender at each remote location. More than one instrument can be connected to a single HP-IB extender. Do determine if you need an HP-IB extender, refer to “Allowable HP-IB Cable Lengths”.

Standard Coax HP-IB Extender

The standard extender can control devices up to 250 meters away using 75 ohm coaxial cable. You must order two coaxial connectors (HP 92226A), and shielded 75 ohm coaxial cable (HP 92179G). When ordering cable specify the desired length in meters (minimum length is 100 meters).

Option 013 Optical Fiber HP-IB Extender

The 013 extender can control devices up to 1000 meters away using optical fiber cable. Order cable using the part number HFBR-AXDxxxx where xxxx represents the desired length of cable (in meters).

HP 85043A System Cabinet

The HP 85043A System Cabinet stands 128 cm (50.5 in) high, 60 cm (23.6 in) wide, and 80 cm (31.5 in) deep. It comes with support rails, AC power distribution, and rack mounting hardware.

Connector Savers

A “connector saver” is an adapter or short cable that saves wear-and-tear on the mixer input connectors. Hewlett-Packard recommends that you use connector savers on the RF inputs of the mixers. This is especially important on the input of the test mixer, because the test antenna is often changed. Use an appropriate connector saver from the following list:

Type	HP Part Number
3.5-mm male to 3.5-mm female	85027-60006
3.5-mm female to 3.5-mm female	85027-60005 (supplied with HP 85320A/B)
Type-N male to 3.5-mm female	1250-1744
Type-N female to 3.5-mm female	1250-1745

If you need a short cable, order a 0.5 meter cable such as the HP 85381C with 3.5-mm connector on one end. Choose a connector for the other end that will mate with the antennas you test.

A cable has an additional benefit: It allows you to mount the mixer a short distance away from the test antenna. This provides more flexibility and strain relief when mounting the modules.

Connector Cleaning Supplies

- Ultrajet: 9310-6395
- Alcohol wipes: 92193N
- Lint-Free cloths: 9310-4242
- Small foam swabs: 9300-1270
- Large foam swabs: 9300-0468

Touch Up Paint

Touch up paint is shipped in spray cans. Spray a cotton swab with paint and apply it to the damaged area.

Table 1-2. Touch Up Paint

Color	Where the Color is Used	Part Number
Dove Gray	Front panel frames, portions of front handles, mixer modules	6010-1146
French Gray	Side, top, and bottom covers	6010-1147
Parchment Gray	Rack mount flanges, front panels	6010-1148

Specifications and Environmental Characteristics

Specifications

The performance of the HP 8530A is not specified by itself. This is because performance is interdependent on the frequency converter used. If you purchased the HP 8530A with a system, look at the system manual for specifications. Otherwise, look in the frequency converter's manual.

Environmental Characteristics

Temperature, Humidity, Altitude, RFI

Table 1-3. Environmental Conditions

Temperature	
For Operation:	+5 to +40°C (+41 to +104°F)
For Storage:	-40 to +65°C; (-40 to +158°F)
Humidity	
For Operation:	5% to 95% at +40°C or less (non condensing)
For Storage:	5% to 95% at +65°C or less (non condensing)
Pressure Altitude	
Operation or Storage:	Less than 4,600 meters (15,000 feet)
Radio Frequency Interference	
For Operation:	Any radiated fields at 20 MHz \pm 10 kHz must be \leq 1 volt/meter.

Electrical Requirements

Voltage: 90 to 127, 195 to 253 Vac

Power: 460 VA maximum

Frequency: 47.5 to 66 Hz

Size and Weight

46.0 cm (18.1 in) wide (with handles)

42.6 cm (16.75 in) wide (without handles)

32.4 cm (12.75 in) high (with feet)

31.3 cm (12.3 in) high (without feet)

56.9 cm (22.4 in) deep (with handles)

52.2 cm (20.55 in) deep (without handles)

Net Weight: 40.5 kg (89 lbs)

Shipping Weight: 65 kg (143 pounds)

Allowable HP-IB Cable Lengths

You are allowed two meters of cable length for each instrument that is connected to the main HP-IB bus. A typical system has a computer, printer (or plotter), receiver, and positioner-controller connected to the main HP-IB bus (four devices). The total HP-IB cable length allowed in this example system is $2 \times 4 = 8$ meters. Under *no* circumstances can the total cable length ever exceed 20 meters, no matter how many devices are in the system.

If your system exceeds the allowed HP-IB cable length, you must use HP-IB extenders for one of the devices.

Allowable System Bus Cable Lengths

Calculate the system bus limitation separately, using the same formula. There is usually one instrument connected to this bus (the RF source).

$$2 \text{ (meters/device)} \times 1 \text{ (device)} = 2 \text{ meters allowable length}$$

Because the RF source is often far away from the receiver, HP-IB extenders are commonly used.

Compatible Instruments

The following instruments are compatible with the HP 8530A.

Compatible LO Sources

The LO source firmware revision must be compatible with the receiver.

HP 8350 Plug-Ins

HP 83525A	HP 83592A	HP 83540A
HP 83592B	HP 83590A	

Compatible Instruments, Printers, Plotters, and External Monitors

HP 8360 Family Sources

Table 1-4. Required options for HP 85360 LO sources

Model	Recommended Options	Special Option Requirements
HP 83620A	008	HP 83620A's with a serial prefix less than 3103A require option H87. If cable length between the LO source and HP 85309A is greater than 7 meters, contact your local HP representative.
HP 83621A	None	HP 83621A's with a serial prefix less than 3103A require option H87.
HP 83622A	008	HP 83622A's with a serial prefix less than 3103A require option H87. If cable length between the LO source and HP 85309A is greater than 7 meters, contact your local HP representative.
HP 83623A	008	HP 83623A's with a serial prefix less than 3103A require option H87.
HP 83624A	008	HP 83624A's with a serial prefix less than 3103A require option H87.
HP 83630A	008	
HP 83631A	None	HP 83631A's with a serial prefix less than 3103A require option H87.
HP 83640A	008	None
HP 83642A	008	None
HP 83650A	008	None
HP 83651A	None	None

Fast measurement speed and Quick Step mode

Older sources such as HP 8340/41 or early HP 8360s had slower frequency switching speeds than newer HP 8360 sources. Typically, these slower sources limited the receiver to Frequency Domain measurement speeds of 35 to 70 ms per frequency point. “fast measurement speed” refers to receiver operation with a newer, faster, HP 8360 source.

Quick step mode is a different way of making faster measurements, it increases the speed of Step Sweep measurements by up to six times. Refer to “Step Type” in Chapter 17 for more information.

The following table shows the hardware and firmware requirements for fast measurement speed and Quick Step mode. Any source with firmware *not* listed on this table will have Frequency Domain measurement speeds similar to an HP 8340-family source, and it will not be compatible with the Quick Step mode. Both RF and LO sources must be equipped as shown below to attain fast measurement speed. Some older sources cannot be upgraded.

Compatible Instruments, Printers, Plotters, and External Monitors

Table 1-5. Compatible Sources for Fast Measurement Speeds

HP Model	Hardware Serial Prefix	Firmware Revision ¹	Upgrade Kit
83630A, 83650A, or 83651A	All	≥ March 8, 1991 ²	Compatible—None required
83621A or 83631A	< 3103A	≥ March 8, 1991 ²	Requires HP 83601A hardware kit ³
	3103A	≥ March 8, 1991 ²	Requires 08360-60167 firmware kit
	3104A to 3111A	≥ March 8, 1991 ²	Requires 08360-60201 firmware kit
	≥ 3112A	≥ March 8, 1991 ²	Compatible—None required
83620A, 83622A, 83623A, 83624A, or 83640A	< 3145A	≥ Nov 14, 1991 ²	Not Compatible ⁴
	≥ 3145A	≥ Nov 14, 1991 ²	Compatible—None required
83642A	Not Compatible		Not Compatible ⁴

1 For millimeter wave band “W” compatibility, Firmware revision date must be ≥ October 23, 1992

2 If the firmware revision is dated earlier than March 8, 1991, it is *not* compatible, even if the hardware *is* compatible.

3 Includes installation.

4 Cannot be upgraded.

Compatible RF Sources

- Any HP 8340/41 synthesized source (see note below).
- Any HP 8360 (836xx) family synthesized source.

Note

Although any HP 8340 or 8341 will function with this receiver, units with firmware dated 11 May 1988 (and later) allow you to make faster Step Sweep measurements than earlier units. The firmware date is displayed whenever you turn the HP 8340/41 ON. To utilize the faster measurement capability, you must either:

Connect the HP 8340/41 STOP SWEEP BNC to the receiver’s STOP SWEEP BNC.

or

Place a BNC short on the HP 8340/41 STOP SWEEP connector.

If you do not have this firmware revision, and wish to upgrade, you can order the HP 11875A upgrade kit. Contact your local sales office for details.

Fast Measurement Speeds and Quick Step Mode

Refer to “Fast measurement speed and Quick Step mode”, earlier in this section.

Compatible Frequency Converters

A frequency converter is required to downconvert RF frequencies to the 20 MHz IF frequency required by the HP 8530A. The following frequency converters are available:

HP 85310A Distributed Frequency Converter.

The standard HP 85310A allows the receiver to measure microwave frequencies from 2 to 26.5 GHz. The remote mixers allow the reference and test antennas to be separated by up to 30 meters (100 feet).

The HP 85310A is comprised of an HP 85309A LO/IF Unit and HP 85320A/B external mixers. The advantage to the HP 85310 is high sensitivity. External mixers mount on the reference and test antenna masts.

HP x85325A Millimeter Wave Subsystem

When you use the HP 85325A MM-Wave mixer system, the HP 85310A allows you to measure MM-Wave frequencies in the R, Q, U, V or W bands.

HP 8511A/B Frequency Converter (Test Set)

The HP 8511A frequency converter covers RF/microwave frequencies from 45 MHz to 26.5 GHz. The HP 8511B frequency converter covers RF/microwave frequencies from 45 MHz to 50 GHz. The HP 8511A or B offers simple setup and low cost frequency conversion. The HP 8511A or B can also be used as a network analyzer test set during optional HP 8510C operation. In this configuration the HP 8511 requires an external signal separation device (such as a directional coupler).

Compatible Printers

The HP 8530A can print to the printers listed below. RS-232 or HP-IB models can be used in each category. RS-232 printers work with the internal printer/plotter spooler, HP-IB printers do not.

- HP Laser printers and compatibles (RS-232 supplied, HP-IB not supported)
- HP DeskJet, DeskJet Plus and DeskJet 500 printers (RS-232 supplied, HP-IB not supported).
- HP DeskJet 500C is supported *for black printouts only. Color printouts are currently NOT supported with this printer.*
- HP PaintJet (order option 001 for RS-232, option 002 for HP-IB)
- HP PaintJet XL printers (order option 1AX for RS-232, option 1A8 for HP-IB)
- HP ThinkJet printer (HP 2225D provides RS-232, HP 2225A provides HP-IB)
- HP QuietJet or QuietJet Plus printers (HP 2227A with standard width carriage, RS-232 supplied, HP-IB not supported)

Compatible Plotters

RS-232 plotters work with the internal printer/plotter spooler, HP-IB plotters do not. The following HP-IB or RS-232 plotters are supported:

- HP 7550A/B or Plus (requires HP 24542H cable for RS-232 use. Order option 005 for HP-IB use)
- HP 7470A (out of production)
- HP 7475A (option 1 provides RS-232, option 002 provides HP-IB)
- HP 7440A ColorPro (option 1 provides RS-232, option 002 provides HP-IB)

Compatible External Monitors

The HP 8530 is designed to work with monitors that meet these four specifications:

- Horizontal scan rate of 25.5 kHz must be supported.
- Vertical scan rate of 60 Hz must be supported.
- The monitor must accept separate R G B signals.
- The monitor must accept RGB signals at .7 volts.

Multisync monitors commonly meet all these requirements. The monitor can have one or two sync inputs (composite sync or separate H, V sync), and positive and negative sync is supported.

Some of the monitors that can be run with the HP 8530A are listed below:

Table 1-6. External Monitors

Manufacturer	Model
NEC	Multisync XL
NEC	Multisync II
NEC	Multisync Plus
Nanao	Flexscan 8060
Concorde Technologies	CT 5117 Multiflat Plus 17 CT 5121 Multiflat Plus 21
IYYAMA Electric Co	MF 5117 Multiflat Plus 17

At the time this manual was published, the only compatible HP monitor was the HP 35741BM. This monitor has no sync connections as such. Sync pulses are superimposed on the green video signal.

The HP 8530A *cannot* drive dedicated-format monitors such as CGA, EGA, VGA or SVGA.

System Overview

Chapter Contents

The following topics are covered in this chapter

- Principles of Operation
 - Description of HP 8530A Internal Processes
 - Analog Signal Process Stages
 - Digital Data Process Stages
- Factory Preset State
- Hardware State

Principles of Operation

This information is provided so you can have a better understanding of how the HP 8530A makes measurements. If desired, you can skip this section and come back to it when convenient.

Description of HP 8530A Internal Processes

A simplified block diagram of the HP 8530A receiver is shown in Figure 2-1. It is a high performance vector receiver with four inputs, two independent digital processing channels, and an internal microcomputer that controls measurement, digital processing, and input/output operations. Examples of “digital processing” are features such as averaging, time domain, calibration, and so on. A special System Bus gives the receiver complete control over the RF source and, if required, LO source. This interface allows the receiver to make hard copy outputs to HP-IB compatible printers or plotters. Two RS-232 ports are also supplied for printing or plotting.

The system must contain a frequency converter, which down converts the RF measurement frequencies to the 20 MHz IF required by the HP 8530A. To create the IF frequency, the HP 8511A/B frequency converter uses a built-in local oscillator. The built-in LO is digitally tuned by the HP 8530A. The digital tuning data is sent over the “Test Set Interconnect” that links the HP 8530A and the HP 8511A/B. The local oscillator mixes the measurement signals with a similar frequency that is offset by 20 MHz. The result is the 20 MHz IF signal. Other down converters, such as the HP 85310A, require another source to supply an LO signal. The HP 8530A tunes external LO sources with HP-IB commands sent over the System Bus.

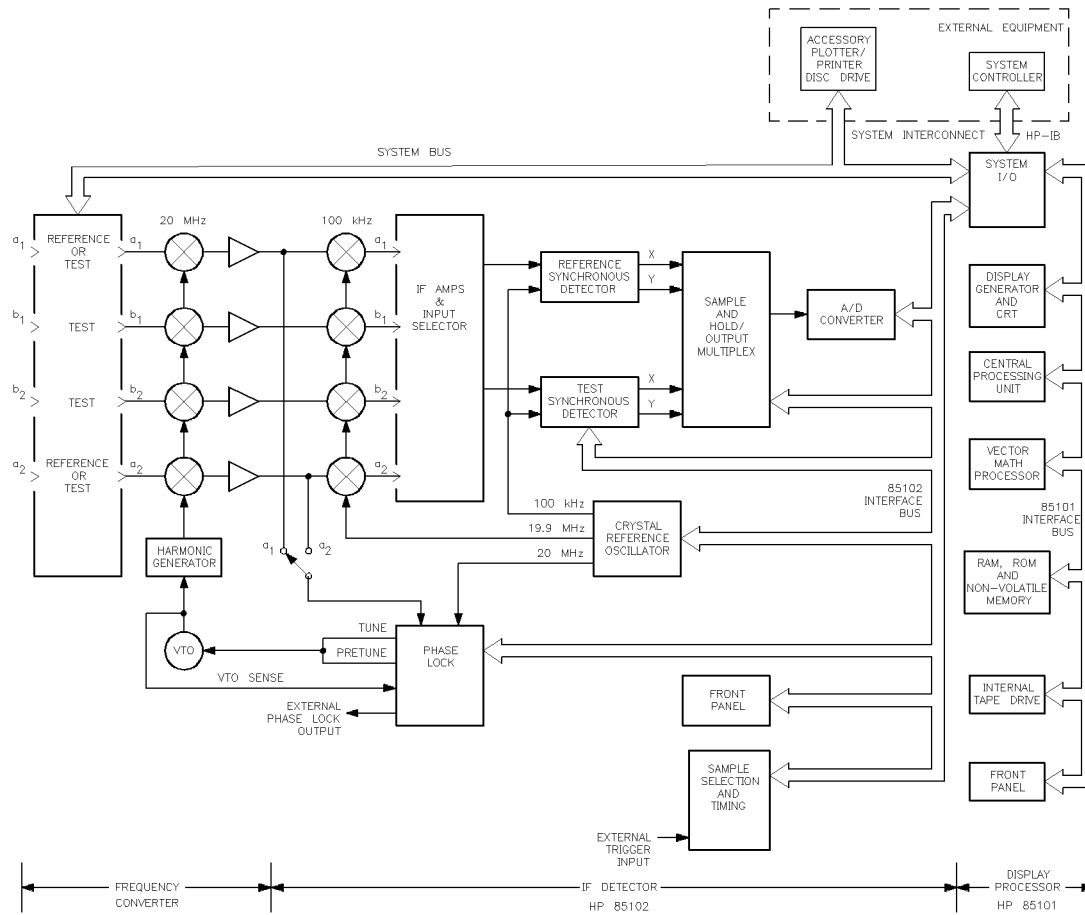

Figure 2-1. Simplified System Block Diagram

The HP 8530 has two main sections, illustrated in Figure 2-2.

Analog Section

In the analog section, analog circuitry detects the real (x) and imaginary (y) values of the input signals. The real,imaginary values are then converted into digital values.

Digital Section

In the digital section, the microprocessor takes the digital data and performs any selected data processing (averaging, calibration, time domain, and so on). The instrument then displays the results in any format you choose. You can also output the results to printer, plotter, disc, or external computer. There are two identical digital processing paths, called Channel 1 and Channel 2. You can have different features turned ON in the two channels, and view the different results. You can show the results of both channels on the screen at the same time, using controls under the **DISPLAY** key.

Principles of Operation

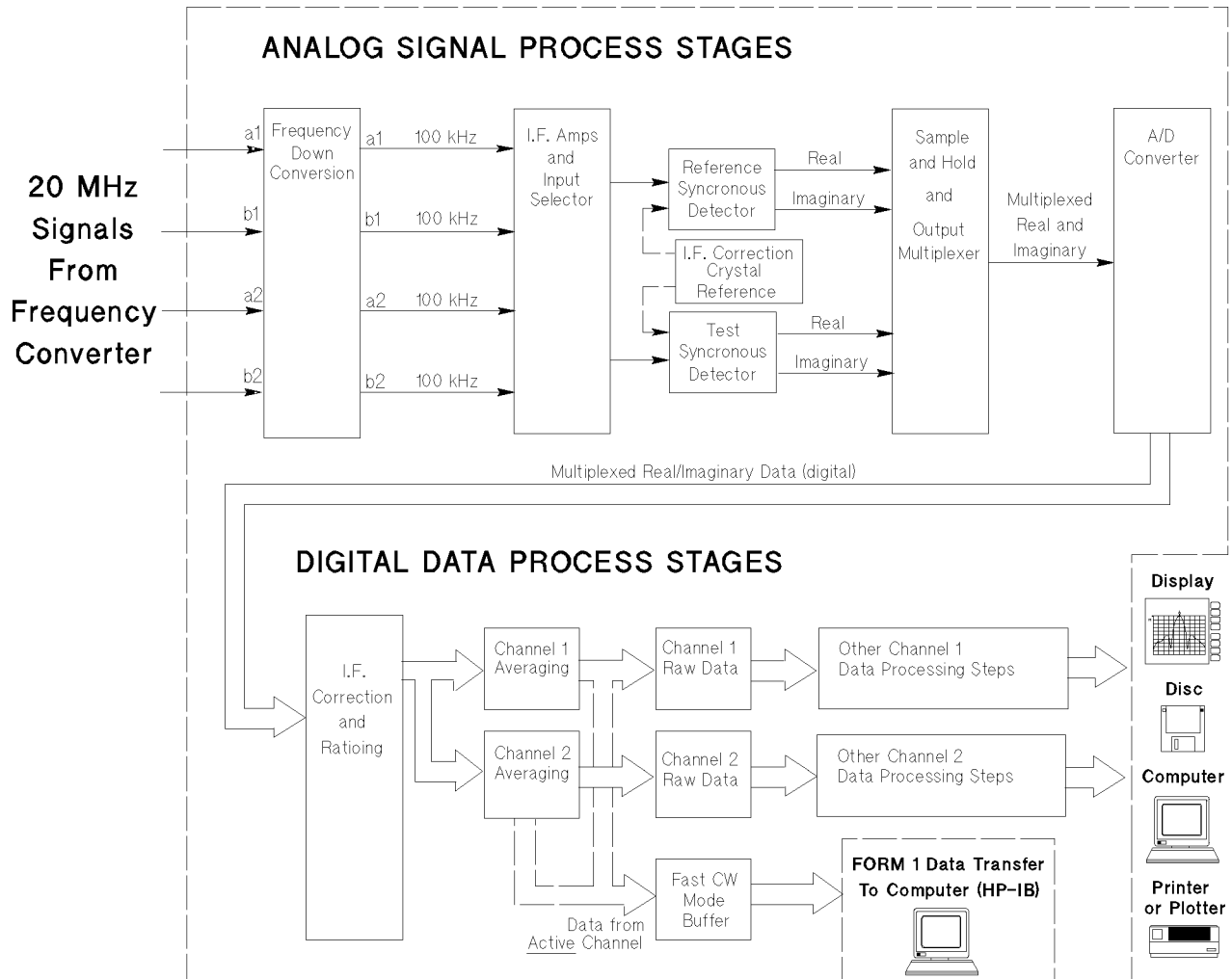

Figure 2-2. HP 8530A Measurement Data Flow Diagram

Analog Signal Process Stages

During a typical Frequency Domain measurement, the test signal source is swept from a lower to a higher frequency. During a typical Angle Domain measurement, a single frequency is measured while the antenna-under-test is moved around one axis.

Initially, the HP 8530A receives up to four 20 MHz signals from the external frequency converter. The receiver separately down converts each signal to a 100 kHz IF carrier frequency that can be used by the detection circuitry. (Refer to Figure 2-1.) Because frequency conversions are phase coherent, and the IF signal paths are carefully matched (by design). Thus, magnitude and phase relationships between the input signals are maintained throughout the frequency conversion and detection stages. Automatic, fully-calibrated autoranging IF gain stages maintain the IF signal at optimum levels for detection over a wide dynamic range.

Each measurement channel can use input a1 or a2 as the reference signal. The selected input is also used as the phase-lock reference.

Note In hardware gating applications, the pulsed reference signal may not be suitable for phase locking. In this case, you can use the other reference input for phase locking. For example, assume your pulsed reference is on input a1, you can use a2 as the phase lock reference.

Any of the three remaining inputs can be used as test inputs.

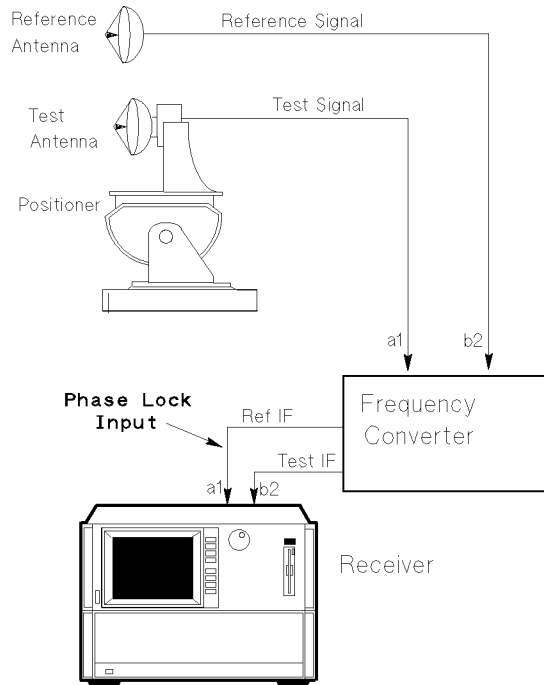

Figure 2-3. Phase Lock Reference

The input selector sends one test signal and one reference signal to the synchronous detectors. When these are measured, the input selector sends the other test/reference signals.

The synchronous detectors develop the real (x) and imaginary (y) parts of the test or reference signal by comparing the input to an internally-generated 100 kHz sine wave. This method practically eliminates drift, offsets, and circularity errors as sources of measurement uncertainty. Each x,y pair is sequentially converted to digital values which are sent to the main microprocessor.

Digital Data Process Stages

Digital signal processing proceeds under the control of the receiver's firmware operating system executed by the main microprocessor.

About the Main Microprocessor

The main microprocessor is a 32 bit Motorola 68020 microprocessor running at a clock speed of 16 MHz. The firmware operating system takes advantage of multi-tasking software architecture and several distributed processors to provide very fast data acquisition and display update speed.

Principles of Operation

Internal Data Flow

Figure 2-4 shows the parallel design of the two channels. Data has already been converted to digital information at this point in the receiver's processing.

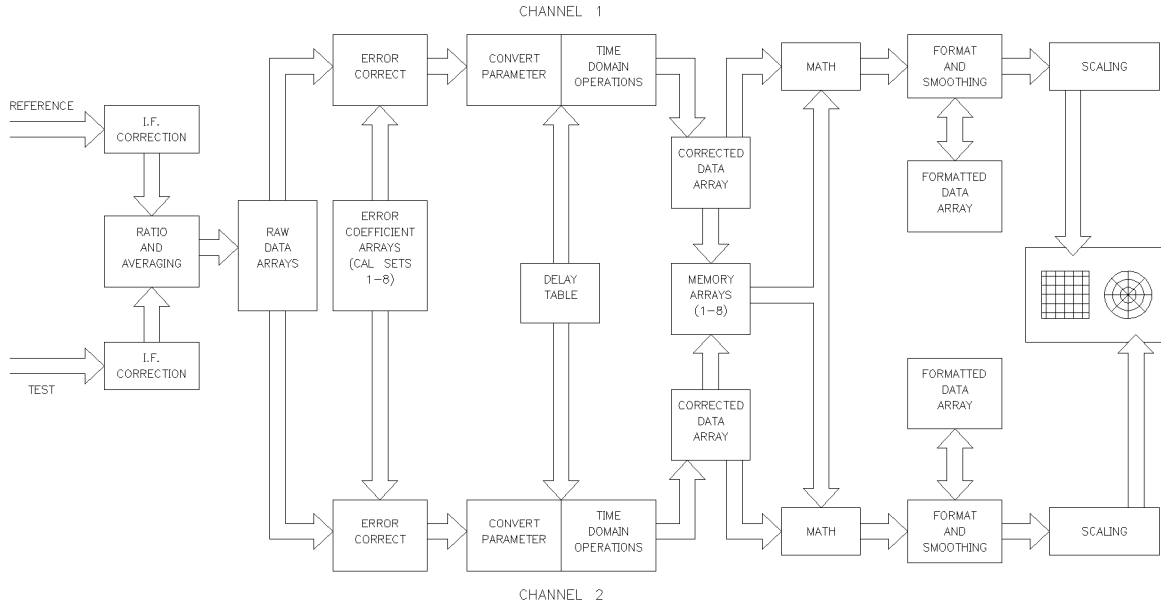

Figure 2-4. Independent Data Processing in Each Channel

Raw Data Stages

The microprocessor accepts the digitized real and imaginary data, and corrects IF gain and quadrature errors before any other data processing is done. The calibration coefficients used in the *IF correction* stage are calculated periodically with an automatic self-calibration. This automatic feature is different from the user calibration features. Next, the inputs are ratioed together and identical copies of the data are sent to independent Channel 1 and Channel 2 data processing paths.

There are eight raw data arrays. (Each parameter has its own raw data array, and each channel has its own separate group of four parameters each.) The raw data array can be stored to disc, or be transferred to or from a computer. You can actually send raw data into the receiver from a computer, and the HP 8530A will process that data through later stages as if it were measured data.

Now, any selected averaging is performed on Channel 1 or Channel 2. If the Fast CW mode is in use, data is sent to the Fast CW buffer from the *active channel*. If Fast CW mode is not being used, Channel 1 averaged data is stored in the Channel 1 raw data array. Similarly, Channel 2 averaged data is stored in the Channel 2 raw data array.

Data "arrays" are data holding locations. A data array holds one X,Y data pair in a special compressed data format called "Form 1." This format is described in the *HP 8530A Keyword Dictionary*. The Fast CW buffer can send data to computer if you are using the Fast CW mode. The buffer contains up to 100,000 X,Y data pairs in Form 1 format.

Error Correction

If calibration is ON, the calibration “error coefficient” values are used to modify the raw data. These coefficients contain the measurement offset values created during the calibration process.

Convert Parameter

The corrected data for each displayed parameter is modified *if* the Convert Parameter feature is active. What is Convert Parameter? To explain this feature you must first realize that the HP 8530 can directly ratio any two combinations of its a1, a2, b1, or b2 inputs with one exception. *The b2 input can never be the denominator in a ratio.* For example, a1/b2 is normally impossible. However, you can select b2/a1 *then turn on Convert Parameter.* The HP 8530 will *measure* b2/a1, then *mathematically invert* the results.

Time Domain Operations

The data is then sent through the time domain transform if this optional feature is turned ON. The Delay Table is accessible by computer controller. The delay table allows you to modify the data to suit special needs. This feature is explained under “Delay Table” in the keyword dictionary.

Corrected Data Array

The data is now stored in the Corrected Data Array. The corrected data for the *active parameter* on the *active channel* are stored in this array. This data array can be stored to disc, or be transferred to or from a computer. If data is transferred from the computer into the array, later processing steps will be performed on that data.

Memory Arrays

These arrays hold data you have stored to one of the eight trace memories using functions under the **DISPLAY** key. Each parameter on each channel have a specific memory number assigned to it:

Table 2-1. Memory Numbers for Each Parameter on Each Channel

Channel/Parameter Memory Number	
Channel 1	
PARAM 1	Memory #1
PARAM 2	Memory #2
PARAM 3	Memory #3
PARAM 4	Memory #4
Channel 2	
PARAM 1	Memory #5
PARAM 2	Memory #6
PARAM 3	Memory #7
PARAM 4	Memory #8

Trace Math

The next stage is trace math processing. Trace math performs a selected mathematical operation using normal data as one operand, and memory data as the other.

Principles of Operation

Format and Smoothing

Data is now modified as needed for the selected display format. If smoothing is ON, the data is smoothed.

Formatted Data Array

The data is then sent to the Formatted Data Array. This data can be stored to disc, or be transferred to or from a computer. Data in this array is a simple scalar value, it is no longer a complex (vector) value.

Scaling and Display

The last step to scale the data (as specified by the user) and display it on the screen.

Channel Coupling

Many “stimulus” settings (such as RF power; start, stop, increment angle; start, stop, or CW frequency, number of points, and so on) are “coupled” (always the same) between the two channels. If a stimulus feature is “coupled,” you cannot choose different settings (for that feature) between Channel 1 and Channel 2. If a stimulus feature is “uncoupled,” you can choose different settings (for that feature) in the two channels. If you want to know whether a specific feature is coupled or uncoupled, look it up in the keyword dictionary (or just try it).

Automatic Recall of Instrument Settings

The receiver remembers most measurement settings when you switch back and forth between channels, domains, parameters, or display formats. (This feature remembers all measurement settings *except* stimulus settings.) This feature is automatic, and does not require you to use the Save or Recall functions. The feature is called “limited instrument state memory.”

Limited instrument state memory works by assigning a hierarchy to the instrument settings. Here is the hierarchy:

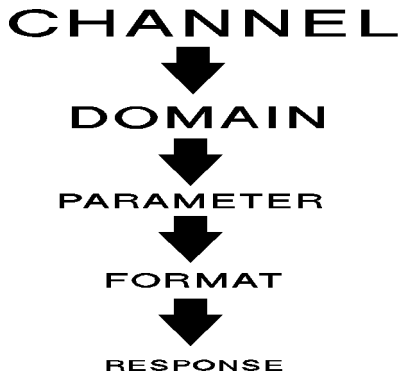

- Channel (1 or 2)
- Domain (Frequency, Angle, or Time)
- Parameter (1, 2, 3, or 4)
- Format (any display format)
- Response (scale and reference line)

Every mode in the above list *remembers* all settings you make *that are lower in the hierarchy*. For example, assume you choose the following measurement settings.

Channel 1
Angle Domain
Parameter 3
Log mag (format)
Reference -10 dB
Scale 5 dB/div

Now you go to Channel 2 and make completely different settings.

When you go back to Channel 1, the settings shown above will automatically resume. This hierarchical memory applies to all the controls in the above list.

Automatic Recall of Instrument Settings

The Added Benefit of the SAVE/RECALL feature

Stimulus settings are not part of the limited instrument state memory explained above. To save stimulus settings along with all the other settings, you must use the SAVE/RECALL feature. Two other advantages of the Save/Recall feature are:

- Saved instrument states can be stored to disc.
- Instrument states saved to Save/Recall register 8 becomes the default power-ON or User Preset state.

Factory Preset State

The Factory Preset State consists of the factory default values selected for various functions. The following is a partial list of the preset state or value associated with a function. If you have a question on a specific function, refer to the individual entry in the *HP 8530A Keyword Dictionary*.

Table 2-2. Instrument Factory Preset Conditions

INSTRUMENT STATE	Selected Channel = 1, No Menu Displayed SAVE/RECALL Instrument States 1-8 Not Changed.
DOMAIN	Frequency GATE OFF.
STIMULUS	Maximum sweep range of source and test set. NUMBER OF POINTS = 201, Source Power = depends upon source. SWEEP TIME = 166 ms, Sweep Mode: STEP sweep, CONTINUAL Step Type: NORMAL
PARAMETER	Channel 1 = Param 1, Channel 2 = Param 2.
FORMAT	Channel 1 = LOG MAG. Channel 2 = LOG MAG.
RESPONSE	SCALE = 10 dB/division, REF VALUE = 0 dB, REF POSN = 5, ELECTRICAL DELAY = 0 seconds, COAXIAL, AVERAGING = OFF, SMOOTHING = OFF, PHASE OFFSET = 0 degrees, MAGNITUDE OFFSET = 0 dB, MAGNITUDE SLOPE = 0 dB/GHz, NORMALIZE OFF.
CAL	CORRECTION OFF, $Z_0 = 50$ Ohms, VELOCITY FACTOR = 1.0, TRIM SWEEP = 0, CAL SETS 1-8 = Not Changed.
DISPLAY	SINGLE CHANNEL, DATA. Trace Memories 1-8 Not Changed. Display Colors Not Changed. Date/Time Clock On.
SYSTEM	HP-IB Addresses Not Changed. CRT ON, IF GAIN = AUTO. MULTIPLE SOURCE = OFF
MARKER	all OFF, Δ OFF, DISCRETE Marker List On, All Param/1 Marker.
COPY	PLOT ALL = FULL PAGE Param 1 Data = Pen 3. Param 2 Data = Pen 5. Param 3 Data = Pen 6. Param 4 Data = Pen 4. Graticule = Pen 1. Plot Type = Color.

HARDWARE STATE

In general, the Hardware State functions are those that are required for proper operation at power up and relate more to the hardware configuration of the receiver. These functions are not affected by either `USER PRESET` or `FACTORY PRESET`. Values or text shown in parenthesis are factory default settings.

■ HP-IB Addresses

ADDRESS of 8530 (16)

ADDRESS of SYSTEM BUS (17)

ADDRESS of SOURCE #1 (19)

ADDRESS of CONVERTER (20)

ADDRESS of PLOTTER (Selected bus: HP-IB, Address: 5)

ADDRESS of PRINTER (Selected bus: HP-IB, Address: 1)

ADDRESS of DISC (0)

ADDRESS of SOURCE #2 (31)

ADDRESS of PASS-THRU (31)

ADDRESS of REMOTE SWITCH (9)

ADDRESS of RF SWITCH (31)

■ Disc Unit Number 0

■ Disc Volume Number 0

■ System Phaselock Type (Internal)

■ System Phaselock Speed (Normal)

■ System Phaselock Step Type (Reads Source in System to Determine)

■ Multiple Source Values

RF Source #1

Numerator (1)

Denominator (1)

Offset (0)

LO Source #2

Numerator (0)

Denominator (1)

Offset (0)

Receiver

Numerator (1)

Denominator (1)

Offset (0)

■ HP-IB Response to PRES; Command (User Preset)

■ Warning Beeper (On)

■ Power Level RF Source #1 (+10 dBm)

■ Power Level LO Source #2 (+10 dBm)

Automatic Recall of Instrument Settings

■ CRT Display Colors

- Background Intensity (0%)
- Softkeys (Bright White)
- Warnings (Bright Red)
- P1 Data (Bright Yellow)
- P2 Data (Bright Cyan)
- P3 Data (Bright Salmon)
- P4 Data (Bright Green)
- Graticule (Dim Grey)
- Marker Symbols (White)
- P1 Memory (Dim Yellow)
- P2 Memory (Dim Cyan)
- P3 Memory (Dim Salmon)
- P4 Memory (Dim Green)
- Stimulus Values (Dim White)

■ External Video Sync (Sync on Green, Negative)

■ Power Leveling

- Source 1 (internal)
- Source 2 (internal)

Front and Rear Panel

Chapter Contents

- Front Panel Display Features
 - Display Annotation Areas
 - One-Character Special Display Annotations
 - Using Softkey Menus
- Front Panel Features
- Rear Panel Features

Front Panel Display Features

Display Annotation Areas

Figure 3-1 shows a single-parameter display and its annotation areas.

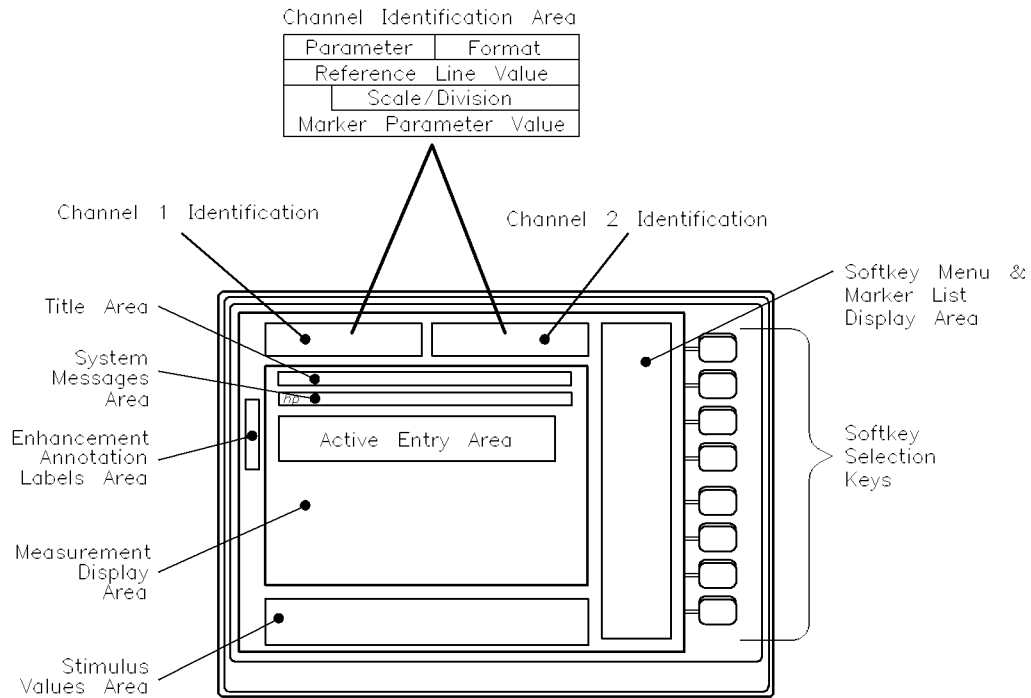

Figure 3-1. Annotation Areas for Single Parameter display mode

For simplicity, only one type of display mode is discussed here. If you need information about the various display modes, refer to “One-Character Special Display Annotations”.

Channel/Parameter Identification Area

Measurement information appears at the top of the display for this display mode. The parameter information, display format, reference line value, and the scale/division are shown. Color matches the identification labels to the trace display. The active parameter is indicated by a “▶” symbol, and the color of the stimulus values (at the bottom of display) match the color of the active parameter.

In the Single Parameter and Dual Channel display modes, Channel 1 information appears on the left and Channel 2 information appears on the right.

Stimulus Values Area

The current start/stop, center/span, or single point stimulus settings appear along the bottom of the display, and match the color of the active channel/parameter to emphasize the channel/parameter you are controlling.

Active Entry Area

The active entry area of the display identifies the current active function for the selected channel/parameter, and matches the color of the active channel/parameter to emphasize the channel/parameter you are controlling. Press **ENTRY OFF** to clear this area.

Title Area

The title area provides a space to enter up to 50 characters of information about the measurement. Notice that the location of this area depends on the display mode. An example of how to create a title is given in this chapter in later paragraphs.

System Messages Area

Prompts, error messages, and procedural advisories appear in the system messages area located below the Channel 1 identification labels.

If an error that affects the measurement occurs, a message is displayed and a “beep” may signal you to look at the message.

Note

An Error message remains on the display until:

- It is replaced by another system message.
- You press a function key such as **START** or **USER PRESET**.
- You manually clear the message by pressing **ENTRY OFF** (located above the knob).

Note that error messages do not disappear automatically. This it is possible for an error message to remain on the display, even if the error condition no longer exists.

One-Character Special Display Annotations

Along the left side of the screen, certain one-character labels appear when you select receiver functions that affect the accuracy or presentation of the measurement trace. These labels are:

* = Measurement Incomplete.

A = Averaging is ON.

C = Calibration is ON.

D = Normalization, Electrical Delay, Phase Offset, Magnitude Offset, or Magnitude Slope ON.

E = External or HP-IB trigger mode is ON.

G = Time Domain Gating ON.

H = Hold mode is ON.

M = Multiple Source ON.

O = Power has changed more than 24 dB between adjacent data points, and automatic IF gain control could not fully track the change. This reduces measurement accuracy by a very small amount. Refer to “IF Gain” near the end of Chapter 17.

S = Smoothing is ON.

These symbols are present if the given condition exists on any displayed channel/parameter. That is, for dual channel displays, if either channel has smoothing turned on, the “S” is shown.

The measurement incomplete symbol “*” is displayed in several situations. After any *measurement restart*, it signifies that the first sweep has not been completed. When this

Front Panel Features

symbol disappears you can be certain that all basic data acquisition and error correction functions (except possibly averaging) are complete.

CRT annotation for Cartesian displays includes Trace labels:

- 1→ indicates Channel 1, on the left side of the graticule.
- ←2 indicates Channel 2, on the right side of the graticule.
- > is the Reference Line Position symbol for Channel 1 (appears on the left side of the screen).
- < is the Reference Line Position symbol for Channel 2 (appears on the left side of the screen).

Softkey Menu and Marker List Display Area

Softkey menus appear in the area on the right side of the display, and beside them are the eight keys used to make menu selections. Menus and how to make selections are discussed below.

The softkey menu display area is also used to display marker values and the internal date/time clock of the receiver. Markers and the date/time clock can only be displayed when menus are not being displayed. The different types of marker displays and the date/time clock are discussed in the section titled “Display” in later chapters. An example of how to change the date/time clock is given in the paragraph titled “Example: Using Menus”, in this chapter.

Using Softkey Menus

The HP 8530 receiver system has a series of menus and sub-menus. Various operations can be selected, modified, and recalled using front panel keys and the eight softkeys (located to the right of the display).

The Menu Structures chapter of the HP 8530A Keyword Dictionary shows all instrument menus (in a series of fold out illustrations). HP-IB commands are shown next to each softkey where applicable. This is the fastest and easiest place to see an overview of softkey menus.

This Operating and Programming Manual also shows the menus used by the HP 8530, organized by functional group, along with explanations of each function.

How to Tell when a Function is Selected

If the function sets a value only, then the current value is displayed in the active entry area when the function is activated. Use the knob, ▲ ▼, number/units, or =MARKER keys (in the ENTRY block) to choose the desired value. With other functions, the softkey title of the selected function is underlined.

Mutually-Exclusive functions

You can tell if several choices are mutually-exclusive because their softkey titles are connected by vertical lines like this:

```
SWR
 |
LINEAR
```

Other Softkey Protocol and Details

Some softkeys bring up other menus. Press the front panel key labeled PRIOR MENU to return to the menu previously displayed. If the current menu is a first-level menu, pressing this key clears the softkey menu area.

Front Panel Features

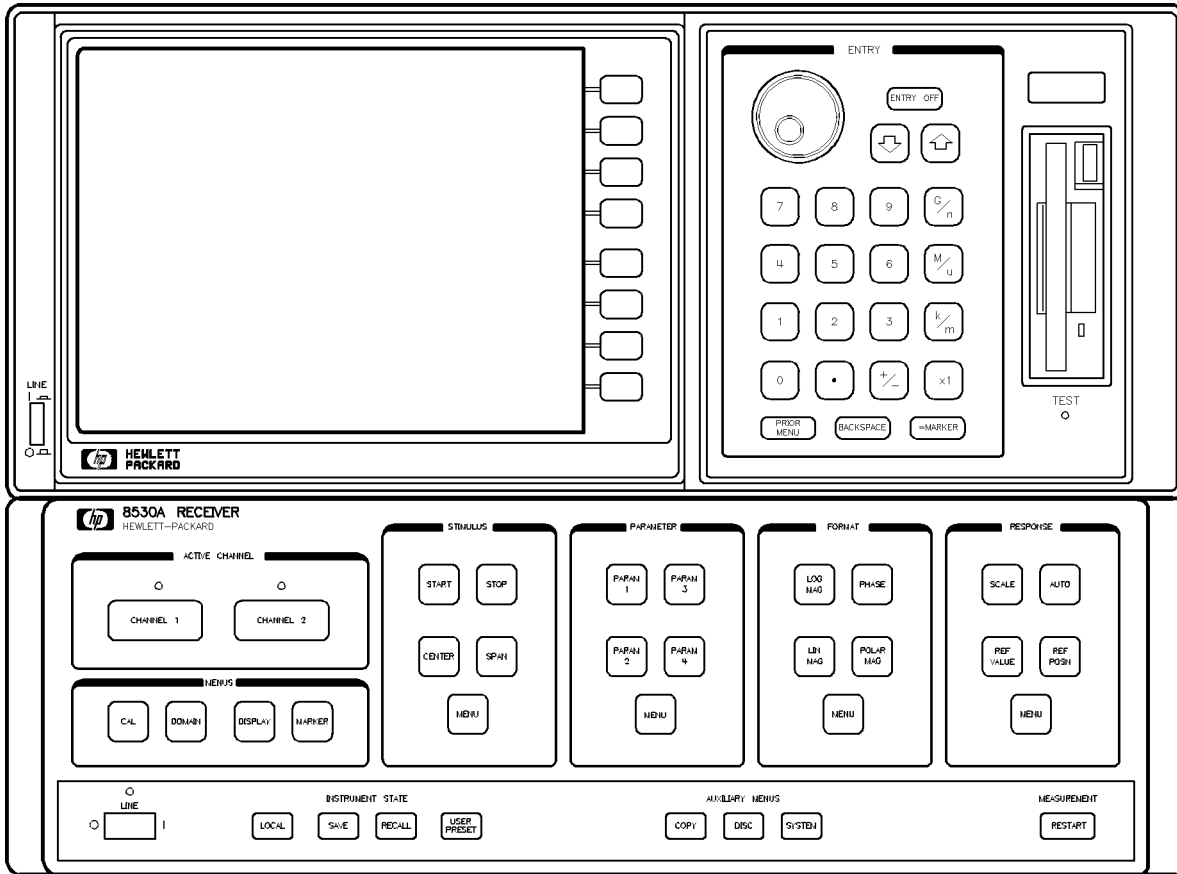

Figure 3-2. HP 8530A Front Panel

Channel Selection

The receiver has two separate, identical measurement channels. The channel feature is much like having two HP 8530 receivers setting next to one another.

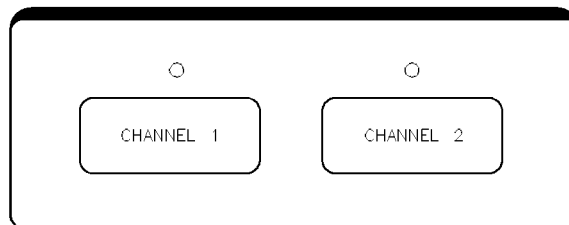

Figure 3-3. Channel Selection Keys

Channel 1 and 2 can have different PARAMETER, FORMAT, or RESPONSE settings. In addition, you can select Time Domain on one channel, and Frequency Domain on the other: *For example, you could set Channel 1 to Frequency Domain, PARAM 1. Then you could set Channel 2 to Time Domain, PARAM 2.* The receiver will measure each channel and display the

Front Panel Features

data. You can view the data separately (by changing channel), or you can display both sets of data side-by-side (dual channel split) or superimposed (dual channel overlay).

Many “stimulus” settings (such as RF power; start, stop, increment angle; start, stop, or CW frequency, number of points, and so on) are “coupled.” If a stimulus feature is “coupled,” you cannot choose different settings for Channel 1 versus Channel 2. If a stimulus feature is “uncoupled,” you can choose different settings in the two channels. If you want to know whether a specific feature is coupled or uncoupled, look it up in the keyword dictionary.

Basic Measurement Functions

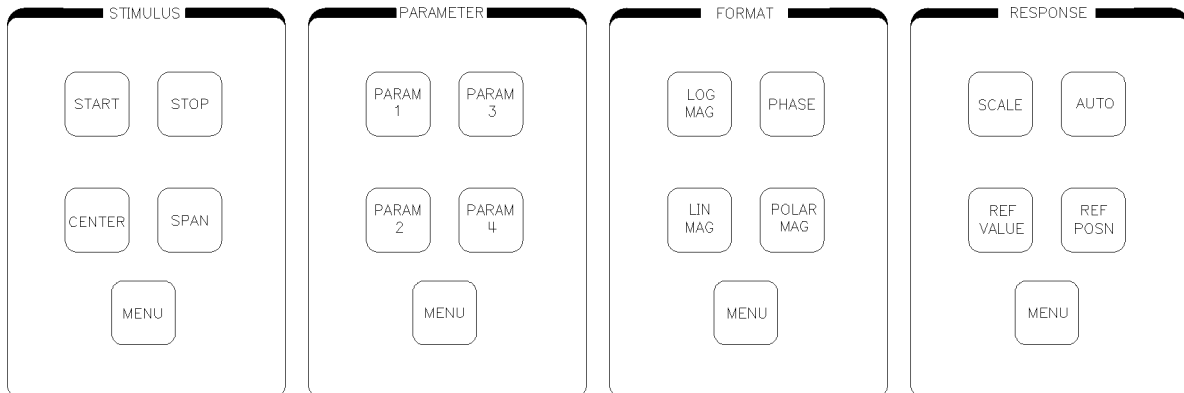

Four of the main control blocks on the front panel are STIMULUS, PARAMETER, FORMAT, and RESPONSE. These are described below:

STIMULUS This block lets you select RF power levels, and desired frequency and angle settings. It also controls how you can trigger the instrument to take each point of data. For example, you can trigger off the Record Increment pulses (coming into the receiver's EVENT TRIGGER jack from the positioner controller) by selecting EXTERNAL trigger. Alternatively, you can trigger over HP-IB using the GET command.

PARAMETER The PARAMETER block contains the predefined input ratio keys **PARAM 1** (b1/a1), **PARAM 2** (b1/a2), **PARAM 3** (b2/a1), and **PARAM 4** (b2/a2). The normal measurement mode for the receiver is to mathematically ratio (divide) the data from the test and reference antennas. Ratioed measurements reduce most errors caused by the range, and shows the actual performance of the Antenna Under Test. You can redefine any of the parameter keys to ratio any two inputs you desire. You can also look at any single input using the **SERVICE 1 a1** through **SERVICE 4 b1** softkeys.

FORMAT Format keys let you choose how the data is displayed on the screen. You can select logarithmic magnitude (**LOG MAG**), linear magnitude (**LIN MAG**), phase (**PHASE**), polar logarithmic magnitude (**POLAR MAG**), and polar linear magnitude **LINEAR ON POLAR** (located under the **FORMAT MENU** key)

RESPONSE The response block keys let you set the display scale and reference line. Functions under the MENU key let you turn on averaging and normalization. (Normalization allows you to set the peak of the main lobe to 0 dBi and measure other parts of the trace relative to the peak.)

Each major control block has functions that are not mentioned here. Refer to Chapter 6, 7, 8, and 9 for descriptions of these features.

Front Panel Features

ENTRY Block

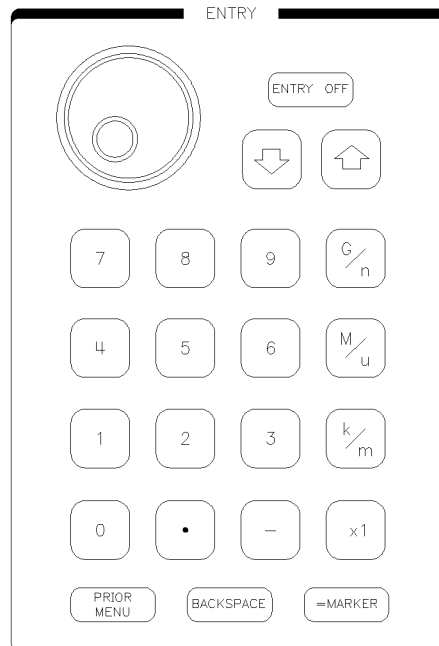

In some cases it is necessary to supply numeric values for a specific function, such as angle or frequency. The 10 digit keypad is used to supply these values. The keys to the right of the digits terminate the value with the appropriate units. Use $\boxed{G/n}$ (Giga/nano), $\boxed{M/\mu}$ (Mega/micro), $\boxed{k/m}$ (kilo/milli) and $\boxed{x1}$ (basic units: dB, dBm, degrees, seconds, Hz) as applicable. In addition to entering data with the keypad, the knob can be used to make continuous adjustments, while the \blacktriangle and \blacktriangledown keys allow values to be changed in steps.

Changing Values Using the Numeric Keypad

To change a value using the numeric keypad:

1. Select the function (start angle, frequency, or any other function that requires a value). This function becomes the “active function.”
2. Enter the new value using numeric, decimal, and the $\boxed{+/-}$ toggle. $\boxed{+/-}$ changes the sign of the number. If you make a mistake, press the $\boxed{BACKSPACE}$ key. (If you have already pressed a terminator key, you must re-enter the entire value).
3. Terminate the entry with the appropriate units.

Table 3-1. Numeric Value Terminator Key Usage

Key Name	Angle	Frequency	Power	Power Slope	Time	Distance
G/n	-	GHz	-	-	ns	nm
M/ μ	-	MHz	-	-	μ s	μ m
k/m	milli degrees	kHz	-	-	ms	mm
x1 ¹	degrees	Hz	dBm	dB/Ghz	s	m

¹ $\boxed{x1}$ always represents single units.

Other Keys in the Entry Block

ENTRY OFF

Removes old error messages or active function text from the screen. “Active function text” is a message such as: START –90° that appears when you change the value of a function.

PRIOR MENU

This key takes you to the previous softkey menu.

=MARKER

This key can be useful when you are using markers. The easiest way to explain what **=MARKER** does is by example. Assume you are making a frequency response measurement, and the last marker you moved (the active marker) is sitting at 11 GHz. Now assume you want to change the center frequency to 11 GHz. All you need to do is press **CENTER** **=MARKER**. The marker position (11 GHz) will become the center frequency.

Another way to use **=MARKER** is to transfer the marker *value* to another function. As an example, assume you want to set the display reference line to the value of the active marker (for example, assume the marker value is –13.2 dB). Press **REF VALUE** **=MARKER**, and the display reference line will change to the value of the active marker.

MENUS Block

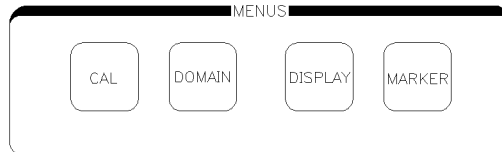

The four keys under MENUS are **CAL**, **DOMAIN**, **DISPLAY**, and **MARKER**:

CAL

Softkeys under **CAL** allow you to perform:

- Antenna calibration
- Radar cross section (RCS) calibration
- 1-Port network analyzer calibration

DOMAIN

The HP 8530 has three modes of operation, called domains:

- Frequency Domain
- Angle Domain
- Optional Time Domain

DISPLAY

Softkeys under **DISPLAY**:

- Display one, two, three, or four parameter measurements.
- Save the data trace to temporary storage memory.
- Display memory traces.
- Perform trace math functions on memory traces.
- Allow you to change display intensity or colors.
- Allow you to choose video settings for an external monitor.

MARKER

Softkeys under **MARKER** allow you to activate up to five markers. Each marker shows amplitude or phase values for a desired point on the measurement trace. Marker Functions are:

- Basic markers on the display trace.
- Delta marker mode.

Front Panel Features

- Marker search modes.
- Marker list modes.

All the above features are explained in Chapter 5, Menu Block.

INSTRUMENT STATE Block



The four keys in the INSTRUMENT STATE block are **LOCAL**, **SAVE**, **RECALL**, and **USER PRESET**.

The **LOCAL** key has two uses:

- If you are controlling the receiver with a computer, the front panel keys will not respond to touch. Pressing **LOCAL** returns control to you.
- **LOCAL** also allows you to examine or change HP-IB addresses the receiver uses to control peripherals and other instruments.

More information on the **LOCAL** key is provided in Chapter 11, Instrument State Block.

SAVE and **RECALL** allow you to save and recall up to eight different measurement setups (instrument states). You can also save your current setup as the “USER PRESET” state by saving it to register 8. The receiver will return to that state whenever the instrument is turned on, or if you press **USER PRESET**.

An **instrument state** is defined as the condition of all current measurement settings, including all domain, stimulus, parameter, format, and response settings.

More information on the **SAVE** and **RECALL** keys are provided in Chapter 14, Save and Recall.

AUXILIARY MENUS Block



The “AUXILIARY MENUS” contain the **COPY**, **DISC**, and **SYSTEM** keys.

COPY controls hardcopy output, either printing or plotting. These features are explained in Chapter 16, Printing and Plotting.

DISC controls saving, loading, viewing, deleting, or undeleting disc files. You can also format floppy discs (using DOS or LIF format), or select an external disc drive. These features are explained in Chapter 15, Disc Operation.

SYSTEM menus control internal functions of the HP 8530. For example, you can select normal or wide IF bandwidth, or control phase locking. These features are explained in Chapter 17.

If using remote mixers, you can control the RF-to-LO frequency ratio (to select the desired harmonic mode) using the Multiple-Source menu. This is explained in “Controlling Multiple Sources” in Chapter 17.

MEASUREMENT RESTART Key

This key tells the receiver to abort the current measurement and start over. When you are in the Frequency or Time domain, you can press this key whenever you want.

When using the Angle Domain, follow this procedure:

1. Stop the positioner controller and prepare it for a new scan.
2. Press **RESTART**. This will abort the current measurement and return the HP 8530A to the start of the next scan.

HP-IB Mode/Diagnostic Indicator

A small display above the disc drive comprises the HP-IB Mode/Diagnostic Indicator. The indicator contains the characters **R L T S 8 4 2 1**.

R	When ON, shows that the receiver is in the HP-IB Remote Mode.
L	When ON, shows that the receiver is in the HP-IB Listener Mode.
T	When ON, shows that the receiver is in the HP-IB Talker Mode.
S	When ON, shows that an SRQ service request has been asserted.
8 4 2 1	These are self-test indicators. They normally flash various numbers during power-on, then go out. If one or more numbers stay on permanently there is a problem in the receiver.

The HP-IB and SRQ functions are discussed in Chapter 18, HP-IB Programming.

Built-In Disc Drive

The built in disc drive allows you to save measurement data, data from memory, instrument configuration setups, save/recall registers, calibration data, or user-created graphics. Both DOS and LIF disc formats are supported, and both disc types are automatically recognized. DOS format is compatible with MS-DOS[®] based computers, such as IBM PCs and compatibles. LIF format is compatible with Hewlett-Packard computers, such as the HP 9000 Series 300 workstation family. The drive accepts high-capacity 1.44 MB discs. (Disc capacity is different when using LIF format.)

Recessed TEST button

The front panel TEST button resets the main microprocessor. The receiver performs all self test routines and a Factory Preset. Use a small diameter object such as a straightened paper clip to press the recessed button.

Rear Panel Features

Rear Panel Features

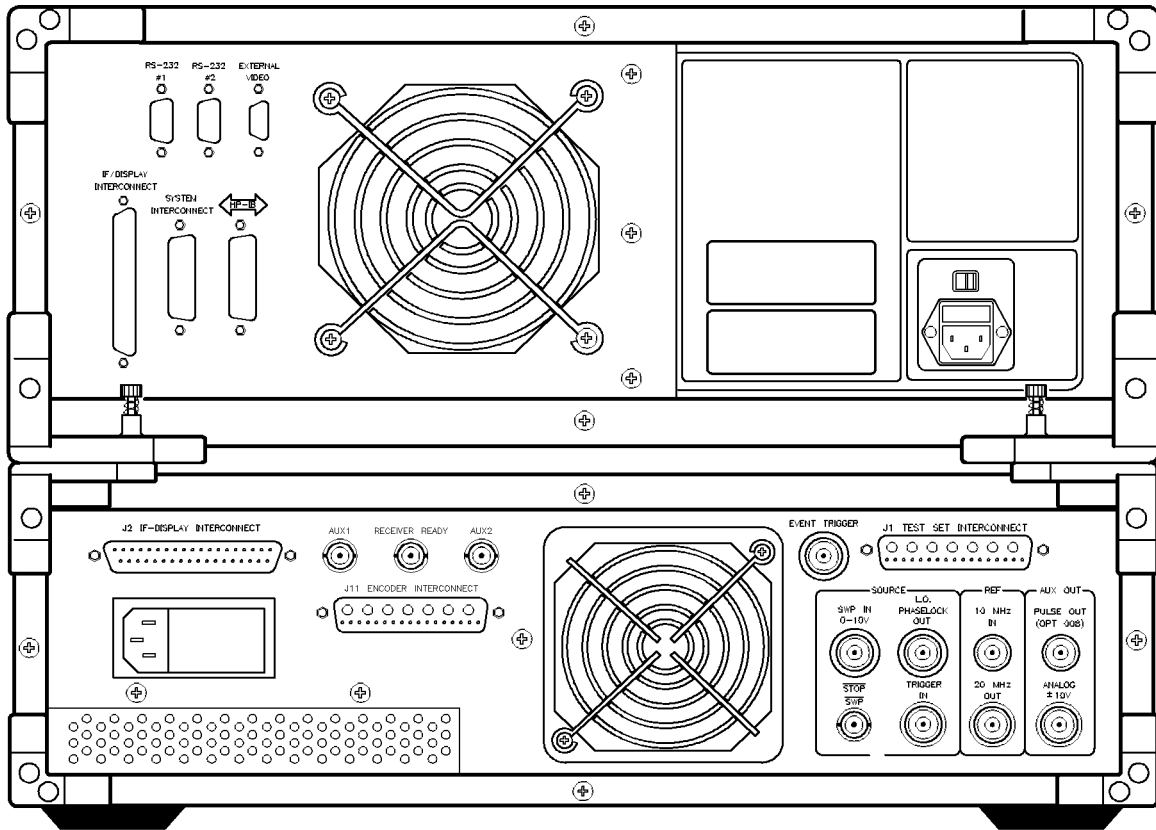

Figure 3-4. Rear Panel Features

Top Box Rear Panel

RS-232 #1 and RS-232 #2

These are standard 9 pin male RS-232 serial connectors. The HP 8530A sends serial RS-232 printing or plotting commands out these ports. The receiver has dedicated printer/plot buffers for these outputs, although the buffer for port #1 is larger. It is recommended that Port #1 be used for high resolution printers such as the HP DeskJet or Laser printers. The larger printer buffer allows the instrument to finish servicing the printout more quickly, and return to making measurements.

You can select RS-232 #1 or RS-232 #2 for your serial printer or plotter through the **LOCAL MORE** menu.

RS-232 PORT #1 and #2
Pin Out

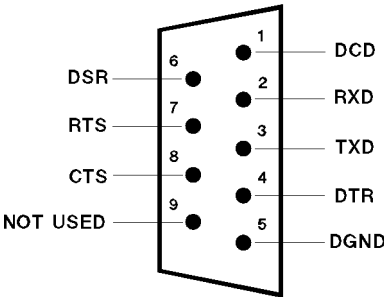

EXTERNAL DISPLAY

The EXTERNAL DISPLAY port drives external multisync monitors. The receiver supports all monitors that meet the requirements listed in Chapter 1. The Display section of Chapter 5 explains how to install and configure an external monitor.

EXTERNAL DISPLAY
Pin Out

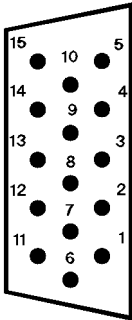

Pin	Signal	Pin	Signal	Pin	Signal
15	No Connection	10	EXTSYNCRTN	5	No Connection
14	EXTVSYNC	9	No Connection	4	No Connection
13	EXTHSYNC	8	EXTBLUERTN	3	EXTBLUE
12	No Connection	7	EXTGREENRTN	2	EXTGREEN
11	DGND	6	EXTREDRTN	1	EXTRED

IF/DISPLAY INTERCONNECT

This interface is the communication link between the top and bottom portion of the HP 8530. The IF/DISPLAY INTERCONNECT cable must be connected or the receiver will not function.

SYSTEM INTERCONNECT (System Bus Connector)

This bus allows the receiver to control slave instruments (RF source, LO source, printers, or plotters). RF and LO sources *must* be connected to the System Bus *not to the main HP-IB bus*. Printers and plotters can be placed on the System Bus if you want the HP 8530A to control them.

Rear Panel Features

The System Bus has the same length limitations as the main HP-IB bus. Instruments on this are addressed using a two-digit address from 01 to 31.

HP-IB Connector (HP-IB Bus)

The HP-IB bus allows the receiver to be controlled by an external computer. The bus is compatible with IEEE 488 dated 1978, and IEC 625-1.

Line Voltage Selector

This switch allows you to select between 115 or 230 Vac mains.

Line Voltage Fuse

The replacement part number for the 3 amp line voltage fuse is 2110-0665. The fuse value for the top box is the same for both line voltage positions.

Bottom Box Rear Panel

IF/DISPLAY INTERCONNECT

Refer to the description under “Top Box Rear Panel,” above.

AUX1, AUX2, RECEIVER READY BNCs

These are not currently used. Some special options may use one or more of these connectors.

ENCODER INTERCONNECT

This connector is used to communicate with the HP 85370A Position Encoder. *The HP 8530A must be equipped with option 005 before it can operate with the HP 85370A Position Encoder.*

EVENT TRIGGER BNC

This jack receives TTL external trigger signals from the positioner controller. Triggering occurs on the negative edge of the trigger pulse. External triggering is selected through the STIMULUS **(MENU) MORE TRIGGER MODE** menu.

TEST SET INTERCONNECT

This interface allows the receiver to communicate with the HP 8511A/B frequency converter. If the receiver used in HP 8510C “mode,” this interface communicates with network analyzer test sets.

SWEEP IN 0-10V BNC

When using an HP 8340/41 or 8350 RF source, connect the source’s SWEEP OUT jack to this receiver input. This, in conjunction with the STOP SWP connection, allows the Ramp Sweep mode to function.

L.O. PHASELOCK OUT BNC

This jack provides a phase locking signal to an HP 8350A LO source. It should be connected to the FM IN jack of the HP 8350.

STOP SWP BNC (Stop Sweep)

The STOP SWP jack has two functions:

- HP RF sources have a corresponding STOP SWEEP jack. The RF source pulls STOP SWEEP low during band crossings and sweep retrace. This allows the receiver to wait for these events when in Ramp Sweep mode.
- When in external triggering or HP-IB triggering mode, the receiver allows STOP SWP (TTL) to go HIGH when the receiver is ready to take more data. STOP SWP is pulled LOW when the receiver is NOT ready to take data.

TRIGGER IN BNC

When using an HP 836xx family RF source, connect the source's TRIGGER OUT jack to this receiver input. This, in conjunction with the STOP SWP connection, allows the Ramp Sweep and Quick Step modes to function.

10 MHz IN BNC

This jack allows you to lock the HP 8530A timebase to the timebase of the (synthesized) source. This is recommended if your system uses a synthesized LO source.

20 MHz OUT BNC

This jack is used for service functions.

PULSE OUT (OPT 008) BNC

This jack is not used by the HP 8530A at this time.

ANALOG $\pm 10V$ BNC

This jack is used for service functions.

Line Voltage Selector (Bottom Box)

A removable line voltage selector card allows you to select the appropriate ac mains voltage.

Line Voltage Fuse (Bottom Box)

If the voltage selector is set to 100 or 120V, use the 2.0 amp replacement fuse, part number 2110-0002. If the voltage selector is set to 220 V or 240 V, use the 1.5 amp replacement fuse, part number 2110-0043.

Active Channel Block

Introduction

This chapter describes the two channels in the receiver, how they work, as well as showing more detail on the internal workings of the receiver.

The Two Channels

The receiver has two separate, identical measurement channels. The channel feature is much like having two HP 8530 receivers setting next to one another.

The term “active channel” refers to the channel that was activated last. When you select a parameter, change measurement settings, and so on, you affect the *active channel*. In the same way, only one parameter (PARAM 1, PARAM 2, PARAM 3, or PARAM 4) can be the active parameter at any given time. The same applies to markers.

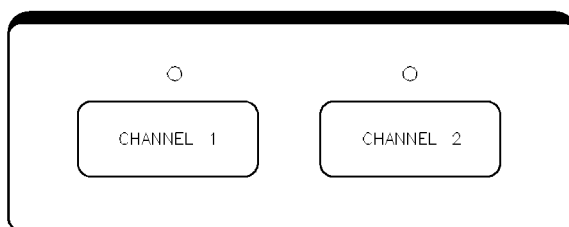

Figure 4-1. Channel Selection Keys

Independent Channel Settings

Channel 1 and 2 can have different PARAMETER, FORMAT, or RESPONSE settings. In addition, you can select Time Domain on one channel, and Frequency Domain on the other. For example, you could set Channel 1 to Frequency Domain, PARAM 1. Then you could set Channel 2 to Time Domain, PARAM 2. The receiver will measure each channel and display the data. You can view the data separately (by changing channel), or you can display both sets of data side-by-side (dual channel split) or superimposed (dual channel overlay). These functions are available under the **DISPLAY** key.

Internal Data Flow

The internal data flow in each channel is described in Chapter 2, System Overview.

Menus Block

Chapter Contents

- Calibration
- Domain
- Display
- Markers

Calibration

Section Contents

This section explains:

- Information Pertaining to All Calibration Types
 - What is Calibration?
 - Calibration Requirements
- Specific Calibration Procedures
 - Antenna Calibration
 - RCS Calibration
 - Network Analyzer Calibration
 - Response Calibration
 - Response & Isolation Calibration
 - 1-Port Calibration
- Supplementary Calibration Subjects
 - Storing and Loading Calibration Data (to/from disc)
 - Turning ON an Existing Cal Set
 - Principles and Care of Calibration Standards
 - Verifying Calibration Data
 - Modifying Network Analyzer Calibration Kit Definitions
 - Modifying a Calibration Set (error correction data)
 - Adjusting trim sweep
 - Creating a Standard Gain Antenna Definition

Information Pertaining to All Calibration Types

What is Calibration?

Calibration, regardless of the exact type, reduces repeatable systematic errors caused by the system, the chamber, or the antenna range. To achieve this, the receiver measures one or more standards of known characteristics. During calibration, the receiver:

1. Measures the standard.
2. Compares the results to the known characteristics of that standard.
3. Calculates the exact amount of inaccuracy, and how much the measurement data must be adjusted to compensate for it. The adjustment values are called “error coefficients.”
4. Stores the error coefficients in memory.

When actual measurements are made, the calibration feature subtracts the error coefficient values, making the measurement much more accurate.

Calibration Requirements

The HP 8530A can perform three types of calibration:

Antenna Calibration	Antenna calibration allows measured data to be expressed in dBi (dB relative to an isotropic radiator). A standard gain antenna with known or defined gain values at specific frequencies is used as a transfer standard to calibrate the system.
RCS Calibration	Response and Background calibration reduces range errors using a calibration target of known radar cross section. The Response portion of the calibration measures the reflections of the calibration target. The Background portion measures the empty antenna chamber to characterize and compensate for clutter. After performing an RCS calibration, measurements are expressed in dBsm (decibels per square meter).
Network Analyzer Calibration	Network analyzer calibration greatly reduces repeatable systematic errors during network analysis measurements. A network analyzer calibration transfers the accuracy of your calibration standards to the measurement of your device. Network analyzer calibration standards are supplied in a “calibration kit” which must be purchased separately. Calibration kits are made for specific frequency ranges and connector types.

Calibration Requirements

Calibration issues become much simpler if you calibrate using the same equipment and instrument settings that you plan to use during the measurement.

Use the Same Equipment Setup in the Measurement

You *must* calibrate using the same adapters and cables that will be used for the measurement. If the adapters or cables are changed between calibration and measurement, unpredictable errors will result due to the fact that the error coefficients determined during calibration are incorrect for the altered setup. Even disconnecting and reconnecting the same adapter can cause inaccuracy. If you change the setup, you must perform the measurement calibration procedure again to calculate appropriate error terms for the new setup.

Settings You Can Change after Performing a Calibration

1. You can perform a network analyzer calibration in the frequency Domain, then change to time domain, and the calibration will remain valid.
2. You can calibrate using a specific number of points, then make a measurement using a *smaller* number of points.
3. You can perform an antenna calibration in the frequency domain, then change to the Angle or Time Domain, and the calibration will still be valid. (If you change to the Angle Domain, some HP 8530 receivers turn the calibration OFF. You must manually turn the calibration ON again.)
4. You can perform a swept frequency calibration (in Ramp or Step sweep mode), then select a Single frequency measurement. (Some HP 8530 receivers require you to turn the calibration ON again.)

5. You can change start and stop angle while in Angle Domain.

Setting Changes that Require Special Consideration

Other settings can be changed, but require special consideration.

Changing Parameter

The HP 8530A automatically turns calibration OFF if you change parameter. However, it allows you to turn the calibration ON again for the new parameter. If you are not careful, this can result in invalid data. There are situations (explained below) where you can change parameter and get valid measurement results. The important thing to remember is that you must know when the results are valid, and avoid situations where invalid data would result. The instrument will not warn you.

To understand the considerations involved, remember that *a calibration applies to a specific hardware setup (a specific collection of cables, adapters, and so forth, connected in one specific way)*. As long as the parameter you select will measure that equipment as it was originally set up, the calibration will be valid.

For example, assume you originally connected the equipment to inputs b1 and a1, and performed the calibration using b1/a1 ratio. You can select any parameter key that is currently defined as b1/a1 and the calibration will be valid. (You can redefine any parameter key to be b1/a1.)

Changing Stimulus Values

Changing any of the following settings will cause the message CAUTION: CORRECTION MAY BE INVALID to be displayed. Calibration remains ON.

- Source Power
- Power Slope
- Dwell Time
- Sweep Time
- Sweep Modes
- Trim Sweep Value

Settings that should not be changed

Selecting a Different Frequency Range

If you have performed any type of calibration across a frequency range, and then change frequencies, calibration is automatically turned Off, and CORRECTION RESET is displayed.

Selecting a Greater Number of Points

If you calibrate using a certain number of points, you cannot perform a measurement using a greater number of points. If you attempt to select a greater number of points, calibration is automatically turned Off, and CORRECTION RESET is displayed.

Calibration Requirements

Using Averaging

For all calibrations, use the same or greater averaging factor than will be used for the device measurement. In general, use an averaging factor of 8 or 16 for most measurements. Hewlett-Packard recommends that you increase the averaging factor for the isolation portion of the calibration (in RCS calibration this is the background calibration). This can be easily accomplished by turning Averaging ON before beginning the calibration, then leaving averaging factor as the active function during the calibration.

If you are using averaging

If averaging is ON during calibration, then the correct number of measurements needed to provide fully averaged data are automatically taken. For Ramp sweeps this means that $n+1$ sweeps, where n is the current averaging factor, are taken. For Step, Single Point, or Frequency List, each data point is averaged n times (where n is the selected number of averages).

Calibration Requirements

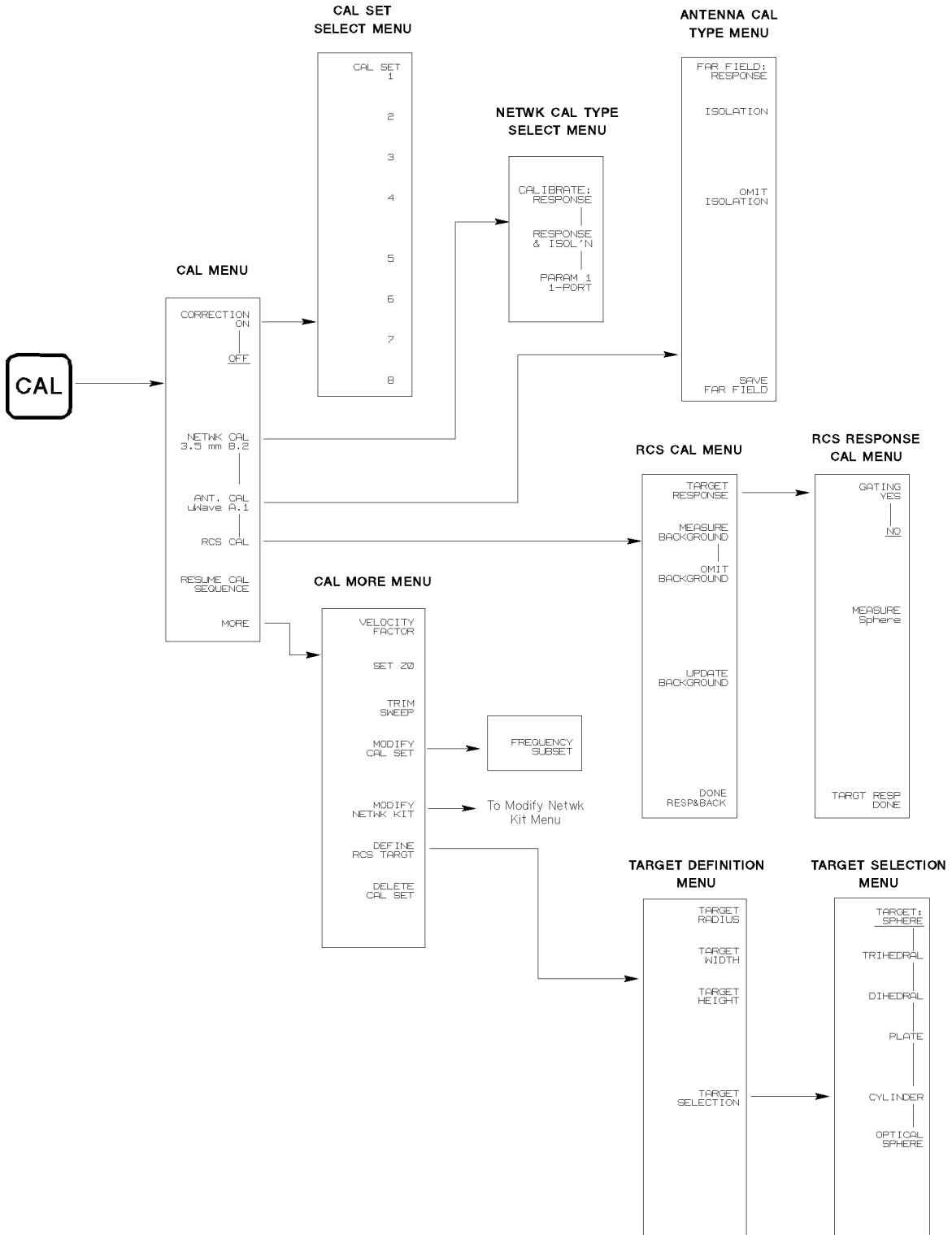

Figure 5-1. Cal and Cal Type Menus

Specific Calibration Procedures

The following pages contain information about specific types of calibration, including step-by-step procedures on performing calibrations.

The receiver provides the following calibration types:

- Antenna Calibration
- RCS Calibration
- Network Analyzer Calibration (only described in the operating and programming manual)
 - Response Calibration
 - Response and Isolation Calibration
 - 1-Port Calibration

Antenna Calibration

Antenna calibration allows measured data to be expressed in dBi (dB relative to an isotropic radiator). A standard gain antenna with known or defined gain values at specific frequencies is used as a transfer standard to calibrate the system.

Calibrating with a standard gain antenna corrects for the transmission response errors.

An optional part of antenna calibration is an “isolation calibration.” This calibration reduces crosstalk errors between input channels. The isolation cal requires a high quality RF load as a calibration standard. The load you need is determined by the connector type and frequency range of your system.

Important Terms

Cal	“Cal” is an abbreviation for “Calibration.”
Cal Definition	A cal definition is an ASCII file you create using a text editor. It contains theoretical or measured frequency and gain values for the standard gain antenna. You can create the file using any computer-based text editor which can save text in plain ASCII format. The file can then be loaded into the receiver from a DOS or LIF disc. A cal definition contains up to seven “antenna definitions.”
Antenna Definition	The gain data for a specific standard gain antenna is called an “antenna definition.”
Cal Set	A finished calibration data file. During the calibration, the standard gain antenna is measured and its performance is compared to one or more antenna definitions. Any differences are stored in an internal “cal set register.” These differences are the error coefficients which, when subtracted from the measurement, result in calibrated results. In antenna calibration, the final measurement data is expressed in units of antenna gain (dBi). Cal sets can be stored in internal registers or to disc.

Angle Domain and Frequency Domain Calibrations

If you perform a calibration while in angle domain, the calibration will be at one frequency. (Angle Domain makes measurements at only one frequency.)

If you perform a calibration while in Frequency Domain, you can calibrate over a range of frequencies.

Using a Frequency Domain Calibration in Angle Domain.

HP recommends that you calibrate using Frequency Domain, which calibrates over a range of frequencies. You can then switch to Angle Domain, and pick any of the frequencies from the Frequency Domain calibration. This gives you instant access to many calibrated frequencies (one at a time) when in Angle Domain.

Only one limitation applies; the frequency you want to measure (in angle domain) must exist in the original calibration. The receiver does not interpolate between calibrated frequencies.

Here are the basic steps involved in antenna calibration:

Antenna Calibration Overview

Note Steps 1 and 2 are not necessary if you use one of the supplied standard gain antenna definitions, or if you have already created your own definition.

- 1 Create an ASCII file with Standard Gain Antenna Data (a definition). Save the file to HP 9000 Series 300 (LIF) or DOS compatible disc (filename must begin with AC_). LIF filenames can have up to seven additional characters: AC_XXXXXXX, DOS filenames can have up to five additional characters, plus an extender: AC_XXXXX.XXX

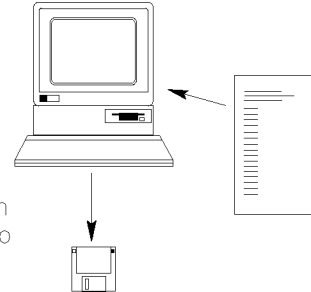

- 2 Load the Standard Antenna Definition into the HP 8530A from the disc.

- 3 Mount the standard gain antenna and find boresight.

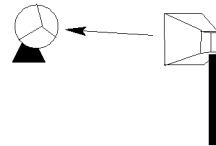

- 4 Choose Angle Domain or Frequency Domain.



- 5 If using Angle Domain, choose the calibration frequency using the **FREQUENCY of MEAS.** softkey.

If using Frequency Domain, choose calibration frequencies using start, stop, and number of points, or use frequency list mode to enter specific frequencies.

- 6 Start the calibration. The receiver creates calibration data based on the standard gain antenna.

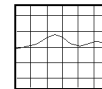

- 7 If you are making a calibration using two or more standard antennas, mount the next standard gain antenna, find boresight, and calibrate.

- 8 If desired, perform an isolation calibration to reduce channel crosstalk.

- 9 Save the calibration to a Cal Set Register.

- 10 If desired, store the calibration to disc.



Standard Gain Antenna Definitions

To perform a calibration, the receiver must know the published gain values of the standard gain antenna. HP has supplied a file containing data for seven Narda standard gain horns.

If You Are Using a Narda Standard Gain Horn that is Already Defined:

Data for Narda models 638, 639, 640, 642, 643, 644, and 645 are supplied in a single cal definition file. This file, AC_NAR1, is supplied on the Antenna/RCS Cal Disc which was shipped with the HP 8530A. If you are using one of these horns, load AC_NAR1 as explained below:

1. Insert the Antenna/RCS Cal Disc into the HP 8530A's disc drive.
2. Press **(DISC)** **LOAD** **CAL KITS** **ANTENNA CAL DEF**, the receiver will display a file directory showing AC_NAR1. Since it is the only cal definition on that disc, it will already be highlighted.
3. Press **LOAD FILE**.

When you perform the antenna calibration you will see the Narda horns listed in a softkey menu. Information on the Narda horns is provided at the end of the calibration section. Please note that your Narda standard gain horn calibration data may be different than the data on file AC_NAR1.

If You Are Not Using One of the Pre-Defined Narda Horns:

Create your own cal definition file as explained in "Creating a Standard Gain Antenna Definition", at the end of this chapter. You will need a personal computer and a text editor that can save text in plain ASCII format.

Note

If you calibrate over a wide frequency range, you may need to use two or more standard gain antennas. Some users have asked us: "When calibrating, what happens when two of the standard gain antennas have overlapping frequencies?" The answer is: Where the frequencies overlap, the receiver uses the calibration data for the standard gain antenna that was measured last.

Performing an Antenna Calibration

Frequency Domain Calibration

Initial Setup, Finding Boresight

1. Mount the standard gain antenna on the proper antenna mount and connect it to your system.
2. Press: **(RECALL)** **MORE** **FACTORY PRESET**.
3. Press: **(DOMAIN)** **FREQUENCY**.
4. Press: **STIMULUS** **(MENU)** **SINGLE POINT**.
5. Press **(CENTER)** and enter a frequency in the approximate center of the calibration frequency range.
6. Press **(MARKER)**.
7. Select the desired axis on the positioner controller.

Antenna Calibration

8. Move the positioner so the antenna is somewhere near its boresight position (a rough approximation is fine).
9. Move the positioner until the flat line reaches maximum amplitude (or minimum amplitude if your antenna has a null at boresight). It is helpful to watch the marker value readout (in the upper-left portion of the display). This digital readout of the amplitude makes it easy to observe small (0.1 dB) changes.
10. Boresighting is usually interactive between axes, so repeat steps 5, 6, and 7 for each axis until true boresight is found.

Choosing Calibration Stimulus Settings

1. Perform step a or b below, depending on if you want to calibrate at one or more frequency points.
 - a. If you only want to calibrate at a single frequency press STIMULUS **(MENU)** **SINGLE POINT**. Press **(CENTER)** followed by the desired frequency, proceed to *Antenna Calibration Steps*, below.
 - b. To calibrate over a range of frequencies, you must choose a sweep mode. Any mode will work *but the Frequency List mode is strongly recommended*. The Frequency List **STEP SIZE** function allows you to enter a *known increment frequency*. This is why the Frequency List mode is better when performing a calibration. Ramp and step sweep modes only allow you to choose a **NUMBER of POINTS**, and *the receiver* chooses the increment frequency. This limits flexibility in the calibration and often results in inconvenient increment values (like 17.67 MHz). STEP SIZE allows *you* to choose a step size that is *convenient*.

Note Ramp Sweep mode is not always usable, depending on how your system is configured. Ramp Sweep mode will not function in systems that use an LO source. In addition, Ramp Sweep requires two BNC connections between the receiver and the RF source.

Sometimes wide frequency ranges require you to use two or more standard gain antennas to cover the whole frequency range. If this is the case, enter the entire frequency range during the procedure below.

To use Frequency List mode, as recommended, perform the following sub steps:

- i. Press STIMULUS **(MENU)** **MORE** **EDIT LIST**.
- ii. Press **EDIT** **SEGMENT: START** and enter the desired start frequency (for example, 8.2 GHz).
- iii. Press **STOP** and enter the desired stop frequency (for example, 12.4 GHz).
- iv. Press **STEP SIZE** and enter the desired frequency increment value. Assume for a moment that your standard gain antenna has documented gain values every 50 MHz. You can choose smaller increments (for example, 25 MHz), and the receiver will interpolate between known gain points. (Straight-line interpolation is performed.)
- v. Press **DONE**. The receiver will display the number of points it will use in the measurement, based on the selected step size.
- vi. Press **DONE** again.
- vii. Press **FREQUENCY LIST** to select Frequency List mode.

Antenna Calibration Steps

2. Press the **CAL** key (located in the MENUS block), then press:

ANT. CAL uWave A.1 FAR FIELD:RESPONSE

A menu will appear with seven standard gain antenna definitions to choose from.

3. Select the definition for your standard gain antenna. If you must create a definition for your standard gain antenna, refer to “Creating a Standard Gain Antenna Definition”, at the end of this chapter.

The receiver will now measure the standard gain antenna, and create a list of offsets called a “Cal Set.”

If you only want to measure one standard gain antenna, press **DONE RESPONSE** and proceed to “Finishing the Gain Calibration,” below.

Note

If you see the error message: **CAUTION: ADDITIONAL STANDARDS NEEDED**, the standard gain antenna does not cover the entire frequency range of the calibration. You should do one of the following things:

- a. Measure an additional standard gain antenna to cover the additional frequencies.
 - b. Use a standard gain antenna that covers the entire frequency range. *If your antenna is specified to cover the selected frequency range: Make sure the standard gain antenna definition really has entries for the entire frequency range of that antenna. The person who created the “definition” file for that antenna may not have entered values for its entire range. Refer to the section on creating standard gain antenna definitions, in this chapter.*
 - c. Select a calibration frequency span that is within the frequency range of the standard gain antenna and do the calibration over again.
-

4. If you are calibrating for a wide frequency range, requiring more than one standard gain antenna:
 - a. Mount the next standard gain antenna.
 - b. If necessary, boresight the antenna. You must stay in the current Domain and Sweep Mode. For example, if you are currently in Frequency List mode, the receiver must remain in this mode during boresighting or the calibration will be ruined. With a marker still ON, turn the antenna until boresight (for that axis) is found. Turn the antenna in small steps because of the delay between completed sweeps. Do this for each axis until boresight is found.
 - c. Select the appropriate standard gain antenna definition from the softkey menu.
 - d. Repeat these sub-steps for each standard gain antenna you need to measure.
 - e. Press **DONE RESPONSE** when you are done.

If the error message: **CAUTION: ADDITIONAL STANDARDS NEEDED** appears, then the definitions for your standard gain antennas do not cover the entire frequency range you have selected. There are either gaps between adjacent definitions, or they do not provide full coverage near the beginning or end of the frequency range.

Finishing the Gain Calibration

5. You are now done with the gain portion of the calibration. Now you should decide if you want to perform an “isolation calibration.” An isolation calibration reduces crosstalk between inputs (either reference-to-test or test-to-test), and requires a high-quality 50Ω load.

Antenna Calibration

- a. If you *do not* want to perform an Isolation Calibration, press **OMIT ISOLATION** and proceed to “Saving the Cal Set to a Cal Set Register.”
- b. If you want to perform an isolation calibration, refer to “Isolation Calibration,” below.

Isolation Calibration

6. Replace the standard gain antenna with a 50 Ω load. Make sure the load’s connector is torqued as shown in Table 5-1 to prevent RF leakage.

Table 5-1. Proper Connector Torque

Connector	Torque cm-kg	Torque N-cm	Torque in-lbs	Wrench Part Number
Type-N	52	508	45	8710-1935
3.5 mm	9.2	90	8	8720-1765
SMA	5.7	56	5	8710-1582
2.4 mm	9.2	90	8	8720-1765

7. Press **ISOLATION**. The receiver will perform the isolation calibration.

Saving the Cal Set to a Cal Set Register

8. Press **SAVE FAR FIELD**. A menu of eight cal set registers will appear. Press any of the eight register softkeys and the cal set will be saved to that register.

The receiver will now turn calibration ON, so any measurement you make will be calibrated.

Angle Domain Calibration

Initial Setup, Finding Boresight

1. Mount the standard gain antenna on the proper antenna mount and connect it to your system.
2. Press **(RECALL) MORE FACTORY PRESET**.
3. Press **(DOMAIN) ANGLE**.
4. Press **STIMULUS (MENU) SINGLE ANGLE**.
5. Press **FREQUENCY OF MEAS**, then enter the desired calibration frequency.
6. Press **MORE CONTINUAL**.
7. Press **TRIGGER MODE TRIG SRC FREE RUN**.
8. Select the desired parameter, **(PARAM 1)**, **(PARAM 2)**, **(PARAM 3)**, or **(PARAM 4)**.
9. Turn on Marker 1 by pressing **(MARKER) MARKER 1**.
10. Now use the positioner controls to move the antenna. Watch the data readout for Marker 1. When the marker reaches peak value you have found the boresight for that particular axis.
11. Repeat for each axis, if necessary. Boresighting is iterative so you may have to measure back and forth between axes until the true boresight is found.

Antenna Calibration Steps

1. Press the **(CAL)** key (located in the MENUS block), then press:

```
ANT. CAL uWave A.1 FAR FIELD:RESPONSE
```

A menu will appear with seven standard gain antenna definitions to choose from.

2. Select the definition for your standard gain antenna. If you must create a definition for your standard gain antenna, refer to “Creating a Standard Gain Antenna Definition”, at the end of this chapter.

The receiver will now measure the standard gain antenna, and create a list of offsets called a “Cal Set.”

Press **DONE RESPONSE** and proceed to “Finishing the Gain Calibration,” below.

Finishing the Gain Calibration

3. You are now done with the gain portion of the calibration. Now you should decide if you want to perform an “isolation calibration.” An isolation calibration reduces crosstalk between inputs (either reference-to-test or test-to-test), and requires a high-quality 50Ω load.
 - a. If you *do not* want to perform an Isolation Calibration, press **OMIT ISOLATION** and proceed to “Saving the Cal Set to a Cal Set Register.”
 - b. If you want to perform an isolation calibration, refer to “Isolation Calibration,” below.

Antenna Calibration

Isolation Calibration

4. Replace the standard gain antenna with a 50 Ω load. Make sure the load's connector is torqued as shown in Table 5-2 to prevent RF leakage.

Table 5-2. Proper Connector Torque

Connector	Torque cm-kg	Torque N-cm	Torque in-lbs	Wrench Part Number
Type-N	52	508	45	8710-1935
3.5 mm	9.2	90	8	8720-1765
SMA	5.7	56	5	8710-1582
2.4 mm	9.2	90	8	8720-1765

5. Press **ISOLATION**. The receiver will perform the isolation calibration.

Saving the Cal Set to a Cal Set Register

6. Press **SAVE FAR FIELD**. A menu of eight cal set registers will appear. Press any of the eight register softkeys and the cal set will be saved to that register.

The receiver will now turn calibration ON, so any measurement you make will be calibrated.

Important Note On Antenna Measurements

Before you make actual measurements (with calibration ON), IT IS VITAL THAT YOU READ THE FOLLOWING:

The frequencies you measure must exactly match the frequencies in the cal set file.

For example, assume you have calibrated from 10 GHz to 11 GHz with a step size of 100 MHz.

The calibrated frequencies in the cal set are:

10.0 GHz	10.6 GHz
10.1 GHz	10.7 GHz
10.2 GHz	10.8 GHz
10.3 GHz	10.9 GHz
10.4 GHz	11.0 GHz
10.5 GHz	

You can measure any of these frequencies during the actual measurement. You cannot, however, measure *any other* frequencies. For example, you cannot measure 10.55 GHz. *The receiver does not interpolate between frequencies in the cal set.*

This is another reason why Frequency List mode is so useful when performing calibrations. *Entering a known, convenient step size makes it easy to know what frequencies are in the cal set. Thus, you know precisely which frequencies you can measure with that calibration.*

Things to Try

Assume you created a calibration in the Frequency Domain, using the Frequency List mode, and you save the cal set to Cal Set Register 1. Now go to the Angle Domain. Some HP 8530A receivers will now display the message CAUTION: CORRECTION RESET. Simply press **CAL** **CORRECTION ON CAL SET 1** to turn the calibration ON again. The Frequency Domain calibration is still valid, even though you are now in the Angle Domain. You can select any of the frequencies in the original Frequency Domain calibration, and the calibration will remain valid.

Now change the start and stop angle, notice that the calibration remains valid.

RCS Calibration

RCS Calibration Description

This section explains how to perform an RCS calibration. RCS Response and Background calibration reduce range errors using a calibration target of known radar cross section. The Response portion of the calibration reduces phase and amplitude discrepancies between the test and reference channels (tracking errors). The Background portion measures the empty antenna chamber to reduce undesired reflections (clutter). After performing an RCS calibration, log magnitude measurements are expressed in decibels per square meter (dBsm).

You should become familiar with concepts presented in the Time Domain chapter before performing an RCS calibration.

Important Information about Gating During the Calibration

Keep the following in mind if using gating during RCS calibration:

- After the RCS calibration is completed, the calibrated response of the Calibration Target will move, and the gate will no longer be centered around it. To make sure that you do not accidentally leave the gate around the old (now incorrect) position, the receiver turns gating OFF once calibration is done. When you perform actual RCS measurements, turn gating back ON and center it around the response of your measurement target. Usually the target will be at 0.00 seconds.
- Remember, gating has limitations. Do not use gating if:
 - You are measuring a limited frequency span or number of points.
 - If using a frequency list where the points are not evenly spaced.

RCS Calibration Overview

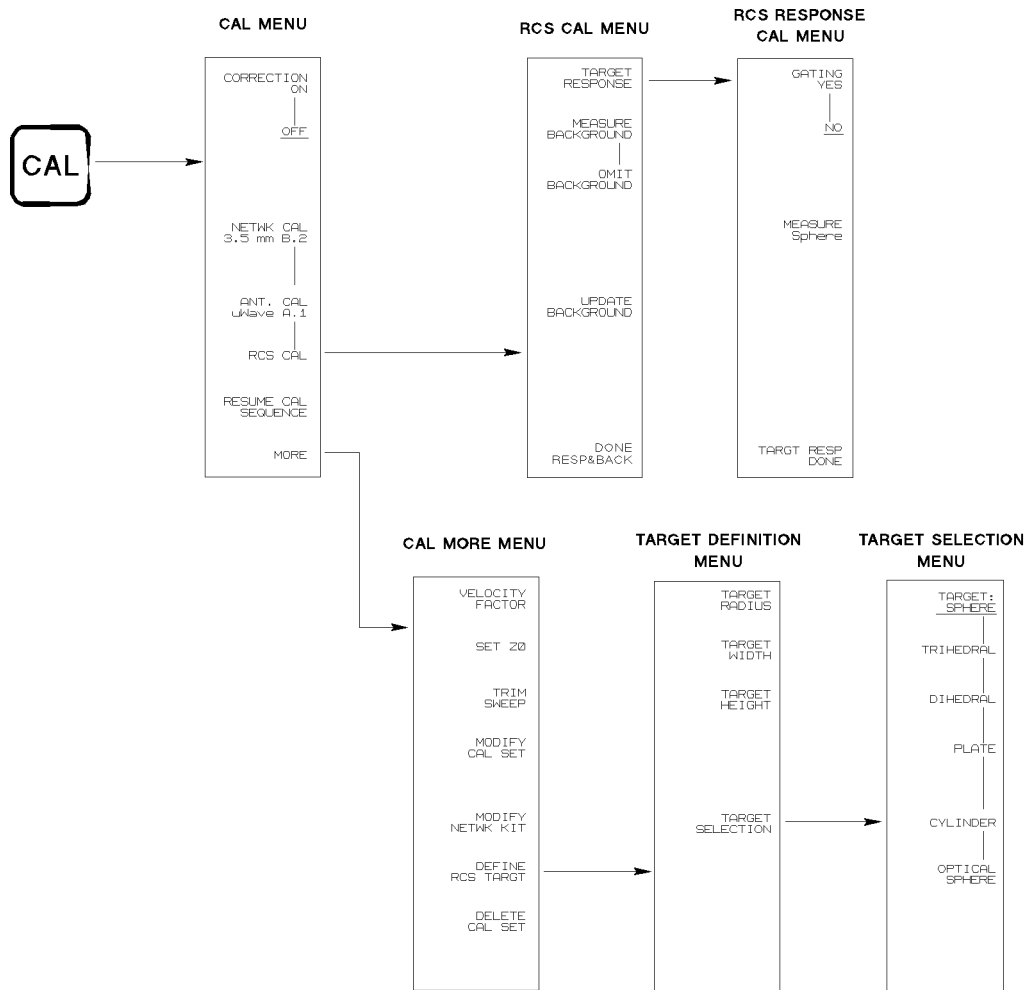

Figure 5-2. Menus Associated with RCS Calibration

1. Determine the requirements of your measurement, including:
 - a. Stimulus Settings
 - b. Range Resolution
 - c. Alias Free Range
 - d. Gating Requirements

These requirements will determine the stimulus, window, and gate settings you should use.

2. Select Frequency Domain
3. Select stimulus settings, using one of the following methods:
 - Set start and stop frequency and number of points. This method is acceptable if you are performing RCS calibrations for use in the Time Domain.
 - Use Frequency List mode with a start frequency, stop frequency, and a specific frequency step value. This method allows you to know the exact frequencies represented in the calibration. This method is preferable if you are going to make RCS measurements in the Angle Domain. Why? Because you can then make calibrated measurements at any

RCS Calibration

frequency that exists in the calibration. (Remember, when making actual measurements, the receiver cannot interpolate between calibrated frequencies.)

4. If desired, turn ON gating.
5. If desired, turn ON Averaging.
6. Specify RCS target type and its physical dimensions.
7. Perform the actual RCS calibration.
8. After the calibration, use **UPDATE BACKGROUND** if you change target mounts or if other changes occur to the background. This updates the calibration so it is accurate given the new background conditions.

RCS Calibration Procedure

As mentioned above, first determine the needs of your measurement, then use the information in Chapter 13, Time Domain Measurements, to calculate required start frequency, stop frequency, and number of points, or the Frequency List mode settings required.

Select Stimulus Values

1. Enter the required frequency values using Start, Stop, and Number of Points, or by using the Frequency List mode.

Select Gating (if Desired)

Gating is explained in the Time Domain chapter.

2. Use Gating as explained below:
 - a. If you are going to perform a gated calibration, make sure any previous calibrations are OFF. THIS IS VERY IMPORTANT.

Press **(CAL) CORRECTION OFF**

- b. Next, determine the location and width of the target response. An easy way to do this is to use display math:
 - i. Remove the RCS target and allow the receiver to measure one full frequency sweep.
 - ii. Save the measurement to memory by pressing:

(DISPLAY) DATA -> MEMORY

- iii. Select math subtraction mode by pressing:

SELECT DEFAULTS MATH OPERATIONS MINUS (-)

- iv. Place the target on the mount, and allow another full measurement sweep.

- v. Select Data minus Memory mode by pressing:

(DISPLAY) MATH (-)

- vi. Only the target response will appear on the screen.

- c. Press **(DOMAIN) TIME BAND PASS SPECIFY GATE**.

- d. Choose the gate position and size using the gate **START** and **STOP**, or **CENTER** and **SPAN** softkeys.

- e. Select gate shape by pressing **GATE SHAPE**, then either **MAXIMUM**, **WIDE**, **NORMAL**, or **MINIMUM**. In most circumstances, the factory default (Normal) is the best choice.

- f. Turn Gating ON by pressing **(PRIOR MENU) GATE ON**.
- g. Position the gate around the target response.

If your target is a sphere, the placement of the gate is critical. Spheres produce a secondary reflection caused by RF energy propagating around the back of the sphere, which ultimately arrives back at the receive antenna. This produces the secondary reflection, known as a “creeping wave.”

- If the creeping clearly separate from the main target response, place the gate around just the main response. In this case make sure you select the **OPTICAL SPHERE** model when you define the RCS target (the next step).
- If the main target response and the creeping wave are not clearly distinct and separate, position the gate around both of them. In this case make sure you select the **TARGET: SPHERE** model when you define the RCS target (the next step).

Do not attempt to gate out very large background reflections, or subsequent measurements will not be accurate.

Define the RCS Target

The next step is to select the type of RCS target you use during calibration, and enter its physical dimensions.

3. Press **(CAL) MORE DEFINE RCS TARGET TARGET SELECTION**.
4. Select the type of calibration target by pressing one of the following:

TARGET: SPHERE	PLATE
TRIHEDRAL	CYLINDER
DIHEDRAL	OPTICAL SPHERE

If You are Using a Sphere:

If you are NOT using gating during the calibration, *always* select **TARGET: SPHERE**.

The Difference between Sphere and Optical Sphere

The top selection, **SPHERE**, computes the exact solution for the radar cross section of a perfectly conducting sphere.

The **OPTICAL SPHERE** selection computes the radar cross section of the sphere based on geometric optics - in which the RF signal is treated as “optical rays” according to physical principles of reflection and refraction. The optical sphere selection is best used when the wavelength of the RF energy is large enough that it approximates the behavior of light. This is called the “optical region” of the sphere. The RF energy is in the sphere’s “optical region” when the following relationship between wavelength and sphere radius is true:

$$(2\pi r \div \lambda) > 10$$

Where λ is wavelength and r is the radius of the sphere.

NOTE: Radar Cross Section data for all target types except **SPHERE** are based on geometric optics.

5. Press **(PRIOR MENU)**.
6. Enter the required (metric) dimensions of the target using the appropriate dimension softkeys for each type of target:

RCS Calibration

TARGET RADIUS

TARGET HEIGHT

TARGET WIDTH

Figure 5-3 shows the dimensions required for each type of target.

To specify dimensions in meters, terminate the value with $(x1)$. To specify dimensions in millimeters, use (k/m) .

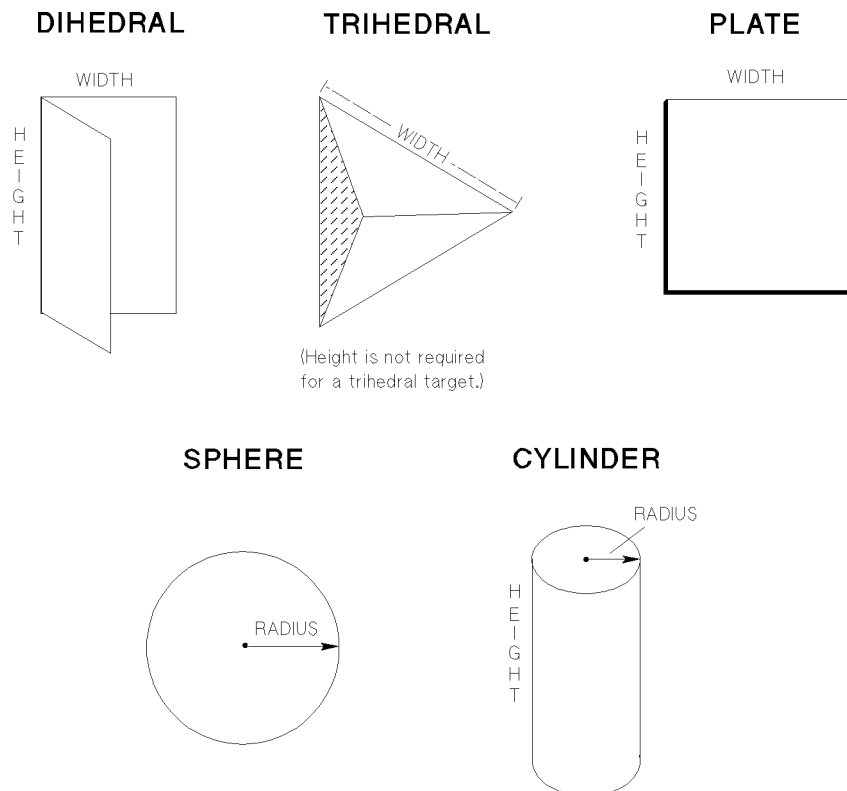

Figure 5-3. Dimensions Required by Different Target Types

Note On Dihedral and Plate targets, height and width are interchangeable. Trihedral and sphere targets only require one dimension to be specified.

Select Averaging (if Desired)

7. If desired, turn Averaging ON and set it to the required value. For example, press:

RESPONSE (MENU) AVERAGING ON/restart n [x1]]. Where n is the desired averaging factor.

Perform the Calibration

8. Make sure the RCS target is on the mount.

9. Press (CAL) RCS CAL TARGET RESPONSE.

10. If gating is ON, you can select whether it will affect the calibration. To make current gating settings affect the calibration, press GATING YES. If GATING NO is selected, current gating settings will not affect the calibration.

11. Measure the calibration target by pressing **MEASURE target name**. (This softkey displays the name of the currently-selected target.)

At this time the receiver performs a response calibration on the target. This part of the calibration reduces magnitude and phase discrepancies between the test and reference channels (tracking errors).

12. Press **TARGT RESP DONE**

Optional Background Calibration

The next step is to measure the background. The background consists of the chamber and mount without the RCS calibration target. This part of the calibration is an isolation calibration. It reduces the effects of undesired chamber reflections (clutter).

If you do not want to perform the background portion of the calibration, press **OMIT BACKGROUND DONE RESP&BACK**. Now select one the of eight cal set registers to hold the calibration data.

To perform the background calibration:

13. Remove the RCS target.
14. Press **MEASURE BACKGROUND**
15. Press **DONE RESP&BACK**. Now select one the of eight cal set registers to hold the calibration data.
16. Now proceed with normal RCS measurements.

If you used single sweep mode to find the target response (earlier in this procedure), remember to change sweep mode back to the type needed for actual measurements. Most often this is the Continual mode.

Updating the Background

Once calibration is done, if you change the RCS mount, or the background changes, you should update the background. To do this:

1. Make sure the appropriate RCS calibration is ON.
2. Press: **(CAL) RCS CAL UPDATE BACKGROUND**
3. Press **DONE RESP&BACK**. Now select one the of eight cal set registers to hold the calibration data:
 - a. You can store the updated calibration to the register which holds the original version, or:
 - b. If you change mounts regularly, you can store the updated calibration to a different cal set register. Then you can recall the register appropriate for each RCS mount.

Network Analyzer Calibrations

This section explains network analyzer calibrations in detail.

What is Network Analyzer Calibration?

Network analyzer calibration greatly reduces repeatable, system-induced errors. This is achieved by first measuring the magnitude and phase response of one or more high-quality standards. The standards, described below, are placed (one at a time) where the device under test (DUT) would normally be. In other words, if the DUT would normally be placed at the end of a certain cable, that's the exact spot you should place the standard device. This removes errors caused by the cable and its associated connectors. This location is called the "test port." The number of standards required depends on the calibration type.

Standards

Here are the devices that may be required during a network analyzer calibration:

- Open** An open is a termination that presents an open circuit to the receiver. A natural question to ask at this point is: "Why use a special termination when you could just remove the device under test and leave the connection open?" The reason is that a simple open connection has unwanted capacitance that adversely affects the calibration. A "shielded open" termination solves this problem.
- Short** A short is a termination that presents a short circuit at the test port.
- Load** There are two types of loads, fixed loads (lowband and broadband), and sliding loads.
- Fixed loads are small terminations that present a nearly perfect 50 ohm impedance. This absorbs almost all RF energy that is produced by the RF Source. There are two types of fixed load: lowband and broadband.
- A sliding load is a long device with a moving plunger. This type of load is only used in 1-Port calibrations. The sliding load has index marks along its length. These marks allow you to move the plunger to different positions required by the 1-Port calibration. The device has a designed-in "mismatch" whose phase vector changes as you move the mismatch element (the mismatch element moves when you move the plunger). The receiver compares the vector change at the different element positions, and interpolates (very accurately) the directivity errors in the system.

Calibration Kits

The calibration standards mentioned above can be obtained by purchasing a Hewlett-Packard calibration kit. Cal kits can only be used with the connector type they are designed for. (For example, there are different kits for 3.5-mm and type-N connector types.)

Always use a cal kit that has the proper connector types for your test port. Do not use adapters with a cal kit of the wrong connector type. Your test port can have adapters on it, provided that the adaptor will remain in place when you attach the DUT.

Data files provided with each cal kit must be loaded into the receiver. These data tell the receiver the expected performance values of the standards. Cal kit data files are also called "cal kit definitions" in this manual, because they *define* the actual performance of the devices.

After the receiver measures the standards, it compares their apparent performance with the information in the cal kit definition. Any differences are due to errors in the system or cables. The receiver produces a list of the differences, called calibration coefficients. When

you later make actual measurements, the calibration coefficients correct for the errors in the system, thus producing highly accurate measurements. The dynamic range and accuracy of the measurement is then limited by random errors and drift effects, and by the accuracy to which the characteristics of the standard devices are known. This is the basic concept of vector accuracy enhancement.

Other publications discuss the causes of these errors, details of the accuracy enhancement error model, the physical aspects of the calibration standards, the mathematical response models of the standards, and the vector mathematics used to correct the measured data. Background theory and additional application information is described in the HP Application Note "Vector Accuracy Enhancement."

Loading a Cal Kit Definition

1. Insert the disk.
2. Press **DISC** **LOAD** **CAL KITS** **NETWORK CAL KIT**.

A menu will appear showing the contents of the disc. HP cal kit discs actually contain data files for several calibration kits.

3. Use the knob to select the data file for your cal kit.
4. Press **LOAD FILE**.

Important Definitions

Cal	"Cal" is an abbreviation for "calibration."
Cal Kit	A cal kit is a purchased set of calibration standards, including shorts, opens, and loads.
Cal Kit Definition	A data file that contains highly accurate data on the performance of the cal kit devices.
Cal Set	A data file that holds the error coefficients for a single calibration. There are eight cal set registers in the HP 8530A, and you can save or load cal sets to or from disc.
Standard Class	A "standard class" would include all versions of one type of termination. For example, the "shorts" standard class is composed of all short terminations, including male or female types.

Types of Network Analyzer Calibration

There are three types of network analyzer calibration available.

Response	A Response calibration measures and compensates for amplitude and phase differences between the test and reference paths (tracking errors). The basic purpose of the cal is to compensate for any attenuation or phase shift on either the test or reference paths. The result of the calibration is that the test and reference paths look nearly identical (electrically). The advantage is that systematic tracking errors are greatly reduced.
Response & Isolation	The response portion of the calibration is identical to the response calibration explained above. The isolation calibration reduces the effects of crosstalk, which will improve the

Network Analyzer Calibrations

dynamic range of the system. Isolation cal is of great benefit when measuring filters or attenuators. High dynamic range helps assure that low-level signals are not masked by crosstalk responses.

PARAM 1 1-Port

The 1-Port calibration measures three classes of standards to measure directivity, source match, and tracking (frequency magnitude and phase) errors. A 1-Port calibration is only available for Parameter 1. However, you can redefine Parameter 1 to ratio any two inputs you desire.

Calibration Overview

In a typical application:

- Set up your system for the measurement you want to make.
- Select the type of cal you want to perform, Response, Response & Isolation, or PARAM 1 1-Port.
- Connect the first calibration standard and press the softkey for that standard. Repeat this step for each required standard.
- Save the calibration in any of eight calibration set memories.
- Make actual measurements

The following diagram shows a typical operating sequence used when the device under test is measured using more than one set of stimulus conditions (frequency range, number of points, source power).

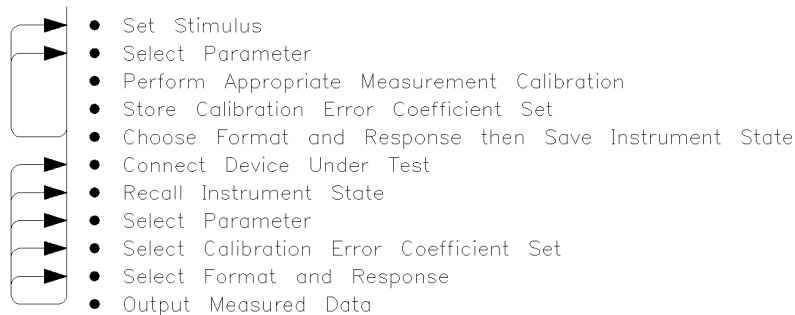

Response Calibration

A Response calibration measures and compensates for amplitude and phase differences between the test and reference paths (tracking errors). The comparison is done at the exact point in the test setup that the device under test (DUT) is usually connected. In other words, if your DUT is normally connected at the end of a 5 meter cable, then the calibration standard should be placed on the end of that cable during the calibration.

The basic purpose of the cal is to compensate for any attenuation or phase shift on either the test or reference paths. The result of the calibration is that the test and reference paths look nearly identical (electrically). The advantage is that systematic tracking errors are greatly reduced.

A Response calibration requires a single standard class to measure the selected reference path's frequency response (amplitude and phase). To perform a calibration for reflection measurements, you can use an open or a short. For transmission calibration use a "thru" (a short cable). Refer to Figure 5-4.

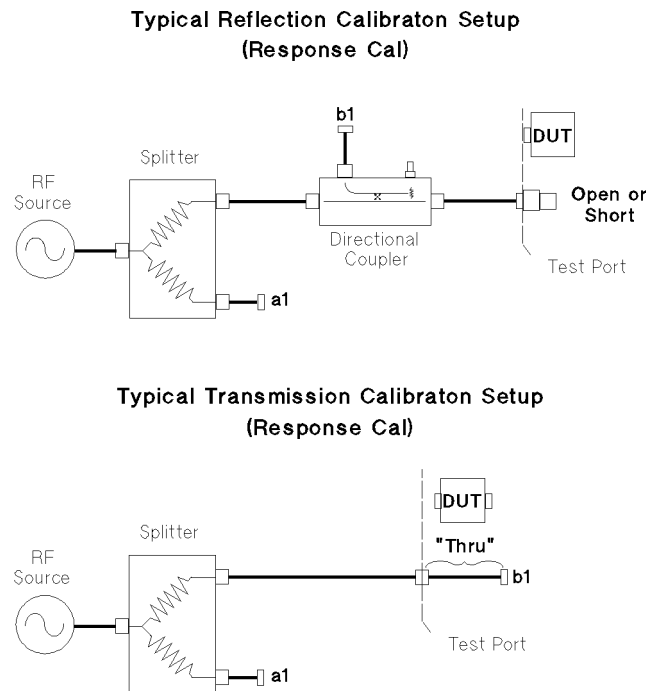

Figure 5-4. Calibration Setup for Response Cal

When **DONE** is selected, the receiver calculates error coefficients. The coefficients modify normal measurement data so any amplitude and phase differences between test and reference paths are minimized.

Both basic and service parameters can use this calibration method.

Response and Isolation Calibration

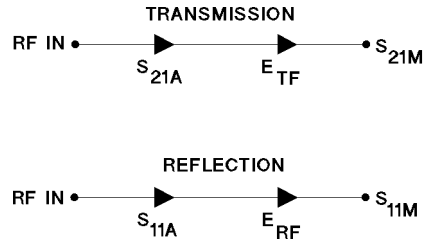

Figure 5-5. Transmission and Reflection Response Error Models

Response Calibration Procedure

1. Press **DOMAIN** **FREQUENCY**.
2. Select the desired Parameter and Stimulus settings.
3. Press **CAL** **NETWK CAL** **CALIBRATE: RESPONSE**.
4. At the test port (see Figure 5-4):
 - a. If calibrating for reflection measurements, connect an open or a short to the test port.
 - b. If calibrating for transmission measurements, connect a length of transmission line (a “thru”) between the test port and the b1 input.
5. Torque the connection, or connections, as specified in Table 5-1.

Important If the standard labels (shown on the display) includes an M (male), or an F (female), *choose the sex that applies to the test port connector*. This only occurs when you are using sexed test port connectors such as type-N.

For example: Assume the test port has a female type-N connector. You should choose the **OPEN (F)** or **SHORT (F)** softkey. *The sex shown on the softkey menu refers to the sex of the test port, not to the sex of the calibration standard.*

6. Press **SHORT**, **OPEN**, or **THRU**, depending on the type of standard you have connected.

While the standard is being measured, the message: **WAIT-MEASURING CAL STANDARD** appears. *Do not press any front panel key while this message is displayed unless it is your intent to stop the calibration process.* When the standard has been measured, the standard name will be underlined.

You only need to measure one standard for a Response calibration.

7. Press **DONE RESPONSE**. The Cal Set Save menu will now appear.
8. Press any of the eight cal set register softkeys to save the cal set.

If the calibration memory register has an asterisk (*) next to it there is already a calibration stored in it. If you select that register anyway, the old calibration set will be deleted and replaced by the new one. If internal storage is already full, a calibration set must be deleted using **DELETE CAL SET** before calibration can proceed. Selecting a calibration set to receive error coefficient data automatically replaces the old data with the new data.

Error Correction Now Goes ON

The receiver will now turn calibration ON automatically. You can now make calibrated measurements.

Response and Isolation Calibration

A Response calibration reduces tracking errors. Tracking errors are phase and magnitude systematic differences in the test and reference paths. This subject is discussed in more detail in Response Calibration, earlier in this section. The response portion of this calibration will greatly reduce measurement errors caused by tracking differences.

The isolation calibration reduces the effects of crosstalk, which will improve the dynamic range of the system. Isolation cal is of great benefit when measuring filters or attenuators. High dynamic range helps assure that low-level signals are not masked by crosstalk responses.

The response and isolation calibration requires two standard classes. The calibration standards you need for the response calibration depends on whether you are making a reflection or transmission measurement.

Response Calibration

For reflection calibration you need to use an open or a short. For transmission calibration use a “thru” (a short cable). Refer to Figure 5-4.

Isolation Calibration

Isolation calibration requires the use of one or two loads. Refer to Figure 5-6. If you are calibrating for reflection measurements, place a single load as shown. If you are calibrating for transmission measurements, place two loads as shown in Figure 5-6

**Typical Reflection Calibration Setup
(Isolation Cal)**

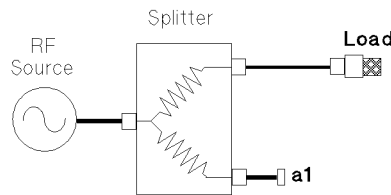

**Typical Transmission Calibration Setup
(Isolation Cal)**

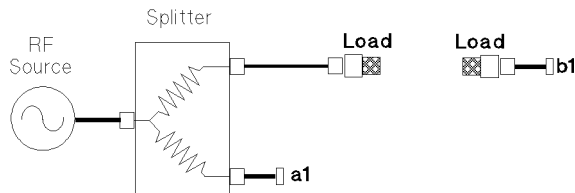

Figure 5-6. Calibration Setup for Isolation Cal

Figure 5-7 shows the error model for transmission/reflection response and isolation errors.

Response and Isolation Calibration

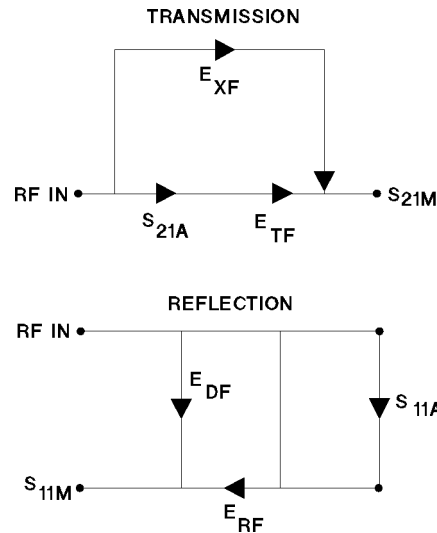

Figure 5-7.
Transmission/Reflection Response and Isolation Error Model

Response & Isolation Procedure

1. Press **DOMAIN** **FREQUENCY**.
2. Select the desired Parameter and Stimulus settings.
3. Press **CAL** **NETWK CAL** **CALIBRATE: RESPONSE & ISOL'N**.
4. Press **RESPONSE**.
5. At the test port (see Figure 5-4):
 - a. If calibrating for reflection measurements, connect an open or a short to the test port.
 - b. If calibrating for transmission measurements, connect a length of transmission line (a “thru”) between the test port and the b1 input.
6. Torque the connection, or connections, as specified in Table 5-1.

Important If the standard labels (shown on the display) includes an M (male), or an F (female), *choose the sex that applies to the test port connector*. This only occurs when you are using sexed test port connectors such as type-N.

For example: Assume the test port has a female type-N connector. You should choose the **OPEN (F)** or **SHORT (F)** softkey. *The sex shown on the softkey menu refers to the sex of the test port, not to the sex of the calibration standard.*

7. Press **SHORT**, **OPEN**, or **THRU**, depending on the type of standard you have connected.

While the standard is being measured, the message: **WAIT-MEASURING CAL STANDARD** appears. *Do not press any front panel key while this message is displayed unless it is your intent to stop the calibration process.* When the standard has been measured, the standard name will be underlined.

You only need to measure one standard for a Response calibration.

8. Press **DONE RESPONSE**.

Response and Isolation Calibration

9. At the test port (see Figure 5-6):
 - a. If calibrating for reflection measurements, connect a load to the test port.
 - b. If calibrating for transmission measurements, connect loads to both the test port and to the b1 input.
10. Torque the connection, or connections, as specified in Table 5-1.
11. Press **ISOL 'N STD**.
12. After **WAIT-MEASURING CAL STANDARD** is no longer displayed, press **SAVE RESP&ISOL**.
The Cal Set Save menu will now appear.
13. Press any of the eight cal set register softkeys to save the cal set.

If the calibration memory register has an asterisk (*) next to it there is already a calibration stored in it. If you select that register anyway, the old calibration set will be deleted and replaced by the new one. If internal storage is already full, a calibration set must be deleted using **DELETE CAL SET** before calibration can proceed. Selecting a calibration set to receive error coefficient data automatically replaces the old data with the new data.

Error Correction Now Goes ON

The receiver will now turn calibration ON automatically. You can now make calibrated measurements.

1-Port Calibration

1-Port Calibration

This calibration error model provides the best accuracy for measurement of a 1-port device, providing full vector error correction for directivity, source match, and reflection signal path frequency response. The procedure uses three standards, usually a shielded open circuit, a short circuit, and a load. Refer to Figure 5-8.

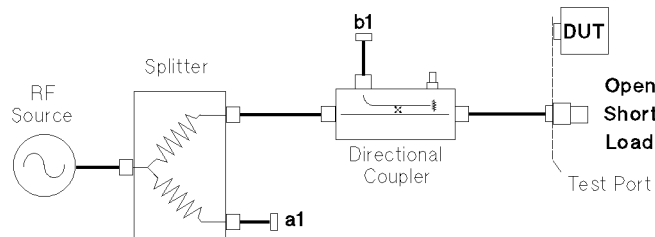

Figure 5-8. Calibration Setup for 1 Port Cal

During the 1-Port calibration, all standards are connected at the test port (the point at which the DUT will be connected during normal measurements). 1-Port calibrations are only available with PARAM 1. However, you can redefine PARAM 1 to ratio any two inputs you desire.

Figure 5-9 shows the error model for transmission/reflection response and isolation errors.

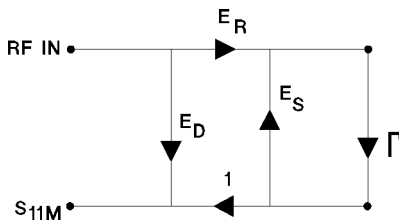

Figure 5-9. 1-Port Error Model

Standards Required for a 1-Port Calibration

The 1-Port calibration sequence requires a minimum of three standards, an open, a short, and at least one standard from the Loads menu.

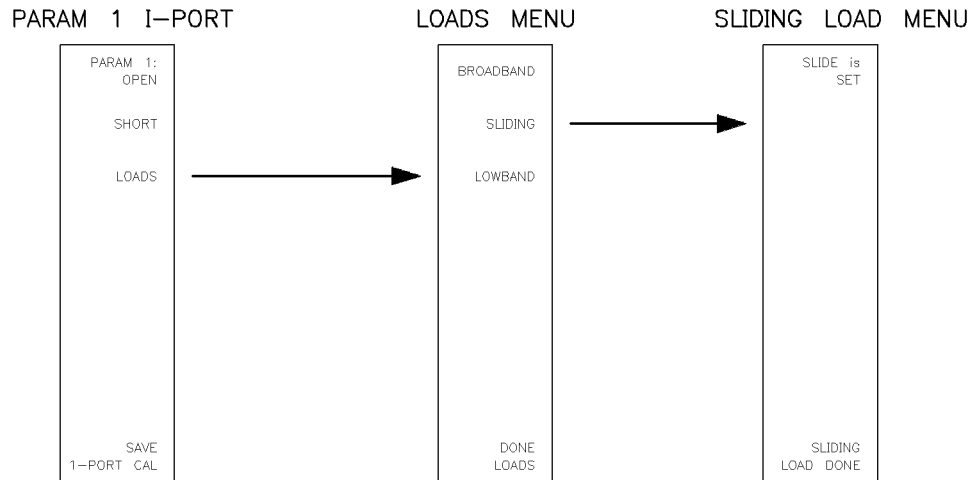

Figure 5-10. 1-Port Cal Menu

For some calibration kits, the standards on the Loads menu are specified as to the frequency range they cover:

- LOWBAND** lowband loads are used for low microwave frequencies, usually up to 2 or 3 GHz.
- BROADBAND** broadband loads are used over the full frequency range of the system.
- SLIDING** sliding loads are used for high microwave frequencies, usually starting at 2 or 3 GHz.

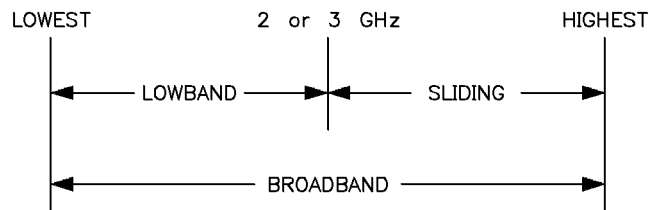

Figure 5-11. LOADS Frequency Ranges

Performing a 1-Port Calibration

1. Press **DOMAIN** **FREQUENCY**.
2. Select the desired Stimulus settings.
3. Press **PARAM 1** **CAL** **NETWK CAL** **PARAM 1** **1-PORT**.
4. At the test port (see Figure 5-8), connect a shielded open circuit and torque it properly.

Important If the standard labels (shown on the display) includes an “M” (male), or an “F” (female), *choose the sex that applies to the test port connector*. This only occurs in sexed test port connectors such as type-N.

For example: Assume your test port has a female connector. You should choose the **OPEN (F)** softkey. *The sex shown on the softkey menu refers to the sex of the Test Port, not to the sex of the calibration standard.*

1-Port Calibration

5. Press **PARAM 1: OPEN**. Open circuit data is measured.

While the standard is being measured, the message: **WAIT-MEASURING CAL STANDARD** appears. *Do not press any front panel key while this message is displayed unless it is your intent to stop the measurement process.* When the standard has been measured, the standard name will be underlined.

6. Connect a short to the test port.

7. Press **PARAM 1: SHORT**. Short circuit data is measured.

8. Press **PARAM 1: LOADS** to present the Loads menu. The loads you must use depends on the frequency range of the calibration. The calibration kit will have the appropriate standards for the frequency range covered by the kit. Measure the load, or loads, that apply to your setup:

- a. If required, connect a broadband load to the test port. Press **BROADBAND**.

- b. If required, connect a lowband load to the test port. Press **LOWBAND**.

- c. If required, connect a sliding load, and perform the following:

- i. Move sliding element to the first index mark.

- ii. Press **SLIDE IS SET**.

- iii. In this way measure five to eight *more* index marks, pressing **SLIDE IS SET** each time.

- iv. Press **SLIDING LOAD DONE**.

9. Press **DONE LOADS**. If the message **ADDITIONAL STANDARDS NEEDED** appears, then the loads were not specified for the current frequency range (for example, only the **LOWBAND** load was used for a sweep that crossed 2 GHz).

10. Press **SAVE 1-PORT CAL** then select any of the eight cal set registers.

If the calibration memory register has an asterisk (*) next to it there is already a calibration stored in it. If you select that register anyway, the old calibration set will be deleted and replaced by the new one. If internal storage is already full, a calibration set must be deleted using **DELETE CAL SET** before calibration can proceed. Selecting a calibration set to receive error coefficient data automatically replaces the old data with the new data.

Error Correction Now Goes ON

The receiver will now turn calibration ON automatically. You can now make calibrated measurements.

Supplementary Calibration Subjects

This portion of the calibration section discusses supplemental calibration subjects:

- Storing and Loading Calibration Data (to/from disc)
- Turning On an Existing Cal Set
- Principles and Care of Calibration Standards
- Verifying Calibration Data
- Modifying Network Analyzer Cal Kit Definitions
- Modifying a Network Analyzer Cal Set (error correction data)
- Adjusting Trim Sweep
- Creating a Standard Gain Antenna Definition

Storing and Loading Calibration Data (to/from disc)

Storing the Cal Set to Disc

Calibrations are sensitive to receiver stimulus settings. When you save a calibration to internal memory or to disc, you should also save the current instrument state the same way. If saving to disc, name the instrument state so you will know that it applies to the cal set file. Later, when you want to use that calibration set, you must first activate the instrument state that applies to that cal set.

There are two ways to store cal sets to disc.

- You can store a single cal set to a file.
- You can store all eight cal sets to a single file.

Storing a Single Cal Set to a File

1. Insert a formatted disk, label side facing the CRT.
2. Press **(DISC) STORE CAL SET 1-8**, then select the cal set register (1 through 8) that you want to store to disk.
3. Use the “label maker” menu that appears to enter a name for the file. The file name prefix (CS_) is already entered. Use the knob and **SELECT LETTER** softkey to enter the desired file name. You can enter up to seven characters. Press **STORE FILE**.

Replacing an Existing File

If you want to replace an existing file, do not use the label maker feature. Instead, press **REPLACE MENU**, a directory of cal set files (on the current disc) will appear. Use the knob to select the file you want to replace, then press **REPLACE FILE**.

Storing and Loading Calibration Data

Storing Multiple Cal Sets to a File

If you have created several cal sets, you can store them all to a single file by performing the following steps:

1. Press **DISC** **STORE CAL SET ALL**.
2. Use the “label maker” menu that appears to enter a name for the file. The file name prefix (CAL_) is already supplied. Use the knob and **SELECT LETTER** softkey to enter the desired file name. Press **STORE FILE**.

If you want to replace an existing file, do not use the label maker features. Instead, press **REPLACE MENU**, a directory of cal set files (on the current disc) will appear. Use the knob to select the file you want to replace, then press **REPLACE FILE**.

Loading Cal Sets from Disc

During normal work sessions you may need to load a cal set from disc and turn calibration ON. Before you turn the calibration ON, remember to load the instrument state you saved for that calibration.

Loading a File Containing a Single Cal Set

1. Load the instrument state that applies to the cal set you want to load.
2. Use **RECALL** to activate the instrument state you just loaded.
3. Press **DISC** **LOAD CAL SET 1-8**.
4. Press the softkey for the register you want the cal set loaded into, (1 through 8).
5. A directory will appear that lists the cal set files on the disc. Use the knob to select the desired cal set and press **LOAD FILE**.
6. Now turn calibration ON by pressing **CAL** **CORRECTION ON**.
The cal set register menu will appear, allowing you to select one of the eight cal sets. Select the one you just loaded.

Loading a File Containing Multiple Cal Sets

If you saved multiple cal sets to disc using the CAL SET ALL feature, you can load the file as follows:

1. Press **DISC** **LOAD CAL SET ALL**.
2. A directory will appear that lists the “multiple cal set files” on the disc. Use the knob to select the desired multiple cal set file and press **LOAD FILE**.
3. Load the instrument state that applies to the cal set you want to use.
4. Use **RECALL** to activate the instrument state you just loaded.
5. Turn calibration ON by pressing **CAL** **CORRECTION ON**, then select the desired cal set from the cal set menu.

Turning ON an Existing Cal Set

CORRECTION OFF and **CORRECTION ON** provide selection of calibrated (ON) or non-calibrated (OFF) vector measurement data. The C display annotation shows that correction is applied to the measurement.

Pressing **CORRECTION ON** brings the Cal Set Selection menu onto the display and the message **SELECT CALIBRATION SET** onto the display. Cal set registers that actually contain cal sets are marked with an asterisk (*). Select a register to recall that calibration set and apply it to the measured data.

Exiting and Resuming a Calibration Procedure

You can leave the cal menu at any time. For example, assume you want more averaging or want to change display scale. To re-enter the calibration process, press **(CAL) RESUME CAL SEQUENCE**. This command resumes the calibration procedure where you left off, and saves any calibration data you have already taken.

Example 1: You are in the middle of a 1-Port calibration, and have already measured two standards. Before you measure the third you press **RESPONSE (MENU)** and activate averaging. In order to return to the calibration properly, press **(CAL) RESUME CAL SEQUENCE**. The calibration will resume at the point you were at previously. The data from the first two standards will be retained. Now go measure the third standard.

Example 2: You are performing an RCS calibration, and have finished the background portion. You now go to the Target Response portion of the cal, and press **GATING YES**. Unfortunately, you have forgotten to turn gating ON in the Domain menu, and an error message appears on the screen. Press **(DOMAIN) SPECIFY GATE GATE ON**, then **(CAL) RESUME CAL SEQUENCE**. Continue with the RCS cal.

Limitations

Do not change any settings that affect the calibration (such as stimulus settings) in the middle of a calibration. Doing so would invalidate the data for the standards you measured previously.

If you leave the Cal menu structure by pressing a function which displays another menu, press **(CAL) RESUME CAL SEQUENCE**. The last cal menu for which data is available will be displayed.

Proper Connector Torque

Before performing a calibration, or regular measurements, it is important that all system connections be torqued to specifications (refer to Table 5-3). If system connections are not properly torqued, the calibration or measurement you make may be inaccurate.

Table 5-3. Proper Connector Torque

Connector	Torque cm-kg	Torque N-cm	Torque in-lbs	Wrench Part Number
Type-N	52	508	45	8710-1935
3.5 mm	9.2	90	8	8720-1765
SMA	5.7	56	5	8710-1582
2.4 mm	9.2	90	8	8720-1765

Principles and Care of Calibration Standards

This section explains the special care required by network analyzer calibration standards, principles behind their use, and common problems associated with them.

Calibration Standards Require Careful Handling

For best accuracy and repeatability, use great care in handling and storing the cal standards. Their performance and accuracy depend on very precise mechanical tolerances, sometimes on the order of a few ten thousandths of an inch. Therefore, cal standards must be handled and stored more carefully than ordinary devices.

Proper Inspection, Cleaning, and Connection

Inspect and clean the connectors using the methods recommended in the calibration kit manuals. Before using cal standards, gage the test port connectors, standards, cables, and the test device to verify that the mating plane dimensions of all connectors are within the allowable tolerances. To minimize repeatability errors, use an appropriate torque wrench when tightening connections. Cal Kit manuals supply detailed information on cal standards, and explain proper techniques for using them.

Principles of Operation

Network analyzer accuracy-enhancement is accomplished by measuring known cal standards. The measured response is compared to the predicted response, then error terms are derived from the magnitude and phase difference between the measured response and the predicted response. The predicted response is determined by using a complex mathematical model which predicts the magnitude and phase response of the cal standard over its entire frequency range. Thus, the accuracy improvement which can be expected is directly related to how well the models predict the response of the standard. The model for each standard is specified in a data file on the disc supplied with the calibration kits.

Examples of “perfect” standards are shown in the assumptions made for the fixed and sliding loads used in reflection calibration. The device impedance is assumed to be exactly the system characteristic impedance, Z_0 , usually 50 ohms.

Quality of the Standards Affects Accuracy

The quality of the load used for calibration determines the effective directivity for reflection measurements. A high quality fixed load exhibits the lowest repeatable return loss. The quality of the sliding load is determined by the return loss of:

- The connector.
- The transmission line between the connector and the sliding element.

Standard Models Differ Depending on Connector Type

Standard models differ according to connector type. For example, the short circuit in the Hewlett-Packard 7 mm calibration kit is modeled as a perfect zero ohm termination, having a reflection coefficient of $1\angle\pm 180^\circ$ positioned at the reference plane. The short circuit in the Hewlett-Packard 3.5-mm calibration kit is modeled as a perfect short displaced about 1 cm from the reference plane.

Specifications for the shielded open circuits add a reactive phase shift to the modeled response characteristic. In order to model the typical non-linear phase shift, the shielded open circuit is assumed to exhibit a phase shift with frequency that can be approximated using the equation

Modifying Network Analyzer Cal Kit Definitions

$$C_{\text{total}} = C_0 + C_1 * F + C_2 * F^2 + C_3 * F^3$$

Where C_0 is the DC capacitance, $C_1 * F$ is the capacitance times frequency, $C_2 * F^2$ is the capacitance times frequency squared, and $C_3 * F^3$ is the capacitance times frequency cubed. The shielded open circuits in the 3.5 mm calibration kit use a center pin extender, so the models for these devices also include a linear phase shift component to account for the offset from the reference plane.

Specifications, Modifying a Cal Kit

The specifications contained on the calibration kit data file are nominal values based on typical expected responses of the standards. If you wish to substitute your own standards, or change the models for the standards supplied in the calibration kit, you may use the `MODIFY CAL KIT` sequence.

Common Problems

Common calibration problems which can be traced to standards are:

- Non-repeatable contact due to wear, dirt, grease, or other contaminants on the contacting surfaces or other accessible parts of the standard. Assure that the standard is properly cleaned. Make sure the connector is dry.
- Connector damage due to connecting the standard to a connector with mechanical defects or out-of-spec tolerances. Use the connector gage on both the test port and the standard prior to measurement calibration.
- Poor contact due to improper alignment or torquing practice. Use the correct connection technique and the proper torque wrench for each connection.
- Using cal standards whose response does not match the constants in HP 8530 Cal Kit memory. Load the proper cal kit data file for the cal kit you are using.

Verifying Calibration Data

Immediately following calibration, and at intervals during the measurement process, it is recommended that you measure a standard device with known responses. This is to verify that the system characteristics have not changed thus making the current calibration error coefficients invalid. Measuring a device from the calibration kit used for measurement calibration will allow you to determine that the system is making repeatable measurements. The measured response of a calibration standard will be exactly the modeled response if the connection is repeatable.

To determine measurement accuracy, however, it is necessary to measure an independent standard with known responses, such as the attenuators or air lines in the HP 8510 verification kit, or a standard you produce that is representative of the devices you are testing. If standards-quality data for the device is available, it can be compared with your measurement results to determine accuracy. If the data is outside acceptable limits and good technique was used during the calibration, then the system characteristics have changed, thus making the current calibration error coefficients invalid. Standards-quality measurement data is supplied with the HP verification devices.

Modifying Network Analyzer Calibration Kit Definitions

The Modify Cal Kit menu structure allows you to create or change the mathematical model and label for each calibration standard and to specify how the standards are used in the calibration process. The following paragraphs provide an overview of the sequence used to modify a calibration kit definition. Detailed descriptions of each part of the calibration kit definition is included in the *HP 8530 Keyword Dictionary*. The calibration kit definition for each calibration kit is provided as a Cal Kit data file on the disc supplied with each calibration kit, and it is listed in the Standard Definitions and Standard Class Assignments tables in the calibration kit manual.

You may explore the Modify Cal Kit menus without actually changing any part of the definition stored in 8530 memory. Each time **NETWK CAL 1** or **MODIFY 1 NETWK KIT** is pressed, the selected calibration kit definition is loaded from non-volatile memory to active memory. Definitions and assignments that are not actually changed remain the same. The kit definition is not re-stored into non-volatile memory until **KIT DONE (MODIFIED)** is pressed, so if you are simply examining the contents, exit the menu structure by pressing **(CAL)**, then **NETWK CAL**, *do not* press **KIT DONE (MODIFIED)**.

Before entering the Modify Cal Kit menu structure, make certain that you have a copy of the calibration kit definition you are about to modify. If necessary, copy the calibration kit definition to disc by using the **(DISC) STORE CAL KITS NETWORK CAL KIT** operation in the disc menu.

Now locate the calibration kit documentation tables found in the calibration kit manuals and use them as worksheets to specify the characteristics of each standard, the label for the standard, assign each standard to one or more classes, to specify the label for each class, and finally to specify the new label for the modified calibration kit.

To modify the calibration kit definition:

1. Press **(CAL) MORE MODIFY CAL SET**.
2. Press **SELECT STANDARD**, then select the device definition to be modified by entering a Standard Number (a numeric between 1 and 22). Now press **(x1)**.
The Standard Type menu is displayed with the current standard type underlined. Press the appropriate standard type key,
3. Enter the appropriate characteristics of the standard using the Standard Definitions and the Specify Offset menus.
4. Label the standard using **LABEL STD** key and the Title menu. This label will appear on the cal Standard Selection menu during the calibration procedure.
5. Repeat this sequence for each new or modified standard in the calibration kit. Standard definitions not changed during this process are included in the modified calibration kit with their pre-existing values.
6. Press **SPECIFY CLASS**, then use the Specify Class menus to assign appropriate standards to each of the classes required for the calibration type. When you select a class, the current standard numbers assigned to that class are listed in the title area. Enter one, or a sequence of, standard number followed by **(x1)** for each standard to be used in the class, then press **CLASS DONE (SPEC'D)**.
7. Now press **LABEL CLASS** and name each new or changed standard class. This label will appear on the appropriate cal menus when there is more than one standard assigned to the class.

Modifying Network Analyzer Cal Kit Definitions

8. Repeat this procedure for each of the Standard Classes required for the calibration procedure.
9. Next, press **LABEL KIT** and name the modified calibration kit. This name will appear in the Cal menu, under the softkey label **NETWK CAL**.
10. Finally, press **KIT DONE (MODIFIED)** to store the new kit in place of the current kit.

The last character in the calibration kit label is replaced with * when that kit definition has been modified. This is why you must give the modified kit your a new label.

Modifying a Network Analyzer Cal Set

You can modify a calibration set in the following ways:

- Reduce the number of points measured after a calibration set has been created.
- Create a new set by zooming in on a frequency subset of the original calibration set frequency range.

Reduce Number of Points After Calibration

This type of modification allows the number of points to be reduced without affecting the calibration or the endpoints of the current frequency range. Thus, after a calibration using 801 points, either 401, 201, 101, or 51 points can be selected. This is accomplished by skipping over alternate frequency points. For example, when the number of points is reduced from 801 to 51, only every other point is measured.

Effects in Step Sweep Mode

This feature is designed for use in step sweep applications where you want to calibrate using the maximum number of points, but perform portions of the test using less frequency resolution. In these instances test time can be reduced by selecting fewer number of points, resulting in a shorter time for the frequency sweep.

In the example shown in Figure 5-12, measurement calibration is performed using step sweep and 801 points, then the number of points is reduced to 51. The time required to update the trace is decreased by a factor of about 16. When necessary, the original number of points can be selected by either changing the **NUMBER OF POINTS** selection, or, by recalling the original calibration set.

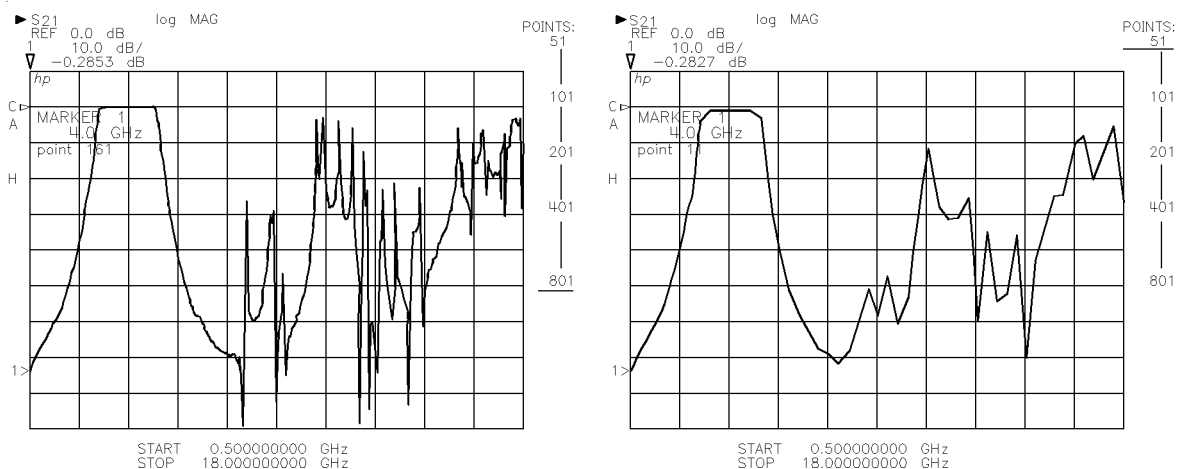

Figure 5-12. Reduced Number of Points After Calibration

If a number of points greater than the original calibration is selected, a caution message is displayed and correction is turned off.

Effects in Ramp Sweep Mode

The number of points can also be reduced after calibration in the ramp sweep mode. However, in order for the data to remain valid, the sweep time cannot change. This limits the usefulness of this feature for ramp sweeps.

Modifying a Network Analyzer Cal Set

After Factory Preset, the receiver automatically selects a faster sweep for 51 points than for 801 points. If the receiver's sweep time is changed after calibration, a caution is displayed in order to alert the user to examine the resulting data carefully. The dynamics of the measurement process change and the accuracy of the data may be affected. For best results press **STIMULUS** **(MENU)** then **SWEEP TIME** and set the sweep time to 200 ms (milliseconds) prior to measurement calibration. Now the sweep time will remain constant regardless of the **NUMBER OF POINTS** selection.

Defining a Frequency Subset

After calibration in either ramp, step, or frequency list sweep mode, a subset of the current frequency range can be selected by choosing new **START/STOP** or **CENTER/SPAN** frequencies and a new calibration set. This provides a very useful "frequency zoom" function by allowing the user to select any subset of the current frequency sweep. This results in faster sweeps because fewer points are measured. The frequency subset menu is shown in Figure 5-13.

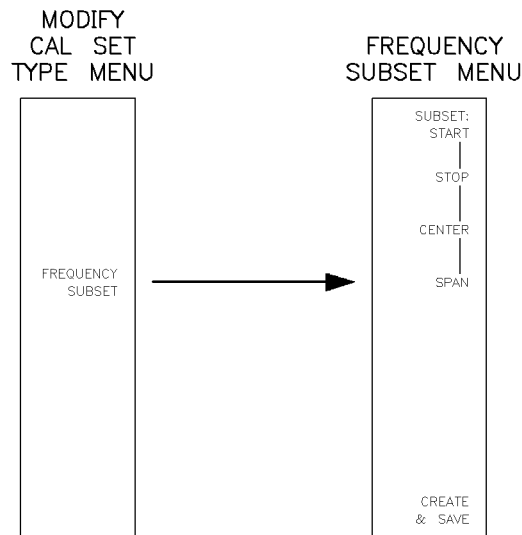

Figure 5-13. Modify Cal Set, Frequency Subset Menu

Create and Save the Frequency Subset

To define a frequency subset:

1. Turn correction ON.
2. Press:

(CAL) **MORE**
MODIFY CAL SET
FREQUENCY SUBSET

As shown in Figure 5-14, markers appear on the trace to show you the current **START/STOP** or **CENTER/SPAN** of the frequency subset.

3. Position these markers by pressing the **SUBSET: START**, **SUBSET: STOP**, **SUBSET: CENTER** or **SUBSET: SPAN** softkeys and using the knob, step keys, or numeric entry keypad.
4. Now press **CREATE & SAVE**, then select a new calibration set. If you choose a register that holds an existing cal set, the new cal set will overwrite the one currently in that register.

Modifying a Network Analyzer Cal Set

The appropriate error coefficients from the existing calibration set are transferred to the new calibration set, a frequency list is created and stored, the frequency list sweep mode is selected, and corrected data for the subset is displayed.

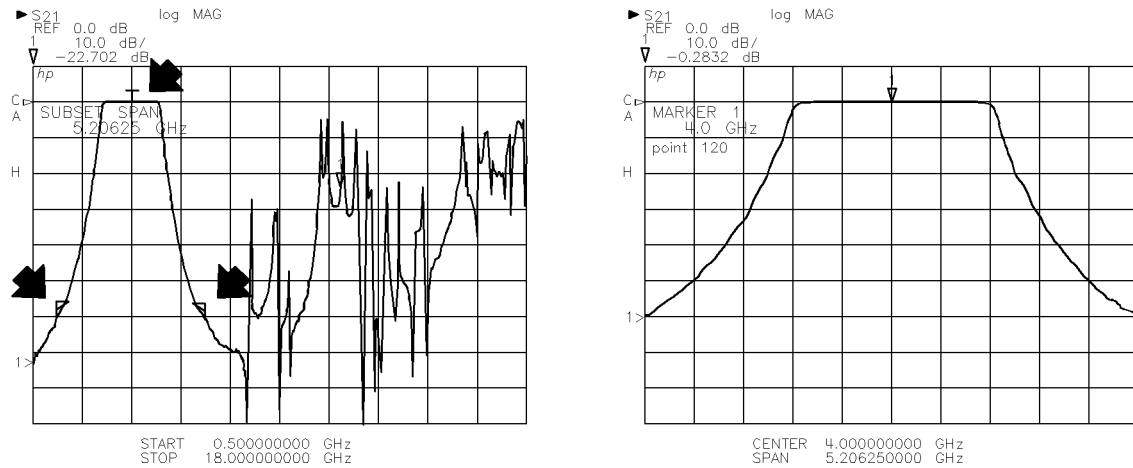

Figure 5-14. Defining a Frequency Subset

Note that the frequencies in the subset may be examined by selecting **STIMULUS (MENU), MORE, EDIT LIST**. If this list is edited, correction is turned Off. To return to the original frequency sweep, recall the original calibration set. To select the frequency subset sweep, recall the new calibration set.

Effects in Ramp Sweep Mode. A frequency subset created from a ramp sweep may be less accurate than the original ramp sweep because the original calibration took place in ramp sweep while the new frequency subset is measured in the frequency list sweep mode. Since the ramp sweep is not phaselocked at each frequency point, the slight potential frequency difference at each point between the ramp and frequency list sweeps may cause the displayed data to change.

To reduce this effect, prior to calibration in the ramp sweep mode, set the sweep time to 200 ms or greater, and perform the trim sweep (HP 8350-series and 8340-series sources only) adjustment. The trim sweep adjustment, along with the slower sweep time minimizes the frequency difference at each point and improve accuracy of the data. For HP 8360-series sources put the receiver in the **SYSTEM BUS 'LOCAL'** mode and press the source front-panel keys **(USER CAL) FullUser Cal** (use the Front-Panel Emulator Program for those sources with no front-panel keys).

Adjusting Trim Sweep

The Trim Sweep Adjustment procedure applies to HP 8340, and only to measurements made in the Ramp sweep mode. Trim Sweep adjusts the end frequency at band switch points. It minimizes the frequency difference between the end frequency of one band and the start frequency of the next band.

Trim Sweep is considered a part of the measurement calibration process because it provides most improvement when it is accomplished for each particular frequency range. The **TRIM SWEEP** setting is saved as part of the instrument state when you press **(SAVE) INSTRUMENT STATE n**, and as part of the limited instrument state saved when you save a calibration set. It is set to zero by **FACTORY PRESET**.

Trim Sweep Procedure

To adjust trim sweep, your HP 8530A system must be setup to make an actual ratioed measurement. The setup can be an antenna measurement, RCS, or a network analyzer-type setup. The specific type of setup is not important, as long as it is a ratioed measurement (two inputs are in use), and you can see an actual measurement trace on the screen. For example, you could use a standard antenna measurement setup. If the HP 8530A is not currently in a system, place a splitter on the output of the RF source, and inject the two signals into the frequency downconverter.

NOTE: In an RCS system you should place a reflector in the target zone.

1. Press **(RECALL) MORE FACTORY PRESET**.
2. Select the PARAM key that is appropriate for the inputs you are using (**(PARAM 1)** for b1/a1, for example).
3. Set the START/STOP or CENTER/SPAN controls to sweep the frequency range of interest.
4. Select STIMULUS **(MENU) STEP**. When the sweep is complete, press **DISPLAY DATA → MEMORY MATH (/)**. When the next sweep is complete, the trace should be a flat line at zero degrees.
5. Press STIMULUS **(MENU) RAMP**. The displayed trace may exhibit a sharp phase transition at the band switch points. Sharp transitions indicate the need to adjust **TRIM SWEEP**.
6. Press **(CAL) MORE TRIM SWEEP**. Then use the knob to adjust the phase trace for minimum phase change at the band switch points. When the best (flattest) phase trace is achieved, press **(SAVE) INSTRUMENT STATE n** to save this setting. Now proceed with the appropriate measurement calibration.

Creating a Standard Gain Antenna Definition

Introduction

If you use different standard gain antennas than those already defined, you must create a “cal definition.” To do this, you must:

- Create an ASCII text file on a computer.
- Save the file to disc
- Load the file into the HP 8530A.

This section explains how to create your own definitions.

Important Terms

Cal Definition	A cal definition is an ASCII file you create using a text editor. It contains theoretical or measured frequency and gain values for one or more standard gain antennas. You can create the file using any computer-based text editor which can save text in plain ASCII format (which can save the file to an MS DOS® or HP LIF disc). The file can then be loaded into the receiver from the disc. The cal definition file can contain up to seven “antenna definitions.”
Antenna Definition	The gain data for a specific standard gain antenna is called an “antenna definition.” As mentioned above, a <i>cal definition</i> contains up to seven antenna definitions.

The Supplied Cal Definition

The HP 8530A is *not* shipped with a cal definition in memory. However, a pre-defined cal definition (AC_NAR1) is supplied on the Antenna RCS/Cal Disc, which was shipped with the receiver. You can load AC_NAR1, or a cal definition you create, by following the instructions in “Loading the Cal Definition into the HP 8530A”. Details on AC_NAR1 are provided at the end of this section.

Required Hardware

A cal definition is a simple ASCII text file. You can create a cal definition using:

- Any computer that can save ASCII files to MS-DOS compatible discs.
- Any computer that can save ASCII files to discs formatted in Hewlett-Packard Logical Interchange Format (LIF).

You **MUST** use a text editor that can save plain ASCII files!

Creating an Antenna Definition

A cal definition is composed of up to seven individual antenna definitions. Each antenna definition applies to a specific standard gain antenna. Use the following instructions to create an antenna definition.

Choosing the Number of Frequency Points to Define

If the performance of the standard gain antenna is linear, you only need to define a few frequency points across the frequency band. Most standard gain antennas are not very linear, so a greater number of frequency points are recommended. You can define up to 201 frequency points.

Covering a Wide Frequency Range

You can define antenna definitions for up to seven standard gain antennas. This provides continuous coverage over a wide frequency range. The calibration feature allows you to measure up to seven antenna definitions for a single calibration.

Determine Required Stimulus Values

Determine the exact frequencies you want to use in the antenna definition. Hewlett-Packard recommends that you choose frequencies that cover the entire range of your standard gain antenna, even if you only make measurements at single frequencies.

- Start frequency of your standard.
- Stop frequency of your standard.
- Difference between frequency points (the frequency increment).
- Number of frequency points.

The start and stop frequencies you already know from the published data.

Choosing the Number of Points

The more points you use the more accurate the calibration will be. The limiting factor is usually the published data for the standard antenna. The accuracy and resolution of the standard gain antenna graphs or tables will be the limiting factor in calibration accuracy.

Determining the Frequency Increment

To determine the frequency increment, divide the *frequency span* by the (*number of points* - 1).

For example:

- Start frequency = 2 GHz
- Stop frequency = 4 GHz

The frequency span is 2 GHz

Creating a Standard Gain Antenna Cal Definition

Assume the standard gain antenna's graph or table provides 21 decipherable data values across the 2 GHz frequency span:

Divide the frequency span by *number of points - 1*:

$$2 \times 10^9 / (21 - 1) = 100 \text{ MHz}$$

The first frequency in your antenna definition is the start frequency (2 GHz in this example). From there, 20 *additional* points exist, each spaced 100 MHz apart. The first three frequencies would be:

- 2,000,000,000 Hz
- 2,100,000,000 Hz
- 2,200,000,000 Hz

The last frequency point would be the stop frequency.

Determining Gain Values at Each Frequency Increment (Graph Format)

Next, you must determine the gain values at each frequency increment. Figure 5-15 shows a typical graph-style data sheet for a standard gain antenna.

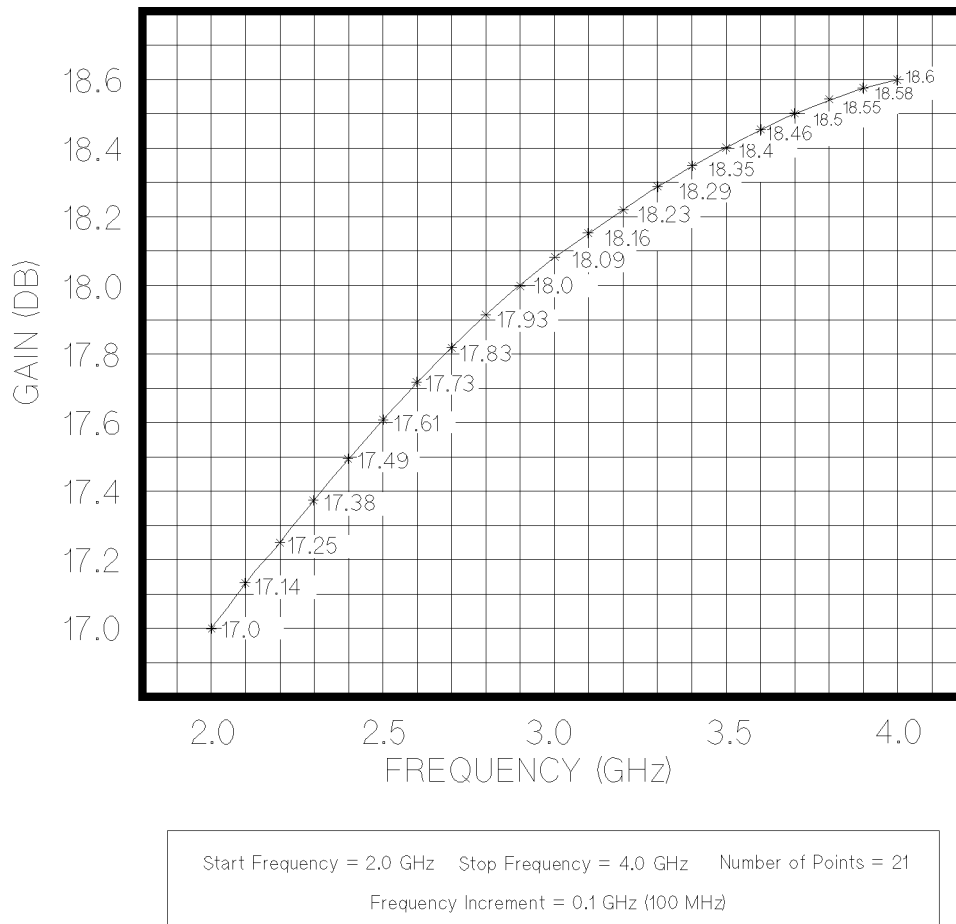

Figure 5-15. Typical Standard Gain Antenna Performance Graph

1. Choose the start and stop frequencies. Examples shown in Figure 5-15 are 2 and 4 GHz, respectively.

Creating a Standard Gain Antenna Cal Definition

2. Mark the graph at each frequency increment. In the example graph an increment frequency of 100 MHz is used. You **MUST** use evenly-spaced frequency points, “Even Frequency Increments” explains why.
3. On the graph for *your* standard antenna, determine the gain at each frequency increment. Figure 5-15 shows example gain values for 21 frequencies spaced 100 MHz apart.
4. Write down each gain value in ascending order corresponding to the frequencies they represent.

If Using Data in Table Format

Table 5-4 shows an example performance specification table:

Table 5-4. Example Standard Gain Antenna Performance Table

FREQ. (GHz)	GAIN dB	FREQ. (GHz)	GAIN dB	FREQ. (GHz)	GAIN dB
12.4	13.82	14.3	15.02	16.2	16.21
12.5	13.88	14.4	15.08	16.3	16.28
12.6	13.95	14.5	15.14	16.4	16.34
12.7	14.01	14.6	15.20	16.5	16.41
12.8	14.07	14.7	15.26	16.6	16.46
12.9	14.14	14.8	15.33	16.7	16.52
13.0	14.21	14.9	15.39	16.8	16.59
13.1	14.27	15.0	15.45	16.9	16.65
13.2	14.33	15.1	15.52	17.0	16.71
13.3	14.40	15.2	15.58	17.1	16.76
13.4	14.46	15.3	15.65	17.2	16.81
13.5	14.52	15.4	15.71	17.3	16.87
13.6	14.58	15.5	15.77	17.4	16.93
13.7	14.65	15.6	15.83	17.5	16.99
13.8	14.71	15.7	15.89	17.6	17.05
13.9	14.77	15.8	15.95	17.7	17.11
14.0	14.84	15.9	16.02	17.8	17.18
14.1	14.90	16.0	16.09	17.9	17.24
14.2	14.96	16.1	16.15	18.0	17.30

The example graph has 57 evenly spaced frequency points that are 100 MHz apart. You will simply enter these gain values into the ASCII data file. You **MUST** use evenly-spaced frequency points, “Even Frequency Increments” explains why.

Even Frequency Increments

The frequency increments in the antenna definition must be evenly spaced. If you look at the example on the next page you will see why: The lines between BEGIN and END hold the gain values. Notice that these lines do *NOT* specify the frequency of each gain value. Because of this, the calibration feature must calculate the actual frequencies given the defined start frequency, stop frequency and number of points. For this reason the antenna definition gain values must represent evenly spaced frequency values.

When you perform the actual calibration you can choose any frequency points you wish. A *calibration* can be performed at any frequencies you choose. The frequencies used in the cal do *not* have to be the same as the frequencies in the antenna definition. (When calibrating, the

Creating a Standard Gain Antenna Cal Definition

receiver will interpolate between frequency points in the definition.) Remember, however, that a *calibration* must contain *all* the frequencies required by your measurements. When *making measurements*, the receiver *does not* interpolate between *calibration points*.

Required ASCII File Format

The ASCII file must follow the CITIfile format supported by the HP 8530A. Figure 5-16 shows an example file for the data in Figure 5-15. At first the file looks complicated. However only the items pointed out in Figure 5-16 are variable. To save time, start by editing an existing calibration definition file. One is supplied on the Antenna RCS/Cal Disc, which was supplied with the receiver. The file name of the file is AC_NAR1.

The cal definition shown in Figure 5-16 contains only one antenna definition. A cal definition with *two* antenna definitions is shown in “Creating a Cal Definition with Multiple Antenna Definitions”, later in this chapter.

```
CITIFILE A.01.01
#NA VERSION HP8530A.01.00
NAME ANTENNA_DEF
#NA DEF_LABEL 'uWaveA.1' ← Defines the antenna calibration softkey label.
#NA STANDARD 1 ← This is cal definition #1 (of seven possible).
#NA STANDARD_LABEL 'SASGH-1.10' ← Defines softkey label for this definition.
VAR FREQ MAG 21 ← Enter Number of Points here.
DATA GAIN[1] DB ← Enter Start stimulus value.
SEG_LIST_BEGIN ← Enter Stop stimulus value.
SEG 2000000000 4000000000 21 ← Enter Number of Points (again).
SEG_LIST_END
BEGIN
1.70E1
1.714E1
1.725E1
1.738E1
1.749E1
1.761E1
1.773E1
1.783E1
1.793E1
1.80E1
1.809E1
1.816E1
1.823E1
1.829E1
1.835E1
1.84E1
1.846E1
1.85E1
1.855E1
1.858E1
1.86E1
END
```

Enter gain values for each stimulus point.
"E1" indicates 10¹.

Figure 5-16. Typical Standard Gain Antenna Performance Graph

In-Depth Description of a Cal Definition

The example below is of a cal definition that contains one antenna definition. The top four lines are the header for the entire file. These lines must only occur once, at the top of the file.

```
CITIFILE A.01.01
#NA VERSION HP8530A.01.00
#NAME ANTENNA_DEF
```

These three lines should be included exactly as shown. The firmware revision on line 2 “HP8530A.01.00” does *not* need to be changed if your HP 8530A has a later firmware revision. Keeping line 2 exactly as shown above is acceptable. These lines are part of the file header.

```
#NA DEF_LABEL uWaveA.1
```

This line defines the title for the antenna calibration softkey. You can change the label “uWaveA.1” to any label you want, up to the limit of ten characters. This line is part of the file header.

```
#NA STANDARD 1
```

This line starts defining the antenna definition. When creating several antenna definitions, the number “1” should be incremented (2, 3, and so on) for each successive antenna definition. “Creating a Cal Definition with Multiple Antenna Definitions” shows an example of this.

```
#NA STANDARD_LABEL SASGH-1.10
```

This defines the softkey label for this antenna definition. You can change the label “SASGH-1.10” to any label you want, up to a maximum of ten characters. It is recommended the label be changed to reflect the type and frequency range of the standard gain antenna.

```
VAR FREQ MAG 21
```

Enter the number of frequency points at the end of this line (where the number 21 is located in this example). The rest of this line always stays the same.

```
DATA GAIN [1] DB
```

This line does not affect the antenna definition in any way, but we recommend you leave it in. (Future firmware revisions may require this line.)

```
SEG LIST BEGIN
SEG 2000000000 4000000000 21
SEG LIST END
```

These three lines define the start frequency, stop frequency, and the number of points (again). Frequencies must be expressed in Hertz. Never change the first or third line.

Creating a Standard Gain Antenna Cal Definition

```
BEGIN
1.70E1
1.714E1
1.725E1
.
.
.
1.855E1
1.858E1
1.86E1
END
```

The commands “BEGIN” and “END” must surround the gain values for each frequency. Enter each gain value on a separate line. Gain values must be in ascending order corresponding to the frequencies they represent.

Saving the Cal Definition File

Save the ASCII file to MS DOS or HP LIF disc.

Note The filename must begin with the three characters: AC_ (The two letters AC followed by an underscore character.)

Loading the Cal Definition into the HP 8530A

To load a cal definition file:

1. Insert the disc into the HP 8530A's drive.
2. Press **(DISC) LOAD CAL KITS ANTENNA CAL DEF**, the receiver will display a file directory of all cal definition files on that disk.
3. Use the knob to select the desired cal definition and press **LOAD FILE**.

Press **(CAL)**. Notice that the key **ANT. CAL** contains the name you chose for that cal definition.

Press **ANT. CAL FAR FIELD: RESPONSE**. You will see your antenna definition names next to the softkeys buttons.

Creating a Cal Definition with Multiple Antenna Definitions

You can create up to seven antenna definitions in a single cal definition file. To do this, simply add one antenna definition right after another in the file. Do not repeat lines 1 through 4. Change “STANDARD 1” to “STANDARD 2” in the second antenna definition, to “STANDARD 3” in the third, and so on.

Change the label in the “#NA STANDARD LABEL” line in each antenna definition. Use labels that are appropriate for each standard gain antenna. Do not use underscore _ characters in labels. To avoid problems use keys A through Z, numbers 0 through 9, and dashes (-).

Here is an example of two antenna definitions in one file.

```
CITIFILE A.01.01
#NA VERSION HP8530A.00.26
NAME ANTENNA_DEF
#NA DEF_LABEL uWave A.1
#NA STANDARD 1
#NA STANDARD_LABEL SASGH-1.10
VAR FREQ MAG 10
DATA GAIN[1] DB
SEG_LIST_BEGIN
SEG 1100000000 1700000000 10
SEG_LIST_END
BEGIN
1.63E1
1.64E1
1.65E1
1.66E1
1.67E1
1.68E1
1.685E1
1.69E1
1.7E1
1.71E1
END
#NA STANDARD 2
#NA STANDARD_LABEL SA12-1.70
VAR FREQ MAG 10
DATA GAIN[1] DB
SEG_LIST_BEGIN
SEG 1700000000 2600000000 10
SEG_LIST_END
BEGIN
1.61E1
1.62E1
1.64E1
1.65E1
1.67E1
1.68E1
1.69E1
1.7E1
1.71E1
1.72E1
END
```

When you load this file into the receiver, these two antenna definitions will go into top two Far-Field:Response menu positions.

Creating a Standard Gain Antenna Cal Definition

Details on the Supplied Antenna Definitions

The supplied cal definition contains seven Narda antenna definitions. This cal definition is *not* loaded into receiver memory at the factory. Refer to Table 5-5. Only one cal definition file can be loaded into the receiver at one time.

The Narda cal definition file is supplied on the Antenna/RCS Cal Disc, under the file name: AC_NAR1. The Antenna/RCS Cal Disc is DOS compatible. The file AC_NAR1 has two uses:

- You can load AC_NAR1 into the HP 8530A.
- You can make copies of the file and modify them to create your own definitions.

Table 5-5. Antenna Definitions in the Supplied Cal Definition

Definition Name	Manufacturer	Model Number	Frequency Range
NAR 645	Narda	645	1.70 to 2.60 GHz
NAR 644	Narda	644	2.60 to 3.95 GHz
NAR 643	Narda	643	3.95 to 5.85 GHz
NAR 642	Narda	642	5.40 to 8.20 GHz
NAR 640	Narda	640	8.20 to 12.40 GHz
NAR 639	Narda	639	12.40 to 18.00 GHz
NAR 638	Narda	638	18.00 to 26.50 GHz

The most recently-loaded cal definition is saved in non-volatile memory, and is retained when you turn AC power OFF.

Domain

The Domain menu provides selection of the three possible domains of the network analyzer:

- Frequency Domain.
- Time Domain (requires option 010).
- Angle Domain.

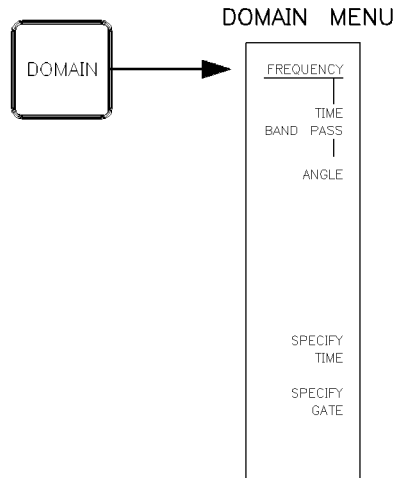

Figure 5-17. Domain Menu

Frequency Domain

Allows you to measure antenna magnitude and phase performance across one or more frequencies. Frequency Domain measurements must be made at a single *angle*. In Frequency Domain mode, the x-axis of the display is frequency. Internal triggering (free run trigger mode) is commonly used when measuring frequency, but external triggering can be used as well. You can measure a single frequency, or choose from Ramp, Step or Frequency List sweep modes.

Frequency Domain

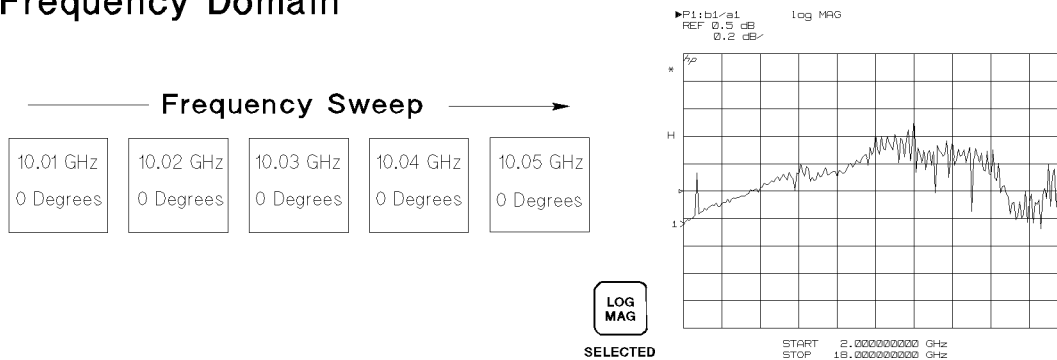

Figure 5-18. Frequency Domain

Domain

Time Domain (Time Band Pass)

This optional feature allows you to make RCS measurements or see the time response of an antenna (time is shown on the displays x-axis). One use of time domain is when measuring multi-path range reflections. Internal triggering is usually used in this mode.

Time domain data is mathematically calculated from Frequency Domain data. This is done using the “chirp-Z” inverse Fourier transform. Therefore, the first step in time domain measurements is to make a measurement in the Frequency Domain.

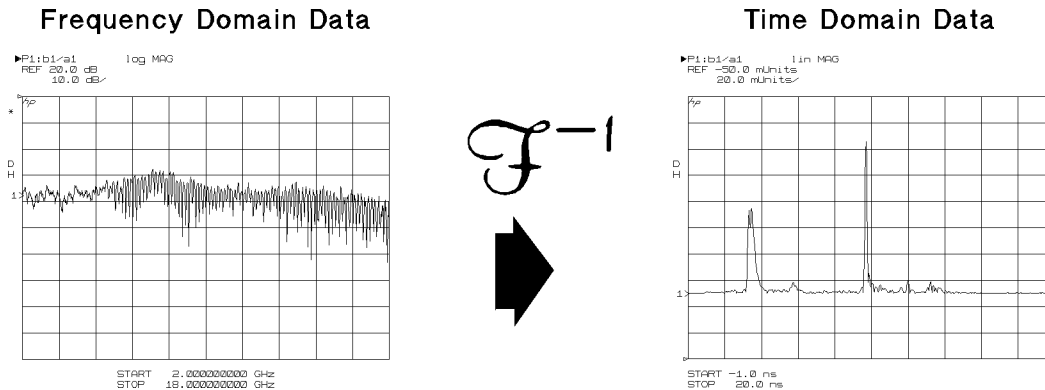

Angle Domain

Allows you to make angle scan measurements at a single frequency. In Angle Domain mode, the x-axis of the display is angular degrees. External triggering is used (HP-IB or TTL) in this mode. You can measure a single angle, or a range of angles.

Angle Domain

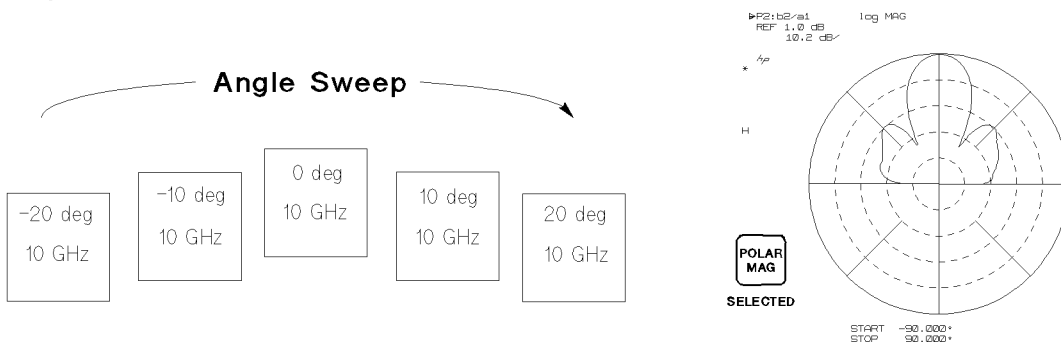

Specify Time and Specify Gate

These functions are described in Chapter 13, Time Domain Measurements

Display

Section Contents

This section discusses the front panel display, and functions available under the **DISPLAY** key.

- **DISPLAY** Key Functions
- Displaying More than One Trace
- Adjusting the Display
 - Changing CRT Intensity
 - Changing Background Intensity
 - Changing Display Colors
- Using an External Monitor
- Using Trace Memory
- Using Trace Math
 - Changing the Default Trace Math Function
 - Performing a Trace Math Operation
 - Comparing Channel 1 Data with Channel 2 Data

DISPLAY Key Functions

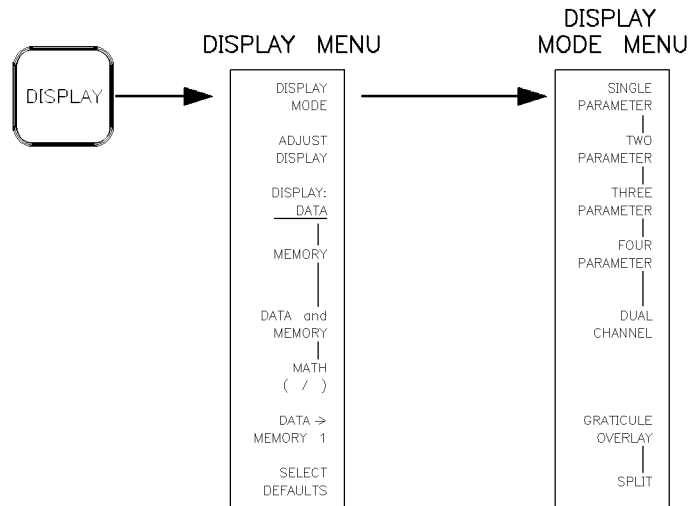

Figure 5-21. Display and Display Mode Menus

Press **DISPLAY**. Choices under the Display menu allow you to:

- View single or dual channel display.
- View one, two, three, or four parameters.
- Change the color attributes of the CRT.
- Configure the receiver for an external monitor.
- Save traces to memory and display recall them on the screen.

Adjusting the Display

- Perform complex trace math. Trace math performs vector addition, subtraction, multiplication, or division between the current data trace and the memory trace.

Displaying More than One Trace

A simple rule explains if the receiver WILL measure a specific parameter:

If the parameter is displayed on the screen, it will be measured.

The opposite of this rule is also true:

If the parameter is NOT displayed on the screen, it will NOT be measured.

The number of parameters to be measured is selected with the following softkeys:

SINGLE PARAMETER	Measures and displays one parameter. Choose the desired parameter by pressing (PARAM 1), (PARAM 2), (PARAM 3), or (PARAM 4) keys.
TWO PARAMETER	Measures and displays PARAM 1 and PARAM 2 for the active channel.
THREE PARAMETER	Measures and displays PARAM 1, PARAM 2, and PARAM 3 for the active channel.
FOUR PARAMETER	Measures and displays all four parameters for the active channel. The parameters in the inactive channel will not be measured.
DUAL CHANNEL	Measures and displays one parameter (of your choice) in each channel. For each channel, choose the desired parameter by pressing (PARAM 1), (PARAM 2), (PARAM 3), or (PARAM 4) keys.

Adjusting the Display

Changing CRT Intensity

To change the overall display intensity press:

(DISPLAY) ADJUST DISPLAY INTENSITY. Use the knob or entry keys to enter the intensity value desired. Terminate entries with the (x1) key.

The factory default value is set to 83%. This value lengthens the CRT life. The intensity level cannot be saved or recalled, it remains as set unless you perform a factory preset.

Changing Background Intensity

Background intensity can be changed to any value from 0 to 100%. The factory default value is zero. Background intensity can be saved and recalled.

Changing Display Colors

The displayed colors can be changed. Color changes can be saved and recalled. Figure 5-22 shows the Adjust Display menu.

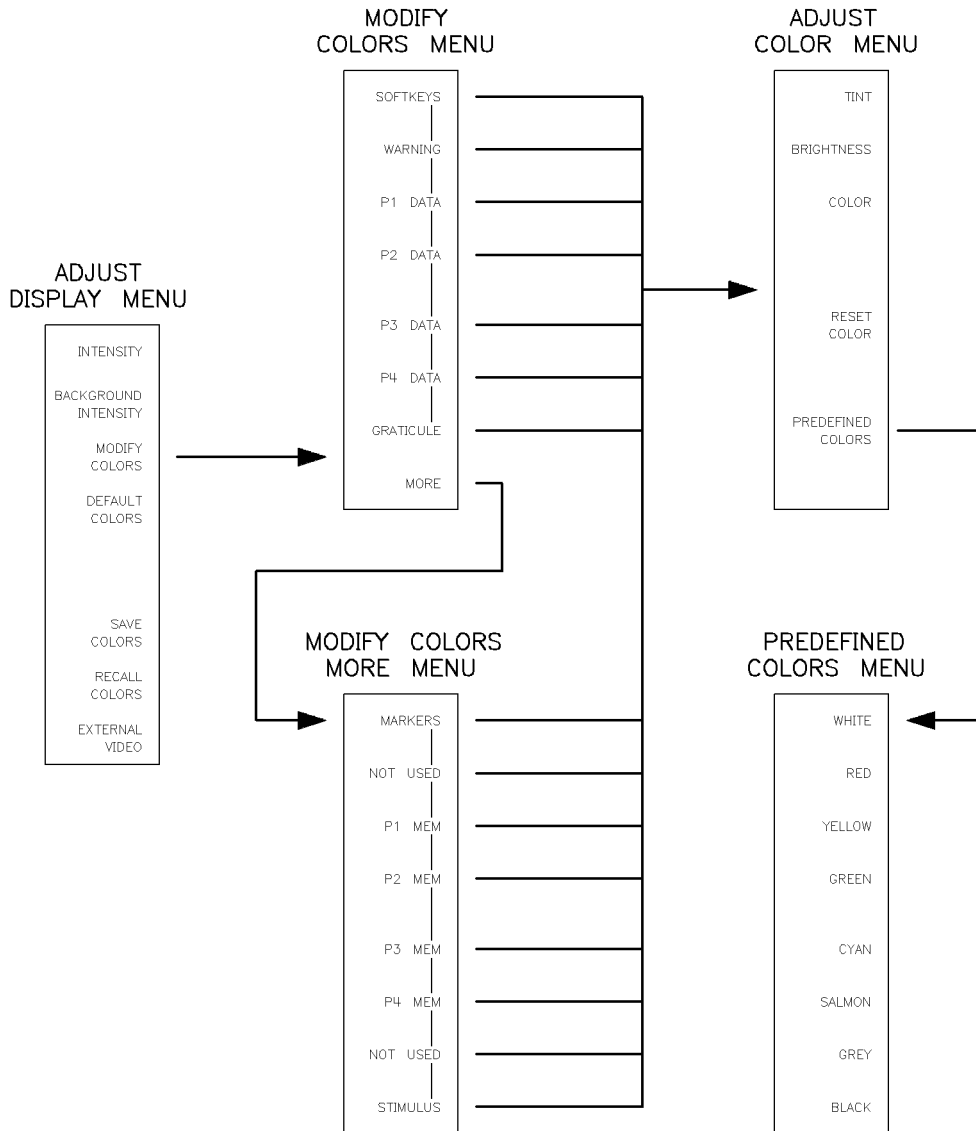

Figure 5-22. Adjust Display Menu

If you press **DEFAULT COLORS**, display attributes revert to the factory default colors and background intensity. The following table lists default color definitions:

Adjusting the Display

Table 5-6. Default Settings for Display Elements

Display Element	Color	Tint	Brightness %	Color %
Softkeys	white	0	100	0
Warning	red	0	100	100
Parameter 1 Data	yellow	14	100	100
Parameter 2 Data	cyan (blue)	53	100	60
Parameter 3 Data	salmon (pink)	0	100	36
Parameter 4 Data	green	38	93	100
Graticule	gray	0	49	0
Markers	white	0	80	0
Parameter 1 Memory	yellow ¹	11	70	85
Parameter 2 Memory	cyan ¹ (blue)	60	70	60
Parameter 3 Memory	red ¹	0	75	55
Parameter 4 Memory	green ¹	41	63	85
Stimulus Value Readout	white	0	90	0

¹ The standard color has been modified, using different tint, brightness, or color intensity. This is why the color is darker than the standard color.

How to Modify Colors

The following steps demonstrate how to change, save, and recall the colors for the displayed elements.

1. Press **DISPLAY** **ADJUST DISPLAY** **MODIFY COLORS**. This keystroke sequence displays the Modify Colors menu.
2. Choose one of the display elements shown on the menu. For example, press **MORE** **STIMULUS**. By selecting the stimulus element, you have actually chosen to modify the color assigned to the stimulus value notation shown on the display. Now you can adjust the tint, brightness, and color saturation for that color. The tint, brightness, and color default settings vary with the display element or color selected.
 - a. Press **BRIGHTNESS**. Use the knob to vary the intensity of the color from very dim (cannot be seen at 0%) to very bright (100%).
 - b. Press **COLOR**. Use the knob to vary the color saturation of the color from white (0%) to all color (100%).
 - c. Press **TINT**. Tint is the range of hues. Tint ranges from red, through green and blue, and back to red.

The tint setting for the primary colors is as follows:

yellow = 14.
blue (cyan) = 53.
red = 0.

Adjusting the Display

3. The **RESET COLOR** softkey returns the display element/color to the default color definition for that color.
4. Press **PREDEFINED COLORS** to display the menu of colors with predefined definitions for tint, brightness, and color.
5. Choose one of the predefined colors, for example **GREEN**. The display element/color turns green and the last active function, tint value, in this case, is shown.
6. To save the color modifications you have made, press **(PRIOR MENU)** as many times as necessary to return to the Adjust Display menu or press **(DISPLAY) ADJUST DISPLAY**. Now, press **SAVE COLORS**.
7. To recall a previously saved color setup, press **RECALL COLORS**.

Using an External Monitor

The receiver is designed to work with external multisync video monitors. The controls in this menu allow you to configure the system to work with specific monitor types.

How to Tell if a Monitor will be Compatible

Here are the monitor compatibility requirements:

- The monitor must have separate R-G-B inputs. These can either be individual jacks, or a multi-pin connector (if the proper adapter or cable is available). The cable supplied with the HP 8530A will plug into separate jacks.
- The monitor must be compatible with a 25.5 kHz horizontal scan rate.
- The monitor must be compatible with a 60 Hz vertical scan rate.
- The monitor must accept 0.7 V input levels on its RGB inputs, with a 75 ohm impedance.
- H,V sync inputs (if the monitor is equipped with them) must be TTL compatible.

Many multisync monitors meet these requirements. Note that the external video controls have no effect on the HP 8530's built-in display.

Adjusting the Display

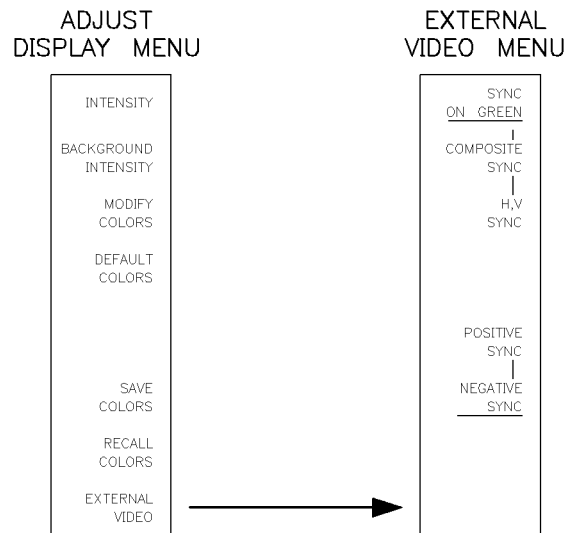

Figure 5-23. External Video Menu

Installing an External Monitor

External video connections are made with the D1191A external video cable, provided with the receiver. The following pages show four major types of multisync monitors, and explain how to install them.

Monitors that Use Separate Horizontal and Vertical Sync

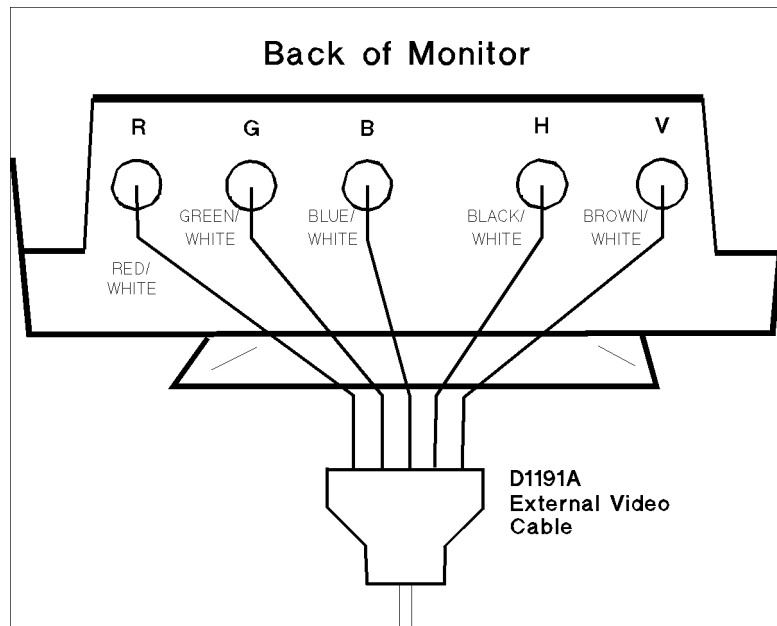

Figure 5-24. Monitor with Two Sync Connectors (Separate H,V Sync)

The figure above represents a monitor that uses separate horizontal and vertical sync signals. Connect the five cables as shown. Connect the other end of the cable to the HP 8530A rear-panel EXTERNAL DISPLAY connector.

HP 8530A Settings

1. Press **[DISPLAY]** **ADJUST DISPLAY** **EXTERNAL VIDEO** **H,V SYNC**.
2. Look in the operator's manual for the monitor and determine if it requires a positive or negative sync pulse.

On the receiver, press **POSITIVE SYNC** or **NEGATIVE SYNC** as required.

Monitor Settings

Read the monitor's operating manual. *If necessary*, configure monitor switches or controls for:

- 0.7 V R-G-B inputs, 75 ohms.
- Horizontal sync rate of 25.5 kHz.
- Vertical sync rate of 60 Hz.

The monitor should now be operational.

Adjusting the Display

Monitors that Use One Sync Connector

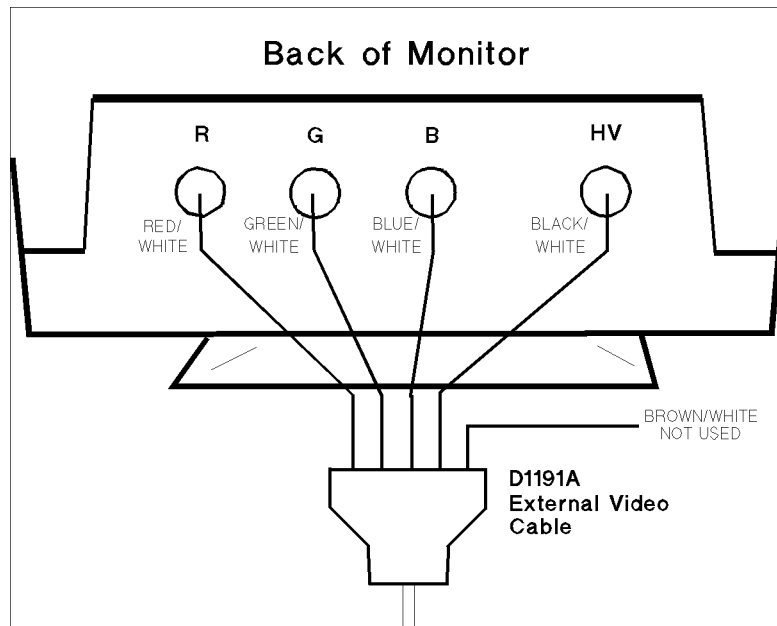

Figure 5-25. Monitor with one Sync Connector (Composite Sync)

The figure above represents a monitor that uses a composite sync signal (which combines horizontal and vertical sync signals on one line). Connect four of the cables as shown. The brown/white cable is not needed. Connect the other end of the cable to the HP 8530A rear-panel EXTERNAL DISPLAY connector.

HP 8530A Settings

1. Press **DISPLAY** **ADJUST DISPLAY** **EXTERNAL VIDEO** **COMPOSITE SYNC**.
2. Look in the operator's manual for the monitor and determine if it requires a positive or negative sync pulse.

On the receiver, press **POSITIVE SYNC** or **NEGATIVE SYNC** as required.

Monitor Settings

Read the monitor's operating manual. *If necessary*, configure monitor switches or controls for:

- 0.7 V R-G-B inputs, 75 ohms.
- Horizontal sync rate of 25.5 kHz.
- Vertical sync rate of 60 Hz.

The monitor should now be operational.

Monitors with No Sync Connectors

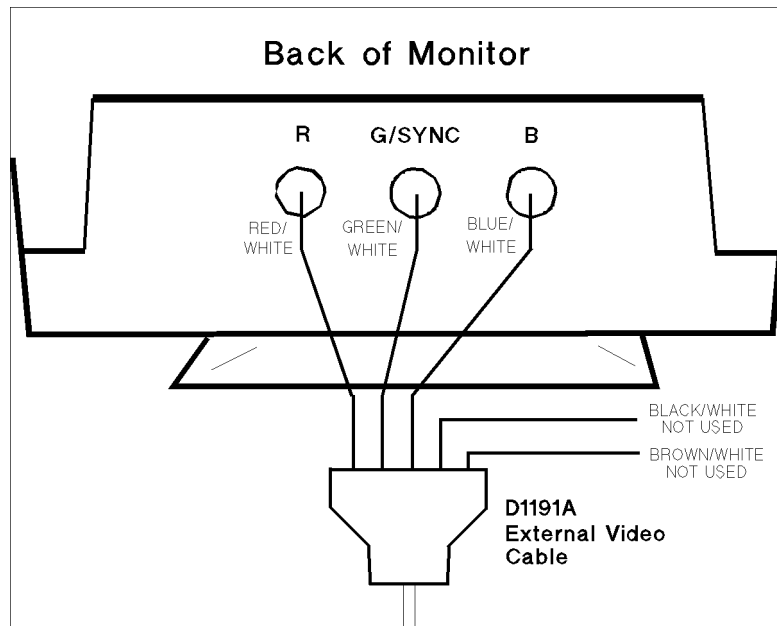

Figure 5-26. Monitor with No Sync Connectors (Sync on Green)

The figure above represents a monitor that requires sync signals to be superimposed on the green video line. Connect the R-G-B cables as shown. The black/white and brown/white cables are not needed. Connect the other end of the cable to the HP 8530A rear-panel EXTERNAL DISPLAY connector.

HP 8530A Settings

Press **DISPLAY** **ADJUST DISPLAY** **EXTERNAL VIDEO** **SYNC ON GREEN**.

Negative sync is standard for “sync on green” monitors, and the HP 8530A selects this mode automatically.

Monitor Settings

Read the monitor’s operating manual. *If necessary*, configure monitor switches or controls for:

- 0.7 V R-G-B inputs, 75 ohms.
- Horizontal sync rate of 25.5 kHz.
- Vertical sync rate of 60 Hz.

The monitor should now be operational.

Adjusting the Display

Monitors that Support All Sync Types

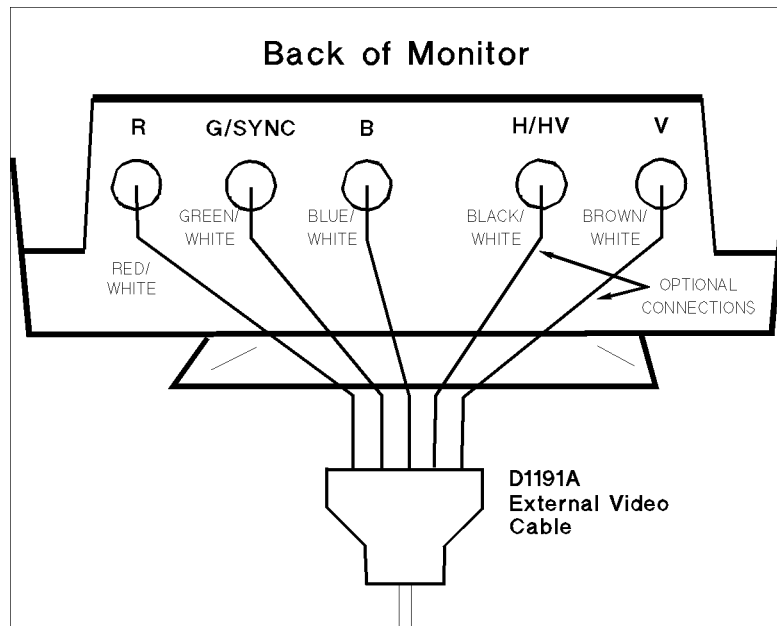

Figure 5-27. Monitor Supporting All Sync Types

The figure above represents newer monitors that support all sync types:

- Sync on Green
- Composite Sync
- Separate H,V Sync

You can install this kind of monitor using any of the preceding setups. Such monitors usually lock-on (automatically) to any sync you supply. If you don't want any extra BNC cables laying around behind the monitor, plug in all five BNC connections. Connect the other end of the cable to the HP 8530A rear-panel EXTERNAL DISPLAY connector.

HP 8530A Settings

1. Press **DISPLAY** **ADJUST DISPLAY** **EXTERNAL VIDEO**.
2. Choose the sync mode which is appropriate for the sync connections you have made: **H,V SYNC**, **COMPOSITE SYNC**, or **SYNC ON GREEN**. If you have connected all five connectors, you can choose *any* of the HP 8530A sync modes.
3. Look in the operator's manual for the monitor and determine if it requires a positive or negative sync pulse.

On the receiver, press **POSITIVE SYNC** or **NEGATIVE SYNC** as required.

Monitor Settings

Read the monitor's operating manual. *If necessary*, configure monitor switches or controls for:

- 0.7 V R-G-B inputs, 75 ohms.
- A horizontal sync rate of 25.5 kHz.
- A vertical sync rate of 60 Hz.
- Sync Type (composite, sync or green, or H,V.)

The monitor should now be operational.

When external video configuration settings change

The instrument will never change external video settings once you have made them. The only exception is if you load the operating system again, or change from HP 8530A operation to optional HP 8510C operation, or vice versa. Changing between these two “modes” requires the applicable operating system to be loaded.

Using Trace Memory

You can store a measurement in one of eight trace memories and then compare it with the current measurement trace data in any format. Using softkeys in the Display menu, the Data and Memory traces can be displayed alone or simultaneously (Data and Memory).

In both single channel and dual channel operation the display data, memory, and trace math operations are always uncoupled; you may select memory operations independently for each channel.

Storing a Trace in Memory

Press the **DISPLAY** key in the **MENUS** block to bring the top level Display menu onto the CRT. Factory Preset selects **DISPLAY: DATA** for both channels, which displays the current data trace.

To store the current trace to memory, press: **DATA → MEMORY 1**.

Each parameter (in each channel) is saved to a predefined memory register. For example, Parameter 1 on Channel 1 is normally stored to memory register 1. The following table shows the default memory registers for each parameter in each channel:

Table 5-7. Memory Numbers for Each Parameter on Each Channel

Channel/Parameter	Memory Number
Channel 1	
PARAM 1	Memory #1
PARAM 2	Memory #2
PARAM 3	Memory #3
PARAM 4	Memory #4
Channel 2	
PARAM 1	Memory #5
PARAM 2	Memory #6
PARAM 3	Memory #7
PARAM 4	Memory #8

The memory in use is displayed in the **DATA → MEMORY** softkey label.

Displaying the Memory Trace

To display only the stored memory trace, press **DISPLAY: MEMORY**. Notice that when the memory trace is displayed:

- The trace indicator for Cartesian displays (1 for channel 1 or 2 for channel 2), disappears. This indicator is normally displayed at the end of the trace.
- If a sweep is in progress, it stops.

Adjusting the Display

- The parameter label (in the channel identification area) changes to show which memory is displayed.

Settings that can, and cannot be changed. You may select any format and response setting to view the stored trace. The Stimulus (START) and (STOP) controls are not active. The marker is operational, reading the frequency and value of the memory trace.

Displaying Data and Memory at the Same Time

Press **DISPLAY: DATA and MEMORY**. The two traces are then displayed on the same grid, using the same scale/division, reference line value, and reference line position used for the current data trace. The parameter label includes the label of the memory trace (M1, M2, M3 and so on).

Again, notice that the current data trace is annotated by the channel number (1 or 2 at the end of the trace), and that the memory trace is not annotated. The marker reads only the current data trace.

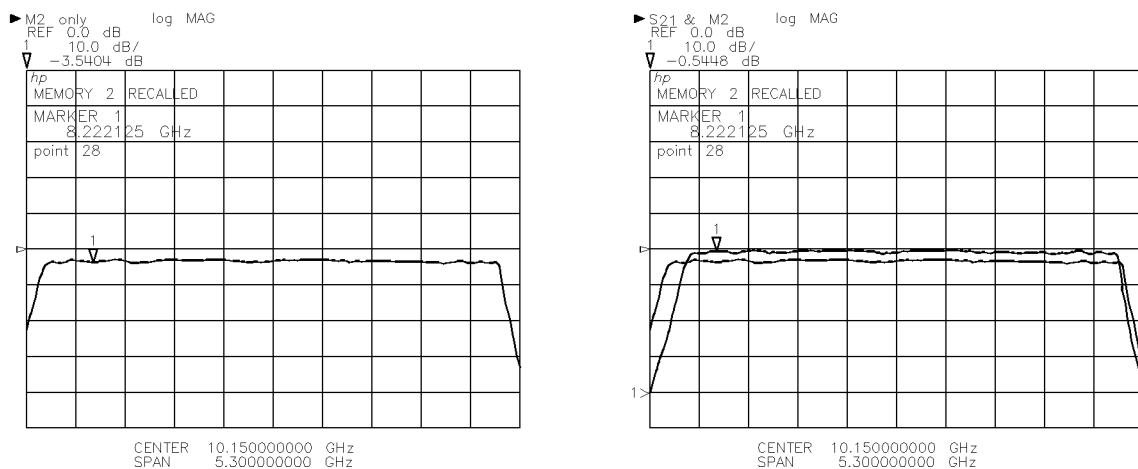

Figure 5-28. Display of Memory, Data and Memory

Settings that can, and cannot be changed. When you are displaying Data and Memory, certain receiver settings must remain the same or Data and Memory will automatically turn Off. Changing the following settings will cause this to occur:

- Domain
- Number of Points
- Start Angle, Stop Angle
- Increment Angle
- Turning calibration On or Off

Other receiver settings can be changed for the current trace, without affecting the Display and Memory feature.

Selecting Default Memory

As mentioned earlier, each parameter (in each channel) saves to a specific memory register. The “select defaults” feature allows you to choose any of the eight memory locations for any parameter (on either channel). You could select memory 7 for Parameter 1 (on channel 1), for example.

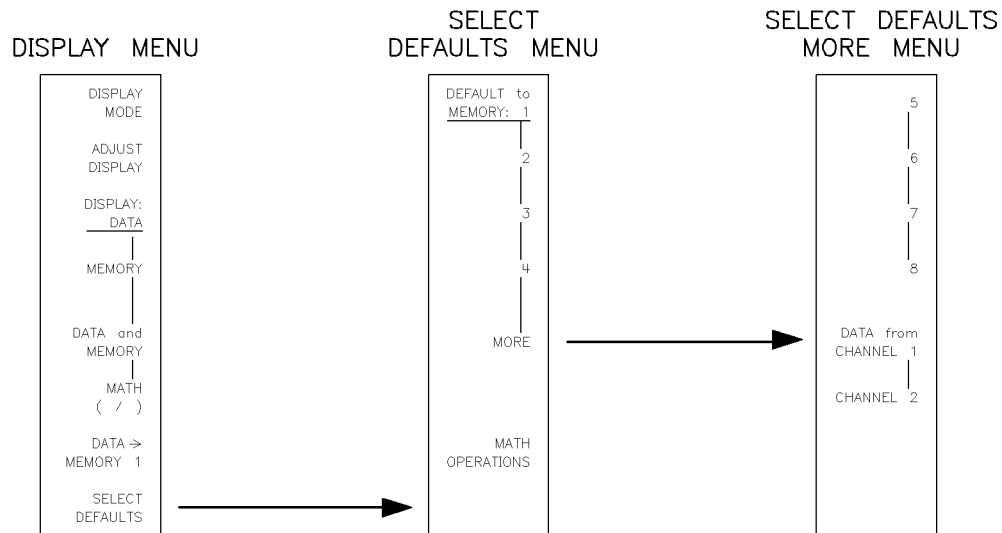

Figure 5-29. Select Default Trace Memory

1. Press **CHANNEL 1** or **CHANNEL 2**.
2. Press **DISPLAY** **SELECT DEFAULTS** to display the Select Defaults menu. The current default memory for the selected channel is underlined.
3. Press **DEFAULT to MEMORY: 1**, **2**, **3**, **4**, or **MORE** **DEFAULT to MEMORY 5**, **6**, **7**, or **8**. This selects the memory register for the currently selected parameter (for the current channel).

The Display menu reappears, and the **DATA → MEMORY** label shows the current selection.

Volatile and non-volatile trace memories. Memory registers 1, 2, 3, and 4 are non-volatile memories (their contents are not lost when instrument power is turned off). Memories 5, 6, 7, and 8 are volatile (their memory contents are lost when power to the instrument is turned off).

Operational life of non-volatile memory. Memory registers 1, 2, 3, and 4 use solid-state memory that is rated for a at least 10,000 **DATA → MEMORY** operations. If this number of storage operations is exceeded, the memory could “wear out.” This is not likely to occur within the lifetime of the instrument. However, if you control the receiver with a computer, and use repetitive **DATA → MEMORY** operations, HP recommends that you use memory registers 5, 6, 7, or 8 instead of 1, 2, 3, or 4.

Using Trace Math

Using Trace Math

Complex mathematical operations include:

- Vector addition.
- Vector subtraction (current data – memory data).
- Vector multiplication.
- Vector division (current data ÷ memory data).

These operations can be performed on the Data trace using a selected memory, or, in dual channel operation, from the other channel.

After Factory Preset, the default math operation for both channel 1 and channel 2 is **MATH (/)**. You can change the math function to addition, subtraction, or multiplication using the Select Defaults menu. This is explained below. You can choose one math function for Channel 1 and another for Channel 2.

Changing the Default Trace Math Function

If a different mathematical operation is desired:

1. Select **CHANNEL 1** or **CHANNEL 2**.
2. On the Display menu, press **SELECT DEFAULTS**. This displays the Select Defaults menu (shown in Figure 5-30).
3. Press **MATH OPERATIONS**. This displays the Math Operations menu (Figure 5-30). The current selection is underlined. In the following descriptions, the term “trace” refers to complex data pairs in real, imaginary format. When the term “corrected” is used, it means that the data is calibrated *if* a valid calibration is currently active.
4. Press one of the following softkeys:

PLUS (+) Adds the corrected Data trace and Memory trace.

MINUS (–) Subtracts Memory trace from the corrected Data trace.
Data Trace – Memory Trace

MULTIPLY (*) Multiplies the corrected Data trace with the Memory trace.

DIVIDE (/) Divides the corrected Data trace by the Memory trace.
Data Trace ÷ Memory Trace

If the current trace and the stored trace are identical, the complex ratio between them is 1 and a Cartesian display of the result is a flat line at 0 dB, degrees, or seconds. Figure 5-29 shows a typical result of such a comparison. A polar display of the result is a small cluster of points at 1 ∠ 0°.

The display shows the result of the operation and the selected operation appears in parentheses () with **MATH** on the Display menu.

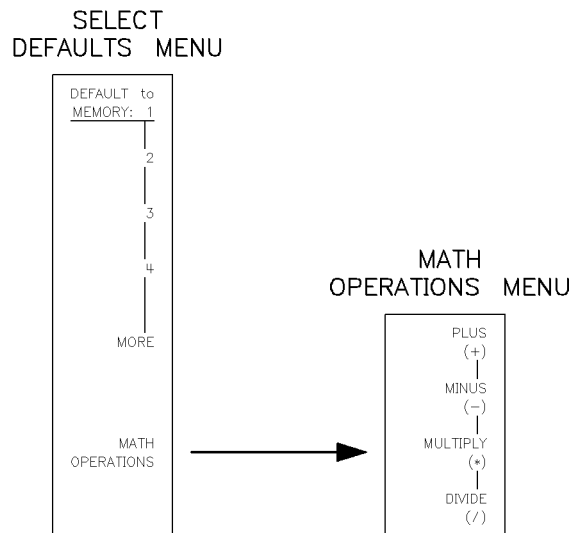

Figure 5-30. Select Default Trace Math

Performing a Trace Math Operation

To perform a trace math operation (in this example the default operation, division, is shown):

1. Store the trace in memory by pressing:

DISPLAY DATA → MEMORY

2. Press: **MATH (/)**

The display then shows the ratio of the current trace over the stored trace. Notice that the parameter label in the channel identification area changes to show that the math operation is being performed.

Complex math operations are performed on the real and imaginary data from the corrected data array for the selected channel. The data is processed by the math function *before* display formatting and thus the results can be viewed in any format.

Comparing Channel 1 Data with Channel 2 Data

Press **DISPLAY** **SELECT DEFAULTS** **MORE** to access **DATA from CHANNEL 1** and **DATA from CHANNEL 2**.

DATA from CHANNEL 1 and **DATA from CHANNEL 2** allow you to perform trace math using current data from one channel and current data from the other channel. As an example of using this capability, proceed as follows:

Press the following keys:

CHANNEL 2 **PARAM 1**

DISPLAY **DISPLAY MODE** **DUAL CHANNEL** **SPLIT**

CHANNEL 1 **PRIOR MENU**

SELECT DEFAULTS **MORE** **DATA from CHANNEL 2**

MATH (/)

Using Trace Math

Channel 1 now displays the complex ratio of channel 1 data divided by channel 2 data. Remember that Channel 2 trace math is independent from Channel 1. That is why Channel 2 is displaying normal data (without trace math) at this time. You set up Channel 1 for trace math in the above steps, but you did not select trace math for Channel 2.

Although it is intended that this operation be used in dual channel operations, if a Channel 1 single channel display is now selected, the feature uses the last Channel 2 data acquired. It is important to note that Channel 2 must have been selected for at least 1 sweep after `DATA from CHANNEL 2` was selected in order for the result to be meaningful.

Measurement Markers

Section Contents

- Marker Functions
- Using Standard Markers
- Delta Mode Markers
- Marker Search Modes
- Examples of Marker Use

Marker Functions

Marker functions are:

- Simple markers on the display trace
- Delta (Δ) marker mode
- Marker search modes
- Marker list modes

In addition, you can choose whether markers can move only to measured values or continuously along the trace.

Using Standard Markers

Markers are most often used to read the trace value at the marker position. The trace value of the active marker is displayed in the Channel Identification block directly below scale/division. The stimulus value (frequency, time, or angle depending upon the domain selected) at the marker position is displayed in the Active Function area of the screen.

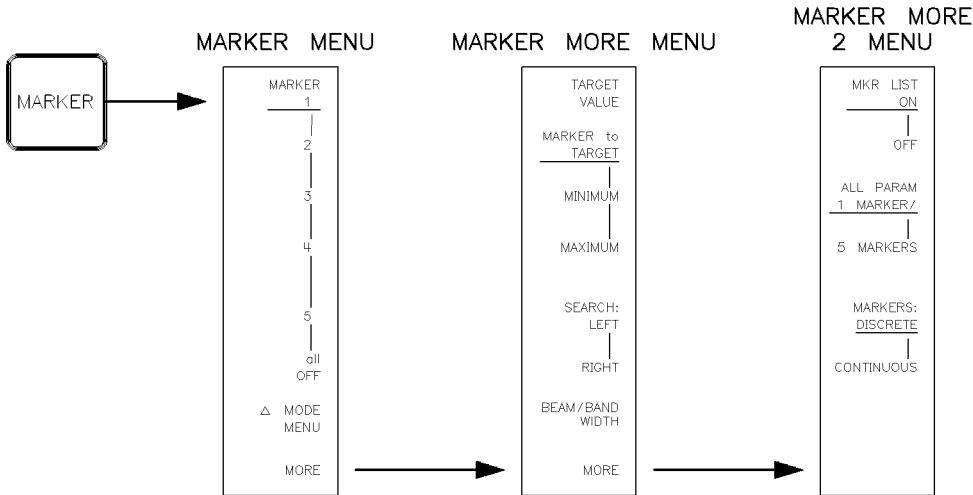

Figure 5-31. MARKER Key and Marker Menus

Standard Marker Functions

Select the Active Marker

Markers are made active by pressing the **(MARKER)** key in the MENUS block and choosing a marker from the Marker menu.

1. Press **(MARKER)**.

This causes the last selected marker to be displayed on the trace and display the Marker menu. (Marker 1 is the default active marker.) You can now move the active marker to any position on the trace using the knob, step, or numeric keys.

2. Press **MARKER 1**, **2**, **3**, **4**, or **5** softkeys to select another of the five measurement markers as the active marker.
3. Use the knob, step, or numeric keys to position the marker.

The active marker is indicated by a ∇ symbol, and the other markers are indicated by Δ symbols. Thus in Figure 5-32, Marker 1 is active, Markers 2, 3, 4, and 5 are not active. To read the value or change the position of a marker, you must make it the active marker.

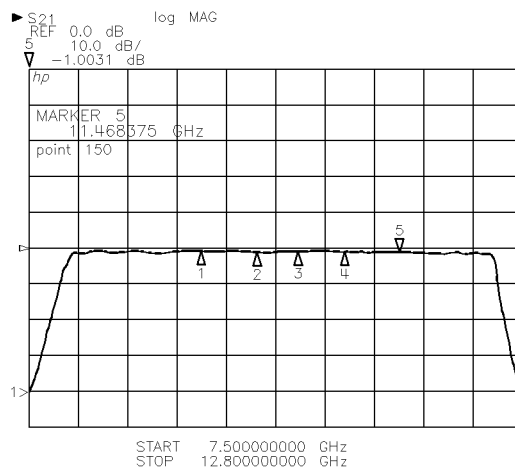

Figure 5-32. Markers on Trace

To move the active marker to the position of a given stimulus value, enter the numeric value and its units. For example to move **MARKER 2** to 5 GHz, press:

(MARKER) **MARKER 2** **(5)** **(G/n)**

When you press the units terminator, the active marker moves to the data point nearest to that stimulus value. It also displays the trace value (amplitude or phase) in the active entry portion of the display.

Press the \blacktriangle or \blacktriangledown step keys to move the active marker left (\blacktriangledown) or right (\blacktriangle) 1 x division (1/10 of the stimulus span).

Marker values remain displayed even when you select another function (such as **(SCALE)**). The knob/entry keys no longer control the marker position, but the marker and the trace value remain displayed.

To remove all marker values from the CRT display press the softkey **all OFF**.

Marker Units

The units given for the trace value depend on the current selected display format. Refer to Table 5-8.

Table 5-8. Marker Units

FORMAT	MARKER Basic Units
Frequency Domain: Time Domain:	
LOG MAG	dB
LIN MAG	ρ (unitless) (reflection) τ (unitless) (transmission)
PHASE	degrees ($^{\circ}$)
POLAR MAG	dB; $\angle \varphi^{\circ}$ (reflection) dB; $\angle \theta^{\circ}$ (transmission)
SWR	(unitless)
LIN on POLAR	$\rho \angle \varphi^{\circ}$ (reflection) $\tau \angle \theta^{\circ}$ (transmission)
REAL	x (unitless)
IMAGINARY	jy (unitless)
Angle Domain	
LOG MAG	dB
LIN MAG	ρ (unitless) (reflection) τ (unitless) (transmission)
PHASE	degrees ($^{\circ}$)
POLAR MAG	dB; $\angle \phi^{\circ}$ (reflection) dB; $\angle \phi^{\circ}$ (transmission)
SWR	(unitless)
LIN on POLAR	$\rho \angle \phi^{\circ}$ (reflection) $\tau \angle \phi^{\circ}$ (transmission)
REAL	x (unitless)
IMAGINARY	jy (unitless)

For unitless quantities such as Linear Magnitude and Real, the marker value is displayed in units (u= units; mu= milliunits). A reflection coefficient measurement of 0.94 is displayed as 940.00 milliunits.

Continuous and Discrete Markers

Press **MARKER**, then **MORE MORE** to display the third Marker menu. The two choices, **MARKERS DISCRETE** and **MARKERS CONTINUOUS**, select how the marker moves along the trace.

MARKERS DISCRETE In this mode, markers can only be placed on an actual stimulus point. As they move, markers will jump from one stimulus point to another.

MARKERS CONTINUOUS In this mode, markers can be placed at any stimulus value. If a marker is placed between two measured stimulus points, the receiver performs straight-line interpolation to provide the marker with a value. The accuracy of the marker readout is not specified, and the resulting data value must be used with some discretion.

Standard Marker Functions

Marker List Displays

The third Marker menu also contains the marker list functions:

- MARKER LIST ON/OFF
- FOUR PARAM 1 MARKER/
- FOUR PARAM 5 MARKERS

The “Marker List” is a data readout that displays up to five marker values. This list cannot be seen if softkey titles are on the screen, because they use the same display area as the softkey titles.

Example of the Default Mode (“Four Param 1 Marker” mode)

1. Select four parameter display by pressing:

DISPLAY DISPLAY MODE FOUR PARAMETER

2. Turn on a marker, then press **PRIOR MENU** until you see the marker data displayed. It normally appears as shown below:

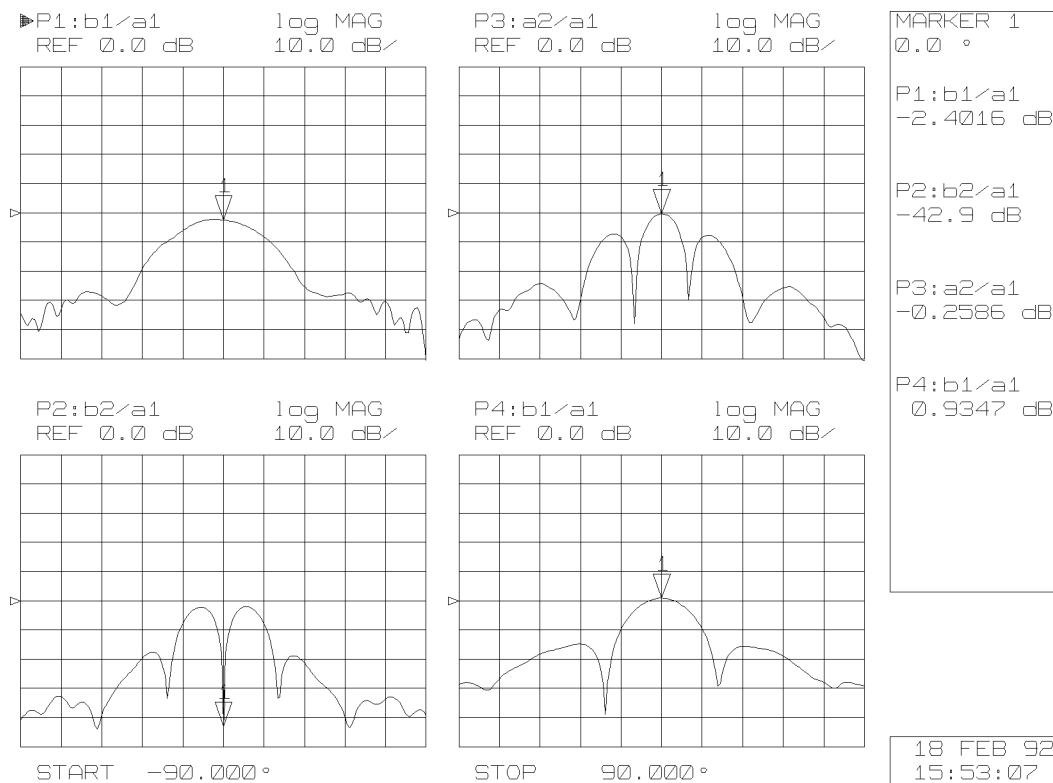

Figure 5-33. Default Marker Data Display (Four Param 1 Marker mode)

Four Param 1 Marker Mode

The default marker list mode is the “Four Param 1 Marker” mode, illustrated in Figure 5-33. This mode shows data for only one marker, but the values for that marker are shown for each displayed parameter.

- At the top of the marker data readout is the stimulus value for the active marker (Marker 1 in this case). In this example the active marker is at 0 degrees.

Standard Marker Functions

- The first data readout (from the top) shows the Marker 1 value for Parameter 1.
- The second data readout shows the Marker 1 value for Parameter 2.
- The third data readout shows the Marker 1 value for Parameter 3.
- The fourth data readout shows the Marker 1 value for Parameter 4.

Four Param 5 Marker Mode

Figure 5-34 shows a typical display with **MARKER** MORE MORE FOUR PARAM 5 MARKER selected:

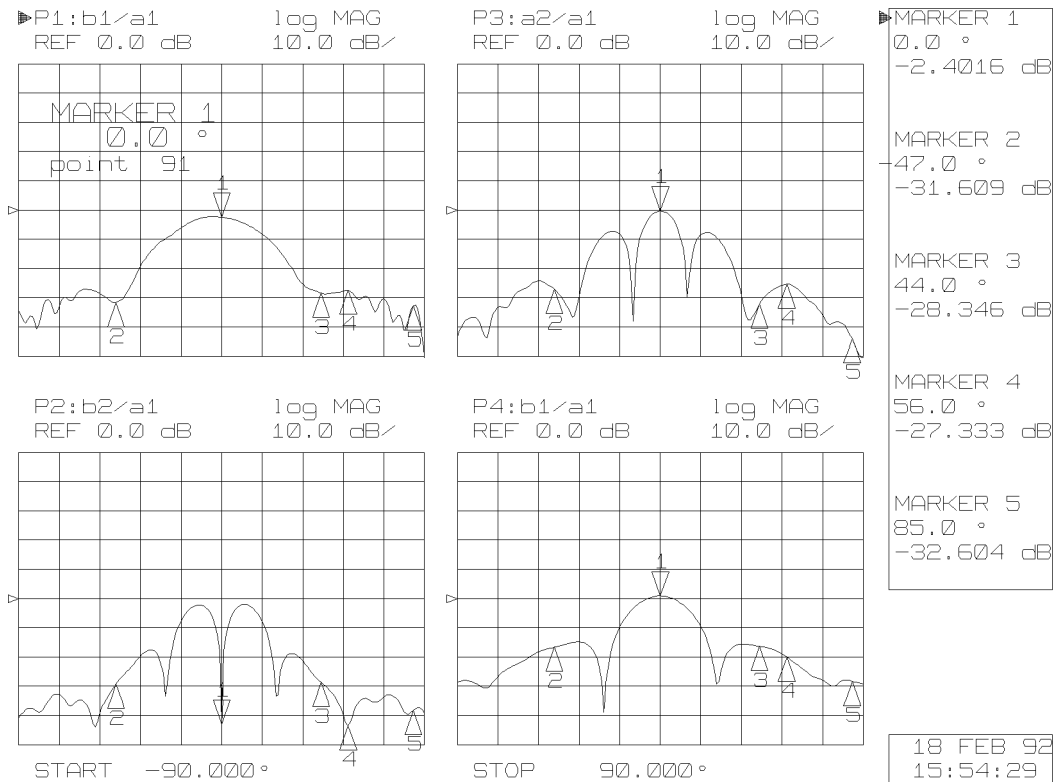

Figure 5-34. Four Param 5 Marker mode

In this mode, up to five marker values are shown on the screen, but they only apply to the *active parameter*. For example, in Figure 5-34 Parameter 1 is the active parameter. To see the marker values for Parameter 2, press **PARAM 2**.

Notice the ► symbol next to the Marker 1 annotation. This symbol denotes the active marker. You do *not* have to turn on all five markers to use this mode.

Marker List On/Off

The **MARKER LIST ON/OFF** softkey turns the marker list feature On or Off.

Delta Mode Markers

Use the delta (Δ) marker mode to read the difference in trace value and stimulus value between any currently selected active marker and another marker designated as the reference marker.

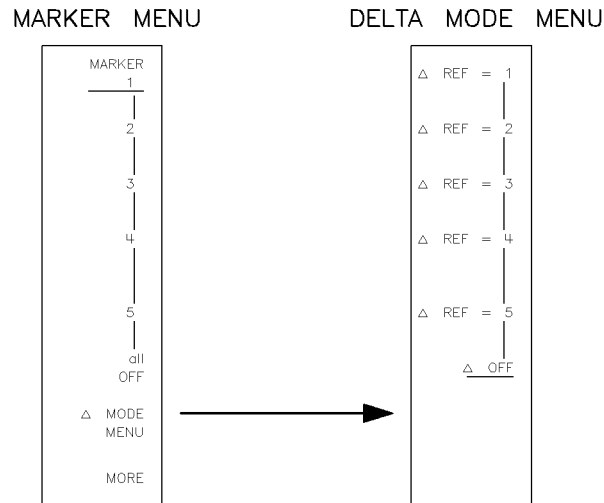

Figure 5-35. Marker and Δ Mode Menus

The Δ mode sequence uses both the Marker menu and the Δ mode menu as follows:

1. Press **MARKER**. A marker is displayed and the Marker menu appears. Use the knob to position this marker to any desired point on the trace.
2. Press the **Δ MODE MENU** softkey. This displays the Δ mode menu.
3. Choose the reference marker by pressing a softkey **Δ REF = 1**, **2**, **3**, **4**, or **5**, different from the current active marker. Any marker can be designated as the reference marker, causing the currently selected active marker to read relative to it.

The Marker menu reappears on the display with the designated marker labeled Δ REF =.

4. Use the knob to position the active marker anywhere on the trace. The stimulus difference between the active marker and the reference marker is displayed as the active entry. The trace value difference between the active marker and the reference marker is displayed in the normal marker readout. The “normal” marker readout is located above the measurement graticule, on the left-hand side.

If the current active –and the reference marker are at the same position, the displayed value is zero.

If the current active marker is also selected as the reference marker, the displayed value is zero at all points on the trace because the marker is reading relative to itself.

To exit the Δ marker mode press **Δ MODE MENU**, **Δ OFF**.

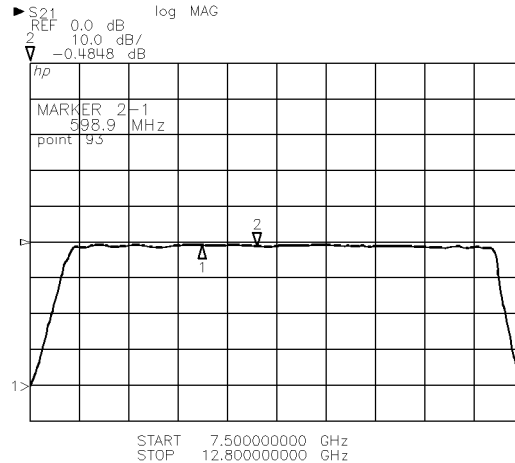

Figure 5-36. Δ Mode Markers on Trace

Marker Search Modes

Select any marker search mode by pressing **MARKER**, **MORE**, then **MARKER to MINIMUM**, **MARKER to MAXIMUM**, **MARKER to TARGET**, or **BEAM/BAND WIDTH**. When you press one of these softkeys, the mode selection is underlined and the selected search is executed.

MARKER to MINIMUM and **MARKER to MAXIMUM** always find the minimum or maximum data point on the trace, respectively.

BEAM/BAND WIDTH finds the bandwidth of the display trace in the frequency domain. The bandwidth value is set by the **TARGET VALUE** key. This function uses marker 3, marker 4, and marker 5. If any of these markers are active when the **BANDWIDTH** or **BEAM WIDTH** function is executed they will be reset.

This function only works in the frequency domain with a logarithmic display (LOG MAG, LOG POLAR).

In the angle domain **BEAM/BANDWIDTH** will find the beamwidth of the displayed traces, similar to the frequency domain function.

MARKER to TARGET begins at the lowest stimulus value (the left side on Cartesian displays), and searches for the target value.

- If in discrete marker movement mode, the search stops at the stimulus point nearest to the target value. The search always stops at the nearest actual measurement point that is below the target value.
- If in continuous marker movement mode, the search stops at the target value. The active function shows the stimulus value and the actual trace value is shown in the marker readout.

Unsuccessful target searches result in the message **TARGET VALUE NOT FOUND**.

Set the target value by pressing **TARGET VALUE** then enter the target value for the current Format using the knob, step, or numeric keys. Switch between formats to see that the target

Delta Marker Functions

value is different for each format selection. Factory Preset selects a certain target value for each format, for example -3 dB for **(LOG MAG)**.

As an example:

1. Move the marker to any position on the trace, then press **TARGET VALUE**, **=MARKER**.
2. Now move the marker to another position on the trace, then press **MARKER to TARGET**. The marker moves to the trace value closest to the target value,

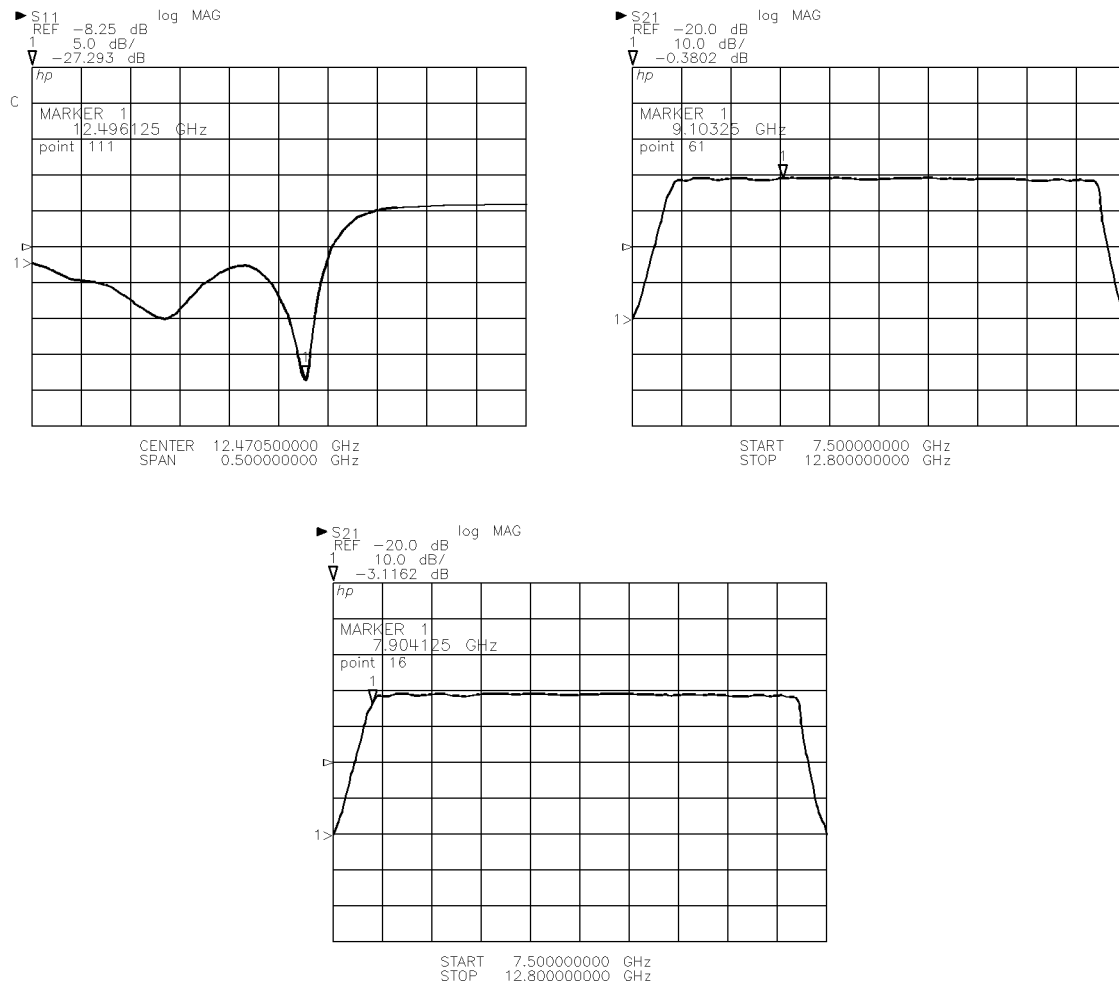

Figure 5-37. Marker Search Modes

Search Right and Search Left

Press **SEARCH RIGHT** or **SEARCH LEFT** to search for the next minimum, maximum, or target value beginning from the present marker position to the right or left on the trace, respectively. The search always find a next minimum or next maximum, although another target value may not be found.

Δ Mode Operation

When operating in the Δ mode, the target searches begin from the current reference marker instead of the lowest stimulus value. For example, a target search for -3 dB moves the active marker to the next point -3 dB relative to the reference marker, to the right or left of the reference marker, if a point exists.

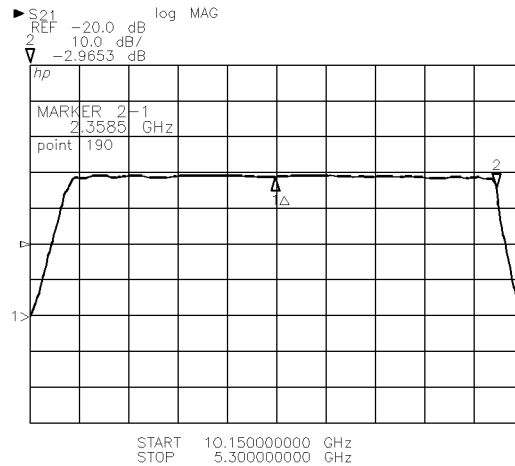

Figure 5-38. Δ Mode Marker to Target

Example of Delta Marker Use

1. Press **RECALL** **MORE** **FACTORY PRESET**.
2. Make a measurement or load a measurement data file that has several maximums and minimums. Remember, when you load a data file from disc you must place the receiver in HOLD mode (using the Stimulus menus). If you are in Angle Domain, make sure the current start angle, stop angle, and increment angle result in the same number of angles as used in the data file. Refer to the chapter on disc drive operation for more information.
3. Press **MARKER**. Marker 1 is active by default. The stimulus value and the trace value are displayed in the upper-left corner of the display. The Marker menu also appears.
4. Position the marker on the trace using the knob, the step keys, or numeric entry.
5. Press **MARKER 2**. Marker 2 is now active. Note the triangle symbol at marker 1 inverts to indicate that it is no longer the active marker. Position marker 2.
6. Press **MARKER 1**. Marker 1 is now active; Marker 2 symbol inverts.
7. Press **Δ MODE MENU**, then press **Δ REF = 2**. The delta symbol appears near marker 2 to indicate that it is the reference marker. The stimulus difference and trace value difference between the active marker and the reference marker (active - reference) is displayed.
8. Use the knob to move marker 1.
9. Press **MARKER 3**. Marker 3 is now the active marker and it reads relative to marker 2.

Delta Marker Functions

10. Press **(PRIOR MENU)**. The marker list appears in the softkey menu display area. Notice that all readings are differences between the reference marker (2) and the other markers. Marker 3 is denoted as the active marker by the ▶ symbol in the marker list.
11. Press **(MARKER) Δ REF = 2**. Marker 2 is now active and it reads relative to itself. Use the knob to position marker 2.
12. Press **Δ MODE MENU**, then **Δ OFF**. Marker 2 is active and it reads the trace value.
13. Press **all OFF**. The markers disappear.
14. Press **(MARKER)**, **MORE**, **MARKER to MINIMUM**. Marker 2 (which was the last active marker) moves to the minimum trace value.
15. Press **SEARCH LEFT**. Marker 2 moves to the next trace minimum between the present marker position and the beginning of the trace.
16. Press **(PRIOR MENU)**, **MARKER 1**, **MORE**, **MARKER to MAXIMUM**. Marker 1 moves to the maximum trace value.
17. Press **MARKER to TARGET**. Marker 1 begins from the lowest stimulus value and moves to the measurement point that is closest (but less than) the target value. If the message **TARGET VALUE NOT FOUND** appears, press **TARGET VALUE** and enter an appropriate value for the current format, then press **MARKER to TARGET** again.
18. Press **SEARCH RIGHT**. Marker 1 moves to the first target value to the right (increasing stimulus) of its present position, if another target value is found.
19. Press **SEARCH LEFT**. Marker 1 moves to the first target value to the left (decreasing stimulus) of its present position, if found.
20. Press **(PRIOR MENU)**, **Δ MODE MENU**, then **Δ REF = 2**. Now marker 1 is active and marker 2 is the reference.
21. Press **MORE**, **MARKER to TARGET**. Marker 1 begins from the current reference marker position and moves to the first point closest to the target value, if found.
22. Press **SEARCH RIGHT**. Marker 1 moves to the first target value to the right (increasing stimulus) of the reference marker position, if found. Press **SEARCH LEFT**. Marker 1 moves to the first target value to the left (decreasing stimulus) of the reference marker, if found.
23. Press **(PRIOR MENU) Δ MODE MENU Δ OFF all OFF**.

Beamwidth and Bandwidth Functions

The receiver can determine beamwidth automatically using the Beam/Band Width function. If the instrument is in Frequency Domain, the **BEAM/BAND WIDTH** key determines bandwidth. If the instrument is in Angle Domain, the **BEAM/BAND WIDTH** key determines beamwidth.

The default “target value” is for beamwidth or bandwidth at -3 dB. The “target value” specifies the dB value (below the peak) where beam width is measured. To set the target value to a different number, press **(MARKER) MORE TARGET VALUE (+/-) n (x1)**. Where n is the target value in dB. The **(+/-)** key is required because the target value is most likely a negative value (-6 dB, and so on).

Press **(MARKER) MORE BEAM/BAND WIDTH**, the value is now displayed on the screen.

This function automatically turns ON delta markers.

Stimulus Functions

Chapter Contents

This chapter describes the Stimulus functions of the HP 8530A. The following topics are described:

- Angle Domain Stimulus Controls
 - Measurement Frequency
 - Increment Angle
 - Sweep Mode (single or swept angle)
 - HP 85370A Position Encoder Controls
- Frequency/Time Domain Stimulus Controls
 - Setting Frequency Sweep
 - Selecting the Number of Points to Measure
 - Source Sweep Modes
 - Creating a Frequency List
 - Sweep Time
- Stimulus Controls Applicable to All Domains
 - Sweep Execution, Hold, Single, Number of Groups, Continual
 - Setting Stimulus Power
 - Trigger Modes (Free Run, External, or HP-IB)

Introduction to Stimulus Functions

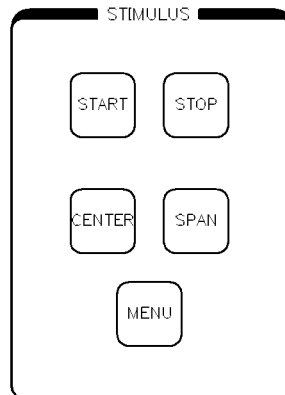

Figure 6-1. STIMULUS Function Block

Stimulus block keys (and the associated Stimulus menus) allow you to setup and control the stimulus parameters of the RF and LO source. The **START**, **STOP**, **CENTER** and **SPAN** keys control frequency, time, or angle, depending on the domain that is currently selected.

The STIMULUS **MENU** key displays the top level Stimulus menu. This menu controls:

- In Angle Domain:
 - Source Power (RF and LO sources)
 - Measurement Frequency (a single CW frequency)
 - Increment Angle (angular distance between measurement points)
 - Sweep Modes (Single or Swept Angle)
 - Trigger modes (Free Run, External, or HP-IB)
- In Frequency and Time Domain:
 - Source Power (RF and LO sources)
 - Sweep time
 - Number of data points taken during the sweep.
 - Sweep modes (Frequency List, Ramp, or Step)
 - Trigger modes (Free Run, External, or HP-IB)

The Stimulus Power menu and Stimulus More menu are the same in all domains, and are described later in this chapter.

Angle Domain Stimulus Controls

In Angle Domain, **START** and **STOP** are used to set the start and stop angle, and the Stimulus menu provides other functions as well. There are two versions of Stimulus menu: One version applies to the Angle Domain, the other applies to the Frequency *and* Time Domains.

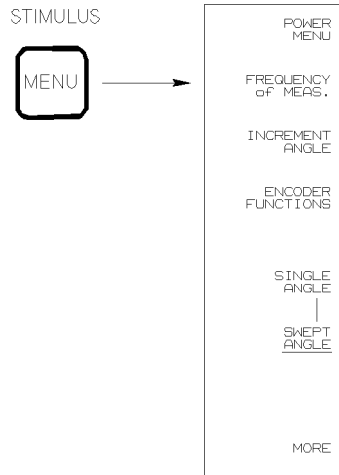

Figure 6-2. Stimulus Menu (in Angle Domain)

Setting Measurement Angles

When making Angle Domain measurements, you can enter a desired angle span using the **START** and **STOP** keys. For example, press **START** -90 **(x1)**, then **STOP** 90 **(x1)** to setup a pattern measurement from -90° to $+90^\circ$. To correct errors made during entry, use the **BACKSPACE** key.

Other methods are available for setting angle span, such as using the **CENTER** and **SPAN** keys, or using the knob, or **▲** **▼** keys to change values.

Setting Measurement Frequency

Press **STIMULUS** **(MENU)** to enter the main Stimulus menu.

FREQUENCY of MEASUREMENT selects the CW frequency of the Angle Domain measurement. The HP 8530A can only make angle measurements at one frequency. If you want to make multiple-frequency measurements at multiple angles, you must use an external computer controller with appropriate software.

Example of Use:

Press **FREQUENCY of MEASUREMENT** 10 **(G/n)** to set the measurement frequency to 10 GHz.

Angle Domain Stimulus Controls

Setting Increment Angle

INCREMENT ANGLE, coupled with the Start and Stop Angle, tells the receiver how many points of data it should acquire during the measurement.

For example, assume you select the following:

Start Angle: -90°
Stop Angle: $+90^\circ$
Increment Angle: 1°

This measurement would result in 181 points of data. In this case the receiver knows it must take 181 points of data before the measurement is finished. If you are using external trigger mode (with triggers sent by the positioner controller), the receiver will expect 181 *triggers* before the measurement is finished. Refer to the section on External Triggering (later in this chapter) for more details.

Remember, the receiver does not control the positioner controller. The receiver depends on the trigger pulses from the positioner controller (or on HP-IB GET commands from a computer) to know exactly when data should be acquired. Also, the receiver has no way of knowing the actual direction the positioner is pointing. The receiver assumes that the positioner is at the start angle when the first trigger occurs. *Be sure that the first trigger occurs when the positioner is at the start angle.* In the above example this would be at -90° . Triggers occurring before this will cause the receiver to start the measurement too early.

For example, assume that a certain positioner controller issues a trigger pulse at -91° . The receiver would take one point of data and assume that it applies to the start angle (-90°). The measurement would continue, with data being offset by 1° throughout the rest of the measurement (this example assumes the increment angle is set to 1°).

Example of Use:

Press **INCREMENT ANGLE** 2 **(x1)** if the positioner controller is set to an increment angle of 2 degrees. Terminate Increment Angle entries with one of the following terminator keys:

(k/m) millidegrees
(x1) degrees

Selecting Sweep Mode (single or swept angle)

SINGLE ANGLE and **SWEPT ANGLE** determine whether the receiver will acquire data at a single angle, or over a span of angles. These two softkeys are toggles, selecting one turns the other OFF.

Use Single Angle mode to boresight an antenna. Use Swept Angle mode to make pattern measurements.

HP 85370A Position Encoder Operation

Introduction

This section applies only if you are using an HP 85370A. It describes the HP 8530A softkeys that control the HP 85370A Position Encoder. Remember, the HP 85370A works only when the HP 8530A is equipped with option 005, Position Encoder Interface. This section assumes the positioner encoder is properly installed and configured.

Note If external triggers are used, do *not* apply a trigger signal to the HP 8530A EVENT TRIGGER when using the HP 85370A. Apply an external trigger only when using the HP 8530A External Trigger mode.

Position Encoder Softkeys

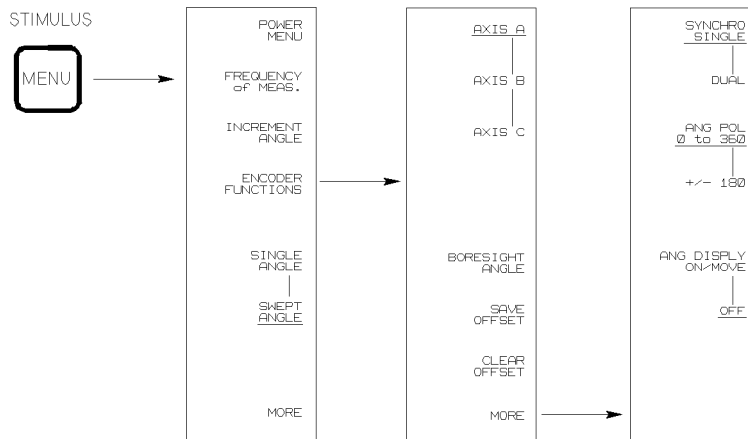

Figure 6-3. Position Encoder (option 005) Softkeys

Angle Domain Stimulus Controls

To access the Position Encoder menus press:

DOMAIN **ANGLE**
STIMULUS **MENU** **ENCODER FUNCTIONS**

The position encoder softkeys are:

■ Position encoder operation functions:

AXIS A , **AXIS B** , or **AXIS C**
ENCODER ANGLE and **BORESIGHT ANGLE**
SAVE OFFSET and **CLEAR OFFSET**

■ Position encoder configuration functions (press **MORE** to see these functions):

SYNCHRO SINGLE or **DUAL**
ANG POL 0 to 360 or **+/-180**
ANG DISPLY ON/MOVE or **OFF**

Configuration Functions

Single and Dual Synchro

The single and dual synchro control softkeys are:

SYNCHRO SINGLE Selects single synchro (1:1) operation. This is also referred to as coarse resolution mode. This setting is independently applied to each axis.

DUAL Selects dual synchro (1:1 and 36:1) operation. This is also referred to as fine resolution mode. This setting is independently applied to each axis.

Selecting single and dual synchro mode for any axis. (Select single and dual settings independently for each axis.)

1. Press: **DOMAIN** **ANGLE**
STIMULUS **MENU** **ENCODER FUNCTIONS**
2. Select the desired axis by pressing: **AXIS A** , **AXIS B** , or **AXIS C**
3. Press: **MORE** **SYNCHRO SINGLE** or **DUAL**
4. Repeat the last two steps for each axis.

Angle Display Modes

The angle display mode softkeys are:

ANG POL 0 to 360 Causes the HP 8530A and the position encoder to display angles in 0 to 360° format.

+/-180 Causes the HP 8530A and the position encoder to display angles in ±180° format.

ANG DISPLY ON/MOVE This softkey performs two functions:
1. If angle display is already turned ON, this softkey moves the angle readout to a different position on the display. There are five different positions.

2. It turns the angle readout ON if it was previously OFF. This affects the HP 8530A display.

From the Encoder More menu, press **ANG DISPLY ON/MOVE**. The position of the angle readout changes. There are five possible positions. One of the positions is above the Time/Date box, in the lower right-hand corner of the screen. This position cannot be seen if softkeys are being displayed. Press **(PRIOR MENU)** until the softkey menus disappear, and you will be able to see the angle readout.

OFF

Turns the HP 8530A angle display OFF.

Operational Functions

Axis Controls

AXIS A, **AXIS B** and **AXIS C** select the axis that is currently in use. Angles are displayed for the selected axis on the HP 8530A and on the position encoder. When changing between axes, the receiver recalls any previously used offset, (described later) and which synchro mode was selected, (single or dual).

Boresight Angle

BORESIGHT ANGLE places the active marker at the peak of the antenna pattern. This is the first step during boresighting. Once the active marker is at the peak, this value can be saved as an offset. Subsequent measurements will show the peak at 0°. **BORESIGHT ANGLE** turns OFF any delta markers that are in use.

The normal marker features may also be used to place an active marker on boresight. It is easiest to find boresight using normal marker functions if the antenna has a non-symmetrical shape.

Use this function during boresighting when using swept angle mode. This command places the active marker at the current position range of the displayed trace. If this angle is out of the display range it will put the active marker to the start angle. This function turns OFF any delta markers that are in use. It can also be used to enter an offset angle using the numeric keys.

Offset Functions

The softkeys that control angle offset are shown below:

SAVE OFFSET

For use after boresighting. **SAVE OFFSET** “zeros” the angle readout on the receiver and position encoder. *The offset does not take effect until the next angle scan of the positioner.* This step would be performed after using the **BORESIGHT ANGLE** or **ENCODER ANGLE** keys. (The active marker may also be moved to boresight manually, then use **SAVE OFFSET**.) You may also press:

ENCODER ANGLE n **(X1)** **SAVE OFFSET**, where n is the desired angle.

For example, assume boresight for axis A is at +7 degrees, and the active marker has been placed at that position (using normal marker functions or **BORESIGHT ANGLE**). Pressing **SAVE OFFSET** (and taking another sweep) would cause boresight to appear at 0°. All angle readings will be displayed relative to that angle (for that axis only).

CLEAR OFFSET

Clears the offset memory completely and eliminates any offset currently in use for the displayed axis.

Angle Domain Stimulus Controls

Details about Save Offset

Offsets are axis independent. Save Offset operates independently for each of the three axes. The receiver also remembers the offsets you used last for each axis.

Adding incremental offsets. If conditions cause the boresight to change, move the active marker to the new boresight (manually, or with BORESIGHT ANGLE, or ENCODER ANGLE), and press SAVE OFFSET again. The incremental change will be added to the offset. SAVE OFFSET remembers the first offset used, and adds or subtracts subsequent SAVE OFFSET values incrementally to the original value.

Here is an example of how Save Offset works. Assume boresight for axis A is at $+7^\circ$. Move the active marker to that angle (by whatever means), press SAVE OFFSET and measure another sweep. Boresight will now appear to be at 0° (angle readings are offset by 7°).

Later in the day you change antennas, and boresight moves 1° in a positive direction. If a marker is placed at that point, and SAVE OFFSET is pressed again, the offset will change by 1° , for a total offset of 8° . Remember, the change will not take effect until the next angle scan.

CLEAR OFFSET clears the offset memory, so a new starting offset may be entered. Offset is actually cleared on the next angle scan.

The offset value is saved with the instrument state when the **SAVE** and **RECALL** keys are used. This allows different offsets to be saved in the Save/Recall registers for later use.

Encoder Settings and Save/Recall Registers

All the encoder configuration and operational settings are saved when the Save/Recall registers are used.

Details about Save Offset

Offsets are axis-independent. Save Offset operates independently for each of the three axes. The receiver also remembers the offsets you used last for each axis.

Adding incremental offsets. If conditions cause the boresight to change, move the active marker to the new boresight (manually or with BORESIGHT ANGLE), and press SAVE OFFSET again. (NOTE: you *must* take another sweep before pressing SAVE OFFSET a second time.) The incremental change will be added to the offset. SAVE OFFSET remembers the first offset you use, and adds or subtracts subsequent SAVE OFFSET values incrementally to the original value. You must take a sweep between each press of the SAVE OFFSET softkey.

Here is an example of how Save Offset works. Assume boresight for axis A is at $+7^\circ$. You move the active marker to that angle (by whatever means) and you press SAVE OFFSET. Now you measure another sweep. Boresight will now appear to be at 0° (angle readings are offset by 7°).

Later in the day you change antennas, and boresight moves 1° in a positive direction. If you press SAVE OFFSET again, the offset will change by 1° , for a total offset of 8° .

CLEAR OFFSET clears the offset memory, so you enter a new starting offset. Offset is actually cleared on the next sweep.

The offset value is saved with the instrument state when you use the **SAVE** and **RECALL** keys. This allows you to save different offsets in the Save/Recall registers for later use.

Using offset functions. The Offset function is discussed in “To Find Boresight” in Chapter 5 of the *HP 8530A User’s Guide*.

Frequency/Time Domain Stimulus Control

The Stimulus keys **(START)**, **(STOP)**, **(CENTER)**, and **(SPAN)** set the frequency or time parameters for the measurement. The softkeys under the STIMULUS **(MENU)** key allow you to use other stimulus functions as well.

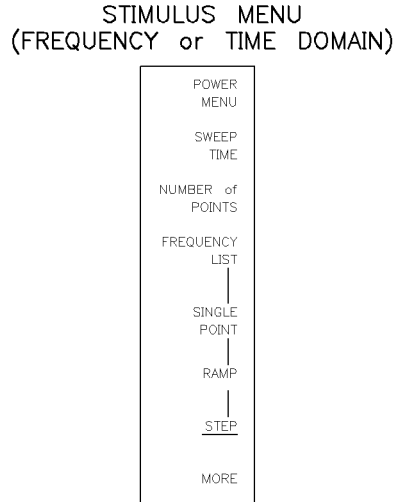

Figure 6-4. Stimulus Menu (in Frequency or Time Domain)

Setting Frequency Values

When making Frequency Domain measurements, you can enter a desired frequency span with the **(START)** and **(STOP)** keys, or with the **(CENTER)** and **(SPAN)** keys. Enter specific frequency values using the knob, **(▲)** **(▼)** keys, or number keys in the ENTRY block. Terminate numeric entries with an appropriate terminator key:

- (G/n)** GHz or nanoseconds
- (M/μ)** MHz or microseconds
- (k/m)** kHz, or milliseconds
- (x1)** Hz, dBm, seconds (in power slope mode: dB/GHz)

To familiarize yourself with the source controls, press **(START)**, **(STOP)**, **(CENTER)**, or **(SPAN)**, and observe the current stimulus values at the bottom of the display. Use the ENTRY block keys to change values.

Rotate the knob or press a step key, notice that the value is instantly changed. Now enter a value using the number keys, then terminate the entry by pressing one of the terminator keys. When you press one of the terminator keys, the value is entered and the system is set to the specified value.

For example to change the start frequency to 2 GHz, press:

(START) 2 **(G/n)**

Or

2000 **(M/μ)**

In both examples above, the same frequency is selected for the start frequency. To correct errors made during entry, use the **(BACKSPACE)** key.

Frequency/Time Domain Stimulus Controls

If you press **(START)** or **(STOP)**, the Start/Stop display mode is automatically selected, and you can set the start or the stop frequency. If you press **(CENTER)** or **(SPAN)**, the center/span display mode is selected and you can set the center frequency or the span width.

The range of possible frequency settings depends on the frequency limits of the RF source and frequency converter.

When to Use START/STOP versus CENTER/SPAN

Start and Stop settings are most useful when you are performing pass/fail testing over the full frequency band of the device or antenna under test. Center and Span are convenient if you see a spurious response at one frequency and want to zoom in to see it closely.

Spurious responses are never at nice, even frequencies, that are easy to enter through the front panel. Rather, they are *always* at weird frequencies like 11.432987345 GHz. The receiver has a convenient feature which makes it easier to select such a frequency. Simply place a marker on the spurious response, then press **(CENTER)** **(=MARKER)**. The center frequency will be set to the same frequency as the marker. This is explained in more detail below:

Selecting Frequencies Using Markers

You can instantly set **(START)**, **(STOP)**, or **(CENTER)** to the frequency of the active marker. Here's how:

1. Turn on a marker.
2. Use the knob to position the marker anywhere on the trace.
3. Press any of the three keys: **(START)**, **(STOP)**, or **(CENTER)**
4. Press the **(=MARKER)** key (in the bottom of the ENTRY block). The marker frequency value now becomes the new start, stop, or center frequency.

Selecting the Number of Points to Measure

After a Factory Preset, the receiver selects 201 points per sweep. In the Frequency Domain this produces 200 equally spaced *frequency* intervals.

To change the number of points:

1. Press STIMULUS **(MENU)** **NUMBER** of **POINTS**. This brings the Number of Points menu onto the display. The current value is underlined.
2. Press the appropriate softkey to select 51, 101, 201, 401, or 801 points. Sweep time increases when you choose a higher number of points.

Frequency/Time Domain Stimulus Controls

NUMBER of POINTS MENU

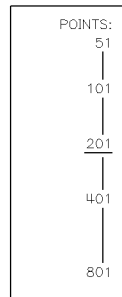

Figure 6-5. Number of Points Menu

Number of points is always coupled, meaning that selecting the number of points for one channel automatically selects the same number of points for the other channel.

With broadband sweeps, responses that are narrow with respect to the frequency interval may not be accurately represented. For example, with a 10 GHz sweep width, the frequency resolution is:

Number of Points	Frequency Resolution (10 GHz Span)
51	200 MHz
101	100 MHz
201	50 MHz
401	25 MHz
801	12.5 MHz

This means that with 51 points selected, responses that are narrower than 200 MHz are not represented accurately using a 10 GHz sweep width. Figure 6-6 shows the effect of changing the number of points from 51 to 401 in such a measurement.

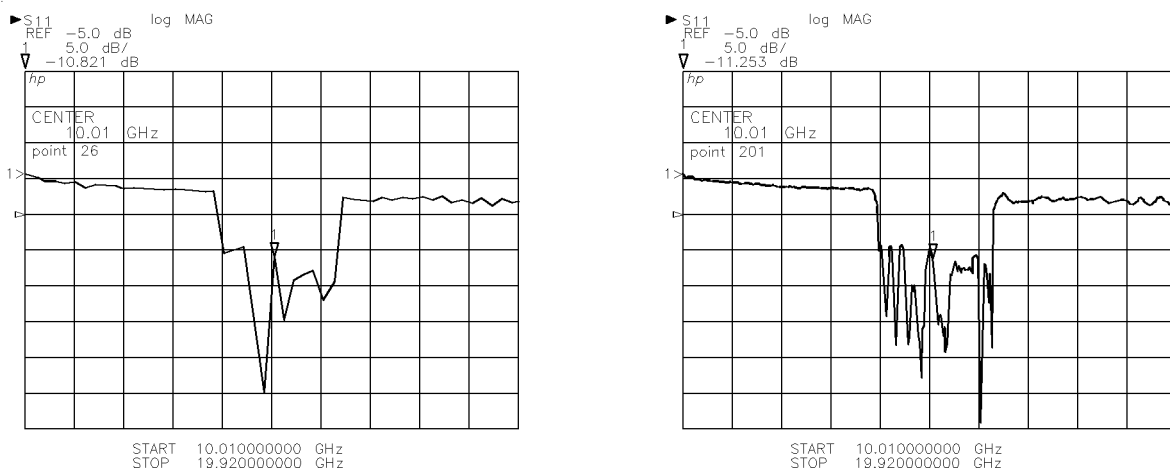

Figure 6-6. Narrow Band Responses Shown with 51 Points (left) and 401 Points (right)

Frequency/Time Domain Stimulus Controls

Source Sweep Modes

Four source sweep mode selections are available on the Stimulus menu.

RAMP

The source is swept in a continuous analog sweep from the lower to upper frequency and data is acquired without stopping the sweep. This mode is compatible with synthesized or non-synthesized sources.

For HP 8350 sources, RAMP selects the standard analog sweep with open loop YIG oscillator tuning accuracy and repeatability.

For HP 8340/41 sources, RAMP selects standard analog “lock and roll” sweep. The source is phase-locked at all frequencies for sweep widths less than 5 MHz.

To use Ramp sweep mode with an HP 8340/41 or 8350 source:

- Connect the receiver’s SWEEP IN 0-10V BNC to the source’s SWEEP OUT BNC.
- Connect the receiver’s STOP SWP BNC to the source’s STOP SWEEP BNC.

For HP 836xx sources, RAMP selects enhanced analog “lock and roll” sweep. The source reads its frequency at the end of the first sweep and adjusts the slope and offset of the 0 to 10V sweep voltage ramp so subsequent sweeps are more accurate. The receiver processes the first sweep (called the “learn” sweep), at a slightly slower speed than subsequent sweeps.

To use Ramp Sweep mode with an HP 836xx source:

- Connect the receiver’s TRIGGER IN BNC to the source’s TRIGGER OUT BNC.
- Connect the receiver’s STOP SWP BNC to the source’s STOP SWEEP BNC.

STEP

The source is tuned and phaselocked at each frequency point. This mode is available only with synthesized sources. You can select two speeds for the Step mode using controls under the (SYSTEM) key. These are Normal Step and Quick Step. Refer to “Step Type” in Chapter 17. Quick Step mode requires the same BNC connections (listed above) as required when using an HP 836xx with Ramp mode (TRIGGER IN, STOP SWP). (Quick Step mode does not function in a system that uses multiple sources.)

SINGLE POINT

Sets the source to the center frequency of the sweep already selected in the Ramp or Step sweep mode. Single Point mode only measures one point of data. Displaying one point of data on the screen would result in one little dot in the middle of the screen. To make the signal level easier to see, the receiver duplicates the data so a flat horizontal line goes across the entire display.

FREQUENCY LIST

Allows you to enter a list of frequencies, or frequency spans, for measurement. For non-synthesized sources, the receiver sets the source to CW mode and tunes it to each frequency point in the list. For synthesized sources, the source is phase-locked at each frequency point, as in the Step sweep mode.

Frequency/Time Domain Stimulus Controls

Before you select Frequency List mode, create a list of frequencies to measure. This process is explained in “Frequency List Mode”, later in this chapter.

Selecting a Sweep Mode

To select a source mode:

1. Press STIMULUS (MENU). The current source mode is underlined.
2. Use the corresponding softkey to select the source mode: RAMP STEP SINGLE POINT or FREQUENCY LIST.

You may switch between Ramp, Step, Single Point, and Frequency List modes at any time.

Entering Ramp, Step, and Single Point Stimulus Values

For Ramp and Step sweep modes, enter the frequency span using the (START), (STOP), (CENTER), and (SPAN) controls. To select another frequency in the single point mode, press (CENTER) and the annotation C.W. will appear in the active entry area. Now enter the new frequency using the knob, step, or numeric keys.

Speed of Ramp, and Step Modes (in HP 8511 systems)

When using 64 averages or less, taking one sweep in Step or Frequency List modes takes the same time as approximately 100 sweeps in the Ramp Mode. This comparison assumes you are using Normal Step mode. If your RF source supports Quick Step mode, Step Sweep measurement speed can be increased up to six times. Notice that measurement time at each step changes very little until averaging factor is set to 128 or greater. Quick Step mode requires the STOP SWEEP and SOURCE TRIGGER (BNC cables) to be connected between the receiver and RF source. (Quick Step mode does not function in a system that uses multiple sources.)

More information on Quick Step mode is provided in Chapter 17.

Frequency List Mode

Frequency List allows you to measure arbitrary frequencies, or frequency bands. The frequency list is made up of segments and each segment may consist of a single CW frequency or a frequency span. The span may be specified using start/stop or center/span keys. You can select the number of data points to be acquired by choosing a *frequency step size* or a *number of points*.

Before you select Frequency List mode, you must enter a list of frequencies to measure. If the Frequency List mode is selected and a frequency list has not been created, the message FREQUENCY LIST EMPTY appears and the sweep mode is not changed.

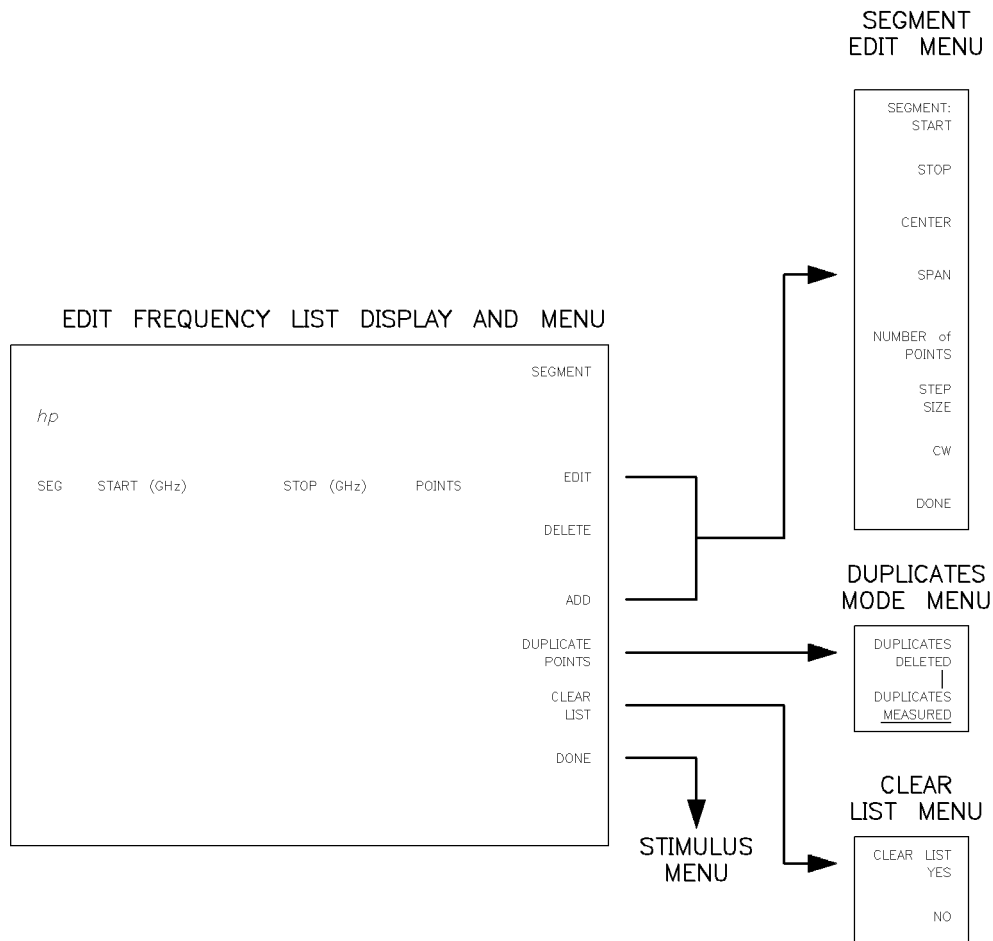

Figure 6-7. Frequency List Menu Structure

Creating a Frequency List

The following instructions explain how to create and edit a frequency list.

Entering the First Segment

To create a frequency list:

1. Press **STIMULUS** (**MENU**), **MORE**, then **EDIT LIST**. The Frequency List menu appears as shown above.
2. Press **ADD**, the first segment appears.
3. Press **SEGMENT: START** and enter the start frequency of the first segment.
4. Press **SEGMENT: STOP** and enter the stop frequency of the segment.
5. Press **SEGMENT: STEP SIZE** and enter the frequency step.
6. Press **SEGMENT: DONE**. Now press **DONE** again to return to the main Stimulus menu, then press **FREQUENCY LIST**. The sweep of the frequency list now begins.

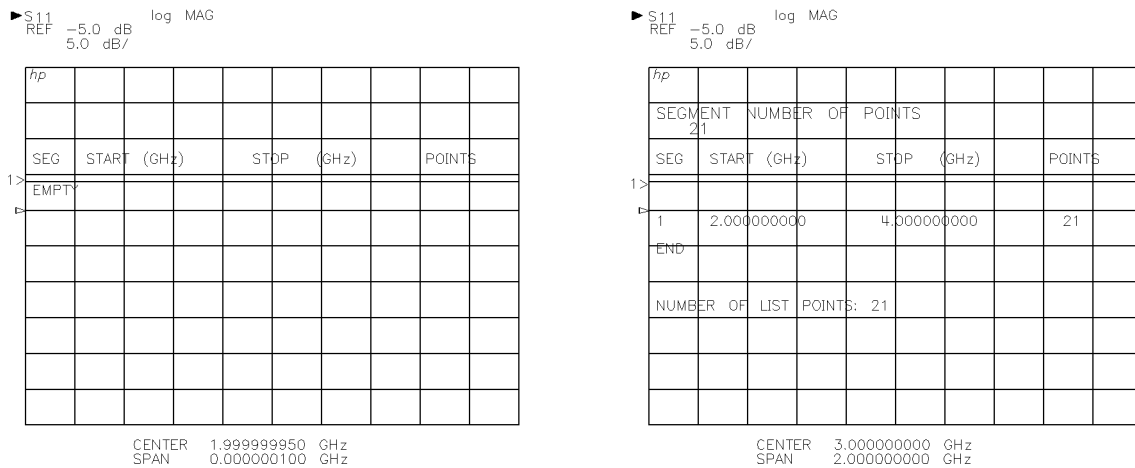

Figure 6-8. Enter the First Segment

Add Segments

To add a segment to the list:

1. Press **EDIT LIST**, then press **ADD**. Each time you press **ADD** the current segment is duplicated.
2. Enter new segment values by following the instructions given previously, then press **SEGMENT: DONE**.

The segments do not have to be entered in any particular order, they are sorted automatically by start or CW frequency each time you press **SEGMENT: DONE**. If you try to add more than the maximum allowed number of segments or frequency points, a warning message is displayed.

Frequency/Time Domain Stimulus Controls

Editing the Frequency List

Changing a Segment

To change the contents of the list, press **EDIT LIST** to display the edit Frequency List menu, press **SEGMENT** to choose a segment, then press **EDIT**.

The **SEGMENT** key determines the segment to be edited or deleted. Press **SEGMENT** then enter the number of the segment in the list or use the knob or step keys to scroll the pointer > to the segment number. Press **EDIT** to edit the current segment. The segment edit menu appears, allowing you to change any of the segment characteristics.

Please note that the **(START)**, **(STOP)**, **(CENTER)**, and **(SPAN)** keys in the Stimulus block are not used during the frequency list editing process.

For example, enter a frequency list as follows:

1. Press **STIMULUS (MENU), MORE EDIT LIST**.
2. Press the following keys:
 - a. **ADD SEGMENT: START (2) (G/n)**.
 - b. **SEGMENT: STOP (4) (G/n)**.
 - c. **SEGMENT: STEP SIZE (100) (M/μ)**.
 - d. **SEGMENT: DONE DONE FREQUENCY LIST**.

The frequency list sweep starts.

In the Frequency List mode, you can edit, add, and delete the segments while making a measurement. When you press **SEGMENT: DONE**, the frequency list segments are arranged in ascending order and the measurement restarts using the new frequencies.

Deleting a Segment

When you press **DELETE** the current segment is deleted.

Adding a Segment

Now add a segment to the list as follows:

1. Press **STIMULUS (MENU) MORE EDIT LIST**.
2. Press the following:
 - a. **ADD SEGMENT: START (4) (G/n)**
 - b. **SEGMENT: STOP (8) (G/n)**
 - c. **SEGMENT: STEP SIZE (200) (M/μ)**
 - d. **SEGMENT: DONE**

The sweep restarts and the new list is measured.

Duplicate Points

If you followed the above sequence, notice that the point at 4 GHz is brighter. This is because it is being measured and plotted twice. Later, in the Printing and Plotting chapter, you will see that you can print the list of measured frequencies and values in tabular format. If you performed this operation you would see that 4 GHz is listed twice. If this is an undesired duplication, press **DUPLICATE POINTS**, then **DUPLICATES DELETED**. The sweep is restarted and any duplicate point is measured and displayed only once.

Frequency List Save and Recall

Of course you may save the current frequency list in the same way as any instrument state is saved, by using the **(SAVE)** and **(RECALL)** keys.

Selecting All Segments or a Single Segment

It is very convenient to define all segments of the frequency list, perform the measurement calibration, and then select a single segment for viewing. This simplifies measurement calibration because all segments are calibrated with a single connection of the standards and speeds the measurement process because you can examine only the segment of interest for the current test.

When you press **FREQUENCY LIST** with more than one segment defined, the menu allows selection of either **ALL SEGMENTS** or **SINGLE SEGMENT**. Press **SINGLE SEGMENT** to cause the current selected segment to become the active segment and the receiver to measure that segment. Use the step keys, knob, or numeric entry to select the segment for measurement.

Figure 6-9 shows the display when the complete frequency list is swept, then after a single segment is selected. The current listing of frequency list segments is displayed with the arrow pointing to the current segment. If you do not want the frequency list displayed, press **STIMULUS (MENU)** and it disappears but segment number remains the active function. Note that the Stimulus values at the bottom of the screen show the actual frequency range being measured and that Correction remains ON.

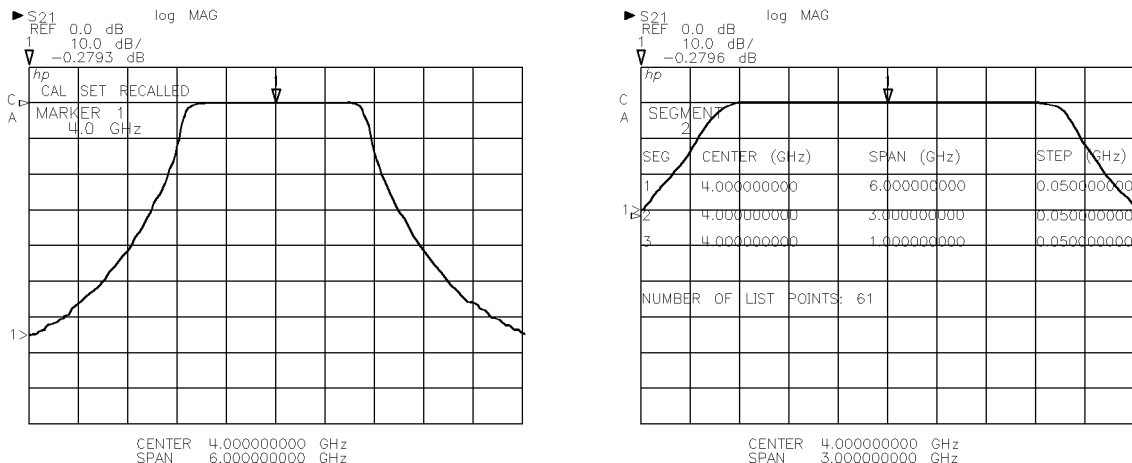

Figure 6-9. Frequency List, Display of Single Segment

Frequency/Time Domain Stimulus Controls

Exit Frequency List

To exit the Frequency List mode, press STIMULUS (MENU), then press RAMP, STEP, or SINGLE POINT. The frequency endpoints of the frequency list are used for the Ramp or Step sweep.

FACTORY PRESET clears the frequency list and selects DUPLICATES MEASURED.

Sweep Time

In Ramp mode, pressing STIMULUS (MENU) displays the SWEEP TIME softkey. This function allows you to change the amount of time it takes to complete a frequency sweep. If you have selected Step or Frequency List mode, SWEEP TIME changes to DWELL TIME. Dwell time is the amount of time the receiver waits before measuring the data *after* the source has settled at the next frequency point.

To change the sweep time:

1. Press STIMULUS (MENU), SWEEP TIME. The current value appears in the active entry area.
2. Use the ENTRY block controls to set the new sweep time. Terminate with one of the following keys:
 - (k/m) milliseconds
 - (x1) seconds

If the sweep time/dwell time selected is faster than the DUT response time, the measurement response will be distorted. Distortion of the trace, or an error message, indicates that the sweep is too fast.

Usually, the optimum sweep time can be determined using the formula:

$$\text{Sweep Time (s)} > [\text{Span (GHz)} \times \text{Group Delay (ns)}] / 100$$

The length of the dwell time can be determined by using the formula:

$$\text{Dwell Time (ms)} = \text{Sweep Time (ms)} \div (\text{Number of Points} - 1)$$

Select the fastest possible sweep time or the shortest possible dwell time that does not result in distortion of the trace. In the Ramp sweep mode, the Factory Preset state selects a sweep time of 166.0 ms/sweep for 51, 101, 201, and 401 points, or 184 ms/sweep for 801 points.

Distortion Caused by Excessively-Fast Sweep Time

Measurements using far field ranges, or narrow band antennas, may be sensitive to sweep time. Two conditions, coupled with a fast sweep time, can distort a measurement:

- If the sweep width is wider than the device's bandwidth.
- If there is a significant delay between the transmitter and the device under test.

This occurs because the device does not have time to respond fully to the Stimulus signal. If distortion is occurring, the trace will change when the sweep time is slowed. The following example shows the effects of this type of distortion.

Example: Effects of Sweep Time

If you use a far field range, or test narrow-band antennas (such as narrow-band flat plate antennas), determine optimum sweep speed as follows:

1. Set up the measurement and notice the appearance of the trace at the Preset sweep time.
2. Store this trace in memory by pressing (DISPLAY), DATA→MEMORY, DISPLAY: DATA and MEMORY .
3. Then use the Stimulus menu to set the sweep time to 110 milliseconds/sweep.
4. Compare the new trace to the original. Store this new trace by pressing (DISPLAY), DATA→MEMORY and change the sweep time again.
5. Repeat this process until you reach the fastest possible sweep time with no change in the trace. This is the optimum sweep time for that device using that frequency span and number of points.

Instructions for storing and comparing traces are provided in the “Display” section of this manual.

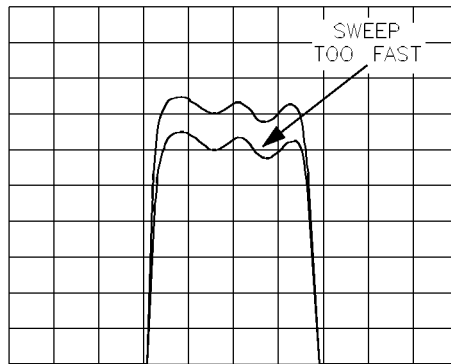

Figure 6-10. Effects of Sweep Time

Sweep Execution, Hold/Single/Number of Groups/Continual

You can choose the number of frequency sweeps, or angle scans, using the **HOLD**, **SINGLE**, **NUMBER of GROUPS**, and **CONTINUAL** softkeys. These softkeys are available when you press **STIMULUS** **(MENU)** **MORE**.

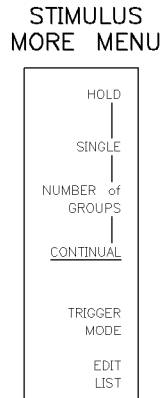

Figure 6-11. Stimulus More Menu

HOLD

Hold mode stops the measurement process. Most processing functions can be changed while in this mode unless they require additional sweeps. When in this mode the enhancement annotation **H** appears on the display. This is the mode you should use when loading data files from disk. When you load data in Hold mode, the receiver will process it according to current instrument settings and display it on the screen.

SINGLE

This softkey executes a measurement restart, takes a single group of sweeps, and then places the receiver in **HOLD** mode.

NUMBER of GROUPS

This softkey initiates a specific number of measurement sweeps, then places the receiver in Hold mode. To enter a number of groups, press **NUMBER OF GROUPS** followed by a numeric entry and **(x1)**. Entering a number of groups automatically forces a measurement restart.

After the group is finished an **H** appears in the annotation area, showing that the receiver is in Hold mode. You may restart the number of groups at any time by entering a number and pressing **(x1)**.

CONTINUAL

In this mode the receiver continually executes the sweeps required to produce a measurement. This is the Factory Preset selection.

To resume continual operation, press **CONTINUAL** at any time.

Why use Number of Groups?

A group of sweeps consists of the number of frequency sweeps necessary to present data for the current measurement. For example, if in Ramp sweep mode with averaging on, the trace is fully averaged by $n+1$ groups of sweeps, where n is the averaging factor. Number of Groups can be used to signify that the measurement is complete. If the Averaging Factor is 16, then press **NUMBER of GROUPS**, enter 17, **(x1)**. When the measurement is complete, the receiver goes into the Hold mode.

Using Step sweep or Frequency List, 1 sweep always equals 1 group because all necessary data is taken at each frequency step. Regardless of the averaging factor you may enter **NUMBER of GROUPS**, **(1) (x1)** for this configuration.

Coupled/Uncoupled Channels

Most features in the receiver are uncoupled, which means you can choose different settings in each channel. Many Stimulus settings, however, are coupled (if you change a coupled setting in one channel, it affects the other channel as well).

How to tell if a function is coupled

To determine if any given function is coupled or uncoupled, make it the active function. Press **(CHANNEL 1)**, change the function value, and then press **(CHANNEL 2)**. If the active function value shown for Channel 2 has also changed, the two channels are coupled. Otherwise the function is always uncoupled and can be set independently. The *HP 8530A Keyword Dictionary* explains whether any given function is coupled or uncoupled.

Setting Stimulus Power

The following paragraphs describe controls for setting and monitoring RF power.

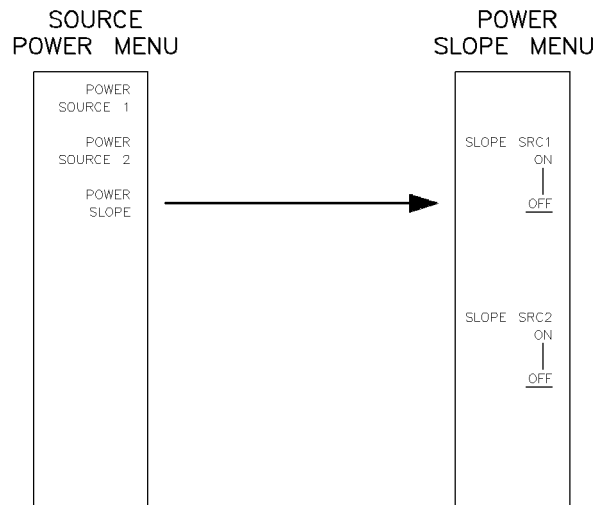

Figure 6-12. Source Power Menu

Stimulus Controls Applicable to All Domains

Setting Source Output Power

The **POWER SOURCE 1** softkey allows you to set the RF source's output power. The output power setting applies to the power at the source's RF OUTPUT connector. After Factory Preset, the source RF power level is usually set to +10 dBm. In most applications this level does not need to be changed.

Be aware of your source's maximum power output, especially at higher frequencies.

Maximum power from RF sources is generally less at higher frequencies. If the sources UNLEVELED indicator comes on you are requesting more power than the source can produce *across the selected frequency band*. It is not harmful for the source to operate *unleveled*. Also, unleveled power usually does not affect ratioed measurements.

If you need to change RF source power, perform the following steps:

1. Press STIMULUS (MENU) **POWER MENU** **POWER SOURCE 1**. The current value appears on the display.
2. Use the ENTRY block controls to set the new source power level. Press the (x1) key to set the source RF power in dBm.

Messages appear on the display if the selected power is too low or too high for proper receiver operation:

IF OVERLOAD indicates that the power level is too high for the receiver inputs.

PHASE LOCK LOST, NO IF FOUND, VTO FAILURE, or similar messages indicate that the receiver is not getting enough power to make measurements. This may be caused by the RF power being too low, or by a problem (incorrect connections or a failure) in the measurement system.

Remember that (ENTRY OFF) must be pressed to clear an error message, it does not go away automatically when you correct the problem.

Please note that all keys associated with a second source (source 2) apply to Multiple Source applications and are described in Chapter 17.

Using Power Slope

RF source power is internally leveled at its RF output. However, at times it is necessary to compensate for losses through cables, or some other system problem. The power slope function enters a power offset that increases as the frequency sweep progresses. The common use for this feature is to compensate for higher cable losses as frequency increases, thus preserving dynamic range.

Press **POWER SLOPE** **SLOPE SRC1 ON** and enter a positive or negative power slope offset in dB/GHz. Input a positive offset if you are compensating for cable losses. The source will start the next sweep at the base power setting, then increase (or decrease) power as the sweep progresses. Press **SLOPE SRC1 OFF** to turn off the power slope function. Factory Preset selects slope off.

Trigger Modes

Pressing STIMULUS **(MENU)** MORE TRIGGER MODE shows the following menu:

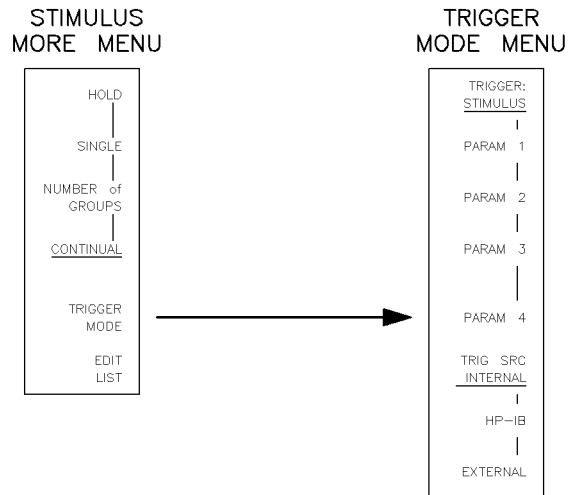

Figure 6-13. Trigger Mode Menu

The Three Triggering Modes

The HP 8530A provides three trigger modes. Press STIMULUS **(MENU)** MORE TRIGGER MODE , then one of the following:

TRIG SRC INTERNAL

In Angle Domain, internal triggering is appropriate when using the HP 85370A Position Encoder. If you *do not* use the Position Encoder, use External Trigger or HP-IB Trigger (described below). Internal triggering causes the receiver to trigger itself automatically.

TRIG SRC HP-IB

HP-IB Trigger. In this mode a computer controller must issue a GET command over the HP-IB bus to start a measurement. The receiver pulls the rear panel STOP SWEEP BNC line (TTL) HIGH when ready to take data. More information on HP-IB triggering is supplied under “TRIG SRC HP-IB” in the keyword dictionary.

TRIG SRC EXTERNAL

This mode is appropriate if your system *does not* use the HP 85370A Position Encoder. This trigger mode starts a measurement when a negative-edge TTL signal arrives at the rear panel EVENT TRIGGER input BNC. The trigger pulse usually comes from the positioner controller’s INCREMENT Trigger output. This allows the positioner to trigger a measurement at each increment angle. The receiver pulls the rear panel STOP SWEEP BNC line (TTL) HIGH when ready to take data.

The annotation **E** appears on the left-hand side of the display if you are using external or HP-IB triggering. Trigger settings are stored with the instrument hardware state, not with the instrument state.

Stimulus Controls Applicable to All Domains

External and HP-IB Triggering Controls

When you select HP-IB or external triggering, the trigger menu softkeys `TRIGGER: STIMULUS`, and `TRIGGER: PARAM 1` through `TRIGGER: PARAM 4` become active. When selected, these keys make the receiver wait for a trigger before measuring a specific parameter or before moving to the next stimulus point.

Here is a description of each trigger control softkey:

<code>TRIGGER: STIMULUS</code>	When turned ON (underlined), <code>TRIGGER: STIMULUS</code> forces the receiver to wait for a trigger before moving to the next stimulus point. (This is the next angle in Angle Domain, or the next frequency in Frequency Domain.) <code>TRIGGER: STIMULUS</code> allows you to use RF sources that are not compatible with the HP 8530A System Bus.
<code>TRIGGER: PARAM 1</code>	When turned ON, the receiver to waits for a trigger pulse before measuring parameter 1.
<code>TRIGGER: PARAM 2</code>	When turned ON, the receiver to waits for a trigger pulse before measuring parameter 2.
<code>TRIGGER: PARAM 3</code>	When turned ON, the receiver waits for a trigger pulse before measuring parameter 3.
<code>TRIGGER: PARAM 4</code>	When turned ON, the receiver waits for a trigger pulse before measuring parameter 4.

Each of these softkeys is an ON/OFF toggle, and you can turn them on or off in any combination. When a softkey title is underlined, that function is ON. When the title is not underlined, the function is OFF.

How these Functions Work when One Parameter is Being Measured

The `TRIGGER: STIMULUS` function can always be used. However, the `TRIGGER: PARAM` functions work differently. If you are only displaying (measuring) one parameter, only the `TRIGGER: PARAM` softkey for *that* parameter will effect triggering.

For example, if you are viewing parameter 2, as shown in Figure 6-14, only the `TRIGGER: PARAM 2` softkey will work. The other parameter-related softkeys `TRIGGER: PARAM 1`, `TRIGGER: PARAM 3`, and `TRIGGER: PARAM 4` will be ignored, because these parameters are not being measured.

**Custom External Triggering:
1 Parameter Displayed
(Parameter #2)**

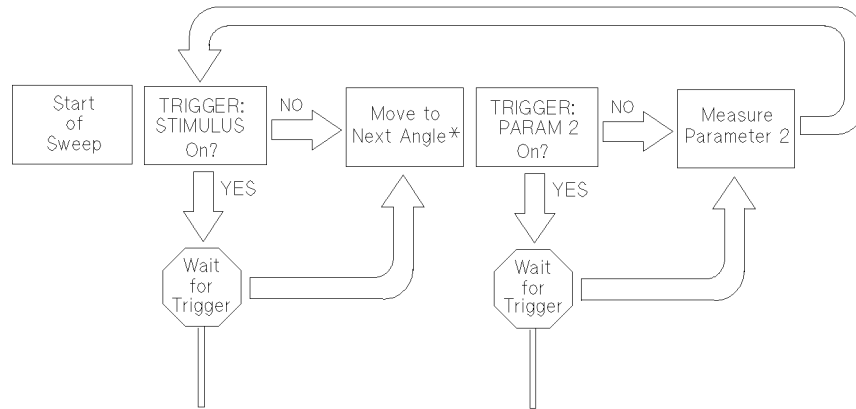

*At the beginning of the sweep this is the start angle

Figure 6-14. Custom External Triggering Flowchart (one parameter)

How these Functions Work when Multiple Parameters are Being Measured

If more than one parameter is being measured, the receiver will check the ON/OFF condition of each softkey (TRIGGER: PARAM 1, TRIGGER: PARAM 2, TRIGGER: PARAM 3, and TRIGGER: PARAM 4) before it measures them. Refer to Figure 6-15. If TRIGGER: PARAM 1 is on, for example, the receiver will wait for a trigger before it measures parameter 1. This process repeats for each parameter.

EXAMPLE 1.

TRIGGER: STIMULUS	ON
TRIGGER: PARAM 1	OFF
TRIGGER: PARAM 2	OFF
TRIGGER: PARAM 3	OFF
TRIGGER: PARAM 4	OFF

In this example, the receiver will:

1. Wait for one trigger before moving to the initial angle or frequency (stimulus value).
2. When the trigger arrives, the receiver will move to the initial stimulus value (start frequency or start angle), then measure *all four* parameters.
3. This process repeats for each successive stimulus value.

Note that only one trigger is required per stimulus point. Thus, the receiver can trigger off the Record Increment output from a positioner controller.

The most common use for TRIGGER: STIMULUS is when using an RF source that is not controlled by the HP 8530. TRIGGER: STIMULUS allows you to move the source to the next stimulus point, then have the receiver make the measurement.

EXAMPLE 2.

TRIGGER: STIMULUS	OFF
TRIGGER: PARAM 1	ON
TRIGGER: PARAM 2	OFF
TRIGGER: PARAM 3	OFF
TRIGGER: PARAM 4	OFF

Stimulus Controls Applicable to All Domains

In this example, the receiver will:

1. Proceed immediately to the first stimulus point, then wait for a trigger pulse before measuring parameter 1.
2. When the trigger arrives, the receiver will measure *all four* parameters. Why? Since the other three “wait for a trigger” softkeys are OFF, they will be measured along with parameter 1.
3. This process repeats for each successive stimulus point.

This configuration is the default external trigger setup, and will work if using the Record Increment from a positioner controller. Remember, only displayed parameters are measured. If you only have Parameters 1, 2, and 3 on the display, Parameter 4 will not be measured.

EXAMPLE 3:.

```
TRIGGER: STIMULUS   OFF
TRIGGER: PARAM 1    ON
TRIGGER: PARAM 2    OFF
TRIGGER: PARAM 3    ON
TRIGGER: PARAM 4    OFF
```

In this example, the receiver will:

1. Proceed immediately to the first stimulus point, then wait for a trigger pulse before measuring parameter 1.
2. When the trigger arrives, the receiver will measure parameters 1 and 2, then it will stop and wait for another trigger.
3. When the second trigger arrives, the receiver will measure parameters 3 and 4.
4. This process repeats for each successive stimulus point.

This setup could be used if you need to measure two parameters, then switch inputs using external hardware (before measuring the second two parameters).

Note If you are in External Trigger mode, and you turn all five softkeys OFF, the receiver will never wait for any triggers. Instead, it would “free run” as if it were in the Internal Trigger mode. *However*, the HP 85370A Position Encoder would not work properly in this case. The Encoder requires that you select the actual Internal Trigger mode (`TRIG SRC INTERNAL`) or it will not operate properly.

Stimulus Controls Applicable to All Domains

Custom External Triggering: 4 Parameters Displayed

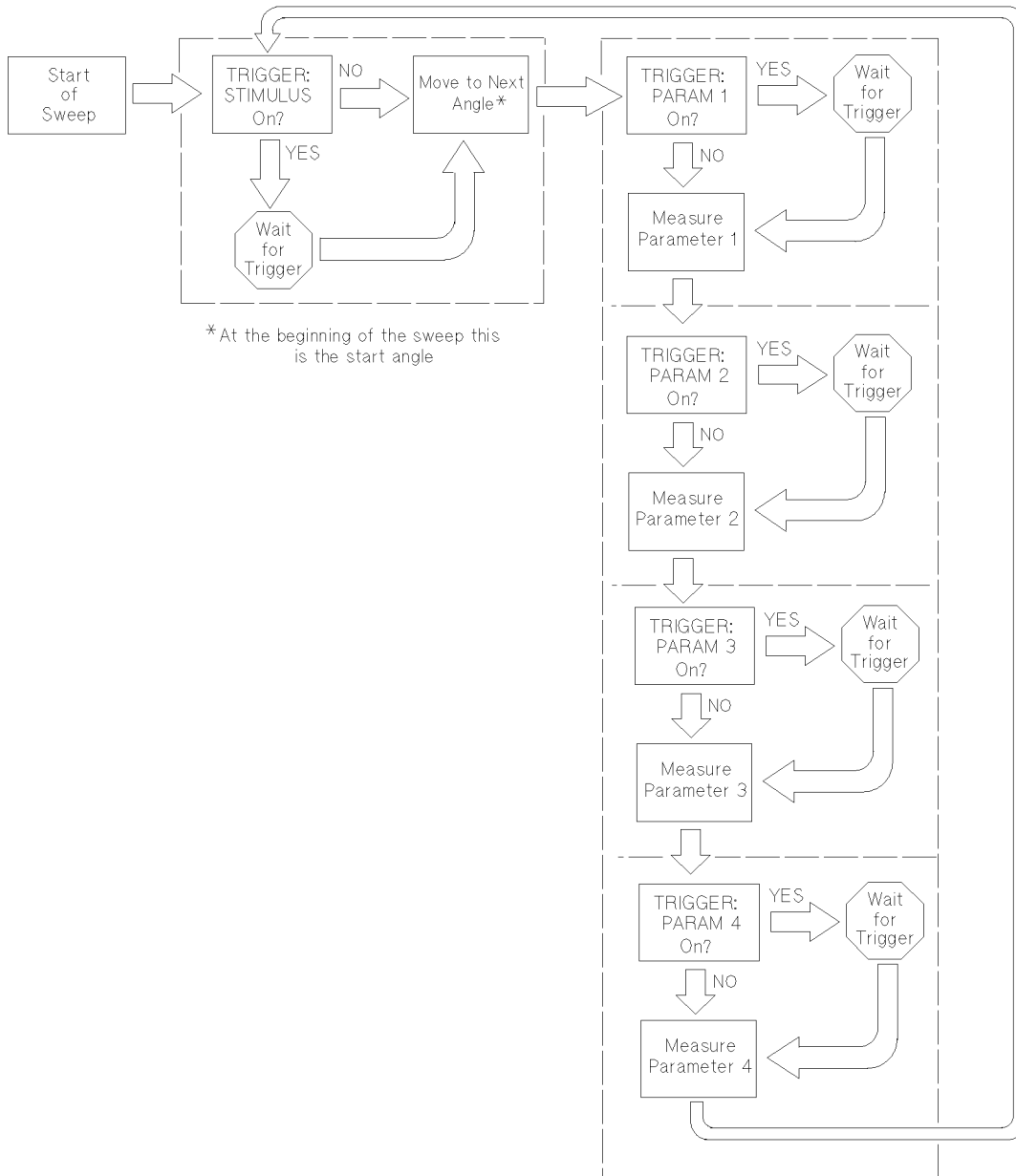

Figure 6-15. Custom External Triggering Flowchart (four parameters)

Parameter Functions

PARAMETER block keys select the parameter to be measured and displayed. The Parameter *menus* allow you to measure the signal levels on the four receiver inputs, and change Basic Parameter definitions.

Chapter Contents

- Basic Parameters
- Parameter Menu
- Service Parameters
- Redefining Parameters
- Changing the Display Title

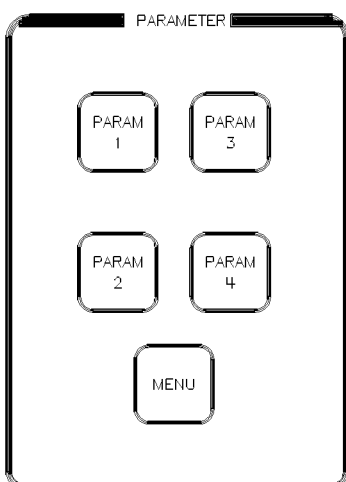

Figure 7-1. Parameter Function Block

Parameter Functions

Basic Parameters

The **PARAM 1**, **PARAM 2**, **PARAM 3**, and **PARAM 4** keys select the “Basic Parameter” to be measured and displayed. The label P1, P2, P3, or P4 appears above the measurement graticule, showing which parameter you selected. By default, Basic Parameters select ratioed measurements.

Parameter Menu

Pressing the **PARAMETER (MENU)** key displays the Parameter menu. This menu (and the menus under it) allow you to:

- Select Service Parameters, which allow you to measure the signal levels arriving at the receiver inputs.
- Change the definitions of the four Basic Parameters.
- Change the display title (annotation).

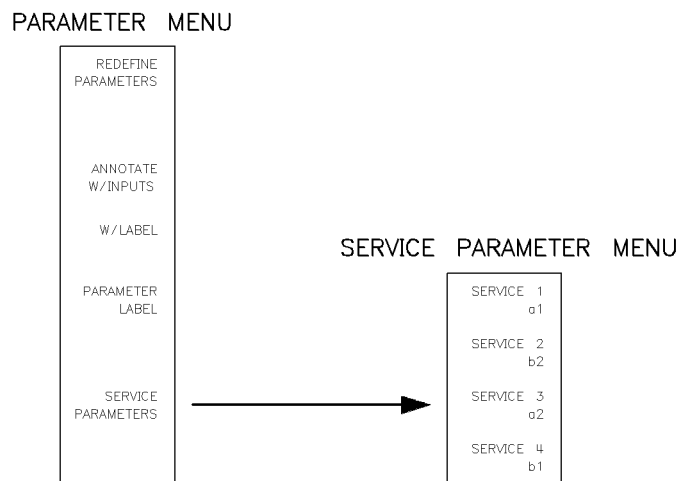

Figure 7-2. Parameter Menu

Service Parameters

SERVICE 1 a1, **SERVICE 2 b2**, **SERVICE 3 a2**, and **SERVICE 4 b1**, allow you to measure the unratioed power at the receiver a1, a2, b1, or b2 inputs.

For example, press **PARAMETER (MENU)**, then **SERVICE 1 a1**. Figure 7-3 shows a typical display of this measurement. This display represents the power incident at the a1 input, which is often the reference signal for antenna/RCS measurements. Now select **SERVICE 2 b2**. This measures the b2 input, which is often a reference signal input.

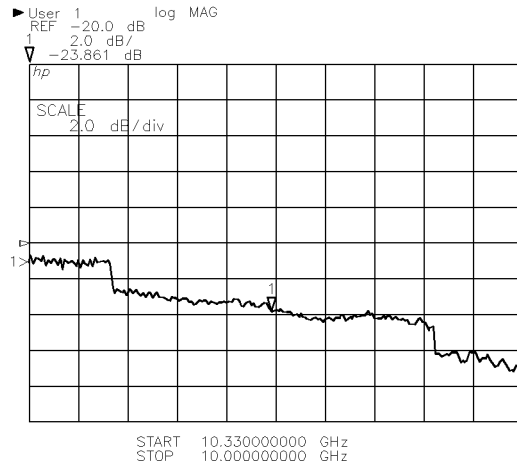

Figure 7-3. Typical SERVICE 1, a1 Measurement

Power Accuracy of Service Parameter Measurements

Service Parameter measurements are not displayed with power meter accuracy, and they do not compensate for the frequency response and conversion loss of HP 8530A internal components. However, these service parameters, when properly used, are of great value in setting up the receiver to achieve maximum accuracy and dynamic range.

Redefining Parameters

Redefining parameters makes it possible to:

- Select a1 or a2 as the phase lock input.
- Change the measurement ratio for any of the four Basic Parameters.

FACTORY PRESET restores all basic and service parameter definitions to their standard values.

Table 7-1 lists the standard parameter definitions selected when the **FACTORY PRESET** key is pressed.

Table 7-1. Standard PARAMETER Definitions

Function	Parameters							
	Basic				Service			
	Param 1	Param 2	Param 3	Param 4	a1	b2	a2	b1
Drive Port	1	1	1	1	1	1	1	1
Phase Lock	a1	a1	a1	a1	a1	a1	a1	a1
Numerator	b1	b2	a2	b1	a1	b2	a2	b1
Denominator	a1	a1	a1	a1	NO RATIO			
Conversion	OFF	OFF	OFF	OFF	OFF	OFF	OFF	OFF

Parameter Functions

Descriptions of Each Definition Type

DRIVE	This selects the RF power drive port if using an S-parameter test set.
PHASE LOCK	This selects which reference input, a1 or a2, is the phase lock reference. It is possible to input the test signal on one reference input (a1 for example) and use the other for the phase lock reference. The input you select in this menu should reflect the input receiving the phase lock signal. This is valuable if your reference signal is not suitable for phase locking (for example, if it is less than 40 dBm, or if it is pulsed—as with a hardware gating system).
NUMERATOR	Selects the input which will be the numerator in a ratioed measurement. The SERVICE FUNCTIONS softkey accesses a series of functions which are related to troubleshooting and repair of the instrument, and have no operational use.
DENOMINATOR	Selects the input which will be the denominator in a ratioed measurement. If you select NO RATIO the input defined as the numerator will be measured in a non-ratioed fashion. The b2 input cannot be selected as a denominator. You can get around this limitation using the Conversion feature, described below:
CONVERSION	As mentioned in the denominator description, you cannot select b2 as the denominator in a measurement. Here is an example of how to get around this limitation: Assume you need to measure b1/b2, (you are using a1 or a2 for your phase locking signal). All you must do is select a b2/b1 measurement, and press CONVERSION 1/PARAM . This measures b2/b1, but inverts the measurement mathematically, resulting in b1/b2 data.

Redefine Basic Parameters

To redefine one of the basic parameters (PARAM 1, PARAM 2, PARAM 3, PARAM 4):

1. Press **PARAMETER (MENU)**.
2. Press the front-panel key in the **PARAMETER** block that corresponds to the parameter to be redefined: **(PARAM 1)**, **(PARAM 2)**, **(PARAM 3)**, or **(PARAM 4)**.
3. Press **REDEFINE PARAMETER**. This displays the redefine parameter menu.
4. Use the softkeys to choose the phase lock, numerator, denominator, and conversion definitions to be used in the new definition of the parameter:

Press the softkey corresponding to the item on the redefine parameter menu to be redefined. This displays a menu of the available choices, and the current selection is underlined. Press the softkey corresponding to the new definition.

Changes are executed immediately when the softkey corresponding to the new definition is pressed.

5. When the parameter has been redefined, press **REDEFINE DONE** to save the state that has been defined. Now each time you select this parameter, your definition is displayed.

Please note that Factory Preset restores the standard definitions given in Table 7-1. Redefined basic parameters cannot be recalled as part of an instrument state.

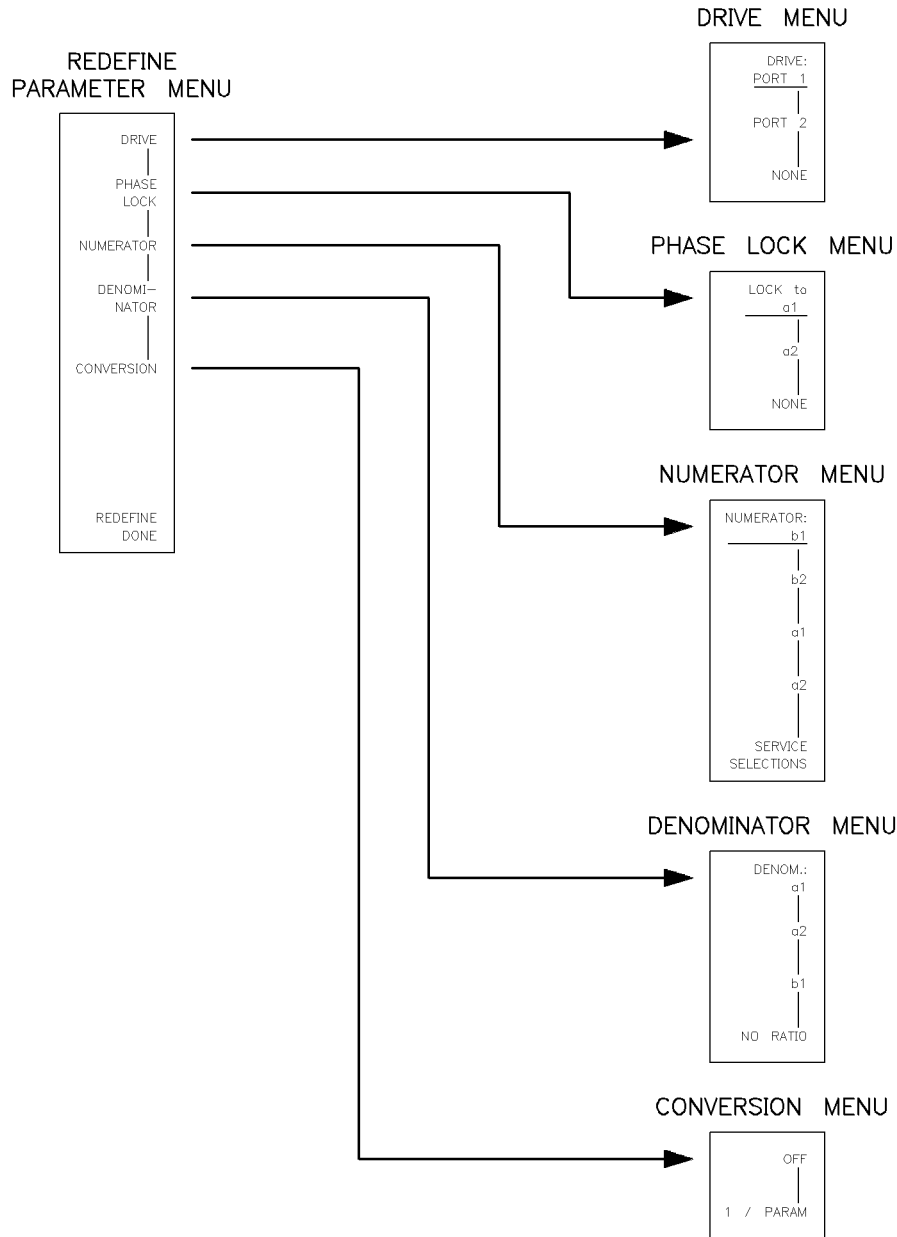

Figure 7-4. Redefine Parameter menu Structure

Changing the Display Title

Each displayed measurement has an annotation (a title), above it. By default, this title displays the ratio for that measurement (b1/a1, for example). You can change the annotation to a user-selected alpha-numeric title. Here's how:

1. Press: **PARAMETER** (MENU) **PARAMETER LABEL**
2. Use the label-maker menu to select a 5 character label, press **TITLE DONE** when you finish.
3. Press: **ANNOTATE W/LABEL**

To revert back to the measurement ratio as a title, press: **ANNOTATE W/INPUT**

Format Functions

Introduction

Format block keys and the Format menu, shown in Figure 8-1, allow choices of the format used in displaying the measurement. Any format may be chosen for any parameter.

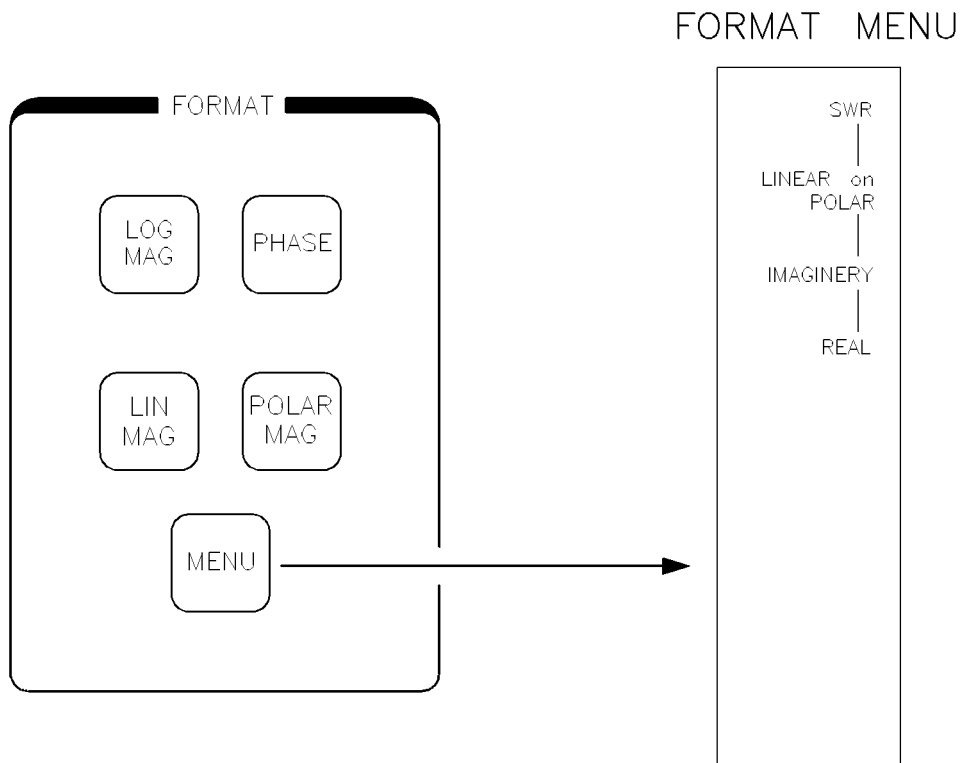

Figure 8-1. Format Function Block and Format Menu

Display Format Keys

The following formats are available from the main front panel Format keys:

- | | |
|------------------|--|
| LOG MAG | Displays magnitude data in Cartesian logarithmic format. |
| PHASE | Displays phase data in Cartesian format. |
| LIN MAG | Displays magnitude data in Cartesian linear format. |
| POLAR MAG | Displays magnitude data in logarithmic polar format. |

Format Functions

Format Menu Softkeys

The following formats are available when you press **FORMAT** **(MENU)**:

SWR	Standing Wave Ratio in Cartesian format.
LINEAR on POLAR	Magnitude data in linear polar format.
REAL	Shows the real portion of the measurement data in Cartesian format.
IMAGINARY	Shows the imaginary portion of the measurement data in Cartesian format.

Important Information Regarding Polar Format

“Polar display format” in Angle Domain is completely different from polar format in Frequency Domain. Refer to Figure 8-2.

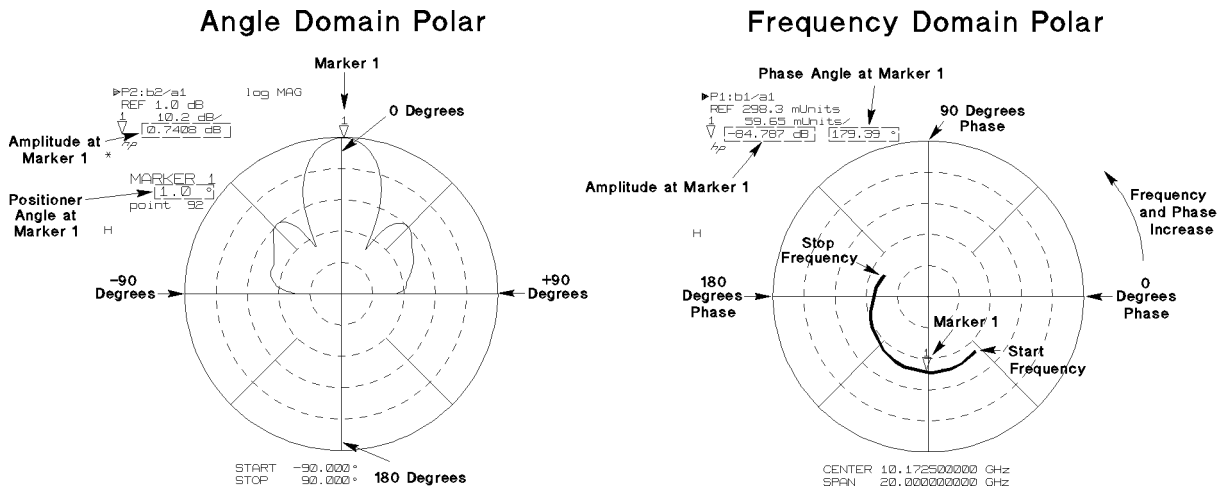

Figure 8-2. Differences in Angle and Frequency Domain Polar Formats

Polar in the Angle Domain

The polar display (on the left) shows the radiation pattern of the antenna. The magnitude of the data (in dB or dBi) is displayed versus positioner angle. Zero degrees is located at the top-center part of the display. Increasing angle values proceed clockwise.

Polar in Frequency Domain

The polar display (on the right) shows the magnitude and phase response of the antenna (or device) under test versus angle. Zero degrees phase angle is at the right-hand side of the polar graticule, and increasing phase angles proceed counter-clockwise from zero.

Format Examples

The following pages show example display formats. The first two pages show all eight formats applicable to Frequency Domain. The last page shows formats typically used in Angle Domain.

The examples on the following pages explain the key and softkey commands used to set them up. Only display commands are given, steps on setting up the actual measurement are not included.

Cartesian Log Format

Refer to Figure 8-3. This is one of the most commonly used formats.

The sample measurement also uses all five markers. There are markers at the peak of the main lobe, at the -3 dB points, and at each main sidelobe. Also, delta markers are turned ON, with Marker 1 as the reference marker. Thus, Markers 2 through 5 show and logarithmic amplitude values relative to Marker 1. Marker use is explained in the Marker Functions section.

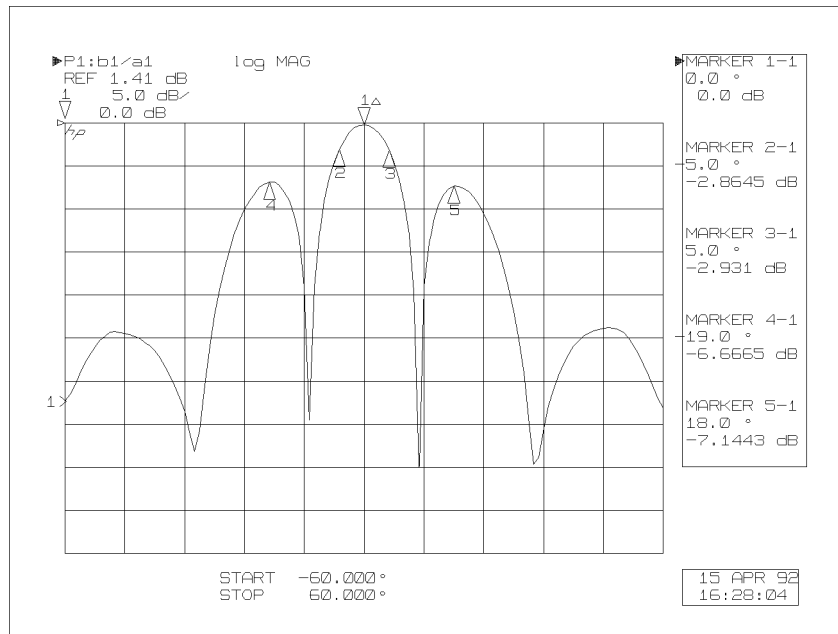

Figure 8-3. Cartesian Log Format for a Single Parameter

To set up your receiver for this type of display, perform the following steps:

1. Press: **LOG MAG**
2. Press **REF POSN** 10 **(x1)** (This sets the reference line to the top graticule).
3. Press **SCALE** 5 **(x1)** (This sets vertical scale to 5 dB per division).
4. After the measurement, the peak of the main lobe may go off the top of the screen. If this occurs, press **REF VALUE** and turn the knob clockwise until the peak is visible.

Format Functions

Polar Log Format

The polar logarithmic format is used often in antenna measurements. The sample shown in Figure 8-4 is an example of an Angle Domain measurement.

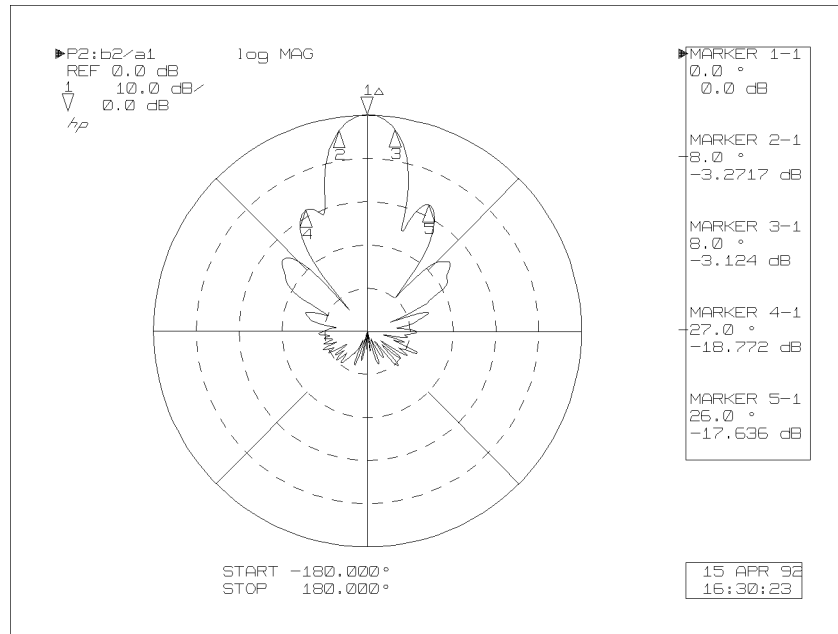

Figure 8-4. Polar Log Format for a Single Parameter

To set up your receiver for this type of display, perform the following steps:

1. Press: **(POLAR MAG)**
2. Press **(SCALE)** **(10)** **(x1)** (This sets vertical scale to 10 dB per division).
3. After the measurement, the peak of the main lobe may go off the top of the screen. If this occurs, press **(REF VALUE)** and turn the knob clockwise until the peak is visible.

Cartesian Log Format, Two Parameter Overlay

Figure 8-5 shows how you can view two traces at once. This figure shows the sum and the difference signals from a monopulse antenna.

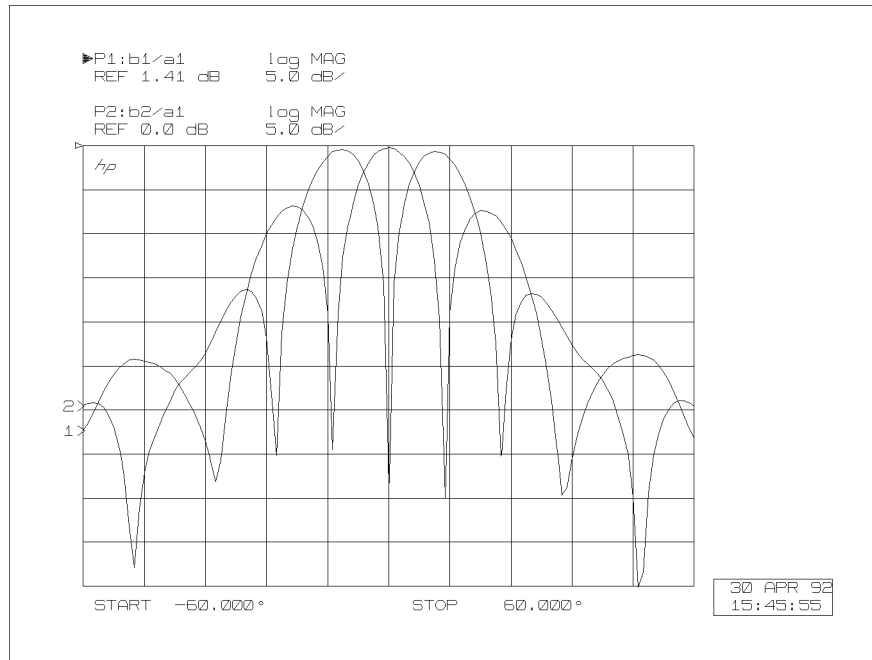

Figure 8-5. Dual Channel Overlay Display

To set up your receiver for this type of display, perform the following steps:

1. Set up the measurement. Measure one of the signals on Parameter 1, and the other on Parameter 2.
2. Press:
3. Press: **PARAM 1**
4. Press: **LOG MAG**
5. Press **REF POSN** 10 **(x1)** (This sets the reference line to the top graticule).
6. Press **SCALE** **5** **(x1)** (This sets vertical scale to 5 dB per division).
7. Press: **PARAM 2**
8. Press: **LOG MAG**
9. Press: **REF POSN** 10 **(x1)**
10. Press: **SCALE** **5** **(x1)**
11. After the measurement, the peak of the main lobe may go off the top of the screen. If this occurs, press **PARAM 1** **REF VALUE** and turn the knob clockwise until the peak is visible. If necessary, adjust the reference value of Parameter 2 as well.
12. You can show these two signals side by side by pressing: **DISPLAY** **DISPLAY MODE** **SPLIT**

Format Functions

Log Format, Dual Channel Split

Figure 8-6 shows how you can view two traces side by side. This figure also shows the sum and the difference signals from a monopulse antenna. Notice that this is a dual channel measurement. Dual channel measurements can do some things that simple two-parameter measurements cannot. The receiver sends the data for each channel through independent, parallel data processing paths. Because of this, there are several features you can set independently between the two channels. Time Domain processing, trace math, delay table, and smoothing can be ON in one channel and OFF in the other, or may have different settings.

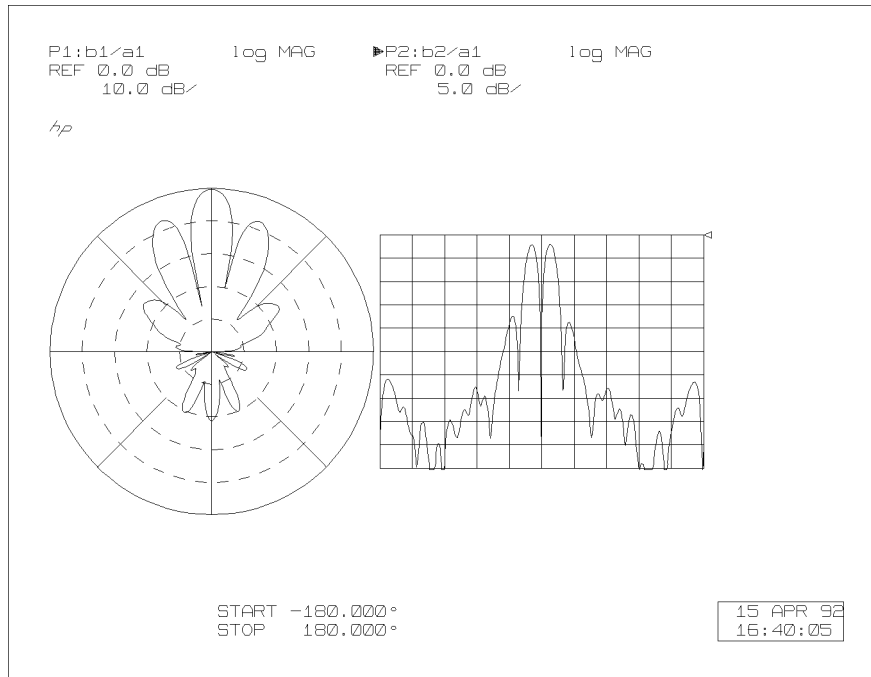

Figure 8-6. Dual Channel Split Display

To set up your receiver for this type of display, perform the following steps:

1. Press: **[DISPLAY] DISPLAY MODE DUAL CHANNEL SPLIT**
2. Press: **[CHANNEL 1] [PARAM 1] [POLAR MAG]**
3. Press **[SCALE] [7] [x1]** (This sets vertical scale to 7 dB per division).
4. Press: **[CHANNEL 2] [PARAM 2]**
5. Press: **[LOG MAG]**
6. Press: **[REF POSN] 10 [x1] [SCALE] [5] [x1]**
7. After the measurement, the peak of the main lobe may go off the top of the screen. If this occurs, press **[CHANNEL 1] [REF VALUE]** and turn the knob clockwise until the peak is visible. Note the actual reference value used.

Press **[CHANNEL 2]** and enter the same reference value as used in Channel 1.

Frequency and Time Domain Data Shown Simultaneously

Figure 8-7 shows frequency and time domain data placed on the screen at the same time. This is possible using dual channel display mode. Channel 1 is placed in Frequency Domain mode, and Channel 2 is placed in Time Domain mode.

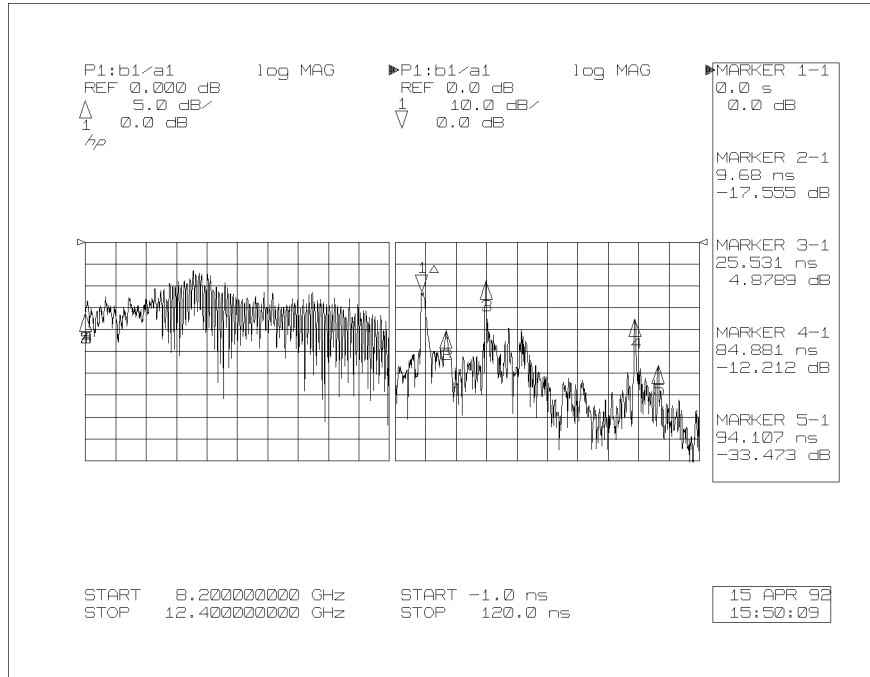

Figure 8-7. Frequency and Time Domain Display

To set up your receiver for this type of display, perform the following steps:

1. Press: **[DISPLAY]** **DISPLAY MODE** **DUAL CHANNEL** **SPLIT**
2. Press: **[CHANNEL 1]** **[DOMAIN]** **FREQUENCY** **[PARAM 1]**
3. Press: **[LOG MAG]**
4. Press: **[REF POSN]** **10** **[x1]** (This sets the reference line to the top graticule).
5. Press **[SCALE]** **5** **[x1]** (This sets vertical scale to 5 dB per division).
6. Press: **[CHANNEL 2]** **[PARAM 2]** **[LOG MAG]** **TIME BAND PASS**
7. Press: **[REF POSN]** **10** **[x1]**
8. Press: **[SCALE]** **10** **[x1]**
9. After the measurement, adjust scale and reference settings as required.

Response Functions

Response block function keys provide various options in positioning the trace and the reference line on the display. The associated Response menu structure offers selections for:

- Normalizing measurement data to the peak of the main lobe.
- Averaging and smoothing (noise reduction techniques).
- Adding magnitude slope and offset, and phase offset.
- Using electrical delay features.

Chapter Contents

- Changing Display Scale and Reference
- Response Menu
 - Normalizing Data
 - Magnitude Slope and Magnitude Offset
 - Phase Offset
 - 40 dB and 60 dB Pattern
 - Trace Averaging and Smoothing
 - Delay Features
 - Electrical Delay
 - Setting Velocity Factor
 - Auto Delay

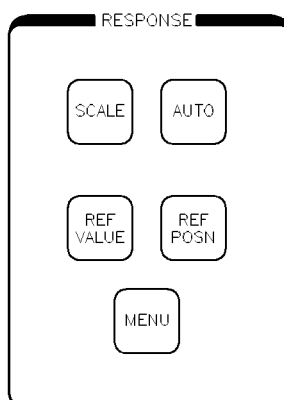

Figure 9-1. Response Function Block

Changing Display Scale and Reference

Setting Scale and Reference Values Automatically

Press **(AUTO)** to automatically select a scale and reference value that results in the display of the entire trace. You can make further adjustments as desired. For Cartesian displays, **(AUTO)** usually works best when the reference line is at the center of the measurement grid.

Changing Display Scale Manually

Press **(SCALE)**, and then use the knob, step, or numeric **(x1)** keys in the ENTRY block to change the scale/division value. The trace expands or contracts around the reference position line.

Changing the Position of the Reference Line Manually

Press **(REF POSN)** to move the reference position line on Cartesian displays. **(REF POSN)** does not function in polar displays.

The reference position line for Channel 1 is identified by the > indicator on the left of the graticule; for Channel 2 it is the < indicator on the right side of the graticule.

At Factory Preset **(REF POSN)** is set to 5. To move the reference position line, press **(REF POSN)**, and then use the knob, step, or numeric keys to change its position. If you use the numeric keys, 0 is the bottom graticule; 10 is the top graticule. Terminate a numeric entry with **(x1)**.

Changing the Value of the Reference Line Manually

Use **(REF VALUE)** and the knob, step, or numeric and units keys to assign a new value to the Cartesian reference position line or the polar outer circle. The trace is positioned relative to the reference position so changing the reference value moves the trace, but does not change the marker value. For polar displays, changing **(REF VALUE)** is equivalent to changing scale/division.

The Effect of Factory Preset on Display Settings

Factory Preset assigns an appropriate **(SCALE)**, **(REF VALUE)**, and **(REF POSN)** setting for each format of each parameter on each channel. Color assignments are not changed by Factory Preset.

Response Menu

Press the RESPONSE (MENU) key to display the Response menu. The Response menu structure offers selections for:

- Normalizing measurement data to the peak of the main lobe.
- Averaging and smoothing (noise reduction techniques).
- Adding magnitude slope and offset, and phase offset.
- Using electrical delay features.

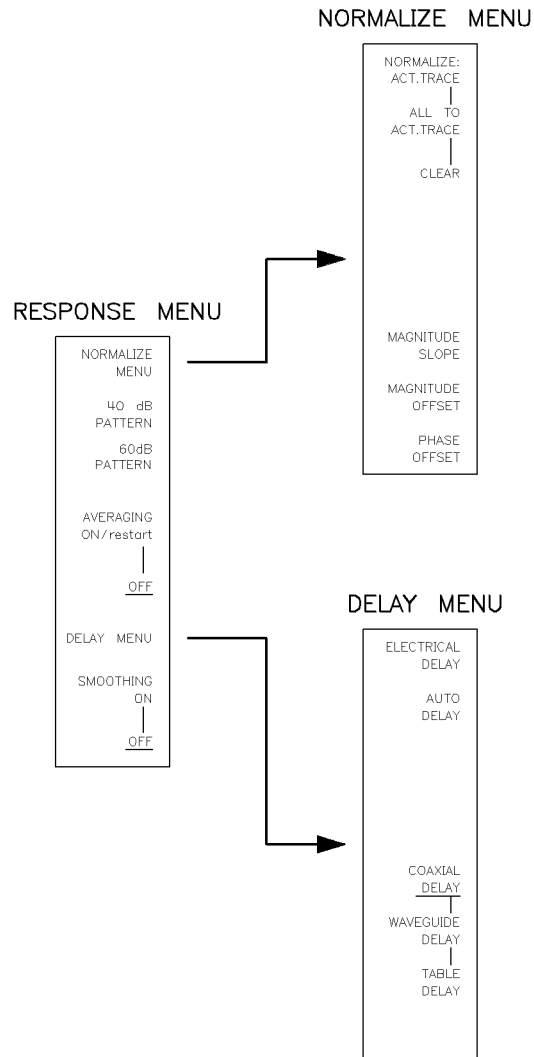

Figure 9-2. Response Menu Structure

Response Functions

Normalizing Data

Pressing RESPONSE **(MENU)** **NORMALIZE MENU** accesses the normalization functions of the receiver:

NORMALIZE ACT. TRACE

“Normalize Active Trace.” This softkey sets the peak magnitude of the active parameter’s trace (beam peak) to 0 dB. Markers placed on any other part of the *active parameter’s trace* will display values that are relative to the 0 dB peak. This operation only affects the active trace.

ALL TO ACT.TRACE

“Normalize All to Active Trace.” This softkey finds the largest magnitude value in the active parameter’s trace (beam peak) and sets it to 0 dB. Markers on *all traces* will display values that are relative to the peak of the active parameter’s trace. All of the traces are normalized with the magnitude offset of the active parameter.

CLEAR

This softkey sets all of the magnitude offsets on all traces to 0.

Note

If you use the magnitude offset feature, you should be careful when using normalize functions. **NORMALIZE ACT. TRACE**, **NORMALIZE ALL TO ACT.TRACE**, and **CLEAR** modifies the values used by the magnitude offset feature.

Using **NORMALIZE ACT. TRACE** or **NORMALIZE ALL TO ACT.TRACE** causes the **D** annotation to appear on the display. This shows that the magnitude offset has been changed.

Magnitude Slope and Magnitude Offset

Press RESPONSE **(MENU)** **NORMALIZE MENU** to access the magnitude slope, magnitude offset, and phase offset functions.

Magnitude slope and magnitude offset produce an effect on the displayed Frequency or Time Domain traces. Magnitude slope adds a magnitude offset that begins at 0 dB at 0 Hz, and increases by the selected dB/GHz over the frequency sweep. Magnitude offset adds a constant magnitude value to each frequency point. A non-zero value for either function causes the **D** annotation to be displayed.

Reasons for using magnitude slope and offset include:

- Viewing deviation from constant magnitude.
- Viewing compensation for magnitude loss versus frequency.
- Viewing compensation for insertion of a series attenuator in the test setup.

Phase Offset

The phase offset function adds a fixed phase shift to each frequency point of the current selected trace. It also changes the marker value. Phase offset can be set independently for each parameter in each channel.

When the phase offset value is other than 0 degrees for the current parameter, the **D** enhancement annotation appears on the left side of the CRT to indicate that phase offset is applied to the current trace.

40 dB and 60 dB Pattern

These softkeys allow you to instantly view either of two common display setups:

- 40 dB Pattern Displays a 40 dB range, from 0 dB to –40 dB. It also places the reference line at the top of the display, and sets the value of the reference line to 0 dB. If **LIN MAG** or **LOG MAG** are selected, scale is set to 4 dB/division. If a polar display is selected, scale is set to 8 dB/division.
- 60 dB Pattern Is similar to the 40 dB Pattern function, but displays a 60 dB range (from 0 dB to -60 dB.)

Trace Averaging and Smoothing

Averaging reduces random noise variations in measurements, improving both accuracy and resolution. Smoothing changes the effective measurement aperture by averaging adjacent measurement points. Both averaging and smoothing can be used simultaneously. Both can be set independently for each channel.

Averaging

Averaging enhances meaningful resolution and increases dynamic range by effectively decreasing the input noise bandwidth.

Press **AVERAGING ON/restart** then use the knob, step, or numeric keys to select the averaging factor applied to the displayed data. Terminate a numeric entry with **x1**.

When averaging is turned on, the \bar{n} enhancement annotation appears on the display. Averaging restarts when:

- The averaging factor is changed.
- An important measurement or display characteristic is changed.
- When a measurement calibration device is selected for measurement.
- When **AVERAGING ON/restart** or the MEASUREMENT **RESTART** key is pressed.

Averaging details. In the Ramp sweep mode, the new trace, weighted by $1/n$, is summed with the current trace, weighted by $(n-1)/n$, where n is the averaging factor. This is an exponential running average. Also, the averaging factor selection controls the number of sweeps taken for measurement of a standard during measurement calibration. When a calibration standard selection key is pressed, $n+1$ groups are automatically taken, where n is the selected averaging factor.

Note that in the Ramp sweep mode: Each time averaging is restarted, the averaging algorithm starts with a small averaging factor, and increases the averaging factor group-by-group, up to the selected factor. This allows fast convergence to the final value. This fast convergence algorithm means that the trace is fully averaged in $n+1$ sweeps rather than $4n$ sweeps, as would be the case if the fast convergence were not used.

In the Step sweep, Single Point, and Frequency List sweep modes, each data point is averaged n times as it is read, so only one sweep is required to present fully averaged data. This is a linear block average.

Notification when averaging is finished. You can use the **NUMBER of GROUPS** function on the STIMULUS menu to signal when the trace is fully averaged. Here's how:

1. Enter the averaging factor as explained above. For example, assume you require an averaging factor of 16.

Response Functions

2. With an averaging factor of 16, enter **NUMBER of GROUPS** 17 (x1). When the H annotation appears, the data is fully averaged. The receiver is now in Hold mode.

Averaging factor recommendations. Select an averaging factor appropriate to the operation being performed. When adjustments to the test device or test setup are made, select a lower averaging factor (128 or below) to see changes quickly. If a very noisy trace is being analyzed, use a higher value (up to 4096) and allow more time for the trace to settle.

Averaging operates in factors which are powers of 2 (2^n). Averaging factors which are not powers of 2 are rounded down to the closest power of 2. For example, if a factor of 150 is entered, it is rounded down to 128.

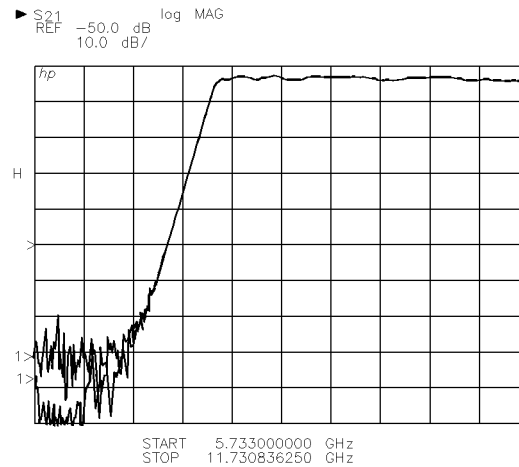

Figure 9-3. Results of Averaging

Smoothing

Smoothing operates on Cartesian data formats in much the same way as a video filter operates, producing a linear moving average of adjacent points. The selected smoothing aperture is displayed in percent of sweep width, as shown in Figure 9-4.

When smoothing is applied to the trace the S annotation appears. The smoothing aperture (the width of the linear moving average) is displayed in degrees, Hz, or seconds, depending upon the domain selected. When polar display formats are selected, trace data is not smoothed. However, the smoothing aperture is displayed.

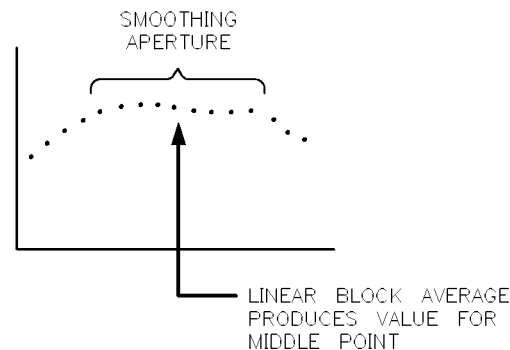

Figure 9-4. Smoothing Operation

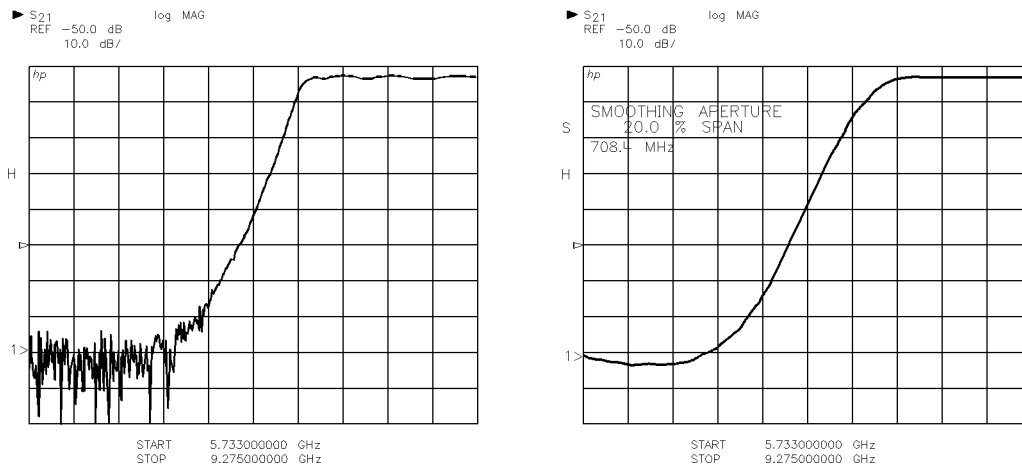

Figure 9-5. Results of Smoothing

Delay Features

Electrical Delay

The electrical delay function acts as an electronic line stretcher, providing a calibrated phase compensation versus frequency with femtosecond resolution. In effect, the specified delay is added to the reference signal path in order to make measurements such as deviation from linear phase, described later in the Viewing Data Chapter. Electrical Delay can be set independently for each parameter on each channel and affects both the phase and delay frequency domain trace and the time domain trace.

Using Electrical Delay

Press RESPONSE (MENU) DELAY MENU ELECTRICAL DELAY. The Active function shows electrical delay in terms of seconds, as well as the equivalent length (in meters), relative to the current Velocity Factor setting. After Factory Preset, Velocity Factor is relative to the speed of light in free space.

For example, select (PHASE), and then use the knob to change the value. Notice that when delay is added, the Δ annotation appears on the left side of the display. You can use the step keys and the numeric and units keys to enter the amount of electrical delay desired.

Delay Options

The two options for the electrical delay feature are:

- COAXIAL DELAY
- WAVEGUIDE DELAY

Coaxial and Waveguide softkeys allow you to select the media type simulated by the electrical delay function.

Coaxial Delay. Factory Preset selects COAXIAL DELAY which applies a linear phase compensation to the trace. That is, the effect is the same as if a corresponding length of perfect vacuum dielectric coaxial transmission line was added to the reference signal path.

Response Functions

Waveguide Delay. Selecting **WAVEGUIDE DELAY** applies a non-linear phase shift which follows the standard dispersive phase equation for rectangular waveguide. When **WAVEGUIDE DELAY** is pressed the active function becomes the **WAVEGUIDE CUTOFF** frequency, which is used in the phase equation. Choosing a Start frequency less than the Cutoff Frequency results in phase errors.

Table Delay

The **TABLE DELAY** selection allows an array of real,imaginary data pairs input by the user via the HP-IB to be applied to the data for the selected channel. Selecting **TABLE DELAY** disables Electrical Delay, Magnitude Slope, and Magnitude Offset. This array must be loaded using HP-IB (see description in the Programming section of this volume), then the table may be stored and loaded using the disc drive.

Selecting Velocity Factor

The relative velocity factor of propagation can be selected. Press:

CAL MORE VELOCITY FACTOR

The active function is now Relative Velocity Factor. After Factory Preset, this value is 1.0 which is the equivalent of the speed of light in free space (2.997925×10^8 meters per second). The range of the relative velocity factor is 0.001 to 500, with values less than 1 indicating that the propagation velocity is less than the speed of light in free space.

For example, the relative velocity is 1 divided by the square root of the dielectric constant for the media, ϵ_r . For waveguide media in standard air, the dielectric constant is about 1.00064, giving a relative velocity factor of about 0.999680.

Changing the velocity factor changes only the supplementary distance readout.

Auto Delay

A major use of electrical delay is to:

- Provide the line stretcher function in deviation from linear phase measurements.
- To balance the reference and test signal path lengths to find the electrical length of the test device.

The **AUTO DELAY** key automatically selects the appropriate value of electrical delay to balance the reference and test signal path lengths and thus result in a reasonable balanced (flat) phase trace at the marker position. When you press **AUTO DELAY**, the phase values at the marker position and the two adjacent points are sampled and electrical delay is added in order to make the phase constant. You may then make fine adjustments of Electrical Delay to achieve the desired trace.

Entry Block Controls

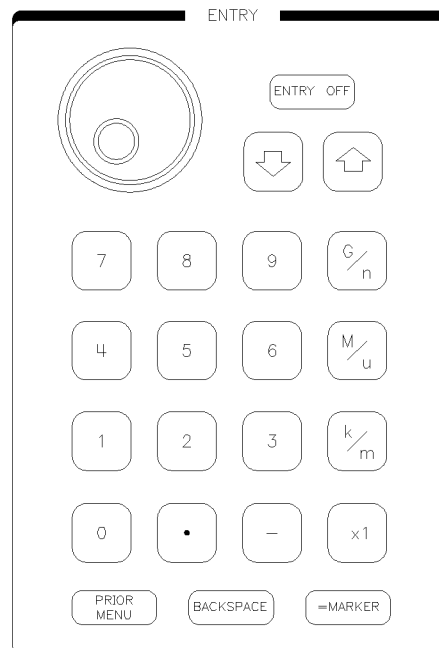

In some cases it is necessary to supply numeric values for a specific function, such as angle or frequency. The 10 digit keypad is used to supply these values. The keys to the right of the digits terminate the value with the appropriate units. Use $\overline{G/n}$ (giga/nano), $\overline{M/\mu}$ (mega/micro), $\overline{k/m}$ (kilo/milli) and $\overline{x1}$ (basic units: dB, dBm, degrees, seconds, meters, Hz) as applicable. In addition to entering data with the keypad, the knob can be used to make continuous adjustments, while the \blacktriangle and \blacktriangledown keys allow values to be changed in steps.

Entry Block

Changing Values Using the Numeric Keypad

To change a value using the numeric keypad:

1. Select the function (start angle, frequency, or any other function that requires a value). This function becomes the “active function.” Notice that the function now appears in the “active function area” of the display.
2. Enter the new value using numeric keys, decimal point, and a terminator key. To change the sign of the entry, press $\boxed{+/-}$. If you make a mistake, press the $\boxed{\text{BACKSPACE}}$ key. (If you have already pressed a terminator key, you must re-enter the entire value).
3. Terminate the entry with the appropriate units.

Table 10-1. Numeric Value Terminator Key Usage

Key Name	Angle	Frequency	Power	Power Slope	Time	Distance
G/n	–	GHz	–	–	ns	nm
M/ μ	–	MHz	–	–	μ s	μ m
k/m	milli degrees	kHz	–	–	ms	mm
x1 ¹	degrees	Hz	dBm	dB/Ghz	s	m

¹ $\boxed{x1}$ always represents single units.

Other Keys in the Entry Block

$\boxed{\text{ENTRY OFF}}$

Removes old error messages or active function text from the screen. “Active function text” are messages like `START -90°` that appear when you changed the value of a function.

$\boxed{\text{PRIOR MENU}}$

This key takes you to the previous softkey menu.

$\boxed{= \text{MARKER}}$

This key can be useful when you are using markers. The easiest way to explain what $\boxed{= \text{MARKER}}$ does is by example. Assume you are making a frequency response measurement, and the last marker you moved (the active marker) is sitting at 11 GHz. Now assume you want to change the center frequency to 11 GHz. All you need to do is press $\boxed{\text{CENTER}}$ $\boxed{= \text{MARKER}}$. The marker position (11 GHz) will become the center frequency.

Another way to use $\boxed{= \text{MARKER}}$ is to transfer the marker *value* to another function. As an example, assume you want to set the display reference line to the value of the active marker (for example, assume the marker value is -13.2 dB). Press $\boxed{\text{REF VALUE}}$ $\boxed{= \text{MARKER}}$, and the display reference line will change to the value of the active marker.

Instrument State Block

Chapter Contents

This chapter discusses the following keys:

- LOCAL
- SAVE and RECALL
- USER PRESET

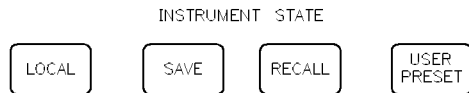

Figure 11-1. Instrument State Block Keys

The four keys in the INSTRUMENT STATE block are **LOCAL**, **SAVE**, **RECALL**, and **USER PRESET**.

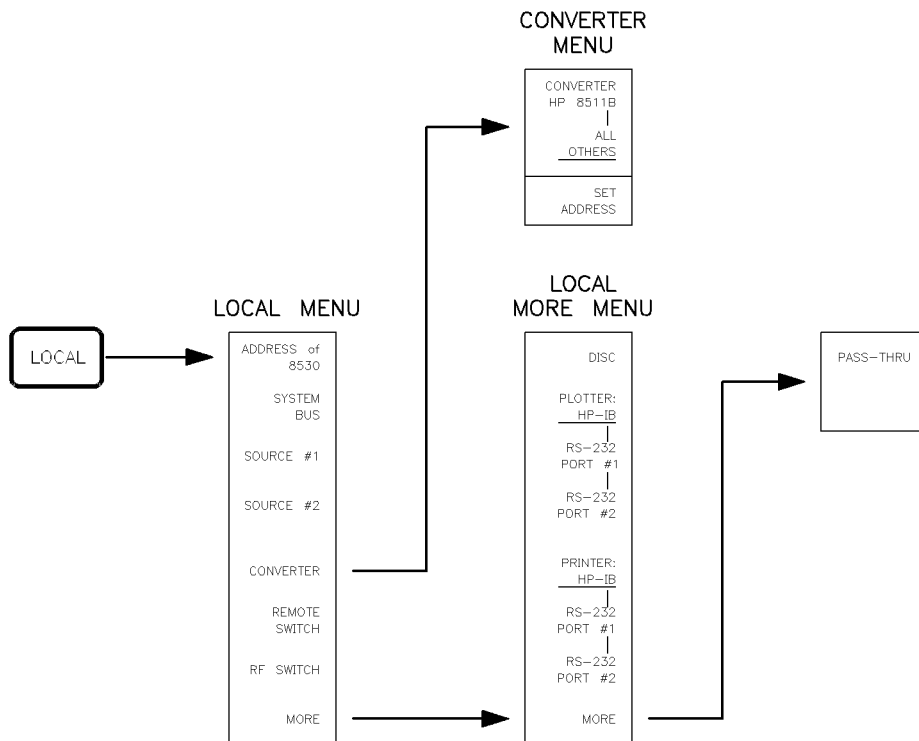

Figure 11-2. LOCAL Key Menus

Instrument State Block

LOCAL

The **LOCAL** key has two uses:

- If you are controlling the receiver with a computer, the front panel keys will not respond to touch. Pressing **LOCAL** returns control to you.
- **LOCAL** also allows you to examine or change HP-IB addresses the receiver uses to control peripherals and other instruments on the System Bus.

LOCAL Softkey Menus

The softkeys under **LOCAL** determine the HP-IB addresses the receiver uses when it communicates with:

- Printers or plotters on either RS-232 bus, or on the (HP-IB) System Bus.
- Instruments on the System Bus.

Here is a list of the softkeys and a description of each one:

ADDRESS OF 8530	This defines the HP-IB address of the HP 8530A. The HP 8530A will respond to HP-IB commands (sent over the main HP-IB bus) when this address is used.
SYSTEM BUS	This defines the address of the system bus. A computer controller can send commands directly to the HP 8530A's system bus when it uses this address. Before this occurs you must first program the destination System Bus address using PASS-THROUGH , explained below. (This feature is explained in greater detail in Chapter 18, HP-IB Programming.)
SOURCE #1	Defines the System Bus address the receiver uses when controlling an RF source.
SOURCE #2	Defines the System Bus address the receiver uses when controlling an LO source. To use an LO source, the Multiple Source mode must be turned on, as explained in Chapter 17.
CONVERTER	Brings up the Converter Menu, which allows you to select: <ul style="list-style-type: none">■ The type of frequency converter in use.■ The System Bus address for the frequency converter. These controls are explained below: Press CONVERTER HP 8511B if you are using the HP 8511B frequency converter. Press ALL OTHERS if you are <i>not</i> using an HP 8511B frequency converter. SET ADDRESS defines the System Bus address the receiver uses when controlling the HP 8511 frequency converter. (Standard HP 8511A's do not need to be connected to the System Bus at all.) Enter address 31 if using a standard HP 8511A, assuming it is not connected to the System Bus. Use address 20 for an HP 8511A option 001 or for an HP 8511B, because they are connected to the System Bus.

If you have an HP 8511A with option 001, and you need the multiplexed IF feature: Connect the HP 8511A to the System Bus, and enter address 20.

If you are using an HP 85309A frequency converter, enter address 31.

REMOTE SWITCH

Defines the System Bus address the receiver uses when controlling a remote switch.

RF SWITCH

Defines the System Bus address the receiver uses when controlling an RF switch.

Pressing **MORE** accesses the following commands:

DISC

Defines the System Bus address the receiver uses when controlling an external disc drive.

PLOTTER: HP-IB

Defines the System Bus address the receiver uses when controlling an HP-IB plotter.

PLOTTER: RS-232 PORT #1

Tells the receiver to send plots to RS-232 port #1.

PLOTTER: RS-232 PORT #2

Tells the receiver to send plots to RS-232 port #2.

PRINTER: HP-IB

Defines the System Bus address the receiver uses when creating printouts.

PRINTER: RS-232 PORT #1

Tells the receiver to send printouts to RS-232 port #1.

PRINTER: RS-232 PORT #2

Tells the receiver to send printouts to RS-232 port #2.

Pressing **MORE MORE** accesses this command:

PASS THROUGH

It is possible for a computer controller to send HP-IB commands through the HP 8530A to a device on the System Bus. When this occurs, the computer "hands" the command to the HP 8530A (by sending to the **SYSTEM BUS** address). The HP 8530A then passes the command to the device (on the System Bus) at the address specified by **PASS THROUGH**.

Instrument State Block

SAVE and RECALL

SAVE and **RECALL** allow you to save and recall up to eight different measurement setups (instrument states). An **instrument state** is defined as the condition of all current measurement settings, including all domain, stimulus, parameter, format, and response settings.

When you press **SAVE** or **RECALL**, a menu appears which lists the eight Save/Recall registers. When saving, choose the register you want to hold the instrument state. If an asterisk (*) is next to the register number, an instrument state is already in that register. If you select a register that has an instrument state in it, you will overwrite the old instrument state with the current one.

When you recall an instrument state, current instrument settings change to those defined in the instrument state. If you save the instrument state to Save/Recall register #8, it becomes the User Preset state. Refer to “User Preset,” at the end of this chapter.

Storing Instrument States to Disc

You can save instrument states to disc, as explained in Chapter 15, Disc Drive Operation.

An instrument state you load from disc does not automatically go into effect. After loading the instrument state to a register, you must then press **RECALL** and select that register.

USER PRESET

You can save your current setup as the “USER PRESET” state by saving it to Save register 8. The receiver will return to that state whenever the instrument is turned on, or if you press **USER PRESET**.

Viewing Data

Chapter Contents

- Viewing Multiple Parameters and Channels
- Viewing Data from Disc

Viewing Multiple Parameters and Channels

The HP 8530A allows you to display:

- One, two, three, or four Parameters for a single Channel.
- One parameter from each of the two channels.
- Split or Overlay display.

How Many Parameters does the Receiver Measure?

The receiver does not measure all parameters at all times. A simple rule explains which parameters will be measured:

If the parameter is displayed on the screen, it will be measured.

The opposite of this rule is also true:

If the parameter is NOT displayed on the screen, it will NOT be measured.

Selecting the Number of Parameters or Channels to Display

Press **DISPLAY** **DISPLAY MODE**. The number of parameters to be measured is selected with the following softkeys:

SINGLE PARAMETER	measures and displays one parameter. Choose the desired parameter by pressing PARAM 1 , PARAM 2 , PARAM 3 , or PARAM 4 keys.
TWO PARAMETER	measures and displays PARAM 1 and PARAM 2 for the active channel.
THREE PARAMETER	measures and displays PARAM 1, PARAM 2, and PARAM 3 for the active channel.
FOUR PARAMETER	measures and displays all four parameters for the active channel. The parameters in the inactive channel will not be measured.
DUAL CHANNEL	measures and displays one parameter (of your choice) in each channel. For each channel, choose the desired parameter by pressing PARAM 1 , PARAM 2 , PARAM 3 , or PARAM 4 keys.

Viewing Data from Disc

The following rules apply to loading data from disc:

- Before loading data from disc, place the receiver in Hold mode by pressing STIMULUS (MENU) MORE HOLD. Otherwise the data you load will be immediately overwritten with new data.
- In Frequency Domain, the currently-selected number of points must match the number of points in the data file. For example, if you want to load a Frequency Domain data file with 801 points, make sure you set the HP 8530A to Frequency Domain mode, and select STIMULUS (MENU) NUMBER of POINTS 801 softkey.
- In Angle Domain, the current Start, Stop, and Increment Angle settings must result in a number of measurement angles that matches those in the disc file.

For Example. You currently have Start Angle set to -90° , Stop Angle to $+90^\circ$, and Increment Angle to 1° . This results in 181 measurement angles. You could load any disc file that has 181 angles in it.

To load a file with a different number of measurement angles, set the Start, Stop, and Increment Angle to values that will result in the appropriate number of angles.

Note: The Start Angle, Stop Angle, and Increment Angle do *not* have to match those in the disc file. The only requirement is that the *current number of measurement angles* must match the *number of angles in the file*. Assume you are using the settings listed in the above example. You could load a file with a Start Angle set to -45° , Stop Angle to $+45^\circ$, and Increment Angle to 0.5° . In both cases the number of angles in the measurement is 181.

- If you load Raw data, the receiver places it in the Raw data array, and performs all subsequent data processing functions on it. This includes calibration (if turned on) as well as all display formatting. After all processing is done the data appears on the screen.
- If you load “Data” data (corrected data), the receiver places the data in the Corrected data array, performs all display formatting. After all processing is done the data appears on the screen.
- If you want to load a display memory file, make sure all memory functions are off. You can make sure of this by pressing (DISPLAY) DISPLAY: DATA. This selection displays current measurement data.

1. Now that the requirements have been explained, press:

(DISC) LOAD MORE

2. Now you can choose whether to load Raw data, “Data” (error corrected) data, or Formatted data. Press the softkey that corresponds the type of data you saved previously.
3. Use the knob or ▲ ▼ keys to select the file you wish to load.
4. Press (LOAD FILE). The data will appear on the display.

Introduction to Time Domain RCS and Antenna Measurements

Chapter Contents

- Introduction
- Using Front Panel Controls in Time Domain Mode
- Time Domain General Theory
- Time Domain Radar Cross Section Measurements
- Range Gating
- Time Domain Antenna Impedance Measurements
- Time Domain Transmission Measurements

Introduction

This chapter explains how to make reflection and transmission measurements in the Time Domain. Measurements made in the Frequency Domain are transformed mathematically into the Time Domain using the internal high-speed computer in the HP 8530A. The Time Domain response provides very useful insight into the RCS or antenna measurement. This chapter explains basic Time Domain concepts and describes how to use this feature in:

- Radar Cross Section Measurements
- Antenna Impedance Measurements
- Antenna Transmission Response Measurements

All HP 8530As have Time Domain menu keys. However, Time Domain operation only functions if the receiver has option 010. If your HP 8530A is not equipped with this option, the message `FUNCTION NOT IMPLEMENTED` will appear if you select a Time Domain function.

Using Front Panel Controls in Time Domain Mode

In the Time Domain, the STIMULUS keys (`START`), (`STOP`), (`CENTER`), and (`SPAN`) refer to time, and they affect the horizontal (time) axis of the display. Time domain settings are independent of the selected frequency range. You can enter time values using the knob, step keys, or the keypad. The keypad terminators refer to time in seconds:

- `G/n` represents nanoseconds
- `M/ μ` represents microseconds
- `k/m` represents milliseconds
- `x1` represents seconds

Enter picoseconds as a decimal nanosecond value. For example, to enter 10 picoseconds, press `.01 G/n`.

Time Domain General Theory

In *Frequency Domain measurements*, a device's response to RF energy at CW or sweeping frequencies is measured. A Time Domain measurement determines a device's response to a *specific waveform*, as a function of time. An example is when bouncing an RF radar pulse off an object and measuring the return RCS signal.

With "direct measurement" systems (such as time domain reflectometers), Time Domain measurements are made by sending a known waveform pulse (or impulse) out to the device under test (DUT), and measuring the waveform returned as a function of time. The HP 8530A does not measure time domain directly, since it is a frequency measuring device. However, any waveform can be mathematically formed by adding many frequencies together. Therefore, the receiver can measure DUT performance at various frequencies and then mathematically calculate its Time Domain response. In most ways, the mathematical model is actually superior to systems that measure Time Domain directly. Noise performance is usually much better, and the time axis is very stable and accurate. The calibration feature of the HP 8530A also improves measurement performance, which is not possible in direct measurement systems.

The relationship between the Frequency Domain measurement and the Time Domain response is described by the Fourier Transform:

Frequency Domain \rightarrow Time Domain
 $H(f) \quad \longrightarrow \quad h(t)$

It is therefore possible to measure the response of an antenna or an RCS target in the Frequency Domain and then *mathematically calculate* the inverse Fourier Transform of the data to give the Time Domain response. The receiver does this calculation using Chirp-Z Fast Fourier Transform (FFT) computation techniques. As explained later in this chapter, the Chirp-Z FFT has advantages over standard FFT techniques.

Time Domain Radar Cross Section Measurements

Time Domain Radar Cross Section (RCS) testing provides a way to determine the target's RCS response. Time Domain characterize the response of the test target to an RF-Burst having a specific an impulse envelope.

Viewing a Time Domain RCS Measurement

To view a Time Domain RCS measurement, you must first set up the measurement parameters and make a measurement in the Frequency Domain. As you will see later, there is much interdependency between the Frequency and Time Domain responses. Figure 13-1 shows a typical RCS measurement configuration using a pair of broadband transmit and receive horn antennas. The target (a metal cylinder) is mounted on a foam target mount, located inside an anechoic chamber. The target is measured from 8 GHz to 12 GHz with 801 frequency points. (Using a large number of points in the Frequency Domain measurement has many advantages, as will be explained throughout this chapter.) Figure 13-2 shows the Frequency Domain and the Time Domain response of the target.

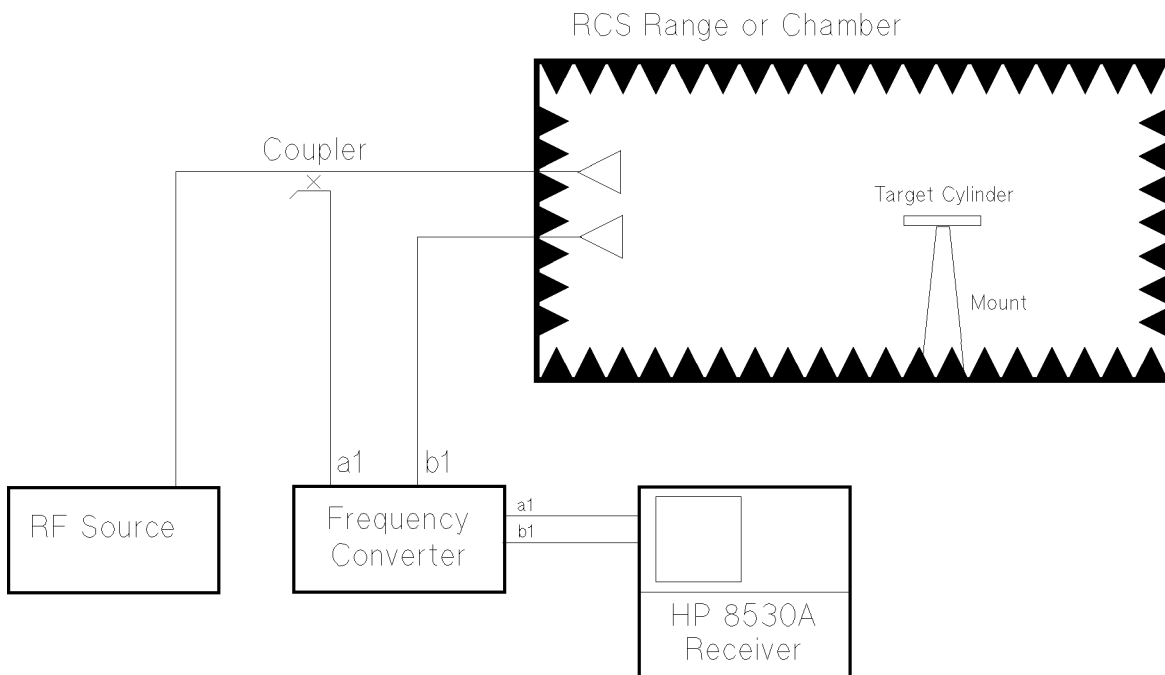

Figure 13-1. Typical RCS Measurement Configuration

Time Domain RCS Measurements

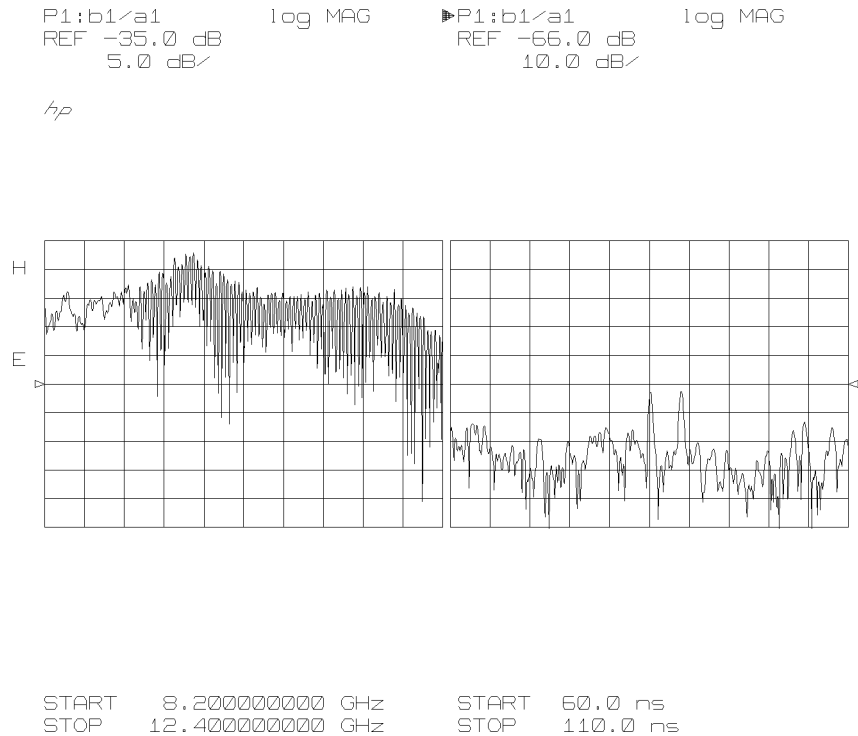

Figure 13-2. Frequency Domain Response versus Time Domain Response

The Time Domain response is calculated from band-limited Frequency Domain data. The receiver shows the calculated response of the target *to an RF burst with an impulse-shaped envelope*. The Time Domain response contains information from every measurement frequency point. The most useful display format is LOG MAGNITUDE (Cartesian) format, which displays the envelope of the impulse response.

The Frequency Domain RCS measurement is a composite response of all of the scatterers present on the target. The Time Domain measurement shows the effect of each individual scatterer as a function of time (or distance). In Time Domain, the target gives two separate responses of approximately equal amplitude (which are caused by reflections from the front and back ends of the target). Note that the presence of two closely-spaced Time Domain responses (of approximately equal amplitude) produces the large amount of ripple in the Frequency Domain response. This happens because the two RCS responses are adding in and out of phase.

Interpreting The Time Domain RCS Response

The Time Domain response measures RCS versus down range, and the horizontal time axis corresponds to the two-way travel time to the test target and back. The vertical axis corresponds to the RCS response of the target and test range. Figure 13-3 shows only the Time Domain response of the target with an expanded scale.

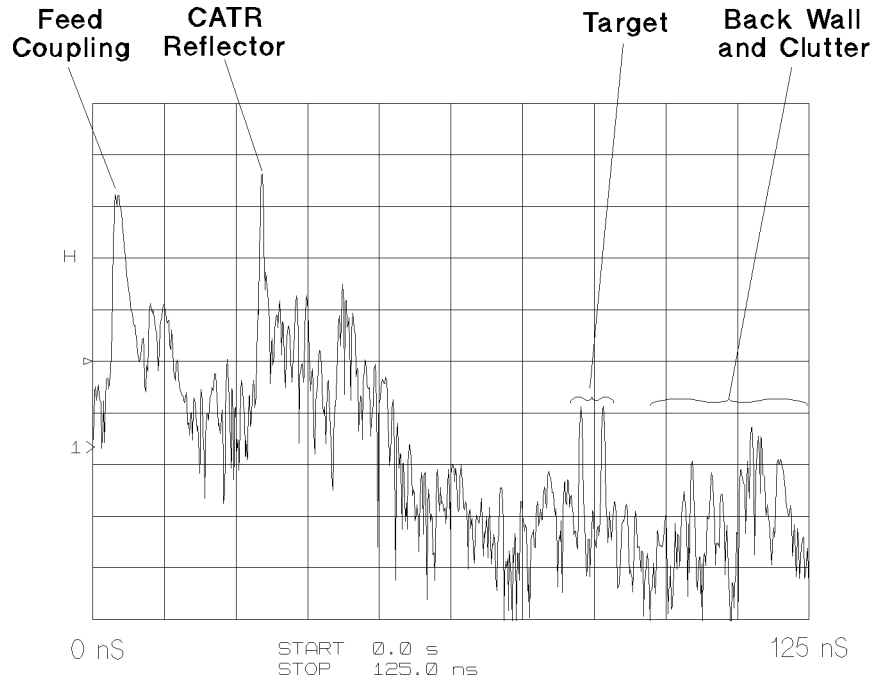

Figure 13-3. Typical RCS Time Domain Response

- The first response on the display (at 4 ns) is caused by the coupling between the horn antennas.
- The next largest response, located at 29.5 ns, is the RCS reflection from the Compact Antenna Range Reflector.
- Next, the reflection at 85 ns is caused by the test target.
- Other responses can be caused by reflections from the back wall of the anechoic chamber or from secondary reflections of energy within the test range.

Note To convert from time to distance in RCS measurements, multiply the time scale by:
 $0.5 \times \text{the velocity of light } (2.998 \times 10^8 \text{ m/sec})$
 The factor of 0.5 accounts for the 2-way travel time of the impulse in the RCS (reflection) measurement.

RCS Down-Range Resolution

RCS Down-Range Resolution refers to the minimum separation between target scatterers that can be resolved by the Time Domain impulse. For the HP 8530A, this is determined by the width of the Time Domain impulse (which is inversely proportional to the measurement frequency span). Wider frequency spans result in narrower Time Domain impulse widths and better RCS down-range resolution.

The RCS down-range resolution depends on the measurement frequency span and the window that is selected. Table 13-1 gives the approximate formulas for the impulse width for the different RCS waveforms.

Time Domain RCS Measurements

RCS Waveforms

The HP 8530A can provide a number of different Time Domain waveform shapes as the test stimulus. Three built-in waveforms offer trade-offs between Time Domain impulse width and sidelobe levels. The feature which provides different Time Domain waveforms is called “windowing.” Windowing describes the technique of modifying the Frequency Domain data prior to its conversion to Time Domain data.

The Windowing feature was provided to reduce ringing in the Time Domain response (the impulse “sidelobes”), or to allow users to modify the impulse waveform to meet their own needs. Sidelobes are created by the abrupt transitions in the Frequency Domain measurement at the start and stop frequencies.

The “MINIMUM” window provides the narrowest Time Domain impulse but causes relatively high (–13 dB) sidelobes. The resulting Time Domain impulse is useful in resolving closely spaced scatterers of similar amplitude, but it is ineffective in resolving target scatterers of widely different amplitudes.

The “NORMAL” window provides a Time Domain impulse with a good compromise between impulse width and sidelobe level (–44 dB). The NORMAL window is the default (factory preset) selection, and it is recommended for most RCS measurements.

The “MAXIMUM” window provides a Time Domain impulse with no detectable sidelobes, but with a significant increase in impulse width.

Table 13-1.
Approximate Impulse Width Formulas for Different Window Types
(Time Domain Waveforms).

Window Type	Impulse Width Formula	Impulse Sidelobe Level
Minimum	$1.20 \div \text{Frequency Span} \times 1.0$	–13 dB
Normal	$1.20 \div \text{Frequency Span} \times 1.6$	–44 dB
Maximum	$1.20 \div \text{Frequency Span} \times 2.4$	–90 dB

User-Defined Waveforms

For computer controlled measurement systems, it is possible to program the HP 8530A with a user-defined windowing function (for example, with Hamming or Hanning windows). To do this, load the Frequency Domain coefficients (for your special window) into the HP 8530A “Delay Table.” There is one delay table for each channel. Initially, this table must be supplied over HP-IB from a controller.

The delay table consists of a complex (real and imaginary) data entry for each point in the data trace. Each entry can be thought of as a complex scaling factor, which is multiplied with the measured data just after error correction and before Time Domain. Because the operation takes place before Time Domain processing, the delay table can be used to create user-defined Time Domain waveforms.

With Table Delay and the MINIMUM window selected, the HP 8530A will display the Time Domain response of the RCS target according to the user-supplied waveform. Refer to “Table Delay” in the Keyword Dictionary for more information.

Time Domain Digital Resolution

Digital Resolution is defined as the ability to locate a single response in time. In other words, if only one response is there, this is how closely you can pinpoint the peak of that response. The Digital Resolution is equal to the digital resolution of the CRT (which is the time span displayed divided by the number of points). Maximum Digital Resolution is achieved by centering the response on the display and then reducing the time span. Therefore, the Digital Resolution is always much finer than the Down-Range Resolution.

The digital resolution of the Time Domain trace is determined by the Number of Points measured in the Frequency Domain and by the time span that is displayed. The HP 8530A digital Inverse Fourier Transform method applies these points to the time span that is displayed. *Therefore, it is possible to obtain increasingly higher digital resolution of the Time Domain trace by reducing the displayed time span.* This is an advantage the Chirp Z Fast Fourier Transform (FFT) has over standard FFT processing methods. Standard FFT methods require the Number of Points to be spread across the entire Time Domain Alias-Free Range, thereby limiting the digital resolution.

By reducing the displayed time span, you can usually obtain sufficient digital resolution for viewing the RCS responses, even with a low number of Frequency Domain points. Note that increasing the digital resolution does not increase the ability to resolve individual target scatterers. Higher digital resolution simply gives better point-to-point resolution of a Time Domain trace.

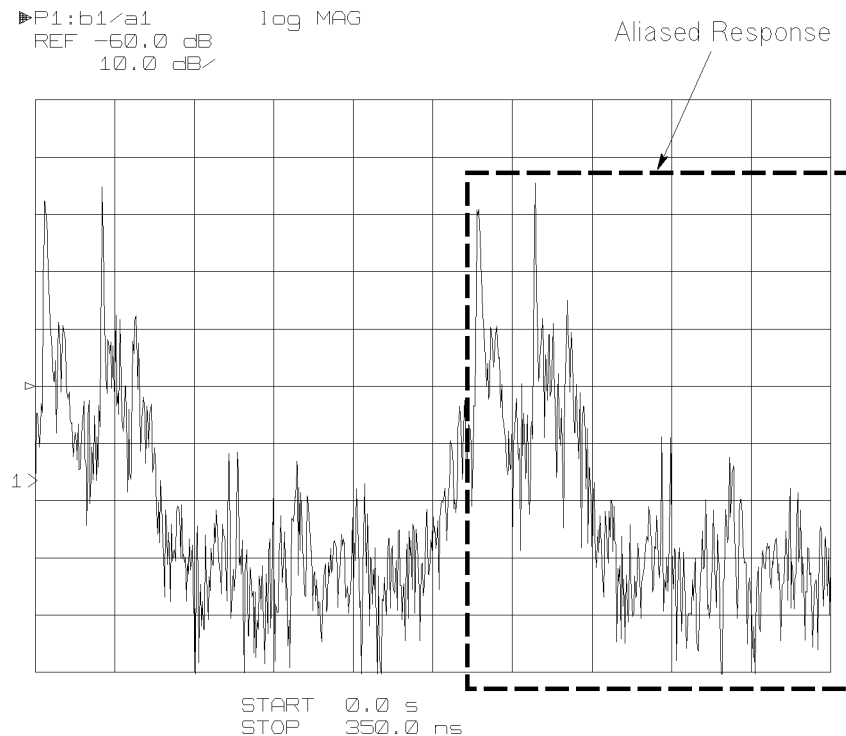

Figure 13-4. Typical Aliased Response

Time Domain RCS Measurements

RCS Alias-Free Range

Alias-Free Range is the length in time that a measurement can be made without encountering a repetition of the response (see Figure 13-4). The repetition of the Time Domain response occurs at regular intervals of time and is a consequence of the Frequency Domain RCS response being measured at discrete frequencies, rather than over a continuous spectrum. The separation between Time Domain response repetitions is known as the Alias-Free Range, and it is exactly equal to $1/\Delta F$ (the spacing between Frequency Domain data points). Alias-Free Range is therefore directly proportional to the Number of Points and inversely proportional to the frequency Span (Stop – Start frequency). Alias-Free Range can be calculated using the following formula.

Alias-Free Range = $1/\Delta F$ or (Number of Points – 1) \div Frequency Span

Aliasing

The term aliasing is an undesired condition where Time Domain repetitions overlap. To prevent aliasing with RCS measurements, make sure:

Time Domain Alias-Free Range \geq approximately twice the RCS chamber length

As a sample calculation, for a 401 point measurement from 8.2 GHz to 11.2 GHz (SPAN = 3.0 GHz), the Alias-Free Range is:

$(401 - 1) \div 3.0 \text{ GHz} = 133 \text{ nsec}$ (40.0 meters).

Thus, the length of the test range from the *range antennas* to the *chamber back wall* must be 20 meters or less (one half of the Alias-Free Range). Otherwise the Time Domain responses will overlap (aliasing occurs). Remember to multiply by the relative velocity of light to get actual physical length.

How to Increase Alias-Free Range

To increase the Alias-Free Range, it is recommended that you first increase the Number of Points measured in the Frequency Domain. If going to the maximum Number of Points (801) is not sufficient, then you must reduce the Frequency Domain measurement span. Reducing frequency span also reduces the RCS Time Domain resolution. So reduce the measurement frequency span only as much as is absolutely necessary.

How to Distinguish an Aliased Response from a Real Response

When aliasing occurs, it can be difficult to tell the real Time Domain response from an aliased response. Here is one way to determine whether a response is real:

1. Save the Time Domain response into memory.
2. Select Frequency Domain.
3. Decrease the measurement frequency span a small amount.
4. Allow a full frequency sweep.
5. Select Time Domain.
6. Display data and memory.

Since reducing the frequency span increases the Alias-Free Range, any aliased response will move along the time axis. Any real Time Domain response will remain stationary, although it will change in appearance slightly.

Measurement Errors and Calibration

Measurement errors are caused by undesired range reflections, different electrical characteristics between the test and reference channels, and other causes. This section discusses the causes of common measurement errors, and explains how calibration is used to reduce these errors.

Time Domain Noise Floor Reduction

One advantage of the HP 8530A Time Domain conversion technique is that it reduces receiver noise in the Time Domain, proportional to the Number of Points measured in the Frequency Domain. The Time Domain noise is lower by $10 \log(\text{Number of Points})$, which greatly increases the Time Domain dynamic range.

For example, for a measurement at 801 frequency points, converting to the Time Domain will reduce the receiver noise by 29 dB! (This is also known as “processing gain.”) Because of this, most RCS measurements will be limited by residual chamber clutter rather than receiver noise.

Effects of RCS Calibration on Time Domain Responses

RCS calibration reduces the effects of systematic measurement errors (those that are stable and repeatable), and displays the RCS of the target in dBsm (dB relative to a square meter). RCS calibration affects both Frequency and Time Domain data. Refer to the two-term error model shown in Figure 13-5.

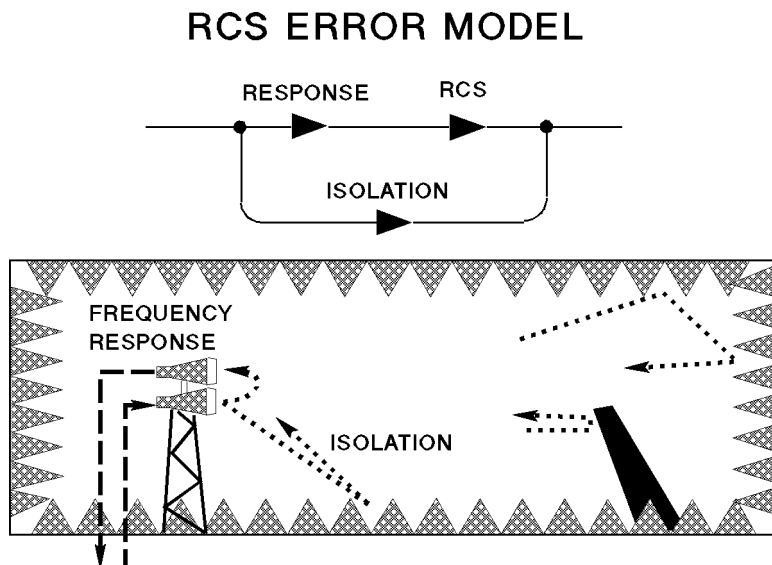

Figure 13-5. RCS Isolation and Response Error Model

Isolation Error Term (Range Clutter). The RCS Isolation error term accounts for RCS “range clutter.” This is caused by leakage between the transmit and receive antennas and by spurious reflections within the anechoic chamber. These signals arrive in parallel with the target responses, and they limit the receiver’s ability to measure small RCS targets.

Frequency Response Error Term. The Frequency Response error term accounts for electrical differences between the test and reference paths, caused by the test system. The signals in the test and reference channels do not track each other perfectly because the cables, connectors, antennas, and other components in the test and reference paths are not identical. This causes measurement errors because the receiver measures the response of the *test setup* along with the performance of the *device under test*. Frequency response errors are the differences in phase and amplitude (between the test and reference paths), caused by the test setup itself.

Time Domain RCS Measurements

The frequency response error term accounts for these differences, as well as other “non-RCS” measurement effects. To the extent that these measurement errors are repeatable, they can be quantified (during calibration) and their effects removed from the measured data.

RCS Calibration makes two separate measurements:

- It measures the reference target.
- It measures the empty chamber.

The order of measurement does not affect calibration. After these two measurements are finished, the HP 8530A:

- Subtracts the chamber response (background) from the reference target response.
- Divides the result by the theoretical response of the reference target to give the frequency response error term.

The empty chamber response is then used as the isolation error term.

If the target mount changes, simply install the new target mount (with calibration turned ON) and perform an “Update Isolation” calibration. Refer to the RCS Calibration section for more details.

RCS Calibration is performed on Frequency Domain data, and therefore affects both Frequency Domain and Time Domain RCS responses. Of particular interest in this section are the effects of calibration on the Time Domain responses (see Figure 13-6).

Horizontal Axis: Target Zone Shift. The location of the reference target along the time axis will change when RCS calibration is turned ON. With calibration OFF, the location (in time) of the target zone is determined by:

- The distance between the range antennas and the test target.
- To a lesser extent, by the electrical differences between the test and reference paths. Since calibration is OFF, frequency response errors still affect the measurement.

When the receiver turns calibration ON, it moves the target zone to zero seconds (because of the phase calibration performed on the Frequency Domain data).

Vertical Axis: Clutter Removal and Reference Level Shift. RCS calibration will also apply background subtraction to remove much of the range clutter from the Time Domain RCS measurement. This makes the target response more visible.

After calibration, the receiver adjusts the overall reference level to display the target amplitude in dBsm.

Before Calibration

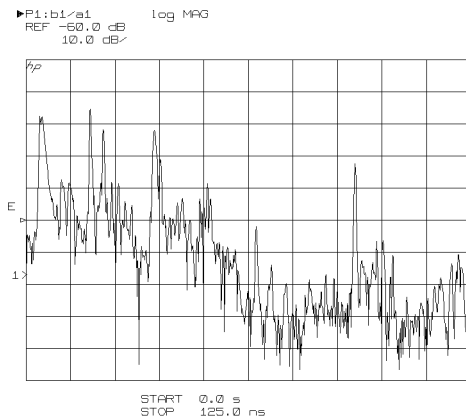

After Calibration

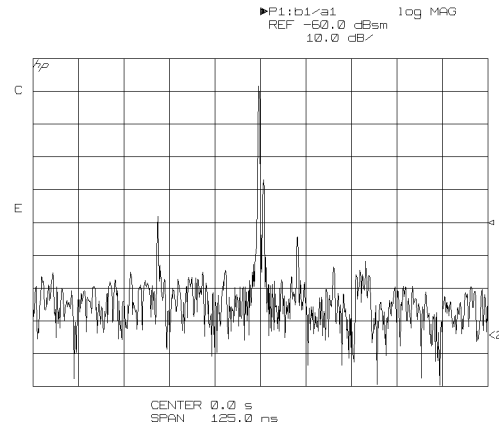

Figure 13-6. Time Domain RCS Response Before and After Calibration

Target Shadowing and Target Scattering

RCS calibration can be less effective when removing range clutter behind the target zone. This is because the target “shadows” a portion of the chamber directly behind itself. While the target is in place, it may block some of the transmitted RF energy from the back wall of the chamber. During the first part of the calibration, the receiver measures the target plus the background. The background measured has the shadow. Next, you remove the target and the receiver measures just the background, however, the shadow no longer exists. This causes the background subtraction to be less accurate. After calibration, a large back-wall reflection may reappear if the calibration target is large.

In addition, the target can scatter energy toward the walls and ceiling, which can cause spurious responses that arrive after the target zone responses.

Shadowing and target scattering reduce the receiver’s ability to observe small RCS responses when large target responses are also present.

RCS Measurement Concepts

It is important to understand the following concepts when interpreting measured RCS responses.

Masking

Target masking is when the RCS response of one target scatterer will affect the measured response of each subsequent scatterer. This occurs because the energy reflected from (or absorbed in) the first scatterer never reaches those that are behind it. The result is that the subsequent scatterers will present a lower RCS response than would occur if the first scatterer was not present.

Reverberations

Complex RCS targets will often have reverberations that occur within the target structures. This causes their RCS Time Domain responses to be distributed (in time) beyond the calculated target electrical length.

It is important to consider masking and reverberations when determining the best frequency and Time Domain settings for viewing the target.

Range Gating

The HP 8530A Gating feature allows you to selectively view individual portions of the Time Domain response. Once you gate out unwanted Time Domain responses, you can then view the data in the Frequency Domain: the effects of the Time Domain responses outside of the gate will be removed. For RCS measurements, this allows the user to gate out unwanted RCS responses (those that originate outside the target zone). Thus, gating mathematically removes undesired responses from both time and Frequency Domain data. Refer to Figure 13-8.

A Gate is a band-pass shaped Time Domain filter. The user has direct control over the gate width and location. There are three Gate indicators:

- START and STOP The Gate START and STOP indicate the -6 dB cutoff times.
Gate SPAN = STOP – START.
- CENTER The GATE CENTER indicates the center time (not frequency) of this filter.

A Gate has a bandpass filter shape, as shown in Figure 13-7.

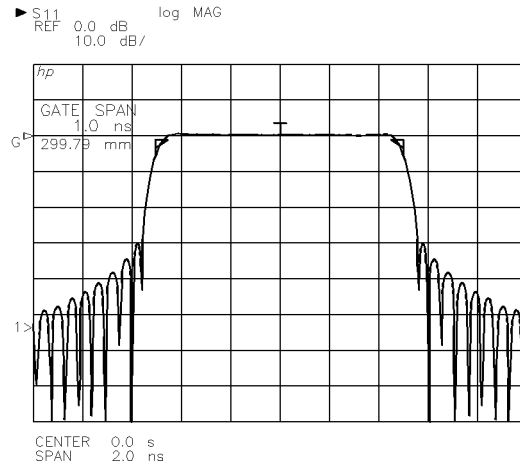
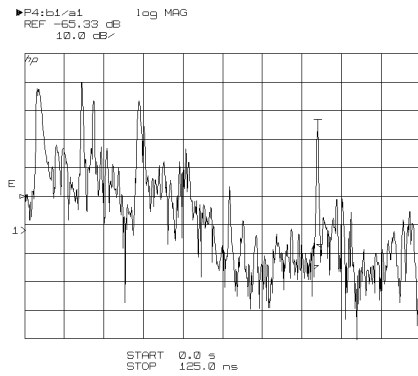

Figure 13-7. Typical Gate Shape

Gating Example

This example demonstrates the use of gating to reduce the effects of unwanted RCS responses when measuring a metal sphere. The gate is centered around the target zone and, with the gate applied, the effects of the responses outside the gate are removed. In the Frequency Domain, this removes the high frequency ripple from the response. Figure 13-8 shows the effects of gating in the Frequency and Time Domains.

Time Domain
Gating Off



Frequency Domain
Gating Off

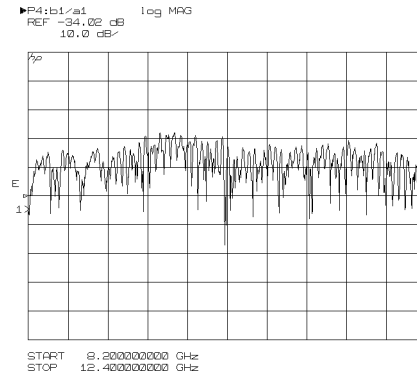

Time Domain
Gating On

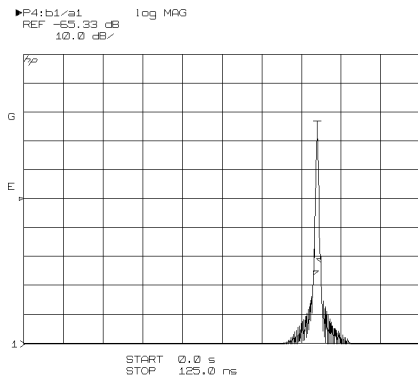

Frequency Domain
Gating On

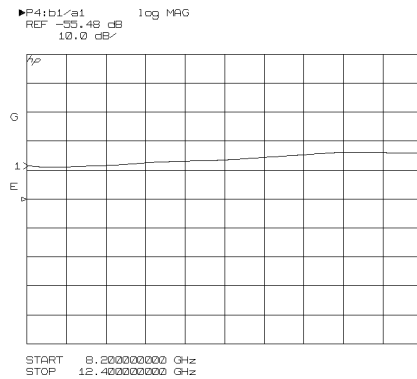

Figure 13-8. The Effects of Gating in Time and Frequency Domains

Select Gate Shape

Four different Gate shapes are available:

- Minimum
- Normal
- Wide
- Maximum

As shown in Figure 13-9, each of the Gates have different passband flatness, cutoff rate, and sidelobe levels. T_1 indicates the Gate Span which is the time between the Gate start and stop indicators. T_2 is the time between the edge of the Gate Passband and the -6 dB Gate stop time. T_3 (equal to T_2) is the time between the Gate stop time and the point where the filter first reaches the level of the highest Gate Sidelobe. The Gate characteristics for each Gate shape are listed in Table 13-2.

Time Domain RCS Measurements

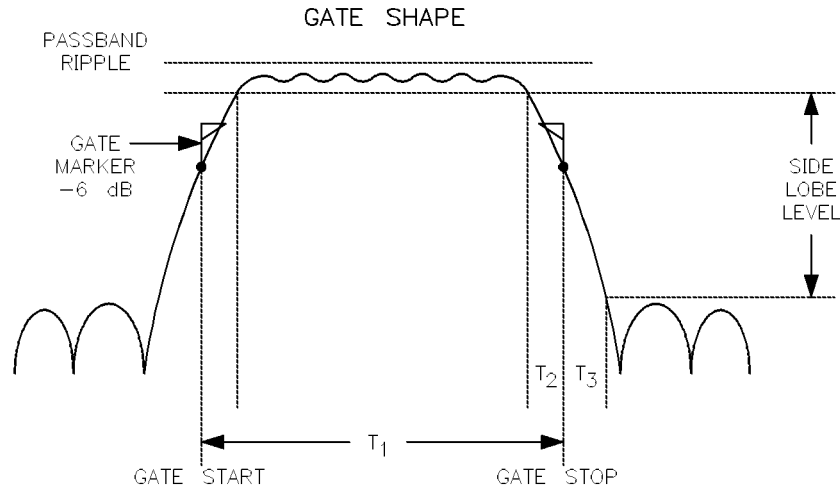

Figure 13-9. Gate Characteristics

Table 13-2.
Gate Shape Characteristics Using Different Window Settings

Gate Shape	Passband Ripple	Sidelobe Levels	Cutoff Time $T_2 = T_3$	Minimum Gate Span T_1
Minimum	± 0.40 dB	-24 dB	$0.6/f_{\text{span}}$	$1.2/f_{\text{span}}$
Normal	± 0.04 dB	-45 dB	$1.4/f_{\text{span}}$	$2.8/f_{\text{span}}$
Wide	± 0.02 dB	-52 dB	$4.0/f_{\text{span}}$	$8.0/f_{\text{span}}$
Maximum	± 0.01 dB	-80 dB	$11.2/f_{\text{span}}$	$22.4/f_{\text{span}}$

The Passband Ripple and Sidelobe Levels are descriptive of the gate (filter) shape. The Cutoff Time, $T_2 = T_3$ (see Figure 13-9), indicates how fast the gate filter rolls off. For each gate shape, there is also a Minimum Gate Span ($T_{\text{min}} = 2 \times T_2$) which gives a filter passband of zero.

An easy way to calculate minimum Gate Span is shown in the far right column in Table 13-2. For example, if you are using Normal Gate Shape, minimum Gate Span = $2.8 \div$ frequency span.

Entering a Gate span that is smaller than minimum will produce a distorted filter shape which:

- Will have no passband.
- Will have a wider shape.
- May have higher sidelobe levels.
- Will give an incorrect indication of gate Start and Stop times.

Therefore, you should always select a Gate Span that is higher than the minimum value. The cutoff time and the minimum Gate Span are inversely proportional to the frequency span of the measurement as indicated in Table 13-2.

For best results using Gating, you should:

- Always center the Gate around the response (or responses) that you want to retain in the measurement.
- Make the Gate Span wide enough to include all of those responses.

Gating During RCS Calibration

The HP 8530A RCS Calibration procedure allows you to use gating during calibration. The gated calibration applies the Gate to the frequency response error term (E_r) only, allowing removal of the effects of shadowing and scattering caused by the reference target.

Gating (during RCS calibration) better characterizes the reference target and the frequency response error (E_r) of the measurement system.

The “Gating during Calibration” feature is located in the Target Response menu. There are two selections:

GATING YES If selected, the HP 8530 will use the current gate settings during the gated calibration. If Gating is currently turned OFF, the HP 8530 will prompt you to first set up and turn on the gate before measuring the reference target. NOTE: you can re-enter the existing calibration by pressing “RESUME CAL”. Once you have set up the gate, you do not have to start the calibration over again.

GATING NO If selected, no gate is used (in the calibration), regardless of whether gating is turned ON or OFF.

With gating ON during RCS calibration, the receiver applies the current Time Domain gate settings to the data that results *from the raw measured data of the reference target minus the background*. The gate provides better characterization of the reference target, because it removes the effects of interactions of the reference target with the test chamber. Gating can remove the effects of reference target scattering, and it can also reduce the effects of reference target shadowing. Remember that gating only removes responses that lie outside of the gate.

Setting the Gate for a Gated RCS Calibration

You should select gate Start, Stop, Center, and Span times while viewing the reference target response in the Time Domain. Make the gate span wide enough to include the full target zone response. At minimum, the gate span should be at least wide enough to be centered on the peak response of the reference target and include its full Time Domain response.

If your target is a sphere, the placement of the gate is critical. Spheres produce a secondary reflection caused by RF energy propagating around the back of the sphere, which ultimately arrives back at the receive antenna. This produces the secondary reflection, known as a “creeping wave,” located in time by $(2 + \pi) \times \text{radius} \times c$ (c = velocity of light) after the main (specular) response from the front of the sphere.

If the creeping wave is clearly separate from the main target response, place the gate around just the main response. In this case make sure you select the **OPTICAL SPHERE** model when you define the RCS target (as explained the section on RCS calibration).

If the main target response and the creeping wave are not clearly distinct and separate, position the gate around both of them. In this case make sure you select the **TARGET: SPHERE** model when you define the RCS target.

Because the gate start and stop indicators show the -6 dB points of the gate filter, it is important to locate them beyond the peak of the responses that are to be kept within the gate to prevent distorting the responses.

Do Not Use Gating When . . .

- You are measuring a small frequency span or number of points.
- If using a frequency list where the points are not evenly spaced.

Time Domain RCS Measurements

Do not attempt to gate out very large background reflections, or subsequent measurements will not be accurate.

Note Be sure to turn OFF any existing calibration before making the gate settings for a gated calibration. RCS calibration (gated or ungated) moves the target zone to zero seconds in the Time Domain. Because of this, setting the gate while calibration turned ON will put the gate in the wrong place. Since this will produce a bad calibration, the HP 8530A will issue a warning if you attempt to do this. If this ever happens, press TIME DOMAIN, GATING, GATE OFF, and then return to the calibration by pressing CAL, RESUME CAL.

Using Gating During Subsequent Measurements

If gating is used during the calibration, HP recommends that it also be used in subsequent calibrated RCS measurements. After calibration is finished, the receiver turns the gate OFF automatically. It does this because the RCS calibration procedure shifts the target zone to zero seconds, and the current gate would be in the wrong place. Move the Gate center to the appropriate location around zero seconds before turning the gate back ON.

Effects of Gating on Background Calibrations

Gating has no effect on the isolation portion of any calibration, gated or ungated. It is applied only to the difference trace that is used when constructing the frequency response error term during a gated RCS calibration.

Time Domain Antenna Impedance Measurements

Time Domain is also very useful when measuring antenna impedance. This type of measurement requires you to add a coupler to the measurement configuration, as shown in Figure 13-10. For antenna impedance measurements, the Time Domain response gives a measure of reflection coefficient versus time. This can give significant insight into the design of the antenna.

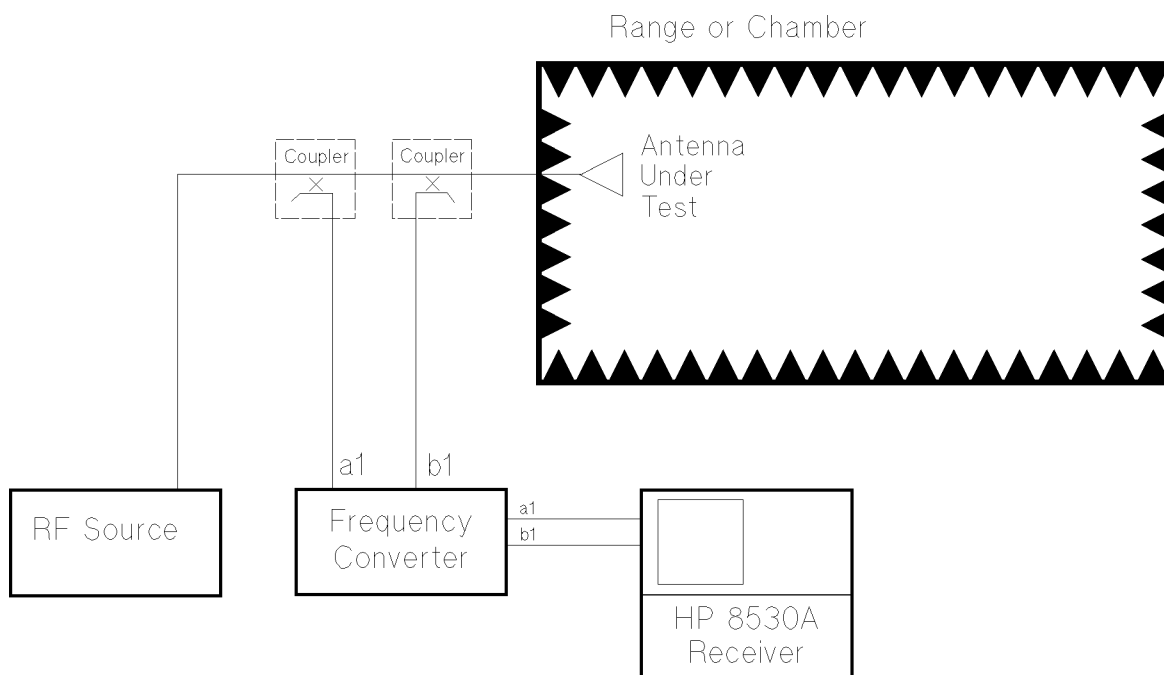

Figure 13-10. Time Domain Antenna Impedance Measurement Setup

Time Domain concepts are often very similar between Radar Cross Section measurements and antenna impedance measurements. This section will discuss only those areas that are unique to impedance measurements. Please refer to the section on Time Domain RCS Measurements for additional information on Time Domain measurements.

As an example of a measurement using Time Band Pass, consider the reflection of a standard gain antenna, measured at the end of a cable.

Procedure

1. Perform a 1-port calibration, as explained in the Calibration section.
2. Then connect the standard gain antenna to the test cable, being careful not to move the cable (which could invalidate the 1-port calibration).
3. Press: **DOMAIN** **TIME BANDPASS**
4. Press **LOG MAGNITUDE** **AUTO** to display the trace and observe the Time Domain response of the antenna. Figure 13-11 shows a typical Frequency Domain and Time Domain response.

Time Domain Antenna Impedance Measurements

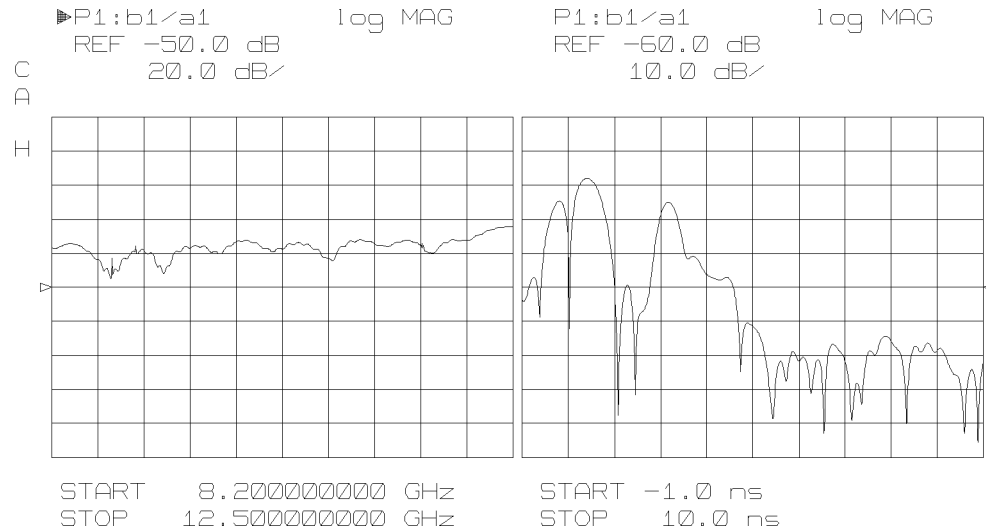

Figure 13-11. Typical Frequency and Time Domain Response of an Antenna

Interpreting the Time Band Pass Reflection Response Horizontal Axis.

NOTE: When you read the following paragraph, you need to know the definition of the term “calibration plane.” A “calibration plane” is the exact place (electrically) where you placed the calibration standards during a calibration. This is the only location in the system that is actually calibrated.

In Time Band Pass reflection measurements, the horizontal axis represents the amount of time that it takes for an impulse, launched at the “calibration plane,” to reach the discontinuity in the antenna and return. Thus, this is the two-way travel time to the discontinuity.

The Marker reads out both the time and the electrical length to the discontinuity. The electrical length is obtained by multiplying the time by the velocity of light in free space (2.997925E8 m/sec). To get the physical length, multiply the displayed electrical length by the relative velocity of light in the transmission medium of the antenna, or use the **VELOCITY FACTOR** function. Using Velocity Factor along with Electrical Delay can produce accurate distance measurements in dispersive media such as waveguide. Refer to the description of the Electrical Delay feature in the Response chapter.

Interpreting the Time Band Pass Reflection Response Vertical Axis.

The quantity displayed on the vertical axis depends on the selected display format. Time Band Pass defaults to the Linear Magnitude format, which displays the response in reflection coefficient (ρ) units. This can be thought of as an average reflection coefficient of the discontinuity over the frequency range of the measurement.

Other useful formats are listed in Table 13-3. The Time Band Pass response gives the magnitude of the reflection only and has no direct impedance information (R, L, or C).

Table 13-3. Useful Time Band Pass Formats

Format	Trace Value
LINEAR MAG	Reflection Coefficient Units
LOG MAG	Return Loss (dB)
SWR	SWR Units

Time Domain Antenna Impedance Resolution

Time Domain antenna impedance resolution refers to the minimum separation between antenna impedance discontinuities that can be resolved by the Time Domain impulse. For the HP 8530A, this is determined by the width of the Time Domain impulse, which is inversely proportional to the measurement frequency span. A wider measurement frequency span will produce a narrower Time Domain impulse, which gives better resolution of the antenna discontinuities.

Formulas for determining the impulse width and impulse shape are given in Table 13-1 in the section on Time Domain RCS measurements.

Antenna Impedance Alias-Free Range and Aliasing

Time Domain antenna impedance measurements also have an Alias-Free Range that is equal to $1/\Delta F$, the spacing between Frequency Domain data points (the same as for RCS measurements). In general, aliasing is much less limiting for antenna impedance measurements than for RCS measurements. It is recommended that the Alias-Free Range be at least twice as large as the electrical length of the antenna.

To increase the Alias-Free Range, first increase the Number of Points measured in the Frequency Domain. If going to the maximum Number of Points (801) is not sufficient, reduce the Frequency Domain span. (Reducing frequency span also reduces the RCS Time Domain resolution. So reduce the measurement frequency span only as much as is absolutely necessary.)

Effects of 1-Port Calibration on Antenna Impedance Time Domain Responses

The purpose of 1-port calibration is to reduce the effects of systematic measurement errors (those that are stable and repeatable), and to display the antenna impedance both in Frequency and Time Domain. Antenna calibration uses a three term error model, as shown in Figure 13-12.

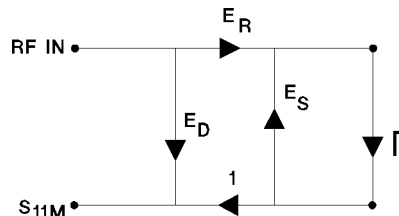

Figure 13-12. Antenna Impedance 1-Port Error Model

The 1-port impedance error model contains directivity, source match, and Frequency Response error terms. Directivity is an isolation type of error term that arrives in parallel with the response of the antenna. It is characterized by measuring a very high quality broadband 50 ohm load (from a calibration kit). The Source Match error term represents the non-ideal impedance match that the measurement system presents to the antenna. (An indirect analogy in RCS error measurements is the multi-dimensional “scattering” responses caused by the reference target. Because source match of the antenna impedance measurement configuration is confined to one dimension, it can be characterized and be used in calibration.) The Frequency Response error term describes the phase and amplitude differences between the test and reference channels. Source Match and Frequency Response error terms are characterized by measuring a shielded (and modeled) open circuit and a short circuit (offset short circuits

Time Domain Antenna Impedance Measurements

are used in waveguide in place of the open circuit). With a balanced test configuration, these measurement errors are very stable and repeatable, and their effects can be removed from the measured data.

Note

When calibrating at the end of a cable, it is important to minimize the movement of the cable during and after the measurement calibration (since this can change its frequency response and invalidate the calibration). In addition, to minimize the effects of changing temperature on measurement calibration, it is important that the test and reference cable lengths be approximately equal. (To test for this, measure a short circuit with no calibration applied and view the Frequency Domain phase. A well balanced test configuration will have little or no phase change with frequency when a coaxial short circuit is measured.)

Effects of 1-Port Calibration

With calibration OFF, the location (in time) of the antenna impedance is determined by the electrical balance of the test and reference cables. After calibration is applied, the reference plane will be shifted to zero seconds (this is a result of the phase calibration that occurs to the Frequency Domain data). The 1-port calibration greatly improves the accuracy of the impedance measurement.

Antenna Impedance Time Domain Concepts

The following concepts are important to understand when interpreting the measured antenna impedance Time Domain responses.

Masking in Impedance Measurements

Masking is a physical phenomenon that occurs when an impulse response of one impedance discontinuity affects (or hides) the response of subsequent discontinuities in the antenna. This occurs because the energy reflected from (or absorbed in) the first discontinuity never reaches the second. The net effect is that the subsequent discontinuities will present a lower impedance than would occur if the first discontinuity was not present. In addition, the antenna under test will radiate energy during the impedance measurement. This radiated energy can reflect off nearby objects and be received by the test antenna. This appears in the Time Domain as an impedance response that is far separated (in time) from the response of the actual antenna. For this reason, it is recommended that the antenna be pointed toward free space (if outdoors) or towards low reflection absorber when making impedance measurements. Gating can be used to remove the effects of these radiated-reflected signals from the impedance measurement.

Gating in Impedance Measurements.

The HP 8530A Gating feature provides the ability to selective view individual portions of the Time Domain response. After converting back to the Frequency Domain, the effects of the Time Domain responses *outside of the gate* are removed. For antenna impedance measurements, this allows the user to view the responses of individual discontinuities within the antenna. You can also gate out responses caused by radiated-reflected responses. See the section on RCS Gating for a discussion of gate filter shapes. There is no provision for using gating during a 1-port calibration (because of its inherent high accuracy). However, gating can be used after 1-port calibration is turned ON.

Time Domain Antenna Transmission Measurements

Time Domain is also useful when making antenna transmission measurements and characterizing the antenna test range for multipath signals.

Time Domain concepts are very similar between Radar Cross Section measurements and antenna transmission measurements. This portion of the manual will cover only those areas that are unique to antenna transmission measurements. Please refer to the section on Time Domain RCS Measurements for additional detail on Time Domain measurements.

Time Domain Characterization of Antenna Range Multipath

Antenna range multipath describes signals received by the test antenna from directions other than line-of-sight from the transmitter.

The dominant sources of multipath responses occurring in outdoor ranges are the:

- Responses caused by direction illumination of the ground.
- Energy reflecting from nearby buildings or other objects.

For indoor ranges, multipath can be caused by:

- Reflections from non-ideal absorber material
- Direct illumination from the feed antenna of a compact antenna test range (CATR) to the test antenna.
- Scattering off of CATR reflectors
- Re-radiation of the receive antenna that illuminates close-in obstacles and causes secondary responses.

These multipath responses arrive in parallel with the main line-of-sight response. Because the reception of multipath depends on the radiation pattern of the antenna and its orientation, the resulting errors are not stationary and there is no simple mathematical technique to characterize and remove them. However, Time Domain analysis of the test range can help to determine their levels, which can help in the placement of absorber or other structures to reduce their reception by the test antenna.

Antenna range geometry is a significant factor when attempting to distinguish Time Domain transmission responses. The difference in the main path and ground path can be determined using the following formula (for equal antenna heights and a flat ground contour). The difference between these two paths on a conventional outdoor range depends on the height (H) of the antennas above ground and the distance (D) between the transmit and receive antennas.

$$\Delta = (\text{Square Root } (D^2 + (2H)^2)) - D$$

Usually, higher antennas or shorter distance between transmit and receive towers cause a greater difference between the direct and ground path responses.

Antenna Impulse Response

The following concepts are important to understand in interpreting the measured antenna transmission Time Domain responses. Formulas for determining the Time Domain impulse width and impulse shape are the same as given in Table 13-1, in the RCS Time Domain section. However, due to the dispersion and to internal reflections, many antennas have Time Domain response that extends longer in time than would be expected, as shown in Figure 13-13.

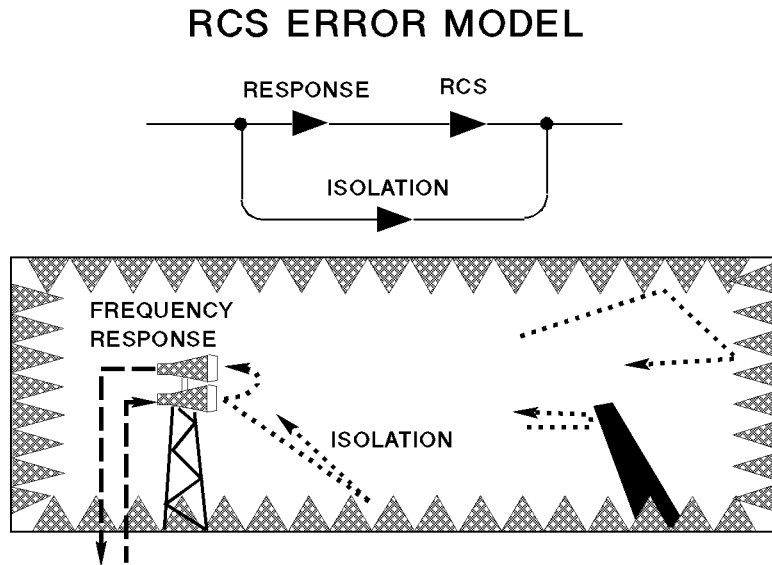

Figure 13-13. Responses in a Typical RCS Range

When using Time Domain to distinguish between main path responses and ground path responses, the path difference Δ must be greater than the impulse response of the antenna under test. In general, broadband antennas have shorter duration transmission Time Domain impulse responses. It is recommended that the antenna be characterized only over its operational bandwidth. Measuring an antenna outside of its bandwidth will not reduce its impulse response width, and it may adversely affect the Time Domain measurement.

Antenna Transmission Alias-Free Range and Aliasing

Time Domain transmission response measurements also have an Alias-Free Range that is equal to $1/\Delta F$, where ΔF is the spacing between Frequency Domain data points (the same as for RCS measurements). Usually, aliasing is much less limiting for antenna transmission measurements than for RCS measurements. It is recommended that the Alias-Free Range of the measurement be less than the greatest difference between the line-of-sight path and multi-path signals. Note that this difference is usually far less than the actual length of the antenna test range.

To increase the Alias-Free Range, first increase the Number of Points measured in the Frequency Domain. If going to the maximum Number of Points (801) is not sufficient, then you must reduce the Frequency Domain span. Since this reduces the Time Domain resolution, it is recommended that you keep the frequency span as wide as possible (within the operating bandwidth of the test antenna).

Effects of Antenna Calibration

The purpose of antenna gain calibration is to calibrate the antenna transmission response in dBi (relative to an isotropic radiator). Although the intention is to reduce the effect of all test range measurement errors, the only error terms that can be characterized are the receiver isolation (crosstalk) and the range/receiver frequency response. A 2-term error model is used. However, this does not remove the effects of multipath. The frequency response error term is characterized by measuring a standard gain antenna.

Before calibration is turned ON, the location (in time) of the antenna transmission response is determined by the difference between the line-of-site transmission path and the reference

Time Domain Antenna Transmission Measurements

signal transmission path. After antenna calibration is turned ON, the main antenna transmission response in time shifts to zero seconds.

Gating

The HP 8530A Time Domain gating feature can remove the effects of unwanted Time Domain responses. For antenna test ranges where there is adequate separation of the line-of-sight and multipath responses, Time Domain gating can remove the effects of the range multipath, with significant results. When converting back to the Frequency Domain, the effects of the Time Domain responses outside of the gate are removed. See the earlier section on RCS Gating for a discussion of gate filter shapes.

For automated antenna systems, the Time Domain gating feature can remove the effects of multipath from antenna pattern measurements. This procedure involves making broadband measurements at discrete rotation angles (stepped positioner motion). During the measurement (or afterwards in post-processing), the Time Domain gating feature can be used to remove the multipath from each multiple frequency measurement. After the measurement is complete, the end result is up to 801 different antenna patterns (one for each measurement frequency) that have had the effects of multipath removed. For more information, obtain the paper "Making Accurate Antenna and Radar Cross Section Measurements," which is available upon request.

Errors Caused by the Gating Process

When using gating to remove the effects of unwanted response paths, it can be difficult to determine the resulting measurement accuracy in the Frequency Domain response. Usually the net result is better because of the reduction of the unwanted signal, but it is difficult to determine just how much better. The following guidelines are suggested.

First, consider the effect of the unwanted signal on the desired response. Table 13-4 lists the measurement error that can be caused by stray signals at different levels relative to that of the desired response.

Table 13-4. Gating Uncertainty

Unwanted Signal to Desired Signal Ratio	± Amplitude Uncertainty	Phase Uncertainty
10 dB	Completely in error	Completely in error
0 dB	+6 dB – ∞ dB	±45 deg
-10 dB	+2.4 dB – 3.3 dB	±18 deg
-20 dB	+0.83 dB – 0.92 dB	±5.7 deg
-30 dB	+0.27 dB – 0.28 dB	±1.8 deg
-40 dB	+0.09 dB – 0.09 dB	±0.57 deg

If setting a gate span also reduces some of the main response, then you will incur the an error proportional to the relative level of the response to the main level. Again, Table 13-4 is a good guideline in determining the effect of this operation.

SAVE and RECALL

Saving and Recalling Instrument States

SAVE and **RECALL** allow you to save and recall up to eight different measurement setups (instrument states). An **instrument state** is defined as the condition of all current measurement settings, including all domain, stimulus, parameter, format, and response settings.

When you press **SAVE** or **RECALL**, a menu appears which lists the eight Save/Recall registers. When saving, choose the register you want to hold the instrument state. If you select a register that has an instrument state in it, you will overwrite the old instrument state with the current one.

When you recall an instrument state, current instrument settings change to those defined in the instrument state.

Storing Instrument States to Disc

You can save instrument states to disc, as explained in Chapter 15, Disc Drive Operation.

An instrument state you load from disc does not automatically go into effect. After loading the instrument state to a register, you must then press **RECALL** and select that register.

USER PRESET

You can save your current setup as the “USER PRESET” state by saving it to Save register 8. The receiver will return to that state whenever the instrument is turned on, or if you press **USER PRESET**.

FACTORY PRESET

To return the receiver to its factory-default settings (shown below), press:

RECALL **MORE** **FACTORY PRESET**

Factory Preset State

The Factory Preset State consists of the factory default values selected for various functions. The following is a partial list of the preset state or value associated with a function. If you have a question on a specific function, refer to the individual entry in the *HP 8530A Keyword Dictionary*.

Save and Recall

Table 14-1. Instrument Factory Preset Conditions

INSTRUMENT STATE	Selected Channel = 1, No Menu Displayed SAVE/RECALL Instrument States 1-8 Not Changed.
DOMAIN	Frequency GATE OFF.
STIMULUS	Maximum sweep range of source and test set. NUMBER OF POINTS = 201, Source Power = depends upon source. SWEEP TIME = 166 ms, RAMP SWEEP, CONTINUAL,
PARAMETER	Channel 1 = Param 1, Channel 2 = Param 2.
FORMAT	Channel 1 = LOG MAG. Channel 2 = LOG MAG.
RESPONSE	SCALE = 10 dB/division, REF VALUE = 0 dB, REF POSN = 5, ELECTRICAL DELAY = 0 seconds, COAXIAL, AVERAGING = OFF, SMOOTHING = OFF, PHASE OFFSET = 0 degrees, MAGNITUDE OFFSET = 0 dB, MAGNITUDE SLOPE = 0 dB/GHz, NORMALIZE OFF.
CAL	CORRECTION OFF, $Z_0 = 50$ Ohms, VELOCITY FACTOR = 1.0, TRIM SWEEP = 0, CAL SETS 1-8 = Not Changed.
DISPLAY	SINGLE CHANNEL, DATA. Trace Memories 1-8 Not Changed. Display Colors Not Changed. Date/Time Clock On.
SYSTEM	HP-IB Addresses Not Changed. CRT ON, IF GAIN = AUTO. MULTIPLE SOURCE = OFF
MARKER	all OFF, Δ OFF, DISCRETE Marker List On, All Param/1 Marker
COPY	PLOT ALL = FULL PAGE Param 1 Data = Pen 3. Param 2 Data = Pen 5. Param 3 Data = Pen 6. Param 4 Data = Pen 4. Graticule = Pen 1. Plot Type = Color.

Disc Drive Operation

Chapter Contents

- Features
- Disc Capacities
- ASCII and Binary File Types
- Compatible Disc Types
- Changing between DOS and LIF discs
- Initializing Discs
- Storing Disc Files
- Loading Disc Files
- Viewing a Directory of Files
- Deleting Disc Files
- Un-Deleting Disc Files
- Using an External Disc Drive
- Disc Unit and Volume Number
- Guide to Saving Data
- Sharing a System
- Viewing or Plotting Old Data (from disc)
- CITIfile Reference

Features

Features under the **(DISC)** key allow you to save measurement, calibration, or instrument state information to disc. This information can be retrieved when desired. You can use the built-in internal disc drive, or compatible external disc drives. External drives must be connected to the system bus. You can control these devices using the **(DISC)** key in the AUXILIARY MENUS block, and its associated menus.

The **(DISC)** key and related menus allow you to:

- Store files (save various types of data to internal or external disc).
- Load files (load a disc file containing data).
- Delete files from internal or external disc.
- Un-Delete the last file you deleted.
- View a directory of files
- Initialize new discs.
- Use internal or external disc drives.

Both internal disk and SS/80 type external disc drives can provide data storage for instrument states, calibration error coefficient sets, calibration kit definitions, measurement data, memory data, hardware states, user display memory, delay table, or machine dump (these terms are defined later in this chapter).

Disc Functions

Compatible Disc Types, Disc Storage Capacity

The receiver can initialize floppy discs using DOS format or Logical Interface Format (LIF). DOS format is used by PC compatibles, LIF is used by HP 9000 series 200/300 workstations. The HP 8530 uses high-density or low-density 3.5 inch discs. *Use only certified double-sided discs or you may cause excessive wear to the disc drive.*

Table 15-1. Disc Storage Capacities

Disc Type	LIF Capacity	DOS Capacity
Low Density	622 KB	720 KB
High Density	1.244 MB	1.44 MB

DOS Subdirectories

The HP 8530A can only access files on the “root” directory of a disc. Files cannot be accessed in DOS subdirectories.

Disc Menu

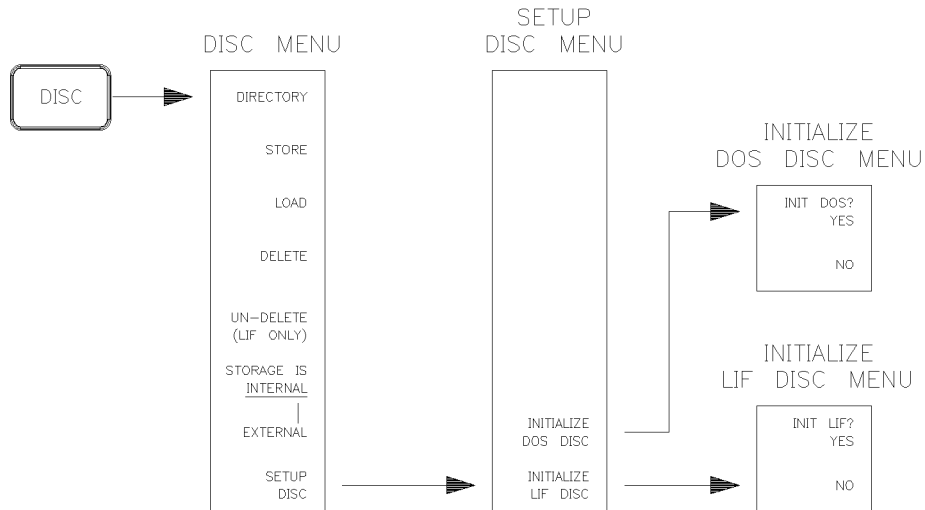

Figure 15-1.
Disc Menu, Data Type Select Menu, Setup Disc Menu, and Initialize Disc Menu

ASCII and Binary File Types

The receiver can save some file types in binary file format, and others in ASCII format. The format used for each type of data cannot be changed by the user, and are listed in Table 15-2.

All other types of data are saved as shown in Table 15-2.

Binary data files require less disc space and the file transfer is faster. If the cal set file is to be read by a computer, use ASCII format.

Table 15-2 shows the information you can store to internal or external disc drives, and the data format the receiver uses when saving it (ASCII or binary).

Table 15-2. Information You Can Store To Disc, and How it is Saved

Files Saved in ASCII Format	Files Saved in Binary Format
Memory data	Network Analyzer Calibration Kit
RAW measurement data	Calibration kit definitions
DATA (corrected) measurement data	The user portion of the display memory
FORMATTED measurement data	Hardware state
The electrical delay table	Instrument states
Calibration error coefficient sets	Machine dump
Antenna Calibration Definition	

The ASCII data is saved in the CITIfile ASCII format. CITIfile adds informative headers to the information in the file, and allows data to be exchanged with the Hewlett-Packard Microwave Design System. Complete information on the CITIfile format is provided at the end of this chapter.

Changing between DOS and LIF Discs

When you insert a formatted disc, the receiver can automatically tell whether it is LIF or DOS format. The only time you must choose between LIF and DOS is when you initialize discs.

Initializing Discs

1. Before you initialize a floppy disc make sure the write-protect tab is completely shut.
2. Insert the disc with the label-side facing left.
3. Press **(DISC) SETUP DISC**.
4. To initialize the disc using DOS format, press **INITIALIZE DOS DISC INIT DOS? YES**.
5. To initialize the disc using LIF format, press **INITIALIZE LIF DISC INIT LIF? YES**.

The initialization process takes about 2 minutes 20 seconds per disc.

Disc Functions

Note The disc drive has a light that comes ON when the disc is being accessed. Do not eject the disc when this light is ON or you could lock-up the receiver. If this occurs, simply place the disc back into the drive.

Storing Disc Files

Files that are associated with *internal instrument operation* (instrument states, hardware states, machine dumps, and so on) are stored in binary format. *Measurement data* is always stored in “CITIfile” ASCII format. The “CITIfile” format has informative headers, and allows data to be exchanged with other programs. Complete information on the CITIfile format is provided at the end of this chapter.

1. Insert an initialized disc.
2. Press **DISC** **STORE**.
3. Choose the type of file by pressing one of the following keys:

INST STATE 1-8

Press this softkey, then select the instrument state register you want to store to disc.

INST STATE ALL

Press this softkey to store all eight instrument states to one file.

MEMORY 1-8

Press this softkey, then select the memory register you want to store to disc.

MEMORY ALL

Press this softkey to store all eight memories to one file.

CAL SET 1-8

Press this softkey, then select the cal set you want to store to disc.

CAL SET ALL

Press this softkey to store all eight cal sets to one file.

CAL KITS

Press this softkey, then select the cal kit definition you want to store to disc (Network Cal Kit or Antenna Cal Definition). RCS cal definitions cannot be stored to disc.

Press **MORE** to see the following choices:

DATA: RAW	Press this softkey to store the raw data array for the active channel.
DATA	Press this softkey to store the calibrated data array for the active channel.
FORMATTED	Press this softkey to store the formatted data array for the active channel.
DELAY TABLE	Press this softkey to store the electrical delay table to disc.
USER DISPLAY	Press this softkey to store User Display graphics to disc.
HARDWARE STATE	Press this softkey to store multiple source mode settings, HP-IB settings for external hardware, and test set (frequency converter) states.
MACHINE DUMP	Press this softkey to store the following instrument registers to a single disc file:

- a. Current instrument state
- b. Instrument states 1–8
- c. Cal sets 1–8
- d. Cal kits
- e. Hardware state
- f. Memories 1–8

When you load a machine dump from disc, the contents of these internal registers are replaced with the data from the machine dump file.

Note: Before saving a machine dump file, store your current measurement setup in Save Register 8 (the user preset/power ON register). Later, when that machine dump is loaded, the receiver will wake up in that state. When a machine dump file is loaded, the receiver wakes up with whatever is in Register 8. The machine dump does not automatically remember your desired setup *unless* it is stored in Register 8.

4. A “label maker” menu will appear. Notice that the menu has a list of alpha-numeric characters and a selector arrow. The file name prefix for the selected type of data will already be entered for you.

If you want to overwrite an existing file, press **REPLACE FILE**. A list of the current disc files will appear on screen. (The receiver will only list the type of files selected in step 3. For example, if you are storing a Raw data file, only raw data files will be shown in the directory listing).

Use the knob or **▲ ▼** keys to select the file you want to replace, then press **REPLACE FILE**. The instrument will now store the file to disc.

5. If you are creating a new file enter the desired file name as follows:
 - a. Using the rotary knob, place the cursor under the first desired letter or number. Press **SELECT LETTER**. If you make a mistake press **BACK SPACE**. Continue until you have selected all desired characters. You can enter up to seven characters. Note: If saving to DOS discs, the sixth and seventh characters will become a file name extender. For example: RD_12345.67

Disc Functions

- b. When you are done entering file name characters, press `STORE FILE` to store the file to disc.

The error message `CAUTION: DISC IS WRONG FORMAT, INITIALIZE TO USE` means:

- A. The disc has never been initialized.
- B. The disc is not a compatible format. Apple Macintosh's (GCR) format is not compatible, for example. Use a DOS or LIF compatible disc, or copy any important files off the disc and initialize it in DOS or LIF format.

Loading Disc Files

You can load files in any sequence with the following considerations:

- Before loading measurement data, turn on hold mode by pressing:

STIMULUS `(MENU) MORE HOLD`

Otherwise the data you load will be immediately overwritten with new data.

- In Frequency Domain, the currently-selected number of points must match the number of points in the data file. For example, if you want to load a Frequency Domain data file with 801 points, make sure you set the HP 8530A to Frequency Domain mode, and select STIMULUS `(MENU) NUMBER of POINTS 801`.

- In Angle Domain, the current Start, Stop, and Increment Angle settings must result in a number of measurement angles that matches those in the disc file.

For Example. You currently have Start Angle set to -90° , Stop Angle to $+90^\circ$, and Increment Angle to 1° . This results in 181 measurement angles. You could load any disc file that has 181 angles in it.

To load a file with a different number of measurement angles, set the Start, Stop, and Increment Angle to values that will result in the appropriate number of angles.

Note: The Start Angle, Stop Angle, and Increment Angle do *not* have to match those in the disc file. The only requirement is that the *current number of measurement angles* must match the *number of angles in the file*. Assume you are using the settings listed in the above example. You could load a file with a Start Angle set to -45° , Stop Angle to $+45^\circ$, and Increment Angle to 0.5° . In both cases the number of angles in the measurement is 181.

If you do not perform these initial steps, the current "number of points" may not match the number of data values in the disc file. If this occurs, an error message similar to the following will appear:

`CAUTION: UNABLE TO LOAD 181 POINTS`

- If you load Raw data, the receiver places it in the Raw data array, and performs all subsequent data processing functions on it. This includes calibration (if turned on) as well as all display formatting. After all processing is done the data appears on the screen.
- If you load "Data" data (corrected data), the receiver places the data in the Corrected data array, performs all display formatting. After all processing is done the data appears on the screen.
- Calibration must be turned OFF when you load cal sets.
- If the display memory feature is ON (a memory trace is displayed on the screen), you can only load memory data files into *empty* memory registers. If the display memory feature is OFF, you can load memory data files into *any* memory register.

Loading a File

Perform the following steps to load a disc file.

1. Press **DISC** **LOAD**.
2. Now choose the type of file you want to load.
3. If you choose to load an instrument state, memory, cal set, or cal kit.
 - a. Choose the specific destination register. For example, if you choose **CAL SET 1-8** the receiver now displays **CAL SET 1** through **8** register choices. Select the desired register to hold the cal set data.

If you select any other data type you do not have to select a destination register.

4. A “file selector” box now appears on the screen. The file selector shows a directory of all files of the desired type. For example, if you chose **CAL SET 1-8**, the file selector lists only the *cal set files* on the disc.
5. Use the **▲ ▼** keys or knob to highlight the desired file, then press **LOAD FILE**. The file will now load from disc.

Viewing a Directory of Files

Press **DISC** **DIRECTORY** to display a directory of all the files on the inserted disc. Each disc can hold many files in each data type. There are often more files on the disc than can be seen at one time. Use the knob to scroll through the file listing.

Each HP 8530A data file type has a three-character prefix. The prefix is convenient for two reasons:

- It allows the HP 8530A to show only the files of a specific type. When you are loading a Cal Set file, it is convenient to see a listing that only includes that type of file.
- If you are performing a directory listing of the disc, the prefixes show the exact type of each file.

Table 15-3. File Types and Prefixes

File Type	Prefix	File Type	Prefix
Cal Kit	CK_	Instrument State All	IA_
Cal Set	CS_	Raw Data	RD_
Cal All	CA_	Data	DD_
Memory File	DM_	Formatted	FD_
Memory All	MA_	Display	UD_
Inst State	IS_	Delay Table	DT_
Hardware State	HS_	Machine Dump	MD_
Program	PG_	Antenna Definition	AC_

Deleting Disc Files

DELETE eliminates the specified file from the disc. To delete a file:

1. Press **DISC** **DELETE**.
2. Now, select the type of file you wish to delete.
3. A File Selector box will now appear on the screen, listing all disc files of the selected type. Place the box-shaped cursor over the file you wish to delete (using the knob or ▲ ▼ keys).
4. Press **DELETE FILE**. The file will be deleted. If you made a mistake and really did not want to delete the file, un-delete the file as explained below:

Un-deleting Disc Files

This feature only works on discs that have been formatted in the Logical Interchange Format (LIF).

Press **UN-DELETE** to restore the most recently deleted file. You cannot retrieve a deleted file if any of the following actions occur:

- If you store another file on the disc after the deletion.
- If you remove the disc and then reinsert it.
- If you delete a second file. (The un-delete feature only works on the *last* file you deleted.)

Using an External Disc Drive

Compatible Disc Drives

An external disc drive must be HP-IB compatible. It must be able to use the Hewlett-Packard SS/80 protocol, and be capable of being formatted to 256 bytes per sector.

You can use a floppy disc, hard disc, or combination hard/floppy drive.

Disc Unit Number and Disc Volume

The softkeys **DISC UNIT NUMBER** and **DISC VOLUME** only apply to external disc drives.

Connections and Configuration Settings

Install the drive using the installation portion of the disc drive's operating manual, and the following instructions. If you have a hard drive, read about setting up "volumes" in the drive's manual. Hewlett-Packard hard discs can be partitioned into two or more volumes, which act like separate drives.

1. Connect the external drive to the receiver's System Bus.
2. Select the number of desired hard disc volumes using the hard disc's rear panel selector.
3. Make sure the external drive's HP-IB address matches the address in the receiver's HP-IB address menu (press **LOCAL** **MORE** **DISC**). You can change the address shown in the address

menu by entering the actual address followed by the **(x1)** key. Alternatively, you can change the HP-IB address switches on the external disc drive. Turn the disc drive Off, then On if you change its HP-IB switch settings.

4. Press **(DISC)** **STORAGE IS EXTERNAL** then **SET UP DISC** to select the unit and volume number (explained below).
5. If using a disc drive that has more than one drive mechanism (unit), you must select the specific drive you want to use. The default is 0 (usually the left drive on a dual floppy drive, or the hard disc in a floppy/hard disc combination drive).

If you want to use the right-hand drive (in a dual floppy system), or the floppy drive in a hard disc/floppy drive:

Press **(DISC)** **SET UP DISC** **DISC UNIT NUMBER** **(1)** **(x1)**

Refer to the disc drive's operating manual to verify the unit numbers used by your drive.

6. Hard drives can be partitioned into one or more "volumes." Volumes act like separate drives, even though they are, in fact, part of the same physical disc. A control wheel on the back of the hard disc selects the number of volumes that can be used. Select the specific volume you want to address by pressing:

(DISC) **SET UP DISC** **DISC VOLUME**, then enter the desired volume number and press **(x1)**. Volume 0 through 7 may be specified. Factory Preset selects volume 0.

Note You must initialize each hard disc volume before use. Refer to "Initializing a Hard Disc" later in this section.

If the disc drive does not respond to subsequent commands the message NO DISC is displayed. Check the disc address again (both on the unit itself and in the receiver's **(LOCAL)** Menu), Also check and the unit and volume number again.

Initializing a Hard Disc

If using a hard disc for the first time you must initialize each volume. You can do this using a computer, or using the HP 8530A. To initialize the hard disc using the HP 8530A, follow these steps:

1. Set the volume number to 0 by pressing: **(DISC)** **SET UP DISC** **DISC VOLUME** **(0)** **(x1)**.
2. Press: **INITIALIZE LIF DISC**
3. Press **INIT LIF? YES**. Depending on the size of that volume it will take between 10 to 30 minutes to initialize.
4. Select the next volume number (if using a multi-volume drive), repeat steps 1, 2, and 3.
5. Repeat the above steps for each volume.

Disc Functions

Guide to Saving Data

This section explains two common applications for saving data.

First of all, a more in-depth description of the different file types will be helpful in this discussion:

Instrument States	<p>These states contain front panel settings, including:</p> <ul style="list-style-type: none">■ Instrument settings■ Frequency list segments■ Whether calibration was On or Off■ Whether the Delay table was On or Off■ Whether user display was on or off■ The cal set in use (if any) for that state■ Whether electrical delay was On or Off <p>The instrument state does <i>not</i> keep track of calibration data, cal kit definitions, user delay table contents, or any settings that control external hardware.</p>
Memory	<p>These store a display data trace. These stored traces can be viewed next to current data. Memory trace data can be used as an addend, subtrahend, multiplicand, or dividend of current data using trace math features.</p>
Cal Sets	<p>A cal set contains all the error coefficients for a calibration you have performed.</p>
Cal Kit	<p>Contains the mathematical models for the precision standards in a calibration kit.</p>

Note: In the following descriptions, data is described as being affected by various features (averaging, calibration, and so on). Such user-selected features only affect the data when turned On.

Raw Data	<p>Raw data is averaged, but no other processing is performed. This data is stored in an internal memory array called the “Raw Data Array.” Raw data is composed of complex data pairs (real,imaginary) for each stimulus point.</p>
“Data” Data	<p>This is measurement data that has been processed by calibration, electrical delay, the user-defined delay table, and time domain. “Data” data is stored in an array in complex data pairs.</p>
Formatted Data	<p>This is measurement data that has been processed by trace math, smoothing, and has been formatted according to any display settings. If you have selected a Cartesian display format, formatted data is no longer a complex value, but is scalar (magnitude only). If you have selected Polar format, formatted data is a complex value.</p>
Delay Table	<p>The delay table allows you to mathematically change each raw data point with a complex (real,imaginary) multiplier of your own choosing. The result is saved in the “Data” data array. The receiver multiplies each measurement data pair with the corresponding number pair in your delay table.</p>
User Display	<p>Contains user-defined graphic elements drawn on the display.</p>
Hardware State	<p>These are mostly settings found under the (SYSTEM) or (LOCAL) keys. These settings control HP-IB addresses, multiple source settings, and other hardware-related settings. The hardware state also controls the default RF source power.</p>
Machine Dump	<p>Stores the following registers:</p> <ul style="list-style-type: none">■ All eight Instrument States

- The Hardware State
- All eight Memory registers
- All eight Cal Sets
- All Antenna Cal Definitions and Network Analyzer Cal Kits
- Delay Table
- User Display graphics

Sharing a System

Often several users must share the receiver. When you finish your session it is useful to save your setup so you can begin working quickly during your next session.

In this application you should:

1. Store one or more instrument state files to disc, as needed. If you have saved many different instrument states you may want to store them all at once using the `INSTR STATE ALL` softkey.
2. If you have performed one or more calibrations, store them to disc. If you used many different calibrations, you may want to save them all at once using the `CAL SET ALL` softkey. Save an instrument state for each cal set. This will ensure that you can recall the settings that are applicable for each calibration.

Calibrations are sensitive to ambient temperature and humidity, and therefore have a limited life span. In addition, a cal set's life can be limited because of changes to the system's components (including wear). You can use "old" calibrations if you measure a well-known device and compare the data to expected data. You can then decide whether or not the old calibration is still useful.

3. If using a special calibration kit, store the cal kit definition to disc too.
4. It is a good idea to save the hardware state to disc, especially if your receiver is controlling more than one source. The hardware state saves all multiple source settings. The hardware state also saves various HP-IB settings for external hardware. You can skip this if the hardware setup rarely or never changes.
5. If using a user-generated delay table, store it to disc.
6. If you created special graphic elements, store them to disc.

Saving Everything

If you use a large number of states, cal sets, memories, and so on, you may find that storing using `Machine Dump` is easier. This takes longer than saving one or two individual types of data, and takes up more disc space. However, this may be the best method in complex situations.

When you load a Machine Dump from disc, the contents of applicable internal registers are replaced with the data from the machine dump file.

A Machine Dump file *does not* automatically save the current *measurement settings*. Before saving a Machine Dump, always save the current measurement setup to save register 8. If you do this, the instrument will return to a known setup when you load the Machine Dump file.

Viewing or Plotting Old Data

If you know you want to plot, analyze, or view data at a later date, store the Raw, "Data," or "Formatted" data to disc.

CITIfile Reference

CITIfile is a standardized data format, used for exchanging data between different computers and instruments. CITIfile stands for “Common Instrumentation Transfer and Interchange” file format.

CITIfile defines how the data inside an ASCII package is formatted. Since it is not tied to any particular disc or transfer format, it can be used with any operating system (BASIC, DOS, UNIX, etc.), with any disc format (LIF, DOS, HFS, etc.), or with any transfer mechanism (disc, LAN, GPIB, HP-IB, and so on).

By careful implementation of the standard, instruments and software packages using CITIfile are able to load and work with data created on another instrument or computer. It is possible, for example, for a receiver to directly load and display data measured on a scalar receiver, or for a software package running on a computer to read data measured on the receiver.

CITIfiles use ASCII text format. While this format does take up more bytes of space than binary format, ASCII data is a standard type of format which is supported by all operating systems. In addition, the ASCII format is accepted by most text editors. This allows files to be created, examined, and edited easily, making CITIfile easier to test and debug.

This section describes CITIfile data format. The following topics are covered:

- How Disc Files are Named
- Which Files are Stored in CITIfile Format
- What is in a CITIfile
- CITIfile Keyword Reference
- CITIfile Receiver-Specific (#NA) Definitions
- Error Array Numbering
- CITIfile Examples
- Converting Between Disc Formats

Disc Files

The receiver allows you to select the file name of your choice. However, it add a three character prefix to the beginning of the file name. Each type of data file has a unique prefix.

Table 15-4. File Name Prefixes

Prefix	File Type	File Format	Prefix	File Type	File Format
AC_	Antenna Definition	CITIfile	IA_	Instrument State All	Binary
CK_	Calibration Kit	Binary	PG_	Program	Binary
CS_	Calibration Set	CITIfile or Binary	RD_	Raw Data	CITIfile
CA_	Cal All	CITIfile	DD_	Data Data	CITIfile
DM_	Memory File	CITIfile	FD_	Formatted Data	CITIfile
MA_	Memory All	CITIfile	UD_	User Display	Binary
HS_	Hardware State	Binary	DT_	Delay Table	CITIfile
IS_	Instrument State	Binary	MD_	Machine Dump	Binary

The current receiver CITIfile version is unable to read files unless they have an appropriate prefix. There are other prefixes but they only apply to binary files (instrument states and so on).

What is in a CITIfile

A typical CITIfile package is divided into two parts: a *header* portion which shows information about measurement settings, and a *Data* portion which usually contains measurement or calibration data.

Here is a typical CITIfile created while in the Frequency Domain:

```

..... Header
CITIFILE A.01.01
#NA VERSION HP8530A.01.12
#NA TITLE
NAME RAW_DATA
#NA REGISTER 1
VAR FREQ MAG 51
DATA P[1] RI
SEG_LIST_BEGIN
SEG 1000000000 2000000000 51
SEG_LIST_END
COMMENT      YEAR MONTH DAY HOUR MINUTE SECONDS
CONSTANT TIME 1992  01  13  09   46   23.0
.....
BEGIN Data
-3.54545E-2,-1.38601E-3
 0.23491E-3,-1.39883E-3
 2.00382E-3,-1.40022E-3
Remaining data values (51 total)
END
.....

```

Here is a typical CITIfile created while in the Angle Domain:

```

..... Header
CITIFILE A.01.01
#NA VERSION HP8530A.01.12
#NA TITLE
NAME RAW_DATA
#NA REGISTER 1
VAR ANGLE MAG 181
DATA P[1] RI
SEG_LIST_BEGIN
SEG -90.0 90.0 181
SEG_LIST_END
#NA CW_FREQ 1000000000
COMMENT      YEAR MONTH DAY HOUR MINUTE SECONDS
CONSTANT TIME 1992  01  13  15   59   28.0
.....
BEGIN Data
-6.09008E-1,1.66412E0
Remaining data values (181 total)
-8.39721E-1,7.72583E-1
END
.....

```

The Header

Each line in the header usually starts with a keyword, followed by various parameters. A dictionary of CITIfile keywords is provided in “CITIfile Keyword Reference”.

CITIfile Title Line

The title line describes the implementation of CITIfile in use. For example:

```
CITIFILE A.01.01
```

Device-Specific Information

The # lists settings that apply to a specific device. For example, #NA POWER1 1.0E1 would mean that source #1 is set to 1 dBm. All varieties of the #NA keyword are listed in Table 15-6.

# NA VERSION HP8530A.01.04	The receiver also uses this line to announce its model number (HP 8530A) and firmware revision (01.04):
#NA TITLE	This line shows any display title you had placed on the screen. This is explained in more detail in “HP 8530 Receiver Keywords”, later in this section.
#NA NAME RAW_DATA	The receiver uses this line to state whether the CITIfile contains raw, calibrated, formatted, memory, or calibration set data. More on #NA NAME is explained in “HP 8530 Receiver Keywords”.
#NA REGISTER 1	This line shows which instrument register held the data when you stored it to disc.

Domain Information (independent variable declaration)

The VAR keyword defines the independent variables. FREQ indicates that the receiver was in Frequency Domain. The terms ANGLE or TIME indicate that the receiver was in either Angle Domain or Time Domain, respectively. The number at the end of this line is the number of measurement points (51 in the Frequency Domain example, 181 in the Angle Domain example).

```
VAR FREQ MAG 51
```

```
VAR ANGLE MAG 181
```

Type of Measurement Data (dependent variable declaration)

The DATA keyword defines the dependent variables. This includes the measured parameter (for example “P[1]” indicates that the measurement data is from a Parameter 1 measurement). “RI” indicates that the information in the second half of the CITIfile (the data section) contains pairs of data in Real,Imaginary format.

```
DATA P[1] RI
```

The receiver only supports the real,imaginary style of data list at this time.

Stimulus Information

In Angle Domain. In Angle Domain, the stimulus is always expressed as follows:

```
SEG_LIST_BEGIN
SEG -90 90 181
SEG_LIST_END
```

The middle line contains the actual stimulus information. The data is given in this order: *Start Angle, Stop Angle, Number of Angles Measured*.

CITIfile Reference

In Frequency Domain. When in Frequency Domain, two formats are used (depending on the current sweep mode). In Sweep or Ramp mode, the following format is used:

```
SEG_LIST_BEGIN
SEG 1000000000 2000000000 51
SEG_LIST_END
```

The frequency information is in this order: *Start Frequency, Stop Frequency, Number of Points.*

If you are using FREQUENCY LIST mode, the following format is used:

```
VAR_LIST_BEGIN
1000000000
1100000000
1200000000
VAR_LIST_END
```

Each frequency in the list is included.

CW Frequency (Angle Domain Only)

Angle Domain CITIfiles will show the CW frequency of the measurement:

```
#NA CW_FREQ 1000000000
```

Date and Time

The file will also show the date and time you saved the file. 24 hour "military" time format is used.

```
COMMENT          YEAR MONTH DAY HOUR MINUTE SECONDS
CONSTANT TIME 1992  01  13  15   59   28.0
```

Data

The CITIfile stores data arrays. An array is numeric data that is arranged with one data element per line. A CITIfile package may contain more than one array of data. Arrays of data start after the BEGIN keyword, and stop at the END keyword.

```
BEGIN
-3.54545E-2,-1.38601E-3
0.23491E-3,-1.39883E-3
2.00382E-3,-1.40022E-3
END
```

Determining the Type of Measurement that Created the Data

The DATA keyword is followed by a term that denotes the type of measurement (Param 1, Param 2, Param 3, or Param 4) and shows that data is in the Real,Imaginary format.

For example:

```
DATA P[1] RI
Remember; a frequency list may exist here.
BEGIN
0.86303E-1,-8.98651E-1
8.97491E-1,3.06915E-1
-4.96887E-1,7.87232E-1
```

```
.
And so on, down to the end of the list...
-5.65338E-1,-7.05291E-1
END
```

This example shows real,imaginary data for an Param 1 measurement. The number to the left of the comma (,) is real data, the number to the right of the comma is imaginary data.

CITIfile Packages

The header and data portion shown above make up one CITIfile “package.” There can be more than one CITIfile package in a given disc file. With the HP 8530 receiver, for example, storing “memory all” will save all eight of the memories held in the instrument. This results in a single file which contains eight CITIfile packages.

Multiple Data Lists in a Single Package

There may be more than one list of dependent variables (measurement data) in a CITIfile package. If so, there will be a data statement for each list. Here is an example:

```
DATA P[1] RI
DATA P[2] RI
DATA P[3] RI
DATA P[4] RI
Remember, a frequency segment list may exist here.
BEGIN
list of data values for Param 1
END
BEGIN
list of data values for Param 2
END
BEGIN
list of data values for Param 3
END
BEGIN
list of data values for Param 4
END
```

CITIfile Keyword Reference

Table 15-5. CITIfile Keyword Reference

Keyword	Example and Explanation																		
CITIFILE	<p>Example: CITIFILE A.01.01</p> <p>Identifies the file as a CITIfile, and indicates the revision level of the file. The CITIFILE keyword and revision code must precede any other keywords.</p> <p>The CITIFILE keyword at the beginning of the package assures the device reading the file that the data that follows is in the CITIfile format. The revision number allows for future extensions of the CITIfile standard.</p> <p>The revision code shown here following the CITIFILE keyword indicates that the machine writing this file is using the A.01.01 version of CITIfile as defined here.</p>																		
NAME	<p>Example: NAME CAL_SET</p> <p>Allows the current CITIfile “package” to be named. The name of the package should be a single word with no embedded spaces. A list of standard package names follows:</p> <table border="0" data-bbox="516 867 1406 1276"> <thead> <tr> <th data-bbox="516 867 808 898">Label</th> <th data-bbox="808 867 1406 898">Definition</th> </tr> </thead> <tbody> <tr> <td data-bbox="516 905 808 936">RAW_DATA</td> <td data-bbox="808 905 1406 936">Uncorrected data.</td> </tr> <tr> <td data-bbox="516 942 808 1031">DATA</td> <td data-bbox="808 942 1406 1031">Data that has been error corrected. When only a single data array exists, it should be named “DATA”.</td> </tr> <tr> <td data-bbox="516 1037 808 1068">FORMATTED</td> <td data-bbox="808 1037 1406 1068">Corrected and formatted data.</td> </tr> <tr> <td data-bbox="516 1075 808 1106">MEMORY</td> <td data-bbox="808 1075 1406 1106">Data trace stored for comparison purposes.</td> </tr> <tr> <td data-bbox="516 1113 808 1144">CAL_SET</td> <td data-bbox="808 1113 1406 1144">Coefficients used for error correction.</td> </tr> <tr> <td data-bbox="516 1150 808 1182">CAL_KIT</td> <td data-bbox="808 1150 1406 1182">Description of the standards used</td> </tr> <tr> <td data-bbox="516 1188 808 1247">ANTENNA_DEF</td> <td data-bbox="808 1188 1406 1247">Model and serial numbers of standard gain antenna.</td> </tr> <tr> <td data-bbox="516 1253 808 1283">DELAY_TABLE</td> <td data-bbox="808 1253 1406 1283">Delay coefficients for calibration.</td> </tr> </tbody> </table>	Label	Definition	RAW_DATA	Uncorrected data.	DATA	Data that has been error corrected. When only a single data array exists, it should be named “DATA”.	FORMATTED	Corrected and formatted data.	MEMORY	Data trace stored for comparison purposes.	CAL_SET	Coefficients used for error correction.	CAL_KIT	Description of the standards used	ANTENNA_DEF	Model and serial numbers of standard gain antenna.	DELAY_TABLE	Delay coefficients for calibration.
Label	Definition																		
RAW_DATA	Uncorrected data.																		
DATA	Data that has been error corrected. When only a single data array exists, it should be named “DATA”.																		
FORMATTED	Corrected and formatted data.																		
MEMORY	Data trace stored for comparison purposes.																		
CAL_SET	Coefficients used for error correction.																		
CAL_KIT	Description of the standards used																		
ANTENNA_DEF	Model and serial numbers of standard gain antenna.																		
DELAY_TABLE	Delay coefficients for calibration.																		
VAR	<p>Example: VAR FREQ MAG 201</p> <p>Defines the name of the independent variable (FREQ), the format of values in a VAR_LIST_BEGIN table (MAG) (if used), and the number of data points (201).</p>																		

Table 15-5. CITIfile Keyword Reference (continued)

Keyword	Example and Explanation										
#	<p>Example: #NA POWER1 1.0E1</p> <p>Allows variables specific to a particular type of device to be defined. The pound sign # tells the device reading the file that the following variable is for a particular device.</p> <p>The NA shown here indicates that the information is for a network analyzer or a receiver. This convention allows new devices to be defined without fear of conflict with keywords for previously defined devices. The device identifier (NA) may be any number of characters.</p>										
SEG_LIST_BEGIN	<p>Indicates that a list of segments for the independent variable follow.</p> <p>Format for the segments is: <i>segment type</i> (SEG), <i>stimulus start</i>, <i>stimulus stop</i>, <i>number of points</i>. There are several <i>segment types</i> in the CITIfile format guidelines, however, CITIfile revision A.01.01 supports only SEG (a linear segment). Therefore, the middle line in the SEG LIST will always start with SEG.</p> <p>The current SEG LIST implementation only supports a single segment. If there is more than one segment, the VAR_LIST_BEGIN construct is used.</p>										
SEG_LIST_END	Defines the end of a list of independent variable segments.										
VAR_LIST_BEGIN	Indicates that a list of the values for the independent variable (declared in the VAR statement) follow.										
VAR_LIST_END	Defines the end of a list of values for the independent variable.										
DATA	<p>Example: DATA P[1] RI</p> <p>Defines the name of an array of data that will be read later in the current CITIfile “package”, and the format that the data will be in. Multiple arrays of data are supported by using standard array indexing as shown above. Version A.01.01 of CITIfile only supports the RI (real and imaginary) format, and a maximum of two array indexes.</p> <p>Commonly used array names include the following:</p> <table data-bbox="516 1289 1182 1461"> <tr> <td>P</td> <td>Parameter</td> </tr> <tr> <td>S</td> <td>S parameter</td> </tr> <tr> <td>E</td> <td>Error Term</td> </tr> <tr> <td>VOLTAGE</td> <td>Voltage</td> </tr> <tr> <td>VOLTAGE_RATIO</td> <td>a ratio of two voltages (A/R).</td> </tr> </table>	P	Parameter	S	S parameter	E	Error Term	VOLTAGE	Voltage	VOLTAGE_RATIO	a ratio of two voltages (A/R).
P	Parameter										
S	S parameter										
E	Error Term										
VOLTAGE	Voltage										
VOLTAGE_RATIO	a ratio of two voltages (A/R).										

HP 8530-Specific (#NA) Definitions

Data Grouping

Data arrays of the same type, obtained during a single measurement operation, are stored in a single CITIfile package. For an error correction, this means that all the error correction arrays are stored in the same CITIfile package. For S-parameter data, this means that all the parameters acquired during a measurement operation are stored in the same CITIfile package. The term “package” was defined earlier in this section.

HP 8530 Receiver Keywords

The definition of CITIfile allows for statements that are specific to a certain type of device. Table 15-6 lists the currently defined commands for the #NA (network analyzer/receiver) keyword. (The term #NA originated with the HP 8510, and originally stood for “Network Analyzer.”)

Table 15-6. Network Analyzer/Receiver Statements

Statement	Explanation
#NA ARB_SEG <i>x y p</i>	A list segment, as entered by the user. <i>xx</i> = start value <i>y</i> = stop value <i>p</i> = number of points
#NA CAL_TYPE <i>cc</i>	The type of calibration used: Where <i>cc</i> = 1 through 5: 1 = response cal. 2 = response and isolation cal. 3 = one port cal on port #1. 4 = not used 5 = not used 6 = antenna calibration 7 = RCS calibration
#NA CW_FREQ <i>frequency</i>	The CW frequency of an Angle Domain measurement. This is a “write only” command. When a CITIfile is loaded, the receiver will NOT read this line, and it will NOT change the current CW frequency.
#NA DUPLICATES <i>dd</i>	“Delete duplicates” flag. Determines if points listed more than once should be measured more than once. If <i>dd</i> = 0, then points listed more than once are measured as many times as they are listed. If <i>dd</i> = 1, then a particular point is measured once.
#NA FREQ_INFO <i>ii</i>	The frequency information flag. If <i>ii</i> = 0, then frequency information is not displayed on the instrument’s screen. If <i>ii</i> = 1, then frequency information is displayed on the screen.
#NA IF_BW <i>gg</i>	The IF bandwidth setting of the receiver. <i>gg</i> = IF bandwidth in Hertz.

Table 15-6. Network Analyzer/Receiver Statements (continued)

Statement	Explanation
#NA PARAMS <i>aa</i>	Bitmap of valid parameters for a calibration. Where <i>aa</i> = bit positions 1-8: Bit #1 = Param 1 Bit #2 = Param 2 Bit #3 = Param 3 Bit #4 = Param 4 Bit #5 = Service 1 a1 Bit #6 = Service 2 b2 Bit #7 = Service 3 a2 Bit #8 = Service 4 b1 A bit equal to one means that the calibration is valid for that parameter, a zero means that the calibration is not valid for that parameter. Bit #0 is the least significant bit.
#NA POWER1 <i>pp</i>	Power level of signal source #1. <i>pp</i> = power in dBm.
#NA POWER2 <i>pp</i>	Power level of signal source #2. <i>pp</i> = power in dBm.
#NA POWER_SLOPE <i>ss</i>	Change in power versus frequency for source 1. <i>ss</i> = dBm/GHz
#NA POWER_SLOPE2 <i>ss</i>	Same as POWER_SLOPE but for source 2.
#NA REGISTER <i>nn</i>	Register in instrument that the current data package was stored in. <i>nn</i> = number of register.
#NA SLOPE_MODE <i>mm</i>	On/off flag for source 1 power slope. <i>mm</i> = 0 is off <i>mm</i> = 1 is on
#NA SLOPE_MODE2 <i>mm</i>	Same as SLOPE_MODE but for source 2.
#NA SPAN <i>xx yy pp</i>	The sweep parameters: <i>xx</i> = start value <i>yy</i> = stop value <i>pp</i> = number of points

Table 15-6. Network Analyzer/Receiver Statements (continued)

Statement	Explanation
#NA STANDARD <i>nn</i>	Antenna calibration definition standard (1 through 7). <i>nn</i> = number of standard.
#NA SWEEP_MODE <i>ss</i>	Type of sweep done to make measurements: 0 = swept 1 = stepped 2 = single point 3 = fast CW 4 = list
#NA SWEEP_TIME <i>tt</i>	The sweep time of the receiver: <i>tt</i> = time in seconds.
#NA TITLE <i>user title</i>	A user-defined title will appear here, if the user has created a title for the measurement. Creating titles is done using the (SYSTEM) DISPLAY FUNCTIONS TITLE functions. This CITIfile line is a “write only” function. When a CITIfile is loaded, the receiver will NOT read this line, and it will NOT place the title on the screen.
#NA TRIM_SWEEP <i>tt</i>	Linearity adjustment value for swept sources. Not Applicable for HP 8360 series sources.

Error Array Numbering

Current receiver implementations use between one and three error coefficient arrays in order to perform error correction. The CAL_TYPE keyword description in Table 15-6 lists the currently defined calibration types. Table 15-7 defines the meanings of each coefficient array with respect to the error model used.

Table 15-7.
Names of Error Coefficient Arrays
for Different Calibration Types

Error Array Name	Frequency Response	Response & Isolation	All 1-Port
E1	Er or Et	Ed or Ex	Ed
E2	—	Er or Et	Es
E3	—	—	Er

CITIfile Examples

The following are examples of CITIfile packages.

A Display Memory File

This example shows a receiver display memory file. Notice that there is no frequency information in the file. This is because data in display memory is not linked to frequency.

Note that instrument-specific information (#NA information) is also stored in this file.

#NA REGISTER 1 indicates that the file is for memory register 1. This Frequency Domain measurement had 51 points.

```
CITIFILE A.01.01
#NA VERSION HP8530A.01.12
#NA TITLE
NAME MEMORY
#NA REGISTER 1
VAR FREQ MAG 51
DATA P RI
COMMENT          YEAR MONTH DAY HOUR MINUTE SECONDS
CONSTANT TIME 1992  01  14  11    26   50.0
BEGIN
0.75256E-1,8.95263E-1
-5.81298E-1,-2.24731E0
0.63400E-1,3.82476E-1
Remaining data values (51 total)
END
```

Data File Examples

This example shows a data file (a CITIfile package created from the “data” register of the receiver).

Data File Example 1: Frequency Domain, Step or Ramp Mode

In this case, 51 points of real and imaginary data was stored, and frequency information was recorded in a segment list table.

```

CITIFILE A.01.01
#NA VERSION HP8530A.01.12
#NA TITLE
NAME DATA
#NA REGISTER 1
VAR FREQ MAG 51
DATA P[1] RI
SEG_LIST_BEGIN
SEG 2000000000 3700000000 51
SEG_LIST_END
COMMENT      YEAR MONTH DAY HOUR MINUTE SECONDS
CONSTANT TIME 1992  01  14  11    08    59.0
BEGIN
2.70355E-1,3.94592E-1
1.40112E0,-3.10156E0
1.33209E-1,0.97396E-1
Remaining data values (51 total)
END

```

CITIfile Reference

Data File Example 2: Frequency Domain, Frequency List Mode

This example shows a Frequency List measurement with two segments.

```
CITIFILE A.01.01
#NA VERSION HP8530A.01.12
#NA TITLE
NAME DATA
#NA REGISTER 1
VAR_FREQ_MAG 6
DATA P[1] RI
#NA DUPLICATES 0
#NA ARB_SEG 2000000000 2200000000 3
#NA ARB_SEG 3500000000 3700000000 3
VAR_LIST_BEGIN
2000000000
2100000000
2200000000
3500000000
3600000000
3700000000
VAR_LIST_END
COMMENT      YEAR MONTH DAY HOUR MINUTE SECONDS
CONSTANT TIME 1992  01  14  11   19   40.0
BEGIN
-1.76202E0,-1.32629E-1
-6.40991E-1,-1.06561E0
-3.87542E-1,-2.67059E-1
9.01001E-1,2.00903E0
-1.67541E-1,-6.97937E-1
-1.06005E0,-5.41259E-1
END
```

When an instrument's frequency list mode is used, as it was in this example, a list of frequencies is stored in the file after the VAR_LIST_BEGIN statement.

The frequency list used in this measurement contained two segments. The first was from 2.0 to 2.2 GHz, with a step size of 100 MHz. This information is shown in the CITIfile as:

```
#NA ARB_SEG 2000000000 2200000000 3
```

The second segment is from 3.5 to 3.7 GHz, with a 100 MHz step size, as shown in the CITIfile:

```
#NA ARB_SEG 3500000000 3700000000 3
```

All six frequency points for this cal set are listed between VAR_LIST_BEGIN and VAR_LIST_END

Data File Example 3: Angle Domain

This example shows an Angle Domain Measurement. The start angle is -10 degrees, stop angle is 10 degrees, and increment angle is 1 degree. A total of 21 angles were measured.

```
CITIFILE A.01.01
#NA VERSION HP8530A.01.12
#NA TITLE
NAME RAW_DATA
#NA REGISTER 1
VAR ANGLE MAG 21
DATA P[1] RI
SEG_LIST_BEGIN
SEG -10.0 10.0 21
SEG_LIST_END
#NA CW_FREQ 1000000000
COMMENT      YEAR MONTH DAY HOUR MINUTE SECONDS
CONSTANT TIME 1992  01  13  15   59   28.0
BEGIN
-6.09008E-1,1.47932E0
-6.10301E-1,1.66412E0
-5.99076E-1,1.85746E0
Remaining data values (21 total).
END
```

CITIfile Reference

A Three-Term Cal Set File

This example shows network analyzer 1-Port cal set file. 1-Port calibrations compensate for three error terms, directivity, tracking, and source match. Therefore, there are three data portions in a 1-Port cal set CITIfile. These three arrays of error correction data are defined by using three DATA statements, E[1] to E[3].

When a cal set file is loaded, it must include the original instrument settings for that calibration. As explained in the Calibration chapter, calibrations are sensitive to certain instrument settings, known collectively as the “limited instrument state.” You must use the limited instrument state that was in effect when the calibration was created. To accomplish this, the CITIfile stores all settings in the limited instrument state. This is why there are so many #NA statements in the CITIfile example below.

```
CITIFILE A.01.01
#NA VERSION HP8530A.01.12
#NA TITLE
NAME CAL_SET
#NA REGISTER 4
VAR FREQ MAG 6
DATA E[1] RI
DATA E[2] RI
DATA E[3] RI
#NA SWEEP_TIME 9.999994E-2
#NA POWER1 1.0E1
#NA POWER2 1.0E1
#NA PARAMS 2
#NA CAL_TYPE 4
#NA POWER_SLOPE 0.0E0
#NA POWER_SLOPE2 0.0E0
#NA SLOPE_MODE 0
#NA SLOPE_MODE2 0
#NA TRIM_SWEEP 0
#NA SWEEP_MODE 5
#NA LOWPASS_FLAG -1
#NA FREQ_INFO 1
#NA IF_BW 10000
#NA SPAN 2000000000 3700000000 6
#NA DUPLICATES 0
#NA ARB_SEG 2000000000 2200000000 3
#NA ARB_SEG 3500000000 3700000000 3
VAR_LIST_BEGIN
2000000000
2100000000
2200000000
3500000000
3600000000
3700000000
VAR_LIST_END
COMMENT      YEAR MONTH DAY HOUR MINUTE SECONDS
CONSTANT TIME 1992  01  14  10   59   21.0
BEGIN
-0.20507E-1,-1.112E0
-3.013E-1,8.05297E-1
2.80151E0,4.87060E0
-2.94296E-1,-1.01257E-1
4.83673E-1,-6.42150E-1
-5.97778E-1,-1.35675E0
END
BEGIN
-8.02612E-1,-6.63574E-1
-7.09594E-1,-6.14410E-1
9.23535E0,-1.90615E1
-2.59613E-1,1.45568E-1
```

```

-2.99499E0,-2.98901E0
-8.99047E-1,-1.1427E0
END
BEGIN
1.95709E0,1.52410E0
1.62799E0,-6.76574E-1
1.30937E2,-1.10546E1
8.17138E-1,-9.95513E-1
-5.57226E0,3.15771E0
-1.32922E0,2.67529E0
END

```

A “DATA” Measurement Data File with Four Parameter Display On

This example shows what is saved when four parameter display is turned on. Note that the instrument saves data for all four parameters, Param 1, Param 2, Param 3, and Param 4. You can choose Raw, Data, or Formatted data as with single parameter mode.

```

CITIFILE A.01.01
#NA VERSION HP8530A.01.12
#NA TITLE
NAME DATA
#NA REGISTER 1
VAR FREQ MAG 51
DATA P[1] RI
DATA P[2] RI
DATA P[3] RI
DATA P[4] RI
SEG_LIST_BEGIN
SEG 2000000000 5000000000 51
SEG_LIST_END
COMMENT      YEAR MONTH DAY HOUR MINUTE SECONDS
CONSTANT TIME 1992  01  14  09   54   52.0
BEGIN
2.28668E-1,-8.42804E-1
5.21728E-1,-5.88806E-1
4.63378E-1,3.89648E-1
Remaining data values (51 total)
END
BEGIN
7.93487E-1,-5.46844E-1
-1.93560E0,4.61731E-1
3.49548E-1,1.51519E0
Remaining data values (51 total)
4.85855E-1,4.27047E-1
END
BEGIN
1.10870E-1,-3.44604E-1
0.80329E-1,1.30134E-1
-8.57055E-1,1.24285E0
Remaining data values (51 total)
END
BEGIN
3.51599E0,-2.99499E0
1.20880E-1,-1.88468E-1
3.14086E-1,2.11315E0
Remaining data values (51 total).
END

```

Copy (Printing and Plotting)

Chapter Contents

- Compatible Printers and Plotters
- Installation Considerations
- RS-232 Print/Plot Buffers
- Adding Your Own Annotations to the Display
- Printing
 - Installing a Printer
 - Using a Laser Printer
 - Standard Configuration
 - High Speed Configuration
 - Using an HP DeskJet, DeskJet Plus, or DeskJet 500 Printer
 - Using an HP QuietJet, QuietJet Plus, PaintJet or PaintJet XL Printer
 - Using an HP ThinkJet Printer
 - Printing One Snapshot per Page
 - Printing Two Snapshots per Page
 - Printing Tabular Measurement Data (as text)
 - Printing Instrument Settings and System Configuration (as text)
- Plotting
 - Installing a Plotter
 - One Color or Multi-Color Plots
 - Selecting Pen color
 - Plotting One Snapshot Per Page
 - Plotting Individual Display Components
 - Plotting a Selected Quadrant (four snapshots per page)

Compatible Printers and Plotters

A list of compatible printers and plotters is provided in Chapter 1, General Information, of the *HP 8530A Operating and Programming Manual*.

Installation Considerations

The following topics explain the printing and plotting capabilities of the HP 8530A.

Supported Interfaces

The **(COPY)** key (in the AUXILIARY MENUS block) provides the means to control output to an HP-IB or RS-232 plotter or printer.

Connecting an HP-IB Printer or Plotter

If you use an HP-IB printer or plotter, connected it to the System Bus. HP-IB outputs are not buffered, after giving the print or plot command you must wait until the plot/print is finished before pressing any other keys. Pressing any key during the output aborts the plot or print and can cause a timing error. If you need to abort a plot or print use the **ABORT PRINT/PLOT** softkey found on the first level Copy menu.

Connecting an RS-232 Printer or Plotter

The HP 8530A has two serial interfaces. You can select either of these interfaces for printing or plotting. In addition, you can assign one of the ports to a printer, and the other to a plotter.

An RS-232 plotter/printer normally accepts data and does not “answer” or “acknowledge” that data has been received and as such, the receiver may be unable to determine if a plotter/printer is connected to the RS-232 port selected. A message saying that the plot is complete may result even if no plotter/printer is connected.

Selecting the HP-IB (System Bus) or RS-232 Ports

Softkeys in the **(LOCAL)** menu allow you to:

- Select HP-IB (System Bus), RS-232 Port #1, or RS-232 Port #2 for serial printers or plotters.
- Set the HP-IB address of an HP-IB printer or plotter. Information on address selection is provided in the SYSTEM chapter.

RS-232 Print/Plot Buffers

Both RS-232 ports have a built-in print/plot buffer. The receiver can dump most (or all) of the data into the buffer during the print or plot. Once all of the data has made it into the buffer, the buffer continues to send the data to the printer or plotter, and the receiver can make measurements again.

The buffer in RS-232 Port #1 is much larger than the one in RS-232 PORT #2. Therefore, it is preferable to connect your printer or plotter to Port #1. This becomes more important when making high resolution printouts at 150 or 300 DPI. (These high resolutions are available if you use an HP DeskJet or laser printer.) High resolution printouts contain a large amount of data, which takes longer to send to the printer. The larger buffer in Port #1 holds more data, reducing the time it takes to resume measurements. Print resolution is explained fully in the printer setup section.

The System Bus does not supply a print/plot buffer. Because of this, measurements are suspended until the print or plot is completely finished.

Adding Your Own Annotations to the Screen

You can add your own text annotations to the screen before printing or plotting. To do this:

1. Press **(SYSTEM)** **DISPLAY FUNCTIONS** **TITLE**. A “label maker” menu will appear.
2. Use the front panel knob to place the selection cursor under the first desired letter or number. Press **SELECT LETTER**.
3. Repeat this step for each desired character. Press **SPACE** to insert a space, and **BACKSPACE** to back up if you make a mistake. **ERASE TITLE** will remove the title from the screen.
4. Press **TITLE DONE** when you are finished entering the title.

Printer Setup

Using a Printer

This section explains:

- How to install RS-232 or HP-IB printers.
- How to configure the printer and the HP 8530A.
- How to Print

Printing Features

The printing feature allows you to:

- Print an exact copy of the display (a “snapshot”).
- Print measurement data in table form.
- Print instrument settings and system configuration.
- Print in Color, Monochrome, Portrait, or Landscape mode.
- Print one snapshot (measurement display) per page
- Print two snapshots per page.

What is Printed

The displayed measurement is printed or plotted exactly as displayed on the screen. The softkey menus do not appear on prints/plots unless you select them using an HP-IB command. The marker list and real-time clock are printed (if they are active), unless softkey menus are being printed.

Installing a Printer

Installation is described in the *HP 8530A On-Site Service Manual*.

Selecting the Output Port

Select the appropriate output port for your printer as follows:

1. Turn the receiver ON.
2. If using a serial printer: Press **LOCAL** **MORE** **PRINTER: RS-232 PORT #1** or **PRINTER: RS-232 PORT #2**, depending on which serial port you used.
3. If using an HP-IB printer: Press **LOCAL** **MORE** **PRINTER: HP-IB**. The message **PRINTER HP-IB ADDRESS 1** will appear on the screen.

Printer and HP 8530A Configuration

The next step is to make appropriate switch settings on the printer, as explained in following pages. Also, the HP 8530A must be configured so it controls your printer properly. This is done with the Define Print menus, located under the **COPY** key. Refer to Figure 16-1.

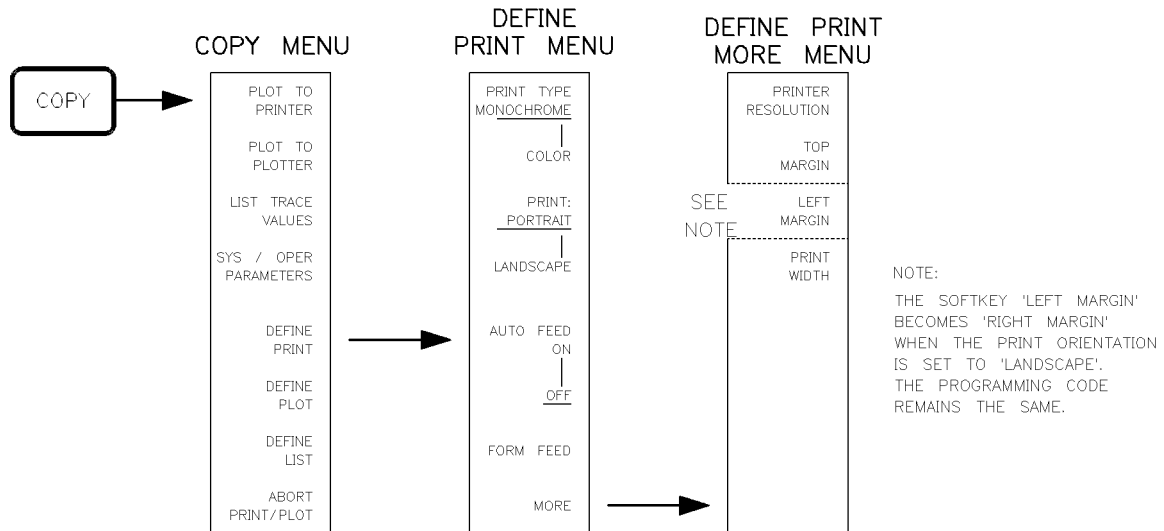

Figure 16-1. Define Print Menu

The required settings are dependent on the type of printer you use. The following pages explain how to setup:

- HP-Compatible Laser Printers
- HP DeskJet, DeskJet Plus, or DeskJet 500 Printers
- HP QuietJet or QuietJet Plus Printers
- HP PaintJet or PaintJet XL Printers
- HP ThinkJet Printers
- Non-HP Printers

Printer Setup

Using a Laser Printer

Connect the printer as explained in the installation chapter of the *HP 8530A On-Site Service Manual*.

Configuring the Laser Printer

There are two ways to configure a laser printer.

- | | |
|------------|--|
| Standard | This configuration requires no extra equipment and provides normal laser printer print speeds. Customers have asked for faster laser print-outs than the standard setup provides (it takes about 7 minutes to print one page at 300 DPI). This speed problem is caused by the laser printer, not with the HP 8530. However there is a clever way to get around the problem and speed printing up significantly. So why even talk about the “standard” (slow) method? Answer: Because the high speed method requires a special printer cartridge that you may not have. |
| High Speed | The high speed configuration requires a special plug in cartridge for the printer. With this cartridge, a simple measurement display will print in about 12 seconds. A <i>very</i> complex print takes about 2 minutes 20 seconds. Most prints will come out in 1 minute or less. |

Standard Configuration

Turn the laser printer ON. Refer to the laser printer’s operating manual.

Select SERIAL input/output (I/O).

Use the factory default RS-232 settings for the printer:

Baud Rate	9,600
Robust Xon	ON
DTR Polarity	HI

These settings never have to be entered again.

Other Laser Printer Settings

1. If using metric paper sizes, refer to the printer manual for setup instructions.
2. Make sure paper is loaded

Configuring the Receiver

Selecting Printer Resolution

The HP 8530 allows you to select four different print resolutions for laser printers: 75, 100, 150, and 300 dots per inch (DPI). To choose a specific resolution:

1. Press **[COPY]** **[DEFINE PRINT MORE PRINTER RESOLUTION]**.
2. Enter the desired value using the keypad, and press **[x1]**.

Note: Higher resolutions take longer to print.

For instructions on making actual printouts, refer to “Printing”.

High Speed Configuration

As mentioned above, you will need a special cartridge called the “Plotter in a Cartridge” from Pacific Data Products. This device programs the laser printer so it understands plotter commands (HP-GL). The cartridge essentially turns the laser printer into a plotter. The “laser plotter” accepts HP-GL commands and “draws” the picture in its own memory. The printer then produces a page based on the “drawing” in its memory.

Why it is Faster?

In *normal* laser printer operation, the analyzer must send pixel data for the *entire page* - even if the displayed measurement is very simple. A whole page of pixels at 300 DPI requires a little over 1 megabyte of data. It takes a long time to transfer this much data over the serial bus. With HP-GL emulation, printing is faster for two reasons: 1. There is far less data to transfer since only HP-GL commands must be sent over the serial bus. 2. The laser printer must only change memory locations that equate to black pixels. The majority of memory locations (those that represent white pixels) do not need to be accessed. This saves even more time.

My printer has Built-In HP-GL, Do I still Need the Cartridge?

Yes. To use the built-in HP-GL emulation mode, laser printers *usually* require the computer or instrument to send a special “escape sequence” code. The code turns HP-GL mode ON. Such printers usually do not allow you to turn HP-GL mode ON from the front panel. At this time, the HP 8530A cannot send this special code, so you must use a special cartridge to use HP-GL mode.

Ordering the Cartridge

There are two versions of Plotter in a Cartridge:

Standard	For use with the HP LaserJet Series II.
“Personal Edition” (P.E.)	For use with the HP LaserJet IIP, IID, III, and IIID.

You can order either of these cartridges from many computer suppliers. We found them for about half suggested retail price at:

DH Systems: 1940 Cotner Ave,
Los Angeles, CA 90025
(800)-747-4755
Attention: Sales Department

The part number to order from DH Systems is:

Standard	DH 701-PCRT
Personal Edition	DH 702-PCRT-P

If you want to contact the manufacturer of the cartridge, call or write:

Pacific Data Products
9125 Rehco Road, San Diego, CA. 92121
Phone: (619) 552-0880
Fax: (619) 552-0889

Printer Setup

Printer memory required

The plotter in a Cartridge requires 1.5 Mbytes of printer memory in order to operate.

Setting up the Printer

1. Turn the laser printer ON. Refer to the laser printer's operating manual to perform the following.
2. Select SERIAL input/output (I/O).
3. Use the factory default RS-232 settings for the printer:

Baud Rate	9,600
Robust Xon	ON
DTR Polarity	HI

Other Laser Printer Settings

1. If using metric paper sizes, refer to the printer manual for setup instructions.
2. Turn the printer OFF.
3. Install the "Plotter in a Cartridge." If your printer has two cartridge slots make sure you use the left slot.
4. Turn the printer ON.
5. Make sure paper is loaded

Configuring the Receiver

The following instructions will look unusual because you will be telling the HP 8530A to *plot*. Remember, the laser printer will look just like a plotter to the HP 8530A.

1. Determine which HP 8530A RS-232 port has the printer connected to it. (HP recommends RS-232 Port #1 because it has a larger printer buffer than RS-232 Port #2.)
2. Press **(LOCAL)** **MORE** and **PLOTTER: RS-232 PORT #1** or **PLOTTER: RS-232 PORT #2**. Be *sure* you have chosen the appropriate port under "PLOTTER:" on the softkey menu.
3. To "print" press:

(COPY) **PLOT TO PLOTTER** **PLOT: ALL**

For other "printing" options, refer to the section on *PLOTTING* later in this chapter. Remember, the receiver thinks the laser printer is a plotter.

Note You may want to photocopy the following notice and tape it near your HP 8530A:

TO PRINT:

1. Make sure the "Plotter In a Cartridge" is Installed. Turn the printer OFF when installing the cartridge! (Remember, it goes in the left cartridge slot.)
2. On the HP 8530, press **COPY**, **PLOT TO PLOTTER**, **PLOT:ALL** (trust us on this).

This could save the "occasional" user a great deal of confusion when they try to make print outs.

Switching Between a Real Plotter and an HP-GL-emulating Laser Printer

To switch between a laser printer (acting like a plotter) and a real plotter, you must select the port to which the desired device is connected.

Press **LOCAL MORE**, then press one of the following softkeys:

- | | |
|--------------------------------|---|
| PLOTTER: HP-IB | Press this to select a real plotter connected to the HP-IB bus. |
| PLOTTER: RS-232 PORT #1 | Press this to select a real plotter or "laser plotter" connected to RS-232 Port #1. |
| PLOTTER: RS-232 PORT #2 | Press this to select a real plotter or "laser plotter" connected to RS-232 Port #2. |

Printer Setup

Using an HP DeskJet, DeskJet Plus, or DeskJet 500 Printer

Choose the serial (RS-232) or HP-IB setup, depending on how your printer is equipped:

Serial Setup

Connect the printer as explained in the service manual. The HP 8530A does not support the Centronics interface.

Serial DIP switch settings

Make sure all DIP switches (mounted in the lower-front portion of the printer) are all in the down position. These recommended switch settings assume you are using 8.5 by 11 inch paper. If using metric paper sizes, refer to the printer manual for proper DIP switch settings.

Prepare the Printer for Use

Load the paper, then turn the printer ON.

Configuring the Receiver

Selecting Printer Resolution

The HP 8530 allows you to select four different print resolutions for HP DeskJet printers: 75, 100, 150, and 300 dots per inch (DPI). To choose a specific resolution:

1. Press **(COPY) DEFINE PRINT MORE PRINTER RESOLUTION**.
2. Enter the desired value using the keypad, and press **(x1)**.

Note: Higher resolutions take longer to print.

Now refer to "Printing" for instructions on making actual printouts.

Additional Steps Required for the HP DeskJet 500C

The color capabilities of the HP DeskJet 500C are NOT currently supported. You can use this printer to make black printouts by performing the following steps:

1. Make sure the Receiver is set to Monochrome mode by pressing:

(COPY) DEFINE PRINT PRINT TYPE MONOCHROME

2. Remove the color ink cartridge, place it in a safe, clean place. Be careful not to touch the electrical contacts.
3. Install a black ink cartridge. Part numbers for black cartridges are supplied in Appendix D of the *HP 8530A Users Guide*.

Using an HP QuietJet, QuietJet Plus, PaintJet, or PaintJet XL Printer

Choose the serial (RS-232) or HP-IB setup, depending on how your printer is equipped:

Serial Setup

Connect the printer as explained in the service manual.

Serial DIP switch settings

Make sure all DIP switches are positioned as shown in Figure 16-2. If necessary, refer to the printer's user's guide for switch location. These recommended switch settings assume you are using 8.5 by 11 inch paper. If you are using Metric paper sizes, refer to the printer manual for the appropriate switch settings.

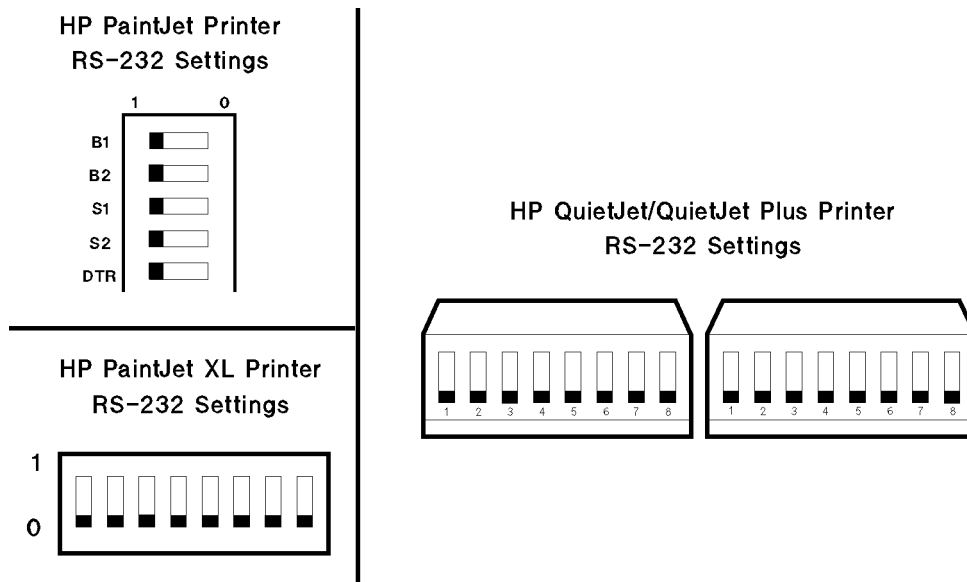

Figure 16-2. HP QuietJet and PaintJet (Family) Printer Serial Switch Settings

HP-IB Setup

Connect the printer as explained in the service manual.

HP-IB address DIP switch settings

Set the printer DIP switches as shown in Figure 16-3. The HP 8530A uses address 01 as the default HP-IB address for printers. Figure 16-3 shows proper switch settings (with the HP-IB address set to 01). If you are using Metric paper sizes, refer to the printer manual for the appropriate switch settings.

Printer Setup

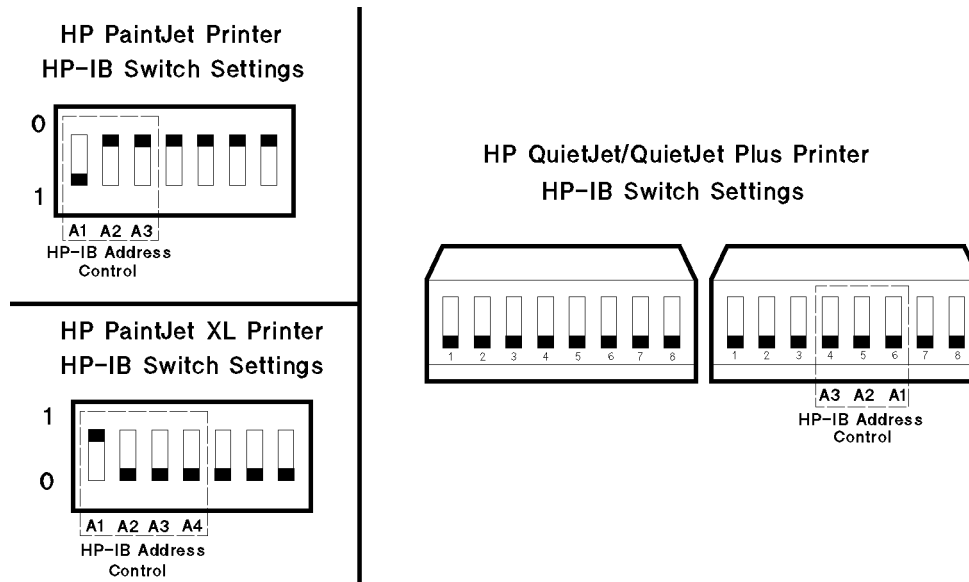

Figure 16-3. HP QuietJet and PaintJet (Family) Printer HP-IB Switch Settings

Prepare the Printer for Use

1. Load the paper, then turn the printer ON.

On HP QuietJet, QuietJet PLUS, and PaintJet Printers (not XL):

2. Move the Paper Advance Knob (on the right-hand side of the printer) to advance the paper. Set the top of the page so it is just above the inkjet print head. These printers automatically set Top of Form to the current position when the paper Advance Knob is moved.

Configuring the Receiver

Selecting Printer Resolution (HP QuietJet and QuietJet Plus printers)

The HP 8530 allows you to select two different print resolutions for HP QuietJet printers, 96 and 192 dots per inch (DPI). To choose a specific resolution:

1. Press **(COPY)** **DEFINE PRINT** **MORE** **PRINTER RESOLUTION**.
2. Enter the desired value using the keypad, and press **(x1)**.

Note: higher resolutions take longer to print. Refer to “Printing” for instructions on making actual printouts.

Selecting Printer Resolution (HP PaintJet and PaintJet XL printers)

90 DPI is the only resolution supported for these printers. This resolution is selected automatically when you select color printing (see below).

Printing In Color

If using the HP PaintJet or PaintJet XL printers, set the HP 8530A for color printing as follows:

Press **(COPY)** **DEFINE PRINT** **COLOR**. Making this selection automatically sets the printer resolution for an HP PaintJet or PaintJet XL printer (90).

Now refer to “Printing” for instructions on making actual printouts.

Using an HP ThinkJet Printer

Choose the serial (RS-232) or HP-IB setup, depending on how your printer is equipped:

Serial Setup

Connect the printer as explained in the service manual.

Serial DIP switch settings

Make sure all DIP switches (mounted on the back of the printer) are down (off). These recommended switch settings assume you are using 8.5 by 11 inch paper. If you are using Metric paper sizes, refer to the printer manual for the appropriate switch settings.

HP-IB Setup

Connect the printer as explained in the service manual.

HP-IB address DIP switch settings

The HP 8530A uses address 01 as the default HP-IB address for printers. Figure 16-4 shows proper switch settings (with the HP-IB address set to 01). These recommended switch settings assume you are using 8.5 by 11 inch paper. If you are using Metric paper sizes, refer to the printer manual for the appropriate switch settings.

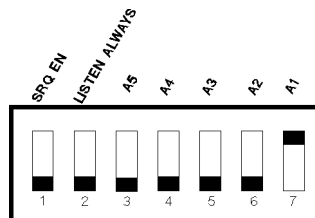

Figure 16-4. HP ThinkJet printer HP-IB Switch Settings

Prepare the Printer for Use

1. If using metric paper sizes, refer to the printer manual for setup instructions.
2. Turn the printer ON.
3. Load the fan-fold paper. Use the **[LF]** key to advance the paper. Set the top of the page so it is just above the inkjet print head.
4. Turn the printer OFF, then ON to set top of form.

Configuring the Receiver

Selecting Printer Resolution

The HP 8530A allows you to change printer resolution. The HP ThinkJet printer, however, can only be used with the 96 dots per inch (DPI) setting. To check the current printer resolution setting:

1. Press **[COPY] DEFINE PRINT MORE PRINTER RESOLUTION**.
2. If necessary, press **[9] [6] [x1]**.

Refer to “Printing” for instructions on making actual printouts.

Printer Setup

Using Non-HP Printers

Choose the serial (RS-232) or HP-IB setup, depending on how your printer is equipped:

Serial Setup

Connect the printer as explained in the service manual.

Serial DIP switch settings

Refer to the User's Guide for your printer, make sure the following settings are made:

Table 16-1. Serial Printer Settings for Other Printers

Item	Proper Setting
Serial ¹	ON
BAUD Rate	9600
Parity	None
XON-XOFF/DTR	XON-XOFF
7/8 Bits	8 Bits
Stop Bits	1

¹ Most laser printers must be set to SERIAL mode by the user.

HP-IB Setup

Connect the printer as explained in the service manual.

HP-IB address DIP switch settings

Refer to the printer's User's guide for instructions. The default address used by the HP 8530 is 01.

Before Printing

Load paper and, if using fan-fold paper, align the paper properly. Turn the printer ON, set top of form.

Now refer to the Printing and Plotting chapter in the *HP 8530 Users Guide* for instructions on making actual printouts.

Printing

The printing feature allows you to:

- Print an exact copy of the display
- Print tabular data
- Print instrument settings and system configuration

Printouts can be made in Portrait or Landscape mode.

Landscape and Portrait Printing

Next, define the print orientation. Select either **PRINT PORTRAIT** or **PRINT LANDSCAPE**. Portrait orientation is the factory default. See Figure 16-5 and Figure 16-6.

Press **MORE** to set the printer resolution, margins widths and total print width.

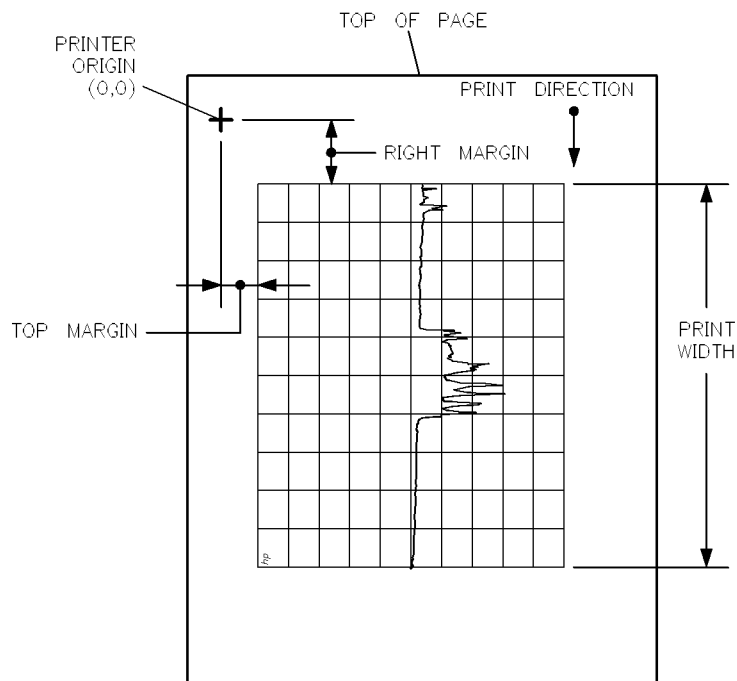

Figure 16-5. Landscape Printer Orientation

Printing

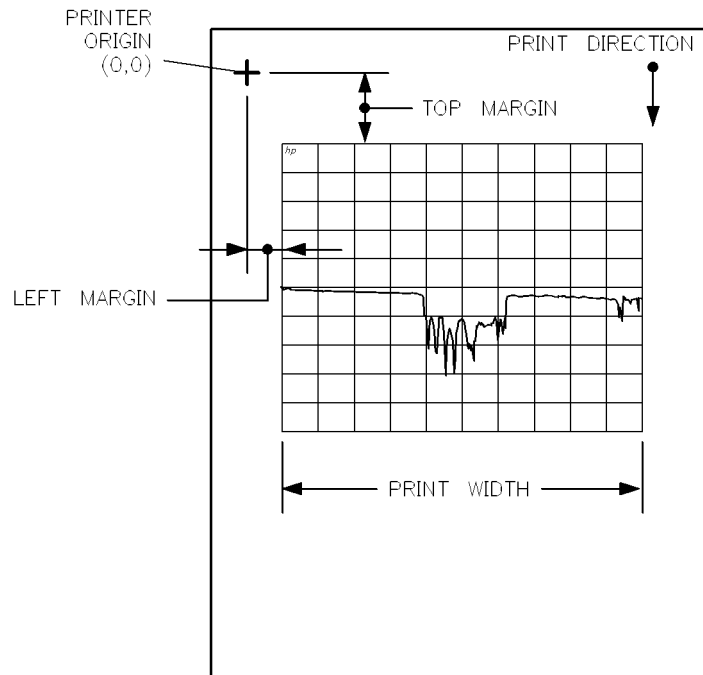

Figure 16-6. Portrait Printer Orientation

Printing One Snapshot per Page (Portrait or Landscape)

Two printout sizes are available, half page (use portrait mode) and full page (use landscape mode).

1. Select Portrait or Landscape orientation by pressing: **COPY** **DEFINE PRINT**, then press **PORTRAIT** or **LANDSCAPE**.
2. Press **AUTO FEED ON**.
3. To print, press **PRIOR MENU** **PLOT TO PRINTER**.

Printing Two Snapshots per Page

By leaving the Auto Form Feed feature OFF, and Portrait mode ON, two screen snapshots can be printed to a single page:

1. Press **COPY** **DEFINE PRINT** **PORTRAIT** **AUTO FEED OFF**.
2. Press **PRIOR MENU** **PLOT TO PRINTER**. The printer will now start printing the first snapshot. (Laser printers will show a flashing LED or other data transfer indication.)

Note Once you have pressed **PLOT TO PRINTER**, wait until **PLOT COMPLETE** is displayed before you press *any* other front panel key (otherwise the print will abort).

3. After **PLOT COMPLETE** appears on the screen, you can press keys on the HP 8530A. Before printing the second snapshot you can change instrument settings, make another measurement, or load data from disc.

HP PaintJet XL printers will stop printing when the first snapshot is 3/4 complete. This is normal, it will finish the snapshot when you perform the next step.

4. Press **(COPY)** (if necessary), then **PLOT TO PRINTER**. The next snapshot will be sent to the printer.

If using a laser printer, the data transfer indicator will start flashing again. *Wait for the laser printer transfer indicator to stop flashing before proceeding to the next step.*

HP PaintJet XL printers will stop printing when the second snapshot is 3/4 complete. This is normal, it will finish the snapshot when you perform the next step.

5. When the printer stops printing (or when the laser printer data transfer light stops flashing), press **DEFINE PRINT FORM FEED**. (This step is not required if you are using an HP ThinkJet Printer.)

FORM FEED causes fanfold-paper printers to go to the top of the next page. It causes laser printers to eject the page.

Alternatively, you can press **(FORM FEED)** on the printer. (Some printers must be taken OFF LINE before you can form feed.)

Note If you abort a printout, always use form feed to eject the partial printout. This is especially important on laser printers, otherwise a portion of the aborted snapshot will be superimposed on your next printout.

Printing Tabular Measurement Data

You can print out all measurement data points for the active parameter, or for all four parameters in the active channel:

1. Select Auto feed by pressing **(COPY) DEFINE PRINT AUTO FEED ON**.
2. To print, press **(PRIOR MENU) LIST TRACE VALUES**.
 - a. To print data for the active parameter only, press **LIST ONE PARAMETER** in the new menu.
 - b. To print data for all four parameters, press **LIST ALL PARAMETERS**

The list below shows an example of an Frequency Domain list trace value output.

FREQUENCY (HZ)	dB	
7.5000000000E+09	-4.0609370000E+01,	0.0000000000E+00
7.5062500000E+09	-4.0003900000E+01,	0.0000000000E+00
7.5132500000E+09	-3.9474610000E+01,	0.0000000000E+00
7.5198750000E+09	-3.8996090000E+01,	0.0000000000E+00
7.5265000000E+09	-3.8386710000E+01,	0.0000000000E+00

The first column is the always the stimulus value, followed by two columns of trace values in the basic units selected by the current FORMAT selection. If the marker value consists of a single value, for example LOG MAG or PHASE, the second column is zero.

Changing the format of the tabular data

To change the format of the list trace data, press **(COPY) DEFINE LIST**. This displays the define list menu as shown in Figure 16-7.

Printing

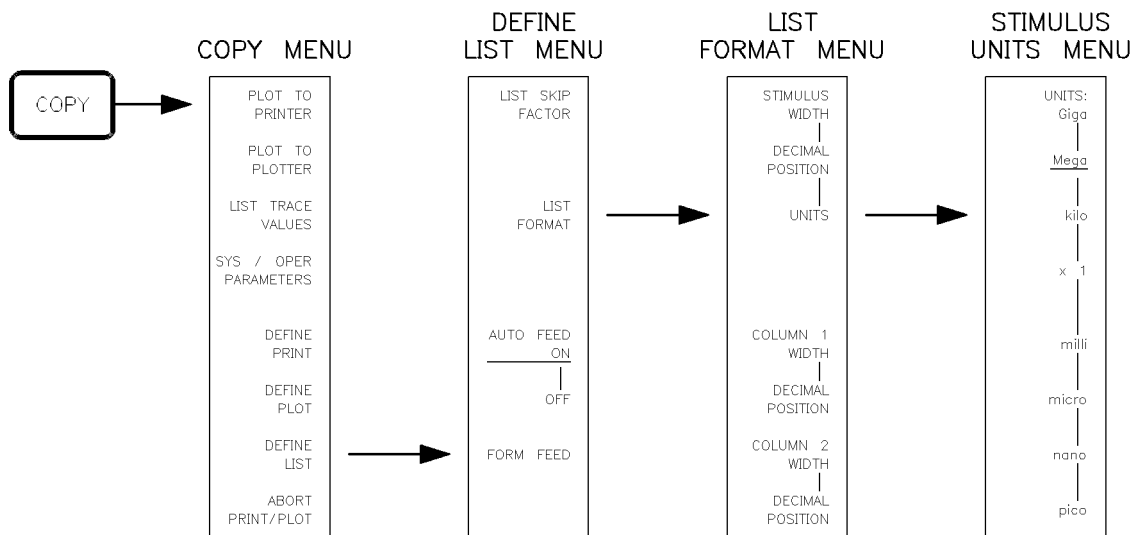

Figure 16-7. Define List Menu

You can define various format aspects of the printed tabular data.

The number of lines of data printed depends upon the number of points selected (Stimulus menu) and the list skip factor. When the skip factor = 1, all frequency points are printed. When the skip factor = 2, every other frequency point is printed, and so on with larger skip factors. At skip factor = 4 (default value) with 201 frequency points of data, the list contains 51 points of information, one full (8.5 x 11 inch) page. To set skip factor, press **LIST SKIP FACTOR** and use the knob or numeric entry keys to enter a value.

Press **LIST FORMAT** to view the menu selections that control the column formats.

You can adjust the overall number of characters of the printed stimulus data as well as the decimal position and the units selected. Select **STIMULUS: WIDTH** and use the knob or numeric entry keys to enter a number representing the desired number of characters. The minus sign and decimal point are counted as characters. The column heading varies with the domain currently active. Select **STIMULUS DECIMAL POSITION** to set a value that represents the number of digits after the decimal point. Select **STIMULUS UNITS** to view the available stimulus unit selections. (**STIMULUS UNITS** performs no function in Angle Domain, since the only available units are degrees.)

The value for stimulus units change depending on the domain selected. The default settings are:

- Angle: Degrees
- Frequency: MHz
- Time: milliseconds

The column 1 and column 2 information is formatted in similar manner.

COLUMN 1 WIDTH sets the overall number of characters printed for column 1 and

COLUMN 1 DECIMAL POSITION sets the number of digits after the decimal point.

COLUMN 2 WIDTH and **COLUMN 2 DECIMAL POSITION** set the column 2 format aspects.

For those printers with automatic paper feed capabilities you can select: **FORM FEED** to cause a page to automatically eject from the printer and **AUTO FEED ON/OFF** to set the automatic next page load to either on/off.

Printing Instrument Settings and System Configuration

The Copy menu also makes it possible to document the HP 8530 system configuration (System Parameters) and instrument settings (Operating Parameters). Refer to Figure 16-8 for the menu.

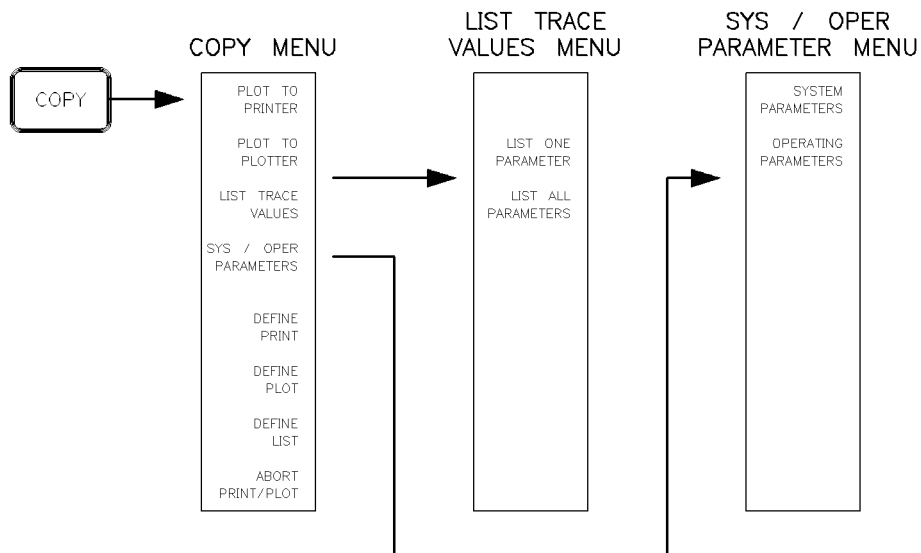

Figure 16-8. System/Operating Parameters Menu

To display the current system operating parameters, press **SYS/OPER PARAMETERS** then press **SYSTEM PARAMETERS** or **OPERATING PARAMETERS**.

Next, press **LIST PARAMETERS** or **PLOT PARAMETERS**, depending on whether you have a printer or plotter. Current page position and pen number are used for the plot. To restore the measurement display press the softkey **RESTORE DISPLAY** or any front-panel key other than a softkey.

Refer to Table 16-2 for a typical system parameters listing.

Printing

Table 16-2. Typical Initialized System Parameters Listing

hp			RESTORE DISPLAY PRINT PARAMETERS
SYSTEM PARAMETER	Channel 1	Channel 2	PLOT PARAMETERS
8530 HP-IB ADDRESS	16	16	
SYSTEM BUS ADDRESS	17	17	
SOURCE HP-IB ADDRESS	19	19	
SOURCE 2 HP-IB ADDRESS	31	31	
CONVERTER HP-IB ADDRESS	20	20	
PLOTTER HP-IB ADDRESS	5	5	
PRINTER HP-IB ADDRESS	1	1	
DISC HP-IB ADDRESS	0	0	
PASS-THRU ADDRESS	31	31	
USER DISPLAY ADDRESS	31	31	
SRQ MASK (PRIMARY)	0	0	
SRQ MASK (SECONDARY)	0	0	

Operating parameters provides two pages of documentation for the present system state. Refer to Table 16-3 and Table 16-4. The examples below assume the receiver is in Frequency Domain.

Table 16-3. Typical Operating Parameters Displays (first page)

			RESTORE DISPLAY LIST PARAMETERS
OPERATING PARAMETER	Channel 1	Channel 2	
			PLOT PARAMETERS
NUMBER of POINTS	201	201	
SWEEP TIME	100.0 ms	100.0 ms	
SOURCE 1 POWER	10.0 dBm	10.0 dBm	
SOURCE 1 POWER SLOPE	0.0 dB/GHz	0.0 dB/GHz	
	OFF	OFF	
SOURCE 2 POWER	10.0 dBm	10.0 dBm	
SOURCE 2 POWER SLOPE	0.0 dB/GHz	0.0 dB/GHz	
ELECTRICAL DELAY	0.0 s	0.0 s	
PHASE OFFSET	0.0 °	0.0 °	
MAGNITUDE SLOPE	0.0 dB/GHz	0.0 dB/GHz	
MAGNITUDE OFFSET	0.0 dB	0.0 dB	
IF AVERAGING FACTOR	1.0	1.0	
	OFF	OFF	
			PAGE PARAMETERS

Table 16-4. Typical Operating Parameters Displays (second page)

			RESTORE DISPLAY LIST PARAMETERS
OPERATING PARAMETER	Channel 1	Channel 2	
SMOOTHING APERTURE	0.0 % SPAN	0.0 % SPAN	PLOT PARAMETERS
	OFF	OFF	
Z ₀	50.0 Ω	50.0 Ω	
GATE START	-500.0 ps	-500.0 ps	
GATE STOP	500.0 ps	500.0 ps	
WINDOW	NORMAL	NORMAL	
GATE SHAPE	NORMAL	NORMAL	
	OFF	OFF	
MARKER 1	4.0 GHz	4.0 GHz	
MARKER 2	4.0 GHz	4.0 GHz	
MARKER 3	4.0 GHz	4.0 GHz	
MARKER 4	4.0 GHz	4.0 GHz	
MARKER 5	4.0 GHz	4.0 GHz	
			PAGE PARAMETERS

Installing a Plotter

Using a Plotter

This section explains:

- Installing the Plotter
- Plotting Options
- Plotting

Plotting Features

The plotting feature allows you to:

- Plot an exact copy of the display (a “snapshot”).
- Plot selected display components, such as the data, graticule, markers, or text.
- Plot in one color (monochrome) or in multiple colors (color).
- Plot one snapshot per page
- Plot four snapshots per page.
- Select specific pens and pen colors.

What is Plotted

The displayed measurement can be plotted out exactly as displayed on the screen, or you can print certain screen components such as the data, graticule, markers, or text only. The softkey menus do not appear on plots unless asked for using an HP-IB command. The marker list and real-time clock are always plotted if they are active, unless menus are being plotted.

Installing a Plotter

Installation is described in the *HP 8530A On-Site Service Manual*.

Selecting the Output Port

Select the appropriate output port for your plotter as follows:

1. Turn the receiver ON.
2. If using a serial plotter: Press **(LOCAL) MORE PLOTTER: RS-232 PORT #1** or **PLOTTER: RS-232 PORT #2**, depending on which serial port you used.
3. If using an HP-IB plotter: Press **(LOCAL) MORE PLOTTER: HP-IB**. The message **PLOTTER HP-IB ADDRESS 5** will appear on the screen.

Special instructions for connecting the HP 7550

HP 7550 plotters have two RS-232 ports, however, *the two ports are wired differently*. You should use the male RS-232 port (marked “COMPUTER”). *The RS-232 cables shipped with the HP 8530A will not work with the HP 7550, you must order an HP 24542H cable.*

HP 7550B and 7550 Plus plotters must be placed in “7550A Emulation” mode, with TIMEOUT turned Off. Refer to the HP 7550B or Plus User’s Guide for instructions.

HP 7550B and 7550 Plus Plotters

The HP 7550A/B plotter is configured using its front panel controls. To use either of these plotters you must do the following:

- Select HP 7550A emulation mode.
- Turn the TIMEOUT feature Off.

Instructions on how to perform these steps are provided in the HP 7550B or 7550 Plus User's Guide.

Plotting Options

Press **COPY** to display the Copy menu (Figure 16-9).

Plotting Options

Press **DEFINE PLOT**, select any of the following plotting options:

- Choose **PLOT TYPE: MONOCHROME** (to use one pen only) or **PLOT TYPE: COLOR** (to use all pens).
- Choose different pens for parameter 1, 2, 3, and 4 traces, or for the graticule, using **SET PEN NUMBERS**. (If your plotter has multiple pens.)
- Turn Auto Form Feed ON or OFF.
- Choose full page or 1/4 page plot size using **SELECT QUADRANT** and either select **FULL PAGE** or one of the four quadrant softkeys.

The softkeys **AUTO FEED ON/OFF** and **FORM FEED** apply to plotters with automatic paper feed capabilities. **FORM FEED** causes a page to automatically eject from the plotter. **AUTO FEED ON/OFF** sets the automatic next page load to either on/off.

Selecting Pen Color

For multiple-pen plotters, each display component can be plotted using a different pen/color using the softkey **SET PEN NUMBERS** on the Copy menu.

1. Press **COPY** **DEFINE PLOT** **PLOT TYPE: COLOR** **SET PEN NUMBERS** then press the softkey corresponding to the display element for which, you wish to select a pen number. Insert the pen in the plotter pen slot corresponding to the number selected for that display element. Continue to select pen numbers for the other display elements in the same way.
2. Press **COPY** to return to main Copy menu. Select **PLOT TO PLOTTER** and then the softkey corresponding to the material you wish plotted using the pen numbers just chosen: **PLOT: ALL**, **DATA**, **MEMORY**, **GRATICULE**, **MARKER(S)**, **TITLE**, or **TEXT**.
3. If you selected a single element, wait for the plot to be completed, then repeat the process as often as needed to complete the multi-pen plot.

The following sequence causes the entire plot to be drawn using a single pen.

```
COPY
DEFINE PLOT
```

Plotting Options

PLOT TYPE: MONOCHROME

PRIOR MENU

PLOT TO PLOTTER

PLOT: ALL

Pen selections are saved as part of the Instrument State. The following is a list of the factory default pen number assignments selected also, by the softkey **DEFAULT PEN NUMBERS**.

Table 16-5. Default Pen Numbers

Display Element	Pen Number	Display Element	Pen Number
SOFTKEYS	1	MARKERS	1
WARNING	2	PARAM 1	3
PARAM 1	3	MEM	
DATA		PARAM 2	5
PARAM 2	5	MEM	
DATA		PARAM 3	6
PARAM 3	6	MEM	
DATA		PARAM 4	4
PARAM 4	4	MEM	
DATA		STIMULUS	1
GRATICULE	1		

Plotting

This section explains:

- Plotting all of the display
- Plotting individual display components
- Plotting a selected quadrant (four snapshots per page)

Plotting One Snapshot per Page

1. Press **(COPY)** **DEFINE PLOT** **SELECT QUADRANT** **FULL PAGE**.
2. Press **(COPY)** **PLOT TO PLOTTER**. The plot will begin.

If the marker list feature is on, it is plotted when **PLOT ALL** is executed. The same is true of the date/time clock feature.

Plotting Individual Display Components

To plot only part of the display, press **(COPY)**, **(PLOT TO PLOTTER)**, followed by one of the following:

- **PLOT: ALL**
- **DATA**
- **GRATICULE**
- **MARKER(S)**
- **MEMORY**
- **TITLE**
- **TEXT**
- **ALL FOUR PARAMETERS**.

To plot more than one of these (for example to plot the trace and then the graticule), wait for the first plot to be completed, then, without changing the plotter paper, press the softkey corresponding to the other component you want to plot. Note that on certain plotters you may have to load the paper again before the plot begins.

Plotting

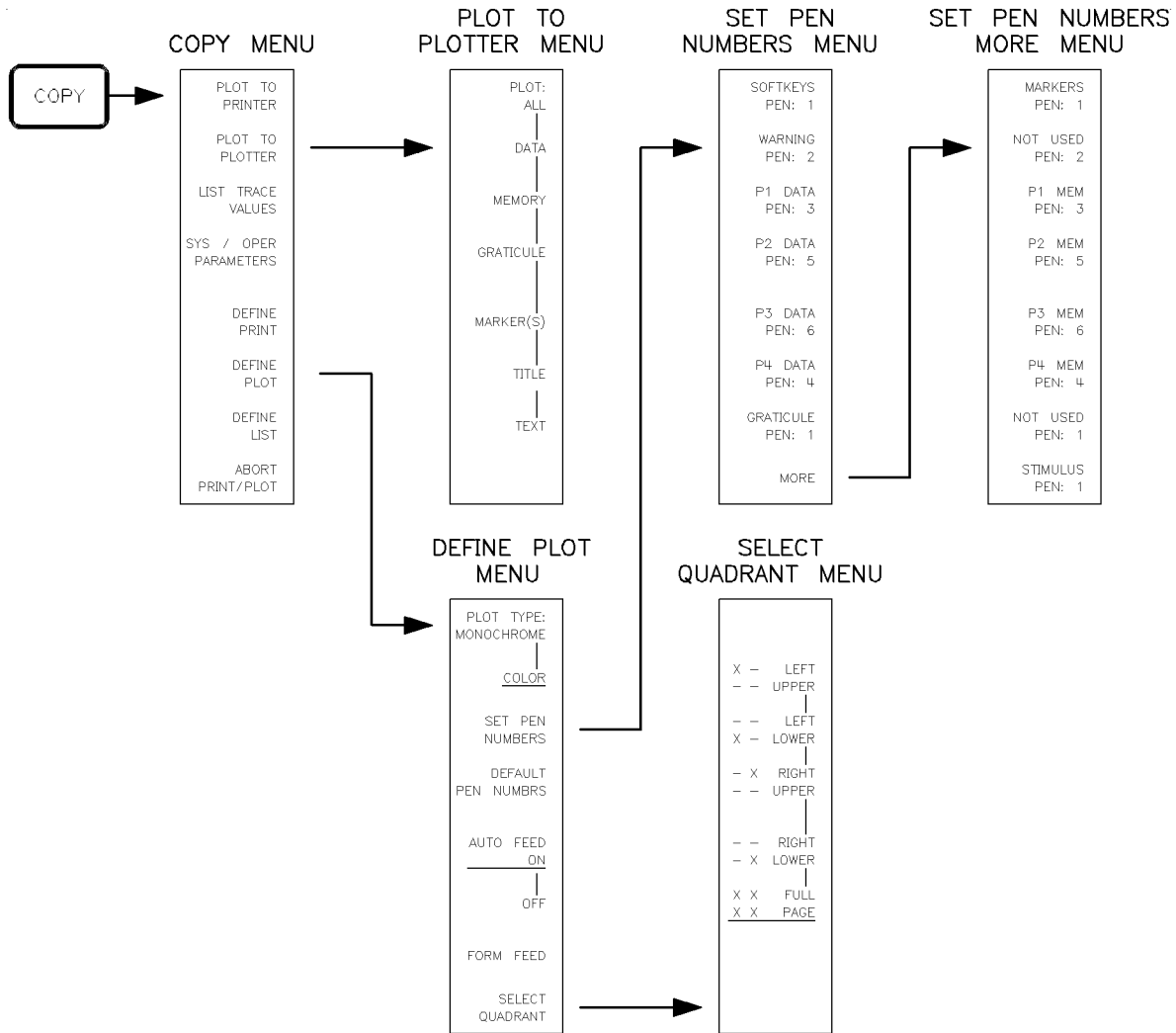

Figure 16-9. Define Plot and Plot to Plotter Menu Structure

Plotting a Selected Quadrant (four snapshots per page)

Factory Preset selects full page plots. The current selection is shown underlined on the select quadrant menu.

To plot all or part of the display at approximately quarter-page size:

1. Press **COPY** **DEFINE PLOT** **SELECT QUADRANT**. This displays the plot quadrant menu.
2. Select the quadrant for the first plot by pressing **LEFT UPPER**, **LEFT LOWER**, **RIGHT UPPER**, or **RIGHT LOWER**.
3. Press **COPY** **PLOT TO PLOTTER** **PLOT: ALL** or one of the softkeys for plotting only part of the display.

The material selected is plotted at approximately one-quarter size in the location you have specified. To select the location for the next plot, select the next quadrant, select the location, then select the material to be plotted. Repeat the process for the next plot. Note that on certain plotters you may have to load and reload the paper to complete all four plots.

Using System Functions

Chapter Contents

The following topics are covered in this chapter

- System Menus
- Controls that Affect the Receiver
 - Phaselock Controls
 - Warning Beeper
 - IF Calibration and Correction
 - Display Functions (Creating a Title, Adjusting the Date/Time Clock)
 - Security Features
- Controls that Affect I/O
 - HP-IB Addresses
 - Power Leveling
 - Remote Switch Recall
 - Controlling Multiple Sources (Multiple Source Menu/mode)
- Service Functions

System Menu

Figure 17-1 shows the main System menu.

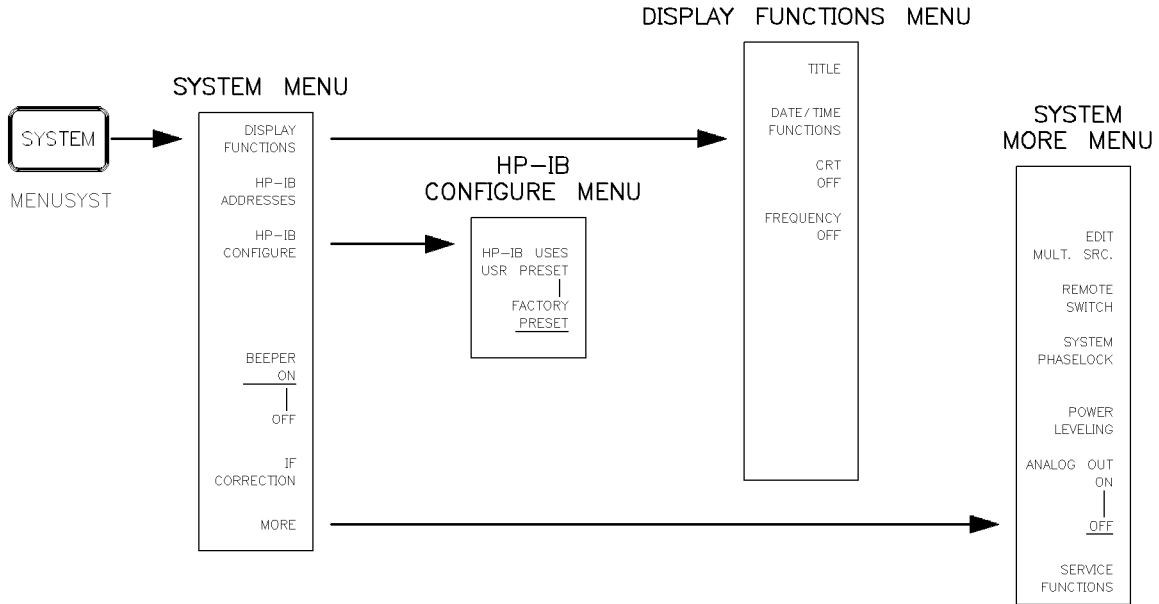

Figure 17-1. Main System Menu and Part of the Display Functions Menu

Controls that Affect the Receiver

The following features only affect the receiver:

Phaselock Controls

Press **(SYSTEM) MORE SYSTEM PHASELOCK** to access the System Phaselock Menu, shown in Figure 17-2. The functions of this menu control the timing of data acquisition cycle and the point where the system is phaselocked.

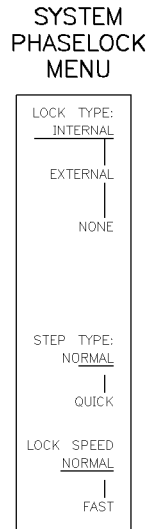

Figure 17-2. System Phaselock Menu

Lock Type

Press **(SYSTEM) MORE SYSTEM PHASELOCK** to access **LOCK TYPE: INTERNAL** or **LOCK TYPE: EXTERNAL**.

- **EXTERNAL** lock type selects the system first IF phase lock, and phase locks on an external LO source. This setting is appropriate if your system uses an HP 85309A LO/IF unit, which uses a non-synthesized LO source such as the HP 8350.
- **INTERNAL** lock type selects the system first IF phase lock, and the internal LO source. This setting is appropriate for systems that use HP 8511A/B frequency converters.
- **NONE** turns phaselock off. This setting is appropriate if your system uses an HP 85309A LO/IF unit, which uses a synthesized LO source such as a HP 836xx family source.

Step Type

Press **(SYSTEM) MORE SYSTEM PHASELOCK** to access the Step Type softkeys.

The step type softkeys control the data acquisition cycle during Frequency Domain measurements. There are two step types, Normal Step and Quick Step. Normal Step is the factory default mode. Once changed by the user, this mode will never change. The mode you choose, either Quick Step or Normal Step, affects measurements made in the Step or Frequency List sweep modes.

Controls that Affect the Receiver

Normal Step. Press **(SYSTEM) MORE SYSTEM PHASELOCK STEP TYPE: NORMAL** to select Normal Step mode.

In normal-step, the receiver tunes to a frequency and measures all necessary parameters before breaking phaselock and tuning to the next frequency. The receiver goes through a complete phaselock sequence at each frequency step.

This method of phaselock requires a software handshake only (occurs through the System Bus). No other external connectors between the source and receiver are required and HP-IB extenders can be used.

Quick Step Mode. Press **(SYSTEM) MORE SYSTEM PHASELOCK STEP TYPE: QUICK** to select Quick Step mode.

Quick Step mode increases the speed of Step sweep measurements up to six times. Quick Step requires a compatible HP 836xx source, a list of compatible HP 836xx sources is provided in “Fast measurement speed and Quick Step mode” in Chapter 1. Quick Step mode does not function in a system that uses multiple sources.

The key attributes of the quick-step phaselock method are:

- Each data acquisition point is fully synthesized.
- The source is “tuned” from point-to-point, it does not break phaselock.
- The receiver remains phaselocked to the source except at the source bandcross points or when the test VTO needs to reset.
- The receiver and source require two BNC connections, described below.
- Typically (depends on averaging), increased data acquisition speed (six times improvement) is achieved by this method of phaselock.

The HP 8530A uses **STEP TYPE: NORMAL** if the source is not compatible with quick step. HP 8340/41 sources are NOT compatible with quick step.

To use Quick Step mode with an HP 836xx RF source:

1. Connect the receiver’s TRIGGER IN BNC to the source’s TRIGGER OUT BNC.
2. Connect the receiver’s STOP SWP BNC to the source’s STOP SWEEP BNC.
3. Press **(SYSTEM) MORE SYSTEM PHASELOCK STEP TYPE: QUICK**

Lock Speed

Press **(SYSTEM) MORE SYSTEM PHASELOCK** to access the Lock Speed controls.

LOCK SPEED NORMAL provides the best frequency accuracy when using Step, Single Point, or Frequency List modes. Lock Speed Normal is the factory default setting. This feature has no effect in Ramp Sweep mode.

LOCK SPEED FAST allows you to increase stepped measurement speed with a tradeoff of decreased frequency accuracy. Fast Speed increases the speed of Step, Single Point, and Frequency List modes. This feature has no effect in Ramp Sweep mode.

Warning Beeper

The **BEEPER ON/OFF** softkeys control whether you hear a “beep” whenever a warning message is displayed. The BEEPER ON position is the factory default.

IF Calibration and Correction

IF calibration/correction is an automatic calibration feature that reduces IF gain and quadrature errors in each of the four input channels (a1, a2, b1 and b2). This process is composed of two features:

IF Calibration IF calibration measures a crystal reference signal and determines gain and quadrature errors for each input channel. A series of error-correction coefficients are calculated. The receiver firmware determines how often IF calibrations should be performed. When the receiver is warming up, it performs IF calibrations often. When the receiver is fully warmed up, it performs IF calibrations less often.

Refer to Figure 2-1. To perform an IF calibration, the receiver measures a 100 kHz reference signal (from a built-in crystal oscillator) with the Test and Reference Synchronous Detectors. Then, IF calibration calculates gain and quadrature errors for each input channel.

The receiver inhibits periodic IF calibrations during Fast CW modes. The user can also turn periodic IF calibrations OFF. You can also force an IF calibration to be performed. Refer to the “IF Calibration Controls,” below, for instructions.

IF Correction *IF Correction* subtracts IF calibration error coefficients from the measurement data. *IF correction* is always ON. IF correction occurs before any other data processing, before data reaches the Raw Data Arrays.

IF Calibration Controls

Press **(SYSTEM) IF CORRECTION** to access the IF Calibration controls, which are described below:

RESET IF CORRECTION	This softkey initiates an IF gain calibration before starting the next group of sweeps.
IF CORRECT: AUTO	This is the factory-default setting. When AUTO is selected, the receiver automatically performs IF calibrations at periodic intervals.
IF CORRECT: MANUAL	This setting stops IF calibrations from occurring automatically. You can manually perform an IF calibration by pressing: RESET IF CORRECTION

Even if Manual mode is selected, the receiver still modifies measurement data with the most-recent IF calibration coefficients.

Controls that Affect the Receiver

Display Functions

Part of the display functions menu is shown in Figure 17-1, the date/time functions menu is shown in Figure 17-3.

Creating a Title

To create or change a title:

1. Press **(SYSTEM)**, **DISPLAY FUNCTIONS**, **TITLE**. This brings the title menu and the existing title onto the display.
2. To enter a character, position the ↑ symbol below the character by turning the knob.
3. Press **SELECT LETTER**. The character appears as the last character in the title area. Repeat this process to write the rest of the title.
4. Use the **BACK SPACE** softkey to erase the first title character to the left of the arrow. When you have finished creating or changing the title, select the softkey labeled **TITLE DONE**.

Deleting a Title

To delete the whole title, press the softkey labeled **ERASE TITLE** or use the **(BACKSPACE)** key in the ENTRY block to erase one character at a time.

Adjusting the Date/Time Clock

DATE/TIME FUNCTIONS MENU

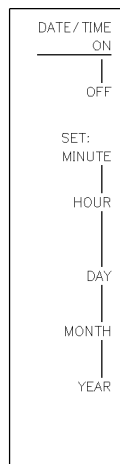

Figure 17-3. Date/Time Functions Menu

To adjust the date/time clock annotation:

1. Press **(SYSTEM)**, **DISPLAY FUNCTIONS**, **DATE/TIME FUNCTIONS**. This brings up the adjust date/time menu.
2. Select **SET YEAR**. Notice that the date/time clock appears in the lower right-hand of the display. Also, notice the prompt in the active entry area. Use the knob to adjust the year.
3. Select **SET MONTH**. Press **(2)** (or other numeric characters from 1 to 12), then press **(x1)** to terminate the entry. Notice that the month annotation is automatically translated to a three letter abbreviation of the month, in the date/time annotation.
4. Select **SET DAY**. Use the **(▲)/(▼)** arrow keys to adjust the day.

Controls that Affect the Receiver

Note that you can use the knob, numeric entry keys with a terminator, or the **▲/▼** arrow key to enter any value. Any association with a particular key is for demonstration purposes only.

In the same manner, you can adjust the hour and minutes of the date/time clock.

Security Features

The **CRT OFF** softkey turns the display off. Filament power to the CRT is turned off, resulting in a blank display. External displays driven by the receiver rear-panel **EXTERNAL DISPLAY** output continue to function. To turn the CRT ON again, press **RECALL MORE FACTORY PRESET**, or recall an Instrument State which was created with the CRT turned ON.

The **FREQUENCY OFF** softkey turns off the display of frequency annotations. All stimulus functions operate normally except that the start, stop, center, and span display values are set to 0.000000000 GHz and the marker frequency value is blanked. Angle and Time Domain stimulus displays are not changed. **FACTORY PRESET** or **RECALL** of Instrument State stored without **FREQUENCY OFF** restores normal Frequency Domain displays.

Controls that Affect I/O

Controls that Affect I/O

The following controls affect how the receiver communicates with external instruments:

HP-IB Addresses

The HP-IB address menu is identical to the main Local menu and address assignments are made the same way. The following is a list of the available address assignments you can make using either of these menus. The factory default values are shown in parenthesis. To learn more about the HP-IB menu, refer to Chapter 11.

Note If you perform either of the following, you must turn the receiver OFF, then ON again:

- When you change the address of any instrument on the System Bus.
- When you replace an RF or LO source with a source having a different model number.

System operating problems can result if you do not follow these precautions.

ADDRESS of 8530 (16)

ADDRESS of SYSTEM BUS (17)

ADDRESS of SOURCE #1 (19)

ADDRESS of SOURCE #2 (31)

ADDRESS of CONVERTER , SET ADDRESS (20)

ADDRESS of REMOTE SWITCH (31)

ADDRESS of RF SWITCH (31)

MORE

DISC (0)

PLOTTER: HP-IB (05)

PLOTTER: RS-232 PORT #1

PLOTTER: RS-232 PORT #2

PRINTER: HP-IB (01)

PRINTER: RS-232 PORT #1

PRINTER: RS-232 PORT #2

MORE

PASS-THRU (31)

To set the System Bus address of the instrument:

1. Check the hardware switch (usually located on the rear-panel) of the instrument. Convert the binary switch setting to decimal format.
2. Select the corresponding receiver softkey for that instrument.
3. Set the decimal value using the knob, step, or numeric entry keys.
4. Terminate with the **(x1)** key.
5. PRESS **(RECALL) MORE FACTORY PRESET**.

HP-IB Configure

The softkeys in this menu control how the system operates in response to a PRES; command (issued by a computer).

- Select **HP-IB USES USR PRESET** to use the PRES; command the same as the front-panel key **(USER PRESET)**.
- Select **HP-IB USES FACTORY PRESET** to use the PRES; command the same as the softkey **FACTORY PRESET** (under **(RECALL) MORE**).

Edit Multiple Source

This softkey accesses the Edit Multiple Source Menu, which allows you to configure the system for:

- LO Sources.
- External Mixers.
- RF frequency multipliers which do not have a digital communications link (source module interconnect) with the RF source.
- Testing special modules that must be tested with an IF output frequency other than 20 MHz.

A complete tutorial on the Multiple Source feature is provided in “Controlling Multiple Sources”, later in this section.

Remote Switch Recall

Recalls a predefined instrument state in an HP 3488A remote switch/control unit. The remote switch must be set up with each correct instrument state required for the measurement before this command is used.

For example, to recall HP 3488A remote switch state #1, press:

(SYSTEM) MORE REMOTE SWITCH 1 (x1)

Power Leveling

Press **(SYSTEM) MORE POWER LEVELING** to enter the System Power Leveling Menu, shown in Figure 17-4. This function is part of the Hardware State and is not changed by power-up or preset or an instrument state recall.

SOURCE 1: INTERNAL

The RF source (source 1) levels its power using its internal leveling when this is selected.

SOURCE 1: EXT. LEVEL

When this is selected, the RF source requires an external leveling loop to complete its leveling loop. Refer to the individual source manual to find information on external leveling requirements.

Controls that Affect I/O

SOURCE 1: MM MODULE

This setting should be used in millimeter wave systems where the source module interface cable is attached to the SOURCE MODULE INTERFACE connector on the RF source.

POWER LEVELING MENU

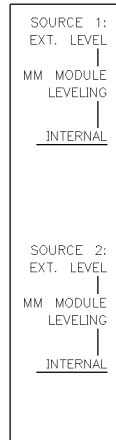

Figure 17-4. System Power Leveling Menu

Source 2 leveling requires two things:

- The LO source HP-IB port must be connected to the receiver System Bus.
- An LO source must be specified in the receiver's Multiple Source Menu before you can change its power leveling type. Other LO source power and phaselock controls (LOCK TYPE) are located in under **SYSTEM** key menus. The Source 2 leveling functions are the same as those used for Source 1.

Frequency Converter Type

The HP 8530A needs to know whether or not you are using an HP 8511B frequency converter. To select the type of frequency converter in use, press:

SYSTEM **HP-IB ADDRESSES** **CONVERTER**

If you are using an HP 8511B frequency converter, press **CONVERTER HP 8511B**. If you are using *any other* type of frequency converter, press **ALL OTHERS**.

Controlling Multiple Sources

Many measurement systems require remote mixers, and therefore require an LO source. Such a system is shown in Figure 17-5. The receiver controls all aspects of RF and LO source frequencies. In setups that use multiple sources, the Multiple Source Menu allows the receiver to properly manage these frequencies.

Here is an example of a setup that requires multiple source mode. The system shown uses an LO source and 3rd harmonic mixers.

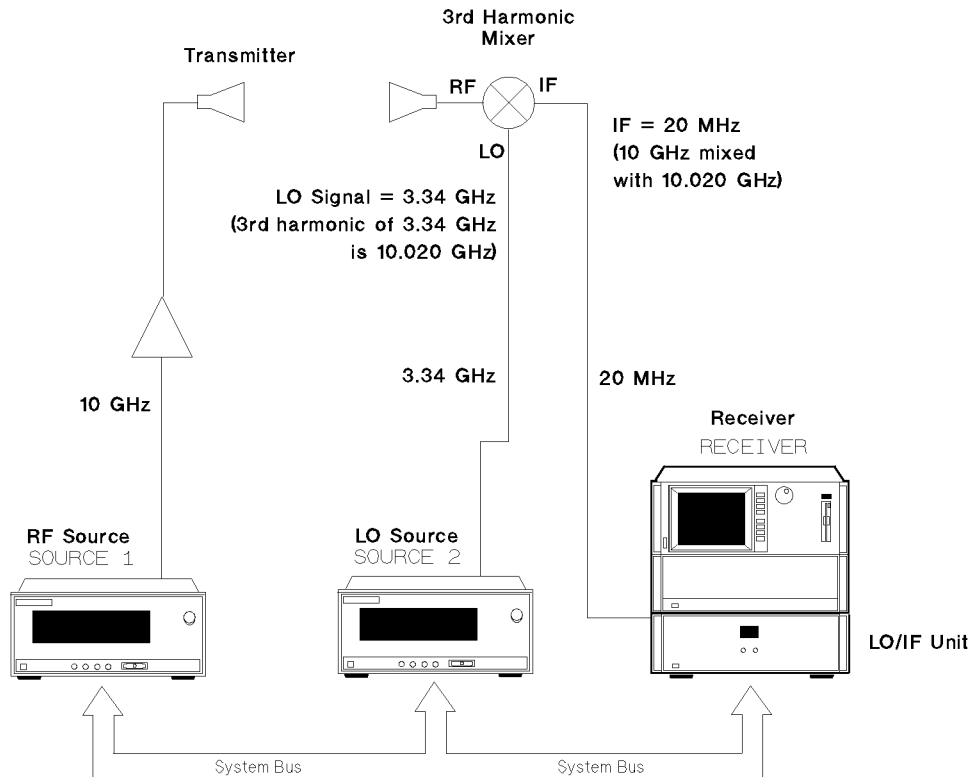

Figure 17-5. Actual LO Frequency Required by a Harmonic Mixer

This setup creates two management tasks for the receiver:

- The LO source must supply the appropriate LO signal to the mixer. The mixer will use the third harmonic of the LO signal. The receiver must compensate by setting the LO source frequency to be 1/3 of the needed frequency. The formula shown in Figure 17-7 would be appropriate for this situation.
- The mixer must produce a 20 MHz IF for the receiver. Therefore, the third harmonic of the LO frequency must be 20 MHz away from the RF frequency.

The Multiple Source Menu provides the special control for this and other types of setups.

Press **(SYSTEM) MORE EDIT MULT. SRC.** to display the Multiple Source Menu. It will appear as shown in Figure 17-6.

Controlling Multiple Sources

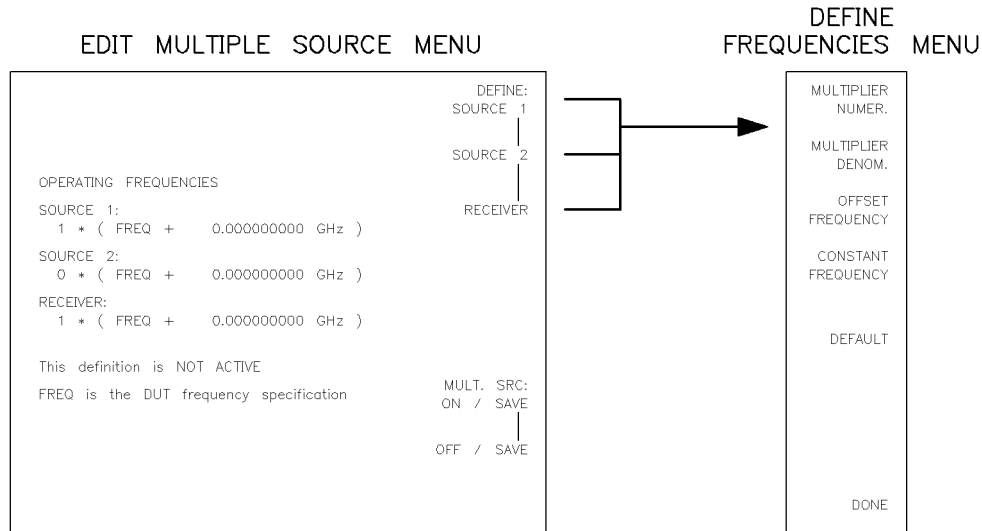

Figure 17-6. Edit Multiple Source Menu

There are three entries in the multiple source mode, labeled: SOURCE 1 (the RF source), SOURCE 2 (the LO source), and RECEIVER. Each of these entries contains a blank formula.

- SOURCE 1 the SOURCE 1 formula tells the receiver to adjust frequency commands sent to the RF source.
- SOURCE 2 the SOURCE 2 formula tells the receiver to adjust frequency commands sent to the LO source.
- RECEIVER the RECEIVER formula tunes the frequency converter to the frequency sent by the mixer.

Examples are provided later for each of these formulas.

Using the Multiple Source Menu

Given the test setup shown earlier, here is an example of how to use the Multiple Source Menu.

Look at the SOURCE 2 line. Like the other two lines, this one is accompanied by a formula. Refer to Figure 17-7 and Figure 17-5.

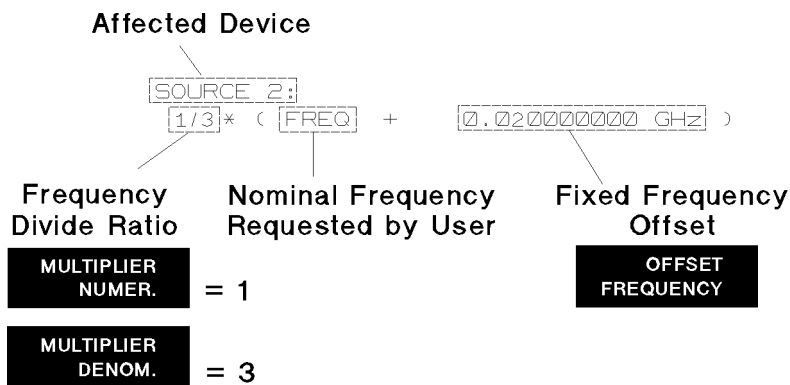

Figure 17-7. Source 2 Modified for 3rd Harmonic Mixer System

Controlling Multiple Sources

The term `FREQ` represents the original *RF* frequency requested by the user. First, the offset (20 MHz) is added to the original frequency value. Since $1/3$ is entered as a multiplier, (`FREQ + 20 GHz`) is now divided by 3.

The functions in the Multiple Source Menu, shown in Figure 17-6, are explained below:

<code>MULTIPLIER NUMER.</code>	As shown in Figure 17-7, the frequency multiplier is entered as a fraction x/y where x is the numerator and y is the denominator. This softkey allows you to enter the numerator, which is 1 in almost all applications. Terminate this entry with <code>(x1)</code> .
<code>MULTIPLIER DENOM.</code>	This allows you to enter the denominator for the frequency multiplier. In harmonic mixer setups, the denominator is always equal to the harmonic used by the mixer. In other words, if the mixer is a 10th harmonic type, use a denominator of 10. Terminate this entry with <code>(x1)</code> .
<code>OFFSET FREQUENCY.</code>	This enters a fixed offset which is added to, or subtracted from, the <code>FREQ</code> frequency. (<code>FREQ</code> represents the stimulus (RF source) frequency requested by the user). In most setups the offset you enter becomes the IF frequency. To enter a positive offset, simply enter the desired offset value. Terminate this entry with an appropriate units key. To enter a negative offset, press <code>(+/-)</code> , enter the value, then press the appropriate units terminator key.
<code>CONSTANT FREQUENCY</code>	When used with <code>SOURCE 1</code> or <code>SOURCE 2</code> , this sets the source to one fixed frequency. When used with <code>RECEIVER</code> , it tunes the frequency converter to measure that particular frequency. Terminate this entry with an appropriate units key.
<code>DEFAULT</code>	Returns the Multiple Source Menu to the factory default settings.
<code>DONE</code>	Press after defining the <code>SOURCE 1</code> , <code>SOURCE 2</code> or <code>RECEIVER</code> formula.

How to Enter the Example Configuration

Still following the original example setup, here are the steps required to configure the Multiple Source Menu for the LO source and 3rd harmonic mixer.

First, configure the `SOURCE 2` formula for a 3rd harmonic mixer, with 20 MHz offset:

1. Press `DEFINE: SOURCE 2.`
2. The multiplier requires two values, the numerator, and denominator. For the example above you would press:
3. `MULTIPLIER NUMER.` 1 `(x1)`
4. `MULTIPLIER DENOM.` 3 `(x1)`
5. `OFFSET FREQUENCY` 20 `(M/μ)`
6. `DONE` (Indicates you are finished defining the Source 2 formula)

Next, configure the `RECEIVER` formula to measure the 20 MHz IF produced by the mixer. Press the following keys:

1. `DEFINE: RECEIVER.`
2. `CONSTANT FREQUENCY` 20 `(M/μ)`

Controlling Multiple Sources

3. `DONE`

Now save the configuration. Before leaving the multiple source menus, either `MULT. SRC: OFF/SAVE` or `MULT. SRC: ON/SAVE` must be selected. If not, all definition changes are lost. These softkeys turn the function on or off and save the equation definitions in the Hardware State. Note that changes can be made and saved with the mode off (using `MULT. SRC: OFF/SAVE`). This means that at power-up the equations are defined but not active.

Figure 17-8 shows how the multiple source menu will look after you perform the above steps, and press `MULT. SRC: ON/SAVE`.

Note Do not be concerned If you see the error message: `CHANGING STEP TYPE TO NORMAL STEP`. This message occurs if the receiver was in the Quick phase lock mode. The receiver cannot use Quick phase lock mode when multiple sources are in use, and selects Normal phase lock mode instead.

```
OPERATING FREQUENCIES
SOURCE 1:
  1 * ( FREQ + 0.000000000 GHz )
SOURCE 2:
  1/3 * ( FREQ + 0.020000000 GHz )
RECEIVER:
  0.020000000 GHz

This definition is ACTIVE

FREQ is the DUT frequency specification
```

Figure 17-8.
Finished Multiple Source Configuration for LO Source and 3rd Harmonic Mixers

Note that the example setup in Figure 17-5 requires NO changes to the default `SOURCE 1` configuration.

Millimeter Wave Mixers

The `SOURCE 2` setup would only change slightly for millimeter wave systems (that use mixers with large harmonic values). For example, Q band mixers use 10th harmonic mixers. To use these mixer types, you would simply enter a 10 as the multiplier denominator. The numerator and offset remain the same.

Uses for the `SOURCE 1` and `RECEIVER` Formulas

As implied above, the three formulas in the Edit Multiple Source menu (`SOURCE 1`, `SOURCE 2`, and `RECEIVER`) compensate for frequency translation that is occurring somewhere in the system.

SOURCE 1 Formula Use

The SOURCE 1 formula could compensate for any frequency translation occurring in the RF portion of the system. An example would be a frequency multiplier *that cannot communicate digitally with the RF source*. HP multipliers and most RF sources have an interconnect bus that allows them to communicate directly. When using these devices you *do not* need to change the SOURCE 1 formula from the default settings. However, if you have a source or multiplier that does *not* have the interconnect, then change the SOURCE 1 formula as needed:

For example, for a 3x multiplier you would enter 1/3 as the multiplier (and no offset). Assume you are using this type of setup, and you request an RF frequency of 45 GHz. The receiver will divide that value by 3 and program the RF source for the new value (15 GHz). The RF source outputs 15 GHz, which is then multiplied (by 3) by the RF multiplier. The multiplier then outputs the desired 45 GHz signal.

RECEIVER Formula Use

All the examples above assume that a 20 MHz IF frequency is available from the frequency converter. These examples are very useful if you are testing discrete antennas. However, some users may need to test modules which contain mixers, and which may not produce 20 MHz IF output.

Figure 17-9 shows an example setup.

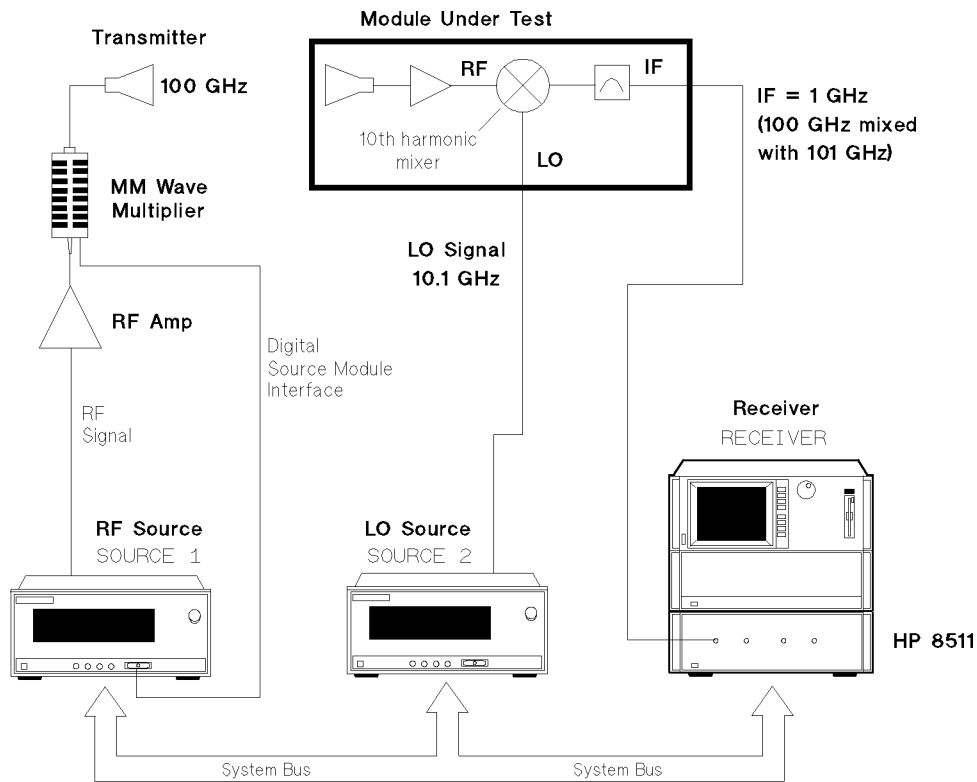

Figure 17-9. Module Testing Example

Note that the Module Under Test contains a 10th harmonic mixer. Also, the module only produces a 1 GHz IF signal. In this example you must modify the SOURCE 2 and RECEIVER formulas as follows:

SOURCE 2

Controlling Multiple Sources

```
1/10 * ( FREQ + 1.000000000 GHz )
```

```
RECEIVER  
1.000000000 GHz
```

(The RECEIVER is set to a CONSTANT FREQUENCY of 1 GHz.)

Why these settings are used. Here are the objectives of this measurement setup:

- The final LO frequency must mix with a 100 GHz RF signal to produce a 1 GHz IF. Therefore the final LO frequency must equal 99 or 101 GHz. For the sake of this example 101 GHz is used.
- The LO frequency output by the LO source must be 1/10th of the required LO frequency. This is because the 10th harmonic mixers will essentially multiply the LO frequency by 10 (by picking the 10th harmonic).
- The setup must allow the receiver/frequency converter combination to measure the 1 GHz IF signal.

These design objectives are met as follows:

- The formula for SOURCE 2 must be:

```
1/10 * (RF FREQ + 1.000000000 GHz)
```

This yields:

```
Source 2 = 1/10 * (100 GHz + 1 GHz)
```

```
Source 2 = 1/10 * 101 GHz
```

```
Source 2 = 10.1 GHz
```

When the mixer picks the 10th harmonic, it will be at 101 GHz. Therefore the IF will be 1 GHz.

- The Receiver must tune the HP 8511 frequency converter to measure 1 GHz. Setting RECEIVER to a constant frequency of 1 GHz does this.

Figure 17-10 shows how the multiple source menu will appear after these changes are made.

```
OPERATING FREQUENCIES  
  
SOURCE 1:  
1 * ( FREQ + 0.000000000 GHz )  
  
SOURCE 2:  
1/10 * ( FREQ + 1.000000000 GHz )  
  
RECEIVER:  
1.000000000 GHz  
  
This definition is ACTIVE  
  
FREQ is the DUT frequency specification
```

Figure 17-10.
Finished Multiple Source Configuration for Hypothetical Module

Service Functions

The service functions menu contain several functions that are useful to you as an operator. Some keys on this menu however, are more appropriate for service personnel and are discussed in the *HP 8530A On-Site Service Manual*.

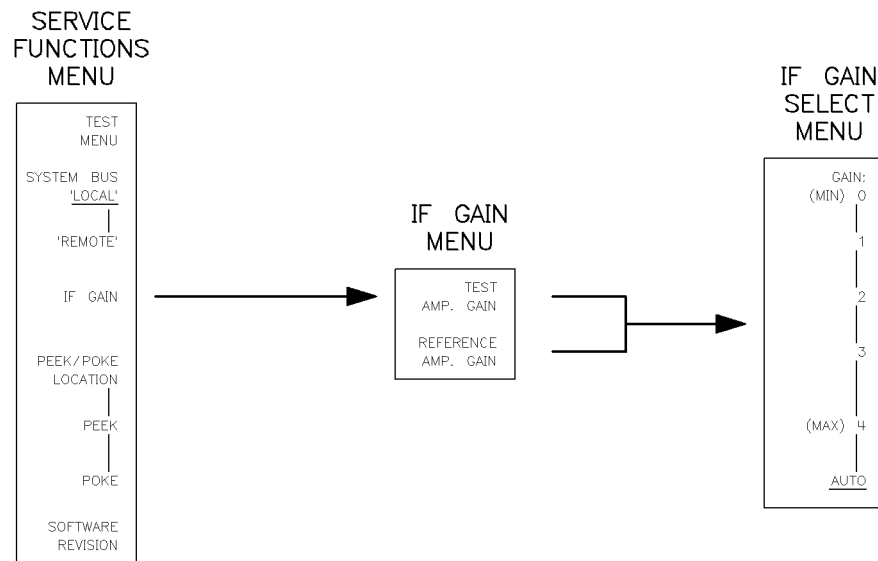

Figure 17-11. Service Functions Menu

To view the service functions menu, press **(SYSTEM) MORE SERVICE FUNCTIONS**.

Test Menu

The test menu is accessed by pressing **(SYSTEM) MORE SERVICE FUNCTIONS TEST MENU**.

Selecting **TEST MENU** disables the HP-IB interface. This menu gives access to self-test menu items. To return to normal operation, enter 15 then **(= MARKER)**, or cycle line power, or press **TEST**. Operation of selections from the test menu are described as part service procedures in the *HP 8530 On-Site Service Manual*.

The following is a list of the options available on the test menu:

Service Functions

Table 17-1. Test Menu

MAIN SERVICE FUNCTIONS MENU	
LOOPING SELF TESTS	SYSTEM COMMANDS
1 A5 PROCESSOR EPROM	15 RUN MAIN PROGRAM
2 A5 PROCESSOR RAM	16 MEMORY OPERATIONS
3 A7 DATA BUS	17 RERUN SELF TEST
4 A4 DISPLAY PROCESSOR	18 REPEAT TEST LOOP
5 A14 DISPLAY RAM	
6 A7 TIMER/CLOCK/RS-232	DISC COMMANDS
7 A7 PUBLIC HPIB	19 LOAD PROGRAM DISC
8 A7 SYSTEM BUS	20 RECORD PROGRAM DISC
9 INTERRUPT SYSTEM	21 INITIALIZE DISC
10 A5 MULTIPLIER	
11 A7 DISC CONTROLLER	SERVICE COMMANDS
12 A6 NON-VOLATILE MEMORY	22 RUN SERVICE PROGRAM
13 IF DETECTOR DATA	23 DIAGNOSE A FAILURE
14 KEYBOARD	
ENTER SELECTION, THEN PRESS =MARKER	

Disc Commands

- 19 LOAD PROGRAM DISC Use this selection to load or reload the operating system. Slide the operating disc into the disc drive. Press (1) (9) (=MARKER). In about one minute, the operating system should be loaded and running.
- 20 RECORD PROGRAM DISC Use this selection to record a backup copy of the operating system on an initialized blank disc. Slide the initialized disc into the disc drive. Press (2) (0) (=MARKER)
- 21 INITIALIZE DISC Use this selection a disc prior to recording the operating system on it. You can use a disc that has been recorded on, but it should be double-sided and of good quality. Slide the disc into the disc drive. Press (2) (1) (=MARKER).

System Bus Softkeys

Use the SYSTEM BUS 'LOCAL' softkey to suspend all activity on the System Bus and enter the *hold* mode. Front panel control of instruments connected to the System Bus is enabled to allow you to change instrument functions not controllable from the receiver.

Selecting SYSTEM BUS 'LOCAL' also allows an external controller to communicate directly with any "appliance" or instrument on the System Bus via the System Bus Address.

Any *pass-thru* command to any "appliance" or instrument on the System Bus causes an automatic System Bus 'LOCAL'.

Selecting SYSTEM BUS 'REMOTE' returns control of instruments on the System Bus to the receiver. Source functions controlled by the receiver are returned to the state represented by the current receiver Instrument State (for example: ramp/step/single point, frequency range, sweep time, source power, and power slope). Other source functions set from its front-panel are not changed. The test set is interrogated and parameter definitions are established (see REDEFINE PARAMETER). Raw data arrays are zeroed and the displayed trace is updated by the next group of sweeps.

Addressing the receiver HP-IB after pass-thru to any System Bus Address (except address 31) causes an automatic System Bus 'Remote'.

IF Gain

The IF Gain menus allow you to select automatic or manual IF gain control for the HP 8530A input signal paths. Remember, the IF section of the receiver:

- Down converts the 20 MHz input signals to a lower frequency, so the signal is easier to manipulate and sample.
- Changes the amount of IF gain so the detectors and A/D converter operate with optimum accuracy (refer to Figure 17-12).
- Selects the input ratio (b1/a1 for example).

Normally the receiver uses automatic gain control. In this mode, the receiver automatically adjusts IF gain for a high signal level (around -15 dBm) at the detectors and A/D converter. This allows the detectors and A/D converter to operate with optimum accuracy. The default (automatic) mode is appropriate for almost all measurement setups.

Why Use Manual control

You should use manual IF gain control if any of the following applies to your measurement:

- There are large power changes between adjacent data points (greater than 24 dB between points).
- The “IF OVERLOAD” message keeps appearing, even though RF Power to the receiver inputs is less than -10 dBm.

This situation can occur when measuring the copolar and crosspolar output of an antenna, when using FASC or FASD Fast CW modes. The FASAD (autoranging Fast CW) and Fast IF Multiplexing modes are immune to this problem.

Why the problem occurs. When the receiver measures a data point, automatic IF gain control detects the power at the input. Assume (for example) that this is a very low power level. The gain control increases IF gain to amplify the signal. This allows the synchronous detectors and A/D converter (shown in Figure 17-12) to operate in their most accurate range. Now assume the receiver measures the next data point, and the power level is much higher. The IF gain stages are still set for the previously-measured low power level. When the large signal arrives, it is amplified greatly and will often overdrive the detectors. The error message “IF OVERLOAD” appears when this occurs.

Figure 17-13 shows a block diagram of the IF gain stage.

Service Functions

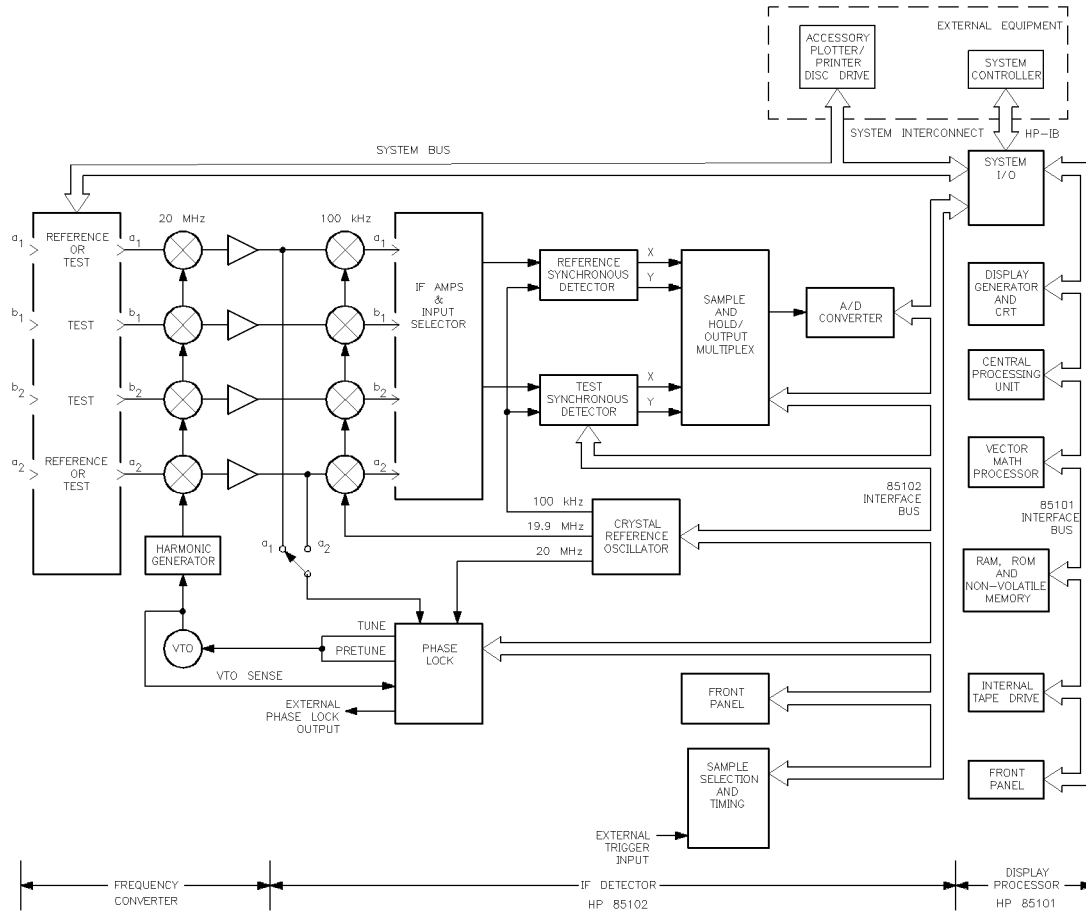

Figure 17-12. Simplified Block Diagram of the HP 8530A Receiver

Note the block in Figure 17-12 titled “IF AMPS & INPUT SELECTOR,” it is this section we will be looking at more closely in Figure 17-13.

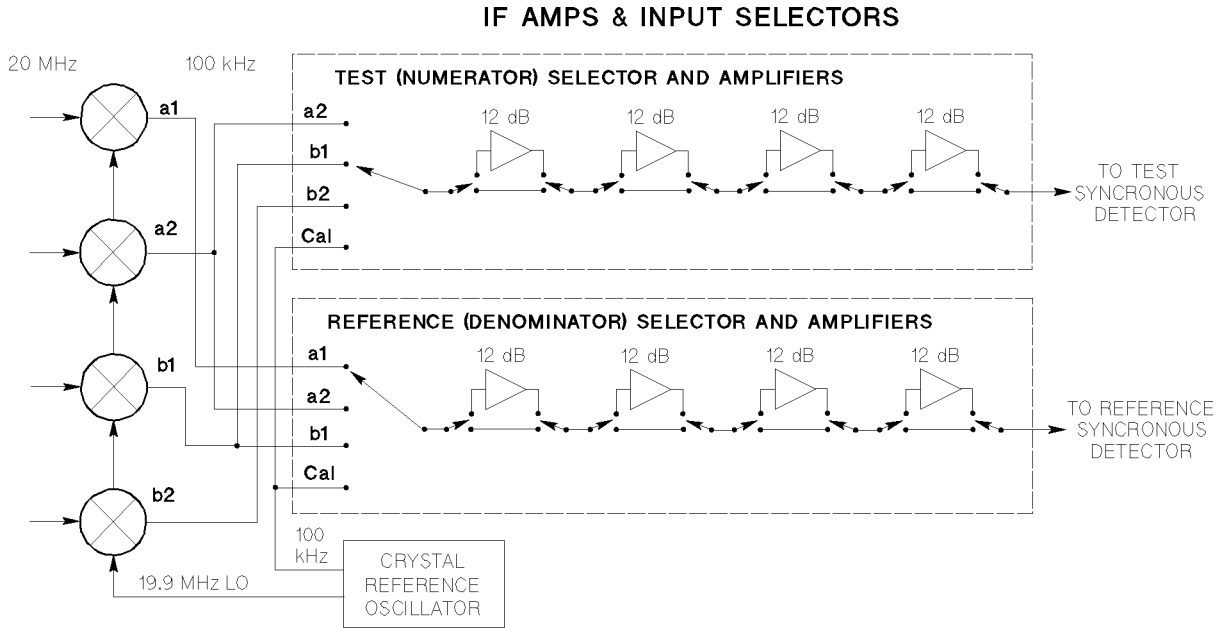

Figure 17-13. Gain Stages in the IF section

You will notice that, in Figure 17-12, the 100 kHz mixers are shown as having only a single output each. This is not really true. Figure 17-13 shows a closer representation of the actual circuitry. The different signals (a1, a2, b1, and b2) are split off and routed to *input selectors*. When you select a specific parameter, a ratio such a b1/a1 is selected. The receiver automatically selects the correct positions on the input selector to send the b1 signal to the test channel, and a1 to the reference channel.

The signals then go to a series of 12 dB amplifiers. In automatic IF gain mode, the receiver controls these amplifiers. These amplifiers can also be controlled manually with the softkeys in the IF Gain Select Menu.

How to Use Manual IF Gain Controls Properly

You can solve the IF OVERLOAD problem by using manual IF gain, and setting it as necessary for the *higher power level*.

Press **SYSTEM MORE SERVICE FUNCTIONS IF GAIN**. Then select gain control for either the test or reference path with **TEST AMP. GAIN** or **REFERENCE AMP. GAIN**. The manual gain control softkeys are now displayed:

- GAIN: (MIN) 0** Turns all four amplifiers OFF for that test or reference path (0 dB gain).
- GAIN: 1** Turns one amplifier ON for that test or reference path (12 dB gain).
- GAIN: 2** Turns two amplifiers ON for that test or reference path (24 dB gain).
- GAIN: 3** Turns three amplifiers ON for that test or reference path (36 dB gain).
- GAIN: (MAX) 4** Turns all four amplifiers ON for that test or reference path (48 dB gain).

No matter which gain setting you choose, the receiver adjusts *displayed* power levels automatically.

Service Functions

Automated Measurement Issues

If you are controlling the receiver using a computer, the Autoranging Fast CW mode (FASTAD), can measure large signal variations. It does this using automatic IF gain control.

Peek and Poke

Caution The POKE function is for qualified service personnel only. Users should *NEVER* use this softkey. *Using POKE is a GUARANTEED way to mess up the receiver's operating system, unless it is done under the supervision of a qualified Hewlett-Packard service representative.* Misusing POKE can cause all kinds of operating and measurement problems. Some problems may corrupt measurement data without the operator being aware of it.

Service personnel should remember that valid POKES can change from one firmware version to the next.

If you have already “poked” some values, you can restore the integrity of the receiver by reloading the HP 8530A operating system. To do this, insert the operating system disc and press:

(SYSTEM) MORE SERVICE FUNCTIONS TEST MENU 19 (=MARKER)

Purpose of Peek and Poke

It is possible to examine memory locations in the receiver using the PEEK softkey, and change their contents using POKE. These functions are for service personnel only.

The SOFTWARE REVISION softkey displays the date and revision code of the operating system firmware. Use this key to determine the firmware revision and to help in communications about the firmware.

HP-IB Programming

This chapter explains how to automate measurement and data processing operations using the receiver system with an external controller over the Hewlett-Packard Interface Bus (HP-IB). Only programming is covered: familiarity with manual operation of the receiver system, gained through Basic Measurements in this volume, is assumed, and details of how each function works are not given unless these are unique to programmed operation or are different for manual and programmed operation.

What is in this Chapter

- What You Can Do with Remote Programming.
- HP-IB Command Information
- Setting up the System
- Transferring Data Out of the Receiver
- Using the Data
- Transferring Data Into the Receiver
- Commonly-Used Queries
- Local Operation
- Programming Examples
- General HP-IB Programming
- BASIC program listing

What You Can Do with Remote Programming

An external computer can be connected to the receiver HP-IB interface to:

- Change instrument settings or set up measurements.
- Transfer data to or from different stages of internal data processing.
- Control instruments connected to the System Bus through the receiver.
- Use the receiver CRT as a graphics display.

HP-IB Command Information

Order of Programming Commands

Use standard HP-IB protocol to program the system state using generally the same sequence as you press receiver front panel hardkeys and softkeys. From the computer, the receiver system is treated as a single instrument, just as the various instruments that make up the system are controlled using the receiver front panel.

Syntax Requirements

Mnemonics may be written using all uppercase characters (as in STAR; which is preferred), or using initial uppercase followed by lowercase (as in Star; which is allowed).

Either uppercase or lowercase characters may be used. The receiver generally accepts syntax with extraneous blanks; however note that spaces are not allowed within the mnemonic name: For example, entering the mnemonic name MARK 1 in a statement would cause a syntax error, but MARK1 would not.

Use the semicolon (;) to separate instructions. Use the comma (,) to separate each value in a series.

If no units terminator follows the value for frequency and time units, the system defaults to receiver Basic Units (Hz, seconds). Other quantities (power, length) do not use a units terminator.

Mnemonics

The program code for each function is a four-to-eight character mnemonic version of its label. Many mnemonics must be followed by a numeric value in the basic measurement units. For example, the STIMULUS **START** key is programmed using STAR. Programming mnemonics for all receiver front panel controls and menu softkeys are given in the *HP 8530A Keyword Dictionary*.

Strings of commands are written in logical sequences, separated by the semicolon, such as

```
OUTPUT 716;"FACTPRES;STAR 2E9;STOP 18E9;PARA1;LINP;MARK1 9E9;"
```

This series of command mnemonics executes a Factory Preset, selects a 2 GHz to 18 GHz sweep, displays Parameter 1 using the polar format, and then positions measurement marker #1 to 9 GHz. The semicolon (;) is used to terminate each individual command. Notice that the values are in units raised to a power of 10. MARK1 9E9 means to place marker #1 (MARK1) to 9 GHz (9×10^9). The E represents "raised to the power of."

Numeric entries and units

Numeric entries with no units terminator are equivalent to pressing the **x1** key in the entry area. Instead of using the "E" exponent system you can simply enter the actual units for frequency, time, or voltage:

Example:

```
OUTPUT 716;"FACTPRES; STAR 2 GHz; STOP 18 GHz; PARA1; LINP; MARK1 9 GHz;"
```

Frequency Use GHz, MHz, and kHz. No terminator is required for Hz units.

Time Use fs, ps, ns, us, and ms. No terminator is required for seconds.

Angle Angles should be entered into your program in degrees units. No terminator is required.

“Next Menu” commands are unnecessary

Certain functions must be programmed in strict order, but it is not necessary to program a key whose only function is to present a new menu. For example, you can set marker 2 to minimum trace value with the sequence:

```
"OUTPUT 716;MARK2; MARKMINI;"
```

These are the only commands you need, even though the front panel key sequence is

MARKER

MARKER 2 MORE

MARKER TO MINIMUM

It is not necessary to program the **MARKER** hardkey or the **MORE** softkey (in fact, there are no HP-IB mnemonics for these keys).

Timing Considerations

In general, timing considerations are handled automatically and data is not presented until it is valid. However, depending upon the speed of the computer, the programmer may need to intervene in order to make certain that the data is ready for use.

The **SING;** and **NUMG;** instructions always hold off execution of the instructions that follow until the specified number of groups is complete. These statements are the primary means of data synchronization. For example, in the sequence:

```
"CHAN1; TIMB; SING; OUTPDATA;"
```

The **SING;** instruction holds off execution of any following instruction, **OUTPDATA;** in this case, until a sweep is complete and the data is ready.

In addition, the output instructions (**OUTPMARK;** and **OUTPACTI;**) are always held off until all preceding instructions are complete. For example:

```
"LOG MAG; MARK1 9 GHz; OUTPMARK;"
```

In this sequence the marker data is not made available until the format change has been executed and the marker has been positioned. Likewise, operations such as **AUTO;** **MARKMAXI;** **MARKMINI;** and **EQUA;** are held off until all preceding instructions are complete.

However, for the array output statements (**OUTPRAW_n;** **OUTPDATA;** **OUTPPFORM;** **OUTPMEMO;** and **OUTPCALC_n;**) the data is always made available immediately without regard to operations which may be in progress, except for **SING;** and **NUMG;**. For example, in the sequence "**TIMB;** **OUTPDATA;**" the instruction **TIMB** performs a Time Domain conversion, this requires a certain length of time. Execution of **OUTPDATA;** is not delayed until the conversion is complete. Thus, the data that is output is probably (depending upon the speed of the computer) not the actual converted data, but the data that existed before the domain conversion.

If it is not desired or necessary to take new data, and you change the channel or domain immediately before requesting data output, use the **WAIT;** instruction. **WAIT;** is used at any time you wish to make certain that the instruction immediately preceding **WAIT;** has completed before the instruction which follows **WAIT;** begins execution. So, for the Time Domain conversion example, use a sequence like the one below:

```
"TIMB; WAIT; OUTPDATA;"
```

This assures that the conversion is complete before the data is made ready for output.

Overview of Computer-Controlled Measurements

In a typical computer-controlled measurement, you:

- Set up the system for a particular measurement.
- Perform an appropriate measurement calibration for each parameter to be measured.
- Save the calibration in a cal set memory.
- Install the test device, measure its response. The receiver will apply calibration offsets to the data.
- Output the data from the desired array to the computer.

The Stimulus settings and Parameter used during the calibration must match those used during the calibrated measurement. Cal sets remember the stimulus settings that were in effect when the calibration was made. When you recall a cal set, it automatically changes the stimulus settings accordingly. The cal set does not remember any non-stimulus settings.

Setting up the System

Connect the External Computer

Connect the computer to the main HP-IB connector. Connect RF sources to the System Interconnect. You must not connect the same device to the HP-IB connection and System Bus at the same time!

Address Settings

Instrument interconnections and the HP-IB System Bus address settings in the receiver system are shown at the beginning of the *HP 8530A Installation Guide*.

The receiver's System Bus uses two-digit HP-IB addresses to control instruments and peripherals connected to it. To change these addresses, use the menu under the receiver's front panel (**LOCAL**) key (the same menu is available under (**SYSTEM**) **HP-IB ADDRESSES**).

Set Up the Measurement Using HP-IB Commands

Set up the measurement using HP-IB Commands, following the guidelines already covered on previous pages. Here is an example setup command string:

```
OUTPUT 716;"FACTPRES;STAR 2E9;STOP 18E9;PARA1;LINM;MARK1 19E9;"
```

This command string:

- Performs a Factory Preset (which selects Frequency Domain and Step Sweep mode)
- Sets start frequency to 2 GHz
- Sets stop frequency to 18 GHz
- Selects Parameter 1
- Selects Linear Magnitude Display Format
- Puts a marker at 19 GHz

Here is another example

```
OUTPUT 716;"FACTPRES;ANGL;STAR -180;STOP 180;FREM 10E9;INCA 0.5;  
TWOP;PARA1;POLM;PARA2;LOGM;EXTTPOIN;"
```

This command string:

- Performs a Factory Preset
- Selects Angle Domain
- Sets start angle -180°
- Sets stop angle 180°
- Sets frequency to 10 GHz
- Sets increment angle to 0.5°
- Selects Two Parameter Display
- Selects Parameter 1
- Sets Parameter 1 to Polar Magnitude display format
- Selects Parameter 2
- Sets Parameter 2 to Log Magnitude Display Format

Other commands are mentioned in the *HP 8530A Keyword Dictionary*. If you do not know the command for a specific function, look at the “Menu Structures” chapter at the end of the Keyword Dictionary. This section has fold-out pages showing all menu maps, each softkey function, and the HP-IB mnemonic for each softkey.

Transferring Data Out of the Receiver

Sending Data to the Computer

You can send measurement data to the computer in one the following ways:

- You can output the current-active marker value.
- You can output a complete data trace.

Before you attempt to transfer data to the computer, you need to know some information about:

- The different receiver data arrays you can transfer.
- The instrument features that affect each data array.
- Which of the five data transfer protocols (formats) you should use.

What Types of Data Are Available from the HP 8530A?

After making a measurement, you can send **raw**, **corrected**, or **formatted** measurement data to the computer. These arrays represent different stages of data processing, illustrated in Figure 18-1.

As explained below, there are specific HP-IB commands used to transfer each type of data array.

HP-IB Programming Basics

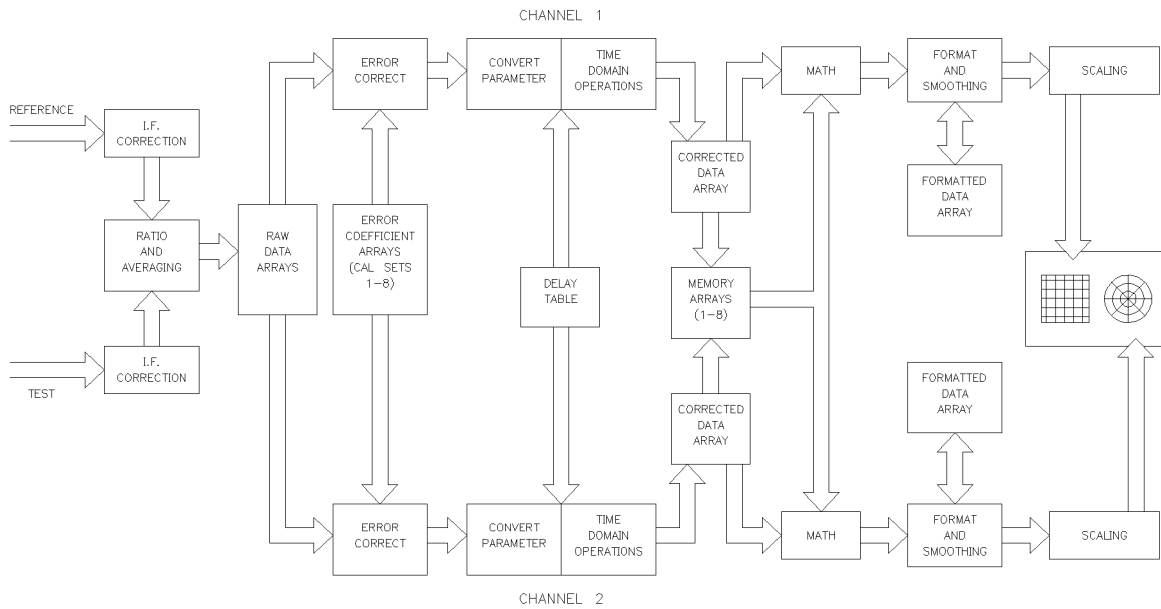

Figure 18-1. Data Processing Stages in the Receiver

The following data arrays can be read by an external computer:

Raw Data

This data array contains the ratioed and averaged measurement data results. (Note: In Fast CW mode, raw data is the only available format.)

To transfer the data from this array to the computer, use the HP-IB command `OUTPRAWn`, where n is the desired parameter (1, 2, 3 or 4). Refer to the *HP 8530A the Keyword Dictionary* for syntax and other information on this command, or about any of the commands mentioned below. The raw array data is in real,imaginary pairs. Raw data can be output for *any parameter at any time* (assuming the parameter is actually being measured). (How can you tell if a parameter is actually being measured? Answer: If a parameter is displayed on the screen, it is being measured by the receiver. If a parameter is *not* displayed, it is *not* measured. For example, if you select a three-parameter display, Parameters 1, 2, and 3 are measured and displayed, Parameter 4 is *not* measured.)

Corrected Data Array

In addition to ratioing and averaging, corrected data has been through:

- Time Domain
- Calibration
- Table Delay, Electrical Delay
- Magnitude Offset

Remember that these features must be ON to affect the data.

To transfer data from this array to the computer, use the HP-IB command `OUTPDATA`. We learned earlier that you can select any *Raw Data* array for transfer. You cannot do this with the Corrected Data array. Instead, `OUTPDATA` outputs the data for the *active parameter* only. The corrected data array is in real,imaginary pairs.

Formatted Data Array

This data has had all the data processing of the Raw and Corrected data arrays, plus smoothing and trace math processing.

To transfer data from this array to the computer, use the HP-IB command OUTPFORM. This command outputs the data for the *active parameter* only.

The data format that you get out of the formatted array depends on the Domain you are in and the display mode you are using:

If in Frequency or Time Domain.

- If you are in a Polar display mode, the formatted array will output real,imaginary data pairs.
- If you are in a Cartesian magnitude display mode ((LOG MAG) or (LIN MAG)), a data pair will be output. The first value will be magnitude data. The second value output is always zero. *The units will match those you selected for the display (dB or linear).*
- If you are in Cartesian Phase display format ((PHASE)), a data pair will be output. The first value will be phase (in degrees). The second value output is always zero.

If in Angle Domain. A data pair will be output. The first value will be magnitude data. The second value output is always zero. *The units will match those you selected for the display (dB or linear).*

Calibration Coefficients

These are the error correction coefficients created during calibration (also called a “Cal Set”). The error coefficient arrays can be read from, or sent to a computer, just like the arrays described above. Refer to the descriptions for the OUTPCALC and INPUCALC commands in the *HP 8530A the Keyword Dictionary*.

Delay Table

Each parameter has its own special array called a “delay table.” The table must be created using an external computer, then be sent to the receiver. The receiver will use the table to modify measurement data. The table contains real/imaginary data pairs in the internal Form 1 compressed format. A typical use is to modify frequency domain data to synthesize a special window shape for use in time domain RCS measurements. Refer to the descriptions for the OUTPDELA and INPUDELA commands in the *HP 8530A the Keyword Dictionary*.

Memory Data

Valid data can be read from this array *if* data has been stored to memory. Refer to the descriptions for the OUTPMEMO command in the *HP 8530A the Keyword Dictionary*. (There is no command to send data directly into a memory from the computer. However, you can send data to the raw or corrected array, then save it to memory using DATI)

A trace currently stored in one of the eight trace math memories may be output by selecting the memory, using

- DEFM1; to select Memory 1,
- DEFM2; to select Memory 2,
- DEFM3; to select Memory 3,
- DEFM4; to select Memory 4,
- DEFM5; to select Memory 5,
- DEFM6; to select Memory 6,
- DEFM7; to select Memory 7, or
- DEFM8; to select Memory 8.

First select the memory using the DEFMn; instruction, turn on memory by issuing a DISPMEMO; instruction, then use OUTPMEMO; to

HP-IB Programming Basics

read currently selected memory. This transfers the memory data in real/imaginary pairs.

Data Always Comes from the Active Channel

Notice that there are two entirely different, parallel, data processing paths shown in Figure 18-1. One path is for Channel 1 and one is for Channel 2. Each channel has raw, corrected, and formatted data arrays. Because the paths are separate and independent, different features can be ON in Channel 1 and OFF in Channel 2. As you have seen, the HP-IB transfer commands let you select the parameter (1, 2, 3 or 4) for data transfer. But, since each channel has four independent parameters, which channel will be used during the transfer? The data transfer always occurs on the Active Channel.

Available Data Transfer Formats

In remote programming you can choose one of four *binary* data formats, or an *ASCII* data format. The formats are listed below:

The descriptions of each Form, below, is provided so you can decide which transfer format is appropriate for your needs. Specific information on byte sizes and structure of these formats is provided in “Preparing the Computer to Transmit or Receive Data”, later in this chapter; and also in the *HP 8530A Keyword Dictionary*.

Form 1 (HP-IB Command: FORM1). Form 1 is significantly different from the other four transfer modes. The biggest difference is that *you can only obtain data from the Raw Array when you use Form 1*. The other four transfer modes let you choose any internal data array for transfer.

Form 1 is the fastest transfer format available, and is almost exclusively used in Fast CW and Fast IF Multiplexing modes. Refer to “FORM 1” in the *HP 8530A Keyword Dictionary* for a full description of this transfer format. Form 1 data can be converted to floating point data in the computer. Form 1 is the *only* transfer format you can use for Fast CW or Fast IF Multiplexing modes.

Form 2 (HP-IB Command: FORM2). 32-bit IEEE 728 floating point format. This format is not commonly used. It consists of a header, a two-byte number indicating how many bytes follow, then the real and imaginary data pairs for each stimulus point.

Form 3 (HP-IB Command: FORM3). This is the recommended format for use with HP 9000 Series 200/300 workstations. It consists of a header, a two-byte number indicating how many bytes follow, then the real and imaginary data pairs for each stimulus point. Form 3 follows the 64-bit IEEE 728 standard format.

Form 4 (HP-IB Command: FORM4). This format is ASCII, and is not as commonly used as other formats. One of the reasons for this is because it is *S L O W*. However, even with this limitation there are still two good circumstances in which Form 4 is useful:

- When first learning how to transfer data. Form 4 comes out in ASCII format that is meaningful to a human being.
- When using GP-IB cards of limited ability. Some third party GP-IB (IEEE 488-2) cards (for PC compatibles) requires ASCII format data.

Form 5 (HP-IB Command: FORM5). This is the recommended format for use with IBM PCs and compatibles. This is a 32-bit DOS-compatible floating point format.

The *HP 8530A Keyword Dictionary* describes each form in detail. It also describes the component pieces of information that accompanies the data.

This example shows the data transfer to the computer when FORM3 is selected:

```
ASSIGN @Rec to 716; FORMAT OFF
OUTPUT @Rec; "FORM3; SING; OUTPDATA"
ENTER @Rec Preamble, Size, Data(*)
```

Use NUMG; or SING; to synchronize data output with completion of data acquisition. The variable Preamble accepts the #A block header, the Variable Size accepts the value representing the total number of data bytes in the block, and Data(*) accepts the real/imaginary data pairs.

If Data(*) is dimensioned to less than the number of points currently selected, then the ENTER operation does not terminate and you may issue another ENTER statement to read the remaining data, or send another receiver command (such as ENT0;) to terminate the receiver data output mode.

How Much Data Is Transferred?

When you *measure* data, the receiver stores data for the entire sweep in the Raw, Corrected, and Formatted arrays. In addition, data for *all displayed parameters* are stored in these arrays.

For example, if you have selected 201 frequency points, each array contains 201 data points. In an Angle Domain measurement from -180 to $+180$ degrees, 361 data points will be in each array (remember, you have to take the start angle -180° into account, that is why there are 361 points, *not* 360 points). If more than one parameter is displayed, a complete set of data exists for each one.

When you transfer *Raw Data*, the *entire array* for the *selected parameter* (1, 2, 3 or 4) is sent to the computer.

When you transfer *Corrected Data* or *Formatted Data*, the *entire array* for the *active parameter* is sent to the computer.

Preparing the Computer to Transmit or Receive Data

Setting up the I/O Path

If you are using HP BASIC, the ASSIGN command sets up the I/O path and its attributes. FORM1 requires the FORMAT attribute to be turned OFF (FORMAT OFF) in the assign statement. All other data formats (2 through 5) require the format attribute to be ON (FORMAT ON). type of data Format (Form 1 through Form 5) transfers data in three portions, each of equal size (mentioned below).

The entire data block to be transferred is composed of:

- A “preamble” or “header” block, composed of the characters #A. All Forms have this header block *except Form 4, and Form 1 when in the FASTCW modes.*
- A size block. This block contains the size (in bits), of the preamble, the size block itself, and each data block. All Forms have this header block, *except Form 4.*
- One data block for each frequency or angular point in the measurement. Each block contains one data pair. Form 4 contains only data blocks.

The size of the preamble, size block, and data blocks

In Form 1 each block is 16 bits long (2 bytes per data point).

In Form 2, each block is 32 bits long (8 bytes per data point).

In Form 3, each block is 64 bits long (16 bytes per data point).

HP-IB Programming Basics

In Form 4, This is an ASCII format, which contains only data blocks, each of which being 24 bytes long. Each of these blocks contain a data pair, in which the two numbers is separated by a comma. Each block is separated by a line feed.

Form 5, each block is 32 bits long (8 bytes per data point).

When the data transfer begins, *HP BASIC* automatically reads the size information in the Size Block, and transfers the data accordingly. Other languages require the user to define these block sizes ahead of time, usually when the I/O path is defined.

Setting Up Variables

Unless you are using Form 4, you must set up an integer variable for the preamble and the Size Block. Dimension an array of appropriate size for the data. Form 4 data requires a string array.

Dynamic Array Allocation

Setting up fixed array sizes is all you may need in simple programs. However, large measurement programs may need to call subroutines that can intelligently determine the size of the required data array. Fortunately, you can write your program so it reads the Size Block and then dynamically allocates the required data array storage, as in this sequence:

```
ENTER Rec_Data;Preamble, Size
N=Size/16 ! 16 bytes per data point using Form 3
REDIM Data(1:N, 1:2)
OUTPUT Rec;"FORM3;OUTPDATA;"
ENTER Rec_Data; Data(*)
```

You can do the same thing in Frequency Domain by making the number of points the active function then reading the value, as in this sequence:

```
OUTPUT Rec; "POIN; OUTPACTI;"
ENTER Rec_Data; Points
REDIM Data(1:Points, 1:2)
OUTPUT Rec;"FORM3;OUTPDATA;"
ENTER Rec_Data; Preamble, Size, Data(*)
```

A similar method could be used for Angle Domain. In this case you can calculate the number of data points by reading the start angle, stop angle, and increment angle. You must make each of these the active function before reading the value.

Note that all transfers use standard IEEE 728 block transfer formats with EOI asserted with the last byte of data.

Performing the Actual Transfer

Now that you know which data array and transfer format to use, and have dimensioned appropriate computer variables and an array, you are ready to perform the actual data transfer.

Example:

The following HP BASIC example performs a data transfer, and demonstrates many commonly-needed tasks, including:

- Measurement setup
- Data acquisition
- Conversion of real and imaginary data into magnitude and phase format
- Printout of the values for each point

This is a complete example. It dimensions all needed variables, shows all HP-IB bus "maintenance" commands, and so on. If you are not using HP BASIC you will have to write the

necessary lines of code for I/O setup. HP BASIC has advanced I/O features, and only requires the ASSIGN command for this.

The sample measurement uses 201 points of data. All loop counters and arrays are written to handle 201 points. Step sweep mode is used, with a single sweep. The example uses Form 3 transfer, but is applicable to Form 2 or Form 5 by changing "FORM3;" in line 210 of the code.

```

1   OPTION BASE 0           !Set loop and array counting at the number 0
3   DIM Data(200,1)        !Dimension a 201 x 2 array to hold transferred data.
5   DIM Mag(200),Phase(200) !Dimension two 1-dimensional arrays to hold the
7                               !final magnitude and phase values for each point.
9   INTEGER Preamble,Size  !Define integer variables for the preamble and
11                              !size blocks.
13  ASSIGN @Rec TO 716      !This sets up the I/O path for the receiver, and
15                              !defines the HP-IB address used to talk to it.
17  !
19  ASSIGN @Rec_data2 TO 716;FORMAT OFF!
21  !
23  CLEAR 716              !
25  OUTPUT @Rec;"USERPRES;" !Tells the receiver to do a User Preset.
27  DEG                   !HP BASIC command to express angles in degrees
29                              !rather than radians.
31  !
33  !The next line selects 201 points, Parameter 1, Log Magnitude display
35  !Log Format, Single Sweep, Form 3:
37  !
39  OUTPUT @Rec;"POIN201;PARA1;LOGM;SING;FORM3;"
41  !
43  OUTPUT @Rec;"OUTPDATA;" !Tells the receiver to output the entire
45                              !Calibrated Array (201 points)
47  !
49  ENTER @Rec_data2;Preamble,Size,Data(*)!Tells the computer to store:
51                              !the Preamble in the "Preamble" variable
53                              !the Size block in the "Size" variable
55                              !All data in the "Data" array
57  !
59  FOR N=0 TO 200          !Start a for/next loop (loops 201 times)
61      Real=Data(N,0)      !These two lines grab the first data point out
63      Imag=Data(N,1)      !of the array (starts with the start freq. point)
65      !
66      !Convert one point of data from real,imaginary to magnitude,phase
67      !
68      !
71      Mag(N)=SQR(Real^2+Imag^2) !Determine Magnitude value
73      IF Imag=0 AND Real<0 THEN !Determine Phase value
75          Phase(N)=-180
77      ELSE
79          Phase(N)=2*ATN(Imag/(Real+Mag(N)))
81      END IF
83      !
85      !Mag(N) and Phase(N) are 1-dimensional arrays that will hold the new
87      !magnitude and phase data.
89      !
91      !
93      !The following two lines simply print the real, imaginary, Magnitude and
95      !Phase values for the first point and every 20th point.
97      !
99      IF N=0 OR N/20=INT(N/20) THEN
101         PRINT "Point: ";N+1;TAB(13);"Real: ";Real;TAB(36);" Imag: ";Imag
103         PRINT "Point: ";N+1;TAB(13);" Mag: ";Mag(N);TAB(36);"Phase: ";Phase(N)
105     END IF
107     !
109     NEXT N
111     !
113     OUTPUT @Rec;"Mark1;"
115     LOCAL 716           !Place receiver back in local mode
117     END

```

Using the Data

As explained earlier, the HP 8530A outputs data in two basic formats:

- Form 1 format
- Real,Imaginary format.

Use the following information to process the data into usable formats.

Preprocessing Form 1 Data

Example 8 converts Form 1 Data into to real,imaginary pairs, which are then converted into linear magnitude, log magnitude and phase data.

Using Real,Imaginary Format for Vector Math

Real and imaginary data in its existing form is useful for vector math. Once you have done any mathematical processing of the data you can convert it into magnitude and phase information as explained below.

Converting Real,Imaginary Data to Magnitude and Phase Data

As explained earlier in this chapter, data is often in real,imaginary data pairs. You can perform vector math on this data directly, or you can convert it into magnitude and phase information (refer to lines 71 through 81 in the programming example shown in “Performing the Actual Transfer”).

Transferring Data Into the Receiver

Raw, Corrected, Formatted Arrays

Trace data should be loaded into receiver memory while in Hold mode to avoid overwriting the loaded data with newly acquired data. When Hold is selected, completion of a data input operation initiates a data processing cycle in which the displayed trace is updated to reflect the new data. The following mnemonics prepare the receiver to transfer data pairs at the receiver HP-IB to the specified array for the currently selected channel:

INPUFORM; load into selected channel Formatted data array,
 INPUDATA; load into selected channel Corrected data array,
 INPURAW1; load into selected channel Param 1 Raw data array,
 INPURAW2; load into selected channel Param 2 Raw data array,
 INPURAW3; load into selected channel Param 3 Raw data array, and
 INPURAW4; load into selected channel Param 4 Raw data array,

INPUDATA; and INPURAW n ; expect data in real,imaginary pairs regardless of the currently selected display format.

Each display Parameter (1 through 4) has its own raw array, corrected array and formatted array. In addition, each channel has an independent set of (four) parameters, each with their own raw, corrected, and formatted arrays.

When you perform an INPUDATA; command, the data is placed in the corrected array for the *active parameter* on the *active channel*. INPUFORM; works the same way.

With raw data, there is a different HP-IB command for each raw data array (INPURAW1; through INPURAW4;). When you issue an INPURAW3; command, data is sent to the Parameter 3 raw data array *in the active channel*.

INPUFORM; requires you to supply data in exactly the same format as the receiver would use during an OUTPFORM operation. (As explained earlier, when you output data from the Formatted Array, the exact form of the data depends on the Domain the receiver is in, and the selected display format. Depending on these conditions, the receiver *outputs* data in a specific way. This is explained in “Formatted Data Array,” earlier in this chapter. When you use INPUFORM; you must make sure you send the data to the receiver in the same way the receiver would use if it were sending the data to the computer.)

Note

You cannot send data to an array if that parameter is not displayed on the screen. When a parameter is shown on the screen, it is essentially turned ON. If a parameter is not on the screen, it is OFF. Usually, you cannot perform functions (of any kind) on a parameter that is not currently shown on the screen. This limitation applies to sending data to the various arrays.

For example, to send data to the corrected array of Parameter 4, one of the following must be true:

- **SINGLE PARAMETER** display mode is selected, *and Parameter 4 is the selected parameter.*
 - **FOUR PARAMETER** display mode is selected, *and Parameter 4 must be the active parameter.*
-

HP-IB Programming Basics

Trace Memories

First, use one the following commands to select the trace memory to be loaded:

```
DEFM1; select Memory 1,  
DEFM2; select Memory 2,  
DEFM3; select Memory 3,  
DEFM4; select Memory 4,  
DEFM5; select Memory 5,  
DEFM6; select Memory 6,  
DEFM7; select Memory 7, or  
DEFM8; select Memory 8,
```

Next, load data into the Corrected data array, using:

```
"INPUdata;"
```

Finally, store the data into the selected memory, using:

```
"DATI;"
```

The data format for these transfers is selected by the FORM1, FORM2, FORM3, FORM4 and FORM5 mnemonics as for the OUTP instructions. One of the FORM n instructions should precede each transfer.

This example shows the data transfer from the computer to receiver Corrected Data array for the currently selected channel using FORM3.

```
OUTPUT Rec; "HOLD; FORM3; INPUdata;"  
OUTPUT Rec; Preamble, Size, Data(*)
```

HOLD prevents overwriting the data just input with data from the next group of sweeps. The variable Preamble holds the #A block header, the Variable Size holds the value representing the total number of data bytes in the block, and Data(*) holds the real/imaginary data pairs.

the receiver accepts data until the specified number of bytes is received, or EOI is detected, then terminates the listen mode. If the number of data bytes is not equal to the value of the Variable Size, the message BLOCK INPUT ERROR is displayed. If the value of the Variable Size does not correspond to the current number of points selected, then the message BLOCK INPUT LENGTH ERROR is displayed. If more than the internally allocated number of bytes are input, these bytes are treated like regular commands, which cause a syntax error. If less than the specified number of bytes are input without an EOI, you may continue with another OUTPUT statement.

Form 4 Input

When using FORM4, always suppress the CR/LF which would normally terminate the OUTPUT statement that sends the INPU instruction as follows.

```
OUTPUT Rec; "HOLD; FORM4; INPUdata;";  
OUTPUT Rec; Data(*)''
```

The semicolon following the last quote mark is used in BASIC to suppress the normal CR/LF sent at the end of the statement. Failure to suppress this character results in the receiver accepting the CR/LF as the first data byte.

Commonly-Used Queries

Marker Value

The marker value is output as two ASCII numbers in the basic units for the selected display format. Use two real variables, for example,

```
Mag,Phase
```

If the marker value consists of a single value, as when LOG MAG (LOGM;) or PHASE (PHAS;) is selected, then the first number becomes the desired value (magnitude or phase) and the second value is set to zero.

Active Function Value

The current value of the active function is read as a single ASCII number in the basic units for the quantity. The following sequence turns on marker 2, moves the marker to the maximum value on the trace. Then OUTPACTI readies the receiver to output the current active function, which is the stimulus value at the marker position in this sequence.

```
"MARK2; MARKMAXI; OUTPACTI;"
```

To accept the data, use a single real variable. For example:

```
Freq
```

Query System State

For instrument state settings that cannot be made the active function, use the Query instructions function. For example:

```
DOMA?
```

This returns the current domain selection as an ASCII string enclosed as quotes, for example "FREQUENCY" if the Frequency Domain is currently selected.

System Status

Important system status information is available by reading a two-byte status word. For example,

```
"OUTPSTAT;"
```

This sets up the receiver to output the status value. You can then read one or two ASCII numbers.

The following instruction outputs a single ASCII message number and, if desired, the text of any System Message appearing on the display.

```
"OUTPERRO;"
```

A change in the status bytes can be set to generate the SRQ on specific events using the SRQM instruction.

Where to Find Other Query Commands

Refer to the *HP 8530A Keyword Dictionary*, near the end of Chapter 3, "Programming Codes."

Local Operation

Return the receiver to local control by pressing the front panel **LOCAL** key or by issuing the HP-IB command GTL 716 or GTL 7 (LOCAL 716 or LOCAL 7 using HP Series 200/300 BASIC language).

Program Debugging Aids

To further assist in program development, statements DEBUON; (Debug On) and DEBUOFF; (Debug Off) are used to control a receiver debug mode in which the instruction currently being executed is displayed in the Title area of the receiver display.

Programming Examples

A sample program is supplied with your receiver, on the *HP 8530A Software Toolkit Disc*. The name of the program is: 8530_PROGX

The program contains many example routines, which show how to perform various programming tasks. The text on the following pages describe each of these examples.

The program requires BASIC 5.0 or higher with the following binaries: IO, MAT, TRANS, and COMPLEX.

The disc also contains three measurement data files that are accessed by some of the programming example routines.

ANG360

ANG180_SUM

ANG180_DEL

These are data files containing angle domain measurement data.

Example 1: Input Syntax Familiarization

This example can help you become familiar with the receiver HP-IB instructions. The first part of this example sends commands (entered by the user) to the receiver. The second part sends query or output commands to the receiver and prints the response. When entering HP-IB commands it is not necessary to use quotation marks or include the final ';'. Syntax errors are detected and cleared.

Refer to the "Example Program Listings" near the end of this chapter for the Example 1 program that is executable using HP BASIC.

```
! Start: !
INPUT "Type 8530 command."; String$
OUTPUT Rec; String$
GOTO Start
```

The Input statement displays a message, then waits for an input (type the string and then press computer Return or ENTER). Using a simple program like this one, you can input commands one at a time and observe the receiver response. At first, try instructions such as:

"STAR 10 GHz"

Refer to the List Programming Codes in the *HP 8530A Keyword Dictionary* to see the syntax requirements for each programmable function.

Enter a sequence of instructions by separating each instruction with a semicolon (;), as follows:

"STAR 2 GHz; STOP 10 GHz; CHAN2; LINP"

The receiver instruction DEBUON causes all receiver instructions to be displayed in the Title area of the receiver display. The last 30 characters in the instruction queue are displayed, with the most recently received instruction at the left of the area, pushing instructions higher on the queue off of the area to the right. This means that the currently executing command may not be visible if the queue is over 30 characters in length. Use the receiver instruction DEBUOFF to disable display of the command queue.

If the receiver does not recognize a mnemonic, or cannot execute it in the correct sequence, then HP-IB activity stops and the instruction in error is shown in the Title area of the receiver display with an upward pointing arrow at the location of the error. You must press **LOCAL**, then continue operation, or issue an HP-IB DCL or SDC (the example program does this for you).

Programming Examples

Commands are executed in the sequence in which they are received by the receiver. When a command is received, the syntax is checked, stored in the command queue, then executed. Some commands, such as SING, free the processor for other tasks during the time that they are executing. If time becomes available while such a command is executing, the process of reading a command, syntax checking, storage in the command queue, and sometimes overlapping execution continues until up to eight commands are stored for pending execution.

The second part of this example sends HP 8530A instructions that prompt a response from the receiver. These are the query commands and the OUTPxxxx; commands. Refer the *HP 8530A Keyword Dictionary* for more information.

```
OUTPUT 716;"STAR; OUTPACTI;"
ENTER 716; Freq
PRINT Freq
```

This will print the current value for Start Frequency.

Example 2: Active Function Output

This example executes a User Preset, then reads and prints the current values for seven active functions. The value for any function that can be made the active function can be read this way. Functions or settings that do not have an active function may be read using query commands. (Refer to the end of Chapter 3 of the *HP 8530A Keyword Dictionary* for a list query commands.)

The value of the current active function is output as a single ASCII value in the basic units of the function. For example:

```
OUTPUT Rec;"MARK1;OUTPACTI;"
ENTER Rec_data;Freq
```

When executed with a marker as the active function, the sequence (above) returns the frequency (in Hertz) at the marker position.

The sequence AVERON; OUTPACTI; outputs the currently selected averaging factor. The sequence ELED; OUTPACTI; returns the currently selected Electrical Delay value in seconds.

The title and various other user-defined labels can also be read over the HP-IB by making it the active function, then reading the characters into a string variable. For example:

```
OUTPUT Rec;"TITL; OUTPTITL;"
ENTER Rec_data; String$
```

This returns the current title as the active function. Note that the title, calibration kit label, standard class label, standard label, and the user parameter label are enclosed in quotation marks. The standard class assignments list does not include the quotation marks.

Example 3: Marker Data Output

This example prints the x and y axis values of a marker in any selected domain or format. A single sweep with averaging (factor of 4) is taken before reading the marker. Then, the display format is queried and appropriate units are printed for the y axis value. Next, the x axis value is read and the selected domain is queried and appropriate units are printed for the x axis.

If the system is currently operating in either the HOLD or the CONTINUAL mode (see STIMULUS menu), then the data is output immediately; if SINGLE, or NUMBER OF GROUPS has been selected, then the data output operation waits until the specified number of sweeps is complete. For example, the following sequence selects the linear magnitude polar display, turns on averaging, and commands 17 groups of sweeps. When complete, marker 1 is turned

on, moved to the maximum trace value, then the marker value is assigned to the variables Mag and Phase:

```
OUTPUT Rec;"LINP; AVERON 16;"
OUTPUT Rec;"NUMG 17; MARK1; MARKMAXI; OUTPMARK;"
ENTER Rec_Data;Mag,Phase
```

The OUTPMARK; statement always transfers two values in standard ASCII format. As shown in Table 18-1, the values depend upon the currently selected display format. Two values are output in every display format, but for Cartesian displays the second value is zero.

Table 18-1. Marker Units

FORMAT	MARKER Basic Units
Frequency Domain: Time Domain:	
LOG MAG	dB
LIN MAG	ρ (unitless) (reflection) τ (unitless) (transmission)
PHASE	degrees ($^{\circ}$)
POLAR MAG	dB; $\angle \varphi^{\circ}$ (reflection) dB; $\angle \theta^{\circ}$ (transmission)
SWR	(unitless)
LIN on POLAR	$\rho \angle \varphi^{\circ}$ (reflection) $\tau \angle \theta^{\circ}$ (transmission)
REAL	x (unitless)
IMAGINARY	jy (unitless)
Angle Domain	
LOG MAG	dB
LIN MAG	ρ (unitless) (reflection) τ (unitless) (transmission)
PHASE	degrees ($^{\circ}$)
POLAR MAG	dB; $\angle \phi^{\circ}$ (reflection) dB; $\angle \phi^{\circ}$ (transmission)
SWR	(unitless)
LIN on POLAR	$\rho \angle \phi^{\circ}$ (reflection) $\tau \angle \phi^{\circ}$ (transmission)
REAL	x (unitless)
IMAGINARY	jy (unitless)

Data taken in the step sweep mode requires only one group of sweeps (NUMG 1; or SING;) because each data point is averaged before the next point is measured.

To move the marker to a specific stimulus value, include a numeric value in the instruction. The following sequence moves marker 1 to the data point closest to 9.123456789 GHz, then transfers the marker value:

```
OUTPUT Rec;"MARK1 9.123456789 GHz; OUTPMARK;"
ENTER Rec_data;Mag,Phase
```

Programming Examples

Example 4: Marker Operation

This example finds the peak-to-peak range of a trace, measures the -3 dB bandwidth of an antenna pattern, and finds the peak of the lobes. The antenna pattern data is loaded by the subroutine Draw_360 from a data file (included on the software toolkit disc). This pattern data is normalized to 0 dB and then "marker searches" are used to determine the bandwidth and lobe peaks.

The marker functions are programmed in the same way as you would press the keys on the front panel. For example:

```
OUTPUT Rec;"MARK2; MARKMAXI; DELR2; MARK1; MARKMINI; OUTPMARK;"
ENTER Rec_data;Mag,Phase
OUTPUT Rec;"OUTPACTI"
ENTER Rec_data;Freq
OUTPUT Rec;"DELO; MARKOFF"
```

This sequence moves marker 2 to the maximum trace value, selects the delta marker mode with marker 2 as the reference marker, moves marker 1 to the maximum trace value, then outputs the difference between marker 2 and marker 1. Then the delta mode is turned off, and the markers are turned off.

To read marker values in dual-channel display modes, first select the channel, as follows:

```
OUTPUT Rec;"MARK1 3.5 GHz;"
OUTPUT Rec;"CHAN1; SING; AUTO; OUTPMARK;"
ENTER Rec_data;Mag,Phase
OUTPUT Rec;"CHAN2; SING; AUTO; OUTPMARK;"
ENTER Rec_data;Mag,Phase
```

The SING instruction (take single group of sweeps) or the NUMG instruction following channel selection, parameter change, or domain change, ensures that the trace has been updated and the data is ready to be read. After SING or NUMG the receiver is placed in the HOLD mode. It is generally best to select the hold mode for data output. Use the CONT (CONTINUAL) instruction to restart the sweep.

When the parameter selection is changed, it is necessary to take at least one group of sweeps to assure current data.

Note that if the system is in Hold mode, the parameter is changed, and raw data is not available, then the raw data array is initialized to the equivalent of measured data equal to 0,0 at every data point. If LOG MAG is selected, the marker magnitude value is approximately -857 dB. The raw data array and trace are updated at the completion of the next group of sweeps.

Example 5: Display Modes

Receiver display modes (single channel, dual channel and multiple parameter) are demonstrated in split and overlay display formats. Also, marker list functions 1 marker/ and 5 markers are shown with a four parameter display.

Example 6: Using =MARKER

Use of the = Marker ("EQUA;") function is demonstrated for reference value, stimulus settings, and offset values. This may be very useful when combined with marker searches.

Use of the (=MARKER) (EQUA;) function to position the trace on the display is shown in the following example.

```
OUTPUT Rec;"CHAN2; LOGM; MARK1; MARKMAXI; REFV; EQUA;"
```

This sequence selects channel 2, selects the LOG MAG display, moves the marker to the maximum point on the trace, then assigns the current marker value to the REF VALUE.

In all EQUA; applications, the current marker value becomes the value of the current active function. Valid functions for use with EQUA; are start, stop, center, span, reference value, electrical delay, phase offset, and the cutoff frequency for waveguide delay.

Example 7: Trace Data Output and Input

In this example, the receiver measures a single sweep, then outputs a 201 point Corrected Data array using FORM 3. After this, the array of real and imaginary pairs is written back to the receiver. Before writing the data, the receiver is put in Hold mode (this prevents the receiver from acquiring new data and over-writing the data being written by the program). The current data is first zeroed (by re-setting the number of points while in Hold mode). This forces the data array to be re-allocated and be initially loaded with zeros (-857 dB). Then the data is written.

Example 8: FORM 1 Data Conversion

After taking a single sweep, the receiver outputs the current data array using FORM 1 output format. This is the fastest form for data transfer. The FORM 1 data is then converted to real,imaginary pairs, which are then converted to linear magnitude, log magnitude and phase data.

Example 9: Using the Disc Drive

The first part of this example stores (to disc) and then loads (from disc) the instrument state, Formatted and Raw data arrays, display memory, and cal kit files. The file transfer can be done using the receiver's internal drive, or a compatible external drive connected to the receiver's System Bus. The program prompts the user to choose which drive to use (internal or external).

In the second part of the example program, the computer reads and displays the disc files (which were stored in part 1 of the program). This is done to show the CITIfile format. A disc drive must be connected *to the computer* during this part of the example program.

The receiver disc drive is very useful during large tests because it provides capacity to store instrument states, cal sets, calibration kits, trace data, and other types of data. Refer to the Disc menu in Chapter 15 for a complete list of data types. The menu maps in the keyword dictionary show all disc functions and HP-IB commands.

Using the Internal Disc

The following example shows how to store files using the built-in disc drive.

Store Instrument State 1 to a file named "IS_INST1"

```
OUTPUT Rec;"STOR; INSS1; DISF ""INST1"";"
```

Notice that you do not have to include the prefix (IS_). The receiver does this automatically.

Programming Examples

Load the receiver memory from the disc as follows:

```
OUTPUT Rec;"HOLD;"
OUTPUT Rec;"CHAN1; LOAD; DATAFORM; 2,9 DISF ""CHAN1"";"
OUTPUT Rec;"CHAN2; LOAD; DATAFORM; 3,10 DISF ""CHAN2"";"
```

The example above loads the Formatted Data files "FD_CHAN1" and "FD_CHAN2".

If HOLD is not programmed, the formatted data traces are overwritten by new data during the next sweep.

Note that in order to use DATAFORM, DATARAW, or DATADATA, the channel to which the data applies must be selected. When loaded, the trace is automatically updated. DATARAW stores information from the Raw data array for the Active Parameter on the Active Channel.

However, there is an exception to this rule: If four parameter display is turned on, DATARAW stores *all four* raw data arrays for the selected channel.

To load a memory trace, the memory display must be off (DISPDATA;). Correction must be off (CORROFF;) before cal sets can be loaded into receiver memory from disc.

Note that the DISF command is used for all disc operations (store, load, replace, delete). The file name must be enclosed in quotation marks, and BASIC usually requires that in order to send the quote symbol that it be doubled.

File Name Prefixes

If you examine the directory following this operation, notice that the file name is given as FD_FILE1. The three character filename prefix is automatically included in the directory listing: it is the way in which the receiver operating system keeps track of the data type. This filename prefix is never used in the filename you select for store, load, or delete disc file operations. However, if the disc is to be read by the external computer directly, the prefix is considered part of the filename and must be used. Table 15-3 shows all file name prefixes used by the receiver.

Printing Your Own Messages on the Receiver Display

Messages of up to 50 characters are displayed using

```
"TITL" "GOOD MORNING" ";"
```

This causes the message GOOD MORNING to appear in the Title area of the receiver display. (The quotation marks are required and BASIC usually requires that in order to send quotation marks, double marks must be used.)

Text and graphics information can be written to the display using a special area of receiver memory, using an internal HP-GL subset or the standard plotting language implemented by the computer.

Example 10: Plots Using Copy

This example requires an XY plotter be connected to the receiver (System Bus or RS-232 port) and be properly addressed. Refer to Chapter 16 for instructions. The program measures a single sweep with autoscaling, then plots each parameter.

Measurement results are output to a plotter connected to the receiver System Bus using a sequence of commands to specify the quadrant on the paper, the pen number, and the data to be plotted. The following sequence plots the four parameters.

```
INPUT "Load Paper, then CONTINUE"
OUTPUT Rec;"PARA1; SING; LEFU; PLOTALL"
OUTPUT Rec;"PARA2; SING; LEFL; PLOTALL"
```

```
OUTPUT Rec;"PARA3; SING; RIGU; PLOTALL"
OUTPUT Rec;"PARA4; SING: RIGL: PLOTALL"
```

PLOTALL causes the entire screen, except the Menu, to be plotted. Other commands to specify the part of the screen to be plotted and the pen color may be used.

Example 11: Trace List to Printer

This example requires a printer to be connected to the receiver (System Bus or RS-232 port) and be properly addressed. Refer to Chapter 16 for instructions. The program prints a tabular listing of the displayed trace. The data is printed in the displayed format (linear polar). A skip factor of 7 is used, so every seventh data point is printed.

The printer connected to the System Bus may be used in the same way as in manual operation.

Example 12: Print/Plot to Receiver System Bus (using

pass-through mode)

This example requires a properly installed printer and plotter connected to the receiver's System Bus. This example will not work with printers or plotters connected to the receiver's RS-232 ports. In this program example, the computer sends commands *through* the receiver to a printer and plotter connected to the receiver's System Bus (pass through mode). The computer sends a title to the printer, and a label to the plotter.

General Input/Output

The receiver can pass computer commands through to devices on the System Bus. In addition, the receiver can allow data to flow back from the device, direct to the computer.

Passing Commands Through the Receiver Devices on the System Bus

The receiver listens to commands sent to either of two addresses:

8530 Address The "8530 Address" (specified under **LOCAL ADDRESS of 8530**) is the address of the 8530 receiver itself. Any commands sent to this address will cause the HP 8530 to perform the function.

System Bus Address The "system bus" address (specified under **LOCAL SYSTEM BUS**) is the address of the System Bus. Commands sent to this address will be passed to a specified device on the System Bus.

How to send pass through commands. First, you must tell the receiver which device you want to access directly. To do this, send the command:

```
ADDRPASS nn
```

Where *nn* is the System Bus address of the desired device.

Note The default address for the System Bus "Pass Through" is 717. Most positioner controllers are set to this address. If you have a positioner controller, and it is set to address 717, either change the address of the positioner controller, or change the System Bus address:

Press **LOCAL SYSTEM BUS nn (x1)**, where *nn* is the desired address (for example, entering 21 will place the system bus at HP-IB address 721).

Why are some addresses three-digit numbers, while others are two-digit numbers?

Programming Examples

When you tell the computer to control an HP-IB device, you must use a three digit address. The first number (usually 7) selects the HP-IB bus, and is called the "HP-IB bus select code." The last two digits are the address of a specific instrument on the bus. For example, when you program the computer to send the "PLOP" command to address 705, the following happens:

1. The "7" tells the computer to select the HP-IB bus I/O card which is set to bus select code 7. (The HP-IB bus uses a "bus select code" because there can be more than one HP-IB bus in a computer system. The select code allows you to access multiple HP-IB busses independently.
2. The computer sends the command "PLOP", along with the two-digit instrument address number (05).
3. All instruments on the bus see the "PLOP" command. But only the device set to address 05 with accept the command and perform it.

(In this example, a plotter set to address 05 would perform the PLOP command, which plots a list of receiver operating parameter values.)

Devices on the receiver's System Bus only use a two-digit address. A "bus select code" is not needed because the receiver is designed with only one System Bus. When you enter the addresses of system bus devices (in the HP 8530A address menu), only two digits are required.

How pass through works. Assume for now that the System Bus address (under **LOCAL SYSTEM BUS**) is still set to 17. Also assume that you have selected a printer of the System Bus with the ADDRPASS 01; command.

Under these conditions, the receiver will accept any command sent to address 717. When such a command is received, the analyzer passes it to the system bus, to the device at address 01. Refer to Figure 18-2.

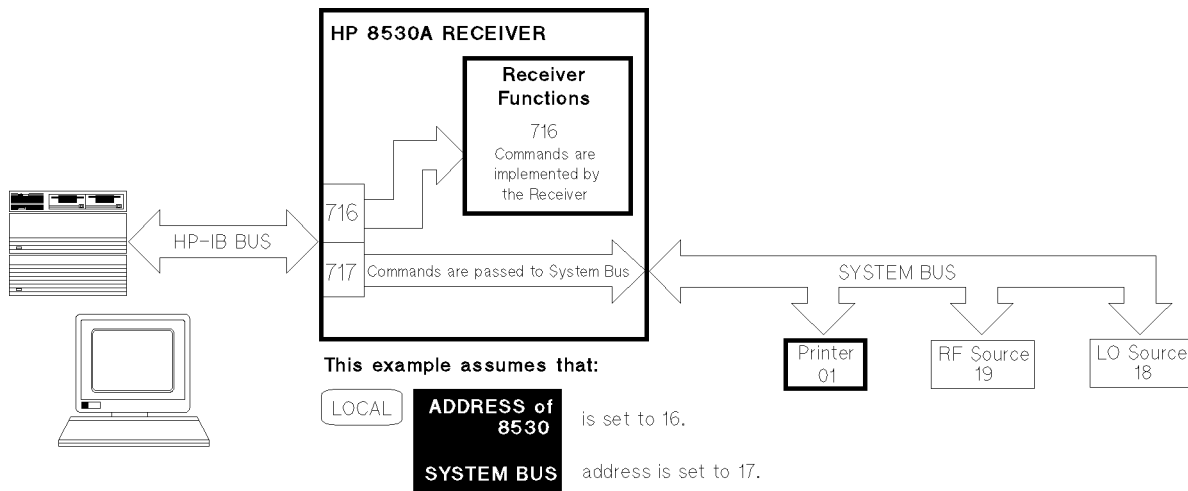

Figure 18-2. Pass Through Flow

Here is an example program:

```
OUTPUT Rec;"ADDRPASS 01;" ! Select address 01 for pass through commands
OUTPUT Rec_systbus; CHR"12" ! Send a form feed command to the printer
```

Remember, "Rec_systbus;" and "Rec_systbusdata" represent the address of the system bus. You must set this up using a statement such as:

```
"ASSIGN @Rec_systbus TO 717"
```

If the device is to output ASCII data, use:

```
ENTER Rec_systbusdata; String$
```

Where String\$ is dimensioned to accept the ASCII string sent from the device. Note that if the device on the System Bus does not terminate its output with the CR/LF, then it is the responsibility of the programmer to terminate the ENTER operation.

The specified pass-thru address remains in effect until changed by the programmer. Instructions and data may be sent to the receiver HP-IB address or to the receiver System Bus address in any sequence. When the receiver System Bus is addressed, an automatic System Bus 'Local' is issued which halts all System Bus activity and places the receiver in Hold. When the receiver HP-IB is addressed following a pass thru, an automatic System Bus 'Remote' is issued which returns control of the System Bus to the receiver.

The addressed device cannot handshake to the computer or respond to HP-IB Universal or Addressed commands via the System Bus.

Pass-Thru of Text to a Printer

You may print directly to the printer using the Pass-Thru mode as follows.

```
OUTPUT Rec;"ADDRPASS 01;" ! Printer's System Bus address is 01
PRINTER IS 717 ! (Rec_systbus)
PRINT "MEASUREMENT NUMBER 1"
```

This example begins with the receiver instruction ADDRPASS 01 that sets the state in which data addressed to 717 (the 8530 System Bus address) is passed-thru to the device at address 01 on the 8530 System Bus. Next, a computer-specific command, HP 9000 Series 200/300 in this example, specifies the hardcopy device as the printer at address 717. Finally, the computer-specific hardcopy output statement outputs the message. The string is accepted at the receiver System Bus address 717 and passed-thru to the printer.

Output to Plotter

It is generally not recommended that HP-GL commands be passed through directly to the plotter on the receiver System Bus because the typical drivers used for this purpose require communication with the computer during the operation, a capability not handled by receiver Pass-Thru. You can, however, plot graphics and text to the receiver User display as described later in this section, then plot the receiver display to the plotter. Examples of printing or plotting using pass-thru are given in the paragraphs describing user display graphics later in this chapter.

User Display Graphics

Example 13: Plot User Graphics HP-GL

User Display functions are demonstrated by using HP-GL commands to draw a series of boxes. The boxes have labels that correspond to areas of the measurement display, which are used by various display formats. The User Display is then:

- Stored to the internal disc.
- Erased
- Reloaded from the disc.

Programming Examples

Example 14: Plot to User Display Using BASIC HP-GL

This example draws a simple graphic on the receiver User display using HP BASIC graphics instructions. Optionally the graphic may be sent to a plotter on the receiver system bus.

Vector diagrams and Text can be written to a reserved area of the receiver display memory via the receiver System Bus using either an HP-GL subset internal to the receiver, or the standard computer language graphics commands. This reserved graphics area is output using PLOTALL; and may be recorded and subsequently reloaded into user display memory using the Disc command USED;.

Vector Diagrams

A vector diagram consists of a PA, Plot Absolute, display instruction followed by any number of x,y integer pairs.

```
OUTPUT Rec;"ADDRPASS 31"  
OUTPUT Rec_sysbus;"CS; PU"  
OUTPUT Rec_sysbus;"PA 128,384; PD; PA 3328,384, 3328,3584,  
128,3584 128,384"
```

ADDRPASS 31 sets up the Pass-Thru mode in which data sent to the 8530 System Bus address, 717, is routed to the User Display area of the receiver display memory. The CS instruction clears the screen. The PU instruction lifts the pen, causing the following PA instruction to draw a blank vector. The PD, Pen Down, causes the following PA instruction to draw a visible line. The PA, Plot Absolute, instruction is followed by the coordinates for the other three corners of the box.

The plotting area of the receiver display is:

x = 0 to 5377, y = 0 to 4095

Figure 18-3 shows internal scaling for PA vector diagrams.

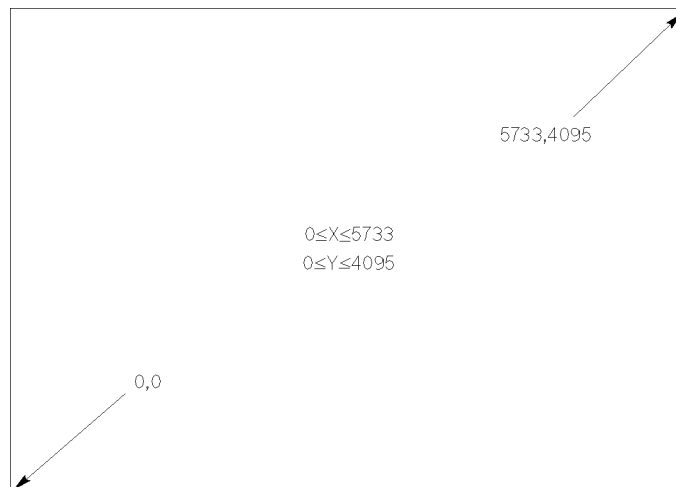

Figure 18-3. PA Vector Scaling

The PR, Plot Relative, instruction moves the pen from its present position to the new position x,y units away.

```
OUTPUT Rec;"ADDRPASS 31"  
OUTPUT Rec_sysbus;"CS; PU"  
OUTPUT Rec_sysbus;"PA 128,384; PD; PR 3200,0, 0,3200,
```

-3200,0, 0,-3200"

This outlines the Menu labels area.

Text

Position standard ASCII text on the screen by addressing the text location with a PA or PR vector. Text between the LB mnemonic and the end of text character, CTRL C, is displayed beginning at the character cell position of the current vector. Figure 18-4 shows the 64 by 128 element character cell which encloses the 48 by 64 element character image area. The LB command is shown in the "PLOT TO PLOTTER ON 8510 SYSTEM BUS" example in the Program Examples section (at the end of this chapter).

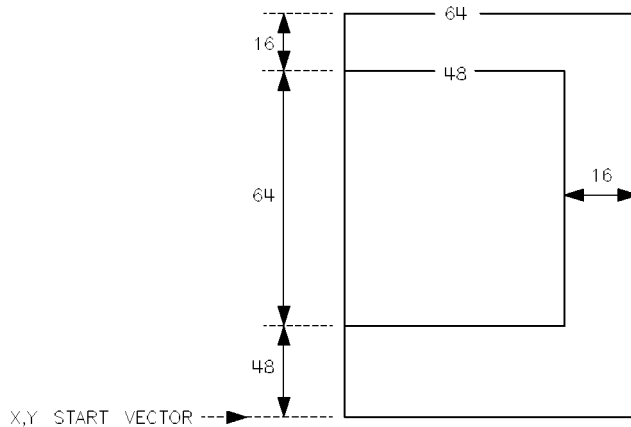

Figure 18-4. Text Character Cell

Select Pen Colors

The color selected for the current operation is specified using the SPn; command, where n = 1 to 16. The color is assigned to the pen in the same order as the colors appear in the set pen numbers menu under the define plot menu of the (COPY) hardkey.

Using the Internal Disc to Store the User Display

By storing the User Display on the receiver disc drive, the vector diagrams and text can be recalled for display even if the computer is disconnected from the receiver. For example:

```
OUTPUT Rec;"STOR; USED; DISF ""USER1"";"
```

This stores the vector and text data presently in user display memory in User Display File 1.

The User Display graphics may be loaded from tape using:

```
OUTPUT Rec;"LOAD; USED; DISF ""USER1"";"
```

This erases the current User Display, then loads and displays the previously stored graphics and text.

Summary of User Graphics Statements

The following statements are used to control plotting of vectors and text into the receiver User Display area of internal memory.

PA x1,y1 Plot Absolute vector. Move the pen from the current location to the location specified by the following x,y pair. Any number of x,y pairs may

Programming Examples

	follow the PA instruction; each number must be separated from the previous number by a comma. $0 \leq x \leq 5377$; $0 \leq y \leq 4095$.
PR	x1,y1 Plot Relative vector. Move the pen from the current location to the relative position specified by the following x,y pair. Any number of x,y pairs may follow the PR instruction; each number must be separated from the previous number by a comma. $0 \leq x \leq 5377$; $0 \leq y \leq 4095$.
PD	Pen Down. When followed by a PA or PR instruction, this instruction will cause a visible vector to be drawn to the new location.
PU	Pen Up. When followed by a PA or PR instruction, this instruction will cause a blank vector to be drawn to the new location.
LB	ASCII character Label Text. The ASCII characters following the LB command are drawn on the display beginning in the character cell at the current vector position. The string must be terminated with the end-of-text character, CNTRL C.
DF	Set to Default state (PU, PA).
SPn	Select Pen (Color), 1 to 5 in the same sequence as shown in the set pen number menu (see COPY).

Summary of User Display Instructions

The following instructions control whether the standard measurement display (graticule, labels, etc.) and the User Display are on or off.

KP	Turn off User Display. Memory contents are not changed.
RP	Turn on User Display. Memory contents are not changed.
PG	Clear (Erase) User Display Memory.
CS	Turn off measurement display (standard graticule, trace, and labels). User display is not affected.
RS	Turn on measurement display. User display is not changed.

Example 15: Redefine Parameter

This example demonstrates the receiver's ability to redefine a parameter's numerator and denominator. The first part defines all four parameters the same, and then uses a four parameter display to show the defined parameter in four different formats. This set-up is saved in Instrument State 5 and may be recalled manually by the user. Next, after a User Preset, data from the sum and difference outputs of a typical monopulse antenna is loaded into Parameters 1 and 2. These parameters are then re-labeled, the display is titled and presented using a two parameter overlay display. This set-up is saved in Instrument State 6.

Example 16: Read and Output Caution/Tell Message

This example prints the number and message of any error or warning shown on the receiver display. The user is first prompted to "Adjust" the receiver to force an error to be displayed. To get an error message, perform any of the following:

- Press the **Marker** key with no function active.
- Perform a disc directory (press **DISC DIRECTORY**) without a disc in the drive.
- Turn Calibration ON, but select an empty cal register.

Example 17: Read and Output Status Bytes

This program example displays the decimal value of the primary and extended status bytes. The user is prompted to “Adjust” the receiver and then the status is read and displayed. Try pressing a front panel key or taking a single sweep.

The tables below show bit assignments of the receiver Primary and Secondary status bytes. These bits are set according to the current instrument state of the receiver system.

Important receiver instructions relating to the status word are:

- OUTPSTAT; Prepare the receiver to output the status word as two ASCII numbers, 0 to 255. Completion clears the status word to 0,0.
- CLES; Clear status bytes to 0,0; clear SRQ.
- SRQM a,b; Send two integer ASCII values, 0 to 255 to set the Service Request Mask. Power On, TEST, and PRESET clear the Service Request Mask to 0,0.

Read Status Bytes

Both status bytes are read using a sequence such as:

```
OUTPUT Rec;"OUTPSTAT;"
ENTER Rec_data; Primary,Secondary
```

Where Primary and Secondary are variables to receive the value of each byte. You may read the status bytes in separate ENTER operations.

After the Power Up sequence is complete, bit 2 of the Extended status byte is set, making the value of OUTPSTAT 0,4.

PRIMARY STATUS BYTE (#1)								
BIT #	7	6	5	4	3	2	1	0
Decimal Value	128	64	32	16	8	4	2	1
Function	Reason in Extended byte	RQS (SRQ issued)	Syntax error	SING, NUMB, CALF, complete	Waiting for GET after reverse device	TRIG waiting for GET FASC; issued ready for external trigger	Data entry complete	CAUTION message displayed

EXTENDED STATUS BYTE (#2)								
BIT #	7	6	5	4	3	2	1	0
Decimal Value	128	64	32	16	8	4	2	1
Function	Not used	Not used	Not used	Not used	Not used	Power ON sequence complete	Key pressed	Not used

Programming Examples

Setting the Service Request Mask

After Power ON, TEST, and Factory Preset, the receiver SRQ mask is set to 0,0 and no changes in the Primary or Secondary status byte will generate an SRQ. To enable generation of an SRQ when one or more of the status bits changes from 0 to 1 (changes from cleared to set), specify the SRQ mask to sense the change in status. Using the receiver SRQM instruction, send two bytes, each having a value from 0 to 255, as follows:

```
OUTPUT Rec; "SRQM 16,0;"
```

This will cause the receiver to generate an SRQ when bit 4 of the Primary Status byte changes from 0 to 1.

Detect and service the SRQ according to the computer protocol. Normal completion of a service cycle clears the receiver status bytes to 0,0 and does not change the SRQ mask.

Examples in the Example Program Listings show various interrupt service routines.

Example 18: Output Key Code

The key code (as documented in the Keyword Dictionary) is printed for any receiver front panel key pressed by the user. The receiver is set to issue a SRQ when a key press occurs.

Example 19: HP-IB Triggered Data Acquisition

In this example, HP-IB triggers are used to measure 51 points of data for four parameters. This is done twice with different trigger definitions. The first sweep measures one point on all four parameters with each trigger (51 triggers). The second sweep requires a trigger for each point on each parameter (204 triggers). When HP-IB trigger mode is first turned ON, and before sending each trigger, primary status byte bit 2 (ready for trigger) is polled so triggers are not sent too fast.

Example 20: Wait Required

This example creates a continuously changing display pattern using an endless loop to update the values for Electrical Delay and Parameter Color. The main feature of this example is the "WAIT;" command that is sent to the receiver. This forces the display to update each time the loop is executed. Without the WAIT command the loop might execute several times before the display updates and certain changes would be missed. Refer to the *HP 8530A Keyword Dictionary* entry for WAIT.

Example 21: Wait Not Required.

This example executes an endless loop which steps a marker to a new frequency and then reads the marker frequency, magnitude, and phase. The OUTPxxxx; commands used to read the marker value automatically hold off further program execution and ensure that the receiver has completed all prior instructions before the marker value is output. It is *not* necessary to send the receiver a WAIT; before reading the marker.

Example 22: Frequency List

This example shows how to define, manipulate, and read frequency list data. First, a three-segment frequency list is defined and activated. Next, the list and the trace data for Parameter 1 is output to the computer. Then, single segments (selected by the user) are swept, the receiver leaves, then re-enters, the Frequency List mode.

Example 23: Using the Receiver's Learn String

This example program performs a User Preset, then prompts the user to change the current instrument state as desired. The learn string is then read out which includes the changes made by the user. Another User Preset is done and then the Learn String is loaded into the receiver. The receiver restores the modified instrument state.

The receiver Learn String is a binary coded string which describes the current instrument state. This string may be read from the receiver to computer memory via the HP-IB, then it may be loaded back into receiver memory in order to reset the system to the state represented by the string. This learn string is transferred using internal receiver binary format (FORM 1), and it is not intended that the user attempt to decode or modify the string. Please note that each firmware revision may create learn strings of greater or smaller size (compared to learn strings created by other firmware revisions). Thus, learn strings created by one firmware version may not be compatible with earlier or later firmware revisions.

The following commands control transfer of the string.

OUTPLEAS; Output Learn String to HP-IB.

INPULEAS; Input Learn String from HP-IB; Set the receiver controls to that state.

The contents of the learn string is identical to the information processed by the SAVE and RECALL features for receiver internal storage, and the DISC Store and Load Instrument State functions for the receiver disc drive.

The following example shows a sequence to transfer the learn string. The learn string is 4390 bytes in length and can be read into an integer type array of length 2195.

```
DIM Integer Learn_string (4000)
OUTPUT Rec;"OUTPLEAS;"
ENTER Rec_data;Preamble, Size
REDIM Learn_string (1:Size/2)
ENTER Rec;Learn_string (*)

.
.
OUTPUT Rec;"INPULEAS;"
OUTPUT Rec;Preamble, Size, Learn_string (*)
```

OUTPLEAS; and INPULEAS; select FORM1 data format transfers. The data is transferred in a sequence beginning with the Preamble, #A; an integer size, that tells the number of bytes to follow, followed by the receiver internal binary format data which represents the control state of the receiver, with EOI asserted on the last byte.

Programming Examples

Example 24: Input Floating Point or ASCII Trace Data

This example writes trace data to the receiver in either Floating Point (FORM 3) or ASCII (FORM 4) formats. The data array is continuously re-written to the display with an offset added each time. *Note the difference in speed between the two data formats.*

Example 25: Table Delay Operations

This example demonstrates how to input, output and apply Table Delay. The Delay Table is also stored and loaded using the receiver internal disc.

Example 26: FAST (CW,AD,D) Data Acquisition

Fast CW setup and operation is demonstrated using an external trigger source. Once the data is collected, it is converted from FORM 1 to real, imaginary data pairs. See Chapter 8, Automatic Measurements, in the *HP 8530A Microwave Receiver User's Guide* for more information on the fast CW mode.

Example 27: Fast IF Multiplexing Operation

This example has been written as a stand-alone program which sets-up a fast IF multiplexing mode measurement of two parameters (using FASMUXMODE 2;) and then measures and transfers the data to the controller. The measurement and transfer will continue until the user exits the program or until the 100k buffer overflows. See Chapter 8, Automatic Measurements, in the *HP 8530A Microwave Receiver User's Guide* for more information on the fast CW mode.

General HP-IB Programming

After the HP-IB REMOTE command is issued, addressing the receiver using an appropriate OUTPUT statement causes the receiver to enter the Remote mode in which the front panel hardkeys and softkeys are locked out. The only key that is not locked out is the **LOCAL** key. After the initial OUTPUT statement, either ENTER or OUTPUT statements are accepted.

Press the **LOCAL** key to restore front panel control functions until the next OUTPUT command is received. Program the Local Lockout command, LLO, to lock out the front panel completely, even the **LOCAL** key. Issue the HP-IB LOCAL command to cancel Local Lockout, then issue a REN command to return the receiver to remote command.

If the receiver is already addressed as a listener, a GTL 716 (LOCAL 716) sets the receiver system to the normal manual mode without changing the current instrument state.

All HP-IB Universal and Addressed Commands and the receiver system response to the commands are listed below. computer-specific and language considerations are discussed in the "Example Program Listings" later in this chapter.

Interface Functions

The following identification codes for the interface functions indicate the receiver HP-IB interface capability. For more information, refer to the *Tutorial Description of the HP-IB*, HP Part No 5952-0156.

SH1	Source Handshake: Full Capability.
AH1	Acceptor Handshake: Full Capability.
T6	Talker: Basic Talker, Serial Poll.
TE0	No Extended Talker.
L4	Listener: Basic Listener.
LE0	No Extended Listener.
SR1	Service Request: Full Capability.
RL1	Remote/Local: Complete Capability.
PP0	No Parallel Poll Capability.
DC1	Device Clear: Full Capability.
DT1	No Device Trigger Capability.
C0	No computer Capability.
E1	Driver Electronic: Tri-State Drive.

Response to HP-IB Universal Commands

The receiver HP-IB responds to the following universal commands from an external computer at any time, regardless of whether or not it is addressed. Refer to the language reference manual of the computer being used to find the corresponding commands allowed by the computer.

DCL	Device Clear: Clears receiver status, no change in instrument state, system is ready to accept HP-IB commands and data.
LLO	Local Lockout: Disables the HP-IB front panel LOCAL key. GTL to clear.
SPD	Serial Poll Disable: Disables the Serial Poll mode over the receiver HP-IB.
SPE	Serial Poll Enable: Enables the Serial Poll mode over the receiver HP-IB.
PPU	Parallel Poll Unconfigure: The receiver system does not respond.

Response to HP-IB Addressed Commands

The receiver HP-IB responds to the following addressed commands when it is addressed as a listener. Refer to the language reference manual of the computer being used to find the corresponding commands allowed by the computer.

GET	Group Execute Trigger: The receiver system, already in the triggered data acquisition mode, initiates the pre-programmed action of continuing the data acquisition process.
GTL	Go To Local: Returns the receiver system to local control. Following GTL, the receiver HP-IB will respond only to HP-IB Universal and Addressed Commands, not to HP-IB data. Issue REN to enable data transfer using computer OUTPUT and ENTER commands.

Programming Examples

REN Remote Enable. Enable all HP-IB command and data functions.
SDC Selected Device Clear: Clears receiver status, no change to instrument state,
 system is ready to accept instructions and data.

The receiver system does not respond to the following Addressed Commands.

PPC Parallel Poll Configure.
TCT Take Control.

Example Program Listing

The following pages contain the program listing for the HP BASIC examples program. The program itself is supplied on the *HP 8530A Software Toolkit Disc*, supplied with the receiver. The name of the program is: 8530_PROGX

The program requires BASIC 5.0 or higher with the following binaries: IO, MAT, TRANS, and COMPLEX.

The program contains many example routines, which show how to perform various programming tasks. The program requires BASIC 5.0 or higher with the following binaries: IO, MAT, TRANS, and COMPLEX.

The disc also contains three measurement data files that are accessed by some of the programming example routines.

ANG360

ANG180_SUM

ANG180_DEL

These are data files containing angle domain measurement data.

The following examples are provided in the program:

- 1 Input Syntax Familiarization
- 2 Active Function Output
- 3 Marker Data Output
- 4 Marker Operations
- 5 Display Modes
- 6 Using = Marker
- 7 Trace Data Output and Input
- 8 FORM 1 Data Conversion
- 9 Using Disc
- 10 Plots Using Copy
- 11 Trace List to Printer
- 12 Print/Plot to Receiver System Bus (using pass-through mode)
- 13 Plot User Graphics HP-GL
- 14 Plot to User Display Using BASIC HP-GL
- 15 Redefine Parameter
- 16 Read and Output Caution/Tell Message
- 17 Read and Output Status Bytes
- 18 Output Key Code
- 19 HP-IB Triggered Data Acquisition
- 20 Wait Required
- 21 Wait Not Required.
- 22 Frequency List
- 23 Learn String
- 24 Input Floating Point (FORM3) or ASCII (FORM4) Trace Data
- 25 Table Delay Operations
- 26 FAST (CW,AD,D) Data Acquisition
- 27 Fast IF Multiplexing Operation

Programming Examples

```
1!           RE-SAVE "8530_PROGX"
3   !           HP8530A.01.40   June 8, 1992
5   !           Rev. A.01.00
7   !
9   ! Copyright @ HEWLETT-PACKARD COMPANY 1992
11  !
13  ! Requires BASIC 5.0 or higher with:
15  !   IO, MAT, TRANS, COMPLEX
17  !
19  ! Used with 201 Point Trace I/O
21  OPTION BASE 0
23  DIM Data(200,1),Formatted_data(200,1)
25  !
27  ! Used with 360 & 181 point angle domain antenna data
29  DIM Ant_data(360,1),Ant_sum(180,1),Ant_del(180,1)
31  !
33  INTEGER Form1_data(1:801,2)  ! Example 8 & 26
35  !
37  INTEGER Learn_string(1:4000)          ! Learn String
39  DIM Input$(200),Input2$(50)
41  INTEGER Length,Error_number,Bytea,Byteb,Points,Segment
43  INTEGER Preamble,Size,Size_list,Mem,Trigs,I,C
45  !
47  DIM Filename$(30),Current_line$(256),Response$(30)
49  !
51  REAL Freq,Real,Imag,Mag,Phase,Exponent
53  !
55  REAL Freq_list(200),Log_mag,Lin_mag
57  !
59  DIM Data_ascii$(200,1)[24]           ! Example 24
61  !
63  ASSIGN @Rec TO 716                   ! Receiver HP-IB address
65  !
67  ! Read ASCII Data to/from HP 8530 HP-IB (OUTPMARK, OUTPACTI, FORM4 I/O)
69  !                                     (OUTPERRO, OUTPSTAT)
71  ASSIGN @Rec_data1 TO 716;FORMAT ON
73  !
75  ! Read non-ASCII Data to/from HP 8530 HP-IB (FORM1, FORM2, and FORM3 I/O)
77  ASSIGN @Rec_data2 TO 716;FORMAT OFF
79  !
81  ! Write to 8530 System Bus
83  ASSIGN @Rec_systbus TO 717
85  !
87  ! Read from HP 8530 System Bus
89  ASSIGN @Rec_systbusdata TO 717;FORMAT ON
91  !
93  Begin:  !
95  REMOTE 7
97  CLEAR 716
99  PRINTER IS 1
101 CONTROL KBD,2;1 ! activate user softkeys
103 GOSUB Load_ant_arrays ! loads antenna data arrays for use later
105 PRINT
107 !
109 PRINT "**** NOTE: User Preset (Instrument State 8) must be saved with an operating,"
111 PRINT "           sweeping, frequency domain state for your system."
113 PRINT
115 PRINT "           Save Instrument State 8 Now If Necessary."
117 LOCAL @Rec
119 LINPUT "Press RETURN",Input$
121 CLEAR SCREEN
```

Programming Examples

```
123 OUTPUT @Rec;"USERPRES;"          ! Make sure that receiver User Presets
125                                     ! to an operating state.
127 !
129 OUTPUT @Rec;"DEBUON; ENT0;"
131 OUTPUT @Rec;"OUTPERRO;"
133 ENTER @Rec_data1;Error_number     ! Clear Message
135 !
137 ! *****
139 ! Edit the following two lines to run a single selected example.
141 ! GOSUB Examplex
143 ! STOP
145 ! *****
147 !
149 LINPUT "Example 1, Input Syntax Familiarization",Input$
151 GOSUB Example1
153 !
155 LINPUT "Example 2, Active Function Output: Press Return",Input$
157 GOSUB Example2
159 !
161 LINPUT "Example 3, Marker Data Output: Press Return",Input$
163 GOSUB Example3
165 !
167 LINPUT "Example 4, Marker Operations: Press Return",Input$
169 GOSUB Example4
171 !
173 LINPUT "Example 5, Single & Dual Displays: Press Return",Input$
175 GOSUB Example5
177 !
179 LINPUT "Example 6, Using =MARKER: Press Return",Input$
181 GOSUB Example6
183 !
185 LINPUT "Example 7, Trace Data Output / Input: Press Return",Input$
187 GOSUB Example7
189 !
191 LINPUT "Example 8, Form1 Data Conversion: Press Return",Input$
193 GOSUB Example8
195 !
197 !
199 LINPUT "Example 9, Using Disc: Press Return",Input$!
201 GOSUB Example9
203 !
205 LINPUT "Example 10, Plots Using Copy: Press Return",Input$
207 GOSUB Example10
209 !
211 LINPUT "Example 11, List Trace Values: Press Return",Input$
213 GOSUB Example11
215 !
217 LINPUT "Example 12, Print / Plot to 8530 System Bus: Press Return",Input$
219 GOSUB Example12
221 !
223 LINPUT "Example 13, Plot User Graphics: Press Return",Input$
225 GOSUB Example13
227 !
229 LINPUT "Example 14, Plot Using BASIC HPGL: Press Return",Input$
231 GOSUB Example14
233 !
235 LINPUT "Example 15, Redefine Parameter: Press Return",Input$
237 GOSUB Example15
239 !
241 LINPUT "Example 16, Read and Output Caution/Tell Message: Press Return",Input$
243 GOSUB Example16
245 !
```

Programming Examples

```
247 LINPUT "Example 17, Read and Output Status Bytes: Press Return",Input$
249 GOSUB Example17
251 !
253 LINPUT "Example 18, Output Key Code: Press Return",Input$
255 GOSUB Example18
257 !
259 LINPUT "Example 19, HPIB Triggered Data Acquisition: Press Return",Input$
261 GOSUB Example19
263 !
265 LINPUT "Example 20, WAIT Required: Press Return",Input$
267 GOSUB Example20
269 !
271 LINPUT "Example 21, WAIT Not Required: Press Return",Input$
273 GOSUB Example21
275 !
277 LINPUT "Example 22, Frequency List: Press Return",Input$
279 GOSUB Example22
281 !
283 LINPUT "Example 23, Learn String: Press Return",Input$
285 GOSUB Example23
287 !
289 LINPUT "Example 24, Input Floating Point or ASCII Data: Press Return",Input$
291 GOSUB Example24
293 !
295 LINPUT "Example 25, Delay Table Operations: Press Return",Input$
297 GOSUB Example25
299 !
301 LINPUT "Example 26, FASTCW Data Acquisition: Press Return",Input$
303 GOSUB Example26
305 !
307 LINPUT "Example 27, Fast Mux Operation: Press Return",Input$
309 CALL Fast_mux ! Fast_Mux Operation is a stand alone sub-program
311 !
313 DISP "END OF EXAMPLES"
315 !
317 STOP
319 !
321 ! *****
323 !
325 Example1: ! INPUT SYNTAX FAMILIARIZATION *****
327 PRINT
329 PRINT "Example 1, Input Syntax Familiarization"
331 !
333 LOCAL @Rec
335 LINPUT "TYPE 8530 INSTRUCTION, THEN RETURN; ENTER 0 TO EXIT",Input$
337 IF Input$[1,1]="0" THEN
339 PRINT
341 GOTO Query
343 END IF
345 OUTPUT @Rec;Input$;";"
347 PRINT Input$,
349 IF BIT(SPOLL(@Rec),5) THEN ! Check for syntax error
351 GOSUB Syntax_error ! Clear error
353 END IF
355 GOTO Example1
357 !
359 Query: !
361 LOCAL @Rec
363 LINPUT "TYPE 8530 QUERY OR OUTPUT INSTRUCTION, THEN RETURN; ENTER 0 TO EXIT",Input$
365 IF Input$[1,1]="0" THEN
367 OUTPUT @Rec;"OUTPERRO;"
```

Programming Examples

```
369     ENTER @Rec_data1;Error_number    ! Clear Message
371     RETURN
373 END IF
375 PRINT Input$,
377 OUTPUT @Rec;Input$;";"
379 IF BIT(SPOLL(@Rec),5) THEN    ! Check for syntax error
381     GOSUB Syntax_error    ! Clear error
383     PRINT
385 ELSE
387     ENTER @Rec_data1;Input$
389     PRINT Input$
391 END IF
393 GOTO Query
395 !
397 Syntax_error:    !
399 PRINT "<< Syntax Error",
401 CLEAR @Rec
403 OUTPUT @Rec;"CLES; OUTPERRO;"
405 ENTER @Rec;Error_number    ! Clear Message
407 RETURN
409 !
411 Example2:    ! ACTIVE FUNCTION OUTPUT *****
413 PRINT
415 PRINT "Example 2, Active Function Value."
417 !
419 OUTPUT @Rec;"USERPRES; LOGM;"
421 !
423 OUTPUT @Rec;"STAR; OUTPACTI;"
425 ENTER @Rec_data1;Value
427 PRINT "Start Frequency =";Value/1.E+6;" Mhz"
429 !
431 OUTPUT @Rec;"STOP; OUTPACTI;"
433 ENTER @Rec_data1;Value
435 PRINT " Stop Frequency =";Value/1.E+6;" Mhz"
437 !
439 OUTPUT @Rec;"POWE; OUTPACTI;"
441 ENTER @Rec_data1;Value
443 PRINT " Power Source 1 =";PROUND(Value,-2);" dbm"
445 !
447 OUTPUT @Rec;"SCAL; OUTPACTI;"
449 ENTER @Rec_data1;Value
451 PRINT "      Scale =";PROUND(Value,-2);" db/"
453 !
455 OUTPUT @Rec;"REFV; OUTPACTI;"
457 ENTER @Rec_data1;Value
459 PRINT " Refrence Value =";PROUND(Value,-2);" db"
461 !
463 OUTPUT @Rec;"MAGO; OUTPACTI;"
465 ENTER @Rec_data1;Value
467 PRINT "Magnitude Offset=";Value;" db"
469 !
471 OUTPUT @Rec;"MAGS; OUTPACTI;"
473 ENTER @Rec_data1;Value
475 PRINT "Magnitude Slope =";Value;" db/Ghz"
477 !
479 OUTPUT @Rec;"ENTO;"
481 !
483 RETURN
485 !
```

Programming Examples

```
487 Example3: ! MARKER DATA OUTPUT *****
489 !
491 PRINT
493 PRINT "Example 3, Marker Data Output"
495 PRINT "Averaging On With a Avg Factor of 4."
497 OUTPUT @Rec;"AVERON 4; MENUFORM;"
499 PRINT "Automatic Holdoff For Single or Number of Groups"
501 PRINT
503 !
505 Again_3: !
507 LOCAL @Rec
509 LINPUT "Set 8530 to desired Format and Domain or E to Exit",Input$
511 IF UPC$(Input$)="E" THEN
513     OUTPUT @Rec;"AVEROFF; FREQ; CONT;"
515     RETURN
517 END IF
519 !
521 OUTPUT @Rec;"HOLD; POIN51;" ! Zero Raw Data
523 !
525 OUTPUT @Rec;"SING;" ! 8530 automatically waits untill SING completes
527 ! before executing further instructions
529 !
531 OUTPUT @Rec;"AUTO; MARK1; MARKMAXI; OUTPMARK;"
533 ENTER @Rec_data1;Mag,Phase ! Read Marker Value, Phase data not used
535 !
537 OUTPUT @Rec;"FORM?;" ! Query Display Format
539 ENTER @Rec_data1;Input$
541 !
543 PRINT "Marker ";
545 SELECT Input$[2;3]
547 CASE "LOG","POL"
549     PRINT "      Mag db = ";
551 CASE "PHA"
553     PRINT "Phase Degrees = ";
555 CASE "SWR"
557     PRINT "      SWR = ";
559 CASE ELSE
561     PRINT "      Mag Units = ";
563 END SELECT
565 PRINT Mag;
567 !
569 OUTPUT @Rec;"OUTPACTI;"
571 ENTER @Rec_data1;Value
573 !
575 OUTPUT @Rec;"DOMA?;" ! Query Domain
577 ENTER @Rec_data1;Input$
579 SELECT Input$[2;4]
581 CASE "FREQ"
583     PRINT " @";Value/1.E+6;" Mhz"
585 CASE "ANGL"
587     PRINT " @";Value;" Degrees"
589 CASE ="TIME"
591     PRINT " @";Value*1.E+9;" nano Seconds"
593 END SELECT
595 GOTO Again_3
597 !
599 Example4: ! MARKER OPERATIONS *****
601 !
603 PRINT
605 PRINT "Example 4, Marker Operations"
607 PRINT "Peak-to-Peak Measurement."
609 OUTPUT @Rec;"USERPRES; ENTO; SING; AUTO; MKRLISTON;"
611 OUTPUT @Rec;"MARK2; MARKMAXI; DELR2; MARK1; MARKMINI; OUTPMARK;"
613 ENTER @Rec_data1;Mag,Phase
```

Programming Examples

```

615 !
617 OUTPUT @Rec;"OUTPACTI;"
619 ENTER @Rec_data1;Freq
621 !
623 PRINT "P-P Mag = ";Mag;" P-P Freq = ";Freq
625 !
627 OUTPUT @Rec;"MKRLISTON;"
629 LINPUT "Press Return",Input$
631 !
633 OUTPUT @Rec;"DELO; MARKOFF; CONT;"
635 Example4a: ! FIND -3 dB BEAMWIDTH *****
637 !
639 PRINT "-3 dB Beamwidth Measurement."
641 !
643 GOSUB Draw_360
645 OUTPUT @Rec;"LOGP; MARK1; MKRLISTON; MARKMAXI;"
647 LINPUT "Press Return To Normalize Pattern To 0 db.",Input$
649 OUTPUT @Rec;"NORMACTT;"
651 OUTPUT @Rec;"TARV -3; MARKTARG; MARK2; SEAR; DELR1; OUTPACTI;"
653 ENTER @Rec_data1;Bwidth
655 PRINT "Main Lobe -3 db Beamwidth = ";Bwidth;" Degrees"
657 OUTPUT @Rec;"MKRLISTON;"
659 !
661 LINPUT "Press Return",Input$
663 OUTPUT @Rec;"DELO; MARKOFF;"
665 !
667 Example4b: ! MARKER SEARCHES *****
669 !
671 ! Search limits in degrees
673 Low_limit=-90
675 High_limit=90
677 !
679 PRINT "Lobe Peak Search ";Low_limit;" to ";High_limit;" degrees"
681 OUTPUT @Rec;"MARK1; MKRLISTON; MARKMAXI;"
683 GOSUB Read_mark
685 PRINT "Main Lobe Is ";PROUND(Mag,-3);" db @ ";Angle;" Degrees"
687 D$="Left"
689 I=1
691 LOOP
693 Prior_angle=Angle
695 IF D$="Left" THEN
697 OUTPUT @Rec;"SEAL;"
699 ELSE
701 OUTPUT @Rec;"SEAR;"
703 END IF
705 GOSUB Read_mark
707 EXIT IF Angle>=High_limit
709 IF Angle<=Low_limit THEN
711 OUTPUT @Rec;"MARKMAXI;"
713 D$="Right"
715 I=-1
717 ELSE
719 IF Angle+I<>Prior_angle THEN ! Check for adjacent points
721 PRINT D$;" Side Lobe Is ";PROUND(Mag,-3);" db @ ";Angle;" Degrees"
723 END IF
725 END IF
727 END LOOP
729 RETURN
731 !
733 Read_mark: !
735 OUTPUT @Rec;"OUTPMARK;"
737 ENTER @Rec_data1;Mag
739 OUTPUT @Rec;"OUTPACTI;"

```

Programming Examples

```
741 ENTER @Rec_data1;Angle
743 RETURN
745 !
747 Example5: ! DISPLAY MODES *****
749 PRINT
751 PRINT "Example 5, Display Modes"
753 OUTPUT @Rec;"USERPRES; POIN51; OUTPERRO;"
755 ENTER @Rec_data1;Error_number ! clear message
757 !
759 Example5a: ! SINGLE CHANNEL DISPLAYS *****
761 !
763 PRINT "Single Channel, Four Parameter Split Display"
765 OUTPUT @Rec;"CHAN1; FOURP; GRATSPLI; MKRLISTON; NUMG1; PARA1; AUTO;"
767 OUTPUT @Rec;"PARA2; AUTO; PARA3; AUTO; PARA4; AUTO; PARA1; CONT;"
769 OUTPUT @Rec;"MKRLFIVM; MARK1; MARK2; MARK3; MARK4; MARK5; ENTO;"
771 PRINT "Marker List shows All Markers for Selected Parameter"
773 !
775 LINPUT "Press Return.",Input$
777 OUTPUT @Rec;"MKRLF0UP; MARK3; ENTO;"
779 PRINT "Marker List shows Active Marker for all Parameters"
781 !
783 LINPUT "Press Return.",Input$
785 OUTPUT @Rec;"GRATOVER;"
787 PRINT "Single Channel, Four Parameter Overlay Display"
789 !
791 LINPUT "Press Return for Channel 2 Display",Input$
793 OUTPUT @Rec;"CHAN2; SING; AUTO; CONT; MARK1; ENTO;"
795 PRINT "Single Channel, Single Parameter Display"
797 PRINT "Single or Multi Parameter Display is Not Coupled"
799 !
801 LINPUT "Press Return",Input$
803 OUTPUT @Rec;"CHAN1; GRATSPLI; TWOP;"
805 PRINT "Single Channel, Two Parameter Split Display"
807 LINPUT "Press Return",Input$
809 OUTPUT @Rec;"THREEP;"
811 PRINT "Single Channel, Three Parameter Split Display"
813 !
815 Example5b: ! DUAL CHANNEL DISPLAYS *****
817 !
819 LINPUT "Press Return for Dual Channel Split Display",Input$
821 OUTPUT @Rec;"DUAC; GRATSPLI;"
823 PRINT "Dual Channel, Single Parameter/Channel Split Display"
825 !
827 LINPUT "Press Return for Dual Channel Overlay Display",Input$
829 OUTPUT @Rec;"GRATOVER;"
831 PRINT "Dual Channel, Single Parameter/Channel Overlay Display"
833 !
835 LINPUT "Press Return to Continue",Input$
837 RETURN
839 !
841 Example6: ! USING = MARKER *****
843 PRINT
845 PRINT "Example 6, Using = Marker"
847 !
849 OUTPUT @Rec;"USERPRES; POIN51; SING; AUTO; CONT; CENT; OUTPACTI;"
851 ENTER @Rec;Freq
853 !
855 OUTPUT @Rec;"MARK1; MARKMAXI;"
857 PRINT "Refrence Value = Marker"
859 LINPUT "Press Return for REF VALUE = MARKER",Input$
861 OUTPUT @Rec;"REFV; EQUA;"
863 !
865 OUTPUT @Rec;"MARK1";Freq-1.E+9;";"
867 PRINT "Start Frequency = Marker"
```

Programming Examples

```

869 LINPUT "Press Return for START FREQ = MARKER",Input$
871 OUTPUT @Rec;"STAR; EQUA;"
873 !
875 OUTPUT @Rec;"MARK2";Freq+1.E+9;";"
877 PRINT "Stop Frequency = Marker"
879 LINPUT "Press Return for STOP FREQ = MARKER",Input$
881 OUTPUT @Rec;"STOP; EQUA;"
883 !
885 OUTPUT @Rec;"PHAS; AUTD; MARK3";Freq;";"
887 PRINT "Phase Offset = Marker"
889 LINPUT "Press Return for PHASE OFFSET = MARKER",Input$
891 OUTPUT @Rec;"PHAO; EQUA;"
893 !
895 RETURN
897 !
899 Example7: ! TRACE DATA OUTPUT / INPUT *****
901 !
903 PRINT
905 PRINT "Example 7, Trace Data Output / Input (FORM3)."
907 !
909 ! Output data from receiver
911 OUTPUT @Rec;"USERPRES;"
913 OUTPUT @Rec;"POIN201; SING; LINP; AUTO; FORM3; OUTPDATA;"
915 ENTER @Rec_data2;Preamble,Size,Data(*)
917 !
919 PRINT "First and last data points of output corrected data array : "
921 PRINT "Point: 1";TAB(13);"Real:";Data(0,0);TAB(36);" Imag:";Data(0,1)
923 PRINT "Point: 201";TAB(13);"Real:";Data(200,0);TAB(36);" Imag:";Data(200,1)
925 !
927 OUTPUT @Rec;"MARK1;"
929 LOCAL @Rec
931 INPUT "Corrected data array read. Press <<Return>> to Continue",Input$
933 !
935 ! Input data to receiver
937 OUTPUT @Rec;"EMTO; POIN201;" ! Zero Trace for effect
939 LINPUT "Data Zeroed, Press Return To Write Data To 8530",Input$
941 !
943 OUTPUT @Rec;"FORM3; INPUDATA;"
945 OUTPUT @Rec_data2;Preamble,Size,Data(*)
947 PRINT "Corrected array data Written (input) to 8530."
949 !
951 RETURN
953 !
955 Example8: ! FORM1 DATA CONVERSION *****
957 !
959 PRINT
961 PRINT "Example 8, Form1 Data Conversion"
963 !
965 ! This example reads FORM1 data (internal binary format) and converts
967 ! it to real & imaginary, linear magnitude, log magnitude and phase.
969 ! The data arrays size will automatically adjust for any number of
971 ! measurement points. Converted values are printed for the first and
973 ! last points.
975 !
977 OUTPUT @Rec;"SING; MARK1;"
979 OUTPUT @Rec;"FORM1; OUTPDATA;" ! or OUTPRAWn; OUTPDATA; OUTPFORM;
981 ! or OUTPDELA; OUTPMEMO;
983 ! note: if using OUTPFORM, Data_re(I) will be in the current display
985 ! format and Data_im(I) will = 0 for all display formats that
987 ! are not plots of real / imaginary pairs. Calculated linear,
989 ! log and phase values are not valid.
991 ENTER @Rec_data2;Preamble,Size ! Size/6 = number of data points
993 !

```

Programming Examples

```
995 REDIM Form1_data(1:Size/6,2) ! dimension 0 = imag mantissa,
997 ! 1 = real mantissa and 2 = common exponent
999 !
1001 ENTER @Rec_data2;Form1_data(*) ! read the data
1003 !
1005 ! Calculate Exponent - The exponent is represented by bits 0-7 of
1007 ! the 16 bit integer, Form1_data(n,2). Bit 7 is the sign bit (1="-",
1009 ! 0="+"). The computed value is offset by -15 to give values which
1011 ! are in a useful range for measurements. Thus, for Form1_data(n,2)
1013 ! values of 0 to 127, exponents range from -15 to 112 and for values
1015 ! of 128 to 255, exponents range from -143 to -16 respectively. This
1017 ! gives a data range of ~ 674 to -860 db using db=20*LGT(2^(exponent)).
1019 ! An alternate, table method is used to decode the exponent in example26.
1021 !
1023 FOR I=1 TO SIZE(Form1_data,1)
1025   Exponent=BINAND(Form1_data(I,2),255) ! bits 0-7 are the exponent
1027   !
1029   IF Exponent<128 THEN ! exponent is positive
1031     Exponent=2^(Exponent-15) ! offset (-15)
1033     !
1035   ELSE ! exponent is negative
1037     Exponent=2^(BINCMP(BINEOR(Exponent,255))-15) ! reverse [EOR],
1039     ! change sign [CMP] and offset [-15] for negative going exponents
1041   END IF
1043   !
1045   ! Calculate real and imaginary data
1047   Real=Form1_data(I,1)*Exponent
1049   Imag=Form1_data(I,0)*Exponent
1051   !
1053   ! Calculate linear magnitude data
1055   Lin_mag=SQRT(Real^2+Imag^2)
1057   !
1059   ! Calculate log magnitude data
1061   Log_mag=20*LGT(Lin_mag)
1063   !
1065   ! Calculate phase data
1067   DEG
1069   IF Imag=0 AND Real<0 THEN
1071     Phase=-180
1073   ELSE
1075     Phase=2*ATN(Imag/(Real+Lin_mag))
1077   END IF
1079   !
1081   IF I=1 OR I=SIZE(Form1_data,1) THEN ! print first and last points
1083     PRINT "Pt";I;" Real = ";Real;" Imag = ";Imag
1085     PRINT " Lin = ";Lin_mag;" Log = ";Log_mag;" Phase = ";Phase
1087     PRINT
1089   END IF
1091 NEXT I
1093 !
1095 REDIM Form1_data(0:2,1:201)
1097 !
1099 PRINT
1101 LOCAL @Rec
1103 RETURN
1105 !
1107 Example9: ! USING DISC *****
1109 !
1111 PRINT
1113 PRINT "Example 9, Using Disc"
1115 OUTPUT @Rec;"USERPRES; POIN51;"
1117 OUTPUT @Rec;"CHAN1; PARA1; SING; DATI;"
1119 OUTPUT @Rec;"CHAN2; PARA4; DUAC; SING; CONT;"
```

Programming Examples

```
1121 !
1123 Disc:      !
1125 LINPUT "Internal or External Disc? (I or E).",Input$
1127 IF UPC$(Input$)="E" THEN
1129     D=1
1131     OUTPUT @Rec;"STOIEXT;"! Use External Disc *****
1133     LINPUT "Insert Disc in External Drive, then Return",Input$
1135 ELSE
1137     D=0
1139     OUTPUT @Rec;"STOIINT;"! Use Internal Disc *****
1141     LINPUT "Insert Disc in Internal Drive, then Return",Input$
1143 END IF
1145 !
1147 Initdisc:  !
1149 LINPUT "Initialize Disc? (ENTER Y or N)",Input$
1151 IF UPC$(Input$)="Y" THEN OUTPUT @Rec;"INID;"
1153 !
1155 Storedisc: !
1157 OUTPUT @Rec;"STOR; INSS1; DISF ""IFILE1"";"
1159 OUTPUT @Rec;"CHAN1; STOR; DATAFORM; DISF ""DFILE1"";"
1161 OUTPUT @Rec;"CHAN2; STOR; DATARAW; DISF ""DFILE2"";"
1163 OUTPUT @Rec;"STOR; MEMO1; DISF ""MFILE1"";"
1165 OUTPUT @Rec;"STOR; CALK1; DISF ""KFILE1"";"
1167 OUTPUT @Rec;"DIRE;"
1169 PRINT "Files Stored To Disc, Directory Displayed"
1171 !
1173 LINPUT "Press Return to Load Data",Input$
1175 !
1177 Loaddisc:  !
1179 PRINT "Load Data"
1181 OUTPUT @Rec;"LOAD; INSS1; DISF ""IFILE1"";"
1183 IF D=1 THEN OUTPUT @Rec;"STOIEXT;" ! If INSS1 STOIINT;
1185 OUTPUT @Rec;"HOLD;"
1187 PRINT "HOLD Avoids Overwriting Data Just Loaded."
1189 OUTPUT @Rec;"CHAN1; LOAD; DATAFORM; DISF ""DFILE1"";"
1191 OUTPUT @Rec;"CHAN2; LOAD; DATARAW; DISF ""DFILE2"";"
1193 OUTPUT @Rec;"CHAN2; DISPDATA; CHAN1; DISPDATA;"
1195 PRINT "Must Turn Both Channel's Memories Off Before Loading any Memory."
1197 OUTPUT @Rec;"LOAD; MEMO1; DISF ""MFILE1"";"
1199 OUTPUT @Rec;"CHAN1; PARA1; DISPDATM; CONT;"
1201 !
1203 LINPUT "Repeat This Sequence? (ENTER Y or N)",Input$
1205 IF UPC$(Input$)="Y" THEN GOTO Example10
1207 !
1209 OUTPUT @Rec;"DIRE;"
1211 LINPUT "Print Contents of a CITIfile? (ENTER Y or N) External Drive Required
        on Controller Bus",Input$
1213 IF UPC$(Input$)="N" THEN RETURN
1215 LINPUT "Output to Printer or Controller CRT? (ENTER P or C)",Input$
1217 IF Input$="P" THEN
1219     LINPUT "Is Printer on 8530 System Bus? (ENTER Y or N)",Input$
1221     IF UPC$(Input$)="Y" THEN
1223         PRINTER IS 717
1225         OUTPUT @Rec;"ADDRPASS 01;"
1227     ELSE
1229         PRINTER IS 701          ! Connected to Controller HP-IB
1231     END IF
1233 ELSE
1235     PRINTER IS 1              ! Print to Controller CRT
1237 END IF
1239 !
1241 LINPUT "INSTALL DISC IN CONTROLLER DRIVE 0, THEN RETURN.",Input$
1243 Citiread:  !
1245 LINPUT "NAME OF CITIfile to Read?",File_name$
```

Programming Examples

```
1247 !
1249 ON ERROR GOSUB File_error
1251 ASSIGN @Discfile TO File_name$
1253 ON END @Discfile GOTO End_of_file
1255 PRINT "DISC FILE NAME=",File_name$
1257 PRINT
1259 LOOP
1261 ENTER @Discfile;Current_line$
1263 PRINT Current_line$
1265 END LOOP
1267 End_of_file: !
1269 PRINT
1271 PRINT "END OF FILE"
1273 PRINTER IS 1
1275 LINPUT "Print Another CITIfile? (ENTER Y or N)",Input$
1277 IF UPC$(Input$)="Y" THEN GOTO Citiread
1279 OFF ERROR
1281 RETURN
1283 !
1285 File_error: !
1287 IF ERRN=56 OR ERRN=53 OR ERRN=58 THEN ! file undefined or wrong type
1289 IF ERRN=56 OR ERRN=53 THEN
1291 PRINT "File ";File_name$;" Not Found. Check Directory On 8530 Display"
1293 ELSE ! ERRN=58
1295 PRINT "File TYPE Must Be ASC. Check Directory On 8530 Display."
1297 END IF
1299 BEEP 300,.1
1301 LINPUT "NAME OF CITIfile to Read?",File_name$
1303 ELSE
1305 OFF ERROR
1307 END IF
1309 RETURN
1311 !
1313 Example10: ! PLOTS USING COPY *****
1315 !
1317 PRINT
1319 PRINT "Example 10, Plots Using Copy"
1321 PRINT "Requires Properly Addressed 8530 Plotter"
1323 LINPUT "Skip This Example ? (ENTER Y or N)",Input$
1325 IF UPC$(Input$)="Y" THEN RETURN
1327 !
1329 OUTPUT @Rec;"DEBUOFF; DISpdata;"
1331 DISP "Press HP 8530 ENTRY OFF or ABORT PRINT/PLOT Softkey to abort Plot."
1333 LINPUT "Load Paper, then Return",Input$
1335 OUTPUT @Rec;"PARA1; SING; AUTO; LEFU; PLOTALL;"
1337 OUTPUT @Rec;"PARA2; SING; AUTO; LEFL; PLOTALL;"
1339 OUTPUT @Rec;"PARA3; SING; AUTO; RIGU; PLOTALL;"
1341 OUTPUT @Rec;"PARA4; SING; AUTO; RIGL; PLOTALL;"
1343 !
1345 RETURN
1347 !
1349 Example11: ! TRACE LIST TO PRINTER *****
1351 !
1353 PRINT
1355 PRINT "Example 11, List Trace Values."
1357 PRINT "Requires Properly Addressed 8530 Printer"
1359 LINPUT "Skip This Example ? (ENTER Y or N)",Input$
1361 IF UPC$(Input$)="Y" THEN RETURN
1363 !
1365 OUTPUT @Rec;"LINP; POIN51; SING; LISSKIP 7; LIST;"
1367 !
1369 RETURN
1371 !
```

Programming Examples

```
1373 Example12: ! PRINT / PLOT TO 8530 SYSTEM BUS *****
1375 !
1377 PRINT
1379 PRINT "Example 12, Print / Plot To 8530 System Bus"
1381 PRINT "Requires Printer and Plotter on HPIB System Bus"
1383 LINPUT "Skip This Example ? (ENTER Y or N)",Input$
1385 IF UPC$(Input$)="Y" THEN RETURN
1387 !
1389 PRINT "Print Title via Pass-Thru."
1391 OUTPUT @Rec;"ADDRPASS 01;"
1393 PRINTER IS 717 ! (Rec_systbus)
1395 PRINT
1397 PRINT "MEASUREMENT NUMBER 1"
1399 PRINT
1401 OUTPUT @Rec;"ENTO;"
1403 PRINTER IS 1
1405 LINPUT "Press Return",Input$
1407 !
1409 Example12a: ! PLOT TO PLOTTER ON 8530 SYSTEM BUS *****
1411 !
1413 PRINT "Plot Label via Pass-Thru."
1415 OUTPUT @Rec;"ADDRPASS 05;"
1417 OUTPUT @Rec_systbus;"CS;PU;PA 2500,2500;PD;LB PASS-THRU;PU;"
1419 OUTPUT @Rec;"ENTO;"
1421 LINPUT "Press Return",Input$
1423 RETURN
1425 !
1427 Example13: ! PLOT USER GRAPHICS USING HP-GL SUBSET (8530A) ***
1429 !
1431 ! 8530A: X=0-5733 Y=0-4095
1433 !
1435 Plot_absolute: !
1437 PRINT
1439 PRINT "Example 13, Plot User Graphics."
1441 OUTPUT @Rec;"ADDRPASS 31;"
1443 OUTPUT @Rec_systbus;"PG; CS; PU;" ! User display on and clear
1445 !
1447 OUTPUT @Rec_systbus;"SP1; PA 0,0; PD;"
1449 OUTPUT @Rec_systbus;"PA 0,4095, 5733,4095, 5733,0, 0,0;"
1451 OUTPUT @Rec_systbus;"PU; PA 2475,3950; PD; LBFULL SCREENA;"
1453 OUTPUT @Rec_systbus;"PU;"
1455 LINPUT "Press Return",Input$
1457 !
1459 OUTPUT @Rec_systbus;"SP2; PA 180,384; PD;"
1461 OUTPUT @Rec_systbus;"PA 180,3585, 4660,3585, 4660,384, 180,384;"
1463 OUTPUT @Rec_systbus;"PU; PA 2420,1980; PD;" ! Polar Center
1465 GOSUB Draw_cross
1467 OUTPUT @Rec_systbus;"PU; PA 2000,3300; PD; LBSINGLE CHANNELA;"
1469 OUTPUT @Rec_systbus;"PU;"
1471 LINPUT "Press Return",Input$
1473 !
1475 OUTPUT @Rec_systbus;"SP3; PA 180,1180; PD;"
1477 OUTPUT @Rec_systbus;"PA 180,2780, 2420,2780, 2420,1180, 180,1180;"
1479 OUTPUT @Rec_systbus;"PU; PA 1300,1980; PD;" ! Polar Center
1481 GOSUB Draw_cross
1483 OUTPUT @Rec_systbus;"PU; PA 250,1500; PD; LBDUAL, CHANNEL 1A;"
1485 OUTPUT @Rec_systbus;"PU;"
1487 LINPUT "Press Return",Input$
1489 !
1491 OUTPUT @Rec_systbus;"SP4; PA 2465,1180; PD;"
1493 OUTPUT @Rec_systbus;"PA 2465,2780, 4705,2780, 4705,1180, 2465,1180;"
1495 OUTPUT @Rec_systbus;"PU; PA 3585,1980; PD;" ! Polar Center
1497 GOSUB Draw_cross
1499 OUTPUT @Rec_systbus;"PU; PA 2665,1500; PD; LBDUAL, CHANNEL 2A;"
```

Programming Examples

```
1501 OUTPUT @Rec_systbus;"PU;"
1503 LINPUT "Press Return",Input$
1505 !
1507 OUTPUT @Rec_systbus;"SP5; PA 180,210; PD;"
1509 OUTPUT @Rec_systbus;"PA 180,1760, 2335,1760, 2335,210, 180,210;"
1511 OUTPUT @Rec_systbus;"PU; PA 1255,980; PD;" ! Polar Center
1513 GOSUB Draw_cross
1515 OUTPUT @Rec_systbus;"SP6; PU; PA 180,2260; PD;"
1517 OUTPUT @Rec_systbus;"PA 180,3805, 2335,3805, 2335,2260, 180,2260;"
1519 OUTPUT @Rec_systbus;"PU; PA 1255,3030; PD;" ! Polar Center
1521 GOSUB Draw_cross
1523 OUTPUT @Rec_systbus;"SP7; PU; PA 2510,2260; PD;"
1525 OUTPUT @Rec_systbus;"PA 2510,3805, 4665,3805, 4665,2260, 2510,2260;"
1527 OUTPUT @Rec_systbus;"PU; PA 3590,3030; PD;" ! Polar Center
1529 GOSUB Draw_cross
1531 OUTPUT @Rec_systbus;"SP9; PU; PA 2510,210; PD;"
1533 OUTPUT @Rec_systbus;"PA 2510,1760, 4665,1760, 4665,210, 2510,210;"
1535 OUTPUT @Rec_systbus;"PU; PA 3590,980; PD;" ! Polar Center
1537 GOSUB Draw_cross
1539 OUTPUT @Rec_systbus;"SP5; PU; PA 250,500; PD; LBFOUR PARAMETERA;"
1541 OUTPUT @Rec_systbus;"PU;"
1543 LINPUT "Press Return",Input$
1545 !
1547 OUTPUT @Rec_systbus;"SP10; PA 4870,0; PD;"
1549 OUTPUT @Rec_systbus;"PA 4870,4095, 5733,4095, 5733,0, 4870,0;"
1551 OUTPUT @Rec_systbus;"PU; PA 4930,2000; PD; LBMENU AREA;"
1553 OUTPUT @Rec_systbus;"PU;"
1555 !
1557 LINPUT "Turn On Measurement Display: Press Return",Input$
1559 !
1561 OUTPUT @Rec;"SINC; MENUDOMA; ENTO;"
1563 OUTPUT @Rec_systbus;"RS;" ! measurement display on
1565 !
1567 LINPUT "Insert Initialized Disc in 8530 Drive: Press Return",Input$
1569 PRINT "Store User Display."
1571 OUTPUT @Rec;"STOIINT; STOR; USED; FILE1;"
1573 !
1575 LINPUT "Turn Off Measurement Display: Press Return",Input$
1577 OUTPUT @Rec_systbus;"CS;" ! measurement display off
1579 !
1581 LINPUT "Erase User Display: Press Return",Input$
1583 OUTPUT @Rec_systbus;"PG;"
1585 !
1587 LINPUT "Turn On Measurement Display: Press Return",Input$
1589 OUTPUT @Rec_systbus;"RS;"
1591 !
1593 LINPUT "Load User Display from Disc: Press Return",Input$
1595 PRINT "Load User Display."
1597 OUTPUT @Rec;"STOIINT; LOAD; USED; FILE1;"
1599 !
1601 LINPUT "Next Example: Press Return",Input$
1603 OUTPUT @Rec_systbus;"PG; RS;"
1605 !
1607 RETURN
1609 !
1611 Draw_cross: !
1613 OUTPUT @Rec_systbus;"PR -200,0, 400,0, -200,0;"
1615 OUTPUT @Rec_systbus;"PR 0,-200, 0,400, 0,-200;"
1617 RETURN
1619 !
1621 Example14: ! PLOT TO USER DISPLAY USING BASIC HP-GL *****
1623 !
1625 PRINT
1627 PRINT "Example 14, Plot Using BASIC HP-GL"
```

Programming Examples

```
1629 OUTPUT @Rec;"SINC; ADDRPASS 31;"
1631 PLOTTER IS 717,"HPGL"
1633 WINDOW 0,4095,0,4095
1635 !
1637 ! HP-GL PLOTTING STATEMENTS
1639 !
1641 FRAME
1643 MOVE 100,100
1645 DRAW 3995,3995
1647 MOVE 3995,100
1649 DRAW 100,3995
1651 MOVE 1500,800
1653 LABEL "BASIC HP-GL"
1655 !
1657 LINPUT "Output Display To 8530 Plotter ? (ENTER Y or N)",Input$
1659 IF UPC$(Input$)="Y" THEN
1661     OUTPUT @Rec;"FULP; PLOTALL;"
1663 END IF
1665 !
1667 OUTPUT @Rec;"ADDRPASS 31;"
1669 OUTPUT @Rec_systbus;"PG; RS;" ! erase user & turn on measurement display
1671 RETURN
1673 !
1675 Example15: ! REDEFINE PARAMETER *****
1677 !
1679 PRINT
1681 PRINT "Example 15, Redefine Parameter"
1683 !
1685 OUTPUT @Rec;"USERPRES; POIN51; FOUPSPLI; DEBUOFF; OUTPERRO;"
1687 ENTER @Rec_data1;Error_number ! clear message
1689 FOR I=1 TO 4
1691     OUTPUT @Rec;"PARA"&VAL$(I)&";NUMEB1; DENOA1; REDD;"
1693 NEXT I
1695 OUTPUT @Rec;"PARA2; PHAS; PARA3; LOGP; PARA4; SWR; MARK1; SAVE5;"
1697 LOCAL @Rec
1699 PRINT "All Parameters Defined The Same, Different Formats"
1701 PRINT "Definition and Set-up Saved in Instrument State 5"
1703 LINPUT "Press RETURN",Input$
1705 !
1707 OUTPUT @Rec;"USERPRES;"
1709 GOSUB Draw_mono
1711 OUTPUT @Rec;"PARA2; PARL""Delta""; PARA1; PARL""Sum"";"
1713 OUTPUT @Rec;"TWO; GRATOVER; ANNOLABE; MARK1; MARKMAXI;"
1715 OUTPUT @Rec;"TITL""Monopulse Sum and Difference Outputs""; SAVE6;"
1717 PRINT "Two Different Parameters With User Labels and Title"
1719 PRINT "Definition and Set-up Saved in Instrument State 6"
1721 !
1723 ! PRESET selects standard User parameter definition.
1725 ! RECALL selects previously saved user parameter definitions.
1727 !
1729 RETURN
1731 !
1733 Example16: ! READ AND OUTPUT CAUTION/TELL MESSAGE *****
1735 !
1737 PRINT
1739 PRINT "Example 16, Read and Output Caution/Tell Message"
1741 LOOP
1743     LOCAL @Rec
1745     LINPUT "Adjust Receiver & Press Return to Read Caution/Tell (E to Exit)",Input$
1747     EXIT IF UPC$(Input$)="E"
1749 !
```

Programming Examples

```
1751     OUTPUT @Rec;"OUTPERRO;"
1753     ENTER @Rec_data1;Error_number,Input$
1755     PRINT Error_number,Input$
1757     !
1759     END LOOP
1761     RETURN
1763     !
1765 Example17: ! READ AND OUTPUT STATUS BYTES *****
1767     !
1769     PRINT
1771     PRINT "Example 17, Read and Output Status Bytes"
1773     LOOP
1775     OUTPUT @Rec;"cles;"
1777     LOCAL @Rec
1779     LINPUT "Adjust Receiver & Press Return to Read Status (E to Exit)",Input$
1781     EXIT IF UPC$(Input$)="E"
1783     OUTPUT @Rec;"OUTPSTAT;" ! output and clear status
1785     ENTER @Rec_data1;Bytea,Byteb
1787     PRINT "Primary =",Bytea,"Extended =",Byteb
1789     END LOOP
1791     RETURN
1793     !
1795 Example18: ! OUTPUT KEY CODE *****
1797     !
1799     PRINT
1801     PRINT "Example 18, Output Key Code"
1803     DISP "PRESS HP 8530 Front Panel Key. (f5 to EXIT.)"
1805     !
1807     OUTPUT @Rec;"DEBUON; CLES; SRQM 128,2;" ! set mask for key press
1809     ON INTR 7 GOSUB Key_code
1811     ENABLE INTR 7;2
1813     GOSUB Blank_keys
1815     ON KEY 5 LABEL " NEXT EXAMPLE" GOTO Exit_example18
1817     GOTO Wait_loop
1819     !
1821 Exit_example18: !
1823     DISABLE INTR 7
1825     GOSUB Keys_off
1827     PRINT ""
1829     RETURN
1831     !
1833 Key_code:      !
1835     Ser_poll=SPOLL(@Rec)
1837     OUTPUT @Rec;"OUTPKEY;"
1839     ENTER @Rec_data1;A
1841     PRINT A;
1843     ENABLE INTR 7
1845     RETURN
1847     !
1849 Example19: ! HPIB TRIGGERED DATA ACQUISITION *****
1851     PRINT
1853     PRINT "Example 19, HPIB Triggered Data Acquisition"
1855     !
1857     OUTPUT @Rec;"USERPRES; STEP; FOURP; CLES; TRGSHPIB; POIN 51;"
1859     GOSUB Ready_for_trig
1861     OUTPUT @Rec;"STITON; PAR1TOFF; PAR2TOFF; PAR3TOFF; PAR4TOFF;"
1863     Trigs=51 ! number of triggers to be sent
1865     PRINT "One trigger per point measures all parameters."
1867     LINPUT "Press Return to start Triggered sweep.",Input$
1869     GOSUB Send_triggers
1871     !
1873     OUTPUT @Rec;"CLES; TRGSHPIB;"
1875     GOSUB Ready_for_trig
```

Programming Examples

```
1877 OUTPUT @Rec;"STITON; PAR1TOFF; PAR2TON; PAR3TON; PAR4TON;"
1879 Trigs=204 ! one trigger per parameter (P1 measured by stimulus trig)
1881 PRINT "One trigger per parameter, per point."
1883 LINPUT "Press Return to Start Triggered Sweep.",Input$
1885 GOSUB Send_triggers
1887 !
1889 INPUT "Press Return For Next Example",Input$
1891 OUTPUT @Rec;"TRGSFRE;"
1893 RETURN
1895 !
1897 Send_triggers: !
1899 FOR I=1 TO Trigs
1901   TRIGGER @Rec
1903   DISP "Trigger";I
1905   GOSUB Ready_for_trig
1907 NEXT I
1909 PRINT "Sweep Complete,";Trigs;" Triggers Sent"
1911 RETURN
1913 !
1915 Ready_for_trig: !
1917 REPEAT
1919   WAIT .01
1921 UNTIL BIT(SPOLL(@Rec),2) ! ready, waiting for trigger
1923 RETURN
1925 !
1927 Example20: ! WAIT Required *****
1929 PRINT
1931 PRINT "Example 20, WAIT Required for display updates."
1933 !
1935 GOSUB Blank_keys
1937 ON KEY 5 LABEL " NEXT EXAMPLE" GOTO Exit_example20
1939 !
1941 OUTPUT @Rec;"DEBUOFF; FOUPOVER; STEP; POIN101; SING;"
1943 OUTPUT @Rec;"PARA1; LINP; DATI; DISPMATH; PHAO 0;"
1945 OUTPUT @Rec;"PARA2; LINP; DATI; DISPMATH; PHAO 90;"
1947 OUTPUT @Rec;"PARA3; LINP; DATI; DISPMATH; PHAO 180;"
1949 OUTPUT @Rec;"PARA4; LINP; DATI; DISPMATH; PHAO 270;"
1951 OUTPUT @Rec;"OUTPERRO;"
1953 ENTER @Rec;Error_number ! clear message
1955 !
1957 T=0 ! initial tint increment value
1959 M=2.5E-11 ! electrical delay increment
1961 !
1963 Eled: !
1965 FOR N=0 TO 1 STEP M
1967   FOR P=1 TO 4
1969     SELECT P ! Choose Parameter
1971     CASE 1
1973       OUTPUT @Rec;"PARA1; COLRP1D;"
1975       T1=T+0
1977     CASE 2
1979       OUTPUT @Rec;"PARA2; COLRP2D;"
1981       T1=T+25
1983     CASE 3
1985       OUTPUT @Rec;"PARA3; COLRP3D;"
1987       T1=T+50
1989     CASE 4
1991       OUTPUT @Rec;"PARA4; COLRP4D;"
1993       T1=T+75
1995     END SELECT
1997     IF T1>100 THEN T1=T1-100
1999     OUTPUT @Rec;"TINT";INT(T1);" ! Change Color
2001     OUTPUT @Rec;"ELED";P*N;"s;" ! Increment Delay
2003     !
```

Programming Examples

```
2005     OUTPUT @Rec;"WAIT; ENTO;" ! This WAIT insures that the 8530 updates
2007                                     ! the display before executing more commands
2009                                     !
2011     T=T+.25 ! tint value increment
2013     IF T>100 THEN T=0
2015     NEXT P
2017     NEXT N
2019     GOTO Eled
2021     !
2023 Exit_example20: !
2025     OUTPUT @Rec;"DEFC;" ! Default Colors
2027     GOSUB Keys_off
2029     RETURN
2031     !
2033 Example21: ! WAIT Not Required (holdoff included in OUTPxxxx) *****
2035     PRINT
2037     PRINT "Example 21, Wait Not Required (OUTPUxxxx holds off further execution)"
2039     !
2041     GOSUB Blank_keys
2043     ON KEY 5 LABEL " NEXT EXAMPLE" GOTO Exit_example21
2045     !
2047     OUTPUT @Rec;"USERPRES; LOGM; SING; AUTO; STAR; OUTPACTI;"
2049     ENTER @Rec;Freq1
2051     OUTPUT @Rec;"STOP; OUTPACTI;"
2053     ENTER @Rec;Freq2
2055     !
2057     OUTPUT @Rec;"MARK1"
2059     LOOP
2061     FOR N=Freq1 TO Freq2 STEP (Freq2-Freq1)/50
2063         OUTPUT @Rec;N;" " ! move marker to new frequency
2065         OUTPUT @Rec;"OUTPACTI;"
2067         ENTER @Rec;Freq ! read current marker frequency
2069         OUTPUT @Rec;"OUTPMARK;"
2071         ENTER @Rec;Mag,Phase
2073         DISP "Marker is ";Mag,Phase;" @ ";Freq;"Ghz"
2075     NEXT N
2077     END LOOP
2079     !
2081 Exit_example21: !
2083     GOSUB Keys_off
2085     OUTPUT @Rec;"CONT;"
2087     RETURN
2089     !
2091 Example22: ! Enter Frequency List *****
2093     !
2095     PRINT
2097     PRINT "Example 22, Frequency List"
2099     !
2101     OUTPUT @Rec;"PARA1;"
2103     OUTPUT @Rec;"EDITLIST;"
2105     OUTPUT @Rec;"SADD; STAR 2 GHz; STOP 4 GHz; STPSIZE 100 MHz; SDON;"
2107     OUTPUT @Rec;"SADD; STAR 4 GHz; STOP 8 GHz; STPSIZE 200 MHz; SDON;"
2109     OUTPUT @Rec;"SADD; STAR 8 GHz; STOP 16 GHz; STPSIZE 400 MHz; SDON;"
2111     OUTPUT @Rec;"DUPD; EDITDONE;"
2113     OUTPUT @Rec;"LISFREQ; SING;"
2115     !
2117     LINPUT "Press Return to Output Frequency List and Data.",Input$
2119     !
2121     OUTPUT @Rec;"POIN; OUTPACTI;"
2123     ENTER @Rec_data1;Points
2125     REDIM Freq_list(Points-1),Data(Points-1,1)
2127     !
2129     PRINT "Read Frequency List and Data from HP 8530."
```

Programming Examples

```
2131 OUTPUT @Rec;"FORM3; OUTPFREL;"
2133 ENTER @Rec_data2;Preamble,Size_list,Freq_list(*)
2135 OUTPUT @Rec;"FORM3; OUTPDATA;"
2137 ENTER @Rec_data2;Preamble,Size,Data(*)
2139 !
2141 PRINT "Selected Unformatted Data from";Points;" Point Frequency List"
2143 FOR I=0 TO Points-1 STEP INT(Points/2)
2145   PRINT "Point";I+1;" is ";Data(I,0);Data(I,1);" @ ";Freq_list(I)
2147 NEXT I
2149 !
2151 Single_seg: !
2153 INPUT "Enter Segment to Sweep (1-3) (0 to Exit).",Segment
2155 IF Segment=0 THEN GOTO 2173
2157 !
2159 OUTPUT @Rec;"CONT; SSEG";Segment;"
2161 OUTPUT @Rec;"SEG?;"
2163 ENTER @Rec_data1;Input$
2165 OUTPUT @Rec;"SEGM; OUTPACTI;"
2167 ENTER @Rec_data1;Segment
2169 PRINT "Segment Being Swept is ";Input$;Segment
2171 GOTO Single_seg
2173 OUTPUT @Rec;"ASEG; MENUSTIM;"
2175 !
2177 LINPUT "Press Return to Select STEP Sweep.",Input$
2179 OUTPUT @Rec;"STEP;"
2181 PRINT "STEP Sweep."
2183 !
2185 LINPUT "Press Return to Select Frequency List.",Input$
2187 PRINT "Turn On Frequency List."
2189 OUTPUT @Rec;"LISFREQ;"
2191 !
2193 LINPUT "Press Return for Next Example",Input$
2195 REDIM Data(200,1)
2197 !
2199 RETURN
2201 !
2203 Example23: ! Learn String *****
2205 PRINT
2207 PRINT "Example 23, Learn String"
2209 !
2211 OUTPUT @Rec;"USERPRES;"
2213 LOCAL @Rec
2215 LINPUT "Set State to Save then Press Return.",Input$
2217 OUTPUT @Rec;"OUTPLEAS;" ! Always FORM1
2219 ENTER @Rec_data2;Preamble,Size
2221 PRINT "Learn String Length=";Size;"Bytes"
2223 REDIM Learn_string(1:Size/2) ! Size Depends Upon Firmware Version
2225 ENTER @Rec_data2;Learn_string(*)
2227 OUTPUT @Rec;"USERPRES;"
2229 !
2231 LINPUT "Press Return to Recall Previous Instrument State.",Input$
2233 OUTPUT @Rec;"INPULEAS;"
2235 OUTPUT @Rec_data2;Preamble,Size,Learn_string(*)
2237 !
2239 RETURN
2241 !
```

Programming Examples

```
2243 Example24:  ! Input Floating Point or ASCII Data *****
2245 PRINT
2247 PRINT "Example 24, Input Floating Point or ASCII Data"
2249 !
2251 GOSUB Blank_keys
2253 ON KEY 5 LABEL " NEXT EXAMPLE" GOSUB Finish
2255 !
2257 OUTPUT @Rec;"HOLD; POIN201; PARA1; LINP; ENTO;"
2259 !
2261 OUTPUT 716;"FORM3; OUTPDATA;" ! Get Preamble and Size for Form 3 Input
2263 ENTER @Rec_data2;Preamble,Size
2265 OUTPUT @Rec;"ENTO;"
2267 !
2269 DEG
2271 Again24:  !
2273 Finish=0
2275 Offset=0
2277 !
2279 LINPUT "ASCII OR FLOATING POINT (A or F)?",Input$
2281 IF UPC$(Input$)="A" THEN
2283   PRINT "Input ASCII (FORM4;) Data"
2285   GOTO Input_ascii
2287 ELSE
2289   PRINT "Input Floating Point (FORM3;) Data"
2291 END IF
2293 !
2295 Input_fp:      ! Input Floating Point
2297 IF Finish=1 THEN GOTO Exit_example24
2299 GOSUB Compute_trace
2301 !
2303 OUTPUT @Rec;"FORM3; INPUDATA;"
2305 OUTPUT @Rec_data2;Preamble,Size,Data(*)
2307 GOTO Input_fp
2309 !
2311 Input_ascii:   ! Input ASCII
2313 IF Finish=1 THEN GOTO Exit_example24
2315 GOSUB Compute_trace
2317 !
2319 OUTPUT @Rec;"FORM4; INPUDATA;";
2321 OUTPUT @Rec_data1;Data_ascii$(*)
2323 !
2325 !
2327 GOTO Input_ascii
2329 !
2331 Finish:  !      Must Finish ASCII Trace Before Exit
2333 Finish=1
2335 RETURN
2337 !
2339 Exit_example24:  !
2341 LINPUT "Repeat Example (Y or N)?",Input$
2343 IF UPC$(Input$)="Y" THEN GOTO Again24
2345 GOSUB Keys_off
2347 RETURN
2349 !
2351 Compute_trace:  !
2353 Offset=Offset-10
2355 FOR I=0 TO 200
2357   Data(I,0)=SIN(2*I+Offset)
2359   Data(I,1)=COS(2*I)
2361 NEXT I
2363 FOR I=0 TO 200
2365   Data_ascii$(I,0)=VAL$(Data(I,0))
2367   Data_ascii$(I,1)=VAL$(Data(I,1))
2369 NEXT I
2371 RETURN
```

Programming Examples

```
2375 Example25:    ! DELAY TABLE OPERATIONS *****
2377 PRINT
2379 PRINT "Example 25, Delay Table Operations"
2381 !
2383 OUTPUT @Rec;"USERPRES; LINP; SING; AUTO; DATI; DISPMATH; MARK1;"
2385 OUTPUT @Rec;"FORM3; OUTPDATA;" ! current trace data is used for delay tbl.
2387 ENTER @Rec_data2;Preamble,Size,Data(*) ! Get Data for Example
2389 !
2391 LINPUT "Press Return to Input Delay Table",Input$
2393 PRINT "Input Delay Table Data"
2395 OUTPUT @Rec;"HOLD; FORM3; INPUDELA;"
2397 OUTPUT @Rec_data2;Preamble,Size,Data(*)
2399 !
2401 LINPUT "Press Return to Turn On Table Delay",Input$
2403 OUTPUT @Rec;"TABD;"
2405 !
2407 LINPUT "Press Return to Turn Off Table Delay",Input$
2409 OUTPUT @Rec;"COAD;" ! Or "WAVD;"
2411 !
2413 LINPUT "Press Return to Output Table Delay",Input$
2415 PRINT "Output Delay Table Data"
2417 OUTPUT @Rec;"FORM3; OUTPDELA;"
2419 ENTER @Rec_data2;Preamble,Size,Data(*)
2421 !
2423 LINPUT "Press Return to Store Delay Table to Disc",Input$
2425 PRINT "Store and Load Delay Table to Disc"
2427 OUTPUT @Rec;"STOIINT; STOR; DELT; DISF""DELT"";"
2429 !
2431 LINPUT "Press Return to Load Delay Table form Disc",Input$
2433 OUTPUT @Rec;"STOIINT; LOAD; DELT; DISF""DELT"";"
2435 !
2437 RETURN
2439 !
2441 Example26:    ! Fast (CW,AD,D) Data Acquisition *****
2443 !
2445 PRINT
2447 PRINT "Example 26, Fast (CW,AD,D) Data Acquisition"
2449 PRINT "PULSE GENERATOR OR AN EXTERNAL TRIGGER SOURCE NEEDED FOR THIS EXAMPLE"
2451 LINPUT "Proceed With This Example? (Y or N)",Input$
2453 IF UPC$(Input$)="N" THEN GOTO Exit_example26
2455 LINPUT "Connect Pulse Gen or an external trigger source to HP 8530 EXT TRIGGER IN.",Input$
2457 !
2459 OUTPUT @Rec;"ENTO; CONT; SINP;"
2461 OUTPUT @Rec;"CENT 10 GHZ;" ! measurement frequency
2463 Again26:    !
2465 GOSUB Blank_keys
2467 ON KEY 5 LABEL " NEXT EXAMPLE" GOSUB Exit_example26
2469 OUTPUT @Rec;"FASC;" ! "FASD;" or "FASAD;" can be used
2471 REPEAT      ! WAIT UNTIL 8530 IS READY TO TAKE DATA.
2473   WAIT .001
2475 UNTIL BIT(SPOLL(@Rec),2)
2477 TRIGGER @Rec ! ISSUE A SINGLE HPIB TRIGGER TO BEGIN FAST MODE.
2479 !
2481 LINPUT "START PULSE GEN. OR EXTERNAL TRIGGER SOURCE THEN PRESS CONTINUE",Input$
2483 DISP "Collecting data, please wait..."
2485 !
2487 REDIM Form1_data(1:100,2) ! THE SIZE OF THIS ARRAY DETERMINES THE NUMBER
2489                          ! OF POINTS MEASURED
2491 ENTER @Rec_data2;Form1_data(*)! GET THE DATA, Continues when array is full
2493 !
```

Programming Examples

```
2495 Data_collected:          ! COLLECT DATA IN FORM 1 FORMAT.
2497 OUTPUT @Rec;"SINP;"      ! EXIT FROM FAST DATA MODE.
2499 OUTPUT @Rec;"OUTPERRO;"  ! CHECK ERROR STATUS.
2501 ENTER @Rec_data1;Error_number,Input$
2503 PRINT "HP 8530A ERROR STATUS: ";Error_number,Input$
2505 PRINT SIZE(Form1_data,1);"Points Data Collected"
2507 !
2509 LINPUT "Press Return to Convert Data",Input$
2511 !
2513 ! This table is used to convert the exponent value from form1 data
2515 REAL Exp_tbl(0:255)
2517 Exp_tbl(0)=2^(-15)      ! BUILD EXPONENT TABLE FOR DATA CONVERSION
2519 FOR I=0 TO 126
2521   Exp_tbl(I+1)=Exp_tbl(I)+Exp_tbl(I)
2523 NEXT I
2525 Exp_tbl(128)=2^(-143)
2527 FOR I=128 TO 254
2529   Exp_tbl(I+1)=Exp_tbl(I)+Exp_tbl(I)
2531 NEXT I
2533 !
2535 FOR N=1 TO SIZE(Form1_data,1) ! CONVERT THE DATA.
2537   Exponent=Exp_tbl(BINAND(Form1_data(N,2),255))
2539   Real=Form1_data(N,1)*Exponent
2541   Imag=Form1_data(N,0)*Exponent
2543   Lin_mag=20*LGT(SQRT(Real^2+Imag^2))
2545   IF N/20=INT(N/20) THEN PRINT "Point";N;" ";Lin_mag
2547 NEXT N
2549 !
2551 Exit_example26:          !
2553 GOSUB Keys_off
2555 LINPUT "Repeat Example? (Y or N)",Input$
2557 IF UPC$(Input$)="N" THEN
2559   RETURN
2561 ELSE
2563   GOTO Again26
2565 END IF
2567 !
2569 ! *****
2571 ! End of Examples. The following subroutines are used by the examples
2573 ! *****
2575 Wait_loop:WAIT .01
2577 GOTO Wait_loop
2579 ! *****
2581 Blank_keys:          ! erases all the softkeys
2583 FOR I=1 TO 8
2585   ON KEY I LABEL "" GOSUB Do_nothing
2587 NEXT I
2589 ! *****
2591 Do_nothing:          !
2593 WAIT .01
2595 RETURN
2597 ! *****
2599 Keys_off:           !
2601 FOR I=1 TO 8
2603   OFF KEY I
2605 NEXT I
2607 ! *****
2609 Load_ant_arrays:    ! Load arrays with antenna data (examples 4 & 15)
2611 ASSIGN @File TO "ANG360"
2613 ENTER @File;Preamble,Size,Ant_data(*)
2615 !
2617 ASSIGN @File TO "ANG180_SUM"
2619 ENTER @File;Preamble,Size,Ant_sum(*)
2621 !
```

Programming Examples

```
2623 ASSIGN @File TO "ANG180_DEL"
2625 ENTER @File;Preamble,Size,Ant_del(*)
2627 ASSIGN @File TO *
2629 RETURN
2631 ! *****
2633 ! The following two subroutines are used by some examples to draw
2635 ! antenna patters to the 8530 display.
2637 ! *****
2639 Draw_360: ! Draws 360 degree antenna pattern
2641 Preamble=9025
2643 Size=5776
2645 OUTPUT @Rec;"DEBUOFF; ANGL; STAR-180; STOP180; INCA1; HOLD; ENTO;"
2647 OUTPUT @Rec;"FORM3; INPURAW1;"
2649 OUTPUT @Rec_data2;Preamble,Size,Ant_data(*)
2651 LOCAL @Rec
2653 RETURN
2655 ! *****
2657 Draw_mono: ! Draws monopulse antenna sum and delta to P1 & P2
2659 Preamble=9025
2661 Size=2896
2663 OUTPUT @Rec;"DEBUOFF; ANGL; TWOP; STAR-90; STOP90; INCA1; HOLD; ENTO;"
2665 OUTPUT @Rec;"FORM3; INPURAW1;"
2667 OUTPUT @Rec_data2;Preamble,Size,Ant_sum(*)
2669 OUTPUT @Rec;"FORM3; INPURAW2;"
2671 OUTPUT @Rec_data2;Preamble,Size,Ant_del(*)
2673 LOCAL @Rec
2675 RETURN
2677 !
2679 !
2681 END
2683 !
2685 !
2687 SUB Fast_mux
2689 PRINT
2691 PRINT "Example 27, Fast Mux Operation"
2693 Fast_mux: ! This is a stand alone sub-program which demonstrates
2695 ! 8530 fast mux operation - Example 27
2697 !
2699 INTEGER Data_buffer(1:30000) BUFFER
2701 INTEGER Setup
2703 REAL Set_pointer,Param_pointer,Data_pointer,Reps,I,Old_pointer
2705 REAL Log_mag(1:2),Phase(1:2)
2707 REAL Exp_tbl(0:255),Exp_Data_16bit(0:800,0:1)
2709 DIM Display$[80],Report$[200]
2711 COMPLEX Data_set(1:2)
2713 ASSIGN @A8530_data TO 716;FORMAT OFF
2715 ASSIGN @A8530_control TO 716;FORMAT ON
2717 Setup=0
2719 Dwell_time=250 !FAST PARAMETER PER POINT MEASUREMENT TIME IN MICROSECONDS (NO AVERAGING)
2721 !!!!!!!!!!!!!!!!!!!!!!!!!!!!!!!!!!!!!!!!!!!!!!!!!!!!!!!!!!!!!!!
2723 ! DISPLAY INITIALIZATION AND INSTRUCTIONS
2725 !!!!!!!!!!!!!!!!!!!!!!!!!!!!!!!!!!!!!!!!!!!!!!!!!!!!!!!!!!!!!!!
2727 PRINTER IS CRT
2729 DEG
2731 GRAPHICS OFF
2733 PRINT "This example demonstrates the FAST IF MULTIPLEXING feature of "
2735 PRINT "the HP 8530A. It requires firmware rev 1.4 or higher. An external"
2737 PRINT "trigger source should be connected to the 8530A Event Trigger input"
2739 PRINT "on the rear panel. The STOP SWEEP input should be disconnected for"
2741 PRINT "this test. During the test, the 8530A will be in MUX MODE 2 in which"
```

Programming Examples

```

2743 PRINT "both b1/a1 and b2/a1 measurements are taken upon the receipt of each"
2745 PRINT "event trigger. The trigger should be a negative going TTL pulse with"
2747 PRINT "a pulse width between 1uS and 100uS. For this example, the minimum "
2749 PRINT "period between two triggers is 500 us (ASSUMES NO AVERAGING)."
```

b1/a1	b2/a1	MEASUREMENT COUNT
MAGNITUDE	PHASE	MAGNITUDE
(dB)	(DEG)	(dB)

```

2751 DISP " PREPARE SYSTEM FOR TEST AS DESCRIBED AND CONTINUE (OR EXIT)"
2753 FOR N=0 TO 4
2755     ON KEY N LABEL "CONTINUE" GOTO Setup
2757     ON KEY N+5 LABEL " EXIT " GOTO No_go
2759 NEXT N
2761 LOOP
2763 END LOOP
2765 Setup: !
2767 DISP "SETTING UP 8530 FOR MEASUREMENT"
2769 FOR N=0 TO 9
2771     OFF KEY N
2773 NEXT N
2775 GOSUB Setup_fastmux      ! INITIALIZATION ROUTINE PUTS 8530A INTO FAST MUX MODE 2
2777 No_go:IF Setup=0 THEN
2779     DISP ""
2781     OUTPUT @A8530_control;"RECA8"
2783     LOCAL @A8530_control
2785     SUBEXIT
2787 END IF
2789 GOSUB Build_table      ! CREATES ARRAY EXP_TBL(*) USED TO CONVERT COMPRESSED DATA
2791                        ! TO BASIC REAL VALUES
2793 Take_data: !
2795 WAIT 1
2797 Repts=0
2799     !!!!!!!!!!!!!!!!!!!!!!!!!!!!!!!!!!!!!!!!!!!!!!!!!!!!!!!!!!!!!!!!!!!!!!!!!!!!!!!
2801     ! DATA DISPLAY
2803     !!!!!!!!!!!!!!!!!!!!!!!!!!!!!!!!!!!!!!!!!!!!!!!!!!!!!!!!!!!!!!!!!!!!!!!!!!!!!!!
2805 PRINT " -----"
2807 PRINT "|          b1/a1          ||          b2/a1          | MEASUREMENT COUNT |"
2809 PRINT "|          ||          ||          ||          ||          ||"
2811 PRINT "|  MAGNITUDE  PHASE  ||  MAGNITUDE  PHASE  |          |"
2813 PRINT "|    (dB)    (DEG)  ||    (dB)    (DEG)  |          |"
2815 PRINT "|          |          ||          |          |          |"
2817 PRINT "|-----|-----||-----|-----|-----|"
2819 DISP "TRIGGER MEASUREMENTS, PRESS SOFTKEY LABELED 'EXIT' WHEN FINISHED"
2821 !
2823 !!!!!!!!!!!!!!!!!!!!!!!!!!!!!!!!!!!!!!!!!!!!!!!!!!!!!!!!!!!!!!!!!!!!!!!!!!!!!!!
2825 ! CONTINUOUS TRANSFER DATA LOOP. USING TRANSFER ALLOWS FOR RAPID INPUT OF DATA
2827 ! FROM THE 8530A. DATA IS DISPLAYED DURING COMPUTORS "SPARE TIME"
2829 !!!!!!!!!!!!!!!!!!!!!!!!!!!!!!!!!!!!!!!!!!!!!!!!!!!!!!!!!!!!!!!!!!!!!!!!!!!!!!!
2831 LOOP
2833 ASSIGN @Buffer TO BUFFER Data_buffer(*)      ! INITIALIZE TRANSFER BUFFER
2835 Old_pointer=0
2837 Set_pointer=1
2839 !
2841     !! TRANSFER STATEMENT: EACH MEASUREMENT IS TRANSFERED IN THREE INTEGERS, OR 6 BYTES,
2843     !! SO COUNT 6 ALLOWS TRACKING OF THE BUFFER AS IT COLLECTS DATA FROM THE INSTRUMENT.
2845 TRANSFER @A8530_data TO @Buffer;RECORDS 10000,EOR (COUNT 6)
2847 FOR N=0 TO 10
2849     ON KEY N LABEL " EXIT ",15 GOTO Finished
2851 NEXT N

```

Programming Examples

```

2853 LOOP
2855 STATUS @Buffer,4;Data_pointer
2857 !! SINCE WE ARE MAKING TWO MEASUREMENTS AT A TIME, THE DISPLAY IS ONLY UPDATED WHEN
2859 !! THE DATA POINTER IS POINTING TO THE END OF A NEW PAIR OF MEASUREMENTS. THIS
2861 !! TECHNIQUE SKIPS A LOT OF DATA DURING FAST MEASUREMENTS, BUT ALLOWS THE DISPLAY
2863 !! TO KEEP UP WITH THE DATA FLOW.
2865 IF Data_pointer MOD 12=0 THEN
2867     IF Data_pointer>Old_pointer THEN
2869         Old_pointer=Data_pointer
2871     !!
2873     !!! THE FOLLOWING LOOP CONVERTS TWO MEASUREMENTS FROM THE 8530 COMPRESSED FORMAT
2875     !!! TO BASIC COMPLEX VALUES. IT THEN CALCULATES THE MAGNITUDE AND PHASE OF EACH
2877     !!! MEASUREMENT AND UPDATES THE DISPLAY
2879     !!
2881     FOR Param_pointer=1 TO 2
2883         Data_pointer=Old_pointer-6*(2-Param_pointer)
2885         Exp=Exp_tbl(BINAND(Data_buffer(Data_pointer/2),255))
2887         Data_set(Param_pointer)=CMPLX(Data_buffer(Data_pointer/2-1)*Exp,Data_buffer
(Data_pointer/2-2)*Exp)
2889         Log_mag(Param_pointer)=20*LGT(ABS(Data_set(Param_pointer)))
2891         Phase(Param_pointer)=ARG(Data_set(Param_pointer))
2893         OUTPUT Display$ USING "|||||",2(2X,S3D.2D,2X,"|||"),#";Log_mag(Param_pointer),
Phase(Param_pointer)
2895         PRINT TABXY(1+25*(Param_pointer-1),17),Display$
2897     NEXT Param_pointer
2899     Data_pointer=Old_pointer
2901     !!
2903     !! NOW PRINT THE CURRENT MEASUREMENT COUNT
2905     !!
2907     PRINT TABXY(5+25*(Param_pointer-1),17);Data_pointer/12+5000*Reps
2909     END IF
2911     END IF
2913     EXIT IF Data_pointer/12=5000 ! THE BUFFER IS RE-INITIALIZED TO PREVENT OVERFLOW
2915     END LOOP
2917     Reps=Reps+1
2919     ASSIGN @Buffer TO *
2921     END LOOP
2923 Finished: !
2925 DISP "CLEARING I/O CHANNEL AND RE-SETTING 8530A"
2927 ABORTIO @A8530_data ! TURN OFF THE TRANSFER
2929 ASSIGN @Buffer TO *
2931 OUTPUT @A8530_control;"SING" ! TURN OFF FAST MUX MODE
2933 OUTPUT @A8530_control;"RECA8" ! PUT 8530A IN STANDARD STATE
2935 FOR N=0 TO 9
2937     OFF KEY N
2939 NEXT N
2941 WAIT 1
2943 ABORT 7
2945 CLEAR 7
2947 LOCAL @A8530_control ! PUT 8530A IN LOCAL
2949 DISP ""
2951 SUBEXIT
2953 Build_table: ! USED FOR DATA CONVERSION
2955 !
2957 Exp_tbl(0)=2^(-15)

```

Programming Examples

```
2959   FOR I=0 TO 126
2961     Exp_tbl(I+1)=Exp_tbl(I)+Exp_tbl(I)
2963   NEXT I
2965   Exp_tbl(128)=2^(-143)
2967   FOR I=128 TO 254
2969     Exp_tbl(I+1)=Exp_tbl(I)+Exp_tbl(I)
2971   NEXT I
2973   RETURN
2975 Setup_fastmux:  !
2977   Setup=0
2979   ABORT 7
2981   CLEAR 7
2983   OUTPUT @A8530_control;"RECA8"          ! START IN KNOWN WORKING STATE
2985   WAIT 3
2987   OUTPUT @A8530_control;"HOLD;SINP"      ! GO TO HOLD MODE, SINGLE POINT
2989   INPUT "ENTER FREQUENCY OF MEASUREMENT (IN GHz)",Freq
2991   OUTPUT @A8530_control;"OUTPERRO"      ! CLEAR THE MESSAGE LINE
2993   ENTER @A8530_control;Report$
2994   ! SET TO SELECTED FREQUENCY, MAKE A CW MEASUREMENT:
2995   OUTPUT @A8530_control;"CENT"&VAL$(Freq)&"GHz;SING"
2996   ! SET FAST MUX DELAY TIME (250 uS)
2997   OUTPUT @A8530_control;"FASPARMTIME "&VAL$(Dwell_time)
2998   ! SET UP FAST MUX MODE 2 (SEE O&P MANUAL FOR OTHERS)
2999   OUTPUT @A8530_control;"FASMUXMODE 2; FASMD"
3001   OUTPUT @A8530_control;"OUTPERRO"      ! CHECK FOR ERRORS DURING SET UP
3003   ENTER @A8530_control;Report$
3005   IF VAL(Report$)<>0 THEN
3007     PRINT TABXY(1,30),"THE FOLLOWING PROBLEM OCCURED DURING 8530A SETUP:"
3009     PRINT ""
3011     PRINT Report$
3013     DISP "RESOLVE PROBLEM AND CONTINUE ( OR EXIT )"
3015     FOR N=0 TO 4
3017       ON KEY N LABEL "CONTINUE" GOTO Setup_fastmux
3019       ON KEY N+5 LABEL "EXIT" GOTO Setup_failed
3021     NEXT N
3023 Wait_for_key:GOTO Wait_for_key
3025   END IF
3027   REPEAT                                ! WAIT FOR 8530A SRQ MASK BIT
3029     WAIT .01
3031   UNTIL BIT(SPOLL(716),2)
3033   TRIGGER @A8530_control                ! DROPS 8530A INTO THE SELECTED FAST DATA MODE
3035   Setup=1                                ! (FAST MUX MODE 2)
3037 Setup_failed:  !
3039   RETURN
3041 SUBEND
```

The Hewlett-Packard Interface Bus, HP-IB, is the Hewlett-Packard implementation of IEEE standard 488, dated 1978, and IEC 625-1. For technical information on the HP-IB, refer to the *Tutorial Description of the Hewlett-Packard Interface Bus*; Part Number 5952-0156. Also see IEEE standard 728-1982, *IEEE Recommended Practice for Code and Format Conventions*.

Operator's Check and Routine Maintenance

Operator's Check

The following system operation checks confirm that the system is functional and ready for performance verification or operation. These simple checks are optional, their intent is to establish confidence in the integrity of the system.

Use a small-diameter object (such as a straightened paper clip) to press the front panel TEST button (located under the disc drive). Observe the display for the self-test sequence:

TESTING

SYSTEM INITIALIZATION IN PROGRESS *(flashes once briefly)*

SYSTEM INITIALIZATION IN PROGRESS
RECALLING INST STATE

The instrument state recalled is exactly the same as a Factory Preset with the addition of resetting the display colors to their default values.

The display should show a trace similar to the figure below.

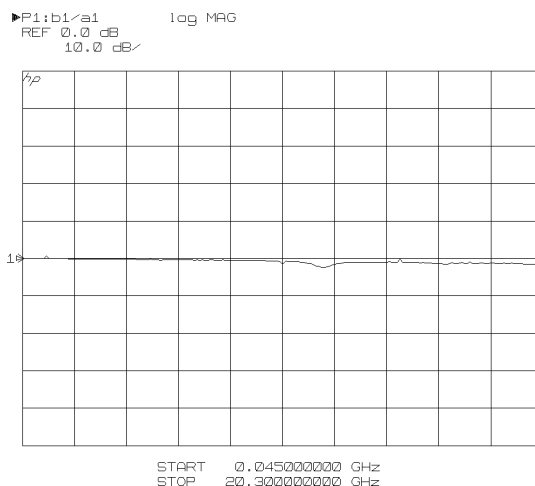

Figure 19-1. Typical Preset State Display

1. Make sure there is an RF signal path between the transmit source and the frequency converter. Use one of the following methods:
 - a. Connect a Transmit antenna to the transmit source, and receive antennas to b2 and a1 frequency converter inputs. For a direct reference signal connection, attach a directional coupler or splitter to the transmit signal. Run a cable from the coupler or splitter directly to the a1 input of the frequency converter.

- b. If you do not wish to use antennas at all: Use a directional coupler (or splitter) and cables to connect the transmit source directly to the a1 and b2 inputs.
2. Use a small-diameter object (such as a straightened paper clip) to press the front panel TEST button (located under the disc drive). Observe the display for the self-test sequence:

TESTING

SYSTEM INITIALIZATION IN PROGRESS *(flashes once briefly)*

SYSTEM INITIALIZATION IN PROGRESS
 RECALLING INST STATE

The instrument state recalled is exactly the same as a Factory Preset with the addition of resetting the display colors to their default values.

The display should show a trace similar to the figure below.

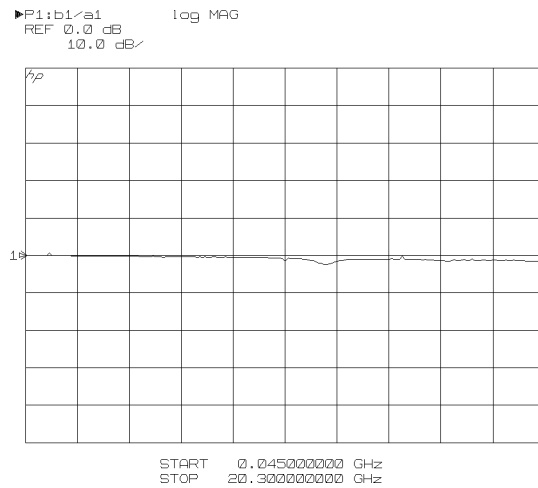

Figure 19-2. Typical Preset State Display

This concludes the basic system test. To thoroughly check the performance of the system, refer to the “Performance Verification” procedures (in the service manual). To operate the system, refer to the operating manual.

Routine Maintenance

Routine Maintenance consists of five tasks that should be performed at least every six months. If the system is used daily on a production line or in a harsh environment, the tasks should be performed more often. The tasks are:

- Maintain proper air flow.
- Inspect and clean connectors.
- Clean the glass filter (and display as required).
- Degauss the display.

Maintain Proper Air Flow

It is necessary to maintain constant air flow in and around your receiver system. If the message, CAUTION: FREQUENCY CONVERTER IS TOO HOT! or CAUTION: TEST SET IS TOO HOT! is displayed, make sure the frequency converter fan is not blocked. Items on top of the frequency converter or around the system may also impede the air flow. The test set *will not* shut down if it becomes too hot! If the HP 8530 overheats, it will shut down until the temperature drops to the operating range.

Additionally, it is recommended that the source fan filter (if any) be inspected periodically and be cleaned if necessary.

Connector Care

The condition of system connectors has a serious affect on measurement accuracy. Worn, out-of-tolerance, or dirty connectors degrade measurement accuracy. For more information on connector care, please see *Application Note 326 Coaxial Systems Principles of Microwave Connector Care*.

Recommended Practices

HP strongly recommends that you use a “connector saver” on the RF input of the mixers. This is especially important on the test mixer, which is connected and disconnected often. A “connector saver” is an adapter or short cable. This practice has two important advantages:

- The “connector saver” receives daily wear, the mixer input connector does not. This greatly extends the life of the mixer’s input connector.
- It is the connector saver that gets dirty with use, not the mixer connector.

When you must clean the connector saver, remove it from the mixer. This protects the mixer from static discharge.

Caution

The HP 8530A and HP down converters contain static sensitive devices. Do not touch the center conductor of any connector, or the center conductor of any cable connected to the HP 8530A or its downconverter. Wear a grounded anti-static strap when cleaning connectors.

How to Inspect Connectors for Wear

Look for metal particles from the connector threads and other signs of wear (such as discoloration or roughness). Visible wear can affect measurement accuracy. Discard or repair any device with a damaged connector. A bad connector can ruin a good connector on the first mating.

Use caution when mating SMA connectors to the mixer's precision 3.5 mm RF input. SMA connectors are not precision devices, and are often out of mechanical tolerances, even when new. An out-of-tolerance SMA connector can ruin the mixer's RF input connector on the first mating. If in doubt, gage the SMA connector before connecting it to the mixer. The center conductor must NEVER extend beyond the mating plane.

How to Clean Connectors

Part numbers for cleaning supplies are provided after the procedure.

1. Blow particulate matter from connectors using an environmentally-safe aerosol such as Ultrajet. This product is recommended by the United States Environmental Protection Agency, and contains chlorodifluoromethane. You can order this aerosol from Hewlett-Packard.
2. Next, use an alcohol wipe to wipe connector surfaces. It is best to wet a small swab with alcohol (from the alcohol wipe) and clean the connector with the swab.
3. Allow the alcohol to evaporate off the connector before making connections

Caution	DO NOT ALLOW EXCESSIVE ALCOHOL TO RUN INTO THE CONNECTOR! Excessive alcohol entering the connector collects in pockets in the connector's internal parts. The liquid will cause random changes in the connector's electrical performance. If excessive alcohol gets into a connector, lay it aside to allow the alcohol to evaporate. This takes up to 3 days. If you attach that connector to another device it can take much longer for trapped alcohol to evaporate.
----------------	---

Connector Cleaning Supplies

- Ultrajet: 9310-6395
- Alcohol wipes: 92193N
- Lint-Free cloths: 9310-4242
- Small foam swabs: 9300-1270
- Large foam swabs: 9300-0468

Clean the Glass Filter (and display as Required)

A gasket between the display and glass filter limits air dust infiltration between them. Therefore, cleaning the outer surface of the glass filter is usually sufficient. Use a soft cloth and, if necessary, a cleaning solution recommended for optical coated surfaces: HP part number 8500-2163 is one such solution.

If, after cleaning the outer surface of the glass filter, the display appears dark or dirty or unfocused, clean the inner surface of the filter, and the display.

Cleaning the display

1. Remove the softkeys cover (a plastic cover through which the front panel softkeys protrude): *carefully* insert a thin, flat screwdriver blade (or your fingernail) between the upper left corner of the softkeys cover and the glass filter. See Figure 19-3. Be extremely careful not to scratch or break the glass. Carefully pull the cover forward and off.
2. Use a #10 TORX driver to remove the two screws that are now visible.

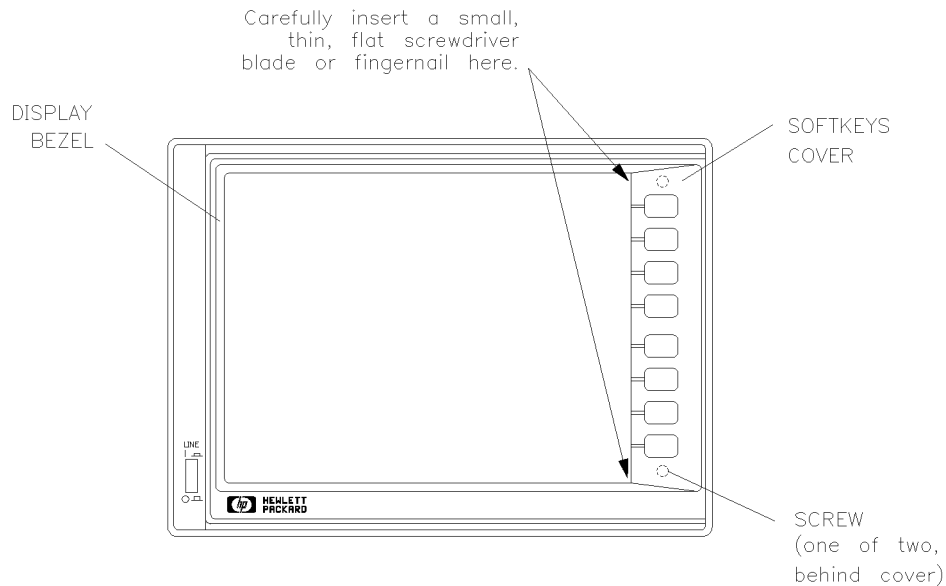

Figure 19-3. Removing the Glass Filter

3. Remove the display bezel assembly by pulling out the end that is now free. Pivot the bezel around its left edge until it is released.
4. Clean the display surface and the inner glass filter surface gently, as in step 1.
5. Allow the surfaces to dry and then reassemble the instrument.

Degauss (Demagnetize) the Display

Caution A degaussing tool will erase diskettes if they are if they are laying nearby!

If the display becomes magnetized, or if color purity is a problem, cycle the power several times. Leave the instrument off for at least 15 seconds before turning it on. This activates the automatic degaussing circuit in the receiver display. If this is insufficient to achieve color purity, a commercially available demagnetizer must be used (either a CRT (cathode ray tube) demagnetizer or a bulk tape eraser can be used). Follow the manufacturer's instructions keeping in mind the following: it is imperative that at first it be placed no closer than 4 inches (10 cm) from the face of the display while demagnetizing the display. If this distance is too far to completely demagnetize the display, try again at a slightly closer distance until the display is demagnetized. Generally, degaussing is accomplished with a slow rotary motion of the degausser, moving it in a circle of increasing radius while simultaneously moving away from the display.

Caution Applying an excessively strong magnetic field to the display face can destroy the CRT.

Like most displays, the CRT can be sensitive to large magnetic fields generated from unshielded motors. In countries that use 50 Hz, some 10 Hz jitter may be observed. If this problem is observed, remove the device causing the magnetic field. Figure Figure 19-4 shows the motion for degaussing the display.

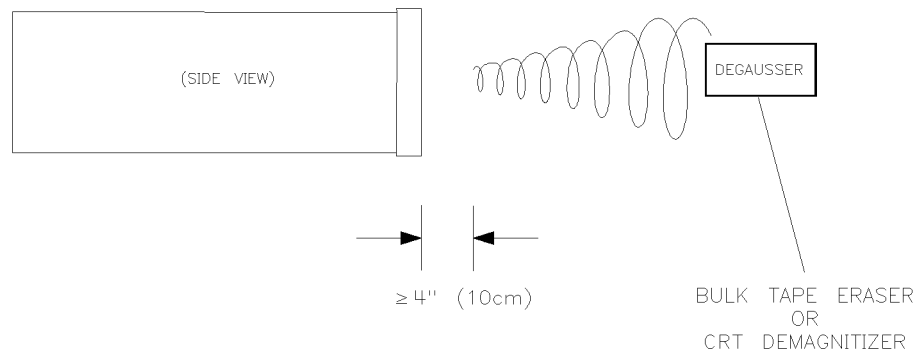

Figure 19-4. Motion for Degaussing the Display

In Case of Difficulty

This chapter explains:

- How to solve common operation problems.
- What to do when common error messages are displayed on the HP 8530A.
- How to solve basic hardware problems.

Chapter Contents

- Common Operation Problems
 - Receiver will not Sweep
 - IF Signal Level Problems
 - LO Signal Level Problems (applies to HP 85309A only)
 - Rotary Joint Problems
- Common Error Messages
- Hardware Problems
 - HP 8530A Locks Up (the controls stop working completely)
 - An Instrument (in the system) will not Respond to Computer Control
 - A System Bus Instrument will not Respond
 - HP 85309 LO/IF Unit Problems

Common Operation Problems

The following problems are listed in this section:

- Receiver will not Sweep
- IF Signal Level Problems
- LO Signal Level Problems
- Rotary Joint Problems

Receiver will not Sweep

First, look at the “annotation” area of the display (on the far left-hand side). See if any of the following annotation letters are displayed:

H This indicates that Hold mode is On. The instrument will not sweep in hold mode. Take the receiver out of Hold mode by pressing:

STIMULUS (MENU) MORE, then select SINGLE, NUMBER of GROUPS, or CONTINUAL.

E This indicates that External Trigger or HP-IB Trigger mode is On. If you want perform measurements that are internally triggered, press:

STIMULUS (MENU) MORE TRIGGER MODE TRIG SRC INTERNAL

Check the Selected Sweep Mode

If you are trying to use Ramp mode, make sure the required BNC cables are connected between the RF source and the receiver. These connections are explained in the Ramp sweep mode description in Chapter 6 (refer to the index under “ramp sweep mode” for the exact page number).

Check the System Phase Lock Setting

The phase lock controls are available under:

(SYSTEM) MORE SYSTEM PHASELOCK

There are three settings, which should be used as explained below:

EXTERNAL Select this mode if the system uses a distributed frequency converter such as the HP 85309A *and an HP 8350B LO source*. Make sure the receiver’s L.O. PHASELOCK OUT connector is connected to the HP 8350B FM IN jack.

INTERNAL Select this mode if the system uses an HP 8511 or S-Parameter (network analyzer) test set.

NONE Select this mode if the system uses a distributed frequency converter such as the HP 85309A *and a synthesized LO source*.

IF Signal Level Problems

To check the HP 8530A's IF signal levels, press PARAMETER **(MENU)** SERVICE PARAMETERS, then press one of the following:

- SERVICE 1 a1 to check the a1 Reference channel IF signal level.
- SERVICE 2 b2 to check the b2 Test channel IF signal level.
- SERVICE 3 a2 to check the a2 Test channel IF signal level.
- SERVICE 4 b1 to check the b1 Test channel IF signal level.

On Systems Using the HP 85309A Frequency Converter

a1 Reference Channel Level

If the LO source is synthesized there is no minimum reference channel level, since phase lock is not used. The maximum signal level is -10 dBm. It is recommended, but not required, that the reference channel signal level be greater than -45 dBm. This will keep the reference channel signal above the noise floor, improving measurement accuracy.

If the LO source is not synthesized, the reference channel signal level must be greater than -45 dBm at the HP 8530A reference input.

To calculate the reference channel IF signal level use the calculations in "Configuring the System for Optimum Dynamic Range," located the Operation chapter of the HP 85301C or 85310A manual. Suspect a problem if the actual measured value is not within ± 6 dB of the calculated value.

b2, b1, a2 Test Channel Level

To calculate the test channel IF signal level use the calculations in "Configuring the System for Optimum Dynamic Range," located the Operation chapter of the HP 85301C or 85310A manual. Suspect a problem if the actual measured value is not within ± 6 dB of the calculated value.

On Systems Using the HP 8511A/B Frequency Converter

a1 Reference Channel Level

The reference channel level must be between -45 and -10 dBm. The signal level must remain at, or above the -45 dBm level (at the receiver's reference input) to maintain phase lock.

To calculate the reference channel IF signal level use the calculations in "Configuring the System for Optimum Dynamic Range," located the Operation chapter of the HP 85301C or 85310A manual. Suspect a problem if the actual measured value is not within ± 6 dB of the calculated value.

b2, b1, a2 Test Channel Level

To calculate the test channel IF signal level use the calculations in "Configuring the System for Optimum Dynamic Range," located the Operation chapter of the HP 85301C or 85310A manual. Suspect a problem if the actual measured value is not within ± 6 dB of the calculated value.

Possible Solutions

No IF Signal

1. Make sure the receiver system is installed correctly, or has not been changed. Refer to the *HP 8530A Installation Guide*.
2. Make sure test and reference antennas are connected to the frequency downconverter. Make sure the transmit antenna are pointing toward them.

Common Operation Problems

3. Perform one of the following sub steps, depending on the frequency converter in your system:
 - a. If your system uses the HP 85309 frequency converter:

Make sure that the IF signal cables from the LO/IF unit's IF OUT to the HP 8530A's J1 TEST SET INTERCONNECT are connected to the correct channels.

Make sure the HP 85309A and LO source are turned ON.
 - b. If your system uses the HP 8511A/B frequency converter:

Make sure the Test Set Interconnect cable is connected between the receiver and the HP 8511A/B.

Make sure that the HP 8511A/B is turned on.

Incorrect IF Signal Level

1. Double-check the calculation in "Configuring the System for Optimum Dynamic Range," located the Operation chapter of the HP 85301C or 85310A manual. Check the receiver system using a standard gain antenna to double-check the calculations.
2. Check the output power level of the transmitter source (and optional amplifier) for the correct level, especially at high frequencies.
3. Make sure the receiver system is installed correctly, or has not been changed. Refer to the *HP 8530A Installation Guide*.
4. If using the HP 85309A frequency converter: Check the detector voltage on the front panel. The voltage should be approximately the value on the reference mixer module label.

LO Signal Level Problems (applies to the HP 85309A only)

LO Signal Is Too Low

If the LO signal level is too low, check the following items:

1. Adjust the LO signal level as shown in the *HP 85301B* or *HP 85310A Operating and Service Manual*.
2. Check the LO signal cables for damage, or high RF insertion loss.
3. Check the rotary joint for high RF insertion loss.

HP 85309A "LO POWER OUT OF RANGE" light is ON During Measurement

If this light is flashing, make sure the HP 85309A POS Z BLANK is connected to POS Z BLANK on the LO source.

If the light is still blinking, or is ON continuously, refer to the service chapter in the *HP 85310A Operating and Service Manual*.

Rotary Joint Problems

Rotary joints must operate at microwave frequencies, and they must physically rotate around a center axis. Because of this, rotary joints are a common source of problems. All of these problems cause measurement error and should be corrected immediately. Some common problems are:

- *Wow* is a fluctuation in the test signal level as the antenna positioner rotates. This causes measurement error at certain antenna positions.
- *High insertion loss* can reduce the LO signal level to the mixers modules. This can increase the mixers conversion loss, making the measurement system unusable. When the rotary joint is worn out, it will often have this problem.
- *Drop outs* are caused by the rotary joint having a high insertion loss at certain frequencies or angular positions. This can cause measurement error only at certain frequencies.
- *Intermittent* rotary joints can cause the test signal to fade randomly. This can cause random measurement errors.
- *Noise on the signal* is caused by an intermittent rotary joint with very fast intermittent fading. This can look like noise on the test signal.

Most of the above problems can be solved by cleaning the rotary joint. If the rotary joint cannot be cleaned, or if cleaning does not solve the problem, replace the rotary joint.

Common Error Messages

The following is a list of HP 8530A error messages. This is not a comprehensive list, and shows messages that are caused by simple procedural errors. If the error message continues to occur then use check for proper installation and setup. Refer to the “Caution/Tell Messages” chapter in the *HP 8530A Keyword Dictionary* for a complete list of error messages.

A

“ABORTED ENCODER TRIGGERED SWEEP”

This message is displayed if you change modes in the middle of a sweep. For example, if you select frequency domain instead of angle domain, or if you select a different sweep mode in the middle of a sweep.

“ADDITIONAL STANDARDS NEEDED”

In Antenna Calibration

The antenna definitions you used during the calibration do not cover the entire frequency range of the cal. There are either gaps between adjacent antenna definitions, or they do not provide full coverage at the beginning or end of the frequency range. You must measure one or more additional standards to cover the entire frequency range.

In Network Analyzer Calibration

The calibration standards you used during the calibration do not cover the entire frequency range of the cal. The standards you have measured do not provide full coverage over the selected frequency range. You must measure one or more additional standards to cover the entire frequency range.

C

“CALIBRATION RESET”

Occurs when you change settings such that the calibration is incompatible with the measurement. Calibration goes OFF if this message is displayed.

“CORRECTION MAY BE INVALID”

Occurs when you change settings and the receiver is not sure if the calibration is still valid. Calibration remains ON.

E

“ENCODER NOT FOUND”

The HP 85370A Position Encoder is not connected to the back of the HP 8530A.

“ENCODER OFFSET ANGLE ALREADY SAVED”

The receiver does not allow you to press **SAVE OFFSET** twice *in the same sweep*, unless you clear the first offset. If you want to change the offset value (without taking another sweep), press **CLEAR OFFSET**, then **SAVE OFFSET**.

F

“FREQUENCY CONVERTER IS TOO HOT!”

Occurs if the fan on the HP 8511A/B frequency converter is blocked with paper or other object. Items on top of the frequency converter or around the system may also impede the air flow. The test set *will not* shut down if it becomes too hot!

I

“IF OVERLOAD”

This occurs if the power going to any receiver input is greater than -10 dBm. You should lower the power level going to the inputs.

System cables can have less power loss at lower frequencies. Long cables can cause significant losses at high frequencies. If you turn RF power up, you might overdrive the receiver inputs at lower frequencies. Solve this problem using the Power Slope feature. Power Slope increases RF power as the sweep progresses. This feature is explained near the end of Chapter 6, Stimulus.

Common Error Messages

N

“NO IF FOUND”

The usual cause is inadequate power at the reference input of the HP 8530A (a1 is usually used as the reference input). Verify that the appropriate power levels are available, especially at the reference phase lock input by pressing:

PARAMETER (MENU) SERVICE PARAMETERS

SERVICE 1 a1

The signal level should be between -45 and -10 dBm.

If you are using an HP 85309A frequency converter, make sure you are *not* using Ramp sweep mode. Use Step sweep mode instead.

O

“OPTION #005 NOT INSTALLED”

The position encoder functions cannot be used unless the HP 8530A is equipped with option 005. This message is displayed if your HP 8530A does not have option 005 installed. Option 005 adds a new PC (printed circuit) board to the HP 8530A, and adds a new rear panel connected (ENCODER INTERCONNECT). Contact your HP representative for more information.

“OVERSPEED ERROR - BACKUP”

You are moving the positioner so fast that the HP 85370A Position Encoder cannot track the measurement. Overspeed conditions may occur when the measurement uses high averaging factors with small increment angles. To correct the error:

1. Stop forward movement.
2. Move the positioner backwards until the receiver beeps.
3. Continue with the measurement either at a slower rate, with a larger increment angle, or with a smaller averaging factor.

P**“PHASE-LOCK LOST”**

This error message occurs when the HP 8530A is not receiving a signal at the reference input while a measurement is in process. The reference input is usually a1, but this can be changed to the a2 input by the user. The usual cause of this problem is inadequate power at the reference input of the HP 8530A. Verify that the reference input receives between -45 dB and -10 dB.

Phase Lock Problems when using Hardware Gating

Do not attempt to phase lock to a signal that is sent through a hardware gate. Use a separate phase lock signal. For example: Assume you use hardware gating and your test and reference signals pass through a hardware gate. You are using b1 as the test input and a1 as the reference input. By default, phase lock is set to a1. However, the gated signal arriving at a1 is essentially a pulsed signal with a low duty cycle. The result is an average power level that is too low to use for phase locking. To solve the problem, split off the test signal before it gets to the hardware gate, and connect it to the a2 input. Select the a2 input as the phase lock reference by pressing:

PARAMETER (MENU) REDEFINE PARAMETER PHASE LOCK a2

S**“SOURCE (1 or 2) FAILURE - RF UNLOCKED”**

This error often occurs if the RF or (if used) LO source do not have anything connected to their STOP SWP connectors. You can solve this problem in either of two ways:

- You can connect the STOP SWP line to the STOP SWP connector on the back of the receiver.
- You can connect a BNC short to the source's STOP SWP connector.

“SWEEP SYNC ERROR”

This error may occur if the HP 8530A is in the *RAMP* mode, and the appropriate BNC connections have not been made. Refer to the Ramp sweep mode description in Chapter 6 (refer to the index under “ramp sweep mode” for the exact page number).

“SYSTEM BUS ADDRESS ERROR”

NOTE: References to an LO source, below, only applies to systems that use the HP 85309A frequency converter.

The receiver cannot communicate with the RF or LO source, or the CONVERTER address in the HP-IB menu is set improperly.

1. Make sure the RF and LO source HP-IB cables are connected to the receiver's System Bus (directly or through HP-IB extenders).
2. Make sure the SOURCE 1 (RF) and SOURCE 2 (LO) addresses shown in the receiver's HP-IB menu match the actual addresses of the RF and LO sources.)

Common Error Messages

3. If using the HP 85309A, make sure CONVERTER in the receiver's HP-IB menu is set to 31.
4. If using the HP 8511A/B, make sure CONVERTER in the receiver's HP-IB menu is set as explained below:
 - A. *If using an HP 8511A with option 001*, make sure it is connected to the receiver's System Bus. The factory default HP-IB address is 20. Set the CONVERTER address (in the Receiver's HP-IB menu) to match the address setting on the HP 8511A.
 - B. *If using an HP 8511A that does not have option 001*, then you do *not* need it to the System Bus.

If the HP 8511A is *not* connected to the System Bus, enter address 31 for the CONVERTER address of the receiver's HP-IB menu.

If you decide you want the HP 8511A connected to the System Bus (though this connection is not required), enter the HP-IB address of the HP 8511 in the receiver's HP-IB menu.
 - C. *If using an HP 8511B*, make sure it is connected to the receiver's System Bus. The factory default HP-IB address is 20. Set the CONVERTER address (in the Receiver's HP-IB menu) to match the address setting on the HP 8511.
5. If using the HP 85309A frequency converter, check multiple source settings on the receiver. Refer to the HP 85310A or 85301B documentation for details.
6. Check HP-IB extenders by performing these steps:
 - A. Make sure the extenders are set to SLOW mode. NORMAL mode can cause errors.
 - B. Make sure the extenders are plugged in, and that their switches are set properly.
 - C. Check the extender cables for breaks or damage.
7. Disconnect the extender from the receiver.

Turn the receiver OFF, then ON.

Reconnect the extender.
8. If all the above is correct:
 - A. Suspect a failure in one of the extenders (if applicable). Connect the source directly to the receiver System Bus and check operation.
 - B. Suspect a bad HP-IB cable, or a bad extender coaxial cable.
 - C. After checking all other items, suspect a failure in one of the instrument's HP-IB circuits. Check each unit to see if it can communicate with other devices.

T**“TEST SET IS TOO HOT!”**

Occurs if the fan on the HP 8511A/B frequency converter is blocked with paper or other object. Items on top of the frequency converter or around the system may also impede the air flow. The test set *will not* shut down if it becomes too hot!

U**“UNABLE TO RAMP THIS DUAL SOURCE SETUP”**

This message only applies if you are using the HP 85309A frequency converter. The caution message will occur if you try to put the HP 8530A in *RAMP* mode with two synthesized sources. The HP 8530A should be in *STEP* mode.

V**“VTO FAILURE”****If Using the HP 8511A/B**

If you are using an HP 8511A/B frequency downconverter:

1. Make sure the HP 8511A/B is turned ON.
2. Make sure the TEST SET-IF INTERCONNECT is connected between the receiver and the HP 8511A/B.
3. Make sure the HP 8530A is set for internal phase lock by pressing:
 - a. **(SYSTEM) MORE**
 - b. **SYSTEM PHASELOCK LOCK TYPE: INTERNAL**

If Using the HP 85309A

The following steps apply if you are using the HP 85309A frequency converter, and then only if you are using a non-synthesized LO source (such as a HP 8350B).

- Make sure a BNC cable is connected between the HP 8530A's *LO PHASELOCK OUT* and the LO source's *FM INPUT*.
- Make sure the HP 8530A is set for external phase lock by pressing:
 1. **(SYSTEM) MORE**
 2. **SYSTEM PHASELOCK EXTERNAL**

Hardware Problems

This section is not intended to be a comprehensive hardware troubleshooting guide. Instead this section discusses common problems and how to fix them. Refer to the HP 8530A service manual (or the service documentation for the frequency converter) for detailed information on troubleshooting and repair of the measurement system. The following problems are discussed:

- HP 8530A Locks Up
- An Instrument will not Respond
- HP 85309 (LO/IF Unit) Problems

HP 8530A Locks Up

“Lock up” is a condition where the HP 8530A refuses to operate and will not respond to front panel keystrokes, including **LOCAL**.

If Your System Uses the HP 8511A/B

Use a straightened paper clip or other small diameter object to press the HP 8530A TEST button (this is a recessed button located under the disc drive, use a straightened paper-clip to press it). The receiver should re-initialize itself and operate properly.

If Your System Uses the HP 85309A

When you turn on external phase lock mode (**SYSTEM MORE SYSTEM PHASELOCK EXTERNAL**), the HP 8530A expects to find an HP 8350 connected as the LO source. The HP 8530A can lock up under the following circumstances:

- The HP 8350 is not connected to the System Bus.
- The HP 8350 is connected, but is turned off.
- The HP 8350 is connected, but its HP-IB address does not match the “SOURCE #2” address set in the HP 8530A Local menu.
- A synthesizer (such as an HP 8340/41 or 836xx-series) is connected to the System Bus instead of an HP 8350. If a synthesizer is used as the LO source, phase lock should be set to NONE. (press **SYSTEM MORE SYSTEM PHASELOCK NONE**.)

If any of the above problems existed, correct it and press the TEST button on the HP 8530A. It should now operate properly.

An Instrument will not Respond to Computer Control

This section applies to instruments that will not respond to remote computer control.

1. Make sure each instrument is plugged in and is turned ON. If an instrument’s display is dark, check its line fuse. On a HP 836xx series source with no front panel display, make sure the green AC power LED is ON.
2. Make sure the computer software is using the correct address for that device.
3. Set the instrument to local mode and try to operate it manually.

If the instrument operates manually

1. Make sure the instrument’s HP-IB cable is connected to the computer’s HP-IB bus (directly or through HP-IB extenders).
2. Make sure the instrument is set to the correct HP-IB address.

3. Check HP-IB extenders by performing these steps:
 - a. Make sure the extenders are set to SLOW mode. NORMAL mode can cause errors.
 - b. Make sure the extenders are plugged in, and that their switches are set properly.
 - c. Check the extender cables for breaks or damage.
4. Disconnect the extender from the receiver.
Turn the receiver OFF, then ON.
Wait 20 seconds.
Reconnect the extender.
5. If all of the above is correct:
 - a. Suspect a failure in one of the extenders. Connect the source directly to the receiver System Bus and check operation.
 - b. Suspect a bad HP-IB cable, or a bad extender coaxial cable.
 - c. After checking all other items, suspect a failure in one of the instrument's HP-IB circuits.

If the instrument does not operate manually

Suspect a failure within the instrument itself.

A System Bus Instrument will not Respond

This section applies to instruments on the System Bus that will not respond to remote HP 8530A or computer control.

1. Make sure each instrument is plugged in and is turned ON. If an instrument's display is dark, check its line fuse. On a HP 836xx series source with no front panel display, make sure the green AC power LED is ON.
2. If controlling the system with a computer:
 - a. Make sure the software is using the right address for that device. If using the Pass-Through feature, make sure you are using it as explained in Chapter 18, HP-IB Programming.
 - b. Press **LOCAL** on the HP 8530A. Try to control the System Bus instrument from the HP 8530A front panel.

If the HP 8530A can control the instrument, suspect an improper HP-IB connection between the HP 8530A and the computer. (If the connection looks good, try replacing the HP-IB cable.)
 - c. If the HP 8530A cannot control the instrument, set the instrument to local mode and try to operate it manually.

If the instrument operates manually

1. Make sure the instrument's HP-IB cable is connected to the receiver's System Bus (directly or through HP-IB extenders).
2. Make sure the instrument is set to the correct HP-IB address. (Make sure the address shown in the receiver's HP-IB menu matches the actual address of the instrument.) When using the HP 85309A, the receiver's CONVERTER address should always be set to 31 . For instructions on setting the HP-IB menu for an HP 8511A/B frequency converter, refer to the "SYSTEM BUS ADDRESS ERROR" error message description.

Hardware Problems

3. If you are using the HP 85309A frequency converter, and the problem is with one of the sources: check multiple source settings on the receiver. Refer to the HP 85310A documentation for details. Also refer to the description of Multiple Source Mode operation in Chapter 17, Using System Functions.
4. Check HP-IB extenders by performing these steps:
 - a. Make sure the extenders are set to SLOW mode. NORMAL mode can cause errors.
 - b. Make sure the extenders are plugged in, and that their switches are set properly.
 - c. Check the extender cables for breaks or damage.
5. Disconnect the extender from the receiver.
Turn the receiver OFF, then ON.
Wait 20 seconds.
Reconnect the extender.
6. If all of the above is correct:
 - a. Suspect a failure in one of the extenders. Connect the source directly to the receiver System Bus and check operation.
 - b. Suspect a bad HP-IB cable, or a bad extender coaxial cable.
 - c. After checking all other items, suspect a failure in one of the instrument's HP-IB circuits.

If the instrument does not operate manually

Suspect a failure within the instrument itself.

HP 85309A (LO/IF Unit) Problems

This section only applies to HP 85309A frequency converters.

LO/IF Unit Does Not Turn ON

If the DETECTOR VOLTAGE display on the front panel does not light up when the unit is turned on, check the following:

1. Make sure the instrument is plugged into an operating AC power outlet.
2. Check the instrument's line voltage selector. Is it set to your AC power voltage?
3. Check the HP 85309A's fuse.
4. Check the power supply as explained in the service chapter of the HP 85301B or HP 85310A operating and service manual.

The LO POWER OUT OF RANGE Light is ON

This can be caused by the following:

- The LO source is not set to output enough power, increase power output (if possible) to +13 dBm. Make sure your LO source can output enough power at the highest LO frequency.
- The LO source's RF OUTPUT is not connected to the HP 85309A, or if the LO source is turned off. This can also happen if the LO source is on, but its RF output is turned off.
- The LO source cannot supply the requested amount of power in the measurement frequency range. Make sure your LO source is specified to produce +10 dBm in the desired frequency range. If the LO cannot produce enough power at high frequencies, the LO POWER OUT OF

Hardware Problems

RANGE light will come on during the high-frequency portion of the measurement. During this time LO power will not be correct.

- The reference mixer is not connected to the REFERENCE LO OUTPUT of the HP 85309.
- The reference mixer's Detector Output is not connected to the HP 85309A.
- There is a failure of the HP 85309A's ALC circuitry. An ALC failure will usually cause the light to come on permanently, though all equipment is connected properly.

Glossary

Active

The term “active” has two special meanings in HP 8530A documentation:

- “Active function” refers to the last feature you activated *that requires a numeric value*. When you turn the front panel knob, use the step keys, or enter a numeric value, the HP 8530A changes the *active function*.

For example, pressing **START** makes it the active function. Any value changes or entries will affect that function. Start will remain the active function until you select another function *that requires a numeric value*. Pressing **ENTRY OFF** causes the analyzer to remove the function from active status. The knob, step keys, and numeric entry keys will no longer have any effect. **ENTRY OFF** protects the instrument from accidental value changes. Such changes occur most commonly when someone accidentally moves the knob.

- When the term “active” is used next to multiple-choice functions (“active parameter,” “active channel,” “active marker,” and so on), it is referring to the *most recently used choice* in that multiple-choice function. Thus, “active parameter” refers to the most recently used parameter.

Here is an example: Assume you want to use the Redefine Parameter feature to modify a parameter. Redefine Parameter affects the “active” parameter. Thus, you should activate PARAM 1 before using the Redefine Parameter feature.

The terms “active” and “currently-selected” mean the same thing in HP 8530A documentation.

Active Channel

The term “active channel” refers to the channel that was activated last. When you select a parameter, change measurement settings, and so on, you affect the *active channel*. In the same way, only one parameter (PARAM 1, PARAM 2, PARAM 3, or PARAM 4) can be the active parameter at any given time. The same applies to markers.

AUT

AUT is an acronym which stands for Antenna Under Test.

Antenna Definition

An antenna definition is one of seven individual data sets inside a **cal definition**. Each antenna definition has the gain values for a specific standard gain antenna. See “Cal Definition,” below.

Cal

“Cal” is an abbreviation for calibration.

Cal Definition

A “cal definition” is a data set that contains the published gain data for up to seven standard gain antennas. A cal definition is composed of a four-line header, and up to seven individual data sets called **antenna definition**. See “Antenna Definition,” above.

Glossary

Calibration, Antenna

Antenna calibration using a standard gain antenna allows measured data to be expressed in dBi (dB relative to an isotropic radiator). A standard gain antenna with known or defined gain values at specific frequencies is used as a transfer standard to calibrate the system. Calibrating with a standard gain antenna corrects for the transmission response error.

Isolation calibration is also available, which corrects measurement errors caused by receiver cross-talk.

Calibration Coefficients

An internal data array. This is the correction data that was created during calibration (also called “Cal Sets”). You can retrieve the active Cal Set register over HP-IB.

Cal Definition

A calibration definition is an ASCII file you create using a text editor. It contains frequency and gain values that were published for the standard gain antenna.

Cal Set

A finished calibration data file. During the calibration, the standard gain antenna is measured and its response is compared to the cal definition. Any differences are stored in an internal “cal set register.” These differences are the measurement offsets that are used to compute the correct gain value, expressed in dBi. Cal sets can be stored to, or loaded from disc.

When you press **CAL** **CORRECTION ON**, and then choose one of the eight cal sets, the selected calibration data is placed in the Calibration Coefficient Array for that channel.

Channel

The receiver measures the performance of the antenna under test and converts the results into digital data. This data is then duplicated into two identical copies. One copy becomes “Channel 1” data and the other becomes “Channel 2” data.

When you press **CHANNEL 1** on the front panel, most instrument settings you make afterward will affect only the Channel 1 data. When you press **CHANNEL 2** most settings you make afterward will affect only the Channel 2 data. This feature allows you to view two versions of the same measurement at the same time. Each version can use different instrument features, but still represents the same basic measurement data. For example: One version might be calibrated, while the other is uncalibrated. Or, one version might display frequency data, while the other displays Time Domain data.

Such features as calibration, time domain, display formatting, and trace math can be performed independently on the two channels. When you press the **CHANNEL 1** or **CHANNEL 2** key, you make that channel the “active channel.” Any subsequent changes you make to measurement settings will affect that channel.

Some instrument settings are always the same in both channels. Such features are “coupled.” Other settings can be changed in one channel versus the other. Such features are “uncoupled.”

Continual Sweep Mode

When this mode is selected, the receiver makes measurements continuously. This mode is most often used in Frequency or Time Domain measurements. To select this mode, make sure the receiver is in Frequency or Time Domain and press:

STIMULUS **MENU** **MORE** **CONTINUAL**

Corrected Data

There are two internal data arrays that hold “corrected data,” one array for Channel 1, and one for Channel 2. In addition to ratioing and averaging, corrected data has been through time domain and calibration processing (if these features are ON at the time). Also, a user-definable “delay table” can affect corrected data, if used. Refer to the index of the Operating and Programming manual under “delay table” to find more information.

Delay Table

The HP 8530A has a delay table for each channel. When four parameter display is ON, there is a delay table for each parameter in each channel (a total of eight). The delay table allow users to grab, modify, and return measurement data to the instrument. Uses are primarily in RCS applications, where users want to modify the time domain response window. Refer to the index of the Operating and Programming manual under “delay table” to find more information.

DOS

Disc Operating System, the disc format used by IBM PCs and compatible computers.

Form 1

An HP-IB data transfer format. Form 1 is the native internal data format of the receiver. It consists of a header byte, followed by three, 16 bit data words for each stimulus point. Form 1 offers very fast transfer speeds, and it can be converted to floating point data. (High Speed Fast CW only offers Form 1 output.)

Form 2

An HP-IB data transfer format. Form 2 is a 32 bit IEEE 728 format. This format is not commonly used.

Form 3

An HP-IB data transfer format. Form 3 is the recommended format for use with HP 9000 Series 200/300 workstations. It consists of a header, a two-byte number indicating how many bytes follow, then the real and imaginary data pairs for each stimulus point. Form 3 follows the 64 bit IEEE 728 standard format.

Form 4

An HP-IB data transfer format. Form 4 is ASCII, originally used for PCs before Form 5 was created.

Form 5

An HP-IB data transfer format. Form 5 is the recommended format for use with IBM PCs and compatibles. This is a 32 bit DOS-compatible floating point format.

Formatted Data

There are two internal data arrays that hold “formatted data,” one array for Channel 1, and one for Channel 2. This data is scalar (magnitude-only) and reflects display format, scaling, and trace math processing.

Frequency List Mode

This mode is similar to Step Sweep mode, because it phase locks at each measurement frequency. Frequency List mode allows you to enter a list of frequencies you want to measure. You can select any number of frequencies (up to 801) and choose any frequencies you want. You can enter frequencies in any order, but the receiver will measure the frequencies in sequential order from the lowest to the highest frequency.

Glossary

Hardware State

The Hardware State stores multiple source mode settings, HP-IB settings for external hardware, and frequency converter or test set states. The hardware state can be stored to disc. This feature allows you to quickly reconfigure the receiver for different test setups.

Hold Mode

Hold Mode stops measurements. You should place the receiver in this mode if you want to load measurement data from disc. The receiver selects Hold mode after measuring a single sweep, single angle, or number of groups.

Input

Refers to the four HP 8530A signal inputs (a1, a2, b1, and b2). This word is also used when referring to the signal inputs of the frequency downconverter.

Instrument State

An “instrument state” is defined as the condition of all current measurement settings, including all domain, stimulus, parameter, format, and response settings.

LIF

Logical Interchange Format, the disc format used by HP 9000 Series 200/300 computers.

Machine Dump

A Machine Dump stores the following register contents to a single disc file:

- Current instrument state
- Instrument states 1 - 8
- Cal sets 1 - 8
- Cal kits
- Hardware state
- Memories 1 - 8

Machine dump files allow you to change between different test configurations quickly. This feature is useful if you have an HP 8530A with optional HP 8510C operation. Here's why: When you change between HP 8530A and HP 8510C operation, the receiver reverts to factory-default settings, and the contents of all registers is lost. A machine dump can store all these settings to a single disc file, so you can reload the machine dump and restore your setups immediately. NOTE: Before saving a machine dump file, make sure you save the current settings to Save Register 8 (the user preset register). When you later load the machine dump file, the machine will wakes up in the desired state.

Measurement

A “measurement” is a completed data collection activity. What constitutes a measurement depends on the mode you are in.

Measurement Definition when Using Ramp Sweep Mode

In Ramp sweep mode, a “measurement” is a complete sweep spanning the start and stop frequencies. One sweep must be measured if averaging is OFF. If averaging is ON, $n + 1$ sweeps must be measured, where n is the selected averaging factor.

For example, assume you select four parameters, ramp mode, and averaging is set to 4. To take a fully averaged measurement:

- If using Continual mode, allow five sweeps to complete. After five sweeps the data is fully averaged.
- If controlling the receiver by computer, set Number of Groups (NUMG) to 5.

When the measurement starts, the receiver starts measuring 5 complete sweeps of parameter 1. When it finishes, it starts taking 5 complete sweeps of parameter 2. This continues until all four parameters have been measured.

Ramp mode is most often used with internal (free run) triggering. And is almost always used in the Frequency or Time Domains.

Measurement Definition when Using Single Point Mode

In Single Point mode, a measurement is finished when the current frequency point has been measured. If you want to measure more than one parameter, the receiver measures that frequency point for each parameter. This mode is used in the Frequency or Time Domains. Continual sweep and Free Run (internal) triggering are usually used with Single Point mode.

Measurement Definition when Using Step or Frequency List Mode

In Step and Frequency List modes, a measurement is finished when all points between the start and stop frequencies have been measured.

External Triggering:

External Pulse or HP-IB triggering can be modified to suit your needs. By default triggering works as follows:

- If you are displaying a single parameter, each external trigger will measure the AUT at one frequency point, then advance to the next frequency and wait for another trigger.
- If you are displaying four parameters, each trigger will measure all four parameters at one frequency point, then advance to the next frequency and wait for another trigger.

The Trigger Mode feature of the HP 8530A (under STIMULUS **MENU** **MORE** **TRIGGER MODE**) provides more flexibility. You can make the receiver wait for a trigger before measuring any specific parameter. You could measure one parameter per trigger, measure two parameters per trigger, or *any* combination. The only limitation is that you must measure the parameters in numeric sequence (1, 2, 3, 4). You can also make the receiver wait for a trigger before advancing to the next stimulus point. This is helpful if you are using a RF source that is not compatible with the HP 8530A, if using unusual RF multipliers, and so on.

Internal Triggering:

If a single parameter is displayed, the receiver measures one frequency point, advances to the next frequency point, and measures it. This continues automatically until the whole frequency range is measured.

If you are displaying four parameters, each trigger will measure all four parameters at one frequency point, then advance to the next frequency and measure all four parameters again. This continues automatically until the whole frequency range is measured.

Measurement Definition when Using Single Angle Mode

In Single Angle mode, a measurement is finished when the current angle has been measured. Continual measurement mode and Free Run triggering is recommended when using Single Angle mode.

Measurement Definition when Using Swept Angle Mode

In Swept Angle mode, a measurement is finished when all points between the start and stop angles have been measured. External or HP-IB triggering are almost always used with Swept Angle mode.

External Triggering:

External TTL or HP-IB triggering can be modified to suit your needs. By default triggering works as follows:

Glossary

- If you are displaying a single parameter, each external trigger will measure the AUT at one angle, then advance to the next angle and wait for another trigger.
- If you are displaying four parameters, each trigger will measure all four parameters at one angle, then advance to the next angle and wait for another trigger.

The Trigger Mode feature of the HP 8530A (under STIMULUS **MENU** **MORE** **TRIGGER MODE**) provides more flexibility. You can make the receiver wait for a trigger before measuring any specific parameter. You could measure one parameter per trigger, measure two parameters per trigger, or *any* combination. The only limitation is that you must measure the parameters in numeric sequence (1, 2, 3, 4). You can also make the receiver wait for a trigger before advancing to the next angle.

Internal Triggering:

If a single parameter is displayed, the receiver measures the AUT at one angle, advances to the next angle, and measures it. This continues automatically until the whole pattern is measured.

If you are displaying four parameters, each trigger will measure all four parameters at one angle, then advance to the next angle and measure all four parameters again. This continues automatically until the whole pattern is measured.

More information on how the various sweep modes work is provided in the Keyword Dictionary, under the title of each mode.

Memory Data

An internal data array. Valid data can be read from this array (over HP-IB) *if* data has been stored to one of the memory registers. Various trace math functions are possible when using the memory data feature.

Parameter

The input, or input ratio, that you have selected for the measurement. The front panel keys **PARAM 1**, **PARAM 2**, **PARAM 3**, and **PARAM 4** are set at the factory to select different input ratios (b1/a1, b2/a1, and so on). For example, **PARAM 1** divides (ratios) input b1 by a1. You can redefine the PARAM keys so they ratio any two inputs you desire. You can also configure any PARAM key to measure a single input.

Ramp Sweep Mode

Ramp Sweep mode is a non phase-locked sweep in which the receiver tracks the continuous frequency sweep of the RF source. In Ramp Sweep mode, a “measurement” is a complete frequency sweep spanning the start and stop frequencies. To select this mode, make sure the receiver is in Frequency or Time Domain and press:

STIMULUS **MENU** **RAMP**

Only one sweep must be measured if averaging is OFF. If averaging is ON, $n + 1$ sweeps must be measured, where n is the selected averaging factor.

For example, assume you select four parameters, ramp mode, and averaging is set to 4. To take a fully averaged measurement:

- If using Continual mode, allow five sweeps to complete. After five sweeps the data is fully averaged.
- If controlling the receiver by computer, set Number of Groups (NUMG) to 5.

When the measurement starts, the receiver starts measuring 5 complete sweeps of parameter 1. When it finishes, it starts taking 5 complete sweeps of parameter 2. This continues until all four parameters have been measured.

Ramp mode is most often used with internal (free run) triggering. And is almost always used in the Frequency or Time Domains.

Ratio

Most often, users want to divide the test signal input by the reference signal input. This is called a ratio, or ratioed, measurement. (For example, selecting b1/a1 would divide the test signal at b1 by the reference signal at a1.) A ratioed measurement provides common-mode rejection of errors caused by the transmitter or transmit antenna.

Raw Data

A data array that contains the ratioed and averaged measurement data results. There are four raw data arrays, one for each parameter. If dual channel display is selected, the receiver creates eight raw data arrays, four for the parameters in Channel 1, and four for the parameters in Channel 2.

Single Point Mode

Single Point mode phase locks and measures at a single frequency. To select this mode, make sure the receiver is in Frequency or Time Domain and press:

STIMULUS (MENU) SINGLE POINT

Snapshot

A “snapshot” is an exact copy of the data presented on the HP 8530A display. Screen snapshots can be printed or plotted. This term is borrowed from American English, it means “photograph,” but implies that the photograph was taken quickly and without any required preparation.

Step Sweep Mode

Step Sweep mode is a frequency sweep mode where the receiver steps from one measurement frequency to the next, phase locking at each frequency. To select this mode, make sure the receiver is in Frequency or Time Domain and press:

STIMULUS (MENU) STEP

Stimulus

Stimulus is the X-axis of the receiver, it is the range of frequency, time, or angle over which you are making a measurement.

- If you are in Frequency Domain, the measurement stimulus is frequency (kHz, MHz, or GHz).
- If in Time Domain, the actual stimulus is frequency, but this is converted to an X-axis display of time (seconds).
- In Angle Domain, stimulus is angular (degrees).

The HP 8530 measures individual points along the selected “stimulus.” In other words, if you have selected Frequency Domain, the receiver measures a specific number of frequency points. The maximum number of points you can measure is 801, regardless of whether you are measuring frequency, time, or angle.

Glossary

Index

0

0 to 360 degree display mode, selecting, 6-6

1

10 MHz IN, rear panel BNC, 3-15
+/-180 softkey (position encoder function),
6-6
1/PARAM softkey, 7-4
1-port calibration, 5-24
1-port calibration (network analyzer), 5-32

2

20 MHz IF, 2-2
20 MHz OUT, rear panel BNC, 3-15

4

40 dB PATTERN softkey, 9-5

6

60 dB PATTERN softkey, 9-5

7

7550B or 7550 Plus plotters, how to make
them function properly, 16-23

A

a1, a2, b1, and b2 measurement inputs, 1-6
A annotation, 3-3
ABORTED ENCODER TRIGGERED SWEEP,
error message, 20-6
accessories, 1-12
AC power requirements, 1-14
acquisition cycle of data, 6-23
active channel, 4-1
active channel, definition of, Glossary-1
active, definition of, Glossary-1
active entry area, 3-3
active function output, program example,
18-18
active marker, 4-1
active parameter, 4-1
ADDITIONAL STANDARDS NEEDED, error
message, 20-6
addresses, assignment of, 17-8
ADDRESS OF 8530 softkey, 11-2

ADDRESS of CONVERTER softkey, 11-2,
17-10

ADD softkey, 6-14

adjust colors, 5-59

adjusting the display, 5-58

Adjusting the display, 5-58

air flow, 19-3

alias-free range, how to improve, 13-8

alias-free range, in RCS measurements, 13-8

aliasing, 13-8

ALL OTHERS softkey, 11-2, 17-10

allowable cable lengths, HP-IB Bus Cables,
1-15

allowable cable lengths, System Bus Cables,
1-15

ALL SEGMENTS softkey, 6-17

ALL TO ACT.TRACE softkey, 9-4

altitude, operating and storage, 1-14

analog detection stages of HP 8530A, 2-4

ANALOG $\pm 10V$, rear panel BNC, 3-15

ANG DISPLY ON/MOVE and OFF softkeys
(position encoder function), 6-6

ANG DISPLY ON/MOVE softkey, 6-6

angle display (HP 85370A), 6-6

angle display mode (position encoder)
functions, 6-6

angle display ON and OFF (position encoder
function), 6-6

angle domain, 1-4, **5-56**

angle domain, illustration of, 1-4, 5-56

angle, setting start and stop, 6-3

ANG POL 0-360 softkey (position encoder
function), 6-6

ANNOTATE W/INPUT softkey, 7-5

ANNOTATE W/LABEL softkey, 7-5

* annotation, 3-3

annotation areas, 3-2

annotations

*, 3-3

A, 3-3

C, 3-3

D, 3-3

E, 3-3

G, 3-3

H, 3-3

M, 3-3

- O, 3-3
- S, 3-3
- annotations, adding to the screen, 16-3
- antenna calibration, 5-9
 - angle domain versus frequency domain, 5-9
 - description, 5-4
 - important rules, 5-17
 - important terms, 5-9
 - isolation (procedure), 5-14, 5-16
 - loading a cal set from disc, 5-36
 - procedure, 5-11
 - storing a cal set to disc, 5-35
 - using a frequency domain cal in angle domain, 5-9
- antenna calibration, definition of, Glossary-2
- antenna definition, **5-46**, Glossary-1
- antenna range multipath Time Domain measurements, 13-21
- antenna sweep mode, 6-4
- array, corrected (calibrated), 2-7
- array, corrected data, 18-6
- array, formatted data, 2-8, 18-7
- array, memory data, 2-7
- array, raw data, 2-6, 18-6
- ASCII calibration definition file, description, 5-50
- ASCII data format (CITIfile), 15-3
- audio annunciator (beeper), 17-5
- AUT, definition of, Glossary-1
- AUTO**, 9-2
- auto delay, 9-8
- AUTO DELAY softkey, 9-8
- auto feed on/off, 16-23
- AUTO FEED ON/OFF softkey, 16-23
- automatic IF calibration (correction), 17-5
- automatic recall of instrument settings, 2-9
- auto scaling the display, 9-2
- AUX1 rear panel BNC, 3-14
- AUX2 rear panel BNC, 3-14
- AUXILIARY MENUS block, 3-10
- averaging, 9-5
 - in data processing flow, 2-6
- averaging, in internal data flow, 2-6
- AVERAGING ON/restart softkey, 9-5
- averaging, recommended values, 9-6
- AXIS A softkey (position encoder function), 6-7
- AXIS B softkey (position encoder function), 6-7
- AXIS C softkey (position encoder function), 6-7

B

- background calibration, for RCS measurements, 5-23
- background calibration, for RCS measurements, updating, 5-23
- background intensity, 5-58
- background RCS calibration for each RCS mount, 5-23
- BACKSPACE**, 6-3
- BACKSPACE** key, 3-8, 10-2
- basic measurement functions, 3-7
- beam width, determining using markers, 5-83
- beeper, 17-5
- binary data format, 15-3
- block diagram of typical measurement setup, 1-2
- blocked air flow, 19-3
- BORESIGHT ANGLE, 6-7

C

- cabinet, system, 1-12
- cable
 - for external monitor, 5-61
- calculating minimum gate span, 13-14
- cal definition, 5-46, Glossary-1
- cal definition file, for standard gain antennas
 - creating multiple antenna definitions in one cal definition file, 5-53
- cal, definition of, Glossary-1
- cal definition, what this term means, Glossary-2
- calibrated data, 2-7
- calibrated data array, 2-7
- calibration, **5-3**
 - 1-port (network analyzer), 5-32
 - antenna isolation, procedure, 5-14, 5-16
 - cal kits, 5-24
 - exiting and resuming, 5-37
 - principles and care of calibration standards, 5-38
 - requirements, 5-4
 - response and isolation (network analyzer), 5-29
 - response (network analyzer), 5-27
 - resuming a cal procedure after leaving it, 5-37
 - settings that should not be changed, 5-5
 - turning on an existing calibration, 5-37
 - types of, 5-4
 - verifying your calibration, 5-39
 - what is calibration?, 5-3
- calibration, antenna
 - angle domain versus frequency domain, 5-9

- description, 5-4
- important rules, 5-17
- important terms, 5-9
- isolation calibration procedure, 5-14, 5-16
- loading a cal set from disc, 5-36
- procedure, 5-11
- storing a cal set to disc, 5-35
- using a frequency domain cal in angle domain, 5-9
- calibration, antenna, definition of, Glossary-2
- calibration coefficient data arrays, 18-7
- calibration coefficients, definition of, Glossary-2
- calibration definition file
 - creating multiple antenna definitions in one file, 5-53
 - loading, 5-52
 - saving, 5-52
- calibration definition file, example, 5-50
- calibration definition, for standard gain antennas
 - creating, 5-46
 - supplied in HP 8530A, 5-54
- calibration, for RCS measurements, 5-18
- calibration, IF, 17-5
- calibration, in internal data flow, 2-7
- calibration kit data, loading from disc, 5-25
- calibration kits (cal kits), 5-24
- calibration, network analyzer
 - description, 5-4
- calibration, RCS
 - description, 5-4
- CALIBRATION RESET, error message, 20-6
- calibration standards, principles and care of, 5-38
- CAL** key, 3-9
- CAL KITS softkey, 15-4
- CAL SET 1-8 softkey, 15-4
- CAL SET ALL softkey, 15-4
- cal set, definition of, Glossary-2
- cal sets, loading from disc, 5-36
- cal sets, storing to disc, 5-35
- C annotation, 3-3
- caution message
 - test set too hot, 19-3
- caution/tell messages, reading and outputting, program example, 18-28
- CENTER**, 6-3, 6-9
- CGA monitors, (not supported by HP 8530A), 1-19
- change cal set, 5-42
- changing display scale, 9-2
- changing the sign of an entered number, 3-8, 10-2
- channel 1 and 2 data processing, **18-5**
- Channel 1 and 2, relative position in digital processing flow, 2-3
- channel coupling, stimulus settings, 6-21
- channel, definition of, Glossary-2
- channels, **3-5**, 4-1
- channel selection, **3-5**
- channels, selecting, 4-1
- chirp-z time domain transform, 13-2
- CITIfile data format, 15-3
- CITIfile format, 5-50
- cleaning connectors, 19-4
- cleaning supplies, connector, 1-13, 19-4
- cleaning the display, 19-5
- CLEAR}}, in Normalize menu, 9-4
- CLEAR OFFSET softkey (position encoder function), 6-7
- clock adjust, 17-6
- clock speed of microprocessor, 2-5
- clutter, range, 13-9
- coarse
 - and fine synchro (position encoder) functions, 6-6
 - (single, 1:1) synchro mode (position encoder function), 6-6
- COAXIAL DELAY softkey, 9-7
- codes, HP-IB programming, 18-2
- color, 5-59
- color of plotter pens, selecting, 16-23
- color printing, 16-12
- COLOR softkey, 16-12
- common error messages, 20-6
- common problems
 - rotary joint, 20-5
 - weak or missing IF signal, 20-3
 - weak or missing LO signal (applies to HP 85309A), 20-4
- common problems, solving, 20-2
- comparison between HP 8530A and HP 8510C, 1-9
- compatible external displays, 1-19
- compatible external monitors, 5-61
- compatible frequency converters, 1-18
- compatible instruments, 1-15
- compatible LO sources, 1-15
- compatible plotters, 1-19
- compatible printers, 1-18
- compatible RF sources, 1-17
- configuring a printer
 - laser printer, 16-6
- connecting the HP 8530 to a computer, 18-4
- connector
 - care of, 19-3
 - cleaning, 19-4
 - cleaning supplies, 1-13, 19-4
- connector savers, 1-12

CONSTANT FREQUENCY softkey, 17-13
 CONTINUAL softkey, 6-20
 Continual Sweep mode, definition of,
 Glossary-2
 controlling LO sources, 17-11
 controlling multiple sources, 17-11
 controls, front panel, 3-5
 conversion, 7-4
 CONVERSION softkey, 7-4
 converter, frequency, selecting the type in
 use, 11-2, 17-10
 CONVERTER HP 8511B softkey, 11-2, 17-10
 CONVERTER softkey, 11-2, 17-10
 convert parameter, 2-7
 copolar and crosspolar measurements,
 problems with (IF overload error),
 17-19
 corrected data, 2-7
 corrected data array, 2-7, 18-6
 corrected data, definition of, Glossary-3
 corrected measurement data arrays, 18-5
 correcting entry errors, 6-9
 correcting mistakes when entering numbers,
 3-8, 10-2
 correction, IF, 17-5
 CORRECTION MAY BE INVALID, error
 message, 20-6
 coupled and uncoupled stimulus functions,
 3-6
 coupling stimulus settings between channels,
 6-21
 crosspolar and copolar measurements,
 problems with (IF overload error),
 17-19
 CRT colors, 5-59
 CRT intensity, 5-58
 CRT OFF softkey, 17-7
 current axis, selecting (for synchro encoder
 operation), 6-7
 cycle of data acquisition, 6-23

D

D1191A cable for external monitors, 5-61
 D annotation, 3-3
 data acquisition cycle, 6-23
 DATA and MEMORY softkey, 5-68
 data and memory traces, displaying
 simultaneously, 5-68
 data array, corrected, 2-7, 18-6
 data array, formatted, 18-7
 data array, formatted data, 2-8
 data array, memory data, 2-7
 data array, raw, 2-6, 18-6
 data, corrected (calibrated), 2-7
 data file formats, 15-3

data flow, internal, 2-6
 data, formatted, 2-8
 DATA from CHANNEL 1 softkey, 5-71
 DATA from CHANNEL 2 softkey, 5-71
 data, memory, 2-7
 data presentation (display) features, 1-7
 data processing illustration, 2-3
 data processing stages
 raw data, 2-6
 data processing stages, analog detection, 2-4
 data processing stages, digital processing,
 2-5
 data, raw, 2-6
 DATA RAW softkey, 15-5
 DATA → MEMORY 1 softkey, 5-67
 DATA → MEMORY}} operations, maximum
 number of, 5-69
 DATA softkey, 15-5
 data transfer formats
 Form 1, 2-6
 data transfer formats (Form 1 through 5),
 18-8
 date/time clock, adjust, 17-6
 DATE/TIME FUNCTIONS softkey, 17-6
 date/time plot, 16-22
 date/time printout, 16-4
 dB/GHz, selecting, 10-2
 dBm, selecting, 10-2
 DEFAULT PEN NUMBERS softkey, 16-24
 DEFAULT softkey, 17-13
 DEFAULT to MEMORY *n* softkey, 5-69
 DEFINE PLOT softkey, 16-23
 DEFINE PRINT softkey, 16-6, 16-10, 16-12,
 16-13
 DEFINE RECEIVER softkey, 17-14
 DEFINE SOURCE 1 softkey, 17-14
 DEFINE SOURCE 2 softkey, 17-13
 definition, cal (what this term means),
 Glossary-2
 definition file, for standard gain antenna
 saving, 5-52
 definition file, for standard gain antennas
 creating multiple antenna definitions in
 one cal definition file, 5-53
 loading, 5-52
 definition, for standard gain antennas
 creating, 5-46
 example file, 5-50
 supplied in HP 8530A, 5-54
 degauss (demagnetize) the display, 19-6
 delay
 coaxial mode, 9-7
 waveguide mode, 9-8
 delay, electrical, 9-7
 delay table, 2-7, 9-8

- delay table data array, 18-7
- delay table, definition of, Glossary-3
- delay table, program example, 18-32
- DELAY TABLE softkey, 15-5
- deleting disc files, 15-8
- delta marker modes, program example, 18-20
- delta markers, 5-78
- delta markers, using to find beam width, 5-83
- demagnetize the display, 19-6
- denominator, measurement ratio, 7-4
- DENOMINATOR softkey, 7-4
- description of HP 8530A, technical, 2-2
- description of the HP 8530A, 1-2
- design background of the HP 8530A, 1-4
- DeskJet family printers, using, 16-10
- differences between HP 8530A and HP 8510C, 1-9
- digital processing stages of HP 8530A, 2-5
- directory, viewing disc files, 15-7
- disc drive, description, 1-8
- disc drive (external) unit and volume number, 15-9
- disc drive operation, 15-1
- disc drive, using an external drive, 15-8
- disc files
 - deleting, 15-8
 - directory function, 15-7
 - loading, 15-6
 - storing, 15-4
 - un-deleting, 15-8
- discs, compatible types, 15-2
- DISC}} (setting the System Bus address for an external disc drive), 11-3
- discs, formatting, 15-3
- discs, initializing, 15-3
- disc storage capacity, 15-2
- disc storage, program example, 18-21
- disc utilities
 - initializing a hard disc, 15-9
- display
 - change colors, 5-59
 - marker lists, 5-76
- DISPLAY
 - DATA, 5-67
- display annotation areas, 3-2
- display annotation, changing, 7-5
- display annotations, special one-character, 3-3
- display auto scaling, 9-2
- display background intensity, 5-58
- display, cleaning of, 19-5
- DISPLAY DATA and MEMORY softkey, 5-68
- display, demagnetizing, 19-6
- display, external, installing, 5-62
- display features, 1-7
- display features (the front panel display), 3-2
- display formatting in the internal data flow, 2-8
- display functions, 5-57-72
- displaying a single parameter, 5-58, 12-1
- displaying a trace stored in display memory, 5-67
- displaying data and memory traces at the same time, 5-68
- displaying data relative to the peak of the main lobe, 9-4
- displaying four parameters, 5-58, 12-1
- displaying two channels, 5-58, 12-1
- display intensity, 5-58
- DISPLAY** key, 3-9
- DISPLAY MEMORY softkey, 5-67
- display messages, 3-3
- display modes, program example, 18-20
- display scale, changing, 9-2
- displays, external (critical specifications), 1-19
- displays, external (supported), 1-19
- display titles, 3-3
- distributed frequency converter, 1-18
- DIVIDE (/) softkey, 5-70
- domain, angle, 1-4, **5-56**
- domain angle, illustration of, 1-4, 5-56
- domain, frequency, **1-5**, 5-55
- domain, frequency, illustration of, 1-5, 5-55
- DOMAIN** key, 3-9
- domain, time, **1-5**, 5-56
- domain, time, illustration of, 1-5, 5-56
- DOS and LIF disc formats, 15-3
- DOS, definition of, Glossary-3
- DOS disc format, changing to, 15-3
- DOS (Disc Operating System) disc format, 1-8
- down-range resolution, 13-5
- drive port, 7-4
- DRIVE softkey, 7-4
- dual
 - (dual, 36:1) synchro mode (position encoder function), 6-6
 - synchro mode (position encoder function), 6-6
- DUAL CHANNEL softkey, 5-58, 12-1
- DUAL (synchro) softkey (position encoder function), 6-6
- duplicate frequency list points, eliminating, 6-17
- DUPLICATE POINTS softkey, 6-17
- DUPLICATES DELETED softkey, 6-17
- dwel time, 6-18

DWELL TIME softkey, 6-18

E

E annotation, 3-3

editing a frequency list, 6-16

EDIT LIST softkey, 6-14

EDIT MULT. SRC. softkey, 17-11

EGA monitors, (not supported by HP 8530A),
1-19

electrical delay, 9-7

auto, 9-8

automatically balancing test and reference
inputs, 9-8

coaxial mode, 9-7

entering delay values over HP-IB, 9-8

purpose of, 9-8

setting velocity factor, 9-8

waveguide mode, 9-8

ELECTRICAL DELAY softkey, 9-7

electrical requirements, 1-14

electrostatic discharge (ESD), 1-1

encoder

position (HP 85370A) operation, 6-5

ENCODER INTERCONNECT, rear panel
connector, 3-14

ENCODER NOT FOUND error message, 20-7

ENCODER OFFSET ANGLE ALREADY SAVED
error message, 20-7

enhancement labels (symbols and
annotations), 3-3

entering time domain stimulus values, 13-1

ENTRY block, 3-8, 10-1

ENTRY OFF, 6-22

ENTRY OFF key, 3-9, 10-2

environmental characteristics

for HP 8530A, 1-14

equipment supplied, 1-11

error coefficient, 2-7

error messages

ABORTED ENCODER TRIGGERED SWEEP,
20-6

ADDITIONAL STANDARDS NEEDED, 20-6

CALIBRATION RESET, 20-6

CORRECTION MAY BE INVALID, 20-6

ENCODER NOT FOUND, 20-7

ENCODER OFFSET ANGLE ALREADY
SAVED, 20-7

FREQUENCY CONVERTER IS TOO HOT!,
20-7

IF OVERLOAD, 17-19, 20-7

NO IF FOUND, 20-8

OPTION #005 NOT INSTALLED, 20-8

OVERSPEED ERROR - BACKUP, 20-8

PHASE-LOCK LOST, 20-9

SOURCE 1 FAILURE - RF UNLOCKED,
20-9

SOURCE 2 FAILURE - RF UNLOCKED,
20-9

SWEEP SYNC ERROR, 20-9

SYSTEM BUS ADDRESS ERROR, 20-9

TEST SET IS TOO HOT!, 20-11

UNABLE TO RAMP THIS DUAL SOURCE
SETUP, 20-11

VTO FAILURE, 20-11

errors, correcting entry errors, 6-9

EVENT TRIGGER input, 6-23

EVENT TRIGGER input on rear panel, 3-7

EVENT TRIGGER, rear panel BNC, 3-14

Extenders, HP-IB, 1-12

extenders (HP-IB) troubleshooting, 20-10

external disc drive, using, 15-8

EXTERNAL DISPLAY connector, 5-62

EXTERNAL DISPLAY pin out diagram, 3-13

EXTERNAL DISPLAY, rear panel connector
description, 3-13

external displays, critical specifications, 1-19

external displays, supported, 1-19

external monitor, installing, 5-62

external trigger, 6-23, Glossary-5

external trigger (HP-IB triggering), Glossary-5

external triggering, **1-6**, 6-23, Glossary-5

external triggering (HP-IB triggering),
Glossary-5

external video, 5-61

external video monitors, compatible, 5-61

F

factory preset, effect on display settings,
9-2

FACTORY PRESET key, 14-1

fast CW mode buffer, position in data
processing flow, 2-6

fast CW, program examples, 18-32

faster Frequency Domain measurements,
making, 1-16, 1-17

fast IF multiplexing, program example, 18-32

fast measurement speeds, sources compatible
with, 1-16, 1-17

features

display (data presentation), 1-7

features, angle, time, and frequency domain,
1-4

features, description, 1-2

files

deleting, 15-8

directory function, 15-7

un-deleting, 15-8

flow of air, 19-3

Form 1, 2-6

FORM 1 data conversion, program example, 18-21
 Form 1 data transfer format, 18-8
 form 1, definition of, Glossary-3
 Form 2 data transfer format, 18-8
 form 2, definition of, Glossary-3
 FORM 3 and FORM 4, program example, 18-32
 Form 3 data transfer format, 18-8
 form 3, definition of, Glossary-3
 Form 4 data transfer format, 18-8
 form 4, definition of, Glossary-3
 Form 5 data transfer format, 18-8
 form 5, definition of, Glossary-3
 format, 8-2
 imaginary, 8-2
 linear on polar (linear magnitude in polar format), 3-7, **8-2**
 lin mag (linear magnitude in Cartesian format), 3-7, **8-1**
 log mag (logarithmic magnitude in Cartesian format), 3-7, **8-1**
 phase (in Cartesian format), 3-7, **8-1**
 polar mag (logarithmic magnitude in polar format), 3-7, **8-1**
 real, 8-2
 SWR, 8-2
 format control block (on front panel), **8-1**
 format functions, 8-1-7
 format (of display), 3-7, **8-1**
 formatted data, 2-8
 formatted data array, 18-7
 formatted data arrays, 2-8
 formatted data, definition of, Glossary-3
 formatted measurement data arrays, 18-5
 FORMATTED softkey, 15-5
 formatting discs, 15-3
 formatting (display) in the internal data flow, 2-8
 formatting (initializing) a hard disc., 15-9
 FORM FEED softkey, 16-23
 FOUR PARAMETER softkey, 5-58, 12-1
 four parameters, viewing, 5-58, 12-1
 free run trigger, Glossary-5, Glossary-6
 free run triggering, **1-6**, 6-23, Glossary-5, Glossary-6
 frequency converter, HP 8511A/B, 1-18, 2-2
 frequency converter, HP 85310A, 1-18, 2-2
 FREQUENCY CONVERTER IS TOO HOT!
 error message, 20-7
 frequency converters, compatible, 1-18
 frequency converter, selecting the type in use, 11-2, 17-10
 frequency converters, purpose of, 2-2
 frequency domain, **1-5**, 5-55
 frequency domain, illustration of, 1-5, 5-55
 Frequency Domain RCS measurement
 description, 13-4
 frequency down converters, purpose of, 1-2
 frequency list
 deleting duplicate measurements, 6-17
 frequency list, editing, 6-16
 frequency list mode, 6-14
 Frequency List mode, definition of, Glossary-3
 frequency list mode, what comprises a
 complete measurement, Glossary-5
 frequency list, program example, 18-31
 frequency list, save and recall, 6-17
 frequency lists, creating and editing, 6-14
 FREQUENCY LIST softkey, 6-12, 6-14
 frequency list sweep mode, 6-12
 FREQUENCY OFF softkey, 17-7
 FREQUENCY of MEASUREMENT softkey, 6-3
 frequency parameters, setting of, 6-2
 frequency response error term, of RCS
 calibrations, 13-9
 frequency, setting for angle domain
 measurement, 6-3
 frequency, setting for frequency or time
 domain measurement, 6-9
 frequency zoom, 5-42
 front panel controls, 3-5
 front panel display features, 3-2
 fuse, main power, part number (for the
 bottom box), 3-15
 fuse, main power, part number (for the top
 box), 3-14

G

G annotation, 3-3
 gate span, minimum, calculating, 13-14
 gating, 13-12
 gating, during antenna Time Domain
 Impedance measurements, 13-20
 gating during calibration, 13-15
 gating during RCS calibration, 13-15
 gating example, 13-12
 GET command, 6-23
 GET HP-IB command, 1-6
 GigaHertz, selecting, 10-2
 G/n, 10-2
 $\overline{G/n}$ (Giga/nano) key, 3-8, 10-2
 graphics (user) plotting, program example, 18-25

H

H annotation, 3-3
 hard disc, initializing, 15-9

Hard Reset (front panel recessed TEST button), 3-11
 hardware problems, 20-12
 an instrument will not respond to computer control, 20-12
 a System Bus instrument will not respond, 20-13
 HP 85309A LO/IF unit does not turn on, 20-14
 HP 85309A LO power out of range., 20-14
 HP 8530A locks up, 20-12
 hardware state defined, 2-12
 hardware state, definition of, Glossary-4
 HARDWARE STATE softkey, 15-5
 harsh environments and maintenance, 19-3
 height, target, RCS, 5-21
 hierarchical memory of instrument settings, 2-9
 Hold mode, definition of, Glossary-4
 HOLD softkey, 6-20
 HP 3488A remote switch state recall, 17-9
 HP 7550B or 7550 Plus plotters, how to make them function properly, 16-23
 HP 8340/41 RF source, firmware revision considerations, 1-17
 HP 8340/41 RF source, firmware revision upgrade kit (HP 11875A), 1-17
 HP 8340/41, used as an RF Source, 1-17
 HP 8350 sources, used as an LO source), 1-15
 HP 836xx (family) sources, used as an LO source), 1-16
 HP 836xx (family) sources, used as an RF Source, 1-17
 HP 85043A system cabinet, 1-12
 HP 8511A/B frequency converter, 1-18, 2-2
 HP 8511B, selecting for use, 11-2, 17-10
 HP 85309A LO/IF unit problems, 20-14
 HP 8530A and HP 8510C, comparison of, 1-9
 HP 8530A description, 1-2
 HP 8530A locks up, 20-12
 HP 85310A distributed frequency converter, 1-18
 HP 85310A frequency converter, 2-2
 HP 85325A millimeter wave subsystem, 1-18
 HP 85370A position encoder operation, 6-5
 HP 9000 Series 300 workstations, use of LIF disc format, 1-8
 HP DeskJet 500C Printer, trouble when attempting to print, 1-18, 16-10
 HP DeskJet family printers, using, 16-10
 HP-GL graphics, plotting, program example, 18-25
 HP-IB address
 setting the HP-IB address of the HP 8530A, 11-2
 setting the HP-IB address of the System Bus (for use with Pass Through mode), 11-2
 setting the System Bus address for a frequency converter, 11-2
 setting the System Bus address for an external disc drive, 11-3
 setting the System Bus address for an RF switch, 11-3
 setting the System Bus address for a plotter, 11-3
 setting the System Bus address for a printer, 11-3
 setting the System Bus address for a remote switch, 11-3
 setting the System Bus address for pass-through, 11-3
 setting the System Bus address for source #1, 11-2
 setting the System Bus address for source #2, 11-2
 HP-IB addresses, 17-8
 HP-IB address settings, 18-4
 HP-IB cables, maximum length, 1-15
 HP-IB Connector (HP-IB Bus), 3-14
 HP-IB Extenders, 1-12
 HP-IB extenders, troubleshooting, 20-10
 HP-IB interface (system bus), selecting for printer or plotter, 16-2
 HP-IB interface, use with printers and plotters, 16-2
 HP-IB programming, 18-1
 active function output, 18-18
 caution/tell messages, reading and outputting, 18-28
 codes, 18-2
 debugging, 18-16
 delta marker modes, 18-20
 disc storage, 18-21
 display modes, 18-20
 dynamic array allocation, 18-10
 example programs, 18-17
 fast CW modes, 18-32
 fast IF multiplexing, 18-32
 FORM 1 data conversion, 18-21
 FORM 3 and FORM 4, 18-32
 format of data output to the computer, 18-15
 frequency list, 18-31
 HP-GL graphics, 18-25
 HP-IB triggered data acquisition, 18-30
 key code output, 18-30
 learn string, 18-31

- listener-only commands, 18-33
- list of executable examples, 18-35
- marker data output, 18-18
- mnemonics, 18-2
- numeric entries and units terminators, 18-2
- order of commands, 18-2
- outputting the current active function value, 18-15
- outputting the current system state, 18-15
- pass-through mode, 18-23
- pass-thru to System Bus instruments/peripherals, 18-23
- plotting, 18-22
- printing, 18-23
- printing tabular data, 18-23
- printing your own messages on the display, 18-22
- reading marker values in dual channel modes, 18-20
- redefine parameters, 18-28
- status bytes, 18-29
- syntax information, 18-17
- table delay, 18-32
- timing considerations, 18-3
- trace data output and input, 18-21
- transferring trace data to receiver memory, 18-13
- universal commands, 18-33
- user display graphics, 18-25
- user graphics, 18-25
- using = MARKER, 18-21
- wait not required, 18-30
- wait required, 18-30
- HP-IB R, L, T, S, annunciators, 3-11
- HP-IB trigger, 6-23, Glossary-5
- HP-IB triggered data acquisition, program example, 18-30
- HP-IB triggering, **1-6**, 6-23, Glossary-5
- HP-IB USES FACTORY PRESET softkey, 17-9
- HP-IB USES USR PRESET softkey, 17-9
- HP PaintJet, and PaintJet XL printers, using, 16-11
- HP PaintJet, and PaintJet XL printer switch settings, 16-11
- HP QuietJet and QuietJet Plus printer switch settings, 16-11
- HP QuietJet and QuietJet Plus, using, 16-11
- humidity, operating and storage, 1-14
- Hz, selecting, 10-2

I

- IF calibration, 17-5
- IF calibration (correction) controls, 17-5
- IF CORRECT AUTO softkey, 17-5
- IF correction, 17-5
- IF CORRECTION softkey, 17-5
- IF CORRECT MANUAL softkey, 17-5
- IF/DISPLAY INTERCONNECT, rear panel connector, 3-13
- IF Gain, 17-18
- IF Gain controls, automatic and manual, 17-19
- IF GAIN softkey, 17-18
- IF OVERLOAD, 6-22
- IF OVERLOAD, error message, 17-19
- IF OVERLOAD error message, 20-7
- IF signal level problems, 20-3
- IF signal problems, 20-3
- imaginary and real data, 2-3
- imaginary display format, 8-2
- IMAGINARY softkey, 8-2
- impulse envelope, 13-3
- impulse waveforms, different, 13-6
- impulse waveforms, user-defined, 13-6
- increment angle, setting, 6-4
- INCREMENT ANGLE softkey, 6-4
- initializing a hard disc, 15-9
- initializing discs, 15-3
- input, definition of, Glossary-4
- input output features, description of, 1-8
- input ratios, 1-6
- installation, printer, 16-4
- instrument factory preset conditions, 2-11, 14-1
- instruments, compatible, 1-15
- instruments do not respond to computer control, 20-12
- instruments do not respond to HP 8530A control, 20-13
- instrument settings, automatic recall of, 2-9
- INSTRUMENT STATE block, 3-10, **11-1**
- INST STATE 1-8 softkey, 15-4
- INST STATE ALL softkey, 15-4
- intensity, CRT, 5-58
- intensity, display background, 5-58
- internal data flow, 2-6
- internal data processing illustration, 2-3
- internal trigger, 6-23
- internal trigger (free run), Glossary-5, Glossary-6
- internal triggering (free run), Glossary-5, Glossary-6
- isolation calibration procedure, antenna, 5-14, 5-16

K

key code output, program example, 18-30
kiloHertz, selecting, 10-2
k/m, 10-2
(k/m) (kilo/milli) key, 3-8, 10-2

L

landscape printer mode, 16-16
landscape printing orientation, 16-15, 16-16
L annunciator (listener HP-IB mode), 3-11
laser printer configuration, 16-6
laser printers, using, 16-6
learn string (using), program example, 18-31
learn sweep, defined, 6-12
LEFT LOWER softkey, 16-26
LEFT UPPER softkey, 16-26
leveling power, 17-9
LIF and DOS disc formats, 15-3
LIF disc format, changing to, 15-3
LIF (logical interchange format), definition of, Glossary-4
LIF (Logical Interchange Format) disc format, 1-8
limited instrument state memory, 2-9
linear magnitude display format, 8-1
linear on polar display format, 8-2
linear on polar (linear magnitude in polar format), 3-7, **8-2**
LINEAR on POLAR softkey, 8-2
line voltage fuse part number (for the bottom box), 3-15
line voltage fuse, part number (for the top box), 3-14
line voltage selector (for the bottom box), 3-15
line voltage selector (for the top box), 3-14
(LIN MAG), 8-1
lin mag (linear magnitude in Cartesian format), 3-7, **8-1**
LIN on POLAR format, angle domain versus frequency domain, 8-2
LIST ALL PARAMETERS softkey, 16-17
listener annunciator (L), 3-11
listing, programming examples, 18-35
LIST ONE PARAMETER softkey, 16-17
LIST PARAMETERS softkey, 16-19
list skip factor, 16-18
LIST SKIP FACTOR softkey, 16-18
lists, markers display of, 5-76
LIST TRACE VALUES softkey, 16-17
loading calibration kit data from disc, 5-25
loading disc files, 15-6
loading instrument data from disc, 15-1
loading the receiver operating system from disc, 17-18

(LOCAL) key, 3-10, 11-2
LOCAL menu, 17-8
lock speed, 17-4
LOCK SPEED FAST softkey, 17-4
LOCK SPEED NORMAL softkey, 17-4
lock type, 17-3
LOCK TYPE EXTERNAL softkey, 17-3
LOCK TYPE INTERNAL softkey, 17-3
LOCK TYPE NONE softkey, 17-3
logical interchange format (LIF), definition of, Glossary-4
(LOG MAG), 8-1
log mag (logarithmic magnitude in Cartesian format), 3-7, **8-1**
log magnitude display format, 8-1
L.O. PHASELOCK OUT, rear panel BNC, 3-14
LO POWER OUT OF RANGE light is ON (HP 85309A), 20-4
LO power out of range troubleshooting, 20-14
LO signal level problems, 20-4
LO source configuration, 17-11
LO sources, compatible, 1-15

M

machine dump, definition of, Glossary-4
MACHINE DUMP softkey, 15-5
magnitude offset, 9-4
magnitude slope, 9-4
maintenance of the receiver system, 19-3
maintenance, periodic, 19-3
making faster Frequency Domain measurements, 1-16, 1-17
M annotation, 3-3
manual IF calibration (correction), 17-5
marker data output, program example, 18-18
marker functions, 5-73-82
(=MARKER) key, 3-9, 6-10, 10-2
(MARKER) key, 3-9
marker list plots, 16-22
marker list prints, 16-4
marker lists, 5-76
markers
 continuous, 5-75
 delta markers, 5-78, **5-81**
 description, 1-8
 discrete, 5-75
 making a marker the active marker, 5-74
 marker to maximum, 5-79
 marker to minimum, 5-79
 marker to target, 5-79
 moving the marker continuously or by discrete measurement points, 5-75
 search modes, 5-79

search right and left, 5-80
 setting the sweep with markers, 6-10
 units, 5-75
 using, 5-73
 markers, finding beamwidth, 5-83
 markers, removing all markers from the display, 5-74
 marker target search, 5-83
 masking, 13-11
 MATH OPERATIONS softkey, 5-70
 MATH (/) softkey, 5-70
 math, trace, 1-7, 5-70
 MAXIMUM windowing mode, 13-6
 measurement display custom titles, 3-3
 measurement, exhaustive definition of, Glossary-4
 measurement features, 1-4
 measurement inputs
 a1, a2, b1, and b2, 1-6
 (PARAM 1) (PARAM 2) (PARAM 3) and (PARAM 4), 1-6
 ratios of, 1-6
 MEASUREMENT (RESTART), 9-5
 (MEASUREMENT RESTART) key, 3-11
 measurement setup, typical block diagram of, 1-2
 measurements, speeding them up, 1-16, 1-17
 MegaHertz, selecting, 10-2
 MEMORY 1-8 softkey, 15-4
 MEMORY ALL softkey, 15-4
 memory and data traces, displaying simultaneously, 5-68
 memory data, 2-7
 memory data array, 18-7
 memory data arrays, 2-7
 memory data, definition of, Glossary-6
 memory of instrument settings, automatic, 2-9
 memory registers, default registers for each parameter on each channel, 5-67
 MEMORY softkey, 5-67
 memory, trace, 1-7, 5-67
 memory trace, displaying, 5-67
 MENUS block, 3-9
 menus, plotting of, 16-22
 menus, printing of, 16-4
 message areas, 3-2
 meters, selecting, 10-2
 μ meters, selecting, 10-2
 microprocessor
 clock speed, 2-5
 description, 2-5
 type, 2-5
 microseconds, entering time domain values in, 13-1

μ seconds, selecting, 10-2
 Microwave Design System, 15-3
 millimeters, selecting, 10-2
 millimeter wave subsystem, HP x85325A, 1-18
 milliseconds, entering time domain values in, 13-1
 milliseconds, selecting, 10-2
 minimum gate span, calculating, 13-14
 MINIMUM windowing mode, 13-6
 MINUS (-) softkey, 5-70
 M/ μ , 10-2
 (M/ μ) (Mega/micro) key, 3-8, 10-2
 mnemonics, HP-IB programming, 18-2
 modify cal sets, 5-42
 modify CRT colors, 5-60
 monitor, external, installing, 5-62
 monitors, compatible, 5-61
 monitors, external (critical specifications), 1-19
 monitors, external (supported), 1-19
 monitors, external video, 5-61
 MS-DOS[®] compatible computers, use of DOS disc format, 1-8
 multipath antenna measurements in the Time Domain, 13-21
 multiple source menu, 17-11
 multiple source mode, 17-11
 multiple sources, controlling, 17-11
 MULTIPLIER DENOM. softkey, 17-13
 MULTIPLIER NUMER. softkey, 17-13
 MULTIPLY (*) softkey, 5-70
 MULT. SRC ON / SAVE softkey, 17-13

N

nanometers, selecting, 10-2
 nanoseconds, entering time domain values in, 13-1
 nanoseconds, selecting, 10-2
 negative numbers, entering, 3-8
 net weight, 1-14
 network analysis, option 011, 1-8
 network analyzer 1-port calibration, 5-24
 network analyzer calibration
 description, 5-4
 new features of HP 8530A, compared to HP 8510C, 1-9
 NO IF FOUND, 6-22
 NO IF FOUND, error message, 20-8
 noise reduction techniques, 9-5
 non-HP printers, using, 16-14
 non-volatile memory, 5-69
 normalization, 9-4
 NORMALIZE ACT. TRACE softkey, 9-4

NORMALIZE ALL TO ACT.TRACE softkey, 9-4
NORMALIZE MENU softkey, 9-4
normalizing data to the peak of the main lobe, 9-4
normal step mode, 17-3
NORMAL windowing mode, 13-6
number of groups, purpose of, 6-21
NUMBER of GROUPS softkey, 6-20
number of points and frequency resolution, 6-11
number of points, selecting, 6-10
NUMBER of POINTS softkey, 6-10
numbers, entering, 3-8, 10-2
numerator, measurement ratio, 7-4
NUMERATOR softkey, 7-4
numeric values, entering, 3-8, 10-2

O

O annotation, 3-3
offset
 clear (position encoder function), 6-7
 save (position encoder function), 6-7
OFFSET FREQUENCY softkey, 17-13
OPERATING PARAMETERS softkey, 16-19
operating precautions, 1-1
operating system, loading from disc, 17-18
operating system, storing to disc, 17-18
operator's Check, 19-1
OPTION #005 NOT INSTALLED, error message, 20-8
option 011, HP 8510C network analyzer operation, 1-8
options, 1-10
 908, rack mount kit (for instruments without handles), 1-10
 913, rack mount kit (for instruments with handles), 1-10
 option 005, positioner encoder operation, 1-10
 option 010, time domain operation, 1-10
 option 011, add HP 8510C firmware operating system, 1-10
 W31, extended warranty for HP 8530A, 1-10
overheating, 19-3
OVERSPEED ERROR - BACKUP, error message, 20-8

P

PaintJet, and PaintJet XL printers, using, 16-11
PaintJet, and PaintJet XL printer switch settings, 16-11
paint, touch up, 1-13

(PARAM 1), 1-6
PARAM 1 key, 7-2
(PARAM 2), 1-6
PARAM 2 key, 7-2
(PARAM 3), 1-6
PARAM 3 key, 7-2
(PARAM 4), 1-6
PARAM 4 key, 7-2
parameter control block (on front panel), **3-7**
parameter conversion, 7-4
parameter, convert parameter, 2-7
parameter, definition of, Glossary-6
parameter definitions, factory preset, 7-3
parameter functions, 7-1
parameter, redefining, 7-3
parameters, 1-6
parameters, redefining, program example, 18-28
parameters, service, 7-2
pass-through mode, program example, 18-23
PASS THROUGH softkey, 11-3
Peek/Poke, 17-22
pen color, selecting, 16-23
periodic maintenance, 19-3
(PHASE), 8-1
phase display format, 8-1
phase (in Cartesian format), 3-7, **8-1**
phaselock controls, 17-3
phase lock input diagram, 2-5
PHASE LOCK LOST, 6-22
PHASE-LOCK LOST, error message, 20-9
phase lock, phase locking on one reference input, measuring the reference signal on the other, 7-4
phase lock, selecting the phase lock input, 7-4
PHASE LOCK softkey, 7-4
phase offset, 9-4
PHASE OFFSET softkey, 9-4
picoseconds, entering time domain values in, 13-1
pin out diagram, EXTERNAL DISPLAY, 3-13
pin out diagram, RS-232 PORT #1 and #2, 3-12
PLOT ALL FOUR PARAMETERS softkey, 16-25
PLOT ALL softkey, 16-25
plot buffer, 3-12, 16-2
PLOT DATA softkey, 16-25
PLOT GRATICULE softkey, 16-25
PLOT MARKERS(S) softkey, 16-25
PLOT MEMORY softkey, 16-25
plot menus, 16-22
PLOT PARAMETERS softkey, 16-19

PLOTTER

- HP-IB softkey, 11-3
- RS-232 PORT #1 softkey, 11-3
- RS-232 PORT #2 softkey, 11-3
- plotter interfaces, supported, 16-2
- plotter pen color, selecting, 16-23
- plotters, supported, 1-19
- plotters, using the HP 7550B or 7550 Plus properly, 16-23
- PLOT TEXT softkey, 16-25
- plotting, 16-25
- plotting a 1/4 size snapshot in a selected page quadrant, 16-26
- plotting four snapshots per page, 16-26
- plotting individual display components, 16-25
- plotting options, 16-23
- plotting, program example, 18-22
- plotting the entire display, 16-25
- plotting user graphics, program example, 18-25
- PLOT TITLE softkey, 16-25
- PLOT TO PLOTTER softkey, 16-25
- PLOT TYPE COLOR softkey, 16-23
- PLOT TYPE MONOCHROME softkey, 16-23
- plus/minus 180 degree display mode, selecting, 6-6
- PLUS (+) softkey, 5-70
- Poke, 17-22
- polar display format, angle domain versus frequency domain, 8-2
- POLAR MAG**, 8-1
- POLAR MAG format, angle domain versus frequency domain, 8-2
- polar mag (logarithmic magnitude in polar format), 3-7, **8-1**
- polar magnitude display format (linear), 8-1
- portrait printer mode, 16-16
- portrait printing orientation, 16-15, 16-16
- position encoder
 - operation, 6-5
- position encoder angle display, moving, 6-6
- position encoder angle display, turning OFF, 6-6
- position encoder angle display, turning ON, 6-6
- power, compensating for power loss at high frequencies with power slope, 6-22
- power consumption, 1-14
- power leveling, 17-9
- power, setting, 6-21
- POWER SLOPE softkey, 6-22
- power slope, using, 6-22
- POWER SOURCE 1 softkey, 6-22
- precautions when changing addresses of System Bus Instruments, 17-8

- precautions when changing RF or LO sources on the System Bus, 17-8
- PRES command, 17-9
- presetting the HP 8530A, 2-11, 14-1
- preset, user, 1-7
- principles of operation, 2-2
- print buffer, 3-12, 16-2
- PRINTER
 - HP-IB softkey, 11-3
 - RS-232 PORT #1 softkey, 11-3
 - RS-232 PORT #2 softkey, 11-3
- printer configuration
 - HP DeskJet, DeskJet Plus, or DeskJet 500 printers, 16-10
 - HP PaintJet and PaintJet XL printers, 16-11
 - HP QuietJet and QuietJet Plus printers, 16-11
 - HP ThinkJet printer, 16-13
 - laser printer, 16-6
 - laser printers, 16-6
 - non-HP printers, 16-14
- printer installation, 16-4
- printer interfaces, supported, 16-2
- PRINTER RESOLUTION softkey, 16-6, 16-10, 16-12, 16-13
- printers, supported, 1-18
- printing
 - landscape, 16-15, 16-16
 - portrait, 16-15, 16-16
- printing in color, 16-12
- printing instrument settings and system configuration, 16-19
- printing one snapshot per page, 16-16
- printing tabular measurement data, 16-17
- printing two snapshots per page, 16-16
- PRINT LANDSCAPE softkey, 16-15, 16-16
- PRINT PORTRAIT softkey, 16-15, 16-16
- print resolution setting
 - for HP DeskJet family printers, 16-10
 - for HP PaintJet and PaintJet XL Printers, 16-12
 - for HP QuietJet and QuietJet Plus Printers, 16-12
 - for HP ThinkJet printer, 16-13
 - for laser printers, 16-6
- PRIOR MENU** key, 3-9, 10-2
- product description, 1-2
- programming example listing, 18-35
- programming codes, 18-2
- programming examples
 - active function output, 18-18
 - caution/tell messages, reading and outputting, 18-28
 - delta marker modes, 18-20

- disc storage, 18-21
- display modes, 18-20
- fast CW modes, 18-32
- fast IF multiplexing, 18-32
- FORM 1 data conversion, 18-21
- FORM 3 and FORM 4, 18-32
- frequency list, 18-31
- HP-GL graphics, 18-25
- HP-IB triggered data acquisition, 18-30
- key code output, 18-30
- marker data output, 18-18
- pass-through mode, 18-23
- plotting, 18-22
- printing tabular data, 18-23
- redefine parameters, 18-28
- status bytes, 18-29
- syntax information, 18-17
- table delay, 18-32
- trace data output and input, 18-21
- user graphics, 18-25
- using =MARKER, 18-21
- using the learn string, 18-31
- wait not required, 18-30
- wait required, 18-30
- programming mnemonics, 18-2
- programming over HP-IB, 18-1
- PULSE OUT (OPT 008), rear panel BNC, 3-15

Q

- query system state, 18-15
- quick step mode, 17-4
- QuietJet and QuietJet Plus printer switch settings, 16-11
- QuietJet and QuietJet Plus, using, 16-11

R

- rack mount kits, 1-10
- radar cross section calibration, 5-18
- Radar Cross Section Measurements, in the time domain, 13-3
- radius, target, RCS, 5-21
- RAMP softkey, 6-12
- ramp sweep mode, 6-12
- Ramp Sweep mode, definition of, Glossary-6
- ramp sweep mode, what comprises a complete measurement, Glossary-4
- range clutter, 13-9
- range gating, 13-12
- range gating during calibration, 13-15
- range gating example, 13-12
- R annunciator (remote HP-IB mode), 3-11
- ratio, definition of, Glossary-7
- raw data, 2-6, 18-6
- raw data array, 18-6
- raw data arrays, 2-6

- raw data, definition of, Glossary-7
- raw data stages, 2-6
- raw measurement data arrays, 18-5
- RCS background calibration, 5-23
- RCS background calibration, updating, 5-23
- RCS calibration, 5-18
 - description, 5-4
- RCS calibration, effect on Time Domain responses, 13-9
- RCS calibration, for each RCS mount, 5-23
- RCS calibration overview, 5-19
- RCS calibration, using gating with, 13-15
- RCS down-range resolution, 13-5
- RCS gating, 13-12
- RCS gating during calibration, 13-15
- RCS gating example, 13-12
- RCS measurements, converting time to distance, 13-5
- RCS measurement setup, typical, 13-3
- RCS targets, defining dimensions of, 5-21
- RCS target, selecting, 5-21
- RCS target types of, 5-21
- RCS waveforms, 13-6
- RCS waveforms, user-defined, 13-6
- real and imaginary data, 2-3
- real display format, 8-2
- REAL softkey, 8-2
- real-time annotations and plots, 16-22
- real-time annotations and printouts, 16-4
- RECALL COLORS softkey, 5-61
- recalling an instrument state, 11-4, 14-1
- recalling instrument measurement settings, 11-4, 14-1
- RECALL** key, 3-10, 11-4, 14-1
- receiver description, 1-2
- receiver locks up, 20-12
- RECEIVER READY rear panel BNC, 3-14
- record increment pulse, 3-7
- redefine parameter, 7-3
- REDEFINE PARAMETER softkey, 7-4
- redefine parameters, program example, 18-28
- reference line position, changing, 9-2
- reference value, changing, 9-2
- REF POSN**, 9-2
- REF VALUE**, 9-2
- reloading the receiver operating system from disc, 17-18
- remote annunciator (R), 3-11
- REMOTE SWITCH softkey, 11-3
- remote switch state recall, 17-9
- RESET IF CORRECTION softkey, 17-5
- resolution, down-range, 13-5
- resolution setting
 - for HP DeskJet family printers, 16-10

- for HP PaintJet and PaintJet XL Printers, 16-12
- for HP QuietJet and QuietJet Plus Printers, 16-12
- for HP ThinkJet printer, 16-13
- for laser printers, 16-6
- response and isolation calibration (network analyzer), 5-29
- response calibration, for RCS measurements, 5-18
- response calibration (network analyzer), 5-27
- response functions, 9-1
- response menu, 9-3
- RESPONSE (MENU), 9-3
- (RESTART) key, 3-11
- RESTORE DISPLAY softkey, 16-19
- RESUME CAL SEQUENCE softkey, 5-37
- resuming a calibration sequence after leaving it, 5-37
- reverberations in an RCS target, 13-11
- RF burst, 13-3
- RFI, allowable, 1-14
- RF sources, compatible, 1-17
- RF source, setting power, 6-21
- RF SWITCH softkey, 11-3
- RIGHT LOWER softkey, 16-26
- RIGHT UPPER softkey, 16-26
- rotary joints, problems with, 20-5
- RS-232 #1 and RS-232 #2, rear panel connectors, 3-12
- RS-232 interface, use with printers and plotters, 16-2
- RS-232 PORT #1 and #2 pin out diagram, 3-12
- RS-232 PORT #1 softkey, 16-4, 16-22
- RS-232 PORT #2 softkey, 16-4, 16-22
- RS-232 Port, selecting port #1 for a plotter, 11-3
- RS-232 Port, selecting port #1 for a printer, 11-3
- RS-232 Port, selecting port #2 for a plotter, 11-3
- RS-232 Port, selecting port #2 for a printer, 11-3

S

- safety precautions, 1-1
- S annotation, 3-3
- S annunciator (SRQ request), 3-11
- save and recall feature, added benefit over the automatic settings memory (limited instrument state), 2-10
- save and recall registers
 - description, 1-7

- SAVE COLORS softkey, 5-61
- (SAVE) key, 3-10, 11-4, 14-1
- SAVE OFFSET softkey (position encoder function), 6-7
- saving an instrument state, 11-4, 14-1
- saving an instrument state as the user preset state, 11-4, 14-1
- Saving instrument data to disc, 15-1
- saving instrument measurement settings, 11-4, 14-1
- saving trace data to display memory, 5-67
- (SCALE), 9-2
- scaling and display, in the internal data flow, 2-8
- scattering, target, 13-11
- screen annotations, adding to the screen, 16-3
- screen background intensity, 5-58
- screen intensity, 5-58
- search modes, markers, 5-79
- seconds, entering time domain values in, 13-1
- seconds, selecting, 10-2
- security features, 17-7
- SEGMENT DONE softkey, 6-14
- SEGMENT START softkey, 6-14
- SEGMENT STEP SIZE softkey, 6-14
- SEGMENT STOP softkey, 6-14
- SELECT DEFAULTS}} (in the Display menu), 5-70
- SELECT DEFAULTS}} (in the Display Menu), 5-69
- selecting the type of frequency converter in use, 11-2, 17-10
- select quadrant, 16-23
- SELECT QUADRANT softkey, 16-26
- selftest, 19-1, 19-2
- serial interface, 16-2
- serial interface, selecting for printer or plotter, 16-2
- serial ports (RS-232), 3-12
- SERVICE 1 a1 softkey, 7-2
- SERVICE 2 b2 softkey, 7-2
- SERVICE 3 a2 softkey, 7-2
- SERVICE 4 b1 softkey, 7-2
- service functions, 17-17
- SERVICE FUNCTIONS softkey, 17-17
- service parameters, 7-2
- service test menu, 17-17
- SET DAY softkey, 17-6
- SET MONTH softkey, 17-6
- SET PEN NUMBERS softkey, 16-23, **16-23**
- settings, automatic recall of, 2-9
- setting the time and date, 17-6
- SET YEAR softkey, 17-6

shadowing, target, 13-11
 shipping weight, 1-14
 sign of a number, changing, 3-8, 10-2
 single and dual synchro (position encoder) functions, 6-6
 single angle mode, what comprises a complete measurement, Glossary-5
 SINGLE ANGLE softkey, 6-4
 SINGLE PARAMETER softkey, 5-58, 12-1
 single parameter, viewing, 5-58, 12-1
 Single Point mode, definition of, Glossary-7
 single point mode, what comprises a complete measurement, Glossary-5
 SINGLE POINT softkey, 6-12
 single point sweep mode, 6-12
 SINGLE SEGMENT softkey, 6-17
 SINGLE}} single sweep softkey in Stimulus More menu, 6-20
 size and weight information, 1-14
 skip factor, 16-18
 SLOPE SRC1 ON softkey, 6-22
 smoothing, 9-5, **9-6**
 smoothing, in the internal data flow, 2-8
 SMOOTHING softkey, 9-5
 snapshot, definition of, Glossary-7
 snapshot, plotting, 16-25
 snapshot, printing, 16-16
 softkey menu general description, 3-4
 softkey menus, general description and explanation of special markings, 3-4
 SOFTWARE REVISION softkey, 17-22
 SOURCE 1 EXT. LEVEL softkey, 17-9
 SOURCE 1 FAILURE - RF UNLOCKED, 20-9
 SOURCE 1 INTERNAL softkey, 17-9
 SOURCE 1 MM MODULE softkey, 17-9
 SOURCE #1 softkey, 11-2
 SOURCE 2 FAILURE - RF UNLOCKED, 20-9
 SOURCE #2 softkey, 11-2
 source, setting power, 6-21
 sources that provide fastest Frequency Domain measurement speeds, 1-16, 1-17
(SPAN), 6-3, 6-9
 S-parameter measurements, 1-8
 special display annotations, 3-3
 specifications, 1-14
 speed comparison, step versus ramp mode in HP 8511-based systems, 6-13
 speed of microprocessor, 2-5
 SRQ, 18-15
 SRQ annunciator (S), 3-11
 standard gain antenna definition file, example, 5-50
 standard gain antennas
 antenna definitions supplied in HP 8530A, 5-54
 creating a definition file, 5-46
 creating multiple definitions in one cal definition file., 5-53
 loading a cal definition file, 5-52
 saving a cal definition file, 5-52
(START), 6-3, 6-9
 state, definition of, Glossary-4
 static electricity (electrostatic discharge), 1-1
 status bytes, program example, 18-29
 STEP softkey, 6-12
 step sweep mode, 6-12
 Step Sweep mode, definition of, Glossary-7
 step sweep mode, what comprises a complete measurement, Glossary-5
 step type, 17-3
 STEP TYPE NORMAL softkey, 17-3
 STEP TYPE QUICK softkey, 17-3
 stimulus
 coupling settings between channel 1 and 2, 6-21
 uncoupling settings between channel 1 and 2, 6-21
 stimulus control block (on front panel), **3-7**
 stimulus, definition of, Glossary-7
 stimulus functions, 6-2-22
 stimulus functions, coupled and uncoupled, 2-8
 stimulus functions, coupling and uncoupling, 3-6
 stimulus power, setting, 6-21
 stimulus values area, 3-2
(STOP), 6-3, 6-9
 STOP SWEEP BNC, recommendation to connect a BNC short to 8340/41, 1-17
 STOP SWP, rear panel BNC, 3-15
 storing disc files, 15-4
 storing the receiver operating system to disc, 17-18
 storing to disc
 cal kit definitions, 15-4
 cal sets (calibration data), 15-4
 hardware state (configuration settings), 15-4
 instrument state registers (measurement settings), 15-4
 machine dump (all registers and states), 15-4
 measurement data (raw, corrected or formatted), 15-4
 memory registers, 15-4
 storing trace data to display memory, 5-67
 supplied equipment, 1-11

- supported external displays, 1-19
- supported frequency converters, 1-18
- supported instruments, 1-15
- supported LO sources, 1-15
- supported plotters, 1-19
- supported printers, 1-18
- supported RF sources, 1-17
- SVGA monitors, (not supported by HP 8530A), 1-19
- sweep frequency, 6-9
- SWEEP IN 0-10V, rear panel BNC, 3-14
- sweep modes
 - frequency list, 6-12
 - ramp, 6-12
 - single point, 6-12
 - step, 6-12
- sweep modes (frequency domain), frequency list mode, 6-14
- sweep modes (frequency domain), ramp sweep mode, 6-12
- sweep modes (frequency domain), step sweep mode, 6-12
- SWEEP SYNC ERROR, error message, 20-9
- sweep time
 - changing, 6-18
 - determining optimum, 6-18
- sweep time, default settings with different number of points, 6-18
- sweep time, measurement distortion caused by, 6-18
- SWEEP TIME softkey, 6-18
- swept angle mode, what comprises a complete measurement, Glossary-5
- SWEPT ANGLE softkey, 6-4
- switch settings
 - HP PaintJet and PaintJet XL, 16-11
 - HP QuietJet and QuietJet Plus, 16-11
 - HP ThinkJet Printer, 16-13
- SWR display format, 8-2
- SWR softkey, 8-2
- symbols and annotations (enhancement labels), 3-3
- synchro
 - encoder operation, 6-5
- SYNCHRO
 - SINGLE mode (position encoder function), 6-6
 - SINGLE softkey (position encoder function), 6-6
- synchronization with external monitors, 5-62
- syntax information, program example, 18-17
- SYS/OPER PARAMETERS softkey, 16-19
- system bus, 2-2
- System Bus address
 - setting the HP-IB address of the System Bus (for use with Pass Through mode), 11-2
 - setting the System Bus address for a frequency converter, 11-2
 - setting the System Bus address for an external disc drive, 11-3
 - setting the System Bus address for an RF switch, 11-3
 - setting the System Bus address for a plotter, 11-3
 - setting the System Bus address for a printer, 11-3
 - setting the System Bus address for a remote switch, 11-3
 - setting the System Bus address for pass-through, 11-3
 - setting the System Bus address for source #1, 11-2
 - setting the System Bus address for source #2, 11-2
- SYSTEM BUS ADDRESS ERROR, error message, 20-9
- System Bus cables, maximum length, 1-15
- SYSTEM BUS 'LOCAL' softkey, 17-18
- SYSTEM BUS 'REMOTE' softkey, 17-18
- system bus, selecting for printer or plotter, 16-2
- SYSTEM BUS softkey, 11-2
- system cabinet, 1-12
- system functions, 17-2
- SYSTEM INTERCONNECT (System Bus connector), rear panel, 3-13
- (SYSTEM)** key, 17-2
- system menu, 17-2
- system messages, 3-3
- SYSTEM PARAMETERS softkey, 16-19
- system state query, 18-15
- system status information, getting over HP-IB, 18-15

T

- table delay data array, 18-7
- table delay, program example, 18-32
- TABLE DELAY softkey, 9-8
- tabular data, printing, program example, 18-23
- talker annunciator (T), 3-11
- T annunciator (talker HP-IB mode), 3-11
- target height, RCS, 5-21
- target masking, 13-11
- target position shift (in time), 13-10
- target radius, RCS, 5-21
- target, RCS, defining dimensions of, 5-21
- target, RCS, selecting, 5-21

target, RCS, types of, 5-21
 target reverberations, RCS, 13-11
 target scattering, 13-11
 target search with markers, 5-83
 target shadowing, 13-11
 target width, RCS, 5-21
 technical description of HP 8530A, 2-2
 temperature, operating and storage, 1-14
 terminators, units, 3-8, 10-1
 terminator (units) keys and what they represent in different modes, 3-8, 10-2
 TEST button (recessed), 3-11
 test menu, 17-17
 TEST MENU softkey, 17-17
 TEST, recessed button, 19-1, 19-2
 TEST SET INTERCONNECT, rear panel, 3-14
 TEST SET IS TOO HOT!, 20-11
 test set too hot message, 19-3
 theory (principles) of operation, 2-2
 ThinkJet printer configuration, 16-13
 ThinkJet printer switch settings, 16-13
 ThinkJet printer, using, 16-13
 time/date, setting, 17-6
 time domain, **1-5**, 5-56
 Time Domain
 basic principles of operation, 13-1
 time domain gating, 13-12
 time domain gating during calibration, 13-15
 time domain gating example, 13-12
 time domain general theory, 13-2
 time domain, illustration of, 1-5, 5-56
 Time Domain Radar Cross Section Measurements, 13-3
 Time Domain RCS response, interpreting, 13-4
 time domain stimulus values, entering, 13-1
 time domain transform, 13-2
 Time Domain transmission measurements, 13-21
 time to distance conversion in time domain RCS measurements, 13-5
 title
 creating, 17-6
 deleting, 17-6
 title area, definition of, 3-3
 touch up paint, 1-13
 trace data output and input, program example, 18-21
 trace math and trace memory, 1-7
 trace math, changing default math operation, 5-70
 trace math, comparing Channel 1 data with Channel 2 data, 5-71
 trace math, default operation (vector division), 5-70
 trace math operations, 5-70
 trace memory and trace math, 1-7
 trace memory operation, 5-67
 trace, storing to display memory, 5-67
 transfer formats for data
 Form 1, 2-6
 transmission measurements, in Time Domain, 13-21
 TRG SRC EXTERNAL softkey, 6-23
 TRG SRC FREE RUN softkey, 6-23
 TRG SRC HPIB softkey, 6-23
 trigger, external, 6-23, Glossary-5
 trigger, HP-IB, Glossary-5
 triggering
 description, 1-6
 external, **1-6**
 free run, **1-6**
 HP-IB, **1-6**
 triggering, advanced features, 6-24
 triggering, external, 6-23, Glossary-5
 triggering, free run, 6-23
 triggering, HP-IB, 6-23, Glossary-5
 triggering modes, 6-23
 triggering, waiting for a trigger before changing stimulus value, 6-24
 triggering, waiting for a trigger before measuring a specific parameter, 6-24
 TRIGGER IN, rear panel BNC, 3-15
 trigger, internal, 6-23
 trigger modes, 6-23
 TRIGGER MODE softkey, 6-23
 TRIGGER PARAM 1 softkey, 6-24
 TRIGGER PARAM 2 softkey, 6-24
 TRIGGER PARAM 3 softkey, 6-24
 TRIGGER PARAM 4 softkey, 6-24
 TRIGGER STIMULUS softkey, 6-24
 TRIG SRC EXTERNAL , 6-23
 TRIG SRC HPIB , 6-23
 TRIG SRC INTERNAL , 6-23
 trim sweep, adjusting, 5-45
 two channels, viewing, 5-58, 12-1
 typical measurement setup, 1-2

U

UNABLE TO RAMP THIS DUAL SOURCE SETUP, error message, 20-11
 uncoupled and coupled stimulus functions, 2-8, 3-6
 uncoupling stimulus settings between channels, 6-21
 un-deleting disc files, 15-8
 unit number, for external disc drive, 15-9
 units (terminator) keys and what they represent in different modes, 3-8, 10-2

units terminators, 3-8, 10-1
USER DISPLAY softkey, 15-5
user graphics, plotting, program example,
18-25
user preset, defining, 11-4, 14-1
user preset description, 1-7
(USER PRESET) key, 3-10, 11-4, 14-1
using a plotter, 16-22
using = MARKER, program example, 18-21

V

values, entering, 3-8, 10-2
VA rating, 1-14
VELOCITY FACTOR softkey, 9-8
verifying your calibration, 5-39
VGA monitors, (not supported by HP 8530A),
1-19
video monitors, 5-61
video monitors, compatible, 5-61
viewing a 40 dB pattern, 9-5
viewing a 60 dB pattern, 9-5
viewing a single parameter, 5-58, 12-1
viewing data from disc, 12-2
viewing four parameters, 5-58, 12-1
viewing two channels, 5-58, 12-1
volatile memory, 5-69
volume number, for external disc drive, 15-9
VTO FAILURE, 6-22
VTO FAILURE, error message, 20-11

W

wait not required, program example, 18-30
wait required, program example, 18-30
warranty, vii
WAVEGUIDE DELAY softkey, 9-8
weight and size information, 1-14
weight, net, 1-14
weight, shipping, 1-14
width, target, RCS, 5-21
windowing, description of maximum window
mode, 13-6
windowing, description of minimum window
mode, 13-6
windowing, description of normal window
mode, 13-6
windowing mode, recommended, 13-6
windowing, simplified description, 13-6
windowing, user-defined, 13-6

X

x1, 10-2
(x1) (basic units
dB, dBm, degrees, seconds, Hz key, 10-2
(x1) (basic units terminator key), 3-8

Z

zoom, frequency subset, 5-42

