

Errata

Title & Document Type: 8780A Operating Manual

Manual Part Number: 08780-90045

Revision Date: July 1996

HP References in this Manual

This manual may contain references to HP or Hewlett-Packard. Please note that Hewlett-Packard's former test and measurement, semiconductor products and chemical analysis businesses are now part of Agilent Technologies. We have made no changes to this manual copy. The HP XXXX referred to in this document is now the Agilent XXXX. For example, model number HP8648A is now model number Agilent 8648A.

About this Manual

We've added this manual to the Agilent website in an effort to help you support your product. This manual provides the best information we could find. It may be incomplete or contain dated information, and the scan quality may not be ideal. If we find a better copy in the future, we will add it to the Agilent website.

Support for Your Product

Agilent no longer sells or supports this product. You will find any other available product information on the Agilent Test & Measurement website:

www.tm.agilent.com

Search for the model number of this product, and the resulting product page will guide you to any available information. Our service centers may be able to perform calibration if no repair parts are needed, but no other support from Agilent is available.

HP 8780A

VECTOR SIGNAL GENERATOR

10 MHz - 3 GHz
Including Options 001, 002, and 064

SERIAL NUMBERS

This manual applies directly to instruments with serial numbers prefixed 2635A, 2641A, 2643A, 2644A, 2650A, 2708A, 2715A, 2716A, 2725A, 2738A, 2746A, 2943A, 3244A and above.

For additional important information about serial numbers, see INSTRUMENTS COVERED BY MANUAL in Section I.



© Copyright Hewlett-Packard Company 1986, 1987, 1988, 1992
1501 Page Mill Road, Palo Alto, California, U.S.A.

Printed in USA July 1996

CONTENTS

	Page		Page
Section 1			
GENERAL INFORMATION			
Introduction	1-1	Simplified Operation	3-8
Specifications	1-1	Operational Procedure	3-8
Safety Considerations	1-1	Display Configurations	3-9
Instruments Covered by this Manual	1-1	Setting Operating Modes	3-13
Manual Changes Supplement	1-1	Modifying a Selected Parameter	3-18
Description	1-1	Output Control	3-20
RF Output	1-3	Indicator Annunciators	3-21
Modulation	1-3	Hewlett-Packard Interface Bus	
External Filters	1-3	Remote Operation	3-22
External Control	1-3	HP-IB Compatibility	3-22
Options	1-3	Remote Mode	3-23
Electrical Options	1-3	Local-to-Remote Mode Changes	3-23
Mechanical Options	1-3	Local Mode	3-23
Accessories Supplied	1-3	Addressing	3-24
Equipment Required but not Supplied	1-4	Data Messages	3-24
Electrical Equipment Available	1-4	Receiving Data Messages	3-24
Recommended Test Equipment	1-4	Sending the Data Message	3-25
		Receiving the Clear Message	3-25
		Receiving the Trigger Message	3-25
		Receiving the Remote Message	3-25
		Receiving the Local Message	3-25
		Receiving the Local Lockout and Clear Lockout/Set Local Messages	3-26
		Receiving the Pass Control Message	3-26
		Sending the Require Service Message	3-26
		Sending the Status Byte Message	3-26
		Sending the Status Message	3-27
		Sending the Learn String	3-29
		Sending the Status Bit Message	3-30
		Receiving the Abort Message	3-30
		Operator Checks	3-38
		Detailed Operating Instructions	3-47
		Special Functions	3-92
Section 2			
INSTALLATION			
Introduction	2-1		
Initial Inspection	2-1		
Preparation for Use	2-1		
Power Requirements	2-1		
Line Voltage and Fuse Selection	2-1		
Power Cables	2-2		
10 MHz TIME BASE Reference Cable	2-3		
HP-IB Address Selection	2-3		
Interconnections	2-3		
Mating Connectors	2-3		
Operating Environment	2-3		
Bench Operation	2-3		
Rack Mounting	2-3		
Storage and Shipment	2-5		
Environment	2-5		
Packaging	2-5		
Section 3			
OPERATION			
Introduction	3-1		
Panel Features	3-1		
Operating Characteristics	3-1		
Local Operation	3-1		
Remote Operation HP-IB	3-4		
Operator's Checks	3-4		
Operator's Maintenance	3-4		
Turn-On Instructions	3-5		
Operating Characteristics	3-7		
		Section 4	
		PERFORMANCE TESTS	
		Introduction	4-1
		Equipment Required	4-1
		Performance Test Record	4-1
		Calibration Cycle	4-1
		Abbreviated Performance Tests	4-2
		Performance Test Procedures	4-2
		Frequency Range, Resolution and Aging Rate	4-3
		RF Output Level, Flatness and RF Switch On/Off Ratio	4-7
		Residual SSB Phase Noise	4-12
		Harmonics	4-18
		Non-harmonically Related Spurious Responses	4-21
		Frequency Modulation Accuracy (AC Coupled)	4-25

CONTENTS (cont'd)

	Page		Page
Frequency Modulation Rates (AC Coupled)	4-29	BPSK	4-54
Frequency Modulation (DC Coupled)	4-32	QPSK	4-54
FM Rates (3 dB bandwidth)	4-33	8PSK	4-55
FM sensitivity Accuracy	4-33	16QAM	4-56
FM Distortion	4-33	Digital Modulation Data Rates	4-60
Residual FM	4-33	Asynchronous Data Rates	4-61
CW Residual FM	4-33	Single Clock Data Rates	4-62
Scalar Modulation	4-37	Dual Clock Data Rates (Except Opt. 064)	4-63
Scalar Accuracy	4-38	Burst dc On/Off Ratio	4-64
Vector Modulation DC Accuracy	4-41		
Vector Modulation Frequency Response	4-47		
Vector dc Residual	4-48		
Digital Modulation dc Accuracy	4-51		

ILLUSTRATIONS

	Page		Page
1-1. HP Model 8780A with Accessories Supplied and Options 907, 908 and 909	1-2	4-3. Residual SSB Phase Noise Test Setup	4-14
2-1. Line Voltage and Fuse Selection	2-2	4-4. Harmonics Test Setup	4-18
2-2. Power Cable and Mains Plug Part Numbers	2-2	4-5. Spurious Response Test Setup	4-21
2-3. Hewlett-Packard Interface Bus Connection	2-4	4-6. FM Accuracy (AC Coupled) Test Setup	4-26
3-1. Front Panel Features	3-2	4-7. FM Rates (AC Coupled) Test Setup	4-30
3-1a. Front Panel Features (Option 064)	3-2	4-8. FM (DC Coupled) Test Setup	4-34
3-2. Rear Panel Features	3-3	4-9. Scalar Modulation Test Setup	4-38
3-3. Operator's Check Test Setup	3-39	4-10. Vector DC Accuracy Test Setup	4-42
4-1. Frequency Test Setup	4-4	4-11. Vector Frequency Response Test Setup	4-48
4-2. RF Level Test Setup	4-8	4-12. Digital Modulation Accuracy Test Setup	4-52
		4-13. Digital Modulation Data Rates Test Setup	4-61



TABLES

	Page		Page
1-1. Specifications	1-5	3-3. HP-IB Program Codes	3-33
1-2. Supplemental Characteristics	1-10	3-4. Listing of Detailed Operating Instructions	3-47
1-3. Recommended Test Equipment	1-12	3-5. Special Functions	3-93
2-1. Allowable HP-IB Address Codes	2-3	3-6. Hardware Bit Map Special Function 53	3-113
3-1. Operating Characteristics	3-7	4-1. Abbreviated Performance Test	4-2
3-2. Message Reference Table	3-31	4-2. Performance Test Record	4-65

APPENDIX

	Page
A Error Codes	A-1

NOTICE

The information contained in this document is subject to change without notice.

HEWLETT-PACKARD MAKES NO WARRANTY OF ANY KIND WITH REGARD TO THIS MANUAL, INCLUDING, BUT NOT LIMITED TO, THE IMPLIED WARRANTIES OF MERCHANTABILITY AND FITNESS FOR A PARTICULAR PURPOSE. Hewlett-Packard shall not be liable for errors contained herein or direct, indirect, special, incidental or consequential damages in connection with the furnishing, performance, or use of this material.

WARRANTY

A copy of the specific warranty terms applicable to your Hewlett-Packard product and replacement parts can be obtained from your local Sales and Service Office.

Herstellerbescheinigung

Hiermit wird bescheinigt, daß dieses Gerät/System in Übereinstimmung mit den Bestimmungen von Postverfügung 1046/84 funkentstört ist.

Der Deutschen Bundespost wurde das Inverkehrbringen dieses Gerätes/System angezeigt und die Berechtigung zur Überprüfung der Serie auf Einhaltung der Bestimmungen eingeräumt.

Zusatzinformation für Meß- und Testgeräte:

Werden Meß- und Testgeräte mit ungeschirmten Kabeln und/oder in offenen Meßaufbauten verwendet so ist vom Betreiber sicherzustellen, daß die Funkentstörbedingungen unter Betriebsbedingungen an seiner Grundstücksgrenze eingehalten werden.

Manufacturer's Declaration

This is to certify that this equipment is in accordance with the Radio Interference Requirements of Directive FTZ 1046/1984. The German Bundespost was notified that this equipment was put into circulation, and has been granted the right to check the equipment type for compliance with these requirements.

Note: If test and measurement equipment is operated with unshielded cables and/or used for measurements in open setups, the user must ensure that under these operating conditions, the radio frequency interference limits are met at the border of his premises.

SAFETY CONSIDERATIONS

GENERAL

This product and related documentation must be reviewed for familiarization with safety markings and instructions before operation.

This product is a Safety Class I instrument (provided with a protective earth terminal).

BEFORE APPLYING POWER

Verify that the product is set to match the available line voltage and the correct fuse is installed.

SAFETY EARTH GROUND

An uninterruptible safety earth ground must be provided from the main power source to the product input wiring terminals, power cord, or supplied power cord set.

WARNINGS

Any interruption of the protective (grounding) conductor (inside or outside the instrument) or disconnecting the protective earth terminal will cause a potential shock hazard that could result in personal injury. (Grounding one conductor of a two conductor outlet is not sufficient protection.) In addition, verify that a common ground exists between the unit under test and this instrument prior to energizing either unit.

Whenever it is likely that the protection has been impaired, the instrument must be made inoperative and be secured against any unintended operation.

If this instrument is to be energized via an auto-transformer (for voltage reduction) make sure the common terminal is connected to neutral (that is, the grounded side of the mains supply).

Servicing instructions are for use by service-trained personnel only. To avoid dangerous electric shock, do not perform any servicing unless qualified to do so.

Adjustments described in the manual are performed with power supplied to the instrument

while protective covers are removed. Energy available at many points may, if contacted, result in personal injury.

Capacitors inside the instrument may still be charged even if the instrument has been disconnected from its source of supply.

For continued protection against fire hazard, replace the line fuse(s) only with 250V fuse(s) of the same current rating and type (for example, normal blow, time delay, etc.). Do not use repaired fuses or short circuited fuseholders.

SAFETY SYMBOLS



Instruction manual symbol: the product will be marked with this symbol when it is necessary for the user to refer to the instruction manual (see Table of Contents for page references).



Indicates hazardous voltages.



Indicates earth (ground) terminal.

WARNING

The WARNING sign denotes a hazard. It calls attention to a procedure, practice, or the like, which, if not correctly performed or adhered to, could result in personal injury. Do not proceed beyond a WARNING sign until the indicated conditions are fully understood and met.

CAUTION

The CAUTION sign denotes a hazard. It calls attention to an operating procedure, practice, or the like, which, if not correctly performed or adhered to, could result in damage to or destruction of part or all of the product. Do not proceed beyond a CAUTION sign until the indicated conditions are fully understood and met.

SECTION 1 GENERAL INFORMATION

1-1. INTRODUCTION

This manual contains information required to install, operate, and test the Hewlett-Packard Model 8780A Vector Signal Generator. Throughout this manual the HP 8780A Vector Signal Generator will be referred to as "Generator." Figure 1-1 shows the Generator with all of its externally supplied accessories.

This HP 8780A Operating Manual has four sections. The subjects addressed are:

- Section 1 General Information
- Section 2 Installation
- Section 3 Operation
- Section 4 Performance Tests

A copy of the operating information is supplied with the Generator. The Operating Manual should stay with the instrument for use by the operator. Additional copies can be ordered separately through your nearest Hewlett-Packard office. The part number is listed on the title page of this manual.

1-2. SPECIFICATIONS

Instrument specifications are listed in Table 1-1. These specifications are the performance standards or limits against which the instrument may be tested. Supplemental characteristics are listed in Table 1-2. Supplemental characteristics are not warranted specifications, but are typical characteristics included as additional information for the user.

1-3. SAFETY CONSIDERATIONS

This product is a Safety Class I instrument, meaning, one that is provided with a protective earth terminal. The Generator and all related documentation should be reviewed for familiarization with safety markings and instructions before operation. Refer to the Safety Considerations page found at the beginning of this manual for a summary of the safety information. Safety information for installation, operation, and performance testing, is found in appropriate places throughout this manual.

1-4. INSTRUMENTS COVERED BY THIS MANUAL

Attached to the rear panel of the instrument is a serial number identification label. The serial number is in the form: 0000A00000. The first four digits and the letter are the serial number prefix. The last five digits are the suffix. The prefix is the same for identical instruments; it changes only when a configuration change is made to the instrument. The suffix however, is assigned sequentially and is different for each instrument. The contents of this manual apply directly to instruments having the serial number prefix(es) listed under SERIAL NUMBERS on the title page.

1-5. MANUAL CHANGES SUPPLEMENT

The "*Manual Changes Supplement*" provides information necessary to update the manual. The supplement is identified with the manual print date and part number, both of which appear on the title page.

1-6. DESCRIPTION

The microwave synthesized HP 8780A Vector Signal Generator has an RF output frequency range of 10 MHz to 3 GHz. The most important part of the Generator is the variety of wideband modulation capabilities. The wideband techniques and vector modulation allow arbitrary phase and amplitude modulation with I and Q bandwidths up to 350 MHz (up to 700 MHz IF modulation bandwidth). The Generator provides broadband frequency modulation (FM), high performance vector modulation (arbitrary I in-phase and Q quadrature components), and digital phase modulation in BPSK, QPSK, 8PSK, and 16QAM formats. Option 064 provides 64QAM.

The Generator is phase locked to a precision time-base to provide excellent frequency accuracy. The output frequency has a 1 Hz tuning resolution. Long-term frequency stability is dependent on the time base. This is either an internal, or through a rear panel connector, an external reference oscillator. The internal crystal reference oscillator operates at 10 MHz.



HP 8780A



10 MHz TIME BASE
JUMPER CABLE

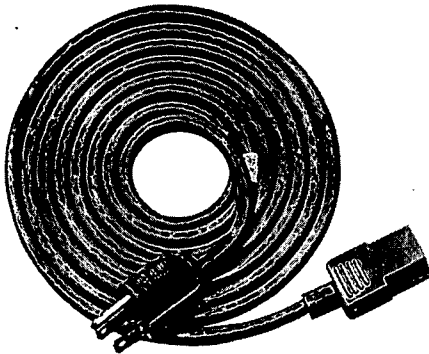

LINE POWER CABLE

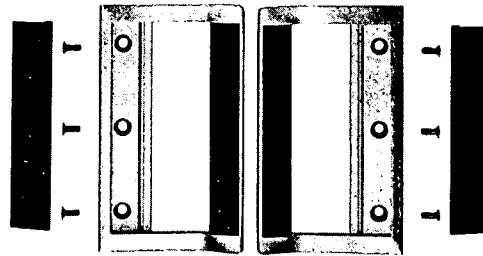

OPTION 907
FRONT HANDLE KIT

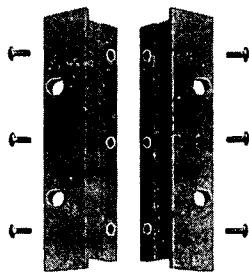

OPTION 908
RACK FLANGE KIT

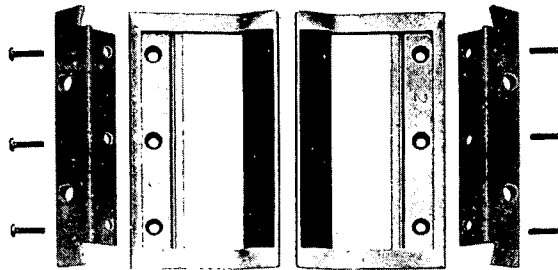

OPTION 909
RACK FLANGE AND FRONT
HANDLE COMBINATION KIT

Figure 1-1. HP 8780A with Accessories Supplied and Options 907, 908, and 909

DESCRIPTION (cont'd)

1-7. RF Output

Front panel RF output power has a range of +10 dBm to -100 dBm for 10 MHz to 2.5 GHz and +4 dBm to -100 dBm for 2.5 GHz to 3.0 GHz. Rear panel coherent carrier output has an RF output level of approximately -20 dBm. Option 002 provides +10 dBm at the coherent carrier output.

1-8. Modulation

The Generator has these modulation capabilities: vector, digital, frequency, and scalar (amplitude). The input signals used to provide these modulation types are:

- Vector or I-Q using I (in phase) and Q (quadrature phase) analog signals.
- Phase shift keying (PSK) using digital inputs.
- Quadrature amplitude using digital inputs.
- Frequency modulation using analog signals.
- Scalar (Amplitude) modulation using analog signals.

Simultaneous modulation is possible when combining modulation types. The combinations permissible are:

- Digital, Scalar
- Digital, Scalar, and FM
- Digital and FM
- Scalar and FM
- Vector and FM

1-9. External Filters

The internal spectral limiting filters for digital modulation are low pass filters with very flat passband response. When needed, I and Q external filters can be used through connectors provided on the rear panel.

1-10. External Control

The Generator is compatible with HP-IB to the extent indicated by the following code: SH1, AH1, T6, TE0, L3, LE0, SR1, RL1, PP1, DC1, DT0, and C0. The Generator interfaces with the bus via three-state TTL circuitry. An explanation of the compatibility code can be found in IEEE Standard 488 (1978), "IEEE Standard Digital Interface for Programmable Instrumentation" or the identical ANSI Standard MC1.1. For more detailed information relating to programmable control, refer to Remote Operation, Hewlett-Packard Interface Bus in Section III of this manual.

1-11. OPTIONS

1-12. Electrical Options

Option 001. All front panel connectors are removed and installed on the rear panel.

Option 002. A +30 dB amplifier is added in line with the coherent carrier output. This provides an RF level of approximately +10 dBm at the coherent carrier rear panel output.

Option 064. Adds sixty-four state quadrature amplitude modulation (64QAM) capability.

1-13. Mechanical Options

The following options may have been ordered and received with the Generator. If they were not ordered with the original shipment and are now desired, they can be ordered from the nearest Hewlett-Packard office using the part numbers included in each of the following paragraphs.

Front Handle Kit (Option 907). Ease of handling is increased with the front panel handles. The Front Handle Kit part number is 5061-9690.

Rack Flange Kit (Option 908). The Generator can be solidly mounted to the instrument rack using the flange kit. The Rack Flange Kit part number is 5061-9678.

Rack Flange and Front Handle Combination Kit (Option 909). This is a unique part which combines both functions. It is not simply a front handle kit and a rack flange kit packaged together. The Rack Flange and Front Panel Combination Kit part number is 5061-9684.

1-14. ACCESSORIES SUPPLIED

The accessories supplied with the Generator are shown in Figure 1-1.

- a. A short gray cable, that must be connected between the 10 MHz TIME BASE OUT and IN on the rear panel, is supplied. The gray cable with BNC connectors has HP Part Number 86701-60063. If an external time base is used the switch must be set accordingly and the external signal connected to the 10 MHz time base in, in place of the supplied gray cable.

ACCESSORIES SUPPLIED (cont'd)

b. The line power cable is supplied in several configurations, depending on the destination of the original shipment. Refer to Power Cables in Section II of this manual.

c. An additional fuse is shipped only with instruments that are factory configured for 100/120 Vac operation. This fuse has a 3.0A rating and is for reconfiguring the instrument for 220/240 Vac operation.

1-15. EQUIPMENT REQUIRED BUT NOT SUPPLIED

When using an external reference, the performance of the external reference should at least match the specifications of the installed 10 MHz Crystal Oscillator. In particular, the frequency should be 10 MHz \pm 50 Hz with an aging rate of less than 5×10^{-10} /day. When using an external oscillator, microphonics generated or line related spurious signals may increase.

1-16. ELECTRICAL EQUIPMENT AVAILABLE

The Generator has an HP-IB interface and can be used with any HP-IB compatible computing controller or computer for automatic systems applications.

1-17. RECOMMENDED TEST EQUIPMENT

Table 1-3 lists the test equipment recommended for use in testing the Generator. The Critical Specification column describes the essential requirements for each piece of test equipment. Other equipment can be substituted if it meets or exceeds these critical specifications.

The Recommended Model column may suggest more than one model. The first model shown is usually the least expensive, single-purpose model. Alternate models are suggested for additional features that would make them a better choice in some applications.

Table 1-1. Specifications

Electrical Characteristics	Performance Limits	Conditions
<p>FREQUENCY Range Resolution Accuracy and Stability Reference Oscillator Frequency Aging Rate</p>	<p>10 MHz to 3 GHz 1 Hz Same as reference oscillator 10 MHz $< 5 \times 10^{-10}/\text{day}$</p>	<p>Except dc FM ¹ After a 24 hour warmup and an oscillator off-time of less than 24 hours</p>
<p>RF OUTPUT Output Amplitude Level Level Range Accuracy Flatness RF Switch On/Off Ratio Coherent Carrier Output</p>	<p>+10 dBm to -100 dBm +4 dBm to -100 dBm $< \pm 2.5 \text{ dB}$ $< \pm 3.5 \text{ dB}$ $< \pm 1.0 \text{ dB}$ $\geq 60 \text{ dB}$ $> -20 \text{ dBm}$</p>	<p>10 MHz to 2.5 GHz > 2.5 GHz to 3.0 GHz > -30 dBm < -30 dBm Carrier > -40 dBm 10 MHz to 200 MHz</p>
<p>SPECTRAL PURITY Residual SSB Phase Noise (Digital, Vector and Scalar residual phase noise is the same as CW) Harmonics</p>	<p>-65 dBc -84 dBc -100 dBc -110 dBc -110 dBc -114 dBc -130 dBc < -35 dBc</p>	<p>1 Hz bandwidth 1 GHz CW mode, +7 dBm Offset from carrier 10 Hz 100 Hz 1 kHz 10 kHz 100 kHz 1 MHz 10 MHz 3244A Instruments and above: Harmonic Products: 10 MHz to 3.0 GHz Carrier: < +7 dBm, 10 MHz to 1.5 GHz See Supplemental Characteristics for carrier from 1.5 to 3.0 GHz 2943A Instruments and below: < +7 dBm, 10 MHz to 2.5 GHz < +1 dBm, 2.5 to 3.0 GHz</p>
<p>¹If the oscillator has been off for 0 to 24 hours, a warmup period of 24 hours is required to obtain an aging rate less than $5 \times 10^{-10}/\text{day}$. If the off-time has been greater than 24 hours, such as for shipping or instrument storage, typically 48 hours are required to reach the specified aging rate.</p>		

Table 1-1. Specifications (cont'd)

Electrical Characteristics	Performance Limits	Conditions
SPECTRAL PURITY (cont'd) Non-harmonically related spurious signals (CW, digital, vector, and scalar) <10 MHz 10 MHz to 3 GHz >3 GHz Residual FM CW, Digital, Vector, or Scalar	<-55 dBc <-60 dBc <-55 dBc <-55 dBc <4 Hz rms	Carrier >-40 dBm >20 MHz from carrier <20 MHz from carrier 300 Hz to 3 kHz bandwidth 50 MHz carrier
FREQUENCY MODULATION ac Coupled Sensitivity Deviation Ranges Rates (3 dB bandwidth) Sensitivity Accuracy Residual FM dc Coupled Sensitivity Deviation Ranges Rates (3 dB bandwidth) Sensitivity Accuracy Distortion Residual FM	1 V p-p produces full scale deviation 50 kHz p-p to 50 MHz p-p 20 Hz to 12 MHz <10% ^{1,2} <200 Hz rms 1 V p-p produces full scale deviation 150 Hz p-p to 150 kHz p-p dc to 10 kHz <12% ³ <5% <5 Hz rms	Settable to 3 digit resolution Deviations <30 MHz p-p Carrier frequency >50 MHz Noninverting mode Rates 50 Hz to 6 MHz Deviations <30 MHz p-p Carrier frequency >50 MHz 300 Hz to 3 kHz bandwidth 50 kHz deviation range and excluding 400 Hz line mains Settable to 3 digit resolution Deviations <10 kHz p-p Rates to 1 kHz Deviations <150 kHz p-p 1 kHz rate 150 kHz p-p deviation 300 Hz to 3 kHz bandwidth Deviation range 150 kHz
SCALAR MODULATION Sensitivity dc Accuracy	0 to +1 Vdc produces zero to full scale envelope modulation <2.0% of full scale	140 MHz carrier and <+7 dBm levels

¹ For instruments with Serial Number Prefixes 2650A and below, sensitivity accuracy is <6%.

² For instruments with Serial Number Prefixes between 2708A and 2943A, sensitivity accuracy is <7.5%.

³ For instruments with Serial Number Prefixes 2943A and below, sensitivity accuracy is <10%.

Table 1-1. Specifications (cont'd)

Electrical Characteristics	Performance Limits	Conditions
SCALAR MODULATION (cont'd)		
dc Residual	<1% of full scale I and Q	Residual I and Q output for 0V input. 140 MHz carrier
Frequency Response (3 dB bandwidth)	dc to 500 kHz	<+7 dBm level 1 GHz carrier
VECTOR MODULATION		
I and Q Inputs Sensitivity	±0.5 volt into 50Ω Produces ±100% of full scale	50Ω source impedance
dc Accuracy	<1.5% of full scale	140 MHz carrier, <+7 dBm levels, and $\sqrt{I^2 + Q^2} \leq 0.5$ volts
dc Residual	<1% of full scale	Residual I and Q output for 0V I and Q input 140 MHz carrier
Frequency Response (3 dB bandwidth)	dc to 350 MHz	1 GHz carrier
DIGITAL MODULATION		
Data Formats	BPSK (Binary Phase Shift Keying)	Digital input line 0 active
<i>2 bits</i> -	QPSK (Quadrature Phase Shift Keying)	Digital input lines 0 and 2 (0 and 3 Option 064) active
<i>3 bits</i> -	8PSK (Eight State Phase Shift Keying)	Digital input lines 0, 1, and 2 (0, 1, and 3 Option 064) active
<i>4 bits.</i> -	16QAM (16 State Quadrature Amplitude Modulation)	Digital input lines 0, 1, 2, and 3 (0, 1, 3, and 4 Option 064) active
	Arbitrary TWO STATE CW BURST	Digital input line 1 active Digital input line 3 (1 Option 064) active
	Option 064 64QAM (64 State Quadrature Amplitude Modulation)	Digital input lines 0, 1, 2, 3, 4 and 5 active
Burst	BPSK, QPSK, 8PSK, 2 STATE or CW	Burst with 8PSK and 2 STATE is not available with Option 064
Alternate Level	BPSK, QPSK	I and Q simultaneous or I only
	BPSK and BURST QPSK and BURST	Except Option 064 Except Option 064
I<Q		Any data format, burst and alternate level

Table 1-1. Specifications (cont'd)

Electrical Characteristics	Performance Limits	Conditions
DIGITAL MODULATION (cont'd) Clock Modes Data Rates Data Input Thresholds Clock Input Thresholds Data and Clock Drive Requirements Data Timing Requirements State dc Accuracy BPSK, QPSK, 8PSK 16QAM, TWO STATE ALT LVL, I<Q Burst dc on/off ratio	Parallel: 0 to 150 MHz clocked 0 to 100 MHz clocked 0 to 50 MHz asynchronous Serial: 0 to 150 MHz clocked and data lines for 0 to 25 MHz 64 QAM symbol rate ECL (-2V termination) GND Variable -2.5V to +2.5V ECL (-2V termination) GND Auto (-2.5V to +2.5V) 0.3 to 3V p-p >3 s >3 s <1.0% of full scale <1.2% of full scale <2.0% of full scale >50 dB	Single, separate I and Q, (except Option 064) or asynchronous Except 64QAM format (Option 064) 64QAM format Option 064 Option 064 Settable with 100 mV resolution Set up time Hold time 140 MHz carrier and <+7 dBm levels 140 MHz carrier
REAR PANEL SYSTEM INTERFACE CONNECTOR (Serial number prefix 2725A and below) 3-Pin Connector	Serial Data Transfer	TTL levels
GENERAL Operating Temperature Range Warm-up and Calibration Power Requirements: Line Voltage +5%, -10% Line Frequency Power Dissipation Compatibility — HP-IB Memory	0°C to +55°C 1 hour warm-up, 4 hours of oper- ation or 5°C temperature change 100, 120, 220, or 240 Vac 48 to 66 Hz 360 to 440 Hz 500 VA SH1, AH1, T6, TE0, L3, LE0, SR1, RL1, PP1, DC1, DT0, C0 Non-volatile (uses battery backup)	Perform front panel calibration All specified line voltages Limited to line voltages of 100 or 120 Vac Maximum All functions program- mable except line switch Contains complete generator operating state plus con- tents of save/recall regis- ters and HP-IB address

Table 1-1. Specifications (cont'd)

Electrical Characteristics	Performance Limits	Conditions
<p>GENERAL (cont'd)</p> <p>Operating and non-operating environment</p> <p>Safety</p> <p>Conducted and Radiated Electro-magnetic Interference</p> <p>Net Weight</p> <p>Dimensions: Height Width Depth</p>	<p>Temperature, humidity, shock, and vibration type tested to MIL-T-28800C Class V requirements</p> <p>Meets requirements of IEC 348 and CSA 556B</p> <p>MIL-STD 461B</p> <p>31.5 kg (70 lb)</p> <p>177 mm (7.0") 426 mm (17") 635 mm (25")</p>	<p>Conducted and radiated interference is within the requirements of methods CE03 and CS01, CS02, CS06, RE02, RS01, and RS03 of MIL-STD-461B. Also within the requirements of VDE 0871 and CISPR Publication 11</p> <p>For ordering cabinet accessories, module sizes are: 7 H (high) 1 MW (module wide) 25 D (deep)</p>

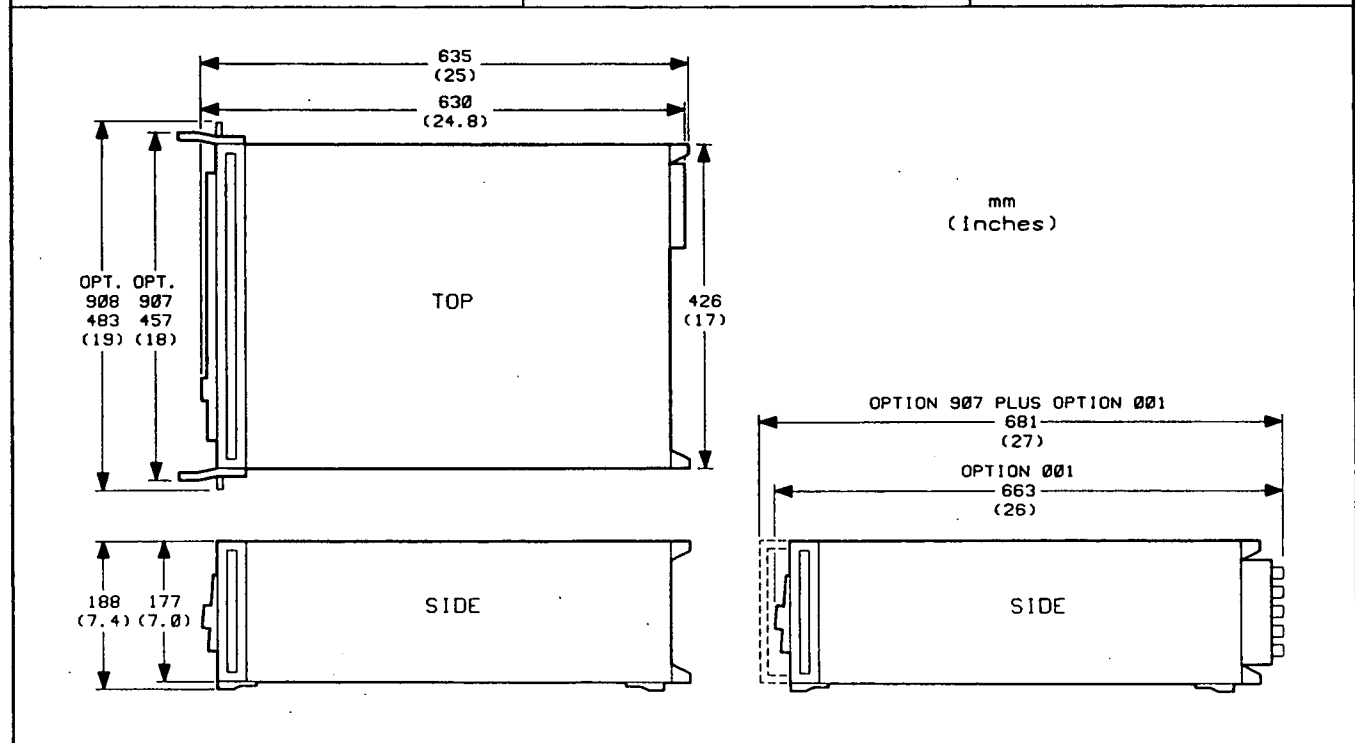

Table 1-2. Supplemental Characteristics

Supplemental characteristics are intended to provide information useful in applying the instrument by giving typical, but non-warranted, performance parameters.

FREQUENCY

Extended Ranges: 1 MHz to 10 MHz
3 GHz to 3.2 GHz

Switching Speed: <100 ms (Fast Mode). In the fast mode, output level accuracy is not specified.
<220 ms (Normal Mode)

Internal Reference: The internal reference oscillator accuracy is a function of time base calibration \pm aging rate, \pm temperature effects, and \pm line voltage effects. Typical temperature and line voltage effects are $<1 \times 10^{-10}/^{\circ}\text{C}$ and $<5 \times 10^{-10}/(+5\% \text{ to } -10\%)$ line voltage change. Reference oscillator is kept at operating temperature in STANDBY mode with the instrument connected to mains power. For instruments disconnected from mains power more than 24 hours, the aging rate is $<5 \times 10^{-10}/\text{day}$ after a 48 hour warmup.

External Reference: 10 MHz at a level of 0.5 to 1 Vrms (+7 to +10 dBm) into 50 Ω . Stability and spectral purity of the microwave output will be partially determined by characteristics of the external reference frequency.

RF OUTPUT

Impedance: 50 Ω
Resolution: 0.1 dB
Output SWR: <1.3:1

COHERENT CARRIER

Frequency Range: 10 MHz to 3 GHz
Output Level: Standard >-20 dBm
Option 002 $>+10$ dBm
Output Impedance: 50 Ω

SPECTRAL PURITY Harmonics: <-35 dBc for Harmonic Products: 3.0 to 12 GHz
Residual Phase Noise

Offset from Carrier	CW 10 MHz—3 GHz	dcFM 10 MHz—3 GHz (2943A and below)	dcFM 10 MHz—3 GHz (3244A and above)	acFM 10 MHz—3 GHz
10 Hz	-74 dBc	—	—	—
100 Hz	-93	-79 dBc	-74 dBc	—
1 kHz	-107	-103	-101	-55 dBc
10 kHz	-115	-115	-114	-82
100 kHz	-115	-115	-115	-106
1 MHz	-117	-117	-117	-117
10 MHz	-130	-130	-130	-130

(>+7 dBm)

Digital, vector, and scalar residual phase noise is the same as CW.

Typical phase noise for 10 MHz offsets is only applicable between 50 MHz and 3 GHz.

FREQUENCY MODULATION

ac coupled

Distortion (Up to 3 MHz rate, 10 MHz p-p deviation) $<0.75\%$
Carrier spurious responses (>20 kHz offset): <-60 dBc
Frequency response (50 Hz to 8 MHz): $<\pm 0.5$ dB
Inverting input same as noninverting

Table 1-2. Supplemental Characteristics (cont'd)

FREQUENCY MODULATION (cont'd)

Differential gain (27.6 MHz p-p deviation): <2%
 Differential phase (27.6 MHz p-p deviation): <1 degree
 Field time distortion: <1%
 Luminance to chrominance delay: <20 ns
 Luminance to chrominance gain: <±0.3 dB
 FM bandwidth decreases at carrier frequencies below 50 MHz

dc coupled

Carrier spurious responses:
 >1 kHz offsets: <-60 dBc
 100 Hz to 1 kHz offsets: <-50 dBc

Input impedance ac or dc coupled: 50Ω

DIGITAL MODULATION

Data and clock input impedances: 50Ω

State dc accuracy (10 MHz to 3 GHz carrier):

BPSK, QPSK: <1.0% of full scale
 8PSK: <1.2% of full scale
 16QAM, two state, alternate level, I<Q: <2.0% of full scale
 64QAM (Option 064): <1.0% of full scale

Burst dc on/off ratio (10 MHz to 3 GHz at 140 MHz carrier): >50 dB

Option 064 Burst dc on/off ratio (10 MHz to 3 GHz): >50 dB

Data asymmetry: <1 ns for clocked modes

Data skew: <1 ns for single clock

Internal baseband spectrum filters to limit spectrum are automatically selected depending on carrier frequency. Data frequency response 3 dB point versus carrier frequency is given below. User can override filter selection by using a special function. Also, provision is made on the rear panel for connection of user supplied baseband filters.

Carrier	Nominal data frequency response	Filter	Special function number 3.1
Up to 138.999999 MHz	42 MHz	0	
139–278.999999 MHz	87 MHz	1	
279–558.999999 MHz	180 MHz	2	
559– and above	255 MHz	3	
Full range with no internal baseband filtering	>350 MHz		

SCALAR MODULATION

Input impedance: 10 kΩ

Accuracy (10 MHz to 3 GHz): <2.0% of full scale

Residual (10 MHz to 3 GHz): <1.0% of full scale

VECTOR MODULATION

Input impedance: 50Ω

SWR: <1.5:1 dc to 350 MHz

dc accuracy (10.0 MHz to 3.0 GHz): <1.5% of full scale
 <1.0% of full scale (Option 064)

dc residual (10.0 MHz to 3.0 GHz): <1.0% of full scale

Table 1-2. Supplemental Characteristics (cont'd)

VECTOR MODULATION (cont'd)

Frequency response (400 MHz to 3 GHz carrier): dc to 350 MHz (-3 dB)

Vector accuracy versus modulating frequency for selected carriers.

Carrier	Modulating Frequency	Amplitude Flatness	Crosstalk between I and Q
70 MHz	1 to 20 MHz	<0.1 dB	<2.0%
140 MHz	1 to 40 MHz	<0.15 dB	<2.0%
500 MHz	1 to 40 MHz	<0.15 dB	<2.0%
1.5 GHz	1 to 100 MHz	<0.3 dB	<4.0%
2.5 GHz	1 to 100 MHz	<0.3 dB	<6.0%

Digital, scalar, and either acFM or dcFM may be used together in any combination. Vector and acFM or dcFM may be used together in any combination.

Table 1-3. Recommended Test Equipment

Equipment	Critical Specifications	Recommended Model	Use
Amplifier (Low Noise)	40 dB Gain <3 dB Noise Figure 50Ω Input and Output 1 kHz-1 MHz Bandwidth	HP 11729-60014 or HP 08640-60506	P
Attenuator (2 required for 8780A option 002 testing)	Attenuation: 10 ±0.6 dB or 20 ± 0.6 dB SWR: dc to 8.0 GHz <1.2:1 >8.0 to 12.4 GHz <1.3:1 >12.4 to 18.0 GHz <1.5:1	HP 8491A Option 010 and Option 020	P
Audio Analyzer	Frequency Range: 20 Hz to 100 kHz Accuracy: 0.3% of setting Resolution: 0.3% Read 1 kHz distortion of <1.0%	HP 8903B	P
Cable, BNC (2 required)	4 feet long	HP 8120-1840	P
Digital Voltmeter	Range: -25 to +25 Vdc Accuracy: ±0.1% of reading Resolution: 0.001 Vdc; 1 mVrms Frequency Response: 20 Hz to 100 kHz	HP 3456A	P, T
70 MHz Modulator- Demodulator (Discriminator-Optional)	Frequency Response (5 Hz to 10 MHz): ±0.2 dB Differential Gain (4.43 MHz): ≤0.7% Differential Phase (4.43 MHz): ≤0.7°	HP 3717A	P, T
Frequency Counter	Range: 9 MHz to 3.001 GHz Resolution: 10 MHz to 3.0 GHz: 1 Hz or better Sensitivity: 10 MHz to 3.0 GHz: -25 dBm	HP 5343A	P, T, O

Table 1-3. Recommended Test Equipment (cont'd)

Equipment	Critical Specifications	Recommended Model	Use ¹
Frequency Standard	Long Term Stability: Better than 1×10^{-10} /day Frequency: 5 MHz or 10 MHz	HP 5065A	P
Pulse/Function Generator (Frequency Synthesizer)	Frequency Range: 10 Hz to 200 MHz Amplitude: 48 mV pk to 480 mV pk, 1.0 Vrms at 1 kHz Flatness: <1.0 dB over frequency range	HP 8116A	P,T
Mixer	Frequency Range: 2 to 18 GHz Doubled Balanced Connectors: 3 port type SMA	RHG DM 1-26 ² or WJ M1G	P
Mixer	Frequency Range: 0.2 to 500 MHz Doubled Balanced Connectors: 3 port BNC	HP 10514A	P
Measuring Receiver	Frequency Range: 6 MHz to 3.0 GHz Measure FM: 75 kHz pk deviation at 1.0 kHz rate Select post detection filters: 300 Hz high pass 3.0 kHz low pass Response: rms Residual FM: <2.0 Hz Tuned RF Power Mode	HP 8902A	P
Network Analyzer	140 MHz polar display CW sweep mode Real/imaginary linear marker readout	HP 8751A or HP 3577A or HP 8753A	P
Oscilloscope	Bandwidth: 50 MHz Two Channels: A and B Chop display between A and B Vertical Sensitivity: 10 mV/div Vertical Input: high impedance dc coupled Delayed Sweep Mode: 20 ns/div External Trigger: Sine wave	HP 54201A	P,T
Power Meter (2 required)	Range: +20 dB to -30 dB Accuracy: ± 0.13 dB Relative Mode	HP 438A or HP 437B or HP436A	P,T,O

Table 1-3. Recommended Test Equipment (cont'd)

Equipment	Critical Specifications	Recommended Model	Use ¹
Power Sensor	Frequency Range: 10 MHz to 3.0 GHz Input Impedance: 50Ω Flatness: ±0.2 dB SWR: <1.25:3 Power Range: -30 to +20 dBm (1 μW to 100 mW)	HP 8481A	P, T, O
Power Sensor (2 required)	Frequency Range: 100 kHz to 3.0 GHz Input Impedance: 50Ω Flatness: ±0.2 dB SWR: <1.25:3 Power Range: -30 to +20 dBm (1 μW to 100 μW)	HP 8482A	P, T, O
Power Splitter	Frequency Range: dc to 18.0 GHz Connectors: Type N	HP 11667A	P, O
Power Supply	Output: +15 Vdc and -15 Vdc Low Ripple: 200 microvolts rms/1 mV pk-pk	HP 6234A or HP 6205C	P
Sensor Module	Frequency: 6-100 MHz Level: +10 dBm to -100 dBm	HP 11722A	P
Signal Generator	Frequency Range: 10 to 350 MHz Level: 13 dBm to -127 dBm	HP 8340B	P
Signature Multimeter		HP 5005B	T
Synthesized Signal Generator (Local Oscillator)	Frequency: 50-1000 MHz Level: 1.0 GHz: +10 dBm Resolution: 0.1 Hz Single Sideband Phase Noise and Spurious Signals: 6 dB better than generator specification	HP 8662A	P
Spectrum Analyzer	Frequency Response: 10 MHz to 18 GHz Flatness: 1 dB in 500 kHz range around 140 MHz Frequency Span per Division: 2 to 500 kHz minimum Amplitude Range: 0 to -80 dB Peak Search Noise Sidebands: >75 dB down 30 kHz from signal at 1 kHz resolution bandwidth	HP 8566B	A, P, T

Table 1-3. Recommended Test Equipment (cont'd)

Equipment	Critical Specifications	Recommended Model	Use ¹
Spectrum Analyzer	Center Frequency: 10 Hz to 10 kHz 1 Hz normalized bandwidth measurement capability Sensitivity: 10 dB per division Dynamic Range: 130 dB Residual Phase Noise: 8 dB better than generator	HP 3561A or HP 3582A	P
Termination (2 required)	Connector: BNC Impedance: 50Ω	HP 11593A	P
¹ A = Adjustments, P = Performance Tests, T = Troubleshooting, O = Operation Verification ² RHG Electronics Laboratory, Inc., 161 East Industry Court, Deer Park, N.Y. 11729, Tel. (516 242-1100, TWX 510-227-6083			

DECLARATION OF CONFORMITY

according to ISO/IEC Guide 22 and EN 45014

Manufacturer's Name: Hewlett-Packard Co.
Manufacturer's Address: Video Communications Division
5301 Stevens Creek Boulevard
Santa Clara, California 95052-8059
U. S. A.

declares that the product

Product Name: Vector Signal Generators
Model Number(s): 8780A 8782B
Product Option(s): All All

conforms to the following Product Specifications:

Safety: IEC 1010-1:1990+A1 / EN 61010-1:1993

EMC: CISPR 11: 1990 / EN 55011:1991 - Group 1 Class A
EN 50082-1: 1992

IEC 801-2:1991 - 4 kV CD, 8 kV AD

IEC 801-3:1984 - 3 V/m

IEC801-4:1988 - 0.5kV Signal Lines, 1kV Power Lines

Supplementary Information:

The product herewith complies with the requirements of the Low Voltage Directive 73/23/EEC and the EMC Directive 89/336/EEC and carries the CE-Mark accordingly.

Santa Clara, 15 NOV 95

Hazel Price
Hazel Price, Manufacturing Manager

Randy White
Randy White, Reliability Engineering Manager

European Contact: Your local Hewlett-Packard Sales and Service Office or Hewlett-Packard GmbH, Department ZQ / Standards Europe, Herrenberger Strasse 130, D-71034 Boeblingen, Germany (FAX +49-7031-14-3143)

SECTION 2 INSTALLATION

2-1. INTRODUCTION

This section provides the information needed to install the Generator. Included is information necessary for initial inspection, power requirements, line voltage selection, power cables, interconnections, environment, instrument mounting, storage and shipment. In addition, this section contains the procedure for setting the HP-IB address.

2-2. INITIAL INSPECTION

WARNING

To avoid hazardous electrical shock, do not perform electrical tests when there are signs of shipping damage to any portion of the outer enclosure (covers, panels, frames).

Inspect the shipping container for damage. If the shipping container or cushioning material is damaged, it should be kept until the contents of the shipment have been checked for completeness and the instrument has been checked mechanically and electrically. The contents of the shipment should be as shown in Figure 1-1; however, all of the options shown may not have been ordered. Sent with the shipment is the HP 8780A Operating Manual. Procedures for checking electrical performance are given in Section 4. If the contents are incomplete, if there is mechanical damage or defect, or if the instrument does not pass the electrical performance tests, notify the nearest Hewlett-Packard office. If the shipping container is damaged, or the cushioning material shows signs of unusual stress, notify the carrier as well as the Hewlett-Packard office. Keep the shipping materials for the carrier's inspection.

2-3. PREPARATION FOR USE

2-4. Power Requirements

WARNINGS

To avoid the possibility of hazardous electrical shock, do not operate this

instrument at line voltages greater than 126.5 Vac with line frequencies greater than 66 Hz. Leakage currents at these line settings may exceed 3.5 mA.

This is a Safety Class I product, meaning that it is provided with a protective earth terminal. An uninterruptible safety earth ground must be provided from the main power source to the product input wiring terminals, power cord, or supplied power cord set. Whenever it is likely that the protection has been impaired, the instrument must be made inoperative and be secured against any unintended operation.

If this instrument is to be energized via an external autotransformer, make sure the autotransformer's common terminal is connected to neutral, that is, the grounded side of the line mains supply.

The Generator requires a power source of 100, 120, 220, or 240 Vac, +5% to -10%, 48 to 440 Hz single phase. Power consumption is 500 VA maximum.

2-5. Line Voltage and Fuse Selection \triangle

CAUTION

BEFORE PLUGGING THIS INSTRUMENT into the line mains voltage, be sure the correct voltage and fuse have been selected.

Verify that the line voltage selection card and the fuse are matched to the power source. See Figure 2-1, Line Voltage and Fuse Selection.

Fuses may be ordered using HP part number 2110-0010, 5.0A (250V, non-time delay) for 100/120 Vac operation and HP part number 2110-0003, 3.0A (250V, non-time delay) for 220/240 Vac operation.

2-6. Power Cables

WARNING

BEFORE CONNECTING THIS INSTRUMENT, the protective earth terminals of this instrument must be connected to the protective conductor of the line mains power cable. The line plug shall only be inserted in a socket outlet provided with a protective earth contact. The protective action must not be negated by the use of an extension cord (power cable) without the protective (grounding) conductor. Grounding one conductor of a two conductor outlet is not sufficient protection.

This instrument is equipped with a three-wire power cable. When connected to an appropriate ac power receptacle, this cable grounds the instrument cabinet. The type of power cable plug shipped with each instrument depends on the country of destination. See Figure 2-2, Power Cable and Line Mains Plug Part Numbers, for the part numbers of power cables actually shipped. Cables are available in different lengths and some with right angle plugs to the instrument. Check with your nearest HP service center for descriptions and part numbers for these cables.

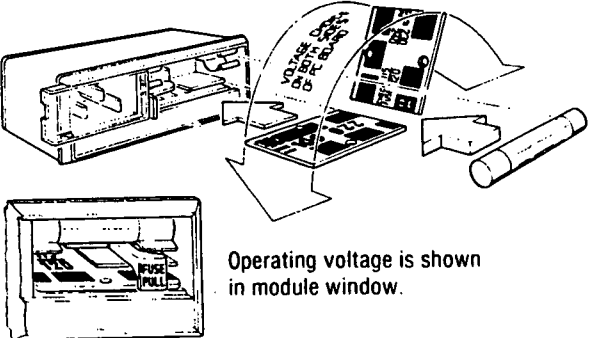

Operating voltage is shown in module window.

SELECTION OF OPERATING VOLTAGE

1. Open cover door, pull the FUSE PULL lever and rotate to left. Remove the fuse.
2. Remove the Line Voltage Selection Card. Position the card so the line voltage appears at top-left corner. Push the card firmly into the slot.
3. Rotate the FUSE PULL lever to its normal position. Insert a fuse of the correct value in the holder. Close the cover door.

WARNING

To avoid the possibility of hazardous electrical shock, do not operate this instrument at line voltages greater than 126.5 Vac with line frequencies greater than 66 Hz (leakage currents at these line settings may exceed 3.5 mA).

Figure 2-1. Line Voltage and Fuse Selection

<p>220/240V OPERATION</p>  <p>PLUG*: SEV 1011.1959-24507 TYPE 12 CABLE*: HP 8120-2104</p>	<p>220/240V OPERATION</p>  <p>PLUG*: NZSS 198/AS C112 CABLE*: HP 8120-1369</p>	<p>100/120V OPERATION</p>  <p>PLUG*: NEMA 5-15P CABLE*: 8120-1378</p>	<p>220/240V OPERATION</p>  <p>PLUG*: NEMA 6-15P CABLE*: HP 8120-0698</p>
<p>220/240V OPERATION</p>  <p>PLUG*: CEE7-VII CABLE*: HP 8120-1689</p>	<p>220/240V OPERATION</p>  <p>PLUG*: DHCK 107 CABLE*: HP 8120-2956</p>	<p>220/240V OPERATION</p>  <p>PLUG*: BS 1363A CABLE: HP 8120-1351</p>	
<p>*The number shown for the plug is the industry identifier for the plug only. The number shown for the cable is an HP part number for a complete cable including the plug.</p>			

Figure 2-2. Power Cable and Mains Plug Part Numbers

2-7. 10 MHz TIME BASE Reference Cable

Connect the gray BNC to BNC cable supplied with the accessories from 10 MHz OUT to IN. These connectors are located on the rear panel with the word JUMP between them. If an external time base reference is used the switch must be set accordingly and the external reference connected to the TIME BASE IN connector.

2-8. Address Selection **HP-IB**

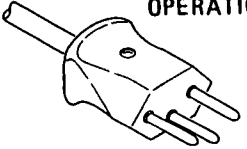
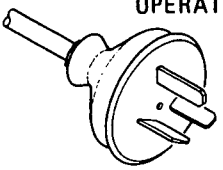
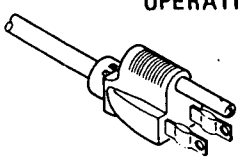
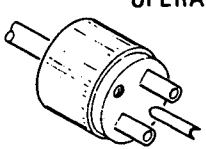
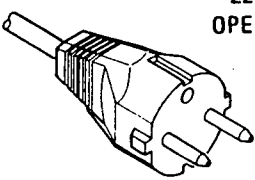
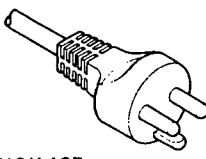
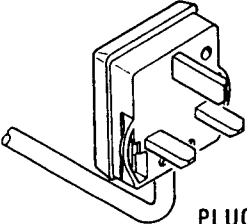
The allowable HP-IB address codes are given in Table 2-1. To set the HP-IB address select special function 25.0 and key in the decimal equivalent of the address using the numeric keypad. As a terminator press the ENT SPCL (Hz) key. The default address at turn on or at preset is the address stored in memory at power down.

2-9. Interconnections

HP-IB. Interconnection data for the Hewlett-Packard Interface Bus is provided in Figure 2-3, Hewlett-Packard Interface Bus Connection.

System Interface. (Serial number prefixes 2725A and below.) The system interface connector located on the rear panel is a three pin connector for serial data transfer at TTL levels.

2-10. Mating Connectors

HP-IB Interface Connector. The HP-IB mating connector is shown in Figure 2-3, Hewlett-Packard Interface Bus Connection. Note that the two securing screws are metric.

Coaxial Connectors. Coaxial mating connectors used with the Generator should be BNC or Type-N male compatible with US MIL-C-39012.

2-11. Operating Environment

The operating environment should be within the following limitations:

- Temperature 0° C to +55° C
- Humidity <95% relative
- Altitude <4600 metres (15 000 feet)

2-12. Bench Operation

The instrument cabinet has plastic feet and fold-away tilt stands for convenience in bench operation. (The plastic feet are designed to ensure self-aligning of the instruments when stacked.) The tilt stands raise the front of the instrument for easier viewing of the front panel.

Table 2-1. Allowable HP-IB Address Codes

Decimal Equivalent ¹	Listen Address Character	Talk Address Character	Last Five Bits of Talk and Listen Switches ¹				
			A5	A4	A3	A2	A1
0	SP	@	0	0	0	0	0
1	!	A	0	0	0	0	1
2	"	B	0	0	0	1	0
3	#	C	0	0	0	1	1
4	\$	D	0	0	1	0	0
5	%	E	0	0	1	0	1
6	&	F	0	0	1	1	0
7	'	G	0	0	1	1	1
8	(H	0	1	0	0	0
9)	I	0	1	0	0	1
10	*	J	0	1	0	1	0
11	+	K	0	1	0	1	1
12	,	L	0	1	1	0	0
13	-	M	0	1	1	0	1
14	.	N	0	1	1	1	0
15	/	O	0	1	1	1	1
16	0	P	1	0	0	0	0
17	1	Q	1	0	0	0	1
18	2	R	1	0	0	1	0
19	3	S	1	0	0	1	1
20	4	T	1	0	1	0	0
21	5	U	1	0	1	0	1
22	6	V	1	0	1	1	0
23	7	W	1	0	1	1	1
24	8	X	1	1	0	0	0
25	9	Y	1	1	0	0	1
26	:	Z	1	1	0	1	0
27	;	[1	1	0	1	1
28	<	?	1	1	1	0	0
29	=]	1	1	1	0	1
30	>	0	1	1	1	1	0

¹Decimal characters relate to the last five bits of both talk and listen addresses.
²Factory-set address.

2-13. Rack Mounting

WARNING

This Generator is heavy for its size, 31.5 kg (70 lbs). Care must be exercised when lifting to avoid personal injury. Use equipment slides when rack mounting.

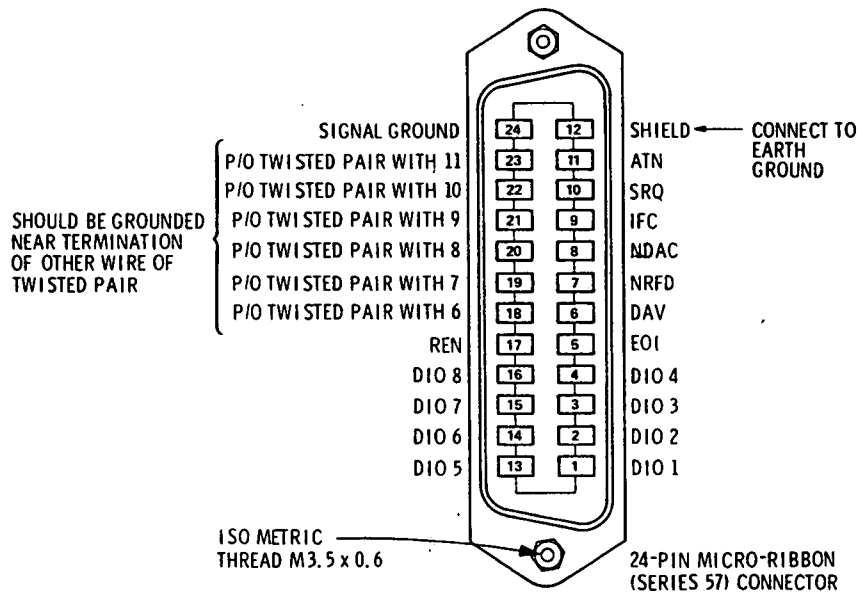

Logic Levels

The Hewlett-Packard Interface Bus Logic Levels are TTL compatible, i.e., the true (1) state is 0.0 Vdc to +0.4 Vdc and the false (0) state is +2.5 Vdc to +5.0 Vdc.

Programming and Output Data Format

Refer to Section III, Operation.

Mating Connector

HP 1251-0293; Amphenol 57-30240.

Mating Cables Available

HP 10833A, 1 metre (3.3 ft), HP 10833B, 2 metres (6.6 ft)
HP 10833C 4 metres (13.2 ft), HP 10833D, 0.5 metres (1.6 ft)

Cabling Restrictions

1. A Hewlett-Packard Interface Bus system may contain no more than 2 metres (6 ft) of connecting cable per instrument.
2. The maximum accumulative length of connecting cable for any Hewlett-Packard Interface Bus system is 20.0 metres (65.6 ft).

Figure 2-3. Hewlett-Packard Interface Bus Connection

Rack Mounting (cont'd)

Rack mounting information is provided with the rack mounting kits. If the kits were not ordered with the instrument as options, they may be ordered through the nearest Hewlett-Packard office. Refer to Mechanical Options, in Section 1.

2-14. STORAGE AND SHIPMENT

2-15. Environment

The instrument should be stored in a clean, dry environment. The following environmental limitations apply to both storage and shipment:

Temperature -55°C to $+75^{\circ}\text{C}$
Humidity $<95\%$ relative
Altitude $<15\,300$ metres (50 000 feet)

2-16. Packaging

Tagging for Service. If the instrument is being returned to Hewlett-Packard for service, please complete one of the blue repair tags located at the end of this manual and attach it to the instrument.

Original Packaging. Containers and materials identical to those used in factory packaging are available through Hewlett-Packard offices. Mark

the container "FRAGILE" to encourage careful handling. In any correspondence refer to the instrument by model number and full serial number.

Other Packaging. The following general instructions should be used for repackaging with commercially available materials.

a. Wrap the instrument in heavy paper or plastic. If shipping to a Hewlett-Packard office or service center, complete one of the blue tags mentioned above and attach it to the instrument.

b. Use a strong shipping container. A double-wall carton made of 2.4 MPa (350 psi) test material is adequate.

c. Use enough shock-absorbing material (75 to 100 mm layer — 3 to 4 inches) around all sides of the instrument to provide a firm cushion and prevent movement in the container. Protect the front panel with an appropriate type of cushioning material to prevent damage during shipment.

d. Seal the shipping container securely.

e. Mark the shipping container "FRAGILE" to encourage careful handling.

3

OPERATION

3-1. Introduction

This section provides operating information for the Generator. Included are both simplified and detailed operating instructions, detailed descriptions of the front and rear panel, local and remote operator's checks, and operator's maintenance.

3-2. Panel Features

Front and rear panel features are described in detail in Figures 3-1 and 3-2. For a more in depth description refer to the Detailed Operating Instructions found in this section.

3-3. Operating Characteristics

Table 3-1 briefly summarizes the major operating characteristics of the Generator. This table is not intended to be a complete listing of all operations and ranges, but gives a general idea of the instrument capabilities. For more information on the Generator capabilities, refer to Table 1-1, Specifications, and Table 1-2, Supplemental Characteristics. For information on HP-IB capabilities, refer to Table 3-2, Message Reference Table.

3-4. Local Operation

Information covering front panel operation of the Generator is given in the sections described below. To quickly learn the operation of the Generator, begin with Operating Characteristics and Simplified Operation. (Operator's Checks can also be used to gain familiarity with the Generator.) Once familiar with the general operation of the Generator, use the detailed operating instructions as a reference for more complete operating information.

Turn-On Information.

Instructions relating to the Generator turn-on procedure and various keystroke sequences are presented to acquaint the user with the general operation of the Generator.

Simplified Operation.

The instructions provide a quick introduction to the operation of the Generator. In addition, an index to the detailed operating instructions exists helping the user to a more complete discussion of the topic of interest.

Detailed Operating Instructions.

The detailed operating instructions provide the complete operating reference for the Generator user. The instructions are identified in marginal copy and are listed by function in Table 3-4.

FRONT PANEL FEATURES

Calibration. The CAL key calibrates the instrument's baseband vector modulator, FM modulator and output level. Periodic calibration is recommended to compensate for component drift with temperature and time.

Instrument State. This group of keys controls many of the initial set-up conditions of the instrument. SAVE and RECALL can be used to save a set-up and recall it later. Some of the set-up parameters that can be controlled are the data threshold and number of clocks for digital modulation, the inversion of digital lines, and the presence of external filters.

Pressing the MSG key in this group shows error and warning messages on the display. When an error or warning condition occurs, the LED on this key will light and stay lit until the key is pressed to examine the message, or until the error condition is changed. If more than one message applies, successive ones can be read by repeatedly pressing the MSG key.

Line Mains Power. The generator uses international symbols for standby (Ⓢ) and on (Ⓡ). In STANDBY, the reference oscillator oven is energized.

Entry. The keys and knob in this section set signal frequency, level, FM deviation, ALT LEVEL, ALT LEVEL I, I<Q, and TWO STATE modulations. Parameters to be changed are selected with one of the SET keys on the left of the section. The parameter is then displayed and can be changed by typing in a new value with the keypad, using the up and down arrows to increment and decrement, or using the knob. If the keypad is used, the units keys on the right of the section terminate the entry.

HP-IB Status. LEDs indicate status of HP-IB operation. LCL key returns the generator from remote to front panel operation unless local lockout is programmed. LCL is also used to display the HP-IB address. As long as this key is held down the HP-IB address will be displayed on the left display.

The Display. LCD display panel shows frequency, amplitude, FM sensitivity, modulation type, easy to read error messages and warnings. It also displays prompts for various instrument set-up commands.

Output Control. This section of the front panel toggles different modulations and the RF output on and off. LEDs in the keys indicate which modulations are on and whether the RF output is enabled. Simultaneous modulations can be selected provided they are compatible. For example QPSK and Scalar may both be selected, but 16QAM and Burst may not (since there aren't enough data lines). Any modulation can be turned off in the same way that is was turned on — by pressing that modulation key.

The RF OUT ON key toggles the Coherent Carrier on and off along with the RF output.

Vector Input. The Vector Input lines are direct I and Q inputs to the vector modulator. Full scale I and Q voltages are $-0.5V$ to $+0.5V$ into 50Ω ; however, vector accuracy is only specified for vectors with magnitudes less than $0.5V$ (the square root of the sum of the squares of I and Q voltages must be less than $0.5V$). I and Q bandwidths are dc to 350 MHz.

RF Output. This is the generator's primary output. It is the test signal generated with all modulation, level and frequency control. For demodulation purposes, a coherent output is provided on the rear panel which has no modulation except for FM.

The Phase Bump special function can be used to shift the RF Output and Coherent Carrier phase with respect to the 10 MHz frequency reference. This makes it possible to change the Vector Signal Generator's phase with respect to another synthesizer. Phase Bump does not change the phase of the Coherent Carrier with respect to the RF Output.

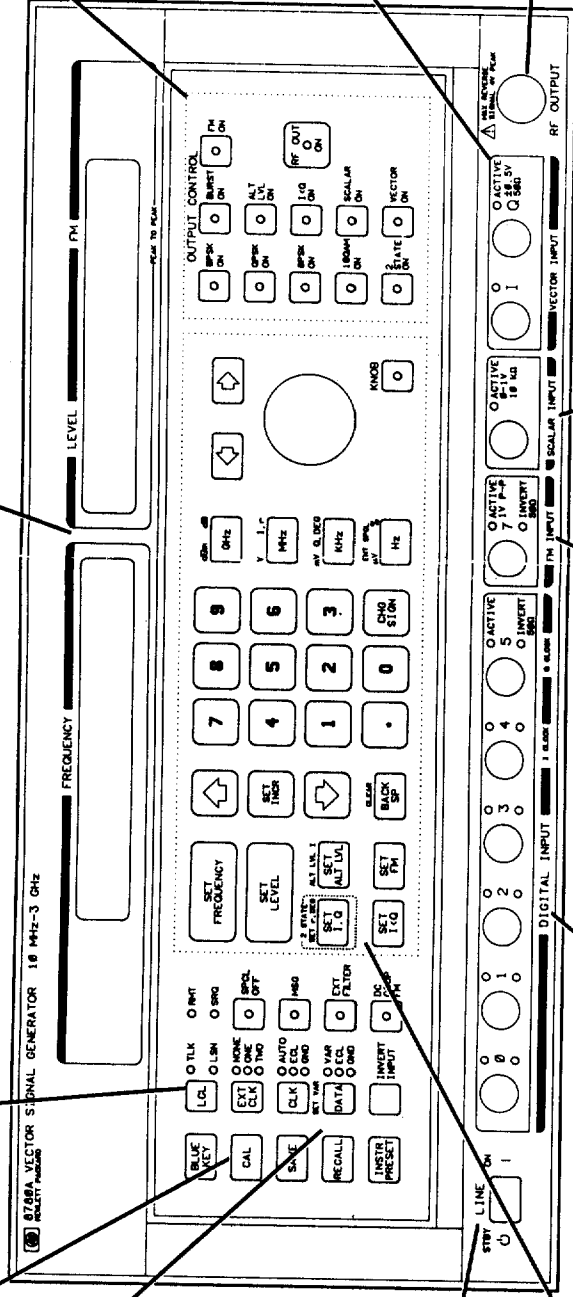

Digital Inputs. There are six 50Ω digital inputs that can be used to do many different quadrature-amplitude and phase-shift-keyed modulations. There are four data and two clock lines. Next to each BNC connector are two LEDs to indicate which lines are active and which lines are inverted. Line terminations are $-2.0V$ for ECL levels and ground for all others.

FM Input. This is the frequency modulation input line and it has a 50Ω impedance. Full scale modulation is obtained with $+0.5V$ to $-0.5V$ for dc FM and 1.0 Vp-p for ac FM. Note that this is the only analog modulation input that can be inverted. This allows the frequency modulated spectrum to be easily reversed. An LED also indicates the line is active when FM is selected.

Scalar Input. The Scalar input has a nominal impedance of 10 k Ω and its full scale range is $0.0V$ to $+1.0V$ with $0.0V$ corresponding to no output. Scalar frequency response is dc to 500 kHz.

Figure 3-1. Front Panel Features

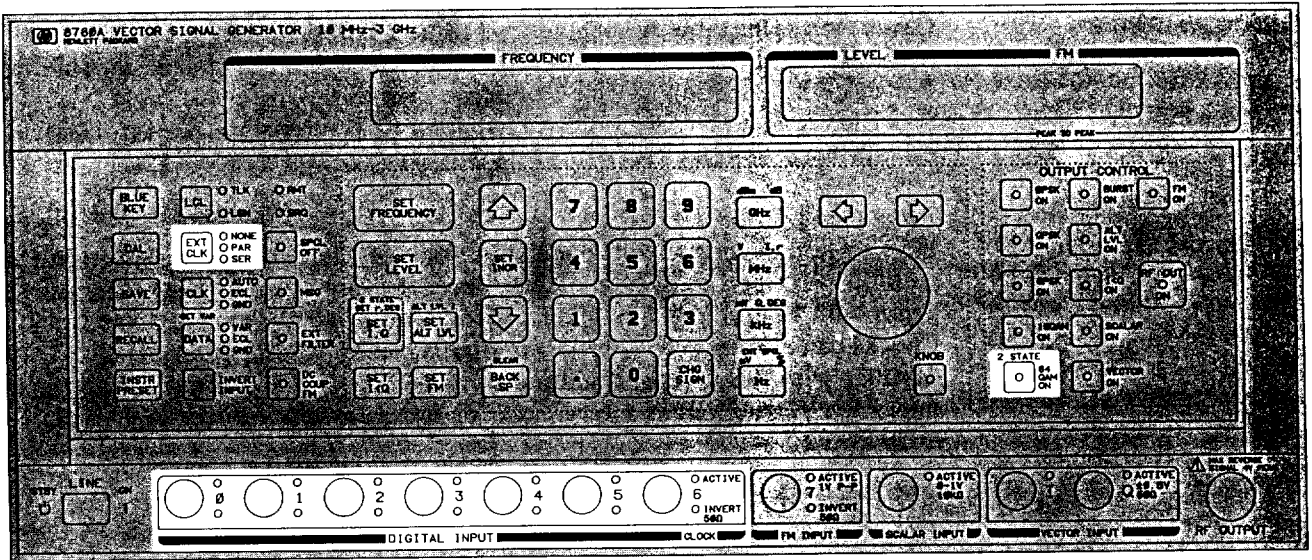

This figure shows front panel features that change for Option 064.

- NOTE: 6 digital input lines (D0, D1, D2, D3, D4, D5)
- 1 clock line (D6)
- EXT CLK (external clock): NONE, PAR (parallel), and SER (serial)
- 64 QAM ON: 64 QAM format selected

Figure 3-1a. Front Panel Features (Option 064)

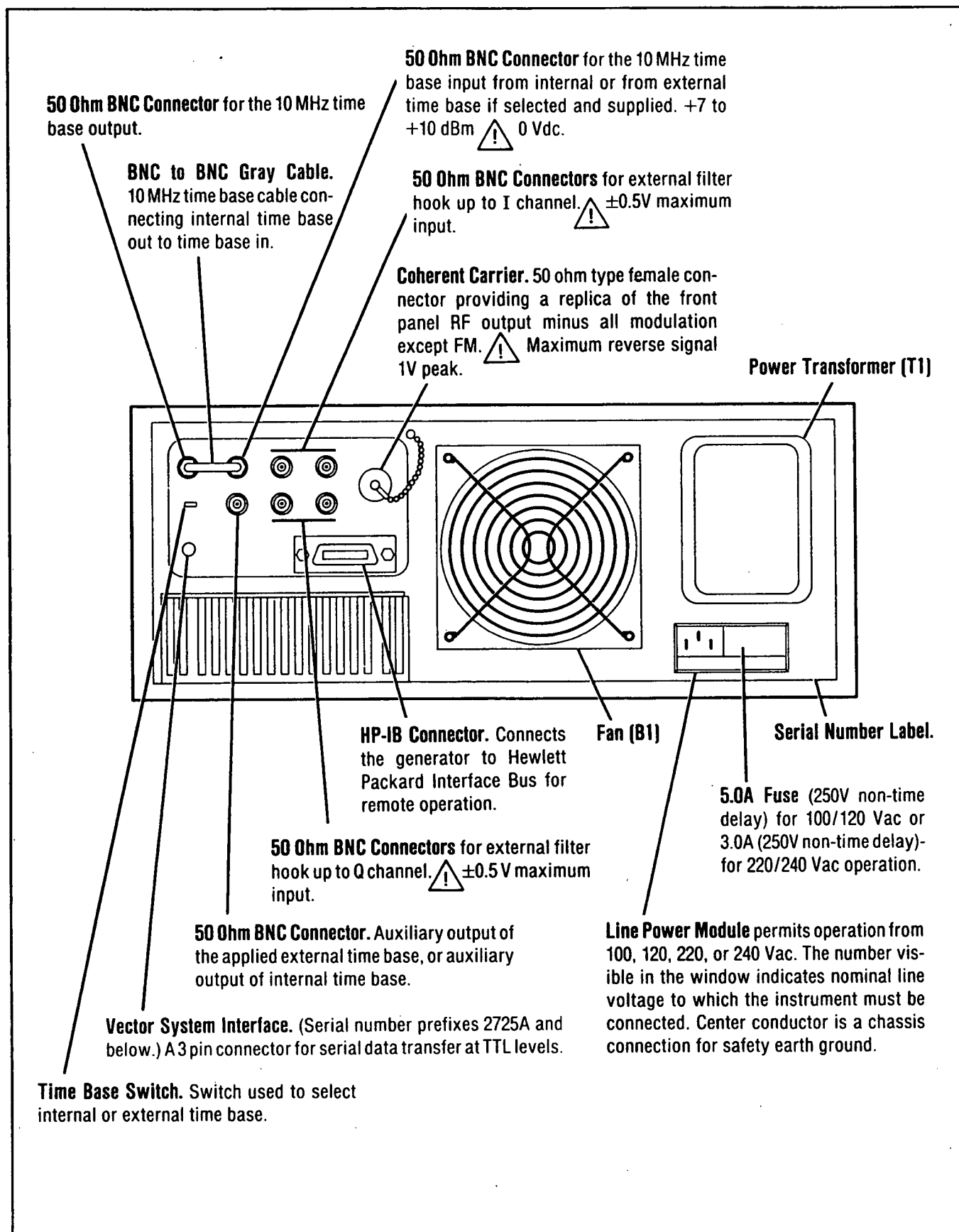

Figure 3-2. Rear Panel Features

3-5. Remote Operation HP-IB

The Generator is capable of remote operation via the Hewlett-Packard Interface Bus (HP-IB).

HP-IB is Hewlett-Packard's implementation of the IEEE Standard 488, "IEEE Standard Digital Interface for Programmable Instrumentation", also described by the identical ANSI Standard MC1.1. For more detailed information relating to programmable control of the Generator, refer to Remote Operation in this section.

This section includes discussions on capabilities, addressing, input and output formats, the status byte and service request. In Table 3-3 is a complete summary of programming codes. In addition, programming examples are given in HP-IB Checks and in the Detailed Operating Instructions.

3-6. Operator's Checks

Operator's Checks are procedures designed to verify proper operation of the Generator's main functions. Two procedures are provided as described below.

Basic Functional Checks. This procedure requires only a minimum of equipment to perform: a microwave counter and a power meter are needed. This procedure assures that most front panel controlled functions are being properly executed by the Generator.

HP-IB Checks. This procedure assumes that front panel operation has been verified by performing the Basic Functional Checks. The HP-IB procedure checks all of the applicable bus messages summarized in Table 3-2.

3-7. Operator's Maintenance

WARNING

For continued protection against fire hazard, replace the line fuse with a 250V fuse of the same rating only. Do not use repaired fuses or short-circuited fuseholders.

Operator's maintenance consists of replacing defective primary fuses. This fuse is located in the line module assembly. Refer to Figure 2-1 for instructions on changing the fuse.

3-8. TURN-ON INSTRUCTIONS

WARNING

Before the instrument is switched on, all protective earth terminals, extension cords, autotransformers and devices connected to it should be connected to a protective earth grounded socket. Any interruption of the protective earth grounding will cause a potential shock hazard that could result in personal injury.

Only 250V normal blow fuses with the required rated current should be used. Do not use repaired fuses or short circuited fuseholders. To do so could cause a shock or fire hazard.

CAUTION

Before the instrument is switched on, it must be set to the voltage of the power source or damage to the instrument may result.

If the Generator is already plugged in, press the rocker LINE switch to ON. The Generator uses international symbols for STANDBY and ON representing the position that the front panel LINE switch is in.

If the power cable is not plugged in, follow these instructions.

On the rear panel:

1. Check the line voltage switch for correct voltage selection.
2. Check that the fuse rating is appropriate for the line voltage used (see Figure 2-1). Fuse ratings are printed on the rear panel.
3. Plug in the power cable and wait for the OVEN COLD message to disappear from the front panel display.
4. On the front panel, press the LINE switch to on.

NOTE

The Generator turns on to the same control settings it had before line power was removed. An exception to this is that it always turns on in the local mode. In addition some HP-IB default conditions are enabled.

When the Generator is turned on, it will execute a power up sequence which will be followed by an automatic RECALL 0. The power up sequence will run some self test routines to verify the operation of ROM, RAM, and the ADC (analog to digital converter). Also a check of front panel displays is done at this time. If any self test failures occur an error message will be indicated by the front panel MSG (message) key indicator turning on. This error message can be responded to by pressing the MSG key noting the message in the display and then referring to the error message table.

If for some reason, RAM content was lost an error message will be displayed and all storage registers initialized to put the Generator into the PRESET state. CAL (calibration) factors are lost and the UNCAL message is displayed. Storage locations 0 through 9 are all set to the PRESET state when a RAM error occurs. This means that in the event of RAM failure the Generator will be in PRESET when it begins operation, and the HP-IB address defaults to 19 at this time.

NOTE

An internal battery is used to retain data in RAM during periods when the Generator is in STBY (standby). This data restores the last control setup that was saved in storage locations zero through nine.

Table 3-1. Operating Characteristics

Frequency	<p>Range: 10 MHz to 3.0 GHz (Extended ranges: 1 MHz to 10 MHz and > 3.0 GHz to 3.2 GHz)</p> <p>Resolution: 1 Hz</p>
RF Output Level	<p>Range: -100 to +10 dBm 10 MHz to 2.5 GHz -100 to +4 dBm > 2.5 to 3.0 GHz</p>
Modulation	<p>FM Rates: ac coupled 20 Hz to 12 MHz dc coupled dc to 10 kHz</p> <p>Peak FM deviation: AC coupled 50 kHz p-p to 50 MHz p-p DC coupled 150 Hz p-p to 150 kHz p-p</p> <p>Scalar (Amplitude): 0 to +1.0 VDC</p> <p>Vector (I and Q) full scale levels: $\pm 0.5V$</p> <p>Digital (Data Formats): BPSK QPSK 8PSK 16QAM 64QAM (Option 064) Arbitrary 2-state BURST</p>
Filters	<p>Baseband: Internal spectral limiting automatic- ally switched with carrier frequency</p> <p>External: I and Q channel filtering (rear panel connectors)</p>
Instrument Preset (INSTR PRESET)	<p>Instrument state:</p> <p>Frequency 70 MHz</p> <p>RF ON</p> <p>Amplitude -100 dBm</p> <p>Modulation OFF</p> <p>Specials OFF</p> <p>No inverted inputs</p> <p>DCFM OFF</p> <p>No external clocks</p> <p>Clock and data levels ECL</p> <p>No external filter</p> <p>Knob (RPG) OFF</p> <p>Software error message buffer empty</p> <p>HP-IB SRQ mask turned off</p>
Calibration (CAL)	<p>Calibrating: Baseband, Level, FM</p>

3-9. SIMPLIFIED OPERATION

The following paragraphs and the pull out card can be used as the introduction to simplified operation.

NOTE

If the instrument does not operate properly and is being returned to Hewlett Packard for service, please complete one of the blue repair tags located at the end of this manual and attach it to the instrument.

3-10. Operational Procedure

Upon receipt of the instrument, or to check the Generator for an indication of normal operation, review the operational procedures. These procedures can familiarize the operator with the Generator and provide an understanding of the operating capabilities.

The Generator has several keys labeled "SET" relating to some function, parameter, or capability. The operational procedures include an explanation of the manual manipulation of the set keys and how to use some of those keys to show that a major portion of the Generator is operating.

Prior to the operator checks is the following section containing the definition of all of the set keys on the Generator. The format of each definition is as follows:

DISPLAY
LENGTH
UNITS
UNITS LENGTH
VALUE RANGE
RESOLUTION
TERMINATORS

DISPLAY defines where the value is displayed. The display of the Generator is broken into two main sections, right and left. Each section consists of 12 character positions. To define where a value will appear the notation used is, for example, LEFT 5, which means that the line will appear in the left display starting at character position 5.

LENGTH defines the number of characters that the value will use in the display.

UNITS defines the possible units that could be displayed next to the value.

UNITS LENGTH defines the length of the units value in the display.

VALUE RANGE defines the range of legal entries for the value.

RESOLUTION defines the smallest increment of the value. The resolution is the displayed resolution and in some cases it may not be possible to change the value displayed by one LSD (least significant digit) increment.

TERMINATORS is a list of the accepted terminators to complete an entry.

3-11. Display Configurations

The following shows some of the different display configurations that are possible.

The Generator has two twelve-character alphanumeric displays: Each character position contains a cursor, and a decimal point. In the following examples it is important to note that the decimal points do not take one complete character space, however, in order to display them here, they do take a complete space.

Here is an example display:

```

1   |   |   ||  |   |   ||
2   2.53356000GZ  -100dM 30.5MZ
3       T

```

In the above display row 1 indicates each character position. The vertical lines are only to indicate place holders and with careful analysis the two twelve character displays can be visualized. Row 2 indicates the data that is displayed in the main display. Row 3 indicates the cursor position with "T" indicating cursor position.

The data displayed in the example is a typical display format. The left display section displays the frequency while the right display section displays the level and the FM deviation range.

In the example it is indicated that the instrument is in the SET FREQUENCY state since the cursor is under the frequency information. When the user turns the KNOB (assuming it is enabled) the digit the cursor is below is incremented or decremented as the KNOB turns. For example, the user turns the KNOB (rotary pulse generator) clockwise generating pulses. The display would read:

```

1   |   |   ||  |   |   ||
2   2.68356000GZ  -100dM 30.5MZ
3       T

```

If the user then pressed the SET INCR key the instrument would enter the SET FREQUENCY INCREMENT state and the display would indicate the following:

```

1   |   |   ||  |   |   ||
2   FREQ INC      1.000000000GZ
3

```

Operation
HP 8780A

The value now displayed in the FREQUENCY position is the current frequency increment. In this and any of the SET INCR modes the KNOB and cursor movement keys are ignored. The user may now start entering the new frequency increment value. Example: user enters the digits 125. The display shows:

```

1  |   |   || |   |   ||
2  FREQ INC      125
3                      T

```

In this display the digits entered are displayed starting at the left hand edge of the frequency field and progressing to the right. Each time a number is entered the cursor moves one position to the right. When the field is entirely filled the cursor will be under the last digit entered and any further numeric entries will be ignored. If the BACK SPACE key was pressed the display will show:

```

1  |   |   || |   |   ||
2  FREQ INC      12
3                      T

```

If the CLEAR function is input the display would show:

```

1  |   |   || |   |   ||
2  FREQ INC      1.000000000GZ
3

```

To complete a SET INCR entry the user would enter an appropriate terminator and that would complete the entry. For example, suppose we are back at display FREQ INC 125 and the user enters the MHz terminator. This would complete the entry and the display would return to that of 2.68356000GZ -100 dM 30.5MZ.

The SET INCR state has now been completed and we are back in the SET FREQUENCY state. The new frequency increment is set at 125 MHz.

The user now presses the UP ARROW key. The display shows:

```

1  |   |   || |   |   ||
2  2.80856000GZ  -100dM 30.5MZ
3          T

```

Note that any entry error will result in the MSG indicator turning on and the termination of that entry with no change taking place. If the KNOB, the UP ARROW, or the DOWN ARROW is used to modify a value and the limits of the value being modified are reached, the MSG indicator is not on and the value stays at the limit.

To change the LEVEL value the user would press the SET LEVEL key. The display would then show:

```

1  |      |  ||  |      |  ||
2  2.80856000GZ  -100dB 30.5MZ
3  |
  
```

The cursor is moved under the LEVEL value to the position it was last in. The user can now modify the LEVEL in the same way that FREQUENCY was modified. To change the LEVEL increment value the user would now press the SET INCR key. The display would show:

```

1  |      |  ||  |      |  ||
2  LEVEL INC      1.0000uV
3  |
  
```

The user can now enter a new increment value. For example, the user now wants to have a level increment of 2.0 dB so he would enter a 2 followed by the dB terminator key. The level increment is now set to 2 dB and pressing the up arrow would result in the display showing the following:

```

1  |      |  ||  |      |  ||
2  2.80856000GZ  -98dB 30.5MZ
3  |
  
```

Note that the LEVEL and the LEVEL INCREMENT values can be in different units (one in dB and the other in volts).

To view and/or change the 2 STATE parameters the user presses either the SET I/Q or the SET r,θ keys. The parameters are then displayed in the right display section.

When the user presses the SET I/Q key, this display shows:

```

1  |      |  ||  |      |  ||
2  2.80856000GZ  I1= 80.2
3  |
  
```

The cursor indicates the value that is currently in the SET mode. To change to SET Q1 mode the user would press the SET I/Q key once. Each time the key is pressed the display changes to the next I/Q value in the sequence. When the Q2 parameter is displayed, pressing the SET I/Q key causes the system to go to the set I1 parameter again. Assume that the display is that of the previous example and the user presses the SET I/Q key twice; the display will now show:

Operation
HP 8780A

```

1  |      |      ||  |      |      ||
2  2.80856000GZ  Q1=  3.0
3                               T

```

The cursor is now at the Q1 value indicating that it can now be modified with any of the value modification keys. If we want to return to the display of example -98dM the user would press the SET LEVEL key thus leaving the SET I/Q state.

Assume that the display is in the state of example above and the user presses the following key sequence: <1> <2> <3> <any terminator>. This is not a legal entry (Q1 has a maximum value of 100.0) and the display would again be that of previous example. The difference the MSG indicator is now on indicating an error condition. If the user were to press the MSG key the display would show:

```

1  |      |      ||  |      |      ||
2  Q1 > 100.0  ERROR 110
3

```

The display remains until the key is released. After the message is gone the display will return to its previous state (that of the previous example). The MSG indicator will go out, unless another message is present, in which case the indicator will remain on.

If the user were now to press the SET FM key the display would show:

```

1  |      |      ||  |      |      ||
2  2.80856000GZ  -98dM 30.5MZ
3                               T

```

The FM range displayed is the peak-to-peak deviation for a 1 volt peak-to-peak input level. If the user were to enter 10MZ this display would show:

```

1  |      |      ||  |      |      ||
2  2.80856000GZ  -98dM 10.0MZ
3                               T

```

Now suppose the user were to decrement the FM with the KNOB by turning it counterclockwise. The display would show:

```

1  |      |      ||  |      |      ||
2  2.80856000GZ  -98dM 9.00MZ
3                               T

```

3-12. Setting Operating Modes

The following rules apply to SET modes:

There are 4 types of SET modes:

Type 1: FREQUENCY, FM and LEVEL

Type 2: TWO STATE, ALT LEVEL, ALT LEVEL I, I<Q, and VAR

Type 3: Increment setting

Type 4: Self terminating (i.e. SAVE/RECALL, INVERT)

Type 1 is entered when the appropriate set key is pressed and remains active until another set key is pressed.

The KNOB (RPG, rotary pulse generator) and UP/DOWN keys are active.

Type 2 is entered when the appropriate set key is pressed and remains active until a nonnumeric key is pressed.

If a different set key is pressed then that set mode becomes active. If a key other than a set key is pressed (nonnumeric also) then the display shows frequency, level and FM (if active) and there is no current entry field. The KNOB and UP/DOWN keys are active when in a type 2 set mode.

Type 3 is entered when there is an active set mode and the SET INCR key is pressed. This mode remains active until terminated

by completion of a numeric entry or a key that is a nonnumeric is pressed. If a different set key is pressed then that set mode becomes active. If a key other than a set key is pressed

then the display shows frequency and level. FM is also displayed (if enabled) and there is no current entry field. When a numeric entry is completed the system will return to the set mode that was active before the SET INCR key was pressed. The RPG and UP/DOWN keys are not active when in a type 3 set mode.

Type 4 is entered when the appropriate (save, recall, invert) key is pressed. This mode is exited when any key is pressed. If a numeric key is pressed it will terminate the entry and execute the function of that key. When type 4 set modes are exited the set mode returns to the set mode that was active before the type 4 set mode was entered. The KNOB and UP/DOWN keys are not active when in a type 4 set mode.

Examples: System is in set frequency;

- A User presses SET INCR
User enters 3.2 MHz
System updates frequency increment
to 3.2 MHz and returns
to set frequency mode.

- B System is in set frequency increment mode
User enters 43.2
User back spaces 4 times
System returns to set frequency mode with
no change to frequency increment.

- C System is in set frequency mode
User enters set level mode
User enters set I1 mode
User turns KNOB....(I1 parameter is modified)
User turns BPSK on
System exits set I1 mode...display shows frequency
level and FM (if enabled)
and no set field is active.

- D System is in set I1 mode
User enters set var data level mode
User selects ECL data levels
System exits set var data level mode...display shows
frequency, level and FM (if enabled)
and no set field
is active.

A few set keys are used to set several parameters. If this is the case, then there is an additional parameter called ORDER OF SEQUENCE. This tells what parameter will be in the set mode when the key is first pressed, pressed again and so forth.

SET FREQUENCY

DISPLAY: LEFT 1
LENGTH: 10
UNITS: Hz kHz MHz Gz
UNITS LENGTH: 2
VALUE RANGE: 10 MHz to 3.0 GHz
RESOLUTION: 1Hz
TERMINATORS: Hz kHz MHz GHz

NOTE

On the display only 10 digits of frequency can be displayed. When the frequency value is too large to display, only the most significant digits are displayed although the entire value is kept internally.

Also if internal filtering is selected the following filters will be selected by frequency:

Frequency Range	Filter Nominal 3 dB Point
0 to 138.999999 MHz	42 MHz
139 to 278.999999 MHz	87 MHz
279 to 558.999999 MHz	180 MHz
559 and above	255 MHz
Full range with no internal baseband filtering.	>350 MHz
With external filter selected 0 to maximum frequency MHz	500

SET LEVEL

DISPLAY: RIGHT 1
 LENGTH: 4
 UNITS: dM V MV uV
 UNITS LENGTH: 2 or 3
 VALUE RANGE: -127.0dBm to +16.0dBm
 100nV to 1.412V
 RESOLUTION: 0.1dBm above -100 dBm
 1.0 dB at or below -100 dBm
 about 0.1% of reading
 TERMINATORS: dBm V mV uV

SET I,Q

DISPLAY: RIGHT 1
 LENGTH: 12
 ORDER OF SEQUENCE: I1 Q1 I2 Q2
 UNITS: % (although any terminator key
 can be used)
 UNITS LENGTH: 4 (Prefix ... I1=)
 VALUE RANGE: -100.0 to +100.0

NOTE

If setting I or Q results in an R vector greater than 100.0% a warning will result since the instrument cannot generate vectors greater than 100.0% within specifications. The instrument will attempt to generate the specified vector. However, the maximum vector length possible is 141.4.

RESOLUTION: 0.1
TERMINATORS: I Q

SET r (radius),
 θ (degrees)

DISPLAY: RIGHT 1
LENGTH: 12
ORDER OF SEQUENCE: r1 DEG1 r2 DEG2
UNITS: θ IS IN DEGREES
UNITS LENGTH: 4 (Prefix... r1=)
VALUE RANGE: r: 0.0 to 141.4
 DEG: -360.0 to +360.0
RESOLUTION: 0.1
TERMINATORS: r DEG

NOTE

Setting r greater than 100.0 will result in a warning since the instrument cannot generate vectors this long within specs. The instrument will do its best to generate the specified vector however.

r can only be > 100.0 for certain values of θ . The values of r and θ must result in an I and/or Q of ≤ 100.0 .

θ_1 is the angle between I axis and r1. θ_2 is the angle between the I axis and r2.

SET FM

DISPLAY: RIGHT 8
LENGTH: 3
UNITS: Hz kHz MHz GHz
UNITS LENGTH: 2
VALUE RANGE: 50.0 kHz to 50 MHz (ac coupled FM)
150 Hz to 150 kHz (dc coupled FM)
RESOLUTION: 1 Hz or 0.1 kHz or 0.1 MHz
TERMINATORS: HZ KZ MZ GZ

SET ALT LVL

DISPLAY: RIGHT 1
LENGTH: 12
UNITS: dB %
UNITS LENGTH: 2
VALUE RANGE: 0.0 dB to 40.0 dB
1 to 100%
RESOLUTION: 0.1 dB or 1%
TERMINATORS: dB, %

SET ALT LVL I

DISPLAY: RIGHT 1
LENGTH: 12
UNITS: dB %
UNITS LENGTH: 2
VALUE RANGE: 0.0 dB to 40.0 dB
1 to 100%
RESOLUTION: 0.1 dB or 1%
TERMINATORS: dB, %

SET I<Q

DISPLAY: RIGHT 1
LENGTH: 12
UNITS: dB %
UNITS LENGTH: 2
VALUE RANGE: 0.0 dB to 40.0 dB
1 to 100%
RESOLUTION: 0.1 dB or 1%
TERMINATORS: dB, %

SET VAR

DISPLAY: RIGHT 1
LENGTH: 12
UNITS: V
UNITS LENGTH: 1
VALUE RANGE: -2.50 to +2.50
RESOLUTION: 0.01 volt
TERMINATORS: V,mV,micro volt

SET INCR In the SET INCREMENT mode the entire display is used to set the increment value for the current SET field. The units, resolution, value range and terminators allowed is the same as that for the currently selected set field. When SET INCR is selected the display will indicate the value of the current increment and will allow the user to enter another value. Examples are in the example section below.

3-13. Modifying a Selected Parameter

The following keys are used to modify a selected parameter and/or enter a parameter from the key pad.

UP ARROW Pressing this key causes the value that the cursor is pointing to to be incremented by the increment value. The cursor does not point to the position that will be incremented; it simply indicates which value on the display will be incremented when this key is pressed. If the key is held down it will auto repeat. If the value is incremented past the maximum value, the display will contain the maximum value. If there is no currently defined entry field this key has no effect.

DOWN ARROW Pressing this key causes the value that the cursor is pointing at to be decremented by the increment value. The cursor does not point to the position that will be decremented; it simply indicates which value on the display will be decremented when this key is pressed. If the key is held down it will auto repeat. If the value is decremented past the minimum value, the display will contain the minimum value. If there is no currently defined entry field this key has no effect.

BACK SPACE Pressing this key causes the previously entered digit to be deleted. Holding down this key causes the function to auto repeat. When this key is pressed and no digit has been entered, no action is taken. When the last digit entered is back spaced over, the displayed field will return to the state it was in before any digits were entered.

CLEAR Pressing this key causes the entered value to be cleared. It has the same function as pressing the back space key until all entered digits have been erased. Pressing clear when no entry has been made causes no action.

NUMERIC KEY PAD The numeric key pad is used to enter numbers when required. A digit entered is displayed in the current set or entry field of the display. When the field is full, any further entries are ignored. If there is no currently defined entry field these keys have no effect.

TERMINATORS These keys cause completion of a numeric entry and also define the units of that entry. When there is only one terminator associated with an entry, any of the terminator keys will cause completion of the entry. Pressing one of these keys when no entry is in progress causes no action.

LEFT ARROW This key moves the cursor left in the current entry field. If this key is held down it will auto repeat. When the cursor reaches the left most position pressing this key may result in the display of two cursors indicating that the cursor is under a digit off the left side of the display. If the number the cursor is under cannot contain digits off the left side

of the display the cursor will not change to two cursors, but will simply remain unchanged. If there is no currently defined entry field this key has no effect. For example, the display has the following:

```

1      |      |      |      |      |
2      |      |      |      |      |
3      |      |      |      |      |
      356.000MZ  -100dM  30.5MZ
                          T

```

Pressing the LEFT ARROW key 2 times results in the following display:

```

1      |      |      |      |      |
2      |      |      |      |      |
3      |      |      |      |      |
      356.000MZ  -100dM  30.5MZ
                          TT

```

indicating that the cursor is off the left side of the display field and under a digit not displayed. Turning the KNOB (RPG, rotary pulse generator) will increment the digit off the left of the display resulting in:

```

1      |      |      |      |      |
2      |      |      |      |      |
3      |      |      |      |      |
      356.000MZ  -100dM  130MZ
                          T

```

RIGHT ARROW This key moves the cursor right in the current entry field. If this key is held down it will auto repeat. When the cursor reaches the right most position and the RIGHT ARROW is pressed the cursor may become two cursors indicating it is under a digit to the right of the display field. If there are no digits to the right of the display field then the cursor remains as one cursor on the right of the display field. If there is no currently defined entry field this key has no effect.

KNOB The KNOB or internally the RPG (rotary pulse generator) is active when the KNOB indicator is on. When active, turning the KNOB clockwise increments the current value at the cursor position. Turning it counter-clockwise decrements the current value at the cursor position. When a value reaches its maximum or minimum value turning the KNOB further results in no change. When the KNOB indicator is off, turning of the KNOB is ignored. If there is no currently defined entry field this key has no effect.

KNOB (key) This key allows the user to enable and disable the RPG input. This key toggles between KNOB enabled and KNOB disabled. When the RPG (rotary pulse generator) is enabled the indicator in the KNOB key is on.

3-14. Output Control

The following keys control the output of the instrument. Some functions cannot be used simultaneously. The following defines the allowed combinations.

- 1) Digital and Scalar
- 2) Digital, Scalar, and FM
- 3) Digital and FM
- 4) Scalar and FM
- 5) Vector and FM

Putting the instrument into any of the above states will remove any state that is no longer consistent according to this table. Any other modulation combinations are not allowed. For example, suppose the system is in QPSK, BURST, ALT LVL and the user presses the key to put the system into BPSK. Since BPSK and QPSK cannot be on at the same time, QPSK would be turned off and BPSK would come on, leaving the instrument in the state: BPSK, BURST, ALT LVL.

- | | |
|---------|---|
| FM ON | This key is used to toggle the state of the FM. When the FM is on the indicator in the FM key is on otherwise the indicator is off. When FM is on the right display will display the current FM setting. When FM is on the FM INPUT ACTIVE indicator is on. |
| BPSK | This key is used to toggle BPSK on and off. When BPSK is on the indicator in the BPSK key is on otherwise the indicator is off. When BPSK is on the DIGITAL INPUT ACTIVE indicator 0 is on. |
| QPSK | This key is used to toggle QPSK on and off. When QPSK is on the indicator in the QPSK key is on otherwise the indicator is off. When QPSK is on the DIGITAL INPUT ACTIVE indicators 0 and 2 (0 and 3 Option 064) are on. |
| 8PSK | This key is used to toggle 8PSK on and off. When 8PSK is on the indicator in the 8PSK key is on otherwise the indicator is off. When 8PSK is on the DIGITAL INPUT ACTIVE indicators 0, 1, and 2 (0, 1, and 3 Option 064) are on. |
| 2 STATE | This key is used to toggle 2 STATE on and off. When 2 STATE is on the indicator in the 2 STATE key is on otherwise the indicator is off. |
| VECTOR | This key is used to toggle VECTOR on and off. When VECTOR is on the indicator in the VECTOR key is on otherwise the indicator is off. When VECTOR is on the VECTOR INPUT ACTIVE indicator is on. |

- SCALAR** This key is used to toggle SCALAR on and off. When SCALAR is on the indicator in the SCALAR key is on otherwise the indicator is off. When SCALAR is on the SCALAR INPUT ACTIVE indicator is on.
- 16QAM** This key is used to toggle 16QAM on and off. When 16QAM is on the indicator in the 16QAM key is on otherwise the indicator is off. When 16QAM is on the DIGITAL INPUT ACTIVE indicators 0, 1, 2, and 3 (0, 1, 3, and 4 Option 064) are on.
- 64QAM** This key is used to toggle 64QAM on and off. When 64QAM is on the indicator in the 64QAM key is on otherwise the indicator is off. When 64QAM is on the DIGITAL INPUT ACTIVE indicators 0, 1, 2, 3, 4, and 5 are on.
- ALT LVL** This key is used to toggle ALT LVL on and off. When ALT LVL is on the indicator in the ALT LVL key is on otherwise the indicator is off. When ALT LVL is on the DIGITAL INPUT ACTIVE indicator 1 is on.
- I<Q** This key is used to toggle I<Q on and off. When I<Q is on the indicator in the I<Q key is on otherwise the indicator is off.
- BURST** This key is used to toggle BURST on and off. When BURST is on the indicator in the BURST key is on otherwise the indicator is off. When BURST is on the DIGITAL INPUT ACTIVE indicator 3 (indicator 1 Option 064) is on.
- RF OUTPUT** This key is used to toggle the RF OUTPUT on and off. When the RF OUTPUT is on the indicator in the RF OUTPUT key is on otherwise it is off.

3-15. Indicator Annunciators

The following is a description of the indicator annunciators and how they are used:

TLK Used to indicate that the instrument is addressed to talk over the HP-IB.

LSN Used to indicate that the instrument is addressed to listen over the HP-IB.

SRQ Used to indicate that the instrument is sending a service request over the HP-IB.

RMT Used to indicate that the instrument has been put into the remote operation state by the HP-IB.

NONE, ONE, TWO Refers to the type of EXT CLK selected.

NONE, PAR, SER Refers to the type of EXT CLK for Option 064.

AUTO, ECL, GND Refers to the type of CLK levels selected.

VAR, ECL, GND Signals the type of DATA levels selected.

ACTIVE Several other indicators both in the front panel keys and near the inputs indicate an active state when on and in active state when off.

INVERT DATA inputs also have an indicator next to them to indicate when the input is inverted.

MSG The indicator in the MSG key indicates to the operator that a message is waiting and needs some response.

SPECIAL The indicator in the SPECIAL key is on when a special function is selected.

3-16. HEWLETT-PACKARD INTERFACE BUS REMOTE OPERATION

The Generator can be operated through the Hewlett-Packard Interface Bus (HP-IB). HP-IB is Hewlett-Packard's implementation of IEEE Standard 488 and the identical ANSI Standard MC1.1. Compatibility, programming and data formats are described in the following paragraphs.

All front panel functions except that of the LINE switch, knob rotation, and back space are programmable via HP-IB.

For more information about HP-IB, refer to IEEE Standard 488 (or the identical ANSI Standard MC1.1), the Hewlett-Packard Electronic Systems and Instruments catalog, and the booklet, "Tutorial Description of the Hewlett-Packard Interface Bus" (HP part number 5952-0156).

A quick test of the Generator's HP-IB interface is described in this section under HP-IB Checks. These checks verify that the Generator can respond to or send each of the applicable bus messages described in Table 3-3.

3-17. HP-IB Compatibility

The Generator's bus compatibility is described by the twelve HP-IB messages listed in Table 3-2. The Generator's compatibility with HP-IB is further defined by the following list of interface functions: SH1, AH1, T6, TE0, L3, LE0, SR1, RL1, PP1, DC1, DT0, and C0. A more detailed explanation of these compatibility codes can be found in IEEE Standard 488-1978 and the identical ANSI Standard MC1.1. The programming capability is described in the twelve HP-IB messages, the most important being the data messages which contain the program codes that set the Generator's mode of operation.

NOTE

Semicolons (;) should be inserted between commands.

3-18. Remote Mode

The Generator always powers up in local mode. It switches to remote operation upon receipt of the Remote message. The Remote message has two parts:

- a. Remote enable (REN) bus control line set true, and
- b. Device listen address received (while REN is true).

When the Generator switches to remote, the front panel REMOTE annunciator turns on.

In remote, the Generator can be addressed to talk or listen. When addressed to listen, the Generator responds to the Data, Clear (SDC), and Local messages. When addressed to talk, the Generator can issue the Data, Require Service, and Status Byte messages. Whether addressed or not, the Generator responds to the Clear (DCL), Local Lockout, Clear Lockout/Set Local, and Abort messages. In addition, the Generator may issue the Require Service and Status Bit messages.

3-19. Local-to-Remote Mode Changes

Local-to-Remote Mode Changes. The Generator switches to remote operation upon receipt of the Remote message. The Remote message has two parts. They are:

- a. Remote enable bus control line (REN) set true.
- b. Device listen address received (while REN is true).

When the Generator switches to remote, the REMOTE annunciator on the front panel turns on and the front panel controls are disabled except for LCL and the LINE switch.

The Generator's control settings remain unchanged with the Local-to-Remote transition.

3-20. Local Mode

Local Capability. In local, the Generator's front panel controls are fully operational and the Generator will respond to a Remote message. The Generator can send a Require Service message, a Status Byte message, and a Status Bit message while in the Local mode.

Whether it is addressed or not, it also responds to the Clear, Local Lockout, Clear Lockout/Set Local and Abort messages. Also whether addressed or not, the Generator can issue the Require Service and Status Bit messages. When addressed to talk, the Generator can issue Data messages and the Status Byte message.

Remote-to-Local Mode Changes. The Generator switches to local from remote whenever it receives a Local (GTL), Abort, or Clear Lockout/Set Local message. (The Clear Lockout/Set Local message sets the Remote Enable control line [REN] false.) The Generator can also be switched to local by turning the LINE switch to STANDBY, and then to ON, or with the LCL key if not in local lockout.

3-21. Addressing

The Generator's address is set to 19 at the factory. The address can be found by pressing and holding the LCL (local) key. To set the address select special function 25.0 and key in the desired address using the numeric keypad. The address can also be set remotely using special function 25.0, to do this you must know the current address so you can set up the instrument to respond to the special function.

Any address between 0 and 30 can be assigned to the Generator. Section II also has the procedure to set the Generator's address.

The Generator interprets the byte on the eight HP-IB data lines (DIO1-08) as an address or a bus command if the bus is in the command mode. The command mode is defined as attention control line (ATN) true and interface clear control line (IFC) false. Whenever the Generator is addressed (whether in local or remote), either the TALK or LISTEN annunciator on the front panel turns on.

3-22. Data Messages

The Generator communicates on the interface bus primarily with Data messages. Data messages consist of one or more bytes sent over the bus' data lines when the bus is in the data mode (attention bus control line [ATN] false). Unless it is set to talk only, the Generator receives Data Messages when addressed to listen. Unless it is set to listen only, the Generator sends Data Messages or the Status Byte message when addressed to talk. All Generator operations available in local mode can be performed in remote mode via Data messages.

3-23. Receiving Data Messages

The Generator responds to Data messages when it is enabled to remote (REN control line true) and addressed to listen. The Generator remains addressed to listen until it receives an Abort message or until its talk address or a universal unlisten command is sent by the controller.

A data message is a string of alternate codes and arguments, where a code is an ASCII character representing a function, such as frequency, RF output level, or modulation, and an argument is an ASCII digit representing a selection of the function. Each code and its argument make a command. Some commands require a terminator to supply the units for the entered value. For example, terminators for frequency entries are "HZ", "KZ", "MZ", and "GZ".

A complete summary of programming formats, codes and arguments is given in Table 3-3. In addition, programming examples are given in HP-IB Checks, and in the Detailed Operating Instructions.

Data Message Input Format. Input Data messages program virtually all Generator functions. The Data message contains a string of device-dependent commands (program commands). Program commands within a Data message are executed when a message unit terminator is received.

Program Command Format. Program commands consist of a header, which in most cases is followed by a parameter field. Command parameters can be words or numbers. For example in the command string "FR 1.5 GZ", using the function, data, units format.

3-24. Sending the Data Message

The Generator remains configured to talk until it is unaddressed to talk by the controller. To unaddress the Generator, the controller must send the Generator's listen address, a new talk address, an Abort message or a universal untalk command.

Before the Generator is addressed to talk, the desired output data must be specified with the appropriate input Data message, a query. Otherwise, the Generator cannot complete the bus data transfer. ~~Queries are program commands that start with a question mark (?).~~
The Generator responds to a query by outputting a Data message containing the value or state of the associated parameter.

Queries, when executed, cause their replies to be placed in the output buffer. Multiple queries on one line result in the last reply writing over the previous replies and an execution error being generated.

All output Data messages are sent with EOI true with the last byte. Refer to Programming Commands in this section for the output format of each query.

3-25. Receiving the Clear Message

The Generator responds to the Clear message by clearing any incomplete entries or messages. The message can take two forms: Device Clear which the Generator responds to only when addressed, and Selected Device Clear, which it responds to whether addressed or not. The Device Clear message does not affect addressing, while the Selected Device Clear message leaves the Generator addressed to listen.

3-26. Receiving the Trigger Message

The Generator does not respond to the Trigger message.

3-27. Receiving the Remote Message

The Remote message has two parts. First, the remote enable bus control line (REN) is held true; second, the device listen address is sent by the controller. These two actions combine to place the Generator in remote mode. Thus, the Generator is enabled to go into remote when the controller begins the Remote message, but it does not actually switch to remote until addressed to listen the first time. When actually in remote, the Generator's front panel REMOTE annunciator lights.

3-28. Receiving the Local Message

The Local message is the means by which the controller sends the Go To Local (GTL) bus command. The Generator returns to front panel control when it receives the Local message.

When the Generator goes to local mode, the front panel REMOTE annunciator turns off.

3-29. Receiving the Local Lockout and Clear Lockout/Set Local Messages

The Generator responds to the Local Lockout and Clear Lockout/Set Local messages.

The Clear Lockout/Set Local message is the means by which the controller sets the Remote Enable (REN) bus control line false. The Generator returns to local mode (full front panel control) when it receives the Clear Lockout/Set Local message. When the Generator goes to local mode, the front panel REMOTE annunciator turns off.

3-30. Receiving the Pass Control Message

The Generator does not respond to the Pass Control message because it does not have controller capability.

3-31. Sending the Require Service Message

The Generator sends the Require Service message by setting the Service Request (SRQ) bus control line true when a previously programmed condition occurs. The Require Service message is cleared when a serial poll is executed by the system controller. During serial poll, the SRQ control line is reset as soon as the Generator places the Status Byte message on the bus.

When the Generator is sending the Require Service message, the front panel SRQ annunciator lights. The annunciator is turned off during the serial poll when the SRQ control line is reset.

3-32. Sending the Status Byte Message

After receiving a Serial Poll Enable (SPE) bus command and when addressed to talk, the Generator sends the Status Byte. The Status Byte message consists of one 8-bit byte in which the bits are set according to the following bit definition.

BIT 7	BIT 6	BIT 5	BIT 4	BIT 3	BIT 2	BIT 1	BIT 0
*	*	*	*	*	*	*	*
NOT	* RQS	* SOFT	* READY	* POWER	* HARD	* NOT	* CAL
USED	*	* ERROR	*	* FAIL	* ERROR	* USED	* DONE
*	*	*	*	*	*	*	*

BIT 0 is set when the system is done executing a calibration cycle. This bit is cleared when the status byte is sent over the HP-IB.

BIT 2 is set when an illegal hardware condition is detected. This bit is cleared when the illegal hardware condition no longer exists and any SRQ generated has been acknowledged.

BIT 3 is set when the instrument powers up. It is cleared when the status byte is sent over the HP-IB.

BIT 4 is set when the instrument is ready to either send or receive data. This means that the instrument has completed its last operation.

BIT 5 is set when an illegal entry is made. It is also set when a calibration error occurs. This bit is cleared when the status byte is sent over the HP-IB.

BIT 6 is set when any other bit is set and the service request mask does not mask out the bit involved. This bit is cleared when the instrument is addressed to perform a serial poll or when the other bits are cleared (BIT 7 is never set when none of the other bits are set).

Bits in the status byte are set depending on the Generator state. If a condition occurs that causes one of the bits in the status byte to be set, then the RQS (Require Service) bit is set and, if masked, an SRQ is generated.

If the Generator is set to listen-only mode, it does not respond to the SPE and SPD (Serial Poll Disable) bus commands and cannot send the Status Byte.

3-33. Sending the Status Message

When the Generator is sent the SM (Status Message) HP-IB command and addressed to talk, it will send the Status Message string. The ASCII string sent has the following format:

AAABBBCCDEFGHIJKLMNOPQRST<CR><LF> where:

AAA	software error code
BBB	hardware error code
CC	modulation format
D	scalar on/off
E	FM on/off
F	DC FM on/off
G	number of external clocks
H	clock level
I	data level
J	external filter on/off
K	alt level I on/off
L	RF power on/off
M	invert 0 on/off
N	invert 1 on/off
O	invert 2 on/off
P	invert 3 on/off
Q	invert 4 on/off
R	invert 5 on/off
S	invert 6 on/off
T	invert 7 on/off

The error numbers for AAA and BBB are defined in Error Messages, found in the Detailed Operating Instructions.

The value of CC has the following meanings:

- 00 TWO STATE modulation
- 01 BPSK
- 02 BPSK and BURST
- 03 BPSK and ALT LEVEL
- 04 BPSK and I<Q
- 05 BPSK, BURST and ALT LEVEL
- 06 BPSK, BURST and I<Q
- 07 BPSK, ALT LEVEL and I<Q
- 08 BPSK, BURST, ALT LEVEL and I<Q
- 09 QPSK
- 10 QPSK and BURST
- 11 QPSK and ALT LEVEL
- 12 QPSK and I<Q
- 13 QPSK, BURST and ALT LEVEL
- 14 QPSK, BURST and I<Q
- 15 QPSK, ALT LEVEL and I<Q
- 16 QPSK, BURST, ALT LEVEL and I<Q
- 17 BURST
- 18 8-PSK
- 19 8-PSK and BURST
- 20 8-PSK and I<Q
- 21 8-PSK, BURST and I<Q
- 22 16-QAM
- 23 16-QAM and I<Q
- 24 TWO STATE and BURST
- 25 VECTOR
- 26 NONE (NO DIGITAL OR VECTOR MODULATIONS SELECTED)
- 27 64QAM format (Option 064)
- 28 64QAM format I < Q (Option 064)

The value of the data for 'on/off' types is a 1 if on and a 0 if off.

The value of G is 0 : NONE NONE (Option 064)
 1 : ONE PAR (parallel) (Option 064)
 2 : TWO SER (serial) (Option 064)

The value of H is 0 : AUTO
 1 : ECL
 2 : GND

The value of I is 0 : VAR
 1 : ECL
 2 : GND

When the status message is sent the next pending MSG (indicated by the indicator in the MSG key being on) is cleared. Therefore, the MSG indicator may go off after the status message is sent. The Generator will send an EOI with the last byte of the string.

3-34. Sending the Learn String

LP1 String Format 408 (415 Option 064) bytes in the following order:

```
FRddddddddddHZISddddddddddHZCRddLVsddd.dDBM   ISdãd.dDBM   CRdd
or
LVd.dddddddddVLIISd.dddddddddVLCRdd
```

```
IOsddd.dENISddd.dENCRdITsddd.dENISddd.dENCRdQOsddd.dENISddd.dENCRd
```

```
QTsddd.dENISddd.dENCRdROISddd.dENCRdRTISddd.dENCRdAOISddd.dENCRd
```

```
ATISddd.dENCRdsFMddddddddHZISddddddddHZCRdSIQdd.dDBRISdd.dDBRCRd
or
SIQdddPC ISdddPC CRd
```

```
AI dd.dDBRISdd.dDBRCRdSALdd.dDBRISdd.dDBRCRd
or
SALdddPC ISdddPC CRdAI dddPC ISdddPC CRd
```

```
VAsd.ddVLIISd.ddVLCRdECdCKdDLdEFdDFdIPa0IPa1IPa2IPa3IPa4IPa5IFMdKNdRFd
```

```
FmSCdTSdBp dQPdEPdQAdVMdALdBRdIQdSQdIPa<CR><LF>
The SQdIPa preceding <CR><LF> above are for Option 064
```

Where d is a digit, s is the sign (- or space) and a is either an "I" or "N".

Each line above is followed by a blank line or another line and then a blank line. When the line following is not blank that means that the text below could be substituted for the first line at the positions indicated. When the LP1 string is sent out there is not a <CR><LF> sent except as the final two characters. The special functions are not included in this string.

When the LP2 command is sent and the Generator is addressed to talk, the following binary data is sent out over the bus.

```
<'@2'><252 bytes of binary data>
```

The special functions are included in this data.

If the data received is sent back to the Generator at a later time the Generator will be configured into the state the Generator was in at the time this data was read.

3-35. Sending the Status Bit Message

The Generator sends the Status Bit message (if configured to do so) as part of the instrument's response to the Parallel Poll Enable (PPE) bus command. In order for the Generator to respond to a PPE bus command, the controller must assign the Generator a single HP-IB data line on which to respond. The controller also assigns the logic sense of the bit. Both tasks are accomplished by the Parallel Poll Configure (PPC) bus command.

The Generator sends the Status Bit message when it receives the PPE bus command. The instrument does not have to be addressed to talk for this function to work.

The data line on which the Generator is assigned to respond is cleared by sending the Parallel Poll Unconfigure (PPU) bus command. At turn-on, the data line is unassigned.

3-36. Receiving the Abort Message

The Abort message is the means by which the controller sets the Interface Clear (IFC) bus control line true. When the Abort message is received, the Generator becomes unaddressed and stops talking or listening.

Table 3-2. Message Reference Table

HP-IB Message	Applicable	Response	Related Commands and Controls	Interface Functions*
Data	Yes	All Generator functions except the LINE switch are bus-programmable. The Generator sends the status byte when addressed to talk.		AH1 SH1 T6 TE0 L3 LE0
Trigger	No	The Generator does not respond to the Group Execute Trigger (GET) bus command. The Generator does not have a device trigger capability.	GET	DT0
Clear	Yes	The Generator responds equally to Device Clear (DCL) and Selected Device Clear (SDC) bus commands by clearing any incomplete entries or messages.	DCL SDC	DC1
Remote	Yes	Remote mode is enabled when the REN bus control line is true. However, remote mode is not entered until the first time the Generator is addressed to listen. The front panel REMOTE annunciator lights when the Generator is actually in the remote mode.	REN	RL1
Local	Yes	The Generator returns to local mode (front panel control) and responds to the Go To Local (GTL) bus command. When entering the local mode no Generator settings or functions are changed.	GTL	RL1

Table 3-2. Message Reference Table (continued)

HP-IB Message	Applicable	Response	Related Commands and Controls	Interface Functions*
Local Lockout	Yes	The Generator responds to the local lockout command.	LLO	RL1
Clear Lockout/ Set Local	Yes	The Generator returns to local (front panel control) and local lockout is cleared when the REN bus control line goes false.	REN	RL1
Pass Control/ Take Control	No	The Generator has no controller capability.		C0
Require Service	Yes	The Generator sets the SRQ bus control line true when one or more of the service request conditions occurs, if it has been enabled to send the Require Service message for that condition.	SRQ	SR1
Status Byte	Yes	The Generator responds to a Serial Poll Enable (SPE) bus command by sending an 8-bit status byte when addressed to talk. If the Generator is holding the SRQ control line true (issuing the Require Service message), bit 6 in the Status Byte and the bit representing the condition causing the Require Service message to be issued will both be true.	SPE SPD	T6

Table 3-2. Message Reference Table (continued)

HP-IB Message	Applicable	Response	Related Commands and Controls	Interface Functions*
Status Bit	Yes	The Generator responds to a Parallel Poll Enable (PPE) bus command by sending a status bit on a switch selected HP-IB data line.	PPE PPD PPC PPU	PP1
Abort	Yes	The Generator stops talking and listening.	IFC	T6, TE0 L3, LE0

*Commands, Control lines, and Interface Functions are defined in IEEE Std 488-1978. Knowledge of these may not be necessary if your controller's manual describes programming in terms of the twelve HP-IB Messages shown in the left column. Complete HP-IB capability as defined in IEEE Std 488 and ANSI Std MC1.1 is: SH1, AH1, T6, TE0, L3, LE0, DT0, DC1, RL1, C0, SR1, and PP1.

Table 3-3. HP-IB Program Codes

Codes with a "#" are listed on the pull out card HP-IB front panel diagram.

- PR # Configure instrument to preset state.
- SP0 # Turn off all selected special functions.
- SSP # Enter the set special function state.
- ST # Save the current front panel settings in an internal storage register
- SV # Save the current front panel settings in an internal storage register
- RC # Recall a front panel setting from an internal storage register.
- CL # Execute a full calibration.
- EC0 # Set the number of external clocks to 'none'.
- EC1 # Set the number of external clocks to 'one'.
- EC2 # Set the number of external clocks to 'two'.
- CK0 # Set the clock level to 'auto'.

Operation
HP 8780A

CK1 #	Set the clock level to 'ECL'.
CK2 #	Set the clock level to 'GND'.
DL0 #	Set the data level to 'VAR'.
DL1 #	Set the data level to 'ECL'.
DL2 #	Set the data level to 'GND'.
EF0 #	Select internal data filters.
EF1 #	Select the external data filters
DF0 #	Select AC coupled FM
DF1 #	Select DC coupled FM
IFM #	Invert (1) or non-invert (0) FM input.
IPI #	Invert a data input 0-7.
IPN #	Not invert a data input 0-7.
UP #	Add increment value to the current set field.
DN #	Subtract increment value from the current set field.
FR #	Enter the 'set frequency' state.
CF	Enter the 'set frequency' state
LV #	Enter the 'set level' state.
LE	Enter the 'set level' state.
AP	Enter the 'set level' state.
PL	Enter the 'set level' state.
IO #	Enter the 'set I1' state.
IT #	Enter the 'set I2' state.
QO #	Enter the 'set Q1' state.
QT #	Enter the 'set Q2' state.
RO #	Enter the 'set R1' state.

RT # Enter the 'set R2' state.

AO # Enter the 'set O1' state.

AT # Enter the 'set O2' state.

SFM # Enter the 'set FM' state.

SAL # Enter the 'set alternate level' state.

SIQ # Enter the 'set I<Q' state.

AI # Enter the 'set alternate level I' state.

VA # Enter the 'set var data level' state.

IS # Enter the currently defined parameter into the 'set increment' state.

GZ # Terminates a frequency entry in GHz.

MZ # Terminates a frequency entry in MHz.

KZ # Terminates a frequency entry in kHz.

HZ # Terminates a frequency entry in Hz.

DBM # Terminates a level entry in dBm.

VL # Terminates a level entry in volts.

MV # Terminates a level entry in mV (millivolts).

UV # Terminates a level entry in uV (microvolts).

DBR # Terminates an entry in dB.

PC # Terminates an entry in percent (%).

EN # Terminates an entry that has only one possible terminator. (Set I/Q for example)

KNO # Disable the KNOB function.

KN1 # Enable the KNOB function.

CW Turn off all selected modulations (cw mode).

FMO # Turn FM off.

Operation
HP 8780A

FM1 #	Turn FM on.
BP0 #	Turn off BPSK.
BP1 #	Turn on BPSK.
EP0 #	Turn off 8-PSK.
EP1 #	Turn on 8-PSK.
TS0 #	Turn off two state modulation format.
TS1 #	Turn on two state modulation format.
VM0 #	Turn off vector modulation format.
VM1 #	Turn on vector modulation format.
QP0 #	Turn off QPSK modulation format.
QP1 #	Turn on QPSK modulation format.
QA0 #	Turn off 16 QAM modulation format.
QA1 #	Turn on 16 QAM modulation format.
SQ0 #	Turn off 64 QAM modulation format.
SQ1 #	Turn on 64 QAM modulation format.
AL0 #	Turn off alternate level modulation format.
AL1 #	Turn on alternate level modulation format.
BR0 #	Turn off burst modulation format.
BR1 #	Turn on burst modulation format.
SC0 #	Turn off scalar modulation format.
SC1 #	Turn on scalar modulation format.
IQ0 #	Turn off I<Q modulation format.
IQ1 #	Turn on I<Q modulation format.
RF0 #	Disable RF output.
RF1 #	Enable RF output.

CR #	Move cursor to the indicated position in current set field.
RM	Cause system, when addressed to talk, to send one binary character that is the current service request mask.
CS	Cause status byte to be set to zero. Note: if there are any hard errors present the hard error bit will be set high again immediately after this command is processed.
LP1	Cause system, when addressed to talk, to send a string of ASCII characters that contains the system configuration. The string is made up of the HP-IB codes so that the system can be restored by sending this string back to the instrument.
LP2	Cause system, when addressed to talk, to send a string of binary characters which contains the current state of the instrument. This string is generated from a SAVE/RECALL file. Thus only the information that can be stored in a SAVE/RECALL file can be accessed in this learn mode.
DA	Turn on all display segments.
@1	Informs instrument to accept the next character from the bus as the BINARY REQUEST SERVICE MASK.
@2	Informs instrument to accept the following string to be processed as the binary characters that were generated from an "LP2" command. Note: The "LP2" command will send the "@2" as the first two characters of its output so there is never any need for the user to send the "@2" command. It is included here for completeness.
OUTPIDEN	Cause system, when addressed to talk, to send a string of characters indicating that this HP-IB address is a HP 8780A Signal Generator.
OI	Same as OUTPIDEN
OUTPCL	Cause system, when addressed to talk, to send a 1<CR><LF> or a 0<CR><LF> indicating if the system is executing a calibration cycle or not.
OC	Same as OUTPCL
OUTPACTI	Cause system, when addressed to talk, to send the current entry field value and suffix over the bus.
OA	Same as OUTPACTI
SM	Cause system, when addressed to talk, to send the system status message. The format of this message is given in the table.
WM	Informs instrument to accept an ASCII value for the SRQ mask.

3-37. Operator Checks

Description The functions of the Generator are checked using a frequency counter, power meter, and a power sensor with appropriate cables.

Equipment

Frequency Counter.....	HP 5343A
Power Meter.....	HP 438A
Power Sensors.....	HP 8480 Series
Power Sensor Cables.....	HP 11730 Series
Power Splitter.....	HP 11667A

- Procedure**
1. After allowing the reference oscillator oven to temperature stabilize, turn on the Generator and observe the front panel power up routine. A check of RAM (random access memory), ROM (read only memory), and of the ADC (analog to digital converter) is performed.
 2. If there is some problem when the power up routine is run, the MSG (message) key indicator will light and the information can be evaluated as to the next step to take.
 3. If the MSG indicator is on, messages can be read by pressing and holding the MSG key to view error code information that may be present. Repeatedly pressing the key will display the next error message. Each message is displayed until the MSG key is released. Refer to ERROR MESSAGE in the Detailed Operating Instructions section.
 4. When the Generator is finished with the power up and the MSG indicator remains off, press the CAL (calibration) key. During calibration over 90% of the hardware is checked.
 5. Observe the front panel display and during calibration the section of the instrument that is being adjusted will be displayed along with a moving symbol to indicate that the calibration is in progress.

6. The three types of calibration are:

- (a) BASEBAND section for I/Q modulation
- (b) LEVEL output frequency section

Frequencies checked

- 10 MHz
- 200
- 500
- 1000
- 1500
- 2000
- 2500
- 3000

- (c) FM (frequency modulation)

7. Observe the MSG indicator and check for error messages.

8. As a follow-on check and to gain more confidence with the front panel manipulation perform the following checks.

9. Connect the equipment as shown in Figure 3-3. Set the frequency counter to use the rear panel 10 MHz reference from the Generator.

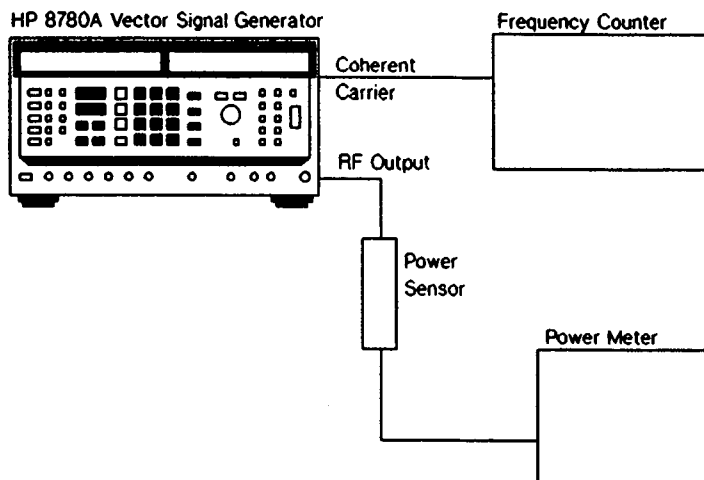

Figure 3-3. Operator's Check Test Setup

10. Press: SET FREQUENCY

Key in a frequency not checked in the output frequency section calibration above.

Check for agreement between the Generator front panel display of frequency and the frequency as read on the frequency counter.

11. Press: SET LEVEL

Key in a power level. Check for agreement between the Generator front panel display of power level and the power level measured on the power meter.

Press: SCALAR (to turn SCALAR on).

Check for a drop of at least 40 dB in power level.

Press: SCALAR (to turn SCALAR off).

12. Press: FM ON
DC COUP FM
INVERT INPUT 6
SET FM 50 kHz

Check for agreement between what the Generator displays and what the frequency counter and power meter measure. This is a check of the dcFM mode. A tolerance of +/- 250 kHz must be allowed in this measurement.

Press: FM (to turn FM off).

Press: INVERT INPUT 3 (Invert input 4 Option 064)

Press: QPSK ON

Measure power then press BURST. This results in a power drop of approximately 40 dB.

Pages 3-41 through 3-46 intentionally left blank.

3-39. DETAILED OPERATING INSTRUCTIONS

The remainder of this section contains detailed instructions for all instrument capabilities. These instructions are organized alphabetically by subject. Refer to Table 3-4 below for a listing of the instructions by function.

Table 3-4. Listing of Detailed Operating Instructions

INSTRUMENT GENERAL
Calibrate
Instrument Preset
Local
Error Message (MSG)
Special/Off
CARRIER FREQUENCY
Set Frequency
DIGITAL MODULATION
BPSK On
QPSK On
8PSK On
16QAM On
64QAM On
Burst On
2 State On
Set I,Q
Set r, Deg
ANALOG MODULATION
Scalar On
Set FM
DC Coupled FM/AC Coupled FM
FM On
Vector On
OUTPUT LEVELS
Set Level
Set Alternate Level
Alternate Level I
Alternate Level On
Set I<Q
I<Q On
RF Output On
DATA INPUTS
Data
Set Variable Data Inputs
Invert Input
CLK
External Clock

Table 3-4. Listing of Detailed Operating Instructions (continued)

EXTERNAL FILTER
External Filter
FRONT PANEL SETTING STORAGE
Save
Recall
DISPLAY CONTROL
Knob
Left and Right Arrows
Set Increment
Up and Down Arrows
Clear
Back Space
Change Sign

ALT LEV I

DESCRIPTION Alternate Level I allows you to set an alternate level for the I vector component only. This command results in an I vector attenuated in power relative to the Q vector output. The attenuation can be input in dB or percent.

PROCEDURE Press the Blue Shift key and the ALT LEV I key (SET ALT LEV) Enter a value for the I vector and terminate in dB or %. Alternate Level I is controlled by Data Input 1. When Data Input 1 is high, the alternate level is used. The maximum input for ALT LEV I is 40 dB or 100%.

EXAMPLE Set up an Alternate Level for I of 50 %.

LOCAL (Key-strokes)	<p>Function: BLUE KEY, ALT LVL I (SET ALT LVL) Data: 5, 0 Units: dB or %, Hz</p>
HP-IB (Program Codes)	<p>Function: AI Data: 50 Units: PC</p>

Parameter	Program Code
Alternate Level I	AI
Percent terminator	PC
dB terminator	DBR

INDICATIONS When you press the blue key, "SHIFT" appears in the Frequency Display. When you press ALT LEV I, "ALT I =" appears in the Level Display. When you enter a value, the value appears and remains until another function is activated.

COMMENTS To activate an Alternate Level I press ALT LVL ON or send the HP-IB command "AL1". Only one Alternate Level or Alternate Level I may be set. When an Alternate Level or an Alternate Level I is set, any values previously set are cleared. Resolution: 0.1 dB or 1%.



RELATED SECTIONS SET ALT LVL, ALT LVL ON, BPSK, QPSK, and SET INCREMENT.

ALT LVL ON

DESCRIPTION An Alternate Level may be set for use with BPSK and QPSK. When this level has been set (see SET ALT LVL and ALT LEV I) it can be activated using the ALT LVL ON key. The ALT LVL ON key will not activate unless either BPSK or QPSK has already been selected.

PROCEDURE To activate an alternate level, press ALT LVL ON so that the indicator in the ALT LVL ON key lights. To deactivate an alternate level press the ALT LVL ON key again so that the indicator turns off.

EXAMPLE Turn Alternate Level on.

LOCAL (Key-strokes)	<p style="text-align: center;">~Function~</p> 
 (Program Codes)	<p style="text-align: center;"><u>AL 1</u> Function</p>

Parameter	Program Code
Alternate Level on	AL1
Alternate Level off	AL0

INDICATIONS When the alternate level is selected the indicator in the ALT LVL ON key lights, and the active indicator for Digital Input 1 lights. The active indicator for Digital Input 0 will also light if BPSK is the modulation type, or the active LEDs for both Digital Input 0 and 2 (0 and 3 Option 064) will light if QPSK is the modulation type.

COMMENTS ALT LVL ON activates Alternate Level or Alternate Level I, whichever was set last. You may not set both an Alternate Level and an Alternate Level I. Whenever you set an Alternate Level any Alternate Level I you had entered is eliminated, and, likewise, any time you set an Alternate Level I any Alternate level you had entered is eliminated.

RELATED SECTIONS SET ALT LVL, ALT LVL I, SET INCREMENT

BACK SP

DESCRIPTION The BACK SP key allows you to back over an entry to correct an error made while entering a value.

PROCEDURE Press and release the BACK SP key once for each digit you wish to back over. If you hold the key down the function will automatically repeat.

EXAMPLE Enter a value for frequency and back over part of it.

<p>LOCAL (Key-strokes)</p>	<p style="text-align: center;"> ~Function~ Data ~Function~ </p> <div style="display: flex; justify-content: space-around; align-items: center;"> <div style="border: 1px solid black; padding: 2px; text-align: center;">SET FREQUENCY</div> <div style="border: 1px solid black; padding: 2px; text-align: center;">1</div> <div style="border: 1px solid black; padding: 2px; text-align: center;">2</div> <div style="border: 1px solid black; padding: 2px; text-align: center;">3</div> <div style="border: 1px solid black; padding: 2px; text-align: center;">4</div> <div style="border: 1px solid black; padding: 2px; text-align: center;">5</div> <div style="border: 1px solid black; padding: 2px; text-align: center; font-size: 0.8em;">CLEAR BACK SP</div> <div style="border: 1px solid black; padding: 2px; text-align: center; font-size: 0.8em;">CLEAR BACK SP</div> <div style="border: 1px solid black; padding: 2px; text-align: center; font-size: 0.8em;">CLEAR BACK SP</div> </div>
<p style="text-align: center;">  (Program Codes) </p>	<p style="text-align: center;">Back Space is Not Accessible Via HP-IB</p>

INDICATIONS When you BACK SPACE the cursor, the digits back spaced over are erased.

RELATED SECTIONS CLEAR

BPSK

DESCRIPTION Bi-Phase Shift Keying (BPSK) modulates data into two states 180 degrees phase shifted from each other.

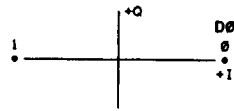

PROCEDURE To activate BPSK press the BPSK ON key. Data input through Digital Input 0 will be output as BPSK signals. To turn BPSK off, press the BPSK ON key again.

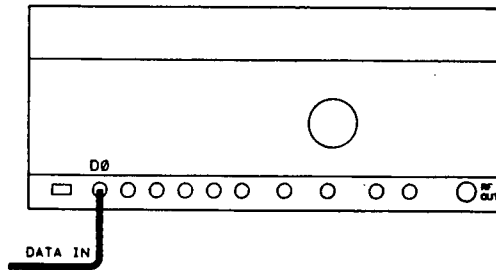

EXAMPLE Activate BPSK. Set up your inputs as shown. Set a carrier frequency and a level. In this example use 1 GHz and .5V.

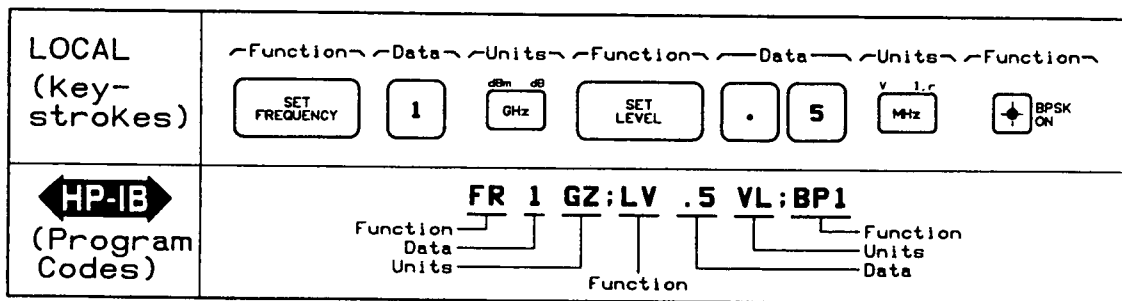

Parameter	Program Code
Turn on BPSK	BP1
Turn off BPSK	BP0

INDICATIONS When BPSK is activated the indicator in the BPSK key turns on and the ACTIVE indicator at Digital Input 0 turns on.

COMMENTS Data input for BPSK may be inverted by using the INVERT INPUT key and inverting Digital Input 0.



RELATED SECTIONS INVERT INPUT

BURST ON

DESCRIPTION Burst mode (Pulse) allows you to suppress the carrier frequency by inputting a logic high to digital input 3 (input 1 Option 064). When used with digital modulation this is useful for generating phase-coded radar pulses.

PROCEDURE To activate burst mode press the BURST ON key so that the indicator in the key lights. When Digital Input 3 (1 Option 064) is low, the carrier is activated and data can be input to Digital Inputs 0, 1, and 2 (0 and 3 Option 064). When Digital Input 3 (1 Option 064) is high, the carrier is suppressed. To deactivate burst mode press the BURST ON key again.

EXAMPLE Activate Burst Mode.

LOCAL (Key-strokes)	<p style="text-align: center;">Function</p> 
 (Program Codes)	<p style="text-align: center;">BR1 Function</p>

Parameter	Program Code
Burst on Burst off	BR1 BR0

INDICATIONS When BURST ON is activated the indicator in the BURST ON key lights and stays on. The active indicator for Digital Input 3 (1 Option 064) lights, and the active LEDs for Digital Inputs 0, 1 and 2 (0,3 BPSK or QPSK Option 064) light depending on whether BPSK, QPSK or 8PSK are used.

COMMENTS BPSK, QPSK, 8PSK, and 2 State (BPSK, QPSK only Option 064) may be used with Burst.

RELATED SECTIONS RF OUT ON

CAL

DESCRIPTION This key activates the calibration procedure of the instrument. The instrument calibrates the digital baseband vector accuracy, output level, and FM. The first calibration procedure checks vector accuracy in both phase and amplitude. The second calibration checks output levels at 10, 200, 500, 1000, 1500, 2000, 2500 and 3000 MHz. At each frequency the power output is checked for about 50 points over the 2048 (4096 Option 064) DAC output levels. A table is generated for each frequency comparing DAC output with power output. The third calibration procedure checks the FM section of the instrument, and generates a table of VCO sensitivity and gain throughout the FM baseband.

PROCEDURE Press and release the CAL key. The instrument will begin by calibrating baseband vector accuracy. A symbol will move back and forth across the FM Display to indicate calibration activity. The symbol will move throughout the baseband, level, and FM calibrations. Calibration takes a little over 1 minute to finish. Pressing another front panel key immediately aborts a calibration. After calibrating, the instrument will return to the settings that existed before calibration was initiated.

EXAMPLE Calibrate the instrument

LOCAL (Key-strokes)	<p style="text-align: center;">~Function~</p> <div style="text-align: center; border: 1px solid black; width: 30px; margin: 0 auto; padding: 2px;">CAL</div>
<div style="text-align: center; border: 1px solid black; width: 30px; margin: 0 auto; padding: 2px;">HP-IB</div> (Program Codes)	<div style="text-align: center;"> CL Calibrate </div>

Parameter	Program Code
Calibrate	CL

INDICATIONS The Frequency Display shows "CALIBRATING" while the instrument is busy calibrating. The Level Display shows "BASEBAND", "LEVEL", or "FM" depending on which stage of the calibration is executing. A symbol moves back and forth across the FM Display the entire time.

COMMENTS The Special Function Codes can also initiate calibrations. The codes for calibrations are:

- 20.0 Normal calibration (same as CAL)
- 20.1 Baseband calibration
- 20.2 Output section calibration (LEVEL)
- 20.3 FM calibration
- 20.4 dcFM calibration (dcFM on and input disabled)
- 20.5 dcFM calibration (dcFM on and input enabled)

If a calibration fails, the MSG (message) key indicator lights. You may read the message by pressing the MSG key.

More detail may be obtained about specific calibration errors by executing the following special functions:

- 51.0 Display service indicator value
- 51.1 Display last baseband CAL error code
- 51.2 Display last output section CAL error code
- 51.3 Display last FM CAL error code

RELATED SECTIONS MSG, SPECIAL

CHG SIGN (Change Sign)

DESCRIPTION This key changes the value of a parameter from positive to negative, or, from negative to positive.

PROCEDURE Enter a value and press CHG SIGN.

EXAMPLE: Set a level of -20 dBm.

<p>LOCAL (Key-strokes)</p>	<p style="text-align: center;"> ~Function~ ~Data~ ~Units~ </p> <div style="display: flex; justify-content: space-around; align-items: center;"> <div style="border: 1px solid black; padding: 2px 5px; text-align: center;">SET LEVEL</div> <div style="border: 1px solid black; padding: 2px 5px; text-align: center;">2</div> <div style="border: 1px solid black; padding: 2px 5px; text-align: center;">0</div> <div style="border: 1px solid black; padding: 2px 5px; text-align: center;">CHG SIGN</div> <div style="border: 1px solid black; padding: 2px 5px; text-align: center;">dBm dB GHz</div> </div>
<p>HP-IB (Program Codes)</p>	<p style="text-align: center;"> LV -20 DBM </p> <div style="display: flex; justify-content: space-around; align-items: center; margin-top: 5px;"> Function Data Units </div>

Parameter	Program Code
Change Sign	-

INDICATIONS A negative sign appears before the value in the display.

COMMENTS Negative values may not be entered for frequency.

CLEAR

DESCRIPTION If you are entering a value and wish to clear it, the CLEAR key will do it.

PROCEDURE Press and release the blue shift key, then press and release the CLEAR key (BACK SP).

EXAMPLE Enter an arbitrary number and CLEAR it.

LOCAL (key-strokes)	
 (Program Codes)	-There is No HP-IB Command for CLEAR

INDICATIONS After pressing the blue shift key "SHIFT" appears in the Frequency Display. When you press CLEAR the entry you were in the process of making is blanked and whatever entry previously existed in the display reappears.

COMMENTS Pressing BACK SP repeatedly until the cursor backs to the first digit will accomplish the same thing.



RELATED SECTIONS BACK SP

CLK

DESCRIPTION This key selects the clock threshold and termination. ECL provides a -2V termination and -1.3V threshold. Ground provides a 0V termination and 0V threshold. AUTO provides a 0V termination and a peak-to-peak mid-point threshold. The threshold is the value above which the input is considered a logic high.

PROCEDURE Press CLK once or twice until the clock mode you wish to select is indicated. The LEDs next to the key indicate which mode is presently selected. ECL is the preset state.

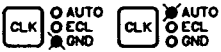
EXAMPLE Select AUTO.

LOCAL (Key-strokes)	<p style="text-align: center;">Function</p> 
 (Program Codes)	<p style="text-align: center;">CK0 Function</p>

Parameter	Program Code
Set clock level to AUTO	CK0
Set clock level to ECL	CK1
Set clock level to Ground	CK2

INDICATIONS The three LEDs to the right of the CLK key indicate which of the clock level modes is in use. Only one LED is lit at any one time.

RELATED SECTIONS EXT CLK

DATA

DESCRIPTION This key selects a data threshold level for Digital inputs. The data threshold level is the level at which data is interpreted as a logic high. The level you may select from are Ground, ECL (emitter-coupled logic), and Variable. To set a variable level use the SET VAR function.

PROCEDURE Press and release the DATA key once or twice to move to the state desired. The LEDs beside the key indicate which state the instrument is presently in. The preset state is ECL.

EXAMPLE Change the DATA state from ECL to VAR.

LOCAL (Key-strokes)	
 (Program Codes)	DL0 Function

Parameter	Program Code
Set DATA to VAR	DL0
Set DATA to ECL	DL1
Set DATA to Ground	DL2
Set Variable Data Level	VA

INDICATIONS The present data threshold state is indicated by one of three LEDs: VAR, ECL, and GND (variable, emitter-coupled logic, and ground).

COMMENTS The variable threshold can be set from -2.54 Volts to +2.54 Volts using the SET VAR function.



RELATED SECTIONS SET VAR, SET INCREMENT

DC COUPLED FM/AC COUPLED FM

DESCRIPTION This key is used to toggle between DC Coupled FM and AC Coupled FM. When DC Coupled FM is selected the indicator within the key lights. The allowed range of deviations for DC coupled FM is 150 Hz to 150 kHz. The allowed range of deviations for AC coupled FM is 50 kHz to 50 MHz. To set the peak-to-peak deviation use the SET FM key (see SET FM). One volt peak-to-peak gives full scale deviation.

PROCEDURE Press the DC COUP FM key so that its indicator lights. To switch back to AC coupled FM press the key again so that the light goes off.

EXAMPLE Set the FM INPUT to DC coupled FM

LOCAL (Key-strokes)	<p style="text-align: center;">Function</p> 
 (Program Codes)	<p style="text-align: center;">DF1 Function</p>

Parameter	Program Code
DC coupled FM	DF1
AC coupled FM	DF0

INDICATIONS When DC coupled FM has been selected, the indicator contained in the DC COUP FM key lights. When AC coupled FM is used, the indicator is off.

COMMENTS If you attempt to set up DC coupled FM and your peak-to-peak deviation is set beyond the range specified (150 kHz), the MSG indicator will light and the peak-to-peak deviation will remain set to the value it had before you tried to change it.



RELATED SECTIONS SET FM, FM ON

ERROR MESSAGE (MSG)

DESCRIPTION The MSG key contains an indicator that lights when the instrument has a message to display. The instrument may have up to three messages to display. These messages can be displayed consecutively by pressing MSG once for each message. WARNINGS are also noted and displayed in the same way. Refer to APPENDIX A at the back of this manual for a listing and explanation of ERROR and WARNING messages.

PROCEDURE When the MSG indicator is on press and hold down the MSG key and read the error message shown across all displays. If after releasing the key the indicator is still on, press the MSG key again to display another message.

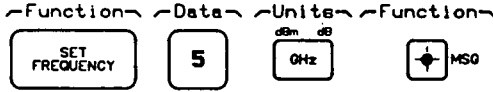
EXAMPLE To force an error try to set the carrier frequency to 5 GHz. An error will occur which may be displayed using the MSG key. The message in this case will read "FREQ > 4.16 GHz ERROR 100".

<p>LOCAL (Key- strokes)</p>	
<p>HP-IB (Program Codes)</p>	

INDICATIONS When an error has taken place the MSG indicator lights. When the MSG key is pressed an error message is displayed across all displays. If the indicator remains on after the message has been read, there is either another message or the message refers to an instrument problem such as a calibration failure. The indicator goes off when the problem is fixed.

COMMENTS Most errors result from the entry of illegal values. Some errors, however, result from hardware malfunctions. When hardware malfunctions, the indicator remains on even after the message has been read from the display. The indicator will only go off when the condition causing the error has been corrected. When there are multiple messages the order in which they are displayed is last-in-first-out. The maximum number of messages that can be buffered before the first one in is lost is three.

RELATED SECTIONS CAL

EXTERNAL CLOCK

DESCRIPTION This instruction details the use of an external clock with the Vector Signal Generator. The standard Generator accepts parallel data on digital input lines D0 to D3. When Option 064 is installed instruments can use parallel data on digital lines D0 to D5 or accept serial data on input line D0 through an internal serial to parallel convertor. Serial input mode is selected using the external clock front panel key or with HP-IB command EC2.

Serial data is clocked into a 6 bit shift register by an external bit rate clock. A symbol rate clock latches the contents of the shift register onto the internal data lines which correspond to the parallel inputs D0 through D5. A symbol consists of six bits. The symbol, or framing, clock is generated by internally dividing the bit clock by six, or is provided externally through input D5 by selecting special function 9.1.

The internal framing clock is intended to be used where the synchronization of the framing clock and 6 bit data words are not important. When data words carrying useful information are used, an external framing clock is required. This feature is enabled by first selecting serial clock mode, and then selecting special function 9.1.

The serial to parallel convertor is simply a 6 bit serial in, parallel out shift register. The serial input of the shift register is connected to digital input D0 when "serial" clock mode is selected. The first data bit is clocked into the register by the positive edge of the bit clock (input D6). This bit is shifted down one as each subsequent data bit enters until it is in the position corresponding to input parallel D5. The second bit clocked into the serial input D0 will correspond to parallel input D4. This continues in like manner for the rest of the six serial bits so that the sixth bit will correspond to parallel input D0. The positive edge of the framing clock latches the parallel outputs of the shift register onto the internal digital lines.

With no external framing clock, the digital states change on the positive edge of every sixth bit clock pulse. With an external framing clock, the states change on the positive edge of the framing clock.

PROCEDURE Pressing the EXT CLK key causes the instrument to sequence through three clock configurations: NONE, ONE, and TWO for the standard instrument or NONE, PAR (parallel), and SER (serial) for Option 064. Indicators show which of the three states the instrument is set to. The

ACTIVE indicator next to the I and Q clock or just clock for Option 064
inputs will be lit accordingly:

	I Clock	Q Clock	Clock (Option 064)
NONE	off	off	NONE
ONE	on	off	PAR (parallel)
TWO	on	on	SER (serial)

The preset state is NONE. Clock inputs are 50 ohm and respond to the clock threshold levels set using the CLK key or the SET VAR function.

EXAMPLE Set up instrument for use with two clock inputs.

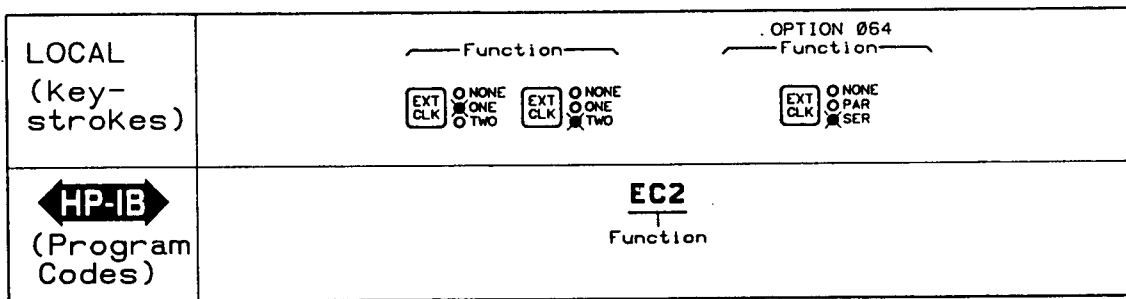

Parameter	Program Code
NONE	EC0
ONE (PAR Opt 064)	EC1
TWO (SER Opt 064)	EC2

INDICATIONS The first time you press EXT CLK, the indicator labeled ONE lights, and the ACTIVE indicator next to the I Clock input lights. When you press EXT CLK again the indicator labeled TWO lights, the indicator labeled ONE goes out, and the ACTIVE indicators for both the I and Q Clock inputs light. If you press the key again, the indicator labeled NONE lights, the indicator labeled TWO goes out, and the I and Q Clock ACTIVE indicators go out.

NOTE

1. A clock on I (D4) will allow data inputs from D0 & D1.
2. A clock on Q (D5) will allow data inputs from D0-D3.

OPTION 064 The first time you press EXT CLK, the indicator labeled PAR lights, and the ACTIVE indicator next to the CLOCK input lights. When you press EXT CLK again the indicator labeled SER lights, the indicator labeled PAR goes out, and the ACTIVE indicator next to the CLOCK remains lit. If you press the key again, the indicator labeled NONE lights, the indicator labeled SER goes out, and the CLOCK ACTIVE indicator goes out.

COMMENTS Serial clock mode is designed to work with 64QAM format. Serial clock mode can be selected with any of the digital modulation formats on an Option 064 instrument but the results are not predictable.

RELATED SECTIONS DATA, SET VAR

EXT FILTER

DESCRIPTION This key toggles between external data filters and internal filters. When the indicator is on, the instrument expects external filters connected to the rear panel by coaxial cables. There are four connectors on the rear panel for filters. Two connectors are for an I channel filter, and two connectors are for a Q channel filter. If external filter is specified and you want to filter only one channel, connect a jumper coaxial cable across the other channel.



The Generator automatically selects internal spectral limiting filters for digital modulations to avoid aliasing or spectral folding that result when single-sided modulation bandwidths exceed the Generator's tuned frequency. The internal filters are low pass with very flat passband response. If the selected filter does not meet your needs, there are two alternatives available. You may choose a different internal filter using Special Function 3.1, or you may use your own external filters.

If DC coupled filters are used, the Generator's calibration routines will compensate for any DC gain imbalances between I and Q filters. For AC coupled filters, gain differences may be manually specified using special functions 4.1 and 5.1. Either of these techniques will ensure good amplitude balance with a minimal loss of vector accuracy provided the overall filter gain or loss is less than 2 dB.

If active filters are used, they must have less than 20 mV DC offsets to avoid loss of resolution in calibration routines.

PROCEDURE Connect a filter to the two BNC connectors on the rear panel that indicate the channel you wish to filter. If you wish to filter the other channel as well, connect a filter across it also. If you do not wish to filter the other channel, connect a jumper across it. Press the EXT FILTER key so that the indicator lights.

EXAMPLE Turn on External Filtering

<p>LOCAL (Key- strokes)</p>	<p>Function</p> 
<p> (Program Codes)</p>	<p><u>EF 1</u> Function</p>

Parameter	Program Code
Select internal filters	EF0
Select external filters	EF1

INDICATIONS When the External Filter option is selected the External Filter indicator is on. When External Filter is not selected the indicator is off.



RELATED SECTIONS BPSK, QPSK, 8PSK, 16 QAM, and 64 QAM

FM ON

DESCRIPTION This key activates the FM INPUT. You should set an FM peak-to-peak deviation using the SET FM key before activating and inputting an FM signal. You should also decide whether you want DC coupled FM or AC coupled FM, and make the selection using the DC COUP FM key.

PROCEDURE Select DC or AC coupled FM using the DC COUP FM key. Connect an FM signal source to the FM INPUT BNC of the Vector Signal Generator. Full scale modulation is obtained with -0.5V to +0.5V for DC coupled FM and 1.0V peak-to-peak for AC coupled FM. Set a peak-to-peak deviation range using the SET FM key. Press FM ON and RF OUT so that the indicators inside both keys light.

EXAMPLE Turn on FM.

LOCAL (Key-strokes)	<p style="text-align: center;">Function</p> 
 (Program Codes)	<p style="text-align: center;">FM1 Function</p>

Parameter	Program Code
Turn on FM	FM1
Turn off FM	FM0
DC coupled FM	DF1
AC coupled FM	DF0
Set FM deviation	SFM

INDICATIONS When FM ON is activated the indicator in the FM ON key lights and the ACTIVE indicator beside the FM INPUT lights. The peak-to-peak deviation range appears in the FM Display.



RELATED SECTIONS SET FM, DC COUP FM

INSTRUMENT PRESET

DESCRIPTION PRESET sets the instrument to the configuration shown below under comments.

PROCEDURE Press and release the PRESET key.

EXAMPLE Preset the instrument.

LOCAL (Key-strokes)	Function 
 (Program Codes)	PR Preset the Instrument

Parameter	Program Code
PRESET	PR

INDICATIONS RF Output drops to -100 dBm, the frequency shifts to 70 MHz, and all modulation is turned off.

COMMENTS Generator functions are preset to the following:

Modulation	OFF
Carrier Frequency	70 MHz
Level	-100 dBm
RF Output	ON
DC-FM	OFF
Special Functions	OFF
Digital Lines	Not inverted
Clock and Data	ECL Levels
Knob	OFF
External Clock	None
External Filter	OFF

Preset clears the HP-IB SRQ mask. Calibration data is retained.

RELATED SECTIONS CAL

INVERT INPUT

DESCRIPTION This instruction details how to invert selected inputs. The inputs that can be inverted are:

		Option 064
0	DIGITAL INPUT 0	0 DIGITAL INPUT 0
1	DIGITAL INPUT 1	1 DIGITAL INPUT 1
2	DIGITAL INPUT 2	2 DIGITAL INPUT 2
3	DIGITAL INPUT 3	3 DIGITAL INPUT 3
4	I CLOCK	4 DIGITAL INPUT 4
5	Q CLOCK	5 DIGITAL INPUT 5
6	No input 6 on standard	6 CLOCK
7	FM INPUT	7 FM INPUT

PROCEDURE Press and release the INVERT INPUT key, then press a data key 0---7.

EXAMPLE Invert the Q CLOCK input.

LOCAL (Key- strokes)	~Function~ ~Data~ <input type="checkbox"/> INVERT INPUT <input type="checkbox"/> 5
 (Program Codes)	IPI 5 Function Data

Parameter	Program Code
Invert input	IPI
Set input to not inverted	IPN
Invert FM	IFM1
Set FM to not inverted	IFM0

INDICATIONS When the INVERT INPUT key has been depressed, the Frequency Display will prompt "ENTER INPUT 0---7". The display will return to its previous state when a digit has been displayed. The lower of the two indicators adjacent to the selected digital input will light.

COMMENTS Any input key other than 0 through 7 will cause an error message to be generated.

INSTR PRESET sets all data inputs to not inverted.



RELATED SECTIONS DATA

I<Q ON

DESCRIPTION This key activates a vector modulation in which the I vectors are less than the Q vectors by a specified amount determined by the function SET I<Q. I<Q is used with digital modulations only.

PROCEDURE Press and release the I<Q ON key so that the indicator in the key lights. To turn I<Q off simply press the I<Q ON key again so that the indicator turns off.

EXAMPLE Turn I<Q on.

LOCAL (Key- strokes)	~Function~ 
 (Program Codes)	<u>IQ1</u> Function

Parameter	Program Code
Turn on I<Q	IQ1
Turn off I<Q	IQ0
Set I<Q	SIQ

INDICATIONS When I<Q ON is activated the indicator in the I<Q ON key lights and stays lit until I<Q ON is deactivated.

RELATED SECTIONS SET I<Q, SET INCREMENT

KNOB

DESCRIPTION The KNOB key enables and disables the knob. When the knob is enabled the Left and Right Arrow keys can be used to change the resolution of the knob. The cursor in the display being manipulated indicates which digit will be incremented or decremented by the rotation of the knob. Moving the cursor to the right increases the resolution, and moving the cursor to the left decreases the resolution. The cursor appears as a triangle found beneath a digit in the display for the function which is presently selected.

PROCEDURE Press and release the KNOB key so that the indicator in the KNOB key lights and stays on. Use the arrow keys to move the cursor to the desired decimal resolution. Turn the knob clockwise to increase the value and counterclockwise to decrease the value.

EXAMPLE Use the knob to adjust an output level.

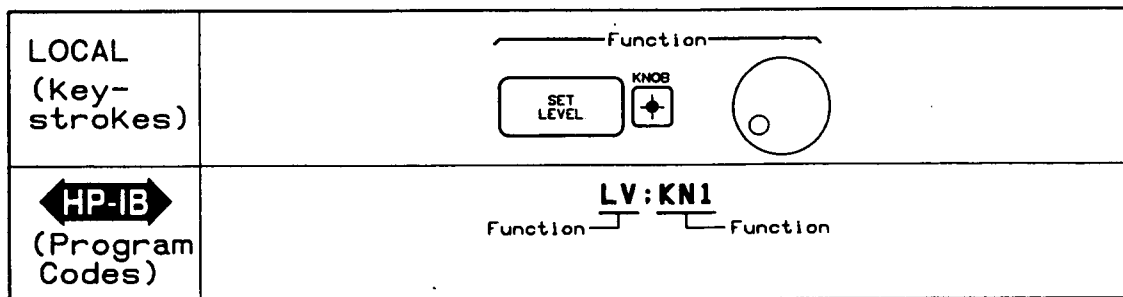

Parameter	Program Code
Enables Knob	KN1
Disables Knob	KN0

INDICATIONS The indicator inside the KNOB key lights when the knob is active. When the knob is turned clockwise the value above the marker increases. When the knob is turned counterclockwise the value above the marker decreases.

COMMENTS There can only be a cursor in one display at a time, but there will be no cursor visible unless some function has been selected. If there is no cursor visible, the knob will have no effect. The Left and Right Arrow keys will move the cursor to the digit you wish to scroll.



RELATED SECTIONS LEFT and RIGHT ARROWS

LEFT and RIGHT ARROWS

DESCRIPTION The Left and Right Arrow keys move the cursor within the display you are presently using. The cursor appears as a triangle beneath a digit in the display which is presently selected.

PROCEDURE To move the cursor one space to the right press the Right Arrow key once and release. To move the cursor one space to the left press the Left Arrow key once and release. To move in either direction twice simply press the arrow key for that direction twice, or hold the key down for about a second and the cursor will repeat.

EXAMPLE Use the left and right arrows to move the cursor in the Frequency Display.

LOCAL (key- strokes)	<div style="text-align: center;"> <p>Function</p>  </div>
 (Program Codes)	<div style="text-align: center;"> <p>FR; CR5</p> </div>



INDICATIONS When an arrow key is pressed the cursor will move right or left depending on which arrow key is pressed.

COMMENTS The HP-IB command "CR", followed by a digit, will set the cursor to the specified position within the current set field.

RELATED SECTIONS KNOB

LOCAL

- DESCRIPTION** This instruction details use of the LCL key to return the instrument to Local control and to examine the HP-IB address of the instrument.
- PROCEDURE** Press the LCL key, read the HP-IB address displayed in the left display, and release the LCL key.
- EXAMPLE** Examine the HP-IB address, and return the instrument to Local operation.

<p>LOCAL (Key- strokes)</p>	<p>~Function~ </p>
<p> (Program Codes)</p>	<p>This Feature is Not Accessible Via HP-IB</p>

- INDICATIONS** HP-IB address is displayed in the Frequency Display. RMT (remote) indicator lights. TLK (talk) and LSN (listen) indicators go out.
- COMMENTS** LCL key is disabled by the HP-IB Local Lockout function.
- RELATED SECTIONS** Local Lockout (see HP-IB)

QPSK ON

DESCRIPTION Quadrature Phase Shift Keying modulates data two bits at a time. There are four I-Q states as shown below.

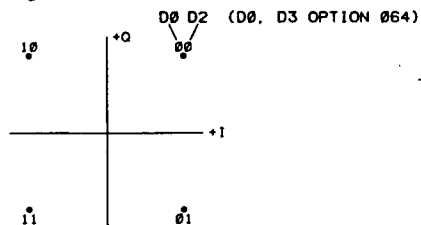

PROCEDURE QPSK is selected by pressing the QPSK ON key. Data is input using Digital Inputs 0 and 2 (0 and 3 Option 064). To turn QPSK off, press the QPSK ON key again QPSK data will be represented as follows:

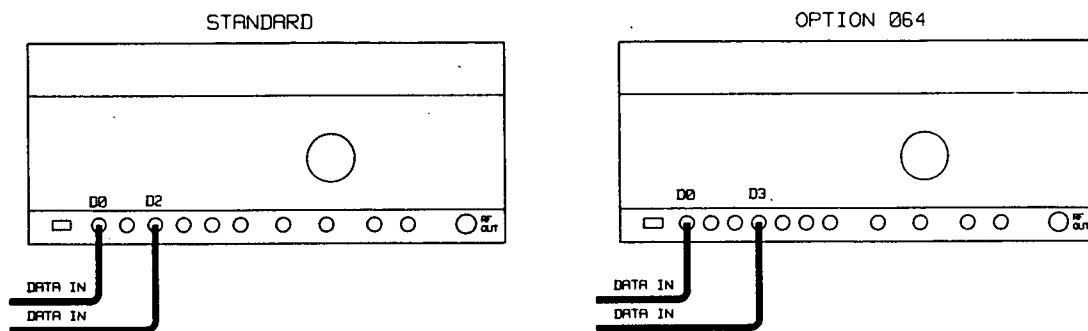

Your instrument should be set up as shown:



EXAMPLE Turn on QPSK

<p>LOCAL (key- strokes)</p>	<p>~Function~  QPSK ON</p>
<p> HP-IB (Program Codes)</p>	<p>QP1 Function</p>

Parameter	Program Code
QPSK ON	QP1
QPSK OFF	QP0

INDICATIONS QPSK ON key indicator lights when QPSK is activated. The active indicators for Digital Inputs 0 and 2 (0 and 3 Option 064) light.

COMMENTS Data inputs may be inverted using the INVERT INPUT key.

RELATED SECTIONS INVERT INPUT

RECALL

DESCRIPTION This instruction details how to recall selectively the stored contents from an internal storage register. The contents of internal storage registers are stored using the SAVE function, which saves entire front panel settings in one of nine registers (1---9).

PROCEDURE Press and release the RECALL key, then a data key (to indicate the register number).

EXAMPLE Recall the stored contents from register 2.

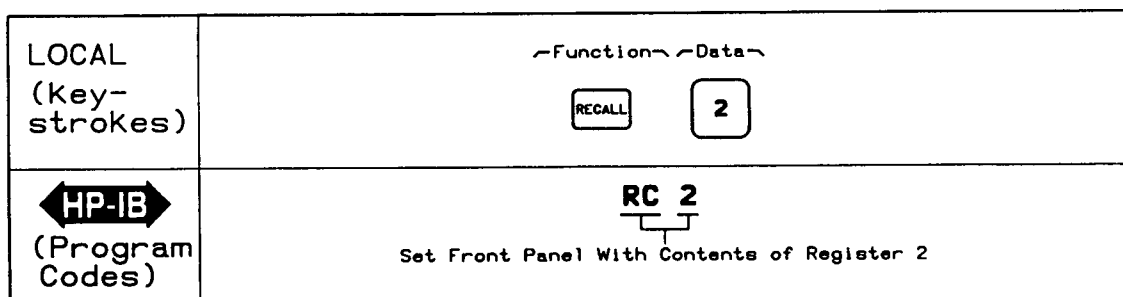

Parameter	Program Code
RECALL	RC

INDICATIONS The frequency display will show "ENTER RECALL" and the level display will show "0-9". When a number is entered the stored contents from the register selected will be recalled and the output of the Vector Signal Generator will be changed to agree with the recalled parameter values.

COMMENTS Ten internal registers are available. Each is capable of storing complete front panel setups.

RECALL clears any previously selected function.

Register 0 is a special case. It functions as an undo register. When a value for a function has been entered and you wish to return the old value press RECALL and 0. The old value will return and the value you had just entered will become the new contents of register 0.



RELATED SECTIONS SAVE

RF OUT ON

DESCRIPTION This key turns on and off the RF output of the Vector Signal Generator. When the RF output is off the output is at least 60 dB below the selected level for levels greater than -40 dBm.

PROCEDURE To turn on the RF OUT, press and release the RF OUT key so that the indicator contained in the key lights.

EXAMPLE Turn on the RF Output.

LOCAL (Key- strokes)	<div style="text-align: center;">  </div>
 (Program Codes)	<div style="text-align: center;"> RF 1 Function </div>

Parameter	Program Code
Enables RF Output	RF1
Disables RF Output	RF0

INDICATIONS When RF Output is enabled the indicator in the RF OUT ON lights and stays on until the RF Output is disabled.

COMMENTS The INSTR PRESET (instrument preset) key will turn the RF OUTPUT on at -100 dBm and 70 MHz.



RELATED SECTIONS INSTR PRESET

SAVE

DESCRIPTION This instruction details how to save complete front panel setups for either selectable or sequential recall or display.

PROCEDURE Press and release the SAVE key, then a data key (to represent the storage register).

EXAMPLE Save the current front panel settings in register 2.

LOCAL (Key-strokes)	<p style="text-align: center;">~Function~ ~Data~</p> <div style="display: flex; justify-content: center; gap: 20px;"> <div style="border: 1px solid black; padding: 2px 5px;">SAVE</div> <div style="border: 1px solid black; padding: 2px 5px;">2</div> </div>
<div style="text-align: center;">  (Program Codes) </div>	<div style="text-align: center;"> <p>SV 2</p>  Store Front Panel Settings in Register 2 </div>

Parameter	Program Code
SAVE	SV

INDICATIONS The frequency display shows "ENTER SAVE" and the level display shows "1---9".

COMMENTS Nine internal registers are available (1---9). Each is capable of storing complete front panel setups.

SAVE clears any previously selected function.

RELATED SECTIONS RECALL, PRESET

SCALAR ON

DESCRIPTION The Scalar Input allows linear amplitude modulation of signals regardless of phase. Scalar may be used with BPSK, QPSK, 8PSK, 16 QAM, 64 QAM and FM. Scalar may not be used with analog vector input modulation.

PROCEDURE Select a Digital Modulation type and set up the instrument for its implementation. Connect a 0 to 1 Volt signal source to the SCALAR INPUT. Press the SCALAR ON key. To turn scalar off press the SCALAR ON key again.

EXAMPLE Use a Scalar Input to modulate QPSK.

LOCAL (Key-strokes)	<p style="text-align: center;">~Function~</p> <div style="display: flex; justify-content: center; gap: 20px;"> <div style="border: 1px solid black; padding: 2px; text-align: center;">QPSK ON</div> <div style="border: 1px solid black; padding: 2px; text-align: center;">SCALAR ON</div> </div>
<div style="border: 1px solid black; padding: 2px; display: inline-block; transform: rotate(-45deg); transform-origin: center;">HP-IB</div> (Program Codes)	<p style="text-align: center;">QP1 ; SC1</p> <div style="display: flex; justify-content: center; gap: 40px;"> Function Function </div>

Parameter	Program Code
Turn on Scalar	SC1
Turn off Scalar	SC0

INDICATIONS When Scalar is activated the indicator in the SCALAR ON key lights and the ACTIVE indicator for the SCALAR INPUT lights.

COMMENTS The SCALAR INPUT has a nominal impedance of 10k ohms, and a full scale range from 0.0V to 1.0V (full scale). To perform traditional AM, add +0.5V DC offset to the modulation input signals.

Scalar frequency response is DC to greater than 500 kHz.

SET ALT LVL

DESCRIPTION An Alternate Level, relative to the output power level, may be set when using BPSK or QPSK. Alternate Levels are set using the SET ALT LVL key, and activated using the ALT LVL ON key. Data line 1 determines whether the alternate level (logic high) or the set level (logic low) are output. Level are set in dB relative to the carrier, or as a percent (%) of the carrier output level, and are always lower than the carrier.

PROCEDURE Press the SET ALT LVL key, then enter a value and terminate with a valid terminator (dB or %).

EXAMPLE Set up an Alternate Level of 3 dB.

LOCAL (Key-strokes)	<p>Function: SET ALT LVL Data: 3 Units: dBm, dB, GHz</p>
 (Program Codes)	<p>Function: SAL Data: 3 Units: DBM</p>

Parameter	Program Code
Set Alternate Level	SAL
dB terminator	DBR
Percent terminator	PC
Turn alternate level on	AL1
Turn alternate level off	AL0

INDICATIONS After pressing SET ALT LVL the LEVEL Display will show the value you enter until you activate another function.

COMMENTS Alternate level is controlled by Data Input 1. Alternate level can be used with burst but not when Option 064 is installed. Resolution: 0.1 dB or 1%.









RELATED SECTIONS SET INCREMENT, INVERT INPUT

SET FM

DESCRIPTION This instruction details setting peak-to-peak deviation range for frequency modulation. Acceptable values for range vary according to the coupling method used. DC coupled FM values range from 150 Hz to 150 kHz. AC coupled FM values range from 50.0 kHz to 50 MHz.

PROCEDURE Press the SET FM key and enter a value and a valid terminator (Hz, kHz, MHz or GHz). Apply a 1V peak-to-peak signal to the FM input to achieve the selected modulation. The deviation varies linearly with input voltage.

EXAMPLE Set peak-to-peak deviation to 23 MHz (settable to 3 digits).

<p>LOCAL (Key-strokes)</p>	<p style="text-align: center;">~Function~ ~Data~ ~Units~</p> <p style="text-align: center;">     </p>
<p> (Program Codes)</p>	<p style="text-align: center;">    </p> <p style="text-align: center;">Function Data Units</p>

Parameter	Program Code
SET FM	SFM
FM ON	FMO
FM OFF	FM1

INDICATIONS After pressing SET FM the values you enter for peak-to-peak deviation will appear in the right display.

COMMENTS There is no internal FM source.

RELATED SECTIONS DC COUP FM, FM ON

SET FREQUENCY

DESCRIPTION This instruction details how to set the carrier frequency.

Operating Characteristics:
Range: 10 MHz to 3.0 GHz
Resolution: 1 Hz

PROCEDURE Press and release the SET FREQUENCY function key, the data keys, and a valid units key.

EXAMPLE Set the carrier frequency to 123.45 MHz

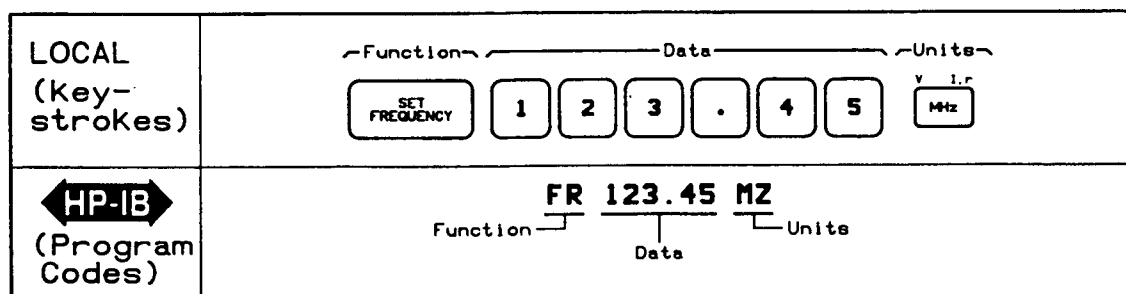

Parameter	Program Code
SET FREQUENCY	FR
GHz	GZ
MHz	MZ
kHz	KZ
Hz	HZ

INDICATIONS The selected frequency will be displayed in the Frequency Display.

COMMENTS Digits selected beyond the specified resolution of the instrument (1 Hz) will be truncated.

Frequency function will remain selected until another function is selected.

RELATED SECTIONS Set Increment

SET INCR (Increment Value Change)

DESCRIPTION This instruction details how to set or change the value of the stored increments used with the step up and step down keys to change frequency, level, FM, and most every parameter in the instrument.

PROCEDURE Press and release a function key, the SET INCR key, the desired data keys, and a valid units key.

EXAMPLE Set a carrier frequency increment of 1 MHz.

LOCAL (Key-strokes)	<p>Function Data Units</p> <p>SET FREQUENCY SET INCR 1 MHz</p>
 (Program Codes)	<p>Function Data Units</p> <p>FR: IS 1 MZ</p> <p>Function Data Units</p>

Parameter	Program Code
SET INCR	IS

INDICATIONS The value of the increment will appear in the level display.

COMMENTS The minimum increment values for each of the main functions are listed as follows:

	Minimum
Carrier Frequency	1 Hz
Output Level	.1 dBm
	0.01 microvolts
FM P-P Deviation	1 kHz

The maximum value for any range is the value one less than the value that would cause the parameter to exceed its range if the increment is added to it.

RELATED SECTIONS SET LEVEL, SET FREQUENCY, SET FM, SET I,Q, SET r,DEG, ALT LVL I, SET ALT LVL, SET I<Q, SET VAR, UP and DOWN ARROWS

SET I,Q

DESCRIPTION This instruction details setting the I and Q vectors to two arbitrary values for two-state modulation. Vectors may be set in either rectangular or polar coordinates. When you press SET I,Q, vectors are set in rectangular coordinates. SET r,DEG is used to set vectors in polar coordinates.

PROCEDURE Press SET I,Q once before each of the four parameters you wish to enter. Parameters are entered in this order: I1, Q1, I2, and Q2. The range of acceptable values is -100.0 to 100.0%, where the value entered represents percent of full scale.

EXAMPLE Set up two coordinates for two-state modulation. Let I1 = 50.5, Q1 = 75.2, I2 = 5, Q2 = -22.8.

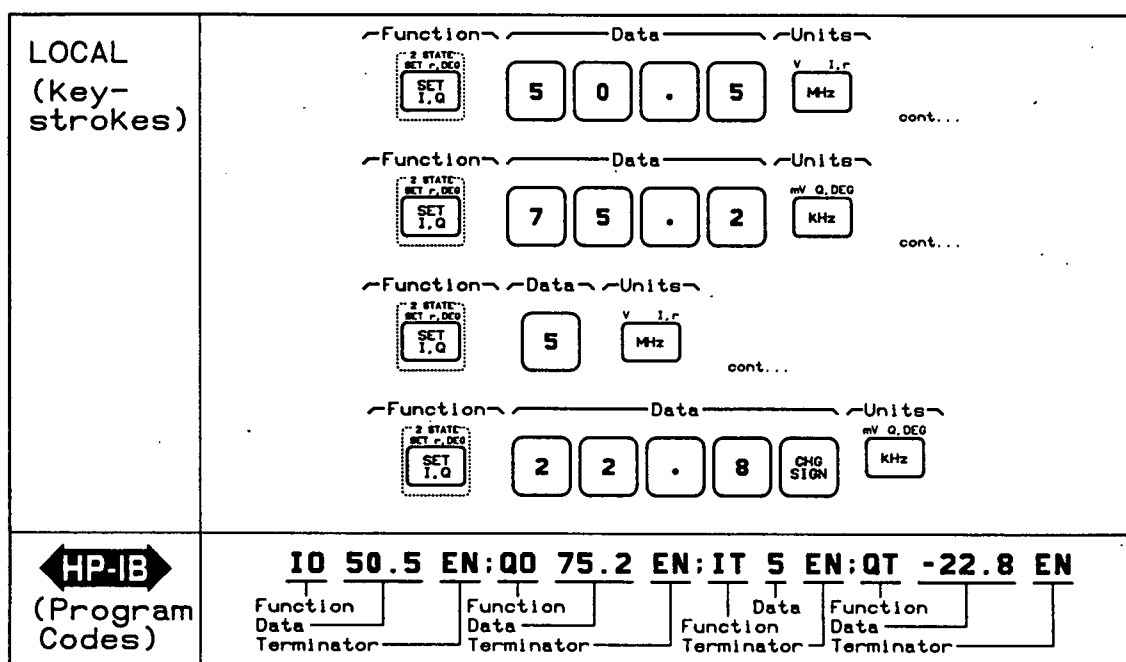

Parameter	Program Code
Two-state on	TS1
SET I1	IO
SET I2	IT
SET Q1	QO
SET Q2	QT
Two-State off	TS0

INDICATIONS After pressing SET I,Q, the Level Display will prompt you for the parameter needed. There are four parameters you need to enter and they are prompted for in the following order: I1=, Q1=, I2=, Q2=

RELATED SECTIONS SET r,DEG; 2 STATE ON; SET INCREMENT

SET I<Q

DESCRIPTION This key enables you to set the I vector component to lower amplitude than the Q vector component. The level may be specified in percent or in dB (relative to the level of the Q vector component).

PROCEDURE Press and release the SET I<Q key. Enter numerical value and terminate in % (percent) or dB. The value range for I<Q is -40.0 through 0.0 dB, or 1 through 100%. The resolution is 0.1 dB or 1%. To observe the result, use the I<Q ON key.

EXAMPLE Set an I level at 50% of the Q level.

LOCAL (Key-strokes)	<div style="text-align: center;"> ~Function~ ~Data~ ~Units~ </div> <div style="text-align: center; margin-top: 10px;"> SET I<Q 5 0 Hz </div>
<div style="text-align: center;">  (Program Codes) </div>	<div style="text-align: center; margin-top: 10px;"> Function Data Units </div> <div style="text-align: center; margin-top: 5px;"> SIQ 50 PC </div>

Parameter	Program Code
Set I<Q	SIQ
dB terminator	DBR
Percent terminator	PC
Turn on I<Q	IQ1
Turn off I<Q	IQ0

INDICATIONS When you press SET I<Q, the Frequency Display will show "I < Q =" and the Level Display will show the present setting, if any (I1 = 50%, for instance). After making an entry, the Level Display will show the value you enter. When the I<Q ON is activated the indicator in the I<Q ON key lights.

RELATED SECTIONS I<Q ON, SET INCREMENT

SET LEVEL

DESCRIPTION This instruction details how to set the output level.

Operating Characteristics:
 Range: +10 dBm to -100 dBm (10 MHz to 2.5 GHz)
 +4 dBm to -100 dBm (2.5 GHz to 3 GHz)
 For Option 064
 +12 dBm to -100 dBm (10 MHz to 3.0 GHz)
 Resolution: 0.1 dBm

PROCEDURE Press and release the SET LEVEL key, the desired data keys, CHG SIGN if appropriate, and a valid units key.

EXAMPLE Set the output level to -5.3 dBm

LOCAL (Key-strokes)	<p style="text-align: center;"> ~Function~ ~Data~ ~Units~ [SET LEVEL] [5] [.] [3] [CHG SIGN] [dBm/dB] [GHz] </p>
(Program Codes)	<p style="text-align: center;"> LV -5.3 DBM Function Data Units </p>

KEYS	HP-IB
SET LEVEL	LV
dBm	DBM
V	VL
mV	MV
Micro/V	UV

INDICATIONS The selected output level will be displayed with sign and units in the LEVEL Display.

COMMENTS Digits selected beyond the specified resolution of the LEVEL display will be ignored. Leading zeros will be blanked. Minus sign may be entered using CHG SIGN key. Level Data entries above +16 dBm are rejected.

RELATED SECTIONS Set Alternate Level, Alternate Level I

SET r,DEG

DESCRIPTION This instruction details setting two arbitrary I-Q vectors for two-state modulation using polar coordinates. Once the coordinates are set, two-state mode is output using the 2 STATE ON key.

PROCEDURE Press the blue shift key and the SET r,DEG key once before entering each of the four values. Enter values in the following order: r1, phi1, r2, phi2. Acceptable values for r1 or r2 are in the range 0 to 141.4%, where values represent percent of full scale. Acceptable values for phi1 and phi2 range from -360.0 to 360.0 degrees.

EXAMPLE Set up two-state modulation using polar coordinates. Let r1 = 50, phi1 = 30 degrees, r2 = 50, phi2 = 120 degrees.

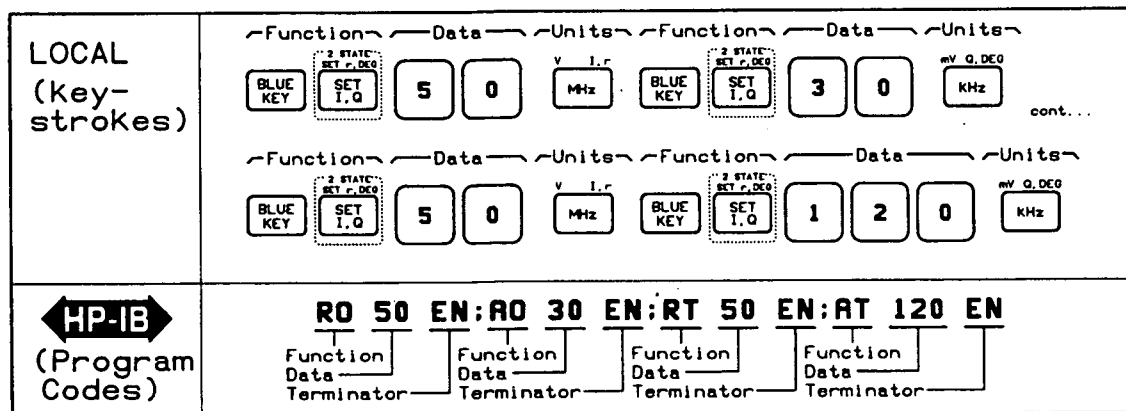

Parameter	Program Code
Two-state on	TS1
Two-state off	TS0
Magnitude 1	RO
Magnitude 2	RT
PHI 1	AO
Phi 2	AT

INDICATIONS The Level Display will show which of the four parameters the instrument is accepting. The display will prompt for parameters in the following order: R1=, DEG1=, R2=, DEG2=

RELATED SECTIONS SET I,Q; 2 STATE ON; SET INCREMENT

Setting Data Inputs Threshold Level

SET VAR

Operation
HP 8780A

DESCRIPTION The SET VAR key allows you to set a threshold level for digital data inputs. When a level is set it applies to all front panel digital inputs. The range for the level is 2.54 to -2.54 V, and the resolution is .01 V. A voltage above the threshold is considered to be a logic high.

PROCEDURE Press and release the Blue Shift key. Press and release the DATA key (SET VAR). Enter a value and terminate with the MHz key (V).

EXAMPLE Set the data trigger level to 1.5V.

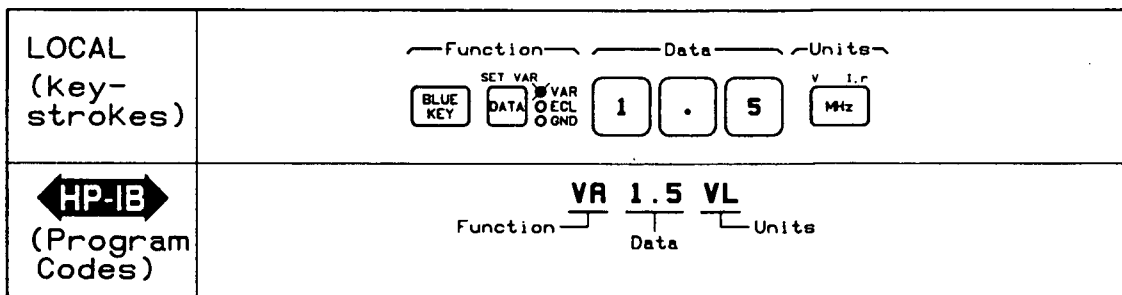

Parameter	Program Code
Set Variable Data Level	VA
Set Data Level to VARIABLE	DL0
Set Data Level to ECL	DL1
Set Data Level to GND	DL2

INDICATIONS When you press SET VAR the Level Display shows "VAR =". As you enter the digits, the values appear in the FM Display.

Variable Data Levels are only in effect when VAR indicator is on.

COMMENTS Variable Data Levels are stored with the other instrument settings in registers 0 through 9 when you SAVE front panel settings.

RELATED SECTIONS DATA

SPECIAL/OFF

DESCRIPTION This key is used to select special functions.

PROCEDURE To select a special function press and release the SPECIAL key, enter the number of the special function (valid range is 0.00 through 99.99), and terminate the entry with the ENT SPCL key (HZ). More than one special can be enabled at a time

EXAMPLE Select a special function. For this example select 20.3, FM Calibration Only.

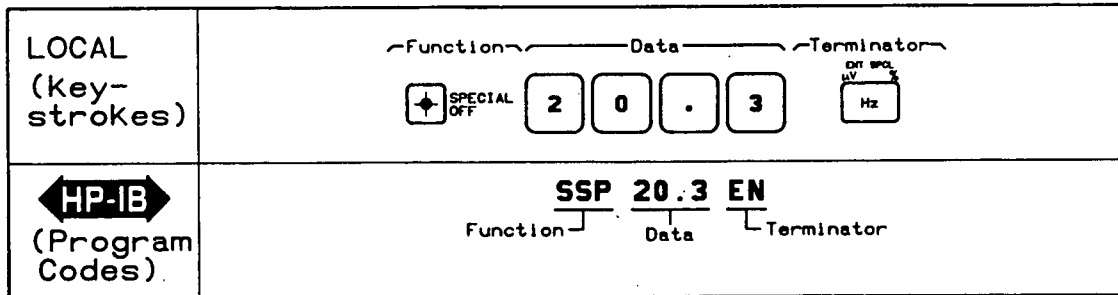

Parameter	Program Code
SPECIAL ON	SSP
SPECIAL OFF	SP0
ENT SPCL	EN

INDICATIONS When you press the SPECIAL key the displays will blank. The Frequency Display will show: ENT SPECIAL 0.00-99.99. As soon as you enter data the display shows the data. The SPECIAL key itself has an indicator to indicate when special functions are in effect.

COMMENTS After four digits have been entered, no more will be accepted. The shift-function key is used to turn all selected special functions off.

Table 3-5. Special Functions

0.0	Show active specials (1 through 10 only)
1.0	Unlock step attenuator range
1.1	Lock step attenuator range to current setting
2.0	Wideband DCFM disabled (normal DCFM now)
2.1	Wideband DCFM enabled
3.0	Baseband filter override OFF
3.1	Baseband filter override ON
4.0	External I-filter correction factor OFF
4.1	External I-filter correction factor ON
5.0	External Q-filter correction factor OFF
5.1	External Q-filter correction factor ON
6.0	Carrier leakage ON
6.1	Carrier leakage OFF
7.0	Pseudo random bit sequence OFF
7.1	Pseudo random bit sequence ON
8.0	Fast frequency switching OFF
8.1	Fast frequency switching ON
9.0	(Option 064)Digital modulation serial input framing OFF Must be in external serial clock mode to select.
9.1	(Option 064)Digital modulation serial input framing ON Must be in external serial clock mode to select.
11.0	All modulation OFF
12.0	Blank display OFF
12.1	Blank display ON
13.0	Exit phase bump mode
13.1	Enter phase bump mode
14.0	DAC_IFSCS (individual baseband DAC control)
14.1	DAC_QFSCS (individual baseband DAC control)
14.2	DAC_ICSO (individual baseband DAC control)
14.3	DAC_QCS0 (individual baseband DAC control)
14.4	DAC_ICS1 (individual baseband DAC control)
14.5	DAC_QCS1 (individual baseband DAC control)
14.6	DAC_ICS2 (individual baseband DAC control)
14.7	DAC_QCS2 (individual baseband DAC control)
14.8	DAC_IOS (individual baseband DAC control)
14.9	DAC_QOS (individual baseband DAC control)
15.0	PHASE_DAC (individual baseband DAC control)
15.1	I_ATTEN (individual baseband DAC control)
15.2	Q_ATTEN (individual baseband DAC control)
20.0	Normal calibration
20.1	Baseband frequency calibration only
20.2	Output level calibration only
20.3	FM calibration only
20.4	dcFM calibration with dcFM turned on, FM input disabled
20.5	dcFM calibration with dcFM turned on, FM input enabled
25.0	Set HP-IB address
30.0	I-baseband debug
31.0	Q-baseband debug

Table 3-5. Special Functions (continued)

50.0	Software version displayed
51.0	Display service (processor board) indicator value
51.1	Display last baseband CAL error code
51.2	Display last output section CAL error code
51.3	Display last FM CAL error code
52.0	Service voltmeter OFF
52.1	Service voltmeter --> Instrument ground
52.2	Service voltmeter --> FM RF module
52.3	Service voltmeter --> Output section
52.4	Service voltmeter --> LO multiplier
52.5	Service voltmeter --> FM baseband module
52.6	Service voltmeter --> I baseband
52.7	Service voltmeter --> Q baseband
52.8	Service voltmeter --> Instrument +10V reference
53.0	Direct hardware control --> section
53.1	Direct hardware control --> start bit
53.2	Direct hardware control --> length
53.3	Direct hardware control --> value
54.0	Display installed options code.
	Binary weighted sum of:
Value	Option#
1	001 - rear panel version
2	002 - high power coherent carrier
4	003 - up converter
8	064 - 64QAM
16	xxx - discrete amplifier installed
70.0	Error checking ENABLED
70.1	Error checking DISABLED (WARNING-may hangup instrument)
99.9	Initialize instrument (erase all calibration factors and reset instrument)

Special Functions.

The most commonly used functions associated with this instrument are found on the front panel. For certain applications, however, other functions are very useful. The HP 8780A contains Special Functions to provide versatility and capabilities to the instrument. These capabilities are accessed using the SPECIAL function key on the front panel of instrument, or by HP-IB commands. The following is a complete list of the functions with brief explanations to guide you in their use.

Show Active Specials (0.0). This Special Function displays on the liquid crystal display which Special Functions (1 through 10) are currently selected.

Unlock Step Attenuator Range (1.0). Aborts Special Function 1.1.

Lock Step Attenuator Range to Current Setting (1.1). This Special Function locks the step attenuator and extends the range tunable with the vernier. This is important when performing sensitivity measurements near a step attenuator switch point where the step attenuator switching might interfere with the measurement. Typical range extension is about 2 dB lower and 6 dB higher than the unextended range. At the high and low ends of the extension some performance degradation is expected and vector accuracy is unspecified.

Wideband DCFM Disabled (2.0). Returns DCFM to its normal operation. Used to return from Special Function 2.1.

Wideband DCFM Enabled (2.1). Wideband DCFM is an unspecified frequency modulation mode that allows up to +/-50 MHz deviations at up to 12 MHz rates. Higher deviations are possible by overdriving the FM input with average signal values typically up to +/- 2.0 V (up to 200 MHz p-p deviations). The input is protected with a relay which disconnects the driving input if the driving signal's average value is too high.

Baseband Filter Override OFF (3.0). Rescinds Special Function 3.1.

Baseband Filter Override ON (3.1). Baseband Filter Override is used to select one of the four built in spectral limiting filters for any given instrument configuration. Normally, the HP 8780A selects a spectral limiting filter that has a passband less than half the tuned frequency to avoid the spectral folding that would occur if modulation bandwidths greater than the Generator's frequency were combined. Baseband Filter Override allows either higher or lower passband filters to be selected from those in the instrument.

The four low pass baseband filters available in the HP 8780A have the following approximate 3 dB frequencies: 40 MHz, 90 MHz, 180 MHz and 250 MHz. The 3 dB roll off frequency for the I and Q channels without filters is greater than 350 MHz.

External I-Filter Correction Factor OFF (4.0). This Special Function returns the instrument from external control of correction factors for the I channel.

External I-Filter Correction Factor ON (4.1). This Special Function allows you to enter your own correction factors for AC or DC coupled filters used externally with the I channel. Normally, the instrument compensates for external filters in its calibration routines if external filter is selected before calibrating. If you wish to compensate manually, however, you may select losses in the range of 0 to 3 dB with a resolution of 0.1 dB using this Special Function. Filters with loss or gain out of this range are not recommended for use with this instrument. Compensation can be made only for dc coupled filters.

External Q-Filter Correction Factor OFF (5.0). This Special Function returns the instrument from external control of correction factors for the Q channel.

External Q-Filter Correction Factor ON (5.1). This Special Function allows you to enter your own correction factors for AC or DC coupled filters used externally with the Q channel. Normally, the instrument compensates for external filters in its calibration routines if external filter is selected before calibrating. you may select losses in the range of 0 to 3 dB with a resolution. If you wish to compensate manually, however, of 0.1 dB using this Special Function. Filters with loss or gain out of this range are not recommended for use with this instrument. Compensation can be made only for dc coupled filters.

Carrier Leakage OFF (6.0). This Special Function eliminates any carrier leakage added using Special Function 6.1.

Carrier Leakage ON (6.1). This Special Function allows you to add some carrier to a digitally modulated signal. Carrier leakage is selected in dBc and can range from -40 to -3 dBc. Carrier leakage is added to the I channel. Digital modulation accuracy may be adversely affected, especially for large amounts of carrier leakage.

Pseudo Random Bit Sequence OFF (7.0). This Special Function halts activity initiated by Special Function 7.1.

Pseudo Random Bit Sequence ON (7.1). The Vector Signal Generator can use its own microprocessor to generate pseudo random bit sequences to drive its digital input lines. The internal pseudo random signals easily generate simple test patterns, and, since all digital lines are driven by different taps of the same sequence, any digital modulation can be generated.

Fast Frequency Switching OFF (8.0). This is the normal mode of operation for the instrument. It insures that the frequency will shift from one frequency to another without a change in the output level (unless the output level you have set is not specified at the frequency you are switching to). This 'calibrated' switching is specified at 220 mS.

Fast Frequency Switching ON (8.1). This special function skips level processing when switching from one frequency to another. The output level is not specified when switching in this mode. Switching speed in this mode is specified at 100 mS.

(Option 064) Framing Clock OFF(9.0). This special function turns off the framing clock inputs when using digital modulation serial input.

(Option 064) Framing Clock ON(9.1). This special function turns on the framing clock inputs when using digital modulation serial input.

All Modulation OFF(11.0). This Special Function turns all analog and digital modulations off.

Display ON (12.0). This Special Function enables the liquid crystal displays. The displays are normally enabled, so this function is only necessary when the displays have been turned off by Special Function 12.1.

Display OFF (12.1). This Special Function is used to turn off the Vector Signal Generator's liquid crystal display to prevent sensitive information from being shown. This is valuable for secure system measurements where frequencies and modulations must be kept secret.

Exit Phase Bump Mode (13.0). Returns from mode initiated by Special Function 13.1.

Enter Phase Bump Mode (13.1). Phase bump shifts the RF output phase with respect to another Generator's output, provided the two generators are phase locked. Phase bump can introduce phase shifts up to +/- 360 degrees in 0.1 degree increments. Phase bump does not shift the phase between the Vector Signal Generator's RF output and coherent carrier. Since the phase of any Generator may drift slightly with respect to its reference, phase bump stability is not specified.

Individual Baseband DAC Control. These Special Functions allow you direct control of any of the Vector Signal Generator's thirteen internal digital-to-analog converters from the front panel. You can control the digital states within the I-Q plane, the quadrature of the modulator, and I and Q channel attenuation. The following is a list of the DAC control Special Functions:

DAC_IFSCS	14.0
DAC_QFSCS	14.1
DAC_ICS0	14.2
DAC_QCS0	14.3
DAC_ICS1	14.4
DAC_QCS1	14.5
DAC_ICS2	14.6
DAC_QCS2	14.7
DAC_IOS	14.8
DAC_QOS	14.9
PHASE_DAC	15.0
I_ATT	15.1
Q_ATT	15.2

Normal Calibration (20.0). This Special Function performs a complete calibration of the instrument, the same calibration performed by pressing the CAL key on the front panel of the instrument.

Baseband Calibration Only (20.1). Output Section Calibration Only (20.2) FM Calibration Only (20.3). These Special Functions calibrate only the baseband, output, or FM sections of the instrument instead of the complete calibration that is done by the front panel CAL key.

dcFM Calibration (20.4). This special function does a dcFM calibration. The dcFM must be turned on and the FM input is disabled.

dcFM Calibration (20.5). This special function does a dcFM calibration. The dcFM must be turned on and the FM input is enabled. This function calibrates out dc offsets on the FM signal.

Set HP-IB Address (25.0). This Special Function can be used to change the HP-IB address of the Vector Signal Generator.

I Baseband Debug (30.0). This special function is used for I Baseband troubleshooting.

Q Baseband Debug (31.0). This special function is used for Q Baseband troubleshooting.

Software Version (50.0). This special function displays the instrument's software version on the liquid crystal displays.

Display Service indicator Value (51.0). This special function displays on the liquid crystal display the value of the service indicator.

Display Last Baseband Calibration Error Code (51.1). This special function will display on the liquid crystal displays the code number of the last baseband error discovered by the instrument. If there are no errors a zero is displayed.

Display Last Output Section Calibration Error Code (51.2). This special function will display on the liquid crystal displays the code number of the last output section error discovered by the instrument. If there are no errors a zero is displayed.

Display Last FM Calibration Error Code (51.3). This special function will display on the liquid crystal displays the code number of the last FM section error discovered by the instrument. If there are no errors a zero is displayed.

Service Voltmeter Functions. The following special functions are used to measure internal voltages using a built-in Service Voltmeter. When one of the voltmeter specials is entered, a reading is displayed on the liquid crystal displays.

Service Voltmeter Off (52.0). Turns off any voltmeter special.

Service Voltmeter ---> HP 8780A Ground (52.1).

Service Voltmeter ---> FM RF Module (52.2).

Service Voltmeter ---> Output Section (52.3).

Service Voltmeter ---> LO Multiplier (52.4).

Service Voltmeter ---> FM Baseband Module (52.5).

Service Voltmeter ---> I Baseband (52.6).

Service Voltmeter ---> Q Baseband (52.7)

Service Voltmeter ---> HP 8780A +10V Reference (52.8) .

Direct Hardware Control. The following four specials enable direct hardware control of the instrument from the front panel.

Direct Hardware Control ---> Section (53.0).

Direct Hardware Control ---> Start Bit (53.1).

Direct Hardware Control ---> Length (53.2).

Direct Hardware Control ---> Value (53.3).

Table 3-6. Hardware Bit Map Special Function 53

SECTION 0 OUTPUT SECTION	Start Bit	Function
	0-10 11-22 23 24 25 26 27 28 29-31	Phase DACS Amp var atten (Option 064 range high=1/low=0) Amplifier off (1=off) 40 dB pad (1=in) 40 dB pad (1=in) 20 dB pad (1=in) 10 dB pad (1=in) Analog multiplexer enable (1=enabled) Analog multiplexer
SECTION 1 LO MULTIPLIER	Start Bit	Function
	0 1 2 3 4 5-7	Unused RF on (1=on) High power amplifier off (1=off) Band switch (0=8-9.5, 1=9.5-11) Analog multiplexer enable (1=enabled) Analog multiplexer
SECTION 2 POWER SUPPLY	Start Bit	Function
	0-6 7	Unused Oven cold interrupt enable (1=enabled)

Table 3-6. Hardware Bit Map Special Function 53 (continued)

SECTION 3 BASEBAND FILTER	Start Bit	Function
	0-7	Q channel attenuator (bit 0=MSB, 0=max atten, 255=min atten)
	8-15	I channel attenuator (bit 8=MSB, 0=max atten, 255=min atten)
	16-27	Q channel offset DAC (bit 16=MSB)
	28-39	I channel offset DAC (bit 28=MSB)
	40-43	Unused
	44	I channel calibration reference (0=GND, 1=0.5V)
	45	Q channel calibration reference (0=GND, 1=0.5V)
	46-47	Unused
	48	Analog input select (0=calibration reference, 1=external inputs)
	49	External filter select (0=not selected, 1=selected)
	50	Vector modulation select (0=not selected, 1=selected)
	51-52	Internal filter select
	53	Interrupt reset (reset on rising edge)
	54	Interrupt enable (1=enabled)
SECTION 4 BASEBAND SWITCH	Start Bit	Function
	0-11	I channel CS2 (bit 0=MSB)
	12-23	I channel CS1 (bit 12=MSB)
	24-35	I channel CS0 (bit 24=MSB)
	36-47	I channel FSC (bit 36=MSB)
	48-59	Q channel CS2 (bit 48=MSB)
	60-71	Q channel CS1 (bit 60=MSB)
	72-83	Q channel CS0 (bit 72=MSB)
	84-95	Q channel FSC (bit 84=MSB)
	96-97	Scalar calibration
	98-99	Scalar modulation bits
	100-101	Clock selection
	102	Q burst (not used Option 064)
	103	Unused

Table 3-6. Hardware Bit Map Special Function 53 (continued)

SECTION 5 BASEBAND BUFFER	Start Bit	Function
	0-9 10-14 15 16 17 18 19 20 21 22 23 24 25 26 27 28 29 30-31	Data threshold DAC Clock control bits Clock termination (0= -2V, 1=GND) Data termination (0= -2V, 1=GND) 1=8PSK and alternate level modes 8PSK (1=on) Invert I clock (1=invert) Invert Q clock (1=invert) Invert bit number 3 (1=invert) Invert bit number 2 (1=invert) Invert bit number 1 (1=invert) Invert bit number 0 (1=invert) Set bit number 3 (1=set) Set bit number 2 (1=set) Set bit number 1 (1=set) Set bit number 0 (1=set) Burst (1=enabled) Unused
SECTION 5a BASEBAND BUFFER	Start Bit (Option 064)	Function (Option 064)
	0-9 10 11 12-14 15 16 17 18 19 20 21 22 23 24 25 26 27 28 29 30	Data threshold DAC Not connected Mod cont.(1=8PSK, Alt Lev, 2State, Burst 0=other) Clock control bits Clock termination (0= -2V, 1= GND) Data termination (0= -2V, 1= GND) 1= 8PSK Invert bit number 5 (1=invert) Invert clock (1=invert) Invert bit number 2 (1=invert) Invert bit number 4 (1=invert) Invert bit number 3 (1=invert) Invert bit number 1 (1=invert) Invert bit number 0 (1=invert) Set bit number 4 (1=set) Set bit number 3 (1=set) Set bit number 1 (1=set) Set bit number 0 (1=set) Set bit number 2 (1=set) Set bit number 5 (1=set)

Table 3-6. Hardware Bit Map Special Function 53 (continued)

SECTION 6 FM BASEBAND MODULE	Start Bit	Function
	0	100 MHz VCXO (1=on)
	1-2	100 MHz PIN switch (2=CW, acFM 1=dcFM)
	3-6	Unused
	7	Interrupt enable (1=enabled)
	8	Calibration mode (0=cal, 1=normal)
	9	Overpower reset (rising edge resets)
	10-12	Analog multiplexer
	13	8 dB pad (1=in)
	14	Unused
	15	Invert (1=inverted at fm output)
	16-25	10 bit variable attenuator DAC
	26	16 dB pad (1=in)
	27	33 dB pad (1=in)
	28	4 dB pad (1=in)
	29	2 dB pad (1=in)
	30-31	Calibration voltage (0= -0.3V, 1= +0.3V, 2=GND)
SECTION 7 FM RF MODULE	Start Bit	Function
	0	acFM lock interrupt enable (1=enabled)
	1	CW/dcFM lock interrupt enable (1=enabled)
	2	FM counter interrupt enable (1=enabled)
	3	FM counter hold (0=count)
	4-6	Analog multiplexer
	7	100 MHz switch (1= to 100 MHz output)
	8-9	Unused
	10	CW/dcFM lock sweep (1= sweep)
	11	acFM divider chain (0= on)
	12	acFM tune (1=disconnected)
	13	CW/dcFM tune to VCO module (1=connected)
	14	Baseband FM to VCO module (1=connected)
	15	100 MHz selection (1=RF source, 0=VCXO)

Display Installed Options Code (54.0). Binary weighted sum of:

Value	Option#
1	001 --- Rear Panel Version
2	002 --- High Power Coherent Carrier
4	003 --- Up Converter
8	064 --- 64 QAM
16	xxx --- Discrete Amplifier Installed

Error Checking ENABLED (70.0). Reverts back to normal error checking modes after use of Special Function 70.1.

Error Checking DISABLED (70.1). This special function disables error checking procedures within the Generator. This function is DANGEROUS because it may cause the instrument to cease functioning.

Initialize Instrument (99.9). This special function is used to set the Vector Signal Generator to its original configuration. It erases all user set frequencies, instrument configurations, and recent calibration information.

UP AND DOWN ARROWS

DESCRIPTION The Up and Down Arrows change selected values in predetermined increments. The amount of increment is set using the SET INCR key.

PROCEDURE Press the Up or Down Arrow once for each step. If you wish to auto repeat a step, hold the key down.

EXAMPLE Increase frequency in 5 MHz increments from 60 to 75 MHz, then step back to 60 MHz

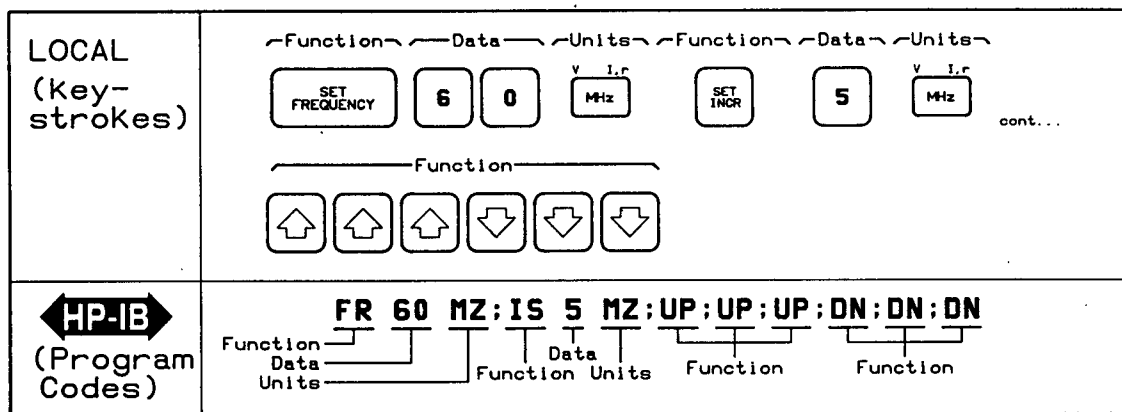

Parameter	Program Code
Step up	UP
Step down	DN
Set Increment	IS

INDICATIONS When you press an Up or a Down Arrow the LCD display for the value changes.

COMMENTS If no function has been selected, pressing an Up or Down Arrow has no effect upon any entry field.



RELATED SECTIONS SET INCR

VECTOR ON

DESCRIPTION Analog entry of I and Q vectors is made using the VECTOR INPUT connectors on the front panel. VECTOR INPUT lines are direct I and Q inputs to the vector modulator.

PROCEDURE Connect an analog source to the I Vector Input, and another analog source to the Q Vector Input. Full scale I or Q signals are +/- 0.5V into 50 ohms. Press and release the VECTOR ON key so that the indicator contained in the key lights. To turn off vector modulation press and release the VECTOR ON key so that the indicator contained in the key turns off.

EXAMPLE Turn on the Vector Modulation.

LOCAL (key-strokes)	<p style="text-align: center;">Function</p> 
 (Program Codes)	<p style="text-align: center;">VM1 Function</p>

Parameter	Program Code
Turn off Vector Modulation	VM0
Turn on Vector Modulation	VM1

INDICATIONS When VECTOR ON is pressed, the indicator in the VECTOR ON key lights, and the active indicators by the I and Q Vector Inputs light. All other active input indicators go off with the exception of the FM Input, which stays on if FM has been selected.



COMMENTS Vector accuracy is only specified within a circular I-Q space with a radius of 0.5V. Although the I or Q signal may independently be +/- 0.5V, the square root of the sum of the squares of I and Q voltages must not be larger than 0.5V to achieve the specified accuracy.

2 STATE ON

DESCRIPTION Two state allows you to use two arbitrary I-Q vectors for digital modulation of the carrier. Two state vector modulation is activated and deactivated by the 2 STATE ON key. The two vectors must be set using the 2 STATE set key (SET I,Q or SET r,DEG).

PROCEDURE After setting two vectors using the SET I,Q or the SET r,DEG keys, turn on 2 STATE by pressing the 2 STATE ON key, or, if you have option 064, the blue shift key and the 64 QAM ON key (2 STATE).

EXAMPLE Turn on 2 STATE

LOCAL (Key-strokes)	<p>~Function~</p> 	<p>OPTION 064 ONLY ~Function~</p> 
 (Program Codes)	<p style="text-align: center;">TS1 Function</p>	

Parameter	Program Code
2 State on	TS1
2 State off	TS0

INDICATIONS After pressing 2 STATE ON the indicator in the 2 STATE ON key lights and stays on until another modulation type is selected. Digital Input 1 goes active and the active indicator for this input lights.

COMMENT 2 STATE works with BURST except in Option 064.

RELATED SECTIONS SET I,Q and SET r,DEG; SET INCREMENT

8PSK ON

DESCRIPTION Eight State Phase Shift Keying modulates three data bits into one of eight possible I-Q vector states. The figure below shows the states and mapping.

PROCEDURE Press and release the 8PSK ON key. The indicator in the key will go on. To turn off 8PSK, press the 8PSK key again. Use Digital Inputs 0, 1 and 2 (0, 1 and 3 Option 064) to enter data. The vectors will be produced as follows:

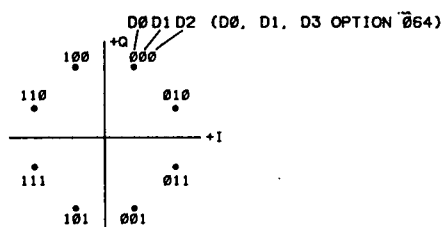

The instrument should be configured as follows:

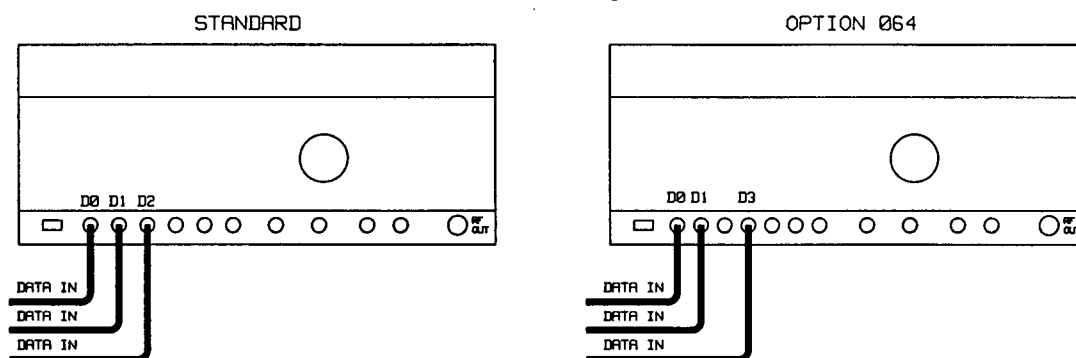

EXAMPLE Set up for 8PSK.

<p>LOCAL (key-strokes)</p>	<p>Function</p> <p>8PSK ON</p>
<p>HP-IB (Program Codes)</p>	<p>EP1 Function</p>

Parameter	Program Code
8PSK ON	EP1
8PSK OFF	EPO

INDICATIONS The indicator in the 8PSK ON key goes on when 8PSK is activated, and off when 8PSK is turned off. The active indicators for Digital Inputs 0, 1 and 2 (0, 1 and 3 Option 064) light when 8PSK is activated.

COMMENTS Data inputs may be inverted using the INVERT INPUT key.

RELATED SECTIONS INVERT INPUT

16 QAM ON

DESCRIPTION Sixteen State Quadrature Amplitude Modulation modulates four data bits into one of sixteen I-Q vector states. See below for states and bit mapping.

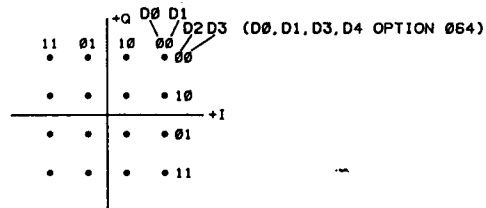

PROCEDURE Press and release the 16 QAM ON key so that the indicator in the 16 QAM ON key lights. To turn off 16 QAM press the 16 QAM ON key again. Connect your data lines to Digital Inputs 0, 1, 2, and 3 (0, 1, 3 and 4 Option 064). Set up the instrument as follows:

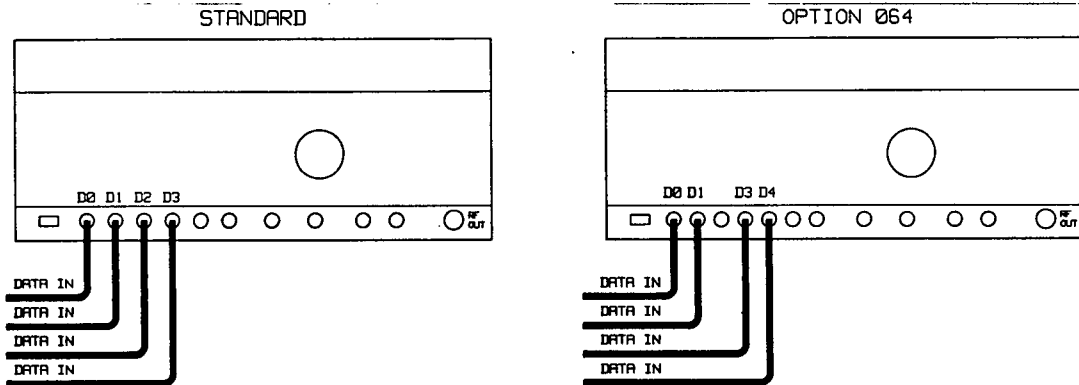

EXAMPLE Turn on 16 QAM

<p>LOCAL (key-strokes)</p>	<p>Function</p> 
<p>HP-IB (Program Codes)</p>	<p>QA1 Function</p>

Parameter	Program Code
16 QAM on	QA1
16 QAM off	QA0

INDICATIONS When 16 QAM is activated the 16 QAM ON key indicator lights and stays on. The active indicator for Digital Inputs 0, 1, 2 and 3 (0, 1, 3 and 4 Option 064) light.

COMMENTS Data inputs may be inverted using the INVERT INPUT key.

RELATED SECTIONS INVERT INPUT

64 QAM ON (option 064 only)

DESCRIPTION Sixty-four State Quadrature Amplitude Modulation modulates six bits of data into sixty-four possible I-Q vector states. This mode is available only in instruments with Option 064. Digital modulations can be generated with either parallel or serial digital inputs. The Generator's that have Option 064 installed the parallel or serial method is selected with the EXT CLK key. The parallel input is asynchronous or uses one clock input. When using the serial input, data is read from line D0 into a shift register that drives all of the parallel inputs. A data rate clock is required. Data is automatically latched at a divide by 6 rate or the user can supply a framing clock at D5 using special function 9.1. When special function 9.1 is active, data is latched when D5 goes high. The first bit into D0 maps to bit D5 and the sixth bit maps to bit D0.

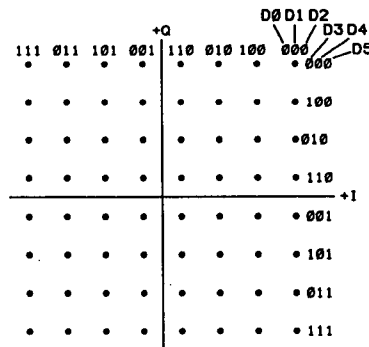

PROCEDURE Press and release the 64 QAM ON key. To turn off 64 QAM press and release the 64 QAM key again. Input data at Digital Inputs 0, 1, 2, 3, 4, and 5. Vector configurations are as follows:

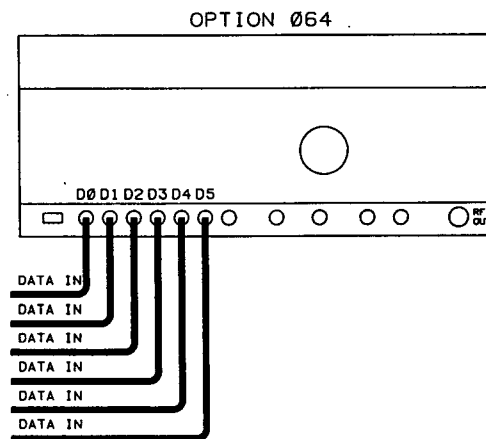

Your instrument should be configured as follows:



EXAMPLE Turn on 64 QAM.

<p>LOCAL (Key- strokes)</p>	<p>Function </p>
<p> (Program Codes)</p>	<p>SQ1 Function</p>

Parameter	Program Code
64 QAM on	SQ1
64 QAM off	SQ0

INDICATIONS When 64 QAM is activated the indicator in the 64 QAM ON key lights and stays on. The active LEDs by Digital Inputs 0, 1, 2, 3, 4, and 5 light.

COMMENTS Data inputs may be inverted using the INVERT INPUT key.

RELATED SECTIONS INVERT INPUT.

Acoustic Noise Emissions

The acoustical noise emissions specifications and general characteristics complies with and shows conformance to the third regulation to the German Equipment Safety Law for the Regulation on Noise Declaration of Machines: 3.GSGV.

Specifications are parameters against which the instrument can be tested. General characteristics are non-warranted parameters included as useful information.

Acoustic Noise Emissions Geraeuschemission

Specifications	Spezifikation
LpA: < 70 dB (A) per ISO 3744	LpA: < 70 dB (A) nach DIN 45635 pt. 1
General Characteristics*	Generelle Eigenschaften*
LpA: Operator Position: 50 dB (typ.) Bystander Position: 42 dB (typ.) per ISO 6081 <i>*Based on type test</i>	LpA: am Arbeitsplatz: 50 dB (typ.) fiktiver Arbeitsplatz: 42 dB (typ.) nach DIN 45635 pt. 19 <i>*Typprüfungsresultat</i>

performance Tests

Introduction

The procedures in this section test the electrical performance of the Generator using the specifications of Table 1-1 as performance standards. These tests are suitable for incoming inspection, troubleshooting, and preventive maintenance. All tests can be performed without access to the interior of the instrument. A simpler operational test is included in Section '3 under Operator's Checks.

Note

If the performance tests are to be considered valid, the following conditions must be met:

1. The Generator must have a 1 hour warmup.
 2. The testing environment must be within $5^{\circ}\text{fm}0\text{C}$ of the temperature during internal self-calibration.
 3. Total, elapsed powered-up time from the last internal self-calibration must be no more than four hours.
 4. The ambient temperature must be within the range of 0 to $55^{\circ}\text{fm}0\text{C}$.
-

Equipment Required

Equipment required for the performance tests is listed in Table 1-3, Recommended Test Equipment. Any equipment that satisfies the critical specifications given in the table may be substituted for the recommended model(s).

Performance Test Record

Results of the performance tests may be recorded in Table 4-2, Performance Test Record. This table is located at the end of this section and lists all of the tested specifications and their acceptable limits. Results recorded at incoming inspection can be used for comparison in periodic maintenance and troubleshooting and after repairs or adjustments.

Calibration Cycle

This instrument requires periodic verification of performance. Depending on the use and environmental conditions, the instrument should be checked using the performance tests at least once each year.

Abbreviated Performance Tests

In most cases, it is not necessary to perform all of the tests in this section. The following tests should be performed after a repairing the Generator or to verify the instrument operation without testing all of the specifications in Table 1-1.

First, perform the Operator's Checks in Section 3. Then, perform only the following performance tests:

1. Paragraph 4-7, Frequency Range, Resolution and Aging Rate
2. Paragraph 4-8, RF Output Level, Flatness and RF Switch On/Off Ratio
3. Paragraph 4-12, Frequency Modulation (AC Coupled)
4. Paragraph 4-14, Scalar Modulation

Table 4-1, contains a list of recommended changes to the performance tests when performing the operation verification. Where alteration of a test is recommended, a justification (remark) is also given. Should individual needs make the justification invalid, the test should be performed in its entirety.

Performance Test Procedures

It is assumed that the person performing the following tests understands how to operate the specified test equipment. Equipment settings, other than those for the Vector Modulation Analyzer, are stated in general terms. For example, a test might require that a spectrum analyzer's resolution bandwidth be set to 100 Hz; however, the sweep time would not be specified and the operator would set that control so that the analyzer operates correctly.

It is also assumed that the person performing the tests will supply whatever cables, connectors, and adapters are necessary.

Table 4-1. Abbreviated Performance Test

Performance Test	Alteration	Remark
Frequency Range, Resolution and Aging Rate	Omit Frequency Aging Rate Test	Secondary Importance
RF Output Level, Flatness and RF Switch On/Off Ratio	Perform Entire Test	
Frequency Modulation (ac Coupled)	Perform Entire Test	
Scalar Modulation	Perform Entire Test	

Frequency Range, Resolution and Aging Rate

Specification

Electrical Characteristics	Performance Limits	Conditions
FREQUENCY		
Range	10 MHz to 3.0 GHz	
Resolution	1 Hz	
Accuracy and Stability	Same as reference oscillator	
Reference Oscillator		
Frequency	10 MHz	
Aging Rate	$<5 \times 10^{-10}$ per day	After a 24-hour warmup and an oscillator off time of less than 24 hours

Description

The test is divided into a frequency range, frequency resolution and frequency aging rate test. Each test is described below.

Frequency Range

A frequency counter is used to verify that the Generator can produce frequencies above 3 GHz and below 10 MHz.

Frequency Resolution

The frequency counter is used to verify that the RF output frequency of the Generator can be tuned in 1 Hz steps.

Frequency Aging Rate

A precision frequency standard (with long term stability better than 1×10^{-10} per day) is used to trigger the oscilloscope at a precise rate. The 10 MHz auxiliary output of the Generator is observed on the oscilloscope display. The time required for a specific phase change is measured immediately and after a period of time. From these two frequency errors, the drift rate is calculated.

Equipment

- Frequency CounterHP 5343A
- Frequency StandardHP 5065A
- OscilloscopeHP 54201A

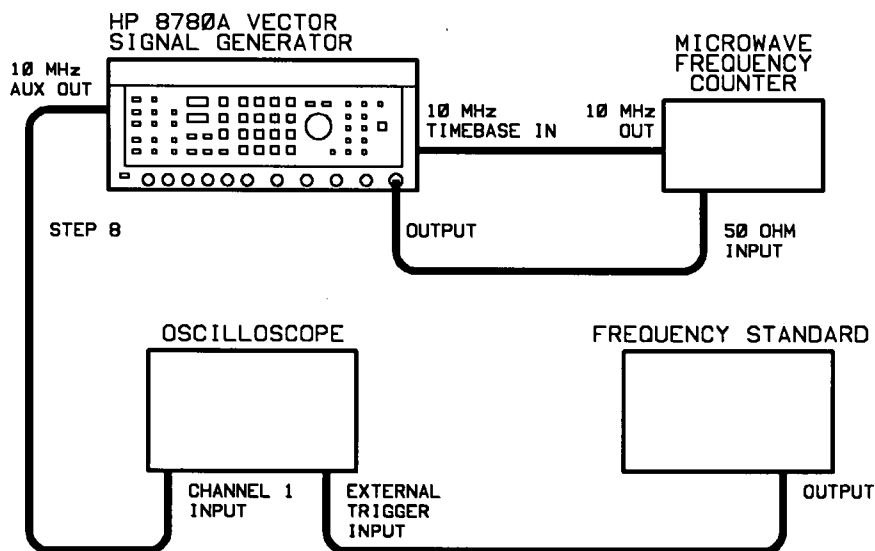

Figure 4-1. Frequency Test Setup

Procedure

Frequency Range

1. Connect the equipment as shown in Figure 4-1. The frequency counter 10 MHz reference out is connected in place of the Generator's 10 MHz internal reference.
2. Press the INSTR PRESET key on the Generator.
3. Set the Generator to 9 MHz at 0 dBm. Verify that the frequency counter indicates less than 10 MHz. This tests the lower limit of the frequency range specification.

_____ (✓) <10 MHz

4. Set the Generator frequency to 3001 MHz. Verify that the frequency counter indicates a frequency greater than 3000 MHz. This tests the higher limit of the frequency range specification.

_____ (✓) >3 GHz

Frequency Resolution

5. Set the Generator to 50 MHz. With the frequency counter resolution set to 1 Hz or better, verify that the frequency counter agrees with the Generator within ± 1 count.
6. Increase the Generator frequency by 1 Hz and assure that the frequency counter display also increases by 1 Hz.

_____ (✓) 1 Hz Resolution

Frequency Aging Rate

7. Reconnect the Generator's internal 10 MHz reference.
8. Connect the Generator's rear panel 10 MHz TIMEBASE AUX OUT to channel 1 of the oscilloscope. Set the vertical coupling of channel 1 for 50 ohms dc coupling. Set the horizontal timebase to 0.1 μ s per division.
9. Connect the frequency standard to the oscilloscope external trigger input.
10. Set the oscilloscope for external triggering and adjust the triggering for a stable display of the Generator's 10 MHz reference frequency.

Note

The internal 10 MHz reference oscillator will typically take 24 to 48 hours to reach its specified aging rate after instrument storage or shipment. In some cases, if extreme environmental conditions were encountered during storage, the reference oscillator could take as long as one week to achieve its specified aging rate.

11. Measure the time required for a phase change of 360° fm0. Record the time (T1) in units of seconds.

T1 = _____seconds

12. Wait for a period of time (from 3 to 24 hours) with the instrument operating. Re-measure the phase change time. Record the period of time between measurements (T2) in hours and the time for the second 360° change (T3) in seconds.

T2 = _____hours

T3 = _____seconds

13. Calculate the aging rate from the following equation:

$$\text{Aging Rate} = \left\{ \left(\frac{1 \text{ cycle}}{f} \right) \left(\frac{1}{T1} - \frac{1}{T3} \right) \left(\frac{T}{T2} \right) \right\}$$

Where:

1 cycle = the phase change reference for the time measurement (360° in this case).

f = the Generator's frequency reference (10 MHz)

T = specified time for aging rate (24 hours)

T1 = initial time

T2 = the time between measurements in hours

T3 = the second time for a 360 degree change (in seconds)

For Example:

$$T1 = 351 \text{ seconds}$$

$$T2 = 3 \text{ hours}$$

$$T3 = 349 \text{ seconds}$$

then:

$$\text{Aging Rate} = \left\{ \left(\frac{1 \text{ cycle}}{10 \text{ MHz}} \right) \left(\frac{1}{351 \text{ s}} - \frac{1}{349 \text{ s}} \right) \left(\frac{24 \text{ h}}{3 \text{ h}} \right) \right\}$$

$$= 1.306 \times 10^{-11} / \text{day}$$

14. Verify that the calculated aging rate is less than $5 \times 10^{-10} / \text{day}$.

Note

If the absolute frequencies of the frequency standard and the Generator's reference oscillator are extremely close (within 1 Hz), the measurement for determining T1, T2 and T3 can be reduced by measuring the time required for a phase change of something less than 360° .

Change the 1 cycle constant in the formula to whichever of the following is appropriate: $180^\circ = 1/2$ cycle, $90^\circ = 1/4$ cycle. The frequency can be adjusted to be within 1 Hz using the 10 MHz Reference Oscillator Adjustment in Section 5, Adjustments, of the Service Manual.

_____ Aging Rate ($< 5 \times 10^{-10}$)

RF Output Level, Flatness and RF Switch On/Off Ratio

Specification

Electrical Characteristics	Performance Limits	Conditions
RF OUTPUT		
Output Amplitude Level		
Standard Calibration Output	+10 to -100 dBm +4 to -100 dBm	10 MHz to 2.5 GHz 2.5 GHz to 3.0 GHz
Accuracy	<±2.5 dB <±3.5 dB	>-30 dBm <-30 dBm
Flatness	<±1.0 dB	
RF Switch On/Off Ratio	>60 dB	Carrier >-40 dBm

Description

The test is divided into RF level accuracy, output level flatness, RF switch on/off ratio and maximum leveled power. Each test is discussed below.

RF Level Accuracy

A measuring receiver is used to measure the RF output level down to -100 dBm. The measuring receiver uses an IF substitution technique in the tuned RF level mode to enable power measurements to be made at levels as low as -100 dBm.

RF Switch On/Off Ratio

The Generator is set to 0 dBm and the level is measured using the measuring receiver. The RF output is then turned off and the residual level is verified to be less than -60 dBm.

Output Level Flatness

A power meter is used to measure the power variation as the Generator is tuned from the lowest to the highest specified frequencies. Flatness is determined as one-half of the difference between the maximum and minimum levels measured.

Maximum Power

The power meter is used to verify that the Generator can produce the specified maximum RF power.

Equipment

Measuring Receiver	HP 8902A
Sensor Module	HP 11722A
Power Meter	HP 436A, HP 437B, or HP 438A
Power Sensor	HP 8481A/HP 8482A

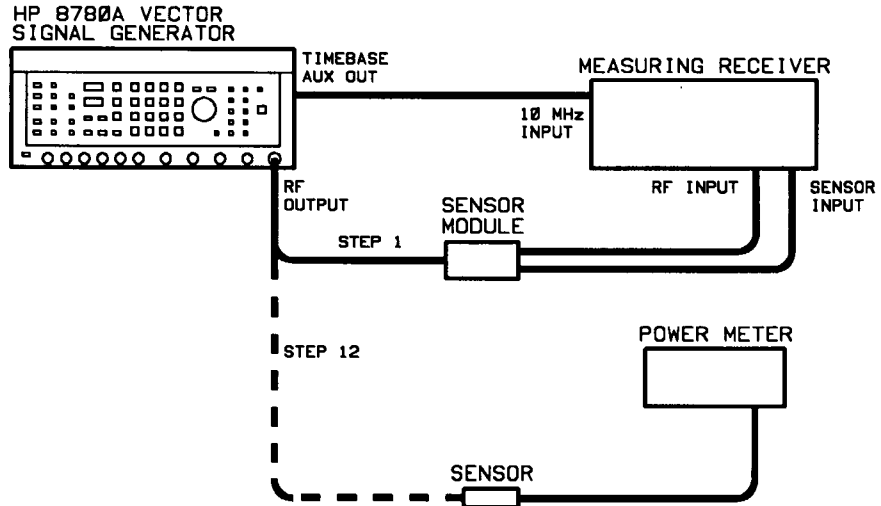

Figure 4-2. RF Level Test Setup

Procedure

RF Level Accuracy

1. Press the INSTR PRESET key on the Generator. Press the CAL key on the Generator to begin an instrument self-calibration.
2. Calibrate and zero the power meter function of the measuring receiver.
 - a. Connect the Sensor Module to the Measuring Receivers' CALIBRATION RF power output.
 - b. Press the RF Pwr key on the Measuring Receiver.
 - c. Press the LOG/LIN key to display the level in units of dBm.
 - d. Press the CALIBRATE key to turn on the reference.
 - e. Press the Zero key to zero the Sensor Module.
 - f. When Zero completed, press the SAVE CAL key (blue key the CAL key).
3. Connect the equipment as shown in figure 4-2.
4. Once the Generator calibration is complete, set the Generator frequency to 100 MHz and output level to +10 dBm.
5. Connect the sensor module to the Generator output. Press the measuring receiver FREQ key. Set the measuring receiver for tuned RF power by pressing the gold key then the RF key. Press the CALIBRATE key to calibrate the tuned RF mode.

Note

If at any time during this test the measuring receiver UNCAL or RECAL annunciator lights, press the CALIBRATE key on the measuring receiver. A measuring receiver calibration should be required when the tuned RF level function is first selected, and then at -40 dBm and -80 dBm.

6. The displayed power level should be +10 dBm \pm 2.5 dB. Record the measured level in the table that follows.
7. Set the Generator output level to each of the levels indicated in the table that follows. Record the power measured by the measuring receiver and copy to Table 4-2.

RF Level Accuracy Results

Generator Level	Lower Limit	Measured Level	Upper Limit
+10 dBm	+7.5 dBm	_____	+12.5 dBm
0 dBm	-2.5 dBm	_____	+2.5 dBm
-10 dBm	-12.5 dBm	_____	-7.5 dBm
-20 dBm	-22.5 dBm	_____	-17.5 dBm
-30 dBm	-32.5 dBm	_____	-27.5 dBm
-40 dBm	-43.5 dBm	_____	-36.5 dBm
-50 dBm	-53.5 dBm	_____	-46.5 dBm
-60 dBm	-63.5 dBm	_____	-56.5 dBm
-70 dBm	-73.5 dBm	_____	-66.5 dBm
-80 dBm	-83.5 dBm	_____	-76.5 dBm
-90 dBm	-93.5 dBm	_____	-86.5 dBm
-100 dBm	-103.5 dBm	_____	-96.5 dBm

RF Switch On/Off Ratio

8. Set the Generator output to 0 dBm. Record the level displayed on the measuring receiver.

_____ dBm On Level

9. Turn the Generator RF output off by pressing the RF OUT ON key (the key indicator should extinguish). Record the level displayed on the measuring receiver. The difference between the level recorded in step 8 and the displayed level should be more than 60 dB.

_____ dBm Off Level

10. Calculate the On/Off ratio by subtracting the Off Level from the On Level. The results should be greater than 60 dB. Record the On/Off ratio below and in Table 4-2.

_____ dB On/Off Ratio (>60 dB)

Output Level Flatness

11. Zero and calibrate the power meter and power sensor.
12. Connect the power sensor to the Generator RF output.
13. Set the Generator to 10 MHz at an output level of 0 dBm. Press the RF Out On key to enable the Generator RF output (the key indicator should be lit).
14. Select relative power measurement on the power meter by pressing the dB [REF] key (HP 436A), or the REL key (HP 438A or HP 437B). This establishes a reference at the current measured level.
15. Slowly tune the Generator from 10 MHz to 3 GHz while observing the power meter. Record the maximum reading and the minimum reading. Adjust the power meter calibration factor as required to match the measurement frequency.

_____ dB Maximum Level

_____ dB Minimum Level

16. Calculate the flatness by subtracting the Minimum Level from the Maximum Level measured. The difference between the maximum level and the minimum level should be less than 2 dB. Record the calculated flatness below and in Table 4-2.

_____ dB Flatness (<2 dB)

Maximum Power

Note

Ignore the Warning LED (Warning 602).

17. Set the power meter to measure in dBm mode.
18. Set the Generator to 10 MHz and set the output level to +10 dBm as indicated by the power meter.
19. Tune the Generator from 10 MHz to 2.5 GHz and note the frequency at which minimum power level occurs.
_____ MHz Minimum power frequency (10-2500 MHz)
20. Tune the Generator to the frequency noted in the previous step. Adjust the output level for a power meter indication of +10 dBm.
21. Tune the Generator from 10 MHz to 2.5 GHz and verify that the power meter indicates at least +10 dBm at all frequencies. Check

the space below and in Table 4-2 if the Generator passes this check.

_____ (✓) 10 MHz to 2.5 GHz (>+10 dBm)

22. Tune the Generator to 2.5 GHz and set the output level to +4 dBm as indicated by the power meter.

23. Tune the Generator from 2.5 GHz to 3 GHz and note the frequency at which minimum power level occurs.

_____ MHz Minimum power frequency (2.5-3 GHz)

24. Tune the Generator to the frequency noted in the previous step. Adjust the output level for a +4 dBm indication on the power meter.

25. Tune the Generator from 2.5 GHz to 3 GHz and verify that the power meter indicates at least +4 dBm at all frequencies. Check the space below and in Table 4-2 if the Generator passes this check.

_____ (✓) 2.5 GHz to 3 GHz (>+4 dBm)

Residual SSB Phase Noise

Specification

Electrical Characteristics	Performance Limits	Conditions
SPECTRAL PURITY		
Residual Phase Noise (Digital, Vector and Scalar residual phase noise is the same as CW)		CW, 1 GHz Carrier, +7 dBm
	<-65 dBc	10 Hz offset from carrier
	<-84 dBc	100 Hz offset from carrier
	<-100 dBc	1 kHz offset from carrier
	<-110 dBc	10 kHz offset from carrier
	<-110 dBc	100 kHz offset from carrier
	<-114 dBc	1 MHz offset from carrier
	<-130 dBc	10 MHz offset from carrier

Description

The Generator RF output is mixed with a local oscillator to produce a dc IF signal that is in phase quadrature. The various specified offsets are then checked using a spectrum analyzer to determine the noise level.

Correction factors are applied to each measurement for using the spectrum analyzer in the log mode, for local oscillator noise contributions and for using a bandwidth greater than 1 Hz.

Note

This test measures the total single-sideband noise of both the Generator and the local oscillator. Therefore, the local oscillator must have a single-sideband phase noise ratio that is less than or equal to the Generator.

Equipment

Low Frequency Spectrum Analyzer HP 3561A or HP 3582A
 Spectrum Analyzer HP 8566B
 Local Oscillator HP 8662A
 Double Balanced Mixer RHG DM 1-26 or WJ M1G
 Attenuator (10 dB) HP 8491A Option 010
 Low Noise Amplifier HP 11729-60014 or HP 08640-60506
 Power Supply HP 6205C
 Oscilloscope HP 54201A

Note

The signal-to-phase noise ratio as measured must be corrected to compensate for 3 errors contributed by the measurement system. These are:

1. Using the spectrum analyzer in the log mode requires a +2.5 dB correction. A Fast Fourier Transform (FFT) spectrum analyzer such as the HP 3561A and HP 3582A does not require this correction.
2. Equal noise contributed by the local oscillator requires a correction of -3 dB. Using the HP 8662A as the local oscillator will not require this correction. Converting the double-sideband measurement to a single-sideband measurement requires an additional -6 dB correction.
3. The spectrum analyzer noise measurement must be normalized to a 1 Hz bandwidth. The noise equivalent bandwidth for Hewlett-Packard spectrum analyzers is 1.2 times the 3 dB bandwidth.

For a 10 Hz bandwidth, the correction for the normalized measurement bandwidth would be:

$$\text{Normalizing Factor (dB)} = 10 \log(1.2 \times 10 \text{ Hz} / 1 \text{ Hz}) = 10.8 \text{ dB}$$

The total correction for 10 Hz bandwidth using the HP 8662A would be:

$$\text{Correction (dBc)} = 2.5 - 6 - 10.8 = -14 \text{ dB}$$

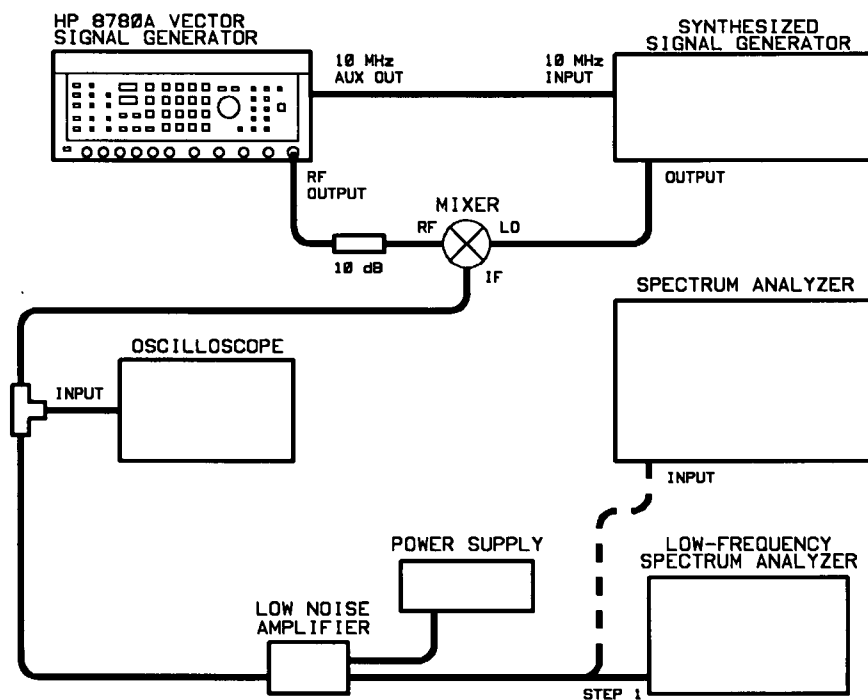

Figure 4-3. Residual SSB Phase Noise Test Setup

Procedure

1. Connect the equipment as shown in figure 4-3, and preset the HP 8780A (device under test).
2. Set the Generator to 1000.010 MHz with an output level of -43 dBm.
3. Set the local oscillator to 1000.000 MHz at a level of +10 dBm.
4. Adjust the spectrum analyzer to view the 10 kHz IF signal.
 - a. Format
 - b. Single (trace)
5. Move the displayed IF signal to the center of the screen and adjust the reference level until the peak of the signal is at the top of the display.
 - a. MKR
 - b. MKR → Peak
 - c. MKR → CTR FREQ
 - d. MKR → Full Scl
6. Adjust the reference level so the displayed signal is 6 dB below the reference level. This compensates for the 6 dB correction for a double- sideband measurement. The 2.5 dB correction for using the spectrum analyzer in the log mode is not required for the HP 3582A spectrum analyzer.
 - a. VERT SCALE

- b. Note the reference level _____.
 - c. Reference level plus 6 DB = _____.
 - d. Define Full Scale
 - e. Enter number from step 6c.
 - f. Press "dBm".
7. Set the Generator to 1 GHz and set the level to +7 dBm.
 8. The top graticule of the spectrum analyzer display is now calibrated for -50 dBc.
 9. With the oscilloscope vertical coupling set to DC, increment the local oscillator frequency by 0.1 Hz. The oscilloscope display should show a slowly varying dc level (0.1 Hz).
 10. Stop the signal displayed on the oscilloscope at 0 Vdc by decrementing the local oscillator frequency by 0.1 Hz. With the oscilloscope displaying a 0 Vdc signal, the local oscillator and the Generator are in phase quadrature.

Note

The quadrature should be checked periodically during the test. If the oscilloscope display does not indicate 0 Vdc, quadrature has been lost and must be re-established as described in steps 9 and 10.

11. Set the spectrum analyzer to measure spectral density. On the HP 3561A this function is the "Spectral Density" math function. On the HP 3582A this is selected with the "1/BW" function. These functions normalize the measurement to a 1 Hz bandwidth and eliminate the need for the bandwidth correction.
 - a. Define trace
 - b. Math FCN Select
 - c. Spectral Density
 - d. ENTER
12. Note the level at a frequency of 10 Hz. The level corresponds to the phase noise level at a 10 Hz offset from the carrier. Note that the top graticule is at -50 dBc. The spectrum analyzer should indicate that the noise power is at least 15 dB below the reference level (<-65 dBc).

_____ dBc, 10 Hz Offset (<-65 dBc)
13. Tune the spectrum analyzer to 100 Hz and note the level. The normalized noise level should be at least 34 dB below the the reference level (<-84 dBc).

_____ dBc, 100 Hz Offset (<-84 dBc)
14. Tune the spectrum analyzer to 1 kHz and note the displayed level. The spectrum analyzer should indicate that the noise power is at least 50 dB below the reference level (-100 dBc).

_____ dBc, 1 kHz Offset (<-100 dBc)

15. Connect the high frequency spectrum analyzer in place of the low frequency spectrum analyzer.
16. Set the Generator to 1000.100 MHz with an output level of -43 dBm.
17. Adjust the spectrum analyzer to view the 100 kHz IF signal.
 - a. Center Frequency
 - b. 100
 - c. kHz
 - d. Frequency Span
 - e. 20
 - f. kHz
18. Move the displayed IF signal to the center of the screen and adjust the reference level until the peak of the signal is at the top of the display.
 - a. Peak Search
 - b. MKR → CF
 - c. MKR → REF LVL
19. Adjust the reference level so the displayed signal is 8.5 dB below the reference level. This compensates for the 6 dB correction for a double-sideband measurement and an additional 2.5 dB correction required due to using the spectrum analyzer in the log mode.
 - a. Note the reference level _____
 - b. Add 8.5 dB to step 19a _____
 - c. REFERENCE LEVEL key
 - d. Enter the number from step 19b
 - e. “-” dBm key
20. Set the Generator to 1 GHz and set the level to +7 dBm.
21. The top graticule of the display is now calibrated for -50 dBc.
22. With the oscilloscope vertical coupling set to DC, increment the local oscillator frequency by 0.1 Hz. The oscilloscope display should show a slowly varying dc level (0.1 Hz).
23. Stop the signal displayed on the oscilloscope at 0 Vdc by decrementing the local oscillator frequency by 0.1 Hz. With the oscilloscope displaying a 0 Vdc signal, the local oscillator and the Generator are in phase quadrature.

Note

The quadrature should be checked periodically during the test. If the oscilloscope display does not indicate 0 Vdc, quadrature has been lost and must be re-established as described in steps 22 and 23.

24. Set the spectrum analyzer resolution bandwidth to 100 Hz.
25. Note the level at a frequency of 10 kHz. The level corresponds to the phase noise level at a 10 kHz offset from the carrier. Note

that the top graticule is at -50 dBc. The displayed level should be at least 40 dB below the top graticule (-90 dBc).

_____ dBc Displayed Level (<-90 dBc)

-20.8 dB Bandwidth correction

_____ dBc, 10 kHz Offset (<-110 dBc)

26. Tune the spectrum analyzer to 100 kHz and note the level. The displayed level should be at least 40 dB below the top graticule (-90 dBc).

_____ dBc Displayed Level (<-90 dBc)

-20.8 dB Bandwidth correction

_____ dBc, 100 kHz Offset (<-110 dBc)

27. Tune the spectrum analyzer to 1 MHz and note the displayed level. The displayed level should be more than 44 dB below the top graticule (-94 dBc).

_____ dBc Displayed Level (<-94 dBc)

-20.8 dB Bandwidth correction

_____ dBc, 1 MHz Offset (<-114 dBc)

28. Tune the spectrum analyzer to 10 MHz and note the displayed level. The displayed level should be more than 60 dB below the top graticule (-110 dBc).

_____ dBc Displayed level (<-110 dBc)

-20.8 dB Bandwidth Correction

_____ dBc, 10 MHz Offset (<-130 dBc)

Harmonics

Specification

Electrical Characteristics	Performance Limits	Conditions
SPECTRAL PURITY Harmonics	<-35 dBc	3244A Instruments and above: Harmonic Products: 10 MHz to 3.0 GHz Carrier: <+7 dBm, 10 MHz to 1.5 GHz see Supplemental Characteristics for carrier from 1.5 to 3.0 GHz 2943A Instruments and below: <+7 dBm, 0.01 to 2.5 GHz; <+1 dBm, 2.5 to 3.0 GHz

Description The harmonics of the Generator RF output signal are measured using a spectrum analyzer.

Equipment Spectrum Analyzer HP 8566B

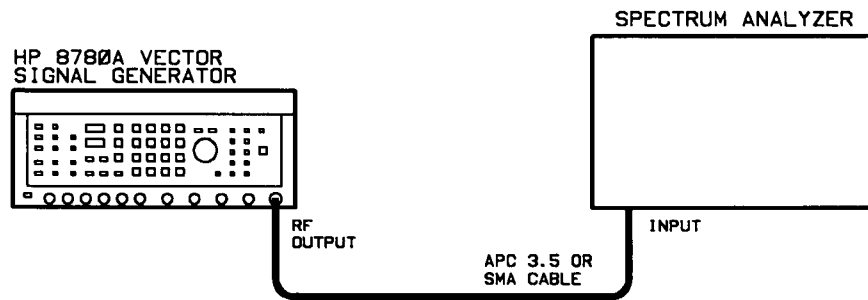

Figure 4-4. Harmonics Test Setup

Note Reasonable care must be taken during these measurements to ensure that the spectrum analyzer does not contribute to the harmonic level. Set the RF attenuation of the spectrum analyzer to at least 20 dB to prevent overdriving the Spectrum analyzer which will increase the harmonic level.

Procedure

1. Press the INSTR PRESET key on the Generator and then the CAL key to begin a self-calibration.
2. Connect the equipment as shown in figure 4-4.
3. Set the Generator to 60 MHz at an output level of 0 dBm.
4. Set the spectrum analyzer to display the 60 MHz Generator signal. Adjust the spectrum analyzer span to 500 kHz with the 60 MHz signal centered on the display.
5. Adjust the Generator output level for a level of 0 dBm as indicated by the spectrum analyzer.

Note

Use the CF STEP SIZE to increment the frequency.

6. Tune the spectrum analyzer to 120 MHz. The second harmonic, now displayed at 120 MHz, should be less than -35 dBm (<-35 dBc). Record the measured amplitude in the table below and in Table 4-2.
7. Tune the spectrum analyzer to 180 MHz. The third harmonic, now displayed at 180 MHz, should be less than -35 dBm (<-35 dBc). Record the measured amplitude below and in Table 4-2.
8. Tune the spectrum analyzer to 240 MHz. The fourth harmonic should be less than -35 dBm (<-35 dBc). Record the amplitude below and in Table 4-2.
9. Repeat steps 4 through 8 for each of the frequencies listed below.

Harmonic Test Results

Generator Frequency	Harmonic Frequency	Measured Level	Limit
60 MHz	120 MHz (2nd)	_____	-35 dBc
60 MHz	180 MHz (3rd)	_____	-35 dBc
60 MHz	240 MHz (4th)	_____	-35 dBc
120 MHz	240 MHz (2nd)	_____	-35 dBc
120 MHz	360 MHz (3rd)	_____	-35 dBc
120 MHz	480 MHz (4th)	_____	-35 dBc
240 MHz	480 MHz (2nd)	_____	-35 dBc
240 MHz	720 MHz (3rd)	_____	-35 dBc
240 MHz	960 MHz (4th)	_____	-35 dBc
480 MHz	960 MHz (2nd)	_____	-35 dBc
480 MHz	1440 MHz (3rd)	_____	-35 dBc
480 MHz	1920 MHz (4th)	_____	-35 dBc
960 MHz	1920 MHz (2nd)	_____	-35 dBc
960 MHz	2880 MHz (3rd)	_____	-35 dBc
960 MHz	3840 MHz (4th)	_____	-35 dBc ¹
1920 MHz	3840 MHz (2nd)	_____	-35 dBc ¹
1920 MHz	5760 MHz (3rd)	_____	-35 dBc ¹
1920 MHz	7680 MHz (4th)	_____	-35 dBc ¹
3000 MHz	6000 MHz (2nd)	_____	-35 dBc ¹
3000 MHz	9000 MHz (3rd)	_____	-35 dBc ¹
3000 MHz	12000 MHz (4th)	_____	-35 dBc ¹

¹ Typical Specification for 3244A and above prefix instruments.

Non-harmonically Related Spurious Responses

Specification

Electrical Characteristics	Performance Limits	Conditions
SPECTRAL PURITY		
Non-harmonically related spurious signals (CW, digital, vector and scalar modes)		Carrier >-20 dBm
<10 MHz	<-55 dBc	<20 MHz from carrier
10 MHz to 3 GHz	<-55 dBc	
	<-60 dBc	>20 MHz from carrier
>3 GHz	<-55 dBc	

Description

A spectrum analyzer is used to check spurious signals to ensure that the spurious signal amplitudes are within specification. The analyzer may also be tuned anywhere within the specified frequency range in search of spurious signals.

Equipment

Spectrum AnalyzerHP 8566B

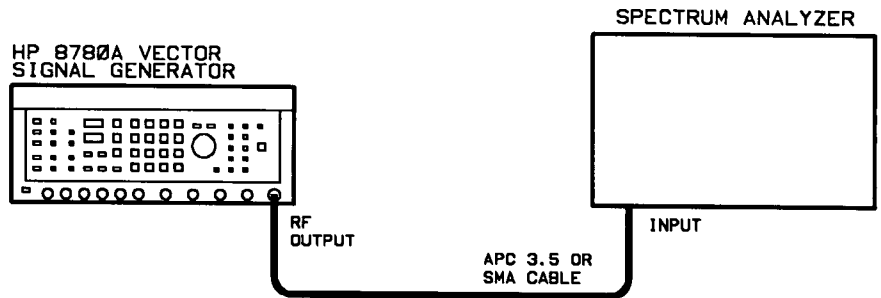

Figure 4-5. Spurious Response Test Setup

Procedure

1. Connect the equipment as shown in figure 4-5.
2. Press the INSTR PRESET key on the Generator to set the instrument to known conditions.
3. Set the Generator to 50 MHz with an output level of 0 dBm.
4. Set the spectrum analyzer to view the 50 MHz Generator output. Use a frequency span of 500 kHz and reference level of 0 dBm.

5. Adjust the generator output for a 0 dBm level as indicated by the spectrum analyzer.
 - a. Peak Search on Spectrum Analyzer
 - b. MKR → CF
 - c. MKR → REF LVL
 - d. CF step size
 - e. 500 kHz

6. Tune the spectrum analyzer slowly below 49.999 MHz in search of spurious responses. The amplitude of any spurious signal observed should be more than 55 dB below the carrier (< -55 dBc). Record the levels of any spurious response found below and in Table 4-2.
 - a. Center FREQ
 - b. Use ↓ arrow key

Note

The spectrum analyzer may also be tuned to any frequency below 10 MHz to search for additional spurious signals. All spurious outputs should be more than 55 dB below the carrier.

Frequency Range	Spurious Signal Frequency	Measured Amplitude	Limit
(<10 MHz)	_____ MHz	_____ dBc	<-55 dBc
(<10 MHz)	_____ MHz	_____ dBc	<-55 dBc
<50 MHz	_____ MHz	_____ dBc	<-55 dBc
<50 MHz	_____ MHz	_____ dBc	<-55 dBc
<50 MHz	_____ MHz	_____ dBc	<-55 dBc

_____ (✓) if no spurs above -55 dBc.

7. Tune the spectrum analyzer from 50.000 MHz to 18 GHz in search of spurious responses. Any spurious response found within 20 MHz of the carrier should be more than 55 dB below the carrier. Spurious responses more than 20 MHz from the carrier should be more than 60 dB below the carrier.
 - a. CENTER FREQ
 - b. Use ↑ arrow until 100 MHz center freq
 - c. CF STEP SIZE
 - d. 100 MHz
 - e. CENTER FREQ
 - f. Use ↑ arrow until 186 Hz (ignore the harmonics)
 - g. If the noise floor gets too close to -60 dBc, press the RES BW key, then the ↓ arrow key, then press the CENTER FREQ key and continue with the ↑ arrow key.

Note

The spectrum analyzer can be tuned to any frequency in the 10 MHz to 18 GHz range, avoiding harmonics of the carrier, to search for additional spurious signals. Harmonics of the carrier should be avoided and different carrier frequencies can be used. Spurious responses within 20 MHz of the carrier are specified to be more than 55 dB below the carrier.

Frequency Range	Spurious Signal Frequency	Measured Amplitude	Limit
50-70 MHz	_____ MHz	_____ MHz	<-55 dBc
50-70 MHz	_____ MHz	_____ MHz	<-55 dBc
70-3000 MHz	_____ MHz	_____ MHz	<-60 dBc
70-3000 MHz	_____ MHz	_____ MHz	<-60 dBc
70-3000 MHz	_____ MHz	_____ MHz	<-60 dBc
70-3000 MHz	_____ MHz	_____ MHz	<-60 dBc
3-18 GHz	_____ MHz	_____ dBc	<-55 dBc
3-18 GHz	_____ MHz	_____ dBc	<-55 dBc
3-18 GHz	_____ MHz	_____ dBc	<-55 dBc
3-18 GHz	_____ MHz	_____ dBc	<-55 dBc
3-18 GHz	_____ MHz	_____ dBc	<-55 dBc
3-18 GHz	_____ MHz	_____ dBc	<-55 dBc

_____ (✓) if no spurs above -55 dBc within 20 MHz of the carrier.

_____ (✓) if no spurs above -60 dBc from 70 MHz to 3 GHz.

_____ (✓) if no spurs above -55 dBc beyond 3 GHz.

8. Set the spectrum analyzer center frequency to 50 MHz. Set the sweep span to 2 kHz.

9. Note the amplitude of any spurious signals between 20 Hz and 1 kHz away from the carrier (both above and below the carrier).

Any spurious signals should be more than 55 dB below the carrier (<-55 dBc).

Note

Spurious signals less than 80 Hz away from the carrier are masked by the resolution of the spectrum analyzer. As a result, the displayed amplitude of these signals are displayed with higher than actual amplitude. If a spectrum analyzer with resolution better than 10 Hz is available, it may be used to determine the actual amplitudes of these spurious signals.

Frequency Range	Spurious Signal Offset	Measured Amplitude	Limit
20-1000 Hz	_____ Hz	_____ dBc	<-55 dBc
20-1000 Hz	_____ Hz	_____ dBc	<-55 dBc
20-1000 Hz	120 Hz	_____ dBc	<-55 dBc
20-1000 Hz	180 Hz	_____ dBc	<-55 dBc
20-1000 Hz	215 Hz	_____ dBc	<-55 dBc
20-1000 Hz	240 Hz	_____ dBc	<-55 dBc
20-1000 Hz	300 Hz	_____ dBc	<-55 dBc
20-1000 Hz	_____ Hz	_____ dBc	<-55 dBc
20-1000 Hz	_____ Hz	_____ dBc	<-55 dBc

_____ (✓) if no spurs above -55 dBc.

Frequency Modulation Accuracy (AC Coupled)

Specification

Electrical Characteristics	Performance Limits	Conditions
<p>FREQUENCY MODULATION</p> <p>ac Coupled</p> <p>Sensitivity</p> <p>Deviation Ranges</p> <p>Sensitivity Accuracy</p> <p>Residual FM</p>	<p>1V p-p for full scale deviation</p> <p>50 kHz p-p to 50 MHz p-p</p> <p><10%^{1,2}</p> <p><200 Hz rms</p>	<p>Settable to 3 digital resolution</p> <p>Rates 50 Hz to 6 MHz Deviations <30 MHz p-p Carrier >50 MHz</p> <p>0.3-3 kHz bandwidth, 50 kHz deviation range (excluding 400 Hz line mains)</p>

1 <6% for Serial Number Prefixes 2650A and below

2 <7.5% for Serial Number Prefixes between 2708A and 2943A

Description The test is divided into an FM accuracy test and a residual FM test. Each test is described below.

FM Sensitivity Accuracy

The Bessel null technique is used to measure FM accuracy.

Residual FM

A measuring receiver is used to directly measure residual FM with no modulating signal.

Equipment

Spectrum Analyzer	HP 8566B
Measuring Receiver	HP 8902A
Sensor Module	HP 11722A
Test Oscillator	HP 8116A
Frequency Counter	HP 5343A
Digital Voltmeter	HP 3456A
Termination, 50Ω load	HP 11593A

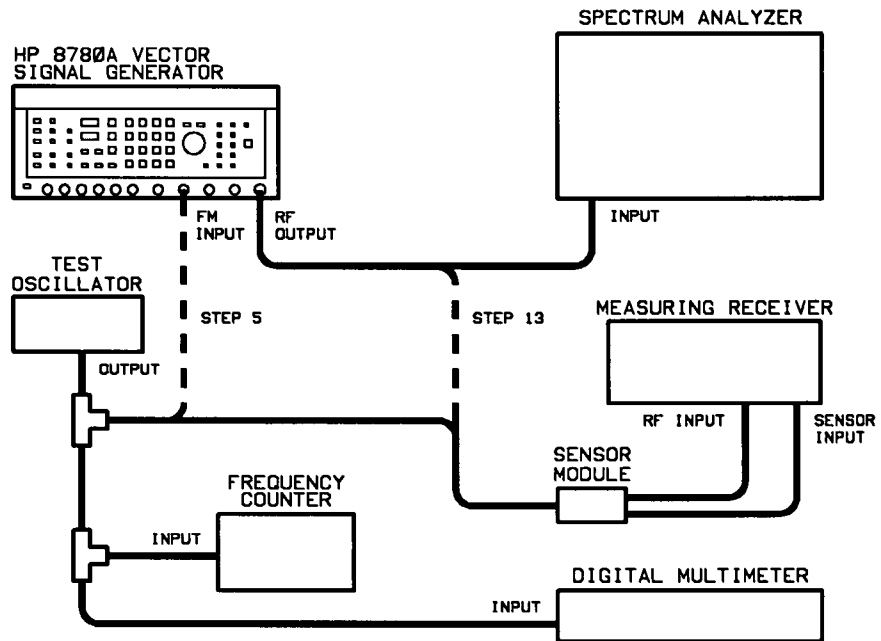

Figure 4-6. FM Accuracy (ac Coupled) Test Setup

Procedure

FM Accuracy

1. Press the INSTR PRESET key on the Generator and then the CAL key to begin a self-calibration.
2. Once the calibration is complete, set the Generator to 70 MHz at an output level of 0 dBm. Connect the equipment as shown in Figure 4-6.
3. With the test oscillator output connected to the sensor module of the measuring receiver, set the measuring receiver to measure RF power (ignore errors).
 - a. INST TRESET (Blue key, then AUTO OPERATION key)
 - b. RF POWER
 - c. LOG/LIN
4. Set the test oscillator to 6.2 MHz at an output level of 3.98 dBm ± 0.01 dB (as indicated by the measuring receiver). Make sure that the test oscillator is enabled.
5. Connect the test oscillator to the Generator FM input.
6. Adjust the spectrum analyzer controls to view the 70 MHz Generator RF output signal (Frequency span 50 MHz).
7. Set the Generator FM range to 30 MHz p-p using the SET FM key and the numeric keypad. Press the FM ON key (should be lit).
8. Adjust the test oscillator frequency until the first carrier null (Bessel null) is found. The first carrier null occurs at a modulating rate of 6.24 MHz for a peak to peak deviation of 30 MHz. The test oscillator frequency should be 6.24 MHz $\pm 10\%$ (5.616-6.864 MHz).
 _____ MHz 30 MHz p-p Range Null Frequency
9. Set the Generator FM range to 1 MHz p-p.
10. Set the test oscillator to 208 kHz with an output level of 353 mV rms (1 Vp-p) as indicated by the voltmeter (AC signal). Set the spectrum analyzer frequency span to 2 MHz.
11. Adjust the test oscillator frequency until the first carrier null occurs. The first carrier null occurs at a modulating rate of 208 kHz for a peak to peak deviation of 1 MHz. The test oscillator frequency should be 208 kHz $\pm 10\%$ (187.2-228.8 kHz).

_____ kHz 1 MHz p-p Range Null Frequency

Residual FM

12. Disconnect the spectrum analyzer and the test oscillator from the Generator.
13. Connect the measuring receiver to the RF output of the Generator.
14. Set the Generator frequency to 50 MHz and the level to 0 dBm. Set the FM range to 50 kHz p-p and ensure that there is no signal at the FM input. A 50 Ω load may be required to prevent noise from interfering with the measurement. (NOTE: FM should be ON).
15. Set the measuring receiver to measure FM. Select the FM RMS detector, the 300 Hz high pass filter and the 3 kHz low pass filters.
 - a. FREQ
 - b. FM
 - c. Blue (FM RMS detector)
 - d. AVG (FM RMS detector)
 - e. 300 Hz HPF
 - f. 3 kHz LPF
16. Record the residual FM displayed on the measuring receiver below and in Table 4-2.

Note

The displayed FM deviation will probably be unstable. For highest repeatability, take the average of 3 readings as the measured residual FM.

_____ Residual FM (<200 Hz rms)

Frequency Modulation Rates (AC Coupled)

Electrical Characteristics	Performance Limits	Conditions
FREQUENCY MODULATION ac Coupled Rates (3 dB Bandwidth)	20 Hz to 12 MHz	Deviations <30 MHz p-p Carrier >50 MHz

Description

FM Rates (bandwidth)

The modulated Generator RF output is demodulated using an FM discriminator. An oscilloscope is used to determine the 3 dB modulation bandwidth by comparing the modulation input signal to the demodulated output signal.

The FM discriminator suggested for this test makes use of a delay line and a mixer to produce a discriminated FM signal. The frequency at both ports of the mixer will be the same which produces an IF signal that is a dc voltage proportional to the phase between the two signals. Since the phase shift of the delay line is dependent on the RF frequency, a change in RF frequency produces a change in phase between the delayed and straight RF signals. This produces a change in the IF voltage which can be monitored with an oscilloscope.

Equipment

- Oscilloscope HP 54201A
- Pulse/ Function Generator (Test Oscillator) HP 8116A
- Power Splitter HP 11667A
- Mixer HP 10514A
- Cable, BNC 48 inches long (2 required) HP 8120-1840

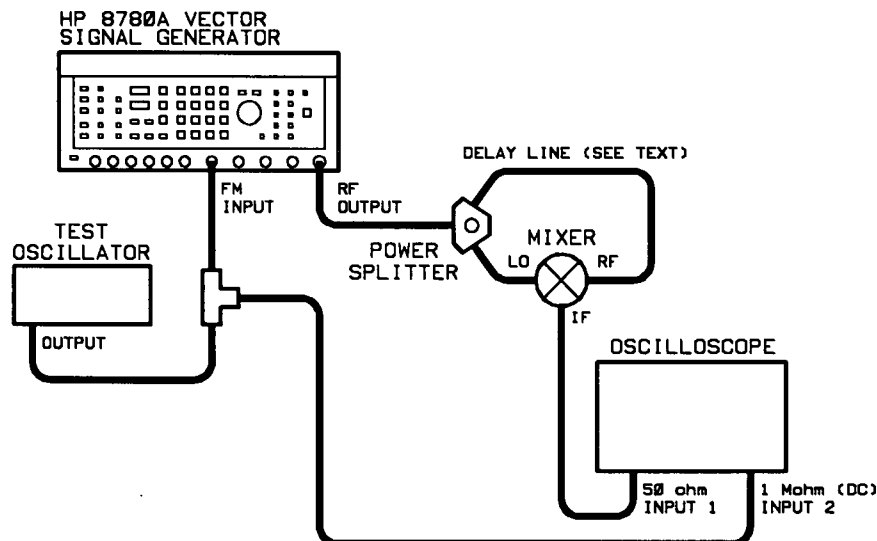

Figure 4-7. FM Rates (ac Coupled) Test Setup

Note

The HP 3717A 70 MHz Modulator-Demodulator can be used to discriminate the FM signal. If the HP 3717A is used, the discriminator should be in normal mode (not telephony). Connect the Generator RF output to the DEMOD IF INPUT connector and connect the oscilloscope to the BB OUTPUT.

Procedure

1. Press the INSTR PRESET key and then the CAL key to begin a self-calibration of the Generator.
2. Connect the equipment as shown in figure 4-7. The delay line should be made up of two BNC cables for a total cable length of 2 m (8 ft). This cable assembly provides a time delay (phase shift) which is used with an RF mixer to demodulate the Generator RF output signal. The cable assembly length directly affects the sensitivity of the measurement.
3. Set the Generator to 500 MHz at an output level of +10 dBm

Note

If the HP 3717A is being used as the FM discriminator, use an output frequency of 70 MHz and a level of 0 dBm.

The following step is not required when using the HP 3717A as the FM discriminator.

4. Adjust the Generator frequency for a 0 Vdc display on channel 1 of the oscilloscope. This will adjust the delay line for quadrature to give the maximum dynamic range out of the delay line discriminator.
5. Activate ac coupled FM mode by pressing the FM ON key. Set the FM range to 10 MHz p-p using the SET FM key and the numeric keypad.

6. Set the test oscillator for a 100 kHz signal at a level of 1 Vp-p as indicated by the oscilloscope. 1 Vp-p will provide a full scale (10 MHz) peak to peak deviation.
7. Adjust the oscilloscope vertical sensitivity (CAL knob) to display both signals over five vertical divisions (or maximum sensitivity). Input 1 of the oscilloscope should use 50Ω coupling. Input 2 of the oscilloscope should use high impedance DC coupling.
8. Adjust the oscilloscope to overlay the channel 1 and 2 signals. Since the amplitude difference between the signals will be used to determine the 3 dB points, it is important that the displayed amplitudes be set equal. There may be a phase difference between the two signals, this is normal and no cause for concern.

Note

If the amplitudes cannot be set equal or the channel 1 signal cannot be adjusted for five vertical divisions, a direct measurement of peak or peak-to-peak voltage must be used. Simply multiply the measured value by the indicated percentage to determine the measurement limits.

For example, if the channel 1 signal is measured at 75 mVp-p and the 70.7% (-3 dB) level is specified, the -3 dB level would be:

$$75 \times 0.707 = 53 \text{ mVp-p}$$

9. Decrease the test oscillator frequency while observing the oscilloscope display. The +3 dB point is reached when the amplitude of the channel 1 signal is 141% (7 divisions) of the channel 2 signal. Note the test oscillator frequency at the 3 dB point. The frequency should be less than 20 Hz.

_____ Hz Lower 3 dB frequency (<20 Hz)

Note

If the amplitude of the signal on input 2 changes, calculate the new 3 dB point using the % method on the previous page.

10. Reset the test oscillator frequency to 100 kHz.
11. Adjust the oscilloscope to display both signals over eight divisions (or maximum sensitivity).
12. Increase the test oscillator frequency while observing the oscilloscope display. The -3 dB point is reached when the amplitude of the channel 1 signal is 70.7% (5.66 divisions) of the channel 2 signal. Note the frequency of the -3 dB point. The test oscillator frequency should be greater than 12 MHz.

_____ MHz Upper 3 dB Frequency (>12 MHz)

Frequency Modulation (DC Coupled)

Specification

Electrical Characteristics	Performance Limits	Conditions
FREQUENCY MODULATION		
dc Coupled		
Sensitivity	1 V p-p for full scale deviation	
Deviation Ranges	150 Hz p-p to 150 kHz	Settable to 3 digit resolution
Rates (3dB Bandwidth)	dc to 10 kHz	Deviations <10 kHz p-p
Sensitivity Accuracy	<12% ¹	Rates to 1 kHz Deviation <150 kHz p-p
Distortion	<5%	1 kHz Rate 150 kHz p-p deviation
Residual FM	<5 Hz rms	300 Hz to 3 kHz bandwidth Deviation range 150 kHz
SPECTRAL PURITY		
Residual FM (CW, Digital, Vector or Scalar)	<4 Hz rms	300 Hz to 3 kHz bandwidth 50 MHz Carrier

¹ <10% for Serial Number Prefixes 2943A and below.

Description The test is divided into FM bandwidth, FM sensitivity accuracy, FM distortion and residual FM tests. In addition, CW residual FM is tested. Each test is described below.

FM Rates (3 dB Bandwidth)

The modulated carrier is demodulated by a measuring receiver. An oscilloscope is used to determine the 3 dB modulation bandwidth by comparing the demodulated signal to the modulation input signal.

FM Sensitivity Accuracy

The measuring receiver is used to directly measure FM sensitivity accuracy.

FM Distortion

The demodulated output of the measuring receiver is measured with a distortion analyzer at the specified rate and deviation.

Residual FM

The measuring receiver is used to directly measure residual FM after disconnecting the modulating signal.

CW Residual FM

The measuring receiver is used to directly measure residual FM after disabling FM mode.

Equipment	Measuring Receiver	HP 8902A
	Oscilloscope	HP 54201A
	Audio Analyzer	HP 8903A/B
	Pulse/Function Generator (Test Oscillator)	HP 8116A
	Digital Voltmeter	HP 3456A
	Frequency Counter	HP 5343A

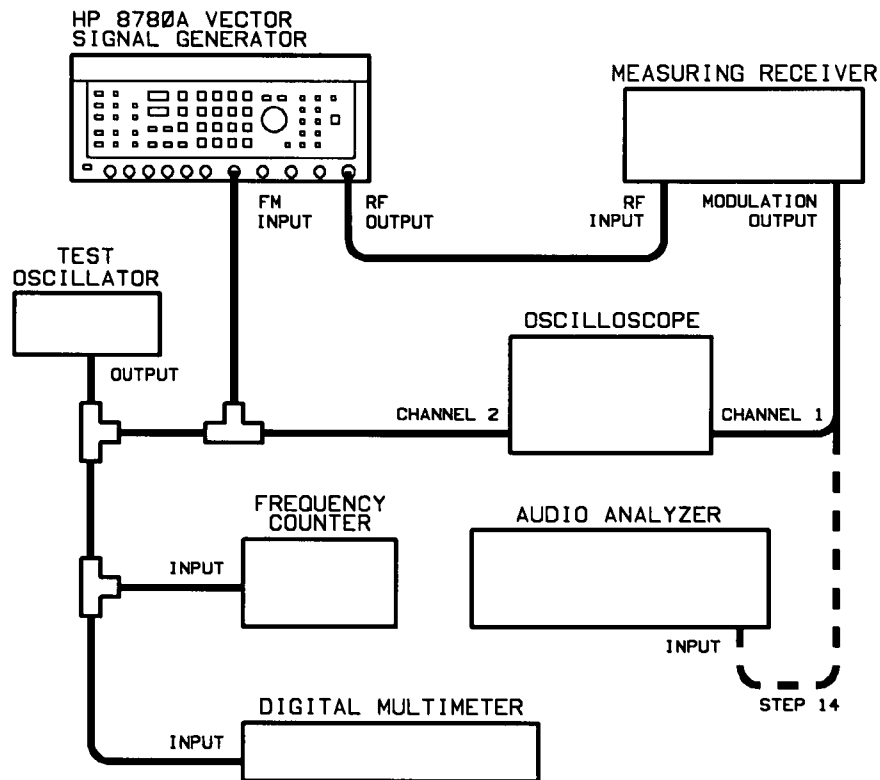

Figure 4-8. FM (dc Coupled) Test Setup

Procedure

FM Rates (3 dB bandwidth)

Note

Filtering on measuring receiver should be out.

1. Press the INSTR PRESET key on the Generator. Press the CAL key to begin a self-calibration of the Generator.
2. Connect the equipment as shown in figure 4-8.
3. Set the Generator frequency to 1000 MHz at a level of 0 dBm.
4. Activate dc coupled FM by pressing the FM ON key followed by the DC COUP FM key. Set the FM range to 150 kHz p-p using the SET FM key and the numeric keypad.
5. Set the test oscillator to 1 kHz and adjust the amplitude for a 75 kHz peak deviation as indicated by the measuring receiver.
 - a. On the measuring receiver
 - b. Blue key
 - c. AUTO OPERATION
 - d. FM
6. Adjust the oscilloscope controls to display both signals over eight divisions.

7. Adjust the oscilloscope to overlay the channel 1 and 2 signals. Since the amplitude difference between the signals will be used to determine the 3 dB bandwidth, it is important that the displayed amplitudes be set equal. There may be a phase difference between the two channels, this is normal and no cause for concern.
8. Increase the test oscillator frequency while observing the oscilloscope display. Verify that the amplitude of the channel 1 signal remains greater than 5.66 divisions (70.7% of the channel 2 signal) to more than 10 kHz.

_____ (✓) if 3 dB Frequency (>10 kHz)

FM Sensitivity Accuracy

9. Set the Generator to 50 MHz with an output level of 0 dBm.
10. Set the the test oscillator to 1 kHz. Adjust the test oscillator amplitude for 75 kHz peak deviation as indicated by the measuring receiver. The input voltage should be 353.6 mVrms $\pm 12\%$ (311.17-396.03 mV rms) as measured on the voltmeter (AC signal).

_____ mVrms 75 kHz Modulation Voltage

11. Set the Generator FM range to 15 kHz p-p.
12. Adjust the test oscillator amplitude for 7.5 kHz peak deviation as indicated by the measuring receiver. The test oscillator amplitude should be 353.6 mVrms $\pm 12\%$ (311.17-396.03 mV rms) as measured on the voltmeter (AC signal).

_____ mVrms 7.5 kHz Modulation Voltage

FM Distortion

13. Set the Generator FM range to 150 kHz p-p.
14. Disconnect the oscilloscope from the measuring receiver and connect the demodulated output of the measuring receiver to the audio analyzer high input.
15. Set the test oscillator to 1 kHz. Adjust the test oscillator amplitude for a 75 kHz peak deviation as indicated by the measuring receiver.
16. Set the audio analyzer to read distortion. The distortion indicated by the audio analyzer should be less than 5%.

_____ dcFM Distortion (<5%)

Residual FM

17. Disconnect the test oscillator from the Generator FM INPUT.

18. Set the measuring receiver to measure FM for a 50 MHz carrier. Select the 300 Hz high pass filter, the 3 kHz low pass filter and the RMS responding detector.
 - a. FREQ
 - b. FM
 - c. FM RMS detector
 - i. Blue key
 - ii. AVG
 - d. 300 Hz HPF
 - e. 3 kHz LPF
19. Wait for the display to stabilize. Read the residual FM directly from the measuring receiver display. The deviation should be <5 Hz rms.

_____ Hz rms dcFM Residual FM (<5 Hz rms)

CW Residual FM

20. Set the Generator to CW mode by pressing the FM ON key (the key indicator should extinguish).
21. Wait for the display to stabilize. Read the CW residual FM directly from the measuring receiver display. The deviation should be <4 Hz rms.

_____ Hz rms CW Residual FM (<4 Hz rms)

Scalar Modulation

Specification

Electrical Characteristics	Performance Limits	Conditions
FREQUENCY MODULATION dc Coupled		
Sensitivity	0 to +1 Volt produces zero full scale modulation	
dc Accuracy	<2% of Full Scale	140 MHz Carrier <+7 dBm Levels
dc Residual	<1% of Full Scale I and Q	Residual I and Q Output for 0V input 140 MHz Carrier
Frequency Resonse	dc to 500 kHz	1 GHz Carrier <+7 dBm Levels

Description

The test is divided into accuracy, frequency response and dc residual. Each test is described below.

Scalar Accuracy

Precise dc voltages are applied to the scalar modulation input to test dc accuracy. A power meter is used to measure the RF carrier level for each voltage.

Scalar Frequency Response

A spectrum analyzer is used to view the modulation sidebands as the modulation rate is swept over the specified range.

Scalar dc Residual

The spectrum analyzer is used to measure scalar dc residual by removing all modulation inputs and measuring the resultant RF carrier level in scalar mode.

Equipment

Spectrum Analyzer	HP 8566B
Pulse/Function Generator (Test Oscillator)	HP 8116A
Digital Voltmeter	HP 3456A
Power Meter	HP 436A, HP 437B, or HP 438A
Power Sensor	Hp 8481A/HP 8482A

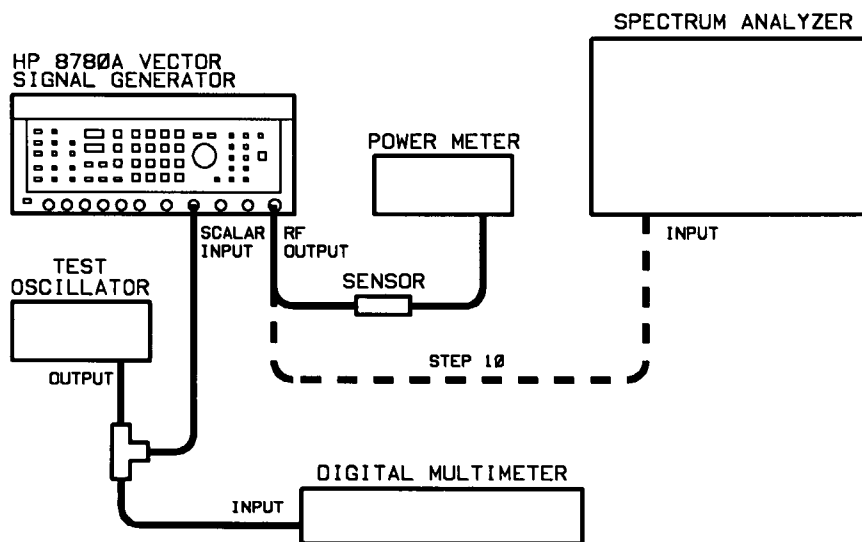

Figure 4-9. Scalar Modulation Test Setup

Procedure**Scalar Accuracy**

1. Press the INSTR PRESET key on the Generator to set the Generator to a known state. Press the CAL key to perform an instrument self calibration.
2. Connect the equipment as shown in figure 4-9.
3. Set the Generator to 140 MHz at an output level of 0 dBm.
4. Select SCALAR modulation on the Generator by pressing the SCALAR ON key.
5. Set the test oscillator for a dc offset of 1.000 ± 0.005 Vdc on the DVM.
 - a. Frequency (FREQ): Set to minimum
 - b. Amplitude (AMP): Set to minimum
 - c. Signal type: Sinewave
 - d. Offset (OFS): Adjust as required
 - e. Output (DISABLE): Off (LED off)
6. Set the power meter to measure relative power levels dB [REF] key (HP 436A) or REL key (HP 437B or HP 438A).
7. Set the test oscillator output for 750 ± 0.5 mVdc on the DVM. The power meter should indicate -2.5 dB (-2.27 to -2.73 dB or 75% $\pm 2\%$ amplitude of the reference amplitude).

_____ dB (75% Scalar Level)

8. Set the test oscillator output for 500 ± 0.5 mVdc on the DVM. The power meter should indicate -6 dB (-5.68 to -6.37 dB or 50% $\pm 2\%$) of the amplitude in CW mode.

_____ dB (50% Scalar Level)

9. Set the test oscillator output for 250 ± 0.5 mVdc on the DVM. The power meter should indicate -12 dB (-11.37 to -12.77 dB or 25% $\pm 2\%$) of the amplitude in CW mode.

_____ dB (25% Scalar Level)

Scalar Frequency Response

10. Connect the spectrum analyzer to the RF output of the Generator.
11. Set the Generator to 1 GHz at an output level of +7 dBm.
12. Set the test oscillator for a 100 Hz sine wave with an amplitude of 0.22 Vrms (0.6 Vp-p) with an offset of 0 Vdc (AC signal).
13. Set the dc offset of the test oscillator to 0.6 Vdc. The signal applied at the scalar input should now be a sine wave with a maximum level of 0.9 volts and a minimum level of 0.3 volts.

Note

The voltage applied at the scalar input should not go below 0 Vdc. The specified range of the scalar input is 0 to 1 V.

14. Adjust the spectrum analyzer to display the 1 GHz RF output signal. Use a small enough span to observe the pair of 100 Hz AM sidebands. The RF input attenuation of the spectrum analyzer should be set to at least 20 dB to avoid amplitude compression of the displayed signal.
15. Set the spectrum analyzer to 2 dB per division vertical sensitivity. Adjust the test oscillator amplitude to place the first modulation sidebands 10 dB below the carrier (5 vertical divisions).
16. Slowly tune the test oscillator from 100 Hz to 500 kHz while observing the first modulation sidebands. The sideband level should not drop more than 3 dB as the test oscillator is tuned.

Note

An effective way to observe the frequency response is to set the carrier to the right edge of the spectrum analyzer display. When the modulation rate is large enough to place the lower sideband at the left edge of the display, reset the start frequency of the spectrum analyzer to place the modulation sideband near the right edge of the display. Several start frequency changes will be required to cover the full modulation rate test.

_____ ($\sqrt{\quad}$) Scalar Bandwidth >500 kHz

Scalar dc Residual

17. Disconnect the test oscillator from the scalar input.
18. Press the INSTR PRESET key on the Generator.
19. Set the Generator to 140 MHz at an output level of +7 dBm.
20. Adjust the spectrum analyzer reference level to place the displayed RF signal at a convenient reference. Set the vertical sensitivity to 10 dB per division.
21. Select SCALAR modulation. The signal on the spectrum analyzer should drop to at least 40 dB below the reference established in the previous step.

_____ dBc Vector dc Residual (<-40 dBc)

**Vector Modulation
DC Accuracy**

Specification

Electrical Characteristics	Performance Limits	Conditions
VECTOR MODULATION I and Q Inputs Sensitivity dc Accuracy	± 0.5 volts into 50Ω $< 1.5\%$ of full scale	Produces $\pm 100\%$ of full scale 140 MHz Carrier $< +7$ dBm Levels $(I^2 + Q^2) < 0.25$ volts ²

Description

The RF output and the coherent carrier of the Generator are connected to a network analyzer to view the real and imaginary (I and Q) components of the RF signal. The network analyzer is calibrated to represent 100% as a full scale reading. Various I and Q component settings are measured with the network analyzer to determine dc accuracy.

Equipment

- Network Analyzer HP 3577A or HP 8753A or 8751A
- Test Oscillator HP 8116A
- Digital Voltmeter (DVM) HP 3456A
- Termination, BNC 50Ω HP 11593A
- 20 dB Attenuator HP 8491A Option 020

Note

A second 20 dB attenuator is required to test a Generator with Option 002 installed. Refer to the procedure for connection instructions. **DO NOT** connect the COHERENT CARRIER output of a Generator with Option 002 installed directly to the network analyzer.

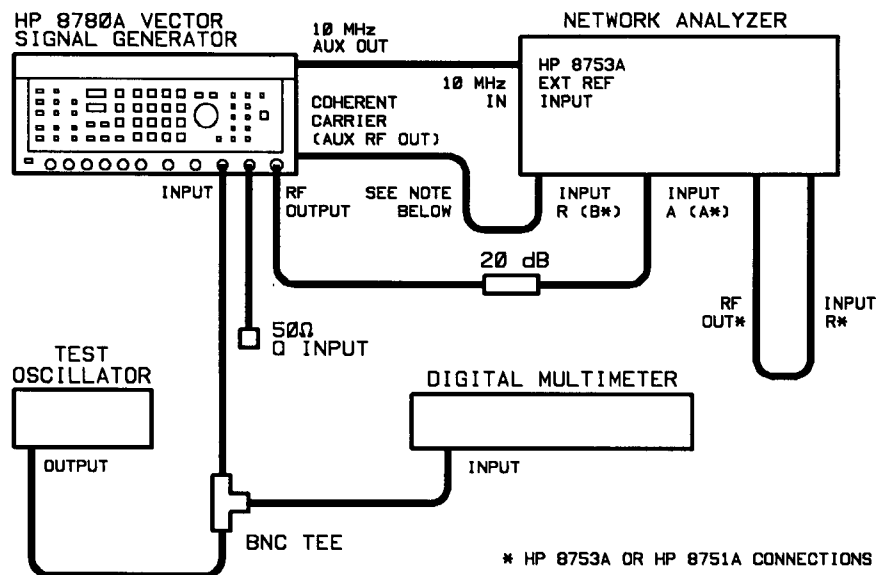

Figure 4-10. Vector dc Accuracy Test Setup

Procedure

1. Press the INSTR PRESET key on the Generator. Press the CAL key to perform a self-calibration.

Note

For an instrument with Option 002 installed, a second 20 dB attenuator must be connected between the COHERENT CARRIER output and the network analyzer R input. This will reduce the COHERENT CARRIER signal level to approximately the same level as the standard instrument.

In addition a 150 MHz low pass filter may be required on the COHERENT CARRIER output for an instrument with Option 002. The filter is used to reduce harmonics of the coherent carrier signal to prevent the harmonics from interfering with the measurement.

2. Connect the equipment as shown in Figure 4-10. The Generator 10 MHz auxiliary output must be connected to the network analyzer to provide a common timebase for the measurements.
3. Once the calibration is complete, set the Generator to 140 MHz at an output level of +7 dBm.
4. Set the Network analyzer to the following settings:

Network Analyzer Settings

Setting	HP 3577A Press these keys/softkeys	HP 8753A or 8751A Press these keys/softkeys
Preset	INSTR PRESET	PRESET
Input	INPUT, USER DEF INPUT, A,/R, ENTER	MEAS, A/B
Display Mode	DISPLY FCTN, POLAR	FORMAT POLAR
Frequency Sweep Mode	SWEEP TYPE, CW	MENU, NUMBER OF POINTS, 3, X1
Frequency	FREQ, 140 MHz	CW FREQ, 140, M (MHz)
Amplitude	AMPTD, -10 dBm	POWER, -10, X1 (dBm)
Bandwidth	RES BW, 10 Hz	AVG, IF BW, 10, X1 (Hz)

Note

In order to obtain the stability for making the following measurements, all instruments must have a warm up time of at least one hour. In addition, the network analyzer and Generator must use a common timebase to prevent a frequency error between instruments. A frequency error will produce a continuous phase shift (rotation) of the displayed signal.

5. Press the VECTOR ON key on the Generator to activate vector modulation.
6. Set the test oscillator for a dc output of $+500 \pm 1$ mVdc as indicated by the voltmeter. This will set the output signal to full scale at a phase angle of 0° .
 - a. Frequency (FRQ): Set to minimum.
 - b. Amplitude (AMP): Set to minimum.
 - c. Signal Type: Sinwave.
 - d. Offset (OFS): Adjust as required.
 - e. Output (DISABLE): Off (LED off).
7. Normalize the network analyzer by entering the following key sequence. Normalizing the displayed signal will place the signal on the horizontal axis (0° phase) with a full scale magnitude. This step is required to calibrate the network analyzer display to the RF output signal of the Generator and to cancel phase shifts due to test setup and frequency related effects.

HP 3577A: MEASR CAL, NORMALIZE

HP 8753A or 8751A: CAL, CALIBRATE MENU, RESPONSE, THRU, DONE:RESPONSE (when done)
8. Set the network analyzer to read the signal in terms of the real and imaginary components (corresponding to the I and Q components) by entering the following key sequence.

HP 3577A: MKR, MARKER M,p R,I (the R,I portion must be highlighted)

HP 8753A or 8751A: MKR, MARKER MODE MENU, POLAR MKR MENU, Re/Im MKR

Note

In the following procedure, maximum averaging (16 points for the HP 8753A) should be used on the network analyzer to provide the highest resolution readings. However, to improve overall measurement speed, turn off averaging when changing the modulation input voltage. This will enable the network analyzer to respond faster to the change in magnitude and phase. Reactivate averaging once the displayed signal has settled. Average-AVG "ON"-key highlighted to "ON".

9. Record the real and imaginary components as indicated by the network analyzer display in the table below. Convert the measured readings to percent by multiplying each reading by 100%. For example, a reading of 993E-3 (993 mU on the HP 8753A) on the network analyzer represents 99.3%. A reading of 100E-6 (100 μ U on the HP 8753A) represents 0.01%.
10. Reset the test oscillator dc output for each of the levels indicated and record the results below. The level at the input of the Generator must be within 1 mVdc of the level indicated.

All readings should be within 1.5% of the indicated values.

I Channel Results

VECTOR INPUT I	Real Component	Imaginary (Residual) Component
+500 mVdc	_____ % (100%)	_____ % (0%)
+250 mVdc	_____ % (50%)	_____ % (0%)
-250 mVdc	_____ % (-50%)	_____ % (0%)
-500 mVdc	_____ % (-100%)	_____ % (0%)

Note

Change AVG to "OFF" when changing inputs then turn "ON" again.

11. Connect the test oscillator to the VECTOR INPUT Q and connect the 50 Ω load to the VECTOR I INPUT.
12. Set the test oscillator output for -500 \pm 1 mVdc as indicated by the voltmeter.
13. Record the real and imaginary components as indicated by the network analyzer display in the table below. Convert the measured readings to percent by multiplying each reading by 100%. For example, a reading of 995E-3 on the network analyzer represents 99.5%.

14. Reset the test oscillator output for each of the levels indicated and record the results below. The level at the input of the Generator must be within 1 mVdc of the value indicated.

Q Channel Results

VECTOR INPUT Q	Real (Residual) Component	Imaginary Component
+500 mVdc	_____ % (0%)	_____ % (100%)
+250 mVdc	_____ % (0%)	_____ % (50%)
-250 mVdc	_____ % (0%)	_____ % (-50%)
-500 mVdc	_____ % (0%)	_____ % (100%)

15. Complete the following table using the values entered in the tables above. Copy the real column results from the first table into the I column below. Copy the imaginary column results from the second table into the Q column below.

Verify also that the worst-case residual level in each of the two tables is within $\pm 1.5\%$ of 0%. If all measurements are within specification, copy the results table into Table 4-2 and proceed with the next test.

_____ (✓) Worst-Case Residual ($0 \pm 1.5\%$)

Vector dc Accuracy Results

VECTOR INPUT	Expected Results	I Channel Results	Q Channel Results
+500 mVdc	$100 \pm 1.5\%$	_____ %	_____ %
+250 mVdc	$50 \pm 1.5\%$	_____ %	_____ %
-250 mVdc	$-50 \pm 1.5\%$	_____ %	_____ %
-500 mVdc	$-100 \pm 1.5\%$	_____ %	_____ %

Note

If any of the results are not within specification, a correction factor must be applied to account for the use of the first measurement point as the true full-scale value. The remaining part of this procedure is used to account for the full scale error introduced by the procedure. The following steps are not required if all measurements are within specification.

16. Calculate the average full scale value by adding the absolute values of the four full scale (± 500 mVdc inputs) and dividing by four.

For example, the average full scale value for readings of +100.0%, -101.6%, +99.9% and -100.3% would be:

$$(100.0 + 101.6 + 99.9 + 100.3)/4 = 100.45\%$$

_____ % Average Full Scale Value

17. Calculate the correction factor by dividing the first measured value (+500 mVdc I channel) by the average full scale value calculated above. The first measured value is used in the calculation since the network analyzer is normalized to this value (making it the full scale reference). This correction will be used to scale each of the readings to the correct scale using the average full scale value as full scale.

_____ Correction Factor (First Measurement/Ave Full Scale)

18. Multiply each of the readings in the results table by the correction factor to determine the corrected reading. each reading should now fall within the indicated limits.

Verify also that all residual readings are within $\pm 1.5\%$ of 0% after being multiplied by the correction factor. Copy the corrected results table and the worst case corrected residual into Table 4-2.

_____ % Worst-Case Corrected Residual ($0 \pm 1.5\%$)

Vector dc Accuracy Results

VECTOR INPUT	Expected Results	I Channel Results	Q Channel Results
+500 mVdc	100 $\pm 1.5\%$	_____ %	_____ %
+250 mVdc	50 $\pm 1.5\%$	_____ %	_____ %
-250 mVdc	-50 $\pm 1.5\%$	_____ %	_____ %
-500 mVdc	-100 $\pm 1.5\%$	_____ %	_____ %

Vector Modulation Frequency Response

Specification

Electrical Characteristics	Performance Tests	Conditions
VECTOR MODULATION		
dc Residual	<1% of Full Scale	Residual I and Q Output for 0 volt I and Q Input, 140 MHz Carrier
Frequency Response (3 dB Bandwidth)	dc to 350 MHz	1 GHz Carrier

Description

The test is divided into a frequency response test and a dc residual test. Each test is described below.

Vector Modulation Frequency Response

The output of the Generator is a double-sideband suppressed carrier signal when vector modulation is selected. The power level is directly proportional to the modulation level plus the frequency response of the modulation circuitry.

By maintaining the modulation signal power constant over the entire modulation frequency range, a direct power measurement of the Generator output level can be made to determine the frequency response. The output level of the Generator should not vary more than 3 dB over the entire modulation frequency range.

Vector Modulation dc Residual

A spectrum analyzer is used to measure the (residual) carrier level with 0 volt modulation inputs. The residual carrier should be more than 40 dB (1%) below the carrier when vector modulation is selected with no modulation input.

Equipment

- Test Oscillator HP 8116A
- Signal Generator HP 8340B
- Spectrum Analyzer HP 8566B
- Power Meter (two required) HP 436A or HP437B or HP 438A
- Power Splitter HP 11667A
- Power Sensor (2 required) HP 8482A
- Digital Voltmeter (DVM) HP 3456A
- Termination, BNC 50Ω HP 11593A

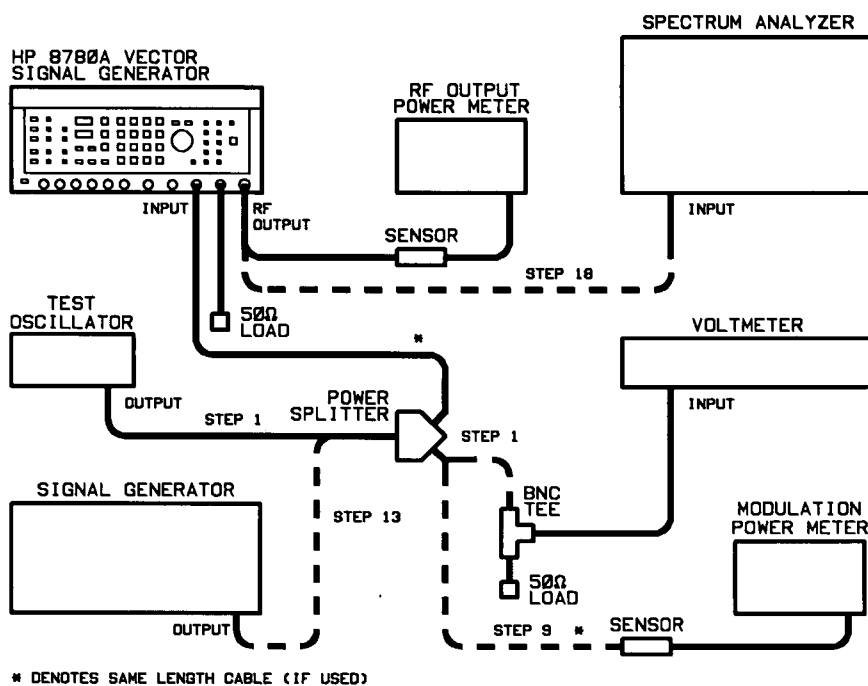

Figure 4-11. Vector Frequency Response Test Setup

Procedure

Vector Modulation Frequency Response

1. Connect the equipment as shown in figure 4-11.
2. Press the INSTR PRESeT key on the Generator. Press the CAL key to begin a self-calibration of the Generator.
3. Set the test oscillator to 100 Hz at an output level of 0.45 Vrms (1.3 Vp-p into 50Ω).
4. Set the Generator to 1 GHz at an output level of 0 dBm.
5. Activate vector modulation by pressing the VECTOR ON key on the Generator.

Note

In the remainder of the procedure, the power meter connected to the Generator RF output will be referred to as the RF output power meter. The power meter connected to the power splitter will be referred to as the modulation power meter.

6. Adjust the test oscillator output level for a Generator output level of 0.0 dBm \pm 0.1 dB as indicated by the RF output power meter.
7. Record the modulation voltage level indicated by the voltmeter. This will be the reference voltage for modulation frequencies less than 100 kHz.

_____ mVrms Modulation Level Reference

8. Tune the test oscillator from 100 Hz to 100 kHz while monitoring the RF output power meter reading. Maintain the output level of the test oscillator at the modulation level reference recorded above. Record the highest and lowest RF output power meter readings.

_____ dBm Maximum Reading (100 Hz to 100 kHz)

_____ dBm Minimum Reading (100 Hz to 100 kHz)

9. Disconnect the voltmeter and BNC tee and 50Ω load from the power splitter and connect the modulation power meter sensor to the power splitter.

Note

The modulation power meter sensor should be connected to the power splitter using a cable that is the same type and length as the cable between the power splitter and the vector modulation input.

10. Record the modulation signal power as indicated by the modulation power meter (connected to the power splitter). This will be used to maintain the modulation signal power at the same level for the remainder of the test.

_____ dBm Modulation Signal Power Level

11. Tune the test oscillator from 100 kHz to 10 MHz while observing the RF output power meter. Adjust the test oscillator output level as necessary to maintain the modulation power meter reading at the reference level recorded above. Record the maximum and minimum readings from the RF output power meter.

_____ dBm Maximum Reading (100 kHz to 10 MHz)

_____ dBm Minimum Reading (100 kHz to 10 MHz)

12. Connect the signal generator in place of the test oscillator.
13. Set the signal generator to 10 MHz and adjust the output level for a modulation power meter indication equal to the reference recorded above (approximately +10 dBm output level).
14. Tune the signal generator from 10 MHz to 350 MHz while observing the RF output power meter. Adjust the signal generator output level as necessary to keep the modulation power meter reading at the reference level recorded above. Record the minimum and maximum Generator output level (as indicated by the RF output power meter).

_____ dBm Maximum Reading (10 MHz to 350 MHz)

_____ dBm Minimum Reading (10 MHz to 350 MHz)

15. Verify that the frequency response over the 100 Hz to 350 MHz is less than 3 dB. The frequency response is calculated by taking

the largest reading of the three bands tested (100 Hz to 100 kHz, 100 kHz to 10 MHz, and 10 MHz to 350 MHz) and subtracting the smallest reading of the three bands.

For example, if the largest (Maximum Reading) reading of 0 dBm occurred in the 100 Hz to 100 kHz range and the smallest (Minimum Reading) reading of -1.4 dBm occurred in the 10 MHz to 350 MHz band, the frequency response would be $0 - (-1.4) = 1.4$ dB.

Mark a check in the following space and in the appropriate entry of Table 4-2 if the frequency response is within specification.

_____ (✓) Vector I Channel Bandwidth, 100 Hz to 350 MHz

16. Repeat steps 3 through 16 with the test oscillator connected to the VECTOR Q INPUT and the 50Ω load connected to the VECTOR I INPUT.

_____ (✓) Vector Q Channel Bandwidth, 100 Hz to 350 MHz

Vector Modulation dc Residual

17. Disconnect all equipment from the Vector Generator.
18. Press the INSTR PRESET key on the Generator.
19. Connect the spectrum analyzer to the Generator RF output.
20. Set the Generator to 140 MHz at an output level of 0 dBm.
21. Adjust the spectrum analyzer to display the 140 MHz CW signal. Use a resolution bandwidth and frequency span combination to place the noise floor at more than 40 dB below the peak of the displayed 140 MHz signal.
22. Connect a 50Ω load to the VECTOR INPUT I and Q inputs of the Generator. The loads will ensure the input voltage is 0 volts.
23. Press the VECTOR ON key to set the Generator to vector modulation mode. The displayed 140 MHz signal should drop by at least 40 dB (<-40 dBc). Record the dc residual level below and in Table 4-2.

_____ (<-40 dBc) Vector Modulation dc Residual

**Digital Modulation
DC Accuracy**

Specification

Electrical Characteristics	Performance Tests	Conditions
DIGITAL MODULATION State dc Accuracy BPSK, QPSK 8PSK 16QAM, TWO STATE, ALT LVL, I<Q	 <1.0% of Full Scale <1.2% of Full Scale <2.0% of Full Scale	 140 MHz Carrier <+7 dBm Levels

Description

The RF output and the coherent carrier of the Generator are connected to a network analyzer to view the real and imaginary (I and Q) components of the RF signal. The network analyzer is calibrated to represent 100% as a full scale reading.

Each digital modulation state is checked to ensure that each state is within the specified tolerance.

Equipment

Network Analyzer HP 3577A or HP 8753A or HP 8751A
 20 dB Attenuator HP 8491A Option 020

Note

A second 20 dB attenuator is required to test a Generator with Option 002 installed. Refer to the procedure for connection instructions. **DO NOT** connect the COHERENT CARRIER output of a Generator with Option 002 installed directly to the network analyzer.

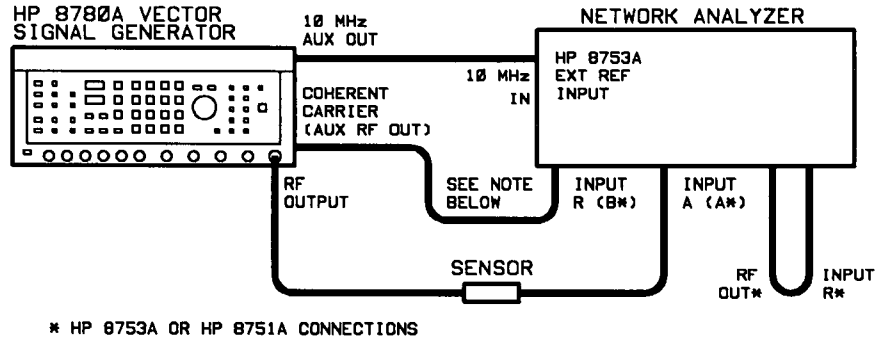

Figure 4-12. Digital Modulation Accuracy Test Setup

Note

In order to obtain the stability for making the following measurements, all instruments must have a warm up time of at least one hour. In addition, the network analyzer and Generator must use a common timebase to prevent a frequency error between instruments. A frequency error will produce a continuous phase shift (rotation) of the displayed signal.

Procedure

1. Connect the equipment as shown in Figure 4-12. The Generator 10 MHz auxiliary output must be connected to the network analyzer to provide a common timebase for the measurements.

Note

For an instrument with Option 002 installed, a second 20 dB attenuator must be connected between the COHERENT CARRIER output and the network analyzer. This will reduce the COHERENT CARRIER signal level to approximately the same level as the standard instrument.

In addition, a 150 MHz low pass filter may be required on the COHERENT CARRIER output for an instrument with Option 002. The filter is used to reduce harmonics of the coherent carrier signal to prevent the harmonics from interfering with the measurement.

2. Press the INSTR PRESET key on the Generator. Press the CAL key to perform a self-calibration.
3. Set the Generator to 140 MHz at an output level of +7 dBm.
4. Press the BPSK ON key on the Generator to activate digital modulation (BPSK format).
5. Set the network analyzer to the following settings:

Network Analyzer Settings

Setting	HP 3577A Press these keys/softkeys	HP 8753A or HP 8751A Press these keys/softkeys
Preset	INSTR PRESET	PRESET
Input	INPUT, USER DEF INPUT, A/R, ENTER	MEAS, A/B
Display Mode	DISPLY FCTN, POLAR	FORMAT, POLAR
Frequency Sweep Mode	SWEEP TYPE, CW	MENU, NUMBER OF POINTS, 3, X1
Frequency	FREQ, 140 MHz	CW FREQ, 140, M (MHz)
Amplitude	AMPTD, -10 dBm	POWER, -10, X1 (dBm)
Bandwidth	RES BW, 10 Hz	AVG, IF BW, 10, X1 (Hz)

6. Normalize the network analyzer by entering the following key sequences. Normalizing the displayed signal will place the signal on the horizontal axis (0° phase) with a full scale magnitude. This step is required to calibrate the network analyzer display to the RF output signal of the Generator and to cancel phase shifts due to test setup and frequency related effects.

HP 3577A: MEASR CAL, NORMALIZE

HP 8753A or HP 8751A: CAL, CALIBRATE MENU,
RESPONSE, THRU, DONE:RESPONSE (when done)

7. Set the network analyzer to read the signal in terms of the real and imaginary components (corresponding to the I and Q components) by entering the following key sequence.

HP 3577A: MKR, MARKER M,P R,I (the R,I portion must be highlighted)

HP 8753A or HP 8751A: MKR, MARKER MODE MENU,
POLAR MKR MENU, Re.Im MKR

Note

In the following procedure, maximum averaging (16 points for HP 8753A) should be used on the network analyzer to provide the highest resolution readings. However, to improve overall measurement speed, turn off averaging when changing the digital modulation state. This will enable the network analyzer to respond faster to the change in magnitude and phase. Reactivate averaging once the displayed signal has settled.

AVG key, AVG "ON" highlighted.

BPSK

8. Record the real and imaginary components as indicated by the network analyzer display in the table below. Convert the measured readings to percent by multiplying each reading by 100%. For example, a reading of 999E-3 (999 mU on the HP 8753A) on the network analyzer represents 99.9%. A reading of 100E-6 (100 μ U on the HP 8753A) represents 0.01%.

The real component should be $+100\% \pm 1\%$ and the imaginary (residual) level should be $0\% \pm 1\%$.

9. Change the digital modulation state by pressing the INVERT INPUT key followed by the numeric 0 key. The invert light near DIGITAL INPUT 0 on the Generator should light to indicate that the input has been inverted.
10. Record the real and imaginary components as indicated by the network analyzer display below. The real component should be $-100\% \pm 1\%$ and the residual component should be $0\% \pm 1\%$.

BPSK Results

DIGITAL INPUT 0	Real Component	Imaginary Component
Normal (0)	_____ % (100%)	_____ % (0%)
Inverted (1)	_____ % (-100%)	_____ % (0%)

Note

If the measurement does not meet specifications, refer to the section entitled CORRECTION FACTORS at the end of this procedure to determine whether a correction factor must be applied to bring the measurement within specification.

QPSK

11. Press the INSTR PRESET (must preset) key on the Generator to reset the instrument.
12. Set the Generator to 140 MHz at an output level of +7 dBm.
13. Select digital modulation with a QPSK format by pressing the QPSK ON key on the Generator.
14. Record the real and imaginary components as indicated by the network analyzer display in the table below.
15. Invert DIGITAL INPUT 0 by pressing the INVERT INPUT key followed by the numeric 0 key.
16. Record the real and imaginary components as indicated by the network analyzer display in the table below.
17. Continue measuring the remaining two states and record the results below. A "1" under the DIGITAL INPUT column

indicates that that input should be inverted. A “0” indicates that the input should be in the non-inverting (normal) mode. An inverted input is indicated by a lighted invert indicator near the appropriate front panel connector (lower indicator).

All readings should be within 1% of the indicated values.

QPSK Results

DIGITAL INPUT ¹		Real Component	Imaginary Component
0	2		
0	0	_____ % (70.7%)	_____ % (70.7%)
1	0	_____ % (-70.7%)	_____ % (70.7%)
1	1	_____ % (-70.7%)	_____ % (-70.7%)
0	1	_____ % (70.7%)	_____ % (-70.7%)

¹ DIGITAL INPUT 0 1 for Option 064

Note

If all measurements are within specification, record the results in Table 4-2.

If any measurement does not meet specifications, refer to the section entitled CORRECTION FACTORS at the end of this procedure to determine whether a correction factor must be applied to bring the measurement within specification.

8PSK

18. Press the INSTR PRESET key on the Generator to reset the instrument.
19. Set the Generator to 140 MHz at an output level of +7 dBm.
20. Select digital modulation with 8PSK format by pressing the 8PSK ON key on the Generator.
21. Record the real and imaginary components as indicated by the network analyzer display in the table below.
22. Invert DIGITAL INPUT 1 by pressing the INVERT INPUT key followed by the numeric 1 key.
23. Record the real and imaginary components as indicated by the network analyzer display in the table below.
24. Continue measuring the remaining six states and record the results below. A “1” under the DIGITAL INPUT column indicates that that input should be inverted. A “0” indicates that the input should be in the non-inverting (normal) mode. An inverted input is indicated by a lighted invert indicator near the appropriate front panel connector (lower indicator).

All measurements should be within 1.2% of the indicated values.

8psk Results

DIGITAL INPUT ¹			Real Component	Imaginary Component
0	1	2		
0	0	0	_____ % (38.3%)	_____ % (92.4%)
0	1	0	_____ % (92.4%)	_____ % (38.3%)
0	1	1	_____ % (92.4%)	_____ % (-38.3%)
0	0	1	_____ % (38.3%)	_____ % (-92.4%)
1	0	1	_____ % (-38.3%)	_____ % (-92.4%)
1	1	1	_____ % (-92.4%)	_____ % (-38.3%)
1	1	0	_____ % (-92.4%)	_____ % (38.3%)
1	0	0	_____ % (-38.3%)	_____ % (92.4%)

¹ DIGITAL INPUT 0 1 3 for Option 064

Note

If all measurements are within specification, record the results in Table 4-2.

If any measurement does not meet specifications, refer to the section entitled CORRECTION FACTORS at the end of this procedure to determine whether a correction factor must be applied to bring the measurement within specification.

16QAM

25. Press the INSTR PRESET key on the Generator to reset the instrument.
26. Set the Generator to 140 MHz at an output level of +7 dBm.
27. Select digital modulation with 16QAM format by pressing the 16QAM ON key on the Generator.
28. Record the real and imaginary components as indicated by the network analyzer display in the table below.
29. Invert DIGITAL INPUT 0 by pressing the INVERT INPUT key followed by the numeric 0 key.
30. Record the real and imaginary components as indicated by the network analyzer display in the table below.
31. Continue measuring the remaining two states and record the results below. A "1" under the DIGITAL INPUT column indicates that that input should be inverted. A "0" indicates that the input should be in the non-inverting (normal) mode. An inverted input is indicated by a lighted invert indicator near the appropriate front panel connector (lower indicator).

All measurements should be within 2% of the indicated values.

16QAM Results

DIGITAL INPUT ¹				Real Component	Imaginary Component
0	1	2	3		
0	0	0	0	_____ % (70.7%)	_____ % (70.7%)
1	0	0	0	_____ % (23.3%)	_____ % (70.7%)
1	1	0	0	_____ % (-70.7%)	_____ % (70.7%)
0	1	0	0	_____ % (-23.3%)	_____ % (70.7%)
0	1	1	0	_____ % (-23.3%)	_____ % (23.3%)
0	0	1	0	_____ % (70.7%)	_____ % (23.3%)
1	0	1	0	_____ % (23.3%)	_____ % (23.3%)
1	1	1	0	_____ % (-70.7%)	_____ % (23.3%)
1	1	1	1	_____ % (-70.7%)	_____ % (-70.7%)
1	0	1	1	_____ % (23.3%)	_____ % (-70.7%)
0	0	1	1	_____ % (70.7%)	_____ % (-70.7%)
0	1	1	1	_____ % (-23.3%)	_____ % (-70.7%)
0	1	0	1	_____ % (-23.3%)	_____ % (-23.3%)
1	1	0	1	_____ % (-70.7%)	_____ % (-23.3%)
1	0	0	1	_____ % (23.3%)	_____ % (-23.3%)
0	0	0	1	_____ % (70.7%)	_____ % (-23.3%)

¹ DIGITAL INPUT 0 1 3 4 for Option 064

Note

If all measurements are within specification, record the results in Table 4-2.

If any measurement does not meet specifications, refer to the section entitled CORRECTION FACTORS at the end of this procedure to determine whether a correction factor must be applied to bring the measurement within specification.

CORRECTION FACTORS

The specification for dc accuracy is presented as a percentage of full scale. Full scale is defined as the average of the full scale states which evenly distributes the full scale error about the true (average) full scale value.

In most cases, selecting one of the full scale states as the full scale value is sufficient to verify that the instrument is within specification. However, if the reference is selected is at one extreme (maximum or minimum), the test may not pass if another full scale value is at the other extreme.

To correct for this error, a scaling factor must be calculated to scale all of the measured values according to the average full scale reading. For example, if the average full scale is 99% (instead of 100% as set up by the measurement), all of the values must be multiplied by a scaling factor so that the two measurements correspond to 100.5% and 99.5% ($100\% \pm 0.5\%$). This reduces the error measured to within the specification.

BPSK. BPSK is a special case in that both states measured are at full scale. In this case, simply average the two values measured and divide the first measured state (nominally 100%) by the result.

For example, if the measurement yielded +100% and -98.5%, the average would be $(100 + 98.5)/2 = 99.25\%$. The scaling factor for BPSK would then be:

$$100\%/99.25\% = 1.0076$$

The corrected values for the measurement would then be 100.75% and -99.2% which are within 1% as specified.

QPSK. To determine the average of the four QPSK states, a calculation is required to determine the magnitude since both the real and imaginary part contribute to the magnitude. To determine each magnitude, perform the following procedure.

1. Square the real and imaginary component of the measured values of the first state (0 0). Record the values.

_____ Real Component Squared (Approximately 4998.5)

_____ Imaginary Component Squared (Approximately 4998.5)

2. Add the two values together and then take the square root of the result. Record this value as the magnitude of the first state.

_____ Magnitude of State 0,0 (Approximately 100)

3. Repeat the root-sum-square procedure for the other three states and record the magnitudes below.

_____ Magnitude of State 1,0 (Approximately 100)

_____ Magnitude of State 1,1 (Approximately 100)

_____ Magnitude of State 0,1 (Approximately 100)

4. Add the four magnitudes together and divide the result by four to determine the average magnitude of the four states. Record the value.

_____ Average Magnitude for QPSK (Approximately 100)

Determine the scaling factor by dividing the first BPSK measurement (nominally 100%) by the average magnitude for QPSK. The first state of BPSK is used as the full scale value because the network analyzer is normalized to this value. Multiply each of the QPSK measurements by the calculated scaling factor to correct for full scale errors.

_____ QPSK Scaling Factor

8PSK. Use the procedure given for QPSK except all eight states must be averaged. Multiply each measurement by the calculated scaling factor to correct for full scale errors.

_____ 8PSK Scaling Factor

16QAM and 64QAM. For the 16QAM, Use the procedure given for QPSK and use the four outside states to average the full scale reference. The outside four states for 16QAM are 0 0 0 0, 1 1 0 0, 1 1 1 1, and 0 0 1 1.

Although 64QAM is not explicitly measured, this procedure can be used to determine the accuracy for 64QAM format. To determine the correction factory for the 64QAM, only the four outside states are used in the averaging. The four outside states for 64QAM are 0 0 0 0 0 0, 1 1 1 0 0 0, 1 1 1 1 1 1, and 0 0 0 1 1 1.

Multiply each measurement by the calculated scaling factor to correct for full scale errors.

_____ 16QAM Scaling Factor

Digital Modulation Data Rates

Specification

Electrical Characteristics	Performance Limits	Conditions
DIGITAL MODULATION		
Data Rates	Parallel: 0 to 150 MHz clocked 0 to 50 MHz asynchronous	
Data Input Levels	ECL (-2V termination) threshold GND threshold Variable -2.5V to +2.5V threshold	Settable with 100 mV resolution
Clock Input Levels	ECL (-2V termination) threshold GND threshold Auto (-2.5V to +2.5V) threshold	
Data and Clock Drive Requirements	0.3 to 3 Vp-p	
Burst dc On/Off Ratio	>50 dB	140 MHz Carrier

Description The test is divided into an asynchronous data rates, single clock data rates, dual clock data rates and burst dc on/off ratio test. Each test is described below.

Asynchronous Data Rates

Data rates are measured by observing the frequency separation between sidebands on a spectrum analyzer as the data rate is increased. The maximum rate is determined by the point where the spacing suddenly drops instead of increasing.

Single Clock Data Rates

Synchronous (clocked) data rates are measured using the sideband spacing technique. This test is equivalent to the parallel data rates specification for instruments with Option 064 installed.

Dual Clock Data Rates (Except Option 064)

Synchronous (clocked) data rates for each clock are measured using the sideband spacing technique. This test does not apply to instruments with Option 064 installed.

Burst dc On/Off Ratio

Burst dc on/off ratio is measured using a spectrum analyzer to verify that the ratio of carrier on to off is at least 50 dB.

Equipment

- Spectrum AnalyzerHP 8566B
- Synthesized Sweeper (Signal Generator) HP 8340B
- Local OscillatorHP 8662A

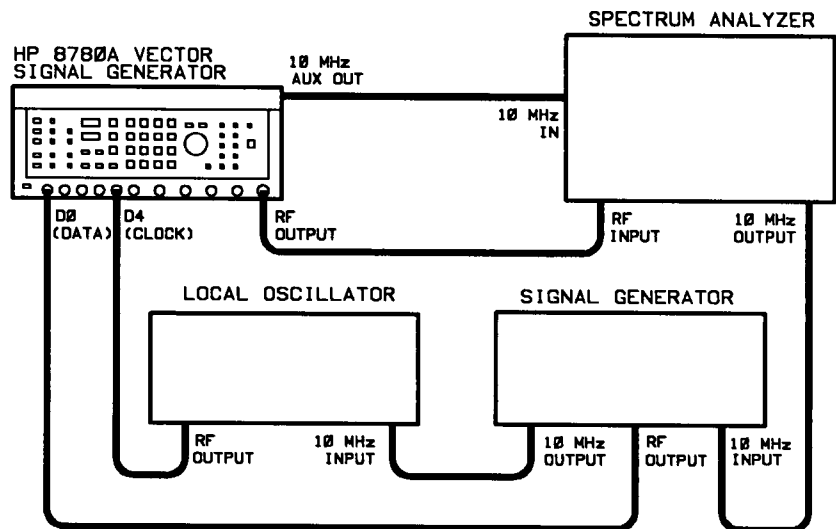

NOTE: IF TESTING AN OPTION 064,
CONNECT THE LOCAL OSCILLATOR TO D8 CLOCK.

Figure 4-13. Digital Modulation Data Rates Test Setup

Procedure

Asynchronous Data Rates

1. Press the INSTR PRESET key on the Generator. Press the CAL key to perform a self-calibration.
2. Connect the equipment as shown in Figure 4-13.
3. Set the Generator to 140 MHz at an output level of +7 dBm.
4. Activate the 16QAM (64QAM if Option 064 is installed) digital modulation format by pressing the 16QAM ON (64QAM ON) key.
5. Set the data threshold to GND by pressing the DATA key until the appropriate indicator is lighted.
6. Set the signal generator (Data) to 10 MHz at a level of +6 dBm.
7. Tune the signal generator (Data) from 10 MHz to greater than 50 MHz (1 MHz steps) while observing the signal on the spectrum

analyzer. The frequency separation between sidebands should increase smoothly until the frequency of the signal generator (Data) has passed 50 MHz. A failure is indicated if the sideband spacing suddenly drops in frequency instead of smoothly increasing.

Record a check (✓) below and in Table 4-2 if the maximum data rate is greater than 50 MHz.

____ (✓) DIGITAL INPUT 0 Asynchronous Data Rate >50MHz

8. Repeat steps 6 and 7 for the remaining digital inputs. Record the results below and in Table 4-2.

____ (✓) DIGITAL INPUT 1 Asynchronous Data Rate >50MHz

____ (✓) DIGITAL INPUT 2 Asynchronous Data Rate >50MHz

____ (✓) DIGITAL INPUT 3 Asynchronous Data Rate >50MHz

Option 064 Only:

____ (✓) DIGITAL INPUT 4 Asynchronous Data Rate >50MHz

____ (✓) DIGITAL INPUT 5 Asynchronous Data Rate >50MHz

Single Clock Data Rates

9. Set the Generator to single clock mode by pressing the EXT CLK key until the ONE indicator is lighted. Set the clock mode to AUTO by pressing the CLK key until the AUTO indicator is lighted. The DATA input mode should be GND.
10. Set the Data Signal Generator to 25 MHz, 0 dBm, and Step Size 1 MHz.
11. Set the Clock Signal Generator to 50 MHz, 0 dBm, and a Step Size of 2 MHz.
12. Step both Signal Generators up in frequency together so that the Clock Signal Generator will always be twice the frequency of the Data Signal Generator.
13. Observe the spacing of the sidebands on the Spectrum Analyzer display. There should be a smooth increase in sideband spacing until at least 75 MHz on the Data Signal Generator (150 MHz on the Clock Signal Generator) is displayed. The sideband spacing should not suddenly stop increasing or begin decreasing until a frequency greater than 75 MHz on the Data Signal Generator (corresponding to a data rate of 150 MHz). Record the result below and in table 4-2.

____ (✓) DIGITAL INPUT 0 Single Clock Data Rate >150 MHz

14. Repeat step 10 for the remaining digital inputs. Record the results below and in Table 4-2.

____ (✓) DIGITAL INPUT 1 Single Clock Data Rate >150MHz

____ (✓) DIGITAL INPUT 2 Single Clock Data Rate >150MHz

_____ (✓) Digital Input 3 Single Clock Data Rate >150MHz

Option 064 Only:

_____ (✓) DIGITAL INPUT 4 Single Clock Data Rate >150MHz

_____ (✓) DIGITAL INPUT 5 Single Clock Data Rate >150MHz

Dual Clock Data Rates (Except Option 064)

15. Set the clock mode to dual clock by pressing the EXT CLK key until the TWO indicator is lighted.
16. Connect the data signal generator to DIGITAL INPUT 0.
Connect the output of the Clock Signal Generator to DIGITAL INPUT 4, I CLOCK.
17. Connect a 50Ω load to DIGITAL INPUT 5, Q CLOCK.
18. Set the data signal generator to 25 MHz, and the Clock Signal Generator to 50 MHz.
19. Step both Signal Generators up in frequency together so that the Clock Signal Generator will always be twice the frequency of the Data Signal Generator.
20. Observe the spacing of the sidebands on the Spectrum Analyzer display. There should be a smooth increase in sideband spacing until at least 75 MHz on the Data Signal Generator (150 MHz on the Clock Signal Generator) is displayed. The sideband spacing should not suddenly stop increasing or begin decreasing until a frequency greater than 75 MHz on the Data Signal Generator (corresponding to a data rate of 150 MHz). Record the result below and in table 4-2.

_____ (✓) DIGITAL INPUT 0 Dual Clock Data Rate >150 MHz

21. Repeat steps 18 through 20 for the DIGITAL INPUT 1. Verify also that connecting the data signal generator to DIGITAL INPUT 2 and DIGITAL INPUT 3 has no affect on the output signal.

_____ (✓) DIGITAL INPUT 1 Dual Clock Data Rate >150 MHz

22. Connect the 50Ω load to DIGITAL INPUT 4, I CLOCK.
23. Connect the data signal generator to DIGITAL INPUT 2.
Connect the output of the Clock Signal Generator to DIGITAL INPUT 5, Q CLOCK.
24. Set the data signal generator to 25 MHz and the Clock Signal Generator to 50 MHz.
25. Step both Signal Generators up in frequency together so that the Clock Signal Generator will always be twice the frequency of the Data Signal Generator.
26. Observe the spacing of the sidebands on the Spectrum Analyzer display. There should be a smooth increase in sideband spacing until at least 75 MHz on the Data Signal Generator (150 MHz on

the Clock Signal Generator) is displayed. The sideband spacing should not suddenly stop increasing or begin decreasing until a frequency greater than 75 MHz on the Data Signal Generator (corresponding to a data rate of 150 MHz). Record the result below and in table 4-2.

____ (✓) DIGITAL INPUT 2 Dual Clock Data Rate >150 MHz

27. Repeat steps 24 through 26 for DIGITAL INPUT 3. Verify also that connecting the data signal generator to DIGITAL INPUT 0 and DIGITAL INPUT 1 has no effect on the output signal. (Ignore the spurs on D0 and D1).

____ (✓) DIGITAL INPUT 3 Dual Clock Data Rate >150 MHz

Burst dc On/Off Ratio

28. Disconnect the inputs to the generator.
29. Press the INSTR PRESET key on the Generator to reset all modulation modes.
30. Set the Generator to 140 MHz at an output level of 0 dBm. Select BURST modulation by pressing the BURST ON key.
31. Adjust the spectrum analyzer to display the 140 MHz RF signal. Note the signal level measured on the spectrum analyzer.

____dBm Reference Carrier Level

32. Invert DIGITAL INPUT 3 (DIGITAL INPUT 1 for Option 064) by pressing the INVERT INPUT key followed by a numeric 3. The signal should drop by at least 50 dB. The burst dc on/off ratio is determined by subtracting the signal level from the Reference Carrier Level recorded above. Record the on/off ratio below and in Table 4-2.

____Burst dc On/Off Ratio >50 dB

Hewlett-Packard Company
 Model HP 8780A
 Vector Signal Generator

Tested By _____

Serial Number _____

Date _____

Table 4-2. Performance Test Record

Test	Min. Result	Actual Result	Max. Result
FREQUENCY RANGE, RESOLUTION, AND AGING RATE			
Frequency Range			
Minimum Frequency	3 GHz	_____ (✓)	10 MHz
Maximum Frequency		_____ (✓)	
Frequency Resolution			
1 Hz Frequency Resolution		_____ (✓)	
Frequency Aging Rate			
Aging Rate		_____	5 X 10 ⁻¹⁰
RF OUTPUT LEVEL, FLATNESS AND RF SWITCH ON/OFF RATIO			
RF Level Accuracy			
+10 dBm Level	+7.5 dBm	_____	+12.5 dBm
0 dBm Level	-2.5 dBm	_____	+2.5 dBm
-10 dBm Level	-12.5 dBm	_____	-7.5 dBm
-20 dBm Level	-22.5 dBm	_____	-17.5 dBm
-30 dBm Level	-32.5 dBm	_____	-27.5 dBm
-40 dBm Level	-43.5 dBm	_____	-36.5 dBm
-50 dBm Level	-53.5 dBm	_____	-46.5 dBm
-60 dBm Level	-63.5 dBm	_____	-56.5 dBm
-70 dBm Level	-73.5 dBm	_____	-66.5 dBm
-80 dBm Level	-83.5 dBm	_____	-76.5 dBm
-90 dBm Level	-93.5 dBm	_____	-86.5 dBm
-100 dBm Level	-103.5 dBm	_____	-96.5 dBm
RF Switch On/Off Ratio	60 dB	_____	
Output Level Flatness		_____	2 dB
Maximum Power			
10 MHz to 2.5 GHz	+10 dBm	_____ (✓)	
2.5 GHz to 3.0 GHz	+4 dBm	_____ (✓)	

Table 4-2. Performance Test Record (continued)

Test	Min. Result	Actual Result	Max. Result
RESIDUAL SSB PHASE NOISE			
10 Hz Offset		_____	-65 dBc
100 Hz Offset		_____	-84 dBc
1 kHz Offset		_____	-100 dBc
10 kHz Offset		_____	-110 dBc
100 kHz Offset		_____	-110 dBc
1 MHz Offset		_____	-114 dBc
10 MHz Offset		_____	-130 dBc
HARMONICS			
60 MHz Carrier			
120 MHz (2nd)		_____	-35 dBc
180 MHz (3rd)		_____	-35 dBc
240 MHz (4th)		_____	-35 dBc
120 MHz Carrier			
240 MHz (2nd)		_____	-35 dBc
360 MHz (3rd)		_____	-35 dBc
480 MHz (4th)		_____	-35 dBc
240 MHz Carrier			
480 MHz (2nd)		_____	-35 dBc
720 MHz (3rd)		_____	-35 dBc
960 MHz (4th)		_____	-35 dBc
480 MHz Carrier			
960 MHz (2nd)		_____	-35 dBc
1440 MHz (3rd)		_____	-35 dBc
1920 MHz (4th)		_____	-35 dBc
960 MHz Carrier			
1920 MHz (2nd)		_____	-35 dBc
2880 MHz (3rd)		_____	-35 dBc
3840 MHz (4th)		_____	-35 dBc ¹
1920 MHz Carrier			
3840 MHz (2nd)		_____	-35 dBc ¹
5760 MHz (3rd)		_____	-35 dBc ¹
7680 MHz (4th)		_____	-35 dBc ¹
3000 MHz Carrier			
6000 MHz (2nd)		_____	-35 dBc ¹
9000 MHz (3rd)		_____	-35 dBc ¹
12000 MHz (4th)		_____	-35 dBc ¹

¹ Typical specification for 3244A and above serial prefix number instruments.

Table 4-2. Performance Test Record (continued)

Test	Min. Result	Actual Result	Max. Result
NON-HARMONICALLY RELATED SPURIOUS RESPONSES			
50 MHz Carrier			
<50 MHz Range		_____ (✓)	-55 dBc
50-70 MHz Range		_____ (✓)	-55 dBc
70-3000 MHz Range		_____ (✓)	-60 dBc
3000-10000 MHz Range		_____ (✓)	-55 dBc
20-1000 MHz Range		_____ (✓)	-55 dBc
FREQUENCY MODULATION ACCURACY (AC COUPLED)			
FM Accuracy (Serial Prefix XXXXA and above)			
30 MHz p-p Range	5.62 MHz	_____	6.86 MHz
1 MHz p-p Range	187 kHz	_____	229 kHz
FM Accuracy (Serial Prefix 2708A and 2943A)			
30 MHz p-p Range	5.77 MHz	_____	6.71 MHz
1 MHz p-p Range	192 kHz	_____	224 kHz
FM Accuracy (Serial Prefix 2650_A and below)			
30 MHz p-p Range	5.86 MHz	_____	6.61 MHz
1 MHz p-p Range	195 kHz	_____	220 kHz
Residual FM		_____	200 Hz
FREQUENCY MODULATION RATES (AC COUPLED)			
Lower 3 dB Frequency		_____	20 Hz
Upper 3 dB Frequency	12 MHz	_____	
FREQUENCY MODULATION (DC COUPLED)			
FM Rates			
3 dB Frequency	10 kHz	_____ (✓)	
FM Sensitivity Accuracy (Serial Prefixes XXXXA and above)			
75 kHz Modulation Voltage	311 mV	_____	396 mV
7.5 kHz Modulation Voltage	311 mV	_____	396 mV
(Serial Prefixes 2943A and Below)			
75 kHz Modulation Voltage	318 mV	_____	389 mV
7.5 kHz Modulation Voltage	318 mV	_____	389 mV
FM Distortion		_____	5%
Residual FM		_____	5 Hz rms
CW Residual FM		_____	4 Hz rms

Table 4-2. Performance Test Record (continued)

Test	Min. Result	Actual Result	Max. Result
SCALAR MODULATION			
Scalar Accuracy			
75% Scalar Level	-2.73 dB	_____	-2.27 dB
50% Scalar Level	-6.37 dB	_____	-5.68 dB
25% Scalar Level	-12.77 dB	_____	-11.37 dB
Scalar Frequency Response	500 kHz	_____ (✓)	
Scalar Residual		_____	-40 dBc
VECTOR MODULATION DC ACCURACY			
Worst Case Residual	-1.5%	_____	+1.5%
Input I, +500 mVdc	+98.5%	_____	+101.5%
Input Q, +500 mVdc	+98.5%	_____	+101.5%
Input I, +250 mVdc	+48.5%	_____	+51.5%
Input Q, +250 mVdc	+48.5%	_____	+51.5%
Input I, -250 mVdc	-51.5%	_____	-48.5%
Input Q, -250 mVdc	-51.5%	_____	-48.5%
Input I, -500 mVdc	-101.5%	_____	-98.5%
Input Q, -500 mVdc	-101.5%	_____	-98.5%
VECTOR MODULATION FREQUENCY RESPONSE			
I Channel Bandwidth	350 MHz	_____ (✓)	
Q Channel Bandwidth	350 MHz	_____ (✓)	
Vector Modulation dc Residual		_____	-40 dBc

Table 4-2. Performance Test Record (continued)

Test	Min. Result	Actual Result	Max. Result
DIGITAL MODULATION DC ACCURACY			
BPSK State Accuracy			
Normal (0) I Component	+99%	_____	+101%
Normal (0) Q Component	-1%	_____	+1%
Inverted (1) I Component	-101%	_____	-99%
Inverted (1) Q Component	-1%	_____	+1%
QPSK State Accuracy			
00, I Component	+69.7%	_____	+71.7%
00, Q Component	+69.7%	_____	+71.7%
10, I Component	-71.7%	_____	-69.7%
10, Q Component	+69.7%	_____	+71.7%
11, I Component	-71.7%	_____	-69.7%
11, Q Component	-71.7%	_____	-69.7%
01, I Component	+69.7%	_____	+71.7%
01, Q Component	-71.7%	_____	-69.7%
8PSK State Accuracy			
000, I Component	+37.1%	_____	+39.5%
000, Q Component	+91.2%	_____	+93.6%
010, I Component	+91.2%	_____	+93.6%
010, Q Component	+37.1%	_____	+39.5%
011, I Component	+91.2%	_____	+93.6%
011, Q Component	-39.5%	_____	-37.1%
001, I Component	+37.1%	_____	+39.5%
001, Q Component	-93.6%	_____	-91.2%
101, I Component	-39.5%	_____	-37.1%
101, Q Component	-93.6%	_____	-91.2%
111, I Component	-93.6%	_____	-91.2%
111, Q Component	-39.5%	_____	-37.1%
110, I Component	-93.6%	_____	-91.2%
110, Q Component	+37.1%	_____	+39.5%
100, I Component	-39.5%	_____	-37.1%
100, Q Component	+91.2%	_____	+93.6%

Table 4-2. Performance Test Record (continued)

Test	Min. Result	Actual Result	Max. Result
16QAM State Accuracy			
0000, I Component	+68.7%		+72.7%
0000, Q Component	+68.7%		+72.7%
1000, I Component	+21.3%		+25.3%
1000, Q Component	+68.7%		+72.7%
1100, I Component	-72.7%		-68.7%
1100, Q Component	+68.7%		+72.7%
0100, I Component	-25.3%		-21.3%
0100, Q Component	+68.7%		+72.7%
0110, I Component	-25.3%		-21.3%
0110, Q Component	+21.3%		+25.3%
0010, I Component	+68.7%		+72.7%
0010, Q Component	+21.3%		+25.3%
1010, I Component	+21.3%		+25.3%
1010, Q Component	+21.3%		+25.3%
1110, I Component	-72.7%		-68.7%
1110, Q Component	+21.3%		+25.3%
1111, I Component	-72.7%		-68.7%
1111, Q Component	-72.7%		-68.7%
1011, I Component	+21.3%		+25.3%
1011, Q Component	-72.7%		-68.7%
0011, I Component	+68.7%		+72.7%
0011, Q Component	-72.7%		-68.7%
0111, I Component	-25.3%		-21.3%
0111, Q Component	-72.7%		-68.7%
0101, I Component	-25.3%		-21.3%
0101, Q Component	-25.3%		-21.3%
1101, I Component	-72.7%		-68.7%
1101, Q Component	-25.3%		-21.3%
1001, I Component	+21.3%		+25.3%
1001, Q Component	-25.3%		-21.3%
0001, I Component	+68.7%		+72.7%
0001, Q Component	-25.3%		-21.3%

Table 4-2. Performance Test Record (continued)

Test	Min. Result	Actual Result	Max. Result
DIGITAL MODULATION DATA RATES			
Asynchronous Data Rates			
DIGITAL INPUT 0	50 MHz	_____ (✓)	
DIGITAL INPUT 1	50 MHz	_____ (✓)	
DIGITAL INPUT 2	50 MHz	_____ (✓)	
DIGITAL INPUT 3	50 MHz	_____ (✓)	
OPTION 064 Only:			
DIGITAL INPUT 4	50 MHz	_____ (✓)	
DIGITAL INPUT 5	50 MHz	_____ (✓)	
DIGITAL INPUT 6	50 MHz	_____ (✓)	
Single Clock Data Rates			
DIGITAL INPUT 0	150 MHz	_____ (✓)	
DIGITAL INPUT 1	150 MHz	_____ (✓)	
DIGITAL INPUT 2	150 MHz	_____ (✓)	
DIGITAL INPUT 3	150 MHz	_____ (✓)	
OPTION 064 Only:			
DIGITAL INPUT 4	150 MHz	_____ (✓)	
DIGITAL INPUT 5	150 MHz	_____ (✓)	
DIGITAL INPUT 6	150 MHz	_____ (✓)	
Dual Clock Data Rates			
(Except Option 064)			
DIGITAL INPUT 0	150 MHz	_____ (✓)	
DIGITAL INPUT 1	150 MHz	_____ (✓)	
DIGITAL INPUT 2	150 MHz	_____ (✓)	
DIGITAL INPUT 3	150 MHz	_____ (✓)	
Burst dc On/Off Ratio			
Burst dc On/Off Ratio	50 dB	_____	



APPENDIX A

ERROR MESSAGES

A complete list of error and warning messages follows:

ERROR 1 1-9 ONLY

There are nine storage registers. This error occurs if you attempt to store front panel settings in a register number >9 or <1 .

ERROR 2 0-7 ONLY

There are eight digital inputs that can be inverted. This error occurs if inversion is attempted on a digital input that does not exist.

ERROR 3 < 30 ONLY

This error occurs if you attempt to set the HP-IB address to a value of thirty or above.

ERROR 100 $\text{FREQ} > 4.16\text{GZ}$

This error occurs if you attempt to enter a frequency above 4.16 GHz. Note that 3 GHz is the top of the specified frequency range.

ERROR 101 $\text{FREQ} < 0\text{HZ}$

This error occurs if you attempt to enter a negative number for frequency. This most frequently happens when you thought you were entering a power level, but the instrument was set to accept a frequency input.

ERROR 102 $\text{LEVEL} > 16\text{dM}$

This error occurs when you attempt to enter a power level above +16 dBm, the maximum level for this instrument.

ERROR 103 $\text{LEV} < -127.0\text{dM}$

This error occurs when you attempt to enter a power level below -127 dBm.

ERROR 104 $\text{LEVEL} > 1.41\text{V}$

The requested RF output voltage is too high. A 1.41 volt rms corresponds to +16 dBm.

ERROR 105 $\text{LEVEL} < 0.1\mu\text{V}$

The requested RF output voltage is too low.

ERROR 106 $I1 > 100.0$

The requested value for the in-phase component of the first arbitrary 2-state setting exceeds the maximum value of 100. A value of 100 sets the vector amplitude to equal the CW signal amplitude.

ERROR 107 $I1 < -100.0$

The requested value for the in-phase component of the first arbitrary 2-state setting exceeds the minimum value of -100. A value of -100 sets the vector amplitude to equal the CW signal amplitude at a phase of 180 degrees.

ERROR 108 $I2 > 100.0$

The requested value for the in-phase component of the second arbitrary 2-state setting exceeds the maximum value of 100. A value of 100 sets the vector amplitude to equal the CW signal amplitude.

ERROR 109 $I2 < -100.0$

The requested value for the in-phase component of the first arbitrary 2-state setting exceeds the minimum value of -100. A value of -100 sets the vector amplitude to equal the CW signal amplitude at a phase of 180 degrees.

ERROR 110 $Q1 > 100.0$

The requested value for the quadrature component of the first arbitrary 2-state setting exceeds the maximum value of 100. A value of 100 sets the vector amplitude to equal the CW signal amplitude.

ERROR 111 $Q1 < -100.0$

The requested value for the quadrature component of the first arbitrary 2-state setting exceeds the minimum value of -100. A value of -100 sets the vector amplitude to equal the CW signal amplitude at a phase of 180 degrees.

ERROR 112 $Q2 > 100.0$

The requested value for the quadrature component of the second arbitrary 2-state setting exceeds the maximum value of 100. A value of 100 sets the vector amplitude to equal the CW signal amplitude.

ERROR 113 $Q2 < -100.0$

The requested value for the quadrature component of the first arbitrary 2-state setting exceeds the minimum value of -100. A value of -100 sets the vector amplitude to equal the CW signal amplitude at a phase of 180 degrees.

ERROR 114 $R1 > 141.4$

The maximum amplitude of an arbitrary 2-state vector cannot be greater than 141.4% of the CW value of the carrier. In addition, a warning message is generated if the length exceeds 100% of the CW value.

ERROR 115 $R1 < 0.0$

The requested amplitude of an arbitrary 2-state vector cannot be less than zero.

ERROR 116 $R2 > 141.4$

The maximum amplitude of an arbitrary 2-state vector cannot be greater than 141.4% of the CW value of the carrier. In addition, a warning message is generated if the length exceeds 100% of the CW value.

ERROR 117 $R2 < 0.0$

The requested amplitude of an arbitrary 2-state vector cannot be less than zero.

ERROR 118 $DEG1 > 360.0$

The maximum angle cannot exceed one full circle. Positive angles are counterclockwise.

ERROR 119 $DEG1 < -360.0$

The maximum angle cannot exceed one full circle. Negative angles are clockwise.

ERROR 120 $ALT > 100\%$

The alternate level output cannot be greater than the primary signal level.

ERROR 121 $ALT < 1\%$

The requested alternate level is lower than 1% of the primary power level. 1% equals 40 dB down.

ERROR 122 $ALT < 0.0\text{dB}$

The requested alternate level is higher than the primary level. This instrument does not have that capability.

ERROR 123 $ALT > 40.0\text{dB}$

The requested alternate level is more than 40 dB below the primary level. The instrument's limit is 40 dB.

ERROR 124 ALT I > 100%

The Alternate-I function does not allow you to set Alternate-I level greater than primary I level.

ERROR 125 ALT I < 1%

The requested Alternate-I value smaller than 1% of the primary I value. 1% equals 40 dB down, the limit of the I/Q modulator.

ERROR 126 ALT I < 0.0dB

The requested Alternate-I is greater than primary I. This instrument does not have that capability.

ERROR 127 ALT I > 40dB

The requested Alternate-I value more than 40 dB below the primary I value. 40 dB down is the limit of the I/Q modulator.

ERROR 128 I<Q > 100%

The I<Q function does not allow you to set I greater than Q.

ERROR 129 I<Q < 1%

The requested I value smaller than 1% of the Q value. 1% equals 40 dB down, the limit of the I/Q modulator.

ERROR 130 I<Q < 0.0dB

The requested I greater than Q. This instrument does not have that capability.

ERROR 131 I<Q > 40.0dB

The requested the I level is more than 40 dB below the Q level. The instrument's limit is 40 dB.

ERROR 132 AC FM > 50MZ

The requested AC coupled FM range is greater than 50 MHz, the maximum capability of this instrument.

ERROR 133 AC FM < 50KZ

The requested AC coupled FM range is less than the instrument can generate because it is beyond the attenuation range of the FM circuits. You may be able to accomplish the same result by setting FM range at or above 50 kHz and using a smaller FM input voltage.

ERROR 134 DC FM >150KZ

The requested DC coupled FM is wider than the capability of the instrument. The maximum deviation range is 150 kHz for DC FM unless special function 2.1 is selected for wideband DC FM (in which case the maximum deviation is 50 MHz).

ERROR 135 DC FM <150HZ The requested DC coupled FM range is less than the instrument can generate because it is beyond the attenuation range of the FM circuits. You may be able to accomplish the same result by setting FM range at or above 150 Hz and using a smaller FM input voltage.

ERROR 136 VAR > 2.54V

The upper limit of the variable data threshold is +2.54 volts. This level is high enough to properly handle TTL logic levels.

ERROR 137 VAR < -2.54V

The lower limit of the variable data threshold is -2.54 volts.

ERROR 138 DEG2 > 360.0

The maximum angle cannot exceed one full circle. Positive angles are counterclockwise.

ERROR 139 DEG2 < -360.0

The maximum angle cannot exceed one full circle. Negative angles are clockwise.

ERROR 140 BAD CURSOR

The cursor position entered is not legal for the current entry field. (This error will only occur when setting the cursor over HP-IB.)

ERROR 141 BAD SPECIAL

A special function number totally out of the valid range has been entered. Most likely caused by not entering the decimal point.

ERROR 142 UNKNOWN SPCL

The requested special function number is one that the instrument does not use.

ERROR 143 HP-IB DATA

The instrument has received invalid data via the interface bus from an external controller (computer).

ERROR 144 BAD FILTER

This error occurs when you select an invalid filter value using Special Function 3.1. (Valid values are 0 through 3.)

ERROR 145 BAD ENTRY

This error occurs when you select an invalid value for carrier leakage using Special Function 6.1. (Valid range is 0 through 40 dB.)

ERROR 200 F INC >4.16GZ

The specified frequency increment is greater than the instruments total output frequency range.

ERROR 201 F INC < 1 HZ

The selected frequency increment is less than 1 Hz, the maximum resolution of this instrument.

ERROR 202 L INC > 127dB

The requested the output level increment is wider than the power range of the instrument.

ERROR 203 L INC < 0.0dB

The requested the output level increment is less than zero dB. Negative values are not accepted here. To decrement, enter a positive value and press the down-arrow.

ERROR 204 L INC >1.41 V

The requested the RF output voltage increment is greater than the output capability of the instrument.

ERROR 205 L INC < 0.1uV

The requested level increment value is smaller then the maximum resolution of the instrument.

ERROR 206 I1 INC >100.0

The increment value cannot exceed the maximum allowable I-phase length. The previous I1 Increment value is retained.

ERROR 207 I1 INC < 0.0

The increment value cannot be a negative number. To decrement, enter a positive value and press the down-arrow.

ERROR 208 I2 INC >100.0

The increment value cannot exceed the maximum allowable I-phase length. The previous I2 Increment value is retained.

ERROR 209 I2 INC < 0.0

The increment value cannot be a negative number. To decrement, enter a positive value and press the down-arrow.

ERROR 210 Q1 INC >100.0

The increment value cannot exceed the maximum allowable Q-phase length. The previous Q1 Increment value is retained.

ERROR 211 Q1 INC < 0.0

The increment value cannot be a negative number. To decrement, enter a positive value and press the down-arrow.

ERROR 212 Q2 INC >100.0

The increment value cannot exceed the maximum allowable Q-phase length. The previous Q1 Increment value is retained.

ERROR 213 Q2 INC < 0.0

The increment value cannot be a negative number. To decrement, enter a positive value and press the down-arrow.

ERROR 214 R1 INC >141.4

The maximum length of the vector cannot exceed 141.4% of the CW value. In addition, a warning message is generated if the length exceeds 100% of the CW value.

ERROR 215 R1 INC < 0.0

The increment value cannot be a negative number. To decrement, enter a positive value and press the down-arrow.

ERROR 216 R2 INC >141.4

The maximum length of the vector cannot exceed 141.4% of the CW value. In addition, a warning message is generated if the length exceeds 100% of the CW value.

ERROR 217 R2 INC < 0.0

The increment value cannot be a negative number. To decrement, enter a positive value and press the down-arrow.

ERROR 218 O1 INC > 360.0

The phase angle increment value cannot exceed 360 degrees.

ERROR 219 O1 INC < 0.0

The increment value cannot be a negative number. To decrement, enter a positive value and press the down-arrow.

ERROR 220 A INC > 100%

The alternate level increment cannot exceed the maximum dynamic range of alternate level.

ERROR 221 A INC < 0%

The increment value cannot be a negative number. To decrement, enter a positive value and press the down-arrow.

ERROR 222 A INC > 40.0dB

The requested value of amplitude increment exceeds the dynamic range of the modulator.

ERROR 223 A INC < 0.0dB

The increment value cannot be a negative number. To decrement, enter a positive value and press the down-arrow.

ERROR 224 ALT I INC > 100%

The Alternate-I increment limit cannot exceed the Alternate-I limit of 100% of the CW amplitude.

The requested value of amplitude increment exceeds the dynamic range of the modulator.

ERROR 225 ALT I INC < 0%

The increment value cannot be a negative number. To decrement, enter a positive value and press the down-arrow.

ERROR 226 ALT I INC>40.0dB

The Alternate-I increment limit cannot exceed the Alternate-I dynamic range of 40 dB. The requested value of amplitude increment exceeds the dynamic range of the modulator.

ERROR 227 ALT I INC <0.0dB

The increment value cannot be a negative number. To decrement, enter a positive value and press the down-arrow.

ERROR 228 I<Q INC>100%

The requested I<Q increment is beyond the dynamic range of the instrument.

ERROR 229 I<Q INC < 0%

The I<Q increment cannot be less than zero.

ERROR 230 I<Q INC>40dB

The requested I<Q increment is beyond the dynamic range of the instrument.

ERROR 231 I<Q INC <0dB

The I<Q increment cannot be less than zero.

ERROR 232 FM INC >50MZ

The requested FM deviation range increment is greater than the maximum deviation range of the instrument in AC FM mode.

ERROR 233 FM INC < 1HZ

The requested FM deviation range increment is less than the resolution available. The smallest increment you can request is 1 Hz.

ERROR 236 VAR INC>2.54V

The requested variable digital threshold increment is greater than the available adjustment range.

ERROR 237 VAR INC<0.00V

A negative variable digital threshold increment is not allowed.

ERROR 238 O2 INC > 360.0

The phase angle increment cannot be greater than 360 degrees.

ERROR 239 O2 INC < 0.0

The increment value cannot be a negative number. To decrement, enter a positive value and press the down-arrow.

ERROR 316 I OR Q > 100

The magnitude of either the in-phase or quadrature-phase component of the vector exceeds 100% of the CW value.

ERROR 400 BAD SECTION

A nonexistent instrument section selected. Valid range is between zero and 7. This error results from incorrect use of service special function 53.0

ERROR 401 BAD STRT BIT

An invalid start bit has been specified for the selected section. This results from incorrect use of service special function 53.1

ERROR 402 BAD LENGTH

An incorrect length for the specified section and start bit has been specified. This results from incorrect use of service special function 53.2

ERROR 403 BAD VALUE

An incorrect data value for the specified section, start bit, and length has been specified. This results from incorrect use of service special function 53.3

ERROR 404 VALUE INC

You have selected an illegal increment value for Special Function 53.3.

ERROR 405 PHASE BUMP

You have specified an illegal value for phase bump using Special Function 13.1. (Legal range is -360.0 to 360.0 degrees.)

ERROR 406 BUMP INC

You have specified an illegal value for incrementing phase bump. This error only occurs while using Special Function 13.1.

ERROR 407 **BAD FACTOR**

You have specified an illegal value for an external filter (I or Q). The legal range is 0.0 to 3.0 dB. This error occurs while using Special Functions 4.1 and 5.1.

ERROR 408 **BAD ENTRY**

Error made in entry of baseband DAC values with special functions

WARNING 500 **FREQ > 3GZ**

The selected output frequency is above the specified upper limit. Power output drops quickly above 3 GHz and may not be the value you expect.

WARNING 501 **FREQ < 10MZ** The selected output frequency is below the specified lower limit. Power output drops slowly below 10 MHz.

WARNING 514 **R LEN > 100.0**

The total length of the vector exceeds 100% of the CW amplitude. The amplitude and phase accuracy may not meet specifications.

WARNING 526 **FM AT 150KZ**

Specified DC FM deviation range is exactly at the upper limit of the instrument.

WARNING 525 **FM AT 50KZ**

Specified AC FM deviation range is exactly at the lower limit of the instrument.

WARNING 601 **UNCAL BB**

Invalid or missing calibration data for the baseband circuits where I/Q modulation is generated. Recover by pressing the CAL key or with special function 20.1

WARNING 602 **UNCAL LEVEL**

Invalid or missing calibration data for the Output Deck. Recover by pressing the CAL key or with special function 20.2

WARNING 603 **UNCAL FM**

Invalid or missing calibration data for the FM Section. Recover by pressing the CAL key or with special function 20.3

HARDWARE WARNINGS

WARNING 800 PRESET STATE

This error message is generated when the contents of the RAM on A11 has been lost or corrupted. Possible causes are discharged battery or RAM failure.

WARNING 801 OVEN COLD

The instrument's timebase oven is cold. It takes about 10 minutes for the oven to warm up after the instrument is plugged in.

WARNING 802 FM OVERPOWER

The maximum allowable FM input voltage has been exceeded. To avoid damage or signal distortion, reduce the voltage below 1 Vrms.

WARNING 803 BB OVERPOWER

One of the vector inputs has been overpowered.

WARNING 804 CAL ABORTED

The instruments internal calibration routine failed and was aborted or interrupted and aborted when a front panel key was pressed. Old calibration data, if any, is retained for all sections for which calibration was not completed.

WARNING 805 UART OVERRUN

Hardware failure.

WARNING 806 A/D CAL FAIL

Hardware failure.

WARNING 807 A/D EOC FAIL

Hardware failure.

WARNING 808 A/D TIMEOUT

Hardware failure.

LO SYNTHESIZER SECTION ERRORS

ERROR 900 LO CHECKSUM

Hardware failure.

ERROR 901 LO HANDSHAKE

Hardware failure.

ERROR 902 LO DATACOMM

Hardware failure.

ERROR 903 A5 HANDSHAKE

Hardware failure.

ERROR 904 A2 UNLOCKED

The A2 Sum Loop is unlocked. Before troubleshooting or changing the assembly, make sure all cables are properly connected.

ERROR 905 A3 UNLOCKED

The A3 Reference Loop is unlocked. Before troubleshooting or changing the assembly, make sure all cables are properly connected.

ERROR 906 A5 UNLOCKED

The A5 Fractional-N Loop is unlocked. Before troubleshooting or changing the assembly, make sure all cables are properly connected.

ERROR 907 REF UNLOCKED

The A4 Timebase loop is unlocked due to a missing timebase signal or a cold timebase oven. The later condition will clear by itself within about 2 minutes after the instrument is plugged in. To correct the first condition, make sure the rear panel timebase jumper is connected and the timebase switch is set to INTERNAL. If an external timebase is being used, make sure it is within 100 Hz of 10 MHz or 50 Hz of 5 MHz.

OUTPUT OR OUTPUT SECTION CALIBRATION ERRORS

ERROR 908 OS CAL FAIL

Output section did not calibrate. Use Special Function 20.2 to rerun or use output special function 51.0 or 51.2 to read service error data from the microprocessor board.

FM OR FM CALIBRATION ERRORS

ERROR 910 IF UNLOCKED

FM section is losing phase lock when the instrument is set to CW. Problem is most likely in A6 FM RF Frame.

ERROR 911 IF UNLOCKED

DC coupled FM problem in A6 FM RF Frame.

ERROR 912 IF UNLOCKED

AC coupled FM problem in A6 FM RF Frame.

ERROR 913 FM CAL FAIL

Some measurement was out of tolerance on the FM Baseband Frame or FM RF Frame during calibration. Use special function 20.3 to attempt FM calibration or use special function 51.0 or 51.3 to read the service error data from the microprocessor board. A table in Section VIII gives details of the possible service errors and their meanings.

BASEBAND/BB CALIBRATION ERRORS

ERROR 920 BB CAL FAIL

Generally caused by a malfunction of Buffer Frame, DAC/Switch Frame, or Filter Frame or loose interconnecting cables. Use special 20.1 to attempt baseband calibration again or use special function 51.0 or 51.1 to read the service error data from the microprocessor board. A table in Section VIII gives details of the possible service errors and their meanings.

GENERAL HARDWARE ERRORS

ERROR 950

ROM failure on the A11 board has occurred during selftest

ERROR 951

RAM failure on the A11 board has occurred during selftest

ERROR 952 HARDWRE FAIL

This message indicates there is a error in the keyboard or the circuits that read it.

ERROR 953 Loop_int_error= HARDWRE FAIL

Loop interrupt error.

ERROR 999 SOFTWARE BUG

The microprocessor has encountered a problem that it cannot otherwise identify.

Customer Order Number

Printed in USA

July 1996

** For HP Internal Reference Only **

Manufacturing Part Number

08780-90045

