

# **Agilent Technologies E6385A Lucent CDMA Base Station Test Software**

## **User's Guide**

**Software Version: A.03.00 and later**

**Agilent Part Number E6385-90001**

**Revision C**

**Printed in UK**

**May 2000**



**Agilent Technologies**

---

## **Restricted Rights Legend**

Use, duplication or disclosure by the U. S. Government is subject to restrictions as set forth in subparagraph (c) (1) (ii) of the Rights in Technical Data and Computer Software clause in DFARS 252.227-7013.

Agilent Technologies  
3000 Hanover Street,  
Palo Alto, CA 94304. U.S.A.

Rights for non-DOD U. S. Government Departments and Agencies are as set forth in FAR 52.227-19 (c) (1, 2).

Information contained in this document is subject to change without notice.

All Rights Reserved. Reproduction, adaptation, or translation without prior written permission is prohibited, except as allowed under the copyright laws.

This material may be reproduced by or for the U.S. Government pursuant to the Copyright License under the clause at DFARS 52.227-7013 (APR 1988).

© Copyright 1999, 2000 Agilent Technologies

---

## **Trademark Acknowledgements**

Hewlett-Packard and HP are registered trademarks of Hewlett-Packard Company.

Microsoft, Windows, and MS-DOS are registered trademarks of Microsoft Corporation.

Pentium is a registered trademark of Intel Corporation.

In this Manual . . . . .	8
Conventions Used . . . . .	9
<b>Product Description</b>	
Test Software Overview . . . . .	12
Who should use the Test Software? . . . . .	13
Included with the Test Software . . . . .	13
Test Software Operation Overview . . . . .	14
Required Equipment . . . . .	15
Test Equipment . . . . .	15
Personal Computer (PC) . . . . .	15
Cables and Adapters . . . . .	15
Optional Equipment . . . . .	17
GPS Time and Frequency Reference Receiver . . . . .	17
Accessory Kits . . . . .	17
Getting Help, Test Software Upgrades, and Training . . . . .	20
<b>Installation</b>	
Overview . . . . .	22
Loading and Running the Test Software . . . . .	23
Navigating the Test Software . . . . .	25
Main Menu Functions . . . . .	25
Changing Settings and Using USER Keys . . . . .	26
Operating the BTS Laptop Utility Program . . . . .	27
System Requirements for BTS Laptop Utility Program . . . . .	28
Installing the BTS Laptop Utility Program . . . . .	28
Configuring the Test Set and PC Serial Ports for Communication with the Test Set . . . . .	29
Configuring the PC to Communicate with the MSC . . . . .	31
Connecting the PC to the Test Set and the MSC . . . . .	32
Connecting the PC to the Test Set . . . . .	32
Connecting the PC to the MSC . . . . .	33
Determining the Test Set to Site Equipment Connections . . . . .	36
Which Clock to Use – SCT Clock or External Reference? . . . . .	36
Which Test Set Port to Use – ANT IN or RF IN/OUT? . . . . .	36
Which Base Station Port to Use – TX Test or TX Antenna? . . . . .	36
Configuring the Test Software . . . . .	38
Test Configuration . . . . .	39
Base Station Configuration . . . . .	41
Establishing a Connection with the MSC for Testing . . . . .	43
Establishing a Direct-Dial Modem Connection . . . . .	43
Establishing a Telnet Connection . . . . .	43
If You Noticed Problems . . . . .	44
<b>Connections</b>	

---

## Contents

Test Set to Base Station Connections . . . . .	46
Test Set to GPS Time and Frequency Reference Receiver Connections	50
<b>Performing Tests</b>	
Overview . . . . .	52
Calibrating the Test Setup . . . . .	53
Selecting Tests . . . . .	54
Running Tests . . . . .	55
For More Information . . . . .	55
Transmit Power Calibration Test (Autoplex Series II) . . . . .	56
Parameters and Specifications Used . . . . .	56
Select and Run the Test . . . . .	57
Review the Results . . . . .	57
Transmit Power Calibration Test (PCS Minicell) . . . . .	58
Parameters and Specifications Used . . . . .	59
Test Set-Up Procedure . . . . .	59
Select and Run the Test . . . . .	60
Pilot Only Test . . . . .	62
Parameters and Specifications Used . . . . .	62
Select and Run the Test . . . . .	62
Review the Results . . . . .	63
Code Domain Tests . . . . .	64
Parameters and Specifications Used . . . . .	64
Select and Run the Test . . . . .	65
Review the Results . . . . .	65
Automated BBA Test . . . . .	66
Parameters and Specifications Used . . . . .	66
Select and Run the Test . . . . .	67
Review the Results . . . . .	67
Spectrum Analyzer Test . . . . .	68
Parameters and Specifications Used . . . . .	68
Select and Run the Test . . . . .	68
Review the Results . . . . .	68
Code Domain Analyzer Test . . . . .	70
Parameters and Specifications Used . . . . .	70
Select and Run the Test . . . . .	70
Review the Results . . . . .	71
CDMA Analyzer Test . . . . .	73
Parameters and Specifications Used . . . . .	73
Select and Run the Test . . . . .	73
Review the Results . . . . .	74
TX Antenna Port Cable Calibration Test . . . . .	75
Parameters and Specifications Used . . . . .	75

Select and Run the Utility .....	75
Review the Results .....	75
TX Test Port Cable Calibration Test .....	76
Parameters and Specifications Used .....	76
Select and Run the Utility .....	76
Review the Results .....	76
TX Test Port Calibration Test .....	77
Parameters and Specifications Used .....	77
Select and Run the Test .....	78
Review the Results .....	78
PN Offset Search Test .....	79
Parameters and Specifications Used .....	79
Select and Run the Test .....	79
Review the Results .....	79
Insertion Loss Measurement .....	80
Parameters and Specifications Used .....	80
Select and Run the Test .....	80
Review the Results .....	81
Return Loss Measurement .....	82
Parameters and Specifications Used .....	82
Select and Run the Test .....	82
Review the Results .....	83
Emission BW & Spurious Test .....	84
Spurious Emissions Measurement .....	84
Emission Bandwidth Measurement .....	84
Parameters and Specifications Used .....	85
Select and Run the Test .....	85
<b>Reference</b>	
Overview .....	88
Accessing Test Software Functions .....	89
SOFTWARE MENU Screen Overview .....	90
Loading a Test Procedure .....	91
Loading the Test Software Card and Procedure .....	92
Customizing a Test Procedure .....	94
Changing Test Parameters .....	95
Changing Pass/Fail Limits .....	98
Saving/Deleting a Procedure .....	101
BTS Laptop Utility Program Windows .....	105
Switch Terminal Window .....	105
Test Set Terminal Window .....	105
Other Data Window .....	105
Test Results Window .....	106

Test Set Screen Capture Window .....	107
Demo (Demonstration) Mode .....	108
Selecting the DEMO Procedure .....	108
Selecting Demo Mode Using the Control Parameter .....	108
Exiting the Demo Mode .....	109
Parameters .....	110
Specifications (Pass/Fail Limits) .....	115
Testing without MSC Control .....	117
Using a PC Card .....	118
Initializing a PC Card .....	118
Troubleshooting PC Card Use .....	118
<b>Troubleshooting</b>	
Error Summary .....	120
Overview .....	120
Troubleshooting the Test Software Installation .....	121
Errors When Loading and Running the Test Software .....	122
Communication Errors .....	123
Errors When First Setting Up or Connecting to MSC .....	123
Communication Errors During Testing .....	123
Troubleshooting Checks for Communication Problems .....	124
Errors While Attempting Measurements .....	125
Acronyms 127	
Acronyms and Meanings .....	128

---

**Preface**

## **In this Manual**

This manual consists of the following parts:

[Chapter 1, “Product Description,” on page 11.](#)

This chapter provides a general description of the Agilent Technologies E6385A Lucent CDMA Base Station Test Software.

[Chapter 2, “Installation,” on page 21.](#)

This chapter provides information on loading and running the Test Software, connecting the equipment, and configuring the Test Set and Test Software.

[Chapter 3, “Connections,” on page 45.](#)

This chapter provides information on connecting the Test Set to the Base Station and other equipment.

[Chapter 4, “Performing Tests,” on page 51.](#)

This chapter provides procedures for running the Test Software tests and utilities, and descriptions of the individual tests and utilities.

[Chapter 5, “Reference,” on page 87.](#)

This chapter provides operational details that are not covered elsewhere in this manual. Topics are arranged alphabetically for quick and easy reference.

[Chapter 6, “Troubleshooting,” on page 119.](#)

This chapter provides information on possible remedies in the event of operational problems.

[Appendix A, “Acronyms,” on page 127.](#)

This appendix provides a list of acronyms and the associated meanings to assist in efficient Test Software operation.



## Conventions Used

Special presentations of text in this manual reflect the appearance of the referenced item. Examples of these special presentations are:

**Menu** – A Test Set front panel key.

**Pause/Continue (Reset)** – A Test Set front panel *shift* function key. The key name in parentheses is the title of the shift function. Press the **Shift** key then the specified key to access the *shift* function.

**Procedure:** – Characters that appear on the Test Set display.

**k1 (Run Test)** – A USER key in the key column next to the display. The words in parentheses are displayed on the screen.

*Title* – Titles of documentation are printed in italics.

Test Set – Refers to the Agilent Technologies 8935 Series E6380A CDMA Base Station Test Set.

Test Software – Refers to the Agilent Technologies E6385A Lucent CDMA Base Station Test Software.

TEST – Refers to the one of the test modules that is part of a test procedure.

PC card – Refers to either the OTP card on which the Test Software is shipped or the SRAM card that is shipped with the Test Software for storing procedures.

PC card is an industry standard term that refers to two types of information storage cards. One meets the specifications of the Personal Computer Memory Card International Association (PCMCIA). The other meets the specifications of the Epson Corporation PC card standard. Agilent Technologies 8935 Series Test Sets use only the PCMCIA type card.

OTP card – Refers to the type of PC card that is used to store the Test Software.

SRAM card – Refers to the type of PC card that is shipped with the Test Software for storing procedures.

BTS – Refers to a Base Transceiver Station.

In procedural steps in this manual, the following words are used to describe cursor and entry actions:

- **Select** – refers any of three possible actions:
  - Positioning the cursor at the appropriate field (**inverse video** area) and pressing the knob.
  - Making an entry using the DATA ENTRY keys and pressing the knob.
  - Making an entry using the DATA ENTRY keys and pressing the **Enter** key.
- **Enter** – means to use the numeric keypad, and the **Enter** key or measurement units keys to make entries to fields. In some procedures, the word “enter” is used to describe the action of entering characters into a field.

---

# 1 Product Description

This chapter contains general information on the Agilent Technologies E6385A Lucent CDMA Base Station Test Software. Included is a list of required equipment to perform the tests, plus a look at the basic Test Software flow.

## Test Software Overview

The Test Software is contained on two One-Time Programmable (OTP) PC cards. One card is used for CDMA testing, the other for AMPS testing. Separate manuals are included for CDMA and AMPS testing.

The Test Software is an Agilent Technologies Instrument BASIC (IBASIC) application used to set up the Test Set for transmitter measurements on CDMA Base Station equipment. The Test Software runs on the Test Set internal IBASIC controller to allow you to perform the following tests:

- Transmit Power Calibration
- Pilot Only Test
- Code Domain Tests
- Automated BBA Test
- Spectrum Analyzer
- Code Domain Analyzer
- CDMA Analyzer
- PN Offset Search
- Insertion Loss Measurement
- Return Loss Measurement
- Emission BW & Spurious

Using a PC modem or a telnet connection, the Test Software can control the Base Station equipment by sending commands to the Mobile Switching Center (MSC). This provides automated testing to reduce time spent at the site and to greatly improve the repeatability of measurements.

As tests are run, the Test Software compares the measured results with user-defined specification limits. These test results may be stored on a personal computer (PC) (ordinarily a laptop PC).

In addition, the following tests are included as calibration and utilities functions.

- TX Antenna Port Cable Calibration
- TX Test Port Cable Calibration
- TX Test Port Calibration
- PN Offset Search
- Insertion Loss Measurement
- Return Loss Measurement

## Who should use the Test Software?

If you are installing, commissioning, or maintaining Lucent Technologies' CDMA cell site equipment, this Test Software will assist you in performing key tests of transmitter performance.

## Included with the Test Software

Included with the Test Software are the following items:

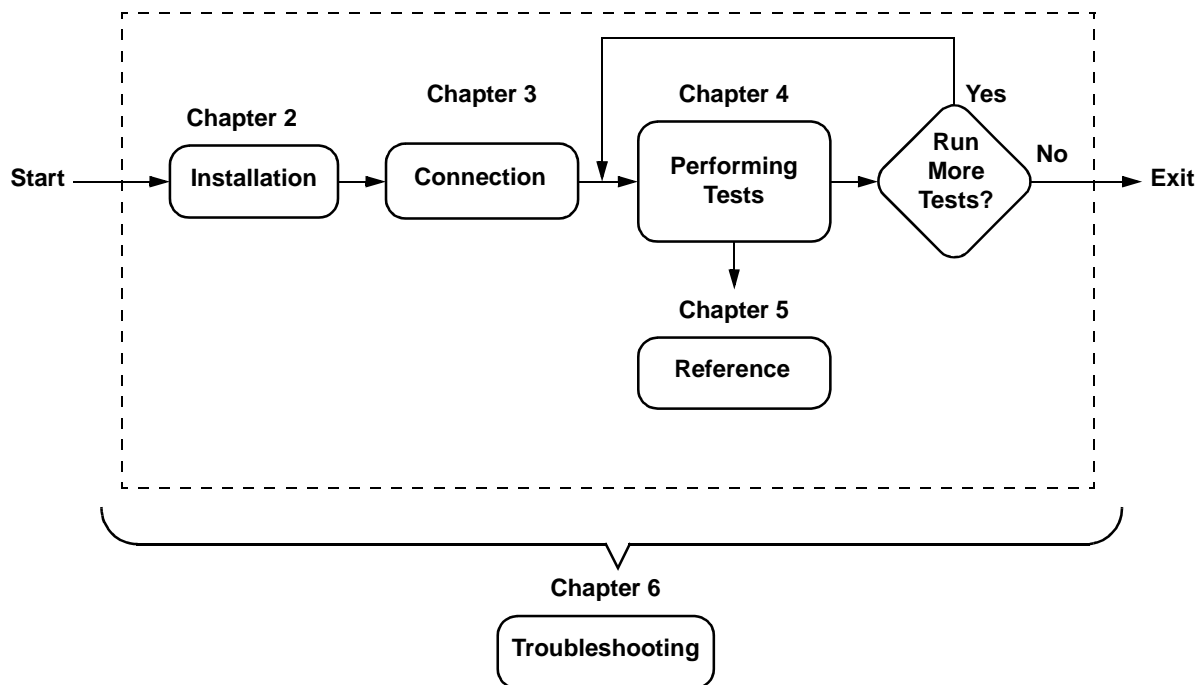
- ❑ PC Card (OTP) containing the Agilent Technologies E6385A Lucent CDMA Base Station Test Software  
Agilent Technologies Part Number: E6385-10001
- ❑ PC Card (OTP) containing the Agilent Technologies E6385A Lucent AMPS Base Station Test Software  
Agilent Technologies Part Number: E6385-10002
- ❑ Blank 1-Megabyte SRAM PC Card  
Agilent Technologies Part Number: 83231A
- ❑ Two 3.5-inch diskettes containing the BTS Laptop Utility program  
Agilent Technologies Part Number: E6385A Opt. K01
- ❑ One 3.5-inch diskette containing the Sample Frequency Plan  
Agilent Technologies Part Number: 5010-1203
- ❑ Agilent Technologies E6385A Lucent CDMA Base Station Test Software User's Guide (this manual)  
Agilent Technologies Part Number: E6385-90001
- ❑ Agilent Technologies E6385A Lucent AMPS Base Station Test Software User's Guide  
Agilent Technologies Part Number: E6385-90002
- ❑ Software License Agreement

## Test Software Operation Overview

Figure 1-1 illustrates the basic steps for Test Software operation. After running the Test Software, you may repeat a test or you may select another test.

Chapter 4, “Performing Tests,” on page 51, provides step-by-step instructions for each of the tests. If you have questions, refer to Chapter 5, “Reference,” on page 87 for more information. If you encounter errors, refer to Chapter 6, “Troubleshooting,” on page 119.

Figure 1-1 Using the Test Software



---

## Required Equipment

Test equipment and other items required for testing are shown in [Figure 1-2](#) and described in the following paragraphs.

### Test Equipment

The Test Software is written specifically to work with the Agilent Technologies 8935 Series E6380A CDMA Base Station Test Set.

### Personal Computer (PC)

The Test Set and Test Software support using a PC to control the site via the MSC. This allows you to dial up or use a telnet connection to log in to the MSC and enter the maintenance craft shell as you would ordinarily for other cell site operations. The PC is connected to the Test Set via the SERIAL 9 port. Most PCs with an available serial port are compatible with the Test Set.

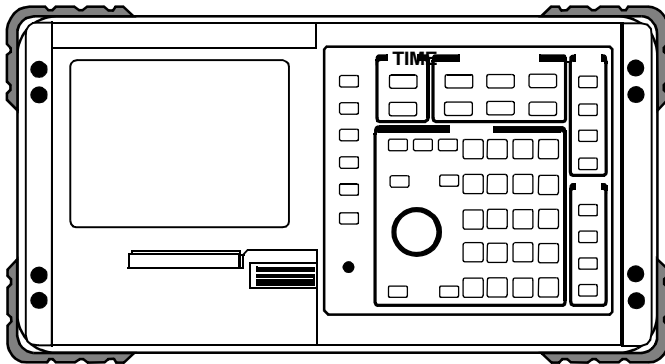
You must install the BTS Laptop Utility program in the PC, so as to relay commands to the MSC from Test Set, collect test data, log commands sent between the Test Set and the MSC, and capture screen images.

### Cables and Adapters

Various cables and adapters are required. These may be purchased from Agilent Technologies or from local sources. See [“Accessory Kits” on page 17](#) for information on optional accessory kits that supply the necessary cables and adapters to connect the Test Set to the Base Station equipment.

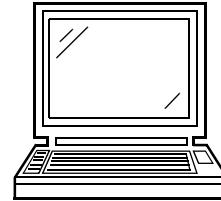
**Figure 1-2 Required Equipment**

**Test Equipment Required:**



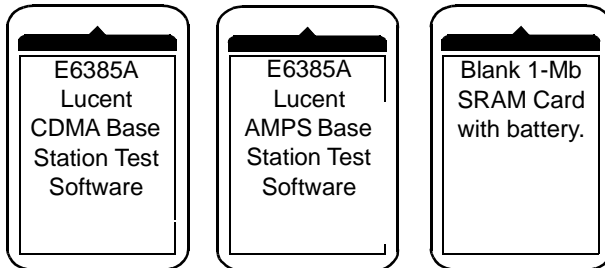
Agilent Technologies 8935 Series E6380A  
 CDMA Base Station Test Set

**You Must Supply:**

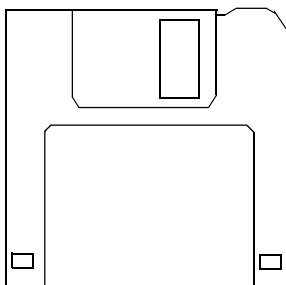


- Laptop PC with Internal Modem
- Null Modem Cable to Test Set 5182-4794

**Supplied with the Test Software:**

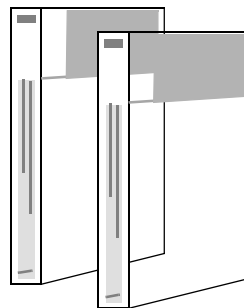


AMPS Test  
 Software Manual  
 (E6385-90002)

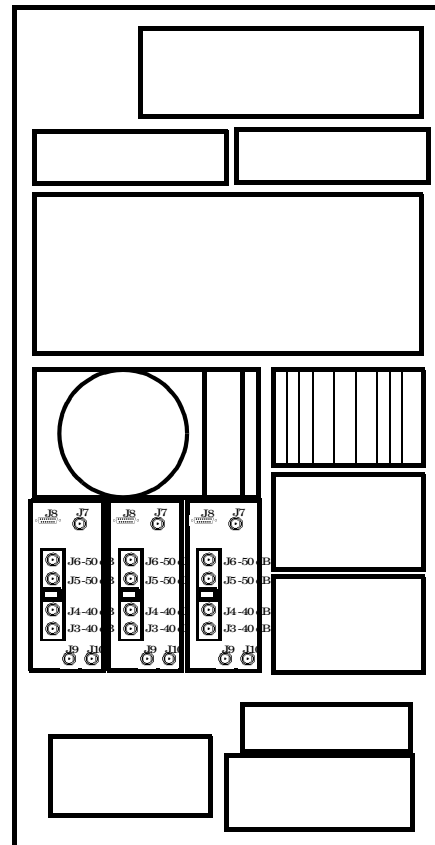


BTS Laptop Utility Program  
 E6385A Option K01  
 (Two diskettes.)

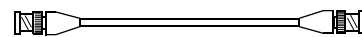
Sample Frequency Plan  
 (5010-1203)  
 (One diskette.)



CDMA Test  
 Software Manual  
 (E6385-90001)  
 (This manual.)



- Lucent CDMA Base Station



- Cables to Connect the Base Station to the Test System

## Optional Equipment

Optional test equipment and other optional items are described in the following sections.

### GPS Time and Frequency Reference Receiver

The Test Software supports the Symmetricom 58503A GPS Time and Frequency Reference Receiver for supplying the timebase signal normally taken from the Base Station equipment.

When connecting to the Base Station SCT modules as the timing reference, the Test Software uses the signals out of the modules as though those signals are correctly timed to GPS time to provide the correct PN offset (see [“Test Set to GPS Time and Frequency Reference Receiver Connections” on page 50](#)). If a problem exists in the Base Station GPS reference or SCT modules, the Base Station PN offset will likely be incorrect.

Use of the 58503A provides a GPS-referenced timing signal that is independent of the Base Station. This helps isolate problems associated with the Base Station own GPS reference equipment and/or SCT module(s). An example of this is an “island cell”, where the Base Station passes performance tests but does not properly interact with adjacent cells during handoffs.

### Accessory Kits

Several kits containing selections of accessories for connecting the Test Set to the Base Station equipment are available from Agilent Technologies. These are described in the following three sections.

#### Agilent Technologies E8300A 8935 Base Station Accessory Kit

The Agilent Technologies E8300A 8935 Base Station Accessory Kit (see [Table 1-1](#)) supplies serial cables, RF cables, and adapters required to connect the Test Set for testing Base Stations.

**Table 1-1 E8300A Base Station Accessory Kit Contents**

Part	Part Number	Quantity	Use
Cable Assembly, N(M) to N(M), 10-ft.	08921-61010	1	Connects the Base Station TX Antenna Port to the Test Set RF IN/OUT port.
Cable Assembly, SMA(M) to BNC(M), 10-ft.	08921-61021	2	Connects Base Station Even Second clock and 19.6608-MHz clock to Test Set.
Cable Assembly, SMA(M) to N(M), 12-ft.	E8300-61002	1	Connects the Base Station TX Test Port to the Test Set ANT IN port.
Cable Assembly, N(M) to N(M), 2-ft.	E8300-61005	1	Used as the calibration cable for Insertion Loss test.
Null Modem Cable Assembly, DB9(F) to DB9(F), 10-ft.	5182-4794	1	Connects the PC serial port to the Test Set SERIAL 9 port.



**Table 1-1 E8300A Base Station Accessory Kit Contents**

Part	Part Number	Quantity	Use
Attenuator, N(M) to N(F), 6-dB	0955-0819	2	Used for cable loss calibration routines.
Adapter, SMA(F) TO N(M)	1250-1250	2	Used for Base Station TX Test Port Cable calibration, adapts to a Type N attenuator.
Adapter, N(F) to N(F)	1250-0777	1	Used for joining Type N cables
Adapter, TNC(M) to N(F)	1250-2361	1	Used for TNC connections on some Base Stations.
Velcro Cable Wrap	1400-2157	10	Used for securing and organizing cables for transporting and during testing.
Verification Guide	E8300-90001	1	Used as a checklist for connector kit contents.
Transit Case	E8300-61006	1	Organizes and transports connectors and cables. Includes spaces for Option 001 parts.
Strain Relief Assembly	E8300-61004	2	Reduces strain on connectors from cables.
Strain Relief Application Guide	E8300-90005	1	Instructions for using strain relief assemblies.

**Agilent Technologies E8300A Option 001 Accessory Kit**

The E8300A Option 001 Accessory Kit (see [Table 1-2](#)) includes the additional parts that are required to run all of the Test Set built-in RF Tools routines. The RF Tools routines are automated measurements used in cell site maintenance (such as antenna sweeps).

**Table 1-2 E8300A Option 001 Accessory Kit Contents**

Part	Part Number	Quantity	Use
Cable Assembly, N(M) to N(M), 2-ft.	8120-8687	2	Used to connect the Test Set to the VSWR bridge.
VSWR Bridge	0955-0829	1	Used to measure return loss
Termination, 50-ohm, N(M)	1250-2656	1	Used to terminate transmission lines.
Termination, short, N(M)	1250-2655	1	Used to terminate the DUT port of the VSWR bridge during return loss tests.
Resistive Power Splitter, 2-way	0955-0827	1	Divide a signal in two.

### Agilent Technologies E6554A 8935 RF Tools Hardware Accessory Kit

**NOTE**

If you do not purchase the Agilent Technologies E8300A Accessory Kit, you may order the Agilent Technologies E6554A RF Tools Hardware Accessory Kit to provide all of the required connectors, cables, and accessories to run the RF Tools tests.

The Agilent Technologies E6554A 8935 RF Tools Hardware Accessory Kit (see [Table 1-3](#)) contains the equipment necessary to run the “Return Loss Measurement” on [page 82](#) and to run the RF Tools ROM programs that reside in the Test Set. Refer to the *Agilent Technologies 8935 CDMA Cellular / PCS Base Station Test Set Reference Guide* for more information about the RF Tools program.

**Table 1-3 E6554A 8935 RF Tools Hardware Accessory Kit**

Part	Part Number	Quantity	Use
Cable Assembly, N(M) to N(M), 2-ft.	8120-8687	2	Used to connect the Test Set to the VSWR bridge.
VSWR Bridge	0955-0829	1	Used to measure return loss
Termination, 50-ohm, N(M)	1250-2656	1	Used to terminate transmission lines.
Termination, short, N(M)	1250-2655	1	Used to terminate the DUT port of the VSWR bridge during return loss tests.
Resistive Power Splitter, 2-way	0955-0827	1	Divides one signal into two signals.
Adapter, BNC(M) to N(F)	1250-0077	2	Connects BNC cables to type N connections.
Attenuator, N(M) to N(F), 6-dB	0955-0826	2	Used during cable loss, insertion loss, and return loss tests.
Transit Case	E6554-61004	1	Organizes and safely transports kit contents.
Verification Guide	E6554-9001	1	Used as a checklist for accessory kit contents.

Product Description

## **Getting Help, Test Software Upgrades, and Training**

For instrument servicing, see the *Agilent Technologies 8935 Series E6380A CDMA Test Set Assembly Level Repair Guide*.

For application assistance, call the Application Hotline (1-800-922-8920, USA and Canada only).

For information about Test Software upgrades and hands-on training, contact the local Agilent Technologies sales engineer.

---

## 2 Installation

This chapter describes the processes required to load and run the Test Software, connect the equipment, and make initial settings to configure the Test Set and the Test Software. *You must complete the procedures in this chapter before attempting measurements with the Test Software.*

## Overview

The procedures included in this chapter are as follows:

1. [“Loading and Running the Test Software” on page 23.](#)
2. [“Navigating the Test Software” on page 25](#)
3. [“Operating the BTS Laptop Utility Program” on page 27.](#)

---

**NOTE**

BTS Laptop Utility program operation requires the use of a personal computer (PC) (usually a laptop PC). The use of a PC is not an absolute requirement, but the test examples in [Chapter 4, “Performing Tests,” on page 51](#) use a PC to control the cell site via the Mobile Switching Center (MSC). The Test Software also supports testing without PC control. If you elect not to use a PC with the Test System, skip the section that describes using the BTS Laptop Utility program and refer to [“Testing without MSC Control” on page 117](#) for a summary of differences when running without the PC.

- 
4. [“Connecting the PC to the Test Set and the MSC” on page 32.](#)
  5. [“Determining the Test Set to Site Equipment Connections” on page 36.](#)
  6. [“Configuring the Test Software” on page 38.](#)
  7. [“Establishing a Connection with the MSC for Testing” on page 43.](#)

## Loading and Running the Test Software

Locate the PC card labeled “Agilent Technologies E6385A Lucent CDMA Base Station Test Software” and follow the steps outlined in [Figure 2-1](#) and [Figure 2-2](#).

**Figure 2-1** Loading and Running the Test Software

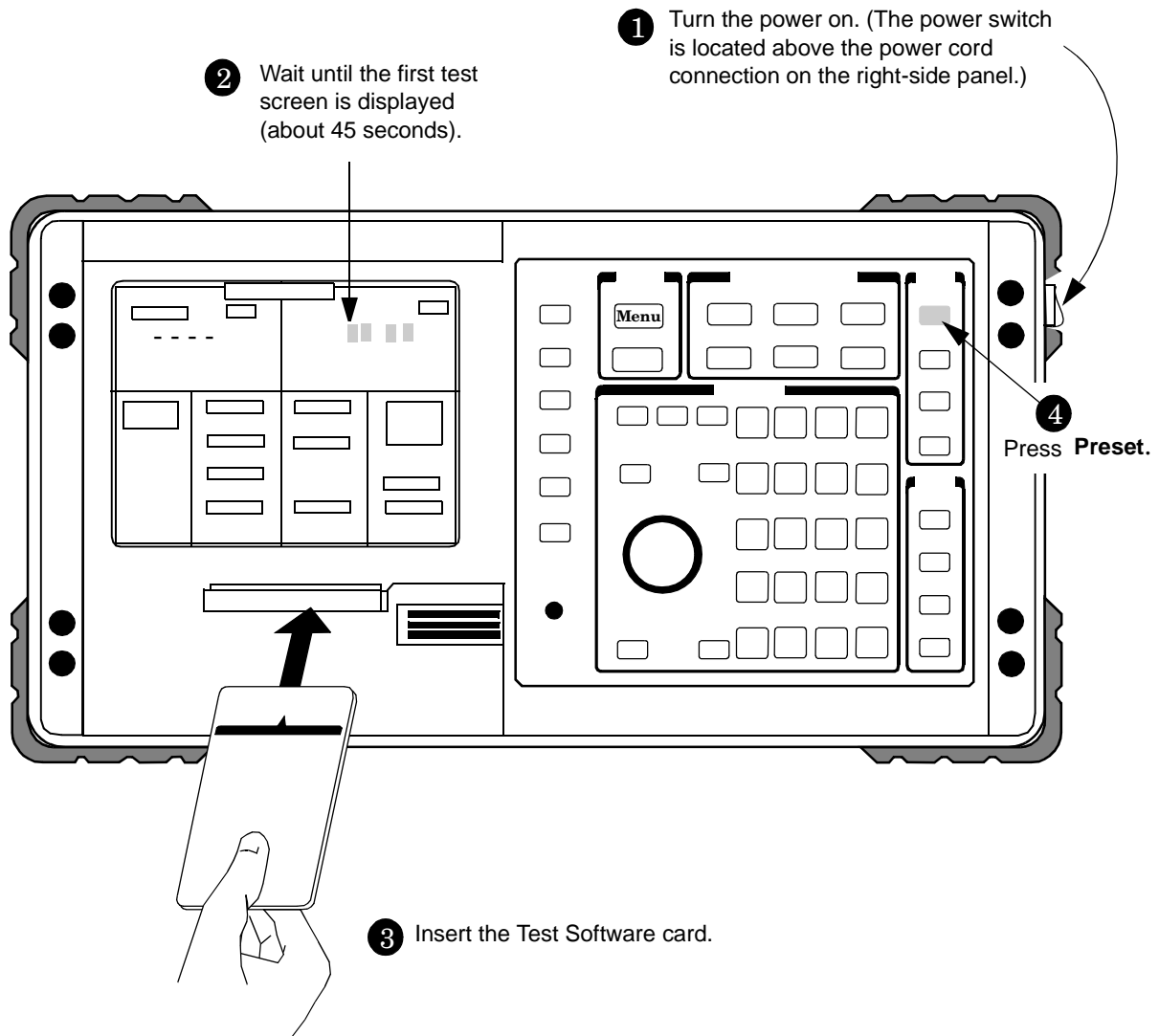
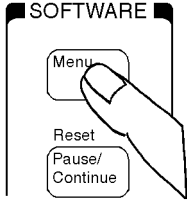













Figure 2-2 Loading and Running the Test Software (continued)

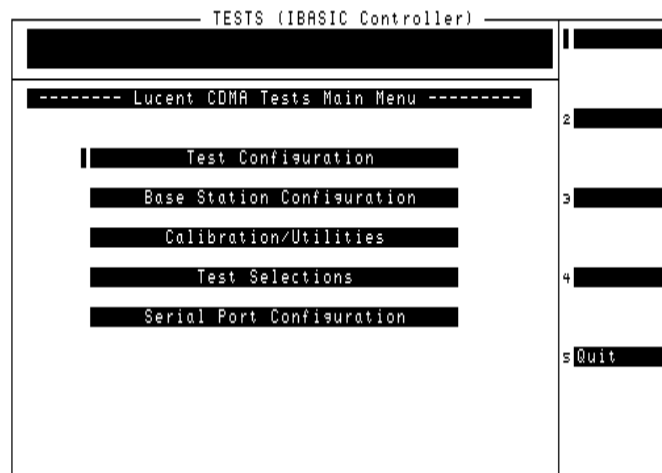
<p><b>5</b> Press the SOFTWARE Menu key to display the Lucent CDMA Tests Main Menu screen.</p> 	<p><b>6</b> Scroll to <b>Select Procedure Location:</b> and select it.</p> <p><b>Position</b></p>  <pre>LOAD TEST PROCEDURE: Select Procedure Location: [REDACTED] Select Procedure Filename: [REDACTED]</pre> <p><b>Select</b></p> 
<p><b>7</b> Scroll to <b>Card</b> and select it.</p> <p><b>Position</b></p>  <pre>Choices: [REDACTED] Card ROM RAM</pre> <p><b>Position</b></p> 	<p><b>8</b> Scroll to <b>Select Procedure Filename:</b> and select it.</p> <p><b>Position</b></p>  <pre>LOAD TEST PROCEDURE: Select Procedure Location: Card Select Procedure Filename: [REDACTED]</pre> <p><b>Select</b></p> 
<p><b>9</b> Scroll to <b>Choices:</b> and select the Procedure name.</p> <p><b>Position</b></p>  <pre>Choices: [REDACTED] DEMO LCDMA</pre> <p><b>Select</b></p> 	<p><b>10</b> Scroll to <b>Run Test</b> and select it. The Test Software will load.</p> <p><b>Position</b></p>  <pre>1 Run Test 2 Continue [REDACTED] 4 Help</pre> <p><b>Select</b></p>  <p>  Loading Time:          First time:          approximately          20 seconds.          After first time:          approximately          8 seconds.     </p>

## Navigating the Test Software

After the Test Software has loaded, the Lucent CDMA Tests Main Menu screen will appear on the Test Set display (see [Figure 2-3](#)).

Configuration operations, test utilities, and tests are grouped into sub-menus. Turn and press the knob to access the desired sub-menu.

**Figure 2-3** Lucent CDMA Tests Main Menu Screen



### Main Menu Functions

- **Test Configuration** – Define test information used by all tests; such as identifying the timing reference signal source, measurement port selection, number of averages, Walsh code power units, cable losses, and Base Station TX Test Port coupling factor.
- **Base Station Configuration** – Enter the specific cell site and Base Station information that the Test Software requires to control the Base Station when communicating with the MSC during tests (after configuring the PC and verifying its operation).
- **Calibration/Utilities** – Access procedures used to ensure optimal calibration of the Test Set and test cables.
- **Test Selections** – Access the available tests.
- **Serial Port Configuration** – Access routines used to define the serial port communication settings for interfacing with the PC serial port.



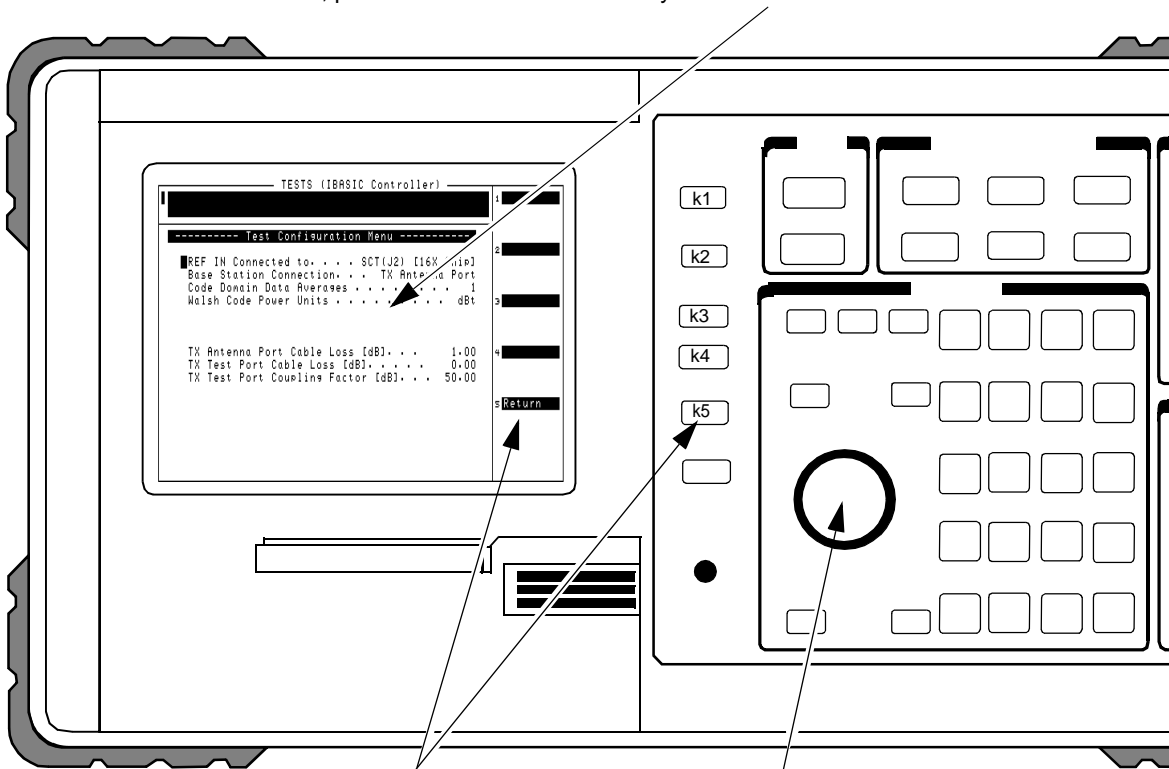
## Changing Settings and Using USER Keys

See [Figure 2-4](#) for information on settings and USER keys.

**Figure 2-4** Settings and USER Keys

### Menu Selections

Some Menu selections are entry fields. When one of these is selected, a highlighted area appears and you may key in a value using the DATA keys, or rotate the knob to change the value in the field. When the desired value is set, press the knob or the **Enter** key.



### USER Keys and Fields

The USER Keys (**k1 - k5**) correspond to fields 1-5 on the right side of the test screen. These keys are used for navigating through menus and for making selections. In many lower-level menus, a "Return" key is provided to display the previous screen.

### Knob

The knob controls the cursor position on the display and is used sometimes to make numeric entries. Pressing the knob has the same effect as pressing the **Enter** key.

---

## Operating the BTS Laptop Utility Program

The Test Software can control the cell site to perform tests in much less time than would be required under manual control. In order to control the Base Station, you may use a PC and modem to dial the MSC directly, or you may use a PC to establish a telnet connection to the MSC. The BTS Laptop Utility program running on that PC allows the Test Set to communicate with the MSC through the PC for automatic testing.

---

### NOTE

The method of site control described in this section is optional, but is highly desirable when possible. If you elect to use other means of controlling the site equipment, some information about the Base Station is still required. Enter the appropriate information in the Base Station Configuration Menu screen (see [“Base Station Configuration” on page 41](#)), skip the rest of this chapter, and start testing (see [Chapter 4, “Performing Tests,” on page 51](#)). See also [“Testing without MSC Control” on page 117](#).

If you elect not to control the MSC using a PC, you may skip the rest of this chapter. Note however, that the procedures in [Chapter 4, “Performing Tests,”](#) use a PC for site control.

---

The BTS Laptop Utility program is shipped with the Test Software on two separate 3.5-inch diskettes. You must install the BTS Laptop Utility program on the PC to communicate with the MSC. The utility program also provides several other helpful functions.

The BTS Laptop Utility program provides the following window functions:

- **Switch Terminal** – A window that: 1) works with the PC internal modem to dial into the MSC, or with the PC and a telnet connection to the MSC, and 2) displays the information sent to and from the MSC.
- **Test Set Terminal** – A window in which you may view commands sent by the Test Set to the MSC.
- **Other Data** – This window is not used in CDMA testing.
- **Test Results** – A window in which automated test results are displayed and may be saved for later use.
- **Test Set Screen Capture** – A window in which to capture screen images and save each as a bit mapped image. This is very helpful when using the Test Set spectrum analyzer or when you wish to capture some other screen. Note that IBASIC program operation must be paused first, by pressing the **Pause/Continue** key, to print any of the TESTS screens used for automated testing.

For more information on the windows in the above list, see [“BTS Laptop Utility Program Windows” on page 105](#). For additional information on using the BTS Laptop Utility program after installation, refer to the online Help topics included with that program.

### System Requirements for BTS Laptop Utility Program

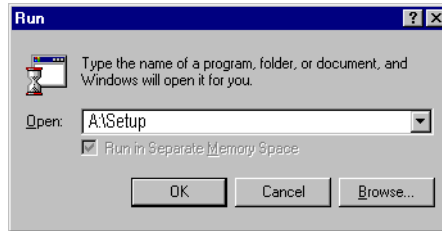
If the PC does not meet the following minimum system requirements, this could cause erratic operation and longer test times.

- 166-MHz Pentium® Processor
- 16 megabytes of RAM
- Windows® 95, Windows 98, or Windows NT 4.0 (Intel based)
- Available RS-232 serial port
- Internal modem

### Installing the BTS Laptop Utility Program

The BTS Laptop Utility program comes compressed on two install diskettes for easy setup on the PC. Simply insert the first diskette into the drive, select **start** then **Run**, then type **A:\Setup**. The install shield will lead you through the installation process (see [Figure 2-5](#)).

**Figure 2-5** Installing the BTS Laptop Utility Program



## Configuring the Test Set and PC Serial Ports for Communication with the Test Set

After installing the BTS Laptop Utility program, you must configure the Test Set and PC serial ports to communicate with the Test Set.

Configure the serial ports as follows:

- Step 1.** On the Test Set, determine and record the Test Set SERIAL 9 port data transfer (baud) rate as follows:
- Load and run the Test Software (see “[Loading and Running the Test Software](#)” on [page 23](#)). The Test Software will display the Lucent CDMA Tests Main Menu screen.
  - Select the **Serial Port Configuration** field. The Test Software will display the Serial Port Configuration Menu screen.
  - Select the **Serial 9 Port Configuration** field. The Test Software will display the Serial 9 Port Configuration Menu screen.
  - Select and set the following Serial 9 Port Configuration Menu fields as appropriate for operation with the BTS Laptop Utility program.
    - **Baud Rate** – Select the field and then select a value from the drop-down **Choices:** list to match the Baud Rate setting in the BTS Laptop Utility program **Preferences, Comm Port Setup** drop-down window. The default value is 9600. However, the Test Software will operate more quickly at 19200, so it is recommended that you change the value to 19200.

---

**NOTE**

**IMPORTANT:** If you select a baud rate greater than 19200, the PC must remain connected to the Test Set or the Test Set will not operate properly, and might appear to be locked up.

- **Data Length** – Select the field and select **8** from the drop-down **Choices:** list.
- **Parity** – Select the field and select **None** from the drop-down **Choices:** list.
- **Stop Length** – Select the field and select **1** from the drop-down **Choices:** list.
- **Flow Control** – The default is **None**. If it is not set to the default, select the field and select **None** from the drop-down **Choices:** list.

---

**NOTE**

For optimum performance, use the following settings for **Flow Control**:

For baud rates  $\leq 19200$ , **Flow Control** should be set to **None**.

For baud rates  $>19200$ , **Flow Control** should be set to **Hardware**.

- Step 2.** On the PC, determine and record the PC serial COM port designation (for example, COM1) from the Windows Device Manager Ports (COM & LPT) selection.
- Step 3.** On the PC, invoke the BTS Utility program. The BTS Utility program tool bar will appear on the PC display.
- Step 4.** Select **SW, TS, OD,** or **TR** (any one will do) from the BTS Laptop Utility program tool bar.

- Step 5.** Select **Preferences**, then **Comm Port Setup**.
- Step 6.** On the **Comm Port Setup** drop-down window, in the **Test Set - Port** list, select the port that the PC will use to communicate with the Test Set, as determined in Step 2.
- Step 7.** On the **Comm Port Setup** drop-down menu, in the **Test Set - Baud Rate** list, select the data transfer rate at which the PC will communicate with the Test Set, as determined in Step 1. This value will not automatically adjust during the session. The recommended baud rate for the Test Set is 19200.

## Configuring the PC to Communicate with the MSC

After installing the BTS Laptop Utility program, if you are using the utility program to communicate with the MSC, you must configure the PC to do so. This may be done in either of two ways: 1) by using modem to dial the MSC directly, or 2) by using a telnet connection. The telnet connection may be either a dial-up Internet connection, or a direct Internet connection. The dial-up Internet connection would use the PC modem; the direct Internet connection would use a PC LAN (the most common of which is ethernet).

### Modem Connection

If you elect to use a modem connection, configure the MSC connection as follows:

- Step 1.** On the PC, determine and record the PC modem port COM designation (for example, COM2) from the Windows Device Manager Modem selection.
- Step 2.** On the PC, invoke the BTS Laptop Utility program. The BTS Laptop Utility program tool bar will appear on the PC display.
- Step 3.** Select **SW**, **TS**, **OD**, or **TR** (any one will do) from the BTS Laptop Utility program tool bar.
- Step 4.** Select **Preferences**, then **Comm Port Setup**.
- Step 5.** On the **Comm Port Setup** drop-down menu, in the **Switch - Port** list, select the PC COM port assigned to the PC modem, as determined in Step 1.

If the modem port is already in use, the Test Software will display a message stating that a device already has control of that port. The most common cause is a communication program running in the PC background. Close the other program and reselect the required COM port.

- Step 6.** On the **Comm Port Setup** drop-down menu, in the **Switch - Baud Rate** list, select the data transfer rate at which the PC will communicate with the modem. Note that this is not the rate at which the modem will communicate with the MSC. Most modems negotiate at the start of the session with the modem on the other end of the line for the best data transfer rate. A typical setting is 57600.

### Telnet Connection

If you elect to use a telnet connection, configure the MSC connection as follows:

- Step 1.** On the PC, invoke the BTS Laptop Utility program. The BTS Laptop Utility program tool bar will appear on the PC display.
- Step 2.** Select **SW**, **TS**, **OD**, or **TR** (any one will do) from the BTS Laptop Utility program tool bar.
- Step 3.** Select **Preferences**, then **Comm Port Setup**.
- Step 4.** On the **Comm Port Setup** drop-down menu, in the **Switch - Port** list, select Telnet.
- Step 5.** On the **Comm Port Setup** drop-down menu, the **Switch - Baud Rate** list is not active for a telnet connection. Make no selection.

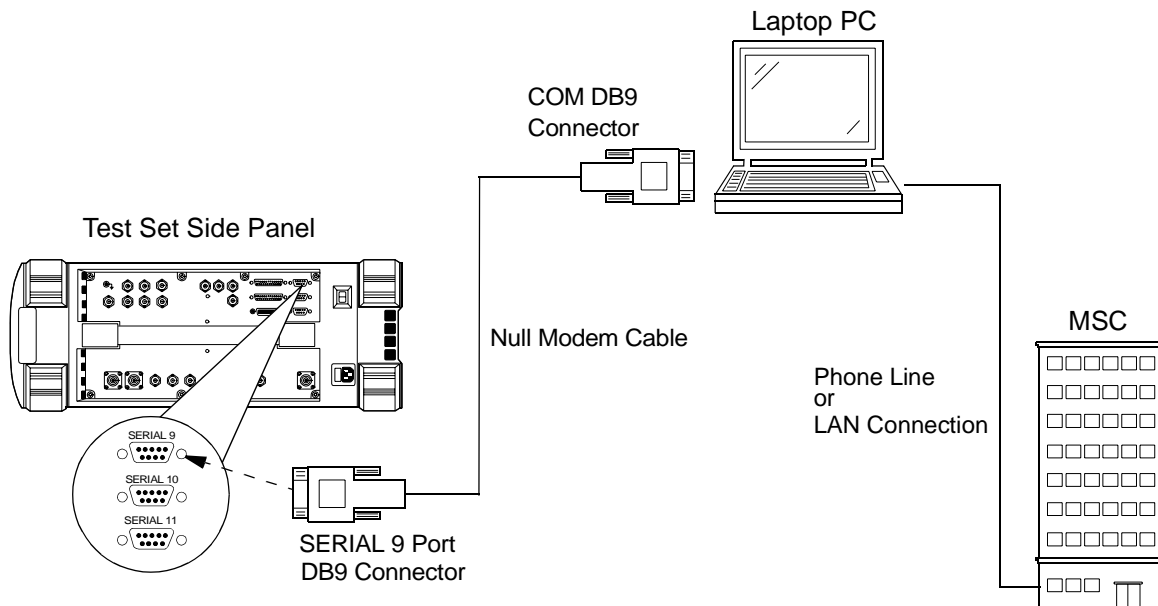
## Connecting the PC to the Test Set and the MSC

The following sections describe the processes for connecting the PC to both the Test Set and the MSC.

### Connecting the PC to the Test Set

Connect a null modem cable (DB9 to DB9) from the Test Set to the COM port of the PC as shown in [Figure 2-6](#).

**Figure 2-6** Test Set to PC and PC to MSC Connection



At this point, you should be able to communicate with the Test Software.

To test the connection, configure the test set as follows, then attempt a screen capture.

#### NOTE

The screen capture function is inoperable while the Test Software is running. The Test Software must be paused.

- Step 1.** If the Test Software is running (a star appears in the upper right-hand corner of the display), press the **Pause/Continue** key to pause it.
- Step 2.** Press the Test Set **Shift** key, then the **Inst Config (I/O Config)** key. The Test Set will display the I/O CONFIGURE screen.
- Step 3.** Select the **serial\_9 In** field and press the knob to toggle the setting to **Inst** (underlined).
- Step 4.** Press the Test Set **Shift** key, then the **Print (Printer Config)** key. The Test Set will display the PRINTER CONFIGURE screen.
- Step 5.** Select the **Model** field and select **DeskJet** from the drop-down **Choices:** list.

- Step 6.** Select the **Printer Port** field and select **Serial 9** from the drop-down **Choices:** list.
- Step 7.** With the cable connections complete and BTS Laptop Utility program running on the PC, press the Test Set **Print** key. The currently-displayed screen should appear in the Test Set Screen Capture window on the PC screen.

## Connecting the PC to the MSC

After installing BTS Laptop Utility program on the PC, you must establish the connection between the PC and the MSC. This may be accomplished using either a direct dial-up modem connection or a telnet connection. These methods are described in the following sections.

Connect the PC to the MSC via a phone line or LAN connection as shown in [Figure 2-6](#)

### Testing a Direct-Dial Modem Connection

The PC modem must be connected to a phone line capable of connecting to the MSC. If no phone line is available at the Base Station, a wireless phone with a properly configured wireless-capable modem will suffice.

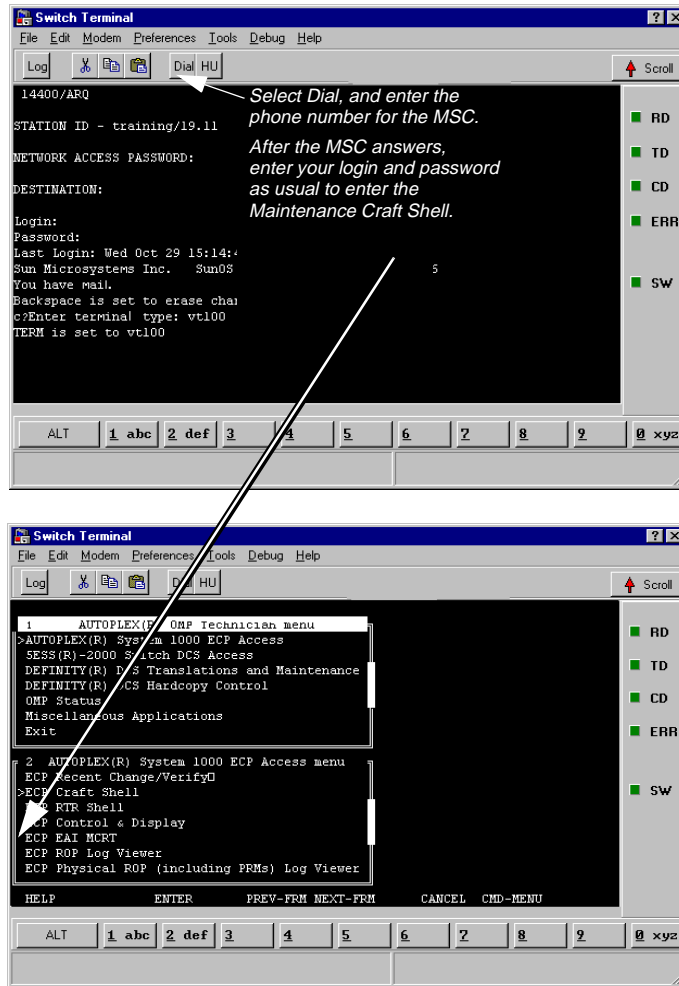
Test a modem connection as follows:

- Step 1.** From the BTS Laptop Utility program tool bar, select **SW**.
- Step 2.** In the **Switch Terminal** window, select **Dial**.
- Step 3.** In the drop-down **Dial** window, enter the MSC phone number, then select **OK** (see [Figure 2-7](#)).
- Step 4.** When prompted in the **Switch Terminal** window by the MSC, enter the same commands that you would use in your usual communication program to log in to the ECP. Once logged into the ECP, enter the maintenance craft shell. When you have finished, a command prompt will appear, which indicates that the MSC is waiting for the next command.

If you intend to start testing the Base Station soon, leave the MSC connection enabled. If some time will elapse before you start testing, log off from the MSC, and click on the **Hangup/Disconnect (HU)** button in the **Switch Terminal** window.



Figure 2-7 Dialing and Logging Into the MSC Using the Switch Terminal Window



### Testing a Telnet Connection

The telnet connection uses the Internet to connect to the MSC. You may use either a direct connection (using a LAN such as ethernet) or a dial-up connection (using the PC modem).

Test a telnet connection as follows:

- Step 1.** Use the PC to establish a telnet connection to the MSC according to your preferred method (direct or dial-up).
- Step 2.** From the BTS Laptop Utility program tool bar, select **SW**.
- Step 3.** In the **Switch Terminal** window, select **Dial**.
- Step 4.** In the drop-down **Dial** window, enter the IP address as the phone number, then select **OK** (see [Figure 2-7](#)).
- Step 5.** When prompted by the MSC in the **Switch Terminal** window, enter the same commands that you would use in your usual communication program to log in to the ECP. Once logged into the ECP, enter the maintenance craft shell. When you have finished, a command prompt will appear, which indicates that the MSC is waiting for the next command.

If you intend to start testing the Base Station soon, leave the MSC connection enabled. If some time will elapse before you start testing, log off from the MSC, and click on the **Hangup/Disconnect (HU)** button in the **Switch Terminal** window.

---

## Determining the Test Set to Site Equipment Connections

At this point in the process, you must decide the clock reference, the Test Set port, and the Base Station port to be used in testing. At appropriate points in a test sequence, the Test Software will display prompts directing you to make connections. For details on the required connections, see [Chapter 3, “Connections,” on page 45](#).

### Which Clock to Use – SCT Clock or External Reference?

If you elect to use the SCT clock signal, connect and enable it as follows:

- Step 1.** Connect the clock signals (19.6608-MHz and even-second) and transmitter output to the Test Set (see [“Test Set to Base Station Connections” on page 46](#)).
- Step 2.** Set the TST CLK switch on the SCT module to ON to enable the Base Station clock signals.

If you elect to use a separate GPS reference instead of the cell site clocks, see [“Test Set to GPS Time and Frequency Reference Receiver Connections” on page 50](#).

### Which Test Set Port to Use – ANT IN or RF IN/OUT?

---

**CAUTION**

The Test Set ANT IN port is only used for very low signal levels  $\leq 60$  milliwatts (17.78 dBm). Therefore, to prevent damage to the Test Set, *never connect this port directly to the Base Station TX Antenna Port*. This port is typically connected to the Base Station TX Test Port.

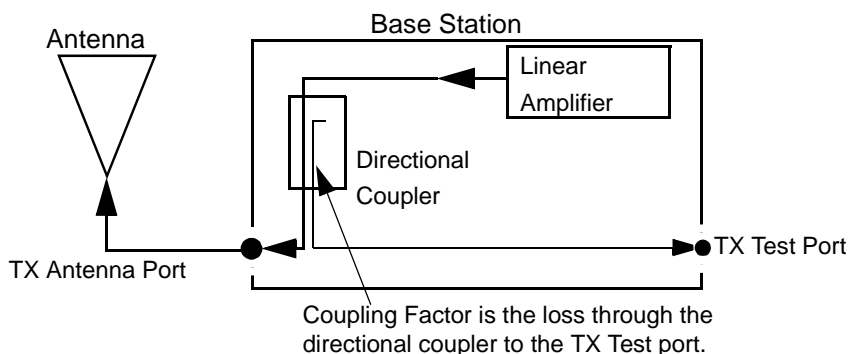
The Test Set RF IN/OUT port is for CDMA signals of  $\leq 15$  watts or continuous wave signals of  $\leq 75$  watts. This is the only port on the Test Set that you should connect directly to the Base Station TX Antenna Port. If power levels from the Base Station exceed the specification of the port, use an appropriate signal attenuator.

### Which Base Station Port to Use – TX Test or TX Antenna?

Testing may be performed while connected to either the Base Station Test Port or the Base Station Antenna Port. Testing at the Antenna Port involves taking the Base Station out of service. The choices are described in the following sections.

#### In-Service Testing Using the Base Station TX Test Port

The Base Station TX Test Port signal is derived from the directional coupler that is connected between the Linear Amplifier and the Base Station TX Antenna Port (see [Figure 2-8](#)). This allows you to make measurements on an active Base Station without disconnecting the transmit antenna and interrupting service. You must enter a value for the coupling factor (loss) through the directional coupler to compensate power measurements (see [“Test Configuration” on page 39](#)). Coupling factors are typically 40 to 70 dB, but might vary, depending on the Base Station design.

**Figure 2-8 Transmitter Output Path Simplified Diagram**

If you are uncertain of the exact coupling factor, the Test Software contains a utility to measure the coupling factor (see “TX Test Port Calibration Test” on page 77).

**NOTE**

If you are uncertain of the Specified Output Power for the transmitter at the Base Station TX Antenna Port, the Test Software must measure the power to calculate the coupling factor. This requires that you take the Base Station out of service to connect the Test Set directly to the Base Station TX Antenna Port during the calibration routine.

One disadvantage to using the Base Station TX Test Port to make measurements is the possibility that its coupler is malfunctioning and therefore will cause erroneous measurements. If TX power measurements fail by a large amount, but you suspect the actual *transmitted* power is correct, take the Base Station out of service and make measurements directly at the Base Station TX Antenna Port to verify the failing reading. If the Test Software is correctly configured, TX power measurements using the Base Station TX Test Port and TX Antenna Port should not differ significantly.

**Out-of-Service Testing Using the Base Station TX Antenna Port**

Disconnecting a TX antenna feed line and connecting the Test Set to the Base Station TX Antenna Port (see Figure 2-8) requires that you first take the Base Station out of service (disable call processing and turn off all transmissions to that TX Antenna Port).

The Base Station may be taken out of service (and turned back on to make measurements) in two ways:

1. Access the MSC using a PC and the BTS Laptop Utility program to control the Base Station through its maintenance software.
2. Call the MSC and have switch personnel control the Base Station for you.

One benefit of testing directly at the Base Station TX Antenna Port is the confidence that the measurement will reflect the true output power of the Base Station at the point at which the antenna feed line connects to the Base Station. This verifies the operation of the full transmission path inside the Base Station. It also provides an opportunity to perform transmission line and antenna testing while the antenna is disconnected from the Base Station.

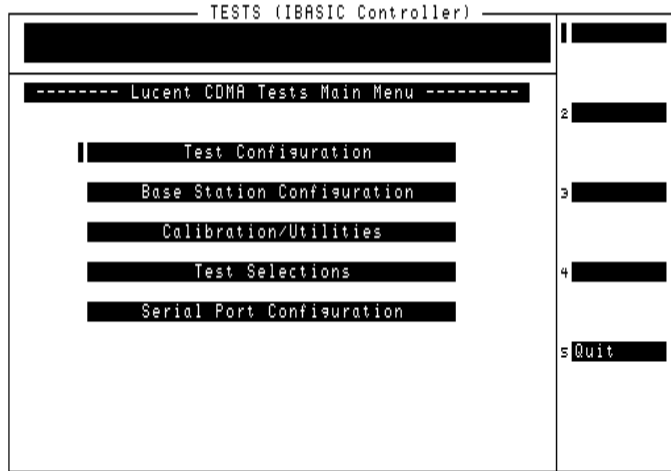
---

## Configuring the Test Software

If the Test Software is not loaded and running, see “Loading and Running the Test Software” on page 23.

After the Test Software has loaded and is running, the Test Software will display the Lucent CDMA Tests Main Menu screen (see Figure 2-9). Configuration operations, test utilities, and tests are grouped into the listed sub-menus. Turn and press the knob to access the desired sub-menu.

**Figure 2-9** Lucent CDMA Tests Main Menu Screen



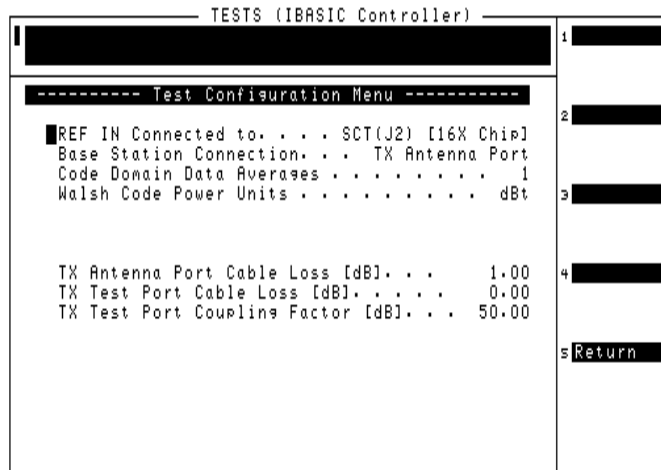
## Test Configuration

Before the Test Software can perform automated Base Station testing, it must have available certain information regarding test conditions. Supply this information on the Test Configuration Menu screen.

Configure the test as follows:

- Step 1.** Select the **Test Configuration** field. The Test Software will display the Test Configuration Menu (see [Figure 2-10](#)).

**Figure 2-10** Specifying Test Configuration Information



- Step 2.** Select the **REF IN Connected to** field and select the source of the input signal from the drop-down **Choices:** list. The selections are: **SCT (J2) [16X Chip]** (typically, the 19.6608-MHz clock from one of the cell site SCT modules) or **GPS [10 MHz]**, which is from a GPS receiver.
- Step 3.** Select the **Base Station Connection** field and select the test port to be used in the measurement from the drop-down **Choices:** list. The selections are: **TX Antenna Port** (which supplies the transmitter power directly to the antenna) or **TX Test Port** (which comes from a directional coupler in the transmitter output).
- Step 4.** Select the **Code Domain Averages** field, rotate the knob to the desired value, then press the knob to select it. Choose this value carefully. More data samples when averaging measurements will increase testing time, but will reduce the effects of small level changes, thus producing higher consistency and providing a higher confidence level for the test results.
- Step 5.** Select the **Walsh Code Power Units** field and select the units in which the Walsh code power will be displayed from the drop-down **Choices:** list. The selections are: **dBt**, **dBm**, and **Watts**. The unit “dBt” refers to the power of a Walsh code relative to the total measured channel power. The units dBm and Watts are measurements of the absolute power for a Walsh code.

- Step 6.** Select the **TX Antenna Port Cable Loss [dB]** field, rotate the knob to the loss value for the cable that you connect from the Test Set RF IN/OUT port to the Base Station TX Antenna port, and press the knob to select it. If you are uncertain of the cable loss value, run the [“TX Antenna Port Cable Calibration Test” on page 75](#) to measure and enter the value automatically.
- Step 7.** Select the **TX Test Port Cable Loss [dB]** field, rotate the knob to the loss value of the cable that you connect from the Test Set ANT IN port to the Base Station TX Test Port, and press the knob to select it. If you are uncertain of the cable loss value, run the [“TX Test Port Cable Calibration Test” on page 76](#) to measure and enter the value automatically.
- Step 8.** Select the **TX Antenna Port Coupling Factor [dB]** field, rotate the knob to the value of the loss through the directional coupler used to provide the transmitter signal to the Base Station TX Test Port, and press the knob to select it. The Test Software will use this value to calculate the transmitter true power output without the requirement for disconnecting the transmit antenna from the TX Antenna port. If you are uncertain of the coupling factor value, run the [“TX Test Port Calibration Test” on page 77](#) to measure and enter this value automatically.

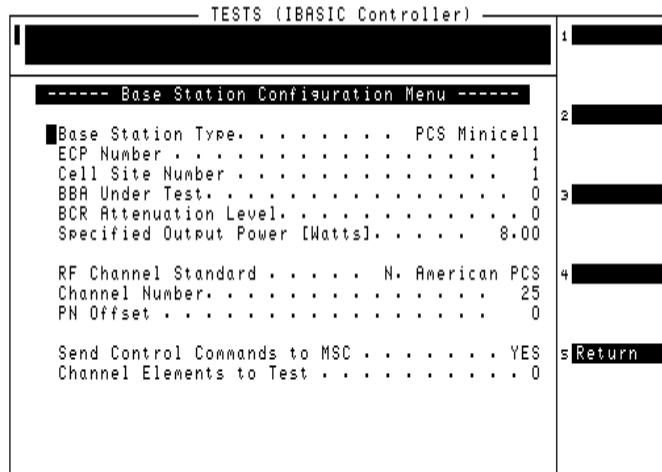
## Base Station Configuration

Before the Test Software can control the Base Station, it must be able to notify the MSC as to the cell site and BBA to test. The Test Software also requires a value as to the amount of power to be measured. You must supply this information on the Base Station Configuration Menu screen.

Configure the Base Station as follows:

- Step 1.** Select the **Base Station Configuration** field. The Test Software will display the Base Station Configuration Menu (see [Figure 2-11](#)).

**Figure 2-11** Specifying Base Station Configuration Information



- Step 2.** Select the **Base Station Type** field and select the type of Base Station to be tested from the drop-down **Choices:** list: **PCS Minicell** or **Autoplex Series II**.
- Step 3.** Select the **ECP Number** field, rotate the knob to the number for the ECP that controls the cell site to be tested, and press the knob to select it.
- Step 4.** Select the **Cell site Number** field, rotate the knob to the number for the cell site to be tested, and press the knob to select it.
- Step 5.** Select the **BBA Under Test** field, rotate the knob to the number of the BBA to be tested, and press the knob to select it.
- Step 6.** Select the **BCR Attenuation Level** field, turn the knob to the value that is to be used to control Base Station power by the MSC when measuring transmitted power, and press the knob to select it. This value will vary according to the Base Station type (model) and geographic location (see [“Transmit Power Calibration Test \(Autoplex Series II\)”](#) on page 56 for more information).



**Step 7.** Select the **Specified Output Power [Watts]** field, turn the knob to the expected output power at the TX Antenna port (foam jumper) or at the Base Station TX Test Port after subtracting the coupling factor, and press the knob to enter it. This value must be set for both manual and automated testing.

---

**NOTE**

This output power setting is for a pilot channel only signal. It is affected by: 1) the number of channel elements that are active, and 2) the BCR attenuation setting and digital gain unit (DGU) settings for the pilot, sync, paging, and traffic channels in the translation table. Use the value specified by Lucent for testing power.

---

**Step 8.** Select the **RF Channel Standard** field and select from the drop-down **Choices:** list the standard to be used when you enter a channel number: **N. American Cellular**, **N. American PCS**, or **Korean PCS P4**.

**Step 9.** Select the **Channel Number** field, rotate the knob to the number for the CDMA channel on which the Base Station is transmitting, and press the knob to select it.

**Step 10.** Select the **PN Offset** field, rotate the knob to the value for the cell site, and press the knob to enter it. If you are uncertain of the offset, run the [“PN Offset Search Test” on page 79](#) to find and enter the number automatically.

**Step 11.** Select the **Send Control Commands to MSC** field.

If you wish to use automated control of the cell site, press the knob to toggle it to **YES**. If you toggle it to **YES**, the **Channel Elements to Test** field will appear on the next line. Rotate the knob to the desired number between 0 and 55, and press the knob to select it; or use the DATA ENTRY keys to enter the number and either press the knob or press the **Enter** key.

If you wish to use manual control of the cell site, press the knob to toggle it to **No**.

**Step 12.** Press the **k5 (Return)** key to return to the Lucent CDMA Tests Main Menu screen.

---

## Establishing a Connection with the MSC for Testing

If it is not set up already, you must establish the connection between the PC and the MSC. This may be accomplished using either a direct dial-up modem connection or a telnet connection. These methods are described in the following sections.

Connect the PC to the MSC via a phone line or LAN connection as shown in [Figure 2-6 on page 32](#).

### Establishing a Direct-Dial Modem Connection

The PC modem must be connected to a phone line capable of connecting to the MSC. If no phone line is available at the Base Station, a wireless phone with a properly configured wireless-capable modem will suffice.

Test a modem connection as follows:

- Step 1.** From the BTS Utility program tool bar, select **SW**.
- Step 2.** In the **Switch Terminal** window, select **Dial**.
- Step 3.** In the drop-down **Dial** window, enter the MSC phone number, then select **OK** (see [Figure 2-7 on page 34](#)).
- Step 4.** When prompted by the MSC in the **Switch Terminal** window, enter the same commands that you would use in your usual communication program to log in to the ECP. Once logged into the ECP, enter the maintenance craft shell. When you have finished, a command prompt will appear, which indicates that the MSC is waiting for the next command.

### Establishing a Telnet Connection

The telnet connection uses the Internet to connect to the MSC. You may use either a direct connection (using a LAN such as ethernet) or a dial-up connection (using the PC modem).

Test a telnet connection as follows:

- Step 1.** Use the PC to establish a telnet connection to the MSC according to your preferred method (direct or dial-up).
- Step 2.** From the BTS Utility program tool bar, select **SW**.
- Step 3.** In the **Switch Terminal** window, select **Dial**.
- Step 4.** In the drop-down **Dial** window, enter the IP address as the phone number, then select **OK** (see [Figure 2-7 on page 34](#)).
- Step 5.** When prompted by the MSC in the **Switch Terminal** window, enter the same commands that you would use in your usual communication program to log in to the ECP. Once logged into the ECP, enter the maintenance craft shell. When you have finished, a command prompt will appear, which indicates that the MSC is waiting for the next command.

---

## **If You Noticed Problems**

If you were unable to load and run the Test Software, make the required entries, or encountered error messages, refer to [Chapter 6, “Troubleshooting,” on page 119](#) for help.

---

## 3 **Connections**

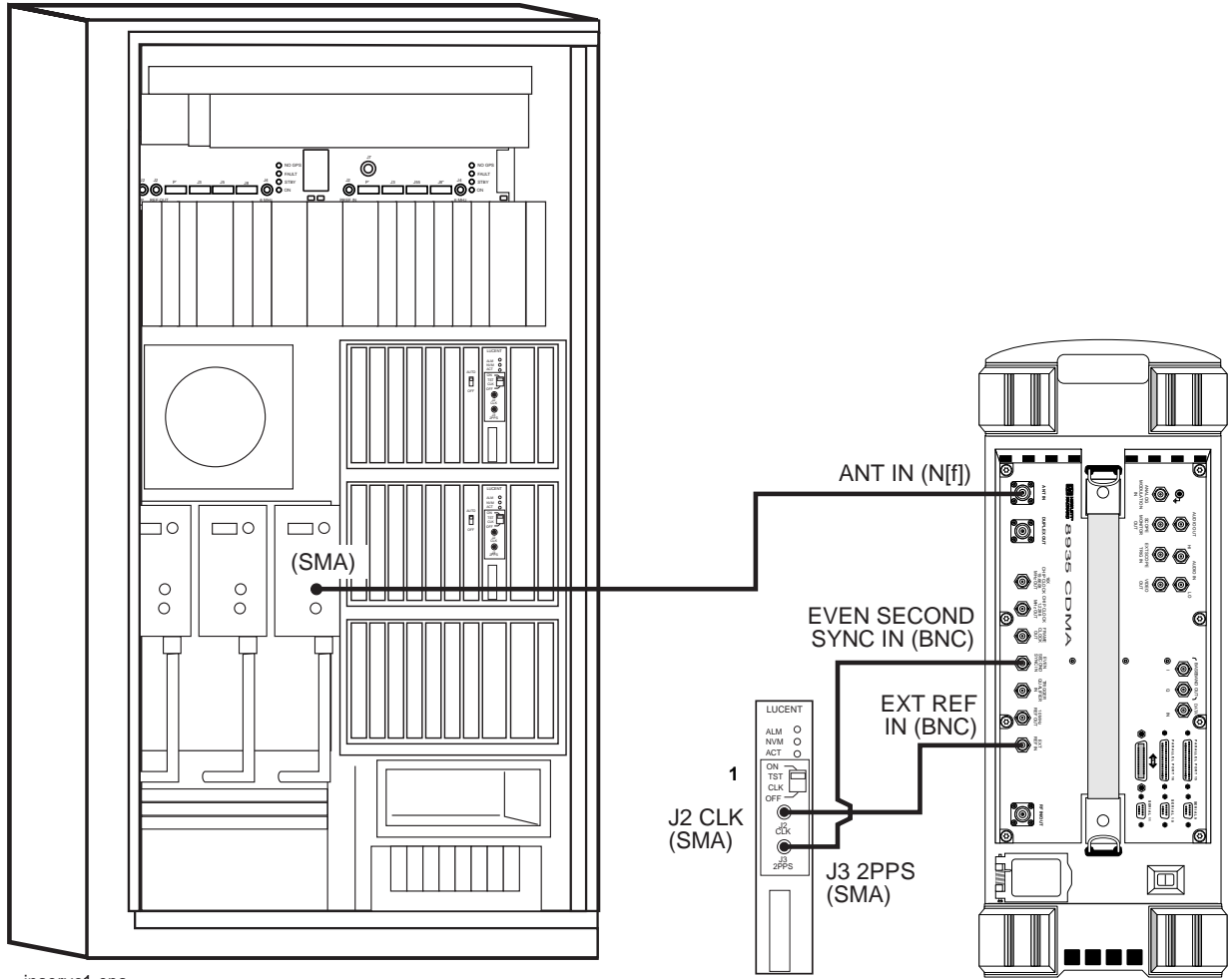
This chapter shows the connections between the Test Set and the Base Station and connections between the Test Set and the GPS Time and Frequency Reference Receiver.

The Test Software will display a screen prompt whenever a connection or a change in connections is required.

## Test Set to Base Station Connections

Figure 3-1, Figure 3-2 on page 47, Figure 3-3 on page 48, and Figure 3-4 on page 49 show connections between the Base Stations and the Test Set. All of the setups use the SCT module clocks for the Test Set reference.

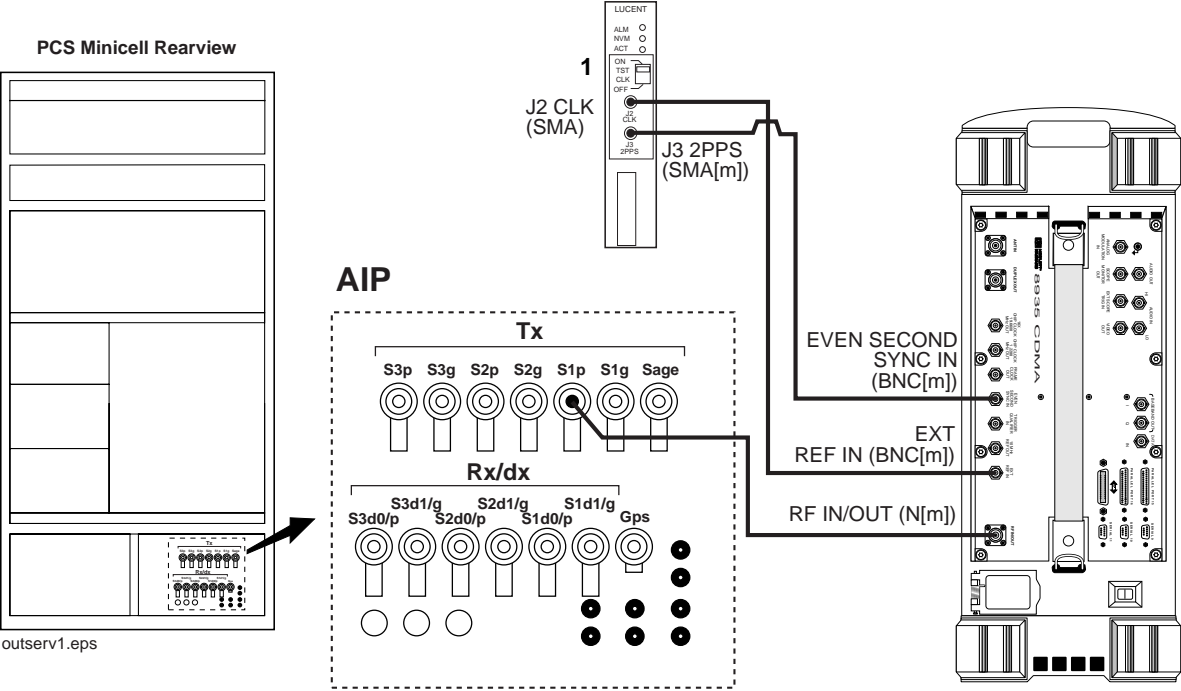
**Figure 3-1** PCS Minicell Base Station TX Test Port (In Service) Connections



inservc1.eps

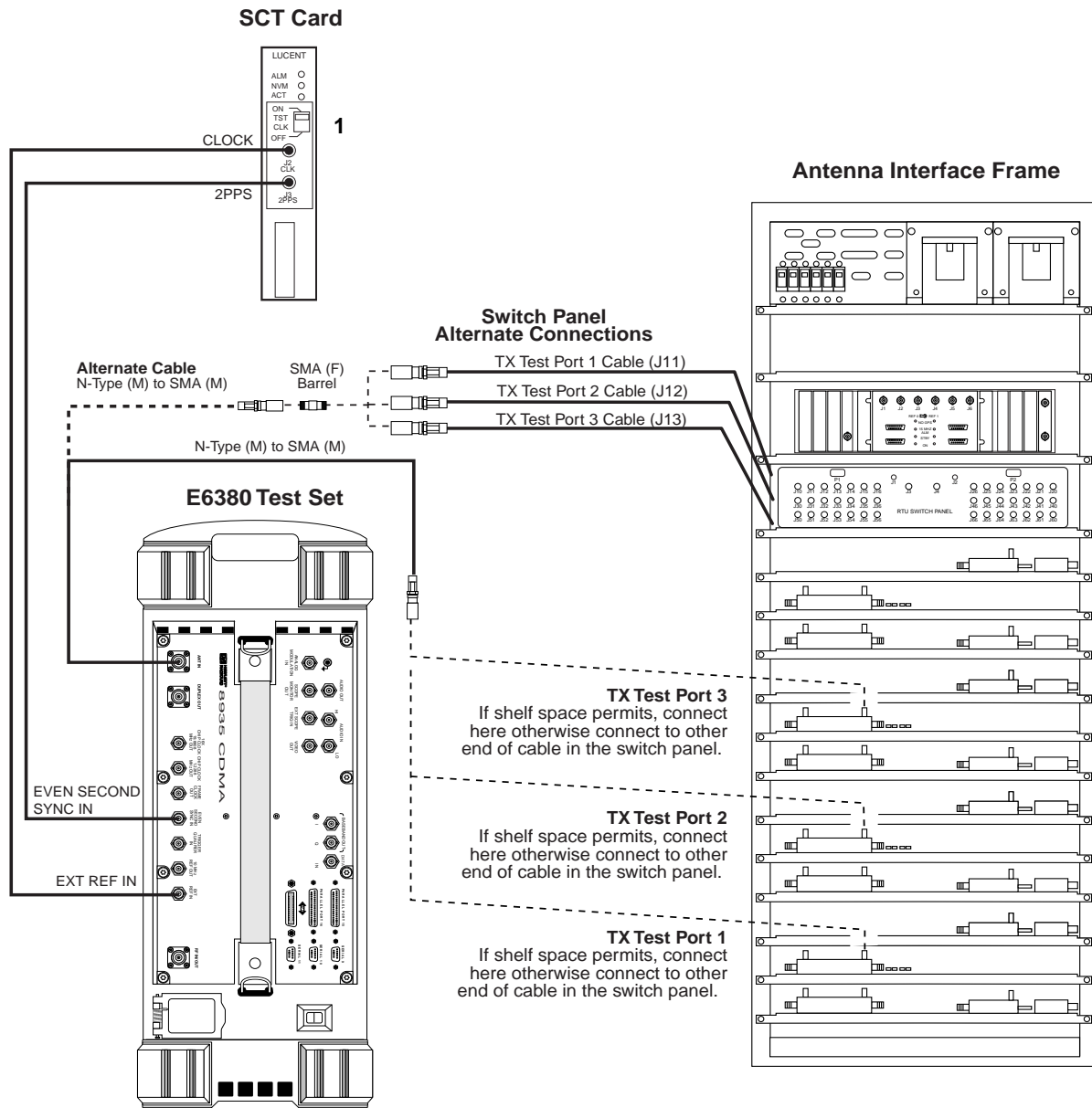
<sup>1</sup>The TST CLK switch on the SCT module must be set to ON.

Figure 3-2 PCS Minicell Base Station TX Antenna Port (Out of Service) Connections



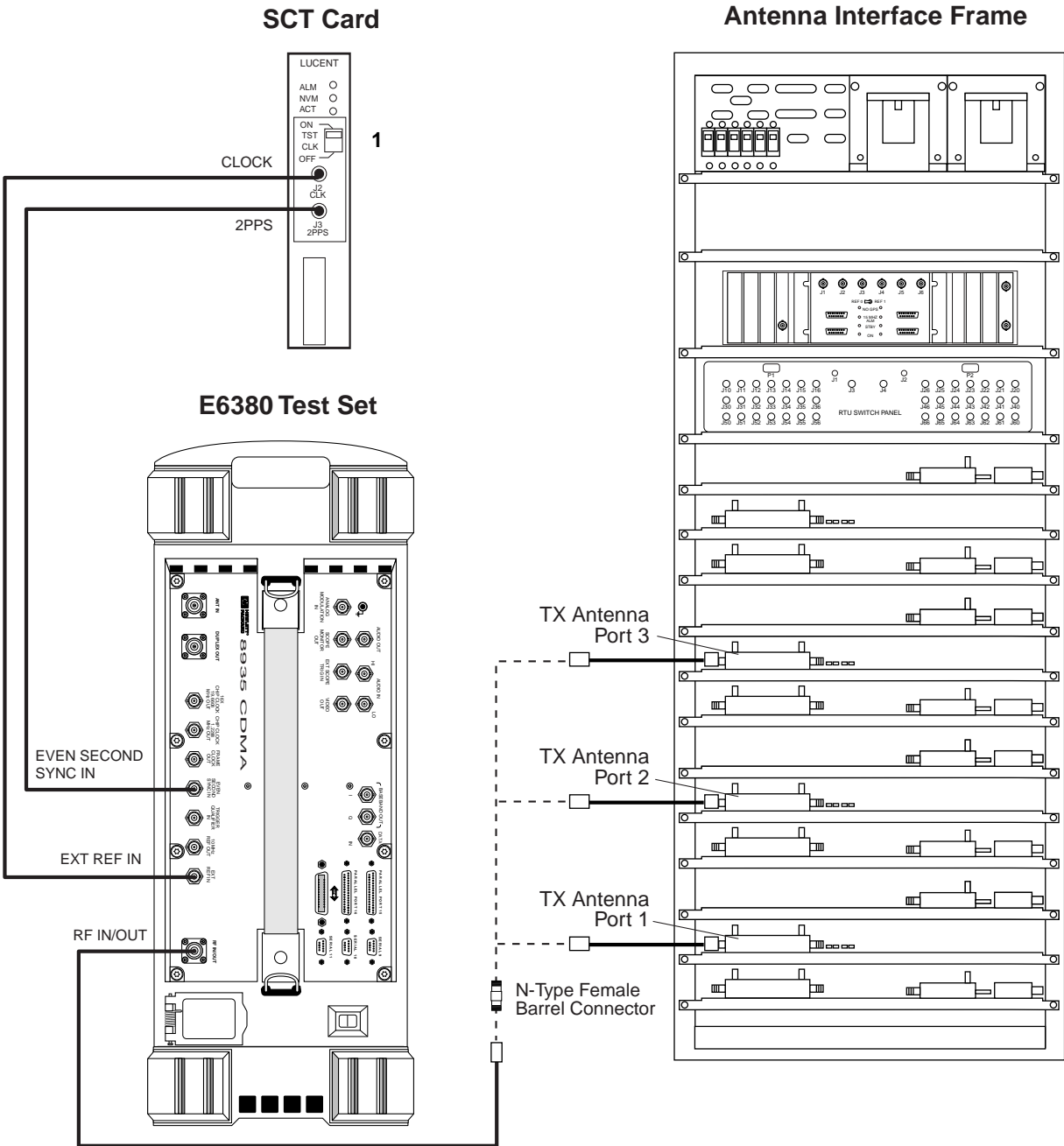
<sup>1</sup>The TST CLK switch on the SCT module must be set to ON.

**Figure 3-3 Series II Base Station Test Port (In Service) Connections**



<sup>1</sup>The TST CLK switch on the SCT module must be set to ON.

Figure 3-4 Series II Base Station TX Antenna Port (Out of Service) Connections



outservice.eps

<sup>1</sup>The TST CLK switch on the SCT module must be set to ON.

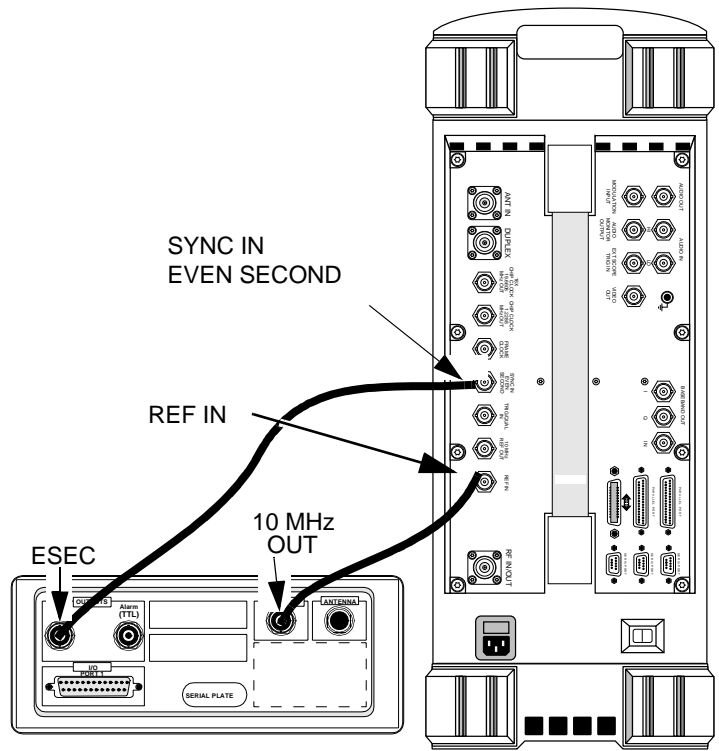


## Test Set to GPS Time and Frequency Reference Receiver Connections

Figure 3-5 shows the connections to the Test Set when using a Symmetricom 58503A GPS Time and Frequency Reference Receiver to establish a time base. This configuration uses a GPS signal for the Test Set timebase instead of connecting to the cell site SCT modules. See “GPS Time and Frequency Reference Receiver” on page 17 for information on electing to use the 58503A.

When using the 58503A, make certain to set the **REF IN Connected** to field on the Test Configuration Menu to **GPS Receiver** (see “Test Configuration” on page 39).

**Figure 3-5** Symmetricom 58503A GPS Time and Frequency Reference Receiver Connections



---

## 4 Performing Tests

This chapter describes detailed procedures to be used in running the Test Software tests and utilities.

## Overview

---

### NOTE

Testing might be interrupted if cell site diagnostics are initiated by the MSC while tests are being run. To prevent this, use a personal computer (PC) (usually a laptop PC) to send a command to inhibit diagnostics from the MSC before testing.

These test procedures describe the process from setting up a test to obtaining test results. To simplify the procedures, all are written to use a PC to communicate with the MSC (where applicable) and the Test Software will be set to send control commands.

Before making measurements, verify that you have performed the following setup and configuration processes:

- [“Loading and Running the Test Software” on page 23.](#)
- [“Operating the BTS Laptop Utility Program” on page 27.](#)
- [“Connecting the PC to the Test Set and the MSC” on page 32.](#)
- [“Configuring the Test Software” on page 38.](#)
- [“Establishing a Connection with the MSC for Testing” on page 43.](#)

## Calibrating the Test Setup

If you did not know the Base Station TX Antenna Port Cable Loss, or the Base Station TX Test Port Cable Loss, or the Base Station TX Coupler Losses when you entered the data on the Base Station Configuration Menu screen, run the following calibration routines to determine these losses. Determining these losses is crucial to obtaining accurate test results.

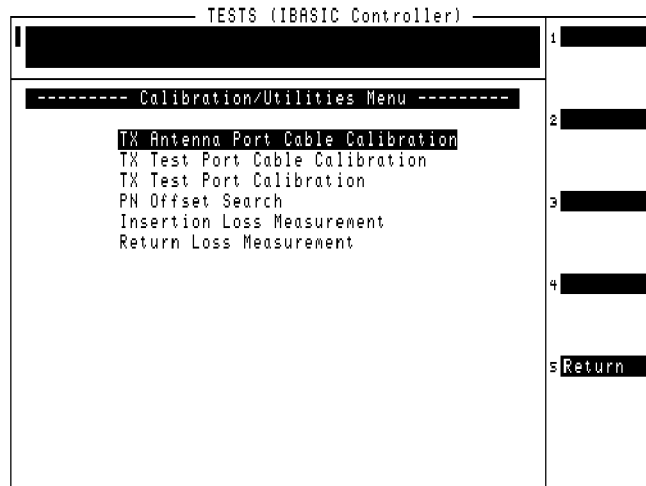
Access these routines by loading and running the Test Software (see [“Loading and Running the Test Software” on page 23](#)) and selecting **Calibration/Utilities** from the Lucent CDMA Tests Main Menu screen. The Test Software will display the Calibration/Utilities Menu screen (see [Figure 4-1](#)). After each measurement, the program will enter the value automatically into the Test Software for future testing (without your having to rerun the routines every time that you test). However, if you run a different program after the measurements, you must re-measure (or re-enter) the values the next time that you use the Test Software.

The Calibration procedures are:

- [“TX Antenna Port Cable Calibration Test” on page 75](#). Run this utility to determine antenna port cable losses at the frequency and power level at which testing will be performed.
- [“TX Test Port Cable Calibration Test” on page 76](#). Run this utility to determine test port cable losses at the frequency and power level at which testing will be performed.
- [“TX Test Port Calibration Test” on page 77](#). Run this utility to determine the exact coupling factor (loss) of the Base Station TX Test Port.

Figure 4-1

### Calibration/Utilities Menu Screen



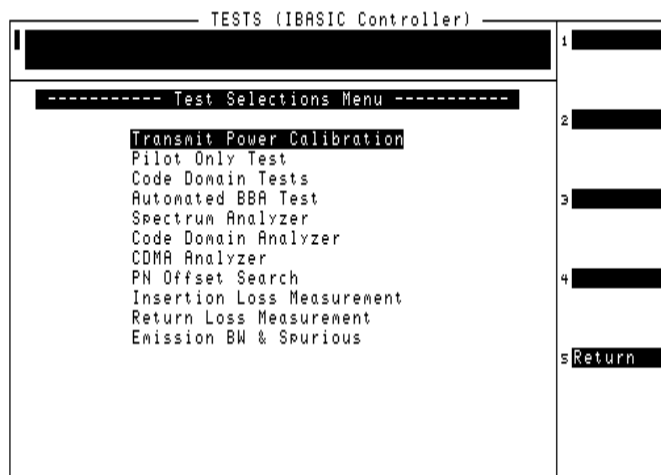
## Selecting Tests

Select tests by loading and running the Test Software (see “Loading and Running the Test Software” on page 23) and selecting the **Test Selections** field on the Lucent CDMA Tests Main Menu screen. The Test Software will display the Test Selections Menu screen (see Figure 4-2). Note that the several calibration and utility procedures (PN Offset Search, Insertion Loss Test, and Return Loss Test) are also available on this screen.

Once you have selected a test to run, see the following list to locate the description of that test.

- “Transmit Power Calibration Test (Autoplex Series II)” on page 56.
- “Transmit Power Calibration Test (PCS Minicell)” on page 58
- “Pilot Only Test” on page 62.
- “Code Domain Tests” on page 64.
- “Automated BBA Test” on page 66.
- “Spectrum Analyzer Test” on page 68.
- “Code Domain Analyzer Test” on page 70.
- “CDMA Analyzer Test” on page 73.
- “PN Offset Search Test” on page 79.
- “Insertion Loss Measurement” on page 80.
- “Return Loss Measurement” on page 82.
- “Emission BW & Spurious Test” on page 84.

**Figure 4-2** Test Selections Screen



## Running Tests

---

**NOTE**

---

Before starting to run operational tests, make certain that you have set PARAMETER 23. [ZZZZ Test Demo Mode \[0=normal 1=demo\]](#) to 0.

You are now ready to select and run tests. On the Test Selections Menu screen, scroll to the test that you wish to run, and press the knob to select it. The test will run. You may then select another test and run it in the same manner. You may repeat this operation as many times as is necessary.

After successfully running the tests, it is recommended that you save all of the configuration information as a procedure file on an SRAM card for later retrieval (see [“Saving/Deleting a Procedure” on page 101](#)). This eliminates the requirement for re-entering the information if you run a different program, change parameters when testing another Base Station, or install new operating system firmware in the Test Set.

### For More Information

**For more details on the tests in this chapter:**

- [“Parameters” on page 110](#)
- [“Specifications \(Pass/Fail Limits\)” on page 115](#)

**If there were problems or error messages were displayed when running a test:**

See [Chapter 6, “Troubleshooting,” on page 119](#).

---

## Transmit Power Calibration Test (Autoplex Series II)

This test provides an analog display of power measurements. This mode is useful when making adjustments to power levels on a transmitter.

This test may be performed in-service using the Base Station TX Test Port, or out-of-service using the Base Station TX Antenna Port (see [“Which Base Station Port to Use – TX Test or TX Antenna?”](#) on page 36).

Features of the power meter display include:

- Tick marks on the meter to indicate when a power level setting is within the desired limits.
- Audible tones to indicate whether the power reading falls within specified limits.

Make certain to use the correct Test Set input port for the power level to be measured (see [“Which Test Set Port to Use – ANT IN or RF IN/OUT?”](#) on page 36).

For Automated Base Station Control:

If you have configured the Test Software to control the Base Station automatically, the Test Software will send a command to the MSC to set the BCR attenuation to the level specified on the Base Station Configuration Menu screen.

However, the Test Software cannot override a minimum BCR attenuation level that has been set in the translation tables of the MSC CEQFACE form. If the measured power is not within specifications, make certain that the **BCR Attenuation** setting on the Base Station Configuration Menu screen is not set to a lower value than the minimum BCR attenuation level listed in the translation tables.

For Manual Base Station Control:

If you have configured the Test Software to require manual control of the Base Station, make certain that the **BCR Attenuation** setting on the Base Station Configuration Menu screen matches the BCR attenuation setting on the MSC CEQFACE control form. If these values are different, the TX Power Meter measurement might be incorrect.

---

### NOTE

Transmitter power is partly controlled by the MSC using the BCR attenuation setting. The value for this setting, and the corresponding TX power of the Base Station, varies between models of Base Station and individual Base Station location.

It is very important that you set correctly the **BCR Attenuation Level** and **Specified Output Power** on the Base Station Configuration Menu screen (see [“Base Station Configuration”](#) on page 41).

---

## Parameters and Specifications Used

The following specifications and parameters are used when running this test. See [Chapter 5, “Reference,”](#) for descriptions of the specifications and parameters.

### Parameters:

- None used for this test.

**Specifications (Pass/Fail Limits):**

- **6. Output Power Adjustment Error.** This specification determines where the low and high tick marks appear on the measurement graphic scale.

**Select and Run the Test**

Perform the Transmit Power Calibration Test as follows:

- Step 1.** From the Lucent CDMA Tests Main Menu screen, select the **Test selections** field. The Test Software will display the Test Selections Menu screen.
- Step 2.** Select the **Transmit Power Calibration** field.
- Step 3.** Follow the displayed instructions and diagram to make the measurement.

**NOTE**

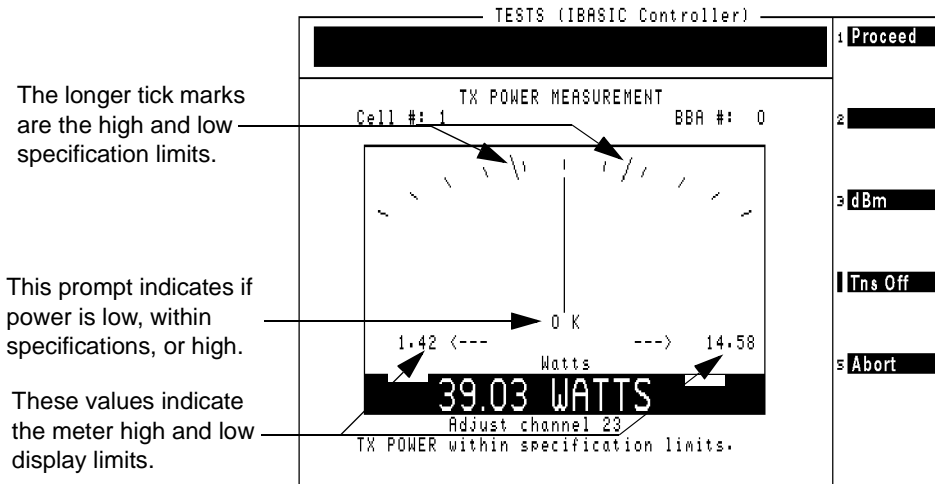
This procedure might include steps that prompt you to disconnect cables from the site antenna ports and make connections to the Test Set. Before removing or re-installing the antenna cables, make certain that the transmitter has been turned off by the MSC (or by switch personnel if not using a PC). The green ACT LEDs on the ACU and BCR modules indicate the transmitter is active, and therefore should be off before disconnecting cables.

**Review the Results**

The Test Software will display the power meter screen (see [Figure 4-3](#)).

The power meter will display defaults to units of Watts. To view the power level in dBm, press the **k3 (dBm)** key. A beeping tone will accompany the measurement to assist in adjusting the transmitter power without looking at the display. Adjust the tone volume by pressing the **k4 (Tns off, Tns quiet, Tns loud)** key.

**Figure 4-3 Power Meter Display**





---

## Transmit Power Calibration Test (PCS Minicell)

This test measures and calibrates the PCS Minicell RF transmit power. This test must be performed with the Base Station out-of-service using the Base Station TX Antenna Port. This test applies to both the 8-watt CDMA transmitter unit (CTU) and the 16-watt high-power CDMA transmitter unit (HPCTU). Also, it allows for settings for custom configurations.

The basic procedure for testing at the Base Station Antenna Output Port is as follows:

- Determine and input to the Test Software which routine diagnostics are to be inhibited on the Base Station during the test, and whether functional testing and call processing are also to be inhibited on the Base Station. The Test Software will send the appropriate CFR commands to the Base Station.
- If not already done, calibrate the Test Cables that will be used in measuring the Base Station output power.
- Determine and input to the Test Software the type of power amplifier used in the Base Station (CTU, HPCTU1, HPCTU2, HPCTU3, or HPCTU4). If you do not know the amplifier type, contact your engineering department.
- Determine the BCR attenuation factor from the forms in an APX/RCV session. After obtaining this information, input it to the Test Software. (You may use the BTS Laptop Utility program **SWITCH TERMINAL** window to set the forms.
- Once the Amplifier Type and BCR Attenuation Factor have been identified to the Test Software, it will determine the number of Channel Elements to add to the carrier to perform the power calibration test.
- Based on the Amplifier Type and BCR Attenuation Factor, the Test Software will determine the Calibration Power Level to be expected from the Base Station. This is the power level to which the amplifier will be adjusted during the test.
- The Amplifier Type selected will require that certain translations be set in the forms in an APX/RCV session. The Test Software will supply the translation values and identify the forms on which to set those values. You may use the BTS Laptop Utility program **SWITCH TERMINAL** window to set the forms.

---

### NOTE

**IMPORTANT:** If you change the translation values for this test, you must restore the values at the end of the test.

- The Test Software will send commands to the Base Station to configure the BBA under test and turn off the transmitter.
- Once the BBA stops transmitting, connect the test cables between the Test Set and the Base Station Power Output to measure the power.
- The Test Software will issue commands to cause the BBA to start transmitting.
- The Test Software will display a power meter to allow you to adjust the Base Station power to the proper range.
- The Test Software will display the Base Station power in watts and dBm on the Test Set screen and in the BTS Laptop Utility program **Test Results** window.
- The Test Software will again turn off the transmitter.

- Once the transmitter is turned off, remove the test cables and re-connect the Base Station power output to the antenna system.
- The Test Software will send commands to the Base Station to restore the BBA.
- The Test Software will then allow you to select whether to re-allow the routine diagnostics, functional test, and call processing that you inhibited at the beginning of the test. Based on your choices, the Test Software will send appropriate commands the Base Station.

---

**NOTE**

If multiple faces are to be tested, repeat the above process for each face to be tested, then verify cell site operation and perform pilot level functional test calibration for any BBAs that were re-calibrated.

---

## Parameters and Specifications Used

The following specifications and parameters are used when running this test. See [Chapter 5, “Reference,”](#) for descriptions of the specifications and parameters.

### Parameters:

- None used for this test.

### Specifications (Pass/Fail Limits):

- [6. Output Power Adjustment Error](#). This specification determines where the low and high tick marks appear on the measurement graphic scale.

## Test Set-Up Procedure

Set up the Test Software and Base Station for running the Transmit Power Calibration Test as follows:

- Step 1.** From the Lucent CDMA Tests Main Menu screen, select the **Test Selections** field. The Test Software will display the Test Selections Menu screen.

---

**NOTE**

The Transmit Power Calibration Test includes steps that prompt you to disconnect cables from the site antenna ports and make connections to the Test Set. Before removing or re-installing the antenna cables, make certain that the transmitter has been turned off by the MSC (or by switch personnel if not using a PC). The green ACT LEDs on the ACU and BCR modules indicate the transmitter is active, and therefore should be off before disconnecting cables.

---

- Step 2.** Select the **Transmit Power Calibration** field. The Test Software will display a prompt directing that you remove RF connections and such.
- Step 3.** Follow the displayed instructions, then press the **k1 (Proceed)** key. The Test Software will display an information screen stating that it is performing calibration, then it will display the Transmit Power Calibration screen.

**Step 4.** On the Transmit Power Calibration screen, scroll to and set the fields as follows:

**Cell Site Number** – Rotate the knob or use the DATA ENTRY keys to enter the number, then either press the knob or the **Enter** key to select that number.

**Measurement Port** – Press the knob to toggle the field to **TX Antenna Port**.

**BBA Number** – Rotate the knob or use the DATA ENTRY keys to enter the number of the BBA, then either press the knob or the **Enter** key to select that number.

**Channel Number** – Rotate the knob or use the DATA ENTRY keys to enter the channel number, then either press the knob or the **Enter** key to select that number.

**PN Offset** – Rotate the knob or use the DATA ENTRY keys to enter the value, then either press the knob or the **Enter** key to select that value.

**Send Control Commands to MSC** – Press the knob to toggle the field to **Yes** to have the Test Software send the control commands.

---

**NOTE**

Although it is usually possible to control the Base Station by manual methods, this test procedure description uses a PC.

**Do you need assistance?** – Press the knob to toggle the field to the desired setting. If you understand the testing setup and wish to just enter the required information for the Test Software to perform the test, select **No**. If you wish to have the Test Software display informational screens at appropriate points in the testing process to assist you in setting up the Base Station for testing, select **Yes**.

**TX Antenna Port Cable Loss** – If you know the loss through the cable, rotate the knob or use the DATA ENTRY keys to enter the value, then either press the knob or the **Enter** key to select that value. If you are uncertain of the value, run the [“TX Antenna Port Cable Calibration Test” on page 75](#) to have the Test Software determine the value and enter it in this field automatically.

**Step 5.** Press the **k1 (Run)** key. The Test Software will run the test.

## Select and Run the Test

Perform the test procedure as follows:

**Step 1.** Assuming that you pressed the **k1 (Run)** key in the Test Set-Up procedure, the Test Software will display the Before Beginning the Power Calibration screen. Follow the on-screen instructions to inhibit routine diagnostics and call processing. Set all fields to **Yes**, then press the **k1 (Snd Cnds)** key. The Test Software will send the commands to inhibit the diagnostics and call processing

If you select **Yes** in the **Do you need assistance?** field, the Test Software will display on-screen instructions to direct you through a step-by-step process to determine the Power Amplifier Type, BCR Attenuation, Number of Channel Elements, and Calibration Power, and to make connections as required. It will also instruct you as to as to how to verify the information in the APX/RCV forms. This information will all be displayed in summary form on the Transmit Power Calibration Menu screen.

If you select **No** in the **Do you need assistance?** field, the Test Software will display the Transmit Power Calibration Menu screen.

**Step 2.** On the Transmit Power Calibration Menu screen, scroll to and set the fields as follows:

**Power Amplifier Type** – Press the knob and select the PA type from the drop-down **Choices:** list. The available choices are: **CTU, HPCTU 1, HPCTU 2, HPCTU 3, HPCTU 4, and CUSTOM.**

**BCR Attenuation** – Rotate the knob or use the **DATA ENTRY** keys to enter the attenuation value, then either press the knob or the **Enter** key to select that number.

---

**NOTE**

The functions of the following two fields are dependent upon the setting of the **Power Amplifier Type** field. The following two fields are operable only if the **Power Amplifier Type** field is set to **CUSTOM.**

**Number of Channel Elements** – If the power amplifier to be tested requires custom settings, rotate the knob or use the **DATA ENTRY** keys to enter the number, then either press the knob or the **Enter** key to select the desired number of channel elements for the test.

If the power amplifier to be tested does not require custom settings, this field will indicate the number of channel elements that will be added to the carrier for the test.

**Calibration Power** – If the power amplifier to be tested requires custom settings, rotate the knob or use the **DATA ENTRY** keys to enter the number, then either press the knob or the **Enter** key to set the power level out of the Base Station for the test.

If the power amplifier to be tested does not require custom settings, this field will indicate the expected power level out of the Base Station.

---

**NOTE**

For the following five fields, verify (and change if necessary) the setting using the **APX/RCV** forms. Use the **BTS Laptop Utility** program on the PC to obtain these forms from the **ECP.**

**IMPORTANT:** If you change these values, remember to restore the settings at the end of the test.

**Traffic Channel Gain - Max for Rate Set 1** – Verify the setting.

**Max Power (Watts)** – Verify the setting.

**Pilot Channel Gain (dgu)** – Verify the setting.

**Paging Channel Gain (dgu)** – Verify the setting.

**Synch Channel Gain (dgu)** – Verify the setting.

**Step 3.** Press the **k1 (Run)** key and follow the on-screen instructions.

## Pilot Only Test

This test performs a suite of CDMA tests on a carrier with only the pilot channel active (no active traffic or paging channels). Therefore, this test may be performed only with the Base Station out-of-service.

The tests performed are:

- Rho (modulation quality)
- Pilot Time offset
- Frequency error
- Carrier feedthrough

## Parameters and Specifications Used

The following specifications and parameters are used when running this test. See [Chapter 5, “Reference,”](#) for descriptions of the specifications and parameters.

### Parameters:

- None

### Specifications (Pass/Fail Limits):

- [1. Carrier Feedthrough](#)
- [5. Frequency Error](#)
- [8. Rho](#)
- [9. Time Offset](#)

## Select and Run the Test

Perform the Pilot Only Test as follows:

- Step 1.** From the Lucent CDMA Tests Main Menu screen, select the **Test Selections** field. The Test Software will display the Test Selections Menu screen.
- Step 2.** Select the **Pilot Only Test** field.
- Step 1.** Follow the displayed instructions and diagram to make the measurement.

---

### NOTE

This procedure might include steps that prompt you to disconnect cables from the site antenna ports and make connections to the Test Set. Before removing or re-installing the antenna cables, make certain that the transmitter has been turned off by the MSC (or by switch personnel if not using a modem). The green ACT LEDs on the ACU and BCR modules indicate the transmitter is active, and therefore should be off before disconnecting cables.

---

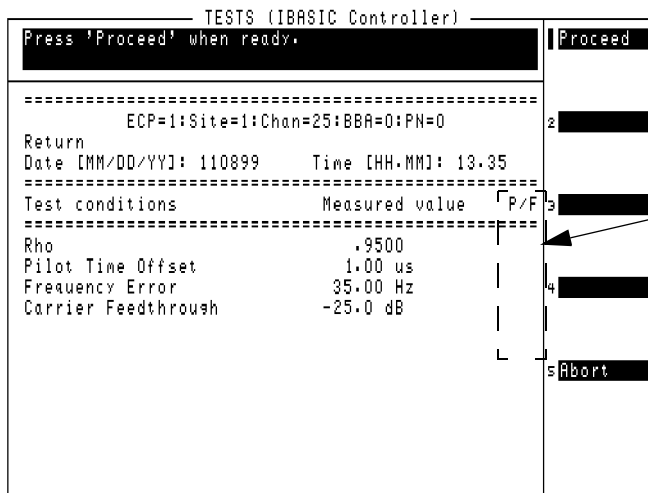
## Review the Results

The Test Software will begin running pilot channel tests on the selected BBA. During the test, results will be displayed with a failure indication if a measurement falls outside the specified limits (see [Figure 4-4](#)).

To see the pass/fail limits for each data point as it is measured, use the BTS Laptop Utility program Test Results window.

When the testing is complete, the Test Software will pause to allow you to review the on-screen test results. Press the **k1 (Proceed)** key to return to the Test Selections Menu screen.

**Figure 4-4** Results from the Pilot Only Test Sequence



The "F" (Fail) indicates that the measured value is outside of the specified limits. To change limits, see ["Changing Pass/Fail Limits"](#) on page 98.

## Code Domain Tests

This test performs a suite of CDMA transmitter tests on the selected BBA. Unlike the Pilot Only test, in this test one or more traffic channels (channel elements) are turned on.

When you are sending commands to the MSC, you must enter the number of channel elements (CEs) to test on the Base Station Configuration Menu screen. Call processing must be deactivated by sending the **Inhibit cp** command in the BTS Laptop Utility program Switch Terminal window or by some other means, before testing begins. For information on enabling automated control, see [“Base Station Configuration” on page 41](#).

The following measurements are performed:

- Time offset
- Frequency error
- Carrier feedthrough
- Code domain tests on traffic channels (if CEs are configured)

TX Walsh code power

Estimated rho

Walsh code timing

Walsh code phase

## Parameters and Specifications Used

The following specifications and parameters are used when running this test. See [Chapter 5, “Reference,”](#) for descriptions of the specifications and parameters.

### Parameters:

- [5. GN Code Domain Power Threshold](#)
- [6. GN Print Inactive Walsh Codes \[0=no 1=yes\]](#)

### Specifications (Pass/Fail Limits):

- [1. Carrier Feedthrough](#)
- [2. Code Domain Floor](#)
- [3. Code Domain Phase](#)
- [4. Code Domain Timing](#)
- [5. Frequency Error](#)
- [9. Time Offset](#)

## Select and Run the Test

Perform the Code Domain Tests as follows:

- Step 1.** From the Lucent CDMA Tests Main Menu screen, select the **Test Selections** field. The Test Software will display the Test Selections Menu screen.
- Step 2.** Select the **Code Domain Tests** field.
- Step 3.** Follow the displayed instructions and diagram to make the measurement.

### NOTE

This procedure might include steps that prompt you to disconnect cables from the site antenna ports and make connections to the Test Set. Before removing or re-installing the antenna cables, make certain that the transmitter has been turned off by the MSC (or by switch personnel if not using a modem). The green ACT LEDs on the ACU and BCR modules indicate the transmitter is active, and therefore should be off before disconnecting cables.

## Review the Results

The Test Software will begin running code domain tests on the selected BBA. After tests are performed, test results will begin showing on the display. See [Figure 4-5](#). Failures will be indicated in the **P/F** column if a measurement falls outside the specified limits.

If you wish to stop testing before the sequence is complete, press the **k5 (Abort)** key. Depending on the state of the system, it might take as long as 60 seconds for the test to stop.

**Figure 4-5** Final Results from the Code Domain Tests

TESTS (IBASIC Controller)		
Press 'Proceed' when ready.		Proceed
=====		
ECP=1:Site=1:Chan=23:BBA=0:PN=0		2
Date [MM/DD/YY]: 071498 Time [HH.MM]: 09.49		
=====		
Test conditions	Measured value	P/F
=====		
Pilot Time Offset	2.37 us	3
Frequency Error	-.88 Hz	
Carrier Feedthrough	-36.18 dB	
Active Walsh code set:		4
TX Walsh Code # 0 Power	-.06 dBt	
Estimated Rho	.9870	5



## Automated BBA Test

This test performs a suite of CDMA transmitter tests on the selected BBA. *This test requires that the Test Software send control commands to the MSC.*

The test sequence includes the following tests:

- Pilot Channel Tests
  - Rho
  - Time Offset
  - Frequency Error
  - Carrier Feedthrough
- Code Domain Tests on traffic channels (if CEs are configured)
  - TX Walsh Code Power
  - Walsh Code Timing
  - Walsh Code Phase
  - Estimated Rho
- Code Domain Tests on pilot and paging channels (active mode)

## Parameters and Specifications Used

The following specifications and parameters are used when running this test. See [Chapter 5, “Reference,”](#) for descriptions of the specifications and parameters.

### Parameters:

- [5. GN Code Domain Power Threshold](#)
- [6. GN Print Inactive Walsh Codes \[0=no 1=yes\]](#)

### Specifications (Pass/Fail Limits):

- [1. Carrier Feedthrough](#)
- [2. Code Domain Floor](#)
- [3. Code Domain Phase](#)
- [4. Code Domain Timing](#)
- [5. Frequency Error](#)
- [8. Rho](#)
- [9. Time Offset](#)

## Select and Run the Test

Perform the Automated BBA Test as follows:

- Step 1.** From the Lucent CDMA Tests Main Menu screen, select the **Test Selections** field. The Test Software will display the Test Selections Menu screen.
- Step 2.** Select the **Automated BBA Test** field.
- Step 3.** Follow the displayed instructions and diagram as prompted to make the measurement.

### NOTE

This procedure might include steps that prompt you to disconnect cables from the site antenna ports and make connections to the Test Set. Before removing or re-installing the antenna cables, make certain that the transmitter has been turned off by the MSC (or by switch personnel if not using a modem). The green ACT LEDs on the ACU and BCR modules should be off.

## Review the Results

The Test Software will begin running tests on the active BBA. See [Figure 4-6](#). As tests are performed, test results will begin showing on the display with a failure indication if a measurement falls outside the specified limits.

If you wish to stop testing before the sequence is complete, press the **k5 (Abort)** key. Depending on the state of the system, it might take as long as 60 seconds to stop the test.

Because the site configuration might not have been reset before testing was aborted, the Test Software will offer a choice to send a “multistop” command to reset the BBAs.

**Figure 4-6** Partial Code Domain Tests Sequence Results

TESTS (IBASIC Controller)		
Active Walsh code set:		1
TX Walsh Code # 0	Power 25.55 dBm	2
TX Walsh Code # 1	Power -10.47 dBm	3
TX Walsh Code # 2	Power -9.83 dBm	4
TX Walsh Code # 3	Power -11.08 dBm	5
TX Walsh Code # 4	Power -10.83 dBm	Abort
TX Walsh Code # 5	Power -11.23 dBm	
TX Walsh Code # 6	Power -10.31 dBm	
TX Walsh Code # 7	Power -8.64 dBm	
TX Walsh Code # 8	Power -10.71 dBm	
TX Walsh Code # 9	Power -9.75 dBm	
TX Walsh Code # 10	Power -11.25 dBm	
TX Walsh Code # 11	Power -10.99 dBm	
TX Walsh Code # 12	Power -10.35 dBm	
TX Walsh Code # 13	Power -9.45 dBm	
TX Walsh Code # 14	Power -10.12 dBm	
TX Walsh Code # 15	Power -9.70 dBm	

## Spectrum Analyzer Test

This test configures the Test Software to display spectrum sweeps. This mode is useful when you would like to verify the presence of a CDMA signal or search for sources of interference.

### Parameters and Specifications Used

The following specifications and parameters are used when running this test. See [Chapter 5, "Reference,"](#) for descriptions of the specifications and parameters.

#### Parameters:

- None used for this test.

#### Specifications (Pass/Fail Limits):

- None used for this test.

### Select and Run the Test

Perform spectrum analyzer measurements as follows:

- Step 1.** From the Lucent CDMA Tests Main Menu screen, select the **Test Selections** field. The Test Software will display the Test Selections Menu screen.
- Step 2.** Select the **Spectrum Analyzer** field.
- Step 3.** Follow the displayed instructions and diagram to make the measurement.

---

#### NOTE

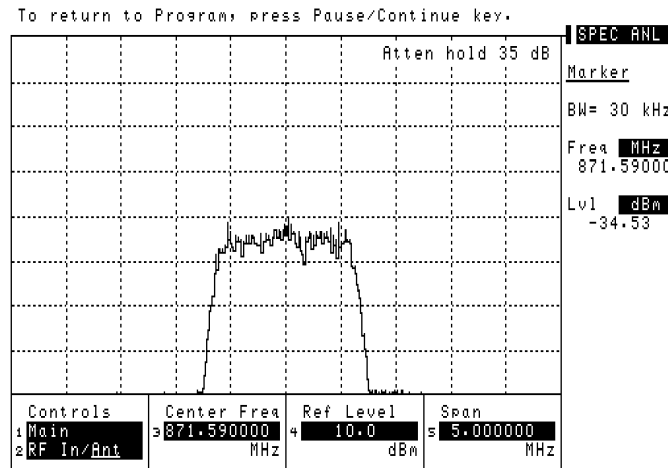
This procedure might include steps that prompt you to disconnect cables from the site antenna ports and make connections to the Test Set. Before removing or re-installing the antenna cables, make certain that the transmitter has been turned off by the MSC (or by switch personnel if not using a modem). The green ACT LEDs on the ACU and BCR modules indicate the transmitter is active, and therefore should be off before disconnecting cables.

---

### Review the Results

The Test Software sets up and displays the spectrum analyzer. See [Figure 4-7](#).

**Figure 4-7** Spectrum Analyzer Display



Use the **Ref Level** and **Span** fields for the best view of the transmitted signal.

Read the marker frequency and level in the upper-right of the display. If you would like to change the marker position, select the **Controls** field, select **Marker**, then use the **Position** field.

**NOTE**

Do not make changes to the **Center Freq** field.

If you would like to view another channel/frequency, return to the Lucent CDMA Tests Main Menu screen and select the **Base Station Configuration** field (to access the Base Station Configuration Menu screen) and change the **Channel Number**, then re-run the test.

When you have finished using the spectrum analyzer, press the **Pause/Continue** key and follow the instructions on the display. The Test Software will return to the Test Selections Menu screen.

## Code Domain Analyzer Test

This test sets up the Test Software to make manual measurements on a CDMA transmitter. This test is useful if you wish to switch between Code Domain Power, Code Domain Timing, and Code Domain Phase measurement screens. It is also useful for examining changes in Code Domain readings over time. Otherwise, it would probably be better to use the automated tests: “Code Domain Tests” on page 64 and “Automated BBA Test” on page 66.

Available measurements in the Code Domain Analyzer screen are:

- Code Domain Power
- Code Domain Timing
- Code Domain Phase

### Parameters and Specifications Used

The following specifications and parameters are used when running this test. See Chapter 5, “Reference,” for descriptions of the specifications and parameters.

#### Parameters:

- None used for this test.

#### Specifications (Pass/Fail Limits):

- None used for this test.

### Select and Run the Test

Perform code domain analyzer measurements as follows:

- Step 1.** From the Lucent CDMA Tests Main Menu screen, select the **Test Selections** field. The Test Software will display the Test Selections Menu screen.
- Step 2.** Select the **Code Domain Analyzer** field.
- Step 3.** Follow the displayed instructions and diagram to make the measurement.

---

#### NOTE

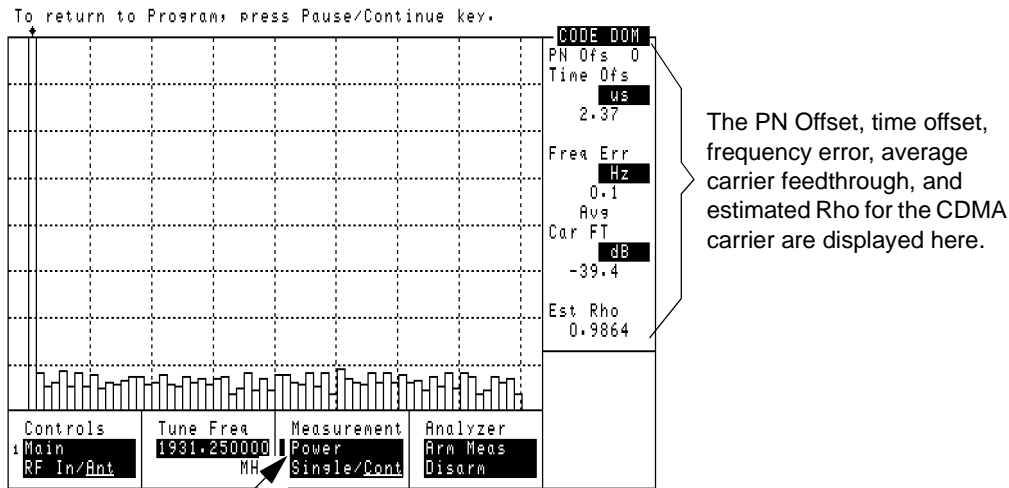
This procedure might include steps that prompt you to disconnect cables from the site antenna ports and make connections to the Test Set. Before removing or re-installing the antenna cables, make certain that the transmitter has been turned off by the MSC (or by switch personnel if not using a modem). The green ACT LEDs on the ACU and BCR modules indicate the transmitter is active, and therefore should be off before disconnecting cables.

---

## Review the Results

The Test Software displays the Code Domain Analyzer (see [Figure 4-8](#)). You may then make changes to the setup fields and view the code domain response for the transmitter signal. Use the **Measurement** field to choose between measurements of power, phase, and timing.

**Figure 4-8** Making Code Domain Analyzer Measurements



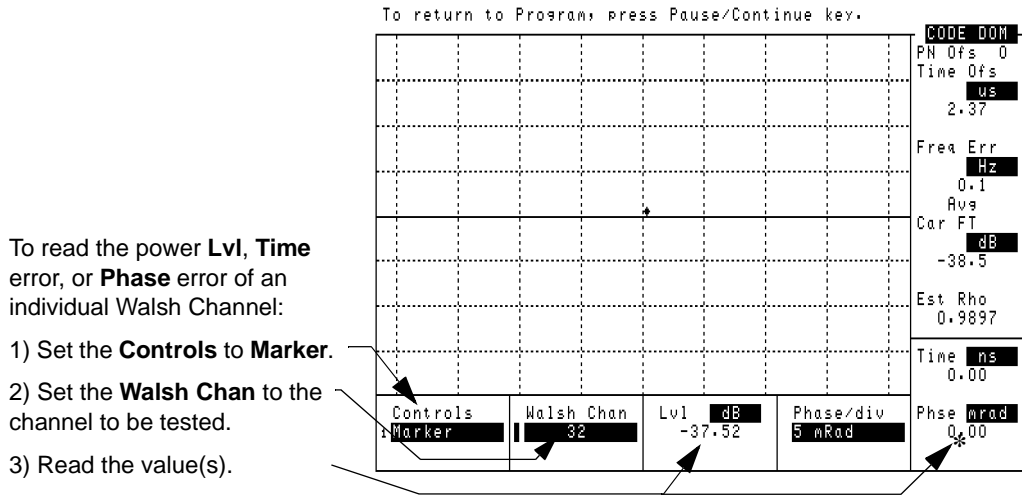
Select the **Measurement** field to change the measurement type to **Fast Pwr**, **Phase**, or **Timing**. For fast power measurements, you must access **FP Setup** in the **Controls** menu and manually set the **Time Offset**.

### NOTE

Do not make changes to the **Tune Freq** field. It has been preset by the Test Software. Changes to other fields might also cause measurements to fail.

Changing the **Controls** field from **Main** to **Marker** allows you to move the marker to any **Walsh Chan** (0-63), with the resulting **Lvl** (level), **Time**, or **Phse** (phase) indicated for the current marker position (depending on the **Measurement** field setting shown in [Figure 4-8](#)). See [Figure 4-9](#).

**Figure 4-9**      **Reading Individual Walsh Channel Measurements**



\* The **Time** and **Phase** measurements are only displayed if the **Measurement** field is set to **Phase** or **Timing**. (See [Figure 4-8](#)).

When you have finished using the code domain analyzer screen, press the **Pause/Continue** key, and follow the directions on the screen. The Test Software will return to the Test Selections Menu screen.

---

## CDMA Analyzer Test

This test sets up the Test Software to make several measurements manually.

The following measurements may be performed:

- Channel Power
- Rho (modulation quality). The following measurements are also displayed when Rho is selected:
  - Time offset
  - Frequency error
  - Carrier feedthrough
- EVM
  - The following measurements are also displayed when EVM is selected:
    - Phase error
    - Magnitude error
- Average Power

---

**NOTE**

The Rho and EVM measurements should be made with all traffic, paging, and sync channels off; only the pilot channel should be transmitting.

### Parameters and Specifications Used

The following specifications and parameters are used when running this test. See [Chapter 5, “Reference,”](#) for descriptions of the specifications and parameters.

#### Parameters:

- [19. TX Antenna Port Cable Loss](#)
- [21. TX Test Port Cable Loss](#)

#### Specifications (Pass/Fail Limits):

- None used for this test.

### Select and Run the Test

Perform CDMA Analyzer operations as follows:

- Step 1.** From the Lucent CDMA Tests Main Menu screen, select the **Test Selections** field. The Test Software will display the Test Selections Menu screen.
- Step 2.** Select the **CDMA Analyzer** field.



**Step 3.** Follow the displayed instructions and diagram to select and make the measurement.

---

**NOTE**

This procedure might include steps that prompt you to disconnect cables from the site antenna ports and make connections to the Test Set. Before removing or re-installing the antenna cables, make certain that the transmitter has been turned off by the MSC (or by switch personnel if not using a modem). The green ACT LEDs on the ACU and BCR modules indicate the transmitter is active, and therefore should be off before disconnecting cables.

---

**Step 4.** Select the desired measurement from the displayed list. The Test Software will configure itself and make the measurement. It might take several seconds before the measurement results are displayed.

### Review the Results

Channel power and average power are displayed as individual measurements. Additional measurements are displayed if Rho or EVM is selected.

When you have finished using the CDMA analyzer, press the **k5 (Return)** key to return to the CDMA Analyzer Choices menu screen.

Press the **k5 (Return)** key again and follow the displayed instructions to return to the Test Selections Menu screen.

## TX Antenna Port Cable Calibration Test

This utility measures the signal loss through the cable used to connect the Test Set to the Base Station TX Antenna Port. This loss must be known when making power measurements. Once this value is measured, you should label the cable indicating the loss through it for future use.

This routine requires the use of two external 6 dB attenuators (pads) and a short calibration cable. These parts are not standard equipment with the Test Set, but are included in the optional accessory kits (see “[Accessory Kits](#)” on page 17).

This test sends no control commands to the MSC.

### Parameters and Specifications Used

The following specifications and parameters are used when running this test. See [Chapter 5, “Reference,”](#) for descriptions of the specifications and parameters.

#### Parameters:

- [19. TX Antenna Port Cable Loss](#)

#### Specifications (Pass/Fail Limits):

None used for this test.

### Select and Run the Utility

Perform the TX Antenna Port Cable Calibration procedure as follows:

- Step 1.** From the Lucent CDMA Tests Main Menu screen, select the **Calibration/Utilities** field. The Test Software will display the Calibration/Utilities Menu screen.
- Step 2.** Select the **TX Antenna Port Cable Calibration** field.
- Step 3.** Follow the displayed instructions to connect the 6-dB pads and calibration cable. Press the **k1 (Proceed)** key to continue.
- Step 4.** Follow the displayed instructions to connect the test cable in series with the calibration cable and pads. Press the **k1 (Proceed)** key to continue making the measurement.

### Review the Results

The Test Software will display the measured insertion loss and test frequency. Press the **k1 (Proceed)** key to continue.

The Test Software displays a query asking if you wish to store the insertion loss as the TX Antenna Port Cable Loss. Use the knob to select **Yes** or **No**.

- If you select **Yes**, the Test Software will enter the value in the Test Configuration Menu screen automatically. Unless you believe that the indicated loss is incorrect, you should select **Yes**.
- If you select **No**, the Test Software will display a query asking if you wish to **Remeasure** the loss or **Return** to the Calibration/Utilities Menu screen.

---

## TX Test Port Cable Calibration Test

This utility measures the signal loss through the cable used to connect the Test Set to the Base Station TX Test Port. This is the Base Station port that samples the transmitter output of the BCR through a directional coupler. This loss must be known when making power measurements. Once this value is measured, you should label the cable indicating the loss through it for future use. This utility sends no control commands to the MSC.

This routine requires the use of two external 6 dB attenuators (pads) and a short calibration cable. These parts are not standard equipment with the Test Set, but are included in the optional accessory kits (see “[Accessory Kits](#)” on page 17).

### Parameters and Specifications Used

The following specifications and parameters are used when running this test. See [Chapter 5, “Reference,”](#) for descriptions of the specifications and parameters.

#### Parameters:

- [21. TX Test Port Cable Loss](#)

#### Specifications (Pass/Fail Limits):

None used for this test.

### Select and Run the Utility

Perform the TX Test Port Cable Calibration routine as follows:

- Step 1.** From the Lucent CDMA Tests Main Menu screen, select the **Calibration/Utilities** field. The Test Software will display the Calibration/Utilities Menu screen.
- Step 2.** Select the **TX Test Port Cable Calibration** field.
- Step 3.** Follow the displayed instructions to connect the 6-dB pads and calibration cable, then press the **k1 (Proceed)** key.
- Step 4.** Follow the displayed instructions to connect the test cable in series with the calibration cable and pads, then press the **k1 (Proceed)** key.

### Review the Results

The Test Software will display the measured insertion loss and test frequency. Press the **k1 (Proceed)** key to continue. The Test Software will display a query asking if you wish to store the insertion loss as the TX Test Port Cable Loss. Use the knob to select **Yes** or **No**.

- If you select **Yes**, the Test Software will enter the value in the Test Configuration Menu screen automatically. Unless you believe that the indicated loss is incorrect, you should select **Yes**.
- If you select **No**, the Test Software will display a query asking if you wish to **Remeasure** the loss or **Return** to the Calibration/Utilities Menu screen.

## TX Test Port Calibration Test

This utility measures the loss associated with testing from the Base Station TX Test Port. This provides to the Test Software a coupling factor to use with measurements from the TX Test Port.

At the start of the test, the Test Software will prompt you to choose either full or specified calibration.

- Full calibration will first measure the level at the Base Station TX Antenna Port, then measure the level at the Base Station TX Test Port. The difference in these levels is used to determine the loss through the TX Test Port.

If automated control of the Base Station is enabled, the Test Software will send commands to the MSC during the test (see [“Base Station Configuration” on page 41](#)). If manual Base Station control is used, you must disable call processing and turn off any transmitters prior to connecting the Test Set to the Base Station TX Antenna Port.

### NOTE

During full calibration, the Test Software will prompt you to connect the Test Set RF IN/OUT port to the Base Station TX Antenna Port using the TX Antenna Port cable. After proceeding, it will prompt you to connect the Test Set ANT IN port to the Base Station TX Test Port using the TX Test Port cable.

For accurate TX Test Port calibration, you must use the correct cables when prompted.

- Specified calibration will use the Specified Output Power level from the Base Station Configuration Menu screen to determine the coupling factor. If the correct output level is specified, the level at the Base Station TX Test Port will be measured and the difference in these levels used to determine the loss through the TX Test Port.

Unless you are certain that the Specified Output Power level is correct ( $\pm 0.5$  dB), you should use the full calibration for the most accurate results.

## Parameters and Specifications Used

The following specifications and parameters are used when running this test. See [Chapter 5, “Reference,”](#) for descriptions of the specifications and parameters.

### Parameters:

- [19. TX Antenna Port Cable Loss](#)
- [21. TX Test Port Cable Loss](#)

### Specifications (Pass/Fail Limits):

- None used for this test.

## Select and Run the Test

Perform TX Test Port Calibration utility operations as follows:

---

### NOTE

This procedure might include steps that prompt you to disconnect cables from the site antenna ports and make connections to the Test Set. Before removing or re-installing the antenna cables, make certain that the transmitter has been turned off by the MSC (or by switch personnel if not using a modem). The green ACT LEDs on the ADU and BCR modules indicate that the transmitter is active, and therefore should be off before disconnecting cables.

---

- Step 1.** From the Lucent CDMA Tests Main Menu screen, select the **Calibration/Utilities** field. The Test Software will display the Calibration/Utilities Menu screen.
- Step 2.** Select the **TX Test Port Calibration** field.
- Step 3.** Select full or specified calibration.
- Step 4.** Follow the directions on the screen.
- Step 5.** Connect the Test Set to the Base Station as indicated and press the **k1 (Proceed)** key to continue after each setup.
  - Full calibration requires two separate measurement setups. Make certain to use the correct test cables for each setup.
  - Specified calibration uses one measurement setup. Make certain to use the TX Test Port cable when making the measurement.

## Review the Results

The Test Software will calculate and display the Base Station TX Test Port coupling factor. You should write this value next to the TX Test Port for future reference.

If you select the **Test Configuration** field (from the Lucent CDMA Tests Main Menu screen), note that the **TX Test Port Coupling Factor [dB]** field now contains the value determined by the test.

Press the **k1 (Proceed)** key to return to the Calibration/Utilities Menu screen, then press the **k5 (Return)** key to return to the Lucent CDMA Tests Main Menu screen.

---

## PN Offset Search Test

This utility may be used when you are testing a BBA and are uncertain of the PN offset value. In this utility, the Test Software tunes to the CDMA channel and searches to find the valid PN offset. The resulting PN offset value is then entered into the **PN Offset** field of the Test Configuration Menu screen.

### Parameters and Specifications Used

The following specifications and parameters are used when running this test. See [Chapter 5, “Reference,”](#) for descriptions of the specifications and parameters.

#### Parameters:

- None used for this test.

#### Specifications (Pass/Fail Limits):

- None used for this test.

### Select and Run the Test

Perform the PN Offset Search operation as follows:

- Step 1.** From the Lucent CDMA Tests Main Menu screen, select the **Calibration/Utilities** field. The Test Software will display the Calibration/Utilities Menu screen.
- Step 2.** Select the **PN Offset Search** field.
- Step 3.** Press the **k1 (Proceed)** key to start the search.

### Review the Results

---

#### NOTE

This procedure might include steps that prompt you to disconnect cables from the site antenna ports and make connections to the Test Set. Before removing or re-installing the antenna cables, make certain that the transmitter has been turned off by the MSC (or by switch personnel). Green ACT LEDs on the ADU and BCR modules indicate that the transmitter is active, and should be off before you disconnect cables.

The setup diagram will prompt you to make connections between the Test Set and the Base Station. Press the **k1 (Proceed)** key when the connections have been made.

The Test Software will start searching for the BBAs PN offset. This is an iterative process and it might take several minutes before returning the PN offset. Once the value has been found, the Test Software will display it on the screen. The Test Software will enter the PN offset returned by the search value into the **PN Offset** field on the Test Configuration Menu screen.

Once the PN offset value appears, press the **k1 (Proceed)** key and follow the displayed instructions to return to the Calibration/Utilities Menu screen.

## Insertion Loss Measurement

This measurement determines the loss associated with RF cables, filters, and other passive devices in the measurement path. This test uses the Test Set internal source and measures the relative loss through the cable or device.

To optimize measurement accuracy, the measurement setup diagram indicates the use of two external 6-dB attenuators (pads) and a short calibration cable. The pads are optional, but should be used if available. These parts are not standard equipment with the Test Set, but are included in the optional accessory kits (see [“Accessory Kits” on page 17](#)).

This test sends no control commands to the MSC.

### Parameters and Specifications Used

The following specifications and parameters are used when running this test. See [Chapter 5, “Reference,”](#) for descriptions of the specifications and parameters.

#### Parameters:

- None used for this test.

#### Specifications (Pass/Fail Limits):

- None used for this test.

### Select and Run the Test

Perform the Insertion Loss Measurement as follows:

- Step 1.** From the Lucent CDMA Tests Main Menu screen, select the **Calibration/Utilities** field. The Test Software will display the Calibration/Utilities Menu screen.
- Step 2.** Select the **Insertion Loss Test** field.
- Step 3.** If prompted to do so, remove the RF connections from the Test Set and press the **k1 (Proceed)** key to perform a channel power calibration. If channel power was recently calibrated, the Test Software might not prompt you to re-calibrate before starting the Insertion Loss test.
- Step 4.** Select the **Loss Measurement Type** field and select the following:
  - **Swept** will measure the loss over the frequency range that you specify in the **Start Frequency** and **Stop Frequency** settings. The **Maximum Expected Loss** for the device to be tested will be used to adjust the scale on the results plot. Use a value slightly greater than expected for the best display resolution. The **Duplex Out Level** into the device being tested may be adjusted if necessary.
  - **Discrete** will measure the loss at the frequency that you specify by entering the **Channel Number** to be tested.
- Step 5.** Press the **k1 (Proceed)** key to start the measurement.
- Step 6.** Connect the short calibration cable as directed, and then press the **k1 (Proceed)** key.

**Step 7.** The Test Software will turn on the source and make a reference measurement, then prompt you to add in the cable or device to be tested. Leave the calibration cable and pads connected to the ANT IN port and insert the cable or device to be measured as shown in the diagram. Press the **k1 (Proceed)** key to make the insertion loss measurement.

## Review the Results

When making a discrete measurement, the Test Software will display the insertion loss as a single numeric value (in units of dB).

When making a swept measurement, the Test Software will display the loss on the screen (in units of dB) and as a plot of loss versus frequency.

- Pressing the **k5 (Scr Dump)** key will cause the Test Software to pause automated operation. Press the **Print** key to send the plot to BTS Laptop Utility program Test Set Screen Capture window. After the plot has displayed, press the **k2 (Continue)** key.
- Pressing the **k1 (Proceed)** key will display the frequency range settings and average insertion loss for the test. From this point, you may press the **k1 (Repeat)** key to test another cable or device, press the **k5 (Return)** key once to display the Insertion Loss Test setup screen, or press the **k5 (Return)** key twice to return to the Test Selections Menu screen.



## Return Loss Measurement

This measurement is used to determine the return loss of a cable, antenna, or other device in the swept mode. An SWR bridge and a 6-dB pad are connected to the Test Set. The Test Software uses the pad to improve the mismatch between the SWR bridge and the ANT IN port on the Test Set. A reference level is measured with an open or short on the bridge and then the return loss is measured with the cable or antenna-under-test. Measured values for minimum and maximum return loss are displayed.

This measurement requires two external 6-dB attenuators (pads), two type-N cables, and an SWR bridge. These parts are not standard equipment with the Test Set, but are included in the optional Agilent Technologies E6554A 8935 RF Tools Hardware Accessory Kit (see “[Accessory Kits](#)” on page 17).

This test sends no control commands to the MSC.

### Parameters and Specifications Used

The following specifications and parameters are used when running this test. See [Chapter 5, “Reference,”](#) for descriptions of the specifications and parameters.

#### Parameters:

- None used for this test.

#### Specifications (Pass/Fail Limits):

- None used for this test.

### Select and Run the Test

Perform the Return Loss Measurement as follows:

- Step 1.** From the Lucent CDMA Tests Main Menu screen, select the **Calibration/Utilities** field. The Test Software will display the Calibration/Utilities Menu screen.
- Step 2.** Select the **Return Loss Test** field.
- Step 3.** If prompted to do so, remove the RF connections from the Test Set and press the **k1** (**Proceed**) key to perform a channel power calibration. If channel power was recently calibrated, the Test Software might not prompt you to re-calibrate before starting the Return Loss test.
- Step 4.** Select the loss **Measurement Type** field and select the following:
  - **Swept** will measure the loss over the frequency range that you specify in the **Start Frequency** and **Stop Frequency** settings. The **Maximum Expected Loss** for the device to be tested will be used to adjust the scale on the results plot. Use a value slightly greater than expected for the best display resolution. The **Duplex Out Level** into the device being tested may be adjusted if necessary.
  - **Discrete** will measure the loss at the frequency that you specify by entering the **Channel Number** to be tested.

**Step 5.** Press the **k1 (Run)** key to start the test.

---

**NOTE**

This procedure might include steps that prompt you to disconnect cables from the site antenna ports and make connections to the Test Set. Before removing or re-installing the antenna cables, make certain that the transmitter has been turned off by the MSC (or by switch personnel). The green ACT LEDs on the ADU and BCR modules indicate that the transmitter is active, and therefore should be off before disconnecting cables.

---

**Step 6.** At the start of the test sequence, the Test Software will display a connection diagram, and prompt you to make a connection between the DUPLEX OUT port, ANT IN port of the Test Set, and the SWR bridge indicated on the on-screen diagram. Press the **k1 (Proceed)** key when the connections have been made.

**Step 7.** The Test Software will turn on the source and makes a reference measurement, then prompt you to add in the DUT (Device-Under-Test). Connect the DUT to be measured, as shown in the diagram, and press the **k1 (Proceed)** key.

### Review the Results

When making a discrete measurement, the Test Software will display the return loss and VSWR as single numeric values.

When making a swept measurement, the Test Software will display the loss on the screen (in units of dB) and as a plot of loss versus frequency.

- Pressing the **k5 (Scr Dump)** key will cause the Test Software to pause automated operation. Press the **Print** key to send the plot to BTS Laptop Utility program Test Set Screen Capture window. After the plot has displayed, press the **k2 (Continue)** key.
- Pressing the **k1 (Proceed)** key will cause the Test Software to display the minimum and maximum return loss and VSWR measured during the test. From this point, you may press the **k1 (Repeat)** key to test another device, press the **k5 (Return)** key once to go to the Return Loss Test setup screen, or press the **k5 (Return)** twice to return to the Test Selections Menu screen.

## Emission BW & Spurious Test

---

### NOTE

This test is applicable to PCS Minicells only. If the **Base Station Type** field on the Base Station Configuration Menu screen is set to **Autoplex Series II**, this test field will not appear on the Test Selections Menu screen.

---

This test performs two measurements on the transmitted signal: emission bandwidth, and spurious emissions, as described in the following two sections. Because these measurements are performed on the transmitter antenna output signal, this test may be performed only with the Base Station out-of-service.

### Spurious Emissions Measurement

The spurious emissions measurement consists of three sections: in-band emissions, 1 MHz adjacent block, and out-of-band emissions. These are described in the following sub-sections.

#### In-Band Emissions

This test measures the spurious emissions within a single PCS block. The PCS block to be tested is determined by the channel number entered on the Base Station Configuration Menu screen. The test measures the emissions power starting 900 kHz below the CDMA carrier to the bottom end of the PCS block in 30-kHz steps and starting 900 kHz above the CDMA carrier to the top end of the PCS block in 30-kHz steps. A 30-kHz measurement bandwidth is used for each step. The emissions power in each measurement step should be less than -45 dBc.

#### 1 MHz Adjacent Block

This test measures the spurious emissions 1 MHz outside of the PCS block tested during the In-Band Emissions Test. The test measures the emissions power starting 1 MHz below the bottom edge of the PCS block up to the block edge in 12.5-kHz steps and from the top end of the PCS block to 1 MHz above the top of the block in 12.5-kHz steps. A 12.5-kHz measurement bandwidth is used for each step. The emissions power in each measurement step should be less than -13 dBm.

#### Out-of-Band Emissions

This test measures the spurious emissions from 1700 MHz to 2000 MHz in 1-MHz steps excluding the PCS block tested during the In-Band Emissions Test. A 1-MHz measurement bandwidth is used for each step. The emissions power in each measurement step should be less than -13 dBm.

### Emission Bandwidth Measurement

Emission bandwidth is defined as two points centered around the carrier, outside of which all emissions are attenuated at least 26 dB below the transmitter power. The Test Software measures the emissions relative to the pass/fail limits setting, which sets the two points about which to test.

## Parameters and Specifications Used

The following specifications and parameters are used when running this test. See [Chapter 5, “Reference,”](#) for descriptions of the specifications and parameters.

### Parameters:

- None used for this test.

### Specifications (Pass/Fail Limits):

- [10. Emission Bandwidth](#)

## Select and Run the Test

Perform the Emission BW & Spurious Test as follows:

- Step 1.** From the Lucent CDMA Tests Main Menu screen, select the **Test Selections** field. The Test Software will display the Test Selections Menu screen.
- Step 2.** Select the **Emission BW & Spurious Test** field.
- Step 3.** The Test Software will display instructions regarding test results. Read the instructions, then press the **k1 (Proceed)** key.
- Step 4.** Enter the “Percentage” of total power in the span. This will be used to determine the emissions bandwidth. The default is 99 percent.

Enter the spectrum analyzer frequency “Span” in which to perform the Emissions Bandwidth Test. The default is 1.499 MHz.

- Step 5.** Follow the displayed instructions and diagram to make the measurement for the Spurious Emissions Test.

---

### NOTE

This procedure includes steps that prompt you to disconnect cables from the site antenna ports and make connections to the Test Set. Before removing or re-installing the antenna cables, make certain that the transmitter has been turned off by the MSC (or by switch personnel if not using a modem). The green ACT LEDs on the ACU and BCR modules indicate the transmitter is active, and therefore should be off before disconnecting cables.

- Step 6.** The Test Software will begin running the spurious emissions test. At the end of the test, a short summary of results will appear on the display. A complete listing of the spurious emissions measurements and the results will be sent to the BTS Laptop Utility program **Test Results** window.
- Step 7.** Press the **k1 (Proceed)** key to start the Emissions Bandwidth Test. The test results will appear on the Test Set display and also in the BTS Laptop Utility program **Test Results** window. Press the **k1 (Proceed)** key after viewing the screen. The final screen will display re-configuration information. Press the **k1 (Proceed)** key again to return to the Test Selections Menu screen.

---

## 5 Reference

This chapter describes Test Software operational details that were not covered in [Chapter 2, “Installation,”](#) on page 21, [Chapter 3, “Connections,”](#) on page 45, and [Chapter 4, “Performing Tests,”](#) on page 51. The information in this chapter is organized by key topics, listed alphabetically.

## Overview

Refer to the following topic areas for detailed instructions on Test Software use:

“Accessing Test Software Functions” on page 89.

“BTS Laptop Utility Program Windows” on page 105.

“Demo (Demonstration) Mode” on page 108.

“Parameters” on page 110.

“Specifications (Pass/Fail Limits)” on page 115.

“Testing without MSC Control” on page 117.

“Using a PC Card” on page 118.

---

## Accessing Test Software Functions

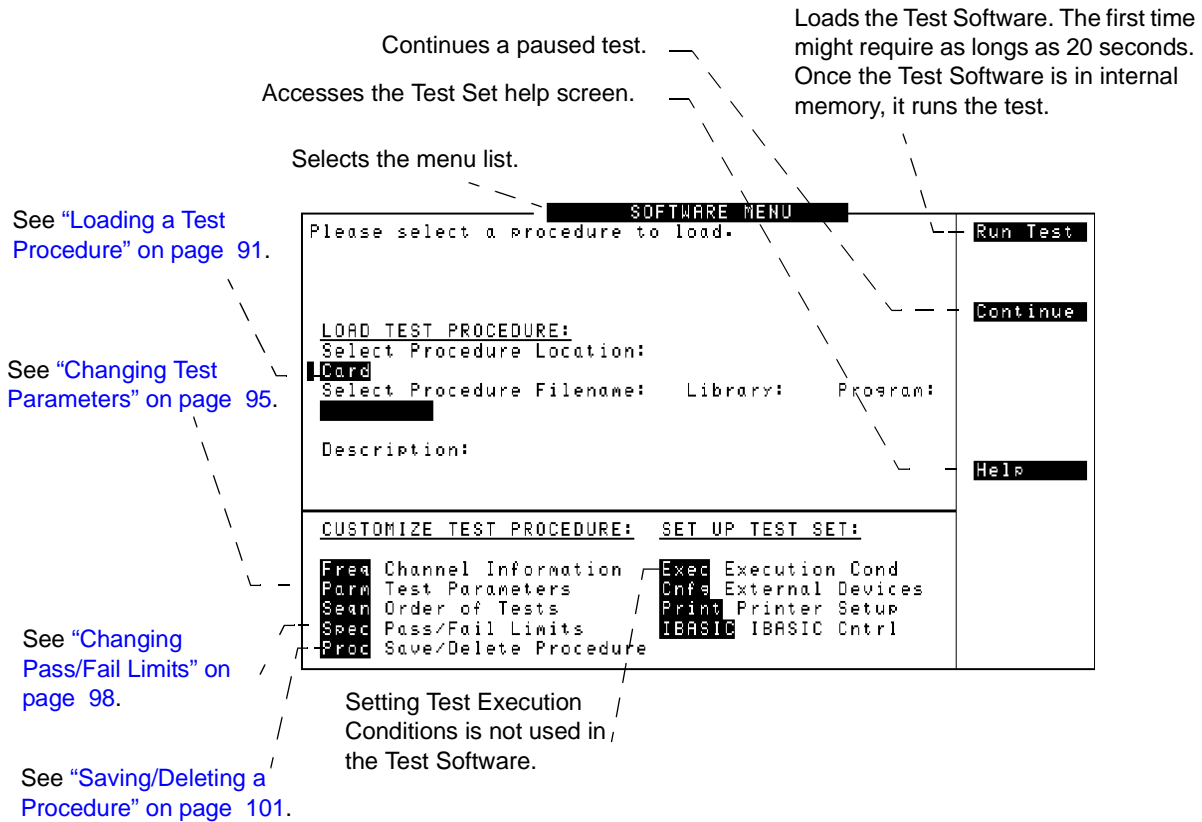
Test Software functions may be accessed from the various menu screens. These include the SOFTWARE MENU screen, which is the master screen from which the others are reached. The following eight sub-sections describe the screens and the functions accessed from those screens.

- “SOFTWARE MENU Screen Overview” on page 90
- “Loading a Test Procedure” on page 91
- “Loading the Test Software Card and Procedure” on page 92
- “Customizing a Test Procedure” on page 94
- “Changing Test Parameters” on page 95
- “Changing Pass/Fail Limits” on page 98
- “Saving/Deleting a Procedure” on page 101

## SOFTWARE MENU Screen Overview

Pressing the front-panel Menu key will cause the Test Set to display the SOFTWARE MENU screen (see Figure 5-1). This screen allows the user to configure and run custom Test Software, access help, proceed with a paused procedure, or access additional test screens.

**Figure 5-1** SOFTWARE MENU Screen



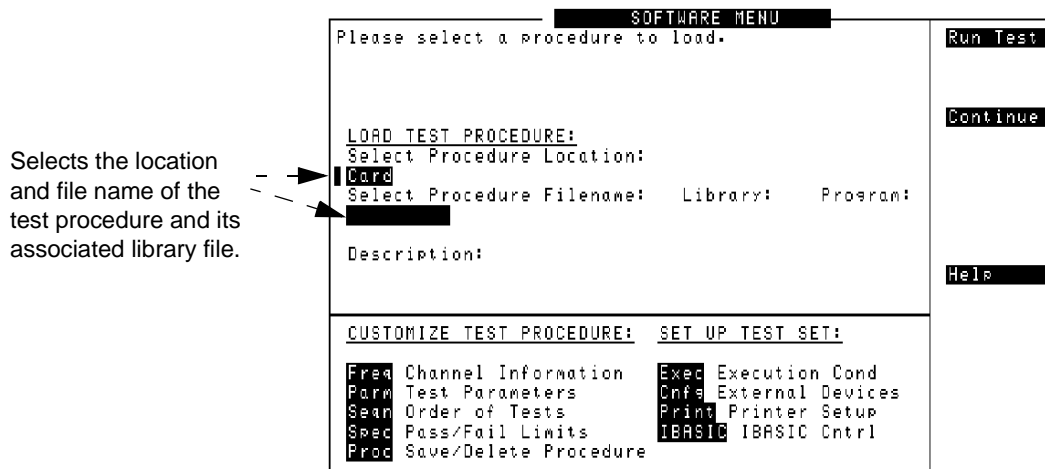


## Loading a Test Procedure

Before you begin testing, you must load the Test Software into the Test Set memory (see [Figure 5-2](#)). To load the Test Software, select the location where the procedure currently resides (in this case, it will be a PC card) and a procedure file name to download into the Test Set memory. The card comes pre-programmed with at least one procedure.

The first time that you select a procedure, the actual Test Software program is not loaded into the Test Set memory until you press the Test Set **k1 (Run Test)** key. It will take approximately 20 seconds for the Test Software program to load. The program will remain in memory after a power-down/power-up cycle, unless it is manually deleted or a new program is loaded.

**Figure 5-2** Loading a Test Procedure

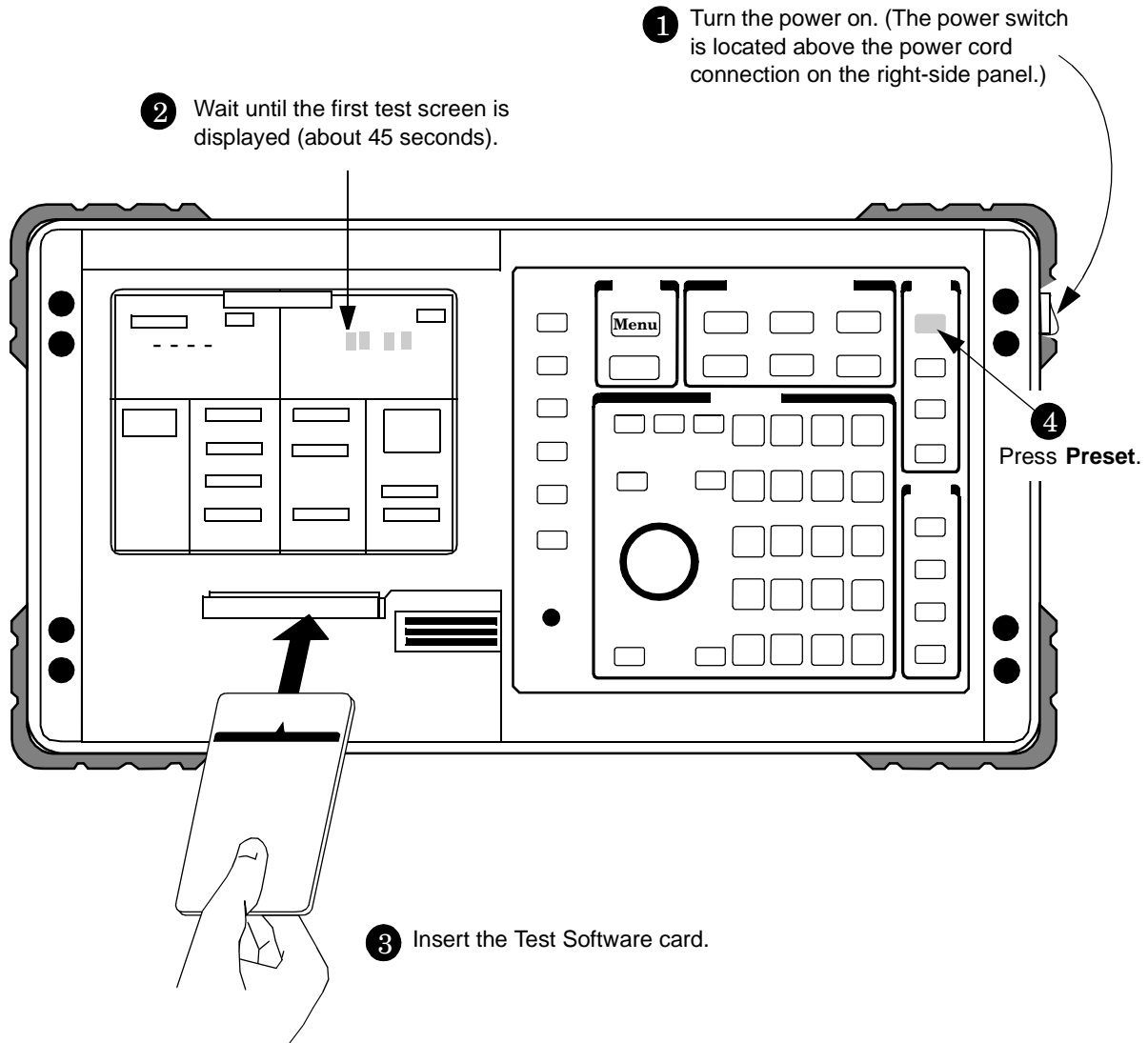


**NOTE** See [“Troubleshooting the Test Software Installation” on page 121](#) for some hints to help debug any problems that you might have during the installation of the Test Software.

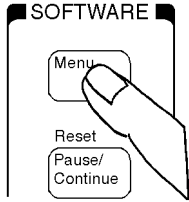







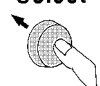


### Loading the Test Software Card and Procedure

Load the Test Software card and a procedure as shown in [Figure 5-3](#) and [Figure 5-4](#).

**Figure 5-3** Loading the Test Software Card



**Figure 5-4 Loading a Procedure**

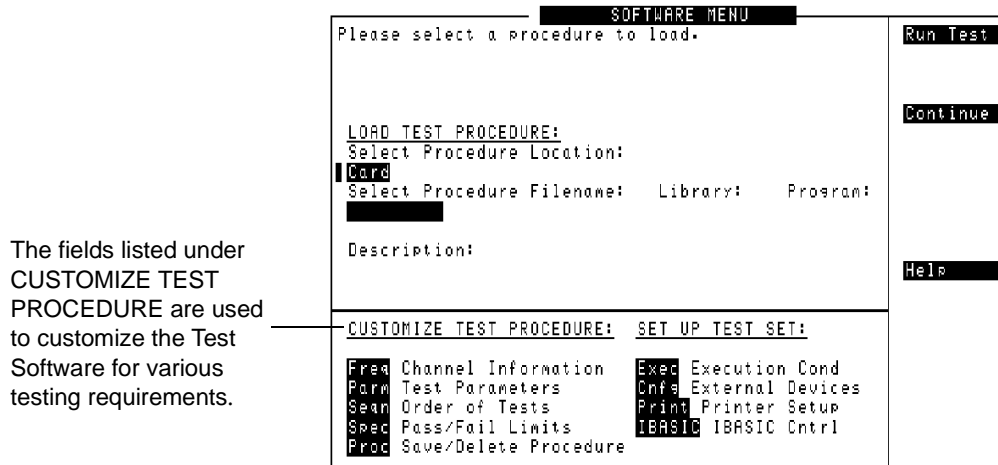
<p><b>5</b> Press the <b>Menu</b> key to display the SOFTWARE MENU screen.</p> 	<p><b>6</b> Scroll to <b>Select Procedure Location:</b> and select it.</p> <p><b>Position</b></p>  <pre>LOAD TEST PROCEDURE: Select Procedure Location: █ Select Procedure Filename: █</pre> <p><b>Select</b></p> 
<p><b>7</b> Scroll to <b>Card</b> and select it.</p> <p><b>Position</b></p>  <pre>Choices: █ Card ROM RAM</pre> <p><b>Position</b></p> 	<p><b>8</b> Scroll to <b>Select Procedure Filename:</b> and select it.</p> <p><b>Position</b></p>  <pre>LOAD TEST PROCEDURE: Select Procedure Location: Card Select Procedure Filename: █</pre> <p><b>Select</b></p> 
<p><b>9</b> Scroll to <b>Choices:</b> and select the Procedure name: LCDMA.</p> <p><b>Position</b></p>  <pre>Choices: █ DEMO LCDMA</pre> <p><b>Select</b></p> 	<p><b>10</b> Scroll to <b>Run Test</b> and select it. The Test Software will load.</p> <p><b>Position</b></p>  <pre>1 Run Test 2 Continue 4 Help</pre> <p><b>Select</b></p>  <p>⌚ Loading Time:          First time:          approximately          20 seconds.          After first time:          approximately          8 seconds.</p>

Reference

## Customizing a Test Procedure

Test Software packages have been designed so that you may make changes easily from the Test Set front panel (see [Figure 5-5](#)). For example, you may insert or delete tests, and later, after running the tests, you may change the pass/fail limits or decide to test different channels. You may store the customized test procedure on an SRAM card so that you may skip these steps in the future, see [“Saving/Deleting a Procedure” on page 101](#).

**Figure 5-5** Customizing a Test Procedure



**NOTE**

The Test Software package might not allow customization of testing procedures. If you attempt to enter a customization screen that is not supported with the current package, the message “Access to secure test information denied” will be displayed.

## Changing Test Parameters

The Test Software uses parameters to optimize the test environment and conditions for the testing situation. The default test parameters are determined by examining the test requirements and specifications from the equipment manufacturer. The Test Software comes with default settings for all test parameters.

Press the **Menu** key, then select the **Parm Test Parameters** field to display the TESTS (Test Parameters) screen (see [Figure 5-6](#)).

The fields in the TESTS (Test Parameters) screen allow you to change test parameters to optimize the testing conditions (see [Figure 5-7](#) and [Figure 5-8](#)). For information on saving customized test parameters, see “Saving/Deleting a Procedure” on page 101.

**Figure 5-6** TESTS (Test Parameters) Screen

Parameter description. The descriptions for the Test Software might be different than shown here.

Selects the parameter to be changed.

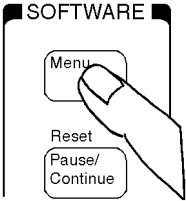







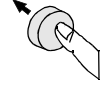

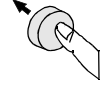

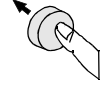

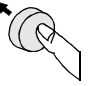

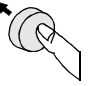

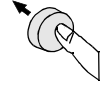

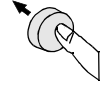

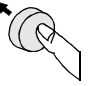

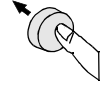
Displays the current parameter setting.

Param#	Description	Value	Units
1	Adjust Power [0=no 1=on fail 2=always]	0.000000	
2	BBA Chan Stand [1=NAC 2=NAP 3=KP4]		
3	BBA Channel Number		
4	BBA PN Offset		
5	GN Code Domain Power Threshold		
6	GN Print Inactive Codes [0=no 1=yes]		
7	GN Stop test if results fail [0=no 1=yes]		
8	LAP Baud Rate [valid test set range]		

3 Print All  
 4 Help  
 5 Main Menu

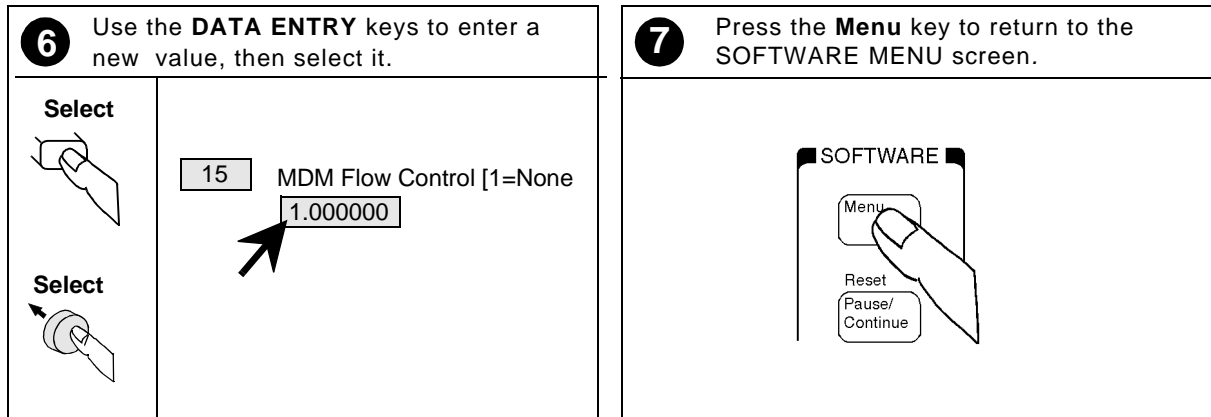
**NOTE** The TESTS (Test Parameters) screen might not be used in the particular Test Software package that you are using, or some fields might not be present, depending on the Test Software application. The message “Access to secure test information denied” will be displayed if the screen is not supported in the Test Software package.

**Figure 5-7** Changing Test Parameters

<p><b>1</b> Press the <b>Menu</b> key to display the SOFTWARE MENU screen.</p> <p>If the Test Software is running, press <b>Shift, Pause/Continue</b> before pressing <b>Menu</b>.</p> 	<p><b>2</b> Scroll to <b>Parm Test Parameters</b> and select it.</p> <table border="1"> <tr> <td data-bbox="828 380 967 499"> <p><b>Position</b></p>  </td> <td data-bbox="980 415 1414 562"> <table border="1"> <tr><td>Freq</td><td>Channel Information</td></tr> <tr><td><b>Parm</b></td><td>Test Parameters</td></tr> <tr><td>Seqn</td><td>Order of Tests</td></tr> <tr><td>Spec</td><td>Pass Fail Limits</td></tr> <tr><td>Proc</td><td>Save/Delete Procedure</td></tr> </table> </td> </tr> <tr> <td data-bbox="828 541 967 661"> <p><b>Select</b></p>  </td> <td></td> </tr> </table>	<p><b>Position</b></p> 	<table border="1"> <tr><td>Freq</td><td>Channel Information</td></tr> <tr><td><b>Parm</b></td><td>Test Parameters</td></tr> <tr><td>Seqn</td><td>Order of Tests</td></tr> <tr><td>Spec</td><td>Pass Fail Limits</td></tr> <tr><td>Proc</td><td>Save/Delete Procedure</td></tr> </table>	Freq	Channel Information	<b>Parm</b>	Test Parameters	Seqn	Order of Tests	Spec	Pass Fail Limits	Proc	Save/Delete Procedure	<p><b>Select</b></p> 	
<p><b>Position</b></p> 	<table border="1"> <tr><td>Freq</td><td>Channel Information</td></tr> <tr><td><b>Parm</b></td><td>Test Parameters</td></tr> <tr><td>Seqn</td><td>Order of Tests</td></tr> <tr><td>Spec</td><td>Pass Fail Limits</td></tr> <tr><td>Proc</td><td>Save/Delete Procedure</td></tr> </table>	Freq	Channel Information	<b>Parm</b>	Test Parameters	Seqn	Order of Tests	Spec	Pass Fail Limits	Proc	Save/Delete Procedure				
Freq	Channel Information														
<b>Parm</b>	Test Parameters														
Seqn	Order of Tests														
Spec	Pass Fail Limits														
Proc	Save/Delete Procedure														
<p><b>Select</b></p> 															
<p>The TESTS (Test Parameters) screen appears on the display.</p>	<p><b>3</b> Scroll to <b>Parm #</b> and select it.</p> <p>(Entries on the display might be different.)</p> <table border="1"> <tr> <td data-bbox="828 821 967 940"> <p><b>Position</b></p>  </td> <td data-bbox="980 905 1414 982"> <table border="1"> <tr><td>1</td><td>Adjust Power [0=no 1=on f</td></tr> <tr><td>0.00000</td><td></td></tr> </table> </td> </tr> <tr> <td data-bbox="828 982 967 1102"> <p><b>Select</b></p>  </td> <td></td> </tr> </table>	<p><b>Position</b></p> 	<table border="1"> <tr><td>1</td><td>Adjust Power [0=no 1=on f</td></tr> <tr><td>0.00000</td><td></td></tr> </table>	1	Adjust Power [0=no 1=on f	0.00000		<p><b>Select</b></p> 							
<p><b>Position</b></p> 	<table border="1"> <tr><td>1</td><td>Adjust Power [0=no 1=on f</td></tr> <tr><td>0.00000</td><td></td></tr> </table>	1	Adjust Power [0=no 1=on f	0.00000											
1	Adjust Power [0=no 1=on f														
0.00000															
<p><b>Select</b></p> 															
<p><b>4</b> Scroll to the <b>Parm #</b> to be changed and select it.</p> <table border="1"> <tr> <td data-bbox="212 1241 352 1381"> <p><b>Scroll</b></p>  </td> <td data-bbox="365 1255 797 1381"> <p>(This parameter number and description are examples.)</p> <table border="1"> <tr><td>15</td><td>MDM Flow Control [1=None</td></tr> </table> </td> </tr> <tr> <td data-bbox="212 1423 352 1543"> <p><b>Select</b></p>  </td> <td></td> </tr> </table>	<p><b>Scroll</b></p> 	<p>(This parameter number and description are examples.)</p> <table border="1"> <tr><td>15</td><td>MDM Flow Control [1=None</td></tr> </table>	15	MDM Flow Control [1=None	<p><b>Select</b></p> 		<p><b>5</b> Scroll to <b>Value</b> and select it.</p> <table border="1"> <tr> <td data-bbox="828 1262 967 1381"> <p><b>Position</b></p>  </td> <td data-bbox="980 1346 1414 1423"> <table border="1"> <tr><td>15</td><td>MDM Flow Control [1=None</td></tr> <tr><td>0.000000</td><td></td></tr> </table> </td> </tr> <tr> <td data-bbox="828 1423 967 1543"> <p><b>Select</b></p>  </td> <td></td> </tr> </table>	<p><b>Position</b></p> 	<table border="1"> <tr><td>15</td><td>MDM Flow Control [1=None</td></tr> <tr><td>0.000000</td><td></td></tr> </table>	15	MDM Flow Control [1=None	0.000000		<p><b>Select</b></p> 	
<p><b>Scroll</b></p> 	<p>(This parameter number and description are examples.)</p> <table border="1"> <tr><td>15</td><td>MDM Flow Control [1=None</td></tr> </table>	15	MDM Flow Control [1=None												
15	MDM Flow Control [1=None														
<p><b>Select</b></p> 															
<p><b>Position</b></p> 	<table border="1"> <tr><td>15</td><td>MDM Flow Control [1=None</td></tr> <tr><td>0.000000</td><td></td></tr> </table>	15	MDM Flow Control [1=None	0.000000											
15	MDM Flow Control [1=None														
0.000000															
<p><b>Select</b></p> 															

Continue on next page

Figure 5-8 Changing Test Parameters (continued)



Reference

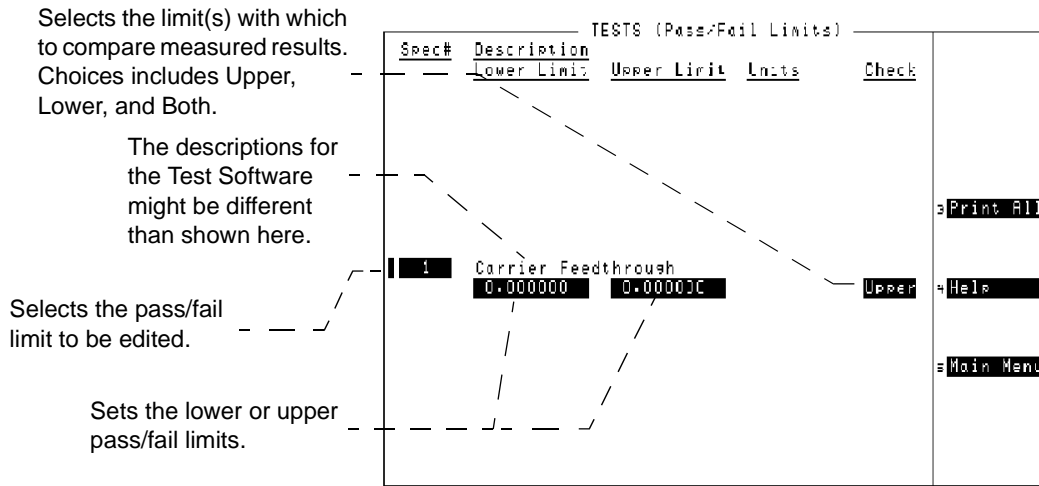
### Changing Pass/Fail Limits

Pass/Fail limits define the values with which a measurement result is compared to determine if the Base Station under test meets the specified standards. Default values are set in the Test Software. These default values may be changed to suit particular requirements.

Press the **Menu** key, then select the **Spec Pass/Fail Limits** field to display the TESTS (Pass/Fail Limits) screen (see [Figure 5-9](#)).

The fields in the TESTS (Pass/Fail Limits) screen allow you to change the pass/fail limits to optimize the testing conditions (see [Figure 5-10](#) and [Figure 5-11](#)). For information on saving customized pass/fail limits, see “Saving/Deleting a Procedure” on page 101.

**Figure 5-9 TESTS (Pass/Fail Limits) Screen**

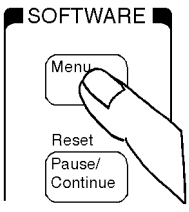

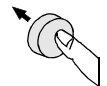

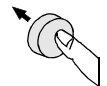

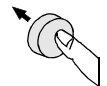

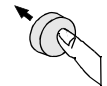
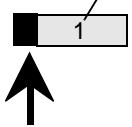

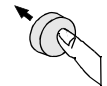
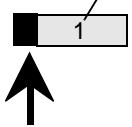

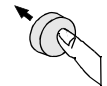
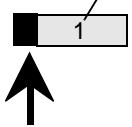


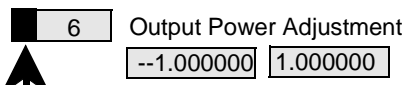


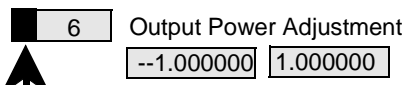

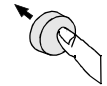
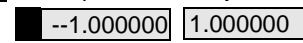

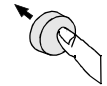
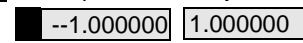


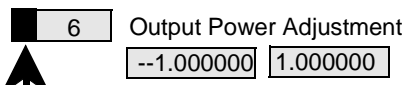

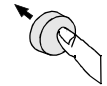
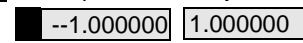


**NOTE**

The TESTS (Pass/Fail Limits) screen might not be used in the particular Test Software package that you are using, or some fields might not be present, depending on the Test Software application. The message “Access to secure test information denied” will be displayed if the screen is not supported in the Test Software package.



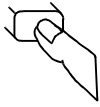
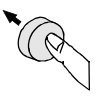



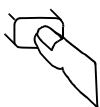
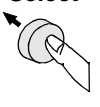

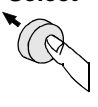


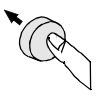


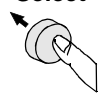
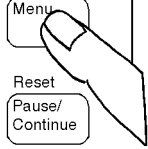
**Figure 5-10** Changing Pass/Fail Limits

<p><b>1</b> Press the <b>Menu</b> key to display the SOFTWARE MENU screen.</p> <p>If the Test Software is running, press <b>Shift, Pause/Continue</b> before pressing <b>Menu</b>.</p> 	<p><b>2</b> Scroll to <b>Spec Pass/Fail Limits</b> and select it.</p> <table border="1"> <tr> <td data-bbox="836 378 966 493"> <p><b>Position</b></p>  </td> <td data-bbox="1031 451 1388 619"> <p>Freq Channel Information                  Parm Test Parameters                  Seqn Order of Tests                  Spec Pass/Fail Limits                  Proc Save/Delete Procedure</p> </td> </tr> <tr> <td data-bbox="836 535 966 661"> <p><b>Select</b></p>  </td> <td></td> </tr> </table>	<p><b>Position</b></p> 	<p>Freq Channel Information                  Parm Test Parameters                  Seqn Order of Tests                  Spec Pass/Fail Limits                  Proc Save/Delete Procedure</p>	<p><b>Select</b></p> 					
<p><b>Position</b></p> 	<p>Freq Channel Information                  Parm Test Parameters                  Seqn Order of Tests                  Spec Pass/Fail Limits                  Proc Save/Delete Procedure</p>								
<p><b>Select</b></p> 									
<p>The TESTS (Pass/Fail Limits) screen appears on the display.</p>	<p><b>3</b> Scroll to <b>Spec #</b> and select it.</p> <table border="1"> <tr> <td data-bbox="836 819 966 934"> <p><b>Position</b></p>  </td> <td data-bbox="1096 850 1388 892"> <p>(Disregard this number.)</p> </td> </tr> <tr> <td data-bbox="836 976 966 1102"> <p><b>Select</b></p>  </td> <td data-bbox="1096 913 1226 1039">  </td> </tr> </table>	<p><b>Position</b></p> 	<p>(Disregard this number.)</p>	<p><b>Select</b></p> 					
<p><b>Position</b></p> 	<p>(Disregard this number.)</p>								
<p><b>Select</b></p> 									
<p><b>4</b> Scroll to the desired <b>Spec #</b> and select it.</p> <table border="1"> <tr> <td data-bbox="219 1260 332 1375"> <p><b>Scroll</b></p>  </td> <td data-bbox="422 1260 730 1291"> <p>(This Spec # is an example.)</p> </td> </tr> <tr> <td data-bbox="219 1417 332 1543"> <p><b>Select</b></p>  </td> <td data-bbox="365 1344 771 1459">  </td> </tr> </table>	<p><b>Scroll</b></p> 	<p>(This Spec # is an example.)</p>	<p><b>Select</b></p> 		<p><b>5</b> Scroll to <b>Lower Limit</b> and select it.</p> <table border="1"> <tr> <td data-bbox="836 1260 966 1375"> <p><b>Position</b></p>  </td> <td data-bbox="1006 1312 1396 1344"> <p>6 Output Power Adjustment</p> </td> </tr> <tr> <td data-bbox="836 1417 966 1543"> <p><b>Select</b></p>  </td> <td data-bbox="1079 1344 1380 1386">  </td> </tr> </table>	<p><b>Position</b></p> 	<p>6 Output Power Adjustment</p>	<p><b>Select</b></p> 	
<p><b>Scroll</b></p> 	<p>(This Spec # is an example.)</p>								
<p><b>Select</b></p> 									
<p><b>Position</b></p> 	<p>6 Output Power Adjustment</p>								
<p><b>Select</b></p> 									

Continue on next page

Reference

**Figure 5-11 Changing Pass/Fail Limits (continued)**

<p><b>6</b> Use the <b>DATA ENTRY</b> keys to enter a new value, then select it.</p> <p><b>Enter</b> </p> <p><b>Select</b> </p> <p>6      Output Power Adjustment  <input type="checkbox"/> -0.500000   <input type="checkbox"/> 1.000000</p> <p>(Enter the desired value.)</p>	<p><b>7</b> Scroll to <b>Upper Limit</b> and select it.</p> <p><b>Position</b> </p> <p><b>Select</b> </p> <p>Output Power Adjustment  <input type="checkbox"/> .500000   <input checked="" type="checkbox"/> 1.000000   dB</p> <p></p>
<p><b>8</b> Use the <b>DATA ENTRY</b> keys to enter a new value, then select it.</p> <p><b>Enter</b> </p> <p><b>Select</b> </p> <p>Output Power Adjustment  <input type="checkbox"/> .500000   <input checked="" type="checkbox"/> 0.500000   dB</p> <p>(Enter the desired value.)</p>	<p><b>9</b> Scroll to <b>Check</b> and select it.</p> <p><b>Position</b> </p> <p><b>Select</b> </p> <p><input checked="" type="checkbox"/> Both</p> <p></p>
<p><b>10</b> Select the choice that should apply to testing and select it.</p> <p><b>Position</b> </p> <p><b>Select</b> </p> <p>Choices:          Upper          Lower  <input checked="" type="checkbox"/> Both          None</p> <p></p>	<p><b>11</b> Press the <b>Menu</b> key to return to the SOFTWARE MENU screen.</p> <p><b>Position</b> </p> <p><b>Select</b> </p> <p>SOFTWARE  <input type="checkbox"/> Menu  <input type="checkbox"/> Reset  <input type="checkbox"/> Pause/Continue</p> <p></p>

### Saving/Deleting a Procedure

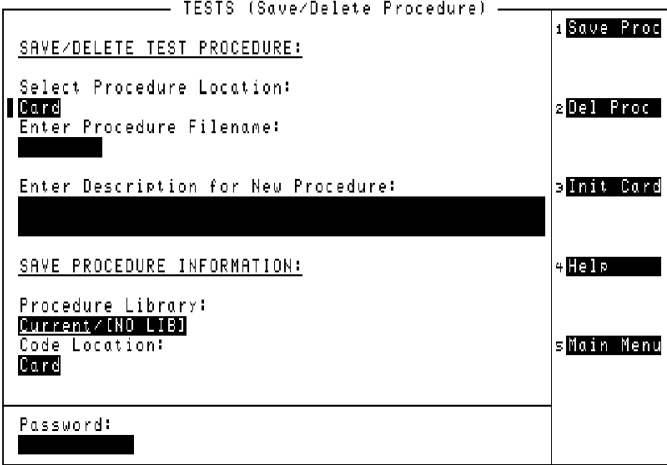
A test procedure is a collection of channel information, test parameters, testing order, and pass/fail limits saved in a file that customizes the Test Software to a specific application. Ordinarily, procedures are saved on an SRAM card.

Press the **Menu** key, then select the **Proc Save/Delete Procedure** field to display the TESTS (Save/Delete Procedure) screen (see [Figure 5-12](#)).

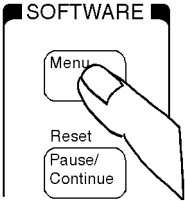

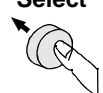

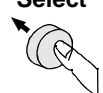

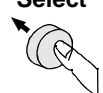

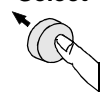


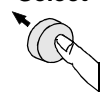


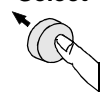


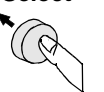

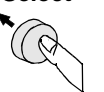
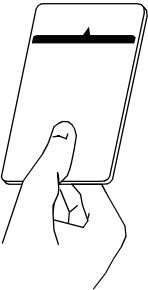

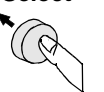
The fields in the TESTS (Save/Delete Procedure) screen allow you to save or delete procedures (see [Figure 5-13](#), [Figure 5-14](#), and [Figure 5-15](#)). When you save a procedure, you save channel information, test parameters, pass/fail limits, and testing order, plus a library that contains the names of all test parameters, pass/fail limits, and tests that are resident in the Test Software. The library file comes from the Test Software and cannot be modified. The library file will be automatically saved on the card that is being used to store the new test procedure.

The process for deleting a procedure is the same as saving a procedure, except that, in Step13, select the **Del Proc** field instead.

**Figure 5-12** TESTS (Save/Delete Procedure) Screen

















**Figure 5-13 Saving a Test Procedure**

<p><b>1</b> Press the <b>Menu</b> key to display the SOFTWARE MENU screen.</p> <p>If the Test Software is running, press <b>Shift, Pause/Continue</b> before pressing <b>Menu</b>.</p> 	<p><b>2</b> Scroll to <b>Proc Save/Delete Procedure</b> and select it.</p> <table border="1"> <tr> <td data-bbox="829 394 964 506"> <p><b>Position</b></p>  </td> <td data-bbox="1036 422 1393 583"> <table border="1"> <tr><td>Freq</td><td>Channel Information</td></tr> <tr><td>Parm</td><td>Test Parameters</td></tr> <tr><td>Seqn</td><td>Order of Tests</td></tr> <tr><td>Spec</td><td>Pass Fall Limits</td></tr> <tr><td>Proc</td><td>Save/Delete Procedure</td></tr> </table> </td> </tr> <tr> <td data-bbox="829 541 964 653"> <p><b>Select</b></p>  </td> <td></td> </tr> </table>	<p><b>Position</b></p> 	<table border="1"> <tr><td>Freq</td><td>Channel Information</td></tr> <tr><td>Parm</td><td>Test Parameters</td></tr> <tr><td>Seqn</td><td>Order of Tests</td></tr> <tr><td>Spec</td><td>Pass Fall Limits</td></tr> <tr><td>Proc</td><td>Save/Delete Procedure</td></tr> </table>	Freq	Channel Information	Parm	Test Parameters	Seqn	Order of Tests	Spec	Pass Fall Limits	Proc	Save/Delete Procedure	<p><b>Select</b></p> 	
<p><b>Position</b></p> 	<table border="1"> <tr><td>Freq</td><td>Channel Information</td></tr> <tr><td>Parm</td><td>Test Parameters</td></tr> <tr><td>Seqn</td><td>Order of Tests</td></tr> <tr><td>Spec</td><td>Pass Fall Limits</td></tr> <tr><td>Proc</td><td>Save/Delete Procedure</td></tr> </table>	Freq	Channel Information	Parm	Test Parameters	Seqn	Order of Tests	Spec	Pass Fall Limits	Proc	Save/Delete Procedure				
Freq	Channel Information														
Parm	Test Parameters														
Seqn	Order of Tests														
Spec	Pass Fall Limits														
Proc	Save/Delete Procedure														
<p><b>Select</b></p> 															
<p>The TESTS (Save/Delete Procedure) screen appears on the Test Set display.</p>	<p><b>3</b> Scroll to <b>Select Procedure Location:</b> and select it.</p> <table border="1"> <tr> <td data-bbox="829 835 964 947"> <p><b>Position</b></p>  </td> <td data-bbox="1036 905 1333 932"> <p>Select Procedure Location:</p> </td> </tr> <tr> <td data-bbox="829 989 964 1100"> <p><b>Select</b></p>  </td> <td data-bbox="1036 940 1138 1052">  </td> </tr> </table>	<p><b>Position</b></p> 	<p>Select Procedure Location:</p>	<p><b>Select</b></p> 											
<p><b>Position</b></p> 	<p>Select Procedure Location:</p>														
<p><b>Select</b></p> 															
<p><b>4</b> Scroll to <b>Card</b> and select it.</p> <table border="1"> <tr> <td data-bbox="224 1276 326 1388"> <p><b>Position</b></p>  </td> <td data-bbox="435 1283 651 1430"> <p>Choices:</p> <table border="1"> <tr><td>■</td><td>Card</td></tr> <tr><td></td><td>RAM</td></tr> <tr><td></td><td>Disk</td></tr> </table> </td> </tr> <tr> <td data-bbox="224 1430 326 1541"> <p><b>Select</b></p>  </td> <td data-bbox="370 1451 711 1507"> <p>(You may also save procedures to an internal RAM disk.)</p> </td> </tr> </table>	<p><b>Position</b></p> 	<p>Choices:</p> <table border="1"> <tr><td>■</td><td>Card</td></tr> <tr><td></td><td>RAM</td></tr> <tr><td></td><td>Disk</td></tr> </table>	■	Card		RAM		Disk	<p><b>Select</b></p> 	<p>(You may also save procedures to an internal RAM disk.)</p>	<p><b>5</b> Insert an initialized PC card into the front-panel card slot.</p> <p>For detailed SRAM card initialization instructions, see <a href="#">"Initializing a PC Card" on page 118.</a></p> 				
<p><b>Position</b></p> 	<p>Choices:</p> <table border="1"> <tr><td>■</td><td>Card</td></tr> <tr><td></td><td>RAM</td></tr> <tr><td></td><td>Disk</td></tr> </table>	■	Card		RAM		Disk								
■	Card														
	RAM														
	Disk														
<p><b>Select</b></p> 	<p>(You may also save procedures to an internal RAM disk.)</p>														

Continue on next page

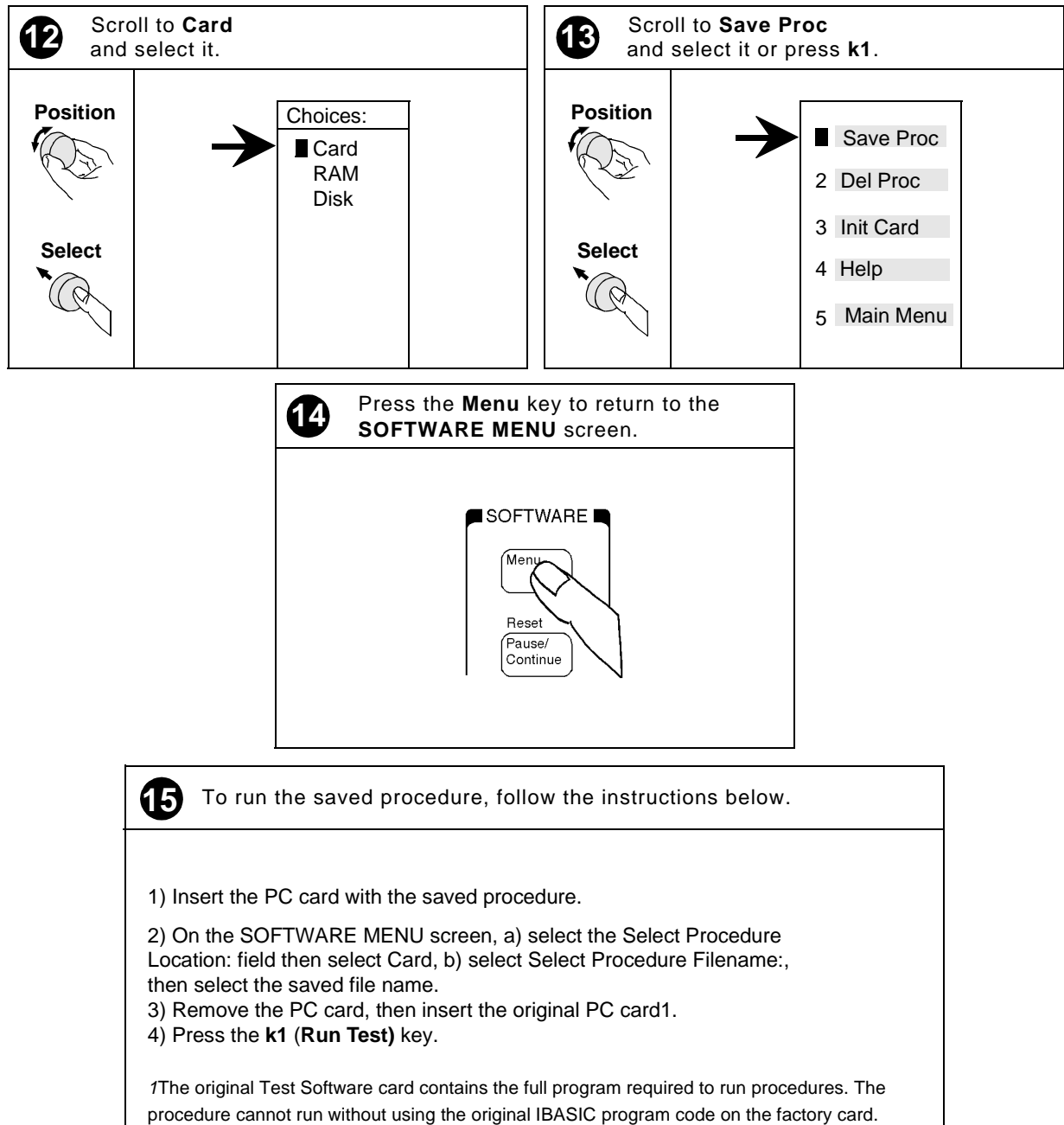
Figure 5-14 Saving a Test Procedure (continued)

<p><b>6</b> Scroll to <b>Enter Procedure Filename:</b> and select it.</p>	<p><b>7</b> Select characters to name the Procedure, then select <b>Done</b>.</p>
<p><b>Position</b>  </p> <p>Enter Procedure Filename:  </p> <p><b>Select</b>  </p>	<p><b>Position</b>  </p> <p>Choices:          Done          Position          Over/Ins          Delete          Del End          Bk space          A          B          C</p> <p><b>Select</b>  </p>
<p><b>8</b> Scroll to <b>Enter Description for New Procedure:</b> and select it.</p>	<p><b>9</b> Select characters for the description, then select <b>Done</b>.</p>
<p><b>Position</b>  </p> <p>Enter Description for New Procedure:  </p> <p><b>Select</b>  </p>	<p><b>Position</b>  </p> <p>Choices:          Done          Position          Over/Ins          Delete          Del End          Bk space          A          B          C</p> <p><b>Select</b>  </p>
<p><b>10</b> Scroll to <b>Procedure Library:</b> and select <b>Current</b>.</p>	<p><b>11</b> Scroll to <b>Code Location:</b> and select it.</p>
<p><b>Position</b>  </p> <p>Procedure Library:  <u>C</u>urrent / [ NO LIB ]</p> <p><b>Select</b>  </p> <p>(The underline indicates which option is selected. Pressing the knob changes the selection.)</p>	<p><b>Position</b>  </p> <p>ROM</p> <p><b>Select</b>  </p>

Continue on next page

Reference

Figure 5-15 Saving a Test Procedure (continued)



---

## BTS Laptop Utility Program Windows

The BTS Laptop Utility program provides five windows in which information may be display or entered. These windows are: **Switch Terminal**, **Test Set Terminal**, **Other Data**, **Test Results**, and **Test Set Screen Capture**.

For information on installing the BTS Laptop Utility program and configuring the PC and Test Set to work together, see “[Operating the BTS Laptop Utility Program](#)” on page 27.

### Switch Terminal Window

The Switch Terminal window functions as essentially a VT100 terminal to accomplish the following:

- It allows you to connect with the MSC, either with the PC internal modem to dial into the MSC, or with the PC and a telnet connection to the MSC.
- It displays the commands sent to the MSC and the replies sent back from the MSC.

### Test Set Terminal Window

The Test Set Terminal window displays commands sent from the Test Set to the MSC.

### Other Data Window

---

#### NOTE

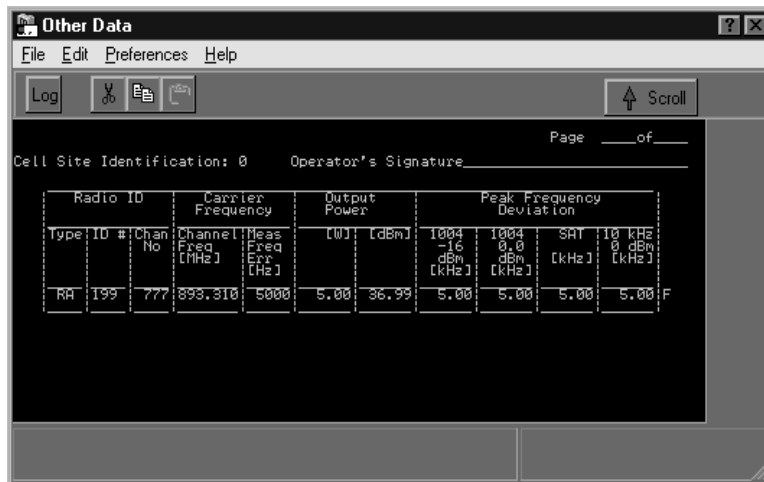
Because frequency plans and short-form test results are not used in CDMA testing, this window is not used in the CDMA application described in this manual. This information is included here because the functionality is always included in the BTS Laptop Utility program.

The **Other Data** window accomplishes the following:

- It allows you to download frequency plans to the Test Set.
- It displays short-form test results.

The short-form test results are sent to the PC automatically and displayed in the window (see [Figure 5-16](#) for an example of the display). By selecting **File, Logging Enabled**, you may enter a file name to save the test results to a file that may be retrieved into a text editor and printed out. **This selection must be done before the test results are sent to the screen.**

**Figure 5-16 Other Data Window Showing Short-Form Test Results**



### Test Results Window

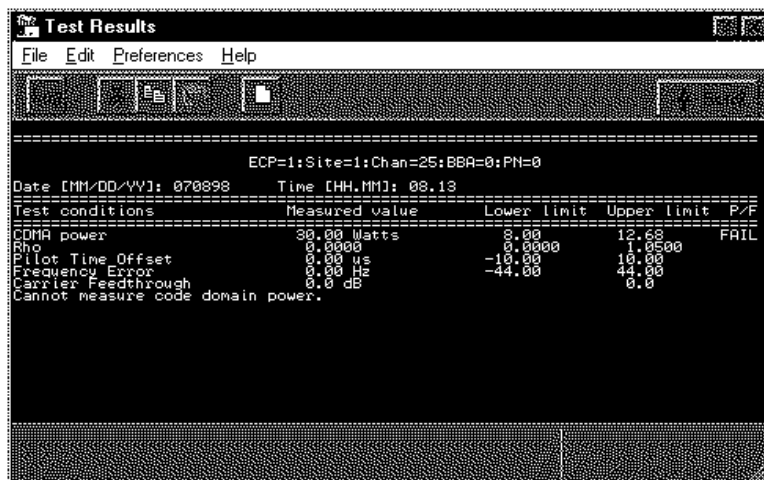
**NOTE**

Because short-form test results are not used in CDMA testing, the test results display in this window, which is ordinarily called “long-form test results” is called simply “test results” in the CDMA application described in this manual.

The **Test Results** window displays test results. These results may be saved for later use (see [Figure 5-17](#) for an example of the display).

The test results are sent to the PC automatically and displayed in the window. By selecting **File, Logging Enabled**, you may enter a file name to save the test results to a file that may be retrieved into a text editor and printed out. **This selection must be done before the test results are sent to the screen.**

**Figure 5-17 Test Results Window Showing Results**





## Test Set Screen Capture Window

The Test Set Screen Capture window allows you to capture a Test Software screen image and save it as a bit map file for later view or use. This is very helpful when using the Test Set spectrum analyzer or when you wish to capture some other screen. Note that IBASIC program operation must be paused first, by pressing the Pause/Continue key, to print any of the TESTS screens used for automated testing.

To capture a Test Software screen, configure the PC and the Test Set, then attempt a screen capture, as follows:

1. If the Test Set SERIAL 9 port and the PC serial port are not configured, configure both ports (see [“Configuring the Test Set and PC Serial Ports for Communication with the Test Set”](#) on page 29).
2. Select the screen that you wish to save and make any required entries on that screen to display the desired information.
3. If the screen that you intend to capture is one that appears only when the Test Software is running (a star appears in the upper right-hand corner of the display), press the **Pause/Continue** key to pause it.
4. Press the Test Set **Shift** key, then the **Inst Config (I/O Config)** key. The Test Set will display the I/O CONFIGURE screen.
5. Select the **Serial\_9 In** field and press the knob to toggle the setting to **Inst** (underlined).
6. Press the Test Set **Shift** key, then the **Print (Printer Config)** key. The Test Set will display the PRINTER CONFIGURE screen.
7. Select the **Model** field and select **DeskJet** from the drop-down **Choices:** list.
8. Select the **Printer Port** field and select **Serial 9** from the drop-down **Choices:** list.
9. If the screen of interest is one that appears only when the Test Software is running, press the **Menu** key. The Test Software will display the SOFTWARE MENU screen.
10. If the screen of interest is one that appears only when the Test Software is running, select the **IBASIC IBASIC Cntrl** field. The Test Software will display again the screen that you set up in Step 2.
11. Press the Test Set **Print** key. The currently-displayed screen should appear in the **Test Set Screen Capture** window on the PC screen.
12. If the screen is satisfactory and you wish to use or view it later, enter a name for the file in the **Test Set Screen Capture** window **Title** field.
13. On the **Test Set Screen Capture** window tool bar, click on the third button from the left (**Save Image**).
14. On the drop-down **Save** window, select the location to which you wish to save the image. Make certain that the **Save as type:** field is set to **.bmp**, and click on **Save**. The file will be saved as a bit-mapped image in the location that you selected.

---

## Demo (Demonstration) Mode

The demonstration mode offers a good method for becoming familiar with the operation of the Test Software. Demo mode allows you to step through the menus and simulate testing without a PC, a connection to the switch, or even a Base Station.

In the demo mode, the system will not send commands to the MSC, but it will perform very much the same as if actually testing a Base Station. When measurements are displayed, it provides sample numbers in order to show how the printout format will appear.

There are two methods for entering the demo mode:

- Selecting the procedure named DEMO.  
and
- Selecting the demo mode using the demo control parameter (see "23. ZZZZ Test Demo Mode [0=normal 1=demo]" on page 114 ).

### Selecting the DEMO Procedure

Select the DEMO procedure as follows:

---

**NOTE**

Once the DEMO procedure is loaded, *it will remain in the Test Set memory until you load another procedure*. Even if you turn off the Test Set and run the Test Software later, the procedure is stored in battery-backed-up memory and will remain ready to run.

- Step 1.** If the Test Software is running, press the **Shift** key, then the **Pause/Continue** key to stop it.
- Step 2.** Press the **Menu** key. The Test Software will display the SOFTWARE MENU screen.
- Step 3.** Select the **Select Procedure Location:** field, then select **Card** from the drop-down **Choices:** list.
- Step 4.** Select the **Select Procedure Filename:** field, then select **DEMO** from the drop-down **Choices:** list.
- Step 5.** Press the **k1 (Run Test)** key to run the Test Software. The Test Software will set the demo control parameter to 1 and operate in demo mode until you load another procedure.

### Selecting Demo Mode Using the Control Parameter

Select the demo mode using the control parameter as follows:

---

**NOTE**

Once the demo mode is enabled, *it will stay on until you turn it off*. Even if you turn off the Test Set and run the Test Software later, the demo mode setting is stored in non-volatile RAM and will still be set.

- Step 1.** If the Test Software is running, press the **Shift** key, then the **Pause/Continue** key to stop it.
- Step 2.** Press the **Menu** key. The Test Software will display the SOFTWARE MENU screen.

- Step 3.** Select the **Parm Test Parameters** field. The Test Software will display the TESTS (Test Parameters) screen.
- Step 4.** Select the **Parm#** field to allow scrolling.
- Step 5.** Scroll to the **ZZZZ Test Demo Mode** field and press the knob again to stop the scrolling function.
- Step 6.** Turn the knob clockwise to place the cursor to the left of the value field (0.000000) below the parameter name.
- Step 7.** Using the DATA ENTRY keys, enter 1.
- Step 8.** Press the **k5 (Main Menu)** key. The Test Software will display the SOFTWARE MENU screen and will operate in demo mode the next time that you run it. If you wish to re-run the Test Software now, press the **k1 (Run Test)** key.

## Exiting the Demo Mode

To turn off the demo mode, enter a value of 0 in the demo mode control parameter as follows:

- Step 1.** If the Test Software is running, press the **Shift** key, then the **Pause/Continue** key to stop it.
- Step 2.** Press the **Menu** key. The Test Software will display the SOFTWARE MENU screen.
- Step 3.** Select the **Parm Test Parameters** field. The Test Software will display the TESTS (Test Parameters) screen.
- Step 4.** Select the **Parm#** field to allow scrolling.
- Step 5.** Scroll to the **ZZZZ Test Demo Mode** field and press the knob again to stop the scrolling function.
- Step 6.** Turn the knob clockwise to place the cursor to the left of the value field (1.000000) below the parameter name.
- Step 7.** Using the DATA ENTRY keys, enter 0.
- Step 8.** Press the **k5 (Main Menu)** key. The Test Software will display the SOFTWARE MENU screen and will operate in normal mode the next time that you run it. If you wish to re-run the Test Software now, press the **k1 (Run Test)** key.

## Parameters

The Test Software uses entries that you make in the Test Parameters screen to customize testing and configure the modem.

A special parameter allows you to run the Test Software in a demo mode, which is useful for familiarization with the operation of the Test Set without connecting to any external equipment (see [“Demo \(Demonstration\) Mode” on page 108](#)).

Most parameters may be entered two ways:

- By loading and running the Test Software and entering all of the information in the Test Configuration, Base Station Configuration, and Printer/Serial Port Configuration menus, the Test Software automatically changes the test parameter settings to match the configuration settings.

Parameters that cannot be set while the Test Software is running include:

- ["1. Adjust Power \[0=no 1=on fail 2=always\]" on page 110](#)
- ["5. GN Code Domain Power Threshold" on page 111](#)
- ["6. GN Print Inactive Walsh Codes \[0=no 1=yes\]" on page 111](#)
- ["7. GN Stop Test if results fail \[0=no 1=yes\]" on page 111](#)
- ["23. ZZZZ Test Demo Mode \[0=normal 1=demo\]" on page 114](#)

- By loading the Test Software and selecting the **Parm Test Parameters** field on the SOFTWARE MENU screen, you may change the settings or any or all parameters from the factory defaults.

This section lists the parameters and describes the use of each. For instructions on changing the parameters and saving the changes on an SRAM card, see [“Changing Test Parameters” on page 95](#) and [“Saving/Deleting a Procedure” on page 101](#).

### 1. Adjust Power [0=no 1=on fail 2=always]

This parameter specifies the manner in which power measurements will be made. The settings have the following effects:

- Select 0 to display power measurements whether those meet the specified pass/fail limits or not. The power meter is not displayed.
- Select 1 to display the adjustment power meter if the measured power is outside the specified pass/fail limits. You may then adjust power to within the limits and continue with testing.
- Select 2 to display the adjustment power meter any time that power measurements are made, whether the values are within the specified pass/fail limits or not.

See Specification ["6. Output Power Adjustment Error" on page 116](#) and Specification ["7. Output Power Error" on page 116](#).

**2. BBA Chan Stand [1=NAC 1=NAP 2=KP4]**

This parameter specifies the channel or frequency assignment to be used.

- Select 1 for North American Cellular.
- Select 2 for North American PCS.
- Select 4 for Korean PCS P4.

**3. BBA Channel Number**

This parameter specifies the channel number for the BBA to be tested.

**4. BBA PN Offset**

This parameter specifies the PN offset for the BBA to be tested. If you are uncertain of this value, run the “[PN Offset Search Test](#)” on page 79) to measure it.

**5. GN Code Domain Power Threshold**

This parameter specifies the level for code domain power measurements. The level of each Walsh channel is compared to this threshold level. If it exceeds the threshold value, the channel is considered **active**. If it falls below the threshold, the Walsh channel is considered **inactive**.

---

**NOTE**

---

The useful range for entries into the **Code Domain Power Threshold** parameter is 0 to –30 dB. If you enter a value outside of this range, the Test Software will use the nearest value within the range.

On **active** Walsh channels (when running code domain test sequences), the Test Software will measure and report:

- Code Domain Power
- Code Domain Timing
- Code Domain Phase

**6. GN Print Inactive Walsh Codes [0=no 1=yes]**

This parameter specifies whether inactive Walsh channels will be reported. It is used with the **Code Domain Power Threshold** parameter. Walsh channels with levels below the **Code Domain Power Threshold** parameter entry are considered **inactive**.

- Select 0 to cause the Test Software not to measure or report the inactive Walsh values.
- Select 1 to cause the Test Software to measure and report the code domain power for each of the inactive Walsh channels.

**7. GN Stop Test if results fail [0=no 1=yes]**

This parameter specifies whether the Test Software will stop on a failed measurement. An **F** appears in the P/F column of the test results to indicate a failure of that data point.

- Select 0 to cause the Test Software to continue running if a measured value is not within specifications.
- Select 1 to cause the Test Software to stop testing if a measured value is not within specifications.

8. **MSC BBA Number [50 Max]**

This parameter specifies the number for the BBA to be tested.

9. **MSC BCR Attenuation [30 dB Max]**

This parameter specifies the BCR attenuation setting for the BBA to be tested.

10. **MSC Cell Site Number [444 Max]**

This parameter specifies the number of the cell site to be tested.

11. **MSC Command Speed Type [0=fast 1=slow]**

This parameter specifies the rate at which commands will be sent to the switch. Some communication links at the switch allow rapid command entry; others return transmission errors when commands are sent rapidly.

- Select 0 for higher speed for most communications with the MSC.
- Select 1 for slower speed if problems arise in communications with the MSC.

12. **MSC ECP Number**

This parameter specifies the number of the ECP that controls the cell site to be tested.

13. **SP9 Baud Rate [valid test set range]**

This parameter specifies the baud rate to be used for communication between the PC and the Test Set SERIAL 9 port. Valid rates (bps) are: 150, 300, 600, 1200, 2400, 4800, 9600, 19200, 38400, and 57600. This setting must match the setting used by the PC communication program. Use the DATA ENTRY keys to enter a value. The default rate is 9600. However, the Test Software will operate most efficiently at 19200, so it is recommended that you enter that value. For more information, see [“Configuring the Test Set and PC Serial Ports for Communication with the Test Set” on page 29.](#)

14. **SP9 Data Length [7 or 8]**

This parameter specifies the number of bits to be used for the serial communication data link between the PC and the Test Set SERIAL 9 port. This setting must match the setting used by the PC communication program. Use the DATA ENTRY keys to enter a value. Enter 8. For more information on using this parameter, see [“Configuring the Test Set and PC Serial Ports for Communication with the Test Set” on page 29.](#)

15. **SP9 Flow Control [1=None 2=Xon 3=Hw]**

This parameter specifies the type of data flow control to be used for the serial communication data link between the PC and the Test Set SERIAL 9 port. This setting must match the setting used by the PC communication program. Use the DATA ENTRY keys to enter a value. For more information on using this parameter, see [“Configuring the Test Set and PC Serial Ports for Communication with the Test Set” on page 29.](#)

- Enter 1 for no flow control. No flow control is strongly recommended for the 19200 baud rate.
- Enter 2 for Xon/Xoff flow control.
- Enter 3 for hardware flow control. This setting must be used for baud rates of 38400 and above.

**16. SP9 Parity [0=0 1=1 2=none 3=even 4=odd]**

This parameter specifies the kind of parity to be used for communication between the PC and the Test Set SERIAL 9 port. The setting must match the setting used by the PC communication program. Use the DATA ENTRY keys to enter a value. For more information on using this parameter, see [“Configuring the Test Set and PC Serial Ports for Communication with the Test Set” on page 29](#).

- Enter 0 for zeros parity.
- Enter 1 for ones parity.
- Enter 2 for no parity. This setting is strongly recommended.
- Enter 3 for even parity.
- Enter 4 for odd parity.

**17. SP9 Stop Length [1 or 2]**

This parameter specifies the stop length for communications between the PC and the Test Set SERIAL 9 port. The setting must match the setting used by the PC communication program. Use the DATA ENTRY keys to enter a value. Enter 1 for 1 stop bit. For more information on using this parameter, see [“Configuring the Test Set and PC Serial Ports for Communication with the Test Set” on page 29](#).

**18. Test Set REF IN [1=CS 2=GPS]**

This parameter specifies the source for the timebase reference signal to be used in testing:

- Select 1 when using the cell site clock signals from the SCT modules.
- Select 2 when you are using a Symmetricom 58503A GPS Time and Frequency Reference Receiver or equivalent.

**19. TX Antenna Port Cable Loss**

This parameter specifies the amount of cable loss to be accommodated when testing from the TX Antenna port. If you are uncertain of this value, run the [“TX Antenna Port Cable Calibration Test” on page 75](#)) to measure it.

**20. TX Output Power**

This parameter specifies the power level (in watts) that the BCR should be transmitting (at the TX Antenna port) when BCR Attenuation is set to 0 (zero).

**21. TX Test Port Cable Loss**

This parameter specifies the amount of cable loss to be accommodated when testing from the Base Station TX Test Port. If you are uncertain of this value, run the [“TX Test Port Cable Calibration Test” on page 76](#)) to measure it.

**22. TX Test Port Coupling Factor**

This parameter specifies the amount of isolation between the BCR transmitter output and the Base Station TX Test Port. If you are uncertain of this value, run the [“TX Test Port Calibration Test” on page 77](#)) to measure it.

23. **ZZZZ Test Demo Mode [0=normal 1=demo]**

This parameter specifies the Test Software operating mode.

- Select 0 to cause the Test Software to operate in normal mode.
- Select 1 to cause the Test Software to operate in demonstration (demo) mode. The demo mode will allow you to run the tests without really testing or connecting to a Base Station. This allows you to become familiar with Test Software operation. For details, see [“Demo \(Demonstration\) Mode” on page 108](#).

24. **BTS Type [1=SII 2=PCS]**

This parameter specifies the type of the Base Station to be tested. Select 1 for a Autoplex Series II Base Station. Select 2 for a PCS Minicell Base Station.



---

## Specifications (Pass/Fail Limits)

The Test Software uses the entries in the TESTS (Pass/Fail Limits) screen to determine if a measurement meets the test requirements. If not, a “fail” indication is generated on the printout (and in some cases you are able to make adjustments and re-test).

This section lists each pass/fail limit name and explains how it is used. For instructions on changing the pass/fail limits and saving the changes to an SRAM card, see [“Changing Pass/Fail Limits” on page 98](#) and [“Saving/Deleting a Procedure” on page 101](#).

### 1. Carrier Feedthrough

These pass/fail limits are used in measuring the performance of the I/Q modulator of the CDMA transmitter.

Units are dBc.

### 2. Code Domain Floor

These pass/fail limits are used when performing code domain tests, and are used if the **Print Inactive Walsh Codes** parameter is set to 1. The **inactive** Walsh channel levels are measured and compared to this value (typically, the levels will fail some upper limit).

Units are dB.

See Parameter ["6. GN Print Inactive Walsh Codes \[0=no 1=yes\]" on page 111](#).

### 3. Code Domain Phase

These pass fail limits are used when performing code domain tests. The Test Set measures the phase of a Walsh channel compared to the pilot (Walsh 0) and compares the result to these limits.

Units are mrad (milliradians).

### 4. Code Domain Timing

These pass/fail limits are used when performing code domain tests. The Test Set measures the time offset of a Walsh channel compared to the pilot (Walsh 0) and compares the result to these limits.

Units are ns (nanoseconds).

### 5. Frequency Error

These pass/fail limits are used in measuring the transmitter frequency error. The Test Software determines the transmitter center frequency and compares it with the ideal frequency, based on the channel number entry. The difference between the two is the frequency error. The calculated frequency error is then compared to these pass/fail limits to determine if the test passes or fails.

Units are Hz (hertz).

#### 6. Output Power Adjustment Error

These pass/fail limits determine the manner in which the power meter will be displayed. When the power meter display is shown, it will include major tick marks that indicate the adjustment range for power settings. If you enter  $\pm 1$  dB as the limits, the meter will be drawn with the ideal setting in the center and major tick marks 1 dB up and 1 dB down from center.

Units are dB.

#### 7. Output Power Error

These pass/fail limits determine whether the power measurement made in automated testing meets specifications. (The previous pass/fail limits setting (**Output Power Adjustment Error**) controls the adjustment diagram in power meter use.) If you set power error pass/fail limits of  $\pm 2$  dB, these limits will be used when a power reading is made. If the power measured is more than 2 dB from the desired setting, a fail indication (**F**) will result.

---

**NOTE**

---

In general, it is best to have the **Output Power Adjustment Error** limits set narrower (smaller) than the **Output Power Error** limits.

Units are dB.

#### 8. Rho

These pass/fail limits are used when measuring rho, a measure of the modulation quality of a CDMA transmitter. Typically, only the lower limit is checked.

This measurement has no units.

#### 9. Time Offset

These pass/fail limits are used when measuring the transmitter time-alignment to system time.

Units are  $\mu\text{s}$  (microseconds).

#### 10. Emission Bandwidth

These pass/fail limits are used as the bandwidth in measuring for two points centered around the carrier, outside of which all emissions are attenuated at least 26 dB below the carrier transmit power.

Units are MHz (megahertz).

---

## Testing without MSC Control

Chapter 4, “Performing Tests,” on page 51, lists the steps for fully automated testing, using the Test Software to control the Base Station. The steps of that chapter use a PC to control the Base Station via the MSC.

If you are using a Test Set setup with no PC and connection to the MSC, the following considerations apply:

- Make certain to set the **Send Control Commands to MSC** field on the Base Station Configuration Menu to **NO**. The Test Set will not send control commands to the MSC using the PC.
- The connection diagrams at the start of each test sequence will include prompts to apply or remove power for the BBA being tested. You must control the transmitter signal (on and off) manually at the site.

---

### NOTE

In addition to turning the transmitter signal on and off, make certain that the proper configuration of the BBA is done for each test. For example, when running the Pilot Only Test, make certain that the pilot channel is the only active channel for that BBA (no paging or traffic channels should be active). For Code Domain tests, you should probably enable traffic, paging, and sync channels in most cases.

- You will probably require an assistant at the MSC to control the Base Station and remove the radios from service.

## Using a PC Card

Before a PC card may be used for the first time, it must be initialized. The following two sections describe the initialization process and offer some troubleshooting information in the event of a problem with the use of a PC card.

### Initializing a PC Card

When a card is new, or the battery has been removed when the card is not inserted into the Test Set, then the card must be initialized to store data. To initialize a PC card follow these steps:

- Step 1.** Insert the PC card into the front-panel card slot
- Step 2.** If a Test Software package is running, press the **Shift** key, then the **Pause/Continue** key to stop it.
- Step 3.** Press the **Shift** key, then the **Inst Config** key. The Test Set will display the I/O CONFIGURE screen.
- Step 4.** Select the **Format Card** field. The Test Set will display a query asking if you wish to "Erase and format the PCMCIA Card?" (YES/NO).
- Step 5.** Press the **Yes On/Off** key, located below and to the right of the knob, to format the card.  
The card is formatted when the cursor stops blinking.

### Troubleshooting PC Card Use

Each of the messages listed below is followed by an explanation of the probable cause.

#### **Directory Overflow.**

- The SRAM card is probably full and cannot store new files. You might have to delete some files on the card to clear memory space or use a new PC card.

#### **Medium uninitialized. Do you want to initialize?**

- The card either not been initialized or has other information stored on it. Initializing overwrites any data that might already be on the card. Press the **Yes On/Off** key to initialize the installed card.

#### **Write protected.**

- The card has been write protected (the switch in the WP position). Slide the write protect switch into the other position before writing.

#### **Medium changed or not in drive. No information was loaded.**

- The card has possibly not been inserted properly. Re-insert and try again.

#### **File name is undefined. No information was loaded.**

- There might be no information (files) stored on the card.
- You might not have inserted the correct card in the PC card slot. Try again with a different card.

---

# 6 Troubleshooting

This chapter contains information that is useful if you encounter Test Software or measurement errors or if you question measurement results.

## Error Summary

### Overview

This chapter lists errors that might be encountered when loading or running the Test Software. The errors are listed roughly in the order of possible occurrence when getting started using the Test Software:

[“Troubleshooting the Test Software Installation” on page 121.](#)

[“Errors When Loading and Running the Test Software” on page 122.](#)

[“Errors When First Setting Up or Connecting to MSC” on page 123.](#)

[“Communication Errors During Testing” on page 123.](#)

[“Errors While Attempting Measurements” on page 125.](#)

### Help for Communication Errors:

The following sections include checks and tools that may be used to troubleshoot communication errors between the Test System and the MSC:

[“Troubleshooting Checks for Communication Problems” on page 124.](#)

---

## Troubleshooting the Test Software Installation

If the Test Software did not install properly, check the following:

- Is the power on?
- Is the PC card inserted in the correct orientation?
- Is the PC card firmly seated in the slot? It should slide in loosely, then be firmly pushed in to make proper contact.
- Did the SOFTWARE MENU screen appear? Pressing the front panel **Preset** key should display the SOFTWARE MENU screen.
- Did TESTS (IBASIC Controller) appear at the top of the display after you pressed the **k1 (Run Test)** key? If not, make certain that you have specified the correct **Procedure Location** and **Procedure Filename**.

If you were unable to load and run the Test Software, make the required entries, or you encountered error messages, refer to other sections of this chapter.

---

### NOTE

If the Test Set displays an error that states “One or more self-tests failed”, there is a hardware problem. In this case, refer to the *Test Set Assembly Level Repair Guide*. If the problem persists, call the Agilent Technologies Factory Hotline from anywhere in the USA or Canada (1-800-452-4844, 8:30 am - 5:00 pm Pacific time).

---

---

## Errors When Loading and Running the Test Software

This group of errors would most often be encountered before the Main Menu appears. Such errors would be most likely to occur the first time that you load and run the Test Software (see [Chapter 2, “Installation,” on page 21](#)). The errors are presented with the error text, followed by a description of the cause, followed by some possible solutions.

- **Symptom: Memory Overflow Errors**

The random access memory (RAM) space of the Test Set is shared by IBASIC programs and save/recall registers. If you have saved a large number of registers in the Test Set, a memory overflow error might occur when you first attempt to load the Test Software.

To correct this, clear some RAM space by deleting some or all of the saved registers. You may do this selectively (one register at a time) or globally (all storage registers at once).

---

**NOTE**

Clearing the registers, whether selectively or globally, is *permanent*. *Registers are not retrievable once deleted*. You may save registers to an SRAM card, as well. Refer to the *Agilent Technologies 8935 Reference Guide* for instructions on this procedure.

---

**To delete a single register:**

- Step 1.** Press the **Recall** key.
- Step 2.** Scroll the cursor to the register to be deleted.
- Step 3.** Press the **Yes On/Off** key to indicate that you wish to clear the register.
- Step 4.** Press the **Yes On/Off** key again to confirm.
- Step 5.** The register will be cleared.

**To delete all saved registers:**

- Step 1.** Press the **Recall** key.
- Step 2.** Scroll to **\*Clr All\*** and press the knob.
- Step 3.** Press the **Yes On/Off** key to confirm.
- Step 4.** All save registers will be cleared.



## Communication Errors

### Errors When First Setting Up or Connecting to MSC

- Message: Base Station did not answer command...

If commands are misunderstood at the MSC end, this error message might occur. Use the **Switch Terminal** window in the BTS Laptop Utility program to send commands and view responses to identify the problem command. Also, refer to [“Troubleshooting Checks for Communication Problems” on page 124](#) for a list of items to check when you have noticed this error.

- Message: Improper communication with MSC. Use the BTS Laptop Utility program to correct the problem and to return all configured BBAs back to active status. Press the **Abort** key to return to main menu.
- The unit-under-test is unavailable. Use the Switch Terminal window in the BTS Laptop Utility program to correct the problem and to return all configured BBAs back to active status. Press the **Abort** key to return to main menu.

If the MSC is unable to free up the requested BBA at the site, it will send a message indicating that the equipment is unavailable. You might have to try testing that BBA at a later time or contact switch personnel for assistance.

### Communication Errors During Testing

Message: Lost the modem carrier. Use the BTS Laptop Utility program to correct the problem and to return all configured BBAs back to active status. Press the **Abort** key to return to the main menu.

This error indicates that communication with the MSC was taking place, but the link was lost sometime during the testing process.

As indicated in the message, you may use the BTS Laptop Utility program to try to re-establish the link with the MSC.

Also check the items in [“Troubleshooting Checks for Communication Problems” on page 124](#) for possible causes of interruptions to the communication between the Test System and the MSC.

## Troubleshooting Checks for Communication Problems

The following list provides items to check when you are having communication difficulties using the external modem to connect to the MSC.

- Cable connections:

Make certain that you have made the proper connections between the Test Set serial port, the phone line or telnet connection, and the personal computer (PC).

A list of cables and part numbers is provided in [“Accessory Kits” on page 17](#).

- Dialing difficulties:

In some cases, you might have to customize the dialing information in order to properly dial and connect to the MSC. For example, if there is a 9 in the dialing sequence to obtain an outside phone line, there might be a short delay before the dial tone is heard. Therefore, a delay after the 9 might be required before the rest of the digits in the sequence are sent. This may be done from the **Switch Terminal** window of the BTS Laptop Utility program. Clicking on the **Dial** button on the **Switch Terminal** window tool bar, and add a comma between the numbers as shown in the following example.

9, 1-509-835-0000

- MSC is not configured to send responses to commands:

After sending a control command to the MSC, the Test Software searches for response commands from the MSC before continuing. It might be that the MSC with which the system is communicating has been configured to not send responses to remote computers. You might have to check with a switch technician to determine if this is the case for the MSC in question.

---

## Errors While Attempting Measurements

The following error messages might be posted once a test mode has begun making measurements:

- Code domain power test failed. Use the BTS Laptop Utility program to correct the problem and to return all configured BBAs back to active status. Press the **Abort** key to return to main menu.

If the Test System is unable to correlate the code domain power measurements, this error will result. Check the following items and re-run the test:

- Entry in the **Channel Number** field in the Base Station Configuration Menu

This could be a problem *if you are not using a PC to control the Base Station via the MSC*. If you enter the wrong channel number, the Test Set will be tuned to an incorrect frequency. You may use the spectrum analyzer mode to verify the presence of a signal.

- Entry in the **PN Offset** field in the Base Station Configuration Menu

If you have entered an incorrect value for the PN offset, the Test Set will not be able to correlate CDMA measurements. You may use the PN Offset Search test from the Main Menu to find the valid PN offset value (see [“PN Offset Search Test” on page 79](#)).

- Even-second clock connection

Check the connection from the source of the even-second clock (at the Base Station). You might have to set the TST CLK switch to the ON position to enable the clock signal. The even-second clock signal should be connected from the Base Station to the EVEN SECOND SYNC IN port on the Test Set.

- Timebase reference clock connection

Check the connection from the source of the timebase reference signal (typically 19.6608 MHz) at the Base Station. You might have to set the TST CLK switch to ON to enable the reference signal. The timebase reference should be connected to the REF IN port on the Test Set (there are alternative connections; see [Chapter 3, “Connections,” on page 45](#)). If a valid clock signal is present during testing, the front-panel Unlock LED on the Test Set will be off.

- Transmitter turned on at time of testing

If you are using a PC connected to the MSC for Base Station control, the Test Set will turn on the transmitter when required for testing. You may verify that the transmitter is on by checking the green ACT LEDs on the front of the ACU and BCR modules. If you are *not* using the PC, you will have to enable the transmitter manually when prompted by the Test Software.

---

## **A**      **Acronyms**

There are numerous acronyms used throughout the wireless communications field. Many of those are used in this manual. The following list provides the meanings for the more significant acronyms for purposes of operating the Test Software.

## Acronyms and Meanings

ACU – Analog Conversion Unit  
AIF – Antenna Interface Frame  
AWGN – Added White Gaussian Noise  
BBA – BIU/BCR/ACU combination  
BCR – Baseband Combiner and Radio  
BIU – Bus Interface Unit  
CAT – Catalog  
CCC – CDMA Cluster Controller  
CCU – CDMA Channel Unit  
CDMA – Code Division Multiple Access  
CE – Channel Element  
CP – Call Processing  
CS – Cell Site  
CR – Carriage Return  
CRT – Cathode Ray Tube  
CRTU – CDMA Radio Test Unit  
dB – deciBel  
dBm – deciBels with respect to 1 milliwatt  
dBt – deciBels with respect to total channel power  
DTMF – Dual Tone Multi Frequency  
DUT – Device Under Test  
Eb/No – Ratio of Energy-per-Bit to Noise spectral density  
ECP – Executive Cellular Processor  
ERP – Effective Radiated Power  
EVM – Error Vector Magnitude  
GPS – Global Positioning System  
LAP – Laptop PC  
LED – Light Emitting Diode  
MHz – Megahertz  
MSC – Mobile Switching Center (also, MTSO)  
OMP – Operations Management Platform  
OOS – Out-Of-Service  
OP – Output Process

OTP – One-Time Programmable  
PC – Personal Computer  
PCS – Personal Communications Services  
PN – Pseudo-Noise  
RAM – Random-Access Memory  
RF – Radio Frequency  
RX – Receiver  
SCT – Synchronized Clock and Tone  
TX – Transmitter  
VSWR – Voltage Standing Wave Ratio  
UCL – UnConditional

## A

Accessing Test Software  
  Functions, 89  
  Changing Pass/Fail Limits, 98  
  Changing Test Parameters, 95  
  Customizing a Test Procedure, 94  
  Loading a Test Procedure, 91  
  Loading the Test Software Card and Procedure, 92  
  Saving/Deleting a Procedure, 101  
  SOFTWARE MENU Screen Overview, 90  
accessory kit, 17  
acronyms list, 128  
adapters, description, 17  
adjust power parameter, 110  
ANT IN port, 36  
Antenna Port connections, 36  
automated BBA test mode, 66

## B

Base Station Configuration menu, 41  
base station control errors, 123  
BBA Chan Stand parameter, 111  
BBA Channel Number parameter, 111  
BBA measurements, 66  
BBA PN Offset parameter, 111  
BTS Laptop Utility program, 15  
  installing, 28  
  operation, 27  
  Other Data Window, 105  
  Switch Terminal Window, 105  
  Test Results Window, 106  
  Test Set Screen Capture window, 107  
  Test Set Terminal Window, 105  
BTS Laptop Utility program system requirements, 28  
BTS Laptop Utility Program Windows, 105  
BTS Type parameter, 114

## C

cables and adapters required, 15  
calibrate TX antenna port mode, 75  
calibrate TX test port cable calibration mode, 76  
Calibrate TX Test Port Calibration mode, 77  
Calibrate TX Test Port mode, 80

carrier feedthrough specification, 115  
CDMA analyzer test mode, 73  
CDMA measurements, 73  
Cell Site Number, parameters  
  MSC Cell Site Number, 112  
changing settings, 26  
Choices, 9  
clock connection, 36  
code domain  
  floor specification, 115  
  measurements, 64  
  phase specification, 115  
  power measurement errors, 125  
  Power Threshold parameter, 111  
  power threshold parameter, 111  
  test mode, 64  
  timing specification, 115  
Command Speed Type, parameters  
  MSC Command Speed Type, 112  
communication errors, 123  
  troubleshooting checks, 124  
configuring the PC, 31  
  configuring the PC serial port, 29  
  configuring the Test Set SERIAL 9 port, 29  
  configuring the Test Software, 38  
connection  
  modem, 31  
  MSC to PC, 32  
  telnet, 31  
  Test Set to PC, 32  
connections  
  clock or external reference, 36  
  hardware, 27  
  reference and even-second clock, 46  
  site equipment to Test Set, 36  
  Test or Antenna port, 36  
  Test Set port, 36  
  Test Set to site equipment, 36  
conventions used, 9

## D

demo (demonstration) mode, 108, 114  
demo mode  
  selecting, 108  
DEMO procedure  
  selecting, 108  
description  
  parameters, 110  
direct-dial modem connection, 43

## E

emission bandwidth  
  test description, 84  
emission bandwidth specification, 116  
ENTER key, 9  
equipment  
  optional, 17  
  required, 15  
error  
  base station control, 123  
  baud rates, 123  
  code domain power measurement, 125  
  communication, 123  
  loading and running, 122  
  measurement, 125  
  modem carrier, 123  
establishing connection with the MSC, 43  
even-second clock connections, 46  
external reference connection, 36

## F

field  
  selecting a, 9  
frequency error specification, 115  
frequency reference  
  GPS, 17  
functions  
  Main Menu, 25

## G

GN Code Domain Power Threshold parameter, 111  
GN Stop Test if results fail parameter, 111  
GPS Frequency Reference, 17

## H

Help, 20  
How to LOAD TEST PROCEDURES, 91

## I

insertion loss measurement mode, 80  
in-service testing, 36  
installing the BTS Laptop Utility program, 28  
instrument, 27  
instrument connections, 27

## K

kit, accessory

- 
- cables, description, 17
  - L**
    - LAP Baud Rate parameter, 112
    - LAP Data Length parameter, 112
    - LAP Flow Control parameter, 112
    - LAP Parity parameter, 113
    - LAP Stop Length parameter, 113
    - Laptop (LAP) baud rate, 112
    - Laptop (LAP) Data Length, 112
    - Laptop (LAP) Flow Control, 112
    - Laptop Parity, 113
    - Laptop Stop Length, 112, 113
    - list
      - acronyms, 128
      - parameters, 110
      - specifications (pass/fail limits), 115
    - load, 23
    - load Test Software, 23
  - M**
    - Main Menu functions, 25
    - measurement errors, 125
    - measuring
      - BBAs, 66
      - CDMA signals, 73
      - code domain, 64
      - pilot only, 62
      - power, 56, 58
      - spectrum, 68, 70
    - menu
      - Base Station Configuration, 41
      - Test Configuration, 39
    - message, error, 122
    - mode
      - automated BBA test, 66
      - calibrate TX antenna port, 75
      - Calibrate TX Test Port, 80
      - calibrate TX test port cable calibration, 76
      - Calibrate TX Test Port Calibration, 77
      - CDMA analyzer test, 73
      - code domain test, 64
      - insertion loss measurement, 80
      - pilot only test, 62
      - PN offset search, 79
      - return loss measurement, 82
      - spectrum analyzer test, 68, 70
      - TX power meter, 56, 58
    - modem
      - carrier error, 123
      - modem connection, 31
    - MSC, 27
    - MSC BBA Number parameter, 112
    - MSC BCR Attenuation parameter, 112
    - MSC connection, 43
    - MSC connections, 27
    - MSC control, testing without, 117
    - MSC ECP Number parameter, 112
  - N**
    - navigating the Test Software, 25
  - O**
    - operating the BTS Laptop Utility Program
      - BTS Laptop Utility program operation, 27
    - operation overview
      - software, 14
    - optional equipment, 17
    - out-of-service testing, 37
    - output power adjustment error specification, 116
    - output power error specification, 116
  - P**
    - parameter
      - adjust power, 110
      - BBA Chan Stand, 111
      - BBA Channel Number, 111
      - BBA PN Offset, 111
      - BTS Type, 114
      - code domain power threshold, 111
      - demo mode, 114
      - GN Code Domain Power Threshold, 111
      - GN Stop Test if results fail parameter, 111
      - LAP Baud Rate, 112
      - LAP Data Length, 112
      - LAP Flow Control, 112
      - LAP Parity, 113
      - LAP Stop Length, 113
      - list, 110
      - MSC BBA Number, 112
      - MSC BCR Attenuation, 112
      - MSC ECP Number, 112
      - print inactive walsh codes, 111
      - REF 8935 REF IN, 113
      - TX Antenna Port Cable Loss, 113
      - TX Output Power, 113
      - TX Test Port Coupling Factor, 113
    - PC, 27
    - configuring, 31
    - PC (personal computer), 15
    - PC connections, 27
    - PC serial port
      - configuring, 29
    - PC to MSC connections, 32
    - PC to Test Set connections, 32
    - performing CDMA tests, 51
    - phone support, 20
    - pilot measurements, 62
    - pilot only test mode, 62
    - PN offset search mode, 79
    - power, 36
    - power measurements, 56, 58
    - power meter, 56, 58
    - print inactive walsh codes parameter, 111
  - R**
    - REF 8935 REF IN parameter, 113
    - reference connections, 46
    - reference, software, 87
    - required equipment, 15
    - return loss measurement mode, 82
    - RF IN/OUT port power, 36
    - rho specification, 116
    - run Test Software, 23
  - S**
    - service, Test Set, 20
    - setup, 27
    - software
      - operation overview, 14
      - reference, 87
    - Software upgrades, 20
    - special display conventions used, 9
    - specification
      - carrier feedthrough, 115
      - code domain floor, 115
      - code domain phase, 115
      - code domain timing, 115
      - emission bandwidth, 116
      - frequency error, 115
      - list, 115
      - output power adjustment error, 116
      - output power error, 116
      - rho, 116
      - time offset, 116
    - spectrum analyzer test mode, 68, 70
    - spectrum measurements, 68, 70
    - spurious emissions
      - test description, 84
-



Stop Test if results fail parameter,  
111  
support, 20  
system requirements  
BTS Laptop Utility program, 28

## T

telnet connection, 31, 43  
Test Configuration menu, 39  
test equipment required, 15  
Test Port connections, 36  
Test Set, 27  
Test Set connections, 27  
Test Set SERIAL 9 port  
configuring, 29  
Test Set service, 20  
Test Set to PC connection, 32  
Test Set to site equipment  
connections, 36  
Test Software  
navigation, 25  
run, 23  
Test Software configuration, 38  
testing without MSC control, 117  
tests, performing CDMA, 51  
time offset specification, 116  
training, 20  
troubleshooting checks for  
communication errors, 124  
TX Antenna Port Cable Loss  
parameter, 113  
TX Antenna Port for out-of-service  
testing, 37  
TX Output Power parameter, 113  
TX power meter mode, 56, 58  
TX Test port coupling factor, 36  
TX Test Port Coupling Factor  
parameter, 113  
TX Test Port for in-service testing,  
36

## U

upgrades, software, 20  
USER keys, 9, 26

## Z

ZZZZ demo mode parameter, 114