



Agilent M9536A AXIe Embedded Controller

User Guide

Errata

Agilent References in this manual

NOTICE: This document contains references to Agilent Technologies. Agilent's former Test and Measurement business has become Keysight Technologies. For more information, go to:

www.keysight.com

About this manual

We've added this manual to the Keysight website in an effort to help you support your product. This manual provides the best information we could find. It may be incomplete or contain dated information.

Support for your product

You can find information about technical and professional services, product support, and equipment repair and service on the web:

www.keysight.com

Select your country from the drop-down menu at the top. Under *Electronic Test and Measurement*, click on *Services*. The web page that appears next has contact information specific to your country.

For more detailed product information, go to: www.keysight.com/find/ <product model>
i.e., for the M9514A, use: www.keysight.com/find/M9514A

Hypertext links to documents on agilent.com are no longer active. Use this substitution to access PDF files:

Broken links have the form: <http://cp.literature.agilent.com/litweb/pdf/> < literature_part_number >

Substitute links with this form: <http://literature.cdn.keysight.com/litweb/pdf/> < literature_part_number >

Where < literature_part_number > has the form: M9300-90001.pdf

For service notes, use: www.keysight.com/find/servicenotes

Notices

© Agilent Technologies, Inc. 2011- 2014

No part of this manual may be reproduced in any form or by any means (including electronic storage and retrieval or translation into a foreign language) without prior agreement and written consent from Agilent Technologies, Inc. as governed by United States and international copyright laws.

Manual Part Number

M9536-90005

Edition

Sixth Edition. May 2014

Printed in Malaysia

Agilent Technologies, Inc.
5301 Stevens Creek Blvd.
Santa Clara, CA 95052 USA

Microsoft® and Windows® are U.S. registered trademarks of Microsoft Corporation.

MATLAB is a U.S registered Trademark of The MathWorks, Inc.

PXI is a registered trademark of the PXI Systems Alliance.

Visual Studio is a registered trademark of Microsoft Corporation in the United States

LabVIEW is a registered trademark of National Instruments

PICMG®, Compact PCI®, and AdvancedTCA® are registered trademarks of the PCI Industrial Computer Manufacturers Group

PCI-SIG®, PCI Express®, and PCIe® are registered trademarks of PCI-SIG

Intel is a registered trademark of Intel Corporation

AXIe and the AXIe logo are trademarks of the AXIe Consortium, Inc.

Sales and Technical Support

To contact Agilent for sales and technical support, refer to the “support” links on the following Agilent web resources:

www.agilent.com/find/M9536A
(product-specific information and support, software and documentation updates)

www.agilent.com/find/assist (worldwide contact information for repair and service)

Information on preventing damage to your Agilent equipment can be found at www.agilent.com/find/tips.

Declaration of Conformity

Declarations of Conformity for this product and for other Agilent products may be downloaded from the Web. Go to <http://regulations.corporate.agilent.com/DoC/search.htm>. You can then search by product number to find the latest Declaration of Conformity.

Warranty

The material contained in this document is provided “as is,” and is subject to being changed, without notice, in future editions. Further, to the maximum extent permitted by applicable law, Agilent disclaims all warranties, either express or implied, with regard to this manual and any information contained herein, including but not limited to the implied warranties of merchantability and fitness for a particular purpose. Agilent shall not be liable for errors or for incidental or consequential damages in connection with the furnishing, use, or performance of this document or of any information contained herein. Should Agilent and the user have a separate written agreement with warranty terms covering the material in this document that conflict with these terms, the warranty terms in the separate agreement shall control.

Technology Licenses

The hardware and/or software described in this document are furnished under a license and may be used or copied only in accordance with the terms of such license.

Restricted Rights Legend

U.S. Government Restricted Rights. Software and technical data rights granted to the federal government include only those rights customarily provided to end user customers. Agilent provides this customary commercial license in Software and technical data pursuant to FAR 12.211 (Technical Data) and 12.212 (Computer Software) and, for the Department of Defense, DFARS 252.227-7015 (Technical Data - Commercial Items) and DFARS 227.7202-3 (Rights in Commercial Computer Software or Computer Software Documentation).

Safety Information

The following general safety precautions must be observed during all phases of operation of this instrument. Failure to comply with these precautions or with specific warnings or operating instructions in the product manuals violates safety standards of design, manufacture, and intended use of the instrument. Agilent Technologies assumes no liability for the customer's failure to comply with these requirements.

General

Do not use this product in any manner not specified by the manufacturer. The protective features of this product must not be impaired if it is used in a manner specified in the operation instructions.

Before Applying Power

Verify that all safety precautions are taken. Make all connections to the module before applying power. Note the instrument's external markings described under "Safety Symbols".

Ground the Chassis

Agilent chassis are provided with a grounding-type power plug. The instrument chassis and cover must be connected to an electrical ground to minimize shock hazard. The ground pin must be firmly connected to an electrical ground (safety ground) terminal at the power outlet. Any interruption of the protective (grounding) conductor or disconnection of the protective earth terminal will cause a potential shock hazard that could result in personal injury.

Do Not Operate in an Explosive Atmosphere

Do not operate the Agilent module/chassis in the presence of flammable gases or fumes.

Do Not Operate Near Flammable Liquids

Do not operate the Agilent module/chassis in the presence of flammable liquids or near containers of such liquids.

Cleaning

Clean the outside of the Agilent module, chassis, or accessory with a soft, lint-free, slightly dampened cloth. Do not use detergent or chemical solvents.

Keep away from live circuits

Operating personnel must not remove equipment covers or shields. Procedures involving the removal of covers and shields are for use by service-trained personnel only. Under certain conditions, dangerous voltages may exist even with the equipment switched off. To avoid dangerous electrical shock, DO NOT perform procedures involving cover or shield removal unless you are qualified to do so.

DO NOT operate damaged equipment

Whenever it is possible that the safety protection features built into this product have been impaired, either through physical damage, excessive moisture, or any other reason, REMOVE POWER and do not use the product until safe operation can be verified by service-trained personnel. If necessary, return the product to an Agilent Technologies Sales and Service Office for service and repair to ensure the safety features are maintained.

Do Not Modify the Instrument

Do not install substitute parts or perform any unauthorized modification to the product. Return the product to an Agilent Sales and Service Office to ensure that safety features are maintained.

In Case of Damage

Instruments that appear damaged or defective should be made inoperative and secured against unintended operation until they can be repaired by qualified service personnel.

CAUTION

A CAUTION notice denotes a hazard. It calls attention to an operating procedure or practice that, if not correctly performed or adhered to, could result in damage to the product or loss of important data. Do not proceed beyond a CAUTION notice until the indicated conditions are fully understood and met.

WARNING

A WARNING notice denotes a hazard. It calls attention to an operating procedure or practice, that, if not correctly performed or adhered to, could result in personal injury or death. Do not proceed beyond a WARNING notice until the indicated conditions are fully understood and met.

Safety Symbols

Products display the following symbols:



Refer to manual for additional safety information.



Earth Ground.



Chassis Ground.



Alternating Current (AC).



Direct Current (DC).



Indicates that antistatic precautions should be taken.



Notice for European Community: This product complies with the relevant European legal Directives: EMC Directive (2004/108/EC) and Low Voltage Directive (2006/95/EC).



This is the symbol for an Industrial, Scientific, and Medical Group 1 Class A product.



ICES/NMB-001 indicates that this ISM device complies with the Canadian ICES-001.



N10149

The C-tick mark is a registered trademark of the Spectrum Management Agency of Australia. This signifies compliance with the Australia EMC Framework regulations under the terms of the Radio Communication Act of 1992.

Waste Electrical and Electronic Equipment (WEEE) Directive 2002/96/EC

This product complies with the WEEE Directive (2002/96/EC) marking requirement. The affixed product label (see below) indicates that you must not discard this electrical/electronic product in domestic household waste.

Product Category: With reference to the equipment types in the WEEE directive Annex 1, this product is classified as a “Monitoring and Control instrumentation” product.

Do not dispose in domestic household waste.

To return unwanted products, contact your local Agilent office, or see www.agilent.com/environment/<product> for more information.



WARNING

This computer contains a lithium-ion battery. There is a risk of fire and chemical burn if the battery pack is handled improperly. Do not disassemble, crush, puncture, short external contacts, dispose of in water or fire, or expose it to temperature higher than 60 °C (140 °F).

Contents

Documentation Map	x
1 Introduction	
Related documentation	1
M9536A at a Glance	2
Front panel LED definitions	2
M9536A Functional Description	4
CPU, Memory and Chipset	5
Memory	5
Intel 5520/ICH10R chipset	5
Peripherals	7
Timer	7
Battery	7
Reset	7
SMBus and I ² C devices	7
GPIO list	8
I/O interfaces	8
USB	8
UXGA Analog Interface	9
Gigabit ethernet	9
Serial port	9
PCIe backplane interface	9
Using the LAN Ports	11
Recommendations	12
Embedded System Module LAN connection	13
2 Controller Operating System	
Activating Microsoft Windows	15
How to verify Windows Activation?	15
Controller Startup	16
Using Agilent Connection Expert	18
AXIe Chassis Web Page	21
AXIe Chassis Soft Front Panel	25
Windows Security	26
Windows updates	26
User data backup	26
System backup and recovery	27
Use the recovery methods	27
Create a System Repair disc	28
Create a System Image	29

Restoring a System Image	31
Chassis Shutdown	33
Power down modes	33
Things not to do	34
Windows Registry	34
Application software	34
Display settings	34
SSD drive	34
Software application licenses	35
Microsoft operating system licensing	35

3 BIOS Setup

Controller BIOS Versions	37
Starting the BIOS Setup Utility	38
BIOS setup utility	39
Navigation	40
Hot key descriptions:	40
Main Menu	41
System time/system date	41
Advanced Menu	42
CPU configuration	42
IDE Configuration	43
Super IO configuration	43
Hardware health configuration	43
USB configuration	44
AHCI configuration	44
MPS Configuration	45
Trusted Computing	45
PCI/PnP Menu	45
Clear NVRAM	45
Plug & Play O/S	45
PCI latency timer	46
Allocate IRQ to PCI VGA	46
Boot Menu	46
Boot settings configuration	46
Security menu	48
Password support	48
Change supervisor password	49
Change user password	49
Chipset Menu	50
CPU bridge configuration	50

North bridge configuration	50
South bridge configuration	51
Boots Graphic Adapter Priority	51
LAN BIOS Init.	51
Spread Spectrum	51
Exit Menu.	51
Save changes and exit.	52
Discard changes and exit	52
Discard changes	52
Load optimal defaults	53
Load fail-safe defaults	53

4 Service

Troubleshooting	55
What if my M9536A controller does not boot?	55
Booting in Safe Mode	56
The controller appears to boot but MS Windows is not working	56
If you need to return the module for service	56
Electrostatic Discharge	57
Switch Settings	57
Serial port switch settings	57
COM mode switch settings (SWX1 and SWX2)	58
Other switch settings	61
Removing the Top Cover	62
Battery Backup	63
Installing Additional Memory	65
Replacing the SSD.	68
Determining the Operating System	68
Replacement Procedure	68
Memory Declassification	71
Procedure for declassifying a faulty controller	71
Controller memory	72

Glossary

Index

Documentation Map

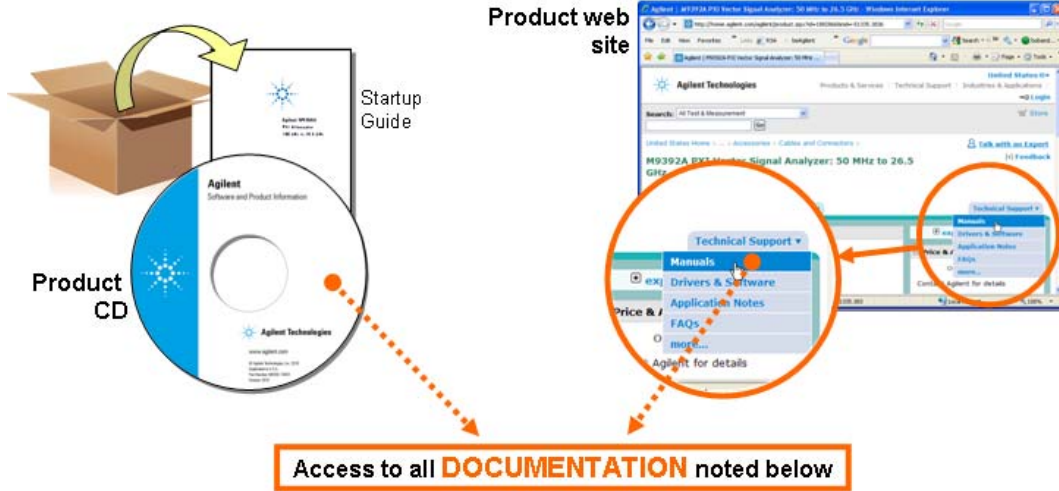

Startup Guide



- Unpack product
- Verify shipment
- Install software
- Install & connect hardware
- Verify operation

Data Sheet



- Product description
- Technical specifications

User Guide



- Setup and configuration
- Operating System
- Basic service including installing additional memory, replacing the hard drive, etc.

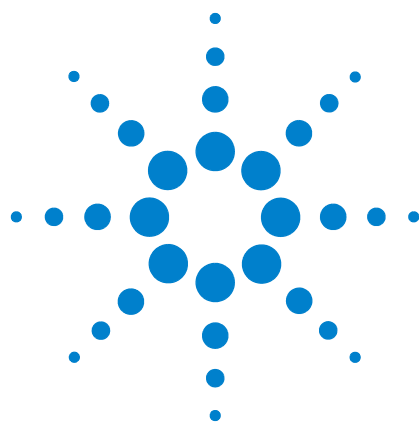

1 Introduction

Agilent's M9536A is a one-slot AXIe compatible embedded PC controller providing a high-performance Gen2 PCI Express link (5.0 GT/s PCI Express) to the AXIe backplane. The M9536A provides a powerful one-slot computer that can be used to build compact AXIe systems while integrating easily with LXI instruments due to the built-in Gigabit LAN interface. Features include

- Gen2 PCI Express link (5.0 GT/s PCI Express) to the AXIe backplane
- One Intel Xeon EP Quad Core L5518 Processor running at 2.13GHz
- 8GB RAM standard, 16GB RAM optional (up to 24 GB RAM Maximum)*
- 160 GB SATA 2.5 inch, solid state hard drive (SSD)
- Front panel with three USB 2.0 ports (type A), two 10/100/1000 BASE-T LAN ports, one serial COM port, and UXGA video port (up to 1600x1200 resolution)
- Preloaded with the Agilent I/O Libraries Suite and your choice of the Microsoft Windows Embedded Standard 7 (WES 7) 32-bit or 64-bit Operating System

Agilent's M9536A is AXIe 1.0 compliant. It does not provide the chassis management functions of an AXIe system module but it does provide application processing power for the chassis. Hence, the controller must be installed in slot #1 of the Agilent M9502A or M9505A AXIe chassis. Agilent's Embedded System Module is required.

Related documentation

Because the Operating System and drivers were installed at the factory and no additional drivers are required, no printed documentation other than this Startup Guide is supplied with the Controller Module.

Adobe Reader is required to view the documentation supplied on the M9536 product information CD. It is available free at: <http://www.adobe.com>. You should install this on your M9536A prior to attempting to open a .PDF file.

For the latest M9536A specifications, go to: www.agilent.com/find/M9536A.

* The M9536A has three 240-pin, RDIMM sockets which support DDR3-1333 REG/ECC RAM sticks. Each socket can support memory modules up to 8GB for a total memory capacity of 24GB. The standard M9536A configuration is a single 8GB memory stick with a factory option to add a second 8GB memory stick. This leaves an empty socket for future expansion. Note: The capability of addressing more than 4GB memory is operating system dependent. A 32-bit OS system may not be able to address the full memory space. To use the full 8GB/16GB/24GB memory, a 64-bit OS must be used.



M9536A at a Glance

The following figure shows the front panel for the M9536A. Detailed information about the module follows in this manual.

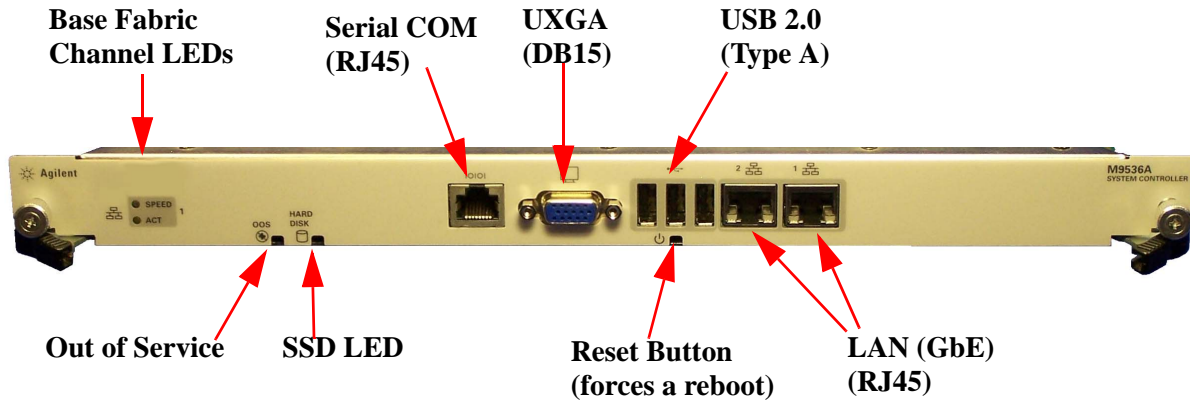

Figure 1 M9536A AXIe Embedded Controller Front Panel

Front panel LED definitions

The following tables list the LEDs on the front panel and a brief description of their use and what they indicate.

Out Of Service (OOS)LED

Out of Service LED (Red)	State
Blink	During BIOS POST
Off	BIOS POST OK
On	After Operating System shutdown

SSD Drive (HDD) LED

Media LED (Green)	State
Blink/on	During access

Base fabric channel LED

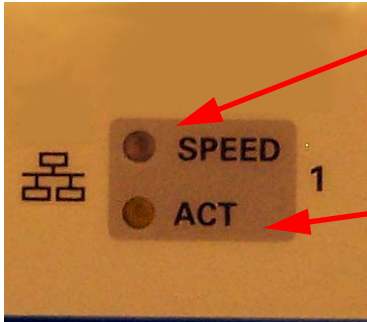
BASE Channel and Fabric Channel LED	
	Base Channel1 Speed/Link 1 Gbps - Amber 100 Mbps - Green
	Base Channel1 ACT (Amber) Blinks when accessing Ethernet I/O

LAN / Gigabit Ethernet (GbE) connector LED

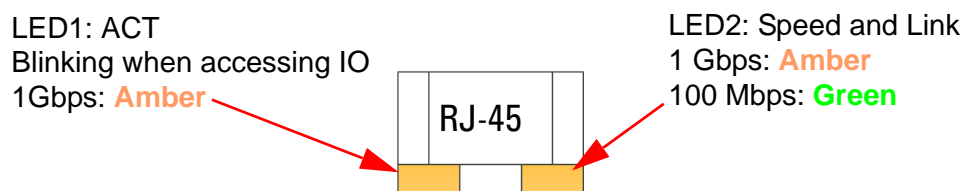

CAUTION

IMPORTANT: Agilent M9502A or M9505A AXIe chassis **must** have firmware revision 1.3.23 or later for the M9536A to identify and communicate with other chassis module. Refer to the Agilent chassis web pages for information on updating the chassis firmware.

NOTE

The drivers and Agilent's IO Libraries Suite installed on the M9536A controller are the current versions available when the module shipped from the factory. You should regularly check Agilent's web sites and download the latest drivers and software:

www.agilent.com/find/M9536A for the embedded controller

www.agilent.com/find/iosuite for IO Libraries

Periodically check for the latest AXIe chassis firmware:

www.agilent.com/find/M9502A for the 2-slot AXIe chassis

www.agilent.com/find/M9505A for the 5-slot AXIe chassis

For example, Agilent's AXIe chassis firmware version 1.3.23 (and later) provides for enhanced fan control and E-Keying that was not supported in earlier chassis firmware versions.

M9536A Functional Description

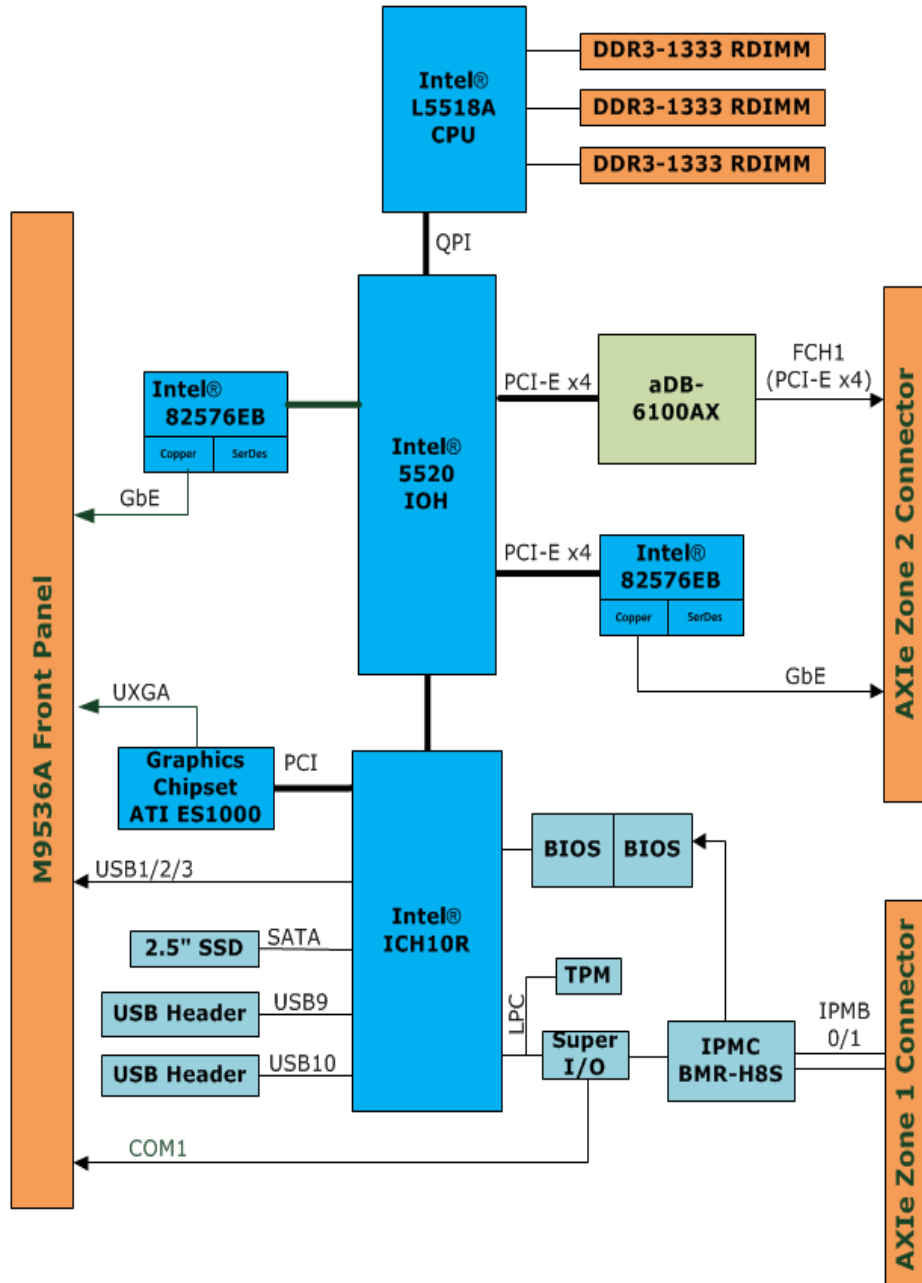

Figure 2 M9536A Functional Block Diagram

CPU, Memory and Chipset

The Intel L5518 Xeon processor is a multi-core processor based on 45 nm process technology. Processor features include two Intel QPI point-to-point links with 5.86GT/s, 8MB of shared cache, and an integrated memory controller. The processor supports all the existing Streaming SIMD Extensions 2 (SSE2), Streaming SIMD Extensions 3 (SSE3) and Streaming SIMD Extensions 4 (SSE4). Also supported are: Execute Disable Bit, Intel 64 Technology, Enhanced Intel SpeedStep Technology, Intel Virtualization Technology (Intel VT), and Intel Hyper-Threading Technology.

The Intel Xeon Processor L5518 has a maximum Thermal Design Power (TDP) of 60W and has an elevated case temperature specification. The elevated case temperatures are intended to meet the short-term thermal profile requirements of NEBS Level 3. All this makes this processor ideal for thermally constrained form factors in the AXIe embedded controller. The following table lists some of the relevant processor specifications:

	Intel L5518 Processor
L2 Cache	8MB
Clock	2.13 GHz
QPI	5.86 GT/s
Maximum Power	60 W

Memory

The M9536A has three 240-pin, RDIMM sockets which support DDR3-1333 REG/ECC RAM sticks. Each socket can support memory modules up to 8GB for a total memory capacity of 24GB. The standard M9536A configuration is a single 8GB memory stick with a factory option to add a second 8GB memory stick. This leaves an empty socket for future expansion. Refer to [“Installing Additional Memory”](#) on page 65 for information on installing additional memory. Note, the other three RDIMM slots are for a second processor which is not used.

Intel 5520/ICH10R chipset

The Intel 5520 Chipset I/O Hub (IOH) provides a connection point between various I/O components and Intel QuickPath Interconnect (Intel QPI) based processors. The Intel 5520 Chipset is combined with Intel Xeon Processor 5500 in their respective two socket platforms. The Intel Xeon 5500 Platform consists of the Intel Xeon Processor 5500 Series, the Intel 5520 Chipset I/O Hub (IOH), the I/O Controller Hub (Intel ICH10), and the I/O subsystem. The processor includes an integrated Memory Controller (IMC) that resides within the processor package. This platform is the first single processing

platform that introduces the Intel Quick- Path Interconnect. Intel QuickPath Interconnect is Intel's next generation point-to-point system interconnect interface and replaces the Front Side Bus.

NOTE

The term IOH refers to the Intel 5520 Chipset I/O Hub (IOH) and ICH10R refers to the Intel 82801JIR ICH10R I/O Controller Hub 10 components.

The IOH provides the interface between the processor Intel Quick- Path Interconnect and industry-standard PCI Express components. The IOH supports the following features and technologies:

- Intel QuickPath Interconnect profile
- Interface to CPU or other IOH (limited configurations) Gen2 PCI Express
- Intel I/O Accelerated Technology (Intel I/OAT) and Intel Quick Data Technology (updated DMA engine with virtualization enhancements)
- Integrated Intel Management Engine (Intel ME)

ATI ES1000 Graphics Controller The M9536A provides an analog UXGA port on the front panel powered by an AMD ES1000 2D graphics controller. The M9536A does not support USB monitor interfaces. It supports the following features:

- 32-bit PCI bus (Rev 2.2), 3.3 V with bus mastering support
- Support for SPI Serial and Flash Memory video BIOS
- Independent DDC lines for both DACs and TMDS connections. Also full AppleSense support on DAC connection
- Static and dynamic Power Management support (APM as well as ACPI) with full VESA DPMS and Energy Star compliance
- Comprehensive testability including full internal scan, memory BIST, I/O xor tree and Iddq
- Full ACPI 1.0b, OnNow, and IAPC (Instantly Available PC) power management, including PCI power management registers
- Bus mastering of 2D display lists
- Triple 10-bit palette DAC supports pixel rates to 350MHz
- DDC1 and DDC2 for plug and play monitors
- Flexible memory support:
 - DDR1 and DDR2 SDRAM and SGRAM
 - 16-bit interface, 8MB to 256MB
- Up to 1GB/s bandwidth.
- Single chip solution in 0.13 micron process, 1.2V CMOS technology in a BGA package

Peripherals

The following standard peripherals are available on the M9536A Embedded Controller:

Timer

The M9536A is equipped with the following three timers:

- **Real-Time Clock:** The ICH10R controller hub contains a real-time clock that performs timekeeping functions and includes 256 bytes of general purpose battery-backed CMOS RAM. Features include an alarm function, programmable periodic interrupt and a 100-year calendar. All battery-backed CMOS RAM data remains stored in an additional EEPROM. This prevents data loss in case the M9536A is operated without a battery.
- **Counter/Timer:** Three 8254-style counter/timers are included on the M9536A as defined for the PC/AT (System Timer, Refresh Request, Speaker Tone Output).
- **High Precision Event Timers (HPET):** In addition to the three 8254-style counters, the ICH10R controller hub includes three High Precision Event Timers (HPET) that may be used by the operating system. They can be used in one-shot and periodic modes to generate an interrupt when the counter reaches a pre-programmed value.

Battery

The M9536A is provided with a 3.0 V “coin cell” lithium battery. This battery runs the clock circuit and retains configuration memory in CMOS RAM while the system is turned off. For instructions on replacing the battery, refer to “[Battery Backup](#)” on page 63.

Reset

The M9536A responds to any of the following conditions by initializing local peripherals:

- Power failure, +5 V supply falls below 4.1 V (typical) or +3.3 V supply falls below 2.93 V (typical)
- Front panel **RESET** push-button pressed. This causes the controller to reboot.
- IPM controller reset

SMBus and I²C devices

The M9536A provides a system management bus (SMBus) hosted by the ICH10R and an I²C bus hosted by the IPM controller, H8S/2168. The following table describes the function and address of the devices.

SMBus Device	Address (HEX)		I ² C Device	Address (HEX)
DIMM A	0XA0		PECI-to-I ² C	0x92
DIMM B	0XA4		LM75	0x9E
DIMM C	0XA8		PCA9555PW	0x40
Clock Gen	0XD2			
Clock Buffer	0XDC			

GPIO list

The following table summarizes GPIO usage on ICH9R IO controller hub:

ICH9R	I/O	Signal	Description
GPI[2]	Input	IOH_ERR-L	IOH Error output signals
GPI[8]	Input	QPI_TTL_CATERR-L	CPU Indicates that the system has experienced a catastrophic error and cannot continue to operate
GPI[23]	Output	USR_LED	User defined LED
GPI[27]	Output	QPI_FREQSELO	QuickPath Interconnect Frequency Strapping Options
GPI[28]	Output	QPI_FREQSEL1	QuickPath Interconnect Frequency Strapping Options
GPI[29]	Output	FM_CPU0_LVDDR3_EN	DDR3L DIMM voltage control (DIMM A/B/C)
GPI[30]	Output	FM_CPU1_LVDDR3_EN	DDR3L DIMM voltage control (DIMM D/E/F)
GPI[32]	Output	POSTOK-L	POST OK to IPMC
GPI[52]	Output	ICH_SMBUS_MUX0	DDR SMBUS Multiplier control
GPI[53]	Output	ICH_SMBUS_MUX1	DDR SMBUS Multiplier control
GPI[56]	Output	QPI_FSEL_PWRGD-L	IOH Hard Reset Triggers a Power-Up Reset control

I/O interfaces

USB

The M9536A supports three, Type-A USB 2.0 ports on the front panel

On the USB 2.0 front panel ports, a USB cable with up to 5 meters in length can be used.

The USB 2.0 ports are high-speed, full-speed, and low-speed capable. Hi-speed USB 2.0 allows data transfers of up to 480 Mb/s, 40 times faster than a full-speed USB (USB 1.1). One USB peripheral may be connected to each port., including a powered or unpowered USB hub.

NOTE

The M9536A host interfaces can be used with maximum 500mA continuous load current as specified in the Universal Serial Bus Specification, Revision 2.0. Short circuit protection is provided. All the signal lines are EMI filtered.

UXGA Analog Interface

The DB-15 female connector on the front panel is for analog display output. The M9536A does not support USB monitor interfaces.

NOTE

Video display resolution: In the M9536A controller, the highest resolution available at 32-bit color is 1280x1024. At 16-bit color, the M9536A supports 1600x1200 resolution. Note that 1600x1200 is a 4x3 aspect ratio. When this resolution is scaled to a 16x9 or 16x10 aspect ratio monitor, the M9536A will function properly but some graphics may appear distorted.

Gigabit ethernet

The M9536A is equipped with two dual-port Intel 82576EBB Gigabit Ethernet controllers. In default configuration, one port is connected to the front panel and one port is connected to the Base Interface channel on the backplane.

Serial port

One PC-compatible serial RS-232, RJ45 port is provided on the front panel with DIP switches SWX1 and SWX2 used to set COM function to either the RS-232 mode or the IPMC debug mode. A complete set of handshaking and modem control signals are supported, with data transfer rates up to 115.2 kB/sec.

PCIe backplane interface

The M9536A PCIe interface is configured as the root complex. The following figure shows a conceptual diagram.

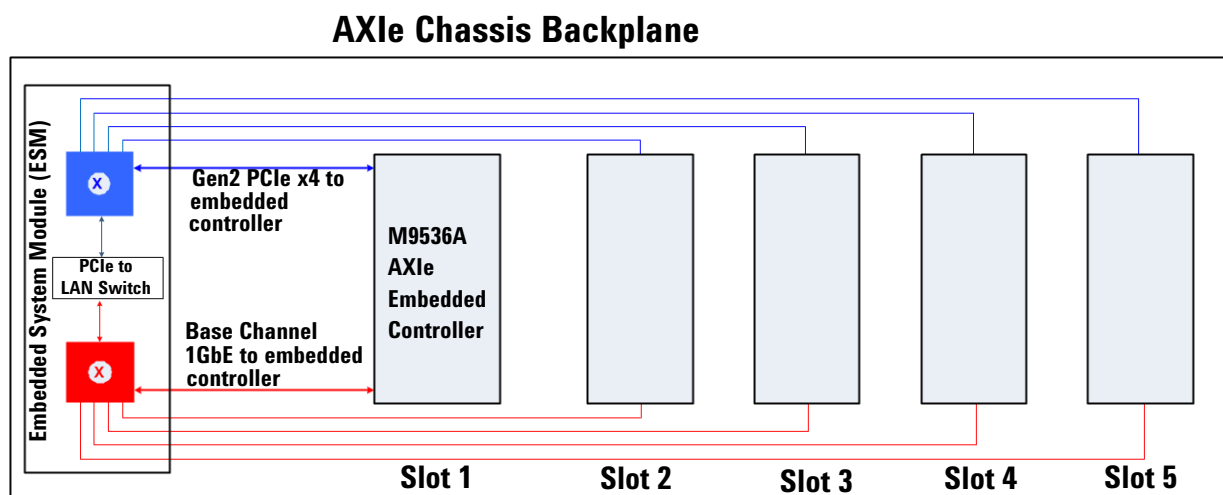

Figure 3 PCIe Backplane Interface

CAUTION

With the M9536A installed, there must be no connection to the ESM module PCIe connector.

Using the LAN Ports

If you installed the Agilent M9536A controller in an Agilent AXIe chassis (such as the M9502A or M9505A), there are a total of three LAN ports accessible on the front panels -- two on the M9536A controller and one on the Embedded System Module (ESM). Windows Device Manager shows a total of five (5) individual Network Interface Cards (NICs); one is not used and one connects to the chassis backplane. Refer to [Figure 4](#) and [Figure 5](#) below.

CAUTION Changing the LAN port connection or removing the LAN cable, may cause Agilent Connection Expert to lose track of LAN-enabled instruments. Reboot the AXIe chassis to restore the complete list of LAN-enabled instruments. Read the following for details.

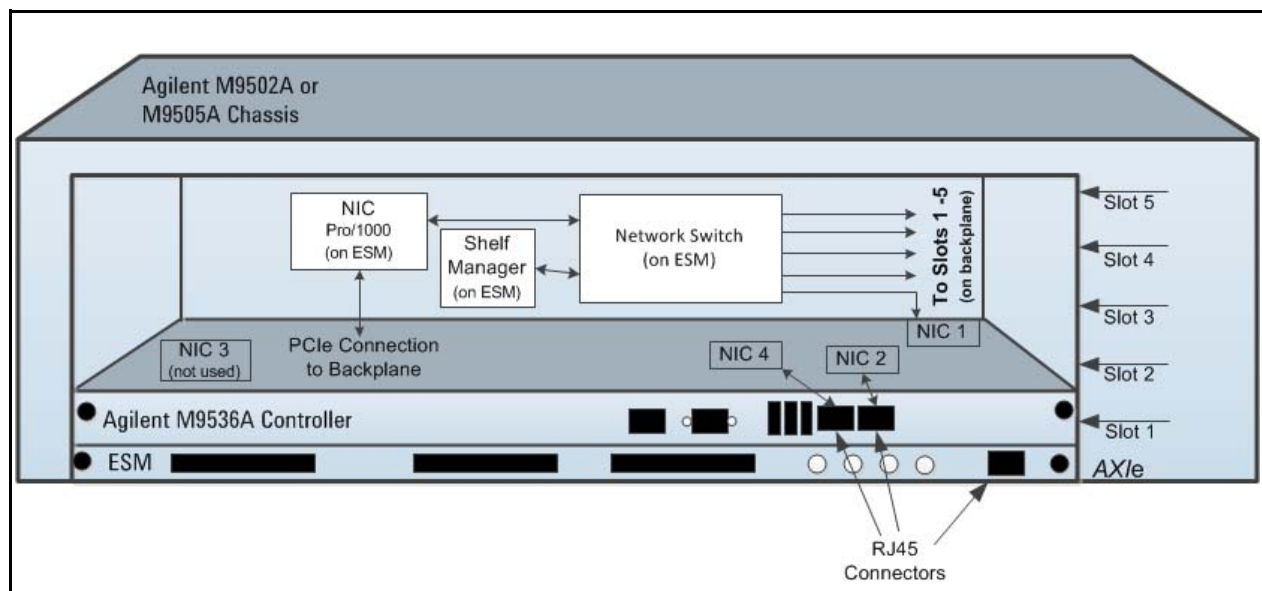

Figure 4 NIC ports reported for the M9536A (NIC 3 is not used)

NIC numbers correspond to the numbering in [Figure 4](#) above. Note that NIC 3 is not used. NIC numbering on your M9536A may be different.

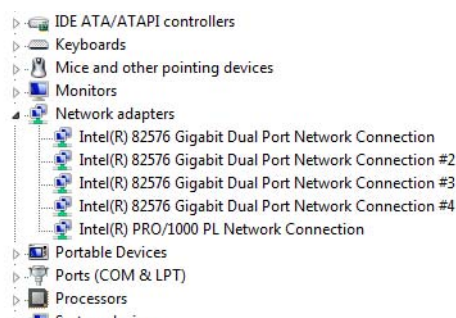

Figure 5 Windows Device Manager showing Network Connections

This section provides overall guidance on selecting and using the M9536A LAN ports. The controller uses the Agilent IO Libraries configuration file to keep track of all instrument connections. Any change to LAN connections after running Connection Expert (adding, removing, or changing LAN cable connections) may cause a change in LAN address and therefore cause Connection Expert to lose track of instruments. If your application programs rely on a specific IP address, these programs may cease to operate if you change LAN cable connections.

If this happens, you should delete the connection in Connection Expert, power down the controller and chassis, and reboot. Rerun IO Libraries Connection Expert to obtain new addresses.

NOTE

With Agilent IO Libraries 16.2 (and later versions) Agilent Connection Expert should automatically identify the AXIe chassis. With Agilent IO Libraries version 16.1, you may need to start Connection Expert, then power down the controller and chassis and reboot them in order for Connection Expert to identify the AXIe chassis.

Recommendations

As a general rule, connect a network LAN cable to the ESM's LAN port and connect LXI instruments to the M9536A's LAN ports. While other configurations are viable, this configuration provides the fastest and most consistent reporting in Agilent Connection Expert. Refer to [Figure 6](#).

- Where you have the network and instruments connected when the chassis and controller first power on determines how quickly Agilent Connection Expert locates network instruments. If necessary, shut down the controller and chassis and reboot.
- If you move a LAN cable while chassis power is applied, Connection Expert may not find all of the instruments available on the network.

For example, if the LAN cable is connected to the ESM when power is first applied to the chassis and subsequently moved to one of the two LAN ports on the controller (while the chassis is still powered on), Connection Expert may only find the M9536A controller and AXIe modules installed in the chassis. Shut down the controller and chassis and reboot to restore Connection Expert's ability to locate other network instruments.

- Connect external LAN-enabled instruments (LXI instruments) to the M9536A controller LAN ports. This allows Agilent Connection Expert to automatically find the instruments. These instruments will have a local LAN IP address or private network range.

LXI instruments may be connected to the ESM's LAN port but Connection Expert may not automatically find them when these instruments are not located on the same LAN subnet range. However, instruments may be added manually using Connection Expert's Add Address feature.

Embedded System Module LAN connection

Changes to the Embedded System Module (ESM) LAN connection are only detected as the ESM is powered up. Therefore, whenever you change the ESM LAN connection do the following:

- 1 Power down the M9536A using the Shut down selection on the Windows Start menu.
- 2 After shut down is complete, power down the chassis using the chassis power button.
- 3 Make the desired change to the LAN connection.
- 4 Use the chassis power button to power up the chassis and M9536A controller.
- 5 After Windows starts, verify that your LAN interface is operating correctly.

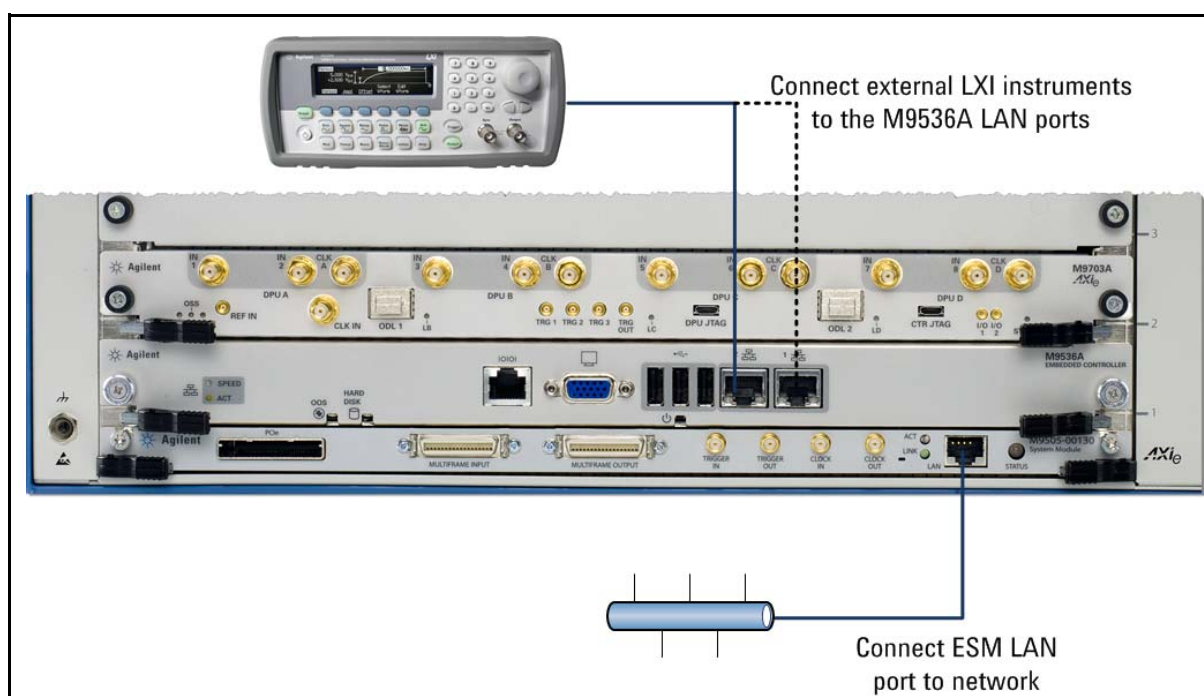

Figure 6 Recommended LAN Connections

Figure 6 shows the recommended LAN connections to the AXIe chassis/ESM and the M9535A. Two other possible LAN connections are shown in Figure 7. Note that you may need to manually add instrument IPO addresses to Agilent Connection Expert.

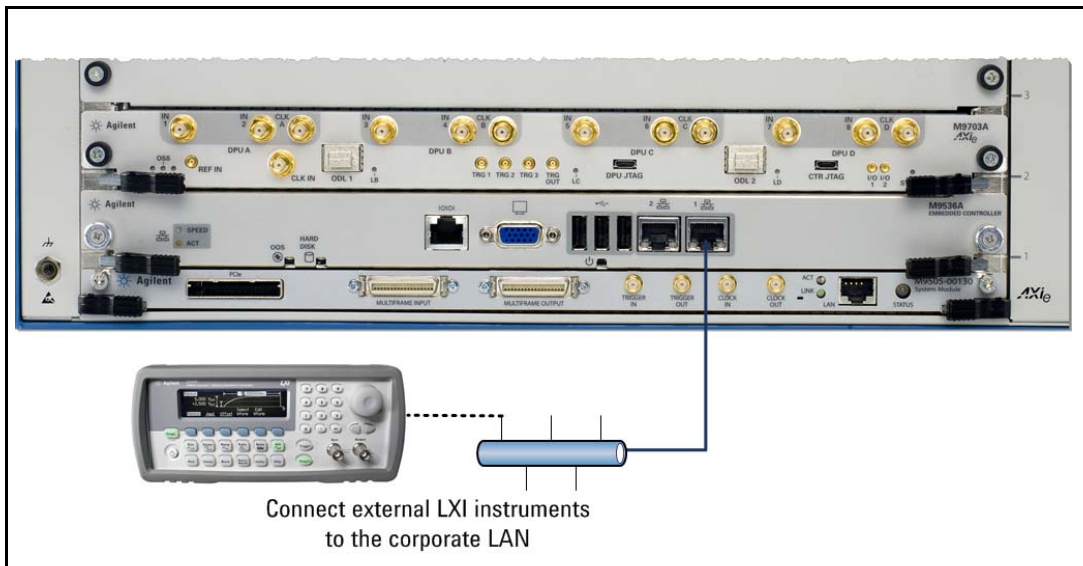
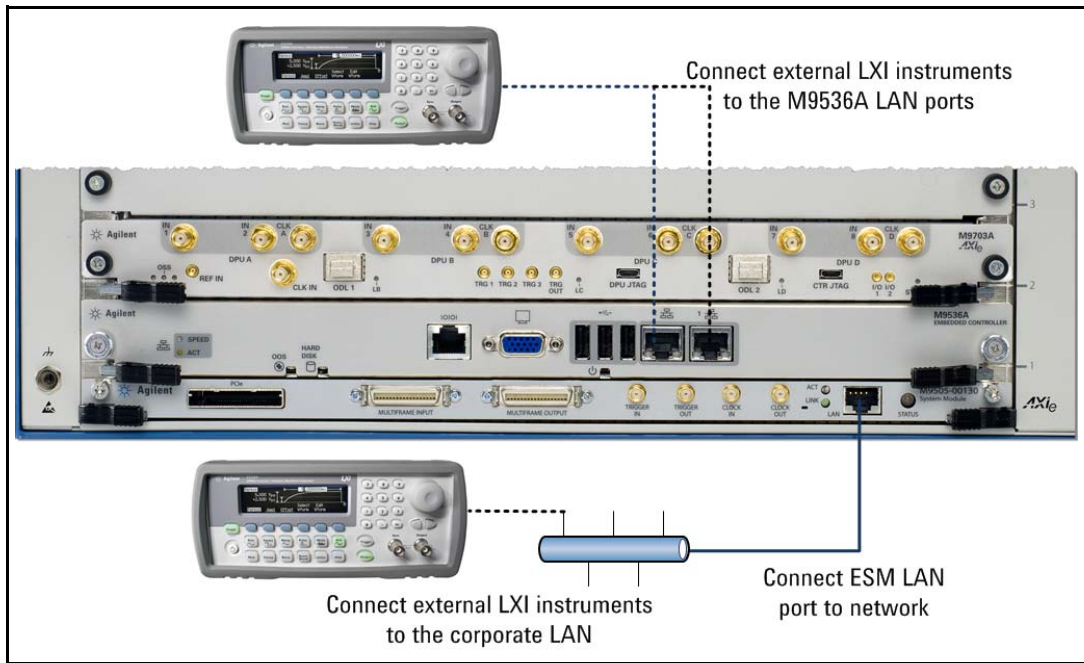

Figure 7 Possible Alternate LAN Connections. You may need to manually add instrument IP addresses to Agilent Connection Expert. (see text)



2 Controller Operating System

Your M9536A comes with the Windows Operating System of your choice (Windows 7 32-Bit, or Windows 7 64-Bit) preinstalled along with Agilent's IO Libraries Suite. This chapter provides general system configuration and preventative maintenance procedures that you, the customer, are responsible for. In general, the M9536A operates as any other PC.

The M9536A controller supports USB CD-ROM drive, USB flash disk, or a USB external hard drive as the first boot device. Please refer to “[Starting the BIOS Setup Utility](#)” on page 38 for information about setting the boot devices. These devices should be configured, installed, and tested with the supplied drivers before attempting to load a new operating system.

Read any release notes and installation documentation provided by the operating system vendor. Be sure to read all the README files or documents provided by the vendor, as these typically note documentation discrepancies or compatibility problems.

Activating Microsoft Windows

Agilent ensures that your copy of Windows 7 is activated at the time it ships from the factory. However, the first time you install and turn on the M9536A and Windows 7 starts, you must accept the End User License Agreement (EULA). A copy of the EULA was included in your controller shipment. A copy of the EULA is included on your controller in the folder:

C:\Windows\System32\en-US\License\OEM\Professional\license.rtf

For information about Windows 7 EULA, go to www.microsoft.com.

How to verify Windows Activation?

To verify Windows Activation, do the following:

- 1 Open the System by clicking the Windows **Start** button. Click **Control Panel**, then **System and Maintenance**, and then click **System**.
- 2 Scroll down to the bottom of the screen. Under **Windows Activation**, you can view the activation status.



CAUTION

By Agilent's agreement with Microsoft, Windows Automatic Update is turned off at installation. You may choose to turn Windows Automatic Update on after starting the operating system. However, Agilent cannot be held responsible for changes to the system caused by the automatic update process. It is possible for automatic updates to cause unexpected behavior in the system.

Controller Startup

After installing the M9536A controller in an AXIe chassis, press the chassis' power on button. After a few moments, the controller will beep indicating it passed its POST self tests. The following screen will display for a few moments:

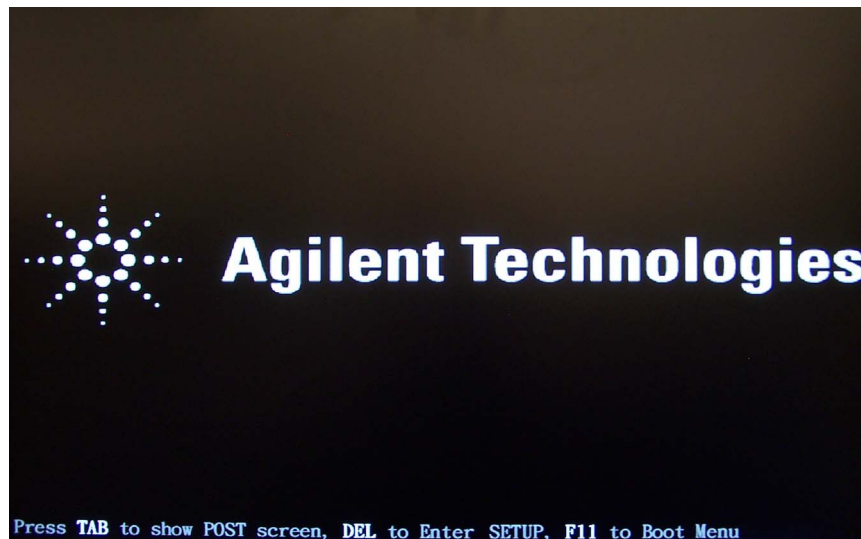

Figure 8 M9536A Startup Screen

Normally, you should simply allow the controller to run through its normal startup routine. However, at this screen, you can press the **DEL** key to enter the **BIOS Setup Utility** (see [Chapter 3, "BIOS Setup"](#)).

You may see the following screen. If so, either press the Enter key or simply ignore it and the Windows OS will start normally. Either one allows the Windows 7 operating system to start normally:

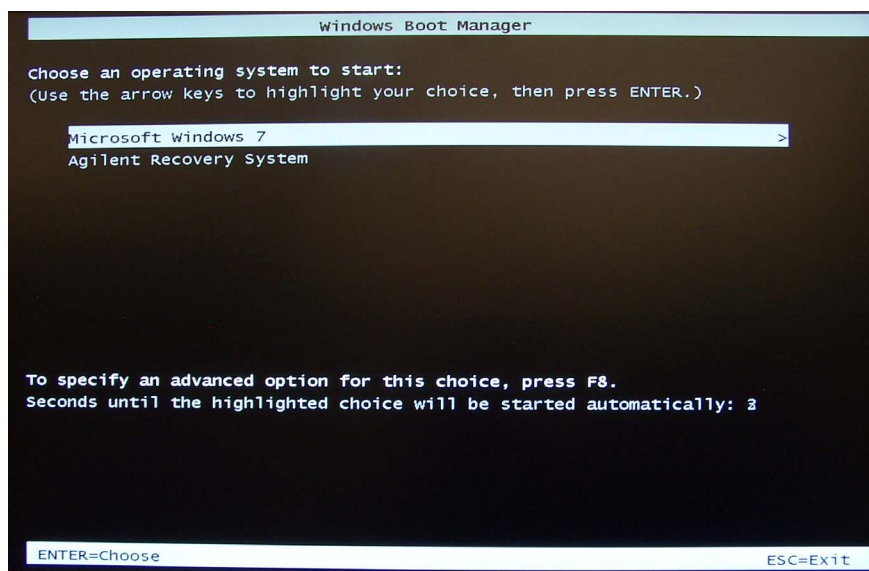

Figure 9 Windows Boot Manager

After a few moments, Microsoft Windows 7 starts. See [Figure 10](#) on the next page.

NOTE

Microsoft Windows 7 is the only operating system installed on your M9536A. There is a small system partition for the Agilent Recovery System. If you select this option, the Windows Boot Manager opens a menu with five selections:

- 1) Run ChkDisk
- 2) Recover the original factory system image
- 3) View troubleshooting documentation
- 4) Repair the system drive
- 5) Exit and restart the instrument.

Enter your selection and press the **OK** button. Follow the instructions on the screen.

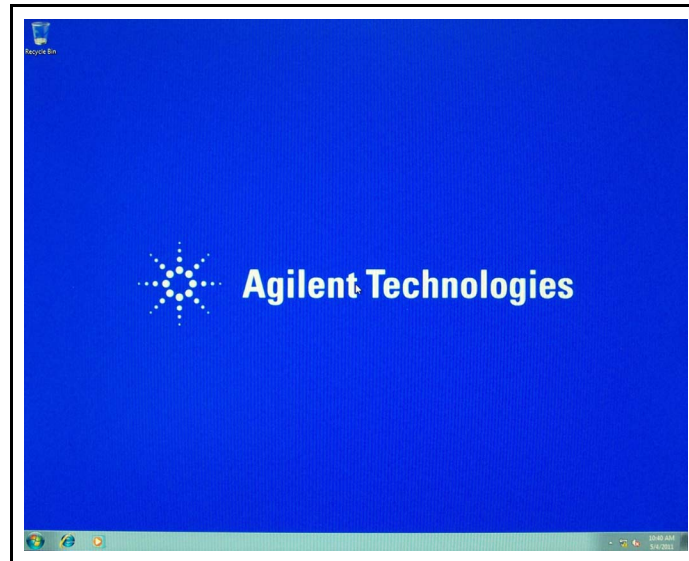

Figure 10 Microsoft Windows 7 running on the Agilent M9536A

Using Agilent Connection Expert

- 1 From the Windows Start button, select **All Programs**. Scroll down to the Agilent IO Libraries Suite folder then select **Agilent Connection Expert**. Alternately, you can double-click the IO control icon (IO) in the lower right Windows Notification area to run Agilent Connection Expert.

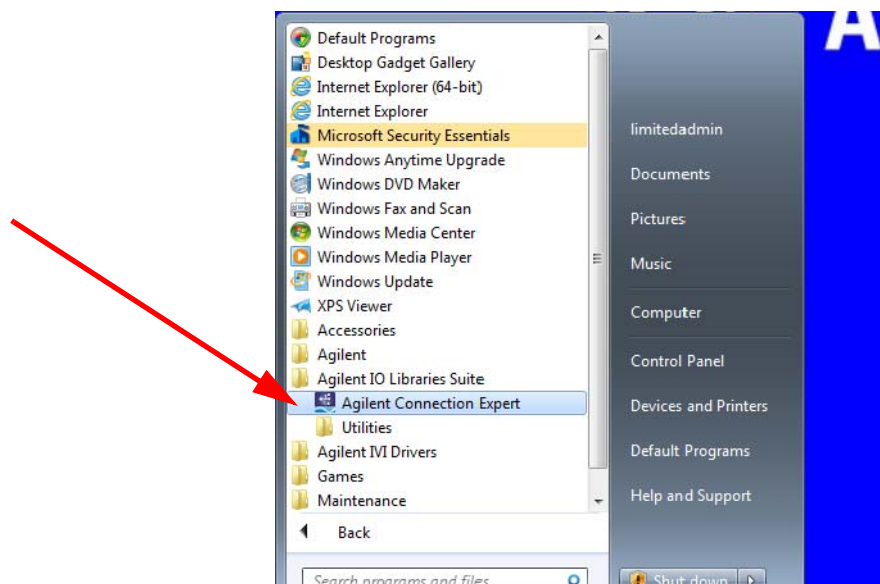

Figure 11 Starting Agilent Connection Expert

- 2 **Figure 12** below shows Agilent Connection Expert (with the M9536A Embedded Controller listed as the PC). Refer to the Agilent IO Libraries documentation for information on using Connection Expert.

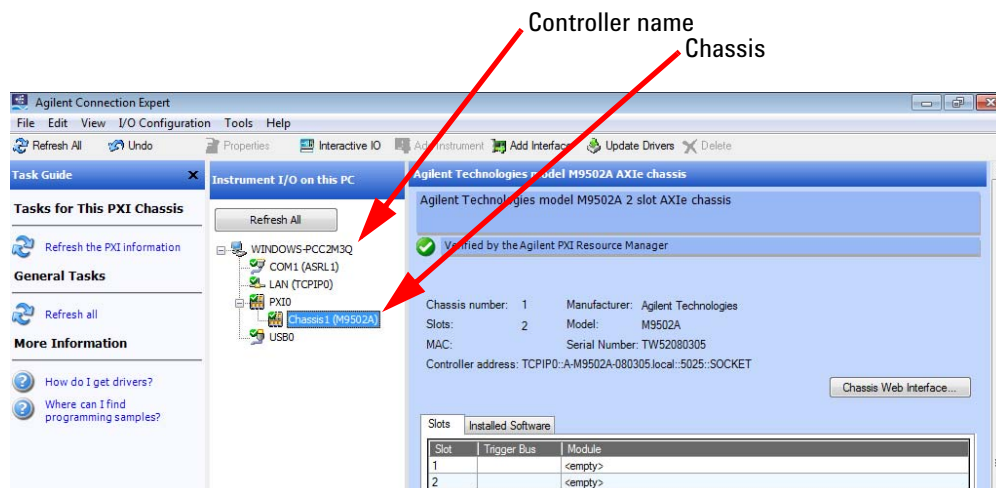

Figure 12 Agilent Connection Expert for an AXIe Embedded Controller

Note that the M950x chassis appears under the PXIO interface. If you are using a LAN connection to the ESM, you may need to select the LAN interface and then select **Add Instrument**. Locate the chassis and then add it.

NOTE

With Agilent IO Libraries 16.2 (and later versions) Agilent Connection Expert should automatically identify the AXIe chassis. With Agilent IO Libraries version 16.1, you may need to start Connection Expert, then power down the controller and chassis and reboot them in order for Connection Expert to identify the AXIe chassis.

- 3 The **Instrument I/O on this PC** pane shows instrument connections available to your controller.

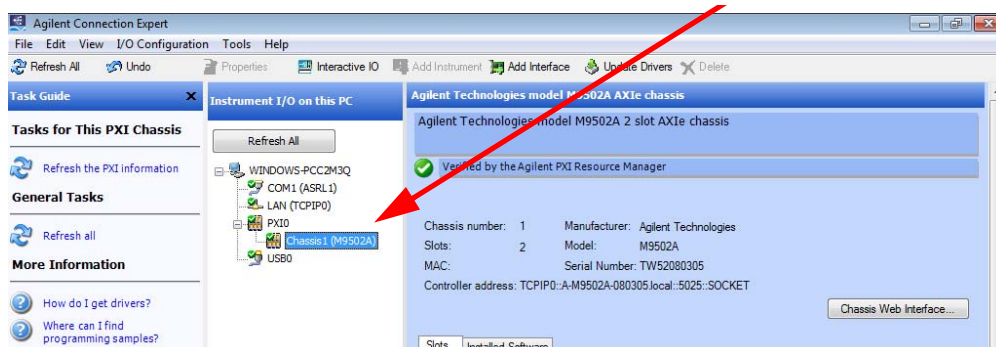

Figure 13 Agilent Connection Expert LAN (TCPIP0) Connection

Verify the green check mark, indicating that the Connection Expert made a LAN connection. Click to highlight the LAN connection.

- 4 In the Connection Expert **Task Guide** pane at left click **Add an Instrument**. Alternately, you can click on the **Add Instrument** button at the top of the page.

The **Add LAN Instruments** page loads in a new window (see Figure 14).

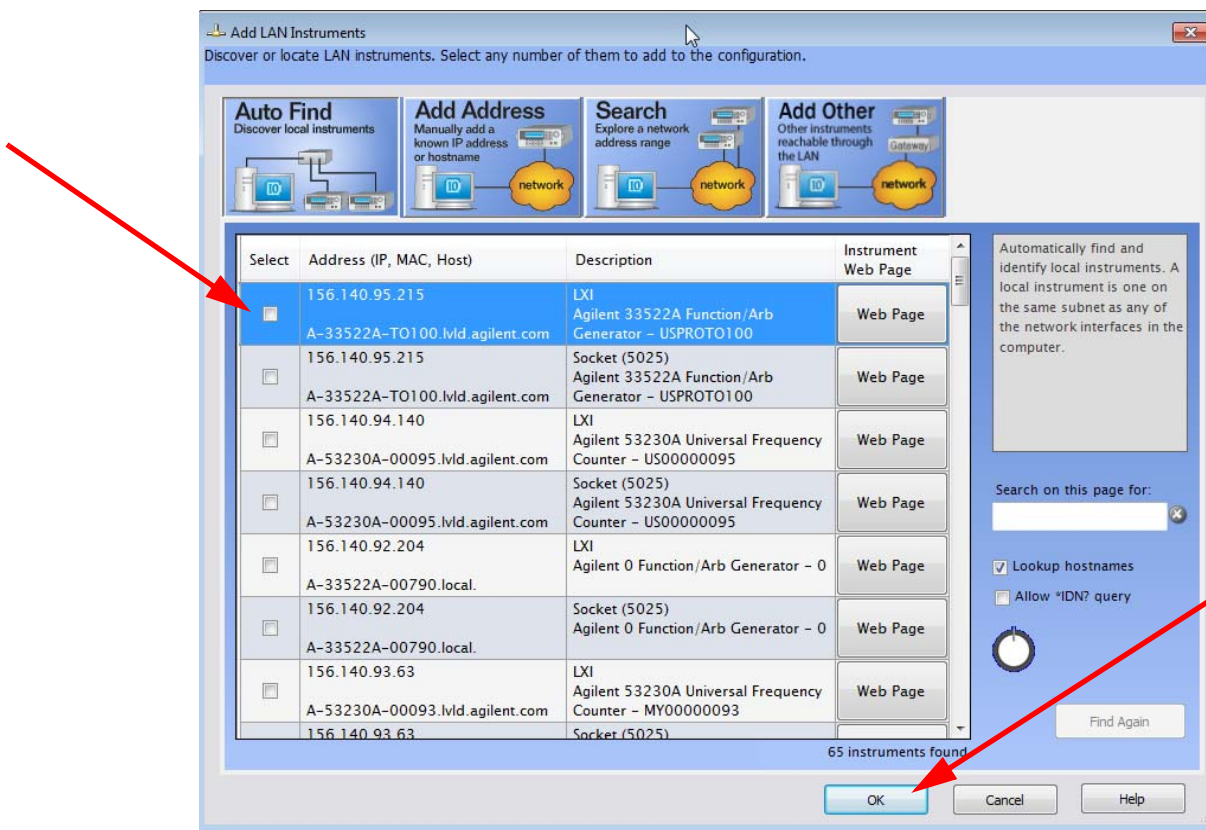

Figure 14 Agilent Connection Expert Auto Find the Chassis and Other Instruments

Your system may have many instruments connected and listed in the display.

Check the box next to the instrument to select it then, and click the **OK** button.

AXIe Chassis Web Page

The AXIe chassis appears in the Connection Expert Explorer Pane (**Instrument I/O on this PC**). In this example, we are showing the Agilent M9505A chassis.

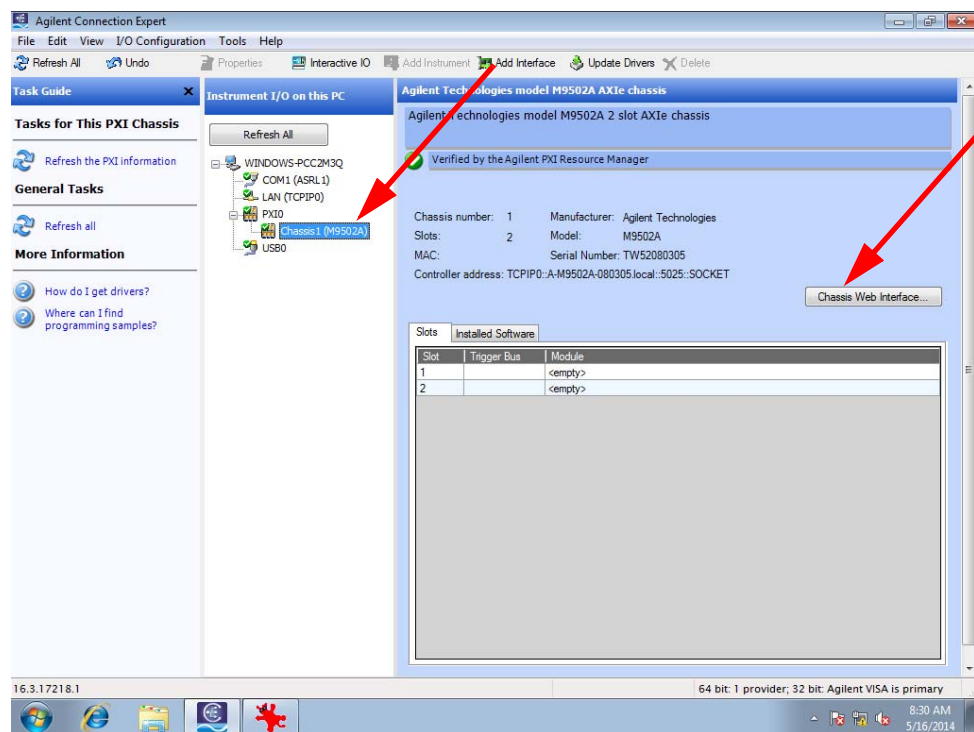

Figure 15 Connection Expert listing the Agilent M9505A Chassis

Click the Instrument Web Interface button to launch the chassis Web Interface. The chassis Web Home page loads in a new window (see [Figure 16](#)).

For detailed information on the AXIe chassis web page, refer to the Agilent M9502A/M9505A AXIe Chassis User Guide.

Home Page Button

Module Configuration Page Button

Chassis Health Page Button

Agilent Technologies M9505A AXLe 5 Slot Chassis

Welcome to your

Web-Enabled M9505A AXLe 5 Slot Chassis

Information about this Web-Enabled M9505A:

Instrument:	M9505A
Serial Number:	A918EA1002
Description:	M9505A AXLe 5 Slot Chassis
DNS Hostname:	A-M9505A-EA1002
IP Address:	156.140.95.40
mDNS Hostname:	A-M9505A-EA1002.local
mDNS Instrument Name:	Agilent M9505A AXLe 5 Slot Chassis - A918EA1002
VISA TCP/IP Connect String:	TCP/IP::156.140.95.40::5025::SOCKET
Firmware Revision:	F5AX-1.3.23-0107-A002e-B#####-CA1.1-DA1.0-E1.3

Turn On Front Panel Identification Indicator

Advanced information about this Web-Enabled M9505A

Use the navigation bar on the left to access your M9505A and related information.

© Agilent Technologies, Inc. 2011

AXLe AdvancedTCA eXtensions for Instrumentation

Figure 16 Chassis Web Page

The Home Page displays identifying information about your chassis and web connection. It displays additional information if you click the Advanced Information drop-down menu button.

On the left side of the page are six buttons: The Home Page button, The LAN Configuration Page button, the Module Configuration Page, the Trigger Routing Page, the Chassis Health Page, and the Help Page. Of these six buttons, only two are relevant to the M9536A Controller:

Module Configuration Page - This button allows you to view basic product and model information for instrument modules loaded -- such as the M9536A -- in the chassis.

Chassis Health Page - Displays PSU voltages, fan speeds and temperature. Provides detailed event alarms for the chassis and any installed Intelligent Platform Management Bus (IPMB)-equipped instrument modules.

- 1 Click on the **Module Configuration Page** button. This opens the Module Configuration Page (Figure 17) which provides the module's serial number and revision.

Module Configuration Page Button

M9536A Information

Module Slot	Product Name	Description	
5	-empty-	P/N	
		S/N	
		Revision	
		Manufacturer	
4	-empty-	P/N	
		S/N	
		Revision	
		Manufacturer	
3	-empty-	P/N	
		S/N	
		Revision	
		Manufacturer	
2	-empty-	P/N	
		S/N	
		Revision	
		Manufacturer	
1	AXIe System Controller	P/N	M9536A
		S/N	B6A6EC1005
		Revision	A3
		Manufacturer	Agilent Technologies
Chassis			
Frame	M9505A	P/N	AG-M9505-00100
		S/N	A918EA1002

Figure 17 Chassis Module Configuration Page

- 2 Click on the **Chassis Health Page** button. This opens the Chassis Health page (Figure 18) that provides backplane rail voltages and operating temperatures in the M9536A Controller.

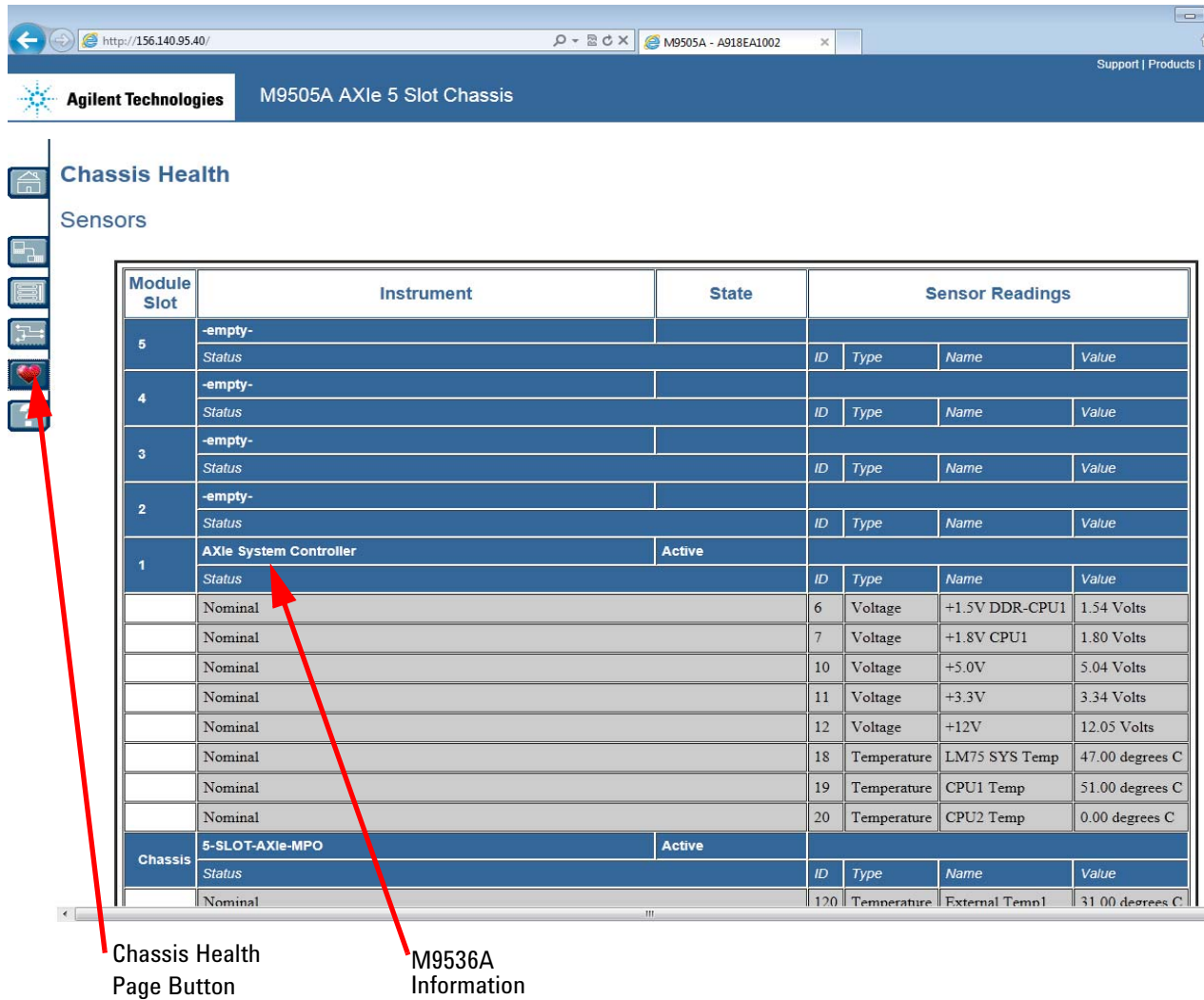

Figure 18 Chassis Health Page

AXIe Chassis Soft Front Panel

To view and use the chassis Soft Front Panel (SFP) software in your M9536A (only applies to the Agilent M9502A and M9505A AXIe chassis), click the **Installed Software** tab in Connection Expert. Then click the Start SSP button.

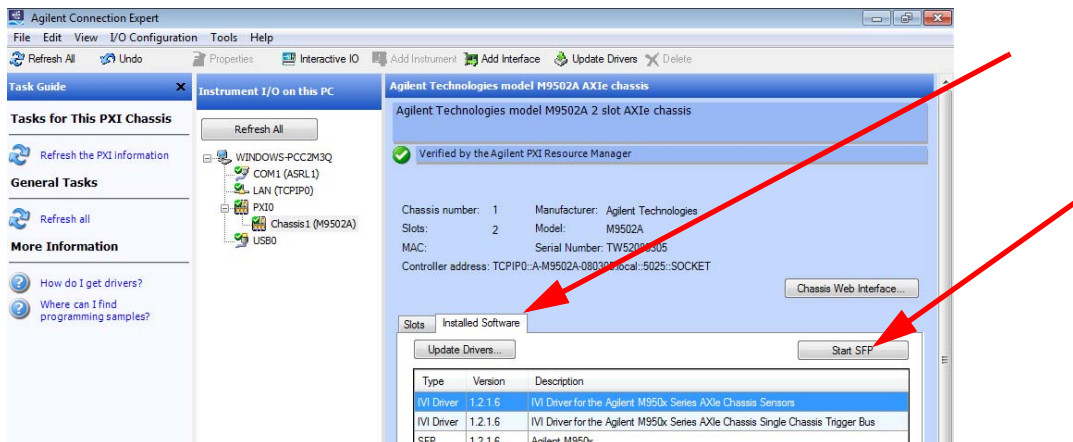

Figure 19 Installed Software Tab in Agilent Connection Expert, Start SFP button

This opens the SFP software. Refer to [Figure 20](#) below. For instructions on using the SFP, refer to the SFP help file.

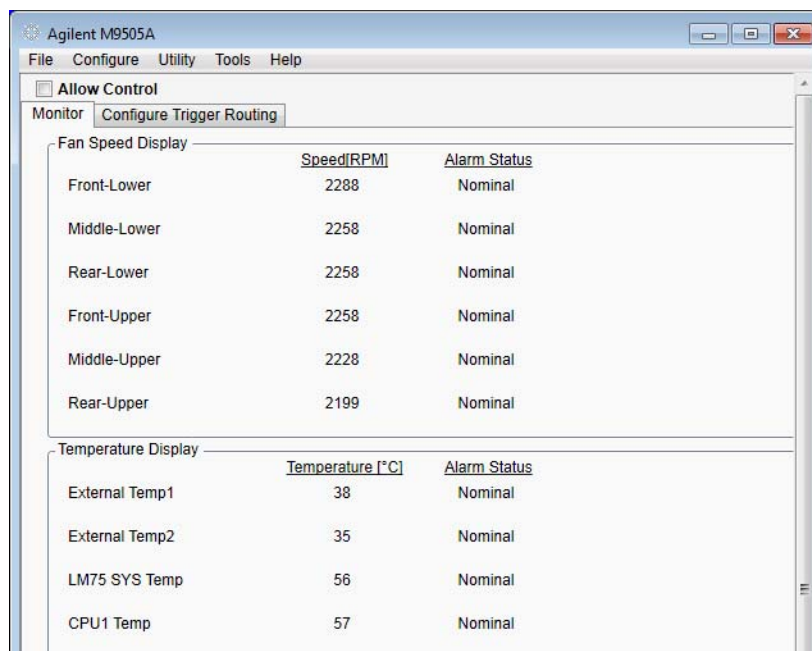

Figure 20 Soft Front Panel for the Agilent M9502A and M9505A AXIe Chassis

Windows Security

If your system is connected to the internet, you should take the following steps to ensure the operating system is protected:

- Use an internet firewall
- Get the latest Windows updates
- Install and use up-to-date antivirus software.

To check the status of, or make changes to, the security settings for your controller, open the Windows Security Center (Start > Control Panel > Security Center).

Windows updates

The default system setting is Windows Automatic Updates is turned off. You need to manually update Windows OS by accessing Internet Explorer and from the **Tools** menu, select **Windows Update**.

NOTE

Downloading and installing Windows Updates can be network and CPU intensive (impacting system performance) and some Windows Updates automatically reboot the controller. Therefore, Windows updates should be performed when the system is not in normal use.

NOTE

There is no antivirus or spyware software included with your controller. Antivirus application software is the customer's responsibility. Having antivirus software installed may have a slight impact on system performance if your system uses intensive network data transfer.

User data backup

All user data should be regularly backed up to an external memory device. This can be done across a network or to a USB device. Your IT department may already have a backup strategy which is suitable for the system and data. Also, user data back up should be done just prior to sending the controller back to Agilent for service if that is ever necessary.

The Windows operating system supplied with your M9536A is licensed for use on the SSD mounted to the controller. If the SSD is replaced, you may be responsible to purchase or relicense the operating system.

System backup and recovery

After activating Windows 7, you should create a System Repair Disk and a System Image as a backup in case you ever need to reinstall the operating system. By definition, a system image is an exact copy of the computer hard drive. A system image includes the Windows 7 operating system files as well as your system settings, application programs, and data files. You should regularly create a system image so that all data, applications, etc. have backups. The system image may be stored on a USB memory stick, multiple CD/DVDs, an external (USB) hard drive, or to a separate LAN drive.

When you restore your hard drive from a system image, it's a complete restoration—you cannot choose individual items to restore, and all of your current programs, system settings, and files are replaced with the contents of the system image. Therefore, you should also keep a regular backup of your data and applications.

You can also create Windows Restore Points to return your system files and settings without affecting data or application files.

Microsoft Windows 7 is the only operating system installed on your M9536A. There is a small system partition for the Agilent Recovery System on the SSD. During the boot process, you are given the choice to boot to Windows 7 normally or boot from the recovery partition. However, you should create a System Repair Disc (also known as a recovery disc) for use if the SSD fails and the M9536A will not boot. See [“Create a System Repair disc”](#) on page 28.

NOTE

Some third-party backup utilities may destroy Agilent's Recovery System partition. If this happens, the Agilent Recovery System will not work.

Use the recovery methods

As mentioned before, during the boot process, you are given the choice to boot to Windows 7 normally or boot from the recovery partition. If you select to boot from the recovery partition, the Windows Boot Manager opens a menu with five selections:

- 1) Run ChkDisk on the system drive
- 2) Recover the original factory system image
- 3) View troubleshooting documentation
- 4) Repair the system drive
- 5) Exit and restart the instrument.

Enter your selection and press the **OK** button. Follow the instructions on the screen.

NOTE

Selection number 2 restores Agilent's original factory system image. All data and system applications are lost.

However, if you are unable to boot from the recovery partition, you will need to use a Windows 7 System Repair disc. You must manually create this System Repair Disc, see “[Create a System Repair disc](#)” later on this page.

- 1 Connect a USB CD/DVD ROM drive to the controller.
- 2 Insert the system repair disc into the CD/DVD ROM drive.
- 3 Turn on the chassis power button.
- 4 When the Agilent startup screen appears (immediately after the POST test beeps) press the <F7> key repeatedly. This opens the M9536A boot menu.
- 5 Use Up/Down arrow keys to select your CD/DVD drive (it will probably have a name such as **HL-DT-STCVRAM**) and press **Enter**.
- 6 If prompted, press any key to start the computer from the System Repair disc.

Create a System Repair disc

NOTE

You will need a separate USB CD/DVD ROM drive to create and use the repair disc.

- 1 Open the Windows **Backup and Recovery** by clicking the **Start** button. Type **Backup** in the **Search programs and files** text box and then select the **Backup and Restore** program.
- 2 In the left pane, select **Create a system repair disc**. Follow the instructions provided on the screen. If you are prompted for an administrator password, type the password. Select the drive letter for the CD/DVD drive and click **Create Disc**.
- 3 The entire process may take several minutes.
- 4 When it is finished, click the **Close** button, then click the **OK** button.
- 5 When finished, label this disc the **Windows 7 Repair Disk 32-bit** or **Windows 7 Repair Disk 64-bit** (as appropriate) and store it in a safe place.

For more detailed information, refer to the Microsoft Windows documentation for Backup and Recovery.

Create a System Image

You should regularly create a system image of the SSD on the M9536A. The following procedure explains how to create an initial system image after activating Windows. For additional and/or specific information regarding Windows backups, system image, system restore, etc., refer to the Microsoft Windows Help system.

NOTE

If you purchase a replacement hard or SSD drive, it must be the same size or larger than the original (160 GB) SSD in your M9536A. You cannot create a system image of one size of hard drive and then try to restore it to a smaller hard drive.

Always store your back up CDs/DVDs, hard drives, memory sticks, etc., in a secure place to prevent unauthorized access to your files

NOTE

Some third-party disk backup utilities may destroy the Agilent backup partition. If this happens, the Agilent Recovery System will not work. follow the instructions provided on the following pages carefully.

- 1 Unhide the Agilent Recovery Partition. If you do not do this, it remains hidden and not included in the system image.
 - a Click the Windows Start button.
 - b Type **CMD** into the **Search programs and files** text box.
 - c Press **CTRL+SHIFT+ENTER**. This is the keyboard shortcut allowing elevation to “Run as Administrator.”
 - d In the DOS Command window, type: **CD** and press **Enter**.
 - e In the DOS Command window, type: **CD Agilent\Scripts**. Press **Enter**.
 - f Type: **HideUnhideRecoveryPartition.vbs unhide**
 - g Press **Enter**
 - h The Agilent Recovery Partition is now unhidden and should appear in the Windows File Explorer.
 - i Close the DOS Command window.

- 2 Connect a USB hard drive to the M9536A. Make certain that Windows identifies and can run the external hard drive.

If you are using a LAN drive, make certain the LAN cable is connected to the M9536A.

NOTE

The external drive must be formatted NTFS.

- 3 To start the system image backup wizard, click on the Windows Start button, then type “**Back Up**” in the **Search programs and files** text box.
- 4 Select the “**Backup your Computer**” link.
- 5 Click on the “**Create a system image**” link.
- 6 This opens the **Create a system image** window. The system automatically searches for available drives to create the system image.
- 7 Select the destination for your system image (a hard disk, one or more DVDs, a network location, etc.).
- 8 Click **Next**.
- 9 In the next screen, make certain that both **SystemDrive (c:)** (**System**) and **Recovery Partition (D:)** are selected (checked).
- 10 Click **Next**.
- 11 Click the **Start Backup** button.
- 12 When the System Image has been created, you will be prompted to create a System Repair Disk. Click **No** if you created a System Repair Disk earlier. If you have not created one earlier, you should create one now; click **Yes** and follow all of the prompts if you need to create a System Repair Disk now.
- 13 Click **Close**.

This completes the creation of a system image. Mark the disk appropriately and store it in a safe place.

For additional information, refer to the Microsoft Windows Backup and Restore help.

Restoring a System Image

Remember, when you restore your hard drive from a system image, it's a complete restoration—you cannot choose individual items to restore, and all of your current programs, system settings, and files are replaced with the contents of the system image. Therefore, you should also keep a regular backup of your data and applications.

To restore the image from a system image backup, perform the following steps:

- 1 Connect a USB CD/DVD ROM drive to the M9536A.
- 2 Insert the System Repair disc into the CD/DVD ROM drive. Note, this is not the System Image disk.
- 3 Connect the external hard drive, LAN cable, etc. for wherever your stored the previously created system image.
- 4 Turn on the chassis.

NOTE

You may need to select a boot option:

- 1 When the Agilent startup screen appears (immediately after the POST test beeps) press the **<F7>** key repeatedly. This opens the M9536A boot menu.
 - 2 Use Up/Down arrow keys to select your CD/DVD drive (it will probably have a name such as **HL-DT-STCVRAM**) and press **Enter**.
-
- 3 If prompted, press any key to start the computer from the system repair disc.
 - 4 Select the **Keyboard entry method** (language).
 - 5 Click **Next**.
 - 6 During the boot process, the computer will ask if you want to use the system recovery tools to help fix Windows problems or restore a previously saved system image. Select **Restore your computer using system image that you created earlier**.
 - 7 Click **Next**.
 - 8 In the next screen, select the CD/DVD drive, and the specific image (date and time saved) that you want to restore.
 - 9 Click **Next**.
 - 10 In the next screen, select the **Format and Repartition Disks** option.
 - 11 Click **Next**.
 - 12 Verify the information on the screen and click **Finish**.
 - 13 Click **Yes**.

Note that it may take several minutes up to a few hours to restore the system image.

When the system image restore is complete, remove the CD/DVD drive and the system image hard drive. Allow the M9536A to restart.

14 Optionally, you can re-hide the Agilent Recovery Partition.

- a** Click the Windows Start button.
- b** Type **CMD** into the Search text box field.
- c** Press **CTRL+SHIFT+ENTER**. This is the keyboard shortcut to trigger elevation to “Run as Administrator.”
- d** In the DOS Command window, type: **CD Agilent\Scripts**. Press **Enter**.
- e** Type: **Run HideUnhideRecoveryPartition.vbs hide**
- f** Press **Enter**
- g** The Agilent Recovery Partition is now hidden and should not appear in the Windows File Explorer.
- h** Close the DOS Command window.

The system is now ready for use.

Chassis Shutdown

As with any PC, Windows-based instruments should not be shutdown by either turning off the power via an external power source or by pulling the power plug out from the rear panel. This could corrupt the operating system. The only approved way to shut down the controller is to execute the Windows shutdown process and then turn off the chassis via the chassis On/Off button.

CAUTION

Pressing the chassis power button immediately removes power from the controller. This may cause loss of data or damage to the controller.

Power down modes

Agilent's M9536A defaults to the Windows High Performance Power Plan. This plan does not allow the controller display to shut off or the controller to enter a sleep or hibernate mode.

NOTE

You should not enable the Microsoft Windows sleep or hibernate modes. It is possible that the M9536A controller could go into sleep mode while it is running a user test program. The controller may not have proper chassis enumeration when it wakes up.

If you have a USB keyboard with a Sleep button (sometimes this is a key with a moon logo), do not use it.

Do not use the Sleep or Hibernate modes from the Startup Button as shown in the following graphic.

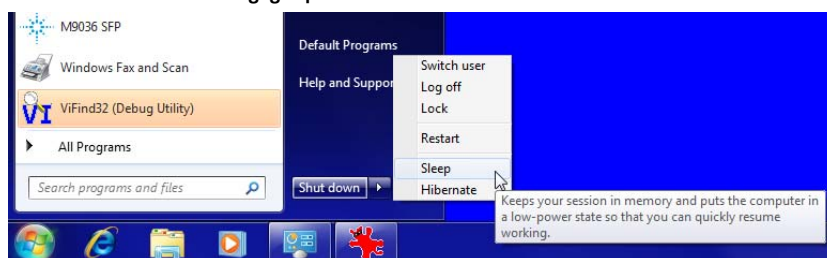

Things not to do

As with any PC, there are several system-level settings and files that you should not change, move, or delete as this could cause a number of difficulties.

Windows Registry

Do not manually make any changes to the registry unless you know exactly what you are doing. Making changes to the registry could affect the controller's ability to boot-up, execute programs, and display desired information.

Application software

Do not remove files under the **C:\Program Files** folder by any means other than using the **Add or Remove Programs** utility found on the Control Panel. Do not remove any software application that was preinstalled by Agilent, even using the **Add or Remove Program** utility, unless you are instructed by Agilent to do so while performing an update.

Display settings

Do not change any of the settings on Settings tab of the Display settings window.

SSD drive

Do not repartition the SSD drive or rename any of the existing partitions. Doing so could cause the controller to either not have the disk space required or not be able to find needed data.

Software application licenses

Some software applications require a license to use to the software. For security reasons the licensing mechanism often uses a composite HostID which depends on several system identifiers. A change to any of these identifiers may result in invalidating the licenses on that system. In general, you can retrieve “lost” Agilent software licenses at any time on the Agilent Software Licensing system (ASL) web site at <http://www.agilent.com/find/softwarelicense>. You will need the license order number and certificate number as well as a valid login and password.

If either of the following occurs, you will need to verify and possibly reissue the license.

- The SSD is reimaged, replaced, or corrupted.
- The controller motherboard is replaced or the primary (system) BIOS serial number has changed.

For more information, refer to the software application documentation.

Microsoft operating system licensing

The Windows operating system supplied with your M9536A is licensed for use on the SSD mounted to the controller. If the SSD is replaced, you may be responsible to purchase or relicense the operating system.



3 BIOS Setup

The Basic Input/Output System (BIOS) is a program that provides a basic level of communication between the processor and peripherals. In addition, the BIOS also contain code for various advanced features applied to the M9536A controller. The BIOS setup program includes menus for configuring settings and enabling M9536A controller features.

NOTE

In general, you will never need to update the BIOS on your M9536A. However, any BIOS update for the M9536A will be available on the Agilent web site: www.agilent.com/find/M9536A

The BIOS is custom designed specifically for the M9536A. Do not attempt to replace it with a generic BIOS.

CAUTION

Changing BIOS settings may lead to incorrect controller behavior and possibly an unbootable controller. If this happens, press SW7 (see “SW7 - Clear CMOS” on page 61) to clear the CMOS memory and restore the default BIOS settings.

Do not change a BIOS setting unless you are absolutely certain of what it does.

Controller BIOS Versions

As of this printing, two versions of BIOS are available for the M9536A -- AG10 and AG16. The only significant difference between AG10 and AG16 is that AG16 BIOS allows the M9536A AXIe Embedded Controller to properly enumerate large PCIe systems, including up to three M9514A AXIe 14-slot Chassis. To determine which version is currently installed in your M9536A:

- 1 Turn chassis power off and then on again.
- 2 At startup, press the **Delete** key when the Agilent Splash screen appears. This opens the BIOS menu Main page displaying the currently installed version of BIOS.



NOTE

BIOS AG16 may be installed only on an M9536A running Microsoft Windows Embedded Standard 7 (WES 7) Operating System. BIOS AG10 of the M9536A BIOS can be installed on the M9536A using either Windows 7 Pro or WES 7. Refer to the User Guide for more information.

Instructions to upgrade or restore a particular BIOS version are available with the BIOS files on the Agilent web site: www.agilent.com/find/M9536A

Starting the BIOS Setup Utility

To enter the BIOS setup screen, follow these steps:

- 1 Power on the chassis with the embedded controller
- 2 Press the <Delete> key when you see the following screen:

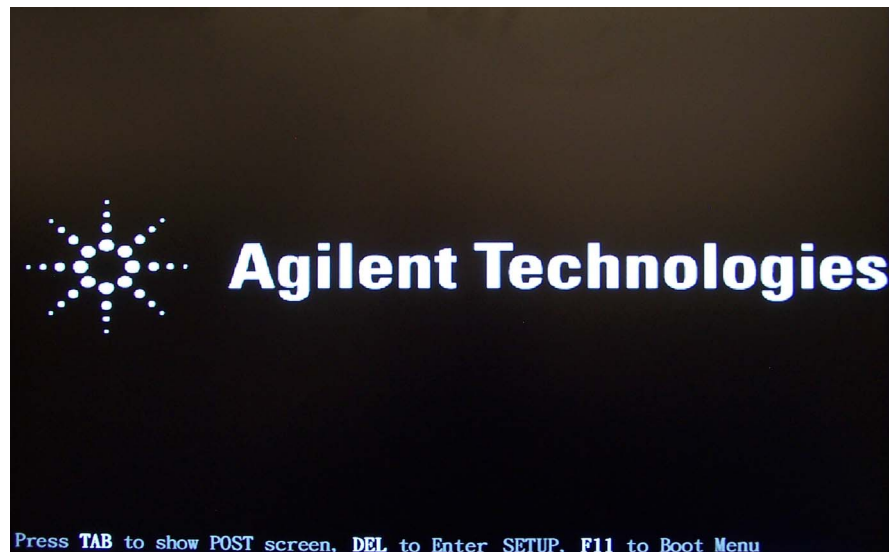

Figure 21 M9536A Startup Screen

- 3 After you press the <Delete> key, the main BIOS setup menu displays. You can access the other setup screens from the main BIOS setup menu, such as the Boot and Security menus.

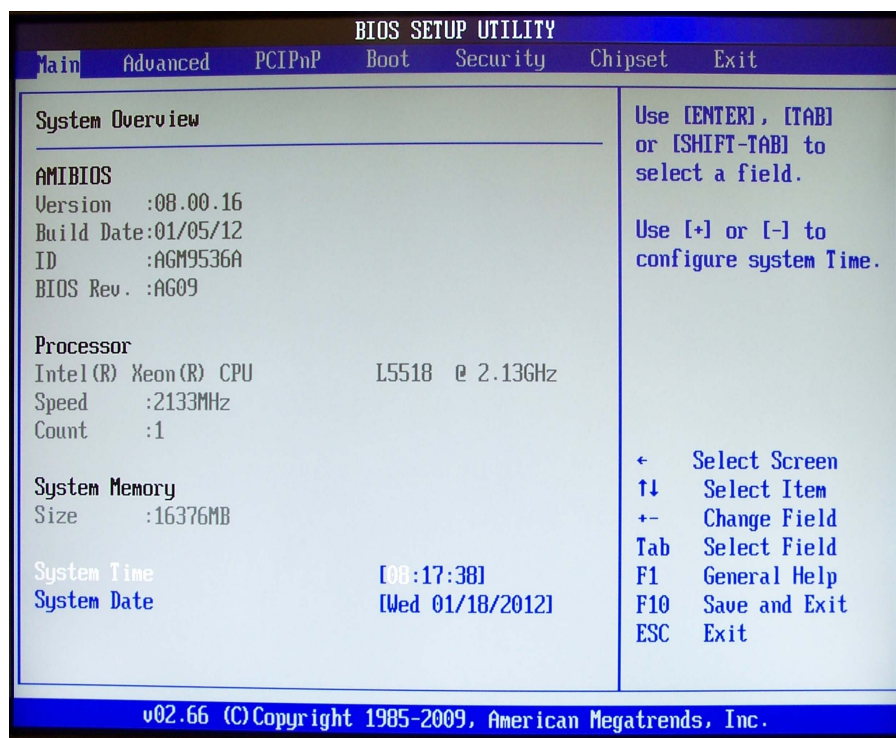

Figure 22 Main BIOS Start Screen

NOTE

In most cases, the **<Delete>** key is used to invoke the setup screen. There are several cases that use other keys, such as **<F1>**, **<F2>**, and so on.

BIOS setup utility

The Main BIOS setup menu is the first screen that you can navigate. Each Main BIOS setup menu option is described in this user guide.

Each of the BIOS setup menu screens has two main frames. The left frame displays all the options that can be configured. “Grayed” options cannot be configured, “Blue” options can be.

The right frame displays the key legend. Above the key legend is an area reserved for a text message. When an option is selected in the left frame, it is highlighted in white. Often a text message will accompany it.

Navigation

The BIOS setup/utility uses a keyboard-based navigation system. Most of the BIOS setup utility hot keys can be used at any time during the setup navigation process.

These keys include <F1>, <F8>, <F10>, <Enter>, <ESC>, etc.

NOTE

There is a hot key legend located in the right frame on most setup screens.

Hot key descriptions:

F1 Press the <F1> key to open the General Help screen.

F8 The <F8> key on your keyboard is the Fail-Safe key. It is not displayed on the key legend by default. To set the Fail-Safe settings of the BIOS, press the <F8> key on your keyboard. It is located on the upper row of a standard 101 keyboard. The Fail-Safe settings allow the motherboard to boot up with the least amount of options set. This can lessen the probability of conflicting settings.

F10 The <F10> key allows you to save any changes you have made and exit Setup. Press the <F10> key to save your changes.

Press the <Enter> key to save the configuration and exit. You can also use the <Arrow> key to select Cancel and then press the <Enter> key to abort this function and return to the previous screen.

ESC The <Esc> key allows you to discard any changes you have made and exit the Setup. Press the <Esc> key to exit the setup without saving your changes. Press the <Enter> key to discard changes and exit. You can also use the <Arrow> keys to select Cancel and then press the <Enter> key to abort this function and return to the previous screen.

Enter The <Enter> key allows you to display or change the setup option listed for a particular setup item. The <Enter> key can also allow you to display the setup sub-screens.

Main Menu

When you first enter the BIOS Setup Utility, you will see the **Main** menu screen. You can return to the **Main** menu screen at any time by selecting the **Main** tab. The Main BIOS Setup screen is shown below; the only fields you can change are the System Time and System Date.

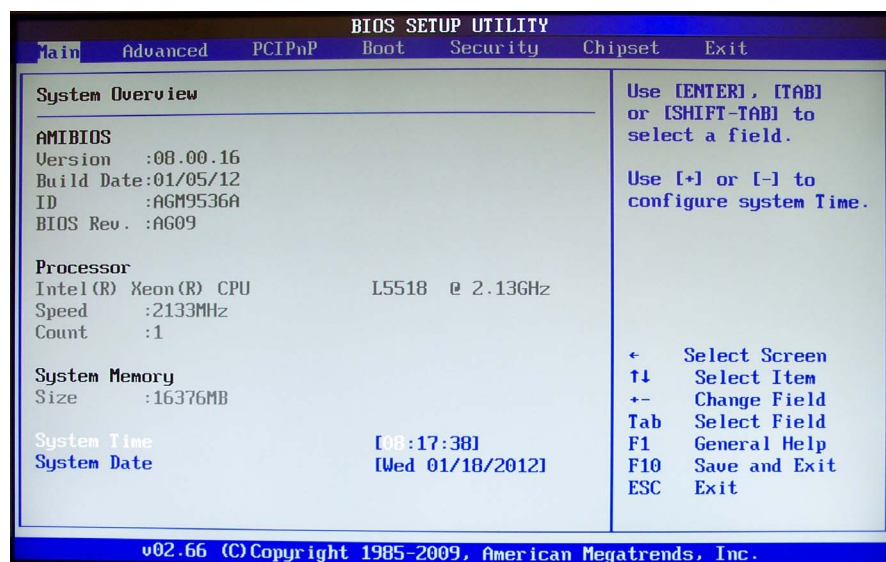

Figure 23 Main BIOS Setup Utility Screen

System time/system date

These options allow you to change the system time and date. Highlight either System Time or System Date using the **<Arrow>** keys. Enter new values using the keyboard. Press the **<Tab>** key or the **<Arrow>** keys to move between fields. The date must be entered in MM/DD/YY format. The time is entered in HH:MM:SS format.

NOTE

The default time is in 24-hour format. For example, 5:30 A.M. appears as 05:30:00, and 5:30 P.M. as 17:30:00.

Advanced Menu

Select the **Advanced** tab from the setup screen. You can select any of the items in the left frame of the screen, such as **SuperIO Configuration**, to go to the sub menu for that item. You can display an **Advanced BIOS Setup** option by highlighting it using the <Arrow> keys. The **Advanced BIOS Setup** screen is shown below.

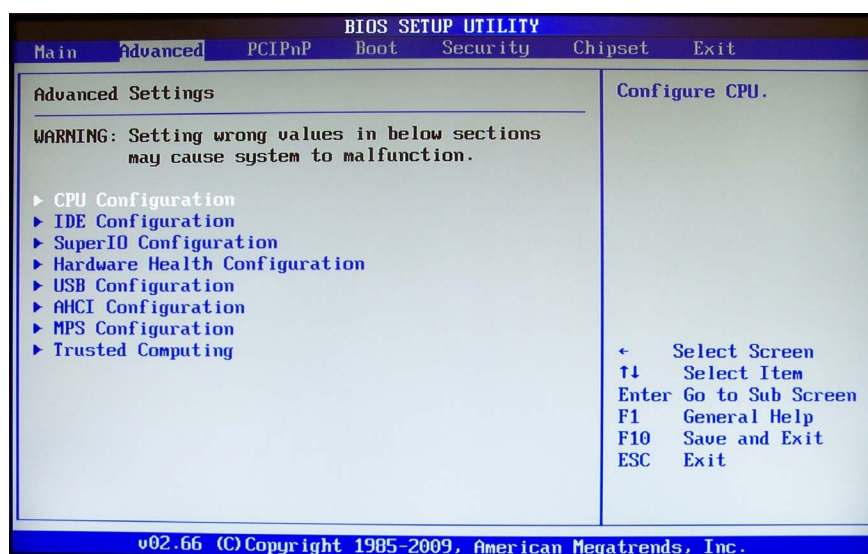

Figure 24 Advanced Settings Menus

The sub menus are described on the following pages.

CPU configuration

You can use this screen to select options for the CPU Configuration Settings. Use the up and down <Arrow> keys to select an item. Use the <+> and <-> keys to change the value of the selected option. A description of the selected item appears on the right side of the screen.

Hardware Prefetcher: This is used for reducing the waiting time of DRAM. The hardware prefetcher looks for streams of data and tries to predict what data will be needed next by the processor and proactively tries to fetch these data. Default is Enabled.

Adjacent Cache Line Prefetch: This is used to choose the optimal use of sequential memory access for performance purpose. Disable this setting for applications that require high use of random memory access. Default is Enabled.

Execute-Disable Bit Capability: Intel's Execute Disable Bit is an hardware-based security feature that can help reduce system exposure to viruses and malicious code. It allows the processor to classify areas in memory where application code can or cannot execute. When a malicious worm attempts to insert code in the buffer, the processor disables code execution, preventing damage and worm propagation. To use Execute Disable bit you must have a PC or server with a processor with Execute Disable Bit capability and a supporting operating system. Default is Enabled.

Intel HT Technology: Hyper-Threading Technology is used to improve parallelization of computations performed on PC microprocessors. A processor with hyper-threading enabled is treated by the operating system as two processors instead of one. Default is Enabled.

Intel Speedstep™ Technology: Intel SpeedStep™ technology allows the system to dynamically adjust processor voltage and core frequency, which can result in decreased average power consumption and decreased average heat production. Default is Enabled.

Intel C-State Technology: This function controls the availability of the CPU C-state power saving technology. Default is Enabled.

IDE Configuration

When entering the PC setup, the BIOS auto detects the presence of IDE devices. This menu screen shows the status of each of those devices. SATA (or Serial Advanced Technology Attachment) is a PC bus interface for connecting host bus adapters to mass storage devices such as the SSD (hard drive).

Super IO configuration

You can use this screen to specify the Win627UHG Super IO Chipset settings. **UART1 to Front Panel** is the only option.

Hardware health configuration

This option displays the current status of all of the monitored hardware devices/components such as voltages and temperatures. In a power management state, the BIOS can adjust (or throttle) the CPU clock speed to reduce power consumption. for example, a Throttle ratio of 50% means the clock is turned off half of its normal operation time. The optimal and fail-safe setting is 50%.

USB configuration

You can use this screen to select options for the USB Configuration. Use the up and down <Arrow> keys to select an item. Use the <+> and <-> keys to change the value of the selected option. The settings are described on the following pages.

Legacy USB Support Legacy USB Support refers to USB mouse and keyboard support. Normally if this option is not enabled, any attached USB mouse or USB keyboard will not become available until a USB compatible operating system is fully booted with all USB drivers loaded. When this option is enabled, any attached USB mouse or USB keyboard can control the system even when there are no USB drivers loaded on the system. Set this value to enable or disable the Legacy USB Support.

- Disabled: Set this value to prevent the use of any USB device in DOS or during system boot.
- Enabled: Set this value to allow the use of USB devices during boot and while using DOS.
- Auto: This option auto detects USB Keyboards or Mice and if found, allows them to be utilized during boot and while using DOS.

Port 64/60 Emulation This option uses USB to receive the IO port 64/60 trap to emulate the legacy keyboard controller.

USB 2.0 Controller Mode The USB 2.0 Controller Mode configures the data rate of the USB port. The options are FullSpeed (12 Mbps) and HiSpeed (480 Mbps).

BIOS EHCI hand-off This option provides a workaround for operating systems without ECHI hand-off support. The EHCI ownership change should be claimed by the EHCI driver.

Legacy USB1.1 HC Support Legacy USB support refers to the USB mouse and keyboard support. If this option is disabled, any attached USB keyboard and mouse will not become available until a USB compatible Operating System is fully booted with all USB drivers installed. If the option is enabled, any attached USB keyboard and mouse can control the system even if USB drivers are not installed.

AHCI configuration

This menu item allows you to enable/disable AHCI BIOS support. When enabled, BIOS will detect the presence of AHCI disks and show which port they are on.

MPS Configuration

Displays the MultiProcessor Specification (MPS) revision number.

Trusted Computing

Indicates the Trusted Computing Group (TCG) and Trusted Platform Module (TPM) support from the BIOS.

PCI/PnP Menu

Select the PCI/PnP tab from the setup screen to enter the **Plug and Play BIOS Setup** screen. You can display a **Plug and Play BIOS Setup** option by highlighting it using the <Arrow> keys. The **Plug and Play BIOS Setup** screen is shown below.

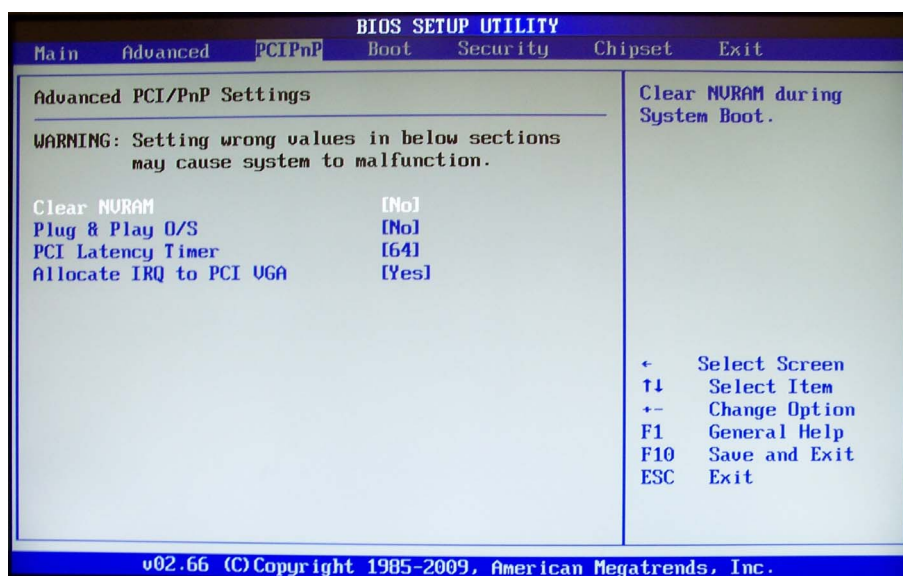

Figure 25 BIOS Setup: Advanced PCI/PnP Settings

Clear NVRAM

Set this to enable/disable Clear NVRAM during system boot. NVRAM content like ESCD will be cleared and updated at next boot.

Plug & Play O/S

- **No:** Let the BIOS configure all the devices in the system.
- **Yes:** Let the operating system configure Plug and Play (PnP) devices not required for boot if your system has a Plug and Play operating system.

PCI latency timer

Set this value to allow the PCI Latency Timer to be adjusted. This option sets the latency of all PCI devices on the PCI bus.

Allocate IRQ to PCI VGA

This value allows (or prohibits) the system from giving the VGA chipset an interrupt address.

Boot Menu

Select the Boot tab from the setup screen to enter the **Boot BIOS Setup** screen. You can select any of the items in the left frame of the screen, such as Boot Device Priority, to go to the sub menu for that item. You can display a **Boot BIOS Setup** option by highlighting it using the **<Arrow>** keys. The Boot Settings screen is shown below:

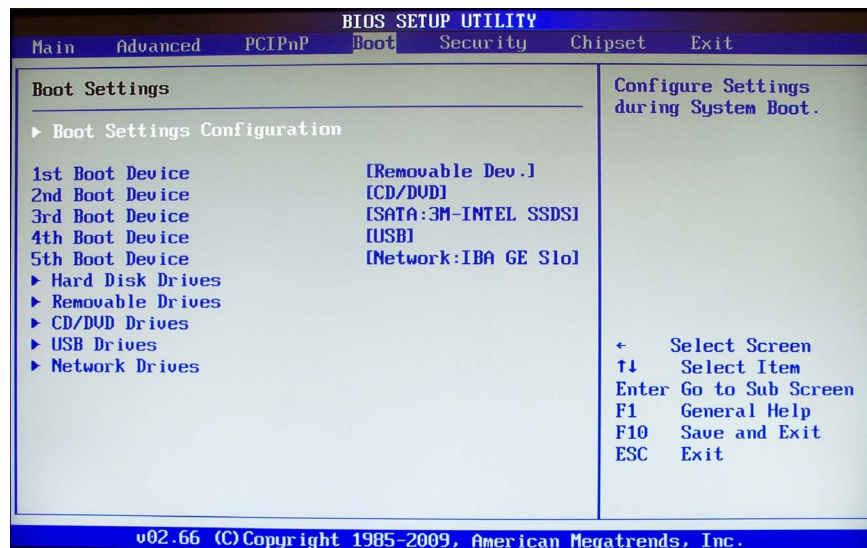

Figure 26 BIOS Setup: Boot Settings

Boot settings configuration

Use this screen to select options for the Boot Settings Configuration. Use the up and down **<Arrow>** keys to select an item. Use the **<+>** and **<->** keys to change the value of the selected option.

Quick Boot:

Disabled – Set this value to allow the BIOS to perform all POST tests.

Enabled – Set this value to allow the BIOS to skip certain POST tests to boot faster.

Quiet Boot:

Disabled – Set this value to allow the computer system to display the POST messages.

Enabled – Set this value to allow the computer system to display the OEM logo.

Bootup Num-Lock: Set this value to allow the Number Lock setting to be modified during boot up.

- **Off** – This option does not enable the keyboard Number Lock automatically. To use the 10-keys on the keyboard, press the Number Lock key located on the upper left-hand corner of the 10-key pad. The Number Lock LED on the keyboard will light up when the Number Lock is engaged.
- **On** – Set this value to allow the Number Lock on the keyboard to be enabled automatically when the computer system is booted up. This allows the immediate use of 10-keys numeric keypad located on the right side of the keyboard. To confirm this, the Number Lock LED light on the keyboard will be lit.

Interrupt 19 Capture: When enabled, allows option ROMs to trap interrupt 19.

Using this BIOS setup screen, you can select network booting and booting into the built-in EFI shell. These options are not described in this manual and Agilent Technical Support does not support using these options. Refer to the Microsoft TechNet library for information on installing Windows to an EFI-based computer.

Security menu

The Security Settings menu allows you to install or change the Supervisor and User passwords.

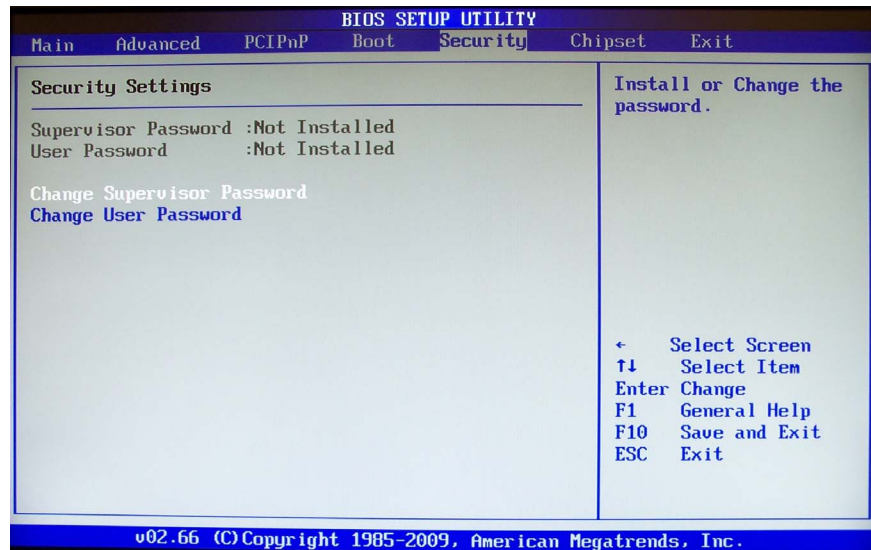

Figure 27 BIOS Setup: Security Settings

Password support

The system can be configured so that all users must enter a password every time the system boots or when Setup is executed, using either or either the Supervisor password or User password. Password Protection provides both a Supervisor and a User password. If you use both passwords, the Supervisor password must be set first.

The Supervisor and User passwords activate two different levels of password security. If you select password support, you are prompted for a one to six character password. Type the password on the keyboard. The password does not appear on the screen when typed. Make sure you write it down. If you forget it, you must drain NVRAM and re-configure (see “Clear NVRAM” on page 45).

The screen shown in Figure 27 changes as you set User and/or Supervisor passwords,

Record the Password: Keep a record of the new password when the password is changed. If you forget the password, you must erase the system configuration information in NVRAM.

To access the sub menu for the following items, select the item and press **<Enter>**:

- Change Supervisor Password
- Change User Password
- Clear User Password

Supervisor Password: Indicates whether a supervisor password has been set.

User Password: Indicates whether a user password has been set.

Clear User Password: Select this option and press **<Enter>** to access the sub menu. You can use the sub menu to clear the user password.

Change supervisor password

Select Change Supervisor Password from the Security Setup menu and press **<Enter>** to access the sub menu.

Enter New Password:

Type the password and press **<Enter>**. The screen does not display the characters entered. Retype the password as prompted and press **<Enter>**. If the password confirmation is incorrect, an error message appears. The password is stored in NVRAM after completes.

Change user password

Select Change User Password from the Security Setup menu and press **<Enter>** to access the sub menu.

Enter New Password:

Type the password and press **<Enter>**. The screen does not display the characters entered. Retype the password as prompted and press **<Enter>**. If the password confirmation is incorrect, an error message appears. The password is stored in NVRAM after completes.

Chipset Menu

Select the Chipset tab from the setup screen to enter the Chipset BIOS Setup screen. You can select any of the items in the left frame of the screen to go to the sub menu for that item. The Chipset BIOS Setup screen is shown below.

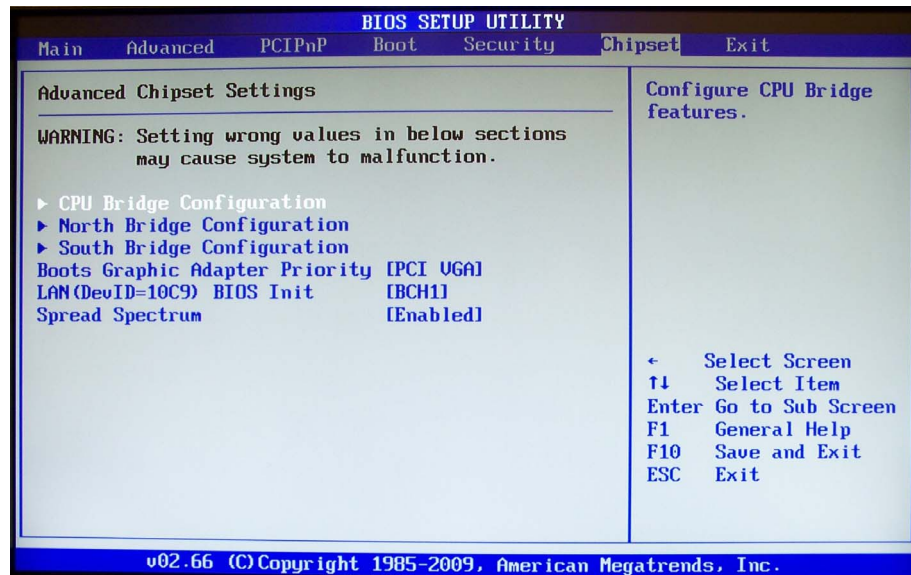

Figure 28 BIOS Setup: Chipset Setup

CPU bridge configuration

The CPU Bridge configuration displays the information and setting of QPI (Quick Path Interface) and memory.

QPI Links Speed: Set to Full-speed for normal operation. Slow-mode is used for debugging.

QPI Frequency: Auto: Let BIOS decide the frequency that the CPU can support (strongly recommend).

Memory Frequency: Auto: Let BIOS decide the frequency that all memory DIMMs can support (strongly recommend).

North bridge configuration

The North Bridge Chipset Configuration screen displays information about the IOH.

South bridge configuration

The South Bridge Chipset Configuration screen displays information and settings for the ICH10R.

USB Functions: Set this value to allow the system to disable, enable, and select a set number of onboard USB ports.

USB Port Configure: The ICH10R contains 2 EHCI controllers which support a total of 12 USB ports. Each EHCI connects 6 ports by default (6x6 USB Ports). Set this option to “8x4 USB Ports” to move ports 11 and 12 from EHCI2 to ECHI1.

USB 2.0 Controller: This option takes effect only when USB Functions are enabled. Enabling will allow USB 2.0 functionality to all USB ports.

SMBUS Controller: Set this value to enable/disable the SMBUS Controller.

Boots Graphic Adapter Priority

Set this value to decide which BUS, PCI or PCIE, get first VGA boot priority.

LAN BIOS Init

Using this BIOS setup screen, you can select network booting. These options are not described in this manual and Agilent Technical Support does not support using these options. Refer to the Microsoft TechNet library for information on installing Windows to an EFI-based computer.

Spread Spectrum

Clock Spread Spectrum - Enables/disables the clock spread spectrum. Enabled may reduce EMI generated by the system.

Exit Menu

Select the Exit tab from the setup screen to enter the Exit BIOS Setup screen. You can display an Exit BIOS Setup option by highlighting it using the <Arrow> keys. The Exit BIOS Setup screen is shown below.

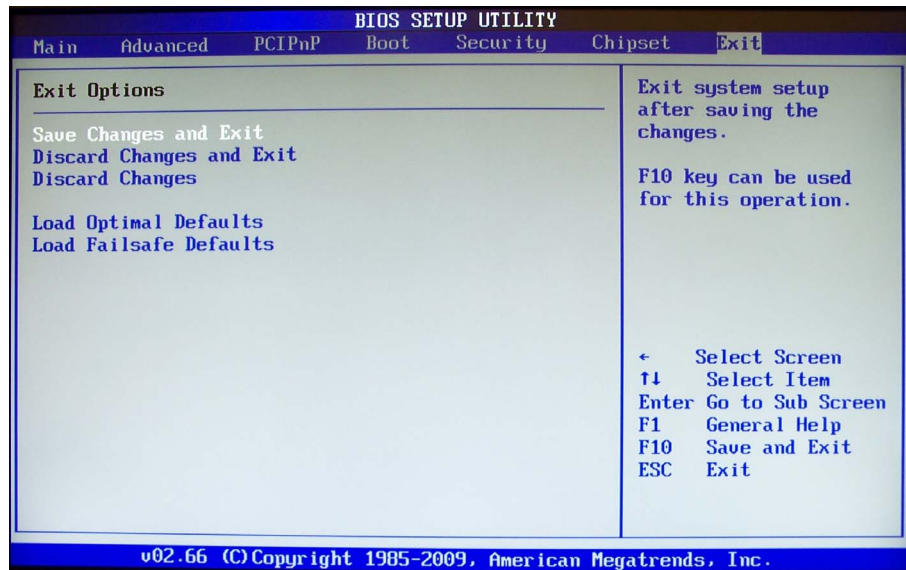

Figure 29 BIOS Setup: Exit

Save changes and exit

When you have completed the system configuration changes, select this option to leave Setup and reboot the computer so the new system configuration parameters can take effect.

Save Configuration Changes and Exit Now?

[Ok] [Cancel]

appears in the window. Select <Ok> to save changes and exit.

Discard changes and exit

Select this option to quit Setup without making any permanent changes to the system configuration.

Discard Changes and Exit Setup Now?

[Ok] [Cancel]

appears in the window. Select <Ok> to discard changes and exit.

Discard changes

Select Discard Changes from the Exit menu and press <Enter>.

Select <Ok> to discard changes.

Load optimal defaults

Automatically sets all Setup options to a complete set of default settings when you select this option. The Optimal settings are designed for maximum system performance, but may not work best for all computer applications. In particular, do not use the Optimal Setup options if your computer is experiencing system configuration problems.

Select Load Optimal Defaults from the Exit menu and press <Enter>.

Select <Ok> to load optimal defaults.

Load fail-safe defaults

Automatically sets all Setup options to a complete set of default settings when you select this option. The Fail-Safe settings are designed for maximum system stability, but not maximum performance. Select the Fail-Safe Setup options if your computer is experiencing system configuration problems.

Select Load Fail-Safe Defaults from the Exit menu and press <Enter>.

Load FailSafe Defaults?

[Ok] [Cancel]

appears in the window. Select <Ok> to load Fail-Safe defaults.

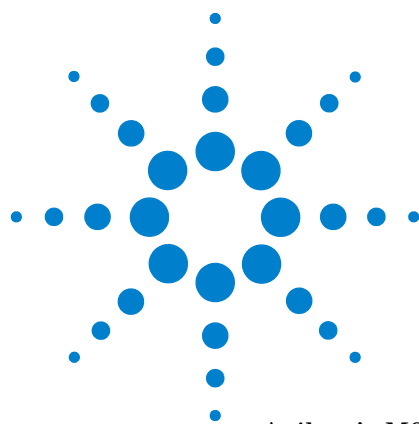

4 Service

Agilent's M9536A AXIe Embedded Controller has some user serviceable parts. In general, you should not need to change switch settings. Always observe Electrostatic Discharge precautions.

NOTE

Periodically check for the latest AXIe chassis firmware:
www.agilent.com/find/M9502A or www.agilent.com/find/M9505A

For example, Agilent's AXIe chassis firmware version 1.3.23 (and later) provides for enhanced fan control and E-Keying that was not supported in earlier chassis firmware versions.

Troubleshooting

What if my M9536A controller does not boot?

There are several possibilities; here are some things to try:

- Make certain the chassis is plugged in to a working source of AC power.
- Check the circuit breaker on the back of the chassis.
- Make certain the controller module is firmly installed and seated in the AXIe chassis.
- Remove all other modules and nonessential cables from the chassis then power it on again.
- Try the M9536A in a different chassis (if available).
- Press the reset button on the controller front panel.
- Do any of the controller LEDs come on? The SSD LED should flash or stay on as the controller boots.
- Does the boot process stop at some point? Does the boot process get to the POST code beeps? Refer to Chapter 2, “[Controller Operating System](#)” on page 15 for the display sequence during boot.
- Does anything appear on the video display? If nothing appears on the monitor, try a different monitor. does the monitor work on a different PC?
- As a last effort, clear the CMOS (“[SW7 - Clear CMOS](#)” on page 61).
- If none of the above tips help, return the controller to Agilent. Refer to “[If you need to return the module for service](#)” on page 56.



Booting in Safe Mode

You may need to reboot the computer into Windows Safe Mode. Booting in Safe Mode prevents extraneous services and programs - including most malware - from loading at startup:

Reboot the controller. During the boot process, repeatedly tap the F8 key which should bring up the “**Windows Advanced Options Menu.**” Use the arrow keys to move to “Safe Mode” and press the Enter key.

The controller appears to boot but MS Windows is not working

When booting, the monitor displays the normal BIOS startup screens but the display is not working for MS Windows. This may include a garbled display, black or white screen, or an out of synch message on the monitor. This is typically caused by the video output set to a higher resolution than the monitor can display. Reboot the computer in Safe Mode and reset the video driver to a lower setting, such as 800x600 and a refresh rate of 60 Hz. Reboot the controller again. Allow it to run normally and start Windows. Now you should be able to increase the screen resolution by selecting: **Windows Start button > Control Panel > Display > Change display settings.**

If you need to return the module for service

Should it become necessary to return the module for repair or service:

- 1 Review the warranty information shipped with your product.
- 2 Contact Agilent to obtain a return authorization and return address. If you need assistance finding Agilent contact information go to www.agilent.com/find/assist (worldwide contact information for repair and service) or refer to the **Support** information on the product web page at: www.agilent.com/find/M9536A.
- 3 Write the following information on a tag and attach it to the controller.
 - Name and address of owner. A Post Office box is not acceptable as a return address.
 - Product model number (for example, M9536A)
 - Product serial number (for example, TWxxxxxxxx).
 - A description of failure or service required.
- 4 Carefully pack the module in its original ESD bag and carton. If the original carton is not available, use bubble wrap or packing peanuts, place the instrument in a sealed container and mark the container “FRAGILE”.
- 5 On the shipping label, write ATTENTION REPAIR DEPARTMENT and the service order number (if known).

NOTE

If any correspondence is required, refer to the product by model number and serial number.

Electrostatic Discharge

Electrostatic discharge (ESD) can damage or destroy electronic components. All work on electronic assemblies should be performed at a static-safe work station. The following figure shows an example of a static-safe work station using two types of ESD protection. Purchase acceptable ESD accessories from your local supplier.

- Conductive table-mat and wrist-strap combination.
- Conductive floor-mat and heel-strap combination.

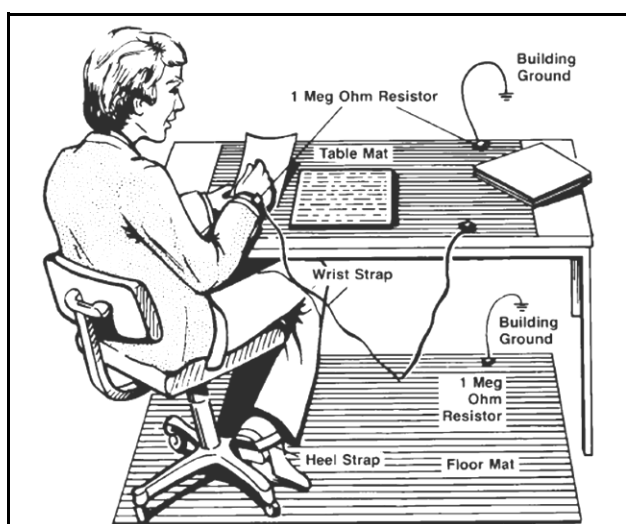

Both methods, when used together, provide a significant level of ESD protection. Of the two, only the table-mat and wrist-strap combination provides adequate ESD protection when used alone. To ensure user safety, the static-safe accessories must provide at least 1 M Ω of isolation from ground.

Switch Settings

Serial port switch settings

One PC-compatible serial RS-232, RJ45 port is provided on the front panel with DIP switches SWX1 and SWX2 used to set COM function to either the RS-232 mode or the IPMC debug mode. A complete set of handshaking and modem control signals are supported, with data transfer rates up to 115.2 kB/sec. The front panel RJ45 COM connector CN14 pin-assignment and DIP switch settings are listed below.

Pin #	Signal	Function
1	DCD#	Data Carrier Detect
2	RTS#	Request to Send
3	DSR#	Data Set Ready
4	TXD	Transmit Data
5	RXD	Receive Data
6	GND	Ground
7	CTS#	Clear to Send
8	DTR#	Data Terminal Ready

COM mode switch settings (SWX1 and SWX2)

Mode	Switch	Pin 1	Pin 2	Pin 3	Pin 4
RS-232 (default)	SWX1	On	On	Off	Off
	SWX2	On	Off	N/A	
IPMC debug port	SWX1	Off	Off	On	On
	SWX2	Off	On	N/A	

Refer to Figure 30 for SWX1 switch location. You must remove the memory module cover to gain access to SWX1.

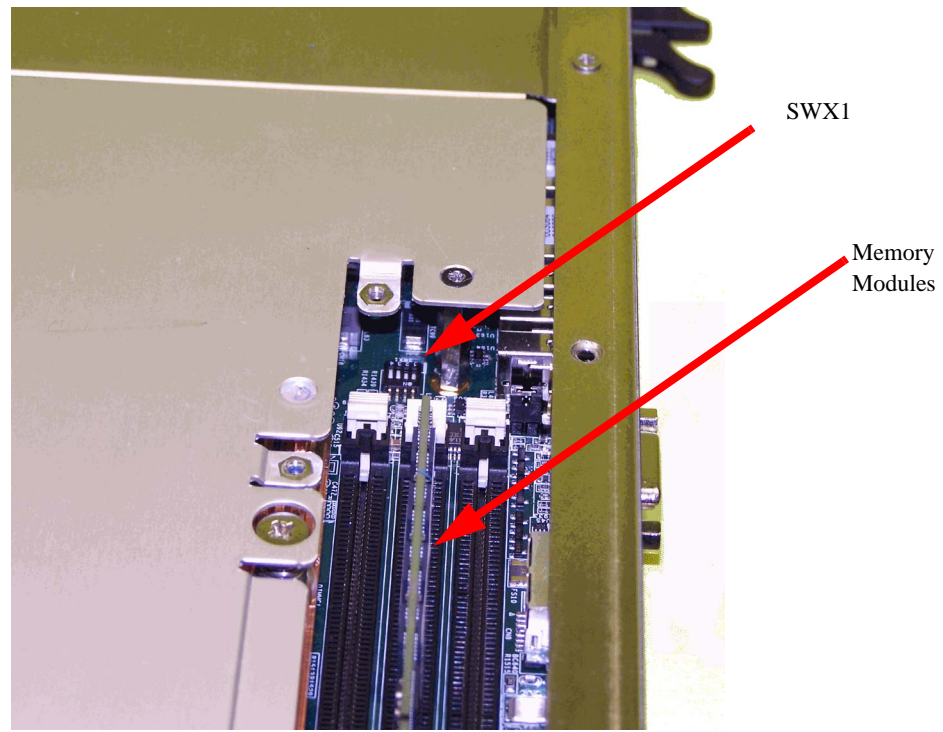

Figure 30 SWX1 Switch Location (cover has been removed)

Figure 31 shows the location for switch SWX2. You do not need to remove any cover to gain access to the switch. The SSD cover is shown removed for clarity.

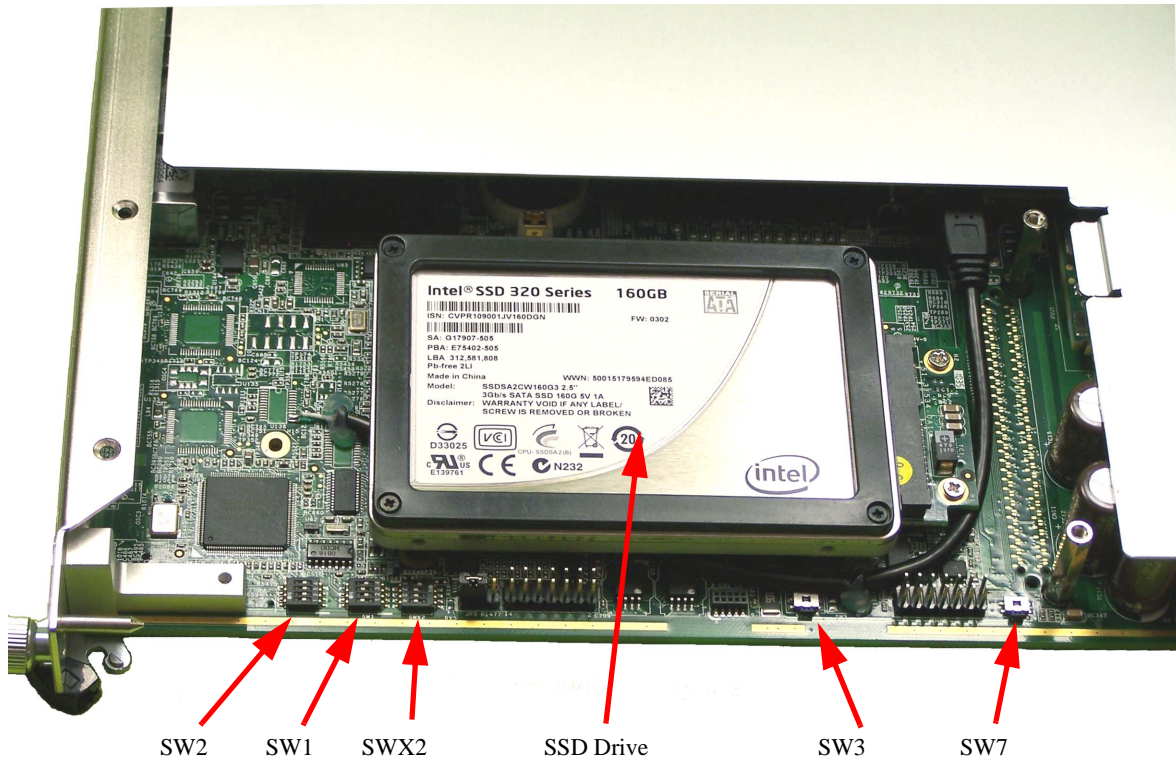

Figure 31 Switch Locations (cover has been removed)

When the switch SWX2 is set to IPMC debug port, the pin assignment of the RJ45 connector is as listed in the following table.

Pin #	Signal	Function
1	NC	Not connected
2	NC	Not connected
3	NC	Not connected
4	DBG_TX	IPMC Transmit Data
5	DBG_RX	IPMC Receive Data
6	GND	Ground
7	NC	Not connected
8	NC	Not connected

Other switch settings

Refer to [Figure 31](#) on page 60 for switch locations. Switch SW1 is for Blade Operation Mode Control and PICMG 3.1 Option Control. Switch SW2 is for debugging purposes. For normal operation, leave the switches in their default settings.

SW1 - Blade Operation Mode Control Normal operation requires a shelf manager for the blade to boot. Standalone mode allows the blade to boot without a shelf manager.

Options	Switch 1	Switch 2
Normal mode (default)	On	Off
Standalone mode	Off	On

SW1 - PICMG 3.1 Option Control

Options	Switch 3	Switch 4
PICMG 3.1 Opt. 1	Off	Off
PICMG 3.1 Opt. 9 (default)	On	Off

SW2 - Debug use only Do not change the position of these switches.

SW2	Switch 1	Switch 2	Switch 3	Switch 4
Default Setting	Off	Off	Off	Off

- Switch 1: On for FWE pin protection; Off for Normal operation
- Switch 2: On for Slave SPI; Off for Master SPI

IPMC Mode Select:

- Switch 3: On for Program mode; Off for Normal operation
- Switch 4: On for Program Mode; Off for Normal operation

SW3 - Factory use only SW3 is a momentary contact switch used for factory testing. Do not depress this switch.

SW7 - Clear CMOS SW7 is a momentary contact switch and is provided to clear the CMOS memory and reset the BIOS values to default. Remove the M9536A from the chassis to press the switch. During reboot, the CMOS settings and date/time will show an error; press the F2 key to restore defaults.

Removing the Top Cover

Although you should never need to remove the top cover, it is important to understand that 14 mounting screws must be removed. Nine of the mounting screws are metal. Five of the mounting screws are nylon and a shield is underneath the top cover to prevent it from touching the processor heat sink. Refer to [Figure 32](#). The shield is permanently adhered to the top cover.

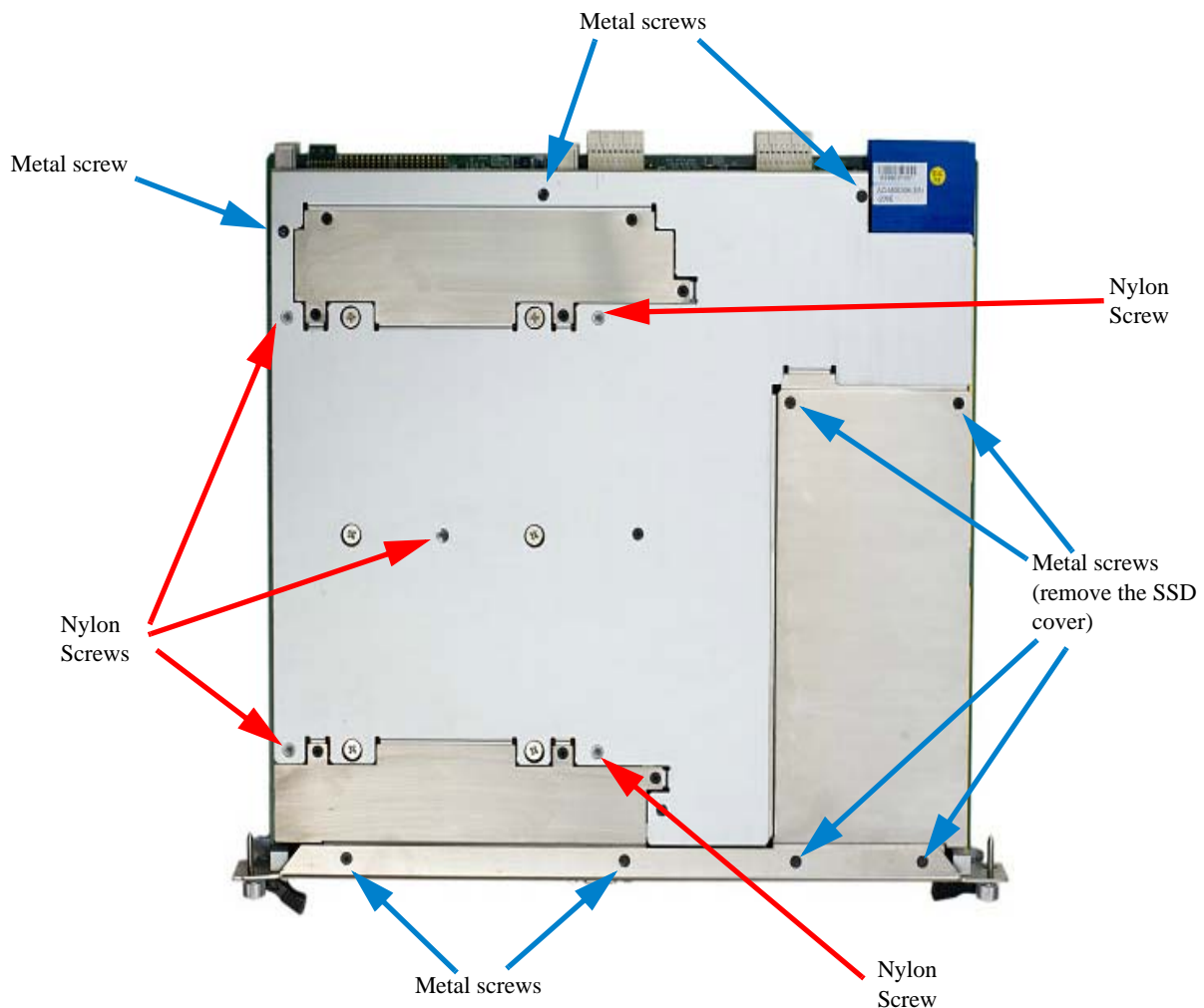

Figure 32 Top Cover Screws. Use a #1 Phillips screwdriver to remove and replace screws.

CAUTION

To avoid damage to the M9536A module, the nylon screws must never be replaced with metal screws. Use only the screws supplied with the module.

Battery Backup

The M9536A is provided with a 3.0 V “coin cell” lithium battery. To replace the battery, proceed as follows:

CAUTION Always observe ESD precautions. See “[Electrostatic Discharge](#)” on page 57.

- 1 Turn off the AXIe Chassis and remove the power cord.
- 2 Remove the M9536A Embedded Controller from the AXIe chassis. Observe all anti-static precautions.

NOTE Replacing the battery is easiest if you remove the SSD first. For instructions on removing the SSD, refer to “[Replacing the SSD](#)” on page 68.

- 3 Remove the SSD cover from the M9536A as shown in Figure 33

Remove these four screws to remove cover

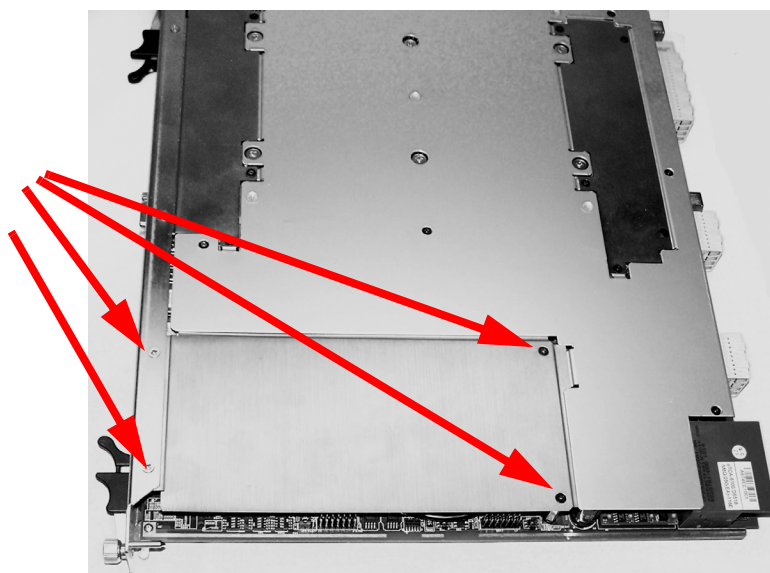

Figure 33 Remove the covers as indicated. Use a #1 Phillips screwdriver.

- 4 (Optional step) Remove the SSD. Instructions for removing the SSD are found in “[Replacing the SSD](#)” on page 68.
- 5 Remove the battery (see Figure 34 below). Press the battery release latch (1). The battery should pop out (2).

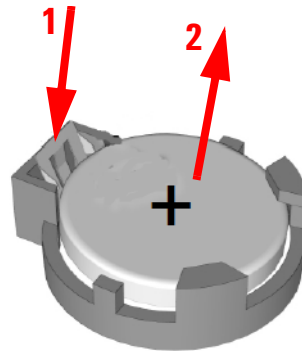

Figure 34 Replacing the Battery

- 6 Place the new battery in the socket. Make sure that you correctly orient the battery for installation. The positive pole (+) must be on the top. You may find it helpful to angle the battery in and pull back on the battery release latch.

NOTE

Replace the lithium battery with an identical battery (CR2032 or equivalent).

- 7 Replace the SSD and the cover.
- 8 Install the embedded controller back in the AXIe chassis and apply power.

NOTE

The battery's operational temperature range is less than that of the M9536A's storage temperature range. For exact range information, refer to the battery manufacturer's specifications.

NOTE

Ensure that the battery is correctly replaced. Replace the battery only with an identical type (CR2032 or equivalent). Dispose of used batteries according to the manufacturer's instructions. Typical battery life varies considerably and depends on operating temperature and standby (shutdown) time of the system. Typical life expectancy of a 225mAh battery is 4 to 5 years with an average on-time of 8 hours per working day at an operating temperature of 30°C. To ensure that the lifetime of the battery has not been exceeded, you should change the battery after 3 to 4 years of service.

- 9 During reboot, the CMOS settings and date/time will show an error; press the F2 key to restore defaults.

Installing Additional Memory

The M9536A has three 240-pin, RDIMM sockets* which support DDR3-1333 REG/ECC RAM sticks. Each socket can support memory modules up to 8GB for a total memory capacity of 24GB. The standard M9536A configuration is a single 8GB memory stick with a factory option to add a second 8GB memory stick. This leaves an empty socket for future expansion. Memory modules larger than 8GB are not supported.

To change or add additional memory, perform the following steps:

CAUTION

Always observe ESD precautions. See “[Electrostatic Discharge](#)” on page 57.

- 1 Power off the AXIe chassis. Remove the ac power cord from the back of the chassis.
- 2 Remove the M9536A controller from the AXIe chassis.
- 3 Position the controller, top side up on the workbench. Remove the four screws and panel as indicated in Figure 35.

Remove these
five screws to
remove cover

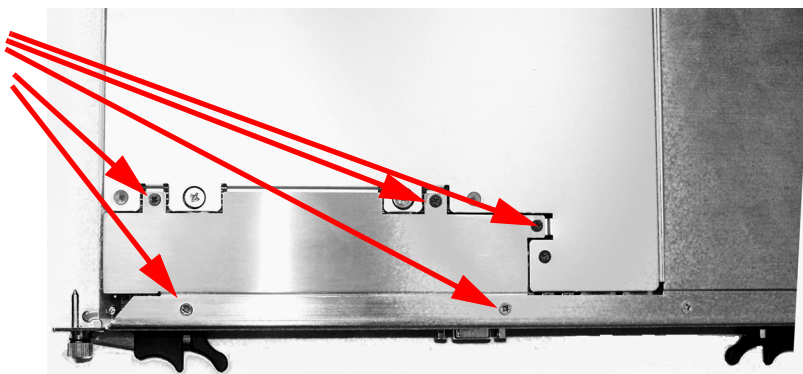

Figure 35 M9536A Disassembly for adding memory. Use a #1 Phillips screwdriver to remove and replace screws.

There are three memory sockets on the motherboard. Figure 36 shows the default and possible arrangements of memory modules in the three sockets.

* Actually, there are six memory sockets installed on the PC board. The back three are for a second processor which is not supported on the M9536A.

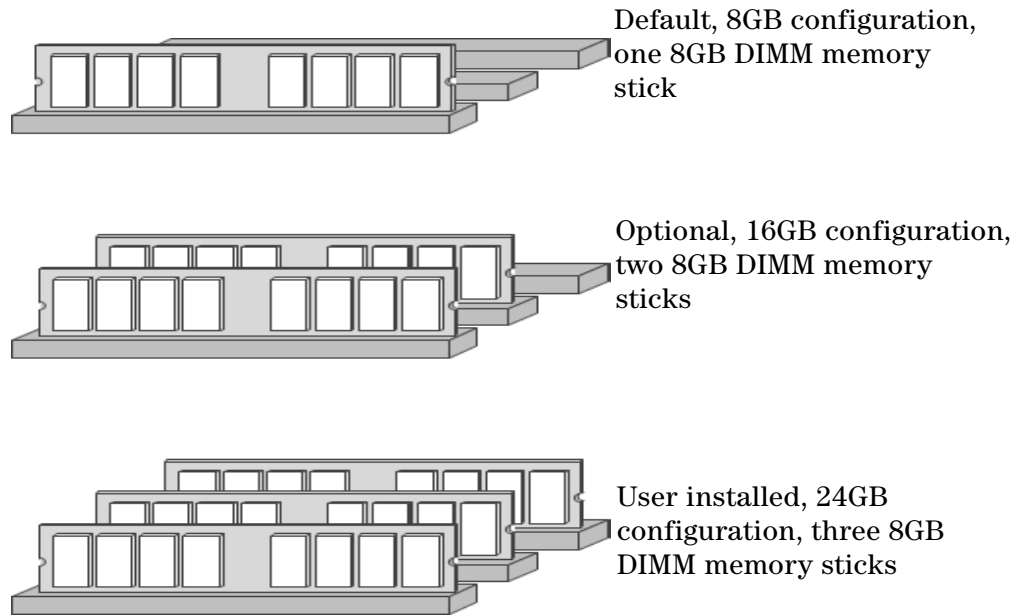

Figure 36 DIMM Module Configurations

To remove memory modules:

- Press down on the module locks on each side of the memory socket. This releases the memory cards from their sockets. Pull out the memory card and set it aside on an anti static container.

To install new memory DIMM modules:

- 1 The DDR DIMM memory has only one notch on the center of the module. The module will only fit with the correct orientation. Align the off-center notch with the key in the middle of the socket. Slide the new memory card in the locks and press firmly until the locks come up and lock into place. You should hear a distinctive click. Refer to the following figure.

1. Insert the DIMM memory module vertically into the socket. Then gently push it in.

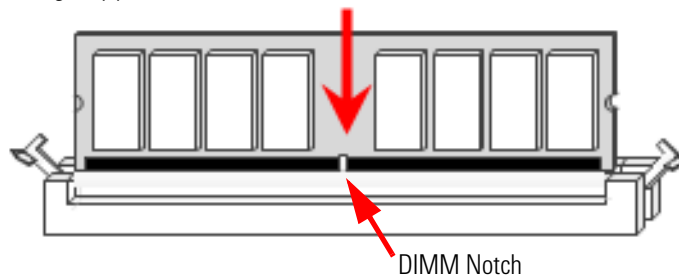

2. The plastic locks at each end of the DIM socket will automatically close.

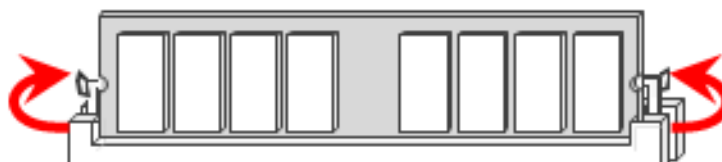

Figure 37 Installing the DIMM Modules

- 2 Replace the cover panel and four screws (Figure 35).
- 3 Replace the AXIe controller in the AXIe chassis and power on the chassis. You can verify the amount of memory in the controller by:
 - a Locate the **Computer** icon on your monitor.
 - b Right click the icon and select **Properties** from the menu.
 - c Under the **System** heading, look for **Installed Memory (RAM)**.

Replacing the SSD

The Agilent M9536A Embedded controller comes with a 160 GB, 2.5” Serial ATA (SATA) II SSD drive.

Determining the Operating System

- 1 Look for identification label on the SSD to determine which operating system to order for replacement. Replacement SSD drives with installed operating systems are available from Agilent with the following part numbers:
 - M9536-55732 Replacement SSD with pre-imaged Win7 32-bit OS.
 - M9536-55764 Replacement SSD with pre-imaged Win7 64-bit OS.
- 2 If there is no identification label on the SSD, look for the option label (near the serial number label) to determine the operating system. Possible options are:

Option Label	Operating System/RAM	Order Agilent Part Number	Description
M08 W73	Windows 7 Pro (32-bit), 8GB RAM	M9536-55732	Replacement SSD with pre-imaged Win7 32-bit OS
M16 W73	Windows 7 Pro (32-bit), 16GB RAM	M9536-55732	Replacement SSD with pre-imaged Win7 32-bit OS
M08 W76	Windows 7 Pro (64-bit), 8GB RAM	M9536-55764	Replacement SSD with pre-imaged Win7 64-bit OS
M16 W76	Windows 7 Pro (64-bit), 16GB RAM	M9536-55764	Replacement SSD with pre-imaged Win7 64-bit OS

Replacement Procedure

To replace the SSD, perform the following steps:

CAUTION

BACK UP YOUR SSD BEFORE PROCEEDING! There are several ways to transfer files from your old drive to the new one. One possible way of doing this is with disk-imaging software. A disk image is an exact duplicate of your existing SSD including the operating systems, user settings, all data files and application software. The imaging software should also create an “emergency” bootable CD or USB drive.

CAUTION

Always observe ESD precautions. See “[Electrostatic Discharge](#)” on page 57.

The replacement SSD must conform to the same dimensions and mounting as the original: 2.75” (69.85mm) wide by 0.37” (9.5mm) high by 3.9” (100.35mm) deep.

- 1 Power off the AXIe chassis.
- 2 Remove the M9536A controller from the AXIe chassis.
- 3 Position the controller, top side up on the workbench. With a #1 Phillips screwdriver, remove the four screws and panel indicated in Figure 38.

Remove these
four screws to
remove cover

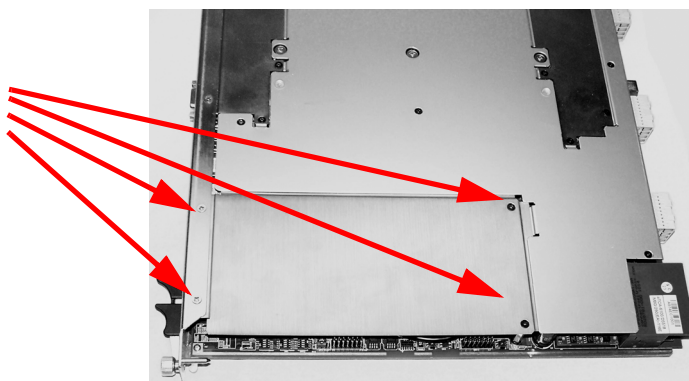

Figure 38 Removing the top-side cover to replace the SSD.

- 4 Carefully, turn the controller over. Remove the four SSD screws as indicated in Figure 39. Be very careful as removing these screws releases the SSD.

Remove these
four screws to
release SSD

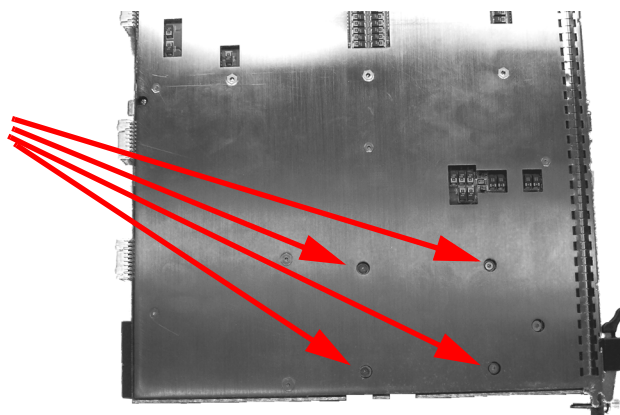

Figure 39 Removing the SSD Mounting Screws

- 5 Supporting the drive from below, carefully turn the controller back over. Gently lift the back end of the SSD drive and slide it out of its socket.
- 6 Remove the four standoffs from the old SSD drive. Install the standoffs onto the new SSD. See Figure 40.

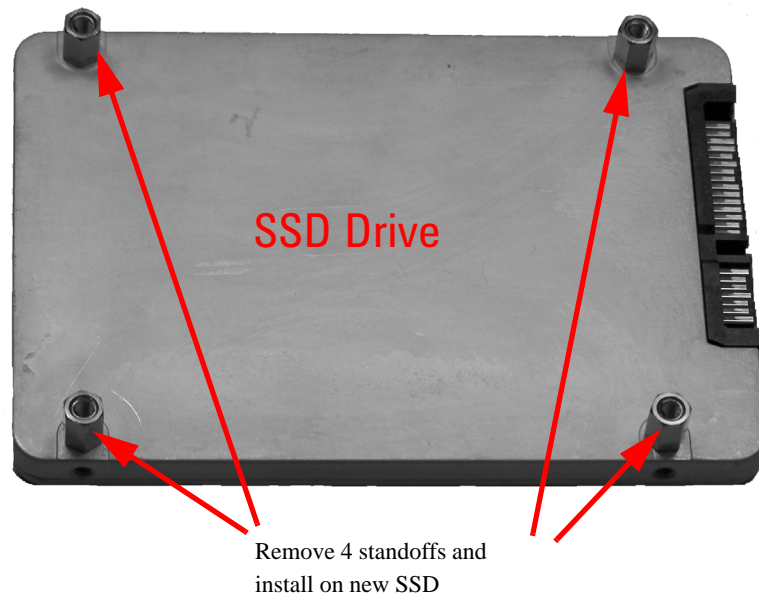

Figure 40 SSD Standoffs

- 7 To replace the SSD, reverse the preceding steps. Angle the new SSD and carefully slide the SSD into the empty socket.

CAUTION

If you feel resistance as you install the new SSD, do not force it. You may have the drive upside down. Damaging the signal pins may render the drive useless.

- 8 Replace the cover and install the controller in your AXIe chassis
- 9 When you power up the chassis, the controller BIOS should automatically detect the new SSD. If you created the disk image on the new SSD, the controller should boot normally and be ready to operate. If you created the image on an external drive, you will need to boot from the emergency CD or USB stick and then use the disk imaging software to transfer the operating system, user settings, application software, data files, etc. to the new SSD.

Memory Declassification

Some test equipment users have a need to “declassify” or “sanitize” their instruments for security purposes. This involves following a procedure to clear all user data from the instrument’s memory. The result is a sanitized instrument that can be removed from a secure area without any chance of classified data being recovered from it. Follow the procedure below to ensure that your controller no longer contains any user configurations or data.

Procedure for declassifying a faulty controller

Even if the M9536A is not able to power on, it may be declassified by removing the SSD (disk drive) from the controller. Follow the procedure “[Replacing the SSD](#)” on page 68.

For additional information, go to: <http://www.agilent.com/find/security> and enter the model number of you controller (M9536A).

Controller memory

The following table lists the types of memory used in the M9536A controller. It explains the memory size, how it is used, its location, volatility, and the sanitization procedure.

Memory type and size	Writable during normal operation?	Data retained when powered off?	Purpose/ contents	Data input method	Location in controller	Sanitization procedure
Main memory (RAM) 8GB or 16GB Std. User may install additional 8GB	Yes	No	Windows Operating System memory	Operating system, user	Mother board	Cycle power. This is volatile memory.
Media Storage 160GB SSD drive	Yes	Yes	Windows Operating System boot device and user files including saved programs, data, settings, images, etc.	Operating System factory installed. Other data is user-saved.	Motherboard	Remove. See instructions below.
8Mbit flash memory for BIOS (Non-volatile memory)	No	Yes	Contains default BIOS settings for use when booting the controller. Contains no user data.	Programmed at factory (or during BIOS upgrade). Settings may be toggled by user.	Motherboard	None
DDR2-533 64MB memory	Nos	No	Video RAM	Controller Video graphics only.	Motherboard	Cycle power. This is volatile memory.

SSD Removal Because it is virtually impossible to completely and selectively erase all user data on a SSD without also destroying the operating system, the best method for maintaining security when the controller must be removed from a secure area is to remove or replace the SSD.

- 1 Turn the AXIe chassis off.
- 2 Remove the controller from the AXIe chassis.
- 3 Remove the SSD drive. For instructions on removing the SSD drive, refer to [“Replacing the SSD”](#) on page 68.

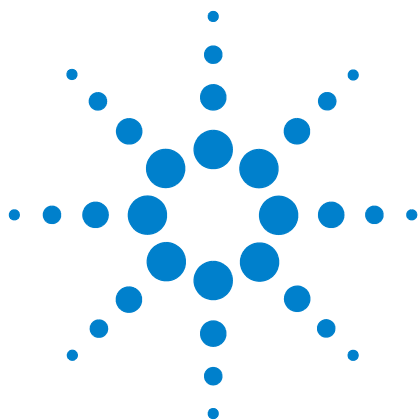

Glossary

Many of the terms in this manual and glossary are AXIe, ATCA or PICMG specific. Refer to the relevant specifications for more detail on these terms.

aDB-6100AX Apple Desktop Bus (ADB) is an obsolete bit-serial computer bus for connecting low-speed devices (mouse, keyboard, etc.) to a computer.

ATCA Advanced Telecommunication Computing Architecture (also known as AdvancedTCA) is a PCI Industrial Computing Manufacturers Group (PICMG) specification. See AXIe below.

AXIe AdvancedTCA eXtensions for Instrumentation is a platform for general purpose modular instrumentation. It is an open industry standard aimed at test equipment and instrumentation. It builds on the experience of VXIbus, PXI and LXI technologies.

Base Channel Supports a 10/100/1000 Base-T LAN port on the backplane of the AXIe shelf.

BMC Baseboard Management Controller

BMR-H8S Board Management Reference design for AdvancedTCA

ESD Electrostatic Discharge. See “[Electrostatic Discharge](#)” on page 57

FRU Field Replaceable Unit. A unit (such as a module or power supply) that the user can replace in the field. Many FRUs are not hot swappable.

GbE Gigabit Ethernet. Ethernet at a rate of 1 gigabit per second.

HPM Hardware Platform Management. PICMG specification that defines an open mechanism to upgrade the resident management software and firmware.

IPMB Intelligent Platform Management Bus. Based on the I²C (also known as Inter IC, IIC or I2C) bus, the IPMB interface provide communication between components on a PC chassis; it is an internal chassis bus that also connects to the external chassis through a bridge chip.



IPMC Intelligent Platform Management Interface. It is used to monitor system health and manage the computer system.

IPMI Intelligent Platform Management Interface.

KCS Keyboard Controller Style.

LPC Low Pin count. An interface specification for legacy I/O. Allows legacy I/O of motherboard components, such a Super I/O chip, to migrate from the ISA/X bus to the new LPC interface while retaining software compatibility. It runs at the PCI 33MHz clock making LPC much faster than the older ISA running with an 8MHz clock.

PCI Peripheral Component Interface bus. A standard for connecting hardware in a computer.

PCI-E PCI Express. Peripheral Component Interface Express (or PCIe) A standard to replace PCI.

PICMG PCI Industrial Computer Manufacturers Group. PICMG is a consortium of hundreds of companies that develop open specifications for high performance telecommunications and industrial computing applications.

SATA Serial ATA or Serial Advanced Technology Attachment. A computer bus interface for connecting host adapters to mass storage devices (hard drives, etc.) This standard is also known as EIDE.

SerDes Serializer/Deserializer. Two blocks used in high speed communications to compensate for limited throughput. They convert data between serial and parallel interfaces.

Super I/O A class of ICs that combines interfaces for a variety of low-bandwidth devices such as serial ports, keyboard and mouse, temperature and fan speed monitoring, etc.

TPM Trusted Platform Module. An IC designed by the Trusted Computing Group (TCG) for storing passwords, encryption keys, digital certificates, etc.

UXGA Abbreviation for Ultra eXtended Graphics Array referring to a standard monitor resolution of 1600×1200 pixels.

Index

A

Advanced menu, 42
Agilent Connection Expert, 18
Agilent Recovery System, 17, 27
AHCI configuration, 44

B

Backup Battery, 7
Backup, user data, 26
Base fabric channel LED, 3
Battery, backup, 7, 63
BIOS
 Advanced menu, 42
 Boot menu, 46
 Chipset menu, 50
 Exit menu, 51
 Main menu, 41
 Password, 48
 PCI/PNP menu, 45
 Security menu, 48
 Setup menu, 37
 Setup Utility menu, 39
 Starting, 37
Block Diagram, 4
Boot menu, 46

C

Change Supervisor Password, 49
Change User Password, 49
Chassis shutdown, 33
Chipset, 5
Chipset menu, 50
Clear CMOS, 37, 61
Clear User Password, 49
CMOS backup battery, 63
CMOS, clear, 37, 61
COM Port, 58
Configuration
 AHCI, 44
 CPU bridge, 50
 Hardware health, 43
 North bridge, 50
 South bridge, 51
 Super IO, 43
 USB, 44
Configuration, CPU, 42
Connection Expert, Agilent, 18
Controller Startup, 16
Controller, ES1000 Graphics, 6
Counter/Timer, 7
CPU, 5
CPU bridge configuration, 50
CPU configuration, 42

D

Date, System, 41
Declassification, memory, 71
Diagram, block, 4
Display resolution, 9

E

Electrostatic Discharge, 57
ES1000 Graphics Controller, 6
ESD, 57
Ethernet, 9
Exit menu, 51

F

Fabric, base channel fabric, 3
Failsafe defaults, 53
Front Panel, 2
Functional Description, 4

G

Gigabit Ethernet, 9
Gigabit Ethernet LEDs, 3
Graphics, controller, 6

H

Hard Drive, 1
Hard drive, 26, 68
Hard Drive LED, 2
Hard drive, replace, 68
Hardware health configuration, 43
Hardware Prefetcher, 42
HDD, 1
Hotkey, 40

I

I/O interfaces, 8
IDE Configuration, 43
Installing Memory, 65
IO Libraries, 18

K

Keyboard (sleep mode), 33

L

LEDs, 2
 Base channel fabric, 3

Gigabit Ethernet, 3
Hard Drive, 2
OOS, 2
Licenses, Software application, 35
Load failsafe defaults, 53

M

Main menu, BIOS, 41
Memory, 1, 5
Memory Declassification, 71
Memory, installing, 65
Mode, sleep, 33

N

North bridge configuration, 50

O

OOS LED, 2
Out of Service LED, 2

P

Panel, front, 2
Password, 48
 Change user, 49
 Supervisor, 49
 User, 49
PCI/PnP menu, 45
Peripherals, 7
 timer, 7
POST, 16
Power on, 16
Prefetcher, hardware, 42

R

RAM, 1
Real-Time Clock, 7
Registry, Windows®, 34
Repair disc, 27
Replace battery, 63
Replace the Hard Drive, 68
Reset, 7
Resolution, video display, 9

S

safety information, iv
Security menu, 48
Security, Windows, 26
Serial Port, 9
Serial port, 57

- Setup, BIOS, 39
- Shutdown, chassis, 33
- Sleep mode, 33
- SMBus, 7
- Software application licenses, 35
- South bridge configuration, 51
- SSD, 1
- SSD, replace, 68
- Starting BIOS, 37
- Startup, 16
- Super IO Configuration, 43
- Supervisor
 - Password, change, 49
- Supervisor Password, 49
- Switch
 - settings, 58, 61
- System
 - Date, 41
 - Time, 41

T

- Time, System, 41

U

- USB, 8
- USB configuration, 44
- USB Keyboard (sleep mode), 33
- User data backup, 26
- User Password, 49
- UXGA, 9

V

- VGA, 9
- video, 9
- Video display resolution, 9

W

- Waste Electrical and Electronic
 - Equipment (WEEE) Directive, v
- Windows security, 26
- Windows Security Center, 26
- Windows® Registry, 34

X

- Xeon processor, 5

© Agilent Technologies, Inc. 2011, 2012, 2014
Printed in Malaysia
Edition 6 May 2014

