

Agilent MOI for HDMI 1.4b Cable Assembly Test

Revision 1.12

24-Apr 2013



**Agilent Method of Implementation (MOI) for HDMI 1.4b
Cable Assembly Test Using Agilent E5071C ENA Option
TDR**

Agilent MOI for HDMI 1.4b Cable Assembly Test

Table of Contents

1.	Modification Record.....	4
2.	Purpose	4
3.	References	4
4.	Resource Requirements	5
5.	Test Procedure	6
5.1.	Outline of Test Procedure	6
5.2.	Instrument Setup.....	7
5.2.1.	Recalling State File.....	7
5.2.2.	Running VBA macro program.....	8
5.3.	Screen Area and Cable Connection	10
5.4.	Calibration and Adjustment	13
5.4.1.	Time Domain Calibration	13
5.4.2.	Measure DUT Length	15
5.4.3.	Frequency Domain Calibration	16
5.4.4.	Perform Auto Port Extension.....	16
5.5.	Measurement and Data Analysis	17
5.5.1.	Data Eye Diagram	17
5.5.2.	Intra-Pair Skew	24
5.5.3.	Inter-Pair Skew	26
5.5.4.	Far End Crosstalk	28
5.5.5.	Attenuation and Phase	30
5.5.6.	Differential Impedance	34
6.	Appendix	37
6.1.	Manual Setup for Time Domain Measurement	37
6.1.1.	Starting Setup	37
6.1.2.	Eye Diagram	37
6.1.3.	Intra-Pair Skew	38

Agilent MOI for HDMI 1.4b Cable Assembly Test

6.1.4.	Inter-Pair Skew	40
6.1.5.	Differential Impedance	40
6.2.	Manual Setup for Frequency Domain Measurement.....	43
6.2.1.	Channel and Trace Settings	43
6.2.2.	Attenuation	44
6.2.3.	Phase.....	44
6.2.4.	Far End Crosstalk	45
6.2.5.	Expand Phase.....	45
6.3.	Limit Test Settings	45
6.3.1.	Turning On/Off Fail Sign	45
6.3.2.	Setting the Warning Beeper	46
6.3.3.	Defining the Limit Line.....	46

Agilent MOI for HDMI 1.4b Cable Assembly Test

1. Modification Record

Revision	Comments	Issue Date
1.00	Initial release	Jun 01, 2011
1.01	Minor modification for errata	Jul 13, 2011
1.10	Added Data Eye Diagram	Jan 16, 2012
1.11	Updated Resource Requirements on N1080B HDMI fixtures	Jul 19, 2012
1.12	Minor modifications	Apr 24, 2013

2. Purpose

This document is intended to provide the measurement procedures for High-Definition Multimedia Interface (HDMI) cable assemblies with Agilent E5071C ENA Option TDR. The procedures are designed to perform tests equivalent to the methodologies defined in the HDMI Compliance Test Specification Version 1.4b (CTS). Devices under test are supposed to be passive HDMI cables. Active cables are out of the scope of this document.

3. References

High-Definition Multimedia Interface Specification Version 1.4b

High-Definition Multimedia Interface Compliance Test Specification Version 1.4b

Agilent MOI for HDMI 1.4b Cable Assembly Test

4. Resource Requirements

1. E5071C ENA Series Network Analyzer with Enhanced Time Domain Analysis Option

Note: Ensure that

- Test set option is any one of 480/485/4D5/4K5
- E5071C firmware revision A.10.05 or above is installed.
- E5071C-TDR application software revision A.01.50 or above is installed.

2. Electronic Calibration Module N4431B (for 480/485) or N4433A (for 4D5/4K5)

3. 3.5 mm cables 8 GHz bandwidth or equivalent x4

4. Certified HDMI receptacle fixtures (ex. Agilent N1080B-H05) x2

5. Certified HDMI plug fixtures (ex. Agilent N1080B-H04) x1

Note: The plug fixture is used for the jitter adjustment in the eye diagram test. It should have similar characteristics to the receptacle fixtures.

6. 50 Ohm terminators to terminate unused fixture connectors x12

7. Female to female adaptors to connect fixture and test cables (if necessary)

Agilent MOI for HDMI 1.4b Cable Assembly Test

5. Test Procedure

5.1. Outline of Test Procedure

1. Instrument Setup

2. Calibration and Adjustment

- Time domain calibration with the setup wizard in TDR application software
- Frequency domain calibration with the VBA macro program

3. Measurements and Data Analysis

Time Domain Measurements

- Data Eye Diagram
- Intra-pair Skew Measurements
- Inter-pair Skew Measurements
- Differential Impedance Measurements

Frequency Domain Measurements

- Far End Crosstalk Measurements
- Attenuation and Phase Measurements

*Note: Hard Keys (Keys located on the Front panel of E5071C) are displayed in **Blue color and Bold**. (Example: **Avg, Analysis**)*

*Note: Soft keys (Keys on the screen) are displayed in **Bold**. (Example: **S11, Real, Transform**)*

*Note: Buttons (in the TDR or VBA) are displayed in **Green color and Bold**. (Example: **Trace, Rise Time**)*

*Note: Tabs (in the TDR) are displayed in **Brown color and Bold**. (Example: **Setup, Trace Control**)*

Agilent MOI for HDMI 1.4b Cable Assembly Test

5.2. Instrument Setup

This section describes procedures for recalling the state file and VBA macro that support the instrument setup. Download “HDMI cable assembly test package” from http://www.agilent.com/find/ena-tdr_hdmi-cabcon.

Extract the zip file and transfer the extracted files to the instrument with a USB flash memory.

5.2.1. Recalling State File

1. If TDR setup wizard appears, click **Close** button on the wizard.
2. Open **Setup** tab (item1).
3. Click **More Function** (item2).
4. Click **Advanced Mode** (item3).

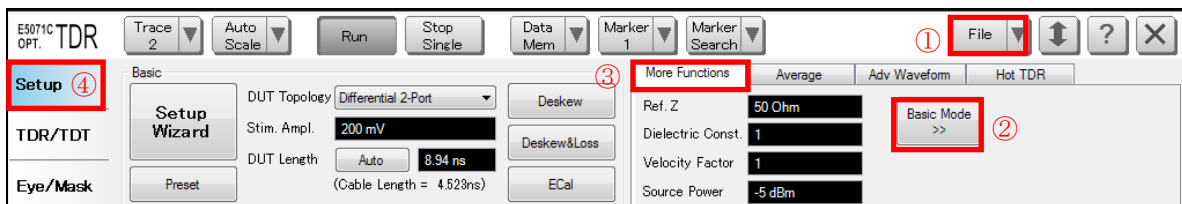

5. A dialog box appears requesting for confirmation. Then click **Yes**. (Clear the check box for “Use Advanced Calibration Methods”)

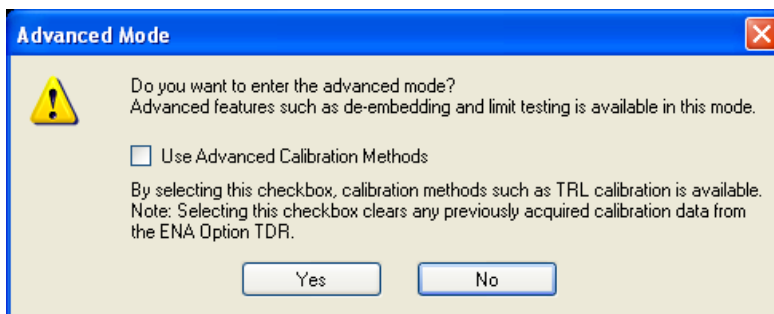

6. Click **File** (item4) and select **Recall State** to open the Recall State dialog box.
7. Specify a folder and a file name, and click **Open**.

For manual measurement setup, refer to 6 Appendix.

Agilent MOI for HDMI 1.4b Cable Assembly Test

5.2.2. Running VBA macro program

1. Installing the VBA macro program

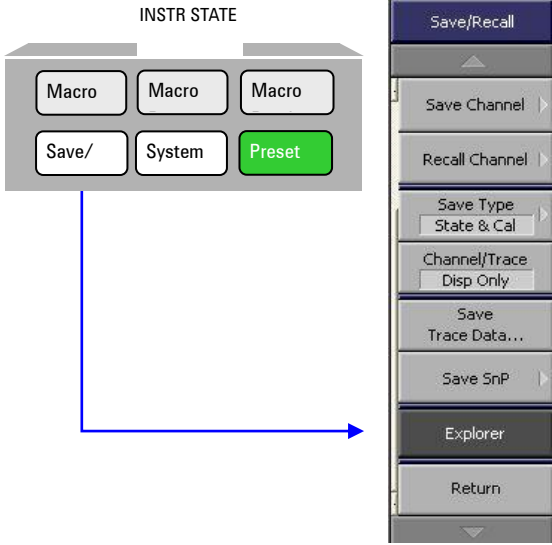

Obtain the VBA macro program from Agilent and install it on the E5071C.

- Press **Save/Recall** on the front panel, then press the **Explorer** soft key.
- Using **Explorer**, copy the file to the “D:¥VBA” folder.

Agilent MOI for HDMI 1.4b Cable Assembly Test

2. Running the VBA macro program

The diagram illustrates the process of running a VBA macro program on an Agilent instrument. It shows the front panel buttons, the Macro Setup menu, and the Load & Run soft key menu.

Front Panel Buttons: INSTR STATE, Macro Setup, Macro Run, Macro Break, Save/Recall, System, Preset.

Macro Setup Menu: Macro Setup, VBA Editor, New Project, Load Project..., Load & Run, Save Project..., Close Editor, Select Macro, Stop.

Load & Run Soft Key Menu: Load & Run, HDMI_Cable, Return.

- Press **Macro Setup** button from the front panel, then click the **Load & Run** soft key.
- Select “HDMI1.4a_Cab...” from the soft key menu and click on it.

Agilent MOI for HDMI 1.4b Cable Assembly Test

5.3. Screen Area and Cable Connection

This section explains the screen area of ENA Option TDR and the test cable connections. ENA Option TDR screen area consists of two channels as shown in Figure 5-1. Channel1 dedicated to time domain measurements is controlled by the TDR application software located at the bottom of the screen, and Channel2 dedicated to frequency domain measurements is controlled by the VBA macro program located at the upper right of the screen.

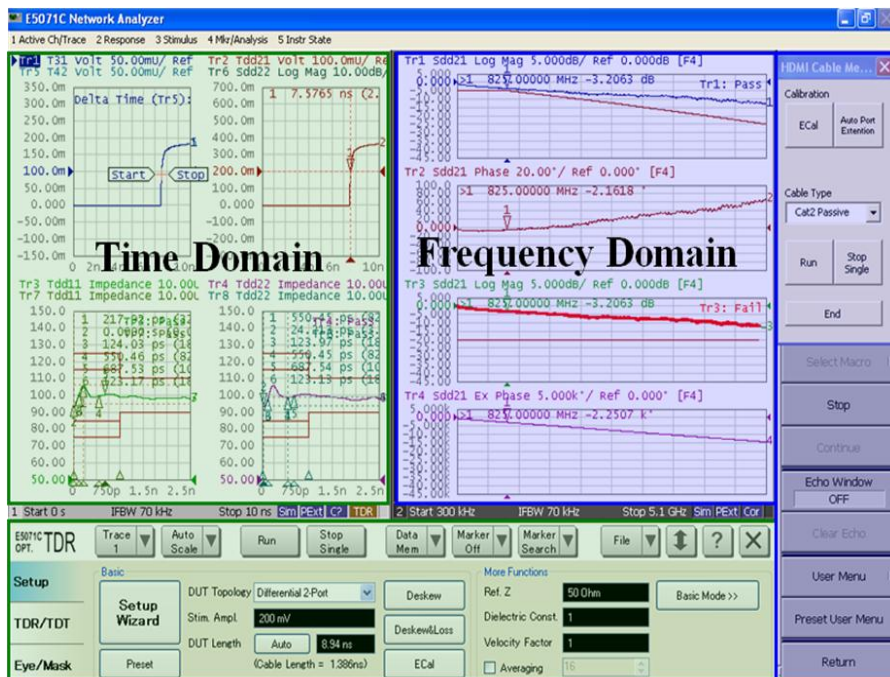

Figure 5-1 Screen area of ENA Option TDR

Agilent MOI for HDMI 1.4b Cable Assembly Test

The cables and fixtures are connected to the instrument as shown in Figure 5-2, but do not connect fixtures and Cable DUT yet.

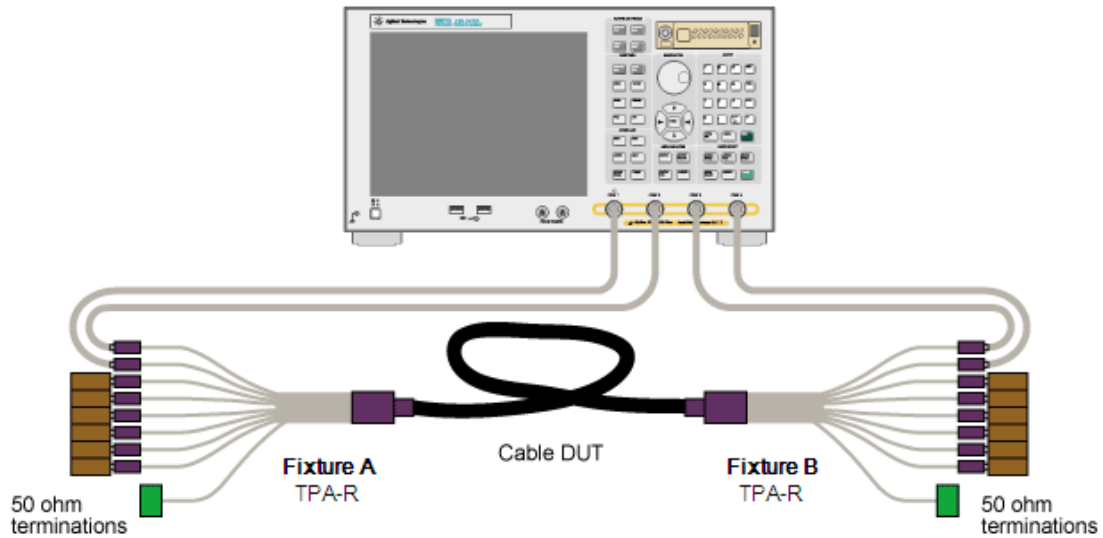

Figure 5-2 Measurement setup example

Table 5-1 and Figure 5-3 show the cable connections and corresponding measurement areas on the screen, respectively. The measurement items of the same background color can be measured with the same cable connections.

Agilent MOI for HDMI 1.4b Cable Assembly Test

Table 5-1 Cable and Fixture Connection

ENA Port Number		Port1	Port2	Port3	Port4	
Fixture PIN Number	Data Eye Diagram	A D0+	A D0-	B D0+	B D0-	
	Intra-Pair Skew	A D1+	A D1-	B D1+	B D1-	
	Inter-Pair Skew	A D2+	A D2-	B D2+	B D2-	
	Attenuation and Phase	A CLK+	A CLK-	B CLK+	B CLK-	
	Differential Impedance					
	Far End Crosstalk		A D0+	A D0-	B D1+	B D1-
			A D0+	A D0-	B D2+	B D2-
			A D0+	A D0-	B CLK+	B CLK-
			A D1+	A D1-	B D2+	B D2-
			A D1+	A D1-	B CLK+	B CLK-
			A D2+	A D2-	B CLK+	B CLK-

Note: A and B represent each one of the test fixtures.

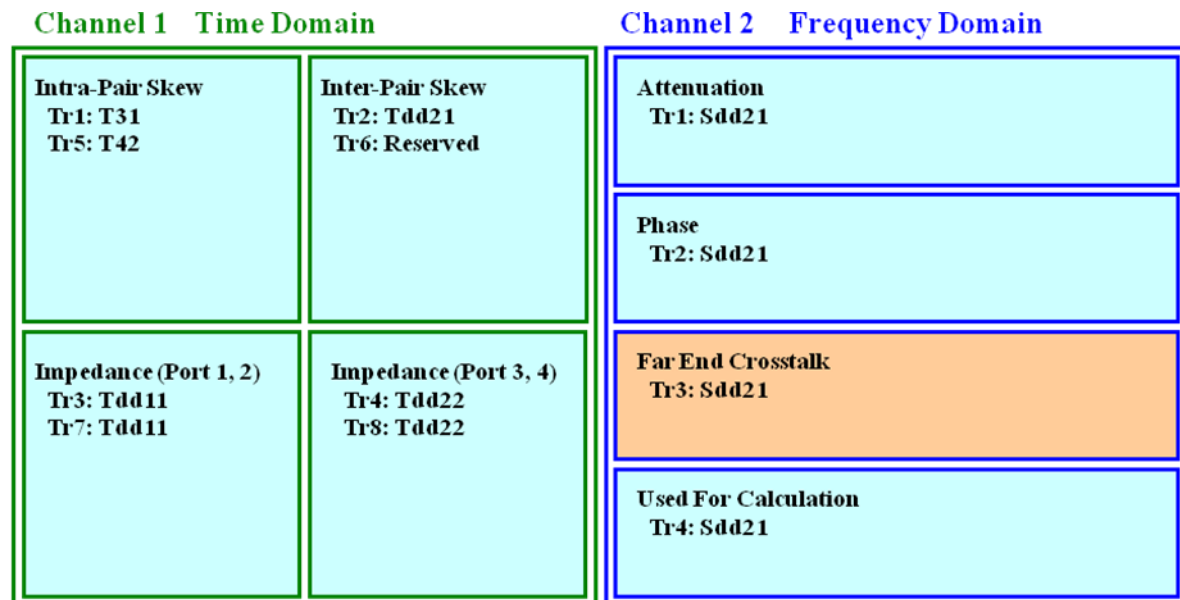

Figure 5-3 Measurement areas when Channel 1 is in TDR/TDT mode.

Agilent MOI for HDMI 1.4b Cable Assembly Test

5.4. Calibration and Adjustment

5.4.1. Time Domain Calibration

1. Connect the cables and ECal module to the E5071C.
2. Press **Channel Next** key to select Channel1.
3. Open **Setup** tab (item1).
4. Click **ECal** (item2) to launch the Full Calibration (ECal) and Fixture Compensation wizard.

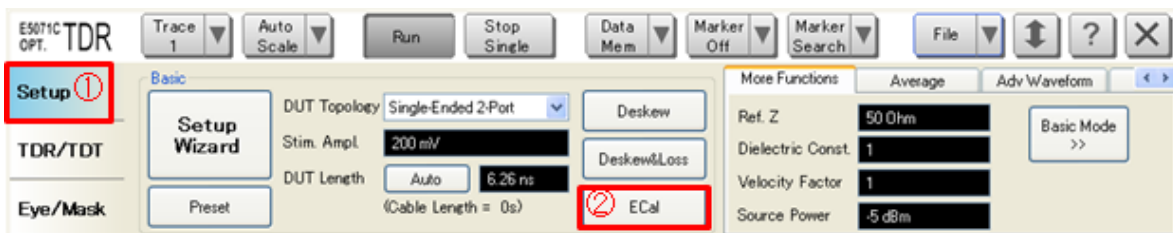

5. Connect all cables to the ECal module.
6. Click **Calibrate** (item3), then it will start the full calibration. Wait until the check-mark appears on the right of Calibrate button.
7. Click **Next** (item4).

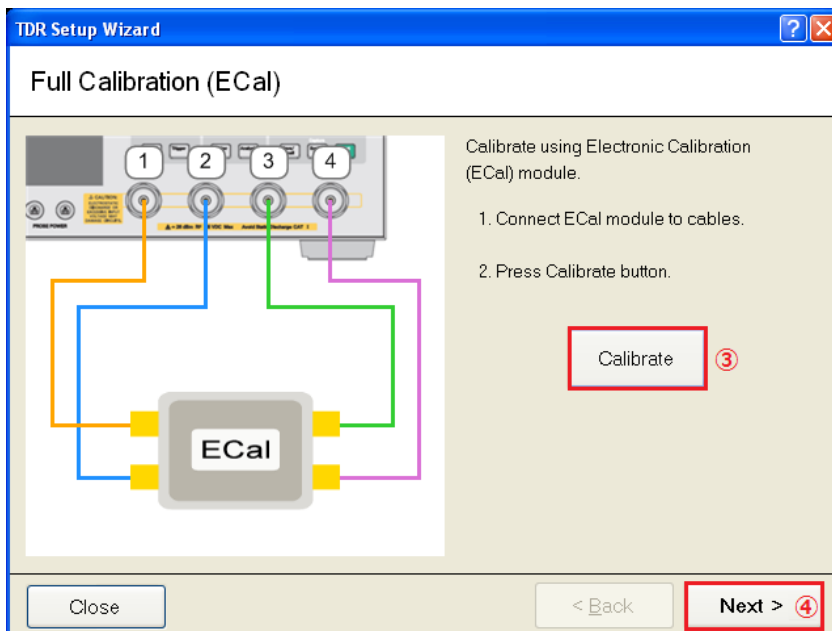

Agilent MOI for HDMI 1.4b Cable Assembly Test

8. Connect all cables to the test fixtures in accordance with the table below.

ENA Port Number	Port1	Port2	Port3	Port4
Fixture PIN Number	A D0+	A D0-	B D0+	B D0-

Note: A and B represent each one of the test fixtures.

9. Click **Fixture Comp** (item5), then it will start the fixture compensation. Wait until the check-mark appears on the right of Fixture Comp button.
10. Click **Finish** (item6).

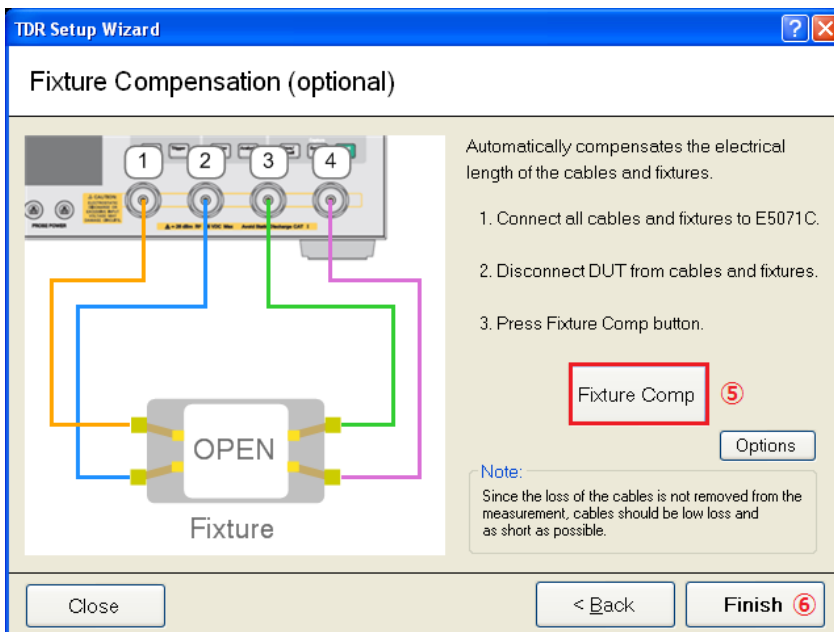

Agilent MOI for HDMI 1.4b Cable Assembly Test

5.4.2. Measure DUT Length

1. Click **Auto** (item1) to measure the DUT Length.

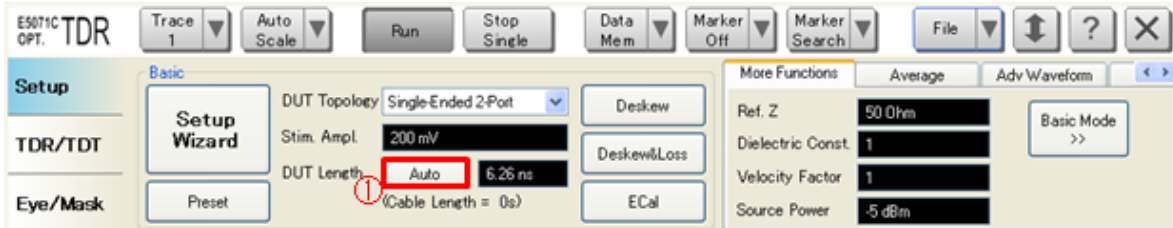

2. Connect the DUT.
3. Click **Measure** (item2), then it will measure the DUT length. Wait until the check-mark appears on the right of Measure button.
4. Click **Finish** (item3).

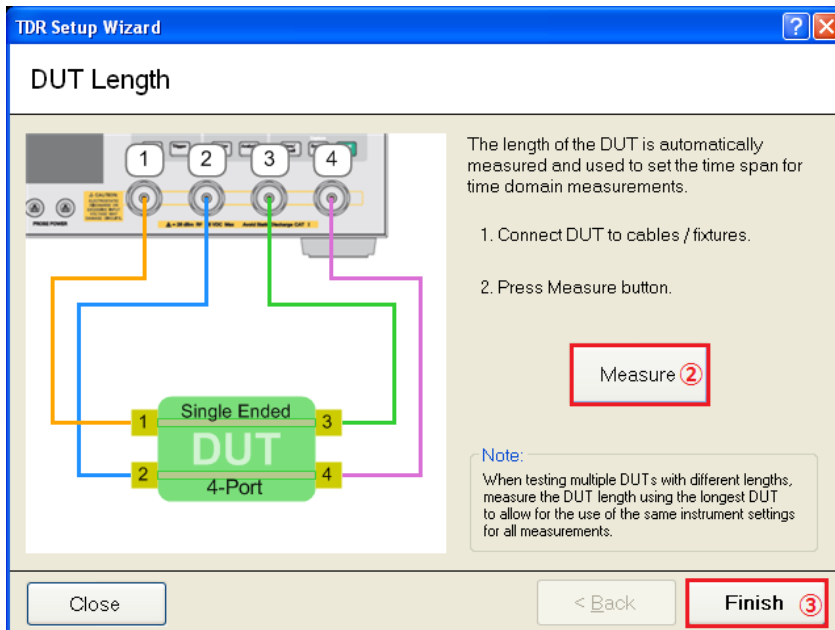

Agilent MOI for HDMI 1.4b Cable Assembly Test

5.4.3. Frequency Domain Calibration

1. Connect all cables to the ECal module.
2. Click **ECal** (item1) to perform the Full Calibration (ECal).

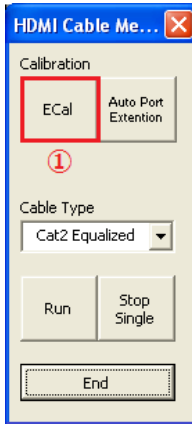

5.4.4. Perform Auto Port Extension

1. Connect the test fixtures as follows. Make the fixture ends open.

ENA Port Number	Port1	Port2	Port3	Port4
Fixture PIN Number	A D0+	A D0-	B D0+	B D0-

Note: A and B represent each one of the test fixtures.

2. Click **Auto Port Extension** (item1) to perform the Auto Port Extension.

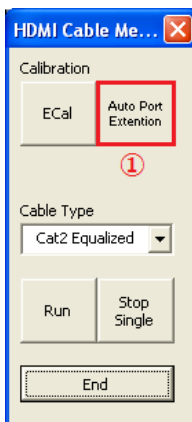

Agilent MOI for HDMI 1.4b Cable Assembly Test

5.5. Measurement and Data Analysis

5.5.1. Data Eye Diagram

Data Rate and Rise Time Adjustment

1. Press **Channel Next** key to select Channel1.
2. Press **Channel Max** key to enlarge Channel1.
3. Open **Eye Mask** tab (item1).
4. Input appropriate **Data Rate** and **Rise Time** (item2) in accordance with your device category. Note that category 2 cables need to be tested with the two kinds of CLK frequencies.

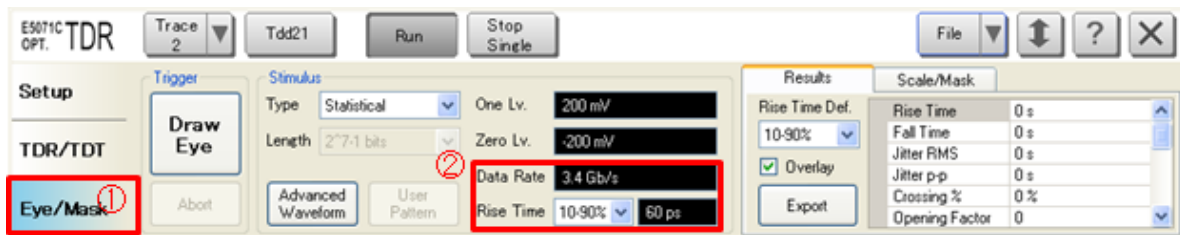

Category	CLK Frequency [MHz]	Data Rate [Mbps]	Rise Time [ps]
1	74.25	742.5	450
2	165	1650	200
	340	3400	60

Jitter Adjustment

Ensure that the mask files included in “HDMI cable assembly test package” are copied to the instrument.

1. Open **Eye/Mask** tab (item1).
2. Open **Scale/Mask** tab (item2).
3. Click **Mask Pattern** (item3), then Mask Pattern Editor appears.
4. Click **Load** (item4) and select an appropriate mask file in accordance with the CDF

Agilent MOI for HDMI 1.4b Cable Assembly Test

field Cable_Configuration.

Category	Configuration	Mask File
1	Home	HDMI1.4b_TP1.msk
	Automotive_EE	HDMI1.4b_TP1.msk
	Automotive_AA	HDMI1.4b_TP1.msk
	Automotive_EA	HDMI1.4b_TP5.msk
2	All	HDMI1.4b_TP1.msk

5. Click **Close** (item5).
6. Activate **Mask Test** checkbox (item6).

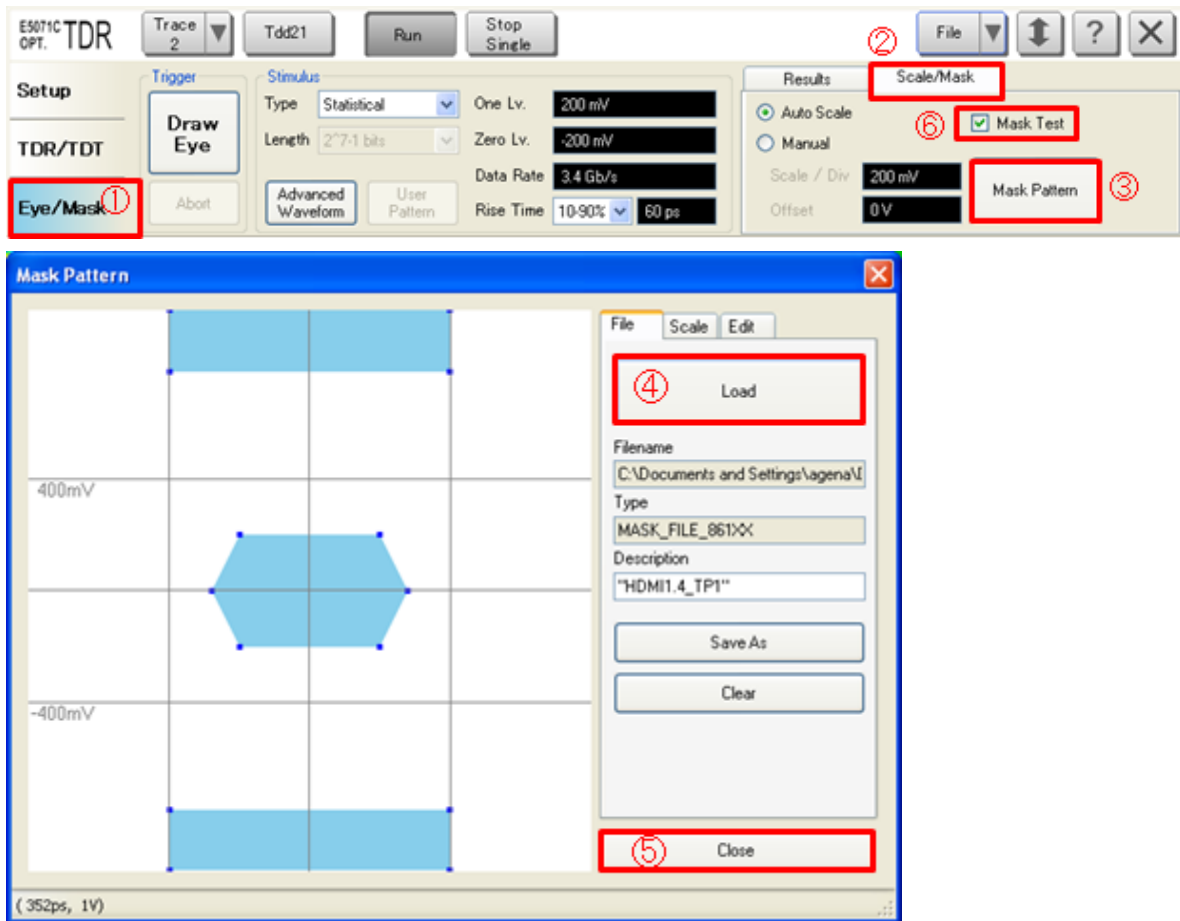

7. Connect the HDMI plug fixture (ex. N1080B Option H04) and receptacle fixture (ex. N1080B Option H05) to the test cables, and mate them as shown in Figure 5-4.

Agilent MOI for HDMI 1.4b Cable Assembly Test

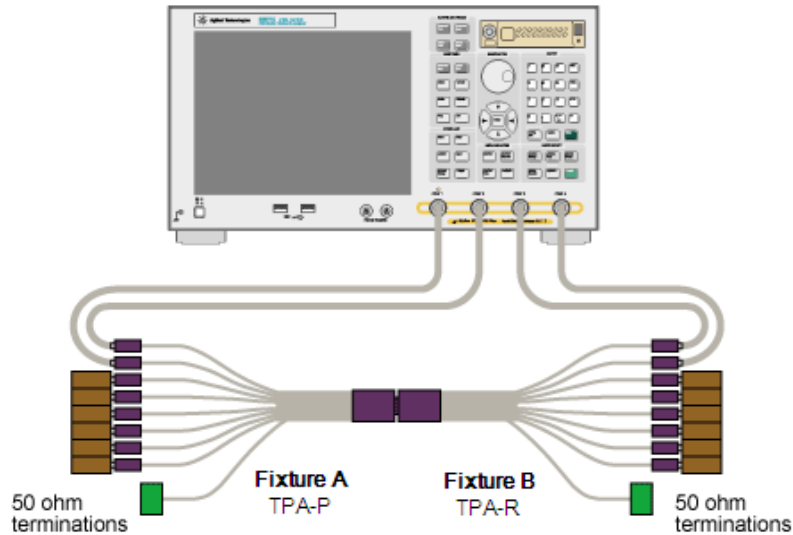
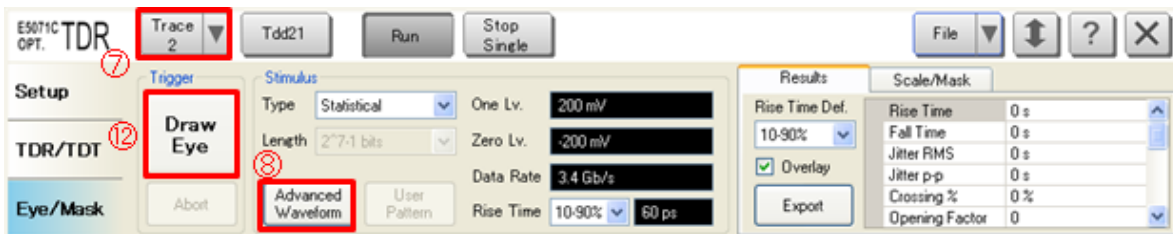

Figure 5-4 Instrument setup for jitter adjustment

8. Select **Trace2** (item7).
9. Click **Advanced Waveform** (item8), then a dialog box appears.
10. Adjust **Magnitude** value (item9) and activate **Enable** checkbox (item10).
11. Click **OK** (item11) to close the dialog box.
12. Click **Draw Eye** (item12).
13. Repeat the previous three steps while adjusting the jitter magnitude until the edge of the eye nearly touches both the left-most and right-most points of the eye mask but without causing the eye mask violation (Figure 5-5).



Agilent MOI for HDMI 1.4b Cable Assembly Test

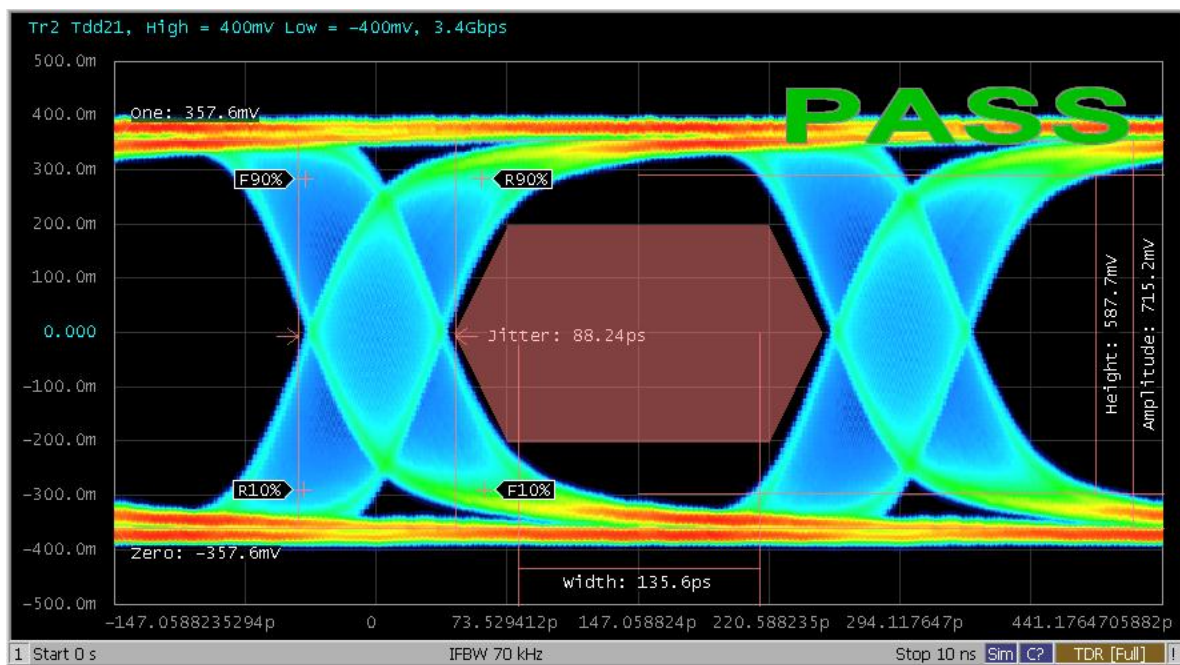
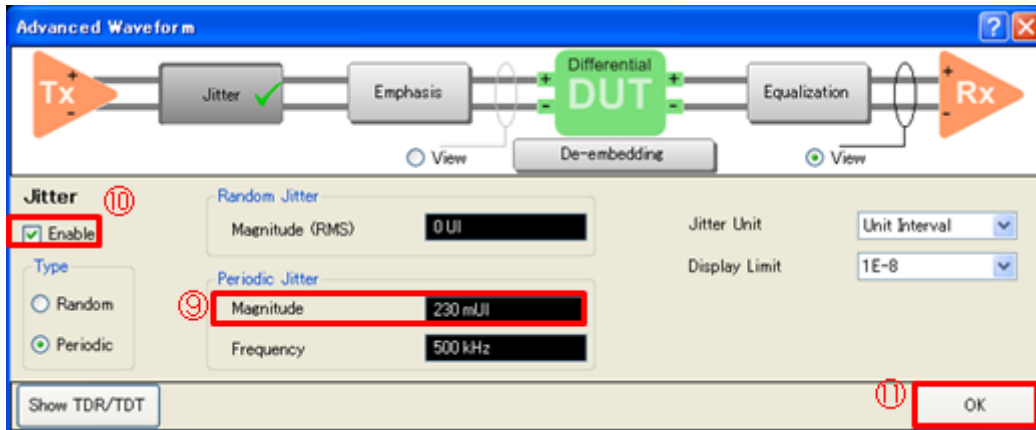

Figure 5-5 The eye diagram of cable input signal with adjusted jitter.

14. Open **Scale/Mask** tab (item2).
15. Click **Mask Pattern** (item3), then Mask Pattern Editor appears.
16. Click **Load** (item4) and select an appropriate mask file in accordance with the CDF field Cable_Configuration.

Agilent MOI for HDMI 1.4b Cable Assembly Test

Category	Configuration	Mask File
1	Home	HDMI1.4b_TP2.msk
	Automotive_EE	HDMI1.4b_TP2.msk
	Automotive_AA	HDMI1.4b_TP5.msk
	Automotive_EA	HDMI1.4b_TP2.msk
2	All	HDMI1.4b_TP2.msk

17. Click **Close** (item5).

Equalizer

If the CLK frequency is 340 MHz, apply the reference cable equalizer. If CDF filed Cable_Configuration is “Automotive_EE” or “Automotive_EA”, also apply the reference equalizer. Ensure that the equalizer files included in “HDMI cable assembly test package” are copied to the instrument.

Category	Configuration	Equalizer File
1	Home	N/A
	Automotive_EE	HDMI1.4b_Cable-Equalizer_Automotive.csv
	Automotive_AA	N/A
	Automotive_EA	HDMI1.4b_Cable-Equalizer_Automotive.csv
2	CLK rate = 340 MHz	HDMI1.4b_Cable-Equalizer.csv

1. Click **Advanced Waveform** (item1), then a dialog box appears.
2. Click **Equalization** (item2).
3. Select **File** under Type (item3).
4. Click **Load** (item4) and specify the equalizer file “HDMI1.4b_Cable-Equalizer.csv”.
5. Activate **Enable** checkbox (item5) and click **OK** (item6) to close the dialog.

Agilent MOI for HDMI 1.4b Cable Assembly Test

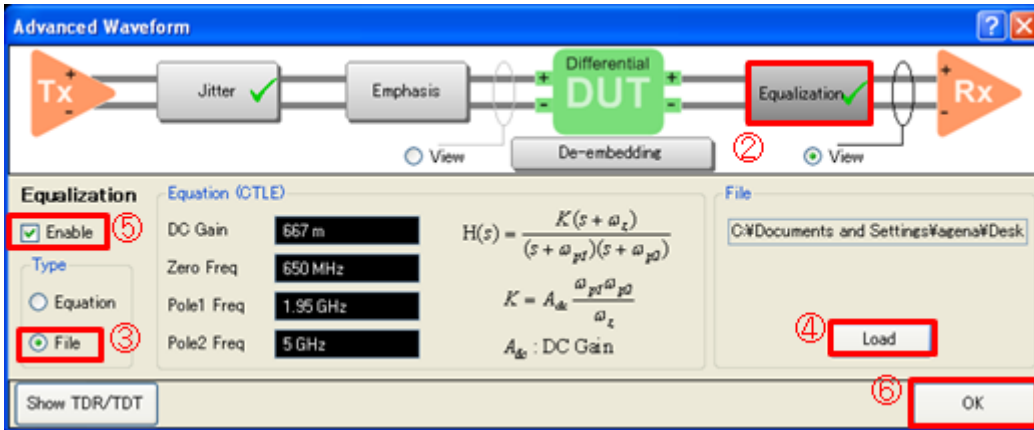
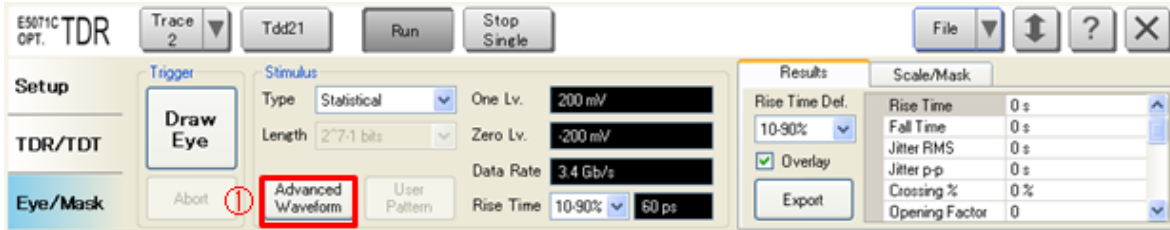

Measurement

1. Open **Eye/Mask** tab.
2. Connect the receptacle fixtures (N1080B Option H05) as follows. Unused fixture pins should be terminated.

ENA Port Number	Port1	Port2	Port3	Port4
Fixture PIN Number	A D0+	A D0-	B D0+	B D0-
	A D1+	A D1-	B D1+	B D1-
	A D2+	A D2-	B D2+	B D2-
	A CLK+	A CLK-	B CLK+	B CLK-

Note: A and B represent each one of the test fixtures.

3. Connect the DUT (HDMI cable) to the test fixture.
4. Click **Stop Single**.
5. Click **Draw Eye**.

Agilent MOI for HDMI 1.4b Cable Assembly Test

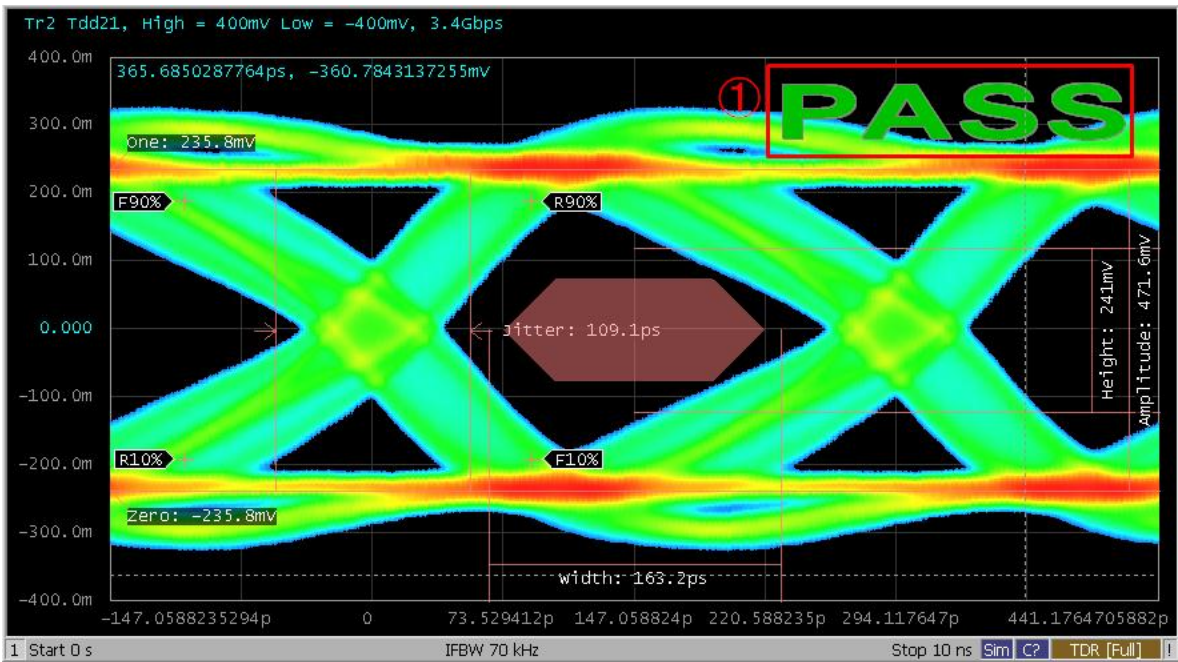

Figure 5-6 The eye diagram of cable output signal

Data Analysis

Read the pass/fail sign on the eye diagram (item1 in Figure 5-6).

Note: After the measurements, turn off the equalizer function.

Agilent MOI for HDMI 1.4b Cable Assembly Test

5.5.2. Intra-Pair Skew

1. Press **Channel Next** key to select Channel1.
2. Press **Channel Max** key to enlarge Channel1.
3. Open **TDR/TDT** tab.
4. Connect the test fixtures as follows. Unused fixture pins should be terminated.

ENA Port Number	Port1	Port2	Port3	Port4
Fixture PIN Number	A D0+	A D0-	B D0+	B D0-
	A D1+	A D1-	B D1+	B D1-
	A D2+	A D2-	B D2+	B D2-
	A CLK+	A CLK-	B CLK+	B CLK-

Note: A and B represent each one of the test fixtures.

5. Connect the DUT (HDMI cable) to the test fixture.
6. Click **Stop Single** for Time Domain measurement.
7. Select **Trace1**.
8. Click **Auto Scale** and **X** to show the overall step response.
9. Record the time at the transition point.
10. Set the horizontal scale to 100 ps/div and adjust the horizontal position based on the recorded time.
11. Apply the same horizontal scale settings to Trace5.
12. Click **Stop Single** for Time Domain measurement.

Agilent MOI for HDMI 1.4b Cable Assembly Test

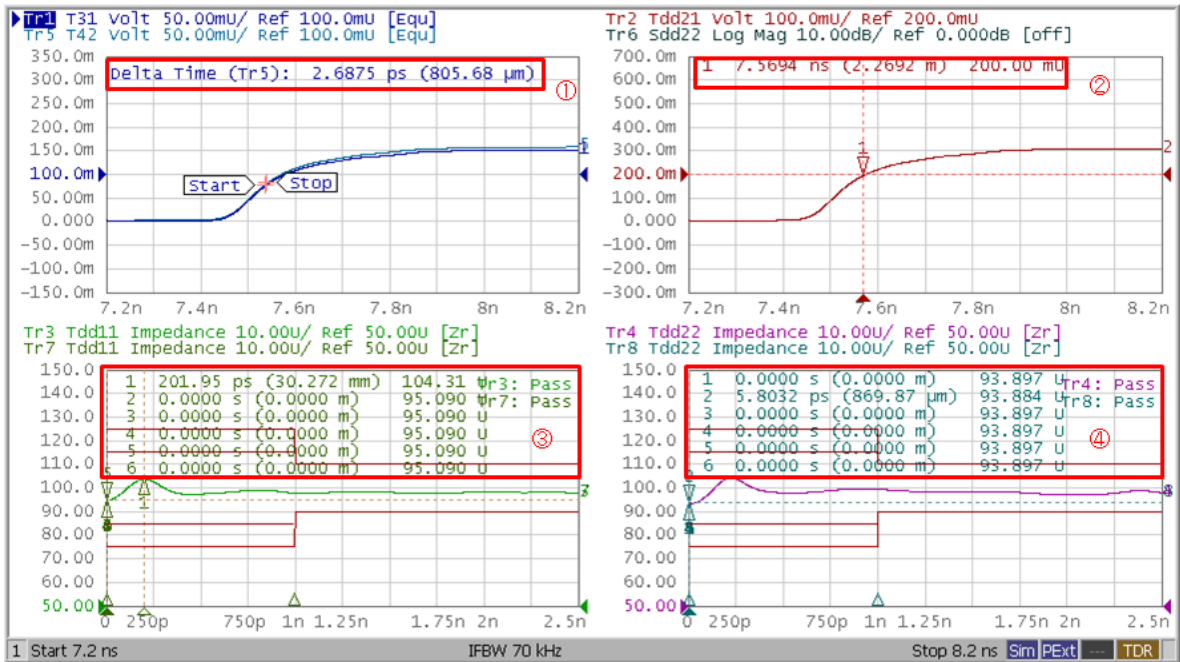

Figure 5-7 Time Domain Measurement Example

Data Analysis

Read the delta time between Trace1 and Trace5 (item1 in Figure 5-7). Check if the value is within the limit below.

Category	Configuration	Limit
1	Home	If the delta time <= 151 ps, then pass. Otherwise fail.
	Automotive_EE	If the delta time <= 336 ps, then pass. Otherwise fail.
	Automotive_AA	If the delta time <= 101 ps, then pass. Otherwise fail.
	Automotive_EA	If the delta time <= 235 ps, then pass. Otherwise fail.
2	All	If the delta time <= 112 ps, then pass. Otherwise fail.

Agilent MOI for HDMI 1.4b Cable Assembly Test

5.5.3. Inter-Pair Skew

Measurement

1. Press **Channel Next** key to activate Channel1.
2. Press **Channel Max** key to enlarge Channel1.
3. Open **TDR/TDT** tab.
4. Connect the test fixtures as follows. Unused fixture pins should be terminated.

ENA Port Number	Port1	Port2	Port3	Port4
Fixture PIN Number	A D0+	A D0-	B D0+	B D0-

Note: A and B represent each one of the test fixtures.

5. Click **Stop Single** for Time Domain measurement.
6. Select **Trace2**.
7. Click **Auto Scale** and **X** to show the overall step response.
8. Record the time at the transition point.
9. Set the horizontal scale to 100 ps/div and adjust the horizontal position based on the recorded time.
10. Click **Stop Single** for Time Domain measurement.
11. Record the Marker 1 value on trace 2 (item2 in Figure 5-7).
12. Connect the test fixtures as follows. Unused fixture pins should be terminated.

ENA Port Number	Port1	Port2	Port3	Port4
Fixture PIN Number	A D1+	A D1-	B D1+	B D1-

13. Click **Stop Single** for Time Domain measurement.
14. Record the Marker 1 value on trace 2 (item2 in Figure 5-7).
15. Connect the test fixtures as follows. Unused fixture pins should be terminated.

ENA Port Number	Port1	Port2	Port3	Port4
Fixture PIN Number	A D2+	A D2-	B D2+	B D2-

16. Click **Stop Single** for Time Domain measurement.
17. Record the Marker 1 value on trace 2 (item2 in Figure 5-7).

Agilent MOI for HDMI 1.4b Cable Assembly Test

18. Connect the test fixtures as follows. Unused fixture pins should be terminated.

ENA Port Number	Port1	Port2	Port3	Port4
Fixture PIN Number	A D3+	A D3-	B D3+	B D3-

19. Click **Stop Single** for Time Domain measurement.

20. Record the Marker 1 value on trace 2 (item2 in Figure 5-7).

21. Connect the test fixtures as follows. Unused fixture pins should be terminated.

ENA Port Number	Port1	Port2	Port3	Port4
Fixture PIN Number	A CLK+	A CLK-	B CLK+	B CLK-

22. Click **Stop Single** for Time Domain measurement.

23. Record the Marker 1 value on trace 2 (item2 in Figure 5-7).

Data Analysis

1. Find the maximum and minimum value from 4 recorded data.
2. Inter-pair Skew = Absolute(maximum value – minimum value)
3. Check if the Inter-pair Skew is within the limit below.

Category	Configuration	Limit
1	Home	If the delta time <= 2.42 ns, then pass. Otherwise fail.
	Automotive_EE	If the delta time <= 5.38 ns, then pass. Otherwise fail.
	Automotive_AA	If the delta time <= 1.61 ns, then pass. Otherwise fail.
	Automotive_EA	If the delta time <= 3.77 ns, then pass. Otherwise fail.
2	All	If the delta time <= 1.78 ns, then pass. Otherwise fail.

Agilent MOI for HDMI 1.4b Cable Assembly Test

5.5.4. Far End Crosstalk

Measurement

1. Press **Channel Next** key to activate Channel2.
2. Press **Channel Max** key to enlarge Channel2.
3. Connect the test fixtures as follows. Unused fixture pins should be terminated.

Table 5-2 Port Connection

ENA Port Number	Port1	Port2	Port3	Port4
Fixture PIN Number	A D0+	A D0-	B D1+	B D1-
	A D0+	A D0-	B D2+	B D2-
	A D0+	A D0-	B CLK+	B CLK-
	A D1+	A D1-	B D2+	B D2-
	A D1+	A D1-	B CLK+	B CLK-
	A D2+	A D2-	B CLK+	B CLK-

Note: A and B represent each one of the test fixtures.

4. Connect the DUT (HDMI cable) to the test fixture.
5. Click **Stop Single** for Frequency Domain measurement.

Agilent MOI for HDMI 1.4b Cable Assembly Test

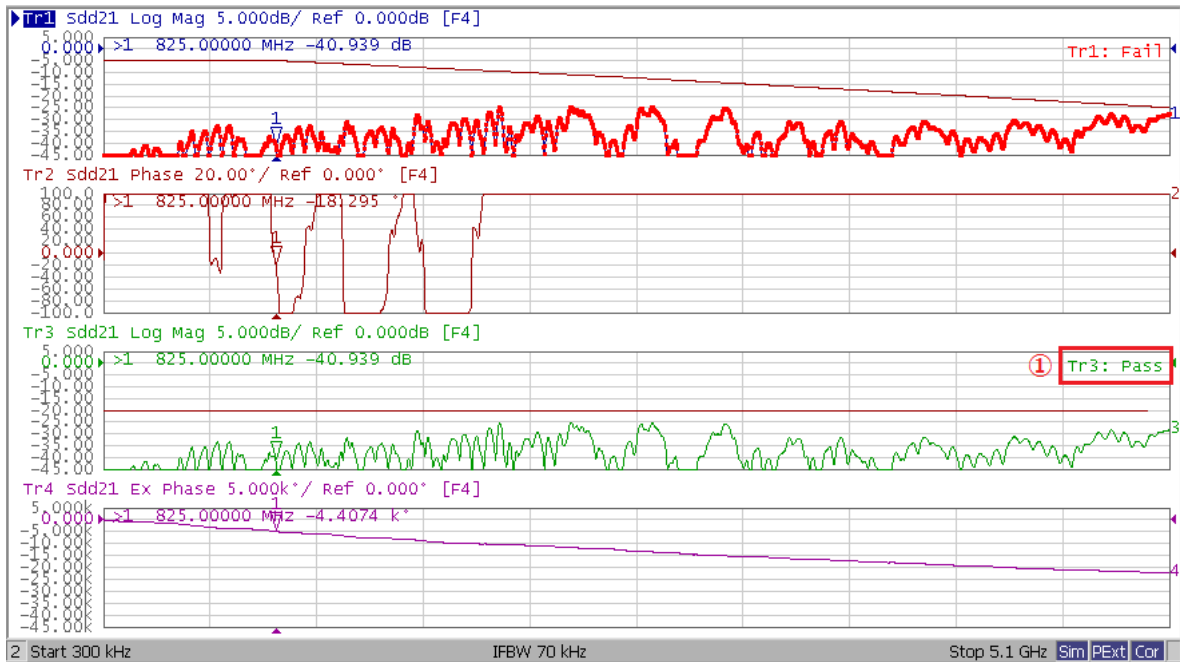

Figure 5-8 Far End Crosstalk Measurement Example

Data Analysis

Read the pass/fail sign on Trace3 (item1 in Figure 5-8).

Agilent MOI for HDMI 1.4b Cable Assembly Test

5.5.5. Attenuation and Phase

Measurement

1. Press **Channel Next** key to activate Channel2.
2. Press **Channel Max** key to enlarge Channel2.
3. Connect the test fixtures as follows. Unused fixture pins should be terminated.

ENA Port Number	Port1	Port2	Port3	Port4
Fixture PIN Number	A D0+	A D0-	B D0+	B D0-
	A D1+	A D1-	B D1+	B D1-
	A D2+	A D2-	B D2+	B D2-
	A CLK+	A CLK-	B CLK+	B CLK-

Note: A and B represent each one of the test fixtures.

4. Connect the DUT (HDMI) cable to the test fixture.
5. Select cable type in accordance with the DUT (item 1).

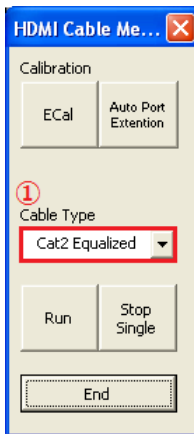

Cable Type	Description
Cat2 Equalized	Category2 Passive Equalizer Cable
Cat2 Passive	Category2 Non Equalized Cable
Cat1 Passive	Category1 Non Equalized Cable

6. Click **Stop Single** for Frequency Domain measurement.

Agilent MOI for HDMI 1.4b Cable Assembly Test

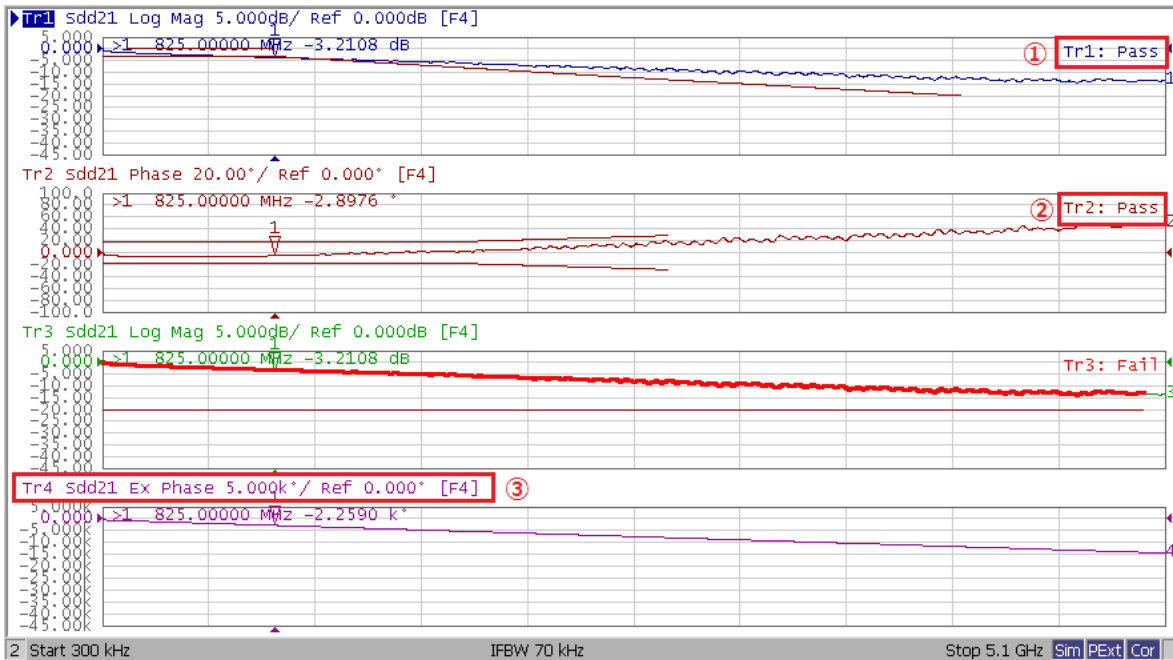

Figure 5-9 Attenuation and Phase Measurement Example

Data Analysis

Attenuation

Read Pass/Fail sign on Trace1 (item1 in Figure 5-9).

Phase (Equalized cable only)

Read Pass/Fail sign on Trace2 (item2 in Figure 5-9).

Expand Phase (Not used in the pass/fail test)

This measurement is only used for the phase measurement calculation (item3 in Figure 5-9).

Description of Phase Measurement

The phase characteristic is plotted as the difference between the linear expanded phase line and the calculated linear approximated value by using “Ordinary least Squares”.

Agilent MOI for HDMI 1.4b Cable Assembly Test

In general, phase response is measured as a linear response shown in Figure 5-10. The phase tolerance is defined as a difference value of measured linear expanded phase and calculated approximated first order line.

The approximation model is “Ordinary Least Squares” of $y=mx$. (Here, “y” is the linear expanded phase value, “x” is frequency corresponding, and “m” is an incline parameter to be calculated. The frequency range used for calculation of “m” is from 300 kHz to 1.7 GHz).

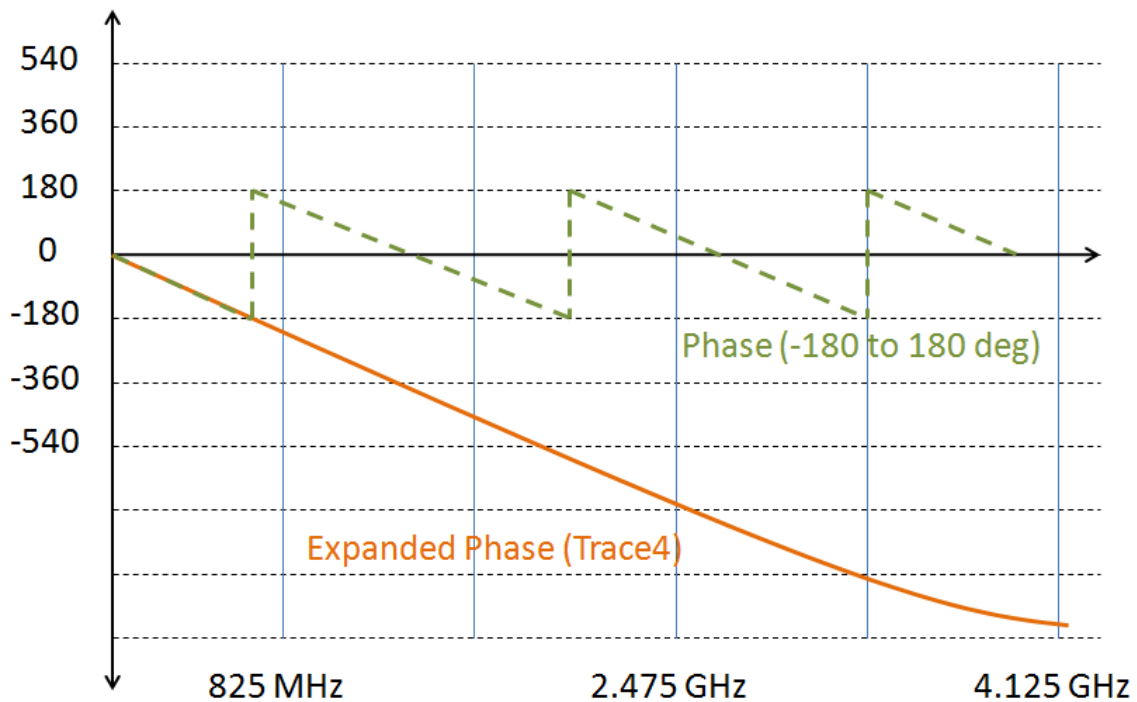

Figure 5-10 Cat2 equalized cable phase measurement method (explanation)

Agilent MOI for HDMI 1.4b Cable Assembly Test

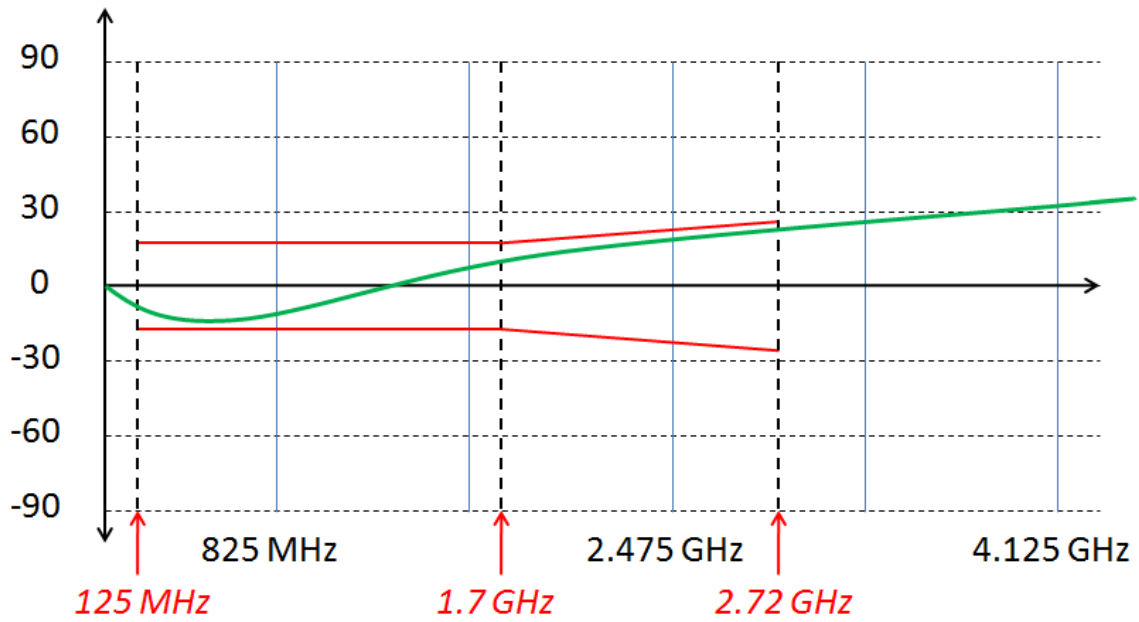

Figure 5-11 Cat2 equalized cable phase limits

Agilent MOI for HDMI 1.4b Cable Assembly Test

5.5.6. Differential Impedance

Measurement

1. Press **Channel Next** key to select Channel1.
2. Press **Channel Max** key to enlarge Channel1.
3. Open **TDR/TDT** tab.
4. Connect the test fixtures as follows. Unused fixture pins should be terminated.

ENA Port Number	Port1	Port2	Port3	Port4
Fixture PIN Number	A D0+	A D0-	B D0+	B D0-
	A D1+	A D1-	B D1+	B D1-
	A D2+	A D2-	B D2+	B D2-
	A CLK+	A CLK-	B CLK+	B CLK-

Note: A and B represent each one of the test fixtures.

5. Connect the DUT (HDMI) cable to the test fixture.
6. Click **Stop Single** for Time Domain measurement.

Data Analysis

The result must meet following criteria.

Cable: If (Cable_Low < 90 ohm) or (Cable_Hi > 110 ohm) then Fail.

Connector: If (Conn1_Low < 75 ohm) or (Conn1_Hi > 125 ohm) then Fail.

If(Conn2_Low < 85 ohm) or (Conn2_Hi > 115 ohm) then

if the duration of violation (t) is 250 psec or longer or there is more than one excursion then Fail.

6. Read Pass/Fail sign on Trace3 and Trace7, and find an overall result from the table in the next page.

Agilent MOI for HDMI 1.4b Cable Assembly Test

Trace3 (Trace4)	Trace7 (Trace8)	Overall Result
Pass	Pass	Pass
Pass	Fail	Check the duration of violation.
Fail	Fail	Fail

7. If Trace3 is pass and Trace7 is fail (item3 in Figure 5-7), confirm if the excursion is only one time and the duration of violation is within 250 psec.

Duration of violation = (Marker4 - Marker3) or (Marker6 – Marker5).

8. Repeat the same test with Trace4 and Trace8 (item4in Figure 5-7).

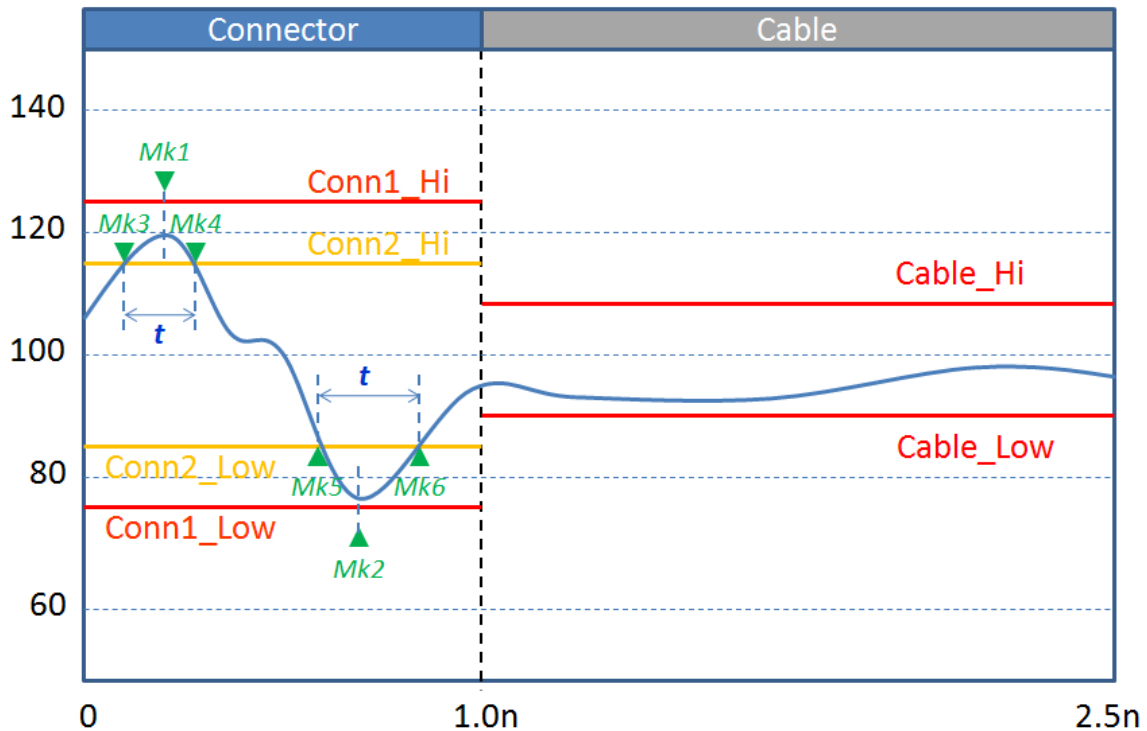

Figure 5-12 Connector and Cable limits for Differential Impedance

Agilent MOI for HDMI 1.4b Cable Assembly Test

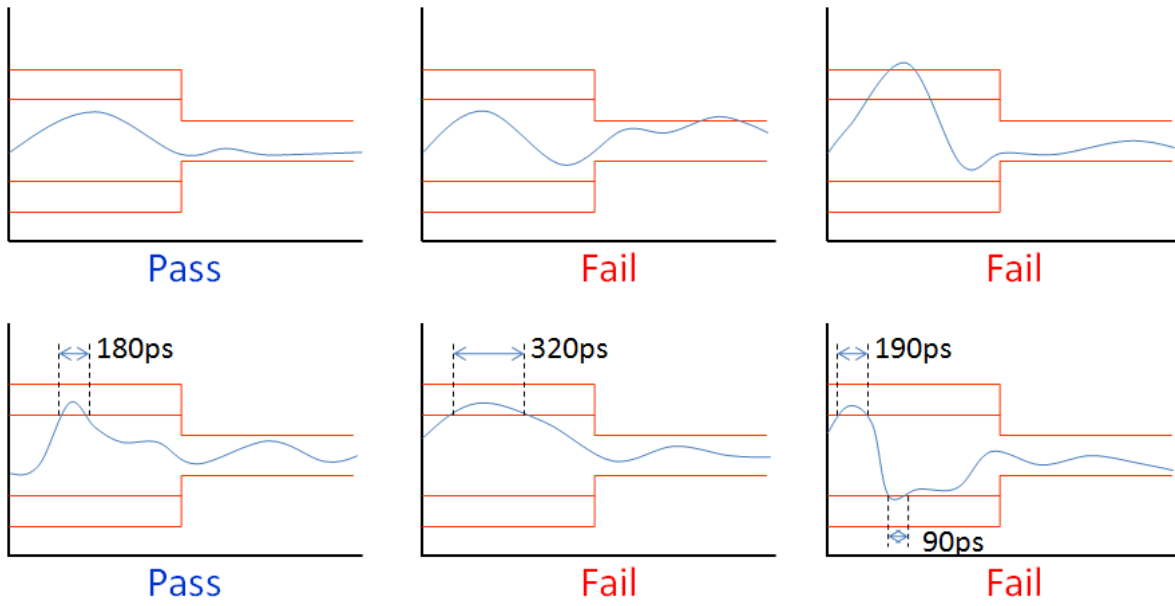

Figure 5-13 Example for Impedance Judgment

Agilent MOI for HDMI 1.4b Cable Assembly Test

6. Appendix

6.1. Manual Setup for Time Domain Measurement

6.1.1. Starting Setup

1. If TDR setup wizard was appeared, click **Close** button in the TDR setup wizard.
2. Open **Setup** tab (item1).
3. Click **Preset** (item2).
4. A dialog box appears requesting for confirmation. Then click **OK**.
5. Set **DUT Topology** (item3) to “Differential 2-port”.
6. Open **More Functions** tab (item4).
7. Click **Advanced Mode** (item5).



8. A dialog box appears requesting for confirmation. Then click **Yes**. (Clear the check box for “Use Advanced Calibration Methods”)

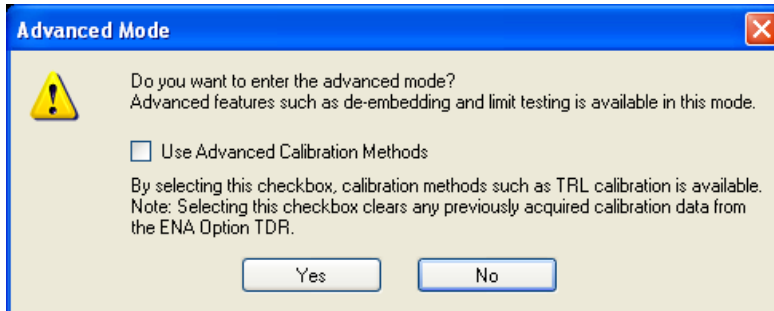

6.1.2. Eye Diagram

1. Click **Stop Single**.
2. Open **Eye/Mask** tab.
3. Set Stimulus **Type** to “Statistical”.
4. Set **One Lv.** to 200 mV
5. Set **Zero Lv.** to -200 mV.

Agilent MOI for HDMI 1.4b Cable Assembly Test

6. Set **Data Rate** to 3.4 Gb/s
7. Set **Rise Time** to 60 ps (10-90%)
8. Click **Advanced Waveform**, then a dialog box appears.
9. Activate **Enable** checkbox.
10. Set **Frequency** to 500 kHz.
11. Click **OK** to close the dialog box.

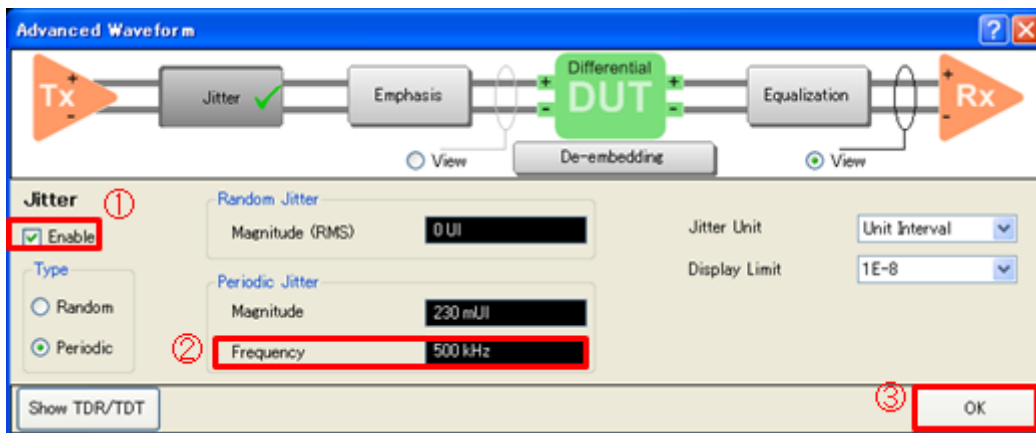

6.1.3. Intra-Pair Skew

6.1.3.1. Measurement Setup

1. Open **TDR/TDT** tab.
2. Select **Trace1**.
3. Open **Parameters** tab.
4. Set **Measure** to “Time Domain” and “Single-Ended”.
5. Set **Format** to Volt.
6. Set **Rise Time** to 200 psec (10-90%).
7. Click **T31** in the table.
8. Click the box below the left knob under Horizontal.
9. Input 1 nsec/div with the Entry dialog box.
10. Click the box below the right knob under Horizontal.
11. Input 0 sec with the Entry dialog box.

Agilent MOI for HDMI 1.4b Cable Assembly Test

12. Click the box below the left knob under Vertical.
13. Input 50 mV/div with the Entry dialog box
14. Click the box below the right knob under Vertical.
15. Input 100 mV with the Entry dialog box
16. Open **Trace Control** tab.
17. Clear **Time** and **Marker** check box under Coupling.
18. Click **Trace Settings Copy** button. Then Trace Settings Copy dialog box appears.
19. Select **Trace1** in the From list.
20. Select **Trace5** in the To list.
21. Click **Copy**.
22. Click **Close**.
23. Select **Trace5**.
24. Open **Parameters** tab.
25. Click **T42** in the table.
26. Select **Trace1**.
27. Click **Marker Search** and select **Δ Time**. Then Delta Time dialog box appears.
28. Check the **Δ Time** check box.
29. Select Trace5 (T42) for **Target (Stop)**.
30. Input **Position (%)** to 50.
31. Click **OK**.

6.1.3.2. Crosstalk Compensation

1. Select **Trace1**.
2. Press **Display** > **Equation Editor...** > Enter an equation "**Intra+= S31-S32**".
3. Check **Equation Enabled** check box.
4. Click **Apply**.
5. Click **Close**.
6. Select **Trace5**.

Agilent MOI for HDMI 1.4b Cable Assembly Test

7. Press **Display** > **Equation Editor...** > Enter an equation “**Intra= S42-S41**”.
8. Check **Equation Enabled** check box.
9. Click **Apply**.
10. Click **Close**.

6.1.4. Inter-Pair Skew

1. Select **Trace2**.
2. Open **Parameters** tab.
3. Set **Measure** to “Time Domain”.
4. Set **Format** to Volt.
5. Set **Rise Time** to 10-90 % and input value to 200 psec.
6. Click **Tdd21** in the table.
7. Click the box below the left knob under Horizontal.
8. Input 1 nsec/div with the Entry dialog box.
9. Click the box below the right knob under Horizontal.
10. Input 0 sec with the Entry dialog box.
11. Click the box below the left knob under Vertical.
12. Input 100 mV/div with the Entry dialog box.
13. Click the box below the right knob under Vertical.
14. Input 200 mV with the Entry dialog box.
15. Press **Marker Search** > **Target**, and set **Target Value** to 200 m.
16. Select **Trace6**.
17. Click **Data Mem** and select **Off**.

6.1.5. Differential Impedance

1. Open **TDR/TDT** tab.
2. Open **Parameters** tab.
3. Select **Trace3**.

Agilent MOI for HDMI 1.4b Cable Assembly Test

4. Set **Format** to Impedance.
5. Set **Rise Time** to 200 psec (10-90%).
6. Click **Tdd11** in the table.
7. Click the box below the left knob under Horizontal.
8. Input 250 psec/div with the Entry dialog box.
9. Click the box below the right knob under Horizontal.
10. Input 0 nsec with the Entry dialog box.
11. Click the box below the left knob under Vertical.
12. Input 10 Ohm/div with the Entry dialog box
13. Click the box below the right knob under Vertical.
14. Input 50 Ohm with the Entry dialog box.
15. Open **Trace Control** tab.
16. Click **Trace Settings Copy** button. Then Trace Settings Copy dialog box appears.
17. Select **Trace3** in the From list.
18. Select **Trace4, Trace7** and **Trace8** in the To list.
19. Click **Copy**.
20. Click **Close**.
21. Open **Parameters** tab.
22. Select **Trace4**.
23. Click **Tdd22** in the table.
24. Select **Trace8**.
25. Click **Tdd22** in the table.
26. Select **Trace7**.
27. Press **Marker Search** > **Search Range**, and set **Start** to 0 and **Stop** to 1n.
28. Click **Search Range** to turn it **ON**.
29. Click **Couple** to turn it **OFF**.
30. Click **Return**.
31. Click **Maker** menu and select **1**.

Agilent MOI for HDMI 1.4b Cable Assembly Test

32. Press **Marker Search** > **Max**.
33. Click **Maker** menu and select **2**.
34. Press **Marker Search** > **Min**.
35. Click **Maker** menu and select **3**.
36. Press **Marker Search** > **Target**, and set **Target Value** to 115.¹
37. Click **Target Transition** > **Positive**.
38. Click **Return**.
39. Click **Maker** menu and select **4**.
40. Press **Marker Search** > **Target**, and set **Target Value** to 115.¹
41. Click **Target Transition** > **Negative**.
42. Click **Return**.
43. Click **Maker** menu and select **5**.
44. Press **Marker Search** > **Target**, and set **Target Value** to 85.¹
45. Click **Target Transition** > **Negative**.
46. Click **Return**.
47. Click **Maker** menu and select **6**.
48. Press **Marker Search** > **Target**, and set **Target Value** to 85.¹
49. Click **Target Transition** > **Positive**.
50. Click **Return**.
51. Click **Tracking** to turn it **ON**.
52. Select **Trace8**.
53. Press **Marker Search** > **Search Range**, and set **Start** to 0 and **Stop** to 1n.
54. Click **Search Range** to turn it **ON**.
55. Click **Couple** to turn it **OFF**.
56. Click **Return**.
57. Click **Maker** menu and select **1**.

¹ Ignore the Target value not found message.

Agilent MOI for HDMI 1.4b Cable Assembly Test

58. Click **Marker Search** > **Max**.
59. Click **Maker** menu and select **2**.
60. Click **Marker Search** > **Min**.
61. Click **Maker** menu and select **3**.
62. Press **Marker Search** > **Target**, and set **Target Value** to 115.¹
63. Click **Target Transition** > **Positive**.
64. Click **Return**.
65. Click **Maker** menu and select **4**.
66. Press **Marker Search** > **Target**, and set **Target Value** to 115.¹
67. Click **Target Transition** > **Negative**.
68. Click **Return**.
69. Click **Maker** menu and select **5**.
70. Press **Marker Search** > **Target**, and set **Target Value** to 85.¹
71. Click **Target Transition** > **Negative**.
72. Click **Return**.
73. Click **Maker** menu and select **6**.
74. Press **Marker Search** > **Target**, and set **Target Value** to 85.¹
75. Click **Target Transition** > **Positive**.
76. Click **Return**.
77. Click **Tracking** to turn it **ON**.

6.2. Manual Setup for Frequency Domain Measurement

6.2.1. Channel and Trace Settings

1. Press **Display**.
2. Click **Allocate Channels** >  .
3. Press **Channel Next**.
4. Click **Num of Traces** > **4**.

Agilent MOI for HDMI 1.4b Cable Assembly Test

5. Click **Allocate Traces** > .

6.2.2. Attenuation

1. Press **Trace Next** to select Trace1.
2. Press **Sweep Setup** > **Sweep Type** > **Lin Freq.**
3. Set **Points** to 1601.
4. Press **Start** > Set start value to 300 kHz.
5. Press **Stop** > Set stop value to 5.1 GHz.
6. Press **Avg** > Set **IF Bandwidth** to 70 kHz.
7. Press **Analysis** > **Fixture Simulator** > **Fixture Simulator** to turn it **ON**.
8. Click **Topology** > **Device** > **Bal-Bal**.
9. Click **Port1 (bal)** > **1-2**.
10. Click **Port2 (bal)** > **3-4**.
11. Click **Return**.
12. Click **BalUn ON All Traces**.
13. Click **Measurement** > **Sdd21**.
14. Press **Format** > **Log Mag**.
15. Press **Marker** > **Marker1** > Set marker value to 825 MHz.
16. Press **Scale**.
17. Set **Scale/Div** to 5 dB/div.
18. Set **Reference position** to 9 Div.

6.2.3. Phase

1. Press **Trace Next** to select Trace2.
2. Press **Meas** > **Sdd21**.
3. Press **Format** > **Phase**.
4. Press **Scale**.
5. Set **Scale/Div** to 20 °/div.

Agilent MOI for HDMI 1.4b Cable Assembly Test

6. Set **Reference position** to 5 Div.

6.2.4. Far End Crosstalk

1. Press **Trace Next** to select Trace3.
2. Press **Meas > Sdd21**.
3. Press **Format > Log Mag**.
4. Press **Scale**.
5. Set **Scale/Div** to 5 dB/div.
6. Set **Reference position** to 9 Div.

6.2.5. Expand Phase

This measurement is used for the phase measurement calculation.

1. Press **Trace Next** to select Trace4.
2. Press **Meas > Sdd21**.
3. Press **Format > Expand Phase**.
4. Press **Scale**.
5. Set **Scale/Div** to 5 °/div.
6. Set **Reference position** to 9 Div.

6.3. Limit Test Settings

The E5071C-TDR provides a capability of setting limit lines to perform pass/fail test on each measurement.

6.3.1. Turning On/Off Fail Sign

If this option is turned on, a fail sign appears when one or more measurement items violate the limit lines. It is useful to check overall test result.

1. Press **Analysis > Limit Test > Fail Sign** to switch the fail sign ON/OFF.

Agilent MOI for HDMI 1.4b Cable Assembly Test

6.3.2. Setting the Warning Beeper

If this option is turned on, a beep is generated when one or more measurement items violate the limit lines.

1. Press **System** > **Misc Setup** > **Beeper** > **Beep Warning** to switch the warning beeper ON/OFF.

6.3.3. Defining the Limit Line

Set limit lines to perform pass/fail tests on the following measurement items.

- Differential Impedance (Trace3, 4, 7, 8 in Channel1)
- Attenuation (Trace1 in Channel2)
- Phase (Trace2 in Channel2)
- Far End Crosstalk (Trace2 in Channel2)

Note: If using the VBA, appropriate limit lines are automatically selected for Attenuation and Phase in accordance with the DUT cable type.

1. Press **Channel Next** key and **Trace Next** key to activate the trace on which limit lines should be set.
2. Press **Analysis** > **Limit Test** > **Edit Limit Line** to display the limit table shown below (Initially, no segments are entered in the limit table). Using the limit table, create/edit a segment.

	Type	Begin Stimulus	End Stimulus	Begin Response	End Response
1	MAX	0 s	600 ps	105 u	105 u
2	MIN	0 s	600 ps	75 u	75 u
3					

3. Enter the limit line data following the tables below.
4. Click **Return**.

Agilent MOI for HDMI 1.4b Cable Assembly Test

5. Click **Limit Line** and turn it **ON**.
6. Click **Limit Test** and turn it **ON**.
7. Repeat 1 to 6 for each Measurement items.

Differential Impedance

Type	Begin Stimulus	End Stimulus	Begin Response	End Response
Max	0 s	1 ns	125 Ohm	125 Ohm
Max	1 ns	2.5 ns	110 Ohm	110 Ohm
Min	0 s	1 ns	75 Ohm	75 Ohm
Min	1 ns	2.5 ns	90 Ohm	90 Ohm

Type	Begin Stimulus	End Stimulus	Begin Response	End Response
Max	0 s	1 ns	115 Ohm	115 Ohm
Min	0 s	1 ns	85 Ohm	85 Ohm

Agilent MOI for HDMI 1.4b Cable Assembly Test

Attenuation (Cat2 Equalized)

Type	Begin Stimulus	End Stimulus	Begin Response	End Response
Min	300 kHz	825 MHz	-10 mdB	-10 mdB
Min	825 MHz	2.475 GHz	-10 mdB	-12 dB
Min	2.475 GHz	4.125 GHz	-12 dB	-20 dB
Max	125 MHz	825 MHz	-5 dB	-5 dB

Note: The limit value depends on the value of at 825 MHz.

Attenuation (Cat2 Passive)

Type	Begin Stimulus	End Stimulus	Begin Response	End Response
Min	300 kHz	825 MHz	-5 dB	-5 dB
Min	825 MHz	2.475 GHz	-5 dB	-12 dB
Min	2.475 GHz	4.125 GHz	-12 dB	-20 dB
Min	4.125 GHz	5.1 GHz	-20 dB	-25 dB

Attenuation (Cat1 Passive)

Type	Begin Stimulus	End Stimulus	Begin Response	End Response
Min	300 kHz	825 MHz	-8 dB	-8 dB
Min	825 MHz	2.475 GHz	-21 dB	-21 dB
Min	2.475 GHz	4.125 GHz	-30 dB	-30 dB

Phase (Only for Cat2 Equalized)

Type	Begin Stimulus	End Stimulus	Begin Response	End Response
Max	300 kHz	1.7 GHz	18°	18°
Max	1.7 GHz	2.72 GHz	18°	28.8°
Min	300 kHz	1.7 GHz	-18°	-18°
Min	1.7 GHz	2.72 GHz	-18°	-28.8°

Agilent MOI for HDMI 1.4b Cable Assembly Test

Far End Crosstalk

Type	Begin Stimulus	End Stimulus	Begin Response	End Response
Max	300 kHz	5 GHz	-20 dB	-20 dB