



**Agilent U2500A Series
USB Simultaneous
Sampling Multifunction
Data Acquisition
Devices**

Service Guide



Agilent Technologies

Notices

© Agilent Technologies, Inc., 2007–2013

No part of this manual may be reproduced in any form or by any means (including electronic storage and retrieval or translation into a foreign language) without prior agreement and written consent from Agilent Technologies, Inc. as governed by United States and international copyright laws.

Manual Part Number

U2541-90013

Edition

Seventh Edition, July 26, 2013

Printed in Malaysia

Agilent Technologies, Inc.
Bayan Lepas Free Industrial Zone,
11900 Penang, Malaysia

Warranty

The material contained in this document is provided “as is,” and is subject to being changed, without notice, in future editions. Further, to the maximum extent permitted by applicable law, Agilent disclaims all warranties, either express or implied, with regard to this manual and any information contained herein, including but not limited to the implied warranties of merchantability and fitness for a particular purpose. Agilent shall not be liable for errors or for incidental or consequential damages in connection with the furnishing, use, or performance of this document or of any information contained herein. Should Agilent and the user have a separate written agreement with warranty terms covering the material in this document that conflict with these terms, the warranty terms in the separate agreement shall control.

Technology Licenses

The hardware and/or software described in this document are furnished under a license and may be used or copied only in accordance with the terms of such license.

Restricted Rights Legend

U.S. Government Restricted Rights. Software and technical data rights granted to the federal government include only those rights customarily provided to end user customers. Agilent provides this customary commercial license in Software and technical data pursuant to FAR 12.211 (Technical Data) and 12.212 (Computer Software) and, for the Department of Defense, DFARS 252.227-7015 (Technical Data - Commercial Items) and DFARS 227.7202-3 (Rights in Commercial Computer Software or Computer Software Documentation).

Safety Notices

CAUTION

A **CAUTION** notice denotes a hazard. It calls attention to an operating procedure, practice, or the like that, if not correctly performed or adhered to, could result in damage to the product or loss of important data. Do not proceed beyond a **CAUTION** notice until the indicated conditions are fully understood and met.

WARNING

A **WARNING** notice denotes a hazard. It calls attention to an operating procedure, practice, or the like that, if not correctly performed or adhered to, could result in personal injury or death. Do not proceed beyond a **WARNING** notice until the indicated conditions are fully understood and met.

Safety Information

The following general safety precautions must be observed during all phases of this instrument. Failure to comply with these precautions or with specific warnings elsewhere in this manual violates safety standards of design, manufacture, and intended use of the instrument. Agilent Technologies, Inc. assumes no liability for the customer's failure to comply with these requirements.

Regulatory Markings



The CE mark is a registered trademark of the European Community. This CE mark shows that the product complies with all the relevant European Legal Directives.

ICES/NMB-001

ICES/NMB-001 indicates that this ISM device complies with Canadian ICES-001.



The CSA mark is a registered trademark of the Canadian Standards Association. A CSA mark with the indicators "C" and "US" means that the product is certified for both the U.S. and Canadian markets, to the applicable American and Canadian standards.



















The UL Mark is a registered trademark of Underwriters Laboratories Inc. UL listing mark with the indicators "C" and "US" indicates the product compliance with both Canadian and U.S. requirements.



The C-tick mark is a registered trademark of the Spectrum Management Agency of Australia. This signifies compliance with the Australian EMC Framework regulations under the terms of the Radio Communications Act of 1992.

Safety Symbols

The following symbols indicate that precautions must be taken to maintain safe operation of the instrument.

	Direct current
	Alternating current
	Both direct and alternating current
	Three-phase alternating current
	Earth (ground) terminal
	Protective conductor terminal
	Frame or chassis terminal
	Equipotentiality
	On (Supply)
	Off (Supply)
	Equipment protected throughout by double insulation or reinforced insulation
	Caution, risk of electric shock
	Caution, hot surface
	Caution, risk of danger (See note.)
	In position of a bi-stable push control
	Out position of a bi-stable push control

General Safety Information

WARNING

- **Do not use the device if it is damaged. Before you use the device, inspect the case. Look for cracks or missing plastic. Do not operate the device around explosive gas, vapor or dust.**
 - **Do not apply more than the rated voltage (as marked on the device) between terminals, or between terminal and external ground.**
 - **Always use the device with the cables provided.**
 - **Observe all markings on the device before connecting to the device.**
 - **Turn off the device and application system power before connecting to the I/O terminals.**
 - **When servicing the device, use only specified replacement parts.**
 - **Do not operate the device with the removable cover removed or loosened.**
 - **Do not connect any cables and terminal block prior to performing self-test process.**
 - **Use only the power adapter supplied by the manufacturer to avoid any unexpected hazards.**
-

CAUTION

- Do not load the output terminals above the specified current limits. Applying excessive voltage or overloading the device will cause irreversible damage to the circuitry.
 - Applying excessive voltage or overloading the input terminal will damage the device permanently.
 - If the device is used in a manner not specified by the manufacturer, the protection provided by the device may be impaired.
 - Always use dry cloth to clean the device. Do not use ethyl alcohol or any other volatile liquid to clean the device.
 - Do not permit any blockage of the ventilation holes of the device.
-

Waste Electrical and Electronic Equipment (WEEE) Directive 2002/96/EC

This instrument complies with the WEEE Directive (2002/96/EC) marking requirement. This affixed product label indicates that you must not discard this electrical/electronic product in domestic household waste.

Product Category:

With reference to the equipment types in the WEEE directive Annex 1, this instrument is classified as a “Monitoring and Control Instrument” product.

The affixed product label is shown as below:

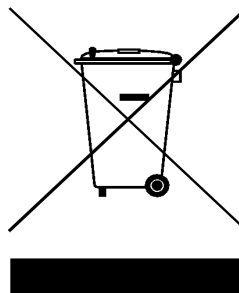

Do not dispose in domestic household waste

To return this unwanted instrument, contact your nearest Agilent office, or visit:

<http://www.agilent.com/environment/product>

for more information.

In This Guide...

1 Characteristics and Specifications

This chapter specifies the product specifications and electrical measurement specifications of the U2500A series USB simultaneous sampling multifunction DAQ devices.

2 Calibration

This chapter describes the step-by-step calibration procedures that covers hardware setup, self calibration, performance verification procedures, and adjustment procedures.

3 Dismantle Procedures

This chapter shows the step-by-step disassemble procedures and lists the available replacement parts together with its part number for the U2500A series USB simultaneous sampling multifunction DAQ devices.

4 Troubleshooting and Self-Test Procedures

This chapter includes the information on general troubleshooting hints and self test procedures for the U2500A series USB simultaneous sampling multifunction DAQ devices.

A Appendix A Connector Pins Configuration

All the U2500A series USB simultaneous sampling multifunction DAQ devices pins configuration are provided in this appendix.

THIS PAGE HAS BEEN INTENTIONALLY LEFT BLANK.

Contents

1	Characteristics and Specifications	
	Product Characteristics	2
	Product Specifications	3
	Electrical Measurement Specifications	8
	Test Conditions	10
2	Calibration	
	Introduction	12
	Types Of Signal Sources	14
	Ground-referenced signal sources	14
	Floating signal sources	14
	Input Configurations	15
	Differential Input Mode	15
	Hardware Connection	17
	Self-Calibration	21
	Calibration and Performance Verification Procedure	27
	Adjustment Procedures	28
	Calibration Procedure	30
	Step1: On-board 5V calibration	30
	Step2: Self calibration	31
	Step3: DAQ configuration and verification test	32
	Performance Verification Steps	34

Contents

	Analog input	34
	Analog output	40
3	Dismantle Procedures	
	General Disassemble	50
	Mechanical disassemble	50
	Replacement Parts	54
4	Troubleshooting and Self-Test Procedures	
	Troubleshooting	58
	Self-Test Procedures	60
A	Appendix A Connector Pins Configuration	
	Introduction	62
	Connector Pins Configuration for U2531A/U2541A/U2542A	63
	55-pin Connector (J1) Pins Configuration	65

List of Figures

- Figure 1-1 Operational common mode voltage range 7
- Figure 2-3 The analog input and calibrator connection 18
- Figure 2-4 The analog input and calibrator connection 18
- Figure 2-5 The analog output and DMM connection 20
- Figure 2-6 The analog output and DMM connection 20
- Figure 2-7 Launch the Interactive IO in Agilent Connection Expert 22
- Figure 2-8 Interactive IO dialog box 23
- Figure 2-9 Self Calibration Form dialog box in Agilent Measurement Manager 24
- Figure 2-10 Self Calibration Form dialog box in Agilent Measurement Manager with a device being selected 25
- Figure 2-11 Self Calibration Form dialog box in Agilent Measurement Manager showing the status and result of the self-calibration process 26
- Figure 2-12 5 V calibration steps 28
- Figure 2-13 On-board 5 V calibration steps 30
- Figure 2-14 Self calibration steps and SCPI commands 31
- Figure 2-15 DAQ settings and test steps for analog input 32
- Figure 2-16 DAQ setting and test steps for analog output 33
- Figure 2-17 Calibrator output hardware connection 34
- Figure 2-18 Analog output channel A0201 with DMM 1 40
- Figure 2-19 Analog output channel for A0202 for DMM 2 41
- Figure A-1 Connector in vertical view 62
- Figure A-2 Connector in horizontal view 62
- Figure A-3 Pins configuration for U2531A/U2541A/U2542A 63
- Figure A-4 Connector (J1) 55-pin 65

Contents

List of Tables

Table 1-1	Analog input product specifications for U2500A series DAQ devices	3
Table 1-2	Analog output product specifications for U2500A series DAQ devices	3
Table 1-3	Digital I/O product specifications for U2500A series DAQ devices	4
Table 1-4	General purpose digital counter product specifications for U2500A series DAQ devices	4
Table 1-5	Analog trigger product specifications for U2500A series DAQ devices	4
Table 1-6	Digital trigger product specifications for U2500A series DAQ device	5
Table 1-7	Analog input product specifications for U2500A series DAQ devices	5
Table 1-8	Physical product specifications for U2500A series DAQ devices	5
Table 1-9	Power consumption product specifications for U2500A series DAQ devices	5
Table 1-10	Environment product specifications for U2500A series DAQ devices	5
Table 1-11	General product specifications for U2500A series DAQ devices	6
Table 1-12	Analog input electrical measurement specifications for U2500A series DAQ devices	8
Table 1-13	Analog output electrical measurement specifications for U2500A series DAQ devices	8
Table 1-14	Dynamic range test for U2500A series DAQ devices.	10
Table 1-15	Bandwidth Test for U2500A series DAQ devices.	10
Table 2-1	Step-by-step descriptions for 5 V calibration flow chart	29
Table 2-2	Offset error for U2541A/U2542A	36
Table 2-3	Offset error for U2531A	36
Table 2-4	Gain error for U2541A/U2542A	38
Table 2-5	Gain error for U2531A	39
Table 2-6	Offset error for U2541A/U2542A	42
Table 2-7	Offset error for U2531A	42
Table 2-8	Gain error for U2541/U2542A.	43
Table 2-9	Gain error for U2531A	43
Table A-1	Pins legend for U2531A/U2541A/U2542A	64
Table A-2	U2500A series J1 connector pin assignment	65
Table A-3	U2500A series J1 connector legend	66

THIS PAGE HAS BEEN INTENTIONALLY LEFT BLANK.

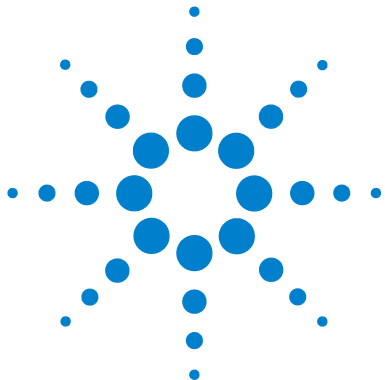

1 Characteristics and Specifications

Product Characteristics	2
Product Specifications	3
Electrical Measurement Specifications	8
Test Conditions	10

This chapter specifies the characteristics, environmental conditions, and specifications of the U2500A DAQ devices.



Product Characteristics

REMOTE INTERFACE	<ul style="list-style-type: none">• Hi-Speed USB 2.0• USBTMC Class Device ^[1]
POWER REQUIREMENT	<ul style="list-style-type: none">• +12 VDC (TYPICAL)• 2 A (MAX) input rated current• Installation Category II
POWER CONSUMPTION	+12 VDC, 480 mA maximum
OPERATING ENVIRONMENT	<ul style="list-style-type: none">• Operating temperature from 0 °C to +55 °C• Relative humidity at 15% to 85% RH (non-condensing)• Altitude up to 2000 meters• Pollution Degree 2• For indoor use only
STORAGE COMPLIANCE	–20 °C to 70 °C
SAFETY COMPLIANCE	Certified with: <ul style="list-style-type: none">• IEC 61010-1:2001/EN 61010-1:2001 (2nd Edition)• USA: UL61010-1: 2004• Canada: CSA C22.2 No.61010-1:2004
EMC COMPLIANCE	<ul style="list-style-type: none">• IEC/EN 61326-1 1998• CISPR 11: 1990/EN55011:1991, Class A, Group 1• CANADA: ICES-001: 1998• Australia/New Zealand: AS/NZS 2064.1
SHOCK & VIBRATION	Tested to IEC/EN 60068-2
IO CONNECTOR	68-pin female VHDCI Type
DIMENSION (WxDxH)	<ul style="list-style-type: none">• 120.00 mm x 182.40 mm x 44.00 mm (with plastic casing)• 105.00 mm x 174.54 mm x 25.00 mm (without plastic casing)
WEIGHT	<ul style="list-style-type: none">• 565 g (with plastic casing)• 400 g (without plastic casing)
WARRANTY	Three years

[1] Requires a direct USB connection to the PC so the appropriate driver can be installed in the USB modular instrument or USB DAQ module.

Product Specifications

Table 1-1 Analog input product specifications for U2500A series DAQ devices

Analog Input			
Model Number	U2531A	U2541A	U2542A
Resolution	14 bits	16 bits	
Number of channels	4 Differential Input Channels (software selectable/channel)		
Maximum sampling rate per channel	2 MSa/s	250 kSa/s	500 kSa/s
Programmable bipolar input range ^[1]	± 10 V, ± 5 V, ± 2.5 V, ± 1.25 V		
Programmable unipolar input range	0 to 10 V, 0 to 5 V, 0 to 2.5 V, 0 to 1.25 V		
Input coupling	DC		
Input impedance	1 G Ω / 100 pF		
Operational common mode voltage range	± 7.5 V maximum ^[6]		
Overvoltage protection	Power on: Continuous ± 30 V, Power off: Continuous ± 15 V		
Trigger sources	External analog/digital trigger, SSI/star trigger ^[2]		
Trigger modes	Pre-trigger, delay-trigger, post-trigger and middle-trigger		
FIFO buffer size	Up to 8 MSa		

Table 1-2 Analog output product specifications for U2500A series DAQ devices

Analog Output	
Model Number	U2531A U2541A U2542A
Resolution	12 bits
Number of channels	2
Maximum update rate	1 MSa/s
Output ranges	0 to 10 V, ± 10 V, 0 to AO_EXT_REF, \pm AO_EXT_REF ^[3]
Output coupling	DC
Output impedance	0.1 Ω Typical
Stability	Any passive load up to 1500 pF
Power-on state	0 V steady state
Trigger sources	External analog/digital trigger, SSI/star trigger ^[2]
Trigger modes	Post-trigger and delay-trigger
FIFO buffer size	1 channel used: Maximum 8 MSa 4 channels used: Maximum 2 MSa/ch
Glitch Energy	5 ns-V [Typical] 80 ns-V [Maximum]
Driving Capability	5 mA
Function generation mode	Sine-wave, square-wave, triangle, sawtooth and noise waveform

1 Characteristics and Specifications

Table 1-3 Digital I/O product specifications for U2500A series DAQ devices

Digital I/O	
Model Number	U2531A U2541A U2542A
Number of bits	24-bit programmable input/output
Compatibility	TTL
Input voltage	$V_{IL} = 0.7 \text{ V}$ maximum, $I_{IL} = 10 \text{ }\mu\text{A}$ maximum $V_{IH} = 2.0 \text{ V}$ minimum, $I_{IH} = 10 \text{ }\mu\text{A}$ maximum
Input voltage range	-0.5 V to +5.5 V
Output voltage	$V_{OL} = 0.45 \text{ V}$ maximum, $I_{OL} = 8 \text{ mA}$ maximum $V_{OH} = 2.4 \text{ V}$ minimum, $I_{OH} = 400 \text{ }\mu\text{A}$ maximum

Table 1-4 General purpose digital counter product specifications for U2500A series DAQ devices

General Purpose Digital Counter	
Model Number	U2531A U2541A U2542A
Maximum count	$(2^{31} - 1)$ bits
Number of channels	Two independent up/down counter
Compatibility	TTL
Clock source	Internal or external
Base clock available	48 MHz
Maximum clock source frequency	12 MHz
Input frequency range ^[4]	0.1 Hz to 6 MHz at 50% duty cycle
Pulse width measurement range	$(0.167 \text{ }\mu\text{s}$ to $178.956 \text{ s}) \pm 0.0833 \text{ }\mu\text{s}$

Table 1-5 Analog trigger product specifications for U2500A series DAQ devices

Analog Trigger	
Model Number	U2531A U2541A U2542A
Trigger source	All analog input channels, External analog trigger (EXTA_TRIG)
Trigger level	\pm Full scale for internal; $\pm 10 \text{ V}$ for external
Trigger conditions	Above high, below low and window (software selectable)
Trigger level resolution	8 bits
Bandwidth	400 kHz
Input impedance for EXTA_TRIG	20 k Ω
Coupling	DC
Overvoltage protection	Continuous for $\pm 35 \text{ V}$ maximum

Table 1-6 Digital trigger product specifications for U2500A series DAQ device

Digital Trigger	
Model Number	U2531A U2541A U2542A
Compatibility	TTL/CMOS
Response	Rising or falling edge
Pulse width	20 ns minimum

Table 1-7 Analog input product specifications for U2500A series DAQ devices

Calibration ^[5]	
Model Number	U2531A U2541A U2542A
On board reference voltage	5 V
Temperature drift	±2 ppm/°C
Stability	±6 ppm/1000 hours

Table 1-8 Physical product specifications for U2500A series DAQ devices

Physical	
Model Number	U2531A U2541A U2542A
Dimension	120 mm x 182.40 mm x 44 mm (W x D x H) with plastic cover 105 mm x 174.54 mm x 25 mm (W x D x H) without plastic cover
I/O connector	68-pin female VHDCI Type
Weight	565 g with plastic casing 400 g without plastic casing

Table 1-9 Power consumption product specifications for U2500A series DAQ devices

Power Consumption			
Model Number	U2531A	U2541A	U2542A
Input voltage (DC)	+12 VDC	+12 VDC	+12 VDC
Input current	480 mA maximum	390 mA maximum	390 mA maximum

Table 1-10 Environment product specifications for U2500A series DAQ devices

Environment	
Model Number	U2531A U2541A U2542A
Operating temperature	0 to 55 °C
Storage temperature	-20 °C to 70 °C
Relative humidity	15% to 85% RH (non condensing)

1 Characteristics and Specifications

Table 1-11 General product specifications for U2500A series DAQ devices

General	
Model Number	U2531A U2541A U2542A
Remote interface	Hi-Speed USB 2.0
Device class	USBTMC Class Device ^[7]
Programmable interface	Standard Commands for Programmable Instruments (SCPI) and IVI-COM

[1] Maximum input voltage for analog input is ± 10 V.

[2] System Synchronous Interface (SSI) and star-trigger commands are used when modular devices are used in modular instrument chassis (U2781A).

[3] Maximum external reference voltage for analog output (AO_EXT_REF) is ± 10 V.

[4] Measurement frequency's resolution = $12 \text{ MHz}/n$, $n = 2, 3, 4, 5, \dots, 120M$
= 6 MHz, 4 MHz, 3 MHz, 2.4 MHz, 2.0 MHz, ..., 0.1 Hz (up to six decimal points)

[5] Recommended for 20 minutes warm-up time.

[6] Refer to [Figure 1-1](#) for more information.

[7] Requires a direct USB connection to the PC so the appropriate driver can be installed in the USB modular instrument or USB DAQ module.

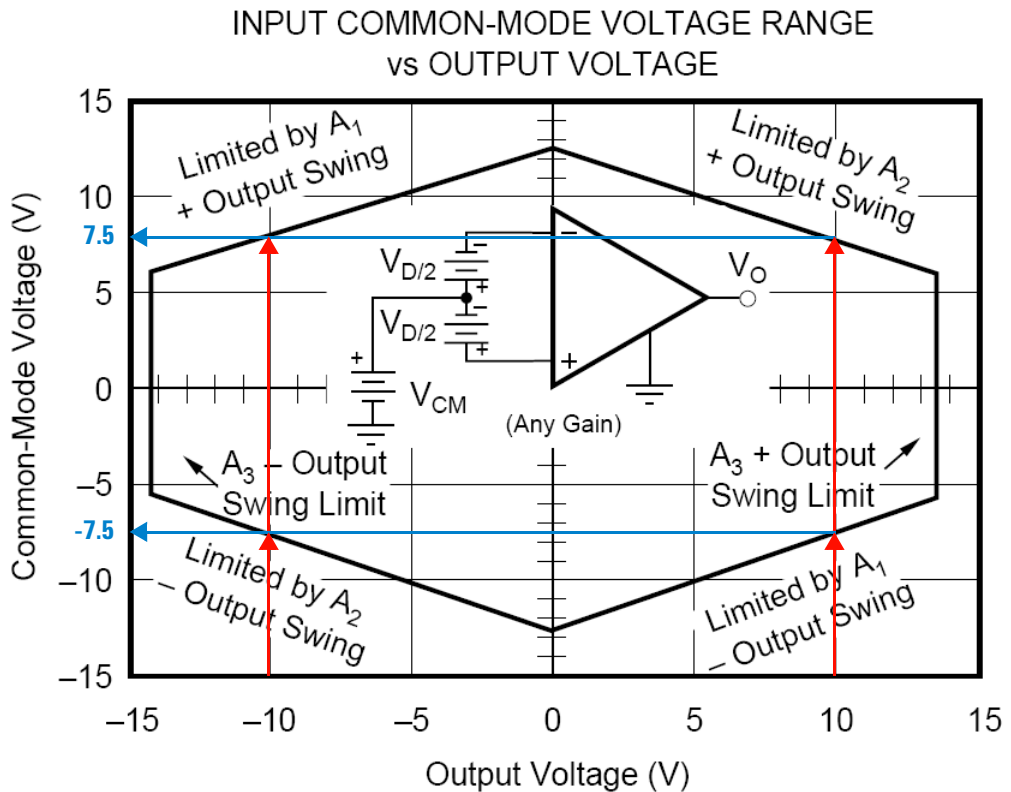

Figure 1-1 Operational common mode voltage range

This graph shows that the common mode voltage range is tightly linked with the output voltage. The output voltage range of the DAQ devices is ± 10 V. Therefore, the common mode voltage range is ± 7.5 V. Any operation beyond these voltage ranges may produce unexpected and unreliable results, and should be avoided.

Electrical Measurement Specifications

Table 1-12 Analog input electrical measurement specifications for U2500A series DAQ devices

Analog Input Measurement ^[1]						
Model Number	U2531A		U2541A		U2542A	
Function	23 °C ± 5 °C	0 °C to 18 °C 28 °C to 55 °C	23 °C ± 5 °C	0 °C to 18 °C 28 °C to 55 °C	23 °C ± 5 °C	0 °C to 18 °C 28 °C to 55 °C
Offset Error ^[2]	±2 mV	±2 mV	±1 mV	±1mV	±1mV	±1 mV
Gain Error ^[2]	±6 mV	±6 mV	±2 mV	±2.5 mV	±2 mV	±2.5 mV
–3 dB small signal bandwidth	1.2 MHz		600 kHz		1.0 MHz	
1% THD large signal bandwidth	400 kHz		400 kHz		400 kHz	
System noise ^[3]	2 mVrms		0.5 mVrms		0.5 mVrms	
CMRR (DC to 60 HZ)	64 dB		80 dB		80 dB	
Spurious-free dynamic range (SFDR)	76 dB		88dB		86 dB	
Signal-to-noise and distortion ration (SINAD)	70 dB		82 dB		80 dB	
Total harmonic distortion (THD)	–72 dB		–84 dB		–84 dB	
Signal-to-noise ratio (SNR)	72 dB		84 dB		82 dB	
Effective number of bits (ENOB)	11.3-bit		13.3-bit		13.0-bit	
Channels Cross Talk ^[4]	66 dB		84 dB		80 dB	

Table 1-13 Analog output electrical measurement specifications for U2500A series DAQ devices

Analog Output Measurement ^[1]						
Model Number	U2531A		U2541A		U542A	
Function	23 °C ± 5 °C	0 °C to 18 °C 28 °C to 55 °C	23 °C ± 5 °C	0 °C to 18 °C 28 °C to 55 °C	23 °C ± 5 °C	0 °C to 18 °C 28 °C to 55 °C
Offset error	±1 mV	±3 mV	±1 mV	±3 mV	±1 mV	±3mV
Gain error	±3 mV	±4 mV	±2 mV	±4 mV	±2 mV	±4 mV
Slew rate	15 V/μs	15 V/μs	15 V/μs	15 V/μs	15 V/μs	15 V/μs
Rise time	1.1 μs	1.2 μs	1.1 μs	1.2 μs	1.1 μs	1.2 μs
Fall time	1.1 μs	1.2 μs	1.1 μs	1.2 μs	1.1 μs	1.2 μs
Settling time to 1% output error	2 μs		2 μs		2 μs	

[1] Specification are for 20 minutes warm-up, self-calibration at temperature 23 °C and bipolar input voltage range of ± 10 V.

[2] The measurement are calculated with 100 points averaging of data.

[3] The noise rms value is the standard deviation of 20k points.

[4] The cross talk measurement are tested up to input frequency at $F_{in} = (\text{Max Sampling}) / 2$.

Test Conditions

Specifications are based on the following test conditions.

Table 1-14 Dynamic range test for U2500A series DAQ devices.

Dynamic Range Test	Model Number	Test Conditions (DUT setting at ± 10 V bipolar)
SFDR, THD, SINAD, SNR, ENOB	U531A	Sampling Rate: 2 MSa/s Fundamental Frequency: 19.927 kHz Number of points: 65536 Fundamental Input Voltage: FSR -1 dB FS
	U2541A	Sampling Rate: 250 kSa/s Fundamental Frequency: 2.4109 kHz Number of points: 8192 Fundamental Input Voltage: FSR -1 dB FS
	U2542A	Sampling Rate: 500 kSa/s Fundamental Frequency: 4.974 kHz Number of points: 16384 Fundamental Input Voltage: FSR -1 dB FS

Table 1-15 Bandwidth Test for U2500A series DAQ devices.

Bandwidth Test	Model Number	Test Conditions (DUT setting at ± 10 V bipolar)
-3 dB small signal bandwidth 1% THD large signal bandwidth	U531A	Sampling Rate: 2 MSa/s Input Voltage: -3 dB small signal bandwidth 10% FSR 1% THD large signal bandwidth FSR -1 dB FS
	U2541A	Sampling Rate: 250 kSa/s Input Voltage: -3 dB small signal bandwidth 10% FSR 1% THD large signal bandwidth FSR -1 dB FS
	U2542A	Sampling Rate: 500 kSa/s Input Voltage: -3 dB small signal bandwidth 10% FSR 1% THD large signal bandwidth FSR -1 dB FS



2 Calibration

Introduction	12
Types Of Signal Sources	14
Ground-referenced signal sources	14
Floating signal sources	14
Input Configurations	15
Differential Input Mode	15
Hardware Connection	17
Self-Calibration	21
Calibration and Performance Verification Procedure	27
Adjustment Procedures	28
Calibration Procedure	30
Step1: On-board 5V calibration	30
Step2: Self calibration	31
Step3: DAQ configuration and verification test	32
Performance Verification Steps	34
Analog input	34
Analog output	40
A/D Data Conversion	44

This chapter provides the descriptions for the equipments that are required for the calibration procedure and the hardware connections for analog input and analog output. The self-calibration procedure, performance verification procedure, and adjustment procedure are also included.



Introduction

Prior to checking the performance of the instrument, ensure that you have all the equipments listed in the following to perform the verification procedure for analog input and analog output.

Equipment checklist:

- ✓ Agilent U2500A Series USB Multifunction DAQ devices
- ✓ Agilent Digital Multimeter (DMM) 33401A/33410A
- ✓ Fluke Calibrator 5220A/5702A
- ✓ Computer with Agilent IO Libraries Suites installed
- ✓ U2901A Terminal Block
- ✓ USB Mini-B Cable
- ✓ U2901A SCSI Cable

Follow the following steps to ensure the instrument gives accurate analog input readings and analog outputs.

- 1** Perform the self-calibration procedure. See [“Self-Calibration”](#).
- 2** Perform the performance verification procedure. See [“Calibration and Performance Verification Procedure”](#), [“Analog input connection”](#) for information on analog input connection and [“Analog output connection”](#) for information on analog output connection.
- 3** If the instrument gives accurate readings or accurate outputs, adjustment procedure is not necessary. If the instrument does not give accurate readings or accurate outputs, perform the adjustment procedure. See [“Adjustment Procedures”](#).

- 4 After perform the adjustment procedure, repeat the self-calibration procedure and then perform the verification procedure.
- 5 If the instrument still does not give accurate readings or accurate outputs, repeat [step 3](#) and [step 4](#).

Types Of Signal Sources

Ground-referenced signal sources

A ground-referenced signal source is defined as a signal source that is connected in some way to the building's grounding system. This means that the signal source is connected to a common ground point with respect to the U2300A series DAQ (assume the host PC which is connected with DAQ is in the same power ground).

Floating signal sources

A floating signal source is a signal that is not connected to the building's grounding system. It is also a device with an isolated output. Example of floating signal sources are optical isolator output, transformer output, and thermocouple.

Input Configurations

Differential Input Mode

The differential input mode provides two inputs that respond to the difference of the signal voltage. The analog input of the U2300A series DAQ has its own reference ground or signal return path. The differential mode can be used for the common-mode noise rejection if the signal source is ground-referenced. The following figure shows the connection of ground-referenced signal sources under differential input mode.

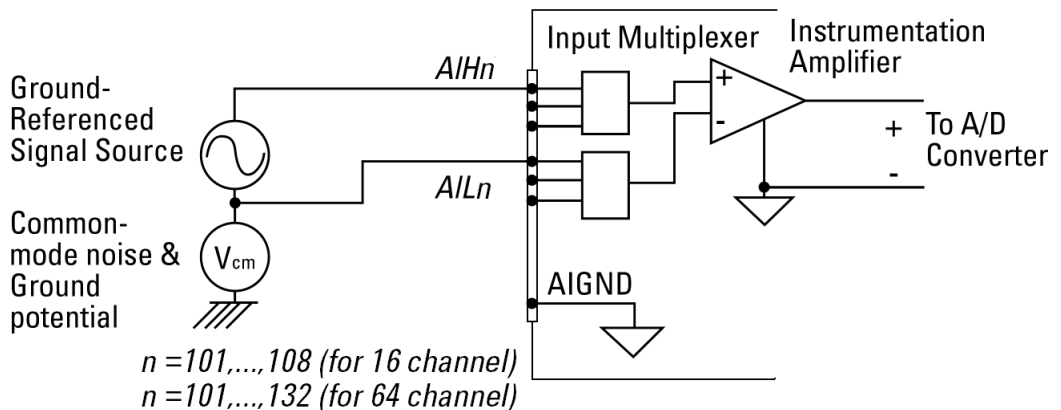

Figure 2-1 Ground-referenced source and differential input mode

The following figure illustrates the connection of a floating signal source to the U2300A series DAQ in differential input mode. For floating signal sources, additional resistor is needed at each channel to provide a bias return path. The resistor value is equivalent to about 100 times the source impedance. If the source impedance is less than 100 Ω , you can connect the negative polarity of the signal directly to AI_GND, as well as the negative input of the Instrumentation Amplifier. The noise couples in differential input mode are less compared to the single-ended mode.

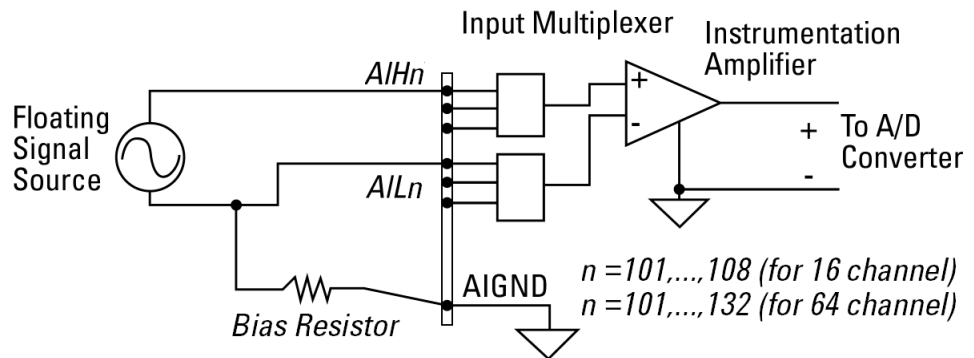

Figure 2-2 Floating source and differential input

NOTE

- Agilent U2300A series DAQ is designed with high input impedance. Please ensure that all the connection are connected properly before acquiring any data. Failing to do so may cause data fluctuation or erroneous readings.
- Unused pins at multiplexing DAQ inputs can be treated as floating source with infinite output impedance. Therefore, necessary grounding system is required in user application system.

Hardware Connection

The connection to verify the analog input readings and analog outputs are different. To verify the analog input readings, see “[Analog input connection](#)” for descriptions on the way to connect the instruments. To verify the analog outputs, see “[Analog output connection](#)” for descriptions on hardware setup.

Analog input connection

The equipments required for analog input connection are the DAQ device, fluke calibrator, terminal block, USB mini-B cable, and SCSI cable. Follow the step-by-step instruction below for analog input connection.

- 1 Connect the DAQ device to a PC with a USB mini-B cable and connect the DAQ device to a U2901A terminal block using the U2901A SCSI cable.

NOTE

- Ensure that the PC has the DAQ device’s driver and the Agilent IO Libraries 14.2 or higher installed. Note that the Agilent Measurement Manager software comes with the standard purchase of the U2500A series DAQ devices.
- If you do not have the DAQ device’s driver and the Agilent IO Libraries 14.2 or higher installed, refer to the *Agilent U2500A Series Data Acquisition Devices and Agilent Measurement Manager Quick Start Guide*, for more information on the installation.

- 2 Short all the DAQ device’s analog input channels. Refer to “[Appendix A Connector Pins Configuration](#)” on page 61” for the pins assignment.
- 3 Connect the DAQ device’s analog input channels to the AIH channel calibrator output.
- 4 Connect the DAQ device’s analog input ALL channel to the calibrator ground. See [Figure 2-3](#). Note that the analog inputs shown in the figure uses U2531A as an example.

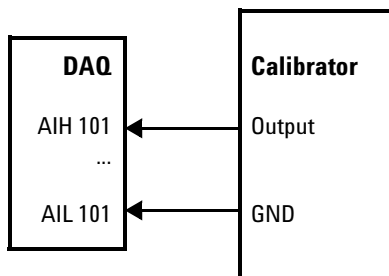

Figure 2-3 The analog input and calibrator connection

Setup diagram

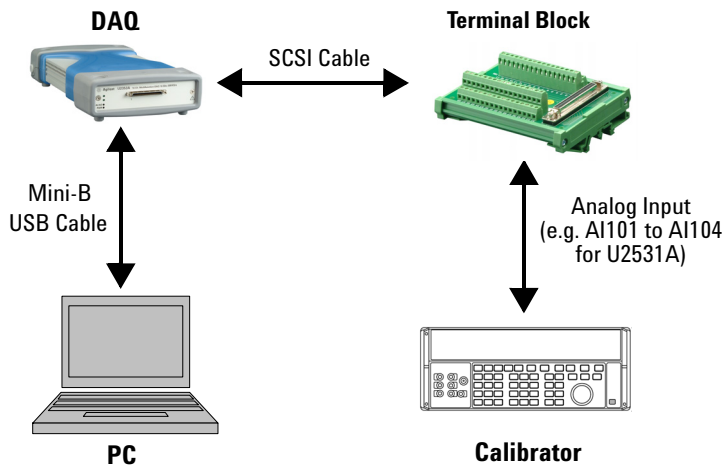

Figure 2-4 The analog input and calibrator connection

Analog output connection

The equipments required for analog output connection are the DAQ device, DMM, terminal block, USB mini-B cable, and SCSI cable. Follow the step-by-step instructions below for analog output connection.

- 1 Connect the DAQ device to a PC with a USB mini-B cable and connect the DAQ device to a U2901A terminal block using the U2901A SCSI cable.

NOTE

- Ensure that the PC has the DAQ device's driver and the Agilent IO Libraries 14.2 or higher installed. Note that the Agilent Measurement Manager software comes with the standard purchase of the U2500A series DAQ devices.
- If you do not have the DAQ device's driver and the Agilent IO Libraries 14.2 or higher installed, refer to the *Agilent U2500A Series Data Acquisition Devices and Agilent Measurement Manager Quick Start Guide*, for more information on the installation.

- 2 Connect a wire at each pin you would like to test on the U2901A terminal block. (Refer to "[Appendix A Connector Pins Configuration](#)" for the pins assignment)
- 3 Connect the DAQ device's analog output channel 1 (AO201) to the DMM input.
- 4 Connect the DAQ device's analog output ground (AO_GND) to DMM GND.
- 5 Repeat [step 3](#) and [step 4](#) for analog output channel 2 (AO202).

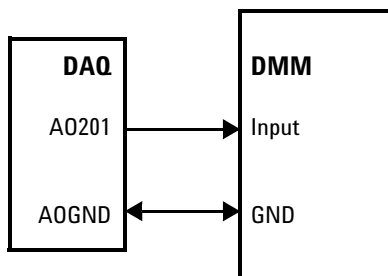

Figure 2-5 The analog output and DMM connection

Setup diagram

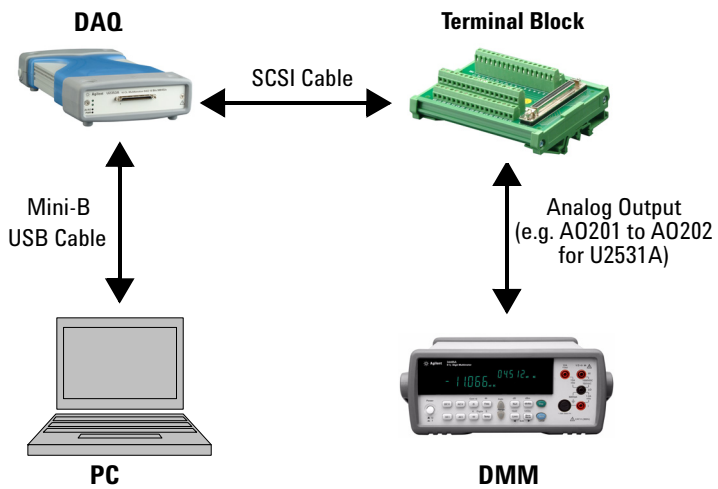

Figure 2-6 The analog output and DMM connection

Self-Calibration

Self-calibration can be operated using the following SCPI command via the Agilent Connection Expert.

```
CALibration:BEgin
```

In calibration mode, the command will initiate a voltage adjustment in sequence for the specified Digital Analog Converter (DAC) channel. This sequence sets a zero and gain adjustment constant for each DAC output.

The function of DAQ device will not carry on until the self-calibration has completed. You can query the status of the self-calibration performed using the following SCPI command.

```
*OPC?
```

Two ways of performing the self-calibration will be introduced in this section. The first option is to use the Agilent Connection Expert to send the SCPI commands and the second option is to use the Agilent Measurement Manager application software.

Option 1: Self-calibration with Agilent Connection Expert

WARNING

- **Unplug all cables that are connected to the DAQ device before performing self-calibration.**
- **Any cables connected to the DAQ device may cause the failure of the self-calibration process.**

- 1 Power on the DAQ and disconnect all connections from DAQ device. Warm it up for 30 minutes to ensure that it is operating in a stable condition.
- 2 Go to **Start > All Programs > Agilent IO Libraries Suite > Agilent Connection Expert** to launch the Agilent Connection Expert.

- 3 Connect the DAQ device to the PC with mini-B type USB cable. The connected DAQ device will be visible in the **Instrument I/O on this PC** panel as illustrated in [Figure 2-7](#).
- 4 Select the DAQ device that you wish to send the SCPI commands to and then click the **Interactive IO** icon on the toolbar to launch the Agilent Interactive IO. See [Figure 2-7](#).

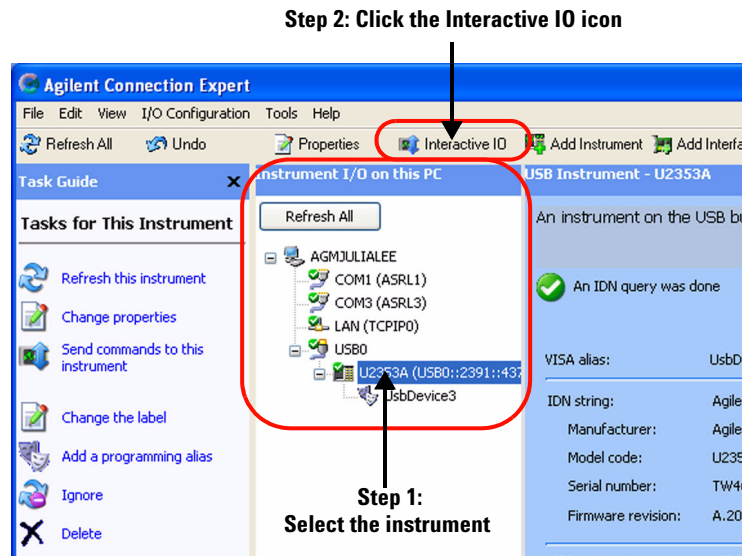

Figure 2-7 Launch the Interactive IO in Agilent Connection Expert

- 5 The **Agilent Interactive IO** dialog box will appear as shown in [Figure 2-8](#). Click **Send & Read** to send the “*IDN?” default command. This instrument’s response should appear in the **Instrument Session History** panel.
- 6 Successful communication between the Agilent Connection Expert and the connected hardware will be shown in the **Instrument Session History** panel. The users may now send other SCPI commands to the instrument.

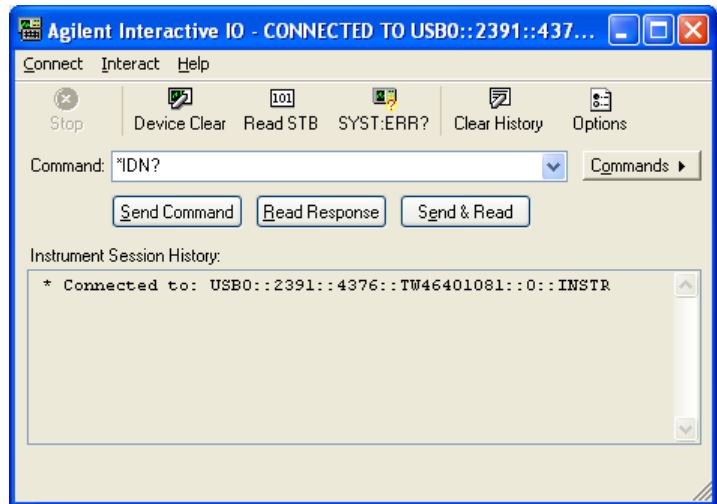

Figure 2-8 Interactive IO dialog box

- 7** Ensure that the DAQ device has been warmed up for 30 minutes. Send the SCPI commands “*RST” and “*CLS” to clear the register in DAQ device.
- 8** Send “CAL:BEG” to start the self-calibration process. This process may take a few minutes to complete.
- 9** Send “*OPC?” to check the operation complete status.
- 10** If “*OPC?” returns 1, send “SYST:ERR?” to check if any system error has occurred during the self-calibration process. If there is no system error, the self-calibration process is done. Otherwise, the self-calibration process is failed.

Option 2: Self-calibration with Agilent Measurement Manager

WARNING

- **Unplug all cables that are connected to the DAQ device before performing self-calibration.**
- **Any cables connected to the DAQ device may cause the failure of the self-calibration process.**

- 1 Power on the DAQ device and disconnect all connections from it. Warm it up for 30 minutes to ensure that it is operating in a stable condition.
- 2 Connect the DAQ device to the PC with mini-B type USB cable. Launch the Agilent Measurement Manager and select the DAQ device you wish to do the self-calibration process.
- 3 Go to **Tools** and select **Self Calibration**.
- 4 The **Self Calibration Form** dialog box will appear as shown below.

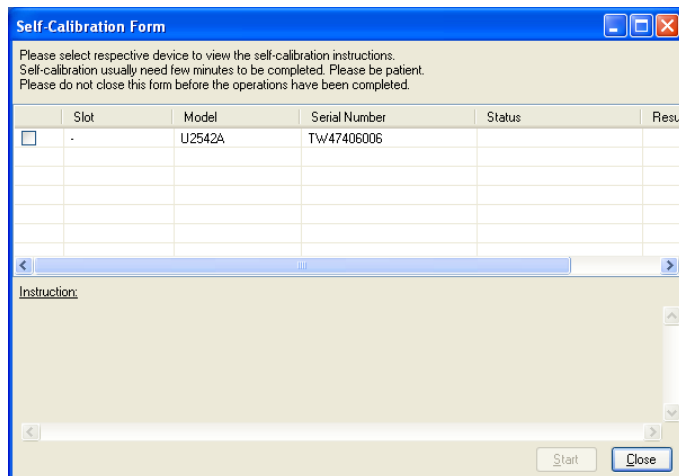

Figure 2-9 Self Calibration Form dialog box in Agilent Measurement Manager

- 5 Select the instrument that you would like to perform self-calibration and the **Start** button will be enabled. Click **Start** to proceed. See [Figure 2-10](#).
- 6 The calibration process will take a few minutes to be completed. Once done, the status and results of the process will be displayed as shown in [Figure 2-11](#).

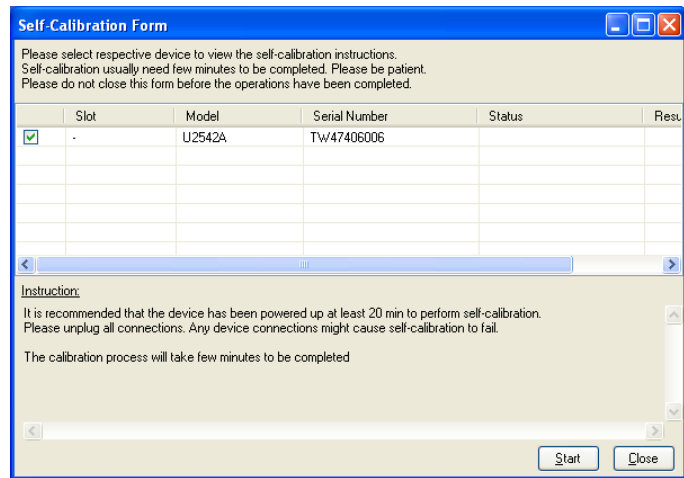

Figure 2-10 Self Calibration Form dialog box in Agilent Measurement Manager with a device being selected

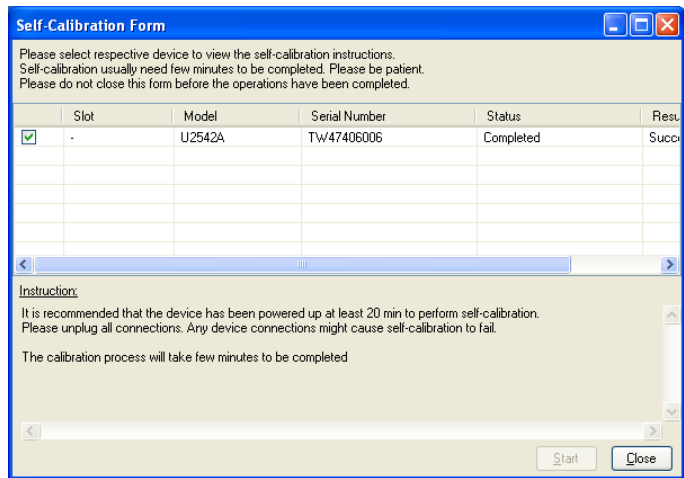

Figure 2-11 Self Calibration Form dialog box in Agilent Measurement Manager showing the status and result of the self-calibration process

Calibration and Performance Verification Procedure

Prior to calibrate the instrument, check the performance of the instrument to see if any adjustment is required, see “[Adjustment Procedures](#)”.

This is to ensure that the DAQ device gives accurate readings or outputs. The performance verification procedure for analog input and analog output are automated and are verify using the *Automated Calibration* software.

Adjustment Procedures

If in the performance verification procedure is not accurate, adjustment procedure is required. The following flowchart shows the steps for 5 V calibration.

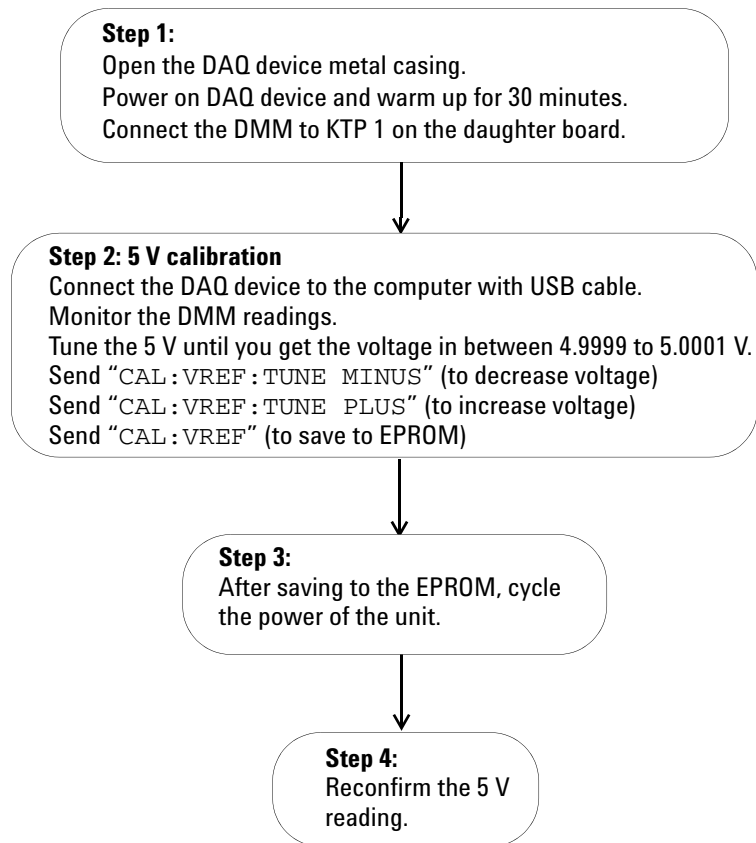



Figure 2-12 5 V calibration steps

Table 2-1 Step-by-step descriptions for 5 V calibration flow chart

Step	Descriptions
Step 1	<p>Before power on the DAQ device, open the DAQ device's metal casing. Refer to "Dismantle Procedures" on page 49" for more information to disassemble the unit. Unscrew the following indicated screw to remove the front metal piece. Then, power on the DAQ device and warm it up for approximately 30 minutes. Connect the DMM to KTP 1 as shown in figure below on the daughter board.</p>
	
Step 2	<p>Ensure that the DAQ device's driver is installed in the computer before connecting it to the computer. The driver can be obtained from the <i>Agilent USB Modular Instrument U2500A & U2600A Series Product Reference CD-ROM</i>. Measure the voltage difference at KTP 1 with the DMM. If the measured voltage is more than 5 V, send the command "CAL : VREF : TUNE MINUS" to decrease the voltage, otherwise if the measured voltage is less than 5 V, send the command "CAL : VREF : TUNE PLUS" to increase the voltage. Tune the voltage until the measured voltage is in the range of 4.9999 V and 5.0001 V. When the tuning process is done, send "CAL : VREF" to save it in the EPROM.</p>
Step 3	<p>Power cycle the DAQ device by turning on and off the DAQ device.</p>
Step 4	<p>Measure the voltage at KTP 1 again to ensure the measured voltage is in the range of 4.9999V to 5.0001 V. If there is any problem occurs, the DMM will not measure the voltage in the specified range. Proceed to self calibration procedure.</p>

Calibration Procedure

The calibration and test steps involve 3 steps:

- 1 Step1: On-board 5V calibration
- 2 Step2: Self calibration
- 3 Step3: DAQ configuration and verification test

Step1: On-board 5V calibration

The flow chart below shows the steps for 5 V calibration.

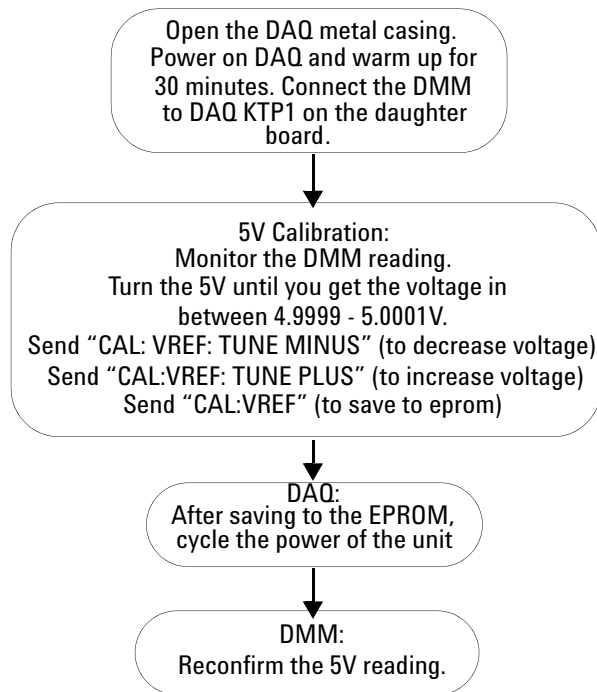

Figure 2-13 On-board 5 V calibration steps

Step2: Self calibration

The following flow chart shows the steps and SCPI commands for the self calibration process.

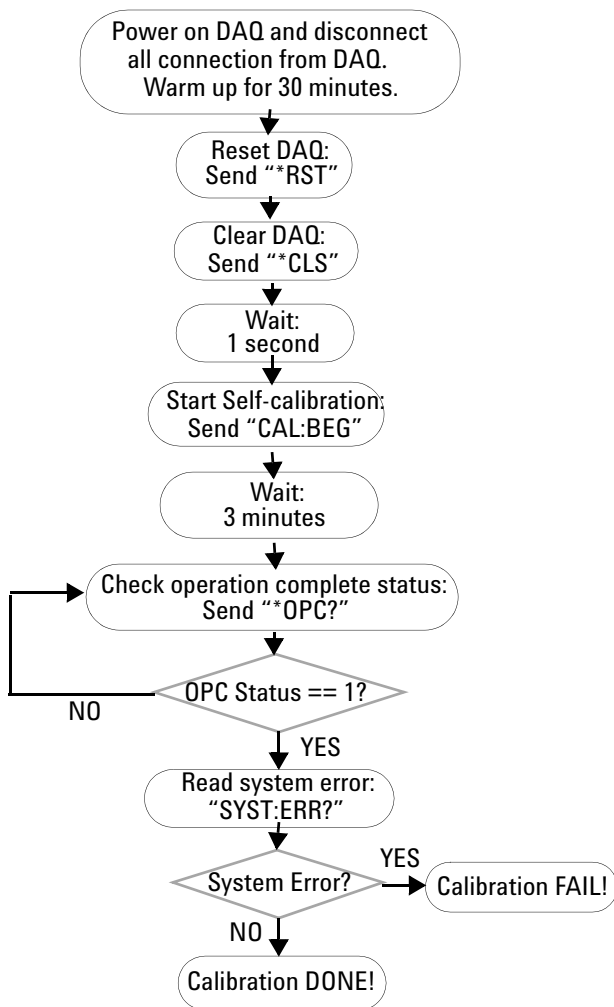

Figure 2-14 Self calibration steps and SCPI commands

Step3: DAQ configuration and verification test

The DAQ settings and test steps for analog input and analog output are shown in the following flow charts.

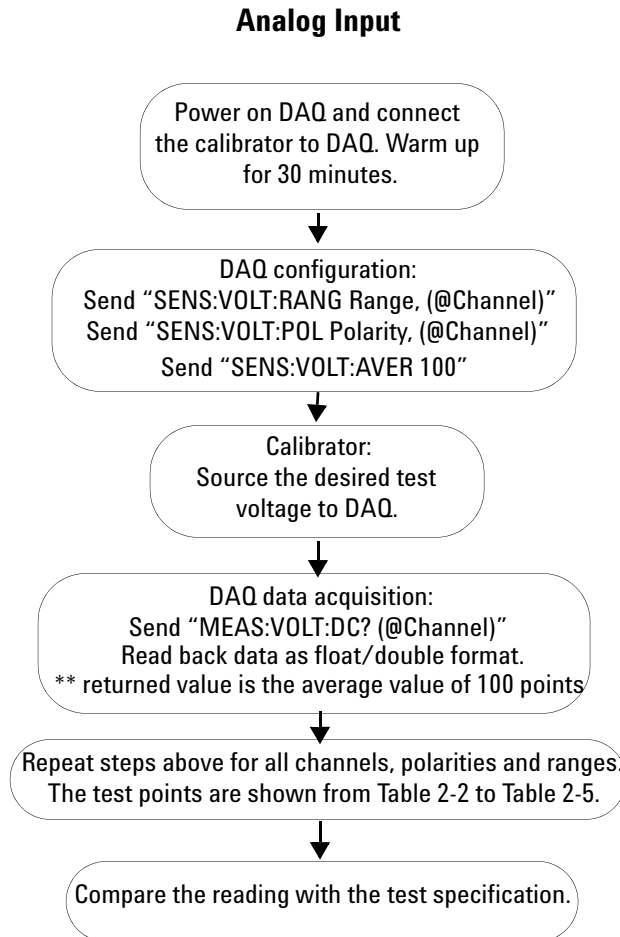

Figure 2-15 DAQ settings and test steps for analog input

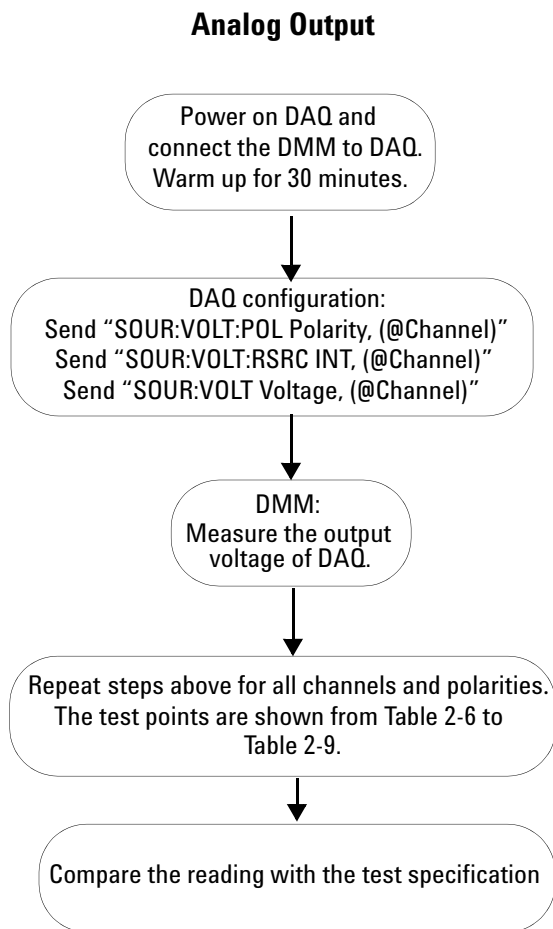

Figure 2-16 DAQ setting and test steps for analog output

Performance Verification Steps

Analog input

- 1 Connect the DAQ device to a PC with a USB mini-B cable and connect the DAQ device to a U2901A terminal block using the U2901A SCSI cable.
- 2 Connect the DAQ device's analog input AIH channel to calibrator output and connect the analog input AIL channel to calibrator ground. Refer to [“Appendix A Connector Pins Configuration”](#) on page 61 for pin assignment. See [Figure 2-3](#) for the hardware connection.

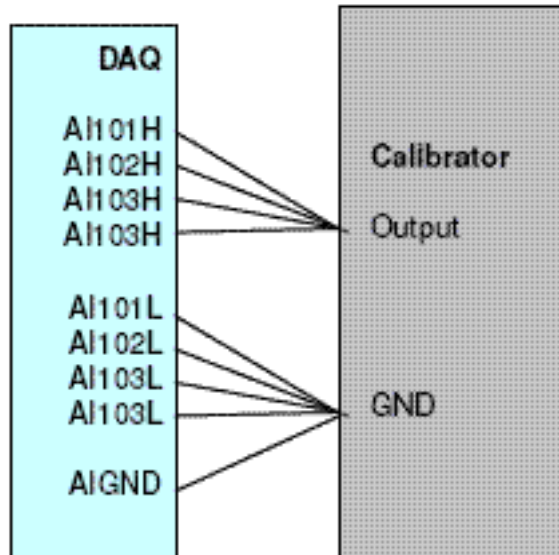

Figure 2-17 Calibrator output hardware connection

NOTE

- The analog inputs shown in the figure uses U2541A as an example only.
- Power on the DAQ device and warm it up for approximately 30 minutes
- Follow the following procedures to verify the Offset error and gain error.

Follow the following procedures to verify offset error:

- 1 Supply an output voltage from calibrator to analog input channels of the DAQ device. Refer to "Test Point" column in the tables below for the output voltage setting from the calibrator.
- 2 Send SCPI commands below for measurement at voltage range BIP 10 V at test point 0 V.

```
*CLS; *RST
```

```
SENS:VOLT:RANG 10, (@101,102,103,104)
```

```
SENS:VOLT:POL BIP, (@101,102,103,104)
```

```
SENS:VOLT:AVER 100,
```

```
MEAS:VOLT:DC? (@101,102,103,104)
```

- 3 Record the measurement reading from DAQ into the table below and calculate the offset error with the formula stated below.

Test Result, Offset Error = DAQ Reading – Calibrator Source Voltage

- 4 Repeat the steps 1 to 3 for voltage range and test point show in table below.

2 Calibration

Table 2-2 Offset error for U2541A/U2542A

Offset Error (V)	Setting	Range (V)		Test Point (V)	Test Limit (V)		Actual Measurement			
		Min	Max		Value	Lower Limit	Upper Limit	CH 101	CH 102	CH 103
0.001	BIP	-10	10	0.00000	-0.00100	0.00100				
0.001	BIP	-5	5	0.00000	-0.00100	0.00100				
0.001	BIP	-2.5	2.5	0.00000	-0.00100	0.00100				
0.001	BIP	-1.25	-1.25	0.00000	-0.00100	0.00100				
0.001	UNIP	0	10	5.00000	4.99900	5.00100				
0.001	UNIP	0	5	2.50000	2.49900	2.50100				
0.001	UNIP	0	2.5	1.25000	1.24900	1.25100				
0.001	UNIP	0	1.25	0.62500	0.62400	0.62600				

Table 2-3 Offset error for U2531A

Offset Error (V)	Setting	Range (V)		Test Point (V)	Test Limit (V)		Actual Measurement			
		Min	Max		Value	Lower Limit	Upper Limit	CH 101	CH 102	CH 103
0.002	BIP	-10	10	0.00000	-0.00200	0.00200				
0.0015	BIP	-5	5	0.00000	-0.00150	0.00150				
0.001	BIP	-2.5	2.5	0.00000	-0.00100	0.00100				
0.001	BIP	-1.25	-1.25	0.00000	-0.00100	0.00100				
0.002	UNIP	0	10	5.00000	4.99800	5.00200				
0.0015	UNIP	0	5	2.50000	2.49850	2.50150				
0.001	UNIP	0	2.5	1.25000	1.24900	1.25100				
0.001	UNIP	0	1.25	0.62500	0.62400	0.62600				

Follow the following procedures to verify gain error:

- 1 Supply an output voltage from the calibrator to the analog input channels. Refer to "Test Point" on table below for the output voltage setting from the calibrator.
- 2 Send SCPI commands below for measurement at voltage range BIP 10V at test point 0V.

```
*CLS; *RST
```

```
SENS:VOLT:RANG 10, (@101,102,103,104)
```

```
SENS:VOLT:POL BIP, (@101,102,103,104)
```

```
SENS:VOLT:AVER 100
```

```
MEAS:VOLT:DC? (@101,102,103,104)
```

- 3 Record the measurement reading from DAQ into the table below and calculate the gain error with the formula stated below.

Test Result, Gain Error = DAQ Reading – Offset Error

- 4 Repeat the steps 1 to 3 for voltage range and test point show in the following table.

2 Calibration

Table 2-4 Gain error for U2541A/U2542A

	Gain Error (V)	Setting	Range (V)		Test Point (V)	Test Limit (V)		Actual Measurement			
			Min	Max		Value	Lower Limit	Upper Limit	CH 101	CH 102	CH 103
Positive Gain	0.001	BIP	-10	10	9.98779	9.98679	9.98879				
Negative Gain	0.001	BIP	-10	10	-9.98779	-9.98879	-9.98679				
Positive Gain	0.001	BIP	-5	5	4.99390	4.99290	4.99490				
Negative Gain	0.001	BIP	-5	5	-4.99390	-4.99490	-4.99290				
Positive Gain	0.001	BIP	-2.5	2.5	2.49695	2.49595	2.49795				
Negative Gain	0.001	BIP	-2.5	2.5	-2.49695	-2.49795	-2.49595				
Positive Gain	0.001	BIP	-1.25	-1.25	1.24847	1.24747	1.24947				
Negative Gain	0.001	BIP	-1.25	-1.25	-1.24847	-1.24947	-1.24747				
Positive Gain	0.002	UNIP	0	10	9.99390	9.99190	9.99590				
Negative Gain	0.002	UNIP	0	10	0.00610	0.00410	0.00810				
Positive Gain	0.001	UNIP	0	5	4.99695	4.99595	4.99795				
Negative Gain	0.001	UNIP	0	5	0.00305	0.00205	0.00405				
Positive Gain	0.001	UNIP	0	2.5	2.49847	2.49747	2.49947				
Negative Gain	0.001	UNIP	0	2.5	0.00153	0.00053	0.00253				
Positive Gain	0.001	UNIP	0	1.25	1.24924	1.24824	1.25024				
Negative Gain	0.001	UNIP	0	1.25	0.00076	-0.00024	0.00176				

Table 2-5 Gain error for U2531A

	Gain Error (V)	Setting	Range (V)		Test Point (V)	Test Limit (V)		Actual Measurement			
			Min	Max		Value	Lower Limit	Upper Limit	CH 101	CH 102	CH 103
Positive Gain	0.006	BIP	-10	10	9.95117	9.94517	9.95717				
Negative Gain	0.006	BIP	-10	10	-9.95117	-9.95717	-9.94517				
Positive Gain	0.003	BIP	-5	5	4.97559	4.97259	4.97859				
Negative Gain	0.003	BIP	-5	5	-4.97559	-4.97859	-4.97259				
Positive Gain	0.002	BIP	-2.5	2.5	2.48779	2.48579	2.49879				
Negative Gain	0.002	BIP	-2.5	2.5	-2.48779	-2.48979	-2.48579				
Positive Gain	0.001	BIP	-1.25	-1.25	1.24390	1.24290	1.24490				
Negative Gain	0.001	BIP	-1.25	-1.25	-1.24390	-1.24490	-1.24290				
Positive Gain	0.003	UNIP	0	10	9.97559	9.97259	9.97859				
Negative Gain	0.003	UNIP	0	10	0.02441	0.02141	0.02741				
Positive Gain	0.0015	UNIP	0	5	4.98779	4.98629	4.98929				
Negative Gain	0.0015	UNIP	0	5	0.01221	0.01071	0.01371				
Positive Gain	0.001	UNIP	0	2.5	2.49390	2.49290	2.49490				
Negative Gain	0.001	UNIP	0	2.5	0.00610	0.00510	0.00710				
Positive Gain	0.001	UNIP	0	1.25	1.24695	1.24595	1.24795				
Negative Gain	0.001	UNIP	0	1.25	0.00305	0.00205	0.00405				

Analog output

- 1 Connect the DAQ device to a PC with a USB mini-B cable and connect the DAQ device to a U2901A terminal block using the U2901A SCSI cable.
- 2 Connect a wire to both of the analog pin you on the U2901A terminal block. (Refer to “[Appendix A Connector Pins Configuration](#)” on page 61 for the pins assignment)
- 3 Prepare two units of 34401A/34410A DMM device
- 4 Connect the DAQ device's analog output channel (AO201) to the first DMM input and AO_GND to the first DMM GND. Repeat the connection for channel AO202 to the second DMM device. See [Figure 2-18](#) and [Figure 2-19](#) for the connection.

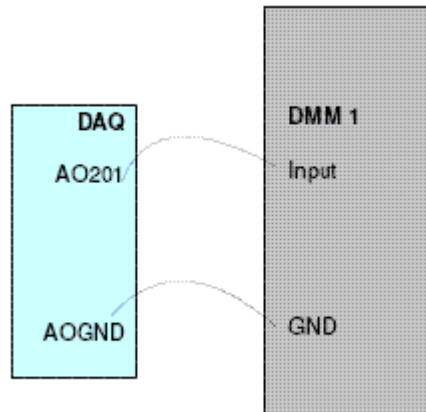

Figure 2-18 Analog output channel A0201 with DMM 1

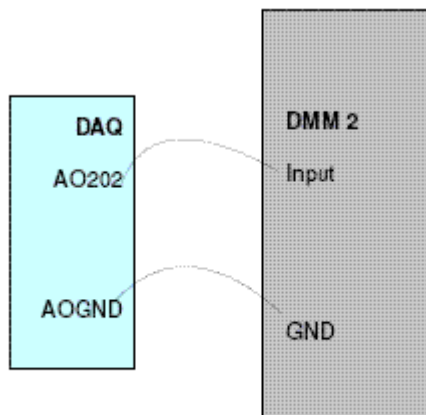

Figure 2-19 Analog output channel for A0202 for DMM 2

Follow the following procedures to verify offset voltage:

- 1 Sending the SCPI commands below for measurement at voltage range BIP 10V:

```
*CLS; *RST
```

```
SOUR:VOLT:POL BIP, (@201,202)
```

```
SOUR:VOLT:RSRC INT, (@201,202)
```

```
SOUR:VOLT 0.0000, (@201,202)
```

- 2 Measure the output voltage from both of the DMM1 and DMM2.
- 3 Record the measurement reading from DMM into the table below and calculate the offset error with the formula stated below.

Test Result, Offset Error = DMM Reading – DAQ Source Voltage

- 4 Repeat the steps 1 to 3 for voltage range and test point show in table below.

2 Calibration

Table 2-6 Offset error for U2541A/U2542A

Offset Error (V)	Setting	Range (V)		Test Point (V)	Test Limit (V)		Actual Measurement	
		Min	Max		Lower Limit	Upper Limit	Channel 201	Channel 202
0.001	BIP	-10	10	0.0000	-0.0010	0.0010		
0.001	UNIP	0	10	0.0000	-0.0010	0.0010		

Table 2-7 Offset error for U2531A

Offset Error (V)	Setting	Range (V)		Test Point (V)	Test Limit (V)		Actual Measurement	
		Min	Max		Lower Limit	Upper Limit	Channel 201	Channel 202
0.001	BIP	-10	10	0.0000	-0.0010	0.0010		
0.001	UNIP	0	10	0.0000	-0.0010	0.0010		

Follow the following procedures to verify gain error:

- 1 Send SCPI commands below for measurement at voltage range BIP 10V :

*CLS; *RST

SOUR:VOLT:POL BIP, (@201,202)

SOUR:VOLT:RSRC INT, (@201,202)

SOUR:VOLT 0.0000, (@201,202)

- 2 Measure the output voltage at DMM1 and DMM2.
- 3 Record the measurement reading from DMM into the table below and calculate the gain error with the formula stated below.

Test Result, Gain Error = DMM Reading – Offset Error

- 4 Repeat the steps 1 to 3 for voltage range and test point show in table below.

Table 2-8 Gain error for U2541/U2542A.

	Gain Error (V)	Setting	Range (V)		Test Point (V)	Test Limit (V)		Actual Measurement	
			Min	Max		Value	Lower Limit	Upper Limit	Channel 201
Positive Gain	0.002	BIP	-10	10	9.9951	9.9931	9.9971		
Negative Gain	0.002	BIP	-10	10	-10.0000	-10.0020	-9.9980		
Positive Gain	0.002	UNIP	0	10	9.9976	9.9956	9.9996		

Table 2-9 Gain error for U2531A

	Gain Error (V)	Setting	Range (V)		Test Point (V)	Test Limit (V)		Actual Measurement	
			Min	Max		Value	Lower Limit	Upper Limit	Channel 201
Positive Gain	0.003	BIP	-10	10	9.9951	9.9921	9.9981		
Negative Gain	0.003	BIP	-10	10	-10.0000	-10.0030	-9.9970		
Positive Gain	0.003	UNIP	0	10	9.9976	9.9946	10.0006		

A/D Data Conversion

A/D data converter converts analog voltage into digital information. This section illustrates the format of acquired raw data from the A/D conversion.

The returned data is in a binary block format. Below is an example of the binary block format for three AI channels (CH 101, CH 102, and CH 103). The data arrangement in data buffer is from lower CH 101 to higher channel CH 103.

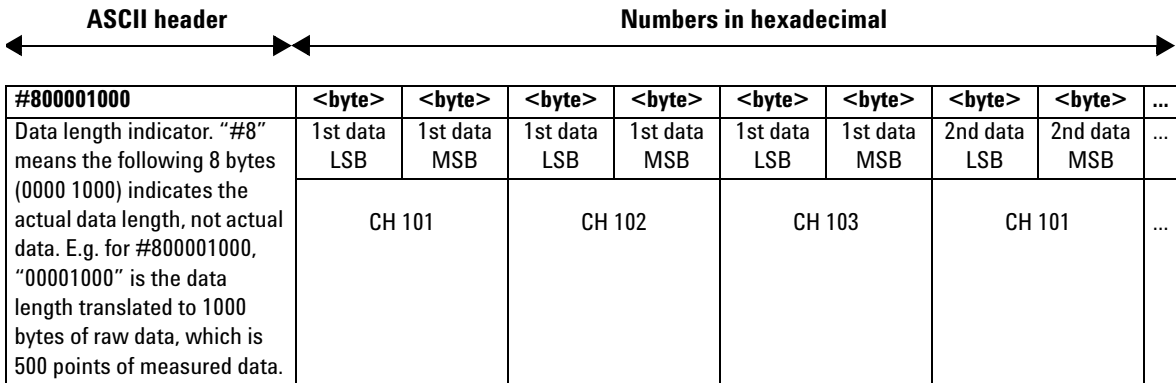

The measured samples in continuous mode acquisition is stored in Little-Endian format. In other words, each measured sample is returned in a way that its least significant byte (LSB) is ordered first; following by its most significant byte (MSB).

16-bit Data Format

LSB	MSB
DDDD DDDD	DDDD DDDD

14-bit Data Format

LSB	MSB
DDDD DDXX	DDDD DDDD

D - Data bits
X - Unused bits

Raw data conversion

To convert the data into actual float number, we need the voltage range and polarity information. Below are the calculations on the raw data conversion for both bipolar and unipolar.

To perform a sample calculation of the conversion, take U2541A as example. Assume that the voltage level is set in the range from 0 V to 10 V for unipolar setting; and -10 V to 10 V for bipolar setting. Sample binary block is as follow.

#800001000	<byte>	<byte>	<byte>	<byte>	<byte>	<byte>	<byte>	<byte>	<byte>	...
	1st data LSB	1st data MSB	1st data LSB	1st data MSB	1st data LSB	1st data MSB	2nd data LSB	2nd data MSB		...
	CH 101		CH 102		CH 103		CH 101			...
Little Endian Format										
#800001000	e0	31	ff	cf	ff	ca	ff	c4		
Convert to Decimal Format										
#800001000	12768		53247		51967		50431			

The resolution for U2541A is 16 bits and the Int16 measured value return by DAQ is 12768. The binary number for 12768 is 00110001 11100000. However, since the data is stored in Little-Endian format, the 16 bits binary read back calculation will be as follow.

	LSB	MSB
Hex value :	e0	31
Binary value :	<11100000>	<00110001>
Decimal value :	12768	

NOTE

The raw data provided by U2500A series DAQ devices is in the byte order of LSB first.

Bipolar:

$$\text{Converted value} = \left(\frac{2 \times \text{Int16 value}}{2^{\text{resolution}}} \right) \times \text{Range}$$

$$\text{Example of converted value} = \left(\frac{2 \times 12768}{2^{16}} \right) \times 10 = 3.896 \text{ V}$$

Unipolar:

$$\text{Converted value} = \left(\frac{\text{Int16 value}}{2^{\text{resolution}}} + 0.5 \right) \times \text{Range}$$

$$\text{Example of converted value} = \left(\frac{12768}{2^{16}} + 0.5 \right) \times 10 = 6.948 \text{ V}$$

NOTE

The converted value is of float type. As such, you may need to type cast the Int16 value to float in your programming environment.

To perform a sample calculation of the conversion, take U2531A as example. Assume that the voltage level is set in the range from 0 V to 10 V for unipolar setting; and -10 V to 10 V for bipolar setting.

The resolution for U2531A is 14 bits and the Int12 measured value return by DAQ is 12768. The binary number for 12768 is 00110001 11100000. However, since the data is stored in Little-Endian format, the 14 bits binary read back calculation will be as follow.

	LSB	MSB
Hex value :	e0	31
Binary value :	<11100000>	<00110001>
Decimal value :	12768	

There are unused bits in the 14-bit data format. Therefore, there is a need to perform a 2-bit right shift operation. Hence, the 14 bits binary read back calculation will be as follows.

$$\begin{array}{r} \text{LSB} \qquad \qquad \text{MSB} \\ \langle 01111100 \rangle \quad \langle 00001100 \rangle \\ = 3192 \end{array}$$

NOTE

The raw data provided by U2500A series DAQ devices is in the byte order of LSB first.

Bipolar:

$$\text{Converted value} = \left(\frac{2 \times \text{Int16 value}}{2^{\text{resolution}}} \right) \times \text{Range}$$

$$\text{Example of converted value} = \left(\frac{2 \times 3192}{2^{14}} \right) \times 10 = 3.896 \text{ V}$$

Unipolar:

$$\text{Converted value} = \left(\frac{\text{Int16 value}}{2^{\text{resolution}}} + 0.5 \right) \times \text{Range}$$

$$\text{Example of converted value} = \left(\frac{3192}{2^{14}} + 0.5 \right) \times 10 = 6.948 \text{ V}$$

NOTE

- The converted value is of float type. As such, you may need to type cast the Int14 value to float in your programming environment.
- For U2531A, there is a need to perform a 2-bit right shift operation. This is because it is equipped with 14-bit ADC and the last 2 bits are truncated.

THIS PAGE HAS BEEN INTENTIONALLY LEFT BLANK.



3 Dismantle Procedures

General Disassemble [50](#)

Mechanical disassemble [50](#)

Replacement Parts [54](#)

This chapter describes the step-by-step disassemble procedures and list the available replacement parts for U2500A series DAQ devices,



General Disassemble

This chapter provides the step-by-step guide on how to dismantle the module and install the replacement assembly. To assemble back the module, follow the instructions in reverse order.

NOTE

The parts shown in the following figures are representative and may look different than what you have in your module.

The removable assemblies include:

- Plastic casing
- Metal casing
- Rear metal casing
- Front metal casing, which is attached to the carrier board and measurement board

Mechanical disassemble

Follow the instructions in this section for the instrument disassemble process.

Step 1: Pull the bumper out to remove the plastic casing.

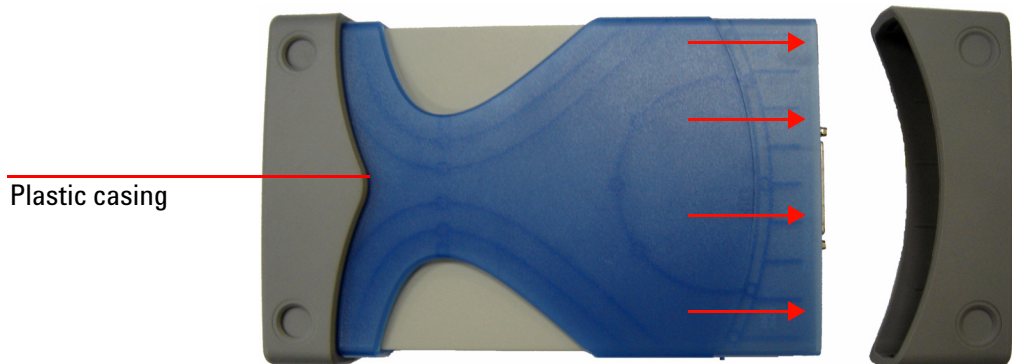

Step 2: Flip the plastic casing open.

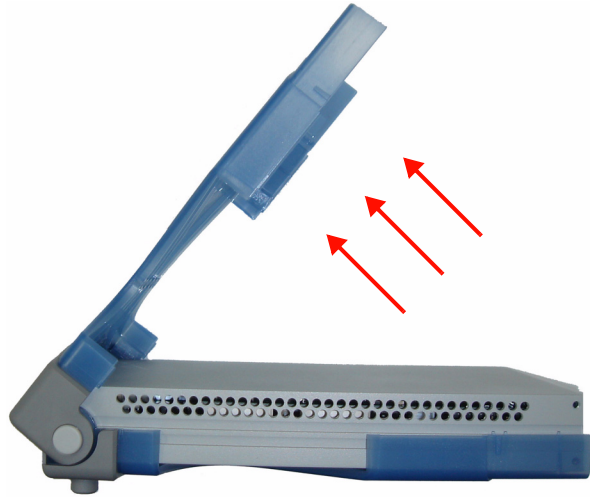

Step 3: Slide the metal casing out of the plastic casing.

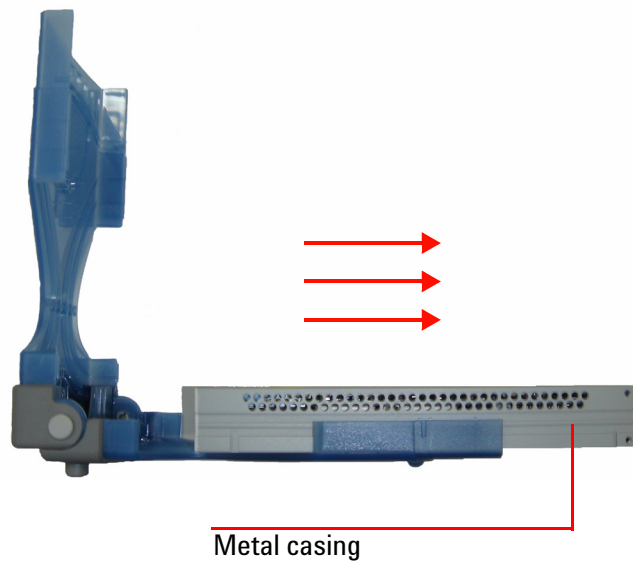

Step 4: Unscrew all the following indicated screws from metal casing.



Step 5: Gently pull the front metal piece out, which is attached to the carrier and measurement boards.



Step 6: Unscrew all the following indicated screws from the metal casing and remove the rear metal piece.



Disassembled parts:

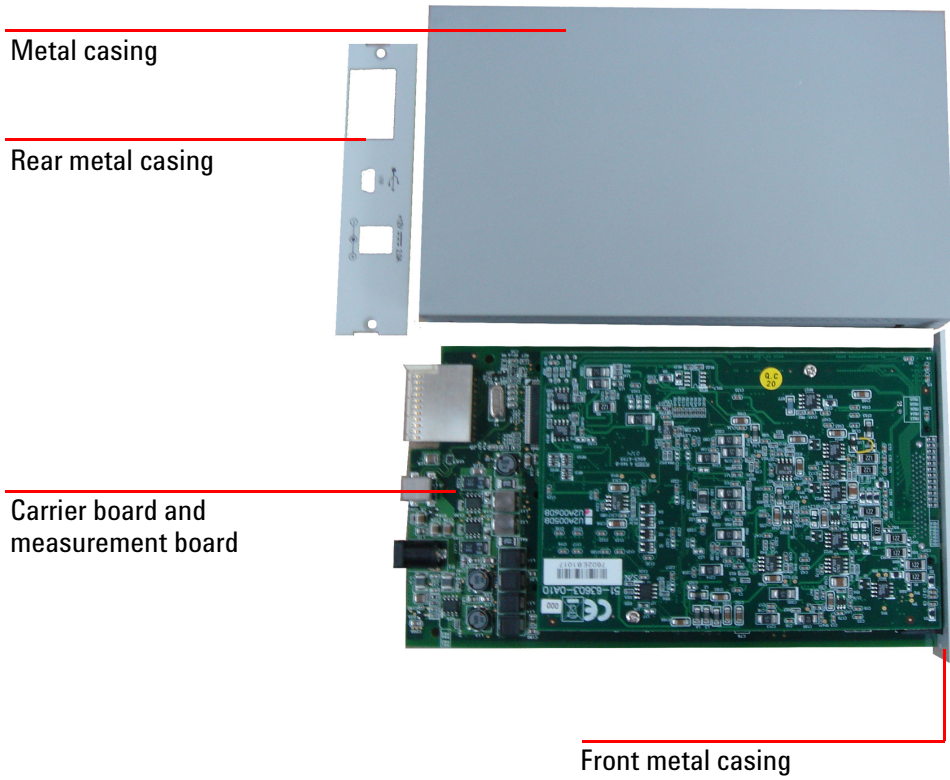

Replacement Parts

This section provides the information of orderable replacement parts for the U2500A series DAQ devices. You can order replacement parts through Agilent's website or you can contact the nearest Agilent Sales Office or Service Centre. To search for the replacement part number online, follow the steps below.

- 1 Launch your Internet Explorer to access Agilent's website (www.agilent.com).
- 2 On the technical support panel, select **Test & Measurement** under the **Parts Information** selection as shown below.

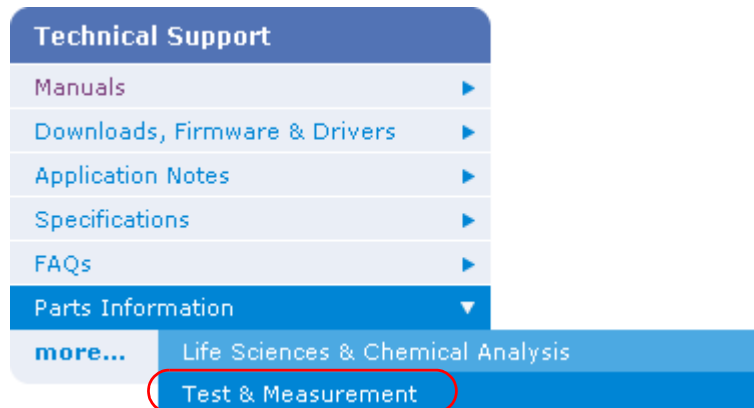

- 3 You can search for the replacement parts by entering a specific replacement part number or by instruments.
 - i To search by part number, type the replacement part number in the text box as shown below.

Search by Part

Part Number

Search by Part [search tips](#)

- ii To search by instrument, type the model number in the text box and click on **View Parts** to select a particular replacement part.

Search by Instrument

Instrument Number

Part Category

Search by Instrument [search tips](#)

Search Results: Instrument Number

Results for: **U2541A*** | Part Category: **All**

1 - 1 of 1. | [click a column heading to sort](#)

Instrument Number	Instrument Description	Replaced by
U2541A	Simultaneous Sampling DAQ, 4-CH differential analog input; 250KS/s;	View Parts

THIS PAGE HAS BEEN INTENTIONALLY LEFT BLANK.

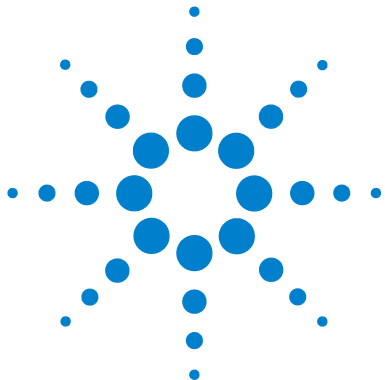

4 Troubleshooting and Self-Test Procedures

Troubleshooting	58
Self-Test Procedures	60

This chapter provides the information on general troubleshooting and self-test procedures.



Troubleshooting

This section provides suggestions for solving general problems that you may encounter with the instrument. It guides you on what to check in the following situations:

1 Power Indicator LED is not lit

Verify that the AC power cord is connected to the power inlet in the DAQ device.

2 Power Indicator LED is lit but the AO/ AI Indicator LED is not lit

Verify that the USB cable is connected to the PC and the USB inlet in the DAQ device.

3 Power Indicator LED is lit and AO/ AI Indicator LED is lit

Verify if the SCPI commands are correct with “SYSTem:ERRor?” command.

4 Power Indicator LED is flashing

Verify that the green LED on the AC/DC adapter is steady. If the LED continues to flash, then there is a hardware defect. Please contact the Agilent Service Center for repair.

If the Agilent U2500A Series USB Multifunction DAQ module is installed in the U2781A 6-slot mainframe, then remove it temporarily and use the AC/DC adapter shipped with the Agilent U2500A Series USB Multifunction DAQ module to power it up.

Refer to the *Agilent U2500A Series USB Simultaneous Sampling Multifunction Data Acquisition Devices Programmer’s Reference* for SCPI error messages.

NOTE

If there is no response from the instrument, contact the nearest Agilent Service Center to obtain further assistance.

Self-Test Procedures

WARNING

Do not connect any cables and terminal block prior to performing self-test procedures.

- 1 Go to **Start > All Programs > Agilent IO Libraries Suite > Agilent Connection Expert** to launch the Agilent Connection Expert.
- 2 Go to **Start > All Programs > Agilent T&M Toolkit > Agilent Interactive IO** to launch the Interactive I/O dialog box.
- 3 Send the SCPI command “*TST?” to the instrument to start perform the self-test of the instrument.
- 4 The command will return either "+0" to indicate all tests passes or "+1" to indicate one or more tests failed.
- 5 If the command returns "+1" , apply SCPI command “SYSTem:ERRor?” to enquire the error message.

NOTE

Refer to *Agilent U2500A Series USB Simultaneous Sampling Multifunction Data Acquisition Devices Programmer's Reference* for SCPI error messages.



A

Appendix A Connector Pins Configuration

Introduction	62
Connector Pins Configuration for U2531A/U2541A/U2542A	63
55-pin Connector (J1) Pins Configuration	65

This appendix attached the pins configuration for all the U2500A series DAQ devices.



Introduction

The U2500A series USB simultaneous sampling multifunction data acquisition (DAQ) devices are equipped with 68-pin female VHDCI type connector. The connector pins configuration for all of the U2500A series DAQ devices are provided in this chapter.

When the DAQ module is used in a modular instrument chassis (U2781A), see [Figure A-1](#) for the pins numbering. When the DAQ module is used as a standalone unit, see [Figure A-2](#).

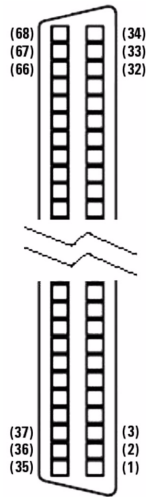

Figure A-1 Connector in vertical view

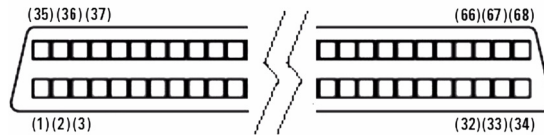

Figure A-2 Connector in horizontal view

Connector Pins Configuration for U2531A/U2541A/U2542A

AIH101	1	35	AIL 101
AIH102	2	36	AIL 102
AIH103	3	37	AIL 103
AIH104	4	38	AIL 104
EXTA_TRIG	5	39	AI_GND
AO202	6	40	AO_GND
AO201	7	41	AO_GND
AO_EXT_REF	8	42	AO_GND
RESERVED	9	43	RESERVED
RESERVED	10	44	RESERVED
RESERVED	11	45	RESERVED
RESERVED	12	46	RESERVED
RESERVED	13	47	EXTD_AO_TRIG
RESERVED	14	48	EXTD_AI_TRIG
COUNT302_CLK	15	49	D_GND
COUNT301_CLK	16	50	D_GND
COUNT301_GATE	17	51	COUNT302_GATE
COUNT301_OUT	18	52	COUNT302_OUT
COUNT301_UPDOWN	19	53	COUNT302_UPDOWN
EXT_TIMEBASE	20	54	D_GND
RESERVED	21	55	RESERVED
Bit-7	22	56	Bit-6
Bit-5	23	57	Bit-4
Bit-3	24	58	Bit-2
Bit-1	25	59	Bit-0
Bit-3	26	60	Bit-2
Bit-1	27	61	Bit-0
D_GND	28	62	D_GND
Bit-3	29	63	Bit-2
Bit-1	30	64	Bit-0
Bit-7	31	65	Bit-6
Bit-5	32	66	Bit-4
Bit-3	33	67	Bit-2
Bit-1	34	68	Bit-0

Figure A-3 Pins configuration for U2531A/U2541A/U2542A

A Appendix A Connector Pins Configuration

Table A-1 Pins legend for U2531A/U2541A/U2542A

Pin	Signal Name	Direction	Reference	Description
1 to 4	AIH<101...104>	Input	AIL<101...104>	Differential positive input for AI channel <101...104>
5	EXTA_TRIG	Input	AI_GND	External AI analog trigger
6	AO202	Output	AO_GND	AO channel 2
7	AO201	Output	AO_GND	AO channel 1
8	AO_EXT_REF	Input	AO_GND	External reference for AO channels
9 to 12	RESERVED	Input	N/A	RESERVED
13, 14	RESERVED	Output	D_GND	RESERVED
15	COUNT<302>_CLK	Input	D_GND	Source of counter <302>
16	COUNG<301>_CLK	Input	D_GND	Source of counter <301>
17, 51	COUNT<301,302>_GATE	Input	D_GND	Gate of counter <301,302>
18, 52	COUNT<301,302>_OUT	Input	D_GND	Output of counter <301,302>
19, 53	COUNT<301,302>_UPDOWN	Input	D_GND	Up/Down of counter <301,302>
20	EXT_TIMEBASE	Input	D_GND	External TIMEBASE
21, 28, 49, 50, 54, 62	D_GND	N/A	N/A	Digital ground
22, 56, 23, 57, 24, 58, 25, 59	DIO502<7,0>	PIO	D_GND	Programmable DIO of Channel 502
26, 60, 27, 61	DIO504<3,0>	PIO	D_GND	Programmable DIO of Channel 504
29, 63, 30, 64	DIO503<3,0>	PIO	D_GND	Programmable DIO of Channel 503
31, 65, 32, 66, 33, 67, 34, 68	DIO501<7,0>	PIO	D_GND	Programmable DIO of Channel 501
35 to 38	AIL<101...104>	Input	N/A	Differential negative input for AI channel<101...104>
39	AI_GND	N/A	N/A	Analog ground for AI
40 to 42	AO_GND	N/A	N/A	Analog ground for AO
43 to 46	RESERVED	Input	N/A	RESERVED
47	EXTD_AO_TRIG	Input	D_GND	External AO waveform trigger
48	EXTD_AI_TRIG	Input	D_GND	External AI digital trigger
21, 55	RESERVED	Input	N/A	RESERVED

55-pin Connector (J1) Pins Configuration

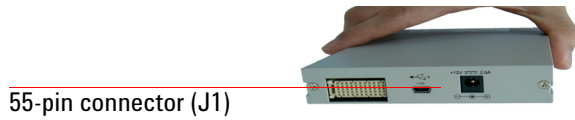

Figure A-4 Connector (J1) 55-pin

Table A-2 U2500A series J1 connector pin assignment

11	GND	+12 V	+12 V	GND	USB_D+	USB_D-	GND
10	GND	+12 V	+12 V	+12 V	GND	GND	GND
9	GND	+12 V	+12 V	+12 V	GND	USB_VBUS	GND
8	GND	LBL0	BRSV	GND	TRIG0	LBR0	GND
7	GND	LBL1	GA0	TRIG7	GND	LBR1	GND
6	GND	LBL2	GA1	GND	TRIG1	LBR2	GND
5	GND	LBL3	GA2	TRIG6	GND	LBR3	GND
4	GND	LBL4	STAR_TRIG	GND	TRIG2	LBR4	GND
3	GND	LBL5	GND	TRIG5	GND	LBR5	GND
2	GND	LBL6	CLK10M	GND	TRIG3	LBR6	GND
1	GND	LBL7	GND	TRIG4	GND	LBR7	GND
	Z	A	B	C	D	E	F

Table A-3 U2500A series J1 connector legend

Pin	Descriptions
+12 V	+12 V power from backplane
GND	Ground
BRSV	Reserved pin
TRIG0 to TRIG7	Trigger bus 0 to 7
STAR_TRIG	Star trigger
CLK10M	10 MHz reference clock
USB_VBUS	USB bused power, +5 V
USB_D+, USB_D-	USB differential pair
LBL <0..7> and LBR <0..7>	Reserved pin
GA0, GA1, GA2	Geographical address pin

www.agilent.com

Contact us

To obtain service, warranty or technical support assistance, contact us at the following phone numbers:

United States:

(tel) 800 829 4444 (fax) 800 829 4433

Canada:

(tel) 877 894 4414 (fax) 800 746 4866

China:

(tel) 800 810 0189 (fax) 800 820 2816

Europe:

(tel) 31 20 547 2111

Japan:

(tel) (81) 426 56 7832 (fax) (81) 426 56

7840

Korea:

(tel) (080) 769 0800 (fax) (080) 769 0900

Latin America:

(tel) (305) 269 7500

Taiwan:

(tel) 0800 047 866 (fax) 0800 286 331

Other Asia Pacific Countries:

(tel) (65) 6375 8100 (fax) (65) 6755 0042

Or visit the Agilent worldwide web at:

www.agilent.com/find/assist

Product specifications and descriptions in this document subject to change without notice. Always refer to the Agilent Web site for the latest revision.

© Agilent Technologies, Inc., 2007–2013

Printed in Malaysia
Seventh Edition, July 26, 2013

U2541-90013



Agilent Technologies