



Agilent U2751A USB Modular Switch Matrix

User's and Service Guide



Agilent Technologies

Notices

© Agilent Technologies, Inc., 2008–2013

No part of this manual may be reproduced in any form or by any means (including electronic storage and retrieval or translation into a foreign language) without prior agreement and written consent from Agilent Technologies, Inc. as governed by United States and international copyright laws.

Manual Part Number

U2751-90011

Edition

Fifth Edition, August 2, 2013

Agilent Technologies, Inc.
5301 Stevens Creek Blvd.
Santa Clara, CA 95051 USA

Trademark Acknowledgements

Pentium is a U.S. registered trademark of Intel Corporation.

Microsoft, Visual Studio, Windows, and MS Windows are trademarks of Microsoft Corporation in the United States and/or other countries.

Warranty

The material contained in this document is provided “as is,” and is subject to being changed, without notice, in future editions. Further, to the maximum extent permitted by applicable law, Agilent disclaims all warranties, either express or implied, with regard to this manual and any information contained herein, including but not limited to the implied warranties of merchantability and fitness for a particular purpose. Agilent shall not be liable for errors or for incidental or consequential damages in connection with the furnishing, use, or performance of this document or of any information contained herein. Should Agilent and the user have a separate written agreement with warranty terms covering the material in this document that conflict with these terms, the warranty terms in the separate agreement shall control.

Technology Licenses

The hardware and/or software described in this document are furnished under a license and may be used or copied only in accordance with the terms of such license.

Restricted Rights Legend

U.S. Government Restricted Rights. Software and technical data rights granted to the federal government include only those rights customarily provided to end user customers. Agilent provides this customary commercial license in Software and technical data pursuant to FAR 12.211 (Technical Data) and 12.212 (Computer Software) and, for the Department of Defense, DFARS 252.227-7015 (Technical Data - Commercial Items) and DFARS 227.7202-3 (Rights in Commercial Computer Software or Computer Software Documentation).

Safety Notices

CAUTION

















A **CAUTION** notice denotes a hazard. It calls attention to an operating procedure, practice, or the like that, if not correctly performed or adhered to, could result in damage to the product or loss of important data. Do not proceed beyond a **CAUTION** notice until the indicated conditions are fully understood and met.

WARNING

A **WARNING** notice denotes a hazard. It calls attention to an operating procedure, practice, or the like that, if not correctly performed or adhered to, could result in personal injury or death. Do not proceed beyond a **WARNING** notice until the indicated conditions are fully understood and met.

Safety Symbols

The following symbols on the instrument and in the documentation indicate precautions which must be taken to maintain safe operation of the instrument.

	Direct current (DC)		Off (supply)
	Alternating current (AC)		On (supply)
	Both direct and alternating current		Caution, risk of electric shock
	Three-phase alternating current		Caution, risk of danger (refer to this manual for specific Warning or Caution information)
	Earth (ground) terminal		Caution, hot surface
	Protective conductor terminal		Out position of a bi-stable push control
	Frame or chassis terminal		In position of a bi-stable push control
	Equipotentiality	CAT I	Measurements performed on circuits not directly connected to MAINS
	Equipment protected throughout by double insulation or reinforced insulation		

General Safety Information

WARNING

- Do not operate the device around explosive gas, vapor, or dust.
- Observe all markings on the device before establishing any connection.
- The device is under CAT I measurement category, do not connect the 25-pin connector to MAINS.



CAT I:
Maximum working voltage:
Standalone 35 Vrms
Modular (Used with U2781A) 180 Vrms

Maximum transient voltage: 300 Vrms

- Do not measure higher than the rated voltage (as marked on the device).
 - Do not operate the device with the cover removed or loosened.
 - Use only the power adapter provided by the manufacturer to avoid any unexpected hazards.
-

CAUTION

- Electrostatic discharge (ESD) can cause damage to the components in the instrument and accessories. The cables or wires should be connected to the plug-in connectors first and covered with the wire casing prior to plugging it into the output connector to prevent ESD from occurring.
 - If the device is used in a manner not specified by the manufacturer, the device protection may be impaired.
 - Always use dry cloth to clean the device. Do not use ethyl alcohol or any other volatile liquid to clean the device.
 - Do not permit any blockage of the ventilation holes of the device.
-

Environmental Conditions

This instrument is designed for indoor use and in an area with low condensation. The table below shows the general environmental requirements for this instrument.







Environmental conditions	Requirements
Operating temperature	0 °C to 50 °C
Operating humidity	20% to 85% RH non-condensing
Storage temperature	-20 °C to 70 °C
Storage humidity	5% to 90% RH non-condensing

CAUTION

The U2751A USB modular switch matrix complies with the following safety and EMC requirements.

- IEC 61010-1:2001/EN61010-1:2001 (2nd Edition)
- Canada: CAN/CSA-C22.2 No. 61010-1-04
- USA: ANSI/UL 61010-1:2004
- IEC 61326-2002/EN 61326:1997+A1:1998+A2:2001+A3:2003
- Canada: ICES-001:2004
- Australia/New Zealand: AS/NZS CISPR11:2004

Regulatory Markings

	<p>The CE mark is a registered trademark of the European Community. This CE mark shows that the product complies with all the relevant European Legal Directives.</p>		<p>The C-tick mark is a registered trademark of the Spectrum Management Agency of Australia. This signifies compliance with the Australia EMC Framework regulations under the terms of the Radio Communication Act of 1992.</p>
<p>ICES/NMB-001</p>	<p>ICES/NMB-001 indicates that this ISM device complies with the Canadian ICES-001. Cet appareil ISM est conforme a la norme NMB-001 du Canada.</p>		<p>This instrument complies with the WEEE Directive (2002/96/EC) marking requirement. This affixed product label indicates that you must not discard this electrical/electronic product in domestic household waste.</p>
	<p>The CSA mark is a registered trademark of the Canadian Standards Association.</p>		

Waste Electrical and Electronic Equipment (WEEE) Directive 2002/96/EC

This instrument complies with the WEEE Directive (2002/96/EC) marking requirement. This affixed product label indicates that you must not discard this electrical/electronic product in domestic household waste.

Product Category:

With reference to the equipment types in the WEEE directive Annex 1, this instrument is classified as a "Monitoring and Control Instrument" product.

The affixed product label is as shown below.



Do not dispose in domestic household waste

To return this unwanted instrument, contact your nearest Agilent Technologies, or visit:

www.agilent.com/environment/product

for more information.

In This Guide...

1 Getting Started

This chapter provides an overview of the U2751A USB modular switch matrix, which includes the product outlook, product dimensions, and product layout. This chapter also contains instructions on how to install and configure the U2751A.

2 Operation and Features

This chapter describes the operation and features that are offered by the U2751A, such as switch controls and relay usage monitoring.

3 Characteristics and Specifications

This chapter contains the characteristics and specifications of the U2751A.

4 Service Information

This chapter provides the guidelines for returning the U2751A to Agilent Technologies for servicing or for servicing it yourself. It also contains the list of replaceable parts.

Declaration of Conformity (DoC)

The Declaration of Conformity (DoC) for this instrument is available on the Web site. You can search the DoC by its product model or description.

<http://regulations.corporate.agilent.com/DoC/search.htm>

NOTE

If you are unable to search for the respective DoC, please contact your local Agilent representative.

THIS PAGE HAS BEEN INTENTIONALLY LEFT BLANK.

Contents

	List of Figures	XIII
	List of Tables	XV
1	Getting Started	1
	Introduction	2
	Product at a Glance	3
	Product Outlook	3
	Product Dimensions	5
	Dimensions Without Bumpers	5
	Dimensions With Bumpers	6
	Standard Shipped Items	7
	Inspection and Maintenance	8
	Initial Inspection	8
	Electrical Check	8
	General Maintenance	8
	Installation and Configuration	9
	U2751A DSub Connector	10
	U2922A Terminal Block	11
	U2922A Terminal Block Installation	14
	55-Pin Backplane Connector Pin Configuration	16
	Chassis Installation	17
2	Operation and Features	19
	Power Up	20
	Switch Control	21

Contents

Relay Cycle Counter	24
System-Related Operation	25
Self-Test	25
Error Conditions	25
SCPI Commands for System-Related Tasks	26
3 Characteristics and Specifications	27
Product Characteristics	28
Product Specifications	30
4 Service Information	33
Checking Defective Relay(s)	34
Replaceable Parts	35
Disassembly Instructions	36
Reassembly Instructions	38
Contacting Agilent Technologies	38

List of Figures

Figure 1-1. 25-pin male DSub connector	10
Figure 1-2. U2922A pin configuration	11
Figure 1-3. U2922A outlook	12
Figure 1-4. U2922A dimensions	13
Figure 1-5. 55-pin backplane connector pin configuration	16
Figure 2-1. Switch matrix concept	21
Figure 2-2. Panel view of the Agilent Measurement Manager	22
Figure 2-3. Panel view of the relay cycle counter	24
Figure 4-4. Defective relay(s) check	34

THIS PAGE HAS BEEN INTENTIONALLY LEFT BLANK.

List of Tables

Table 1-1. Pin assignments	10
Table 1-2. Synchronous Simultaneous Interface (SSI) connector pin description	16
Table 3-3. Electrical and mechanical specifications update per attached data sheet	30
Table 3-1. Electrical and mechanical specifications update per attached data sheet (continued)	31
Table 4-2. Part number and description of replaceable part	35

THIS PAGE HAS BEEN INTENTIONALLY LEFT BLANK.



1 Getting Started

Introduction	2
Product at a Glance	3
Product Outlook	3
Product Dimensions	5
Dimensions Without Bumpers	5
Dimensions With Bumpers	6
Standard Shipped Items	7
Inspection and Maintenance	8
Initial Inspection	8
Electrical Check	8
General Maintenance	8
Installation and Configuration	9
U2751A DSub Connector	10
U2922A Terminal Block	11
U2922A Terminal Block Installation	14
55-Pin Backplane Connector Pin Configuration	16
Chassis Installation	17



Introduction

The U2751A USB modular switch matrix offers a high quality, low cost switching solution for automated test. It can operate as a standalone or modular unit when used with the U2781A USB modular instrument chassis.

The U2751A is a compact 4×8, two-wire modular switch matrix which is controlled remotely over a USB interface via the Agilent Measurement Manager software. The U2751A can also be programmed using the provided drivers or via SCPI commands.

The U2751A has the following features.

- 32 two-wire cross-points organized in a 4 rows by 8 columns configuration
- any combination of rows and columns can be connected at a time. Multiple channels can be closed at the same time
- relay cycle counter

The U2751A offers you the most flexible connection path between your device under test (DUT) and your test equipment, allowing different instruments to be connected to multiple points on your DUT at the same time.

Using the Agilent Measurement Manager, you can instruct the matrix to make or break any of the 32 row-column intersections over the USB interface. More details will be covered in the *Agilent Measurement Manager help file*.

Product at a Glance

Product Outlook

Top View

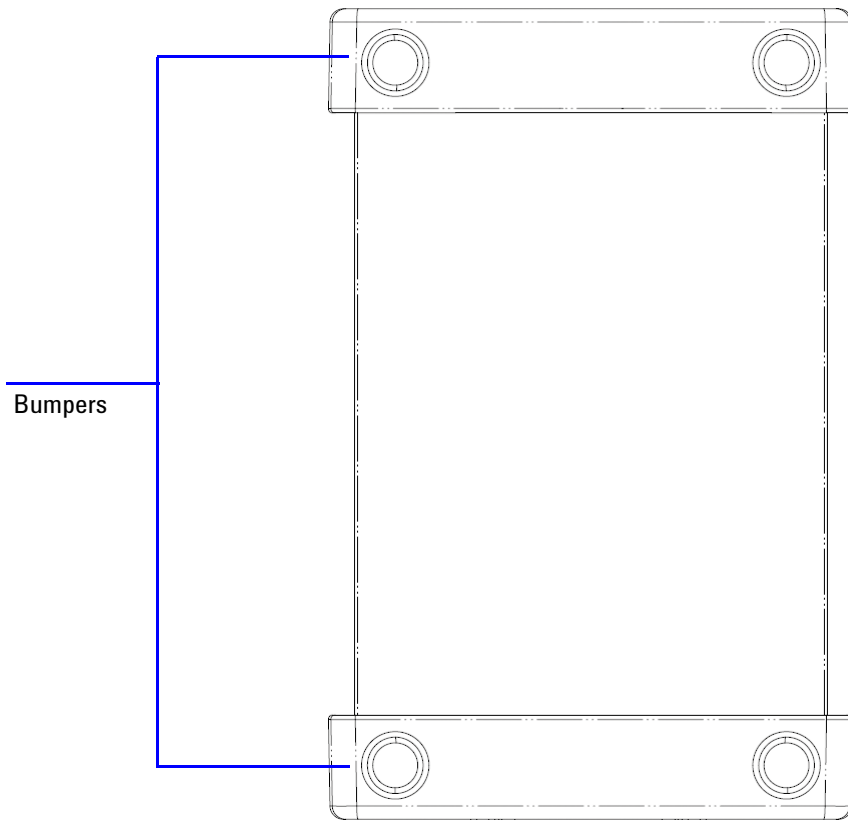

1 Getting Started

Front View

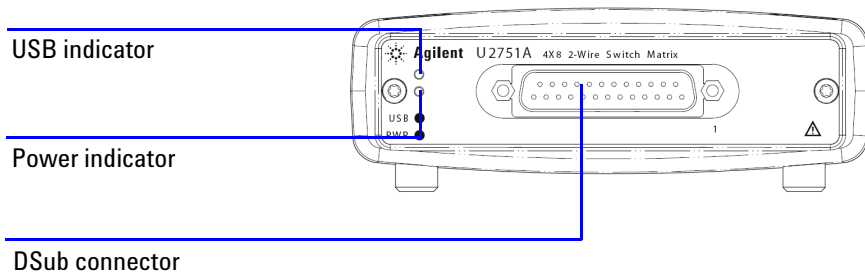

Rear View

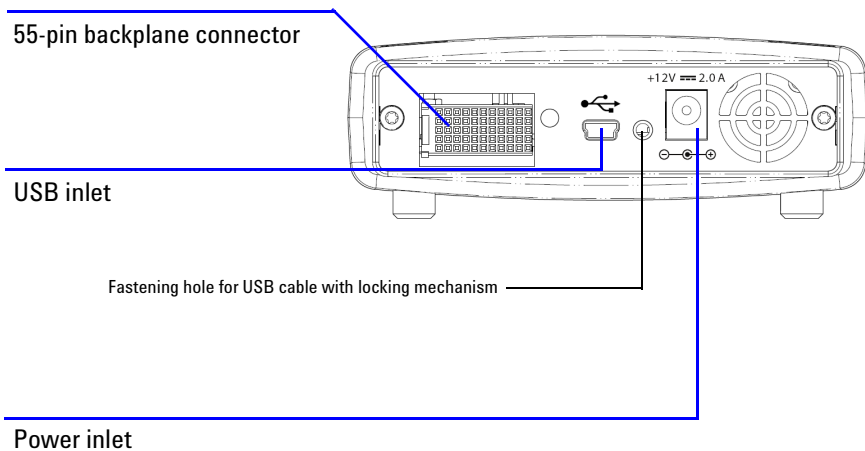

Product Dimensions

Dimensions Without Bumpers

Top View

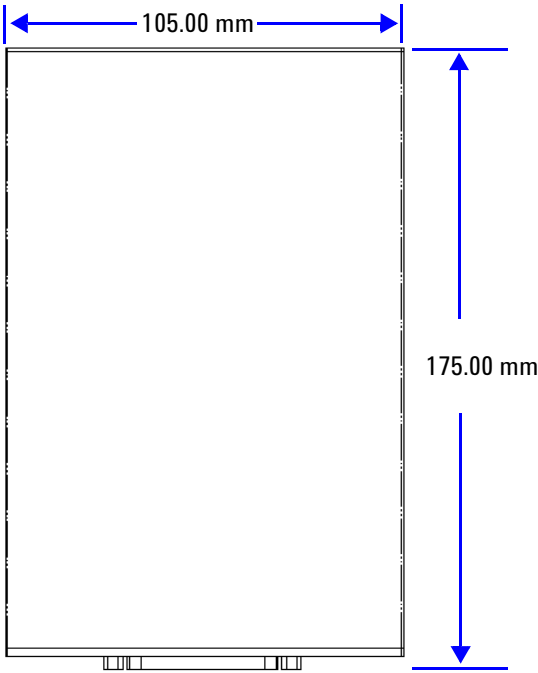

Front View

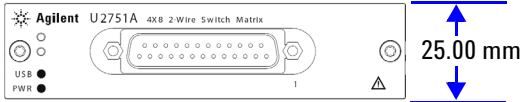

Dimensions With Bumpers

Top View

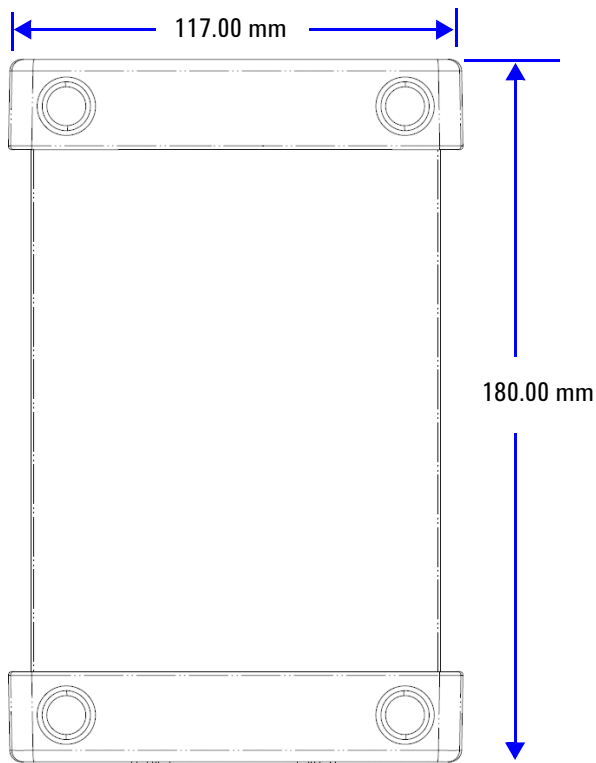

Front View

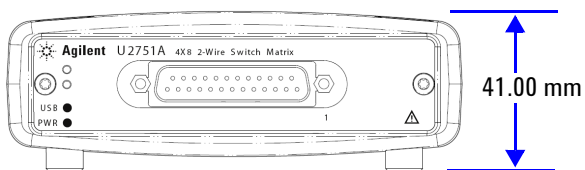

Standard Shipped Items

Verify that you have received the following items with your unit. If anything is missing or damaged, please contact the nearest Agilent Sales Office.

- ✓ 12 V, 2 A AC/DC adapter
- ✓ Power cord
- ✓ USB Standard-A to Mini-B interface cable
- ✓ L-Mount kit (used with the modular instrument chassis)
- ✓ Agilent Automation-Ready CD-ROM (contains the Agilent IO Libraries Suite)
- ✓ Agilent USB Modular Products and Systems Quick Start Guide
- ✓ Agilent USB Modular Products and Systems Product Reference DVD-ROM
- ✓ Agilent Measurement Manager Quick Reference Card

Inspection and Maintenance

Initial Inspection

When you receive your U2751A, inspect the unit for any obvious damage such as broken terminals or cracks, dents, and scratches on the casing that may occur during shipment. If any damage is found, notify the nearest Agilent Sales Office immediately. The front of this manual contains the warranty information.

Keep the original packaging in case the U2751A has to be returned to Agilent in the future. If you return the U2751A for service, attach a tag identifying the owner and model number. Also include a brief description of the problem.

Electrical Check

Chapter 4, “Service Information” on page 33 will provide the complete verification procedure. The procedure will verify to a high level of confidence that the U2751A is operating in accordance with its specifications.

General Maintenance

NOTE

Any repair that is not covered in your modular product manuals should only be performed by qualified personnel.

- 1 Power off your module and remove the power cord and I/O cable from your device.
- 2 Remove your module from the bumper casing.
- 3 Shake off any dirt that may have accumulated on the module.
- 4 Wipe your module with a dry cloth and install the bumper back in place.

Installation and Configuration

Follow the step-by-step instructions shown in the *Agilent USB Modular Products and Systems Quick Start Guide* to get started with the preparations and installation of your U2751A.

NOTE

You need to install the IVI-COM driver if you are going to use the U2751A with Agilent VEE Pro, LabVIEW, or Microsoft® Visual Studio®.

U2751A DSub Connector

The U2751A is equipped with one 25-pin male DSub connector as shown in [Figure 1-1](#).

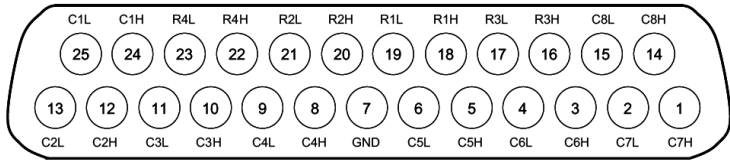

Figure 1-1 25-pin male DSub connector

Pin Assignments

Table 1-1 Pin assignments

Pin	Description	Pin	Description
18	R1H	10	C3H
19	R1L	11	C3L
20	R2H	8	C4H
21	R2L	9	C4L
16	R3H	5	C5H
17	R3L	6	C5L
22	R4H	3	C6H
23	R4L	4	C6L
24	C1H	1	C7H
25	C1L	2	C7L
12	C2H	14	C8H
13	C2L	15	C8L
7	GND		

R represents "Row" and C represents "Column".

H represents "High" and L represents "Low".

U2922A Terminal Block

The U2922A terminal block is an optional accessory to be used with the U2751A. The U2922A which weighs approximately 100 g and has screw-type terminals, offers you a convenient and simple way of making connection to the switch matrix for prototyping applications or an actual system deployment. It allows the user to configure a wide variety of routing options and matrix topologies.

The U2922A pin configuration is in accordance to the 25-pin male DSub connector of the U2751A as shown in the following:

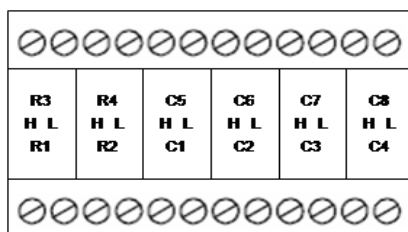

R represents "Row" and C represents "Column".

H represents "High" and L represents "Low".

Figure 1-2 U2922A pin configuration

You may also develop your own terminal block by using a compatible mating 25-pin female DSub connector to the front panel.

NOTE

Ensure that your design meets the clearance and creepage requirements for high voltage application as defined by IEC/EN 61010-1.

1 Getting Started

The outlook and dimensions of the U2922A are shown in [Figure 1-3](#) and [Figure 1-4](#).

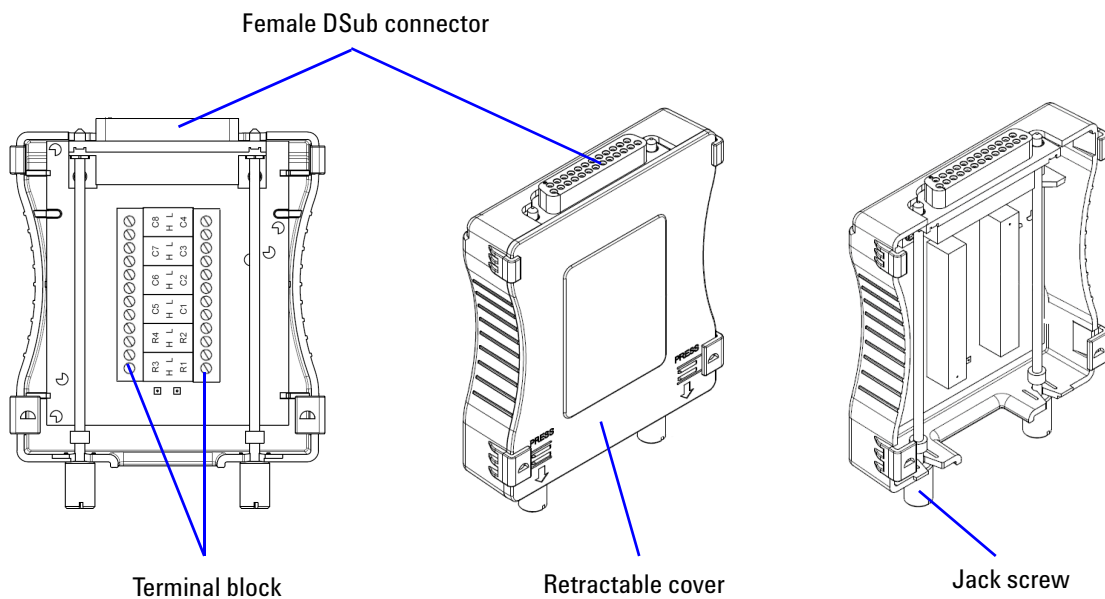
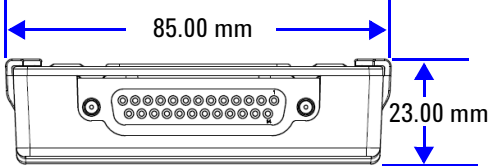
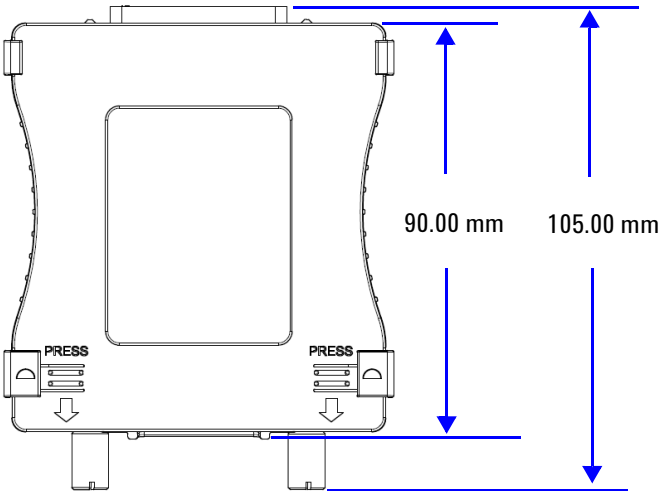

Figure 1-3 U2922A outlook

Rear View



Top View



Front View

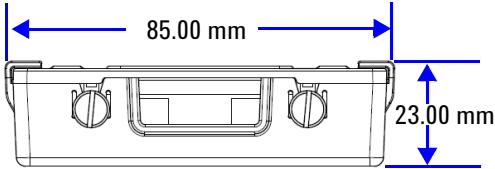

Side View

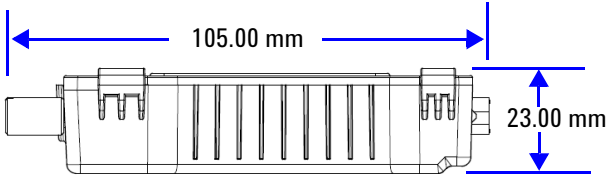

Figure 1-4 U2922A dimensions

U2922A Terminal Block Installation

This section provides the recommended procedure for connecting the U2922A terminal block to the U2751A.

WARNING



- The maximum working voltage of the U2751A with the terminal block for standalone is 35 Vrms and for modular (when used with the U2781A) is 180 Vrms.



- The maximum transient voltage is 300 Vrms.
- Do not remove the retractable cover from the U2922A terminal block during operation to avoid any unexpected hazard.

NOTE

- You are required to connect the cables to the U2922A terminal block prior to attaching the U2922A to the U2751A.
- Ensure that you power-off your device and unplug the U2922A from the U2751A to change the cable connection on the U2922A.

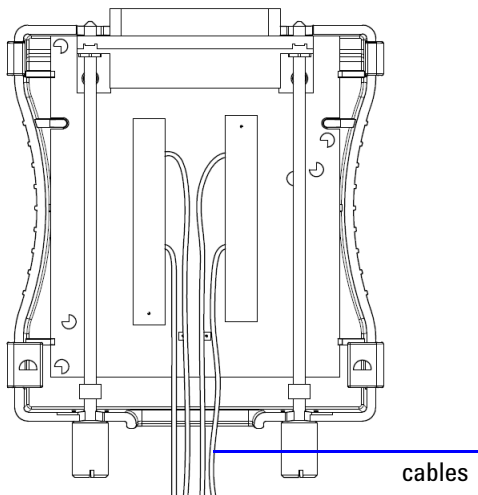

Connect the cables to the terminal block as desired.

Snap-fit clasp of the retractable cover and the housing

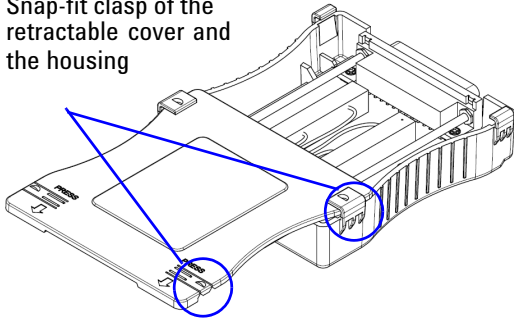

Close your terminal block by slotting in the retractable cover. Check the snap-fit clasp on the cover and the housing to ensure correct orientation of the retractable cover before slotting it in.

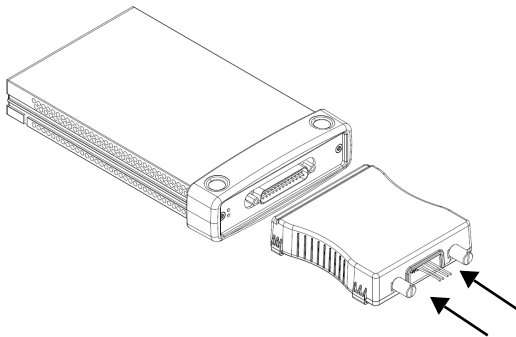

Turn over the U2922A with the retractable cover facing downwards. Then, insert the U2922A to the U2751A as shown.

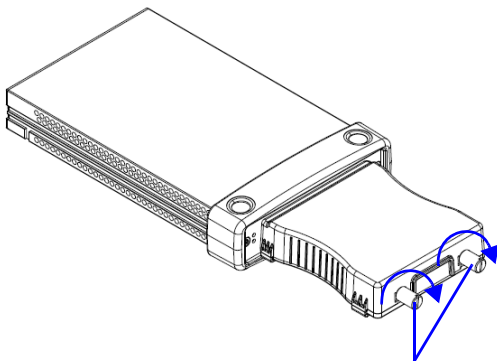

Jack screws of the U2922A

Tighten the jack screws using a screw driver to secure the connection. Ensure that the terminal block is installed correctly with the screws properly tighten for secure operation.

55-Pin Backplane Connector Pin Configuration

The 55-pin backplane connector is used when the U2751A module is inserted into the U2781A USB modular instrument chassis. For more details, refer to the *Agilent U2781A USB Modular Instrument Chassis User's Guide*.

GND	GND	GND	GND	GND	GND	GND	GND	GND	GND	GND	F
NC	NC	NC	NC	NC	NC	NC	NC	VBUS	GND	USB_D-	E
GND	TRIG3	GND	TRIG2	GND	TRIG1	GND	TRIG0	GND	GND	USB_D+	D
TRIG4	GND	TRIG5	GND	TRIG6	GND	TRIG7	GND	+12 V	+12 V	GND	C
nBPUB	CLK10M	GND	STAR_TRIG	GA2	GA1	GA0	NC	+12 V	+12 V	+12 V	B
NC	NC	NC	NC	NC	NC	NC	NC	+12 V	+12 V	+12 V	A
11	10	9	8	7	6	5	4	3	2	1	

Figure 1-5 55-pin backplane connector pin configuration

Table 1-2 Synchronous Simultaneous Interface (SSI) connector pin description

SSI timing signal	Functionality
GND	Ground
NC	Not connected
VBUS	USB bus power sensing input
USB_D+, USB_D-	USB differential pair
TRIG0~TRIG7	Trigger bus
+12 V	+12 V power with 4 A current
nBPUB	USB backplane input detect
CLK10M	10 MHz clock source
STAR_TRIG	Star trigger
GA0,GA1,GA2	Geographical address pin

Chassis Installation

The L-Mount kit is to be installed to your U2751A module. The following instructions describe the simple procedure of installing the L-Mount kit and your module in the U2781A chassis.

- 1** Unpack the L-Mount kit from its packaging.
- 2** Remove your U2751A module from the bumper casing.
- 3** Using a Phillips screwdriver, fasten the L-Mount kit to your U2751A module.
- 4** Insert your U2751A module into the U2781A chassis with the 55-pin backplane connector positioned at the bottom of the module.
- 5** Once you have slotted the module into the chassis, tighten the screws of the L-Mount kit to secure the connection.

THIS PAGE HAS BEEN INTENTIONALLY LEFT BLANK.



2 Operation and Features

Power Up	20
Switch Control	21
Relay Cycle Counter	24
System-Related Operation	25
Self-Test	25
Error Conditions	25
SCPI Commands for System-Related Tasks	26

This chapter describes the features and operation of the U2751A.



Power Up

Take note of the following when you power up the U2751A.

- The U2751A can only be operated via the USB interface.
- Before you can control the U2751A, you need to install the hardware driver and the IO Libraries Suite 14.2 or higher. Both of these are included when you purchase the U2751A. Refer to the *Agilent USB Modular Products and Systems Quick Start Guide* for the installation procedure.
- On the front panel of the U2751A, there are two LED indicators. Refer to [Chapter 1, “Product Outlook”](#) on page 3.
- Power indicator lights up once the U2751A is powered up.
- USB indicator will only blink when there is data exchange activity between the U2751A and the PC.

Switch Control

A matrix switch connects multiple inputs to multiple outputs. A matrix is arranged in rows and columns. For example, the U2751A is a 4x8 matrix that can be used to connect four sources to eight test points as shown in Figure 2-1.

Any column can be connected to any row by activating the corresponding relay that connects the column to the row as shown in Figure 2-1. Each cross-point relay on this module has its own unique channel label representing the row and column. For example, channel 302 represents the cross-point connection between row 3 and column 2.

Be aware that it is possible to connect more than one source to the same point with a matrix. It is vital to make sure that these connections do not create dangerous or unwanted conditions.

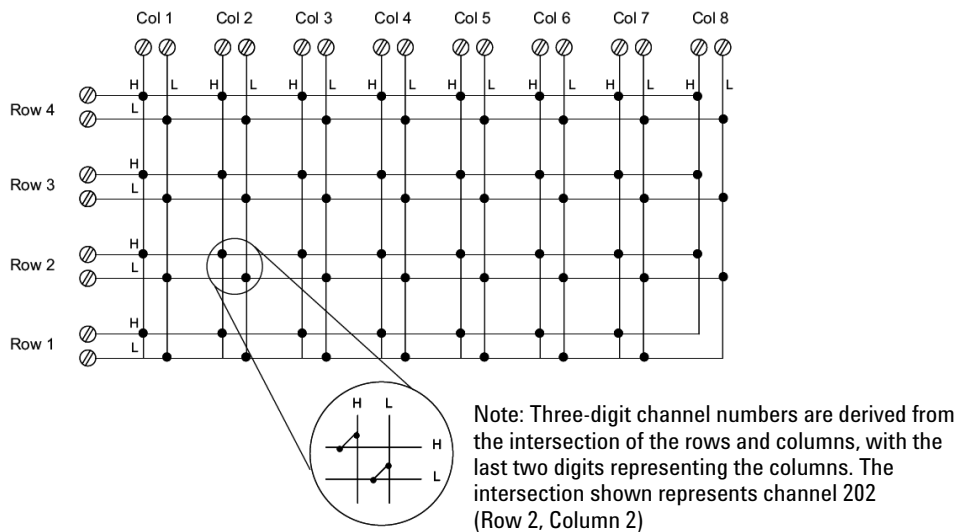

Figure 2-1 Switch matrix concept

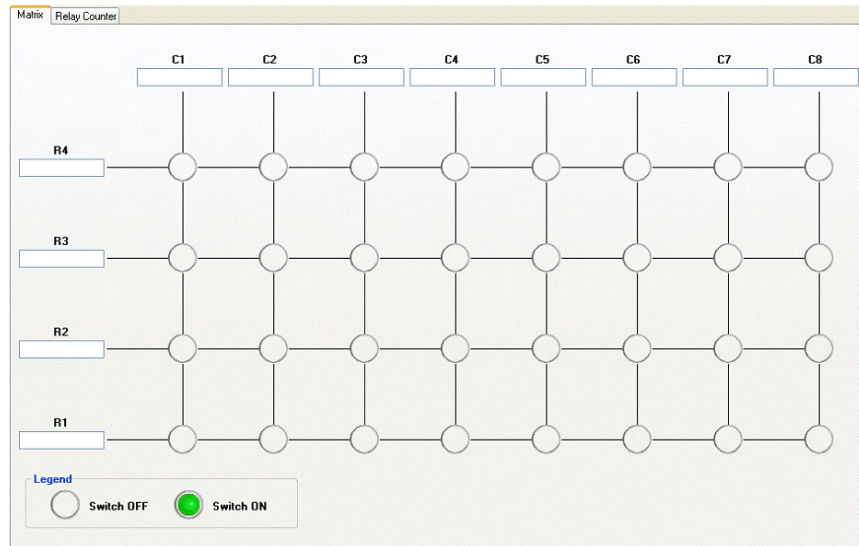

Figure 2-2 Panel view of the Agilent Measurement Manager

Agilent Measurement Manager Operation

Launch the Agilent Measurement Manager software and select the **Matrix** tab. The keyboard shortcut key is **Ctrl+M**.

Connect the instruments and devices as per your application. Key in the names of the instruments and devices in the available text boxes.

Click the cross-point circles on the software to toggle the contact on or off. The connection from the row to the column will be highlighted when the circuit is closed.

SCPI Commands

The following examples show the SCPI commands for executing the closing and opening of the relays.

Example 1, Make contact at channel 302

```
-> *CLS; *RST // Resets the switch to the
                // default power-on state.
                // This command can be
                // ignored if this operation is
                // not required.

-> ROUTe:CLOSE (@302) // Closes the relay at row 3,
                    // column 2.
```

Example 2, Break contact at channel 302

```
-> ROUTe:OPEN (@302) // Opens the relay at row 3,
                    // column 2.
```

Example 3, Make contact at channel 101, 302

```
-> ROUTe:CLOSE (@101,302) // Closes relays at row
                            // 1, column 1 and row
                            // 3, column 2.
```

Relay Cycle Counter

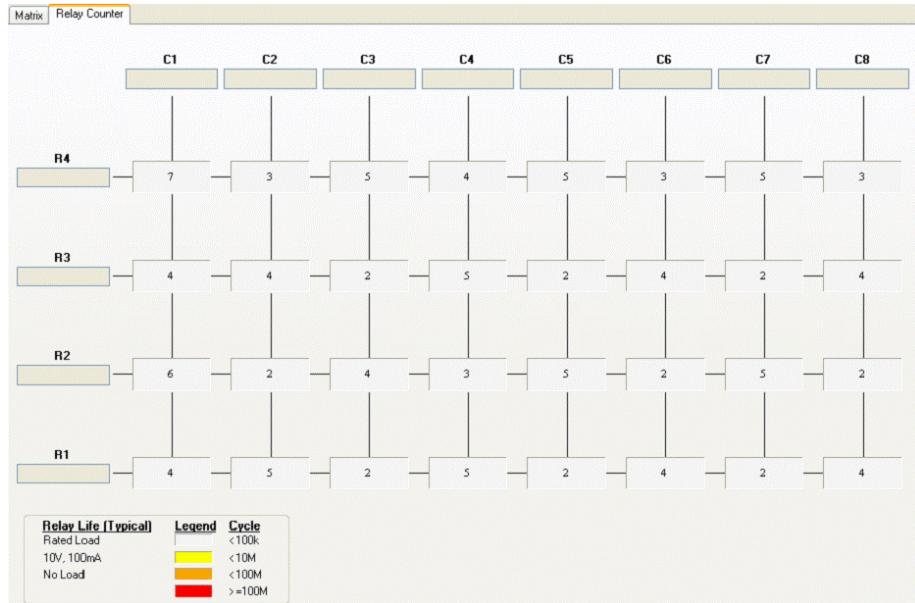

Figure 2-3 Panel view of the relay cycle counter

Agilent Measurement Manager Operation

At the main panel, select the **Relay Cycle Counter** tab. The panel in [Figure 2-3](#) will be displayed. The keyboard shortcut key is **Ctrl+R**.

This feature allows the user to carry out preventive maintenance, which is to replace those relays that are at the end of their life span.

Relay cycles that are above a certain limit will be highlighted in red. Refer to the example in [Figure 2-3](#).

System-Related Operation

This section provides information on system-related topics such as executing a self-test, performing self-calibration routine, and reading error conditions.

NOTE

Do not connect any terminal block or cables prior to performing self-test process.

Self-Test

To perform the self-test, proceed as follows.

Agilent Measurement Manager Operation

Ensure that the switch terminals are not connected to any instrument. Turn on the U2751A. On the application panel, select **Tools > Self-Test**. This will perform a series of communication tests on the module, which take a couple of seconds to complete.

Error Conditions

Agilent Measurement Manager Operation

A message box will appear once an error occurs while operating the U2751A using the Agilent Measurement Manager.

SCPI Commands for System-Related Tasks

The following examples show the SCPI commands for performing certain system-related tasks.

Example 4, Performing system-related tasks

```
-> *CLS; *RST           // Resets the switch to the
                        // default power-on state.
                        // This command can be
                        // ignored if this operation is
                        // not required.

-> *TST?                 // Executes the self-test.

<- +0                    // Returns a +0 if the test
                        // pass else it will return a
                        // +1 if it fails.

-> SYST:ERR?            // Returns the error number
                        // and its corresponding
                        // message string from the
                        // error queue.

<- +0, "No Error"
```



3 Characteristics and Specifications

Product Characteristics 28

Product Specifications 30

This chapter specifies the characteristics, environmental conditions, and specifications of the U2751A.



Product Characteristics

REMOTE INTERFACE¹

- Hi-Speed USB 2.0
- USBTMC 488.2 Class device^{2 3}

POWER CONSUMPTION

- +12 VDC, 2 A maximum
- Installation Category III

OPERATING ENVIRONMENT

- Operating temperature from 0 °C to +50 °C
- Relative humidity at 20% to 85% RH (non-condensing)
- Altitude up to 2000 meters
- Pollution degree 2
- For indoor use only

STORAGE COMPLIANCE

–20 °C to +70 °C

SAFETY COMPLIANCE

Certified with:

- IEC 61010-1:2001/EN61010-1:2001 (2nd Edition)
- Canada: CAN/CSA-C22.2 No. 61010-1-04
- USA: ANSI/UL 61010-1:2004

EMC COMPLIANCE

- IEC 61326-2002/EN61326:1997+A1:1998+A2:2001+A3:2003
- Canada: ICES-001:2004
- Australia/New Zealand: AS/NZS CISPR11:2004

SHOCK AND VIBRATION

Tested to IEC/EN 60068-2

I/O CONNECTOR

DSub 25 male

DIMENSIONS (W × D × H)

- 105.00 × 175.00 × 25.00 mm (without bumpers)
- 117.00 × 180.00 × 41.00 mm (with bumpers)

WEIGHT

- 428 g (without bumpers)
 - 480 g (with bumpers)
-

WARRANTY

- Please refer to http://www.agilent.com/go/warranty_terms
 - 3 years for the product
 - 3 months for the product's standard accessories, unless otherwise specified
- Please take note that for the product, the warranty does not cover:
 - Damage from contamination
 - Normal wear and tear of mechanical components
 - Manuals

CALIBRATION

Annual calibration is not required

- 1 For remote connections using Agilent E5813A, refer to [Chapter 1](#).
- 2 Compatible with Microsoft Windows operating systems only.
- 3 Requires a direct USB connection to the PC so the appropriate driver can be installed in the USB modular instrument or USB DAQ module.

Product Specifications

Table 3-3 Electrical and mechanical specifications update per attached data sheet

	U2751A	
	Without U2922A Terminal Block	With U2922A Terminal Block
Channels/configurations	4×8, 2-wire	
Switch type	Armature latching	
Input characteristics (per channel)		
Max volts ¹		
Standalone	42 VDC/35 Vrms	
Modular (Used with U2781A)	180 VDC/180 Vrms	
Max transient voltage	300 Vrms	
Max current		
Switch current	2 A	
Carry current	2 A	
Power (W, VA) ²	60 W, 62.5 VA	
Volt-Hertz limit	10 ⁸	
General specifications		
Thermal emf (differential)	<3 μV	
Initial closed channel resistance	<1.5 Ω	
DC isolation (ch-ch, ch-earth)	>10 GΩ	
AC characteristics		
Bandwidth ³	45 MHz	30 MHz
Insertion loss		
100 kHz	0.2 dB	0.2 dB
1 MHz	0.3 dB	0.3 dB
10 MHz	<2 dB	<2 dB
45 MHz	<3 dB	<4.5 dB
Capacitance		
HI-LO	55 pF	85 pF
LO-Earth	35 pF	45 pF
Crosstalk at terminal block (ch-ch) ³		
300 kHz	-70 dB	
1 MHz	-60 dB	
20 MHz	-35 dB	
45 MHz	-30 dB	

Table 3-1 Electrical and mechanical specifications update per attached data sheet (continued)

General characteristics	
Relay life, typical	
No load	100 M
10 V, 100 mA	10 M
Related load	100 k
Open/close time	4 ms/4 ms

- 1 DC or AC rms, channel-to-channel or channel-to-earth.
- 2 Limited to 6 W channel resistance power loss per module.
- 3 50 Ω source, 50 Ω load, differential measurements verified with a 4-port network analyzer (Sdd21).

THIS PAGE HAS BEEN INTENTIONALLY LEFT BLANK.



4 Service Information

Checking Defective Relay(s)	34
Replaceable Parts	35
Disassembly Instructions	36
Reassembly Instructions	38
Contacting Agilent Technologies	38

This chapter provides guidelines for returning your instrument to Agilent for service or repair, and for servicing it yourself. A list of replaceable parts is also provided.



Checking Defective Relay(s)

NOTE

It is recommended to have the relay(s) checked when it reaches 10 million cycle counts. The relay cycle count can be obtained by using the Agilent Measurement Manager or sending the following SCPI command:

```
DIAGnostic:RElAy:CYCLes? (@<ch_list>)
```

To check for any defective relay, the equipment required is a digital multimeter with continuity feature.

- 1 Close the particular relay(s). For example: The relay located at Row **x** Column **y**.
- 2 By referring to the connector configuration of the DSub connector, connect one of the DMM test leads to pin **RxL** and another test lead to pin **CyL**. The DMM should indicate that these two pins are connected or shorted.
- 3 Once this is done, use the same method and perform the same test on pins **RxH** and **CyH**. These two pins should be connected or shorted as well.
- 4 Now, open the particular relay(s). Using the same method, check if pins **RxL** and **CyL** are disconnected. Perform the same test on pins **RxH** and **CyH** as well.

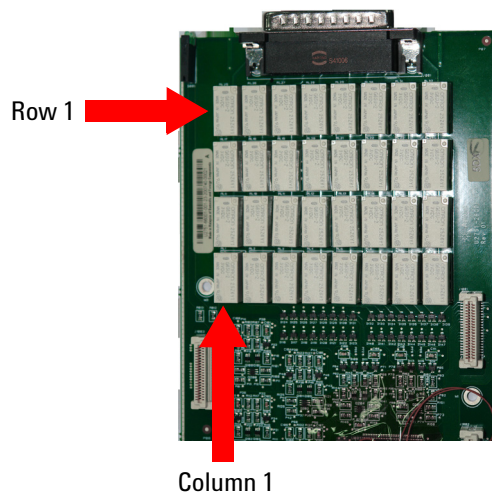

Figure 4-4 Defective relay(s) check

Replaceable Parts

This section contains the information for ordering replacement parts for your instrument. To order the parts, please do the following.

- Contact your nearest Agilent Sales Office or Service Center.
- Provide the part number for the relay.
- Provide the instrument model and serial number.

The part number of the replaceable part and its description are shown in the table below.

Table 4-2 Part number and description of replaceable part

Part number	Description
0490-1896	RELAY 2C 3 VDC-COIL 2A 30 VDC

CAUTION

Electrostatic Discharge (ESD) Precautions

Almost all electrical components can be damaged by electrostatic discharge (ESD) during handling. The following guidelines will help prevent ESD damage when servicing the instrument or any electronic device.

- Disassemble the instruments in a static-free work area *only*.
- Use a conductive work area to dissipate static charge.
- Use a conductive wrist strap to dissipate static charge accumulation.
- Minimize handling.
- Keep the replacement parts in original static-free packaging.
- Remove all plastics, styrofoams, vinyls, papers, and other static-generating materials from the immediate work area.
- Use *only* antistatic solder extractor.

Disassembly Instructions

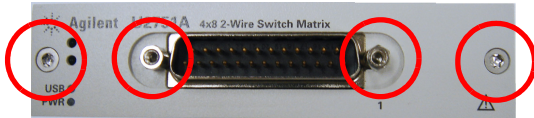

Remove the screws and nuts as shown.

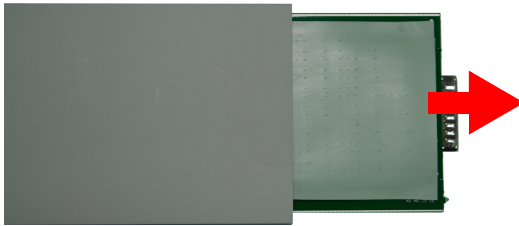

Take the measurement board and carrier board out from the module.

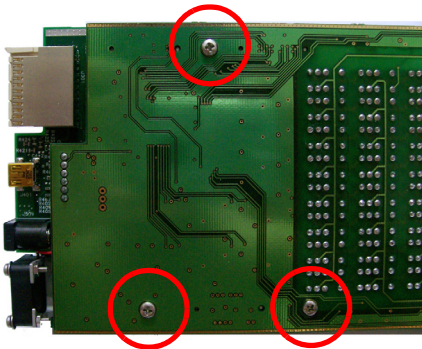

Remove the screws as indicated.

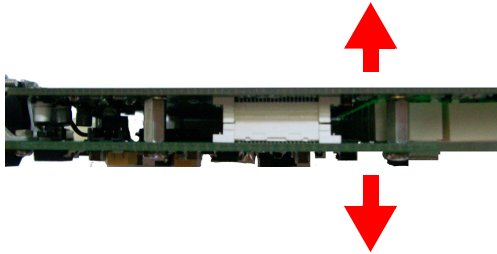

Separate the carrier and measurement board.

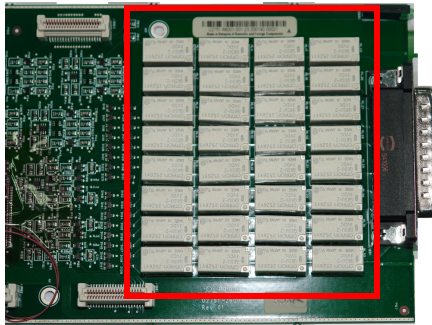

There are 32 relays as shown.

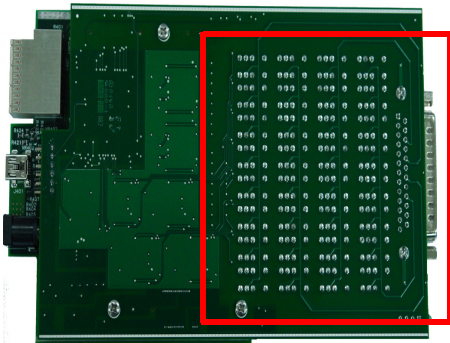

Turn to the opposite side of the measurement board and ensure that only the *defective* relays are desoldered.

Upon replacing the relay(s), reset the relay cycle count to zero by issuing the following SCPI command:

```
DIAGnostic:RELy:CYCLes:CLear (@<ch_list>)
```

Reassembly Instructions

The reassembly process is simply the reverse of disassembly.

Contacting Agilent Technologies

Types of Service Available

If your instrument fails during the warranty period, Agilent will replace the unit for free. The replacement units will be shipped with new calibration certificates.

NOTE

Every replacement unit has its own serial number. The serial number of the defective unit does not transfer to the replacement unit. The warranty period of the replacement unit is based on the remaining warranty of the defective U2751A.

Agilent Unit Exchange

Contact your nearest Agilent Service Center to arrange for the replacement of your instrument. In the U.S., please call 800-829-4444 and then select "Option 3" followed by "Option 1."

NOTE

The defective unit must be returned to Agilent before the replacement unit is shipped to you. Additional information regarding the unit exchange will be provided when you contact Agilent.

Index

#

55-pin backplane connector pin, 16

A

AC

characteristics, 30

Agilent Measurement Manager

help file, 2

operation, 22, 24, 25, 25

panel view, 22

relay cycle count, 34, 37

Agilent U2751A USB Modular Switch Matrix,

Quick Reference Card, 7

B

bandwidth, 30

bumper, 8

bumper casing, 8, 17

C

*CLS, 23, 26

carrier board, 36, 37

Certificate of Calibration, 7

channel label, 21

channels, multiple

chassis

configuration, 2

installation, 17

cleaning, general, 8

column, 2, 10, 21, 22, 23, 34

configuration, instrument

connector, 10

pin assignments, 10

55-pin backplane connector pin, 16

cross-point, 2

D

DC

isolation, 30

defective relays, check, 34

DIAGnostic:RELAy:CYCLes?
(@<ch_list>), 34

device under test. *See DUT*

disassembly. *See relays, replacing*

DSub connector, 10, 34

DUT, 2

E

electrical check, 8

electrostatic discharge. *See precautions*

error conditions

Agilent Measurement Manager
operation, 25

SCPI Commands, 26

F

flowchart, 9

G

GND, 10, 16

I

I/O cable, 8

inspection, initial, 8

introduction

U2751A USB modular switch matrix, 2

IVI-COM driver, 9

L

LED indicators, 20

L-Mount kit, 7, 17

M

matrix, V, VIII, 2, 7, 21, 22

maintenance, general, 8

measurement board, 36, 37

Microsoft® Internet Explorer. *See browser*

modular instrument chassis, 7, 16

modular switch matrix. *See introduction*

module driver. *See installation*

multiplexer, 21

N

nBPUB, 16, 16

NC, 16, 16

O

operating environment

altitude, 28

pollution degree, 28

relative humidity, 28

temperature, 28

operating checklist. *See service*

operation, system related

error conditions, 25

self-test, 25

P

panel view, 22, 24

parts, replaceable, 35

pin assignments, 10

Index

power cord, 7
power up, U2751A, 20
precautions,
 ESD, IV, 35
product characteristics
 dimensions, 28
 EMC compliance, 28
 I/O connector, 28
 operating environment, 28
 power consumption, 28
 remote interface, 28
 safety compliance, 28
 shock and vibration, 28
 storage compliance, 28
 warranty, 29
 weight, 28
product dimensions
 with bumper, 6
 without bumper, 5
product outlook
 front view, 4
 rear view, 4
 top view, 3
product specifications
 AC characteristics, 30
 general characteristics, 31
 general specifications, 30
 input characteristics, 30
purchase items, standard, 7

R

*RST, 23
reassembly. *See relays, replacing*
relay cycle counter, 2, 24
relays, replacing
 DIAGnostic:RElay:CLEar (@<ch_list>),
 37
 disassembly, 36
 ESD precautions, 35
 reassembly, 38
replaceable parts. *See parts, replaceable*
row, 2, 10, 21, 22, 23, 34

S

SCPI commands, 2, 23, 26
self-calibration, 25
self-test, 25, 26
service
 Agilent unit exchange, 38
 types of service available, 38
SSI connector pin, 16
SSI timing signal, 16
STAR_TRIG, 16
switch control
 Agilent Manager Measurement
 operation, 22
 introduction, 21
 SCPI Commands, 23
switch matrix concept, 21
switching, 2, 21
system-related operation, 25

T

*TST, 26
terminal block, 30
terminal block, U2922A. *See U2922A*
test, automated, 2

U

U2922A
 dimensions, 13
 female DSub connector, 11, 15
 installation, 14
 outlook, 12
 pin configuration, 11
 terminal block, 11
USB extension cable, 7
USB indicator, 20
USB interface, 2, 20
USBTMC 488.2, 28

V

VBUS, 16

W

warranty, 29, 38
Windows® 2000 Professional. *See*
 operating system
Windows® Home Edition. *See* operating
 system
Windows® XP Professional. *See* operating
 system

www.agilent.com

Contact us

To obtain service, warranty or technical assistance, contact us at the following phone or fax numbers:

United States:

(tel) 800 829 4444 (fax) 800 829 4433

Canada:

(tel) 877 894 4414 (fax) 800 746 4866

China:

(tel) 800 810 0189 (fax) 800 820 2816

Europe:

(tel) 31 20 547 2111

Japan:

(tel) (81) 426 56 7832 (fax) (81) 426 56 7840

Korea:

(tel) (080) 769 0800 (fax) (080) 769 0900

Latin America:

(tel) (305) 269 7500

Taiwan:

(tel) 0800 047 866 (fax) 0800 286 331

Other Asia Pacific Countries:

(tel) (65) 6375 8100 (fax) (65) 6755 0042

Or visit Agilent World Wide Web at:

www.agilent.com/find/assist

Product specifications and descriptions in this document are subject to change without notice. Always refer to the English version on the Agilent Web site for the latest revision.

© Agilent Technologies, Inc. , 2008–2013

Fifth Edition, August 2, 2013

U2751-90011



Agilent Technologies