

Keysight Technologies U3020AS22

User's and Service Guide

Notice: This document contains references to Agilent. Please note that Agilent's Test and Measurement business has become Keysight Technologies. For more information, go to www.keysight.com.

Notices

© Keysight Technologies, Inc.
2013-2014

No part of this manual may be reproduced in any form or by any means (including electronic storage and retrieval or translation into a foreign language) without prior agreement and written consent from Keysight Technologies, Inc. as governed by United States and international copyright laws.

Manual Part Number

U3020-90013

Print Date

August 2014

Printed in USA

Keysight Technologies Inc.
1400 Fountaingrove Parkway
Santa Rosa, CA 95403

Where to Find the Latest Information

Documentation is updated periodically. For the latest information about these products, including instrument software upgrades, application information, and product information, browse to the following URL, search for the name of your product:

<http://www.keysight.com/find>

Technology Licenses

The hardware and/or software described in this document are furnished under a license and may be used or copied only in accordance with the terms of such license.

Restricted Rights Legend

If software is for use in the performance of a U.S. Government prime contract or subcontract, Software is delivered and licensed as "Commercial computer software" as defined in DFAR 252.227-7014 (June 1995), or as a "commercial item" as defined in FAR 2.101(a) or as "Restricted computer software" as defined in FAR 52.227-19 (June 1987) or any equivalent agency regulation or contract clause. Use, duplication or disclosure of Software is subject to Keysight Technologies' standard commercial license terms, and non-DOD Departments and Agencies of the U.S. Government will receive no greater than Restricted Rights as defined in FAR 52.227-19(c)(1-2) (June 1987). U.S. Government users will receive no greater than Limited Rights as defined in FAR 52.227-14 (June 1987) or DFAR 252.227-7015 (b)(2) (November 1995), as applicable in any technical data.

Warranty

THE MATERIAL CONTAINED IN THIS DOCUMENT IS PROVIDED "AS IS," AND IS SUBJECT TO BEING CHANGED, WITHOUT NOTICE, IN FUTURE EDITIONS. FURTHER, TO THE MAXIMUM EXTENT PERMITTED BY APPLICABLE LAW, KEYSIGHT DISCLAIMS ALL WARRANTIES, EITHER EXPRESS OR IMPLIED WITH REGARD TO THIS MANUAL AND ANY INFORMATION CONTAINED HEREIN, INCLUDING BUT NOT LIMITED TO THE IMPLIED WARRANTIES OF MERCHANTABILITY AND FITNESS FOR A PARTICULAR PURPOSE. KEYSIGHT SHALL NOT BE LIABLE FOR ERRORS OR FOR INCIDENTAL OR CONSEQUENTIAL DAMAGES IN CONNECTION WITH THE FURNISHING, USE, OR PERFORMANCE OF THIS DOCUMENT OR ANY INFORMATION CONTAINED HEREIN. SHOULD KEYSIGHT AND THE USER HAVE A SEPARATE WRITTEN AGREEMENT WITH WARRANTY TERMS COVERING THE MATERIAL IN THIS DOCUMENT THAT CONFLICT WITH THESE TERMS, THE WARRANTY TERMS IN THE SEPARATE AGREEMENT WILL CONTROL.

Safety Notices

CAUTION

A **CAUTION** notice denotes a hazard. It calls attention to an operating procedure, practice, or the like that, if not correctly performed or adhered to, could result in damage to the product or loss of important data. Do not proceed beyond a **CAUTION** notice until the indicated conditions are fully understood and met.

WARNING

A **WARNING** notice denotes a hazard. It calls attention to an operating procedure, practice, or the like that, if not correctly performed or adhered to, could result in personal injury or death. Do not proceed beyond a **WARNING** notice until the indicated conditions are fully understood and met.

Table of Contents

U3020AS22

Description	2
Verifying the Shipment	2
General Performance	3
Power Requirements	3
Environmental Tests	3
Dimensions and Space Requirements	4
General RF Switch Specifications	4
RF Channel Performance	5
Front and Rear Panel Features	6
Controlling the Test Set	9
Controlling the Test Set and Making Measurements	9
LAN Connection using Your Companies Intranet	9
Test Set Control Commands	10
Adding Instruments to the LAN Interface	16
Configuring the LAN Interface	16
Locating the Instrument	16
Configuring the GPIB Interface	17
Adding Instruments to the GPIB Configuration	18
Changing the GPIB Address	18
LAN Configuration Commands	19
IP Address Command	19
Auto IP Address Command	19
DHCP Command	20
DNS Command	20
Domain Name Command	21
Gateway Address Command	21
Host Name Command	22
GPIB Address Command	22
Performance Verification	23
Equipment Required	23
Equipment Setup	23
Measurement Setup	24
Service Information	26
Electrostatic Discharge Protection	26
Theory of Operation	27
Test Set System Operation	27
Controller Module and Power Supply	29
39495EXT Module	29
Distribution Board	29
I/O Distribution Board	29
LED Indicator Board	29
Troubleshooting	30
Front Panel Instrument State LEDs	30
Front Panel Input Port LEDs	31
RF Switch is Not Switching	31
Safety and Information	35
Introduction	35
Safety Earth Ground	35
Declaration of Conformity	35
Statement of Compliance	35
Before Applying Power	36
Connector Care and Cleaning Precautions	37

Contents

- Regulatory Information 38
 - Instrument Markings 38
 - Battery Collection 39
 - Electrical Safety Compliance 39
 - EMI and EMC Compliance. 39
- Keysight Support, Services, and Assistance 40
 - Service and Support Options 40
 - Contacting Keysight 40
 - Shipping Your Product to Keysight for Service or Repair. 40

U3020AS22

Description

The Keysight U3020AS22 is a 300 kHz to 26.5 GHz single connection multiple measurement tests set with 4 ports in the forward path (a1-4), and 4 ports in the reverse path (b1-4) that allow the user to connect a full 12-Port matrix. There are two AUX output ports that allow the unit to connect to another multipoint test set or for some other application. This test set uses mechanical RF switches. The test set mainframe is a rack mountable 4 EIA units high. Switch control is only processed via the LAN or GPIB rear panel interfaces. All front panel RF ports are female 3.5 mm.

Figure 1 U3020AS22



Verifying the Shipment

To verify the contents shipped with your product, refer to the “Box Content List” included with the shipment.

Inspect the shipping container. If the container or packing material is damaged, it should be kept until the contents of the shipment have been checked mechanically and electrically. If there is physical damage refer to [“Contacting Keysight” on page 40](#). Keep the damaged shipping materials (if any) for inspection by the carrier and an Keysight Technologies representative.

General Performance

The Test Set performance is specified for a standalone instrument.

CAUTION This product has an autoranging line voltage input. Be sure the supply voltage is within the specified range.

Power Requirements

- 100-240V AC (50/60 Hz)
- The instruments can operate with mains supply voltage fluctuations up to $\pm 10\%$ of the nominal voltage.
- Air conditioning equipment (or other motor-operated equipment) should not be placed on the same ac line that powers the Test Set.
- U3022AS22 maximum power is 50 W.

Environmental Tests

The U3020AS22 complies with all applicable safety and regulatory requirements for the intended location of use.

- Operating Environment (Indoor Use)
- Operating Temperature 0 to 40 °C
- Storage Temperature: -40 to +70 °C
- Operating Altitude: 0 to 2000 meters (~ 6,562 feet)
- The instrument can safely operate in a relative humidity of 80% for temperatures to 31 degrees C, decreasing linearly to 50% relative humidity at 40 degrees C.

Dimensions and Space Requirements

Standard installation of the U3020AS22 includes configuration and installation on a customer provided lab bench, or table top of adequate size and strength.

Table 1 Test Set Dimensions

Item	Length/Weight
Width	42.5 cm (16.73 in)
Depth	58 cm (22.83 in)
Height	17.78 cm (7 in)
Weight	13.8 kg (30.5 lb)

General RF Switch Specifications

Table 2 Internal RF Switch and Key Parameters

Maximum Input Power Rating	1 Watt (+30 dBm) average into 50 Ohm internal loads.
Switch Life	5 million cycles minimum

RF Channel Performance

Table 3 Typical Performance Characteristics

Freq Range	Limits
Insertion Loss (< dB)	
300 kHz to 26.5 GHz	8.0
Return Loss¹ (-dB)	
300 kHz to 20 GHz	10.0
20 to 26.5 GHz	6.0
Isolation (> dB)	
300 kHz to 26.5 GHz	90.0
Phase Balance² (\pm Degrees) dB)	
300 kHz to 6 GHz	20.0
6 to 26.5 GHz	70.0

1. All front panel ports when internally terminated.
2. For A and B Ports 1 to 4 to the same test port switch paths.

Front and Rear Panel Features

CAUTION Refer to the standard instrument documentation for damage limits to the ports. Verify that your test setup will not cause those limits to be exceeded.

Figure 2 Front Panel

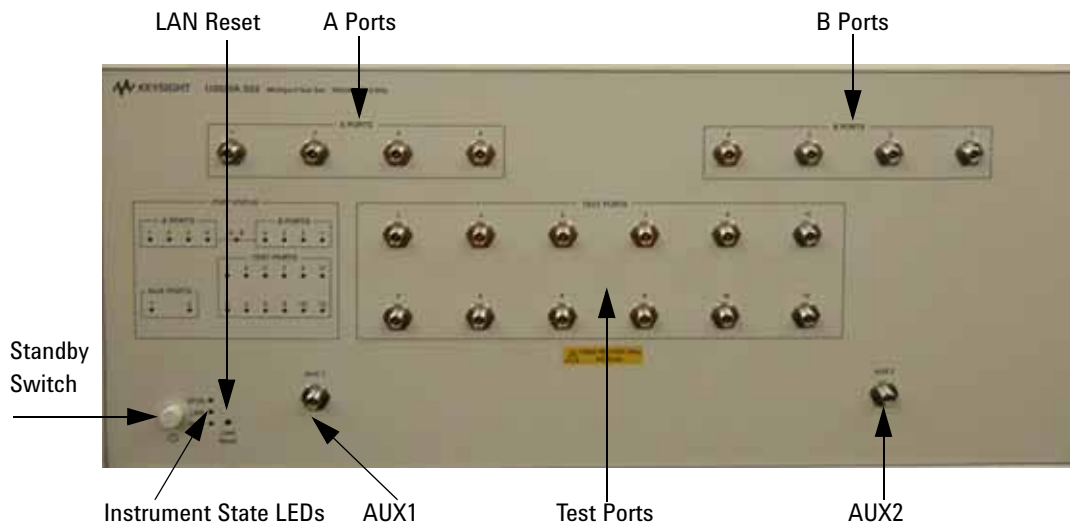

LAN Reset

The LAN reset button restores the instrument's default LAN configuration.

Port Status LEDs

The LED indicators show the active RF Port paths. The Test Port 1-12 LEDs are dual color (amber & green). The A Port and Aux1 LEDs are green. The B Ports and Aux2 LEDs are amber.

- When a Test Port, or Aux1 port is switched to A Port, that port LED will display green.
- When a Test Port, or Aux2 port is switched to B Port, that port LED will display amber.
- When A Port and B Port are connected, their respected port number will light and the center "A-B" LED will also be on.

NOTE If a Test Port display LED is bright yellow, this is an error state indication in which a set of switch commands has configured the A and B Port to the same Test Port. For example, sending command a1p1 then b2p1 to the Test Set the Port Status LED display will show Port A 1 (green), Port B2 (amber), and Test Port 1 (bright yellow). To avoid this switch configuration error, do not send switch commands that select the same Test Port.

Input/Output Ports

There are two separate signal channels, A and B. Each channel has four port. All connectors are 3.5 mm female.

Instrument State LEDs

When the power is applied to the U3020AS22, the instrument enters its power-on sequence which requires several seconds to complete. The LEDs provide information on the state of the instrument during power-on and upgrades of the instrument firmware. [Table 4 on page 7](#) identifies the instrument states based on the color and functioning of the LEDs.

Standby Switch

Note that this switch is Standby only, not a line switch. The main power cord can be used as the system disconnecting device. It disconnects the mains circuits from the mains supply.

Table 4 Instrument State LED Definitions

LED	Color	Instrument State
ATTN LAN PWR	Off Green Green	Instrument in "ready" state LAN connection established - instrument has an IP address - firmware download complete
ATTN LAN PWR	flashing flashing Green	Power-on/boot-up. ATTN and LAN will flash red and then green during the power-on self-test.
ATTN LAN PWR	Off Red Green	No LAN connection due to: - disconnected LAN cable - failure to acquire and IP address - waiting for DHCP-assigned address
ATTN LAN PWR	Green (flashing) Green Green	Instrument Busy State - firmware download (LAN LED red if download over GPIB) - lengthy instrument operation in progress
ATTN LAN PWR	Red (flashing) Green Green	Instrument programming error or self-test error. Error queue is read using SYSTem:ERRor?
ATTN LAN PWR	Off Green (flashing) Green	Instrument identification. Activated from instrument Web interface: ON: Turn on Front Panel Interface Indicator OFF: Turn off Front Panel Interface Indicator

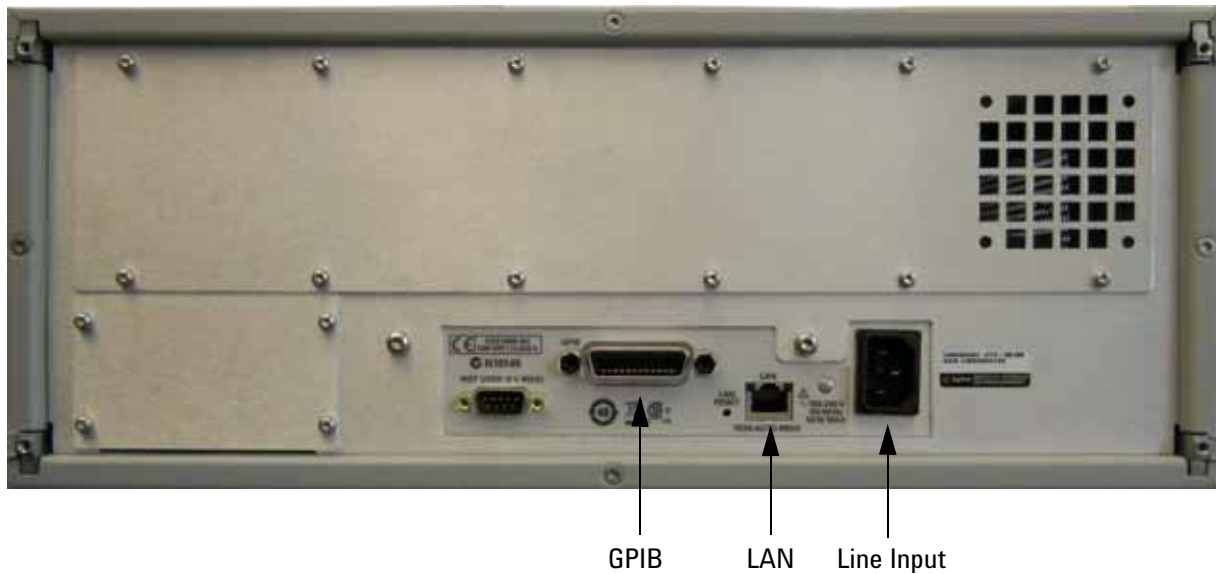
Figure 3 Rear Panel

GPIB Connector

This connector allows the test set to be connected directly to a controller. Factory set address = 26.

LAN

The instrument is controlled over Local Area Network (LAN).

Line Input

The line input contains the power cord receptacle.

Install the instrument so that the detachable power cord is readily identifiable and is easily reached by the operator. The detachable power cord is the instrument disconnecting device. It disconnects the mains circuits from the mains supply before other parts of the instrument. The front panel switch is only a standby switch and is not a LINE switch. Alternatively, an externally installed switch or circuit breaker (which is readily identifiable and is easily reached by the operator) may be used as a disconnecting device.

CAUTION Always use the three-prong ac power cord supplied with this product. Failure to ensure adequate grounding by not using this cord may cause damage to the product.

Controlling the Test Set

Controlling the Test Set and Making Measurements

Keysight U3020A is a “slave” instruments. A controller must be used to control the Test Set. There are two methods that can be used to control the Test Set.

- Using LAN connection

Using GPIB connection

Once the connection between the Controller and the Test Set has been established (LAN or GPIB), the Test Set can be controlled using SCPI commands.

LAN Connection using Your Companies Intranet

Connect the Test Set and your controlling computer to an active instrument LAN line. Open the internet browser application on the computer. Enter this default web address on your browser application: `http://U3020AS22-xxxx`

The Welcome screen for the instrument should be viewable if the LAN connection is working. Select the following screen control buttons to access the SCPI command control window.

1. Browser Web Connect (control button on the left side of the screen)
2. Allow Full control
3. Commands

NOTE The last four digits in the web address (xxxx) are the last four digits of the instruments serial number.

Once the connection between the controller and the Test Set has been established (LAN or GPIB), the test set can be controlled using SCPI commands. Refer to [Table 5 on page 11](#).

Test Set Control Commands

The Test Set has predefined sequence command sets defined at the factory and stored in the non-volatile memory of the controller module. If the specified sequence name is not currently stored in the memory, due to corrupted program or accidentally deleted, an error will be generated. Refer to the Service section of this manual for instructions to remedy this issue.

Syntax

ROUTE:SEQ:TRIGger <command>

Parameters

Refer to [Table 5](#) for commands use to control the Test Set's programmable switches.

Measurement Setup Example

With the following sequence commands, "a2p5" and "b2p10", the Test Set will position the internal RF switches to create the signal paths needed to measure the DUT shown in [Figure 4](#). All unselected front panel ports will be terminated by an internal RF switch 50 Ohm load.

In this example we will configure the system to make an S21 measurement. Network Analyzer Port 1 is the source output port and Port 2 is the receiver port.

Command: ROUT:SEQ:TRIG a2p5; b2p10

" a2p5", will create a signal path from A Port 2 to Test Port 5.

" b2p10", will create a signal path from B Port 2 to Test Port 10.

Figure 4 Measurement Example

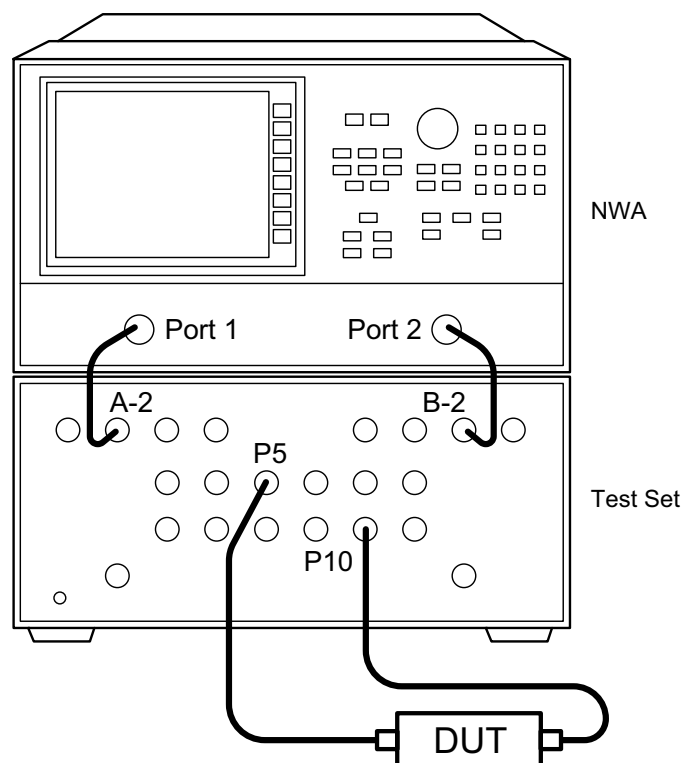

Table 5 Test Set Control Commands

No.	SCPI Command	Connection Path Description	Comments
1	a1p1	A Port 1 to Test Port 1	unselected Ports are terminated
2	a1p2	A Port 1 to Test Port 2	unselected Ports are terminated
3	a1p3	A Port 1 to Test Port 3	unselected Ports are terminated
4	a1p4	A Port 1 to Test Port 4	unselected Ports are terminated
5	a1p5	A Port 1 to Test Port 5	unselected Ports are terminated
6	a1p6	A Port 1 to Test Port 6	unselected Ports are terminated
7	a1p7	A Port 1 to Test Port 7	unselected Ports are terminated
8	a1p8	A Port 1 to Test Port 8	unselected Ports are terminated
9	a1p9	A Port 1 to Test Port 9	unselected Ports are terminated
10	a1p10	A Port 1 to Test Port 10	unselected Ports are terminated
11	a1p11	A Port 1 to Test Port 11	unselected Ports are terminated
12	a1p12	A Port 1 to Test Port 12	unselected Ports are terminated
13	a1aux	A Port 1 to Aux 1	unselected Ports are terminated
14	a2p1	A Port 2 to Test Port 1	unselected Ports are terminated
15	a2p2	A Port 2 to Test Port 2	unselected Ports are terminated
16	a2p3	A Port 2 to Test Port 3	unselected Ports are terminated
17	a2p4	A Port 2 to Test Port 4	unselected Ports are terminated
18	a2p5	A Port 2 to Test Port 5	unselected Ports are terminated
19	a2p6	A Port 2 to Test Port 6	unselected Ports are terminated
20	a2p7	A Port 2 to Test Port 7	unselected Ports are terminated
21	a2p8	A Port 2 to Test Port 8	unselected Ports are terminated
22	a2p9	A Port 2 to Test Port 9	unselected Ports are terminated
23	a2p10	A Port 2 to Test Port 10	unselected Ports are terminated
24	a2p11	A Port 2 to Test Port 11	unselected Ports are terminated
25	a2p12	A Port 2 to Test Port 12	unselected Ports are terminated
26	a2aux	A Port 2 to Aux 1	unselected Ports are terminated
27	a3p1	A Port 3 to Test Port 1	unselected Ports are terminated
28	a3p2	A Port 3 to Test Port 2	unselected Ports are terminated
29	a3p3	A Port 3 to Test Port 3	unselected Ports are terminated
30	a3p4	A Port 3 to Test Port 4	unselected Ports are terminated

Table 5 Test Set Control Commands

No.	SCPI Command	Connection Path Description	Comments
31	a3p5	A Port 3 to Test Port 5	unselected Ports are terminated
32	a3p6	A Port 3 to Test Port 6	unselected Ports are terminated
33	a3p7	A Port 3 to Test Port 7	unselected Ports are terminated
34	a3p8	A Port 3 to Test Port 8	unselected Ports are terminated
35	a3p9	A Port 3 to Test Port 9	unselected Ports are terminated
36	a3p10	A Port 3 to Test Port 10	unselected Ports are terminated
37	a3p11	A Port 3 to Test Port 11	unselected Ports are terminated
38	a3p12	A Port 3 to Test Port 12	unselected Ports are terminated
39	a3aux	A Port 3 to Aux 1	unselected Ports are terminated
40	a4p1	A Port 4 to Test Port 1	unselected Ports are terminated
41	a4p2	A Port 4 to Test Port 2	unselected Ports are terminated
42	a4p3	A Port 4 to Test Port 3	unselected Ports are terminated
43	a4p4	A Port 4 to Test Port 4	unselected Ports are terminated
44	a4p5	A Port 4 to Test Port 5	unselected Ports are terminated
45	a4p6	A Port 4 to Test Port 6	unselected Ports are terminated
46	a4p7	A Port 4 to Test Port 7	unselected Ports are terminated
47	a4p8	A Port 4 to Test Port 8	unselected Ports are terminated
48	a4p9	A Port 4 to Test Port 9	unselected Ports are terminated
49	a4p10	A Port 4 to Test Port 10	unselected Ports are terminated
50	a4p11	A Port 4 to Test Port 11	unselected Ports are terminated
51	a4p12	A Port 4 to Test Port 12	unselected Ports are terminated
52	a4aux	A Port 4 to AUX 1	unselected Ports are terminated
53	b1p1	B Port 1 to Test Port 1	unselected Ports are terminated
54	b1p2	B Port 1 to Test Port 2	unselected Ports are terminated
55	b1p3	B Port 1 to Test Port 3	unselected Ports are terminated
56	b1p4	B Port 1 to Test Port 4	unselected Ports are terminated
57	b1p5	B Port 1 to Test Port 5	unselected Ports are terminated
58	b1p6	B Port 1 to Test Port 6	unselected Ports are terminated
59	b1p7	B Port 1 to Test Port 7	unselected Ports are terminated
60	b1p8	B Port 1 to Test Port 8	unselected Ports are terminated
61	b1p9	B Port 1 to Test Port 9	unselected Ports are terminated

Table 5 Test Set Control Commands

No.	SCPI Command	Connection Path Description	Comments
62	b1p10	B Port 1 to Test Port 10	unselected Ports are terminated
63	b1p11	B Port 1 to Test Port 11	unselected Ports are terminated
64	b1p12	B Port 1 to Test Port 12	unselected Ports are terminated
65	b1aux	B Port 1 to Aux 2	unselected Ports are terminated
66	b2p1	B Port 2 to Test Port 1	unselected Ports are terminated
67	b2p2	B Port 2 to Test Port 2	unselected Ports are terminated
68	b2p3	B Port 2 to Test Port 3	unselected Ports are terminated
69	b2p4	B Port 2 to Test Port 4	unselected Ports are terminated
70	b2p5	B Port 2 to Test Port 5	unselected Ports are terminated
71	b2p6	B Port 2 to Test Port 6	unselected Ports are terminated
72	b2p7	B Port 2 to Test Port 7	unselected Ports are terminated
73	b2p8	B Port 2 to Test Port 8	unselected Ports are terminated
74	b2p9	B Port 2 to Test Port 9	unselected Ports are terminated
75	b2p10	B Port 2 to Test Port 10	unselected Ports are terminated
76	b2p11	B Port 2 to Test Port 11	unselected Ports are terminated
77	b2p12	B Port 2 to Test Port 12	unselected Ports are terminated
78	b2aux	B Port 2 to Aux 2	unselected Ports are terminated
79	b3p1	B Port 3 to Test Port 1	unselected Ports are terminated
80	b3p2	B Port 3 to Test Port 2	unselected Ports are terminated
81	b3p3	B Port 3 to Test Port 3	unselected Ports are terminated
82	b3p4	B Port 3 to Test Port 4	unselected Ports are terminated
83	b3p5	B Port 3 to Test Port 5	unselected Ports are terminated
84	b3p6	B Port 3 to Test Port 6	unselected Ports are terminated
85	b3p7	B Port 3 to Test Port 7	unselected Ports are terminated
86	b3p8	B Port 3 to Test Port 8	unselected Ports are terminated
87	b3p9	B Port 3 to Test Port 9	unselected Ports are terminated
88	b3p10	B Port 3 to Test Port 10	unselected Ports are terminated
89	b3p11	B Port 3 to Test Port 11	unselected Ports are terminated
90	b3p12	B Port 3 to Test Port 12	unselected Ports are terminated
91	b3aux	B Port 3 to Aux 2	unselected Ports are terminated
92	b4p1	B Port 4 to Test Port 1	unselected Ports are terminated

Table 5 Test Set Control Commands

No.	SCPI Command	Connection Path Description	Comments
93	b4p2	B Port 4 to Test Port 2	unselected Ports are terminated
94	b4p3	B Port 4 to Test Port 3	unselected Ports are terminated
95	b4p4	B Port 4 to Test Port 4	unselected Ports are terminated
96	b4p5	B Port 4 to Test Port 5	unselected Ports are terminated
97	b4p6	B Port 4 to Test Port 6	unselected Ports are terminated
98	b4p7	B Port 4 to Test Port 7	unselected Ports are terminated
99	b4p8	B Port 4 to Test Port 8	unselected Ports are terminated
100	b4p9	B Port 4 to Test Port 9	unselected Ports are terminated
101	b4p10	B Port 4 to Test Port 10	unselected Ports are terminated
102	b4p11	B Port 4 to Test Port 11	unselected Ports are terminated
103	b4p12	B Port 4 to Test Port 12	unselected Ports are terminated
104	b4aux	B Port 4 to Aux 2	unselected Ports are terminated
105	alb1	A Port 1 to B Port 1	unselected ports are terminated
106	alb2	A Port 1 to B Port 2	unselected Ports are terminated
107	alb3	A Port 1 to B Port 3	unselected Ports are terminated
108	alb4	A Port 1 to B Port 4	unselected Ports are terminated
109	a2b1	A Port 2 to B Port 1	unselected ports are terminated
110	a2b2	A Port 2 to B Port 2	unselected Ports are terminated
111	a2b3	A Port 2 to B Port 3	unselected Ports are terminated
112	a2b4	A Port 2 to B Port 4	unselected Ports are terminated
113	a3b1	A Port 3 to B Port 1	unselected ports are terminated
114	a3b1	A Port 3 to B Port 2	unselected Ports are terminated
115	a3b3	A Port 3 to B Port 3	unselected Ports are terminated
116	a3b4	A Port 3 to B Port 4	unselected Ports are terminated
117	a4b1	A Port 4 to B Port 1	unselected ports are terminated
118	a4b2	A Port 4 to B Port 2	unselected Ports are terminated
119	a4b3	A Port 4 to B Port 3	unselected Ports are terminated
120	a4b4	A Port 4 to B Port 4	unselected Ports are terminated
121	atem	A Ports 1 to 4 terminated	A port paths terminated
122	bterm	B ports 1 to 4 terminated	B port paths terminated
123	LED_GRN	all green LEDs on	display diagnosis check

Table 5 Test Set Control Commands

No.	SCPI Command	Connection Path Description	Comments
124	LED_YEL	all yellow LEDs on	display diagnosis check
125	LED_ORG	orange LED on	display diagnosis check
126	LED_ON	all LEDs on	display diagnosis check
127	LED_OFF	all LEDs off	display diagnosis check

Adding Instruments to the LAN Interface

This section contains information to configure the U3020A LAN and using Agilent IO Libraries "Connection Expert Utility."

Configuring the LAN Interface

1. Connect the Test Set to the PC.
2. Turn On the Test Set.
3. Select IO Control icon > Agilent Connection Expert from the application window.

Figure 5 Agilent Connection Expert

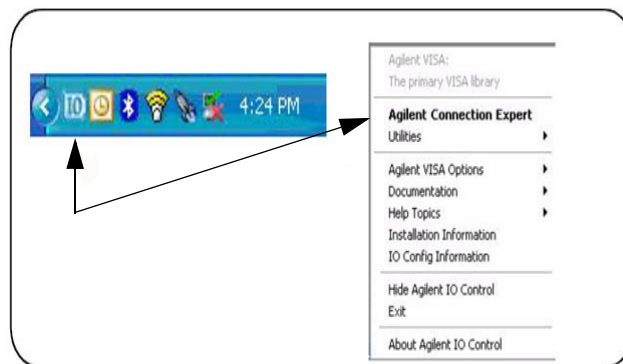

Locating the Instrument

Agilent Connection Expert opens with a "Welcome Screen," and a window similar to that shown in Figure 5. The available computer interfaces are configured during installation of the Agilent IO Libraries and are displayed in the left column (Explorer Pane). The properties of the configured interface are displayed in the right column (Properties Pane).

Figure 6 Explorer and Properties Pane

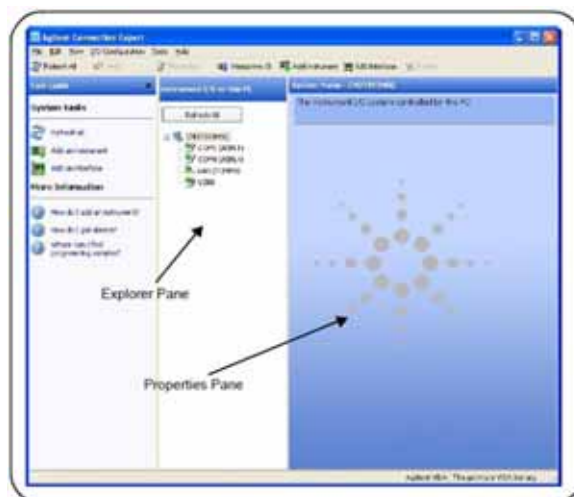

1. Click Add Instrument on the tool bar to search the network for instruments.
2. Select Add LAN Instrument on LAN (TCP/IP0) > OK. Agilent Connection Expert performs an automatic find of all instruments on the same subnet as the computer.
3. Select the desired instruments from the list and click OK. Communication paths to the instruments are verified and the instruments are added to the configured interface.

Figure 7 Adding Instruments

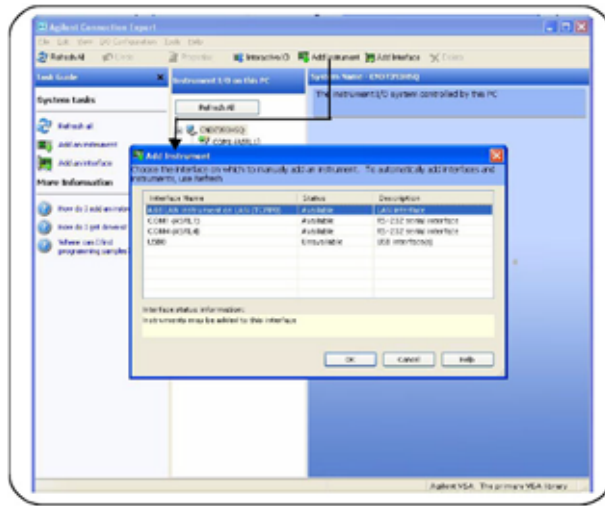

Configuring the GPIB Interface

Programming access to the Test Set is also available through the instrument's GPIB interface. The GPIB connector is located on the rear panel of the instrument.

1. Select the Agilent Control icon > Agilent Connection Expert. If a GPIB card is installed in your computer, the GPIB interface was configured during installation of the IO libraries and is displayed in the Explorer Pane of the "Welcome" Screen.

Figure 8 Agilent Connection Expert



Adding Instruments to the GPIB Configuration

1. Select Add Instrument on the tool bar.
2. Select GPIB Interface > OK.
3. Select U3020A's Address in the GPIB address drop-down list > OK.
(Factory set address = 26)

Changing the GPIB Address

The U3020A GPIB address can only be changed programmatically. The GPIB address command is:

```
SYSTem:COMMunicate:GPIB:ADDRes <address>
```

When the address is changed, the new GPIB address is not updated in the Agilent Connection Expert if the instrument was previously configured.

1. From the Agilent Connection Expert application window, highlight the instrument that's address was changed and click Change Properties in the Configurable Properties application window, change the address to the new address setting and select OK.

LAN Configuration Commands

IP Address Command

This command assigns a static Internet Protocol (IP) address for the U3020A. Contact your network administrator for the valid IP address to use for your instrument.

NOTE If you change the IP address, you must cycle power on the U3020A to activate the new address.

Syntax

```
SYSTem:COMMunicate:LAN:IPADdress <address>
```

```
SYSTem:COMMunicate:LAN:IPADdress?
```

You can also queries the U3020A for the IP address it was assigned to.

Example

The following command sets the IP address:

```
SYST:COMM:IPAD 169.254.149.35
```

The following query returns the IP address currently being used by the instrument (quotes are also returned).

```
SYST:COMM:LAN:IPAD?
```

Typical Response: "169.254.149.35"

Auto IP Address Command

This command disable or enable the use of Auto-IP standard to automatically assign an IP address to the U3020A when on a network that does not have DHCP servers.

Syntax

```
SYSTem:COMMunicate:LAN:AUTOip {OFF|0|ON|1}
```

```
SYSTem:COMMunicate:LAN:AUTOip?
```

Example

The following command disable the Auto-IP:

```
SYST:COMM:LAN:AUTOIP OFF
```

The following query returns the current Auto-IP setting:

```
SYST:COMM:LAN:AUTOIP?
```

Typical Response: 0

DHCP Command

This command disables or enables the use of the Dynamic Host Configuration Protocol (DHCP).

Syntax

```
SYSTem:COMMunicate:LAN:DHCP {OFF|0|ON|1}
```

```
SYSTem:COMMunicate:LAN:DHCP?
```

When DHCP is enable (factory setting), the instrument will try to obtain an IP address from the DHCP server. If a DHCP server is found, it will assign a Dynamic IP address, Subnet Mask, and Default Gateway to the instrument.

When the DHCP is disable or unavailable, the instrument will use the Static IP address, Subnet Mask, and Default Gateway during power-on.

NOTE If you change the DHCP setting, you must cycle power on the U3020A to activate the new setting.

Example

The following command disables DHCP:

```
SYST:COMM:LAN:DHCP OFF
```

The following query returns the current DHCP setting:

```
SYST:COMM:LAN:DHCP?
```

Typical Response: 0

DNS Command

This command assigns the IP address of the Domain Name System (DNS) server. Contact your network administrator to determine if DNS is being used and for the correct address.

Syntax

```
SYSTem:COMMunicate:LAN:DNS <address>
```

```
SYSTem:COMMunicate:LAN:DNS?
```

NOTE If you change the DNS address, you must cycle power on the U3020A to activate the new address.

Example

The following command sets the DNS address:

```
SYST:COMM:LAN:DNS 198.105.232.4
```

The following query returns the DNS address currently being used by the instrument (the quotes are also returned).

```
SYST:COMM:LAN:DNS?
```

Typical Response: "198.105.232.4"

Domain Name Command

This command assigns a Domain Name to the U3020A. The Domain Name is translated into an IP address.

Syntax

```
SYSTem:COMMunicate:LAN:DOMain "<name>"
```

```
SYSTem:COMMunicate:LAN:DOMain?
```

NOTE If you change the Domain Name, you must cycle power on the U3020A to activate the new address.

Example

The following command defines the Domain Name:

```
SYST:COMM:LAN:DOM www.Keysight.com
```

The following query returns the Domain Name currently being used by the instrument:

```
SYST:COMM:LAN:DOM?
```

Typical response: www.Keysight.com

Gateway Address Command

This command assigns a Default Gateway for the U3020A. The specified IP Address sets the Default Gateway which allows the instrument to communicate with systems that are not on the local subnet. Thus, this is the Default Gateway where packets are sent which are destined for a device not on the local subnet, as determined by the Subnet Mask setting. Contact your network administrator to determine if a gateway is being used and for the correct address.

Syntax

```
SYSTem:COMMunicate:LAN:GATEway <address>
```

```
SYSTem:COMMunicate:LAN:GATEway?
```

Example

The following command sets the Default Gateway address:

```
SYST:COMM:LAN:GATEWAY 255.255.20.11
```

The following query returns the Default Gateway address currently being used by the instrument (the quotes are also returned).

```
SYST:COMM:LAN:GATEWAY?
```

Typical Response: "255.255.20.11"

Host Name Command

This command assigns a Host Name to the U3020A. The Host Name is the host portion of the domain name, which is translated into an IP address.

Syntax

```
SYSTem:COMMunicate:LAN:HOSTname "<name>"
```

```
SYSTem:COMMunicate:LAN:HOSTname?
```

NOTE If you change the Domain Name, you must cycle power on the U3020A to activate the new address.

Example

The following command defines a Host Name:

```
SYST:COMM:LAN:HOST "U3020AS22-0101"
```

The following query returns the Host Name currently being used by the instrument (the quotes are also returned):

```
SYST:COMM:LAN:HOST?
```

Typical Response: "U3020AS22-0101"

GPIB Address Command

GPIB Address Command Description

This command assigns a GPIB address to the U3020A.

Syntax

```
SYSTem:COMMunicate:GPIB:ADDRess <address>
```

```
SYSTem:COMMunicate:GPIB:ADDRess?
```

NOTE If you change the GPIB address, you must cycle power on the U3020A to activate the new address.

Example

The following command sets the GPIB address to 26:

```
SYST:COMM:GPIB:ADDR 26
```

The following query returns the current GPIB address:

```
SYST:COMM:GPIB:ADDR?
```

Typical Response: 26

NOTE For a complete list of SCPI commands, refer to the Keysight L449xA RF Switch Platform User's Guide (L4490-90001).

Performance Verification

The following procedure will confirm that the Test Set is functional.

Equipment Required

- Working LAN System
- PNA Network Analyzer with up to 26.5 GHz frequency range
- RF coaxial cables with 3.5 mm connectors

Equipment Setup

1. Configure PNA and Test Set as shown in Figure 7
2. Turn On the PNA and Test Set.
 - The Test Set LED Indicators should indicate the following after 1 minute:
 - ATTN - OFF
 - LAN - ON
 - PWR - ON
3. Preset the PNA.
4. PNA frequency range: 10 MHz to 26.5 GHz.
5. Set the PNA to Measure S21, Scale to 5 dB/Div.

Figure 9 Equipment Setup

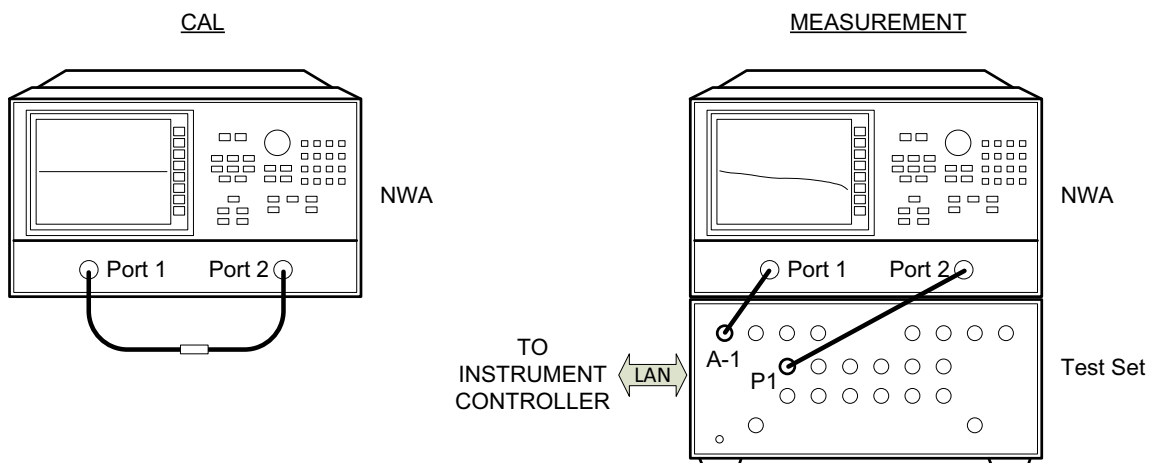

Measurement Setup

1. Cal S21 as shown above by connecting the two RF cable using a 3.5 mm female to female adapter.
2. Normalize the displayed response trace on the PNA.
3. Remove the 3.5 mm adapter from the setup.
4. Connect the PNA Port 1 cable to Test Set A Port 1.
5. Connect the PNA Port 2 cable to Test Set Test Port 1.
6. Establish control of the Test Set with the controller via the LAN connection.
7. Execute the sequence command <ROUT:SEQ:TRIG a1p1 > to create A Port 1 to Test Port 1 signal path. **Figure 10** is representation of the S21 response trace. Markers shown are not provided in the procedure above. Refer to **Table 3 on page 5** for typical Insertion Loss values.
8. While observing the front panel Port Status LED display, verify that A Port1 and Test Port 1 LED's are ON and green in color.
9. Execute each of the available switch path selections from the SCIP command listing and observe that the correct Status LED display pattern is ON, and that the S21 path response is similar to that provided in **Figure 10**.

Figure 10 Typical Port Match Plot

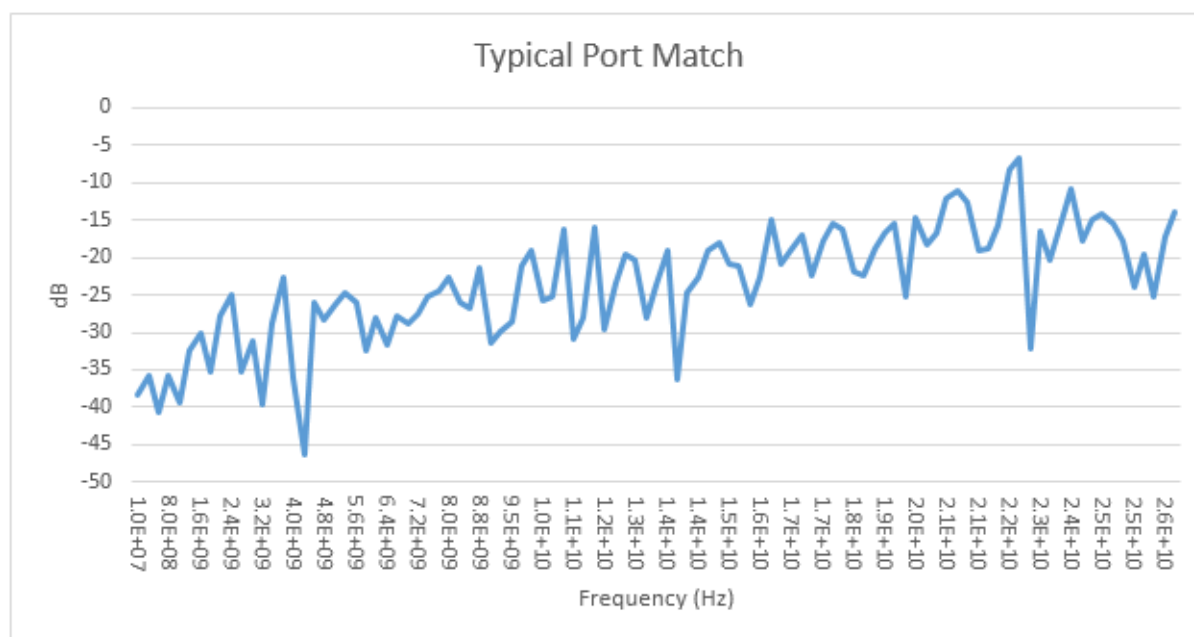

Figure 11 Typical Insertion Loss Plot

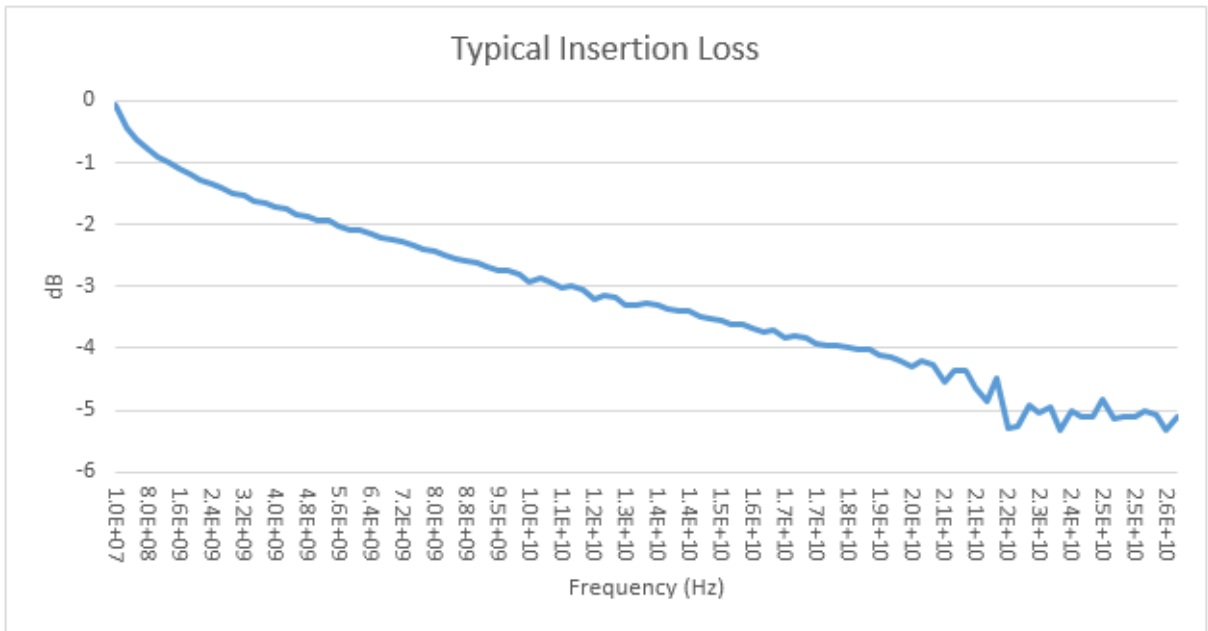
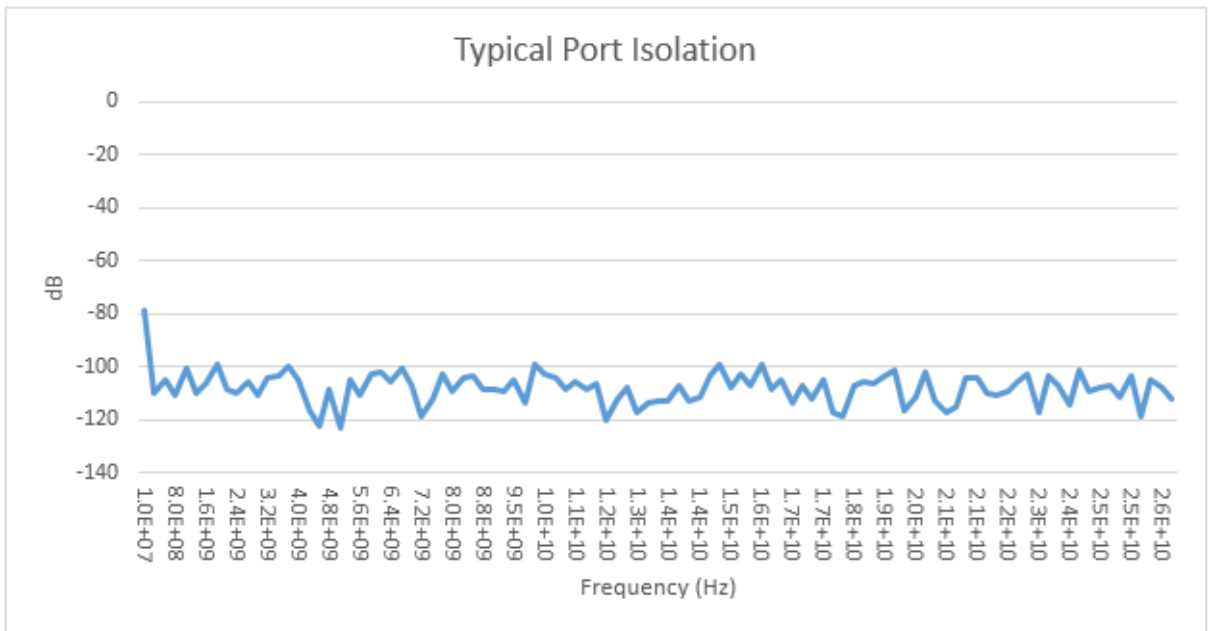

Figure 12 Typical Port Isolation Plot



Service Information

There are many other repair and calibration options available from the Keysight Technologies support organization. The options cover a range of service agreements with varying response times. Contact Keysight for additional information on available service agreements for this product.

WARNING These servicing instructions are for use by qualified personnel only. To avoid electrical shock, do not perform any servicing unless you are qualified to do so.

Electrostatic Discharge Protection

Electrostatic discharge (ESD) can damage or destroy electronic components. The instrument is shipped in materials that prevent damage from static, and should only be removed from the packaging in an anti-static area ensuring that the correct anti-static precautions are taken.

Two types of ESD protection are listed below. Purchase acceptable ESD accessories from your local supplier.

- Conductive table-mat and wrist-strap combination
- Conductive floor-mat and heel-strap combination

Both types, when used together, provide a significant level of ESD protection. To ensure user safety, static-safe accessories must provide at least 1 M Ohm of isolation from ground.

Theory of Operation

This section provides a general description of the U3020AS22 Test Set, followed by a more detailed operating theory. The operation of each component group is briefly described to the assembly level only.

NOTE If you need to disassemble the instrument, be sure to work at an anti-static workstation and use a grounded wrist strap to prevent damage from electrostatic discharge (ESD). See [“Electrostatic Discharge Protection” on page 26](#).

Test Set System Operation

Figure 13 illustrates the components and interconnects of the Test Set. The Test Set's main function is a 2 by 12 matrix with additional ports for single connection multiple measurements.

- Controller Module/Power Supply
- 39495EXT Modules
- Switch Distribution Boards
- RF Switches
- Front Panel Power On Status LED Indicators
- Front Panel RF Switch Status LED indicator

There are no adjustments required for the Agilent U3020AS22 Test Set.

Figure 13 Test Set Block Diagram

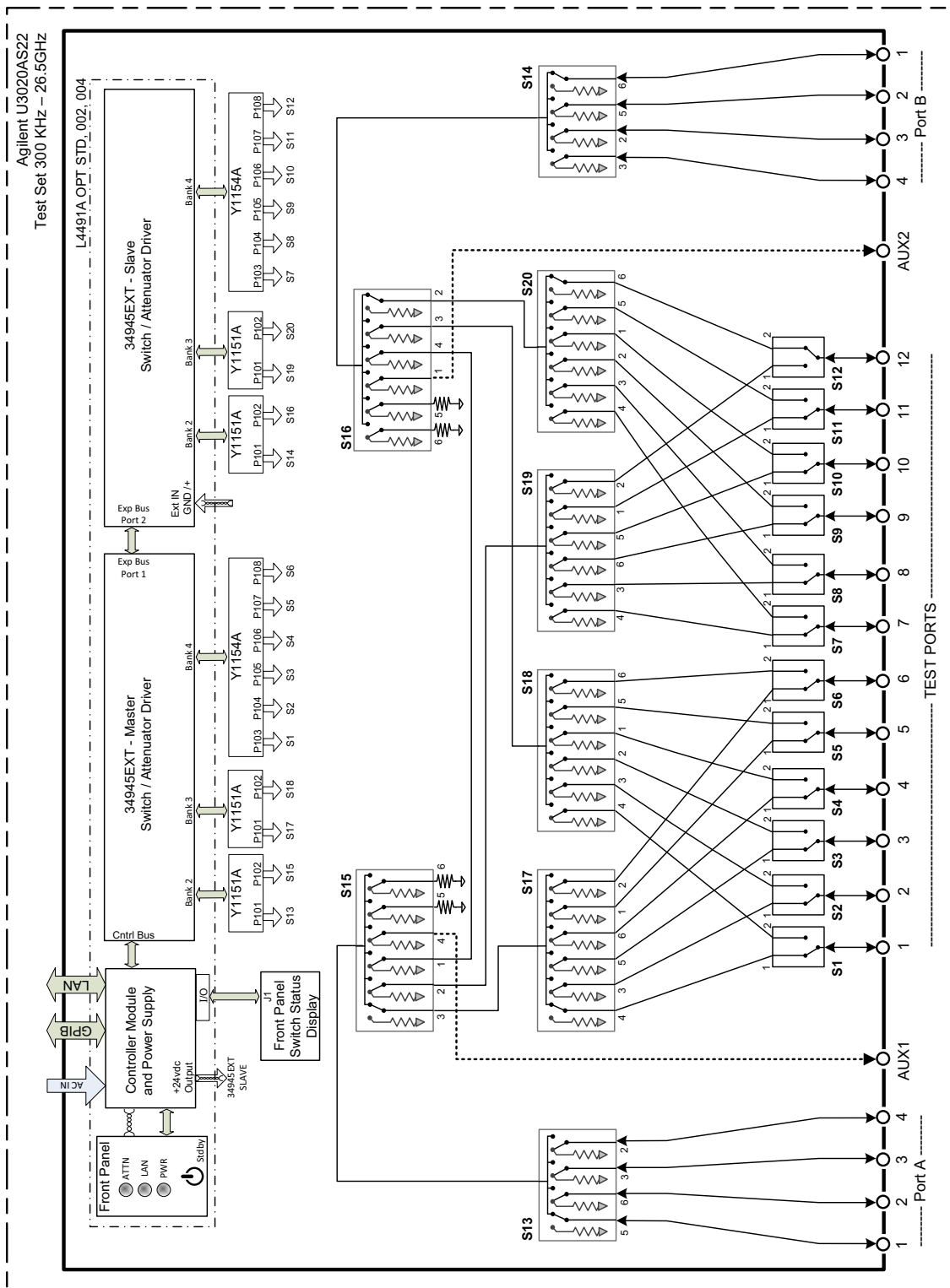

Controller Module and Power Supply

Inside the controller module there are two main components, the AC-DC power supply and controller board. The AC-DC power supply is a 12V/65 W power supply that is converted to various voltages by means of DC-DC converter inside the module. It provides regulated voltages to all assemblies in the Test Set. The internal DC voltage has the following nominal specification:

- +24 V
- +12 V
- +5 V

The controller board is the “brain” of the Test Set, it handles all the communication between the Controller and the Test Set via LAN or GPIB connectivity.

39495EXT Module

This module provides the bias and control signals for the RF Switches.

Distribution Board

The Distribution board (Y1151A and Y1154A) provides a passive control signal interface between the 34945EXT module and the RF Switches.

I/O Distribution Board

The I/O Distribution board provides a passive control signal interface between the controller module I/O port and the front panel Port LED board.

LED Indicator Board

This board provides an LED indication of the Port setting in the Test Set. The LED indicator board is driven by the digital IO of the Test Set.

Troubleshooting

This section contains information for troubleshooting the Test Set to the assembly level only. By following these procedures, you may determine if the power supply, front panel, or main switch board needs replacing. Refer to [Figure 13 on page 28](#) as an aid in troubleshooting.

NOTE If you need to disassemble the instrument, be sure to work at an anti static workstation and use a grounded wrist strap to prevent damage from electrostatic discharge (ESD).

Front Panel Instrument State LEDs

If you suspect a problem with the Instrument State or Input Port LEDs, first refer to the status definitions in [Table 4 on page 7](#) before proceeding. Note that with only a power cable connected to the rear panel of the Test Set, the PWR LED = Green and LAN LED = Red.

1. If the green PWR LED is OFF after depressing the front panel button continue with the following procedure:
 - a. Remove the top cover of the instrument.
 - b. Ensure that the ribbon cable and 2-wire connector are properly in place.
 - c. Measure the DC voltage between the red and black wires. The red wire should measure approximately +12 Vdc.
 - d. If the +12 Vdc is not present on the red wire, measure the three labeled output power supply voltages on the controller module at the green connector.
 - e. If any voltages are not present, the controller module power supply will need to be replaced.
2. If the green PWR LED is 'ON' after depressing the front panel button and the LAN LED is OFF continue with the following procedure:
 - a. Remove the top cover of the instrument.
 - b. Ensure that the ribbon cable and 2-wire connector are properly in place.
 - c. Measure the DC voltage between the red and black wires. The red wire should measure approximately +12 Vdc.
 - d. If any voltages are not present, the controller module power supply will need to be replaced.

Front Panel Input Port LEDs

1. If the Input Port LEDs do not operate when you have executed a Port Selection command on the Test Set continue with the following procedure:
 - a. If you have determined that the RF switch is operating, either by an audible sound or by an RF Input to Output port measurement, remove the top cover of the instrument.
 - b. Ensure that the two ribbon cables going from the Controller Module I/O port to the front panel LED board are properly in place.
 - c. Measure the three labeled output power supply voltages on the Controller Module at the green connector.
 - d. If any voltages are not present, the Controller Module Power Supply will need to be replaced.
 - e. If the Power Supply voltage are all present, suspect the front panel Input Port LED board or the Controller Module I/O section.

RF Switch is Not Switching

1. If the RF Switches are not operating continue with the following procedure:
 - a. Determined if you can hear an audible switching sound.
 - b. If an audible sound is heard, but the switch is not being properly control in order for the correct Port to be selected, it is possible that the instrument Power On preset set has been corrupted.
 - c. Contact Keysight Technologies for support in recovering this preset set.
 - d. If no audible sound is heard, remove the top cover of the instrument.
 - e. Insure that the ribbon cable connections at the distribution board and switch are properly in place.
 - f. Measure the three labeled output power supply voltages on the Controller Module at the green connector.
 - g. If any voltages are not present, the Controller Module Power Supply will need to be replaced.

Figure 14 Top View (Component Locations)

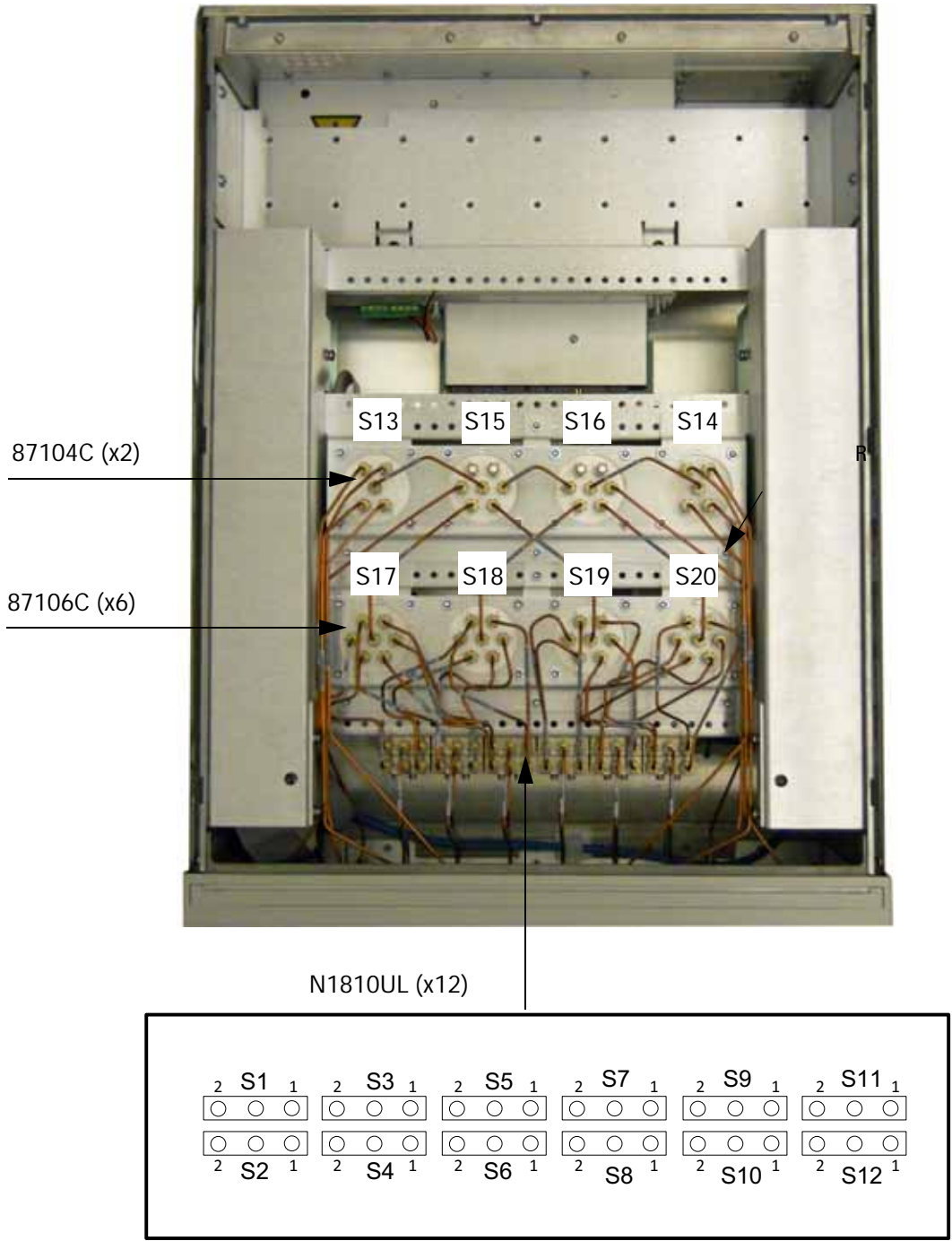

Figure 15 Bottom View (Component Locations)

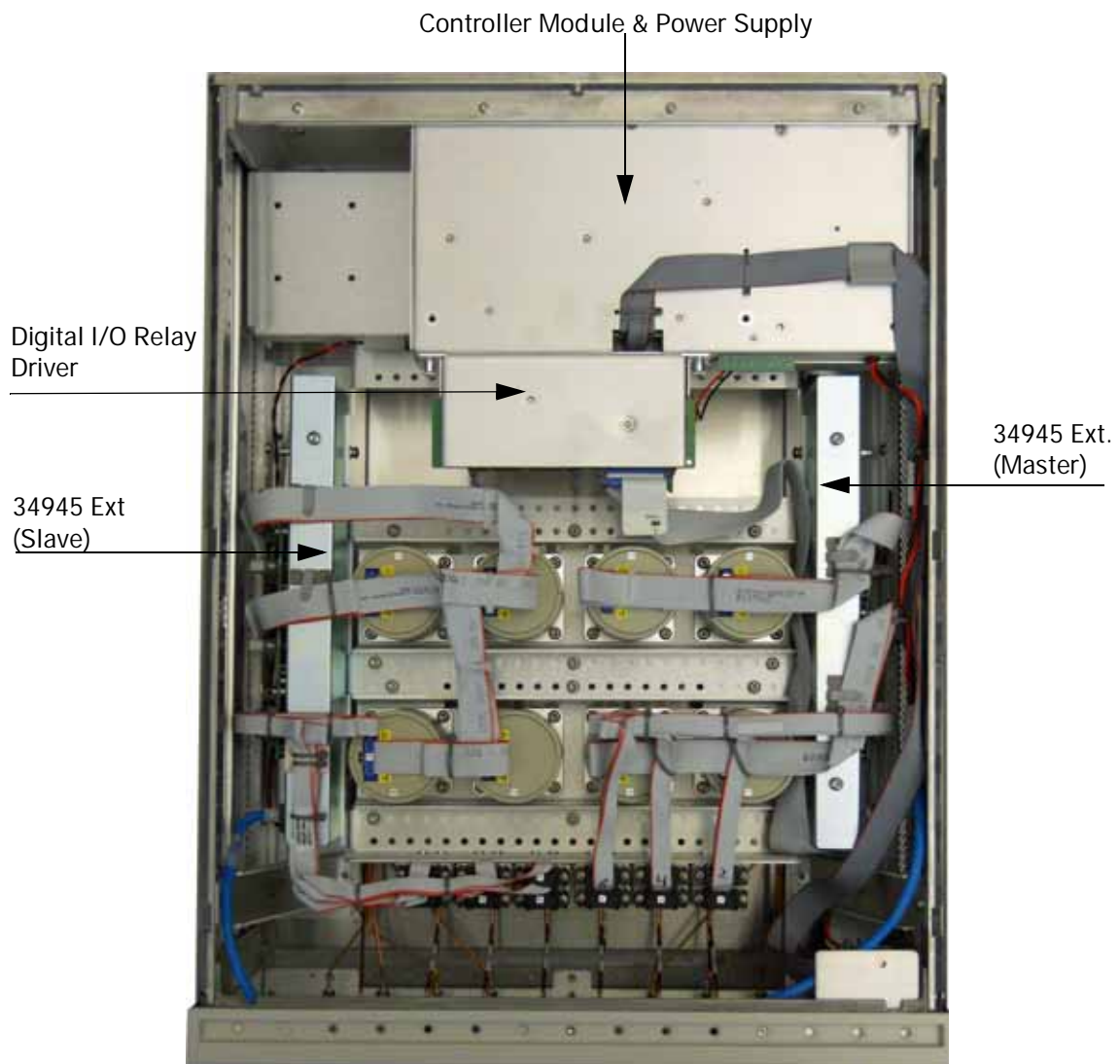
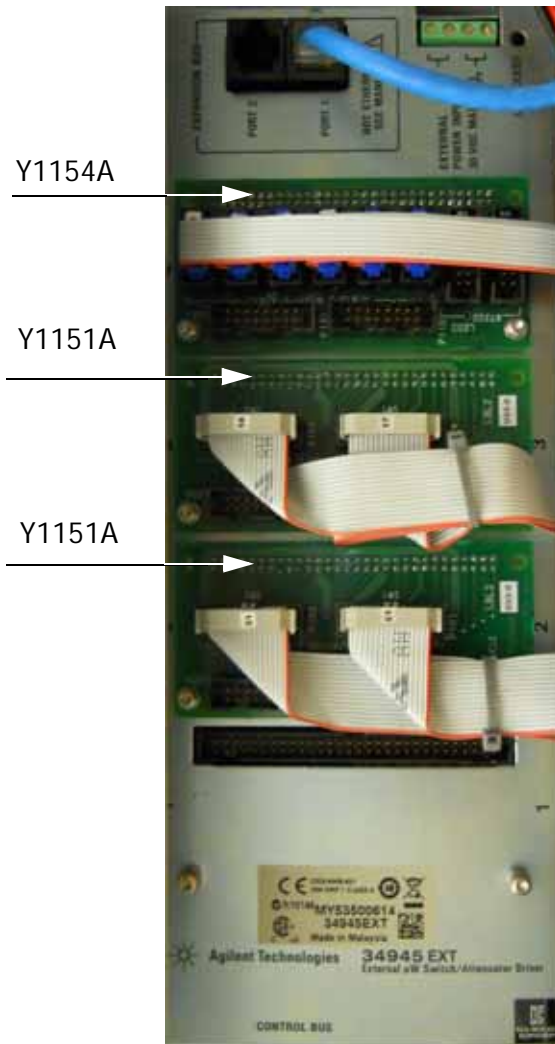
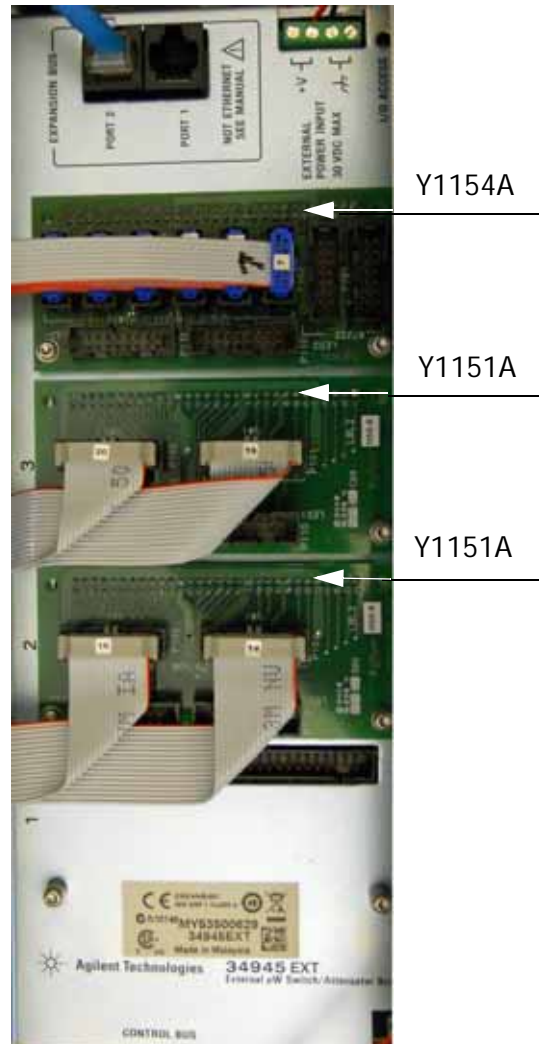

Figure 16 34945 EXT (Distribution Boards)



Master



Slave

Safety and Information

Introduction

Review this product and related documentation to familiarize yourself with safety markings and instructions before you operate the instrument.

This product has been designed and tested in accordance with accepted industry standards, and has been supplied in a safe condition. The documentation contains information and warnings that must be followed by the user to ensure safe operation and to maintain the product in a safe condition.

Safety Earth Ground

WARNING This is a Safety Class I Product (provided with a protective earthing ground incorporated in the power cord). The mains plug shall only be inserted in a socket outlet provided with a protective earth contact. Any interruption of the protective conductor inside or outside of the product is likely to make the product dangerous. Intentional interruption is prohibited.

CAUTION Always use the three prong AC power cord supplied with this product. Failure to ensure adequate earth grounding by not using this cord may cause product damage and the risk of electrical shock.

Declaration of Conformity

A copy of the Declaration of Conformity is available upon request, or a copy is available on the Keysight Technologies web site at <http://regulations.corporate.keysight.com/DoC/search.htm>

Statement of Compliance

This product has been designed and tested in accordance with accepted industry standards, and has been supplied in a safe condition. The documentation contains information and warnings that must be followed by the user to ensure safe operation and to maintain the product in a safe condition.

Before Applying Power

Verify that the premises electrical supply is within the range of the instrument. The instrument has an autoranging power supply.

WARNING If this product is not used as specified, the protection provided by the equipment could be impaired. This product must be used in a normal condition (in which all means for protection are intact) only.

CAUTION The Mains wiring and connectors shall be compatible with the connector used in the premise electrical system. Failure, to ensure adequate earth grounding by not using the correct components may cause product damage, and serious injury.

CAUTION Always use the three prong AC power cord supplied with this product. Failure to ensure adequate earth grounding by not using this cord may cause product damage and the risk of electrical shock.

CAUTION This product is designed for use in Installation Category II and Pollution Degree.

CAUTION Before switching on this instrument, make sure the supply voltage is in the specified range.

CAUTION Verify that the premise electrical voltage supply is within the range specified on the instrument.

CAUTION Ventilation Requirements: When installing the instrument in a cabinet, the convection into and out of the instrument must not be restricted. The ambient temperature (outside the cabinet) must be less than the maximum operating temperature of the instrument by 4 °C for every 100 watts dissipated in the cabinet. If the total power dissipated in the cabinet is greater than 800 watts, forced convection must be used.

WARNING Danger of explosion if battery is incorrectly replaced. Replace only with the same or equivalent type recommended. Discard used batteries according to manufacturer's instructions.

WARNING For continued protection against fire hazard replace line fuse only with same type and rating. The use of other fuses or material is prohibited.

WARNING These servicing instructions are for use by qualified personnel only. To avoid electrical shock, do not perform any servicing unless you are qualified to do so.

WARNING The opening of covers or removal of parts is likely to expose the user to dangerous voltages. Disconnect the instrument from all voltage sources before opening.

WARNING No operator serviceable parts inside. Refer servicing to qualified personnel. To prevent electrical shock, do not remove covers.

WARNING The detachable power cord is the instrument disconnecting device. It disconnects the mains circuits from the mains supply before other parts of the instrument. The front panel switch is only a standby switch and is not a LINE switch (disconnecting device).

Connector Care and Cleaning Precautions

Remove the power cord to the instrument. To clean the connectors use alcohol in a well ventilated area. Allow all residual alcohol moisture to evaporate, and fumes to dissipate prior to energizing the instrument.

WARNING To prevent electrical shock, disconnect the Keysight U3020S22 from mains electrical supply before cleaning. Use a dry cloth or one slightly dampened with water to clean the external case parts. Do not attempt to clean internally.

WARNING If flammable cleaning materials are used, the material shall not be stored, or left open in the area of the equipment. Adequate ventilation shall be assured to prevent the combustion of fumes, or vapors.

Regulatory Information

This section contains information that is required by various government regulatory agencies.

Instrument Markings



The instruction documentation symbol. The product is marked with this symbol when it is necessary for the user to refer to the instructions in the documentation.



The AC symbol indicates the required nature of the line module input power.



This symbol indicates separate collection for electrical and electronic equipment, mandated under EU law as of August 13, 2005. All electric and electronic equipment are required to be separated from normal waste for disposal (Reference WEEE Directive, 2002/96/EC).



This symbol indicates that the power line switch is ON.



This symbol indicates that the power line switch is in the STANDBY position.



This symbol indicates that the power line switch is in the OFF position.



This symbol is used to identify a terminal which is internally connected to the product frame or chassis.



The CE mark is a registered trademark of the European Community. (If accompanied by a year, it is when the design was proven.)



The CSA mark is a registered trademark of the CSA International.



This mark designates the product is an Industrial Scientific and Medical Group 1 Class A product (reference CISPR 11, Clause 5)



This is a marking to indicate product compliance with the Canadian Interference-Causing Equipment Standard (ICES-001).



Direct Current.



The instrument has been designed to meet the requirements of IP 2 0 for egress and operational environment.



The RCM mark is a registered trademark of the Australian Communications and Media Authority



Indicates the time period during which no hazardous or toxic substance elements are expected to leak or deteriorate during normal use. Forty years is the expected useful life of the product.



This symbol on all primary and secondary packaging indicates compliance to China standard GB 18455-2001.



South Korean Certification (KC) mark; includes the marking's identifier code which follows the format: MSIP-REM-YYY-ZZZZZZZZZZZZZZ.

Battery Collection

Do not throw batteries away but collect as small chemical waste, or in accordance with your country's requirements. You may return the battery to Keysight Technologies for disposal. Refer to ["Contacting Keysight" on page 40](#) for assistance.

Electrical Safety Compliance

SAFETY

Complies with European Low Voltage Directive 2014/35/EU

- IEC/EN 61010-1:2010, 3rd Edition
- Canada: CSA C22.2 No. 61010-1-12
- USA: UL std no. 61010-1, 3rd Edition
- Acoustic statement (European Machinery Directive 2022/42/EC, 1.7.4.2U)
 Accoustical noise emission
 LpA<70 dB
 Operator position
 Normal operation mode
 Per ISO 7779

EMI and EMC Compliance

EMC

Complies with European EMC Directive 2014/30/EU

- IIEC 61326-1:2012/EN 61326-1:2013
- CISPR Pub 11 Group 1, class A
- AS/NZS CISPR 11:2011
- ICES/NMB-001
 This ISM device complies with Canadian ICES-001.
 Cet appareil ISM est conforme a la norme NMB du Canada.
- South Korean Class A EMC declaration: This equipment is Class A suitable for professional use and is for use in electromagnetic environments outside of the home.

A () (A)
 , 가 .

Keysight Support, Services, and Assistance

Service and Support Options

There are many other repair and calibration options available from the Keysight Technologies support organization. These options cover a range of service agreements with varying response times. Contact Keysight for additional information on available service agreements for this product.

Contacting Keysight

Assistance with test and measurement needs, and information on finding a local Keysight office are available on the Internet at:

<http://www.keysight.com/find/assist>

You can also purchase accessories or documentation items on the Internet at:

<http://www.keysight.com/find>

If you do not have access to the Internet, contact your field engineer.

NOTE In any correspondence or telephone conversation, refer to the Keysight product by its model number and full serial number. With this information, the Keysight representative can determine the warranty status of your unit.

Shipping Your Product to Keysight for Service or Repair

IMPORTANT Keysight Technologies reserves the right to reformat or replace the internal hard disk drive in your analyzer as part of its repair. This will erase all user information stored on the hard disk. It is imperative, therefore, that you make a backup copy of your critical test data located on the analyzer's hard disk before shipping it to Keysight for repair.

If you wish to send your instrument to Keysight Technologies for service or repair:

- Include a complete description of the service requested or of the failure and a description of any failed test and any error message.
- Remove and retain the front handles and all rack mount hardware. The analyzer should be sent to Keysight in the same configuration as it was originally shipped.
- Remove and retain the front handles and all rack mount hardware. The analyzer should be sent to Keysight in the same configuration as it was originally shipped.
- Contact Keysight for instructions on where to ship your analyzer.