

# LM194,LM394

*LM194 LM394 Supermatch Pair*



Literature Number: SNLS385A

## LM194/LM394 Supermatch Pair

### General Description

The LM194 and LM394 are junction isolated ultra well-matched monolithic NPN transistor pairs with an order of magnitude improvement in matching over conventional transistor pairs. This was accomplished by advanced linear processing and a unique new device structure.

Electrical characteristics of these devices such as drift versus initial offset voltage, noise, and the exponential relationship of base-emitter voltage to collector current closely approach those of a theoretical transistor. Extrinsic emitter and base resistances are much lower than presently available pairs, either monolithic or discrete, giving extremely low noise and theoretical operation over a wide current range. Most parameters are guaranteed over a current range of 1  $\mu$ A to 1 mA and 0V up to 40V collector-base voltage, ensuring superior performance in nearly all applications.

To guarantee long term stability of matching parameters, internal clamp diodes have been added across the emitter-base junction of each transistor. These prevent degradation due to reverse biased emitter current—the most common cause of field failures in matched devices. The parasitic isolation junction formed by the diodes also clamps the substrate region to the most negative emitter to ensure complete isolation between devices.

The LM194 and LM394 will provide a considerable improvement in performance in most applications requiring a closely

matched transistor pair. In many cases, trimming can be eliminated entirely, improving reliability and decreasing costs. Additionally, the low noise and high gain make this device attractive even where matching is not critical.

The LM194 and LM394/LM394B/LM394C are available in an isolated header 6-lead TO-5 metal can package. The LM394/LM394B/LM394C are available in an 8-pin plastic dual-in-line package. The LM194 is identical to the LM394 except for tighter electrical specifications and wider temperature range.

### Features

- Emitter-base voltage matched to 50  $\mu$ V
- Offset voltage drift less than 0.1  $\mu$ V/ $^{\circ}$ C
- Current gain ( $h_{FE}$ ) matched to 2%
- Common-mode rejection ratio greater than 120 dB
- Parameters guaranteed over 1  $\mu$ A to 1 mA collector current
- Extremely low noise
- Superior logging characteristics compared to conventional pairs
- Plug-in replacement for presently available devices

### Typical Applications

Low Cost Accurate Square Root Circuit

$$I_{OUT} = 10^{-5} \cdot \sqrt{10 V_{IN}}$$

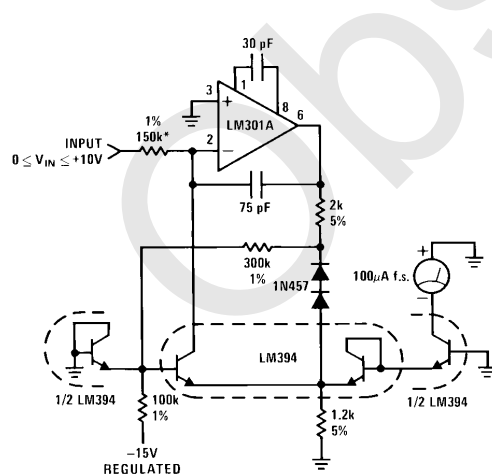

Low Cost Accurate Squaring Circuit

$$I_{OUT} = 10^{-6} (V_{IN})^2$$

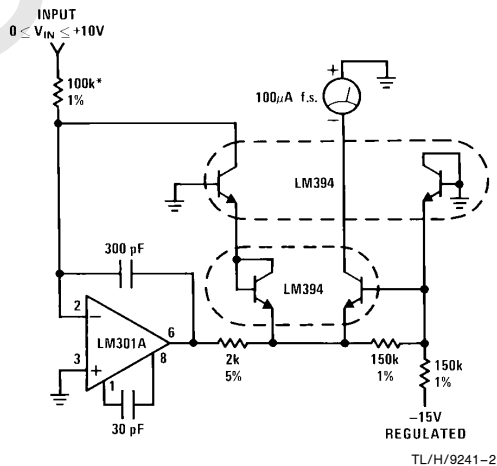

TL/H/9241-1  
\*Trim for full scale accuracy

## Absolute Maximum Ratings

If Military/Aerospace specified devices are required, please contact the National Semiconductor Sales Office/Distributors for availability and specifications. (Note 4)

Collector Current	20 mA
Collector-Emitter Voltage	$V_{MAX}$
Collector-Emitter Voltage LM394C	35V 20V
Collector-Base Voltage LM394C	35V 20V
Collector-Substrate Voltage LM394C	35V 20V
Collector-Collector Voltage LM394C	35V 20V

Base-Emitter Current	$\pm 10$ mA
Power Dissipation	500 mW
Junction Temperature	
LM194	$-55^{\circ}\text{C}$ to $+125^{\circ}\text{C}$
LM394/LM394B/LM394C	$-25^{\circ}\text{C}$ to $+85^{\circ}\text{C}$
Storage Temperature Range	$-65^{\circ}\text{C}$ to $+150^{\circ}\text{C}$

Soldering Information	
Metal Can Package (10 sec.)	260°C
Dual-In-Line Package (10 sec.)	260°C
Small Outline Package	
Vapor Phase (60 sec.)	215°C
Infrared (15 sec.)	220°C

See AN-450 "Surface Mounting and their Effects on Product Reliability" for other methods of soldering surface mount devices.

## Electrical Characteristics ( $T_J = 25^{\circ}\text{C}$ )

Parameter	Conditions	LM194			LM394			LM394B/394C			Units
		Min	Typ	Max	Min	Typ	Max	Min	Typ	Max	
Current Gain ( $h_{FE}$ )	$V_{CB} = 0\text{V}$ to $V_{MAX}$ (Note 1) $I_C = 1\text{ mA}$ $I_C = 100\ \mu\text{A}$ $I_C = 10\ \mu\text{A}$ $I_C = 1\ \mu\text{A}$	350	700		300	700		225	500		
		350	550		250	550		200	400		
		300	450		200	450		150	300		
		200	300		150	300		100	200		
Current Gain Match, ( $h_{FE}$ Match) $= \frac{100 [\Delta I_B] [h_{FE(MIN)}]}{I_C}$	$V_{CB} = 0\text{V}$ to $V_{MAX}$ $I_C = 10\ \mu\text{A}$ to $1\text{ mA}$ $I_C = 1\ \mu\text{A}$		0.5	2		0.5	4		1.0	5	%
			1.0			1.0			2.0		%
Emitter-Base Offset Voltage	$V_{CB} = 0$ $I_C = 1\ \mu\text{A}$ to $1\text{ mA}$		25	100		25	150		50	200	$\mu\text{V}$
Change in Emitter-Base Offset Voltage vs Collector-Base Voltage (CMRR)	(Note 1) $I_C = 1\ \mu\text{A}$ to $1\text{ mA}$ , $V_{CB} = 0\text{V}$ to $V_{MAX}$		10	25		10	50		10	100	$\mu\text{V}$
Change in Emitter-Base Offset Voltage vs Collector Current	$V_{CB} = 0\text{V}$ , $I_C = 1\ \mu\text{A}$ to $0.3\text{ mA}$		5	25		5	50		5	50	$\mu\text{V}$
Emitter-Base Offset Voltage Temperature Drift	$I_C = 10\ \mu\text{A}$ to $1\text{ mA}$ (Note 2) $I_{C1} = I_{C2}$ $V_{OS}$ Trimmed to 0 at $25^{\circ}\text{C}$		0.08	0.3		0.08	1.0		0.2	1.5	$\mu\text{V}/^{\circ}\text{C}$
			0.03	0.1		0.03	0.3		0.03	0.5	$\mu\text{V}/^{\circ}\text{C}$
Logging Conformity	$I_C = 3\text{ nA}$ to $300\ \mu\text{A}$ , $V_{CB} = 0$ , (Note 3)		150			150			150		$\mu\text{V}$
Collector-Base Leakage	$V_{CB} = V_{MAX}$		0.05	0.25		0.05	0.5		0.05	0.5	nA
Collector-Collector Leakage	$V_{CC} = V_{MAX}$		0.1	2.0		0.1	5.0		0.1	5.0	nA
Input Voltage Noise	$I_C = 100\ \mu\text{A}$ , $V_{CB} = 0\text{V}$ , $f = 100\text{ Hz}$ to $100\text{ kHz}$		1.8			1.8			1.8		$\text{nV}/\sqrt{\text{Hz}}$
Collector to Emitter Saturation Voltage	$I_C = 1\text{ mA}$ , $I_B = 10\ \mu\text{A}$ $I_C = 1\text{ mA}$ , $I_B = 100\ \mu\text{A}$		0.2			0.2			0.2		V
			0.1			0.1			0.1		V

**Note 1:** Collector-base voltage is swept from 0 to  $V_{MAX}$  at a collector current of  $1\ \mu\text{A}$ ,  $10\ \mu\text{A}$ ,  $100\ \mu\text{A}$ , and  $1\text{ mA}$ .

**Note 2:** Offset voltage drift with  $V_{OS} = 0$  at  $T_A = 25^{\circ}\text{C}$  is valid only when the ratio of  $I_{C1}$  to  $I_{C2}$  is adjusted to give the initial zero offset. This ratio must be held to within 0.003% over the entire temperature range. Measurements taken at  $+25^{\circ}\text{C}$  and temperature extremes.

**Note 3:** Logging conformity is measured by computing the best fit to a true exponential and expressing the error as a base-emitter voltage deviation.

**Note 4:** Refer to RETS194X drawing of military LM194H version for specifications.

## Typical Applications (Continued)

**Fast, Accurate Logging Amplifier,  $V_{IN} = 10V$  to  $0.1\text{ mV}$  or  $I_{IN} = 1\text{ mA}$  to  $10\text{ nA}$**

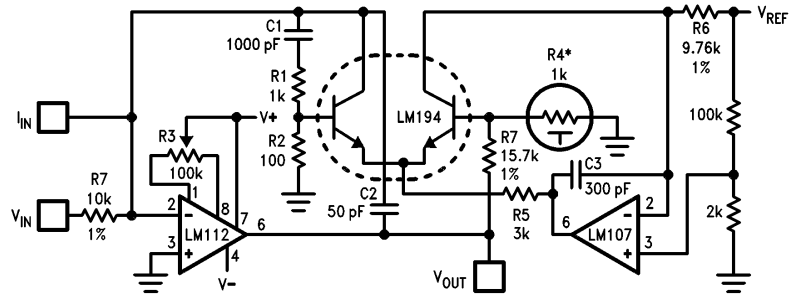

TL/H/9241-3

\*1 k $\Omega$  ( $\pm 1\%$ ) at 25°C, +3500 ppm/°C.  
Available from Vishay Ultronix,  
Grand Junction, CO, Q81 Series.

$$V_{OUT} = -\log_{10} \left( \frac{V_{IN}}{V_{REF}} \right)$$

**Voltage Controlled Variable Gain Amplifier**

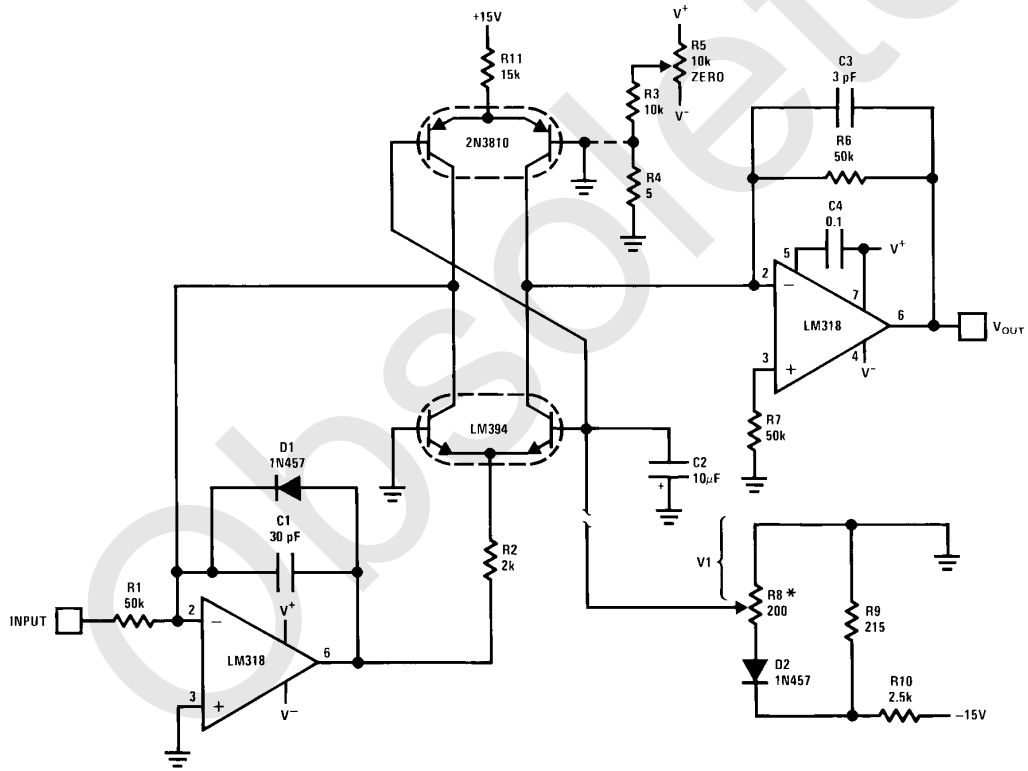

TL/H/9241-4

\*R8-R10 and D2 provide a temperature independent gain control.  
 $G = -336 V_1$  (dB)

Distortion < 0.1%  
Bandwidth > 1 MHz  
100 dB gain range

## Typical Applications (Continued)

### Precision Low Drift Operational Amplifier

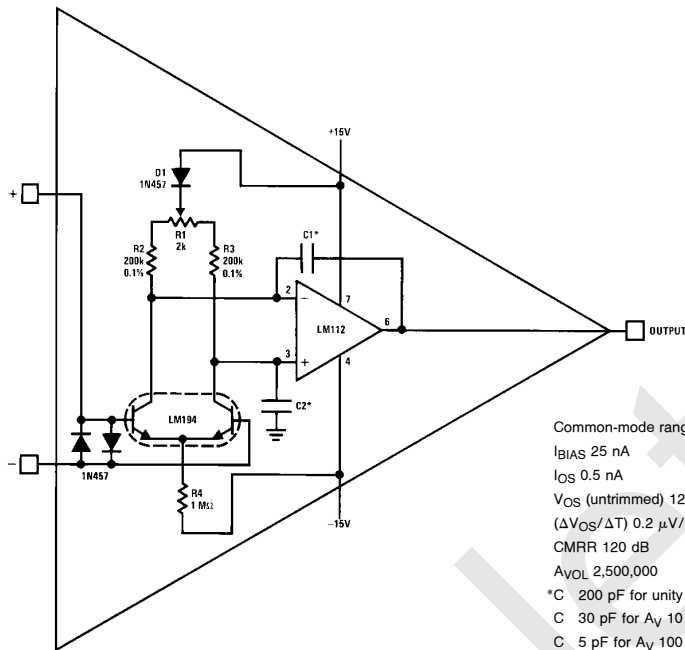

Common-mode range 10V  
 $I_{BIAS}$  25 nA  
 $I_{OS}$  0.5 nA  
 $V_{OS}$  (untrimmed) 125  $\mu$ V  
 $(\Delta V_{OS}/\Delta T)$  0.2  $\mu$ V/C  
 CMRR 120 dB  
 $A_{VOL}$  2,500,000  
 \*C 200 pF for unity gain  
 C 30 pF for  $A_V$  10  
 C 5 pF for  $A_V$  100  
 C 0 pF for  $A_V$  1000

TL/H/9241-5

### High Accuracy One Quadrant Multiplier/Divider

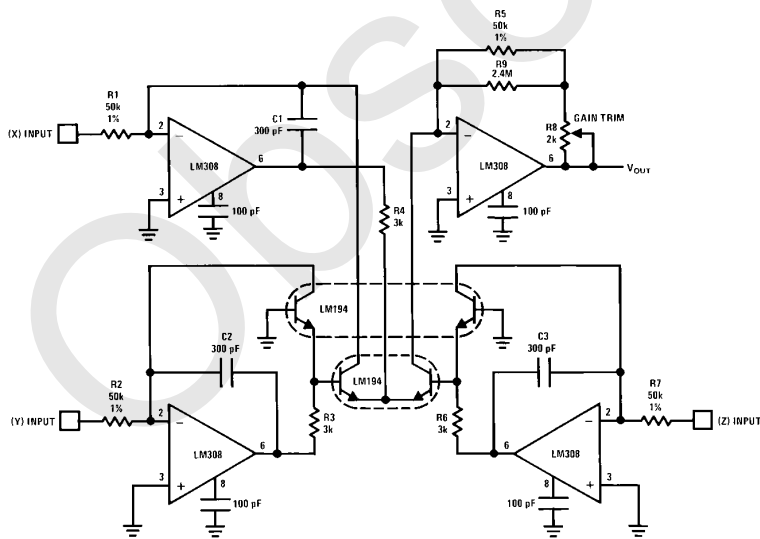

$$V_{OUT} = \frac{(X)(Y)}{(Z)}; \text{positive inputs only.}$$

\*Typical linearity 0.1%

TL/H/9241-6



# Typical Performance Characteristics

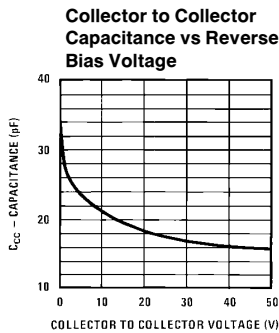
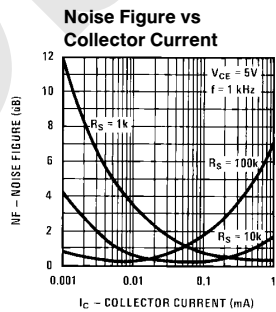
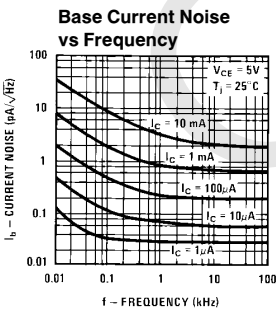
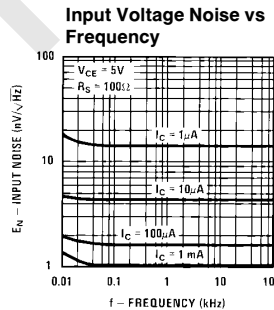
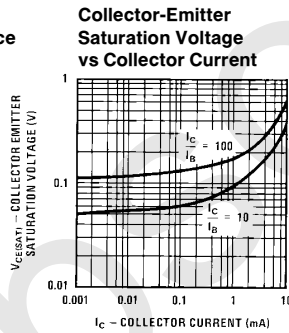
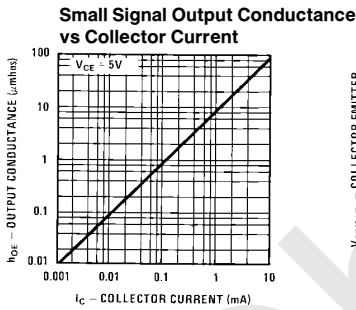
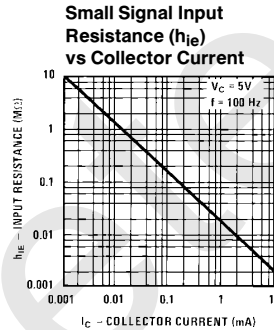
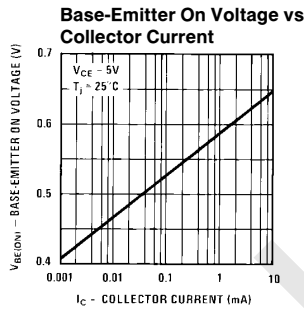
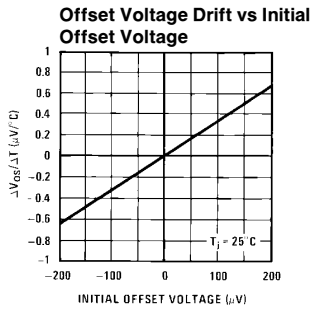
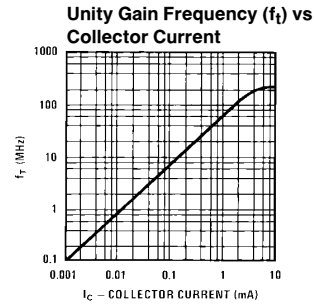
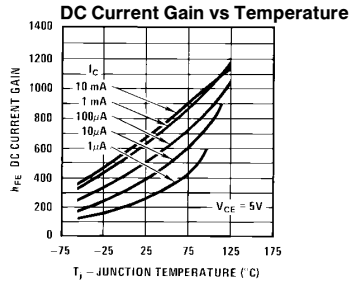
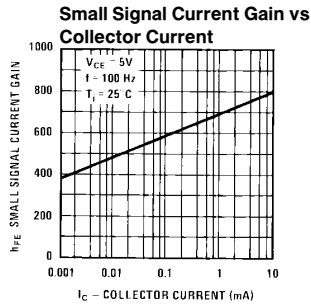

TL/H/9241-8

## Typical Performance Characteristics (Continued)

**Collector to Collector Capacitance vs Collector-Substrate Voltage**

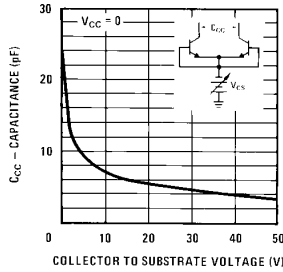

**Emitter-Base Capacitance vs Reverse Bias Voltage**

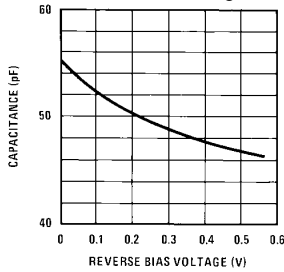

**Collector-Base Capacitance vs Reverse Bias Voltage**

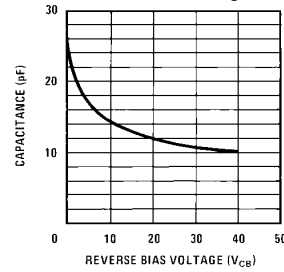

**Collector-Base Leakage vs Temperature**

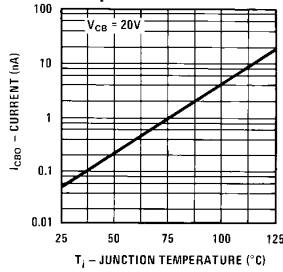

**Collector to Collector Leakage vs Temperature**

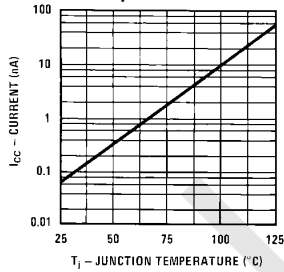

**Offset Voltage Long Term Stability at High Temperature**

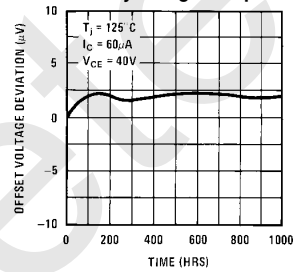

**Emitter-Base Log Conformity**

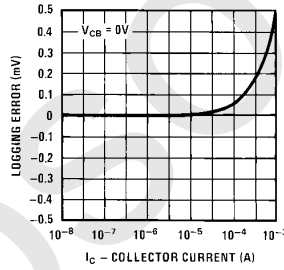

TL/H/9241-9

TL/H/9241-10

### Low Frequency Noise of Differential Pair\*

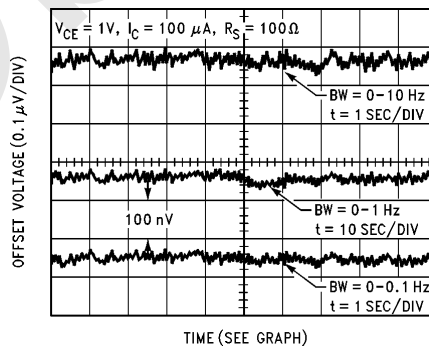

TL/H/9241-11

\*Unit must be in still air environment so that differential lead temperature is held to less than 0.0003°C.



## Connection Diagrams

Metal Can Package

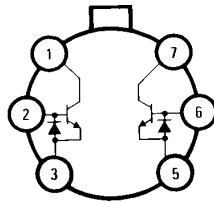

Top View

Order Number LM194H/883\*,  
LM394H, LM394BH or LM394CH  
See NS Package Number H06C

TL/H/9241-12

Dual-In-Line and Small Outline Packages

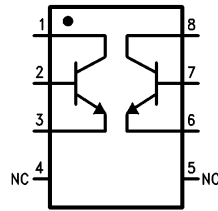

Top View

Order Number LM394N or LM394CN  
See NS Package Number N08E

TL/H/9241-13

\*Available per SMD #5962-877701

**Physical Dimensions** inches (millimeters)

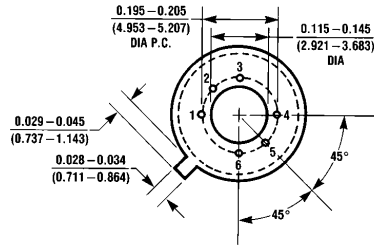
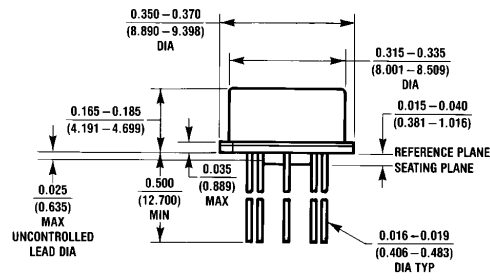

H06C (REV D)

**Metal Can Package (H)**  
**Order Number LM194H/883, LM394H, LM394BH or LM394CH**  
**NS Package Number H06C**

**Physical Dimensions** inches (millimeters) (Continued)

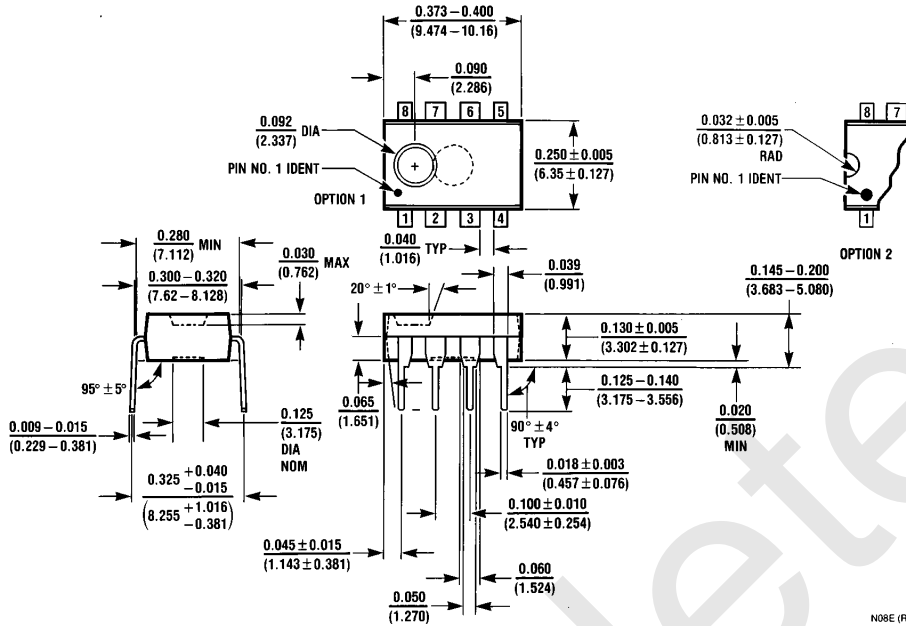

**Molded Dual-In-Line Package (N)**  
**Order Number LM394CN or LM394N**  
**NS Package Number N08E**

N08E (REV F)

**LIFE SUPPORT POLICY**

NATIONAL'S PRODUCTS ARE NOT AUTHORIZED FOR USE AS CRITICAL COMPONENTS IN LIFE SUPPORT DEVICES OR SYSTEMS WITHOUT THE EXPRESS WRITTEN APPROVAL OF THE PRESIDENT OF NATIONAL SEMICONDUCTOR CORPORATION. As used herein:

- Life support devices or systems are devices or systems which, (a) are intended for surgical implant into the body, or (b) support or sustain life, and whose failure to perform, when properly used in accordance with instructions for use provided in the labeling, can be reasonably expected to result in a significant injury to the user.
- A critical component is any component of a life support device or system whose failure to perform can be reasonably expected to cause the failure of the life support device or system, or to affect its safety or effectiveness.



**National Semiconductor Corporation**  
 1111 West Bardin Road  
 Arlington, TX 76017  
 Tel: 1(800) 272-9959  
 Fax: 1(800) 737-7018

**National Semiconductor Europe**  
 Fax: (+49) 0-180-530 85 86  
 Email: cnjwge@tevm2.nsc.com  
 Deutsch Tel: (+49) 0-180-530 85 85  
 English Tel: (+49) 0-180-532 78 32  
 Français Tel: (+49) 0-180-532 93 58  
 Italiano Tel: (+49) 0-180-534 16 80

**National Semiconductor Hong Kong Ltd.**  
 13th Floor, Straight Block,  
 Ocean Centre, 5 Canton Rd.  
 Tsimshatsui, Kowloon  
 Hong Kong  
 Tel: (852) 2737-1600  
 Fax: (852) 2736-9960

**National Semiconductor Japan Ltd.**  
 Tel: 81-043-299-2309  
 Fax: 81-043-299-2408

National does not assume any responsibility for use of any circuitry described, no circuit patent licenses are implied and National reserves the right at any time without notice to change said circuitry and specifications.

## IMPORTANT NOTICE

Texas Instruments Incorporated and its subsidiaries (TI) reserve the right to make corrections, modifications, enhancements, improvements, and other changes to its products and services at any time and to discontinue any product or service without notice. Customers should obtain the latest relevant information before placing orders and should verify that such information is current and complete. All products are sold subject to TI's terms and conditions of sale supplied at the time of order acknowledgment.

TI warrants performance of its hardware products to the specifications applicable at the time of sale in accordance with TI's standard warranty. Testing and other quality control techniques are used to the extent TI deems necessary to support this warranty. Except where mandated by government requirements, testing of all parameters of each product is not necessarily performed.

TI assumes no liability for applications assistance or customer product design. Customers are responsible for their products and applications using TI components. To minimize the risks associated with customer products and applications, customers should provide adequate design and operating safeguards.

TI does not warrant or represent that any license, either express or implied, is granted under any TI patent right, copyright, mask work right, or other TI intellectual property right relating to any combination, machine, or process in which TI products or services are used. Information published by TI regarding third-party products or services does not constitute a license from TI to use such products or services or a warranty or endorsement thereof. Use of such information may require a license from a third party under the patents or other intellectual property of the third party, or a license from TI under the patents or other intellectual property of TI.

Reproduction of TI information in TI data books or data sheets is permissible only if reproduction is without alteration and is accompanied by all associated warranties, conditions, limitations, and notices. Reproduction of this information with alteration is an unfair and deceptive business practice. TI is not responsible or liable for such altered documentation. Information of third parties may be subject to additional restrictions.

Resale of TI products or services with statements different from or beyond the parameters stated by TI for that product or service voids all express and any implied warranties for the associated TI product or service and is an unfair and deceptive business practice. TI is not responsible or liable for any such statements.

TI products are not authorized for use in safety-critical applications (such as life support) where a failure of the TI product would reasonably be expected to cause severe personal injury or death, unless officers of the parties have executed an agreement specifically governing such use. Buyers represent that they have all necessary expertise in the safety and regulatory ramifications of their applications, and acknowledge and agree that they are solely responsible for all legal, regulatory and safety-related requirements concerning their products and any use of TI products in such safety-critical applications, notwithstanding any applications-related information or support that may be provided by TI. Further, Buyers must fully indemnify TI and its representatives against any damages arising out of the use of TI products in such safety-critical applications.

TI products are neither designed nor intended for use in military/aerospace applications or environments unless the TI products are specifically designated by TI as military-grade or "enhanced plastic." Only products designated by TI as military-grade meet military specifications. Buyers acknowledge and agree that any such use of TI products which TI has not designated as military-grade is solely at the Buyer's risk, and that they are solely responsible for compliance with all legal and regulatory requirements in connection with such use.

TI products are neither designed nor intended for use in automotive applications or environments unless the specific TI products are designated by TI as compliant with ISO/TS 16949 requirements. Buyers acknowledge and agree that, if they use any non-designated products in automotive applications, TI will not be responsible for any failure to meet such requirements.

Following are URLs where you can obtain information on other Texas Instruments products and application solutions:

### Products

Audio	<a href="http://www.ti.com/audio">www.ti.com/audio</a>
Amplifiers	<a href="http://amplifier.ti.com">amplifier.ti.com</a>
Data Converters	<a href="http://dataconverter.ti.com">dataconverter.ti.com</a>
DLP® Products	<a href="http://www.dlp.com">www.dlp.com</a>
DSP	<a href="http://dsp.ti.com">dsp.ti.com</a>
Clocks and Timers	<a href="http://www.ti.com/clocks">www.ti.com/clocks</a>
Interface	<a href="http://interface.ti.com">interface.ti.com</a>
Logic	<a href="http://logic.ti.com">logic.ti.com</a>
Power Mgmt	<a href="http://power.ti.com">power.ti.com</a>
Microcontrollers	<a href="http://microcontroller.ti.com">microcontroller.ti.com</a>
RFID	<a href="http://www.ti-rfid.com">www.ti-rfid.com</a>
OMAP Mobile Processors	<a href="http://www.ti.com/omap">www.ti.com/omap</a>
Wireless Connectivity	<a href="http://www.ti.com/wirelessconnectivity">www.ti.com/wirelessconnectivity</a>

### Applications

Communications and Telecom	<a href="http://www.ti.com/communications">www.ti.com/communications</a>
Computers and Peripherals	<a href="http://www.ti.com/computers">www.ti.com/computers</a>
Consumer Electronics	<a href="http://www.ti.com/consumer-apps">www.ti.com/consumer-apps</a>
Energy and Lighting	<a href="http://www.ti.com/energy">www.ti.com/energy</a>
Industrial	<a href="http://www.ti.com/industrial">www.ti.com/industrial</a>
Medical	<a href="http://www.ti.com/medical">www.ti.com/medical</a>
Security	<a href="http://www.ti.com/security">www.ti.com/security</a>
Space, Avionics and Defense	<a href="http://www.ti.com/space-avionics-defense">www.ti.com/space-avionics-defense</a>
Transportation and Automotive	<a href="http://www.ti.com/automotive">www.ti.com/automotive</a>
Video and Imaging	<a href="http://www.ti.com/video">www.ti.com/video</a>

TI E2E Community Home Page

[e2e.ti.com](http://e2e.ti.com)

Mailing Address: Texas Instruments, Post Office Box 655303, Dallas, Texas 75265  
Copyright © 2011, Texas Instruments Incorporated