

Model 261
Picoampere Source
Instruction Manual

Contains Operating and Servicing Information

KEITHLEY

WARRANTY

Keithley Instruments, Inc. warrants this product to be free from defects in material and workmanship for a period of 1 year from date of shipment.

Keithley Instruments, Inc. warrants the following items for 90 days from the date of shipment: probes, cables, rechargeable batteries, diskettes, and documentation.

During the warranty period, we will, at our option, either repair or replace any product that proves to be defective.

To exercise this warranty, write or call your local Keithley representative, or contact Keithley headquarters in Cleveland, Ohio. You will be given prompt assistance and return instructions. Send the product, transportation prepaid, to the indicated service facility. Repairs will be made and the product returned, transportation prepaid. Repaired or replaced products are warranted for the balance of the original warranty period, or at least 90 days.

LIMITATION OF WARRANTY

This warranty does not apply to defects resulting from product modification without Keithley's express written consent, or misuse of any product or part. This warranty also does not apply to fuses, software, non-rechargeable batteries, damage from battery leakage, or problems arising from normal wear or failure to follow instructions.

THIS WARRANTY IS IN LIEU OF ALL OTHER WARRANTIES, EXPRESSED OR IMPLIED, INCLUDING ANY IMPLIED WARRANTY OF MERCHANTABILITY OR FITNESS FOR A PARTICULAR USE. THE REMEDIES PROVIDED HEREIN ARE BUYER'S SOLE AND EXCLUSIVE REMEDIES.

NEITHER KEITHLEY INSTRUMENTS, INC. NOR ANY OF ITS EMPLOYEES SHALL BE LIABLE FOR ANY DIRECT, INDIRECT, SPECIAL, INCIDENTAL OR CONSEQUENTIAL DAMAGES ARISING OUT OF THE USE OF ITS INSTRUMENTS AND SOFTWARE EVEN IF KEITHLEY INSTRUMENTS, INC., HAS BEEN ADVISED IN ADVANCE OF THE POSSIBILITY OF SUCH DAMAGES. SUCH EXCLUDED DAMAGES SHALL INCLUDE, BUT ARE NOT LIMITED TO: COSTS OF REMOVAL AND INSTALLATION, LOSSES SUSTAINED AS THE RESULT OF INJURY TO ANY PERSON, OR DAMAGE TO PROPERTY.



Keithley Instruments, Inc. • 28775 Aurora Road • Cleveland, OH 44139 • 216-248-0400 • Fax: 216-248-6168 • <http://www.keithley.com>

CHINA:	Keithley Instruments China • Yuan Chen Xin Building, Room 705 • No. 12 Yumin Road, Dewai, Madian • Beijing, China 100029 • 8610-2022886 • Fax: 8610-2022892
FRANCE:	Keithley Instruments SARL • BP 60 • 3 allée des Garays • 91122 Palaiseau Cédex • 31-6-0115155 • Fax: 31-6-0117726
GERMANY:	Keithley Instruments GmbH • Landsberger Straße 65 • 82110 Germering • 49-89-849307-0 • Fax: 49-89-84930759
GREAT BRITAIN:	Keithley Instruments, Ltd. • The Minster • 58 Portman Road • Reading, Berkshire RG30 1EA • 44-01734-575666 • Fax: 44-01734-596469
ITALY:	Keithley Instruments SRL • Viale S. Gimignano 38 • 20146 Milano • 39-2-48303008 • Fax: 39-2-48302274
JAPAN:	Keithley KK • Aibido Bldg. • 7-20-2 Nishishinjuku • Shinjuku-ku, Tokyo 160 • 81-3-5389-1964 • Fax: 81-3-5389-2068
NETHERLANDS:	Keithley Instruments BV • Avelingen West 49 • 4202 MS Gorinchem • 31-(0)183-635333 • Fax: 31-(0)183-630821
SWITZERLAND:	Keithley Instruments SA • Kriesbachstrasse 4 • 8600 Dübendorf • 41-1-8219444 • Fax: 41-1-8203081
TAIWAN:	Keithley Instruments Taiwan • 1, Ming-Yu First Street • Hsinchu, Taiwan, R.O.C. • 886-35-778462 • Fax: 886-35-778455

Model 261 Picoampere Source Instruction Manual

© 1983, Keithley Instruments, Inc.
Test Instrumentation Group
All rights reserved.
Cleveland, Ohio, U.S.A.
Third Printing
Document Number: 29046 Rev. C.

**Model 261
Picoampere Source**

Revised 1/16/89

OUTPUT: 10^{-14} A (10^{-11} A full range) to 1.1×10^{-4} A, positive or negative, in eight decade ranges.

ACCURACY: Exclusive of input drop consideration:

RANGE SETTING	SPAN, AMPERE	ACCURACY WITH 10.00 SETTING (10V SOURCE VOLTAGE)	WORST-CASE WITH SETTING OTHER THAN 10.00*
10^{-7} to 10^{-5}	10^{-7} to 1.1×10^{-4}	$\pm 0.25\%$	$\pm 0.25\%$
10^{-8}	10^{-8} to 10^{-7}	$\pm 0.5\%$	$\pm 0.5\%$
10^{-9}	10^{-9} to 10^{-8}	$\pm 0.6\%$	$\pm 0.8\%$
10^{-10}	10^{-10} to 10^{-9}	$\pm 0.6\%$	$\pm 1.1\%$
10^{-11}	10^{-11} to 10^{-10}	$\pm 0.6\%$	$\pm 1.3\%$
10^{-12}	10^{-12} to 10^{-11}	$\pm 0.7\%$	$\pm 1.6\%$
10^{-12}	10^{-14} to 10^{-12}	—	$\pm 2.0\%$

*All accuracies are \pm the percentage given, $\pm 0.01 \times$ range switch setting.

LONG-TERM STABILITY: Will operate within stated specifications for three months after calibration. After three months add 0.15% per month to 10^{-8} through 10^{-12} A range setting accuracy specifications.

TEMPERATURE COEFFICIENT: $\pm 0.1\%/^{\circ}\text{C}$ from 15°C to 30°C on 10^{-7} to 10^{-5} A range settings. Approximately $0.15\%/^{\circ}\text{C}$ on 10^{-12} to 10^{-8} A range settings. Exact values for these ranges supplied with instrument.

WARM-UP TIME: 1 hour.

LINE REGULATION: 0.01% for 10% change in line voltage.

SOURCE VOLTAGE: 0 to 11V in 0.01V steps.

RESOLUTION: 3 significant figures from 10^{-12} A to 1.1×10^{-4} A.

RANGE RESISTORS: 10^5 to $10^{12}\Omega$ in decade steps; $\pm 5\%$.

RANGE RESISTOR ACCURACY: Value with power on, given on certificate.

$\pm 0.5\%$: 10^8 to $10^{12}\Omega$

$\pm 0.1\%$: 10^7 to $10^6\Omega$

$\pm 0.02\%$: $10^5\Omega$.

OUTPUT ISOLATION: Low to ground: $>10^9\Omega$ shunted by $0.001\mu\text{F}$.

CERTIFICATION: A Calibration Certificate is furnished including range resistor values, thermal coefficients, temperature and date of calibration. Certification traceable to the National Institute of Standards and Technology is also available.

POWER: 105–125V or 210–250V (switch selected), 50–60Hz, 6W.

DIMENSIONS, WEIGHT: 155mm high \times 225mm wide \times 300mm deep (6.25 in. \times 9 in. \times 12 in.).
Net weight 4.1kg (9 lbs.).

ACCESSORY SUPPLIED: Model 2611 Test Cable.

TABLE OF CONTENTS

Paragraph	Title	Page
SECTION 1 GENERAL INFORMATION		
1.1	Introduction	1-1
1.2	Model 261 Features	1-1
1.3	Warranty Information	1-1
1.4	Manual Addenda	1-1
1.5	Safety Terms	1-1
1.6	Unpacking and Inspection	1-1
1.7	Using the Model 261 Instruction Manual	1-1
1.8	Specifications	1-1
1.9	Optional Accessories	1-2
SECTION 2 OPERATION		
2.1	Introduction	2-1
2.2	Front Panel Controls and Terminals	2-1
2.3	Rear Panel Controls and Terminals	2-1
2.4	Preparation For Use	2-1
2.5	Basic Operating Procedure	2-1
2.6	Accuracy Considerations	2-3
2.6.1	Input Voltage Drop (Voltage Burden)	2-3
2.6.2	Proper Multiplier Settings	2-3
2.7	Output Connections	2-3
2.8	Input Voltage Drop for Feedback and Shunt-Type Picoammeters	2-4
2.8.1	Feedback-Type Picoammeter	2-4
2.8.2	Shunt-Type Picoammeter	2-4
2.9	Compensation for Input Voltage Drop of Feedback-Type Picoammeter	2-5
2.9.1	Calculating Voltage Drop Error	2-5
2.9.2	Compensating Equation	2-5
2.10	Compensation Drop for Input Voltage Drop of Shunt-Type High-Impedance Picoammeters	2-5
2.10.1	Calculating the Error	2-5
2.10.2	Compensating Equations	2-6
2.11	Compensation for Input Voltage Drop of Shunt-Type Low Impedance Picoammeters	2-6
2.12	Range Resistor Voltage Coefficient	2-6
2.13	Compensation for Temperature Coefficient	2-6
SECTION 3 APPLICATIONS		
3.1	Introduction	3-1
3.2	Current Suppression	3-1
3.3	Galvanometric Measurements	3-1
3.4	Ohmmeter Calibration	3-2
SECTION 4 PERFORMANCE VERIFICATION AND CALIBRATION		
4.1	Introduction	4-1
4.2	Environmental Conditions	4-1
4.3	Recommended Test Equipment	4-1
4.4	Initial Conditions	4-1
4.5	Verification Procedure	4-1
4.5.1	Top Cover Removal	4-1
4.5.2	Range Resistor Verification	4-1
4.5.3	Multiplier Switch Setting Verification	4-2
4.6	Calibration	4-2
SECTION 5 THEORY OF OPERATION		
5.1	Introduction	5-1
5.2	Block Diagram	5-1
5.3	Circuit Description	5-1
5.3.1	Voltage Supply	5-1
5.3.2	Range Resistors	5-1
5.3.3	Kelvin-Varley Voltage Divider	5-2
SECTION 6 MAINTENANCE		
6.1	Introduction	6-1
6.2	Servicing Schedule	6-1
6.3	Top Cover Removal	6-1
6.4	Parts Replacement	6-1

TABLE OF CONTENTS (CONT.)

6.5	Troubleshooting	6-1
6.5.1	Troubleshooting Equipment	6-1
6.5.2	Common Faults	6-1
6.5.3	Troubleshooting Guidelines	6-2
6.6	Fuse Replacement	6-2
SECTION 7 REPLACEABLE PARTS		
7.1	Introduction	7-1
7.2	Parts List	7-1
7.3	Ordering Parts	7-1
7.4	Factory Service	7-1
7.5	Schematic Diagram and Component Layouts	7-1

LIST OF FIGURES

Figure	Title	Page
2-1	Front Panel Controls and Terminals	2-2
2-2	Rear Panel Controls and Terminals	2-2
2-3	Connecting the Model 261 Source	2-3
2-4	High Resistance Paths in Output Connections	2-4
2-5	Simplified Circuit of Feed-Back Type Picoammeter	2-4
2-6	Typical Shunt Type Picoammeter	2-5
3-1	Current Suppression Circuit Connections	3-1
3-2	Galvanometric Measurements	3-1
3-3	Guarded Circuit for Ohmmeter Calibration	3-2
4-1	Top Chassis View	4-2
5-1	Block Diagram	5-1
7-1	Voltage Supply Board, Component Location Drawing	7-1
7-2	Calibration Board, Component Location Drawing, Dwg. No. 30483C	7-2
7-3	AMPERES Range Switch, S102	7-5
7-4	10 ¹² Ω Resistor Assembly (R108)	7-5
7-5	X.01 Multiplier Switch, S103	7-6
7-6	X.01 Multiplier Switch, S104	7-6
7-7	X1 Multiplier Switch, S105	7-6
7-8	Model 261 Schematic Diagram, Dwg. No. 18323E	7-7

LIST OF TABLES

Table	Title	Page
2-1	Current Output Examples	2-3
2-2	Causes of Discrepancy in Model 261 Output Current and Correction Index	2-6
4-1	Recommended Equipment for Verification and Calibration	4-1
4-2	Range Resistor Verification	4-2
4-3	Range Resistor Accuracy	4-2
4-4	Voltage For Multiplier Switch Settings	4-3
4-5	Range Calibration	4-3
6-1	Troubleshooting Guide	6-2
6-2	Fuse Types	6-2
7-1	Model 261 Parts List	7-3
7-2	Mechanical Parts	7-5

SECTION 1

GENERAL INFORMATION

1.1 INTRODUCTION

The Model 261 Picoampere Source is a secondary standard for use in calibrating picoammeters and electrometers. The output of the Model 261 can be adjusted between 10^{-14}A and $1.1 \times 10^{-4}\text{A}$ in eight decade ranges. The source has 3 digit resolution for current outputs between 10^{-12} and 10^{-4}A .

The current output of the Model 261 is derived from a variable voltage source and a selectable range resistance. The voltage supply is highly regulated for stability and uses high-quality components throughout for reliability. The low side of the output can be floated to avoid possible ground loop problems.

1.2 MODEL 261 FEATURES

Important Model 261 features include:

1. 11V Internal Source. The internal voltage source can be set to a value between 0 and 11V in 0.01V increments. This permits accurate calibration of picoammeters and electrometers with input voltage drops up to 10mV without calibration correction.
2. Stable High-Meg Resistance Standards. The high-megohm resistance standards are selected for maximum stability. Individual temperature coefficients and resistance values are supplied with each instrument.
3. Line Operation. The Model 261 is line operated from either 105-125V or 210-250V power sources. Voltage selection is easily accomplished with the rear panel line voltage selection switch.
4. Eight Current Ranges. Eight current ranges are user selectable with a single front panel control.
5. Shielded Output Connector. The UHF output connector on the front panel is Teflon[®] insulated to minimize possible leakage problems.
6. Floating Low Connection. The low side of the output connection can be floated to minimize the effects of ground loops.

1.3 WARRANTY INFORMATION

Warranty information may be found inside the front cover of this manual. If warranty service is required, contact the Keithley representative in your area or the factory to determine the correct course of action. Keithley Instruments, Inc., maintains service facilities in the United States, West Germany, Great Britain, the Netherlands, Switzerland and Austria. Information concerning the application, operation, or service of your instrument may be directed to the applications engineer at any of these locations. Addresses can be found inside the front cover of this manual.

1.4 MANUAL ADDENDA

Changes pertaining to the instrument that occur after the printing of this manual will be found in an addendum included with this manual. Be sure to note any changes before attempting to operate or service the instrument.

1.5 SAFETY TERMS

The **WARNING** heading used in this manual explains dangers that could result in personal injury or death. The **CAUTION** heading used in this manual explains hazards that could damage the instrument.

1.6 UNPACKING AND INSPECTION

The Model 261 was carefully inspected before shipment. Upon receiving the unit, carefully unpack all items from the shipping carton and check for any damage that might have occurred during transit. Report any damage to the shipping agent at once. Save the original packing material in case reshipment becomes necessary. Contact the nearest Keithley representative or the factory if the unit fails to function properly.

The following items are included in every Model 261 shipment:

1. Model 261 Picoampere Source
2. Model 261 Instruction Manual
3. Model 2611 Test Lead Cable
4. Additional accessories as ordered.

1.7 USING THE MODEL 261 INSTRUCTION MANUAL

This manual is intended to familiarize the operator with the operating controls and features of the Model 261 Picoampere Source. Also included is information on calibration, maintenance and spare parts. The manual is divided into the following sections:

1. Sections 2 and 3 contains pertinent operating information, including applications and possible pitfalls to avoid when using the source.
2. Section 4 covers performance verification and calibration procedures.
3. A complete description of operating theory is contained in Section 5.
4. Troubleshooting and maintenance procedures are covered in Section 6.
5. Parts ordering information can be found in Section 7.

1.8 SPECIFICATIONS

A complete list of Model 261 specifications can be found immediately preceding this section.

1.9 OPTIONAL ACCESSORIES

The Model 4003A Rack Mounting Kit allows the Model 261 to be conveniently mounted in a standard 19 inch rack. The overall dimensions of the Model 4003A kit is 5¼ inches high

by 19 inches deep. Two different covers are provided for use with either 10 inch deep or 13 inch deep instruments. Contact your nearest Keithley representative or the factory for information on ordering the Model 4003A.

SECTION 2 OPERATION

2.1 INTRODUCTION

This section contains information necessary to set up the Model 261 and operate the unit. Also included are compensating equations necessary when using the source with measuring instruments with high input voltage drops.

2.2 FRONT PANEL CONTROLS AND TERMINALS

Figure 2-1 shows the front panel of the Model 261. The functions of the various controls and terminals are described below.

POLARITY Switch. The POLARITY switch has four positions which are used to control power, turn the instrument output off and on, and set the polarity of the source output. In the AC OFF position, the Model 261 power is disconnected. In the OFF position, power is applied to the instrument, but the source is disconnected from the output jack. When the POLARITY switch is in this position, the output resistance of the source is equal to the reciprocal of the AMPERES switch setting, regardless of the multiplier settings in use. The + and - positions select positive or negative current output values.

Range (AMPERES) Switch. The range switch selects one of eight decade current ranges between 10^{-5} and 10^{-12} A. The actual output is affected by the positions of the three multiplier switches. When the multiplier switches are in the 1.00 positions, the range switch indicates the actual output current.

Multiplier Switches. The multiplier switches control the internal voltage source of the instrument. These switches provide multiplying values that determine the actual output of the source. To determine the current output, multiply the current range by the multiplier setting. The multiplier switches control the output through the use of a 3-decade Kelvin-Varley divider. The X1 and X.01 switches each have 11 positions between 0 and 10; the X.1 switch has 10 positions between 0 and 9. The illuminated decimal point between X1 and X.1 switches also serves as a pilot lamp.

OUTPUT Receptacle. The OUTPUT receptacle is a Teflon[®] insulated UHF type connector. The low (threaded) side floats from ground unless the COM and GND terminals on the rear panel are connected together. A chassis ground terminal (G) is located next to the OUTPUT connector.

2.3 REAR PANEL CONTROLS AND TERMINALS

Figure 2-2 shows the rear panel of the source. The purpose of the various controls and terminals is described below.

Voltage Switch. The voltage switch sets the source for 105-125V or 210-250V operation. A screwdriver can be used to set the switch to the desired position.

FUSE. By unscrewing the fuse holder cap, the fuse is accessible. See Section 6 for fuse replacement procedures.

Power Cord. The 3-wire cord is permanently attached to the rear panel. The opposite end of the power cord has a standard 3-prong plug attached. This plug should be used only with grounded outlets.

COM and GND terminals. The COM terminal is connected to the low side of the source output. The GND terminal is connected to chassis ground, which is connected to the power line ground wire in the 3-wire power cord. Normally, the GND and COM terminals are connected together with a shorting link, which is provided. The link can be removed to float the low side from ground.

2.4 PREPARATION FOR USE

Before operating the Model 261, perform the following steps:

1. Set the line voltage selection switch to the appropriate setting depending on the local power line voltage. Check to see that the appropriate fuse is installed.

CAUTION

Operating the source on an incorrect line voltage may damage the unit, possibly voiding the warranty.

2. Set the Model 261 front panel controls as follows:
POLARITY Switch: AC OFF
Range Switch: Desired current range
Multiplier Switches: 10.00
3. Plug in the source to AC power and rotate the POLARITY switch to the OFF position. The decimal point pilot light should come on, indicating the unit is receiving power. If not, disconnect the instrument from the power line and check to see that the fuse is good.

2.5 BASIC OPERATING PROCEDURE

Operation of the Model 261 is fairly straight forward. Once the unit is connected to the measuring instrument, the operator need only select the appropriate range and multiplier switch settings and select the output current polarity. The basic operating procedure is as follows:

1. Plug in the instrument to the appropriate power source and rotate the POLARITY switch to the OFF position. The pilot light should indicate that power is applied to the source. Allow a one hour warm-up period for rated accuracy.

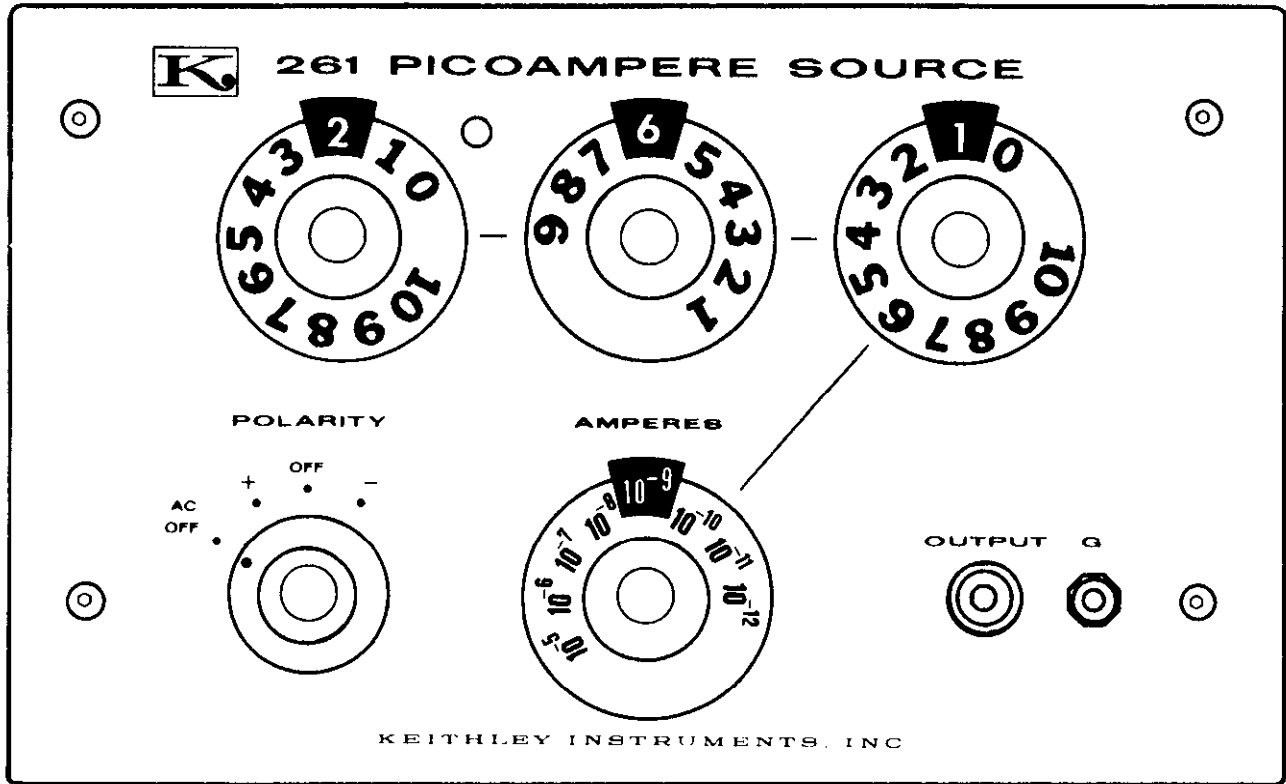

Figure 2-1. Front Panel Controls and Terminals

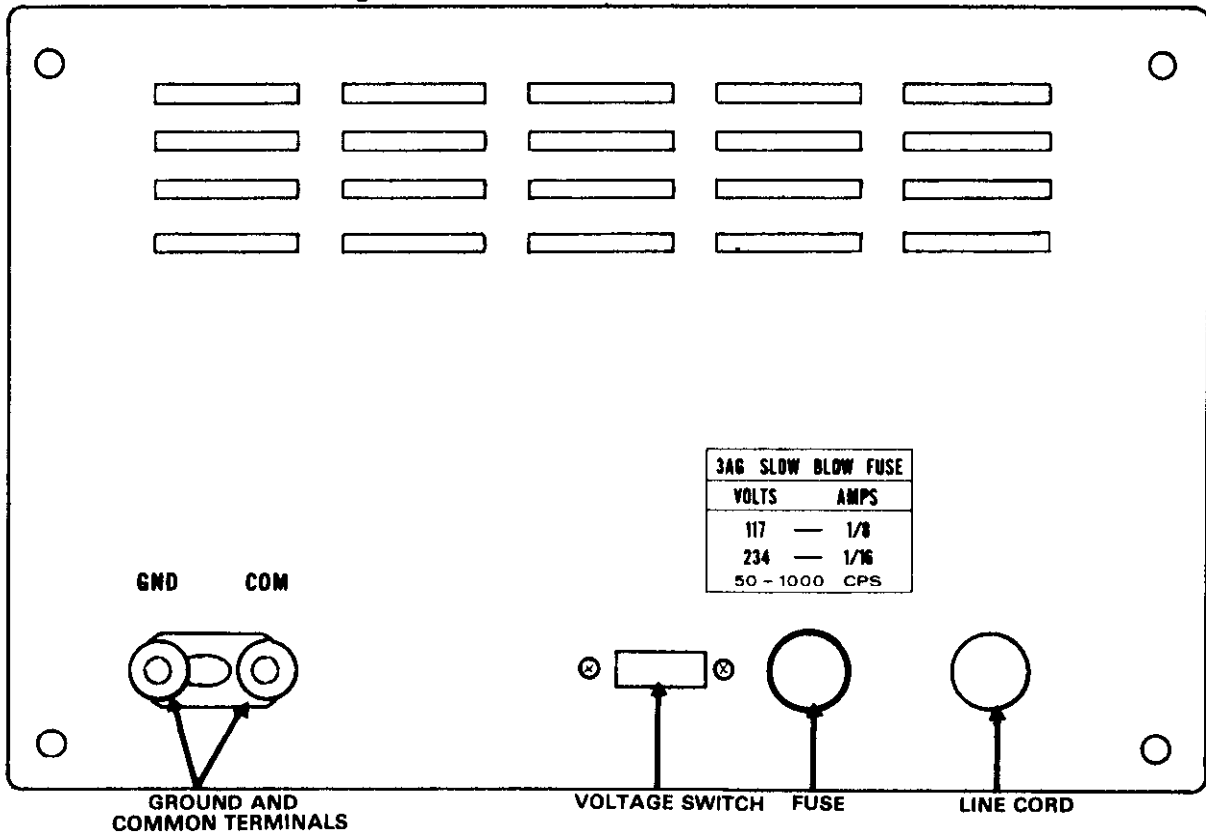

Figure 2-2. Rear Panel Controls and Terminals

2. Connect the source to the measuring instrument as shown in Figure 2-3. Use the supplied Model 2611 cable to make the necessary connections.
3. Select the desired range and multiplier settings according to the required output current. Some examples are shown in Table 2-1. Note that accuracy figures are given with the multiplier settings at 10.00.
4. Place the POLARITY switch in the + or - position, depending on the desired output polarity.

This procedure covers the basic steps for using the Model 261; however, some precautions may be necessary to ensure rated accuracy, as described in the following paragraphs.

Table 2-1. Current Output Examples

Desired Current	Range	Multiplier
60 μ A	10 ⁻⁵	6.00
21.7pA	10 ⁻¹¹	2.17
89.5nA	10 ⁻⁸	8.95
100 μ A	10 ⁻⁵	10.0
1.35pA	10 ⁻¹²	1.35
250nA	10 ⁻⁷	2.50
7.5nA	10 ⁻⁹	7.50
455pA	10 ⁻¹⁰	4.55
3.66 μ A	10 ⁻⁶	3.66

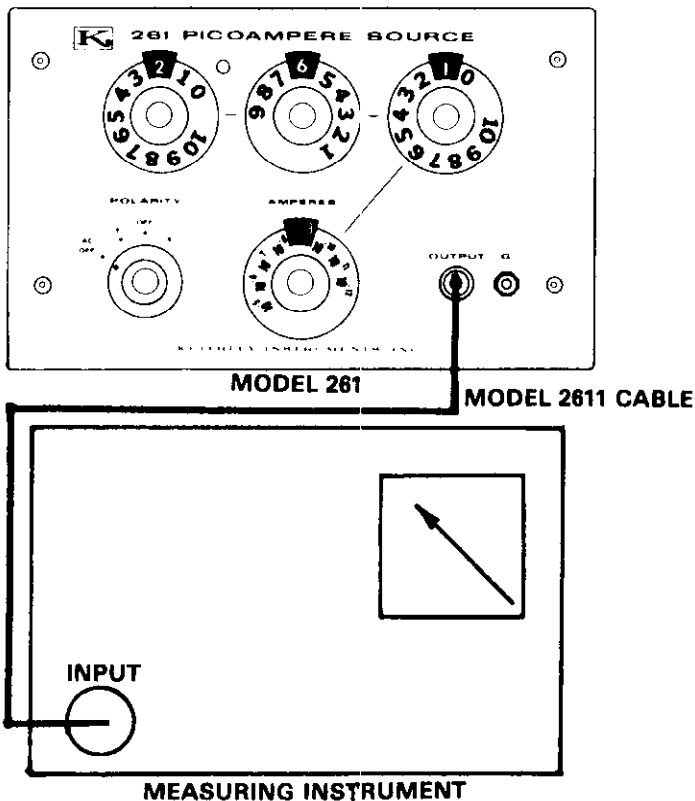

Figure 2-3. Connecting the Model 261 Source

2.6 ACCURACY CONSIDERATIONS

The range switch setting times the multiplier switch setting gives the Model 261 current output. The accuracy of the output, however, depends upon several factors.

Output connections from the source to the picoammeter are very important, especially for the lower ranges. The accuracy of the current at the Model 261 OUTPUT receptacle will mean little if poor or improper hookups are made from the source to the picoammeter.

2.6.1 Input Voltage Drop (Voltage Burden)

For specified output accuracy, the voltage drop of the measuring instrument must be less than 1/1000 of the internal source voltage of the Model 261. The internal source voltage in volts is read directly from the multiplier switch settings, regardless of the range switch setting. The voltage drop of the picoammeter is a characteristic of that instrument; it can be found in its instruction manual or it must be calculated.

For picoammeter with a 1mV or less voltage drop, set the Model 261 multiplier switches to 1.00. For a voltage drop between 10 and 1mV, set the multiplier switches to 10.00 and set the range switch one decade lower. This setting does not affect the Model 261 accuracy for outputs greater than 10⁻⁸A. Note that even for a voltage drop 1/100 of the source voltage, an error of only 1% is added to the specified accuracy.

2.6.2 Proper Multiplier Settings

Setting the multiplier switches to 10.00 ensures the most accurate output current, given the proper voltage drop source voltage ratio. Setting the multiplier switches to other than 10.00 does not affect the accuracy for outputs greater than 10⁻⁸A. In all cases, however, the Model 261 output accuracy is at least that of the worst-case accuracy listed in the accuracy specifications.

When the Model 261 is used on the 10⁻⁹ to 10⁻¹² ranges at other than the calibrated temperature (stated on the calibration certificate furnished with the source) a discrepancy in the output current will occur. On other ranges the effect is not significant.

2.7 OUTPUT CONNECTIONS

Make all connections carefully between the Model 261 and meters having fast response speeds. Tie down cables to avoid vibrations. Cable movements cause meter jitter on the 10⁻⁹A and lower ranges due to capacitance changes.

For currents 10⁻⁸A and less, carefully shield the output connections and the input connections of the picoammeter. Unless the shielding is thorough, any changes in the electrostatic field near the input circuitry will cause definite disturbances on the measuring instrument.

Use high resistance, low-loss materials (such as Teflon® (recommended), polyethylene or polystyrene) for insulation. The insulation leakage resistance of test fixtures and leads should be several orders of magnitude higher than the internal resistance of the source. If it is not, leakage losses will cause lower readings. Coaxial cables used should be a low-noise type which employ a graphite or other conductive coating between the dielectric and the surrounding shield braid.

NOTE

Ground loops may occur when equipment connected to the Model 261 has one side of the input grounded. In this case disconnect the shorting link between the Model 261 COM and GND binding posts. The low side of the output then floats; output isolation from low to ground is greater than $10^9\Omega$ shunted by $0.001\mu F$ with the link removed.

High resistance paths in the output connections do not appreciably reduce the Model 261 current output accuracy if the source is used with a low input voltage drop or feedback-type picoammeter. As an example, the Model 261 is used with a picoammeter with a 1mV drop (Figure 2-4). The source is set to $10^{-12}A$. If the leakage resistance is $10^{12}\Omega$, the error caused by leakage, R_e , is:

$$\frac{0.001mV}{10^{12}\Omega} = 10^{-15}A$$

This is 0.1% of the source current, $10^{-12}A$. Leakage resistance of the Model 2611 Test Cable is nominally greater than $10^{14}\Omega$.

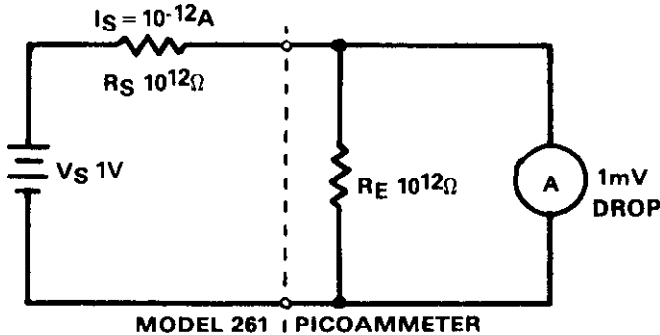

Figure 2-4. High Resistance Paths in Output Connections

2.8 INPUT VOLTAGE DROP FOR FEEDBACK AND SHUNT-TYPE PICOAMMETERS

The output current accuracy is specified under the assumption that the picoammeter input voltage drop is less than 1/1000 of the Model 261 source voltage. Most feedback electrometers will easily meet this condition. Any error caused by the picoammeter voltage drop may be eliminated by calculation if the voltage drop is known. However, only a 1% error is added if the voltage drop is 1/100 of the source voltage.

The general magnitude of the voltage drop is dependent upon the type of circuit the picoammeter uses. Feedback types have a low input voltage drop of approximately 1mV or less. Shunt types generally have a relatively large input voltage drop (about 10mV or more). However, some low-current shunt-type ammeters can be calibrated as if they were the feedback type. To help determine the type of picoammeter under calibration, a brief description of the circuits follows.

2.8.1 Feedback-Type Picoammeter

The feedback-type picoammeter is basically an operational amplifier with a feedback resistor connected between the input and the output as shown in Figure 2-5. If the amplifier input current, I_g , is small compared to the input current, I_i , an expression for the amplifier output voltage, V_o , for an input current of I_i is:

$$V_o = \frac{I_i R_f k}{1-k} \quad \text{Equation 1}$$

where R_f is the value in ohms of the feedback resistor; k is the amplifier gain.

If $k \gg 0$, $V_o \approx -I_i R_f$. The output voltage may be used to drive either a recorder or the meter, M . The input voltage drop, V_i , is:

$$V_i = -V_o/k \quad \text{Equation 2}$$

Typical values for the preceding parameters for a picoammeter are:

- Input current to picoammeter, $I_i = 10^{-12}A$
- Amplifier gain, $k = 10^4$
- Picoammeter feedback resistor, $R_f = 10^{12}\Omega$
- Amplifier output voltage, $V_o = 1V$
- Input voltage drop, $V_i = 100\mu V$

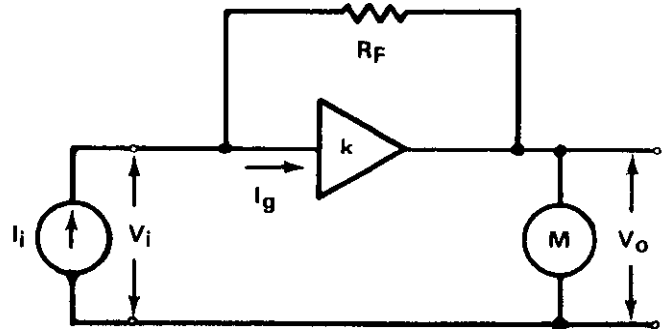

Figure 2-5. Simplified Circuit of Feed-Back Type Picoammeter

2.8.2 Shunt-Type Picoammeter

This type consists of a voltmeter, V , calibrated in amperes, which responds to the IR drop across a shunt resistor, R_s . Refer to Figure 2-6. The voltmeter can be one of two kinds:

A high impedance voltmeter, such as an electrometer, which has an extremely high input impedance, Z_i ; or a low impedance voltmeter.

High Impedance Voltmeter-The input voltage drop, $I_i R_s$, of a picoammeter using a high-impedance voltmeter is usually 1mV or more, due to voltmeter sensitivity limitations. Rise time is usually slow, possibly several minutes for very low current levels. Typical values are:

- Input current to picoammeter, $I_i = 10^{-12}A$
- Picoammeter shunt resistor, $R_s = 10^{10}\Omega$
- Voltmeter input impedance, $Z_i = 10^{14}\Omega$
- Input voltage drop, $V_i = 10mV$

Low Impedance Voltmeter-The circuit of a shunt-type picoammeter using a low-impedance voltmeter is essentially the same as Figure 2-6, except a more sensitive but lower input impedance voltmeter is used. A lower input voltage drop results, but response speed and maximum current sensitivity are usually less. The voltage drop is $I_i R_s$. Typical values are:

- Input current to picoammeter, $I_i = 10^{-10}A$
- Picoammeter shunt resistance, $R_s = 10^6\Omega$
- Voltmeter input impedance, $Z_i = 9 \times 10^7\Omega$
- Input voltage drop, $V_i = 100\mu V$

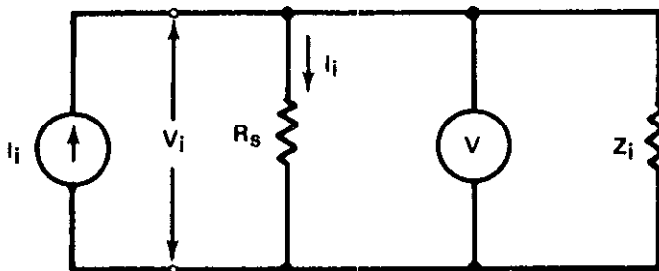

Figure 2-6. Typical Shunt Type Picoammeter

2.9 COMPENSATION FOR INPUT VOLTAGE DROP OF FEEDBACK-TYPE PICOAMMETERS

Errors caused by picoammeter input voltage drops of 1mV or less are negligible for Model 261 outputs between 1.1×10^{-4} and $10^{-11}A$. Following the instructions in paragraph 2.6 will bring the output current accuracy to between $\pm 0.25\%$ and $\pm 0.7\%$.

2.9.1 Calculating Voltage Drop Error

When either the picoammeter voltage drop or input resistance is known, use either Equation 3 or 4 to determine the error.

When the voltage drop is known:

$$E_{vd} = \frac{V_i \times 100}{V_s} \quad \text{Equation 3}$$

where E_{vd} is the percent of error due to the picoammeter input voltage drop;

V_i is the picoammeter input voltage drop in volts;

V_s is the Model 261 source voltage, read directly in volts from the multiplier switch settings.

When the input resistance is known:

$$E_{vd} = \frac{R_i \times 100}{R_s} \quad \text{Equation 4}$$

where R_i is the picoammeter input resistance in ohms;

R_s is the Model 261 source resistance, which is the reciprocal of the range switch setting.

2.9.2 Compensating Equation

If the voltage drop is known, the actual Model 261 output current can be calculated. Equation 5 gives the output current value if the input voltage drop is the only significant source of error.

$$I_a = I_s (V_s - V_i) \quad \text{Equation 5}$$

where I_a is the actual output current from the Model 261;

I_s is the range switch setting (reciprocal of range resistor value);

V_s is the Model 261 source voltage, read directly in volts from the multiplier switch settings;

V_i is the picoammeter input voltage drop in volts.

2.10 COMPENSATION DROP FOR INPUT VOLTAGE DROP OF SHUNT-TYPE HIGH-IMPEDANCE PICOAMMETERS

As long as the voltage drop is less than 1/1000 of the source voltage, errors due to the input voltage drop of this type picoammeter will not affect the Model 261 accuracy. Following the instructions in paragraph 2.6 will bring the accuracy of the Model 261 output current to between $\pm 0.25\%$ and $\pm 0.7\%$. The chief point is setting the multiplier switches to higher values, so that the source voltage is 1000 times the picoammeter input voltage drop. If the meter sensitivity is adjustable, use the most sensitive range to obtain the smallest voltage drop.

NOTE

If the instrument can measure current on either a feedback-type or shunt-type circuit, calibrate on the feedback circuit. For example, calibrate the Keithley Model 610C Electrometer in the FAST mode (feedback circuit) not the normal mode (shunt).

2.10.1 Calculating the Error

Equation 3 determines the error when the picoammeter input voltage drop is known. The voltage drop is easily found, since the meter or other readout device indicates the voltage drop on these type picoammeters.

2.10.2 Compensating Equations

Since the picoammeter voltage drop can be found, the Model 261 output current can be corrected. Equation 6 gives the output current value if the input voltage drop is the only significant source of error and if the voltage drop is less than 1/10 the source voltage.

$$I_a = I_s(V_s - V_i) \quad \text{Equation 6}$$

where I_a is the actual output current from the Model 261;
 I_s is the range switch setting (reciprocal of range resistor value);
 V_s is the Model 261 source voltage, read directly in volts from the multiplier switch setting;
 V_i is the picoammeter input voltage drop in volts.

Using this correction, accuracy is nominally $\pm 0.5\%$ (Model 261 accuracy). This error results from the factory calibration method used for the Model 261 that adjusts the source voltage from that indicated to match the range resistor used.

For greater accuracy, or if the input drop is more than 0.1 times the source voltage, use equation 8 to compensate for the error. The following equation is based on the calibration procedures.

$$V_{s1} = \frac{V_s(R_{s1})}{1/I_s} = V_s R_{s1} I_s \quad \text{Equation 7}$$

where V_{s1} is the actual source voltage;
 V_s is the Model 261 source voltage, read directly in volts from the multiplier switch setting;
 R_{s1} is the actual source resistance from the calibration certificate supplied with the Model 261;
 I_s is the Model 261 range switch setting (reciprocal of range resistor value).

Using equation 7 in equation 6 and substituting V_{s1} for V_s ,

$$I_a = I_s(I_s V_s R_{s1} - V_i) \quad \text{Equation 8}$$

where I_a is the actual output current from the Model 261;
 V_i is the picoammeter input voltage drop in volts read from the meter.

Using equation 8 completely compensates for the error due to the input voltage drop.

2.11 COMPENSATION FOR INPUT VOLTAGE DROP OF SHUNT-TYPE LOW-IMPEDANCE PICOAMMETERS

For the most part, the voltage drop for this type picoammeter is about the equivalent of that of the feedback-type picoammeter-about 1mV or less. Following the directions in paragraph 2.6 will ensure that Model 261 output currents are within the specified accuracy.

To compensate for output current difference caused by input voltage drops, use equation 8. This calculation will be precise, since the voltage drop is read directly from the picoammeter.

2.12 RANGE RESISTOR VOLTAGE COEFFICIENT

Ordinarily, the voltage coefficient of high-megohm resistors can lead to significant errors. However, the range resistors used in the Model 261 have an extremely low voltage coefficient of only 5ppm/V. This low value results in a worst-case current change due to voltage coefficient of only 0.0055% with the multiplier switches set for 11V. Thus, the output discrepancy because of voltage coefficient is one or two orders of magnitude smaller than other sources of error, and can be ignored for all practical purposes.

2.13 COMPENSATION FOR TEMPERATURE COEFFICIENT

When the Model 261 is used for range switch settings above 10^{-8} or when the unit is operated at the temperature indicated on the calibration certificate, no significant errors will occur in the output. However, for range switch settings between 10^{-9} A and 10^{-12} A, the change in range resistance because of temperature coefficient can affect the output considerably.

The Model 261 is calibrated at a specified temperature $\pm 0.5^\circ\text{C}$, which is stated on the calibration certificate, for the various ranges. The certificate also lists the temperature coefficients by range.

Table 2-2. Causes of Discrepancy in Model 261 Output Current and Correction Index

Cause of Discrepancy in Output Current	Picoammeter Type	Affected	Paragraph Reference	Equation to Compensate for Discrepancy
Picoammeter input voltage drop more than 1/1000 of source voltage	Feedback	all	2.9	5
	Shunt-Type	all	2.10	6 or 8
	High-Impedance Shunt-Type	all	2.11	8
Model 261 ambient temperature differs from that stated in Calibration Certificate	all	10^{-8} to 10^{-14}	2.13	9

Compensating Equation—The effect of temperature differences on the Model 261 current can be calculated using equation 9. This gives the output current value if the temperature effect is the only significant source of error.

$$I_a = I_s \left[\frac{1}{1 - (T_2 - T_1) \frac{tc}{100}} \right] \approx I_s \left[1 + (T_2 - T_1) \times .01 \times tc \right] \text{ Equation 9}$$

where I_a is the actual or compensated Model 261 current output;

I_s is the indicated current output (range switch setting times the multiplier switch settings);

T_2 is the room temperature in °C;

T_1 is the calibration temperature in °C;

tc is the temperature coefficient of the range resistor in %/°C given on the calibration certificate.

SECTION 3 APPLICATIONS

3.1 INTRODUCTION

The Model 261 was designed to serve as a secondary source in calibrating picoammeters and electrometers. While this is the primary purpose of the unit, it can also be used for various other applications, including current suppression, galvanometric measurements, and ohmmeter calibration. This section briefly covers the methods for each of these applications; these examples by no means exhausts the possibilities of using the Model 261.

3.2 CURRENT SUPPRESSION

The Model 261 can be used to suppress steady background currents so that a picoammeter or electrometer can measure small variations in signal. For example, the Model 261 can be used to cancel phototube dark currents while the picoammeter measures small variations in the normal output of the phototube.

The basic circuit for current suppression is shown in Figure 3-1. Because of its popularity, the Keithley Model 610C is used as the current measuring device. Other instruments with similar characteristics will serve equally well in this application. Using the Models 261 and 610C, suppression up to 1000 times full scale is possible. Suppression up to at least 100 times full scale is possible with most picoammeters.

The basic procedure for current suppression is as follows:

1. Connect the Models 261 and 610C to the unknown current as shown in Figure 3-1; use the Model 261 test cable or other similar coaxial cable.
2. Set the Model 261 to the desired current as described in Section 2. Set the output polarity of the source opposite to that of the unknown current. Also set the source output value as close as possible to the unknown current.
3. Set the Model 610C FEEDBACK switch to FAST. In this mode, the Model 610C acts as a feedback type picoammeter.
4. Set the Model 610C to the least sensitive current range. Vary the Model 261 source output until a null is reached.
5. Gradually increase the Model 610C sensitivity, nulling the current with the Model 261 controls in each case. Keep the Model 610C multiplier switch on 1.
6. Set both the Models 261 and 610C range switches to the same setting. If the electrometer is set to a lower range, the Model 261 source resistance will divide the Model 610C feedback current, impairing its zero stability.
7. Switch the electrometer multiplier setting gradually from 1 to 0.001. In the lowest setting, the Model 610C current sensitivity is 1000 times the unknown current.

The basic procedure for using this method with other instruments is the same. Check the picoammeter's specifications

to determine any circuit limitations. Always set the picoammeter for the best possible sensitivity.

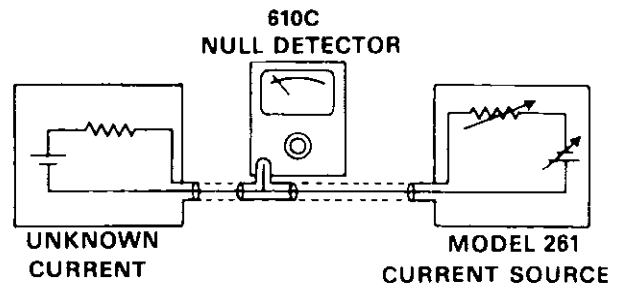

Figure 3-1. Current Suppression Circuit Connections

3.3 GALVANOMETRIC MEASUREMENTS

In practice, using the Model 261 for galvanometric measurements is very similar to the current suppression procedures discussed in the previous paragraph. In this application, the Model 261 bucks out an unknown current, while a measuring instrument, such as the Keithley Model 614, serves as a null detector.

The basic circuit for galvanometric measurements is shown in Figure 3-2. I_U is the unknown current; V_S is the Model 261 source voltage and R_S is the source resistance. I_S is the source current, while I_M is any residual current seen by the instrument. R_F is the picoammeter feedback resistor; k , the amplifier gain; R_M the multiplier resistance.

Follow the same basic procedure for this measurement as described in the last paragraph. Once maximum nulling is achieved, the unknown current value can be determined by adding the Model 261 source output value to any residual value shown on the measuring instrument.

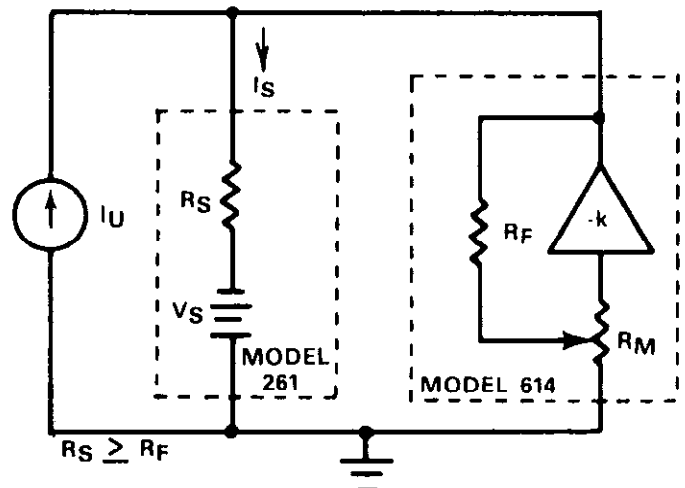

Figure 3-2. Galvanometric Measurements

3.4 OHMMETER CALIBRATION

The Model 261 contains calibrated resistance standards, which make it useful for checking high resistance measuring instruments. The front panel AMPERES switch setting indicates the reciprocal of the internal source resistance. For example, the source resistance will be $1M\Omega$ if the AMPERES switch is in the 10^{-6} position. The exact resistance for any position of the AMPERES switch can be found listed on the supplied calibration certificate.

The basic procedure for ohmmeter calibration is as follows:

1. Set the POLARITY switch to the OFF (not AC OFF) position.
2. Set the AMPERES switch to the reciprocal of the desired resistance.
3. Connect the ohmmeter to the Model 261 OUTPUT connector using an appropriate coaxial cable. See Section 2 for precautions to be taken when making connections.
4. Carefully shield connections when making measurements greater than $10^8\Omega$. Use guarded connections for measurements of $10^9\Omega$ and more, as shown in Figure 3-3. Guarded connections are necessary in such cases to minimize the shunting effects of cable and connector leakage resistance. For example, using the $10^{10}\Omega$ range, a $10^{12}\Omega$ leakage resistance will add an error of 1%. To make the proper connections within the unit, place the CAL-OPERATE switch in the CAL position (see Section 4).

WARNING

Disconnect the instrument from the power line before removing the top cover. Failure to observe this precaution may result in personal injury or death due to electric shock.

Remove the link between the GND and COM terminals on the rear panel of the source. The outer shell of the OUTPUT jack is the guard terminal, while the G binding post next to it is connected to the low side of the ohmmeter.

5. Observe the ohmmeter reading and compare it to the appropriate value listed on the calibration certificate. Range resistor values will be within the stated tolerance for up to three months after factory calibration.

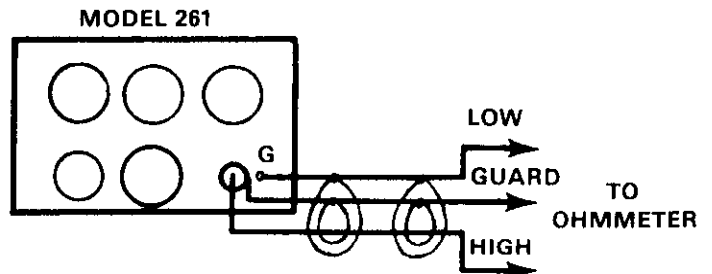

Figure 3-3. Guarded Circuit For Ohmmeter Calibration

SECTION 4 PERFORMANCE VERIFICATION AND CALIBRATION

4.1 INTRODUCTION

This section contains information necessary to verify that Model 261 performance is within specified accuracy and to calibrate the instrument. Model 261 specifications may be found at the front of this manual. Ideally, performance verification should be performed when the unit is first received to make sure that no damage or change in calibration has occurred during shipment. The verification procedure may also be performed if accuracy is suspect or following calibration. If instrument performance is substandard, calibration may be performed as described at the end of this section.

NOTE

If the instrument does not meet specifications, and less than three months have passed since the date of shipment, contact your Keithley representative or the factory to determine the action to be taken.

4.2 ENVIRONMENTAL CONDITIONS

All measurements should be made at an ambient temperature between 18°C and 28°C (65° to 82°F) with a relative humidity less than 80%.

4.3 RECOMMENDED TEST EQUIPMENT

Recommended test equipment for Model 261 performance verification and calibration is listed in Table 4-1. Different equipment may be used as long as the accuracy specifications are at least four times better than Model 261 specifications. If less accurate equipment is used, additional allowances must be made for test equipment inaccuracy.

4.4 INITIAL CONDITIONS

Before performing the following procedures, make sure the Model 261 meets the following conditions:

1. If the unit has been subjected to temperatures below 18°C (65°F) or above 28°C (82°F), allow sufficient time for it to reach a temperature within this range. Generally, it takes

one hour to stabilize an instrument that is 10°C (18°F) outside the allotted range.

2. Turn on the power to the Model 261 and allow it to warm up for at least one hour before beginning verification or calibration procedures.

4.5 VERIFICATION PROCEDURE

Model 261 operation is based on connecting an accurate, known resistor in series with a stable, accurate voltage source. The resulting current is easily predicted with Ohm's law. This same principle can be used to verify Model 261 performance; if both the resistance and voltage are within specifications, it can be assumed that the output current is accurate as well.

4.5.1 Top Cover Removal

The procedure in this section require that the top cover be removed to allow access to test points and the CAL-OPERATE switch. To remove the top cover, proceed as follows:

WARNING

Disconnect the Model 261 from the power line and other instrumentation before removing the top cover.

1. Remove the four screws securing the top cover to the chassis.
2. Grasp the top cover by the handle, and gently pull the cover up and back until it clears the chassis.
3. To replace the cover, reverse the above procedure.

4.5.2 Range Resistor Verification

The following procedure outlines a method which can be used in the field to measure the actual value of the high megohm range resistors. The inherent drift of these resistors sets the 3-month accuracy limit of the Model 261. Note that resistor verification is also necessary to complete calibration.

Table 4-1. Recommended Equipment for Verification and Calibration

Equipment	Manufacturer and Model	Use
Precision Resistance Measuring System	Electro Scientific Industries Model 242A	Measurement of 10 ⁻⁵ Range Resistor
Digital Teraohmmeter	Guildline Model 9520	Measurement of 10 ⁻⁶ through 10 ⁻¹² range resistors.
Digital Multimeter	Keithley Model 179A	Measurement of Power Supply, Kelvin-Varley Voltage Divider

Table 4-2. Range Resistor Verification

Model 261 Amperes Switch Setting	Range Resistance Value (Ohms)	Measuring Potential (Volts)	Measurement Accuracy*
10 ⁻⁵	10 ⁵ ± 0.02%	0.9	± 0.02%
10 ⁻⁶	10 ⁶ ± 1%	10	± 0.03%
10 ⁻⁷	10 ⁷ ± 1%	10	± 0.025%
10 ⁻⁸	10 ⁸ ± 1%	10	± 0.035%
10 ⁻⁹	10 ⁹ ± 1%	10	± 0.05%
10 ⁻¹⁰	10 ¹⁰ ± 2%	10	± 0.07%
10 ⁻¹¹	10 ¹¹ ± 2%	10	± 0.1%
10 ⁻¹²	10 ¹² ± 2%	10	± 0.2%

*Accuracy of equipment listed in Table 4-1.

Table 4-3. Range Resistor Accuracy

Range	Resistor Accuracy
10 ⁵	± 0.02%
10 ⁶ and 10 ⁷	± 0.1%
10 ⁸ through 10 ¹²	± 0.5%

1. Disconnect the Model 261 line cord from the power source.
2. Remove the line connecting the COM and GND binding posts on the rear panel.
3. Set the CAL-OPERATE (Figure 4-1) in the CAL position. In this position, the low side of the range resistor is connected to chassis ground while the low side of the OUTPUT jack is connected as a guard between the high side of the output and ground.
4. Connect the Model 261 OUTPUT jack to the resistance measuring device. Use a suitable cable.
5. Select the desired Model 261 range resistance with the AMPERES switch. The nominal resistor values are equal to the reciprocal of the switch setting.
6. Set the measuring device to the voltage setting in the table.
7. Measure and record the resistance value for each range resistor. The measured value for each resistor should agree with the value stated on the calibration certificate within the tolerance listed in Table 4-3. If not, calibration of the affected ranges will be required.

4.5.3 Multiplier Switch Setting Verification

This procedure checks the accuracy of the divided potential from the voltage supply. Proceed as follows:

1. Connect the Model 179A DMM across the Kelvin-Varley voltage divider. Connect the HI lead to the grey-white wire on the X.01 switch, and connect the LO lead to the black-blue wire connection on the X1 switch (See Figure 4-1).
2. Connect the Model 261 to the power line.
3. Set the unit to the 10⁻⁵ range; set the polarity switch to + and set the multiplier switches to 10.00. The CAL-OPERATE switch should be in the OPERATE position.
4. Adjust R210 (Figure 4-1) for a reading of 10.000 ± 0.005V on the meter.
5. Switch each multiplier switch through the settings listed in Table 4-4 and verify that the required reading is observed on the meter.
6. Return the multiplier switches to the 10.00 setting and adjust R210 for a reading of 10.012 ± 0.005V on the meter.

NOTE

This last step must be performed to return the unit to the stated specifications.

4.6 CALIBRATION

Calibrate the ranges after performing the previous procedures in this section, paragraph 4.5. Range calibration is based on all other adjustments and verifications being complete and accurate. Perform this calibration any time the voltage supply is adjusted or if any Kelvin-Varley resistor or range resistor is replaced.

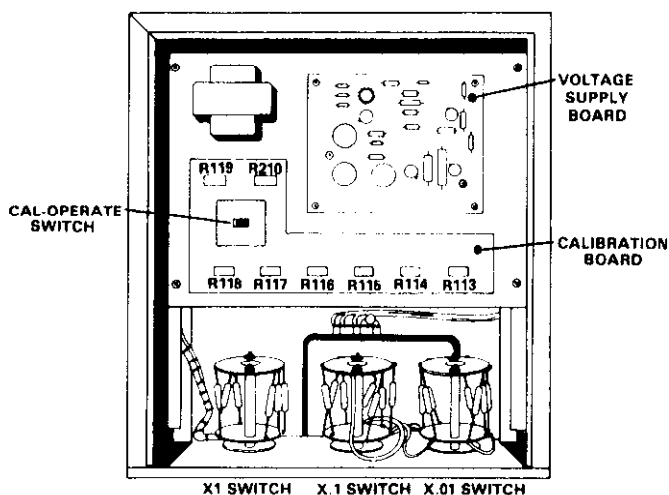

Figure 4-1. Top Chassis View

The basis of this calibration is $I = V/R$. The range potential is adjusted to correspond to the exact range resistor value, so that the current produced is equal to one times the range.

1. Set the Model 261 CAL-OPERATE switch to OPERATE. Connect the Model 261 to the proper line source. Connect the Model 179A Digital Multimeter across the Kelvin-Varley divider. Connect the HI lead to the grey-white wire on the X.01 switch, S103, and the LO lead to the black-blue wire on the X1 switch, S105 (Figure 4-1).
2. Set the Model 261 controls to:
Polarity Switch: +
Range Switch: 10^{-5}
Multiplier Switch: 10.00
3. Adjust the 10^{-5} CAL potentiometer, R210 (Figure 4-1), for $10.012V \pm 5mV$ when read on the Model 179. Setting the voltage 12mV high compensates for any loading errors on the $10^{-5}A$ range.
4. Set the multiplier dials to 10.00; switch the Model 261 through all ranges. Use the internal potentiometer for each range to set the range potential to $10R$ volts \pm the tolerance listed in Table 4-5. R is the exact resistor value found in paragraph 4.5.2 excluding the exponent value.

Example – The 10^{-11} range resistor is measured (paragraph 4.5) and its value is $1.019 \times 10^{11}\Omega$. The range potential is now adjusted when the range switch is set to 10^{-11} and the multiplier switches to 10.00. Using Table 4-5, potentiometer R118 is set so the voltmeter reads $10.190V \pm 5mV$.

Table 4-4. Voltage for Multiplier Switch Settings

Multiplier Switch Settings	Voltage Reading	Tolerance
10.00	10V	$\pm 5mV$
9.00	9V	$\pm 9mV$
8.00	8V	$\pm 8mV$
7.00	7V	$\pm 7mV$
6.00	6V	$\pm 6mV$
5.00	5V	$\pm 5mV$
4.00	4V	$\pm 4mV$
3.00	3V	$\pm 3mV$
2.00	2V	$\pm 2mV$
1.00	1V	$\pm 1mV$
0.90	0.9V	$\pm 1.84mV$
0.80	0.8V	$\pm 1.64mV$
0.70	0.7V	$\pm 1.44mV$
0.60	0.6V	$\pm 1.24mV$
0.50	0.5V	$\pm 1.04mV$
0.40	0.4V	$\pm 0.84mV$
0.30	0.3V	$\pm 0.64mV$
0.20	0.2V	$\pm 0.44mV$
0.10	0.1V	$\pm 0.24mV$
0.09	0.09V	$\pm 310\mu V$
0.08	0.08V	$\pm 280\mu V$
0.07	0.07V	$\pm 250\mu V$
0.06	0.06V	$\pm 220\mu V$
0.05	0.05V	$\pm 190\mu V$
0.04	0.04V	$\pm 160\mu V$
0.03	0.03V	$\pm 130\mu V$
0.02	0.02V	$\pm 100\mu V$
0.01	0.01V	$\pm 100\mu V$
0.00	0.00V	$\pm 100\mu V$

Table 4-5. Range Calibration

Multiplier Switch Setting	Range Switch Setting	Adjustment	$10 \times R$ Volts (R = Range Resistor)	Tolerance
10.00	10^{-6}	R113	R = 10^{-6} Range Resistor	$\pm 5mV$
10.00	10^{-7}	R114	R = 10^{-7} Range Resistor	$\pm 5mV$
10.00	10^{-8}	R115	R = 10^{-8} Range Resistor	$\pm 5mV$
10.00	10^{-9}	R116	R = 10^{-9} Range Resistor	$\pm 5mV$
10.00	10^{-10}	R117	R = 10^{-10} Range Resistor	$\pm 5mV$
10.00	10^{-11}	R118	R = 10^{-11} Range Resistor	$\pm 5mV$
10.00	10^{-12}	R119	R = 10^{-12} Range Resistor	$\pm 5mV$

SECTION 5 THEORY OF OPERATION

5.1 INTRODUCTION

This section contains a block diagram and a detailed description of Model 261 circuit operation.

5.2 BLOCK DIAGRAM

The basic block diagram for the Model 261 is shown in Figure 5-1. The source is made up of three basic sections: a voltage source, a variable voltage divider, and a selectable range resistor.

The voltage source uses a stable zener regulated supply to provide a constant 11V. A 3-dial Kelvin-Varley voltage divider, which has $\pm 0.1\%$ accuracy, is used to set the voltage to a value between 0V and 11V in 0.01V increments. The three front panel multiplier switches contain the divider resistors.

The range switch controls the output current by selecting an appropriate series range resistor. For any combination of front panel controls, the output current can be found simply by dividing the voltage divider output value by the selected range resistance value.

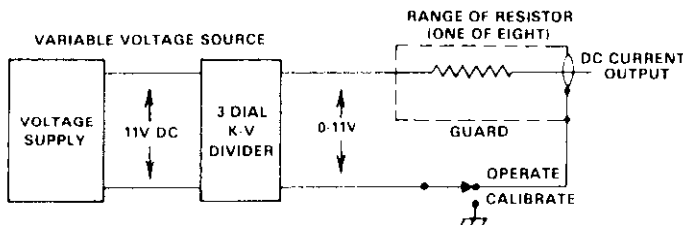

Figure 5-1. Block Diagram

5.3 CIRCUIT DESCRIPTION

For component designations, refer to schematic diagram number 18323E, Figure 7-8 at the end of Section 7.

5.3.1 Voltage Supply

The voltage supply operates from either 105-125V or 210-250V, 50-60Hz, depending on the position of the line voltage selection switch. The DC output of the supply is a stable 11V with 0.01% stability for a 10% change in line voltage.

The power transformer, T201, is specially constructed and shielded to provide better than $10^9\Omega$ shunted by $0.001\mu\text{F}$ isolation from the transformer secondary to ground or line. The secondary of the transformer supplies 15VRMS which is the full-wave rectified by diodes D202 and D203. Filter capacitor C202 filters this voltage to provide approximately 17VDC.

To obtain a stable, accurate voltage, the conduction of the series pass transistor Q202 is regulated by comparing a sample voltage with a reference voltage. The sampling voltage is provided by dividing action of resistors R211, R210, R201, and one of the range calibration resistors (R210, R113-R119). The reference voltage is provided by zener diode, D207. Any difference between these two voltages is amplified by a differential amplifier made up of Q204 and Q205. The signal is further amplified by Q203 and applied to a Darlington pair made up of Q201 and Q202. In this manner, the conduction of Q202 is controlled to oppose any tendency for the output voltage to change. The 11V regulator output is applied to the Kelvin-Varley voltage divider through the POLARITY switch S106.

Transistor Q203 operates at a high gain by connecting its collector to a negative supply voltage. This arrangement permits linear operation of Q202 under wide variations in supply voltage. To supply Q203, one side of the T201 secondary voltage is rectified by D201 and filtered by C201. Resistor R202 and zener diode D204 regulate this voltage to a stable -6V, referred to the collector of Q202.

Resistors R204 and R205 and diode D205 provide current overload protection. Excessive current drawn from the supply causes an increased voltage drop across R204, which forward biases D205, preventing the collector of Q203 from going more negative. Since this prevents Q203's error signal from increasing any further, so Q202 cannot increase conduction, and further current increase is prevented.

5.3.2 Range Resistors

The range resistors, R101 through R108 are mounted on a specially designed rotary switch, range switch S102, which has silver-plated contacts. The 10^{-5} range resistor, R101, is a 0.02% wirewound resistor. Resistors R102 through R104 are 1% carbon film resistors. High-megohm resistors R105 through R107 are special glass-sealed resistors that are individually selected after a 3 month stability test. R108 is made up of ten $10^{11}\Omega$ resistors mounted on a separate assembly, which is then mounted on S102.

Capacitor C101 and resistors R109, R110, and R111 form a damping network to compensate for the capacitance across high-megohm resistors R106 through R108. This network eliminates high current transients when the Model 261 is first turned on. The voltage source connects through one deck of S102 to the range calibration controls, R210, and R113 through R119. These range calibration controls form part of the voltage divider that forms the feedback signal for the regulator in the voltage supply.

The range switch, OUTPUT jack, and the range resistors are encased in a floating shield which is normally connected to the low side of the output. The shield is connected as a guard when the calibration switch S101, is in the CAL position.

5.3.3 Kelvin-Varley Voltage Divider

The Kelvin-Varley voltage divider uses 0.1% precision

resistors, which are mounted on the multiplier switches S103, S104, and S105. These resistors (R120 through R152) are used to divide the 11VDC supplied by the voltage supply down to the selected voltage between 0 and 11V in 0.01 increments. The voltage is selected with the three multiplier switches, S103 through S105.

SECTION 6 MAINTENANCE

6.1 INTRODUCTION

This section contains maintenance and troubleshooting procedures for the Model 261 Picoammeter Source. It is recommended that these procedures be followed as closely as possible to maintain the accuracy of the instrument.

6.2 SERVICING SCHEDULE

The Model 261 requires no periodic maintenance beyond the normal care required of high-quality electronic equipment. Normally, no part should need replacement except the fuse.

Ideally, the high-megohm range resistors should be checked every three months to ensure instrument accuracy. Refer to Section 4 for procedures to be used. The source may also be calibrated if accuracy is suspect. Use the procedures outlined in Section 4 when calibrating the unit. Alternately, the Model 261 may be returned to Keithley Instruments, Inc. for calibration.

6.3 TOP COVER REMOVAL

Maintenance or troubleshooting of the unit will require that the top cover be removed.

WARNING

These instructions are intended for qualified servicing personnel only. Do not remove the top cover unless qualified to do so. Also, disconnect the Model 261 from the power line and other instruments before removing the top cover. Failure to observe these precautions may result in serious personal injury or death because of the possibility of electric shock.

To remove the top cover, use the following procedures:

1. Disconnect the Model 261 from the power line.
2. Remove the screws securing the top cover to the chassis.
3. Grasp the handle on the top cover and carefully separate the cover from the chassis.

The cover can be installed by reversing this procedure. Be sure to line up the holes in the cover with those in the chassis before replacing the screws.

6.4 PARTS REPLACEMENT

Section 7 lists the replaceable parts available for the Model 261. When replacing parts, be sure to use only reliable replacements which meet original specifications. Replace parts only as necessary.

The range resistors are specially selected and aged to ensure rate accuracy for three months after calibration. Normally, these resistors do not need replacement. If replacements are necessary, order them from Keithley Instruments, Inc. In an emergency, these parts can be ordered from another source, but their accuracy or stability cannot be guaranteed. This could seriously affect the accuracy of the source on one or more ranges. In any case, recalibration will be necessary if one of the range resistors is replaced.

CAUTION

Do not touch the body of the range resistors at any time. Contamination of the special insulating material may cause leakage, affecting the accuracy of the source output. The 10^{12} resistor assembly on S102 is not field installable; the instrument must be returned to the factory for repair and calibration if this assembly must be replaced. Do not use any spray-on cleaning material on the S102 assembly.

6.5 TROUBLESHOOTING

The following procedures include instructions for repairing troubles which may occur in the Model 261. Use the procedures outlined and only specified replacement parts. Components can be identified with the help of the schematic and component layout drawings at the end of Section 7. In addition, Section 7 contains several drawings pertaining to resistor locations.

If the trouble cannot be located, the instrument may be returned to Keithley Instruments, Inc. for repair services. Contact your nearest Keithley representative or the factory for information.

6.5.1 Troubleshooting Equipment

The following equipment is recommended for use when troubleshooting the Model 261: Keithley Model 179A or similar DC voltmeter with 0.04% basic DC accuracy and a minimum input impedance of $10M\Omega$.

6.5.2 Common Faults

Table 6-1 lists the most common troubles that might affect the Model 261. If the steps listed in the table do not rectify the problem, a step-by-step circuit analysis may be required. Use the operating theory covered in Section 5 for this purpose.

Table 6-1. Troubleshooting Guide

Difficulty	Probable Cause	Solution
No current output on all Ranges.	Defective voltage supply.	Check Q202 and D208 for "open."
	Defective Kelvin-Varley divider.	Check S103 through S106; check R120 through R152.
No current output on one range.	Defective range resistor.	Check corresponding range resistor for open circuit.
Output too high on all ranges.	Defective voltage supply.	Check Q202 for short.
Output too high on one range.	Defective range resistor.	Check corresponding range resistor.

6.5.3 Troubleshooting Guidelines

If the instrument does not operate at all, check the fuse, line cord, and power source. If these are all found to be in good working order, use the following procedure to troubleshoot the voltage supply. (Refer to the schematic at the end of Section 7 for component designations):

1. Set the front panel POLARITY switch to + and connect the meter between J202 and the emitter of Q202. The voltage should be -11.6V.
2. If the voltage is about -17V, Q202 might be shorted. If the voltage at J202 is much less than -11.6V, check the voltage at the collector of Q202; it should be 17V ±20%. Absence of this voltage indicates the rectifier circuit is not working properly.
3. Measure the voltage at the anode of D204; it should be 17.1V ±10%. If this bootstrap voltage is not sufficient, Q203 will not operate and Q201 and Q202 will be cut off.
4. Check the reference amplifier and error amplifier stages using the schematic diagram voltage levels as a guide.

6.6 FUSE REPLACEMENT

A line fuse protects the Model 261 from possible damage in case of excessive line current. If the unit is totally inoperative, the fuse may be open. To replace the fuse, proceed as follows:

WARNING

Disconnect the instrument from the power line and other instrumentation before replacing the fuse.

1. Locate the fuse holder on the rear panel; rotate the fuse carrier counter-clockwise until the carrier is free of the holder.
2. Remove the fuse carrier from the holder, then remove and discard the defective fuse. Replace the fuse with the type recommended in Table 6-2.

CAUTION

Use only the recommended fuse type; replacing the fuse with a unit with a higher rating may cause instrument damage.

3. Replace the fuse carrier in the holder and rotate the carrier clockwise until it seats in the holder.

Table 6-2. Fuse Types

Operating Limits	Fuse Types	Keithley Part Number
105-125V, 50-60Hz	3AG, 1/8A, 250V, Slow Blow	FU-20
210-250V, 50-60Hz	3AG, 1/16A, 250V, Slow Blow	FU-21

SECTION 7 REPLACEABLE PARTS

7.1 INTRODUCTION

This section contains replacement parts information and a schematic diagram and component drawings for the Model 261.

7.2 PARTS LIST

Table 7-1 lists the replaceable parts for the Model 261. Parts are listed alphabetically according to circuit designation.

7.3 ORDERING PARTS

To place an order for Model 261 parts or obtain parts information, contact your Keithley representative or the factory. See the inside front cover of this manual for addresses. When ordering parts, include the following information:

1. Instrument Model Number
2. Instrument Serial Number
3. Part Description
4. Circuit Designation (where applicable)
5. Keithley Part Number

7.4 FACTORY SERVICE

If the instrument is to be returned to the factory for service, complete the service form which follows this section and return it with the instrument.

7.5 SCHEMATIC DIAGRAM AND COMPONENT LAYOUTS

Parts list, schematic diagram and component location drawings are shown on the following pages.

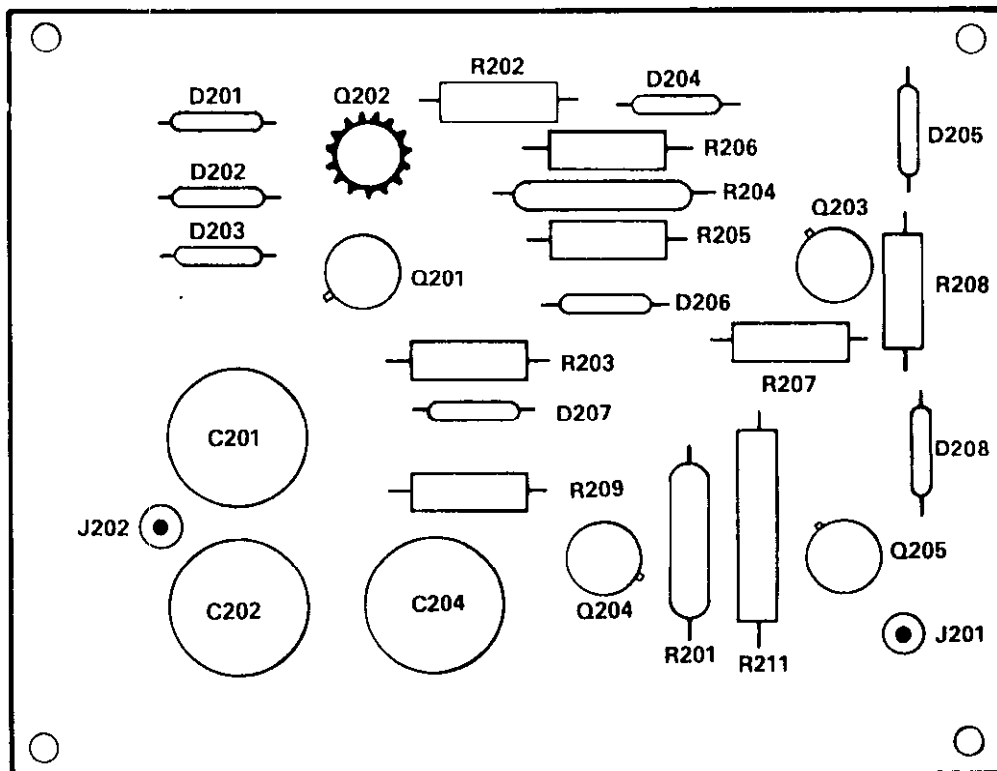
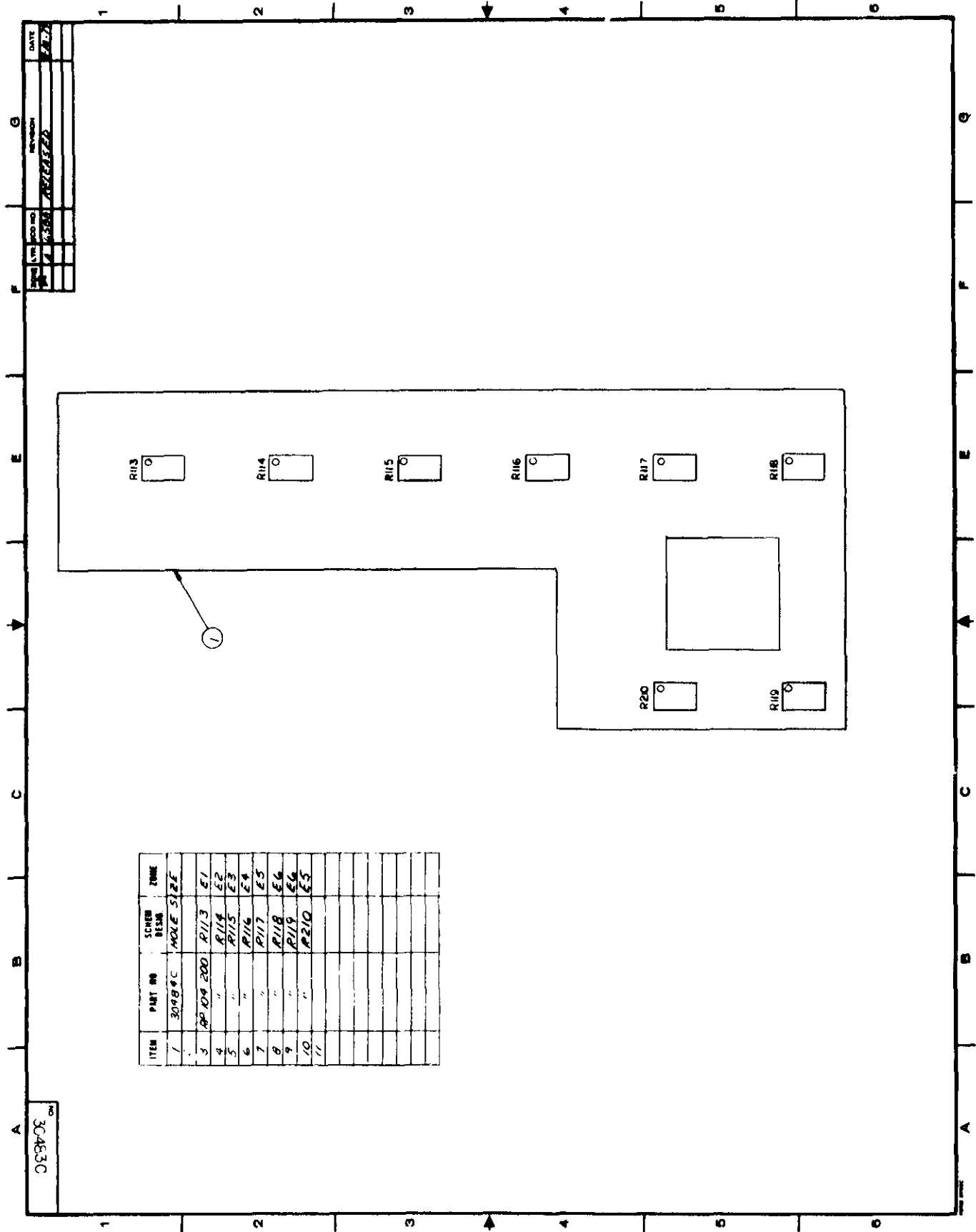

Figure 7-1. Voltage Supply Board, Component Location Drawing



ITEM	PART NO	SCHEM DESCR	ZONE
1	30483C	MOLE SIZE	E1
3	AP 104 200	R113	E2
4	"	R114	E3
5	"	R115	E4
6	"	R116	E5
7	"	R117	E6
8	"	R118	E6
9	"	R119	E5
10	"	R210	E5
11	"		

30483C
OUT

REV	BY	DATE	DESCRIPTION
1	30483C	7/77	RELEASED

Figure 7-2. Calibration Board, Component Location Drawing, Dwg. No. 30483C

Table 7-1. Model 261 Parts List

Circuit Desig.	Description	Location	Keithley Part No.
C101	Capacitor, .1 μ F, 50V, Mylar	Chassis	C-41-0.1
C201	Capacitor, 500 μ F, 25V, Aluminum Electrolytic	Voltage Supply	C-94-500
C202	Capacitor, 500 μ F, 25V, Aluminum Electrolytic	Voltage Supply	C-94-500
C203	Capacitor, .22 μ F, 500V, Ceramic Disc	Voltage Supply	C-22-.01
C204	Capacitor, 500 μ F, 25V, Aluminum Electrolytic	Voltage Supply	C-94-500
D201	Rectifier, Silicon, 1N645	Voltage Supply	RF-14
D202	Rectifier, Silicon, 1N645	Voltage Supply	RF-14
D203	Rectifier, Silicon, 1N645	Voltage Supply	RF-14
D204	Diode, Zener, 1N706	Voltage Supply	DZ-1
D205	Rectifier, Silicon, 1N645	Voltage Supply	RF-14
D206	Rectifier, Silicon, 1N645	Voltage Supply	RF-14
D207	Diode, Zener, 1N823	Voltage Supply	DZ-36
D208	Rectifier, Silicon, 1N645	Voltage Supply	RF-14
DS201	LED, Red	Front Panel	PL-67
F201	Fuse, 1/8A, 250V, (105-125V Operation)	Rear Panel	FU-20
F201	Fuse, 1/16A, 250V, (210-250V Operation)	Rear Panel	FU-21
J101	Binding Post, G	Front Panel	BP-15
J102	Binding Post, GND	Rear Panel	BP-11G
J103	Binding Post, COM	Rear Panel	BP-11B
J104	Receptacle, UHF	Front Panel	CS-64
J201	Test Jack	Voltage Supply	TJ-4
J202	Test Jack	Voltage Supply	TJ-5
P201	Cord Set, 6 foot	Rear Panel	CO-5
Q201	Transistor, PNP, Germanium, 2N1372	Voltage Supply	TG-8
Q202	Transistor, PNP, Silicon, 40319	Voltage Supply	TG-50
Q203	Transistor, PNP, Germanium, 2N1372	Voltage Supply	TG-8
Q204	Transistor, PNP, Germanium, 2N1372	Voltage Supply	TG-8
Q205	Transistor, PNP, Germanium, 2N1372	Voltage Supply	TG-8
R101	Resistor, 100k Ω , .02%, 1/2W Wirewound	S102	R-47-100k
R102	Resistor, 1M Ω , 1%, 1/2W, Carbon	S102	R-12-1M
R103	Resistor, 10M Ω , 1%, 1/2W, Carbon	S102	R-12-10M
R104	Resistor, 100M Ω , 1%	S102	R-289-100M
R105	Resistor, 1G Ω , 1%	S102	R-289-1G
R106	Resistor, 10G Ω , 2%	S102	R-289-10G
R107	Resistor, 100G Ω , 2%	S102	R-289-100G
R108*	Resistor, Assembly, 1T Ω , 2%	S102	32042B
R109	Resistor, 10M Ω , 10%, 1/2W, Composition	S102	R-1-10M
R110	Resistor, 1.5M Ω , 10%, 1/2W, Composition	S102	R-1-1.5M
R111	Resistor, 150k Ω , 10%, 1/2W, Composition	S102	R-1-150k
R113	Potentiometer, 200 Ω , 1/2W, 10%	Calibration Board	RP-104-200
R114	Potentiometer, 200 Ω , 1/2W, 10%	Calibration Board	RP-104-200
R115	Potentiometer, 200 Ω , 1/2W, 10%	Calibration Board	RP-104-200
R116	Potentiometer, 200 Ω , 1/2W, 10%	Calibration Board	RP-104-200
R117	Potentiometer, 200 Ω , 1/2W, 10%	Calibration Board	RP-104-200
R118	Potentiometer, 200 Ω , 1/2W, 10%	Calibration Board	RP-104-200
R119	Potentiometer, 200 Ω , 1/2W, 10%	Calibration Board	RP-104-200
R120	Resistor, 12.8 Ω , .1%, 1/4W, Wirewound	S103	R-67-12.8
R121	Resistor, 12.8 Ω , .1%, 1/4W, Wirewound	S103	R-67-12.8
R122	Resistor, 12.8 Ω , .1%, 1/4W, Wirewound	S103	R-67-12.8
R123	Resistor, 12.8 Ω , .1%, 1/4W, Wirewound	S103	R-67-12.8
R124	Resistor, 12.8 Ω , .1%, 1/4W, Wirewound	S103	R-67-12.8
R125	Resistor, 12.8 Ω , .1%, 1/4W, Wirewound	S103	R-67-12.8
R126	Resistor, 12.8 Ω , .1%, 1/4W, Wirewound	S103	R-67-12.8
R127	Resistor, 12.8 Ω , .1%, 1/4W, Wirewound	S103	R-67-12.8
R128	Resistor, 12.8 Ω , .1%, 1/4W, Wirewound	S103	R-67-12.8
R129	Resistor, 12.8 Ω , .1%, 1/4W, Wirewound	S103	R-67-12.8
R130	Resistor, 12.8 Ω , .1%, 1/4W, Wirewound	S103	R-67-12.8
R131	Resistor, 12.8 Ω , .1%, 1/4W, Wirewound	S104	R-67-12.8
R132	Resistor, 12.8 Ω , .1%, 1/4W, Wirewound	S104	R-67-12.8
R133	Resistor, 12.8 Ω , .1%, 1/4W, Wirewound	S104	R-67-12.8
R134	Resistor, 12.8 Ω , .1%, 1/4W, Wirewound	S104	R-67-12.8
R135	Resistor, 12.8 Ω , .1%, 1/4W, Wirewound	S104	R-67-12.8
R136	Resistor, 12.8 Ω , .1%, 1/4W, Wirewound	S104	R-67-12.8

*R108 is not field installable.

Table 7-1. Model 261 Parts List (Cont.)

Circuit Desig.	Description	Location	Keithley Part No.
R137	Resistor, 12.8Ω, .1%, 1/4W, Wirewound	S104	R-67-12.8
R138	Resistor, 12.8Ω, .1%, 1/4W, Wirewound	S104	R-67-12.8
R139	Resistor, 12.8Ω, .1%, 1/4W, Wirewound	S104	R-67-12.8
R140	Resistor, 12.8Ω, .1%, 1/4W, Wirewound	S104	R-67-12.8
R141	Resistor, 64Ω, .1%, 1/4W, Wirewound	S105	R-67-64
R142	Resistor, 64Ω, .1%, 1/4W, Wirewound	S105	R-67-64
R143	Resistor, 64Ω, .1%, 1/4W, Wirewound	S105	R-67-64
R144	Resistor, 64Ω, .1%, 1/4W, Wirewound	S105	R-67-64
R145	Resistor, 64Ω, .1%, 1/4W, Wirewound	S105	R-67-64
R146	Resistor, 64Ω, .1%, 1/4W, Wirewound	S105	R-67-64
R147	Resistor, 64Ω, .1%, 1/4W, Wirewound	S105	R-67-64
R148	Resistor, 64Ω, .1%, 1/4W, Wirewound	S105	R-67-64
R149	Resistor, 64Ω, .1%, 1/4W, Wirewound	S105	R-67-64
R150	Resistor, 64Ω, .1%, 1/4W, Wirewound	S105	R-67-64
R151	Resistor, 64Ω, .1%, 1/4W, Wirewound	S105	R-67-64
R152	Resistor, 64Ω, .1%, 1/4W, Wirewound	S105	R-67-64
R153	Resistor, 32Ω, .1%, 1/2W, Wirewound	S103	R-67-32
R154	Resistor, 1.8kΩ, 10%, 1/2W, Composition		R-1-1.8k
R201	Resistor, 760Ω, .1%, 1/2W, Wirewound	Voltage Supply	R-58-760
R202	Resistor, 2.2kΩ, 10%, 1/2W, Composition	Voltage Supply	R-1-2.2k
R203	Resistor, 10kΩ, 10%, 1/2W, Composition	Voltage Supply	R-1-10k
R204	Resistor, 10Ω, 1%, 1/2W, Carbon	Voltage Supply	R-12-10
R205	Resistor, 2.7kΩ, 10%, 1/2W, Composition	Voltage Supply	R-1-2.7k
R206	Resistor, 10kΩ, 10%, 1/2W, Composition	Voltage Supply	R-1-10k
R207	Resistor, 634Ω, 1%, 1/8W, Metal Film	Voltage Supply	R-88-634
R208	Resistor, 4.7kΩ, 10%, 1/2W, Composition	Voltage Supply	R-1-4.7k
R209	Resistor, 270kΩ, 10%, 1/2W, Composition	Voltage Supply	R-1-2.7k
R210	Potentiometer, 200Ω, 10%, 1/2W	Calibration Board	RP-104-200
R211	Resistor, 470Ω, (Nominal), 1%, 1/2W, Wirewound	Voltage Supply	R-58-470
S101	Slide Switch (Cal-Operate)	Chassis	SW-45
S102	Rotary Switch less Components, AMPERES	Front Panel	SW-180
	Rotary Switch with Components, AMPERES	Front Panel	18524B
	Knob, Amperes Switch	Front Panel	KN-55
S103	Rotary Switch less Components, X.01 Multiplier	Front Panel	SW-180
	Rotary Switch with Components, X.01 Multiplier	Front Panel	18463B
	Knob, 0-10 Readout	Front Panel	KN-57
S104	Rotary Switch less Components, X.1 Multiplier	Front Panel	SW-159
	Rotary Switch with Components, X.1 Multiplier	Front Panel	18456B
	Knob, 0-9 Readout	Front Panel	KN-56
S105	Rotary Switch less Components, X1 Multiplier	Front Panel	SW-182
	Rotary Switch with Components, X1 Multiplier	Front Panel	18465B
	Knob, 0-10 Readout	Front Panel	KN-57
S106	Rotary Switch, POLARITY	Front Panel	SW-189
	Knob, Polarity Switch	Front Panel	KN-46
S201	Slide Switch	Front Panel	SW-151
T201	Transformer	Chassis	TR-78

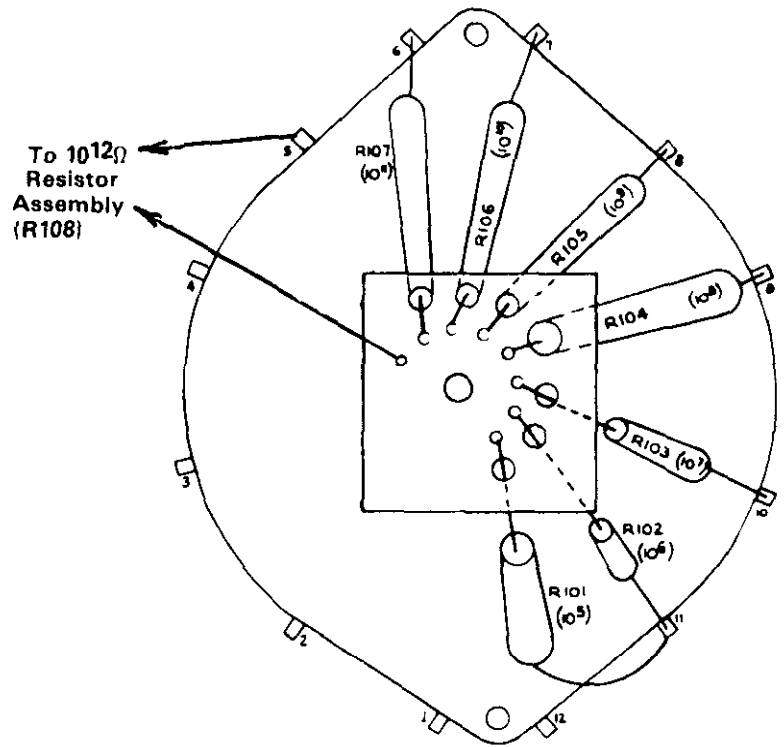
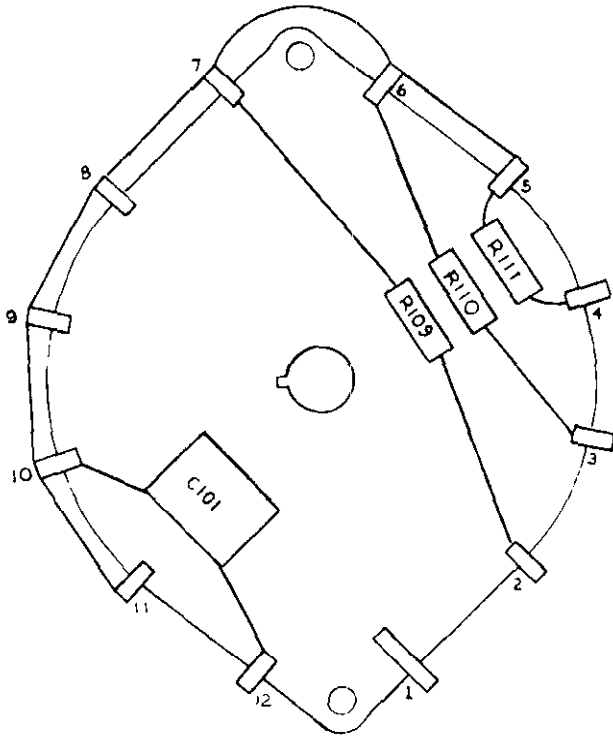

Figure 7-3. AMPERES Range Switch, S102

Table 7-2. Mechanical Parts

Description	Keithley Part No.
Top Cover Assembly	18553B
Handle	HH-18
Bottom Cover Assembly	17148C
Support Assembly Bail Left	19205B
Support Bail Left	14703B
Support Assembly Bail Right	19206B
Support Bail Right	14705B
Feet	FE-5
Feet (Rubber Ball)	FE-6
Bottom Panel	17149C
Front Panel/Chassis Assy.	18559B
Cable Clamp	CC-4
Shorting Link	BP-6
Label	MC-30
Range Switch Shield Assy.	18536B
Front Panel Assembly	18464C

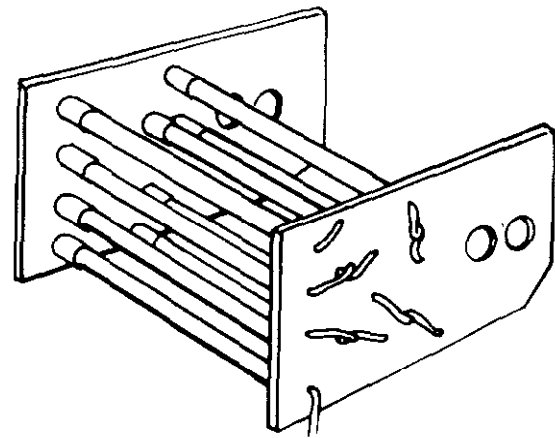

Figure 7-4. $10^{12}\Omega$ Resistor Assembly (R108)

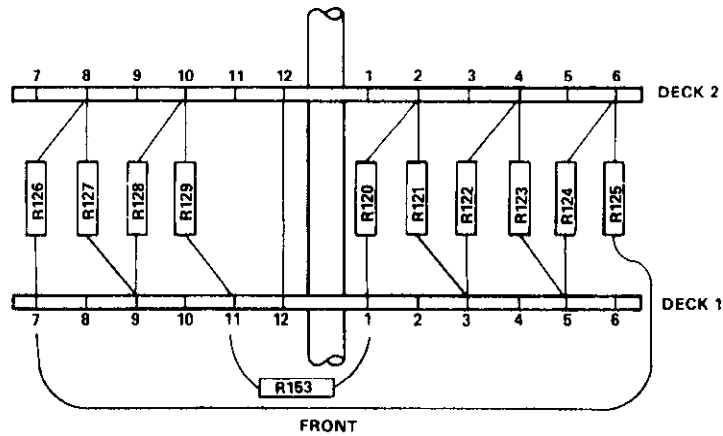

Figure 7-5. X.01 Multiplier Switch, S103

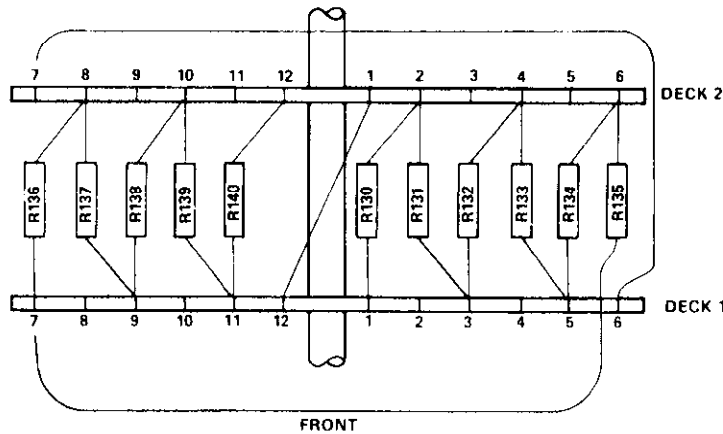

Figure 7-6. X.01 Multiplier Switch, S104

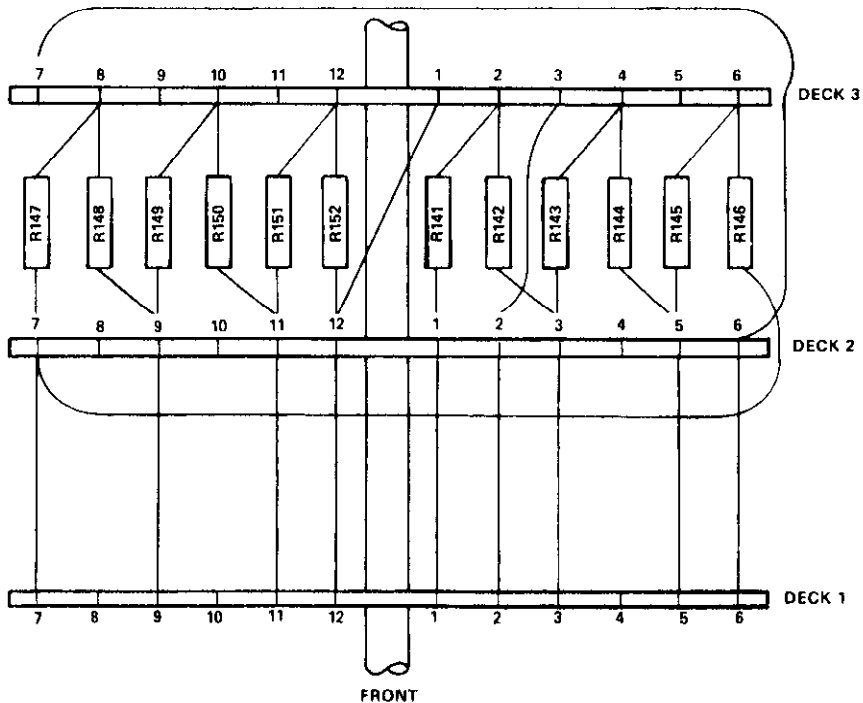
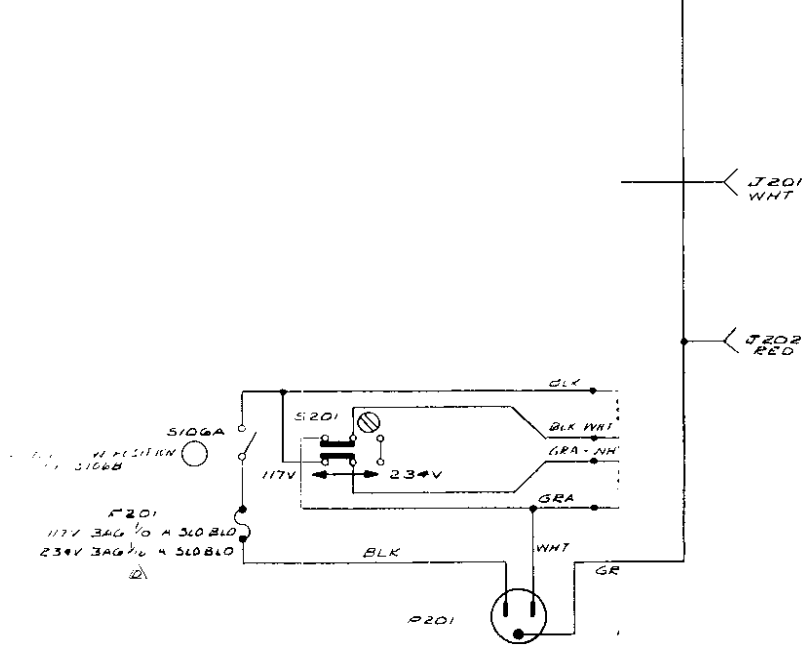
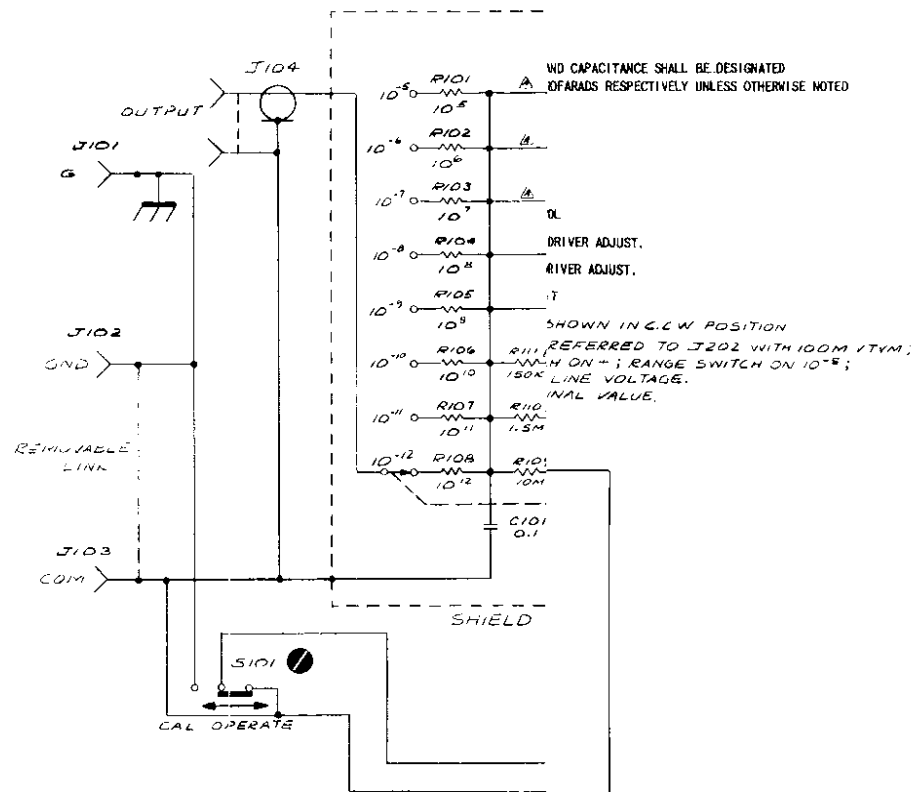

Figure 7-7. X1 Multiplier Switch, S105

REVISIONS			
NO.	DESCRIPTION	DATE	BY
A	PRELIMINARY	1/1/66	WJ
B	REVISED	1/1/66	WJ
C	REVISED	1/1/66	WJ
D	REVISED	1/1/66	WJ
E	REVISED	1/1/66	WJ
F	REVISED	1/1/66	WJ
G	REVISED	1/1/66	WJ
H	REVISED	1/1/66	WJ
I	REVISED	1/1/66	WJ
J	REVISED	1/1/66	WJ
K	REVISED	1/1/66	WJ



HIGHEST REFERENCE DESIGNATION USED						
△	R15	C101	J104	S106	D208	D5201
	T201	F201	R211	C204	S201	J202
REFERENCE DESIGNATIONS NOT USED						
+	Z12					
△	C203					

Figure 7-8. Model 261 Schematic Diagram, Dwg. No. 18323E



Service Form

Model No. _____ Serial No. _____ Date _____

Name and Telephone No. _____

Company _____

List all control settings, describe problem and check boxes that apply to problem. _____

- | | | |
|--|--|--|
| <input type="checkbox"/> Intermittent | <input type="checkbox"/> Analog output follows display | <input type="checkbox"/> Particular range or function bad; specify |
| <input type="checkbox"/> IEEE failure | <input type="checkbox"/> Obvious problem on power-up | <input type="checkbox"/> Batteries and fuses are OK |
| <input type="checkbox"/> Front panel operational | <input type="checkbox"/> All ranges or functions are bad | <input type="checkbox"/> Checked all cables |

Display or output (check one)

- | | |
|-----------------------------------|--|
| <input type="checkbox"/> Drifts | <input type="checkbox"/> Unable to zero |
| <input type="checkbox"/> Unstable | <input type="checkbox"/> Will not read applied input |
| <input type="checkbox"/> Overload | |

- | | |
|---|--|
| <input type="checkbox"/> Calibration only | <input type="checkbox"/> Certificate of calibration required |
| <input type="checkbox"/> Data required | |

(attach any additional sheets as necessary)

Show a block diagram of your measurement system including all instruments connected (whether power is turned on or not). Also, describe signal source.

Where is the measurement being performed? (factory, controlled laboratory, out-of-doors, etc.)

What power line voltage is used? _____ Ambient temperature? _____ °F

Relative humidity? _____ Other? _____

Any additional information. (If special modifications have been made by the user, please describe.)

Be sure to include your name and phone number on this service form.