KEITHLEY

INSTRUCTION MANUAL

MODEL 502

MILLIOHMETER

INSTRUCTION MANUAL

MODEL 502

MILLIOHMMETER

© COPYRIGHT 1975, KEITHLEY INSTRUMENTS, INC.

PRINTED JULY 1977, CLEVELAND, OHIO, U. S. A.

CONTENTS

	SECTION
INTRODUCTION.....	I
SPECIFICATIONS.....	II
OPERATION.....	III
A. Connections	
(1) Low resistances	
(2) Higher resistances	
B. Procedure	
C. Battery Test	
D. Precautions	
CIRCUIT DESCRIPTION.....	IV
MAINTENANCE.....	V
A. Batteries	
B. Trouble Shooting	
C. Schematic, DR 12189 C	
D. Tube Voltage Diagram, DR 12256 C	
E. Replacement Parts List	

SECTION I - INTRODUCTION

The Keithley Model 502 is a battery operated, portable milliohmmeter for measuring resistances from 0.00003 to 1000 ohms. The instrument employs an AC testing method, eliminating zero drift and permitting resistance readings in the presence of DC currents. The reading is presented on a linear scale panel meter.

Typical applications of the instrument include measurement of contact resistance, conductivity of semi-conductor samples, fuse and squib testing, and electrolyte conductivity.

Maximum power dissipation in the sample is 2 microwatts, permitting the measurement of detonator fuses without danger of detonation. In the measurement of contact resistance, the model 502 may be considered a "dry circuit" tester. However, the instrument may be used in the presence of DC biasing currents to measure the change in resistance caused by these currents.

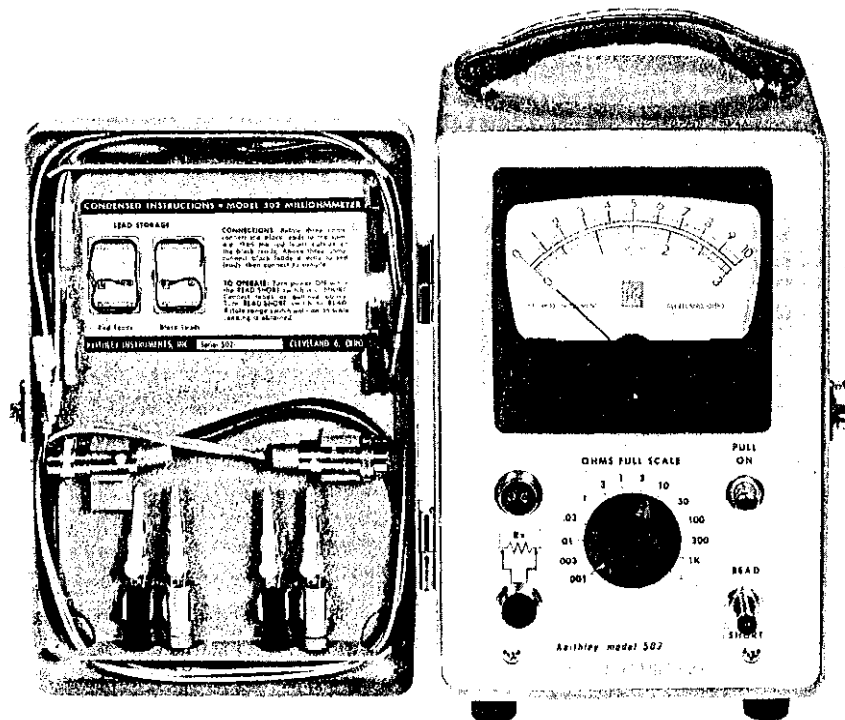

FIGURE 1. Keithley Model 502 Milliohmmeter with carrying case open.

SECTION II - SPECIFICATIONS

RANGES: The test current, the input voltage drop, and the power dissipation ($P_d = 2I_{av}E_{av}$) for full-scale readings on each range are given below:

Range, Ohms	Average Applied Current, Milliamperes	Average Voltage Drop, Microvolts	Maximum Dissipation in Sample, Microwatts
0.001	10	10	0.2
0.003	10	30	0.6
0.01	10.00	100	2.00
0.03	3.33	100	0.66
0.1	1.00	100	0.2
0.3	0.33	100	0.066
1	0.1	100	0.02
3	0.2	600	0.24
10	0.06	600	0.072
30	0.02	600	0.024
100	0.006	600	0.0072
300	0.002	600	0.0024
1000	0.0006	600	0.00072

ACCURACY: 3% of full scale on all ranges except the 0.001-ohm range, where it is 5% of full scale. Less than 2% error is added in measuring samples with a series reactance of 4% of sample resistance.

OUTPUT: Meter only.

SAFETY AND RELIABILITY: Maximum power dissipation in the sample with improper range setting is three milliwatts. Maximum dissipation caused by instrument component failure and improper range setting is six milliwatts.

INPUT ZERO: Lever switch prevents off-scale meter indications while changing samples.

SPEED OF RESPONSE: Five seconds to 90% of final reading on all ranges.

ZERO DRIFT: None.

REPEATABILITY: Within 2%.

WARMUP TIME: Within 30 seconds.

SPECIFICATIONS

MODEL 502 MILLIOHMMETER

BATTERY LIFE: 360 hours minimum.

BATTERY TEST: An internal resistance standard is measured in the Battery Test Position to provide a complete check of battery condition and proper instrument operation.

BATTERY COMPLEMENT: Two RM 401R, two RM 42R, one 412, one 413.

TUBE COMPLEMENT: One 6418, four 6419.

TRANSISTOR COMPLEMENT: Four 2N1381.

ACCESSORIES FURNISHED: Model 5021 Current and Voltage Leads; one set of alligator clips; one set Klipson adapters; mating connectors.

CONNECTORS: Amphenol 80C and 80-PC2F receptacles.

DIMENSIONS: 9 inches high x 6 inches wide x 7 inches deep.

NET WEIGHT: 7-1/2 pounds.

SECTION III - OPERATION

A. CONNECTIONS

(1) Lower resistances (less than 3 ohms).

Each test lead has two clips, one with a red insulator and the other with a black insulator. Use both test leads to make a connection, making sure like-color clips are on the same side of the sample (see Figure 2). Connect the current supply leads to the sample at any point which assures current flow through the entire sample. This connection may include the leads on the sample.

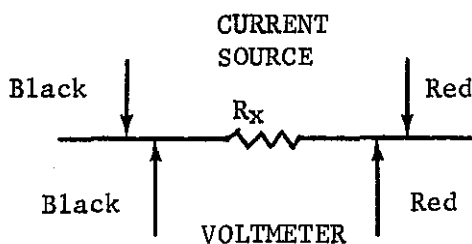

FIGURE 2.

Connect the voltmeter leads across only that part of the sample which is to be measured, as shown in Figure 2. If the terminal or test leads of the resistance being measured are included within the voltmeter clips, the reading will include the resistance of these leads.

NOTE

Do not connect the red clips to the black clips. The clip-to-sample resistance of both voltmeter clips are added in series with the unknown, and large errors can result.

(2) Higher resistances (3 ohms and greater).

For ranges over 3 ohms full scale, the clip contact resistance is insignificant compared with the full scale value, so voltage and current leads may be paired and the standard two-terminal ohmmeter method employed. Of course, the four-terminal method above may be used, but the two terminal method is faster for repeated testing.

B. PROCEDURE

Turn the power ON while the READ-SHORT Switch is at SHORT. The instrument will stabilize in about 15 seconds.

Connect the leads to the sample as outlined above. Then move the READ-SHORT switch to READ. Rotate the OHMS FULL SCALE switch until a suitable on-scale reading is obtained.

The READ-SHORT switch shorts the voltage input in the SHORT position. It keeps the meter pointer on scale while the test leads are being connected to an unknown. If an overload is applied to the input by inadvertently opening the READ-SHORT switch, no damage will result. However, approximately 30 seconds will be required for the amplifier to recover.

C. BATTERY TEST

Before a reading is made, it may be desirable to check overall circuit operation. This is done by rotating the range switch to BATT. - TEST and switching the READ-SHORT switch to READ. The meter should read within $1\frac{1}{2}$ divisions of the red line on the meter face marked BATTERY TEST. Failure of the unit to read within these limits indicates a circuit failure which, in most cases, will be battery failure. Consult SECTION V - MAINTENANCE for battery changes or troubleshooting information.

D. PRECAUTIONS

On full scale ranges of one ohm and below, the amplifier has sensitivities in the microvolt region and a pass band which includes 60 cps. Thus, a loop in the voltage leads which encloses any 60 cps magnetic field may give a meter indication. Care should be exercised to avoid such magnetic loops. Care should also be taken in shielding critical circuits to avoid 60 cps pickup from electric fields; in general, however, the electrostatic pickup is not serious at the impedance involved. One way to test for pickup is to remove the current supply leads with the voltage leads connected to the sample. If no reading appears on the meter, no pickup is present. If some reading does occur due to the presence of 60 cps magnetic field, it may be reduced to a minimum by rotating the meter for minimum pickup. In any case, the instrument reads correctly above any residual reading. For example, if the 502 reads, say, .002 ohms due to the presence of stray fields with the voltmeter leads shorted, a .003 ohm resistance being tested will still read .003 ohms. This is because the 60 cps signal is superimposed on the 100 cps square wave test signal. Thus the 60 cps signal is not rectified and the meter reads only the rectified square wave.

Because of the AC technique employed, inductive and capacitive components in the test impedance may cause some waveform distortion and erroneous readings. Series inductive impedance (at 100 cps) less than 20% of the resistance cause the reading to be less than 2% high. Shunt capacitive admittance (at 100 cps) less than 6% of the conductance cause the reading to be less than 2% low. Listed below are the limiting values of inductance and capacitance to cause 2% error at full scale on any range:

<u>RANGE</u>	<u>MAX SERIES INDUCTANCE</u>	<u>MAX SHUNT CAPACITANCE</u>
.001 ohms	.3 microhenries	over 1000 microfarad
.003	.9	
.01	3	
.03	9	750 microfarad 250 75 25
.1	30	
.3	90	
1.0	.3 millihenries	
3.0	.9	
10.0	3	
30	9	7.5
100	30	2.5
300	90	.75
1000	.3 henries	.25

It is well to remember that basically, the Model 502 is measuring the voltage across the sample resistance due to current flow in the sample. So long as the sample current is generated by the Model 502, no difficulties should be encountered. However, if other currents are flowing in the sample in addition to the test current, these currents must be either small compared with the test current or essentially dc. The Model 502 will read a resistor in the milliohm region which is carrying more than 50 amperes of direct current, but even .01 amperes of alternating current whose frequency is within the pass band of the amplifier will cause a serious error.

When measuring samples across which a dc voltage greater than about .05 volts may appear, a blocking capacitor should be used in series with one current lead and another capacitor in series with one voltage lead. Use 1000 mfd at a voltage rating sufficient to handle the dc sample voltage.

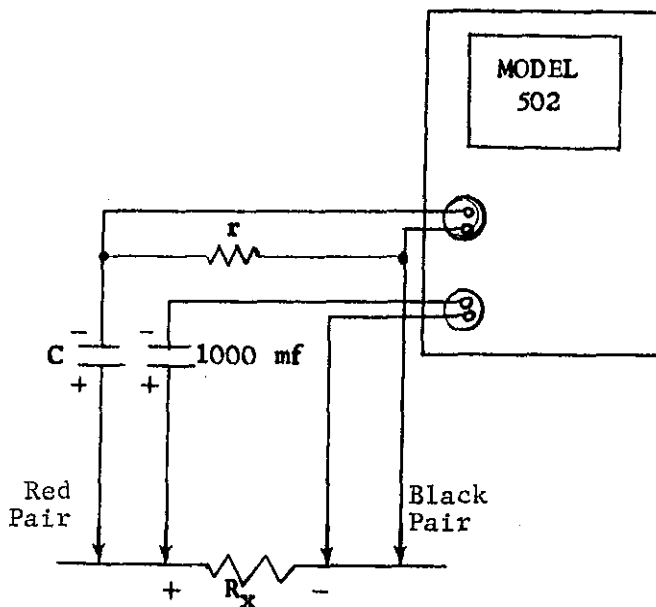

The setup is shown in Fig. 3. If this arrangement is to be used on the ranges below .3 ohm, also include r as shown. This resistor is to provide a d.c. return path for the output transistor, Q_4 .

FIGURE 3

Values of r and C are shown below:

<u>Range</u>	<u>r</u>	<u>C</u>	<u>Added error</u>
.1	100	1000 mfd	-1%
.03	47	1000	-3%
.01	10	4000	-6%
.003	10	4000	-6%
.001	10	4000	-6%

SECTION IV - CIRCUIT DESCRIPTION

The standard method of measuring resistance assumes that test lead resistance is negligible. When measuring resistances at or below the level of lead resistance, a more sophisticated approach is required.

The four-terminal method of resistance measurement consists of supplying current from an isolated current generator to the sample, and measuring the voltage drop across the sample with an isolated voltmeter. The generator is made to supply constant current regardless of lead resistance so that no errors occur due to current lead connection. The voltmeter has large enough input resistance so that the voltage lead resistance does not cause any error. Since there is no current error and voltage error, the resistance is read correctly.

The 502 circuit consists of two parts: a 100 cps transistor squarewave generator supplies the current across the sample and the AC microvolt meter measures the voltage drop. The panel meter is calibrated directly in ohms on a linear scale. Refer to the circuit diagram, DR 12189-C.

(1) Square Wave Generator. The 100 cps square wave is generated by a transistor multivibrator consisting of Q1 and Q2. R146 is a symmetry control which is set at the factory to give a symmetrical square wave. This adjustment is necessary to insure no change in reading when the current leads are reversed. Q3 and Q4 serve as a power amplifier. Transistor Q4 acts essentially as a 100 cps switch connecting and disconnecting B1 across the sample and series resistors R132 through R142. Due to the fact that the output peak voltage is more than 95% of the mercury battery voltage, the change in square-wave amplitude with change of transistor parameters is very small. B6 supplies a small negative bias current through R151 to the output transistor to insure good cut off characteristics, at a high ambient temperature.

(2) AC Amplifier. The ac amplifier is a conventional vacuum tube voltmeter with meter current feedback. The input signal is matched to the vacuum tube input by an input transformer on the more sensitive ranges. Above 1 ohm, the input transformer is not used.

The input voltage is compared to the feedback voltage through R101 and R102 into the grid of V1. V1, V2, V3, V4, and V5 amplify the error signal. The output voltage is full-wave rectified by D1 and D2 to supply indicating meter current. The ac current through the meter and rectifiers flows in R128, R129 or R130 to supply feedback voltage to the first stage. The dividers R103 and R126 or R127 allow separate calibration of the ranges which employ transformer input and the ranges which do not.

ON BATTERY TEST, the unit is automatically placed on the 1000 ohm range. A 500 ohm resistor, R149, is connected into the test position and the external current and voltage leads are disconnected. Since battery current drain is essentially the same on all ranges, this test will indicate faulty batteries immediately by giving a reading less than normal.

SECTION V - MAINTENANCEA. BATTERIES

Under normal conditions the only maintenance required will be the replacement of batteries. To reach the batteries, remove the four screws at the rear and slide the instrument out of the case. The batteries are all located in holders at the top of the instrument.

B1, supplying the current generator, and B3, which supplies the vacuum tube filaments, should have a useful life of about 460 hours unless the instrument is used continuously on the lowest three ranges. This may shorten the life of B1 to 360 hours. B4, which supplies plate potential to the output tube should last through about two changes of B1 and B3. B2, the bias battery, B5, the plate supply for the amplifier, and B6, the negative bias for the output transistor, should last about two years. To be certain of always having fresh batteries, a good practice would be to change all batteries whenever one of the set needs replacement.

B. TROUBLE-SHOOTING

If the circuit fails to perform properly and the batteries are found to be good, a step-by-step procedure should be followed to discover the fault.

First check the current supply wave form at the current output terminals. This should be a 100 cps square wave about 1.3 volts amplitude. Switch to the 1 ohm range so that oscilloscope loading will not affect the wave form. If the desired wave form is not present, check the generator circuit stage by stage. Q1 and Q2 are connected as a multi-vibrator. Q3 and Q4 are cascaded emitter followers which develop the output current drive.

If the current supply works properly, check the voltage amplifier. First compare observed operating potentials with those given in the Voltage Diagram in this section. When operating points are all correct, the amplifier may be checked stage by stage for amplification. Note that V5 is used to supply current to the meter, and therefore has a voltage gain of only about one.

The voltage required at the junction between C115 and the meter diodes for full scale deflection is approximately 0.75 volt RMS.

The Voltage Diagram, DR 12256-C, Circuit Schematic, DR 12189-D and parts list are included at the back of the manual.

SECTION 6. REPLACEABLE PARTS

6-1. REPLACEABLE PARTS LIST. The Replaceable Parts List describes the components of the Model 502 and its accessories. The List gives the circuit designation, the part description, a suggested manufacturer, the manufacturer's part number and the Keithley Part Number. The name and address of the manufacturers listed in the "Mfg. Code" column are contained in Table 2.

6-2. HOW TO ORDER PARTS.

a. For parts orders, include the instrument's model and serial number, the Keithley Part Number, the circuit designation and a description of the part. All structural parts and those parts coded for Keithley manufacture (80164) must be ordered from Keithley Instruments, Inc. In ordering a part not listed in the Replaceable Parts List, completely describe the part, its function and its location.

b. Order parts through your nearest Keithley distributor or the Sales Service Department, Keithley Instruments, Inc.

amp	ampere	Ω	ohm
Comp	Composition	PM Poly	Paper, metallized Polystyrene
DCb	Deposited Carbon	p	pico (10^{-12})
ETB	Electrolytic, tubular	μ	micro (10^{-6})
f	farad	v Var	volt Variable
k	kilo (10^3)	w	watt
M or meg	mega (10^6) or megohms	WW	Wirewound
m	milli (10^{-3})	WWVar	Wirewound Variable
Mfg.	Manufacturer		
MtF	Metal Film		
Mil. No.	Military Type Number		
My	Mylar		

TABLE 1. Abbreviations and Symbols.

MODEL 502 REPLACEABLE PARTS LIST

(Refer to Schematic Diagram 12189D for circuit designations.)

BATTERIES

Circuit Desig.	Description	Mfg. Code	Mfg. Part No.	Keithley Part No.	Fig. Ref.
B1	1.3 v mercury	37942	RM42R	BA-10	
B2	1.35 v mercury	10608	E401	BA-8	
B3	1.3 v mercury	37942	RM42R	BA-10	
B4	8.4 v mercury	10608	E146	BA-9	
B5	1.35 v mercury	10608	E401	BA-8	
B6	8.4 v mercury	10608	E146	BA-9	
B7	8.4 v mercury	10608	E146	BA-9	
B8	8.4 v mercury	10608	E146	BA-9	

CAPACITORS

Circuit Desig.	Value	Rating	Type	Mfg. Code	Mfg. Part No.	Keithley Part No.	Fig. Ref.
C101	2 μ f	50 v	ETB	37942	TC302	C39-2M	
C102	.0022 μ f	200 v	Poly	00686		C55-2200P	
C103	.0082 μ f	100 v	My	84411	663UW-100	C38-.0082M	
C104	.22 μ f	50 v	My	84411	601PE	C41-.22M	
C105	2 μ f	50 v	ETB	37942	TC302	C39-2M	
C106	.001 μ f	100 v	Mica	84171	DM15-102J	C21-1000P	
C107	270 pf	500 v	Mica	84171	DM15-271J	C21-270P	
C108	.22 μ f	50 v	My	84411	601PE	C41-.22M	
C109	2 μ f	50 v	ETB	37942	TC302	C39-2M	
C110	.0001 μ f	500 v	Mica	84171	DM15-101J	C21-100P	
C111	820 pf	300 v	Mica	84171	DM15-821K	C21-820P	
C112	.22 μ f	50 v	My	84411	601PE	C41-.22M	
C113	2 μ f	50 v	ETB	37942	TC302	C39-2M	
C114	.1 μ f	50 v	My	84411	601PE	C41-.1M	
C115	.1 μ f	50 v	My	84411	601PE	C41-.1M	
C116	0.1 μ f	50 v	My	84411	601PE	C41-.1M	
C117	1 μ f	200 v	PM	00656	P8292ZN	C18-1M	
C118	1 μ f	200 v	PM	00656	P8292ZN	C18-1M	
C119	50 μ f	50 v	ETB	37942	TC39	C39-50M	
C120	50 μ f	50 v	ETB	37942	TC39	C39-50M	
C121	820 pf	300 v	Mica	84171	DM15-821J	C21-820P	
C122	22 pf	500 v	Mica	84171	DM15-220J	C21-22P	

DIODES

Circuit Desig.	Type	Number	Mfg. Code	Keithley Part No.	Fig. Ref.
D1	Silicon	1N645	01295	RF-14	
D2	Silicon	1N645	01295	RF-14	

MISCELLANEOUS PARTS

Circuit Desig.	Description	Mfg. Code	Keithley Part No.	Fig. Ref.
J1	Receptacle, Microphone, Voltage (Mfg. No. 80-C)	02660	CS-34	
---	Plug, Microphone, Mate of J1 (Mfg. No. 80-M)	02660	CS-35	
J2	Receptacle, Microphone, Current (Mfg. No. 80PC2F)	02660	CS-32	
---	Plug, Microphone, Mate of J2 (Mfg. No. 80MC2M)	02660	CS-33	
M1	Meter (0-50 μ amp)	80164	ME-13	
S1	Switch, DPDT, ON (Mfg. No. 83053Z)	04009	SW-176	
S2	Toggle Switch, READ-SHORT (Mfg. No. 3003-DL)	82389	SW-59	
S3	Rotary Switch less components, OHMS FULL SCALE	80164	SW-57	
---	Knob Assembly, Ohms Switch	80164	16323A	
T1	Transformer	80164	TR-53	

RESISTORS

Circuit Desig.	Value	Rating	Type	Mfg. Code	Mfg. Part No.	Keithley Part No.	Fig. Ref.
R101	1 M Ω	1%, 1/2 w	MtF	07716	MECT-8	R53-1M	
R102	1 M Ω	1%, 1/2 w	MtF	07716	MECT-8	R53-1M	
R103	60 k Ω	1%, 1/2 w	DCb	79727	CFE-15	R12-60K	
R104	2.2 M Ω	1%, 1/2 w	DCb	79727	CFE-15	R12-2.2M	
R105	10 M Ω	10%, 1/2 w	Comp	01121	EB	R1-10M	
R106	100 k Ω	10%, 1/2 w	Comp	01121	EB	R1-100K	
R107	22 M Ω	10%, 1/2 w	Comp	01121	EB	R1-22M	
R108	2.2 M Ω	10%, 1/2 w	Comp	01121	EB	R1-2.2M	
R109	2.2 M Ω	10%, 1/2 w	Comp	01121	EB	R1-2.2M	
R110	10 M Ω	10%, 1/2 w	Comp	01121	EB	R1-10M	

RESISTORS (Cont'd)

Circuit Desig.	Value	Rating	Type	Mfg. Code	Mfg. Part No.	Keithley Part No.	Fig. Ref.
R111	100 k Ω	10%, 1/2 w	Comp	01121	EB	R1-100K	
R112	22 M Ω	10%, 1/2 w	Comp	01121	EB	R1-22M	
R113	2.2 M Ω	10%, 1/2 w	Comp	01121	EB	R1-2.2M	
R114	2.2 M Ω	10%, 1/2 w	Comp	01121	EB	R1-2.2M	
R115	10 M Ω	10%, 1/2 w	Comp	01121	EB	R1-10M	
R116	100 k Ω	10%, 1/2 w	Comp	01121	EB	R1-100K	
R117	22 M Ω	10%, 1/2 w	Comp	01121	EB	R1-22M	
R118	2.2 M Ω	10%, 1/2 w	Comp	01121	EB	R1-2.2M	
R119	2.2 M Ω	10%, 1/2 w	Comp	01121	EB	R1-2.2M	
R120	10 M Ω	10%, 1/2 w	Comp	01121	EB	R1-10M	
R121	2.2 M Ω	10%, 1/2 w	Comp	01121	EB	R1-2.2M	
R122	47 k Ω	10%, 1/2 w	Comp	01121	EB	R1-47K	
R123	5 k Ω	1%, 1/2 w	DCb	79727	CFE-15	R12-5K	
R124	5 k Ω	1%, 1/2 w	DCb	79727	CFE-15	R12-5K	
R125	1.8 k Ω	1%, 1/2 w	DCb	79727	CFE-15	R12-1.8K	
R126	1 k Ω	10%, 5 w	WWVar	71450	AW	RP3-1K	
R127	100 Ω	10%, 5 w	WWVar	71450	AW	RP3-100	
R128	*91 Ω	1%, 1/2 w	DCb	79727	CFE-15	R12-91	
R129	300 Ω	1%, 1/2 w	DCb	79727	CFE-15	R12-300	
R130	1 k Ω	1%, 1/2 w	DCb	79727	CFE-15	R12-1K	
R131	47 k Ω	10%, 1/2 w	Comp	01121	EB	R1-47K	
R132	60 Ω	1%, 1/2 w	DCb	79727	CFE-15	R12-60	
R133	180 Ω	1%, 1/2 w	DCb	79727	CFE-15	R12-180	
R134	600 Ω	1%, 1/2 w	DCb	79727	CFE-15	R12-600	
R135	1.8 k Ω	1%, 1/2 w	DCb	79727	CFE-15	R12-1.8K	
R136	6 k Ω	1%, 1/2 w	DCb	79727	CFE-15	R12-6K	
R137	3 k Ω	1%, 1/2 w	DCb	79727	CFE-15	R12-3K	
R138	10 k Ω	1%, 1/2 w	DCb	79727	CFE-15	R12-10K	
R139	30 k Ω	1%, 1/2 w	DCb	79727	CFE-15	R12-30K	
R140	100 k Ω	1%, 1/2 w	DCb	79727	CFE-15	R12-100K	
R141	300 k Ω	1%, 1/2 w	DCb	79727	CFE-15	R12-300K	
R142	1 M Ω	1%, 1/2 w	DCb	79727	CFE-15	R12-1M	
R143	82 Ω	1%, 1/2 w	DCb	79727	CFE-15	R12-82	
R144	3 k Ω	1%, 1/2 w	DCb	79727	CFE-15	R12-3K	
R145	*7 k Ω	1%, 1/2 w	DCb	79727	CFE-15	R12-7K	
R146	10 k Ω	10%, 2 w	WWVar	71450	WP	RP9-10K	
R147	*7 k Ω	1%, 1/2 w	DCb	79727	CFE-15	R12-7K	
R148	3 k Ω	1%, 1/2 w	DCb	79727	CFE-15	R12-3K	
R149	500 Ω	1%, 1/2 w	DCb	79727	CFE-15	R12-500	
R150	1 M Ω	1%, 1/2 w	DCb	79727	CFE-15	R12-1M	

*Nominal value, factory set.

RESISTORS (Cont'd)

Circuit Desig.	Value	Rating	Type	Mfg. Code	Mfg. Part No.	Keithley Part No.	Fig. Ref.
R151	15 k Ω	10%, 1/2 w	Comp	01121	EB	R1-15K	
R152	47 k Ω	10%, 1/2 w	Comp	01121	EB	R1-47K	
R153	210 Ω	1%, 1/2 w	DCb	79727	CFE-15	R12-210	
R154	10 M Ω	10%, 1/2 w	Comp	01121	EB	R1-10M	

TRANSISTORS

Circuit Desig.	Number	Mfg. Code	Keithley Part No.	Fig. Ref.
Q1	2N1381	01295	TG-8	
Q2	2N1381	01295	TG-8	
Q3	2N1381	01295	TG-8	
Q4	2N1381	01295	TG-8	

VACUUM TUBES

Circuit Desig.	Number	Mfg. Code	Keithley Part No.	Fig. Ref.
V1	6419	81453	EV-CK6419	
V2	6419	81453	EV-CK6419	
V3	6419	81453	EV-CK6419	
V4	6419	81453	EV-CK6419	
V5	6418	80164	EV-6418-1	

FURNISHED ACCESSORIES

Description	Mfg. Code	Mfg. Part No.	Keithley Part No.
Two Alligator Clips, red	83330	304	AC-3R
Two Alligator Clips, black	83330	304	AC-3B
Two Miniprod Adapter Tips, red	08811	33-160	PP-3R
Two Miniprod Adapter Tips, black	08811	33-162	PP-3B
**Model 5021 Voltage Lead, includes	80164		
. Plug, Microphone	02660	80-M	CS-35
. Phone Tip, Red	83330	237	PP-2R
. Phone Tip, Black	83330	237	PP-2B
**Model 5021 Current Lead, includes	80164		
. Plug, Microphone	02660	80MC2M	CS-33
. Phone Tip, Red	83330	237	PP-2R
. Phone Tip, Black	83330	237	PP-2B

**Model 5021 is a set of current and voltage leads.

00656	Aerovox Corp. New Bedford, Mass.	71450	CTS Corp. Elkhart, Ind.
00686	Film Capacitors, Inc. New York, N. Y.	75042	International Resistance Co. Philadelphia, Pa.
01121	Allen-Bradley Corp. Milwaukee, Wis.	79727	Continental-Wirt Electronics Corp. Philadelphia, Pa.
01295	Texas Instruments, Inc. Semi-Conductor-Components Division Dallas, Texas	80164	Keithley Instruments, Inc. Cleveland, Ohio
02660	Amphenol-Borg Electronics Corp. Broadview, Chicago, Illinois	81453	Raytheon Co. Industrial Components Div. Industrial Tube Operation Newton, Mass.
04009	Arrow-Hart and Hegeman Electric Co. Hartford, Conn.	82389	Switchcraft, Inc. Chicago, Ill.
07716	International Resistance Co. Burlington, Iowa	83330	Smith, Herman H., Inc. Brooklyn, N. Y.
08811	G-C Electronics Co., Inc. Camden, N. J.	84171	Arco Electronics, Inc. Great Neck, N. Y.
10608	Union Carbide Corp. New York, N. Y.	84411	Good-All Electric Mfg. Co. Ogallala, Nebr.
37942	Mallory, P. R., and Co., Inc. Indianapolis, Ind.		

TABLE 2. Code List of Suggested Manufacturers. (Based on Federal Supply Code for Manufacturers, Cataloging Handbook H4-1.)

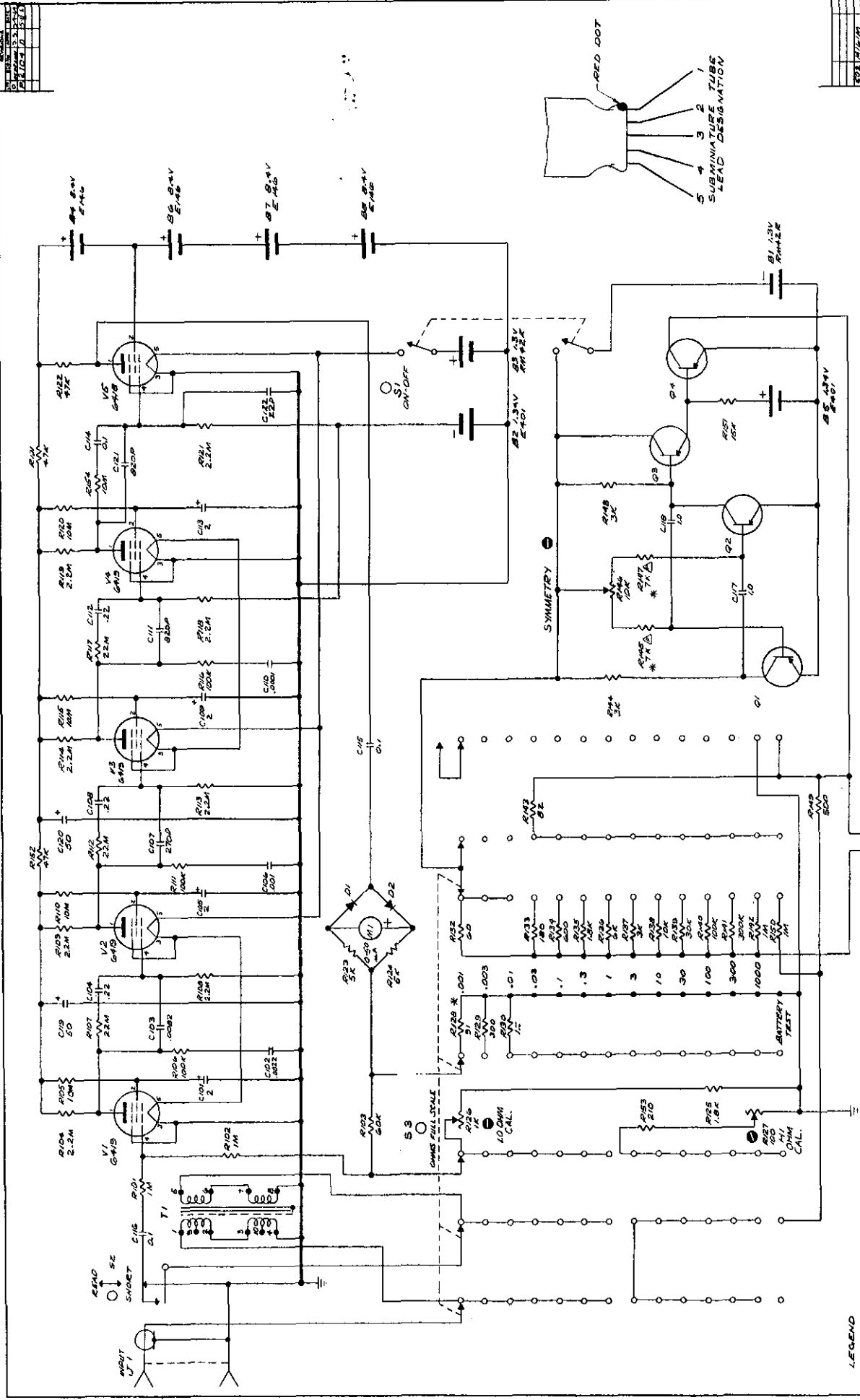

DATE	BY	REVISION	DESCRIPTION
10/1/54	...	1	...
...	...	2	...

QTY	DESCRIPTION	UNIT
1
...

FILE	DATE	BY	DESCRIPTION
...
...

RESISTANCE IN OHMS	SCALE
100	1000
1000	10000

○ PANEL CONTROL
 ● INTERNAL ADJUSTMENT
 * NOMINAL VALUE

NOTE: RESISTANCE IN OHMS
 * 10000 OHMS
 M = 1000 OHMS
 M = 100 OHMS
 K = 1000 OHMS
 P = 10 OHMS
 S = 1 OHMS
 REFLECT WHERE NOTED
 Pg 10-14

12189D

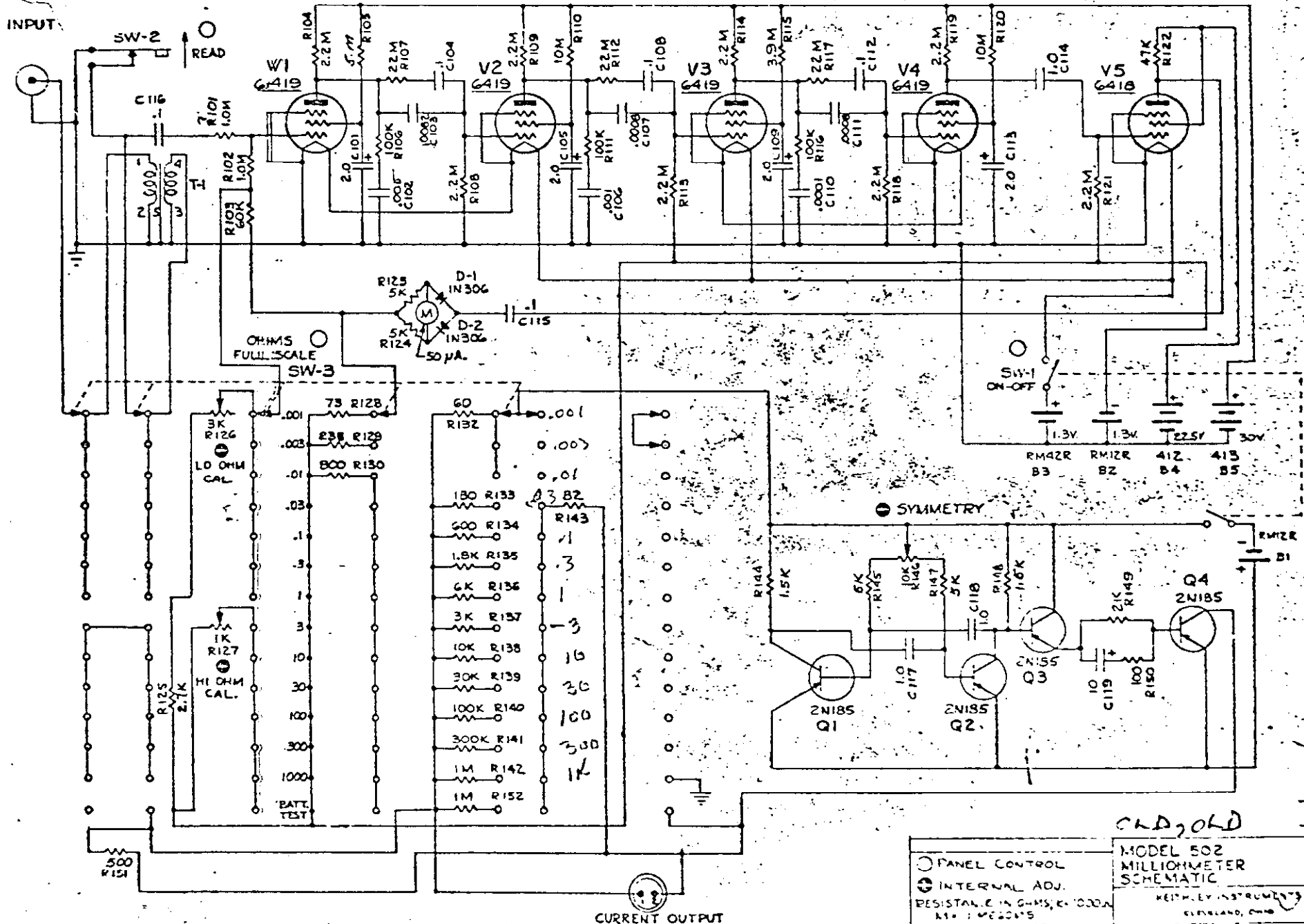

○ PANEL CONTROL
 ⊙ INTERNAL ADJ.
 RESISTANCE IN OHMS, K = 1000
 M = 1,000,000
 CAPACITORS IN MICROFARADS

CHD, OLD I
MODEL 502
MILLIOHMMETER
 KEITH-LY INSTRUMENTS
 CLEVELAND, OHIO
 CR12189-C

REVISED	BY	DATE

UNIT	ECO	NO. OF	DATE
A	16	14	8/21/54

MODEL 502 VOLTAGE CHART

READINGS TAKEN WITH A 100 MEG INPUT VTVM WITH CONTROLS SET AS FOLLOWS:
 RANGE SWITCH AT BATTERY TEST, READ SHORT SWITCH AT SHORT

TUBE VOLTAGES REFERENCED TO CHASSIS GND.

TRANSISTOR VOLTAGES REFERENCED TO EMITTER OF Q1

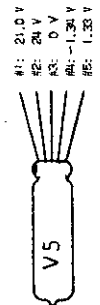
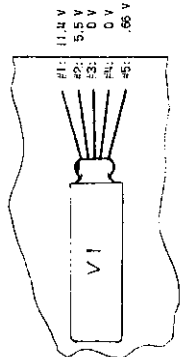
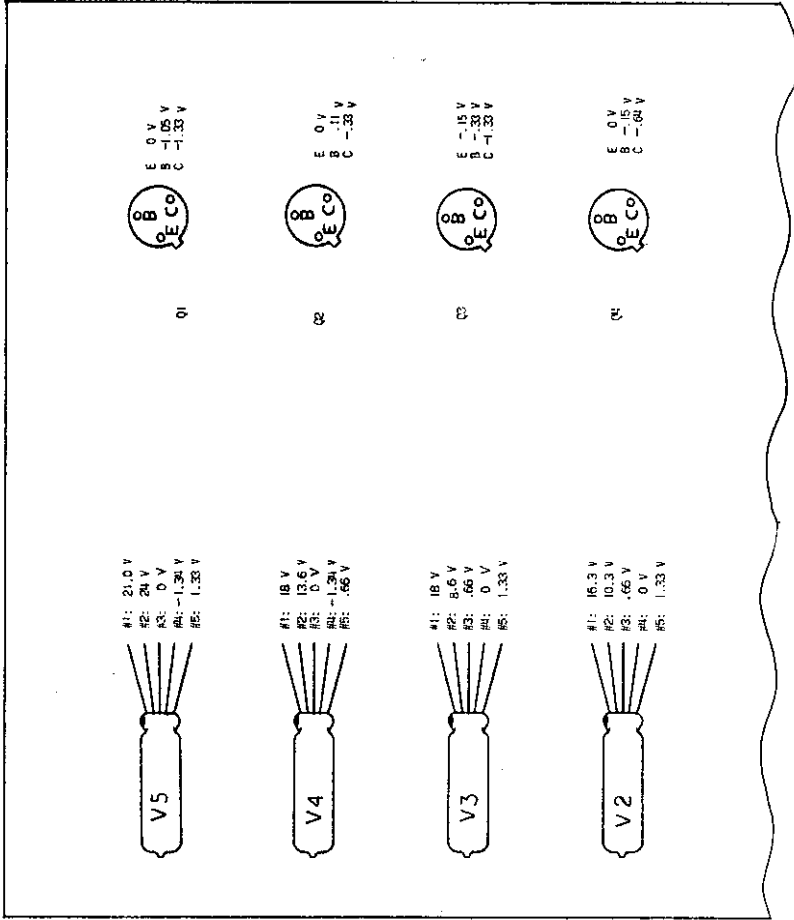

E 0 V
B -0.05 V
C -1.33 V

Q1

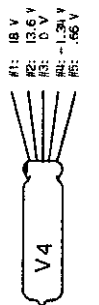

E 0 V
B -1.1 V
C -1.33 V

Q2

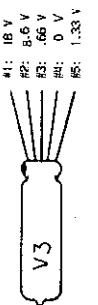

E -1.5 V
B -1.33 V
C -1.33 V

Q3

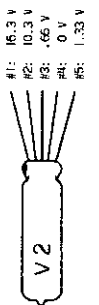

E 0 V
B -1.5 V
C -1.64 V

Q4

DIMENSIONAL TOLERANCES UNLESS OTHERWISE SPECIFIED		DATE	DATE	DATE	DATE
FRAC.	DEC.	AND	ANG	AND	AND
± .004	± .003	± .1°	± .1°	± .1°	± .1°
DO NOT SCALE					
KEITHLEY INSTRUMENTS COMPANY			TITILE		
VOLTAGE CHART			PART NUMBER		
122560			FINISH		
MODEL 1 TEST ASSEMBLY ROOM			DATE		

MODEL 502 VOLTAGE CHART

TUBE AND TRANSISTOR VOLTAGES ARE MEASURED FROM TUBE PIN TO CHASSIS GROUND WITH CONTROLS SET AS FOLLOWS:

RANGE SWITCH AT 'BATTERY TEST'
READ SHORT SWITCH AT 'SHORT'

ALL READINGS ARE APPROXIMATE AND ARE TAKEN WITH AN 11 MEGOHM INPUT RESISTANCE VTVM.

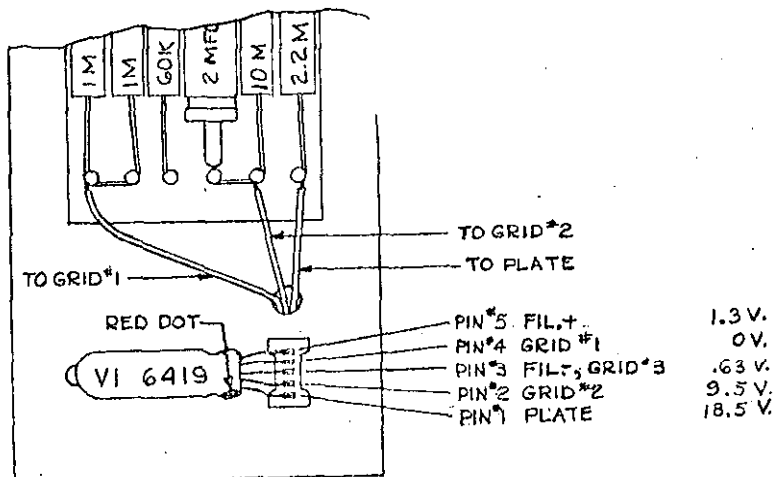
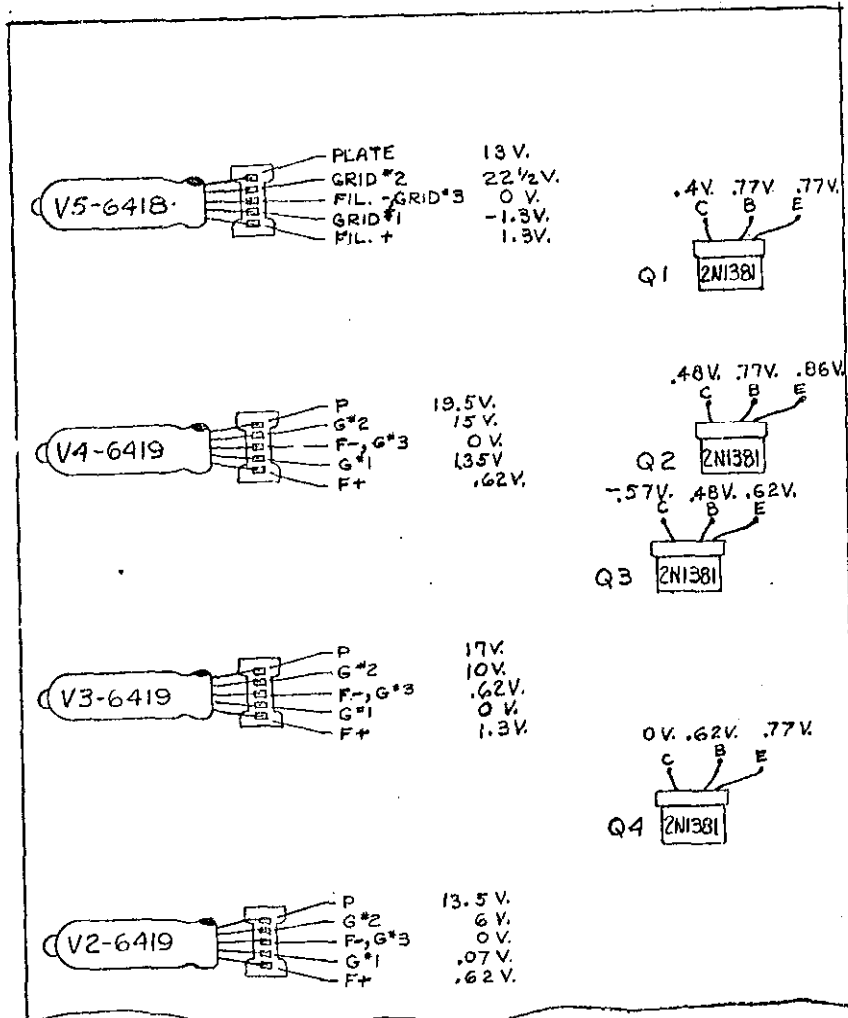

D	EC. O. # 973	1-12-60
C	REVISED PER CHANGE # 74	3-1-60
B	REVISED PER CHANGE # 69	12-18-59
A	REVISED PER CHANGE # 570	12-8-59

MODEL 502
VOLTAGE CHART

KEITHLEY INSTRUMENTS
CLEVELAND, OHIO

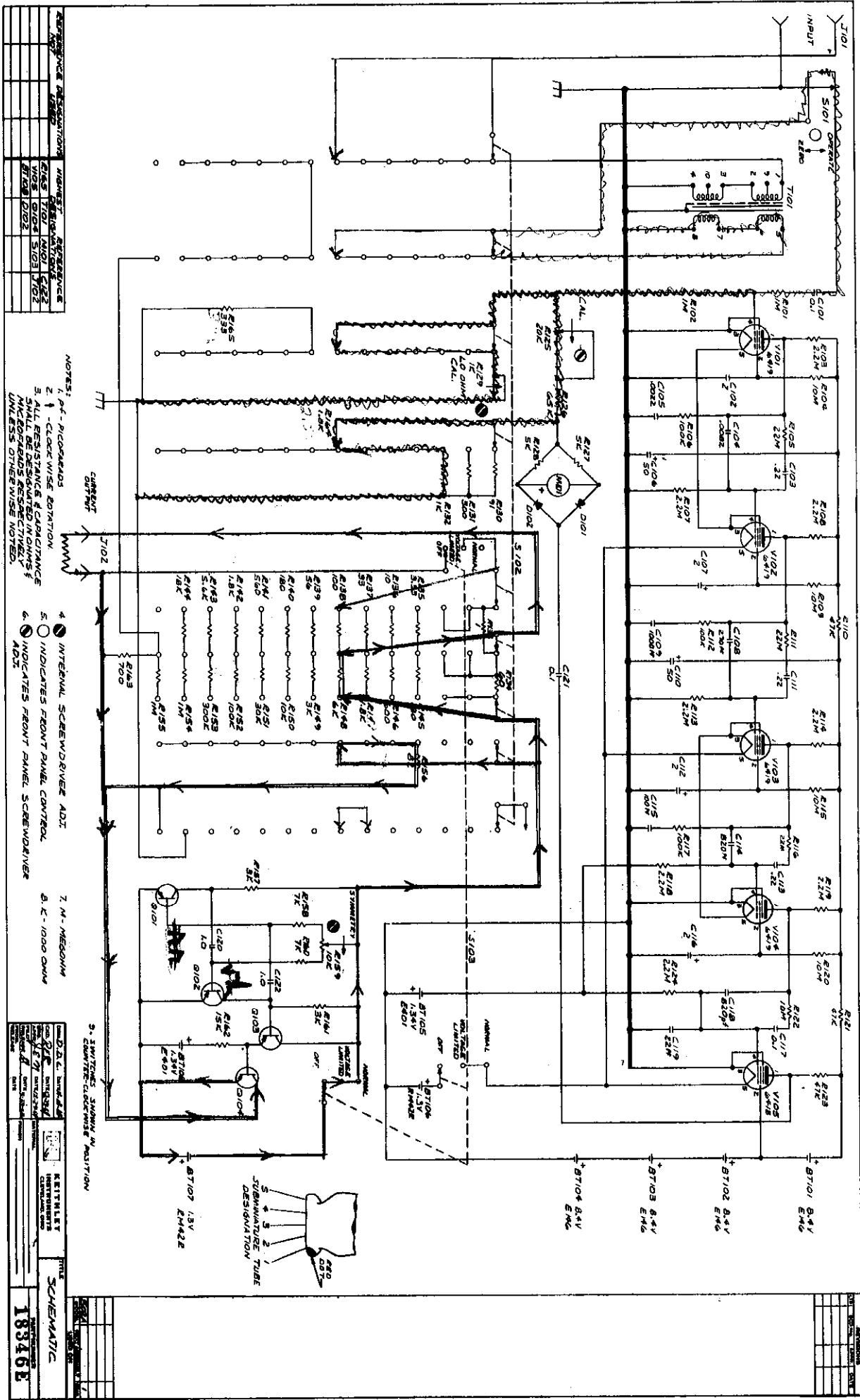

REV.	DATE	BY	CHKD.
1			
2			

NO.	DESCRIPTION	QTY.
1		
2		
3		

REV.	DATE	BY	CHKD.
1			
2			

NO.	DESCRIPTION	QTY.
1		
2		
3		

REV.	DATE	BY	CHKD.
1			
2			

NO.	DESCRIPTION	QTY.
1		
2		
3		

REV.	DATE	BY	CHKD.
1			
2			

NO.	DESCRIPTION	QTY.
1		
2		
3		

REV.	DATE	BY	CHKD.
1			
2			

NO.	DESCRIPTION	QTY.
1		
2		
3		

REV.	DATE	BY	CHKD.
1			
2			

NO. 18346E

18346E

KEITHLEY

Keithley Instruments, Inc./28775 Aurora Road/Cleveland, Ohio 44139/(216) 248-0400/Telex: 98-5469

Keithley Instruments GmbH/Heiglhofstrasse 5/D-8000 Munchen 70/(089) 714-40-65/Telex: 521 21 60

Keithley Instruments, Ltd./1, Boulton Road/GB-Reading, Berkshire RG2 ONL/(0734) 86 12 87

Keithley Instruments SARL/44, Rue Anatole France/F-91121 Palaiseau Cedex/01-014-22-06/Telex: (842) 204188