

KPXI Relay Actuator and Isolated Card

User's Manual

KPXI-RDI-900-01 Rev. A / January 2007

ECA 42912

WARRANTY

Keithley Instruments, Inc. warrants this product to be free from defects in material and workmanship for a period of 1 year from date of shipment.

Keithley Instruments, Inc. warrants the following items for 90 days from the date of shipment: probes, cables, rechargeable batteries, diskettes, and documentation.

During the warranty period, we will, at our option, either repair or replace any product that proves to be defective.

To exercise this warranty, write or call your local Keithley Instruments representative, or contact Keithley Instruments headquarters in Cleveland, Ohio. You will be given prompt assistance and return instructions. Send the product, transportation prepaid, to the indicated service facility. Repairs will be made and the product returned, transportation prepaid. Repaired or replaced products are warranted for the balance of the original warranty period, or at least 90 days.

LIMITATION OF WARRANTY

This warranty does not apply to defects resulting from product modification without Keithley Instruments' express written consent, or misuse of any product or part. This warranty also does not apply to fuses, software, non-rechargeable batteries, damage from battery leakage, or problems arising from normal wear or failure to follow instructions.

THIS WARRANTY IS IN LIEU OF ALL OTHER WARRANTIES, EXPRESSED OR IMPLIED, INCLUDING ANY IMPLIED WARRANTY OF MERCHANTABILITY OR FITNESS FOR A PARTICULAR USE. THE REMEDIES PROVIDED HEREIN ARE BUYER'S SOLE AND EXCLUSIVE REMEDIES.

NEITHER KEITHLEY INSTRUMENTS, INC. NOR ANY OF ITS EMPLOYEES SHALL BE LIABLE FOR ANY DIRECT, INDIRECT, SPECIAL, INCIDENTAL OR CONSEQUENTIAL DAMAGES ARISING OUT OF THE USE OF ITS INSTRUMENTS AND SOFTWARE EVEN IF KEITHLEY INSTRUMENTS, INC., HAS BEEN ADVISED IN ADVANCE OF THE POSSIBILITY OF SUCH DAMAGES. SUCH EXCLUDED DAMAGES SHALL INCLUDE, BUT ARE NOT LIMITED TO: COSTS OF REMOVAL AND INSTALLATION, LOSSES SUSTAINED AS THE RESULT OF INJURY TO ANY PERSON, OR DAMAGE TO PROPERTY.



A G R E A T E R M E A S U R E O F C O N F I D E N C E

Keithley Instruments, Inc.

Corporate Headquarters • 28775 Aurora Road • Cleveland, Ohio 44139
440-248-0400 • Fax: 440-248-6168 • 1-888-KEITHLEY (534-8453) • www.keithley.com

KPXI
Relay Actuator and Isolated Card
User's Manual

©2007, Keithley Instruments, Inc.
All rights reserved.
Cleveland, Ohio, U.S.A.

Document Number: KPXI-RDI-900-01 Rev. A / January 2007

Manual Print History

The print history shown below lists the printing dates of all Revisions and Addenda created for this manual. The Revision Level letter increases alphabetically as the manual undergoes subsequent updates. Addenda, which are released between Revisions, contain important change information that the user should incorporate immediately into the manual. Addenda are numbered sequentially. When a new Revision is created, all Addenda associated with the previous Revision of the manual are incorporated into the new Revision of the manual. Each new Revision includes a revised copy of this print history page.

Revision A (Document Number KPXI-RDI-900-01) January 2007

The following safety precautions should be observed before using this product and any associated instrumentation. Although some instruments and accessories would normally be used with non-hazardous voltages, there are situations where hazardous conditions may be present.

This product is intended for use by qualified personnel who recognize shock hazards and are familiar with the safety precautions required to avoid possible injury. Read and follow all installation, operation, and maintenance information carefully before using the product. Refer to the manual for complete product specifications.

If the product is used in a manner not specified, the protection provided by the product may be impaired.

The types of product users are:

Responsible body is the individual or group responsible for the use and maintenance of equipment, for ensuring that the equipment is operated within its specifications and operating limits, and for ensuring that operators are adequately trained.

Operators use the product for its intended function. They must be trained in electrical safety procedures and proper use of the instrument. They must be protected from electric shock and contact with hazardous live circuits.

Maintenance personnel perform routine procedures on the product to keep it operating properly, for example, setting the line voltage or replacing consumable materials. Maintenance procedures are described in the manual. The procedures explicitly state if the operator may perform them. Otherwise, they should be performed only by service personnel.

Service personnel are trained to work on live circuits, and perform safe installations and repairs of products. Only properly trained service personnel may perform installation and service procedures.

Keithley Instruments products are designed for use with electrical signals that are rated Measurement Category I and Measurement Category II, as described in the International Electrotechnical Commission (IEC) Standard IEC 60664. Most measurement, control, and data I/O signals are Measurement Category I and must not be directly connected to mains voltage or to voltage sources with high transient over-voltages. Measurement Category II connections require protection for high transient over-voltages often associated with local AC mains connections. Assume all measurement, control, and data I/O connections are for connection to Category I sources unless otherwise marked or described in the Manual.

Exercise extreme caution when a shock hazard is present. Lethal voltage may be present on cable connector jacks or test fixtures. The American National Standards Institute (ANSI) states that a shock hazard exists when voltage levels greater than 30V RMS, 42.4V peak, or 60VDC are present. A good safety practice is to expect that hazardous voltage is present in any unknown circuit before measuring.

Operators of this product must be protected from electric shock at all times. The responsible body must ensure that operators are prevented access and/or insulated from every connection point. In some cases, connections must be exposed to potential human contact. Product operators in these circumstances must be trained to protect themselves from the risk of electric shock. If the circuit is capable of operating at or above 1000 volts, no conductive part of the circuit may be exposed.

Do not connect switching cards directly to unlimited power circuits. They are intended to be used with impedance limited sources. NEVER connect switching cards directly to AC mains. When connecting sources to switching cards, install protective devices to limit fault current and voltage to the card.

Before operating an instrument, make sure the line cord is connected to a properly grounded power receptacle. Inspect the connecting cables, test leads, and jumpers for possible wear, cracks, or breaks before each use.

When installing equipment where access to the main power cord is restricted, such as rack mounting, a separate main input power disconnect device must be provided, in close proximity to the equipment and within easy reach of the operator.

For maximum safety, do not touch the product, test cables, or any other instruments while power is applied to the circuit under test. ALWAYS remove power from the entire test system and discharge any capacitors before: connecting or disconnecting cables or jumpers, installing or removing switching cards, or making internal changes, such as installing or removing jumpers.

Do not touch any object that could provide a current path to the common side of the circuit under test or power line (earth) ground. Always make measurements with dry hands while standing on a dry, insulated surface capable of withstanding the voltage being measured.

The instrument and accessories must be used in accordance with its specifications and operating instructions or the safety of the equipment may be impaired.

Do not exceed the maximum signal levels of the instruments and accessories, as defined in the specifications and operating information, and as shown on the instrument or test fixture panels, or switching card.

When fuses are used in a product, replace with same type and rating for continued protection against fire hazard.

Chassis connections must only be used as shield connections for measuring circuits, NOT as safety earth ground connections.

If you are using a test fixture, keep the lid closed while power is applied to the device under test. Safe operation requires the use of a lid interlock.

If a  screw is present, connect it to safety earth ground using the wire recommended in the user documentation.

The  symbol on an instrument indicates that the user should refer to the operating instructions located in the manual.

The  symbol on an instrument shows that it can source or measure 1000 volts or more, including the combined effect of normal and common mode voltages. Use standard safety precautions to avoid personal contact with these voltages.

The  symbol on an instrument shows that the surface may be hot. Avoid personal contact to prevent burns.

The  symbol indicates a connection terminal to the equipment frame.

The **WARNING** heading in a manual explains dangers that might result in personal injury or death. Always read the associated information very carefully before performing the indicated procedure.

The **CAUTION** heading in a manual explains hazards that could damage the instrument. Such damage may invalidate the warranty.

Instrumentation and accessories shall not be connected to humans.

Before performing any maintenance, disconnect the line cord and all test cables.

To maintain protection from electric shock and fire, replacement components in mains circuits, including the power transformer, test leads, and input jacks, must be purchased from Keithley Instruments. Standard fuses, with applicable national safety approvals, may be used if the rating and type are the same. Other components that are not safety related may be purchased from other suppliers as long as they are equivalent to the original component. (Note that selected parts should be purchased only through Keithley Instruments to maintain accuracy and functionality of the product.) If you are unsure about the applicability of a replacement component, call a Keithley Instruments office for information.

To clean an instrument, use a damp cloth or mild, water based cleaner. Clean the exterior of the instrument only. Do not apply cleaner directly to the instrument or allow liquids to enter or spill on the instrument. Products that consist of a circuit board with no case or chassis (e.g., data acquisition board for installation into a computer) should never require cleaning if handled according to instructions. If the board becomes contaminated and operation is affected, the board should be returned to the factory for proper cleaning/servicing.

Table of Contents

Section	Topic	Page
1	Introduction	1-1
	Introduction.....	1-2
	Safety symbols and terms.....	1-2
	Features.....	1-2
	Applications.....	1-2
	Specifications.....	1-3
	General Specifications.....	1-3
	Supporting software.....	1-3
	Programming library.....	1-3
	KIDAQ-LVIEW LabVIEW® driver.....	1-3
	Unpacking and inspection.....	1-4
	Inspection for damage.....	1-4
	Shipment contents.....	1-4
	Instruction manual.....	1-4
	Repacking for shipment.....	1-4
2	Installation	2-1
	Introduction.....	2-2
	Handling precautions.....	2-2
	PXI configuration.....	2-2
	Plug and play.....	2-2
	Configuration.....	2-2
	Troubleshooting.....	2-2
	Installation.....	2-2
3	Operation and Connection	3-1
	PCB Layout.....	3-2
	Model KPXI-RDI-8-16 PCB Layout.....	3-2
	Connector Pin Assignments.....	3-3
	Model KPXI-RDI-8-16 Pin Assignment.....	3-3
	Operation.....	3-3
	Using Relay Output.....	3-3
	Using Isolated Input.....	3-4
	Relay Contact Protection Circuits.....	3-5
4	Registers	4-1
	Introduction.....	4-2
	PCI PnP Registers.....	4-2
	I/O Address Map.....	4-2
	Relay Output and Readback Registers.....	4-3
	Isolation Input Registers.....	4-3
Appendix	Topic	Page
A	KDIO-DRVR User's Guide	A-1
	Introduction to KDIO-DRVR.....	A-2
	About the KDIO-DRVR software.....	A-2
	KDIO-DRVR hardware support.....	A-2

Appendix	Topic	Page
A	KDIO-DRVR User's Guide (continued)	
	KDIO-DRVR language support.....	A-2
	KDIO-DRVR overview.....	A-3
	General configuration function group	A-3
	Actual sampling rate function group	A-4
	Analog output function group.....	A-4
	Digital input function group.....	A-4
	Digital output function group.....	A-6
	Timer/counter function group.....	A-7
	DIO function group	A-8
	Creating a KDIO-DRVR application	A-9
	Contiguous memory allocation in driver for continuous operation	A-9
	Fundamentals of building Windows XP/2000 Application	A-9
	Microsoft® Visual Basic (Version 6.0)	A-9
	Using Microsoft Visual Basic.NET	A-11
	Microsoft Visual C/C++	A-11
	KDIO-DRVR application hints	A-11
	Digital input programming hints	A-12
	Digital output programming hints	A-17
	DAQ event message programming hints.....	A-21
	Interrupt event message programming hints	A-22
	Continuous data transfer in KDIO-DRVR	A-23
	Continuous data transfer mechanism.....	A-23
	Double-buffered / multiple-buffered DI operation.....	A-23
	KDIO-DRVR utilities for Win32.....	A-25
	KDIO-DRVR configuration utility (configdrv).....	A-25
	KDIO-DRVR data file converter utility (KIDAQCvt).....	A-26
B	KDIO-DRVR Function Reference	B-1
	Function description	B-2
	Data types.....	B-2
	Function reference.....	B-2
	Status Codes.....	B-38
	Data file format.....	B-40
	Header	B-40
	ChannelRange.....	B-41
	Data Block	B-42
	Function Support.....	B-43
C	KIDAQ®-LabVIEW Compatible Interface Guide	C-1
	Introduction to KIDAQ®-LabVIEW	C-2
	Overview.....	C-2
	Using KIDAQ LabVIEW VIs in LabVIEW	C-2
	KIDAQ LabVIEW Programming.....	C-3
	Device Driver Handling	C-4
	Windows XP/2000 Device Driver.....	C-4
	Driver Utility	C-4
	KIDAQ Utilities	C-4
	KIDAQ Registry/Configuration utility.....	C-4
	KIDAQ Device Browser	C-4
	KIDAQ LabVIEW VIs Overview.....	C-5
	Analog Input VIs	C-6
	Analog Output VIs	C-6
	Digital I/O VIs.....	C-7
	Timer/Counter VIs.....	C-7
	Calibration and Configuration VIs.....	C-8
	Error Handler VI.....	C-8
	Distribution of Applications	C-8
	Windows XP/2000	C-8

D KIDAQ®-LabVIEW Compatible Function Reference..... D-1

- Introduction D-2
- Hardware support..... D-2
 - KPXI-DIO series: D-2
 - KPXI-DAQ series: D-2
 - Digitizer series: D-2
- Analog input VIs D-3
 - Easy analog input VIs D-3
 - Intermediate analog input VIs D-7
- Analog output VIs D-21
 - Easy analog output VIs D-21
 - Intermediate analog output VIs D-24
 - Advanced analog output VIs D-32
- Digital I/O VIs D-33
 - Easy Digital I/O VIs D-33
 - Intermediate Digital I/O VIs D-37
 - Advanced Digital I/O VIs D-45
- Counter VIs D-46
 - Easy Counter VIs D-46
 - Intermediate Counter VIs D-50
 - Advanced Counter VIs D-63
- Calibration and Configuration VIs D-67
 - Calibration VIs D-67
 - Other Calibration and Configuration VIs D-68
- Service VIs D-70
- Error Codes D-71
- AI Range Codes D-73
- AI Data Format D-76

Service Form

This page left blank intentionally.

List of Figures

Section	Figure	Title	Page
2	Figure 2-1	Typical PXI module installation	2-4
	Figure 2-2	Device manager (successful installation)	2-5
3	Figure 3-1	Model KPXI-RDI-8-16 Layout	3-2
	Figure 3-2	Form C Relay	3-4
	Figure 3-3	Differential Input Circuit	3-4
	Figure 3-4	Model KPXI-RDI-8-16 Isolated Input Circuit	3-5
	Figure 3-5	RC circuit suitable (DC applications)	3-5
	Figure 3-6	RC circuit suitable (DC or AC applications)	3-6
	Figure 3-7	Diode circuit suitable (DC or AC applications)	3-6
	Figure 3-8	Diode and Zener diode circuit (DC or AC applications)	3-7
	Figure 3-9	Varistor circuit (AC and DC applications)	3-7
Appendix	Figure	Title	Page
A	Figure A-1	Open Project dialog box	A-10
	Figure A-2	Basic KDIO-DRVR building blocks	A-12
	Figure A-3	One-shot digital input programming	A-13
	Figure A-4	Synchronous continuous digital input programming	A-14
	Figure A-5	Non-multiple-buffered asynchronous continuous digital input	A-15
	Figure A-6	Multiple-buffered asynchronous continuous digital input	A-16
	Figure A-7	Synchronous continuous digital output programming	A-18
	Figure A-8	Asynchronous continuous digital output programming	A-18
	Figure A-9	Pattern generation digital output programming	A-19
	Figure A-10	Multiple-buffered asynchronous continuous digital output	A-20
	Figure A-11	Double/multiple buffer mode principle	A-24
	Figure A-12	Driver configuration window	A-25
	Figure A-13	DAQ File Conversion Utility	A-26
	Figure A-14	Loading source binary data file	A-27
B	Figure B-1	TOGGLE_OUTPUT mode timing	B-4
	Figure B-2	PROG_ONE_SHOT mode timing	B-4
	Figure B-3	RATE_GENERATOR mode timing	B-5
	Figure B-4	SQ_WAVE_RATE_GENERATOR mode timing	B-5
	Figure B-5	SOFT_TRIG mode timing	B-5
	Figure B-6	HARD_TRIG mode timing	B-5
	Figure B-7	DAQ File Conversion Utility	B-42
C	Figure C-1	Function Browser Options	C-2
	Figure C-2	Functions palette	C-3
	Figure C-3	Keithley PXI Devices Explorer	C-5
D	Figure D-1	Analog input palette	D-3
	Figure D-2	Analog output palette	D-21
	Figure D-3	Digital I/O palette	D-33

This page left blank intentionally.

List of Tables

Section	Table	Title	Page
1	Table 1-1	General Specifications	1-3
3	Table 3-1	CN1 - Model KPXI-RDI-8-16 pin assignment	3-3
	Table 3-2	Pin assignment legend	3-3
4	Table 4-1	Model KPXI-RDI-8-16 Address Map	4-2
	Table 4-2	Data Format of Relay Output and Readback Status Registers	4-3
	Table 4-3	Relay Output	4-3
Appendix	Table	Title	Page
B	Table B-1	Suggested data types	B-2
	Table B-2	Channel_Pn data format	B-16
	Table B-3	Status codes returned by KDIO-DRVR	B-38
	Table B-4	Data file header	B-40
	Table B-5	Data structure of ChannelRange unit	B-41
	Table B-6	KDIO-DRVR model function	B-43
D	Table D-1	KI AI acquire waveform	D-3
	Table D-2	KI AI acquire waveforms	D-4
	Table D-3	KI AI sample channel	D-6
	Table D-4	KI AI sample channels	D-6
	Table D-5	KI AI clear	D-7
	Table D-6	KI AI config	D-9
	Table D-7	2-byte binary array	D-12
	Table D-8	Scaled and Binary Arrays	D-14
	Table D-9	Scaled Array	D-16
	Table D-10	KI AI single scan	D-17
	Table D-11	KI AI start	D-19
	Table D-12	KI AO generate waveform	D-22
	Table D-13	KI AO generate waveforms	D-22
	Table D-14	KI AO update channel	D-23
	Table D-15	KI AO update channels	D-24
	Table D-16	KI AO clear	D-25
	Table D-17	KI AO Config	D-25
	Table D-18	KI AO start	D-27
	Table D-19	KI AO wait	D-28
	Table D-20	KI AO write binary array	D-29
	Table D-21	KI AO write binary array scaled array	D-30
	Table D-22	KI AO Trigger and Gate Config	D-32
	Table D-23	KI Read from Digital Line	D-34
	Table D-24	KI Read from Digital Port	D-34
	Table D-25	KI Write to Digital Line	D-35
	Table D-26	KI Write to Digital Port	D-36
	Table D-27	KI DIO Clear	D-37

Appendix Table	Title	Page
D	Table D-28 KI DIO Config	D-38
	Table D-29 KI DIO Read	D-40
	Table D-30 KI DIO Start	D-42
	Table D-31 KI DIO Write	D-43
	Table D-32 KI DIO Port Config	D-45
	Table D-33 KI Count Events or Time	D-46
	Table D-34 KI Generate Delayed Pulse	D-47
	Table D-35 KI Generate Pulse-Train	D-48
	Table D-36 KI Measure Pulse-Width or Period	D-49
	Table D-37 KI Continuous Pulse Generator Config	D-50
	Table D-38 KI Counter Divider Config	D-52
	Table D-39 KI Counter Read	D-53
	Table D-40 KI Counter Start	D-54
	Table D-41 KI Counter Stop	D-55
	Table D-42 KI Delayed Pulse Generator Config	D-56
	Table D-43 KI Down Counter or Divider Config	D-58
	Table D-44 KI Event or Time Counter Config	D-59
	Table D-45 KI Pulse-Width or Period Measurement Config	D-61
	Table D-46 KI UpDown Counter Config	D-62
	Table D-47 KI ICTR Control	D-63
	Table D-48 KI KPXI-DAQ series devices and Digitizer Series Calibrate	D-67
	Table D-49 KI Route Signal	D-68
	Table D-50 KI SSI Control	D-69
	Table D-51 KI Error Handler	D-70
	Table D-52 Error Codes: KIDAQ LabVIEW VIs	D-71
	Table D-53 Analog Input Range	D-73
	Table D-54 Valid analog input ranges (specified by module)	D-75
	Table D-55 Analog Input data format (by Model)	D-76

In this section:

Topic	Page
Introduction	1-2
Safety symbols and terms	1-2
Features	1-2
Applications	1-2
Specifications	1-3
General Specifications	1-3
Supporting software	1-3
Programming library	1-3
KIDAQ-LVIEW LabVIEW® driver	1-3
Unpacking and inspection	1-4
Inspection for damage	1-4
Shipment contents	1-4
Instruction manual	1-4
Repacking for shipment	1-4

Introduction

Keithley Instruments Model KPXI-RDI-8-16 Relay Actuator and Isolated D/I cards is a digital I/O card for industrial applications in a PXI system.

The Model KPXI-RDI-8-16 provides 8 relay actuators and 16 opto-isolated digital inputs; all relays are Form C. They well suited for constant ON/OFF control devices.

All channels are isolated and suitable for collecting digital input signals in a noisy environment. For identical non-polarized opto-isolated digital input channels, switching can be carried out using AC-filtered or non-AC-filtered channels.

An LED reflects the status of each relay output. When a relay is energized, its corresponding LED will turn ON, otherwise it is OFF.

The relay outputs and digital inputs are controlled by two bytes of I/O addresses. When a bit is read or written, its output status will be controlled, or its input status will be monitored. The I/O signals are routed through to a 37-pin D-type connector on the module's faceplate.

Safety symbols and terms

The following symbols and terms may be found on the KPXI-Isolated DIO series module or used in this manual.

The  symbol indicates that the user should refer to the operating instructions located in the manual.

The  symbol shows that high voltage may be present on the terminal(s). Use standard safety precautions to avoid personal contact with these voltages.

The  symbol on an instrument shows that the surface may be hot. Avoid personal contact to prevent burns.

The **WARNING** heading used in this manual explains dangers that might result in personal injury or death. Always read the associated information very carefully before performing the indicated procedure.

The **CAUTION** heading used in this manual explains hazards that could damage the unit. Such damage may invalidate the warranty.

Features

The Model KPXI-RDI-8-16 Relay Actuator and D/I card provides the following advanced features:

- 32-bit CompactPCI® Bus, Plug and Play
- 8 relay actuator outputs
- 16 opto-isolated digital inputs
- LED indicators to show energized relays
- Jumper selectable AC-filter/non-AC-filter input signals
- On-board relay driving circuits
- On-board digital input signal conditioning circuits

Applications

- Industrial ON/OFF control
- External high power relay driving signal switching
- Laboratory automation

- Industrial automation
- Switch contact status sensing
- Limit switch monitoring
- Useful with A/D and D/A cards to implement a data acquisition and control system

Specifications

Refer to the product data sheet for updated Model KPXI-RDI-8-16 card specifications. Check the Keithley Instruments website at www.keithley.com for the latest updates to the specifications.

Check the Keithley Instruments website at www.keithley.com for the latest updates to the specifications. See below for [General Specifications](#).

General Specifications

Table 1-1
General Specifications

Dimensions	160mm x 100mm
Bus	32-bit PCI bus (in a PXI chassis)
Operating temperature	0°C – 50°C (Operating)
Storage temperature	-20°C - 80°C (Operating)
Humidity	5% to 90% non-condensing
Power Consumption	+5V @ 120mA (No relay energized)

Supporting software

Keithley Instruments provides versatile software drivers and packages for different systems. Keithley Instruments not only provides programming libraries such as DLL's for most Windows® based systems, but also drivers for other software packages such as LabVIEW.¹

All software options are included in the Keithley Instruments CD.

Programming library

KDIO-DRVVR includes device drivers and DLL's for Windows XP and Windows 2000. Therefore, all applications developed with KDIO-DRVVR are compatible on Windows XP/2000. The developing environment can be VB, VC++, BC5, or any Windows programming language that allows calls to a DLL. Documentation includes a User's Guide (refer to [Appendix A: KDIO-DRVVR User's Guide](#)), and a Function Reference (refer to [Appendix B: KDIO-DRVVR Function Reference](#)).

KIDAQ-LVIEW LabVIEW® driver

KIDAQ-LVIEW contains the VI's, which are used to interface with National Instruments® Lab-VIEW® software package. The KIDAQ-LVIEW supports Windows XP/2000. The LabVIEW driver is shipped free with the board. Documentation includes an Interface Guide (refer to

1. National Instruments™, NI, and LabVIEW are trademarks of the National Instruments Corporation.

[Appendix C: KIDAQ®-LabVIEW Compatible Interface Guide](#)), and an interface Function Reference (refer to [Appendix D: KIDAQ®-LabVIEW Compatible Function Reference](#)).

Unpacking and inspection

Inspection for damage

CAUTION Your KPXI-Isolated DIO series module contains electro-static sensitive components that can easily be damaged by static electricity.

Therefore, handle the card on a grounded anti-static mat. The operator should be wearing an anti-static wristband, grounded at the same point as the anti-static mat.

The Model KPXI-RDI-8-16 Relay Actuator and Isolated D/I module was carefully inspected electrically and mechanically before shipment.

Inspect the module carton for obvious damages. Shipping and handling may damage the module. Make sure there are no shipping and handling damages on the module's carton before continuing.

After opening the card module carton, extract the system module and place it only on a grounded anti-static surface with component side up. Save the original packing carton for possible future shipment.

Again, inspect the module for damages. Report any damage to the shipping agent immediately.

Shipment contents

The following items are included with every Model KPXI-RDI-8-16 Relay Actuator and Isolated D/I Module order:

- Model KPXI-RDI-8-16 Relay Actuator and Isolated D/I module
- CD containing required software and manuals

Instruction manual

A CD-ROM containing this User's Manual and required software is included with each Model KPXI-RDI-8-16 Relay Actuator and Isolated D/I Card order. If a hardcopy of the User's Manual is required, you can order the Manual Package (Keithley Instruments Part Number KPXI-RDI-900-01). The Manual Package includes an instruction manual and any pertinent addenda.

Always check the Keithley Instruments website at www.keithley.com for the latest revision of the manual. The latest manual can be downloaded (in PDF format) from the website.

Repacking for shipment

Should it become necessary to return the Model KPXI-RDI-8-16 Relay Actuator and Isolated D/I card for repair, carefully pack the unit in its original packing carton or the equivalent, and follow these instructions:

- Call Keithley Instruments' repair department at 1-888-KEITHLEY (1-888-534-8453) for a Return Material Authorization (RMA) number.
- Let the repair department know the warranty status of the Model KPXI General Purpose DIO series module.
- Write ATTENTION REPAIR DEPARTMENT and the RMA number on the shipping label.

- Complete and include the Service Form located at the back of this manual.

CAUTION The boards must be protected from static discharge and physical shock. Never remove any of the socketed parts except at a static-free workstation. Use the anti-static bag shipped with the product to handle the board. Wear a grounded wrist strap when servicing.

This page left blank intentionally.

In this section:

Topic	Page
Introduction	2-2
Handling precautions	2-2
PXI configuration	2-2
Plug and play	2-2
Configuration	2-2
Troubleshooting	2-2
Installation	2-2

Introduction

This section contains information about handling and installing Keithley Instruments' KIDAQ® KPXI series cards:

- [Handling precautions](#)
- [PXI configuration](#)
- [Installation](#)

Handling precautions

CAUTION Use care when handling the KIDAQ® KPXI series cards. KIDAQ® KPXI series cards contain electro-static sensitive components that can be easily damaged by static electricity.

When handling, make sure to observe the following guidelines:

- Only handle the card on a grounded anti-static mat.
- Wear an anti-static wristband that is grounded at the same point as the anti-static mat.

PXI configuration

Plug and play

As a plug and play component, the board requests an interrupt number via its PXI controller. The system BIOS responds with an interrupt assignment based on the board information and system parameters. These system parameters are determined by the installed drivers and the hardware load recognized by the system. If this is the first time a KIDAQ® KPXI series card will be installed on your Windows® system, a hardware driver needs to be installed. Refer to [Installation](#) for detailed information.

Configuration

Configuration is done on a board-by-board basis for all PCI boards on your system. Configuration is controlled by the system and software. There are no jumper settings required (or available) for base address, DMA, and interrupt IRQ.

The configuration is not static, but is subject to change with every boot of the system as new boards are added or removed.

Troubleshooting

If your system doesn't boot or if you experience erratic operation with your PCI board in place, it's likely caused by an interrupt conflict (perhaps the BIOS Setup is incorrectly configured). In general, the solution, is to consult the BIOS documentation that comes with your system.

Installation

Step 1. Install driver software

Windows will find the new module automatically. If this is the first time a KIDAQ® KPXI series isolated digital I/O card has been installed, a hardware driver needs to be installed. Use the following installation procedure as a guide.

NOTE Keithley Instruments controllers are pre-loaded with the necessary drivers.

For Windows XP/2000:

1. Insert the CD shipped with the module. The CD should auto load. From the base menu install the KDIO-DRVR. This is the hardware driver that recognizes the KPXI series modules. If the CD does not auto load run, then under `x:\KDIO-DRVR\DISK1\`, you will find `SETUP.EXE` (x is the drive letter of your CDROM). This will also run the install.
2. When you complete driver installation, turn off the system.

Step 2. Inspect module

Keeping the “[Handling precautions](#)” information in mind, inspect the module for damage. With the module placed on a firm flat surface, press down on all socketed IC's to make sure that they are properly seated.

If the module does not pass the inspection, do not proceed with the installation.

CAUTION Do not apply power to the card if it has been damaged.

The card is now ready for installation.

Step 3. Install module

Remove power from the system and install the KPXI card in an available slot.

The PXI connectors are rigid and require careful handling when inserted and removed. Improper handling of modules can easily damage the backplane.

To insert the module into a PXI chassis, use the following procedure as a guide:

1. Turn off the system.
2. Align the module's edge with the card guide in the PXI chassis.
3. Slide the module into the chassis until resistance is felt from the PXI connector.
4. Push the ejector upwards and fully insert the module into the chassis. Once inserted, a "click" can be heard from the ejector latch.
5. Tighten the screw on the front panel.
6. Turn on the system.

To remove a module from a PXI chassis, use the following procedure as a guide:

1. Turn off the system.
2. Loosen the screw on the front panel.
3. Push the ejector downwards and carefully remove the module from the chassis.

Figure 2-1
Typical PXI module installation

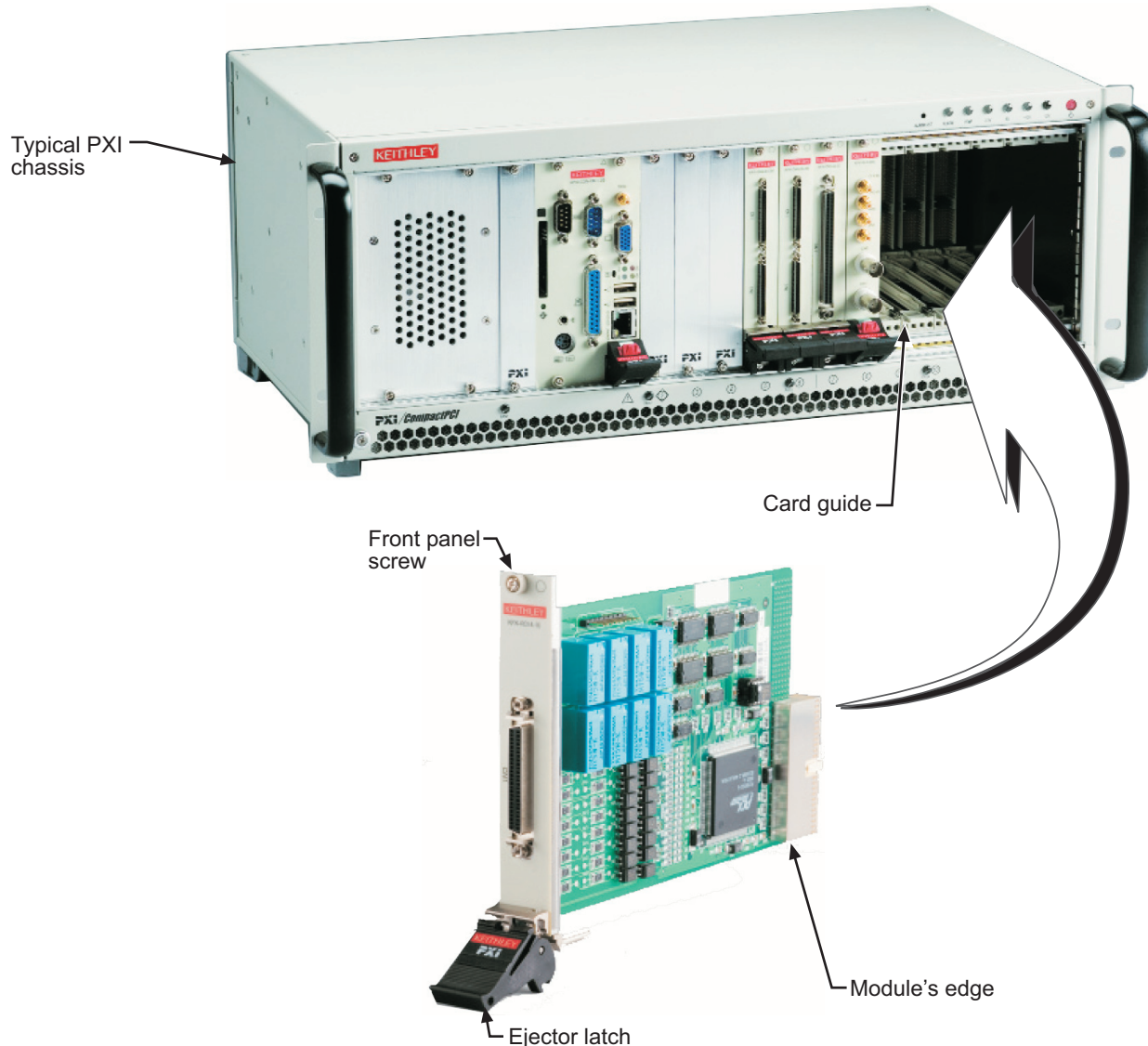

Step 4. Verify installation

When the system is turned on for the first time with a new module present (or a module in a new slot), Windows **Add New Hardware Wizard** attempts to locate the correct driver. If it cannot find the correct driver, even after you have loaded the driver above in Step 1, then force the **Add New Hardware Wizard** to look in Windows system32 directory. The driver files should be in this location. If they are not, shutdown the system, remove the module, and restart the installation process.

When the **Add New Hardware Wizard** finishes, the window will verify whether or not installation was successful. To confirm if the module is installed correctly at a later time, use **Windows Device Manager**. In the **Device Manager** under KIDAQ Boards, look for a device name matching the model number of the newly installed board (see [Figure 2-2](#) for an example). If it is found, installation is complete. If the board appears with a exclamation point or warning in Device Manager, the installation was unsuccessful. If unsuccessful, use **Device Manager** to update the

driver or un-install the module, power down the system, remove the module, and attempt installation again from Step 1.

Figure 2-2
Device manager (successful installation)

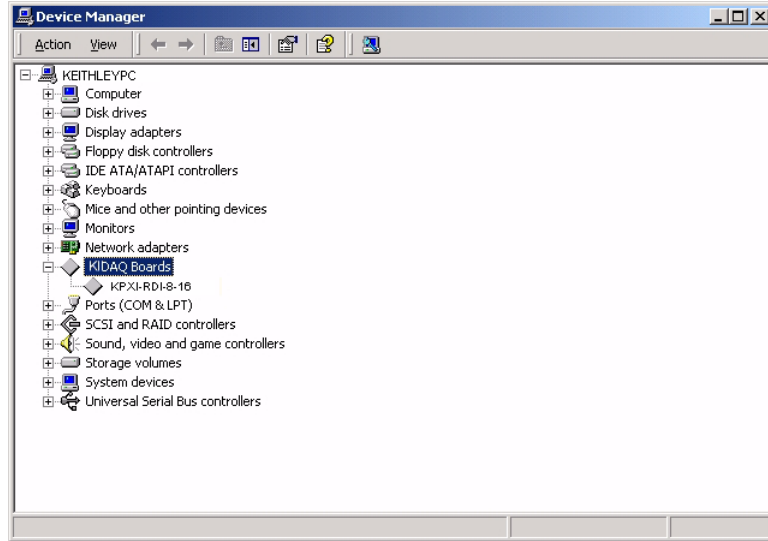

This page left blank intentionally.

In this section:

Topic	Page
PCB Layout	3-2
Model KPXI-RDI-8-16 PCB Layout.....	3-2
Connector Pin Assignments	3-3
Model KPXI-RDI-8-16 Pin Assignment.....	3-3
Operation	3-3
Using Relay Output.....	3-3
Using Isolated Input.....	3-4
Relay Contact Protection Circuits.....	3-5

PCB Layout

Model KPXI-RDI-8-16 PCB Layout

Figure 3-1
Model KPXI-RDI-8-16 Layout

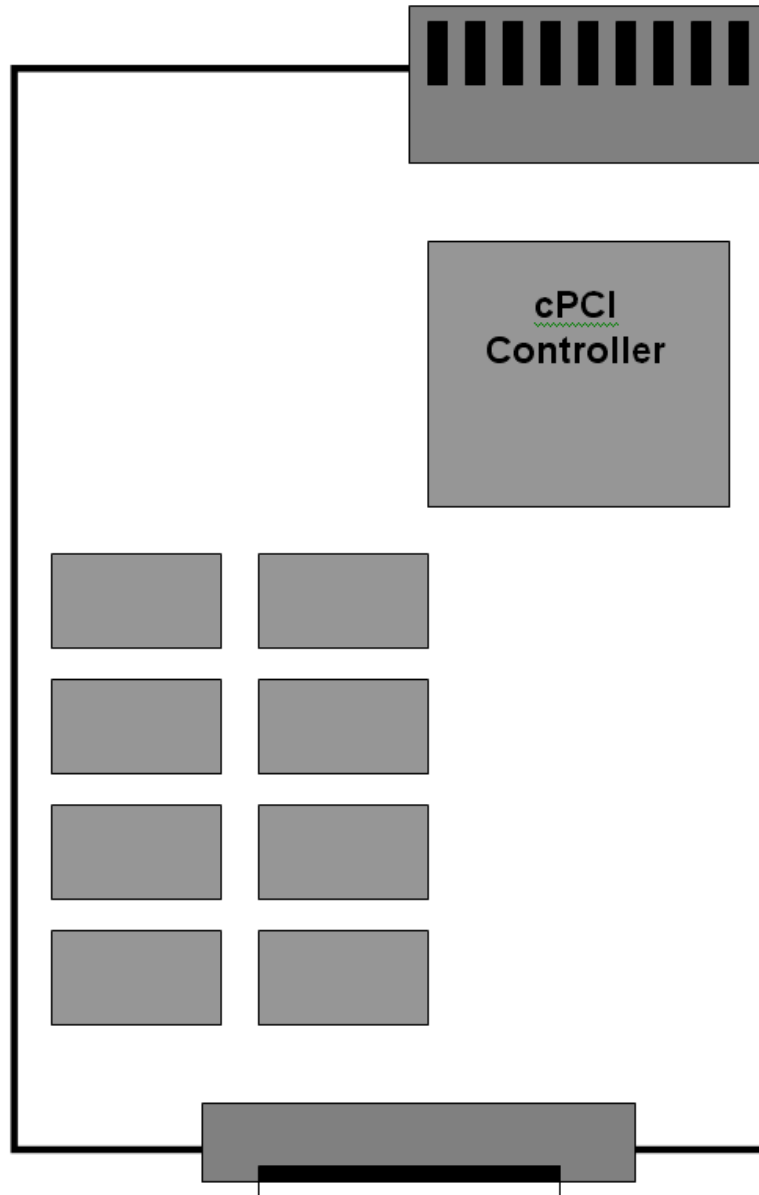

Connector Pin Assignments

Model KPXI-RDI-8-16 Pin Assignment

Table 3-1
CN1 - Model KPXI-RDI-8-16 pin assignment

Signal	Pin	Pin	Signal
IGND	1	26	IGND
DI8	2	27	DI12
DI9	3	28	DI13
DI10	4	29	DI14
DI11	5	30	DI15
DI0L	6	31	DI4H
DI0H	7	32	DI4L
DI1L	8	33	DI5H
DI1H	9	34	DI5L
D2IL	10	35	DI6H
DI2H	11	36	DI6L
DI3L	12	37	DI7H
DI3H	13	38	DI7L
NO0	14	39	NO5
NO1	15	40	NO4
COM0	16	41	COM5
COM1	17	42	COM4
NC0	18	43	NC5
NC1	19	44	NC4
NO2	20	45	NO7
NO3	21	46	NO6
COM2	22	47	COM7
COM3	23	48	COM6
NC2	24	49	NC7
NC3	25	50	NC6

Table 3-2
Pin assignment legend

Legend	
Din:	Digital input channel n
IGND:	Ground of DI n signals
DinH:	Digital input channel n with positive polarity
DinL:	Digital input channel n with negative polarity
NC n:	Normal close pin of relay n
NO n:	Normal open pin of relay n
COM n:	Common pin of relay n

Operation

Using Relay Output

Relays R0 - R3 are form C relays.

NOTE The Model KPXI-RDI-8-16 contains Form C relays only.

Form C Relay: (R0 - R3)

Figure 3-2
Form C Relay

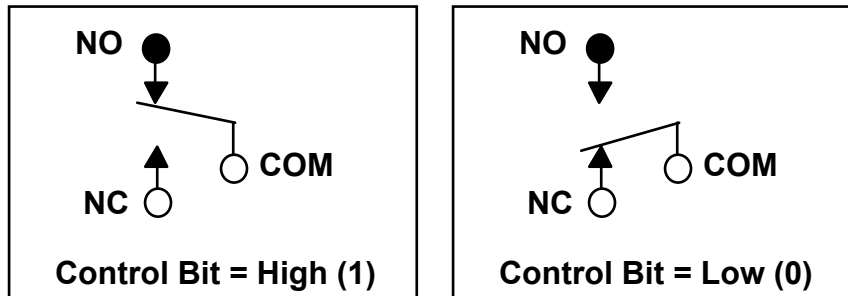

Form C type relays have three contacts: NC (Normal Close), NO (Normal Open), and COM (Common). The COM post, located at the middle, must make contact with either the NO post or NC post. When the control bit is high (1), there is contact between the COM post and NO post. If the control bit is low (0), there is contact between the COM post and NC post.

In normal power-up and reset, the relay is in **low** status.

Using Isolated Input

The circuit diagram of the eight identical opto-isolated control input channels is shown below.

Figure 3-3
Differential Input Circuit

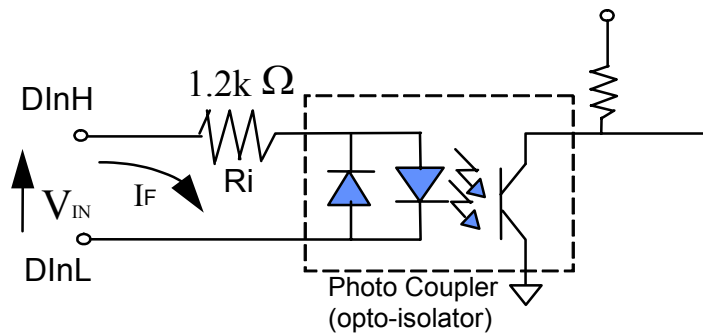

The digital input is first routed through a Photo Coupler (opto-isolator), which is shown in the following diagram.

The Model KPXI-RDI-8-16 contains 16 identical opto-isolated control input channels. While the input signals for channel numbers 8-15 are isolated inputs, the connection is not polarity sensitive whether AC or DC voltage is used.

Figure 3-4
Model KPXI-RDI-8-16 Isolated Input Circuit

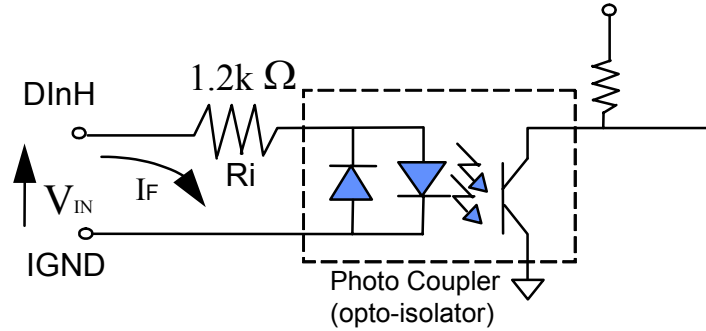

In addition, a single-pole filter with a time constant of about 5ms is used to filter AC inputs passing through.

The normal input voltage range for an active high state is 3 to 24VAC or DC. The normal input range can be extended by changing the resistor (**Ri**) to limit the current (**IF**) through the Photo Coupler (opto-isolator) to about 10mA. The exact resistor value to replace the original resistor **Ri** (1.2KΩ) can be calculated by the following formula.

$$V_{in} = I_F \times R_i$$

$$P_w = V_{in} \times I_F$$

For example, if the input voltage is 110V, then the **Ri** should be replaced by

$$R_i = 110 \text{ (V)} / 0.01 \text{ (A)} = 11 \text{ K}\Omega$$

$$P_w = 110 \text{ (V)} \times 0.01 \text{ (A)} = 1.1 \text{ W}$$

Relay Contact Protection Circuits

The contacts are the most important elements of a relay construction. Contact performance is influenced by contact material, voltage, and current values applied to the contacts.

Another important issue is contact protection; the right contact protection circuit can suppress the counter EMF to a low level. However, note that incorrect use will result in an adverse effect. Typical contact protection circuits are given below:

RC Circuit

This circuit is suitable for DC applications. If the load is a timer, leakage current flow through the RC circuit may cause faulty operation.

Figure 3-5
RC circuit suitable (DC applications)

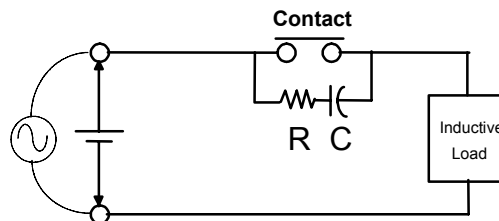

The circuit below is suitable for both DC and AC applications. If the load is a relay or solenoid, the release time is lengthened. Effective when connected to both contacts if the power supply voltage is 24V or 48V and the voltage across the load is 100 to 200V.

Figure 3-6
RC circuit suitable (DC or AC applications)

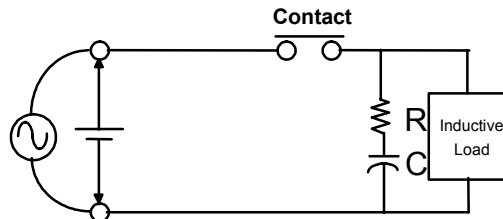

Device Selection:

As a guide in selecting R and C,

- R: 0.5 to 1 Ω per 1V contact voltage
- C: 0.5 to 1 μ F per 1A contact current

Values vary depending on the properties of the capacitor C acting to suppress the discharge the moment the contacts open. Resistor R acts to limit the current when the power is turned on. Test to confirm. Use a capacitor with a breakdown voltage of 200 to 300V. Use AC type capacitors (non-polarized) for AC circuits.

Diode Circuit

This circuit is suitable for DC applications. The diode connected in parallel causes the energy stored in the coil to flow to the coil in the form of current and dissipates it as joule heat at the resistive component of the inductive load. This circuit further delays the release time compared to the RC circuit.

Figure 3-7
Diode circuit suitable (DC or AC applications)

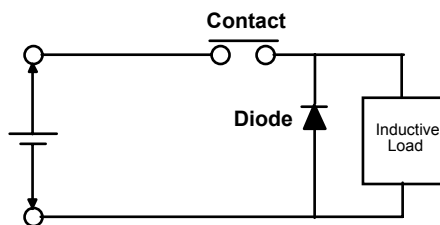

Device Selection

Use a diode with a reverse breakdown voltage of at least 10 times the circuit voltage and a forward current at least as large as the load current.

Diode and Zener diode Circuit

This circuit is also suitable for DC application. Effective when the release time in the diode circuit is too long.

Figure 3-8
Diode and Zener diode circuit (DC or AC applications)

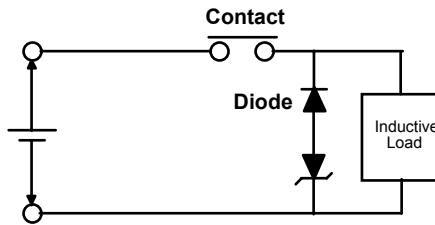

Device Selection

Use a Zener diode with a Zener voltage about the same as the power supply voltage.

Varistor Circuit

This circuit is also suitable for both AC and DC applications. Using the stable voltage characteristics of the varistor, this circuit prevents excessively high voltages from being applied across the contacts. This circuit also slightly delays the release time. Effective when connected to both contacts if the power supply voltage is 24V or 48V and the voltage cross the load is 100 to 200V.

Figure 3-9
Varistor circuit (AC and DC applications)

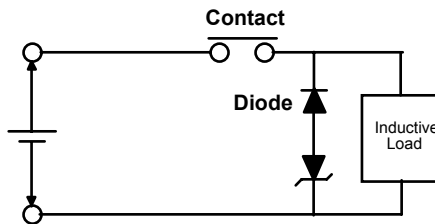

This page left blank intentionally.

In this section:

Topic	Page
Introduction	4-2
PCI PnP Registers	4-2
I/O Address Map	4-2
Relay Output and Readback Registers	4-2
Isolation Input Registers	4-3

Introduction

This section describes the details of the registers and its structure. This information is important for programmers who want to control the hardware with low-level programming.

However, we suggest users have a good understanding of the PCI interface before starting low-level programming. In addition, the contents of this section can help users understand how to use software drivers to manipulate this card.

NOTE *Direct register access can be difficult to program. All users are encouraged to use the KDIO-DRVR driver interface instead of direct access to the registers. This section is included only as a reference for customers who absolutely require the efficiency of register access.*

PCI PnP Registers

This PCI card functions as a 32-bit PCI target device to any master on the PCI bus. There are three types of registers: PCI Configuration Registers (PCR), Local Configuration Registers (LCR) and Model KPXI-RDI-8-16 registers.

The PCR, which is PCI-bus specification compliant, is initialized and controlled by the Plug and Play (PnP) PCI BIOS. Users may obtain more information on the PCI BIOS specification to better understand the operation of the PCR. Please contact PCISIG to acquire PCI interface specifications.

The PCI bus controller PCI-9050 is provided by PLX Technology Inc. (www.plxtech.com). For more information about the LCR, please visit PLX Technology's web site to download relative information. It is not necessary for users to fully understand the details of the LCR if the software library provided is used. The PCI PnP BIOS assigns the base address of the LCR. The assigned address is located at an offset of 14h from the PCR.

The registers are discussed in the next section. The base address, which is also assigned by the PCI PnP BIOS, is located at an offset of 18h from the PCR. Therefore, users can read the address 18h from the PCR to obtain its base address by using the BIOS function call. Do not attempt to modify the base address and interrupt that have been assigned by the PCI PnP BIOS, it may cause resource conflicts with your system.

I/O Address Map

All registers are 8 bits long. Users can access these registers using 8-bit I/O instructions. Using these registers will allow the relays and status of the inputs to be controlled. The following table shows the registers address map, including descriptions and their offset addresses relative to the base address.

Table 4-1

Model KPXI-RDI-8-16 Address Map

Offset	Write	Read	Board
0	Relay Output	Isolation Input	Model KPXI-RDI-8-16
1	Not used	Not used	
2	Not used	Output readback	

Relay Output and Readback Registers

There are 8 relays on each Model KPXI-RDI-8-16 board. Each relay is controlled by one bit in the control register. Bit value '0' means the relay is not energized. The normal open signal line is 'open'. Bit value '1' means the relay is energized and the normal open signal line is now closed.

The initial bit values of the control register are all '0' and the status of the relay can be readback from the readback register. If the relay is open, the corresponding bit value read is '0'. If the relay is closed, the bit value read is '1'.

Table 4-2

Data Format of Relay Output and Readback Status Registers

Bit	7	6	5	4	3	2	1	0
Relay Output	DO7	DO6	DO5	DO4	DO3	DO2	DO1	DO0
Output Readback	RB7	RB6	RB5	RB4	RB3	RB2	RB1	RB0

Isolation Input Registers

There are 8 isolated input channels. The status of the 8 channels can be read from the isolation input register. Each bit corresponds to each channel. Bit value "1" means input voltage is high and "0" means input voltage is low.

Table 4-3

Relay Output

Bit	7	6	5	4	3	2	1	0
Iso. Input	DI7	DI6	DI5	DI4	DI3	DI2	DI1	DI0
Bit	15	14	13	12	11	10	9	8
Iso. Input	DI15	DI14	DI13	DI12	DI11	DI10	DI9	DI8

This page left blank intentionally.

In this appendix:

Topic	Page
Introduction to KDIO-DRVR	A-2
About the KDIO-DRVR software.....	A-2
KDIO-DRVR hardware support.....	A-2
KDIO-DRVR language support.....	A-2
KDIO-DRVR overview	A-3
General configuration function group	A-3
Actual sampling rate function group	A-4
Analog output function group.....	A-4
Digital input function group	A-4
Digital output function group.....	A-6
Timer/counter function group.....	A-7
DIO function group	A-8
Creating a KDIO-DRVR application	A-9
Contiguous memory allocation in driver for continuous operation	A-9
Fundamentals of building Windows XP/2000 Application	A-9
Microsoft® Visual Basic (Version 6.0)	A-9
Using Microsoft Visual Basic.NET	A-11
Microsoft Visual C/C++	A-11
KDIO-DRVR application hints	A-11
Digital input programming hints	A-12
Digital output programming hints.....	A-17
DAQ event message programming hints.....	A-21
Interrupt event message programming hints	A-22
Continuous data transfer in KDIO-DRVR	A-23
Continuous data transfer mechanism	A-23
Double-buffered / multiple-buffered DI operation.....	A-23
KDIO-DRVR utilities for Win32	A-25
KDIO-DRVR configuration utility (configdrv).....	A-25
KDIO-DRVR data file converter utility (KIDAQCvt).....	A-26

Introduction to KDIO-DRVR

About the KDIO-DRVR software

KDIO-DRVR is a software development kit for Keithley Instruments PXI digital I/O modules. It contains a high performance data acquisition driver for developing custom applications under Windows XP or Windows 2000¹ environments.

The memory and data buffer management capabilities free developers from dealing with complex low-level command issues. That is, KDIO-DRVR is constructed to provide a simple programming interface in communication with the Keithley PXI digital I/O modules. The easy-to-use functions provided by KDIO-DRVR allow a programmer to use the features of the module in a high level way.

Using KDIO-DRVR also allows you to take advantage of the power and features of Microsoft Win32s[®] for your data acquisition applications, including running multiple applications and using extended memory. Also, using KDIO-DRVR under in the Microsoft Visual Basic[®] environment makes it easy to create custom user interfaces and graphics.

In addition to the software drivers, some sample programs are provided for your reference to demonstrate use of the driver and decrease development time.

KDIO-DRVR hardware support

Keithley will periodically upgrade KDIO-DRVR for new Keithley PXI digital I/O modules. Please refer to Release Notes for the modules that the current KDIO-DRVR actually supports. The following modules are currently supported by the KDIO-DRVR driver:

- KPXI-DIO-16-16: 16-channel isolated digital I/O module
- KPXI-DIO-48: 48-bit digital I/O module
- KPXI-RDI-8-16: 8 relay output and 16 isolated input module
- KPXI-DIO-32-80M: 80 Mbytes/second Ultra-high speed 32 channels digital I/O module with bus mastering DMA transfer supporting scatter gather technology
- KPXI-DIO-32-32: 32 isolated channels DI & 32 isolated channels DO module
- KPXI-DIO-64-0: 64 isolated channels DI module
- KPXI-DIO-0-64: 64 isolated channels DO module

KDIO-DRVR language support

KDIO-DRVR is a DLL (Dynamic-Link Library) version for using under Windows XP/2000. It can work with any Windows programming language that allows calls to a DLL, such as Microsoft[®] Visual C/Visual C++[®] (5.0 or above), Borland[®] C++ (5.0 or above)², or Visual Basic[®] (4.0 or above), etc.

1. Windows XP, Windows 2000, Microsoft Win32s, Visual C/Visual C++, and Visual Basic are trademarks of the Microsoft Corporation.

2. Borland is a trademark of the Borland Software Corporation.

KDIO-DRVR overview

NOTE *Based on the configuration of an individual module, some of the function groups will not apply to a particular module.*

This section describes the classes of functions in KDIO-DRVR and briefly describes each function.

KDIO-DRVR functions are grouped to the following classes:

- **General Configuration Function Group**
- **Actual Sampling Rate Function Group**
- **Analog Output Function Group**
- **Digital Input Function Group**
 - Digital Input Configuration functions
 - One-Shot Digital Input functions
 - Continuous Digital Input functions
 - Asynchronous Digital Input Monitoring functions
- **Digital Output Function Group**
 - Digital Output Configuration functions
 - One-Shot Digital Output functions
 - Continuous Digital Output functions
 - Asynchronous Digital Output Monitoring functions
- **Timer/Counter Function Group**
- **DIO Function Group**
 - Digital Input/Output Configuration function
 - Dual-Interrupt System Setting function

General configuration function group

Use these functions to initialize and configure the data acquisition card.

KDIO_Register_Card

Initializes the hardware and software states of a KIDAQ PCI-bus data acquisition card. Register_Card must be called before any other KDIO-DRVR library functions can be called for that card.

KDIO_Release_Card

Tells KDIO-DRVR library that this registered card is not used currently and can be released. This would make room for a new card to be registered.

KDIO_GetCardType

Gets the card type of the device with a specified card index.

KDIO_GetCardIndexFromID

Gets the card type and the sequence number of the device with a specified card id.

KDIO_GetBaseAddr

Gets the I/O base addresses of the device with a specified card index.

KDIO_GetLCRAddr

Gets the LCR base address (defined by the PCI controller on board) of the device with a specified card index.

Actual sampling rate function group

KDIO_GetActualRate

Returns the actual sampling rate the device will perform for the defined sampling rate value.

Analog output function group

One-shot analog output functions

KDIO_AO_WriteChannel

Writes a binary value to the specified analog output channel.

KDIO_AO_VWriteChannel

Accepts a voltage value, scales it to the proper binary value and writes a binary value to the specified analog output channel.

KDIO_AO_VoltScale

Scales a voltage to a binary value.

Digital input function group

Digital input configuration functions

KDIO_DI_DIO32M80_Config

Informs KDIO-DRVR library of the trigger source and trigger properties selected for the digital input operation of the KPXI-DIO-32-80M. You must call this function before calling the function to perform continuous digital input operation of the KPXI-DIO-32-80M. This function is used only with Model KPXI-DIO-32-80M.

KDIO_DI_InitialMemoryAllocated

Gets the actual size of digital input DMA memory that is available in the device driver.

One-Shot Digital Input Functions

KDIO_DI_ReadLine

Reads the digital logic state of the specified digital line in the specified port.

KDIO_DI_ReadPort

Reads digital data from the specified digital input port.

Continuous digital input functions

KDIO_DI_ContReadPort

Performs continuous digital input on the specified digital input port at a rate as close as possible to the rate you specified.

KDIO_DI_ContReadPortToFile

Performs continuous digital input on the specified digital input port at a rate as close as possible to the rate you specified and saves the acquired data in a disk file.

KDIO_DI_ContStatus

Checks the current status of the continuous digital input operation.

KDIO_DI_EventCallBack

Controls and notifies the user's application when a specified DAQ event occurs. The notification is performed through a user-specified callback function.

KDIO_DI_ContMultiBufferSetup

Set up the buffer for multi-buffered continuous digital input.

KDIO_DI_ContMultiBufferStart

Starts the multi-buffered continuous digital input on the specified digital input port at a rate as close as possible to the rate you specified.

Asynchronous digital input monitoring functions

KDIO_DI_AsyncCheck

Checks the current status of the asynchronous digital input operation.

KDIO_DI_AsyncClear

Stops the asynchronous digital input operation.

KDIO_DI_AsyncDbfBufferTransfer

Copies half of the data of circular buffer to user buffer. You can execute this function repeatedly to return sequential half buffers of the data.

KDIO_DI_AsyncMultiBufferNextReady

Checks whether the next buffer of data in circular buffer is ready for transfer during an asynchronous multi-buffered digital input operation.

KDIO_DI_AsyncDbfBufferOverrun

Checks or clears overrun status of the double-buffered digital input operation.

Digital output function group

Digital output configuration functions

KDIO_DO_DIO32M80_Config

Informs KDIO-DRVR library of the trigger source and trigger properties selected for the digital output operation of the KPXI-DIO-32-80M. You must call this function before calling the function to perform continuous digital output operation of the KPXI-DIO-32-80M. This function is used only with Model KPXI-DIO-32-80M.

KDIO_DO_InitialMemoryAllocated

Gets the actual size of digital output DMA memory that is available in the device driver.

One-Shot Digital Output Functions

KDIO_DO_WriteLine

Sets the specified digital output line in the specified digital output port to the specified state. This function is only available for those cards that support digital output read-back functionality.

KDIO_DO_WritePort

Writes digital data to the specified digital output port.

KDIO_DO_ReadLine

Reads the specified digital output line in the specified digital output port.

KDIO_DO_ReadPort

Reads digital data from the specified digital output port.

Continuous digital output functions

KDIO_DO_ContWritePort

Performs continuous digital output on the specified digital output port at a rate as close as possible to the rate you specified.

KDIO_DO_ContStatus

Checks the current status of the continuous digital output operation.

KDIO_DO_EventCallback

Controls and notifies the user's application when a specified DAQ event occurs. The notification is performed through a user-specified callback function.

KDIO_DO_PGStart

Performs pattern generation operation.

KDIO_DO_PGStop

Stops pattern generation operation.

KDIO_DO_ContMultiBufferSetup

Set up the buffer for multi-buffered continuous digital output.

KDIO_DO_ContMultiBufferStart

Starts the multi-buffered continuous digital output on the specified digital output port at a rate as close as possible to the rate you specified.

Asynchronous digital output monitoring functions**KDIO_DO_AsyncCheck**

Checks the current status of the asynchronous digital output operation.

KDIO_DO_AsyncClear

Stops the asynchronous digital output operation.

KDIO_DO_AsyncMultiBufferNextReady

Checks whether the next buffer is ready for new data during an asynchronous multi-buffered digital output operation.

Timer/counter function group**Timer/counter functions****KDIO_CTR_Setup**

Configures the selected counter to operate in the specified mode.

KDIO_CTR_Read

Reads the current contents of the selected counter.

KDIO_CTR_Clear

Sets the output of the selected counter to the specified state.

KDIO_CTR_Update

Writes a new initial count to the selected counter.

KDIO_CTR_CT12_ClkSrc_Config

Sets the counter clock source.

KDIO_CTR_CT12_CK1_Config

Sets the source of CK1.

KDIO_CTR_CT12_Debounce_Config

Sets the debounce clock.

DIO function group

Digital input/output configuration functions

KDIO_DIO_PortConfig

This function is only used by the Digital I/O cards whose I/O port can be set as input port or output port. This function informs KDIO-DRVR library of the port direction selected for the digital input/output operation. You must call this function before calling functions to perform digital input/output operation.

Dual-interrupt system setting functions

KDIO_SetDualInterrupt

Controls two interrupt sources of Dual Interrupt system.

KDIO_INT_EventMessage

Controls and notifies the user's application when an interrupt event occurs. The notification is performed through a user-specified callback function or the Windows PostMessage API.

KDIO_INT1_EventMessage

Controls the interrupt sources of INT1 of Dual Interrupt system and notifies the user's application when an interrupt event occurs. The notification is performed through a user-specified callback function or the Windows PostMessage API.

KDIO_INT2_EventMessage

Controls the interrupt sources of INT2 of Dual Interrupt system and notifies the user's application when an interrupt event occurs. The notification is performed through a user-specified callback function or the Windows PostMessage API.

Local interrupt setting functions

KDIO_DIO32M80_SetInterrupt

Controls the interrupt sources (AUXDI and Timer2) of local Interrupt system of KPXI-DIO-32-80M. This function is used only with Model KPXI-DIO-32-80M.

KDIO_AUXDI_EventMessage

Controls AUXDI Interrupt and notifies the user's application when an interrupt event occurs. The notification is performed through a user-specified callback function or the Windows PostMessage API.

KDIO_T2_EventMessage

Controls Timer2 Interrupt and notifies the user's application when an interrupt event occurs. The notification is performed through a user-specified callback function or the Windows PostMessage API.

Creating a KDIO-DRVR application

Contiguous memory allocation in driver for continuous operation

The continuous data transfer functions in KDIO-DRVR input or output blocks of data to or from a Keithley Instruments PXI digital I/O device. To avoid the data transfer performance reduction caused by memory fragmentation, KDIO-DRVR allocates physically contiguous buffers in device driver when the system boots.

KDIO-DRVR provides a utility, **configdrv** to set/modify the sizes of contiguous memory allocated in driver for continuous analog input, analog output, digital input, digital output. Device driver will try to allocate these sizes of memory. The size of initially allocated memory is the maximum memory size that continuous data transfer can be performed. Please refer to the section, **KDIO-DRVR configuration utility (configdrv)**, for the description of this utility.

KDIO-DRVR inputs or outputs blocks of data stored in the driver buffer to or from a Keithley PXI device. For input operations, the specified count of data are transferred to the driver buffer and KDIO-DRVR copies the data from the driver buffer (kernel level) to a user buffer (user level). For output operations, KDIO-DRVR copies the data from a user buffer (driver level) to the driver buffer (kernel level) and transfers outgoing data from the driver buffer to the Keithley PXI device.

However, if only polling I/O is performed, the initially allocated memory is not needed and you can use the utility, **KDIO-DRVR configuration utility (configdrv)** to set the buffer size to be 0.

Fundamentals of building Windows XP/2000 Application

The following paragraphs outline how to create Windows¹ XP/2000 KDAQ-DRVR projects using Microsoft Visual Basic[®] (Version 6.0), Microsoft Visual Basic.NET, and Microsoft Visual C/C++[®].

Microsoft[®] Visual Basic (Version 6.0)

To create a Windows XP/2000[®] Keithley KDIO-DRVR application using the API and Microsoft Visual Basic, follow these steps:

Step 1: Enter Visual Basic and open or create a project to use KDIO-DRVR

To create a new project, select **New Project** from the **File** menu.

To use an existing project:

1. Open the file by selecting **Open Project** from the **File** menu. The **Open Project** dialog box appears ([Figure A-1](#)).

1. Windows XP, Windows 2000, Microsoft Visual Basic.NET, Microsoft Visual C/Visual C++, and Microsoft Visual Basic are trademarks of the Microsoft Corporation.

Figure A-1
Open Project dialog box

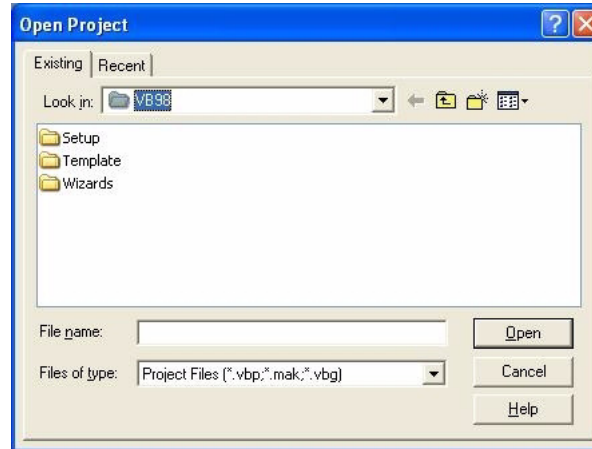

2. Load the project by finding and double-clicking the project file name in the applicable directory.

Step 2: Include function declarations and constants file (kdiodrvr.bas)

If it is not already included in the project, add the **kdiodrvr.bas** file as a module to your project. All function declarations and constants are contained in this file. These function declarations and constants are used to develop data acquisition applications.

Step 3: Design the application interface

Add elements, such as a command button, list box, or text box, etc., on the Visual Basic form used to design the interface. These elements are standard controls from the Visual Basic Toolbox. To place a needed control on the form:

1. Select the needed control from the **Toolbox**.
2. Draw the control on the form. Alternatively, to place the default-sized control on the form, click the form. Use the **Select Objects** tool to reposition or resize controls.

Step 4: Set control properties

Set control properties from the properties list. To view the properties list, select the desired control and do one of the following:

- Press **F4**
 - Select the **Properties** command in the **View** menu
- or
- Click the **Properties** button on the Toolbar.

Step 5: Write the event codes

The event codes define the action desired when an event occurs. To write the event codes:

1. Double-click the control or form needing event code (the code module will appear).
2. Add new code as needed. All functions that are declared in **kdiodrvr.bas** can be called to perform data acquisition operations (refer to tables contained later in this manual).

Step 6: Run your application

To run the application, either:

- Press **F5**
 - Select **Start** from the **Run** menu
- or
- Click the **Start** icon on the Toolbar

Using Microsoft Visual Basic.NET

To create a data acquisition application using KDAQ-DRVR and Visual Basic.NET, use the procedure for [Microsoft® Visual Basic \(Version 6.0\)](#) as an outline, but in step 2, use the file named **KDIODRV.VB** (instead of the file named **kdiodrvr.bas**).

Microsoft Visual C/C++

To create a Windows XP/2000 KDAQ-DRVR library application using the KDAQ-DRVR function library and Microsoft Visual C/C++, follow these steps:

Step 1: Enter Visual C/C++ and open or create a project that will use the KDIO-DRVR

NOTE The project can be a new or existing one.

Step 2: Include function declarations and constants file (kdiodrvr.h)

Include **kdiodrvr.h** in the C/C++ source files that call KDIO-DRVR functions by adding the following statement in the source file:

```
#include "kdiodrvr.h"
```

NOTE: *KDIO-DRVR function declarations and constants are contained in **kdiodrvr.h**. Use the functions and constants to develop data-acquisition applications.*

Step 3: Build your application

1. Set suitable compile and link options.
2. Select **Build** from the **Build** menu (Visual C/C++ 4.0 and higher).
3. Remember to link the Keithley Command Compatible library: **KDIO-DRVR.LIB**

KDIO-DRVR application hints

This section provides the programming schemes showing the function flow of that KDIO-DRVR performs analog I/O and digital I/O.

The figure below shows the basic building blocks of a KDIO-DRVR application. However, except using **KDIO_Register_Card** at the beginning and **KDIO_Release_Card** at the end, depending on the specific devices and applications you have, the KDIO-DRVR functions comprising each building block vary.

Figure A-2
Basic KDIO-DRVR building blocks

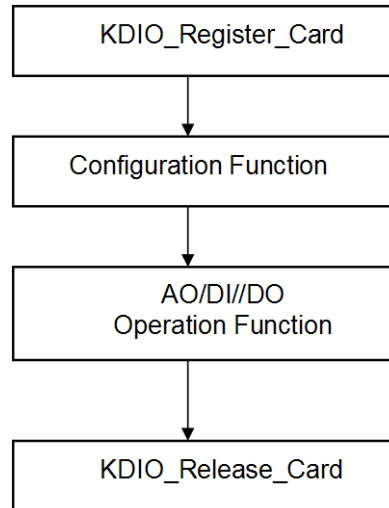

The programming schemes for digital input/output are described individually in the following sections.

Digital input programming hints

KDIO-DRVR provides two kinds of digital input operation — non-buffered single-point digital input operation and buffered continuous digital input operation.

The non-buffered single-point DI uses software polling method to read data from the device. The programming scheme for this kind of DI operation is described in [One-shot digital input programming](#).

The buffered continuous DI uses DMA transfer method to transfer data from device to user's buffer. The maximum number of count in one transfer depends on the size of initially allocated memory for digital input in the driver. We recommend the applications use the **KDIO_DI_InitialMemoryAllocated** function to get the size of initially allocated memory before performing continuous DI operation.

The buffered continuous analog input includes synchronous continuous DI, non-double-buffered asynchronous continuous DI and double-buffered asynchronous continuous DI. They are described in [Synchronous continuous digital input programming](#), [Non-multiple-buffered asynchronous continuous digital input programming](#), and [Multiple-buffered asynchronous continuous digital input programming](#). About the special consideration and performance issues for the buffered continuous digital input, refer to the section titled [Continuous data transfer in KDIO-DRVR](#) for details.

One-shot digital input programming

This section describes the function flow typical of non-buffered single-point digital input readings. While performing one-shot DI operation, the devices whose I/O port can be set as input or output port need to include port configuration function at the beginning of your application.

NOTE The following example uses a KPXI-DIO-48. Other DIO modules are similar (exceptions are noted).

Figure A-3
One-shot digital input programming

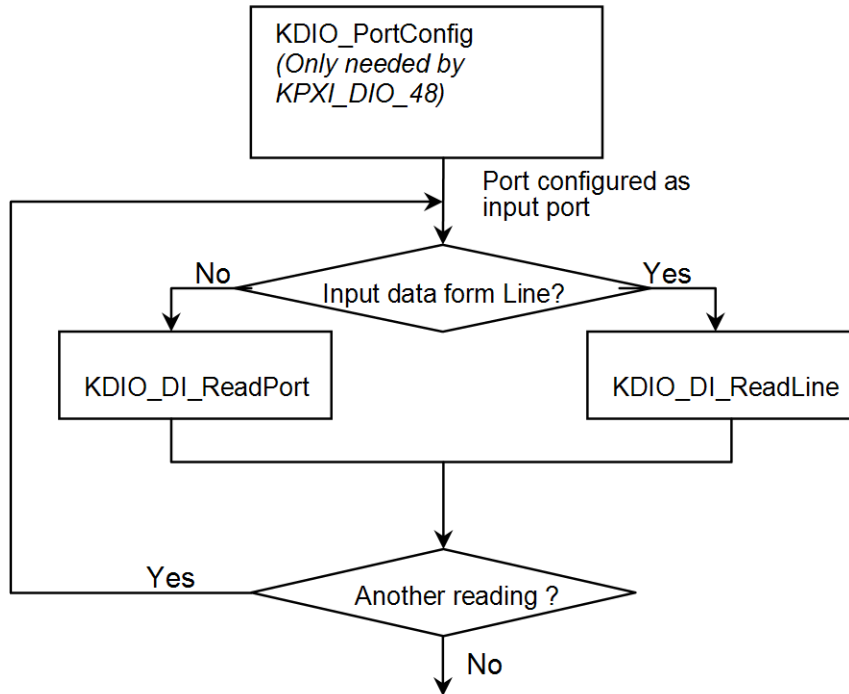

Example Code Fragment

```

card = KDIO_Register_Card(KPXI_DIO_48, card_number);
//port configured
KDIO_PortConfig(card ,Channel_P1A, INPUT_PORT);
KDIO_PortConfig(card, Channel_P1B, INPUT_PORT);
KDIO_PortConfig(card, Channel_P1CL, INPUT_PORT);
KDIO_PortConfig(card, Channel_P1CH, INPUT_PORT);
//DI operation
KDIO_DI_ReadPort(card, Channel_P1A, &inputA);
...
KDIO_Release_Card(card);
  
```

Synchronous continuous digital input programming

This section describes the function flow typical of synchronous digital input operation. While performing continuous DI operation, the DI configuration function has to be called at the beginning of your application. In addition, for synchronous DI, the **SyncMode** argument in continuous DI functions has to be set as **SYNCH_OP**.

NOTE The following example uses a KPXI-DIO-32-80M. Other DIO modules are similar with the exception being that some modules do not require the **_Config** function call (specifically, if the module's ports are dedicated as inputs or outputs only).

Figure A-4

Synchronous continuous digital input programming

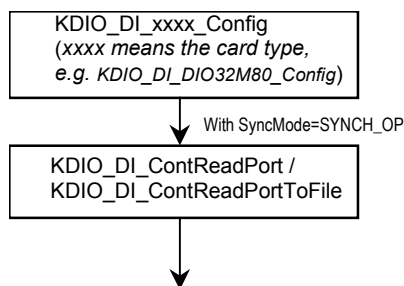

Example Code Fragment

```

card = KDIO_Register_Card(KPXI_DIO_32_80M, card_number);
...
KDIO_DI_DIO32M80_Config (card, 16, TRIG_CLK_10MHZ, DIO32M80_WAIT_NO,
DIO32M80_TERM_ON, 0, 1, 1);
KDIO_DI_ContReadPort(card, 0, pMem, data_size, (F64)sample_rate, SYNCH_OP)
...
KDIO_Release_Card(card);
  
```

Non-multiple-buffered asynchronous continuous digital input programming

This section describes the function flow typical of non-double-buffered asynchronous digital input operation. While performing continuous DI operation, the DI configuration function has to be called at the beginning of your application. In addition, for asynchronous DI operation, the **SyncMode** argument in continuous DI functions has to be set as **ASYNCH_OP**.

NOTE The following example uses a KPXI-DIO-32-80M. Other DIO modules are similar with the exception being that some modules do not require the **_Config** function call (specifically, if the module's ports are dedicated as inputs or outputs only).

Figure A-5
Non-multiple-buffered asynchronous continuous digital input

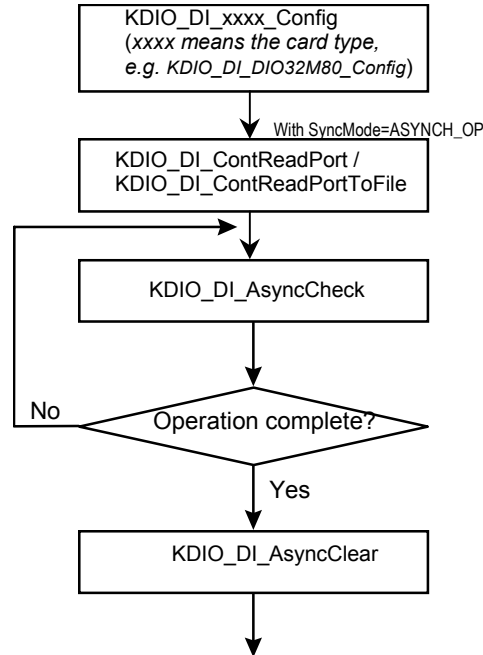

Example Code Fragment

```

card = KDIO_Register_Card(KPXI_DIO_32_80M, card_number);
...
KDIO_DI_DIO32M80_Config(card, 16, TRIG_CLK_10MHZ, DIO32M80_WAIT_NO,
DIO32M80_TERM_ON, 0, 1, 1);
KDIO_DI_ContReadPort(card, 0, pMem, data_size, (F64)sample_rate, ASYNCH_OP)
do {
    KDIO_DI_AsyncCheck(card, &bStopped, &count);
} while (!bStopped);
KDIO_DI_AsyncClear(card, &count);
...
KDIO_Release_Card(card);
  
```

Multiple-buffered asynchronous continuous digital input programming

This section describes the function flow typical of multi-buffered asynchronous digital input operation. While performing continuous DI operation, the DI configuration function has to be called at the beginning of your application. For asynchronous DI, the SyncMode argument in continuous DI functions has to be set as **ASYNCH_OP**.

NOTE The following example uses a KPXI-DIO-32-80M. Other DIO modules are similar with the exception being that some modules do not require the **_Config** function call (specifically, if the module's ports are dedicated as inputs or outputs only).

Figure A-6
Multiple-buffered asynchronous continuous digital input

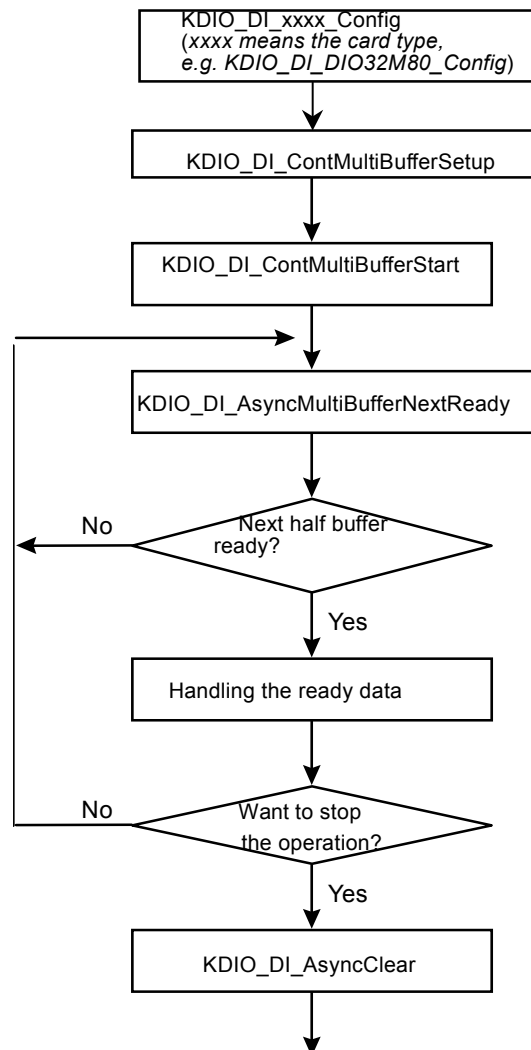

Example Code Fragment

```

card = KDIO_Register_Card(KPXI_DIO_32_80M, card_number);
...
KDIO_DI_DIO32M80_Config(card, 16, TRIG_CLK_10MHZ, DIO32M80_WAIT_NO,
DIO32M80_TERM_ON, 0, 0, 0);
    //setting the DMA buffers repeatedly
    KDIO_DI_ContMultiBufferSetup (card, in_buf, data_size, &BufferId);
KDIO_DI_ContMultiBufferSetup (card, in_buf, data_size, &BufferId);
...
    // start multi-buffered DI
    KDIO_DI_ContMultiBufferStart (card, 0, 1);
do {
    do {
        KDIO_DI_AsyncMultiBufferNextReady(card, &HalfReady, &viewidx);
    } while (!HalfReady);
    //Handling the ready data
} while (!clear_op);
KDIO_DI_AsyncClear(card, &count);
...
KDIO_Release_Card(card);
  
```

Digital output programming hints

KDIO-DRVR provides three kinds of digital output operation — non-buffered single-point digital output operation, buffered continuous digital output operation and pattern generation.

The non-buffered single-point DO uses software polling method to write data to the device. The programming scheme for this kind of DO operation is described in [One-shot digital output programming scheme](#).

The buffered continuous DO uses DMA transfer method to transfer data from user's buffer to device. The maximum number of count in one transfer depends on the size of initially allocated memory for digital output in the driver. We recommend the applications use **KDIO_DO_InitialMemoryAllocated** function to get the size of initially allocated memory before start performing continuous DO operation.

The buffered continuous digital output includes synchronous continuous DO and asynchronous continuous DO. They are described in [Synchronous continuous digital output programming](#) and [Asynchronous continuous digital output programming](#) individually. About the special consideration and performance issues for the buffered continuous digital output, refer to the section titled [Continuous data transfer in KDIO-DRVR](#) for details.

The Pattern Generation DO outputs digital data patterns repeatedly at a predetermined rate. The programming scheme for this kind of DO operation is described in [Pattern generation digital output programming](#).

One-shot digital output programming scheme

This section describes the function flow typical of non-buffered single-point digital output operation. While performing one-shot DO operation, the cards whose I/O port can be set as input or output port need to include port configuration function at the beginning of your application.

NOTE *The following example uses a KPXI-DIO-48. Other DIO modules are similar with the exception being that some modules do not require the **_Config** function call (specifically, if the module's ports are dedicated as inputs or outputs only).*

Example Code Fragment

```
card = KDIO_Register_Card(KPXI_DIO_48, card_number);
//port configured
KDIO_PortConfig(card, Channel_P1A, OUTPUT_PORT);
KDIO_PortConfig(card, Channel_P1B, OUTPUT_PORT);
KDIO_PortConfig(card, Channel_P1CL, OUTPUT_PORT);
KDIO_PortConfig(card, Channel_P1CH, OUTPUT_PORT);
//DO operation
KDIO_DO_WritePort(card, Channel_P1A, outA_value);
...
KDIO_Release_Card(card);
```

Synchronous continuous digital output programming

This section describes the function flow typical of synchronous digital output operation. While performing continuous DO operation, the DO configuration function has to be called at the beginning of your application. In addition, for synchronous DO operation, the **SyncMode** argument in continuous DO functions for synchronous mode has to be set as **SYNCH_OP**.

NOTE *The following example uses a KPXI-DIO-32-80M. Other DIO modules are similar with the exception being that some modules do not require the **_Config** function call (specifically, if the module's ports are dedicated as inputs or outputs only).*

Figure A-7
Synchronous continuous digital output programming

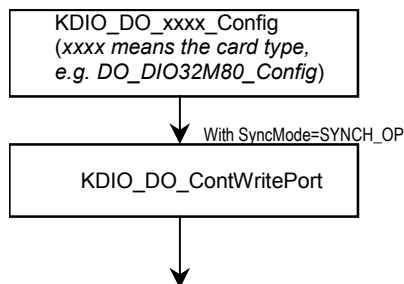

Example Code Fragment

```

card = KDIO_Register_Card(KPXI_DIO_32_80M, card_number);
...
KDIO_DO_DIO32M80_Config (card, 16, TRIG_INT_PACER, DIO32M80_WAIT_NO,
DIO32M80_TERM_ON, 0, 0x40004000);
KDIO_DO_ContWritePort(card, 0, DoBuf, count, 1, (F64)sample_rate, SYNCH_OP);
...
KDIO_Release_Card(card);
  
```

Asynchronous continuous digital output programming

This section describes the function flow typical of asynchronous digital output operation. While performing continuous DO operation, the DO configuration function has to be called at the beginning of your application. In addition, for asynchronous DO operation, the **SyncMode** argument in continuous DO functions for asynchronous mode has to be set as **ASYNCH_OP**.

NOTE The following example uses a KPXI-DIO-32-80M. Other DIO modules are similar with the exception being that some modules do not require the **_Config** function call (specifically, if the module's ports are dedicated as inputs or outputs only).

Figure A-8
Asynchronous continuous digital output programming

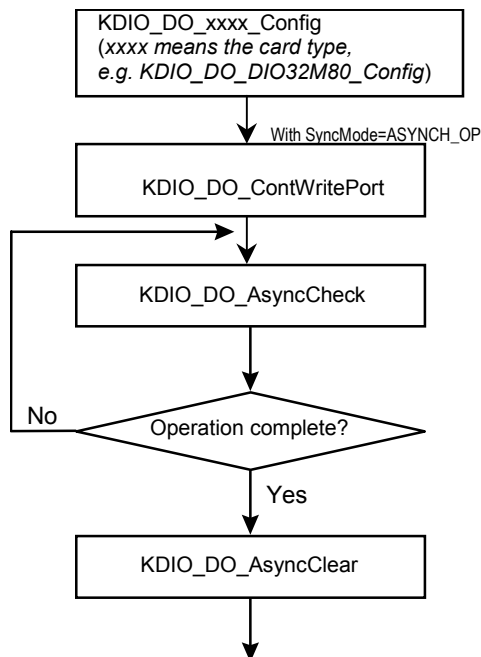

Example Code Fragment

```

card = KDIO_Register_Card(KPXI_DIO_32_80M, card_number);
...
KDIO_DO_DIO32M80_Config (card, 16, TRIG_INT_PACER, DIO32M80_WAIT_NO,
DIO32M80_TERM_ON, 0, 0x40004000);
KDIO_DO_ContWritePort(card, 0, DoBuf, count, 1, (F64)sample_rate, ASYNCH_OP);
do {
    KDIO_DO_AsyncCheck(card, &bStopped, &count);
} while (!bStopped);

KDIO_DO_AsyncClear(card, &count);
...
KDIO_Release_Card(card);
    
```

Pattern generation digital output programming

This section describes the function flow typical of pattern generation for digital output. While performing pattern generation of DO, the DO configuration function has to be called at the beginning of your application.

NOTE *The following example uses a KPXI-DIO-32-80M. Other DIO modules are similar with the exception being that some modules do not require the **_Config** function call (specifically, if the module's ports are dedicated as inputs or outputs only).*

Figure A-9
Pattern generation digital output programming

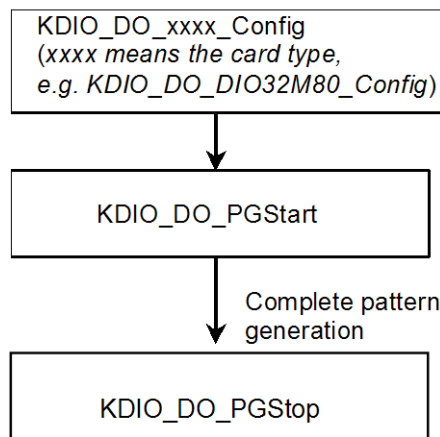

Example Code Fragment

```

card=KDIO_Register_Card(KPXI_DIO_32_80M, card_number);
...
KDIO_DO_DIO32M80_Config (card, 16, TRIG_INT_PACER, DIO32M80_WAIT_NO,
DIO32M80_TERM_ON, 0, 0x40004000);
//start pattern generation
KDIO_DO_PGStart (card, out_buf, 10000, 5000000);
...
//stop pattern generation
KDIO_DO_PGStop (card);
KDIO_Release_Card(card);
    
```

Multiple-buffered asynchronous continuous digital output programming

This section describes the function flow typical of multi-buffered asynchronous digital output operation. While performing continuous DO operation, the DO configuration function has to be called at the beginning of your application. For asynchronous DO, the **SyncMode** argument in continuous DO functions has to be set as **ASYNCH_OP**.

NOTE The following example uses a KPXI-DIO-32-80M. Other DIO modules are similar with the exception being that some modules do not require the **_Config** function call (specifically, if the module's ports are dedicated as inputs or outputs only).

Figure A-10

Multiple-buffered asynchronous continuous digital output

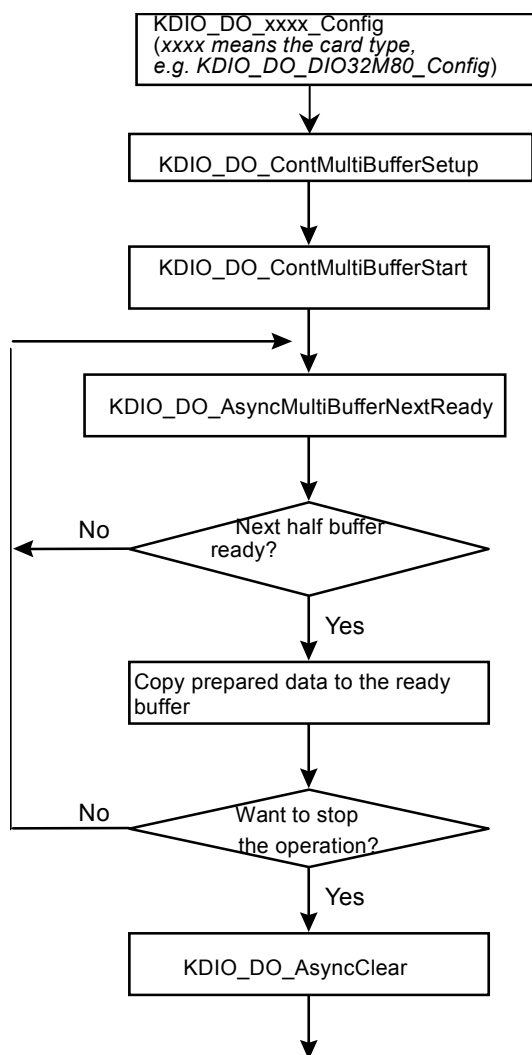

Example Code Fragment

```

card = KDIO_Register_Card(KPXI_DIO_32_80M, card_number);
...
KDIO_DO_DIO32M80_Config (card, 16, /*TRIG_INT_PACER*/TRIG_CLK_10MHZ,
DIO32M80_WAIT_NO, DIO32M80_TERM_ON, 0, 0x00040004)
    //setting the DMA buffers repeatedly
    KDIO_DO_ContMultiBufferSetup (card, out_buf, data_size, &BufferId);
KDIO_DO_ContMultiBufferSetup (card, out_buf, data_size, &BufferId);
...
    // start multi-buffered DO
  
```

```

        KDIO_DO_ContMultiBufferStart (card, 0, 1);
do {
    do {
        KDIO_DI_AsyncMultiBufferNextReady(card, &HalfReady, &viewidx);
    } while (!HalfReady);

    // Copy prepared data to the ready buffer
} while (!clear_op);
KDIO_DO_AsyncClear(card, &count);
...
KDIO_Release_Card(card);

```

DAQ event message programming hints

DAQ Event Message functions are an efficient way to monitor your background data acquisition processes, without dedicating your foreground process for status checking. There are two kinds of events, which are **DI/DO operation completeness** notification event and **buffer ready** notification event.

To receive notification from the KDIO-DRVR data acquisition process in case of special events, you can call `KDIO_DI_EventCallBack`, or `KDIO_DO_EventCallBack` to specify an event in which you are interested.

Event notification is done through user-defined callbacks. When a user-specified DAQ event occurs, KDIO-DRVR calls the user-defined callback. After receiving the message, the user's application can carry out the appropriate task.

The event message mechanism is easy and safe in Windows systems; however, the time delay between the event and notification is highly variable and depends largely on how loaded your system is. In addition, if a callback function is called, succeeding events will not be handled until your callback has returned. If the time interval between events is smaller than the time taken for callback function processing, the succeeding events will not be handled. Therefore this mechanism is not suitable for the frequent events occurrence condition.

NOTE *The following example uses a KPXI-DIO-32-80M. Other DIO modules are similar with the exception being that some modules do not require the **_Config** function call (specifically, if the module's ports are dedicated as inputs or outputs only).*

Example Code Fragment

```

card = KDIO_Register_Card(KPXI_DIO_32_80M, card_number);
KDIO_DI_DIO32M80_Config(card, 16, TRIG_CLK_10MHZ, DIO32M80_WAIT_NO,
DIO32M80_TERM_ON, 0, 0, 0);

// Enable half buffer ready event notification
    KDIO_DI_EventCallBack (card, 1, DBEvent, (U32) DI_DBCallBack );

//Enable DI completeness event notification
KDIO_DI_EventCallBack (card, 1, DIEnd, (U32) DI_CallBack );

KDIO_DI_ContMultiBufferStart (card, 0, 1);
....
KDIO_Release_Card(card);

//Half buffer ready call back function
void DI_DBCallBack()
{
    //half buffer is ready
    KDIO_DI_AsyncDbfBufferTransfer(card, &HalfReady, &viewidx);
    ...
}

```

```

}

//DI completeness call back function
void DI_CallBack ()
{
//DI is completed ]
KDIO_DO_AsyncClear (card, &count);
...
}

```

Interrupt event message programming hints

KDIO-DRVR provides two methods to perform interrupt occurrence notification for Keithley PXI DIO cards that have dual interrupt system.

The Event Message method handles event notification through user-defined callbacks and/or the Windows Message queue (for VB5, through user-defined callbacks only). When a user-specified interrupt event occurs, KDIO-DRVR calls the user-defined callback (if defined) and/or puts a message into the Windows Message queue, if you specified a window handle. After receiving the message, the user's application can carry out the appropriate task.

The event message mechanism is easy and safe in Windows systems; however, the time delay between the event and notification is highly variable and depends largely on how loaded your system is. In addition, if a callback function is called, succeeding events will not be handled until your callback has returned. If the time interval between interrupt events is smaller than the time taken for callback function processing, the succeeding interrupt events will not be handled. Therefore this mechanism is not suitable for the frequent interrupt occurrence condition.

The Event Status checking and waiting method handles interrupt event status checking through Win32 wait functions, such as WaitForSingleObject or WaitForMultipleObjects. This method is useful for the situation that the interrupt event occurs very often, and the applications written in the language that doesn't support function pointers (e.g. VB4).

1. Through user-defined callbacks and the Windows Message queue

Example Code Fragment

```

card = KDIO_Register_Card(KPXI-DIO-16-16, card_number);

//INT1 event notification is through window message
KDIO_INT1_EventMessage (card, INT1_EXT_SIGNAL, hWnd, WM_INT, NULL);

//INT2 event notification is through a callback function
KDIO_INT2_EventMessage (card, INT2_EXT_SIGNAL, hWnd, NULL, (void *) cbfn);
...
//window message handling function
long PASCAL MainWndProc(hWnd, message, wParam, lParam)
{
    switch(message) {
        ...
        case WM_INT: //interrupt event occurring message
            ...
            break;
        ...
        case WM_DESTROY:
//Disable interrupts
        KDIO_INT1_EventMessage (card, INT1_DISABLE, hMainWnd, NULL, NULL);
        KDIO_INT2_EventMessage (card, INT2_DISABLE, hMainWnd, NULL, NULL);
//Release card
        if (card >= 0) KDIO_Release_Card(card);

```

```

PostQuitMessage(0);
break;
...
}
}
...
//call back function
LRESULT CALLBACK cbfn()
{
    ...
}

```

2. Through a Win32 wait function

Example Code Fragment

```

card = KDIO_Register_Card(KPXI-DIO-16-16, card_number);
KDIO_SetDualInterrupt(card, INT1_EXT_SIGNAL, INT2_EXT_SIGNAL, hEvent);
...
//wait for INT1 event
if (WaitForSingleObject(hEvent[0], INFINITE) == WAIT_OBJECT_0) {
    ResetEvent(hEvent[0]);
.....
}
...
//wait for INT2 event
if (WaitForSingleObject(hEvent[1], INFINITE) == WAIT_OBJECT_0) {
    ResetEvent(hEvent[1]);
.....
}
...
if (card >= 0) KDIO_Release_Card(card);

```

Continuous data transfer in KDIO-DRVR

The continuous data transfer functions in KDIO-DRVR input or output blocks of data to or from a plug-in Keithley PXI digital I/O device. For input operations, KDIO-DRVR must transfer the incoming data to a buffer in the computer memory. For output operations, KDIO-DRVR must transfer outgoing data from a buffer in the computer memory to the Keithley PXI digital I/O device. This section describes the mechanism and techniques that KDIO-DRVR uses for continuous data transfer and the considerations for selecting the continuous data transfer mode (sync. or async., double buffered or not, triggered or non-triggered mode).

Continuous data transfer mechanism

KDIO-DRVR uses two mechanisms to perform the continuous data transfer. The first one, interrupt transfer, transfers data through the interrupt mechanism. The second one is to use the DMA controller chip to perform a hardware transfer of the data. Whether KDIO-DRVR uses interrupt or DMA depends on the device. If the device support both of these two mechanisms, KDIO-DRVR decides on the data transfer method that typically takes maximum advantage of available resources.

Double-buffered / multiple-buffered DI operation

KDIO-DRVR uses double-buffering / multiple buffering techniques in its driver software for continuous input of large amounts of data.

Double/multiple buffer mode principle

The data buffer for double (multiple)-buffered continuous input operation is a circular buffer logically. It is logically divided into two equal halves. The double-buffered input begins when device starts writing data into the first half of the circular buffer (Figure A-11a). After device begins writing to the second half of the circular buffer, you can copy the data from the first half into the transfer buffer (user buffer) (Figure A-11b). You now can process the data in the transfer buffer according to application needs. After the board has filled the second half of the circular buffer, the board returns to the first half buffer and overwrites the old data. You now can copy the second half of the circular buffer to the transfer buffer (Figure A-11c). The data in the transfer buffer is again available for process. The process can be repeated endlessly to provide a continuous stream of data to your application (Figure A-11d).

Figure A-11
Double/multiple buffer mode principle

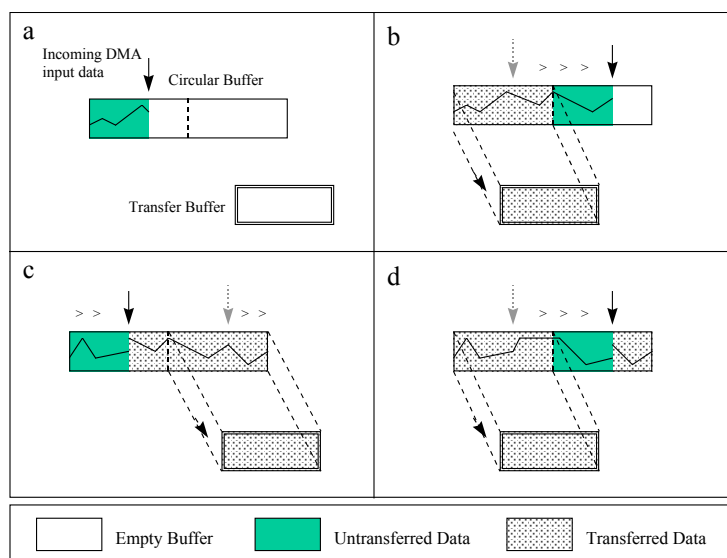

The KDIO-DRVR double buffer mode functions were designed according to the principle described above. If you use `KDIO_DI_AsyncDblBufferMode` to enable double buffer mode, the following continuous AI/DI function will perform double-buffered continuous DI. You can call `KDIO_DI_AsyncDblBufferHalfReady` to check if data in the circular buffer is half full and ready for copying to the transfer buffer. Then you can call `KDIO_DI_AsyncDblBufferTransfer` to copy data from the ready half buffer to the transfer buffer.

Single-buffered versus double (multiple)-buffered data transfer

Single-buffered data transfer is the most common method for continuous data transfer. In single-buffered input operations, a fixed number of samples are acquired at a specified rate and transferred into user's buffer. After the user's buffer stores the data, the application can analyze, display, or store the data to the hard disk for later processing. Single-buffered operations are relatively simple to implement and can usually take advantage of the full hardware speed of the device. However, the major disadvantage of single-buffered operation is that the maximum amount of data that can be input at any one time is limited to the amount of initially allocated memory allocated in driver and the amount of free memory available in the computer.

In double (multiple)-buffered operations, as mentioned above, the data buffer is configured as a circular buffer. Therefore, unlike single-buffered operations, double-buffered operations reuse the same buffer and are able to input or output an infinite number of data points without requiring an infinite amount of memory. However, there exists the undesired result of data overwritten for

double-buffered data transfer. The device might overwrite data before KDIO-DRVR has copied it to the transfer buffer. Another data overwritten problem occurs when an input device overwrites data that KDIO-DRVR is simultaneously copying to the transfer buffer. Therefore, the data must be processed by the application at least as fast as the rate at which the device is reading data. For most of the applications, this requirement depends on the speed and efficiency of the computer system and programming language.

Hence, double buffering might not be practical for high-speed input applications.

KDIO-DRVR utilities for Win32

This section introduces the tools that accompanied with the KDIO-DRVR package.

KDIO-DRVR configuration utility (configdrv)

configdrv is used for the users to **set/modify** the allocated buffer sizes of DI and DO. The default location of this utility is <InstallDir>\Util directory.

[configdrv in Windows XP/2000]

This utility is used to **set/modify** the allocated buffer sizes of DI and DO. The allocated buffer sizes of DI, DO represent the sizes of contiguous Initially Allocated memory for continuous analog input, analog output, digital input, digital output respectively. Its unit is page **KB**, i.e. 1024 bytes. Device driver will try to allocate these sizes of memory at system startup time. The size of initially allocated memory is the maximum memory size that DMA or Interrupt transfer can be performed. It will induce an unexpected result in that DMA or Interrupt transfer performed exceeds the initially allocated size.

The "Driver Configuration" window is shown as below.

Figure A-12
Driver configuration window

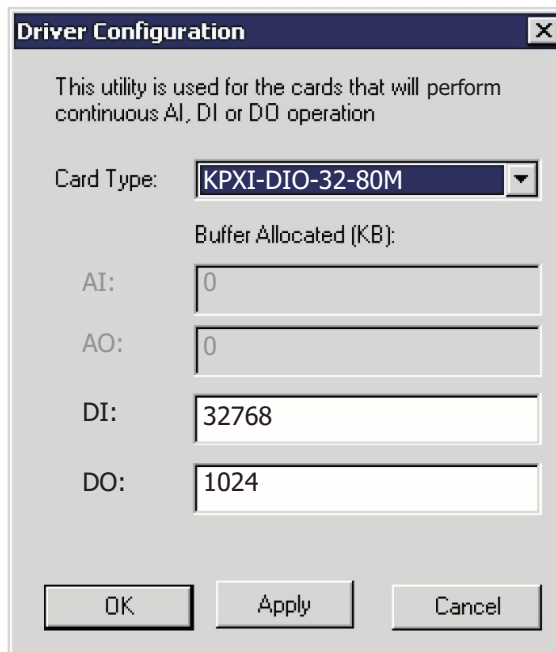

Using **configdrv** to **change the buffer allocated settings** of one of the KDIO-DRVR drivers, select the driver from the **Card Type** combo box.

Inside the allocated buffer size fields of AI, AO, DI and DO are the originally set values. Type the value in the box corresponding to AI, AO, DI, or DO according to the requirement of your applications, and then click "Apply" button.

KDIO-DRVR data file converter utility (KIDAQCvt)

The data files, generated by the KDAQ-DRVR functions performing continuous data acquisition followed by storing the data to disk, is written in binary format. Since a binary file can't be read by the normal text editor and can't be used to analyze the accessed data by Excel, KDAQ-DRVR provides a convenient tool **KIDAQCvt** to convert the binary file to the file format read easily. The default location of this utility is <InstallDir>\Util directory. The **KIDAQCvt** main window is as the following figure:

Figure A-13
DAQ File Conversion Utility

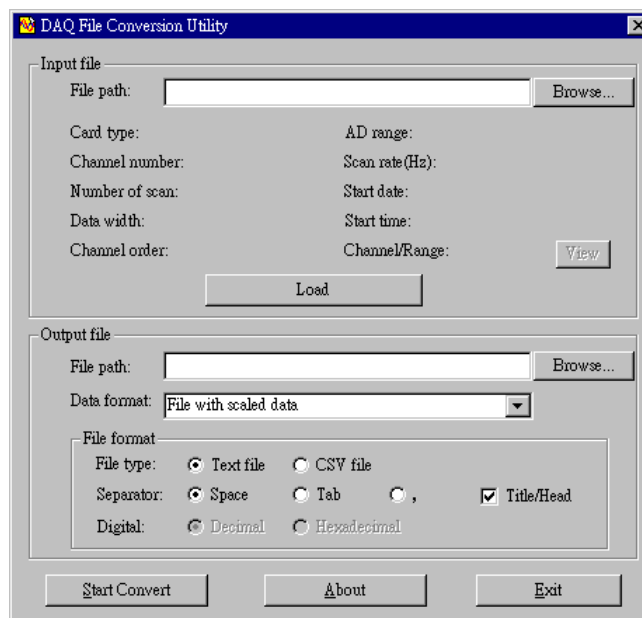

The **KIDAQCvt** main window includes two frames. The upper frame, **Input File frame** is used for the source data file and the lower frame is used for the destination file.

To **load the source binary data file**, type the binary data file name in **File Path** field or click **Browser** button to select the source file from **Input File frame**, and then click **Load** button. As the file is loaded, the information related to the data file, e.g. **data type**, **data width**, **AD Range**, ...etc., are shown in the corresponding fields in "Input File" frame, and the default converted data file path and format are also listed as the figure below.

Figure A-14
Loading source binary data file

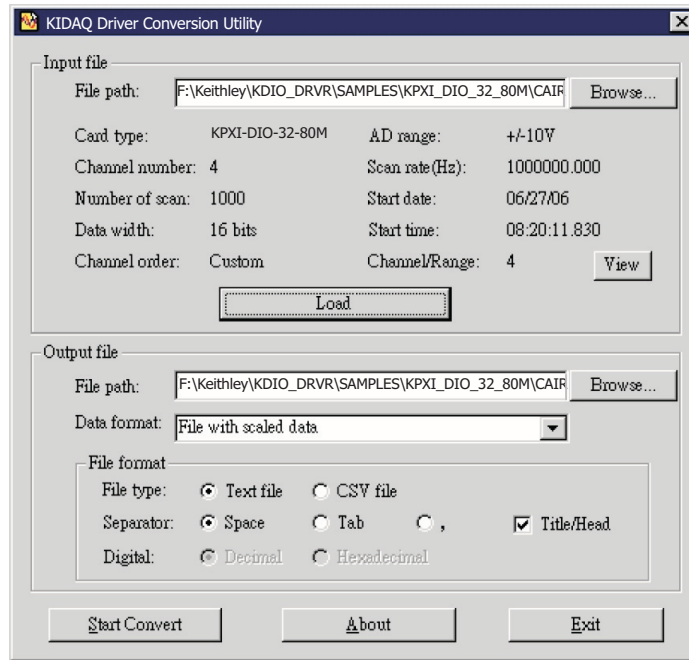

The default **destination file** with a **.cvt** extension is located in the same directory as the source one. To change the default setting, type the file path you wish or click the **Browse** button from **Output File** frame to select the destination file location.

KIDAQCvt provides three types of data format conversions:

Text file with scaled data:

The data in hexadecimal format is scaled to engineering unit (voltage, amp, etc.) according to the card type, data width and data range and then written to disk in text file format. This type is available for the data accessed from continuous AI operation only.

Binary file with scaled data:

The data in hexadecimal is scaled to engineering unit (voltage, amp, etc.) according to the card type, data width and data range and then written to disk in binary file format. This type is available for the data accessed from continuous AI operation only.

Text file with binary codes:

The data in hexadecimal format or converted to a decimal value is written to disk in text file format. If the original data includes channel information, the raw value will be handled to get the real data value. This type is available for the data accessed form continuous AI and DI operations.

The data separator in converted text file is selectable among **space**, **comma** and **Tab**.

If you want to add title/head which includes the card type information at the beginning of file, check the "Title/Head" box.

After setting the properties (File Path, Format, etc.) related to the converted file, you can push **Start Convert** button from the **Output File** frame to perform the file conversion.

This page left blank intentionally.

KDIO-DRVR Function Reference**In this appendix:**

Topic	Page
Function description	B-2
Data types.....	B-2
Function reference.....	B-2
Status Codes	B-38
Data file format	B-40
Header.....	B-40
ChannelRange.....	B-41
Data Block.....	B-42
Function Support	B-43

Function description

This section is provided as a function reference. It contains a detailed description of KDIO-DRVr functions and includes information on KDIO-DRVr [Data types](#) as well as a KDIO-DRVr [Function reference](#) (functions are arranged alphabetically in the reference). Syntax is provided for Microsoft C/C++, and Borland C++, as well as Visual Basic.

Data types

[Table B-1](#) contains data types defined in `kdiodrvr.h`. These data types are used by the KDIO-DRVr library. It is recommended these data types are used in your application programs. [Table B-1](#) contains data type names, ranges, and the corresponding data types for C/C++ and Visual Basic.

NOTE The data types in [Table B-1](#) are defined in `kdiodrvr.h`, but are not defined in `kdiodrvr.bas` (for `.bas` definition files, the table is provided only as a reference).

Table B-1
Suggested data types

Type Name	Description	Range	Type	
			C/C++ (for 32-bit compiler)	Visual Basic
U8	8-bit ASCII character	0 to 255	unsigned char	Byte
I16	16-bit signed integer	-32768 to 32767	short	Integer
U16	16-bit unsigned integer	0 to 65535	unsigned short	Not supported by this type, use the signed integer (I16) instead
I32	32-bit signed integer	-2147483648 to 2147483647	long	Long
U32	32-bit unsigned integer	0 to 4294967295	unsigned long	Not supported by this type, use the signed long integer (I32) instead
F32	32-bit single-precision floating-point	-3.402823E38 to 3.402823E38	float	Single
F64	64-bit double-precision floating-point	-1.797683134862315E308 to 1.797683134862315E309	double	Double

Function reference

KDIO-DRVr is a software driver for Keithley Instruments PXI DIO cards. It is a high performance data acquisition driver for developing custom applications.

Using KDIO-DRVr also lets you take advantage of the power and features of Microsoft Windows for your data acquisition applications. These include running multiple applications and using extended memory. Also, using KDIO-DRVr under environment makes it easy to create custom user interfaces and graphics.

KDIO_CTRL_Clear

Description Turns off the specified counter operation and sets the output of the selected counter to the specified state. This function is supported by the following models: KPXI-DIO-48

Syntax **Microsoft C/C++ and Borland C++**
 I16 KDIO_CTR_Clear (U16 CardNumber, U16 Ctr, U16 State)

Visual Basic
 KDIO_CTR_Clear (ByVal CardNumber As Integer, ByVal Ctr As Integer, ByVal State As Integer) As Integer

Parameters **CardNumber:** The card id number.
Ctr: The counter number.
 Range: 0, 1, 2 for KPXI-DIO-48
state: The logic state to which the counter is to be reset.
 Range: 0 or 1.

Return Code NoError, ErrorInvalidCardNumber, ErrorCardNotRegistered, ErrorFuncNotSupport, InvalidCounter

KDIO_CTR_Read

Description Reads the current contents of the selected counter without disturbing the counting process. This function is supported by the following models: KPXI-DIO-48

Syntax **Microsoft C/C++ and Borland C++**
 I16 KDIO_CTR_Read (U16 CardNumber, U16 Ctr, U32 *Value)

Visual Basic
 KDIO_CTR_Read (ByVal CardNumber As Integer, ByVal Ctr As Integer, Value As Long) As Integer

Parameters **CardNumber:** The card id number.
Ctr: The counter number.
 Range: 0, 1, 2 for KPXI-DIO-48
Value: Returns the current count of the specified counter.
 Range: 0 through 65536 for binary mode (default).
 0 through 9999 for BCD counting mode.

Return Code NoError, ErrorInvalidCardNumber, ErrorCardNotRegistered, ErrorFuncNotSupport, InvalidCounter

KDIO_CTR_Setup

Description Configures the selected counter to operate in the specified mode. This function is supported by the following models: KPXI-DIO-48

Syntax **Microsoft C/C++ and Borland C++**
 I16 KDIO_CTR_Setup (U16 CardNumber, U16 Ctr, U16 Mode, U32 Count, U16 BinBcd)

Visual Basic
 KDIO_CTR_Setup (ByVal CardNumber As Integer, ByVal Ctr As Integer, ByVal Mode As Integer, ByVal Count As Long, ByVal BinBcd As Integer) As Integer

Parameters

CardNumber: The card id number.

Ctr: The counter number.
Range: 0, 1, 2 for KPXI-DIO-48

Mode: The mode in which the counter is to operate. Valid values:

TOGGLE_OUTPUT
 PROG_ONE_SHOT
 RATE_GENERATOR
 SQ_WAVE_RATE_GENERATOR
 SOFT_TRIG
 HARD_TRIG

TOGGLE_OUTPUT: Toggle output from low to high on terminal count. In this mode, the output goes low after the mode set operation, and the counter begins to count down while the gate input is high. When terminal count is reached, the output goes high and remains high until the selected counter is set to a different mode. The following diagram shows the TOGGLE_OUTPUT mode timing diagram.

Figure B-1
TOGGLE_OUTPUT mode timing

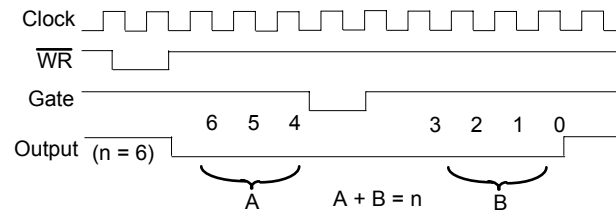

PROG_ONE_SHOT: Programmable one-shot. In this mode, the output goes low on the following rising edge of the gate input and goes high on terminal count. The following diagram shows the PROG_ONE_SHOT mode timing diagram.

Figure B-2
PROG_ONE_SHOT mode timing

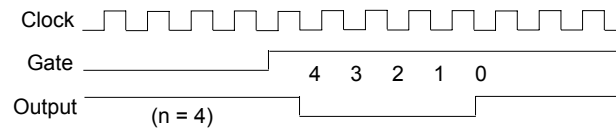

RATE_GENERATOR: Rate generator. In this mode, the output goes low for one period of the clock input. *count* indicates the period from one output pulse to the next. The following diagram shows the RATE_GENERATOR mode timing diagram.

Figure B-3
RATE_GENERATOR mode timing

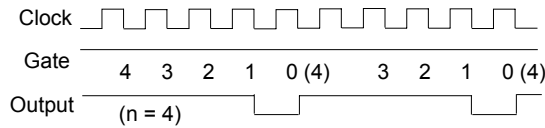

SQ_WAVE_RATE_GENERATOR: Square wave rate generator. In this mode, the output stays high for one half of the *count* clock pulses and stays low for the other half. The following diagram shows the SQ_WAVE_RATE_GENERATOR mode timing diagram.

Figure B-4
SQ_WAVE_RATE_GENERATOR mode timing

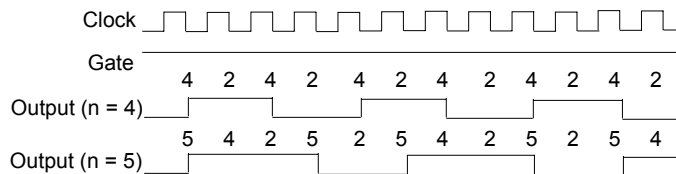

SOFT_TRIG: Software-triggered strobe. In this mode, the output is initially high, and the counter begins to count down while the gate input is high. On terminal count, the output goes low for one clock pulse, then goes high again. The following diagram shows the SOFT_TRIG mode timing diagram.

Figure B-5
SOFT_TRIG mode timing

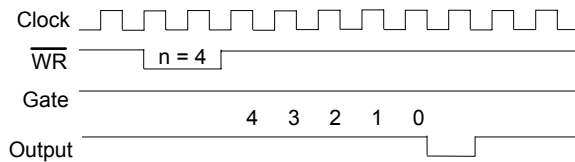

HARD_TRIG: Hardware-triggered strobe. This mode is similar to SOFT_TRIG mode except that the gate input is used as a trigger to start counting. The following diagram shows the HARD_TRIG mode timing diagram.

Figure B-6
HARD_TRIG mode timing

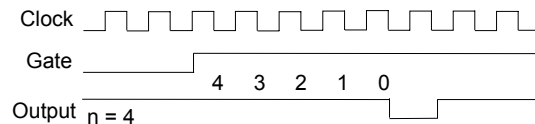

Count: The period from one output pulse to the next.

BinBcd: Whether the counter operates as a 16-bit binary counter or as a 4-decade binary-coded decimal (BCD) counter.

Valid value:

BIN: 16-bit binary counter.

BCD: 4-decade BCD counter.

Return Code NoError, ErrorInvalidCardNumber, ErrorCardNotRegistered, ErrorFuncNotSupport, InvalidCounter

KDIO_CTR_Update

Description A new initial count is written to the selected counter without affecting the counter's programmed mode. This function is supported by the following models:
KPXI-DIO-48

Syntax **Microsoft C/C++ and Borland C++**

```
I16 KDIO_CTR_Update (U16 CardNumber, U16 Ctr, U32 Count)
```

Visual Basic

```
KDIO_CTR_Update (ByVal CardNumber As Integer,  
ByVal Ctr As Integer, ByVal count As Long) As Integer
```

Parameters **CardNumber:** The card id number.

Ctr: The counter number.

Range: 0, 1, 2 for KPXI-DIO-48

count: the new count for the specified counter.
Range: 0 through 65536 for binary mode (default).
0 through 9999 for BCD counting mode.

Return Code NoError, ErrorInvalidCardNumber, ErrorCardNotRegistered, ErrorFuncNotSupport, InvalidCounter

KDIO_DI_DIO32M80_Config

Description Informs KDIO-DRVR library of the trigger source, port width, etc. selected for KPXI-DIO-32-80M card with card ID *CardNumber*. You must call this function before calling function to perform continuous digital input operation. This function is supported by the following models: KPXI-DIO-32-80M

Syntax **Microsoft C/C++ and Borland C++**

```
I16 KDIO_DI_DIO32M80_Config (U16 CardNumber, U16 PortWidth,  
U16 TrigSource, U16 WaitStatus, U16 Terminator,  
U16 I_Cntrl_Pol, BOOLEAN ClearFifo, BOOLEAN DisabledI)
```

Visual Basic

```
KDIO_DI_DIO32M80_Config (ByVal CardNumber As Integer,  
ByVal PortWidth As Integer, ByVal TrigSource As Integer,  
ByVal WaitStatus As Integer, ByVal Terminator As Integer,  
ByVal I_Cntrl_Pol As Integer, ByVal ClearFifo As Byte,  
ByVal DisabledI As Byte) As Integer
```

Parameters **CardNumber:** The card id number.

PortWidth: The width of digital input port (PORT A). The valid value is 0, 8, 16, or 32.

TrigSource: The trigger mode for continuous digital input.

Valid values:

TRIG_INT_PACER: on-board programmable pacer timer

TRIG_EXT_STROBE: external signal trigger
 TRIG_HANDSHAKE: handshaking
 TRIG_CLK_10MHz: 10MHz clock
 TRIG_CLK_20MHz: 20MHz clock

WaitStatus: DI Wait Trigger Status. Valid values are:
 DIO32M80_WAIT_NO: input sampling starts immediately
 DIO32M80_WAIT_TRG: digital input sampling waits rising or falling edge of I_TRG to start DI

Terminator: PortA Terminator On/Off. Valid values:
 DIO32M80_TERM_ON: terminator on
 DIO32M80_TERM_OFF: terminator off

I_Cntrl_Pol: The polarity configuration. This argument is an integer expression formed from one or more of the manifest constants defined in kdiodrvr.h. There are three groups of constants:

(1) DIREQ

DIO32M80_DIREQ_POS: DIREQ signal is rising edge active
 DIO32M80_DIREQ_NEG: DIREQ signal is falling edge active

(2) DIACK

DIO32M80_DIACK_POS: DIACK signal is rising edge active
 DIO32M80_DIACK_NEG: DIACK signal is falling edge active

(3) DITRIG

DIO32M80_DITRIG_POS: DITRIG signal is rising edge active
 DIO32M80_DITRIG_NEG: DITRIG signal is falling edge active

ClearFifo: FALSE: retain the FIFO data
 TRUE: clear FIFO data before perform digital input

DisableDI: FALSE: digital input operation still active after DMA transfer complete. The input data still put into FIFO

TRUE: disable digital input operation immediately when DMA transfer complete

Return Code NoError, ErrorInvalidCardNumber, ErrorCardNotRegistered, ErrorFuncNotSupport

KDIO_DI_AsyncCheck

Description Check the current status of the asynchronous digital input operation. This function is supported by the following models: KPXI-DIO-32-80M

Syntax **Microsoft C/C++ and Borland C++**

```
I16 KDIO_DI_AsyncCheck (U16 CardNumber, BOOLEAN *Stopped,
    U32 *AccessCnt)
```

Visual Basic

```
KDIO_DI_AsyncCheck (ByVal CardNumber As Integer,
    Stopped As Byte, AccessCnt As Long) As Integer
```

- Parameters**
- CardNumber:** The card id of the card that performs the asynchronous operation.
- Stopped:** Whether the asynchronous analog input operation has completed. If *Stopped* = TRUE, the digital input operation has stopped. Either the number of digital input indicated in the call that initiated the asynchronous digital input operation has completed or an error has occurred. If *Stopped* = FALSE, the operation is not yet complete. (constants TRUE and FALSE are defined in kdiodrvr.h)
- AccessCnt:** The number of digital input data that has been transferred at the time the call to `KDIO_DI_AsyncCheck()`. **AccessCnt** is of no use (always returns 0) in `KDIO_DI_AsyncCheck()` and `KDIO_DI_AsyncClear()` with **KPXI-DIO-32-80M** board because on-board chip (PLX9080) of **KPXI-DIO-32-80M** has no function or register to get the current amount of DMA transfer.
- Return Code** NoError, ErrorInvalidCardNumber, ErrorCardNotRegistered, ErrorFuncNotSupport

KDIO_DI_AsyncClear

- Description** Stop the asynchronous digital input operation. This function is supported by the following models: KPXI-DIO-32-80M
- Syntax** **Microsoft C/C++ and Borland C++**
- ```
I16 KDIO_DI_AsyncClear (U16 CardNumber, U32 *AccessCnt)
```
- Visual Basic**
- ```
KDIO_DI_AsyncClear (ByVal CardNumber As Integer,
    AccessCnt As Long) As Integer
```
- Parameters**
- CardNumber:** The card id of the card that performs the asynchronous operation.
- AccessCnt:** The number of digital input data that has been transferred at the time the call to `KDIO_DI_AsyncClear()`.
- If double-buffered mode is enabled, *AccessCnt* returns the next position after the position the last data is stored in the circular buffer. If the *AccessCnt* exceeds the half size of circular buffer, call "KIO_DI_AsyncDbfBufferTransfer" twice to get the data.
- AccessCnt** is of no use (always returns 0) in `KDIO_DI_AsyncCheck()` and `KDIO_DI_AsyncClear()` with **KPXI-DIO-32-80M** board because on-board chip (PLX9080) of **KPXI-DIO-32-80M** has no function or register to get the current amount of DMA transfer.
- Return Code** NoError, ErrorInvalidCardNumber, ErrorCardNotRegistered, ErrorFuncNotSupport

KDIO_DI_AsyncDbfBufferOverrun

- Description** Checks or clears overrun status of the double-buffered/multi-buffered digital input operation. This function is supported by the following models: KPXI-DIO-32-80M
- Syntax** **Microsoft C/C++ and Borland C++**
- ```
I16 KDIO_DI_AsyncDbfBufferOverrun (U16 CardNumber, U16 op,
 U16 *overrunFlag)
```

**Visual Basic**

```
KDIO_DI_AsyncDblBufferOverrun (ByVal CardNumber As Integer,
 ByVal op As Integer, overrunFlag As Integer) As Integer
```

**Parameters**

**CardNumber:** The card id of the card that double-buffered mode to be set.

**op:** check/clear overrun status/flag.  
0: check the overrun status.  
1: clear the overrun flag.

**overrunFlag:** returned overrun status  
0: no overrun occurs.  
1: overrun occurs.

**Return Code** NoError, ErrorInvalidCardNumber, ErrorCardNotRegistered, ErrorFuncNotSupport

**KDIO\_DI\_AsyncDblBufferTransfer**

**Description** Depending on the continuous DI function selected, half of the data of the circular buffer will be logged into the user buffer (if continuous DI function is: *KDIO\_DI\_ContReadPort*) or a disk file (if continuous DI function is: *KDIO\_DI\_ContReadPortToFile*). If the data will be saved in a file, the data is written to disk in binary format, with the lower byte first (little endian).

You can execute this function repeatedly to return sequential half buffers of the data.

For *KPXI-DIO-32-80M*, *KDIO\_DI\_AsyncDblBufferTransfer* **doesn't perform memory transfer** but notifies *kdiodrvr.dll* the data stored in buffer have been handled.

This function is supported by the following models: KPXI-DIO-32-80M

**Syntax** **Microsoft C/C++ and Borland C++**

```
I16 KDIO_DI_AsyncDblBufferTransfer (U16 CardNumber,
 void *Buffer)
```

**Visual Basic**

```
KDIO_DI_AsyncDblBufferTransfer (ByVal CardNumber As Integer,
 Buffer As Any) As Integer
```

**Parameters**

**CardNumber:** The card id of the card that performs the asynchronous double-buffered operation.

**Buffer:** The user buffer to which the data is to be copied. If the data will be saved into a disk file, this argument is of no use.

**Return Code** NoError, ErrorInvalidCardNumber, ErrorCardNotRegistered, ErrorFuncNotSupport, ErrorNotDoubleBufferMode

**KDIO\_DI\_AsyncMultiBufferNextReady**

**Description** Checks whether the next buffer of data in circular buffer is ready for transfer during an asynchronous multi-buffered digital input operation. The returned *BufferId* is the index of the most recently available (newest available) buffer. This function is supported by the following models: KPXI-DIO-32-80M

**Syntax**      **Microsoft C/C++ and Borland C++**

```
I16 KDIO_DI_AsyncMultiBufferNextReady (U16 CardNumber,
 BOOLEAN *NextReady, U16 *BufferId)
```

**Visual Basic**

```
KDIO_DI_AsyncMultiBufferNextReady (
 ByVal CardNumber As Integer, NextReady As Byte,
 BufferId As Integer) As Integer
```

**CardNumber:** The card id of the card that performs the asynchronous multi-buffered operation.

**NextReady:** Whether the next buffer of data is available. If NextReady = TRUE, you can handle the data in the buffer. (constants TRUE and FALSE are defined in kdiodrvr.h)

**BufferId:** Returns the index of the ready buffer.

**Return Code**    NoError, ErrorInvalidCardNumber, ErrorCardNotRegistered, ErrorFuncNotSupport

### KDIO\_DI\_ContMultiBufferSetup

**Description**    This function set up the buffer for multi-buffered digital input. The function has to be called repeatedly to setup all of the data buffers (at most 8 buffers). This function is supported by the following models: KPXI-DIO-32-80M

**Syntax**      **Microsoft C/C++ and Borland C++**

```
I16 KDIO_DI_ContMultiBufferSetup (U16 CardNumber,
 void *Buffer, U32 ReadCount, U16 *BufferId)
```

#### Visual Basic

```
KDIO_DI_ContMultiBufferSetup (ByVal CardNumber As Integer,
 Buffer As Any, ByVal ReadCount As Long,
 BufferId As Integer) As Integer
```

**Parameters**    **CardNumber:** The card id number.

**Buffer:** The starting address of the memory to contain the input data.

**ReadCount:** The size (in samples) of the buffer and its value must be even.

**BufferId:** Returns the index of the buffer currently set up.

**Return Code**    NoError, ErrorInvalidCardNumber, ErrorCardNotRegistered, ErrorFuncNotSupport, ErrorTransferCountTooLarge, ErrorContIoNotAllowed

### KDIO\_DI\_ContMultiBufferStart

**Description**    This function starts multi-buffered continuous digital input on the specified digital input port at a rate as close to the rate you specified. This function is supported by the following models: KPXI-DIO-32-80M

**Syntax**      **Microsoft C/C++ and Borland C++**

```
I16 KDIO_DI_ContMultiBufferStart (U16 CardNumber, U16 Port,
 F64 SampleRate)
```

**Visual Basic**

```
KDIO_DI_ContMultiBufferStart (ByVal CardNumber As Integer,
 ByVal Port As Integer, ByVal SampleRate As Double)
 As Integer
```

- Parameters**
- CardNumber:** The card id number.
  - Port:** Digital input port number. For KPXI-DIO-32-80M, this argument must be set to 0.
  - SampleRate:** The sampling rate you want for digital input in hertz (samples per second). Your maximum rate depends on the card type and your computer system. This argument is only useful if the DI trigger mode was set as internal programmable pacer (TRIG\_INT\_PACER) by calling **KDIO\_DI\_DIO32M80\_Config()**.
- Return Code** NoError, ErrorInvalidCardNumber, ErrorCardNotRegistered, ErrorFuncNotSupport, ErrorInvalidIoChannel, ErrorContIoNotAllowed

**KDIO\_DI\_ContReadPort**

**Description** This function performs continuous digital input on the specified digital input port at a rate as close to the rate you specified. This function is supported by the following models: KPXI-DIO-32-80M

**Syntax** **Microsoft C/C++ and Borland C++**

```
I16 KDIO_DI_ContReadPort (U16 CardNumber, U16 Port,
 void *Buffer, U32 ReadCount, F64 SampleRate, U16 SyncMode)
```

**Visual Basic**

```
KDIO_DI_ContReadPort (ByVal CardNumber As Integer,
 ByVal Port As Integer, Buffer As Any,
 ByVal ReadCount As Long, ByVal SampleRate As Double,
 ByVal SyncMode As Integer) As Integer
```

- Parameters**
- CardNumber:** The card id number.
  - Port:** Digital input port number. For KPXI-DIO-32-80M, this argument must be set to 0.
  - Buffer:** The starting address of the memory to contain the input data. This memory must have been allocated for enough space to store input data. If double-buffered mode is enabled, this buffer is of no use, you can ignore this argument.
  - ReadCount:** If double-buffered mode is disabled, *ReadCount* is the number of input operations to be performed. For double-buffered acquisition, *ReadCount* is the size (in samples) of the circular buffer and its value must be even.
  - SampleRate:** The sampling rate you want for digital input in hertz (samples per second). Your maximum rate depends on the card type and your computer system. This argument is only useful if the DI trigger mode was set as internal programmable pacer (TRIG\_INT\_PACER) by calling **KDIO\_DI\_DIO32M80\_Config()**. For the other settings, you have to set this argument as **CLKSRC\_EXT\_SampRate**.
  - SyncMode:** Whether this operation is performed synchronously or asynchronously.

Valid values:

SYNCH\_OP: synchronous digital input, that is, the function does not return until the digital input operation complete.

ASYNCH\_OP: asynchronous digital input operation

**Return Code** NoError, ErrorInvalidCardNumber, ErrorCardNotRegistered, ErrorFuncNotSupport, ErrorInvalidIoChannel, ErrorTransferCountTooLarge, ErrorContIoNotAllowed

## KDIO\_DI\_ContReadPortToFile

**Description** This function performs continuous digital input on the specified digital input port at a rate as close to the rate you specified and saves the acquired data in a disk file. The data is written to disk in binary format, with the lower byte first (little endian). See [“Data file format” on page B-40 for more information](#). This function is supported by the following models: KPXI-DIO-32-80M

**Syntax** **Microsoft C/C++ and Borland C++**

```
I16 KDIO_DI_ContReadPortToFile (U16 CardNumber, U16 Port,
 U8 *FileName, U32 ReadCount, F64 SampleRate, U16 SyncMode)
```

### Visual Basic

```
KDIO_DI_ContReadPortToFile (ByVal CardNumber As Integer,
 ByVal Port As Integer, ByVal FileName As String,
 ByVal ReadCount As Long, ByVal SampleRate As Double,
 ByVal SyncMode As Integer) As Integer
```

**Parameters** **CardNumber:** The card id number.

**Port:** Digital input port number. For KPXI-DIO-32-80M, this argument must be set to 0.

**FileName:** Name of data file which stores the acquired data

**ReadCount:** If double-buffered mode is disabled, *ReadCount* is the number of input operations to be performed. For double-buffered acquisition, *ReadCount* is the size (in samples) of the circular buffer and its value must be even.

**SampleRate:** The sampling rate you want for digital input in hertz (samples per second). Your maximum rate depends on the card type and your computer system. This argument is only useful if the DI trigger mode was set as internal programmable pacer (TRIG\_INT\_PACER) by calling **KDIO\_DI\_DIO32M80\_Config()**. For the other settings, you have to set this argument as CLKSRC\_EXT\_SampRate.

**SyncMode:** Whether this operation is performed synchronously or asynchronously.

Valid values:

SYNCH\_OP: synchronous digital input, that is, the function does not return until the digital input operation complete.

ASYNCH\_OP: asynchronous digital input operation

**Return Code** NoError, ErrorInvalidCardNumber, ErrorCardNotRegistered, ErrorFuncNotSupport, ErrorInvalidIoChannel, ErrorInvalidSampleRate, ErrorTransferCountTooLarge , ErrorContIoNotAllowed

### KDIO\_DI\_ContStatus

**Description** While performing continuous DI conversions, this function is called to get the DI status. Please refer to the manual for your device for the DI status the device might meet. This function is supported by the following models: KPXI-DIO-32-80M

**Syntax** **Microsoft C/C++ and Borland C++**

```
I16 KDIO_DI_ContStatus (U16 CardNumber, U16 *Status)
```

#### Visual Basic

```
KDIO_DI_ContStatus (ByVal CardNumber As Integer, Status Integer) As Integer
```

**Parameters** **CardNumber:** The card id number.

**Status:** The continuous DI status returned. The description of the parameter *Status* for various card types is the following:

KPXI-DIO-32-80M:

bit 0: '1' indicates DI FIFO is full during input sampling and some data were lost.

bit 1: '1' indicates DI FIFO is full

bit 2: '1' indicates DI FIFO is empty

bit 3 ~ 15: not used

**Return Code** NoError, ErrorInvalidCardNumber, ErrorCardNotRegistered

### KDIO\_DI\_EventCallback

**Description** Controls and notifies the user's application when a specified DAQ event occurs. The notification is performed through a user-specified callback function. The event message will be removed automatically after calling *KDIO\_DI\_Async\_Clear*. The event message can also be manually removed by set the parameter "mode" to 0. This function is supported by the following models: KPXI-DIO-32-80M

**Syntax** **Microsoft C/C++ and Borland C++**

```
I16 KDIO_DI_EventCallback (U16 CardNumber, I16 mode, I16 EventType, U32 callbackAddr)
```

#### Visual Basic

```
KDIO_DI_EventCallback (ByVal CardNumber As Integer, ByVal mode As Integer, ByVal EventType As Integer, ByVal callbackAddr As Long) As Integer
```

**Parameters**    **CardNumber:** The card id of the card that want to be performed this operation.  
**mode:**        add or remove the event message.

Valid values:  
0: remove  
1: add

**EventType:** event criteria. Valid values:

*DIEnd:* Notification for the completeness of asynchronous digital input operation

*DBEvent:* Notification for the next half buffer of data in circular buffer is ready for transfer

**callbackAddr:** the address of the user callback function. KDIO-DRVR calls this function when the specified event occurs. If you wish to remove the event message, set *callbackAddr* to 0.

**Return Code**    NoError, ErrorInvalidCardNumber, ErrorCardNotRegistered, ErrorFuncNotSupport

### KDIO\_DI\_InitialMemoryAllocated

**Description**    This function returns the mapped buffer address of the memory allocated in the driver for continuous DI operation at system startup time. The size of the allocated memory can be got by using the function ***KDIO\_DI\_InitialMemoryAllocated***. This function is supported by the following models: KPXI-DIO-32-80M

**Syntax**         **Microsoft C/C++ and Borland C++**

```
I16 KDIO_DI_InitialMemoryAllocated (U16 CardNumber,
 U32 *MemSize)
```

#### Visual Basic

```
KDIO_DI_InitialMemoryAllocated (ByVal CardNumber As Integer,
 MemSize As Long) As Integer
```

**Parameters**    **CardNumber:** The card id number.  
**MemSize:**      The available memory size for continuous DI in device driver of this card. The unit is KB (1024 bytes).

**Return Code**    NoError, ErrorInvalidCardNumber, ErrorCardNotRegistered

### KDIO\_DI\_ReadLine

**Description**    Read the digital logic state of the specified digital line in the specified port. This function is supported by the following models: KPXI-DIO-16-16, KPXI-DIO-48, KPXI-RDI-8-16, KPXI-DIO-32-80M, KPXI-DIO-32-32, KPXI-DIO-64-0

**Syntax**         **Microsoft C/C++ and Borland C++**

```
I16 DI_ReadLine (U16 CardNumber, U16 Port, U16 Line,
 U16 *State)
```



**Visual Basic**

DI\_ReadLine (ByVal CardNumber As Integer,  
 ByVal Port As Integer, ByVal Line As Integer,  
 State As Integer) As Integer

**Parameters**

**CardNumber:** The card id number.

**Port:** Digital input port number. Valid values:

*KPXI-DIO-16-16:* 0

*KPXI-DIO-48:*

Channel\_P1A, Channel\_P1B,  
 Channel\_P1C, Channel\_P1CL,  
 Channel\_P1CH, Channel\_P2A,  
 Channel\_P2B, Channel\_P2C,  
 Channel\_P2CL, Channel\_P2CH

*KPXI-RDI-8-16:* 0

*KPXI-DIO-32-80M:* 1 (auxiliary input port)

*KPXI-DIO-32-32:* 0

*KPXI-DIO-64-0:* PORT\_DI\_LOW, PORT\_DI\_HIGH

**Line:** The digital line to be read. Valid values:

*KPXI-DIO-16-16:* 0 through 15  
*KPXI-DIO-48:* 0 through 7  
*KPXI-RDI-8-16:* 0 through 15  
*KPXI-DIO-32-80M:* 0 through 3  
*KPXI-DIO-32-32:* 0 through 31  
*KPXI-DIO-64-0:* 0 through 31

**State:** Returns the digital logic state, 0 or 1, of the specified line.

**Return Code** NoError, ErrorInvalidCardNumber, ErrorCardNotRegistered,  
 ErrorFuncNotSupport, ErrorInvalidIoChannel

**KDIO\_DI\_ReadPort**

**Description** Read digital data from the specified digital input port. This function is supported by the following models: KPXI-DIO-16-16, KPXI-DIO-48, KPXI-RDI-8-16, KPXI-DIO-32-80M, KPXI-DIO-32-32, KPXI-DIO-64-0, KPXI-DIO-0-64

**Syntax** **Microsoft C/C++ and Borland C++**

I16 KDIO\_DI\_ReadPort (I16 CardNumber, U16 Port, U32 \*Value)

**Visual Basic**

KDIO\_DI\_ReadPort (ByVal CardNumber As Integer,  
 ByVal Port As Integer, Value As Long) As Integer

**Parameters**    **CardNumber:** The card id number.

**Port:**        Digital input port number. Valid values:

*KPXI-DIO-16-16:* 0

*KPXI-DIO-48:*  
Channel\_P1A, Channel\_P1B,  
Channel\_P1C, Channel\_P1CL,  
Channel\_P1CH, Channel\_P2A,  
Channel\_P2B, Channel\_P2C,  
Channel\_P2CL, Channel\_P2CH

*KPXI-RDI-8-16:* 0

*KPXI-DIO-32-80M:* 1 (auxiliary digital input port)

*KPXI-DIO-32-32:* 0, DIO32I32O\_DI\_SLOT

*KPXI-DIO-64-0:*  
PORT\_DI\_LOW  
PORT\_DI\_HIGH  
DIO64I\_DI\_SLOT

*KPXI-DIO-0-64:* DIO64O\_DI\_SLOT

**NOTE**    *The value, Channel\_Pn, for argument Port is defined as all of the ports (Port A, B and C) in channel n.*

**Value:** Returns the digital data read from the specified port.  
 KPXI-DIO-16-16: 16-bit data  
 KPXI-DIO-48: 8-bit data  
 KPXI-RDI-8-16: 16-bit data  
 KPXI-DIO-32-80M: 4-bit data  
 KPXI-DIO-32-32: 32-bit data  
 KPXI-DIO-64-0: 32-bit data  
 KPXI-DIO-0-64: 32-bit data

**NOTE**    *The data format for Channel\_Pn is as follows:*

Table B-2

**Channel\_Pn data format**

| Channel_Pn | Don't care | PORT C  | PORT B | PORT A |
|------------|------------|---------|--------|--------|
| Bit        | 31 - 24    | 23 - 16 | 15 - 8 | 7 - 0  |

**Return Code**    NoError, CardNotRegistered, ErrorInvalidCardNumber, ErrorCardNotRegistered, ErrorFuncNotSupport

### **KDIO\_DIO32M80\_SetInterrupt**

**Description**    This function controls the interrupt sources (AuxDI0 and Timer 2) of local interrupt system of KPXI-DIO-32-80M and returns the two interrupt events. If an interrupt is generated, the corresponding interrupt event will be signaled. The application can use Win32 wait functions, such as WaitForSingleObject or WaitForMultipleObjects

to check the interrupt event status. This function is supported by the following models: KPXI-DIO-32-80M

**Syntax**      **Microsoft C/C++ and Borland C++**

```
I16 KDIO_ DIO32M80_SetInterrupt (U16 CardNumber,
 I16 AuxDIEn, I16 T2En, HANDLE *hEvent)
```

**Visual Basic**

```
KDIO_ DIO32M80_SetInterrupt (ByVal CardNumber As Integer,
 ByVal AuxDIEn As Integer, ByVal T2En As Integer,
 hEvent As Long) As Integer
```

**Parameters**      **CardNumber:** The card id of the card that want to be performed this operation.

**AuxDIEn:** The control value for AUXDI interrupt. Valid values:  
 0: disabled  
 1: enabled

**T2En:** The control value for Timer2 interrupt. Valid values:  
 0: disabled  
 1: enabled

**hEvent (Win32 Only):** The local interrupt event handles returned. The status of the interrupt event indicates that an interrupt is generated or not.

**Return Code**      NoError, ErrorInvalidCardNumber, ErrorCardNotRegistered, ErrorFuncNotSupport

**KDIO\_AUXDI\_EventMessage (Win32 Only)**

**Description**      Controls the AUXDI interrupt and notifies the user's application when an interrupt event occurs. The notification is performed through a user-specified callback function or the Windows PostMessage API. This function is supported by the following models: KPXI-DIO-32-80M

**Syntax**      **Microsoft C/C++ and Borland C++**

```
I16 KDIO_AUXDI_EventMessage (U16 CardNumber, I16 AuxDIEn,
 HANDLE windowHandle, U32 message, void *callbackAddr())
```

**Visual Basic**

```
KDIO_ AUXDI _EventMessage (ByVal CardNumber As Integer,
 ByVal AuxDIEn As Integer, ByVal windowHandle As Long,
 ByVal message As Long, ByVal callbackAddr As Long)
 As Integer
```

- Parameters**
- CardNumber:** The card id of the card that want to be performed this operation.
  - AuxDIEn:** The control value for AUXDI interrupt. Valid values:
    - 0: disabled
    - 1: enabled
  - windowHandle:** The handle to the window you want to receive a Windows message in when the specified AUXDI event happens. If *windowHandle* is 0, no Windows messages are sent.
  - message:** a message you define. When the specified AUXDI event happens, KDIO-DRVR passes *message* back to you. *message* can be any value.
- In Windows, you can set *message* to a value including any Windows predefined messages (such as WM\_PAINT). However, to define your own message, you can use any value ranging from WM\_USER (0x400) to 0x7fff. This range is reserved by Microsoft for messages you define.
- callbackAddr:** address of the user callback function. KDIO-DRVR calls this function when the specified AUXDI event occurs. If you do not want to use a callback function, set *callbackAddr* to 0.
- Return Code** NoError, ErrorInvalidCardNumber, ErrorCardNotRegistered, ErrorFuncNotSupport

### KDIO\_INT\_EventMessage (Win32 Only)

- Description** Control and notifies the user's application when a specified interrupt event occurs. The notification is performed through a user-specified callback function or the Windows PostMessage API.

When a new event message is added, it will keep active until you call this function by setting 0 to the argument "mode" to remove the specified interrupt event message. To remove a specified message, make sure to provide the event handle to be notified for the message.

This function is supported by the following models:  
 KPXI-DIO-16-16, KPXI-DIO-48, KPXI-DIO-32-32, KPXI-DIO-64-0

- Syntax** **Microsoft C/C++ and Borland C++**

```
I16 KDIO_INT_EventMessage (U16 CardNumber, I16 mode,
 HANDLE evt, HANDLE windowHandle, U32 message,
 U32 callbackAddr)
```

#### Visual Basic

```
KDIO_INT_EventMessage (ByVal CardNumber As Integer,
 ByVal mode As Integer, ByVal evt As Long,
 ByVal windowHandle As Long, ByVal message As Long,
 ByVal callbackAddr As Long) As Integer
```

**Parameters**

**CardNumber:** The card id of the card that want to be performed this operation.

**mode:** The operation mode of adding or removing message:

- 0: remove an existing message interrupt event defined argument *evt*.
- 1: add a new message for a interrupt event defined argument *evt*

**evt:** The **handle of the INT event** wishing to handle.

**windowHandle:** The handle to the window you want to receive a Windows message in when the specified INT event happens. If *windowHandle* is 0, no Windows messages are sent.

**message:** a message you define. When the specified INT event happens, KDIO-DRVR passes *message* back to you. *message* can be any value.

In Windows, you can set *message* to a value including any Windows predefined messages (such as WM\_PAINT). However, to define your own message, you can use any value ranging from WM\_USER (0x400) to 0x7fff. This range is reserved by Microsoft for messages you define.

**callbackAddr:** address of the user callback function. KDIO-DRVR calls this function when the specified INT event occurs. If you do not want to use a callback function, set *callbackAddr* to 0.

**Return Code** NoError, ErrorInvalidCardNumber, ErrorCardNotRegistered, ErrorFuncNotSupport

### KDIO\_INT1\_EventMessage (Win32 Only)

**Description** Controls the interrupt sources of INT1 of Dual Interrupt system and notifies the user's application when an interrupt event occurs. The notification is performed through a user-specified callback function or the Windows PostMessage API. This function is supported by the following models:  
 KPXI-DIO-16-16, KPXI-DIO-48, KPXI-DIO-32-32, KPXI-DIO-64-0

**Syntax** **Microsoft C/C++ and Borland C++**

```
I16 KDIO_INT1_EventMessage (U16 CardNumber, I16 Int1Mode,
 HANDLE windowHandle, U32 message, void *callbackAddr())
```

**Visual Basic**

```
KDIO_INT1_EventMessage (ByVal CardNumber As Integer,
 ByVal Int1Mode As Integer, ByVal windowHandle As Long,
 ByVal message As Long, ByVal callbackAddr As Long)
 As Integer
```

**Parameters**

**CardNumber:** The card id of the card that want to be performed this operation.

**Int1Mode:** The interrupt mode of INT1. The valid values:

- KPXI-DIO-48:*
- INT1\_DISABLE: INT1 Disabled
- INT1\_FP1C0: INT1 by Falling edge of P1C0

INT1\_RP1C0\_FP1C3: INT1 by P1C0 Rising or P1C3 Falling  
 INT1\_EVENT\_COUNTER: INT1 by Event Counter down to zero

*KPXI-DIO-16-16/KPXI-DIO-32-32/KPXI-DIO-64-0:*

INT1\_DISABLE: INT1 Disabled

INT1\_EXT\_SIGNAL: INT1 by External Signal

**windowHandle:** The handle to the window you want to receive a Windows message in when the specified INT1 event happens. If *windowHandle* is 0, no Windows messages are sent.

**message:** a message you define. When the specified INT1 event happens, KDIO-DRVR passes *message* back to you. *message* can be any value.

In Windows, you can set *message* to a value including any Windows predefined messages (such as WM\_PAINT). However, to define your own message, you can use any value ranging from WM\_USER (0x400) to 0x7fff. This range is reserved by Microsoft for messages you define.

**callbackAddr:** address of the user callback function. KDIO-DRVR calls this function when the specified INT1 event occurs. If you do not want to use a callback function, set *callbackAddr* to 0.

**Return Code** NoError, ErrorInvalidCardNumber, ErrorCardNotRegistered, ErrorFuncNotSupport

## KDIO\_INT2\_EventMessage (Win32 Only)

**Description** Controls the interrupt sources of INT2 of Dual Interrupt system and notifies the user's application when an interrupt event occurs. The notification is performed through a user-specified callback function or the Windows PostMessage API. This function is supported by the following models: KPXI-DIO-16-16, KPXI-DIO-48, KPXI-DIO-32-32, KPXI-DIO-64-0

**Syntax** **Microsoft C/C++ and Borland C++**

```
I16 KDIO_INT2_EventMessage (U16 CardNumber, I16 Int2Mode,
 HANDLE windowHandle, U32 message, void *callbackAddr())
```

### Visual Basic

```
KDIO_INT2_EventMessage (ByVal CardNumber As Integer,
 ByVal Int2Mode As Integer, ByVal windowHandle As Long,
 ByVal message As Long, ByVal callbackAddr As Long)
 As Integer
```

**Parameters** **CardNumber:** The card id of the card that want to be performed this operation.

**Int2Mode:** The interrupt mode of INT2. Valid values:

*KPXI-DIO-48:*

INT2\_DISABLE: INT2 Disabled

INT2\_FP2C0: INT2 by Falling edge of P2C0

INT2\_RP2C0\_FP2C3: INT2 by P2C0 Rising or P2C3 Falling  
 INT2\_TIMER\_COUNTER: INT2 by Timer Counter down to zero

*KPXI-DIO-16-16/KPXI-DIO-32-32/KPXI-DIO-64-0:*

INT2\_DISABLE: INT2 Disabled

INT2\_EXT\_SIGNAL: INT2 by External Signal

**windowHandle:** The handle to the window you want to receive a Windows message in when the specified INT2 event happens. If *windowHandle* is 0, no Windows messages are sent.

**message:** a message you define. When the specified INT2 event happens, KDIO-DRVR passes *message* back to you. *message* can be any value.

In Windows, you can set *message* to a value including any Windows predefined messages (such as WM\_PAINT). However, to define your own message, you can use any value ranging from WM\_USER (0x400) to 0x7fff. This range is reserved by Microsoft for messages you define.

**callbackAddr:** address of the user callback function. KDIO-DRVR calls this function when the specified INT2 event occurs. If you do not want to use a callback function, set *callbackAddr* to 0.

**Return Code** NoError, ErrorInvalidCardNumber, ErrorCardNotRegistered, ErrorFuncNotSupport

### KDIO\_PortConfig

**Description** Informs KDIO-DRVR library of the port selected and the direction (Input or output) setting of the selected port. This function is supported by the following models: KPXI-DIO-48

**Syntax** **Microsoft C/C++ and Borland C++**

I16 DIO\_PortConfig (U16 CardNumber, U16 Port, U16 Direction)

#### Visual Basic

DIO\_PortConfig (ByVal CardNumber As Integer,  
 ByVal Port As Integer, ByVal Direction As Integer)  
 As Integer

**Parameters** **CardNumber:** The card id number.

**Port:** The port selected. Valid values:

*KPXI-DIO-48:*  
 Channel\_P1A, Channel\_P1B,  
 Channel\_P1C, Channel\_P1CL  
 Channel\_P1CH, Channel\_P2A,  
 Channel\_P2B, Channel\_P2C,  
 Channel\_P2CL, Channel\_P2CH

**NOTE** *Value, Channel\_Pn, for argument Port is defined as all of the ports (Port A, B and C) in channel n.*

**NOTE** If the port argument of `KDIO_PortConfig` is set to `Channel_PnE`, the channel *n* will be configured as `INPUT_PORT` (the argument `Direction` is of no use here) and the digital input of channel *n* is controlled by external clock.

**Direction:** The port direction of PIO port. Valid values:  
`INPUT_PORT`  
`OUTPUT_PORT`

**Return Code** `NoError`, `ErrorInvalidCardNumber`, `ErrorCardNotRegistered`,  
`ErrorFuncNotSupport`, `ErrorInvalidIoChannel`

## KDIO\_SetDualInterrupt

**Description** This function informs KDIO-DRVR library of the interrupt mode of two interrupt sources of dual-interrupt system and returns dual interrupt events. If an interrupt is generated, the corresponding interrupt event will be signaled. The application can use Win32 wait functions, such as `WaitForSingleObject` or `WaitForMultipleObjects` to check the interrupt event status. This function is supported by the following models: `KPXI-DIO-16-16`, `KPXI-DIO-48`, `KPXI-DIO-32-32`, `KPXI-DIO-64-0`

**Syntax** **Microsoft C/C++ and Borland C++**

```
I16 KDIO_SetDualInterrupt (U16 CardNumber, I16 Int1Mode,
 I16 Int2Mode, HANDLE *hEvent)
```

### Visual Basic

```
KDIO_SetDualInterrupt (ByVal CardNumber As Integer,
 ByVal Int1Mode As Integer, ByVal Int2Mode As Integer,
 hEvent As Long) As Integer
```

**Parameters** **CardNumber:** The card id of the card that want to be performed this operation.

**Int1Mode:** The interrupt mode of INT1. Valid values:

*KPXI-DIO-48:*

`INT1_DISABLE`: INT1 Disabled  
`INT1_FP1C0`: INT1 by Falling edge of P1C0  
`INT1_RP1C0_FP1C3`: INT1 by P1C0 Rising or P1C3 Falling  
`INT1_EVENT_COUNTER`: INT1 by Event Counter down to zero

*KPXI-DIO-16-16/KPXI-DIO-32-32/KPXI-DIO-64-0:*

`INT1_DISABLE`: INT1 Disabled  
`INT1_EXT_SIGNAL`: INT1 by External Signal

**Int2Mode:** The interrupt mode of INT2. Valid values:

*KPXI-DIO-48:*

`INT2_DISABLE`: INT2 Disabled  
`INT2_FP2C0`: INT2 by Falling edge of P2C0  
`INT2_RP2C0_FP2C3`: INT2 by P2C0 Rising or P2C3 Falling  
`INT2_TIMER_COUNTER`: INT2 by Timer Counter down to zero

*KPXI-DIO-16-16/KPXI-DIO-32-32/KPXI-DIO-64-0:*

`INT2_DISABLE`: INT2 Disabled  
`INT2_EXT_SIGNAL`: INT2 by External Signal

**hEvent (Win32 only):** dual interrupt event handles returned. The status of a dual interrupt event indicates that an interrupt is generated or not for the cards



comprising dual interrupts system (KPXI-DIO-16-16, KPXI-DIO-48, KPXI-DIO-32-32, and KPXI-DIO-64-0).

**Return Code** NoError, ErrorInvalidCardNumber, ErrorCardNotRegistered, ErrorFuncNotSupport

### KDIO\_T2\_EventMessage (Win32 Only)

**Description** Controls the Timer2 interrupt and notifies the user's application when an interrupt event occurs. The notification is performed through a user-specified callback function or the Windows PostMessage API. This function is supported by the following models: KPXI-DIO-32-80M

**Syntax** **Microsoft C/C++ and Borland C++**

```
I16 KDIO_T2_EventMessage (U16 CardNumber, I16 T2En,
 HANDLE windowHandle, U32 message, void *callbackAddr())
```

#### Visual Basic

```
KDIO_T2_EventMessage (ByVal CardNumber As Integer,
 ByVal T2En As Integer, ByVal windowHandle As Long,
 ByVal message As Long, ByVal callbackAddr As Long)
 As Integer
```

**Parameters** **CardNumber:** The card id of the card that want to be performed this operation.

**T2En:** The control value for Timer2 interrupt.

Valid values:

0: disabled

1: enabled

**windowHandle:** The handle to the window you want to receive a Windows message in when the specified Timer2 event happens. If *windowHandle* is 0, no Windows messages are sent.

**message:** A user definable message. When the specified Timer2 event happens, KDIO-DRVR passes *message* back to you. *message* can be any value.

In Windows, you can set *message* to a value including any Windows predefined messages (such as WM\_PAINT). However, to define your own message, you can use any value ranging from WM\_USER (0x400) to 0x7fff. This range is reserved by Microsoft for messages you define.

**callbackAddr:** address of the user callback function. KDIO-DRVR calls this function when the specified Timer2 event occurs. If you do not want to use a callback function, set *callbackAddr* to 0.

**Return Code** NoError, ErrorInvalidCardNumber, ErrorCardNotRegistered, ErrorFuncNotSupport

### KDIO\_DO\_DIO32M80\_Config

**Description** Informs KDIO-DRVR library of the trigger source, port width, etc. selected for KPXI-DIO-32-80M card with card ID *CardNumber*. You must call this function before calling function to perform continuous digital output operation. This function is supported by the following models: KPXI-DIO-32-80M

**Syntax****Microsoft C/C++ and Borland C++**

```
I16 KDIO_DO_DIO32M80_Config (U16 CardNumber, U16 PortWidth,
 U16 TrigSource, U16 WaitStatus, U16 Terminator,
 U16 O_Cntrl_Pol, U32 FifoThreshold)
```

**Visual Basic**

```
KDIO_DO_DIO32M80_Config (ByVal CardNumber As Integer,
 ByVal PortWidth As Integer, ByVal TrigSource As Integer,
 ByVal WaitStatus As Integer, ByVal Terminator As Integer,
 ByVal O_Cntrl_Pol As Integer, ByVal FifoThreshold As Long)
As Integer
```

**Parameters**

**CardNumber:** The card id number.

**PortWidth:** The width of digital output port (PORT B). The valid value is 0, 8, 16, or 32.

**TrigSource:** The trigger mode for continuous digital output.

Valid values:

TRIG\_INT\_PACER: on-board programmable pacer timer1

TRIG\_CLK\_10MHz: 10MHz clock

TRIG\_CLK\_20MHz: 20MHz clock

TRIG\_HANDSHAKE: handshaking mode

TRIG\_DO\_CLK\_TIMER\_ACK: burst handshaking mode by using timer1 output as output clock

TRIG\_DO\_CLK\_10M\_ACK: burst handshaking mode by using 10MHz clock as output clock

TRIG\_DO\_CLK\_20M\_ACK: burst handshaking mode by using 20MHz clock as output clock

**WaitStatus:** DO Wait Status.

Valid values are:

DIO32M80\_WAIT\_NO: digital output starts immediately

DIO32M80\_WAIT\_TRG: digital output waits rising or falling edge of O\_TRG to start

DIO32M80\_WAIT\_FIFO: delay output data until FIFO is not almost empty

DIO32M80\_WAIT\_BOTH: delay output data until O\_TRG active and FIFO is not almost empty

**Terminator:** PortB Terminator On/Off.

Valid values are:

DIO32M80\_TERM\_ON: terminator on

DIO32M80\_TERM\_OFF: terminator off

**O\_Cntrl\_Pol:** The polarity configuration. This argument is an integer expression formed from one or more of the manifest constants defined in kdiodrvr.h. There are three groups of constants:

**(1) DOREQ**

DIO32M80\_DOREQ\_POS: DOREQ signal is rising edge active

DIO32M80\_DOREQ\_NEG: DOREQ signal is falling edge active

**(2) DOACK**

DIO32M80\_DOACK\_POS: DOACK signal is rising edge active

DIO32M80\_DOACK\_NEG: DOACK signal is falling edge active

**(3) DOTRIG**

DIO32M80\_DOTRIG\_POS: DOTRIG signal is rising edge active

DIO32M80\_DOTRIG\_NEG: DOTRIG signal is falling edge active

**FifoThreshold:** programmable almost empty threshold of both PORTB FIFO and PORTA FIFO (if output port width is 32).

**Return Code** NoError, ErrorInvalidCardNumber, ErrorCardNotRegistered, ErrorFuncNotSupport

## KDIO\_DO\_AsyncCheck

**Description** Check the current status of the asynchronous digital output operation. This function is supported by the following models: KPXI-DIO-32-80M

**Syntax** **Microsoft C/C++ and Borland C++**

```
I16 KDIO_DO_AsyncCheck (U16 CardNumber, BOOLEAN *Stopped,
 U32 *AccessCnt)
```

### Visual Basic

```
KDIO_DO_AsyncCheck (ByVal CardNumber As Integer,
 Stopped As Byte, AccessCnt As Long) As Integer
```

**Parameters** **CardNumber:** The card id of the card that performs the asynchronous operation.

**Stopped:** Whether the asynchronous digital output operation has completed. If *Stopped* = TRUE, the digital output operation has stopped. Either the number of digital output indicated in the call that initiated the asynchronous digital output operation has completed or an error has occurred. If *Stopped* = FALSE, the operation is not yet complete. (constants TRUE and FALSE are defined in kdiodrvr.h)

**AccessCnt:** The number of digital output data that has been written at the time the call to **KDIO\_DO\_AsyncCheck()**.

**Return Code** NoError, ErrorInvalidCardNumber, ErrorCardNotRegistered, ErrorFuncNotSupport

## KDIO\_DO\_AsyncClear

**Description** Stop the asynchronous digital output operation. This function is supported by the following models: KPXI-DIO-32-80M

**Syntax** **Microsoft C/C++ and Borland C++**

```
I16 KDIO_DO_AsyncClear (U16 CardNumber, U32 *AccessCnt)
```

### Visual Basic

```
KDIO_DO_AsyncClear (ByVal CardNumber As Integer,
 AccessCnt As Long) As Integer
```

**Parameters** **CardNumber:** The card id of the card that performs the asynchronous operation.

**AccessCnt:** The number of digital output data that has been transferred at the time the call to **KDIO\_DO\_AsyncClear()**.

**Return Code** NoError, ErrorInvalidCardNumber, ErrorCardNotRegistered, ErrorFuncNotSupport

## KDIO\_DO\_AsyncMultiBufferNextReady

**Description** Checks whether the next buffer is ready for new data during an asynchronous multi-buffered digital output operation. The returned *BufferId* is the index of the most recently available (newest available) buffer. This function is supported by the following models: KPXI-DIO-32-80M

**Syntax** **Microsoft C/C++ and Borland C++**

```
I16 KDIO_DO_AsyncMultiBufferNextReady (U16 CardNumber,
 BOOLEAN *bNextReady, U16 *wBufferId)
```

**Visual Basic**

```
KDIO_DO_AsyncMultiBufferNextReady (ByVal CardNumber As Integer, NextReady As Byte, BufferId As Integer) As Integer
```

**Parameters**

**CardNumber:** The card id of the card that performs the asynchronous multi-buffered operation.

**NextReady:** Whether the next buffer is ready for new data.

**BufferId:** Returns the index of the ready buffer.

**Return Code** NoError, ErrorInvalidCardNumber, ErrorCardNotRegistered, ErrorFuncNotSupport

### KDIO\_DO\_ContMultiBufferSetup

**Description** This function set up the buffer for multi-buffered digital output. The function has to be called repeatedly to setup all of the data buffers (at most 8 buffers). This function is supported by the following models: KPXI-DIO-32-80M

**Syntax** **Microsoft C/C++ and Borland C++**

```
I16 KDIO_DO_ContMultiBufferSetup (U16 CardNumber,
 void *pwBuffer, U32 dwWriteCount, U16 *BufferId)
```

**Visual Basic**

```
KDIO_DO_ContMultiBufferSetup (ByVal CardNumber As Integer, Buffer As Any, ByVal WriteCount As Long, BufferId As Integer) As Integer
```

**Parameters**

**CardNumber:** The card id number.

**Buffer:** The starting address of the memory to contain the output data.

**WriteCount:** The size (in samples) of the buffer and its value must be even.

**BufferId:** Returns the index of the buffer currently set up.

**Return Code** NoError, ErrorInvalidCardNumber, ErrorCardNotRegistered, ErrorFuncNotSupport, ErrorTransferCountTooLarge, ErrorContIoNotAllowed

### KDIO\_DO\_ContMultiBufferStart

**Description** This function starts multi-buffered continuous digital output on the specified digital output port at a rate as close to the rate you specified. This function is supported by the following models: KPXI-DIO-32-80M

**Syntax** **Microsoft C/C++ and Borland C++**

```
I16 KDIO_DO_ContMultiBufferStart (U16 CardNumber, U16 Port, F64 SampleRate)
```

**Visual Basic**

```
KDIO_DO_ContMultiBufferStart (ByVal CardNumber As Integer,
 ByVal Port As Integer, ByVal SampleRate As Double)
 As Integer
```

**Parameters** **CardNumber:** The card id number.

**Port:** Digital output port number. For KPXI-DIO-32-80M, this argument must be set to 0.

**SampleRate:** The sampling rate you want for digital output in hertz (samples per second). Your maximum rate depends on the card type and your computer system. This argument is only useful if the DO trigger mode was set as internal programmable pacer (TRIG\_INT\_PACER) by calling `KDIO_DO_DIO32M80_Config()`.

**Return Code** NoError, ErrorInvalidCardNumber, ErrorCardNotRegistered, ErrorFuncNotSupport, ErrorInvalidIoChannel, ErrorContIoNotAllowed

**KDIO\_DO\_ContStatus**

**Description** While performing continuous DO conversions, this function is called to get the DO status. Please refer to the manual for your device for the DO status the device might meet. This function is supported by the following models: KPXI-DIO-32-80M

**Syntax** **Microsoft C/C++ and Borland C++**

```
I16 KDIO_DO_ContStatus (U16 CardNumber, U16 *Status)
```

**Visual Basic**

```
KDIO_DO_ContStatus (ByVal CardNumber As Integer,
 Status Integer) As Integer
```

**Parameters** **CardNumber:** The card id number.

**Status:** The continuous DO status returned. The description of the parameter *Status* for various card types is the following:

*KPXI-DIO-32-80M:*

bit 0: '1' indicates DO FIFO is empty during data output and some output data were written twice. Writes '1' to clear this bit

bit 1: '1' indicates DO FIFO is full

bit 2: '1' indicates DO FIFO is empty

bit 3 ~ 15: not used

**Return Code** NoError, ErrorInvalidCardNumber, ErrorCardNotRegistered

**KDIO\_DO\_ContWritePort**

**Description** This function performs continuous digital output on the specified digital output port at a rate as close to the rate you specified. This function is supported by the following models: KPXI-DIO-32-80M

**Syntax**      **Microsoft C/C++ and Borland C++**

```
I16 KDIO_DO_ContWritePort (U16 CardNumber, U16 Port,
 void *Buffer, U32 WriteCount, U16 Iterations,
 F32 SampleRate, U16 SyncMode)
```

**Visual Basic**

```
KDIO_DO_ContWritePort (ByVal CardNumber As Integer,
 ByVal Port As Integer, Buffer As Any,
 ByVal WriteCount As Long, ByVal Iterations As Integer,
 ByVal SampleRate As Single, ByVal SyncMode As Integer)
As Integer
```

**Parameters**      **CardNumber:** The card id number.

**Port:**      Digital output port number. For KPXI-DIO-32-80M, this argument must be set to 0.

**Buffer:**      The starting address of the memory containing the output data. This memory must have been allocated for enough space to store output data.

**WriteCount:**      The number of output operations to be performed.

**Iterations:**      The number of times the data in *Buffer* to output to the Port. A value of 0 means that digital output operation proceeds indefinitely. If the digital output operation is performed **synchronously**, this argument must be set as 1.

**SampleRate:**      The sampling rate you want for digital output in hertz (samples per second). Your maximum rate depends on the card type and your computer system. This argument is only useful if the DO trigger mode was set as internal programmable pacer (TRIG\_INT\_PACER and TRIG\_DO\_CLK\_TIMER\_ACK) by calling **KDIO\_DO\_DIO32M80\_Config ()** . For the other settings, you have to set this argument as CLKSRC\_EXT\_SampRate.

**SyncMode:**      Whether this operation is performed synchronously or asynchronously.

Valid values:

SYNCH\_OP: synchronous digital input, that is, the function does not return until the digital input operation complete.

ASYNCH\_OP: asynchronous digital input operation

**Return Code**      NoError, ErrorInvalidCardNumber, ErrorCardNotRegistered, ErrorFuncNotSupport, ErrorInvalidIoChannel, ErrorTransferCountTooLarge , ErrorContIoNotAllowed

**KDIO\_DO\_EventCallback (Win32 Only)**

**Description**      Controls and notifies the user's application when a specified DAQ event occurs. The notification is performed through a user-specified callback function. The event message will be removed automatically after calling *KDIO\_DO\_Async\_Clear*. The event message can also be manually removed by set the parameter "*mode*" to be 0. This function is supported by the following models: KPXI-DIO-32-80M

|                    |                                                                                                                                                                                                                                                                                                                                                                                                                                                                                                                                                                                                                                                                                                                                         |
|--------------------|-----------------------------------------------------------------------------------------------------------------------------------------------------------------------------------------------------------------------------------------------------------------------------------------------------------------------------------------------------------------------------------------------------------------------------------------------------------------------------------------------------------------------------------------------------------------------------------------------------------------------------------------------------------------------------------------------------------------------------------------|
| <b>Syntax</b>      | <p><b>Microsoft C/C++ and Borland C++</b></p> <pre>I16 KDIO_DO_EventCallBack (U16 CardNumber, I16 mode,     I16 EventType, U32 callbackAddr)</pre> <p><b>Visual Basic</b></p> <pre>KDIO_DO_EventCallBack (ByVal CardNumber As Integer,     ByVal mode As Integer, ByVal EventType As Integer,     ByVal callbackAddr As Long) As Integer</pre>                                                                                                                                                                                                                                                                                                                                                                                          |
| <b>Parameters</b>  | <p><b>CardNumber:</b> The card id of the card that want to be performed this operation.</p> <p><b>mode:</b> add or remove the event message. Valid values:<br/>             0: remove<br/>             1: add</p> <p><b>EventType:</b> event criteria. Valid values are:</p> <p>DOEnd: Notification for the completeness of asynchronous digital output operation</p> <p>DBEvent: Notification for the next half buffer of data in circular buffer is ready for transfer (this value is not valid for KPXI-DIO-32-80M)</p> <p><b>callbackAddr:</b> the address of the user callback function. KDIO-DRVR calls this function when the specified event occurs. If you wish to remove the event message, set <i>callbackAddr</i> to 0.</p> |
| <b>Return Code</b> | NoError, ErrorInvalidCardNumber, ErrorCardNotRegistered, ErrorFuncNotSupport                                                                                                                                                                                                                                                                                                                                                                                                                                                                                                                                                                                                                                                            |

## KDIO\_DO\_InitialMemoryAllocated

|                    |                                                                                                                                                                                                                                                                   |
|--------------------|-------------------------------------------------------------------------------------------------------------------------------------------------------------------------------------------------------------------------------------------------------------------|
| <b>Description</b> | This function returns the available memory size for continuous digital output in the device driver of this card. The continuous digital output transfer size can not exceed this size. This function is supported by the following models:<br>KPXI-DIO-32-80M     |
| <b>Syntax</b>      | <p><b>Microsoft C/C++ and Borland C++</b></p> <pre>I16 KDIO_DO_InitialMemoryAllocated (U16 CardNumber,     U32 *MemSize)</pre> <p><b>Visual Basic</b></p> <pre>KDIO_DO_InitialMemoryAllocated (ByVal CardNumber As Integer,     MemSize As Long) As Integer</pre> |
| <b>Parameters</b>  | <p><b>CardNumber:</b> The card id number.</p> <p><b>MemSize:</b> The available memory size in device driver of this card. The unit is KB (1024 bytes).</p>                                                                                                        |
| <b>Return Code</b> | NoError, ErrorInvalidCardNumber, ErrorCardNotRegistered                                                                                                                                                                                                           |



### KDIO\_DO\_PGStart

**Description** This function performs pattern generation for digital output with the data stored in Buffer at a rate as close to the rate you specified. This function is supported by the following models: KPXI-DIO-32-80M

**Syntax** **Microsoft C/C++ and Borland C++**

```
I16 KDIO_DO_PGStart (U16 CardNumber, void *Buffer,
 U32 WriteCount, F64 SampleRate)
```

**Visual Basic**

```
KDIO_DO_PGStart (ByVal CardNumber As Integer, Buffer As Any,
 ByVal WriteCount As Long, ByVal SampleRate As Double)
 As Integer
```

**Parameters** **CardNumber:** The card id number.

**Buffer:** The starting address of the memory containing the output data of pattern generation. This memory must have been allocated for enough space to store output data.

**WriteCount:** the number of pattern generation output samples.

**SampleRate:** The sampling rate you want for digital output in hertz (samples per second). Your maximum rate depends on the card type and your computer system. This argument is only useful if the DO trigger mode was set as internal programmable pacer (TRIG\_INT\_PACER) by calling **KDIO\_DO\_DIO32M80\_Config ()**.

**Return Code** NoError, ErrorInvalidCardNumber, ErrorCardNotRegistered, ErrorFuncNotSupport, ErrorTransferCountTooLarge

### KDIO\_DO\_PGStop

**Description** This function stops pattern generation for digital output operation. This function is supported by the following models: KPXI-DIO-32-80M

**Syntax** **Microsoft C/C++ and Borland C++**

```
I16 KDIO_DO_PGStop (U16 CardNumber)
```

**Visual Basic**

```
KDIO_DO_PGStop (ByVal CardNumber As Integer) As Integer
```

**Parameters** **CardNumber:** The card id number.

**Return Code** NoError, ErrorInvalidCardNumber, ErrorCardNotRegistered, ErrorFuncNotSupport

### KDIO\_DO\_ReadLine

**Description** Read back the digital logic state of the specified digital output line in the specified port. This function is supported by the following models: KPXI-DIO-16-16, KPXI-DIO-48, KPXI-RDI-8-16, KPXI-DIO-32-80M, KPXI-DIO-32-32, KPXI-DIO-64-0, KPXI-DIO-0-64

**Syntax**      **Microsoft C/C++ and Borland C++**

```
I16 KDIO_DO_ReadLine (U16 CardNumber, U16 Port, U16 Line,
 U16 *State)
```

**Visual Basic**

```
KDIO_DO_ReadLine (ByVal CardNumber As Integer,
 ByVal Port As Integer, ByVal Line As Integer,
 State As Integer) As Integer
```

**Parameters**    **CardNumber:** The card id number.

**Port:**          Digital output port number.

Valid values:

```
KPXI-DIO-16-16: 0
KPXI-RDI-8-16: 0
KPXI-DIO-32-80M: 1 (auxiliary digital output port)
KPXI-DIO-32-32: 0, DIO32I32O_DO_LED
KPXI-DIO-64-0: DIO64I_DO_LED
KPXI-DIO-0-64: PORT_DO_LOW, PORT_DO_HIGH, DIO64O_DO_LED
KPXI-DIO-48: refer to the function KDIO_DI_ReadLine section.
```

**Line:**          The digital line to be accessed.

Valid values:

```
KPXI-DIO-16-16: 0 through 15
KPXI-RDI-8-16: 0 through 7
KPXI-DIO-32-80M: 0 through 3
KPXI-DIO-32-32/KPXI-DIO-64-0/KPXI-DIO-0-64: 0 through 31
KPXI-DIO-48: refer to the function KDIO_DI_ReadLine section.
```

**State:**          Returns the digital logic state, 0 or 1, of the specified line.

**Return Code**    NoError, ErrorInvalidCardNumber, ErrorCardNotRegistered,  
ErrorFuncNotSupport, ErrorInvalidIoChannel

## KDIO\_DO\_ReadPort

**Description**    Read back the output digital data from the specified digital output port. This function is supported by the following models: KPXI-DIO-16-16, KPXI-DIO-48, KPXI-RDI-8-16, KPXI-DIO-32-80M, KPXI-DIO-32-32, KPXI-DIO-64-0, KPXI-DIO-0-64

**Syntax**          **Microsoft C/C++ and Borland C++**

```
I16 KDIO_DO_ReadPort (U16 CardNumber, U16 Port, U32 *Value)
```

**Visual Basic**

```
KDIO_DO_ReadPort (ByVal CardNumber As Integer,
 ByVal Port As Integer, Value As Long) As Integer
```

**Parameters**    **CardNumber:** The card id number.  
**Port:**            Digital output port number.

Valid values:

KPXI-DIO-16-16: 0  
 KPXI-RDI-8-16: 0  
 KPXI-DIO-32-80M: 1 (auxiliary digital output port)  
 KPXI-DIO-32-32: 0, DIO32I32O\_DO\_LED  
 KPXI-DIO-64-0: DIO64I\_DO\_LED  
 KPXI-DIO-0-64: PORT\_DO\_LOW, PORT\_DO\_HIGH, DIO64O\_DO\_LED  
 KPXI-DIO-48: refer to the function *KDIO\_DI\_ReadPort* section.

**Value:**            Returns the digital data read from the specified output port.

Valid values:

KPXI-DIO-16-16: 16-bit data  
 KPXI-DIO-48: 8-bit data  
 KPXI-RDI-8-16: 8-bit data  
 KPXI-DIO-32-80M: 4-bit data  
 KPXI-DIO-32-32: 32-bit data  
 KPXI-DIO-64-0: 32-bit data  
 KPXI-DIO-0-64: 32-bit data

**Return Code**    NoError, ErrorInvalidCardNumber, ErrorCardNotRegistered,  
 ErrorFuncNotSupport, ErrorInvalidIoChannel

**KDIO\_DO\_WriteLine**

**Description**    Sets the specified digital output line in the specified digital port to the specified state. This function is only available for these cards that support digital output read-back functionality. This function is supported by the following models: KPXI-DIO-16-16, KPXI-DIO-48, KPXI-RDI-8-16, KPXI-DIO-32-80M, KPXI-DIO-32-32, KPXI-DIO-64-0, KPXI-DIO-0-64

**Syntax**            **Microsoft C/C++ and Borland C++**

```
I16 KDIO_DO_WriteLine (U16 CardNumber, U16 Port, U16 Line,
 U16 State)
```

**Visual Basic**

```
KDIO_DO_WriteLine(ByVal CardNumber As Integer,
 ByVal Port As Integer, ByVal DoLine As Integer,
 ByVal State As Integer) As Integer
```

**Parameters**    **CardNumber:** The card id number.  
**Port:**            Digital output port number.

Valid values:

KPXI-DIO-16-16: 0  
 KPXI-RDI-8-16: 0  
 KPXI-DIO-32-80M: 1 (auxiliary digital output port)  
 KPXI-DIO-32-32: 0, DIO32I32O\_DO\_LED  
 KPXI-DIO-64-0: DIO64I\_DO\_LED

KPXI-DIO-0-64: PORT\_DO\_LOW, PORT\_DO\_HIGH, DIO64O\_DO\_LED  
 KPXI-DIO-48: refer to the function *KDIO\_DI\_ReadLine* section.

**Line:** The digital line to write to.

Valid values:

KPXI-DIO-16-16: 0 through 15  
 KPXI-RDI-8-16: 0 through 7  
 KPXI-DIO-32-80M: 0 through 3  
 KPXI-DIO-32-32/KPXI-DIO-64-0/KPXI-DIO-0-64: 0 through 31  
 KPXI-DIO-48: refer to the function *KDIO\_DI\_ReadLine* section.

**State:** The new digital logic state, 0 or 1.

**Return Code** NoError, ErrorInvalidCardNumber, ErrorCardNotRegistered,  
 ErrorFuncNotSupport, ErrorInvalidIoChannel

## KDIO\_DO\_WritePort

**Description** Writes digital data to the specified digital output port. This function is supported by the following models: KPXI-DIO-16-16, KPXI-DIO-48, KPXI-RDI-8-16, KPXI-DIO-32-80M, KPXI-DIO-32-32, KPXI-DIO-64-0, KPXI-DIO-0-64

**Syntax** **Microsoft C/C++ and Borland C++**

```
I16 KDIO_DO_WritePort (U16 CardNumber, U16 Port, U32 Value)
```

### Visual Basic

```
KDIO_DO_WritePort (ByVal CardNumber As Integer,
 ByVal Port As Integer, ByVal Value As Long) As Integer
```

**Parameters** **CardNumber:** The card id number.

**Port:** Digital output port number. The cards that support this function (and their corresponding valid values) are as follows:

*KPXI-DIO-16-16:* 0

*KPXI-DIO-48:*

Channel\_P1A, Channel\_P1B, Channel\_P1C, Channel\_P1CL, Channel\_P1CH,  
 Channel\_P2A, Channel\_P2B, Channel\_P2C, Channel\_P2CL, Channel\_P2CH

*KPXI-RDI-8-16:* 0

*KPXI-DIO-32-80M:* 1 (auxiliary digital output port)

*KPXI-DIO-32-32:* 0, DIO32I32O\_DO\_LED

*KPXI-DIO-64-0:* DIO64I\_DO\_LED

*KPXI-DIO-0-64:* PORT\_DO\_LOW, PORT\_DO\_HIGH, DIO64O\_DO\_LED

**NOTE** The value, *Channel\_Pn*, for argument *Port* is defined as all of the ports (Port A, B and C) in channel *n*.

**Value:** Digital data that is written to the specified port.

- KPXI-DIO-16-16: 16-bit data
- KPXI-DIO-48: 8-bit data
- KPXI-RDI-8-16: 8-bit data
- KPXI-DIO-32-80M: 4-bit data
- KPXI-DIO-32-32: 32-bit data
- KPXI-DIO-64-0: 32-bit data
- KPXI-DIO-0-64: 32-bit data

**Return Code** NoError, ErrorInvalidCardNumber, ErrorCardNotRegistered, ErrorFuncNotSupport, ErrorInvalidIoChannel

### KDIO\_GetActualRate

**Description** Gets the actual sampling rate the hardware will perform according to the board type and the rate you want. This function is supported by the following models: KPXI-DIO-32-80M

**Syntax** **Microsoft C/C++ and Borland C++**

```
I16 KDIO_GetActualRate (U16 CardNumber, F64 SampleRate,
 F64 *ActualRate)
```

**Visual Basic**

```
KDIO_GetActualRate (ByVal CardNumber As Integer,
 ByVal SampleRate As Double, ActualRate As Double)
 As Integer
```

**Parameters** **CardNumber:** The card id of the card that wants to perform this operation.  
**SampleRate:** The desired sampling rate.

**ActualRate:** Returns the actual acquisition rate performed. The value depends on the card type and the desired sampling rate.

**Return Code** NoError, ErrorInvalidCardNumber, ErrorCardNotRegistered, ErrorFuncNotSupport

### KDIO\_GetBaseAddr

**Description** Gets the I/O base addresses of the device with a specified card index. This function is supported by the following models: KPXI-DIO-16-16, KPXI-DIO-48, KPXI-RDI-8-16, KPXI-DIO-32-80M, KPXI-DIO-32-32, KPXI-DIO-64-0, KPXI-DIO-0-64

**Syntax** **Microsoft C/C++ and Borland C++**

```
I16 KDIO_GetBaseAddr (U16 wCardNumber, U32 *BaseAddr,
 U32 *BaseAddr2)
```

**Visual Basic**

```
KDIO_GetBaseAddr (ByVal CardNumber As Integer,
 BaseAddr As Long, BaseAddr2 As Long) As Integer
```

- Parameters**    **CardNumber:** The card id of the card that wants to perform this operation.  
                   **BaseAddr:** Returns the I/O base address.  
                   **BaseAddr2:** Returns the second base address #2. This is only available for the devices that support two I/O base addresses.
- Return Code**    NoError, ErrorInvalidCardNumber, ErrorCardNotRegistered, ErrorFuncNotSupport

### KDIO\_GetCardIndexFromID

- Description**    Get the card type and the sequence number of the device with a specified card id. This function is the reverse function of KDIO\_Release\_Card. This function is supported by the following models: KPXI-DIO-16-16, KPXI-DIO-48, KPXI-RDI-8-16, KPXI-DIO-32-80M, KPXI-DIO-32-32, KPXI-DIO-64-0, KPXI-DIO-0-64

- Syntax**            **Microsoft C/C++ and Borland C++**

```
I16 KDIO_GetCardIndexFromID (U16 wCardNumber, U16 *cardType,
 U16 *cardIndex)
```

#### Visual Basic

```
KDIO_GetCardIndexFromID (ByVal CardNumber As Integer,
 cardType As Integer, cardIndex As Integer) As Integer
```

- Parameters**    **CardNumber:** The card id of the card that wants to perform this operation.  
                   **cardType:** Returns the card type.  
                   **cardIndex:** Returns the sequence number of the card with *the same card type*.
- Return Code**    NoError, ErrorInvalidCardNumber, ErrorCardNotRegistered, ErrorFuncNotSupport

### KDIO\_GetCardType

- Description**    Gets the card type of the device with a specified card index. This function is supported by the following models: KPXI-DIO-16-16, KPXI-DIO-48, KPXI-RDI-8-16, KPXI-DIO-32-80M, KPXI-DIO-32-32, KPXI-DIO-64-0, KPXI-DIO-0-64

- Syntax**            **Microsoft C/C++ and Borland C++**

```
I16 KDIO_GetCardType (U16 wCardNumber, U16 *cardType)
```

#### Visual Basic

```
KDIO_GetCardType (ByVal CardNumber As Integer,
 cardType As Double) As Integer
```

- Parameters**    **CardNumber:** The card id of the card that wants to perform this operation.  
                   **cardType:** Returns the card type.
- Return Code**    NoError, ErrorInvalidCardNumber, ErrorCardNotRegistered, ErrorFuncNotSupport

### KDIO\_GetLCRAddr

**Description** Gets the LCR base address (defined by the PCI controller on board) of the device with a specified card index. This function is supported by the following models: KPXI-DIO-16-16, KPXI-DIO-48, KPXI-RDI-8-16, KPXI-DIO-32-80M, KPXI-DIO-32-32, KPXI-DIO-64-0, KPXI-DIO-0-64,

**Syntax** **Microsoft C/C++ and Borland C++**

```
I16 KDIO_GetLCRAddr(U16 wCardNumber, U32 *LcrAddr)
```

**Visual Basic**

```
KDIO_GetLCRAddr (ByVal CardNumber As Integer, LcrAddr As Long) As Integer
```

**Parameters** **CardNumber:** The card id of the card that wants to perform this operation.  
**LcrAddr:** Returns the LCR base address.

**Return Code** NoError, ErrorInvalidCardNumber, ErrorCardNotRegistered, ErrorFuncNotSupport

### KDIO\_Register\_Card

**Description** Initializes the hardware and software states of a Keithley PXI data acquisition card, and then returns a numeric card ID that corresponds to the card initialized. Register\_Card must be called before any other KDIO-DRVr library functions can be called for that card. The function initializes the card and variables internal to KDIO-DRVr library. Because Keithley PXI data acquisition cards meets the plug-and-play design, the base address (pass-through address) and IRQ level are assigned by system BIOS directly. This function is supported by the following models: KPXI-DIO-16-16, KPXI-DIO-48, KPXI-RDI-8-16, KPXI-DIO-32-80M, KPXI-DIO-32-32, KPXI-DIO-64-0, KPXI-DIO-0-64

**Syntax** **Microsoft C/C++ and Borland C++**

```
I16 KDIO_Register_Card (U16 CardType, U16 card_num)
```

**Visual Basic**

```
KDIO_Register_Card (ByVal CardType As Integer, ByVal card_num As Integer) As Integer
```

**Parameters** **CardType:** The type of card to be initialized. Keithley will periodically upgrades KDIO-DRVr to add support for new Keithley PXI data acquisition cards. Please refer to *Release Notes* for the card types that the current release of KDIO-DRVr actually supports. Following are the constants defined in kdiodrvr.h that represent the Keithley PXI data acquisition cards that KDIO-DRVr supports:

- KPXI\_DIO\_16I\_16O (for KPXI-DIO-16-16)
- KPXI\_DIO\_48 (for KPXI-DIO-48)
- KPXI\_RDI\_8R\_16I (for KPXI-RDI-8-16)
- KPXI\_DIO\_32\_80M (for KPXI-DIO-32-80M)
- KPXI\_DIO\_32I\_32O (for KPXI-DIO-32-32)
- KPXI\_DIO\_64I (for KPXI-DIO-64-0)
- KPXI\_DIO\_64O (for KPXI-DIO-0-64)

**card\_num:** The sequence number of the card with *the same card type* (as defined in argument *CardType*) or belonging to *the same card type series* (Except KPXI-DIO-32-80M) plugged in the PXI slot. The card sequence number

setting is according to the PXI slot sequence in the mainboard. The first card (in the most prior slot) is with `card_num=0`. For example, if there two KPXI-DIO-48 cards plugged on your PC, the KPXI-DIO-48 card in the prior slot should be registered with `card_num=0`, and the other one with `card_num=1`.

**Return Code** This function returns a numeric card id for the card initialized. The range of card id is between 0 and 31. If there is any error occurs, it will return negative error code, the possible error codes are listed below: `ErrorTooManyCardRegistered`, `ErrorUnknownCardType`, `ErrorOpenDriverFailed`, `ErrorOpenEventFailed`

## KDIO\_Release\_Card

**Description** There are at most 32 cards that can be registered simultaneously. This function is used to tell KDIO-DRVR library that this registered card is not used currently and can be released. This would make room for new card to register. Also by the end of a program, you need to use this function to release all cards that were registered. This function is supported by the following models: KPXI-DIO-16-16, KPXI-DIO-48, KPXI-RDI-8-16, KPXI-DIO-32-80M, KPXI-DIO-32-32, KPXI-DIO-64-0, KPXI-DIO-0-64

**Syntax** **Microsoft C/C++ and Borland C++**

```
I16 KDIO_Release_Card (U16 CardNumber)
```

### Visual Basic

```
KDIO_Release_Card (ByVal CardNumber As Integer) As Integer
```

**Parameters** **CardNumber:** The card id of the card that want to be released.

**Return Code** `NoError`

## Status Codes

The status codes returned by KDIO-DRVR, including the name and description, are listed in [Table B-1](#). Each KDIO-DRVR function returns a status code that indicates whether the function was performed successfully. When a KDIO-DRVR function returns a negative number, it means that an error occurred while executing the function.

Table B-3

**Status codes returned by KDIO-DRVR**

| Status Code | Status Name                             | Description                                                                          |
|-------------|-----------------------------------------|--------------------------------------------------------------------------------------|
| 0           | <code>NoError</code>                    | No error occurred                                                                    |
| -1          | <code>ErrorUnknownCardType</code>       | The <i>CardType</i> argument is not valid                                            |
| -2          | <code>ErrorInvalidCardNumber</code>     | The <i>CardNumber</i> argument is out of range (larger than 31).                     |
| -3          | <code>ErrorTooManyCardRegistered</code> | There have been 32 cards that were registered.                                       |
| -4          | <code>ErrorCardNotRegistered</code>     | No card registered as id <i>CardNumber</i> .                                         |
| -5          | <code>ErrorFuncNotSupport</code>        | The function called is not supported by this type of card..                          |
| -6          | <code>ErrorInvalidIoChannel</code>      | The specified <i>Channel</i> or <i>Port</i> argument is out of range..               |
| -7          | <code>ErrorInvalidAdRange</code>        | The specified analog input range is invalid.                                         |
| -8          | <code>ErrorContIoNotAllowed</code>      | The specified continuous IO operation is not supported by this type of card.         |
| -9          | <code>ErrorDiffRangeNotSupport</code>   | All the analog input ranges must be the same for multi-channel analog input.         |
| -10         | <code>ErrorLastChannelNotZero</code>    | The channels for multi-channel analog input must be ended with or started from zero. |



Table B-3 (continued)  
**Status codes returned by KDIO-DRVR**

| Status Code | Status Name                | Description                                                                             |
|-------------|----------------------------|-----------------------------------------------------------------------------------------|
| -11         | ErrorChannelNotDescending  | The channels for multi-channel analog input must be contiguous and in descending order. |
| -12         | ErrorChannelNotAscending   | The channels for multi-channel analog input must be contiguous and in ascending order.  |
| -13         | ErrorOpenDriverFailed      | Failed to open the device driver.                                                       |
| -14         | ErrorOpenEventFailed       | Open event failed in device driver.                                                     |
| -15         | ErrorTransferCountTooLarge | The size of transfer is larger than the size of Initially allocated memory in driver.   |
| -16         | ErrorNotDoubleBufferMode   | Double buffer mode is disabled.                                                         |
| -17         | ErrorInvalidSampleRate     | The specified sampling rate is out of range.                                            |
| -18         | ErrorInvalidCounterMode    | The value of the <i>Mode</i> argument is invalid.                                       |
| -19         | ErrorInvalidCounter        | The value of the <i>Ctr</i> argument is out of range.                                   |
| -20         | ErrorInvalidCounterState   | The value of the <i>State</i> argument is out of range.                                 |
| -21         | ErrorInvalidBinBcdParam    | The value of the <i>BinBcd</i> argument is invalid.                                     |
| -22         | ErrorBadCardType           | The value of Card Type argument is invalid                                              |
| -23         | ErrorInvalidDaRefVoltage   | The value of DA reference voltage argument is invalid                                   |
| -24         | ErrorAdTimeOut             | Time out for AD operation                                                               |
| -25         | ErrorNoAsyncAI             | Continuous Analog Input is not set as Asynchronous mode                                 |
| -26         | ErrorNoAsyncAO             | Continuous Analog Output is not set as Asynchronous mode                                |
| -27         | ErrorNoAsyncDI             | Continuous Digital Input is not set as Asynchronous mode                                |
| -28         | ErrorNoAsyncDO             | Continuous Digital Output is not set as Asynchronous mode                               |
| -29         | ErrorNotInputPort          | The value of AI/DI port argument is invalid                                             |
| -30         | ErrorNotOutputPort         | The value of AO/DO argument is invalid                                                  |
| -31         | ErrorInvalidDioPort        | The value of DI/O port argument is invalid                                              |
| -32         | ErrorInvalidDioLine        | The value of DI/O line argument is invalid                                              |
| -33         | ErrorContIoActive          | Continuous IO operation is not active                                                   |
| -34         | ErrorDbfBufModeNotAllowed  | Double Buffer mode is not allowed                                                       |
| -35         | ErrorConfigFailed          | The specified function configuration is failed                                          |
| -36         | ErrorInvalidPortDirection  | The value of DIO port direction argument is invalid                                     |
| -37         | ErrorBeginThreadError      | Failed to create thread                                                                 |
| -38         | ErrorInvalidPortWidth      | The port width setting for KPXI-DIO-32-80M is not allowed                               |
| -39         | ErrorInvalidCtrSource      | The clock source setting is invalid                                                     |
| -40         | ErrorOpenFile              | Failed to Open file                                                                     |
| -41         | ErrorAllocateMemory        | The memory allocation is failed                                                         |
| -42         | ErrorDaVoltageOutOfRange   | The value of DA voltage argument is out of range                                        |
| -50         | ErrorInvalidCounterValue   | The value of count for a counter is invalid                                             |
| -60         | ErrorInvalidEventHandle    | The event handle is invalid                                                             |
| -61         | ErrorNoMessageAvailable    | No event message can be added                                                           |
| -62         | ErrorEventMessgaeNotAdded  | The specified event message doesn't exist                                               |
| -201        | ErrorConfigIoctl           | The configuration API is failed                                                         |
| -202        | ErrorAsyncSetIoctl         | The async. mode API is failed                                                           |
| -203        | ErrorDBSetIoctl            | The double-buffer setting API is failed                                                 |
| -204        | ErrorDBHalfReadyIoctl      | The half-ready API is failed                                                            |
| -205        | ErrorContOPIOctl           | The continuous data acquisition API is failed                                           |
| -206        | ErrorContStatusIoctl       | The continuous data acquisition status API setting is failed                            |
| -207        | ErrorPIOIoctl              | The polling data API is failed                                                          |
| -208        | ErrorDIntSetIoctl          | The dual interrupt setting API is failed                                                |
| -209        | ErrorWaitEvtIoctl          | The wait event API is failed                                                            |
| -210        | ErrorOpenEvtIoctl          | The open event API is failed                                                            |
| -211        | ErrorCOSIntSetIoctl        | The cos interrupt setting API is failed                                                 |
| -212        | ErrorMemMapIoctl           | The memory mapping API is failed                                                        |

Table B-3 (continued)  
**Status codes returned by KDIO-DRVR**

| Status Code | Status Name          | Description                        |
|-------------|----------------------|------------------------------------|
| -213        | ErrorMemUMapSetloctl | The memory Unmapping API is failed |
| -214        | ErrorCTRloctl        | The counter API is failed          |

## Data file format

This section describes the file format of the data files generated by the functions performing continuous data acquisition followed by storing the data to disk.

The data file includes three parts, Header, ChannelRange (optional) and Data block. The file structure is as the figure below:

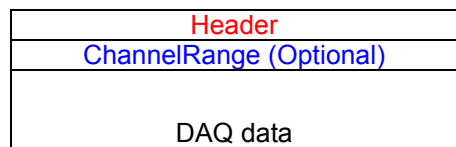

## Header

The *header* part records the information related to the stored data and its total length is 60 bytes. The data structure of the file header is contained in [Table B-4](#).

Table B-4  
**Data file header**

| Header                                                                                                                                                                                               |               |              | Total Length: 60 bytes                                                                                          |
|------------------------------------------------------------------------------------------------------------------------------------------------------------------------------------------------------|---------------|--------------|-----------------------------------------------------------------------------------------------------------------|
| Elements                                                                                                                                                                                             | Type          | Size (bytes) | Comments                                                                                                        |
| ID                                                                                                                                                                                                   | char          | 10           | file ID<br><i>ex. KeithleyDAQ1</i>                                                                              |
| card_type                                                                                                                                                                                            | short         | 2            | card Type<br><i>ex. KPXI_DIO_32_80M</i>                                                                         |
| num_of_channel                                                                                                                                                                                       | short         | 2            | number of scanned channels<br><i>ex. 1, 2</i>                                                                   |
| Channel_no                                                                                                                                                                                           | unsigned char | 1            | channel number where the data read from (only available as the num_of_channel is 1)<br><i>ex. 0, 1</i>          |
| num_of_scan                                                                                                                                                                                          | long          | 4            | the number of scan for each channel<br>(total count / num_of_channel)                                           |
| data_width                                                                                                                                                                                           | short         | 2            | the data width<br>0: 8 bits, 1: 16 bits, 2: 32 bits                                                             |
| channel_order                                                                                                                                                                                        | short         | 2            | the channel scanned sequence<br>0: normal (ex. 0-1-2-3)<br>1: reverse (ex. 3-2-1-0)<br>2: custom* (ex. 0, 1, 3) |
| * If the num_of_channel_range is 0, the ChannelRange block won't be included in the data file.<br>* The channel_order is set to "custom" only when the card supports variant channel scanning order. |               |              |                                                                                                                 |

Table B-4 (continued)

**Data file header**

| Header               |        |              | Total Length: 60 bytes                                                                   |
|----------------------|--------|--------------|------------------------------------------------------------------------------------------|
| Elements             | Type   | Size (bytes) | Comments                                                                                 |
| ad_range             | short  | 2            | the AI range code<br>Please refer to <a href="#">Data file format</a><br>ex. 0 (AD_B_5V) |
| scan_rate            | double | 8            | The scanning rate of each channel<br>(total sampling rate / num_of_channel)              |
| num_of_channel_range | short  | 2            | The number of ChannelRange* structure                                                    |
| start_date           | char   | 8            | The starting date of data acquisition<br>ex. 12/31/99                                    |
| start_time           | char   | 8            | The starting time of data acquisition<br>ex. 18:30:25                                    |
| start_millisecond    | char   | 3            | The starting millisecond of data acquisition<br>ex. 360                                  |
| reserved             | char   | 6            | not used                                                                                 |

\* If the num\_of\_channel\_range is 0, the ChannelRange block won't be included in the data file.  
\* The channel\_order is set to "custom" only when the card supports variant channel scanning order.

## ChannelRange

The *ChannelRange* part records the channel number and data range information related to the stored data. This part consists of several channel & range units. The length of each unit is 2 bytes. The total length depends on the value of *num\_of\_channel\_range* (one element of the file header) and is calculated as the following formula:

$$\text{Total Length} = 2 * \text{num\_of\_channel\_range bytes}$$

The data structure of each ChannelRange unit is contained in [Table B-5](#):

Table B-5

**Data structure of ChannelRange unit**

| ChannelRange Unit |      |              |                                                                                                              |
|-------------------|------|--------------|--------------------------------------------------------------------------------------------------------------|
| Length: 2 bytes   |      |              |                                                                                                              |
| Elements          | Type | Size (bytes) | Comments                                                                                                     |
| channel           | char | 1            | scanned channel number<br>ex. 0, 1                                                                           |
| range             | char | 1            | the AI range code of <i>channel</i><br>Please refer to <a href="#">Data file format</a> .<br>ex. 0 (AD_B_5V) |

## Data Block

The last part is the data block. The data is written to file in 16-bit binary format, with the lower byte first (little endian). For example, the value 0x1234 is written to disk with 34 first followed by 12. The total length of the data block depends on the data width and the total data count.

The file is written in Binary format and can't be read in normal text editor. You can use any binary file editor to view it or the functions used for reading files, e.g. `fread`, to get the file information and data value. KDIO-DRVR provides a useful utility *KIDAQCvt* for you to convert the binary file. The *KIDAQCvt* main window is as the figure below:

Figure B-7  
DAQ File Conversion Utility

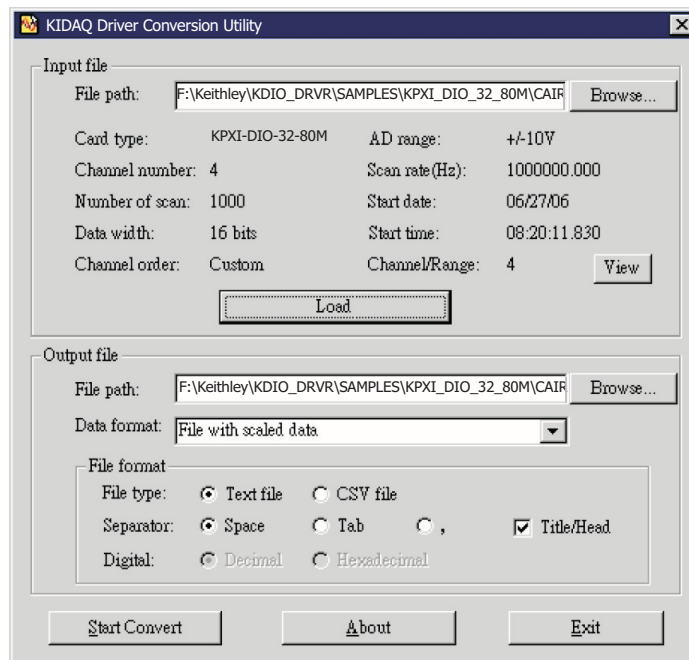

KIDAQCvt first translates the information stored in the header part and the ChannelRange part and then displays the corresponding information in the “Input File” frame of *KIDAQCvt* main window. After setting the properties (File Path, Format, ...etc) of the converted file and push “*Start Convert*” button in the “Output File” frame, *KIDAQCvt* gets rid of header and ChannelRange parts and converts the data in data block according to the card type and the data width. Finally, *KIDAQCvt* writes the converted data to disk. You thus can use any text editor or Excel to view or analyze the accessed data.

# Function Support

This section shows which data acquisition hardware each KDIO-DRVR function supports.

Table B-6  
**KDIO-DRVR model function**

| Function board                    | KPXI       |           |         |             |            |           |           |
|-----------------------------------|------------|-----------|---------|-------------|------------|-----------|-----------|
|                                   | -DIO-16-16 | -RDI-8-16 | -DIO-48 | -DIO-32-80M | -DIO-32-32 | -DIO-64-0 | -DIO-0-64 |
| KDIO_CTR_Read                     |            |           | v       |             |            |           |           |
| KDIO_CTR_Reset                    |            |           | v       |             |            |           |           |
| KDIO_CTR_Setup                    |            |           | v       |             |            |           |           |
| KDIO_CTR_Update                   |            |           | v       |             |            |           |           |
| KDIO_DI_DIO32M80_Config           |            |           |         | v           |            |           |           |
| KDIO_DI_AsyncCheck                |            |           |         | v           |            |           |           |
| KDIO_DI_AsyncClear                |            |           |         | v           |            |           |           |
| KDIO_DI_AsyncDblBufferTransfer    |            |           |         | v           |            |           |           |
| KDIO_DI_AsyncMultiBufferNextReady |            |           |         | v           |            |           |           |
| KDIO_DI_ContMultiBufferSetup      |            |           |         | v           |            |           |           |
| KDIO_DI_ContMultiBufferStart      |            |           |         | v           |            |           |           |
| KDIO_DI_ContReadPort              |            |           |         | v           |            |           |           |
| KDIO_DI_ContReadPortToFile        |            |           |         | v           |            |           |           |
| KDIO_DI_ContStatus                |            |           |         | v           |            |           |           |
| KDIO_DI_InitialMemoryAllocated    |            |           |         | v           |            |           |           |
| KDIO_DI_ReadLine                  | v          | v         | v       | v           | v          | v         |           |
| KDIO_DI_ReadPort                  | v          | v         | v       | v           | v          | v         |           |
| KDIO_DIO32M80_SetInterrupt        |            |           |         | v           |            |           |           |
| KDIO_AUXDI_EventMessage           |            |           |         | v           |            |           |           |
| KDIO_INT_EventMessage             | v          |           | v       |             | v          | v         |           |
| KDIO_INT1_EventMessage            | v          |           | v       |             | v          | v         |           |
| KDIO_INT2_EventMessage            | v          |           | v       |             | v          | v         |           |
| KDIO_PortConfig                   |            |           | v       |             |            |           |           |
| KDIO_SetDualInterrupt             | v          |           | v       |             | v          | v         |           |
| KDIO_T2_EventMessage              |            |           |         | v           |            |           |           |
| KDIO_DO_DIO32M80_Config           |            |           |         | v           |            |           |           |
| KDIO_DO_ContStatus                |            |           |         | v           |            |           |           |
| KDIO_DO_ContWritePort             |            |           |         | v           |            |           |           |
| KDIO_DO_AsyncCheck                |            |           |         | v           |            |           |           |
| KDIO_DO_AsyncClear                |            |           |         | v           |            |           |           |
| KDIO_DO_InitialMemoryAllocated    |            |           |         | v           |            |           |           |
| KDIO_DO_PGStart                   |            |           |         | v           |            |           |           |
| KDIO_DO_PGStop                    |            |           |         | v           |            |           |           |
| KDIO_DO_ReadLine                  | v          | v         | v       | v           | v          | v         | v         |
| KDIO_DO_ReadPort                  | v          | v         | v       | v           | v          | v         | v         |
| KDIO_DO_WriteLine                 | v          | v         | v       | v           | v          | v         | v         |

Table B-6 (continued)  
**KDIO-DRVR model function**

| Function board     | KPXI       |           |         |             |            |           |           |
|--------------------|------------|-----------|---------|-------------|------------|-----------|-----------|
|                    | -DIO-16-16 | -RDI-8-16 | -DIO-48 | -DIO-32-80M | -DIO-32-32 | -DIO-64-0 | -DIO-0-64 |
| KDIO_DO_WritePort  | V          | V         | V       | V           | V          | V         | V         |
| KDIO_GetActualRate |            |           |         | V           |            |           |           |
| KDIO_Register_Card | V          | V         | V       | V           | V          | V         | V         |
| KDIO_Release_Card  | V          | V         | V       | V           | V          | V         | V         |

---

# KIDAQ<sup>®</sup>-LabVIEW Compatible Interface Guide

## In this appendix:

| Topic                                                  | Page |
|--------------------------------------------------------|------|
| <b>Introduction to KIDAQ<sup>®</sup>-LabVIEW</b> ..... | C-2  |
| Overview .....                                         | C-2  |
| Using KIDAQ LabVIEW VIs in LabVIEW .....               | C-2  |
| KIDAQ LabVIEW Programming .....                        | C-3  |
| <b>Device Driver Handling</b> .....                    | C-4  |
| Windows XP/2000 Device Driver .....                    | C-4  |
| Driver Utility .....                                   | C-4  |
| <b>KIDAQ Utilities</b> .....                           | C-4  |
| KIDAQ Registry/Configuration utility .....             | C-4  |
| KIDAQ Device Browser .....                             | C-4  |
| <b>KIDAQ LabVIEW VIs Overview</b> .....                | C-5  |
| Analog Input VIs .....                                 | C-6  |
| Analog Output VIs .....                                | C-6  |
| Digital I/O VIs .....                                  | C-7  |
| Timer/Counter VIs .....                                | C-7  |
| Calibration and Configuration VIs .....                | C-8  |
| Error Handler VI .....                                 | C-8  |
| <b>Distribution of Applications</b> .....              | C-8  |
| Windows XP/2000 .....                                  | C-8  |

## Introduction to KIDAQ®-LabVIEW

This introduction describes how to program your application in LabVIEW<sup>1</sup> using the Keithley KIDAQ driver.

### Overview

Install the KDAQ-DRV, KDIO-DRV, or KDIG-DRV device driver that works with your module before installing the KIDAQ LabVIEW driver. Refer to driver installation information elsewhere in the product manual for the correct driver installation procedure for your module.

KIDAQ LabVIEW VIs (Virtual Instrumentation files) were designed for LabVIEW 6.0 or later. All VIs are stored in 6.0 format. The KIDAQ driver provides a set of VIs that control the KPXI modules from within LabVIEW for fast and simple programming.

To not conflict with the naming of the functions already present in LabVIEW, all KIDAQ LabVIEW VIs have a “KI” prefix. For example, the Analog Input Read VI is called “KI AI Read”.

### Using KIDAQ LabVIEW VIs in LabVIEW

To use KIDAQ LabVIEW VIs, refer to the following procedure as a guideline (using LabVIEW versions 6.0 through 7.2):

**NOTE** *LabVIEW 8 (and later versions) uses a new interface. In LabVIEW 8, the KIDAQ VI set will appear at the bottom of the LabVIEW function palette. To personalize your function palette, click the **Tools menu** item, select **Advanced** and **edit palette set...** from the menus.*

1. Click the **Options** button in the **Controls** or **Functions** palette toolbar to display the **Function Browser Options** dialog box.
2. Select **KIDAQ** view from the **Palette Set** pull-down menu (Figure C-1).
3. Click **OK**. The **Functions** palettes change to the **KIDAQ** view.
4. Then, find KIDAQ LabVIEW VIs in **KIDAQ** icon on the **Functions** palette (Figure C-2).

Figure C-1  
Function Browser Options

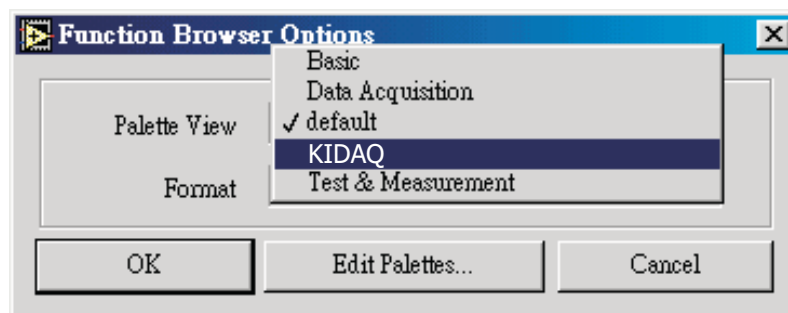

1. LabVIEW™ is a trademark of the National Instruments Corporation. All other trademarks are the property of their respective owners.



Figure C-2  
**Functions palette**

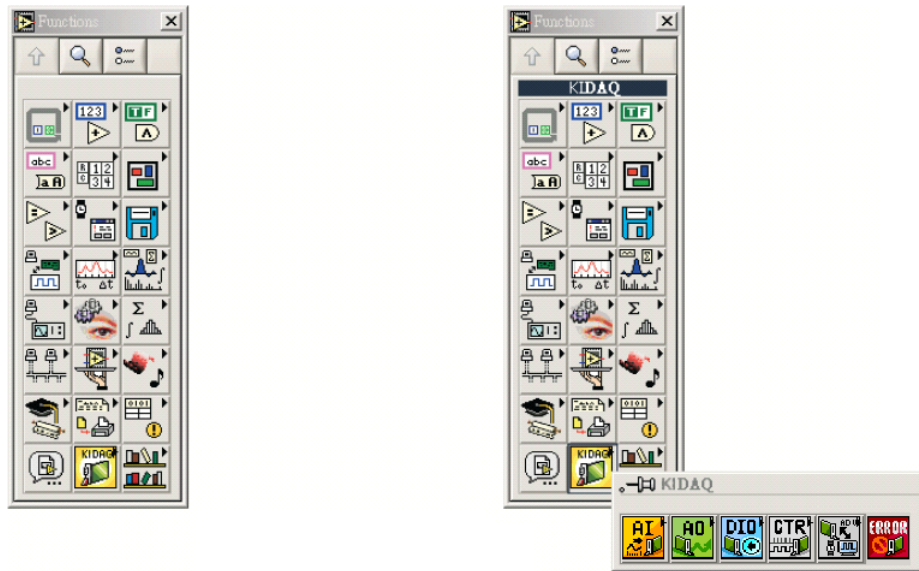

The **KIDAQ** palette contains four sub-palettes that contain the different classes of data acquisition VIs. The VIs are classified as follows:

- Analog Input VIs
- Analog Output VIs
- Digital I/O VIs
- Timer/Counter VIs
- Calibration and Configuration VIs
- Error Handler VI

Most of the VI sub-palettes arrange the VIs in different levels, Easy, Intermediate, or Advanced, according to their functionality.

## KIDAQ LabVIEW Programming

The [KIDAQ LabVIEW VIs Overview](#) briefly describes each VI in KIDAQ LabVIEW. All applications developed with KIDAQ LabVIEW are compatible across Windows XP and 2000. For detailed function information, refer to [Appendix D](#), the [KIDAQ®-LabVIEW Compatible Function Reference](#).

You can find the detailed description of each VI using any of the following ways:

- Select the **Show Help** command in the **Help** menu in LabVIEW. Then, when you put the mouse cursor on KIDAQ LabVIEW VI, LabVIEW will show the description of the VI.
- Refer to [Appendix D](#) of this [User's Manual](#).
- Contact Keithley Instruments via phone, email, or on the web at [www.keithley.com](http://www.keithley.com) for further information.

## Device Driver Handling

Device Driver Handling describes how to configure the KIDAQ PXI cards Windows® XP/2000 device driver.

### Windows XP/2000 Device Driver

Once Windows XP/2000® has started, the Plug and Play function of Windows XP/2000® operating system will find the new Keithley PXI cards. If this is the first time to install Keithley PXI cards in your Windows XP/2000® system, you will be informed to install the device driver. Refer to driver installation information elsewhere in the product manual for the correct driver installation procedure for your module.

### Driver Utility

**NOTE** *The KDAQ-DRV, KDIO-DRV, or KDIG-DRV device driver should be installed before the KDAQ LabVIEW driver. Refer to driver installation information elsewhere in the product manual for the correct driver installation procedure for your module.*

KIDAQ LabVIEW provides a PXI Configuration Utility (*configdrv.exe*). These utilities are used to **set/change** the allocated buffer sizes of AI, AO, DI and DO (Analog Input, Analog Output, Digital Input, Digital Output). The allocated buffer sizes of AI, AO, DI, DO represent the sizes of contiguous Initially Allocated memory for continuous analog input, analog output, digital input, digital output respectively. Its unit is page *KB*, i.e. 1024 bytes. The device driver will try to allocate these sizes of memory at system startup time. If this size of memory is not available, the driver will allocate as much memory as system can provide. The size of initially allocated memory is the maximum memory size that DMA or Interrupt transfer can be performed. It will induce an unexpected result in that DMA or Interrupt transfer performed exceeds the initially allocated size.

## KIDAQ Utilities

This section, KIDAQ Utilities, describes all utilities included in the KIDAQ software.

### KIDAQ Registry/Configuration utility

*configdrv* is used to modify the allocated buffer sizes of AI, AO, DI and DO (Windows® XP/2000). The default installation directory for this utility is **C:\Keithley\KIDAQUtil**. It can also be found in the start menu under **Programs -> Keithley -> KIDAQ LabVIEW Driver -> Configuration Utility**. For detailed information on this utility, refer to device driver guide for you module.

### KIDAQ Device Browser

Device Browser (*KPXIconf.exe*) displays the currently installed and detected KIDAQ hardware. The default installation directory for this utility is **C:\Keithley\KIDAQUtil**. It can also be found in the start menu under **Programs -> Keithley -> KIDAQ LabVIEW Driver -> Device Explorer**. The *KIDAQ device browser* main window is shown in [Figure C-3](#):

Figure C-3  
**Keithley PXI Devices Explorer**

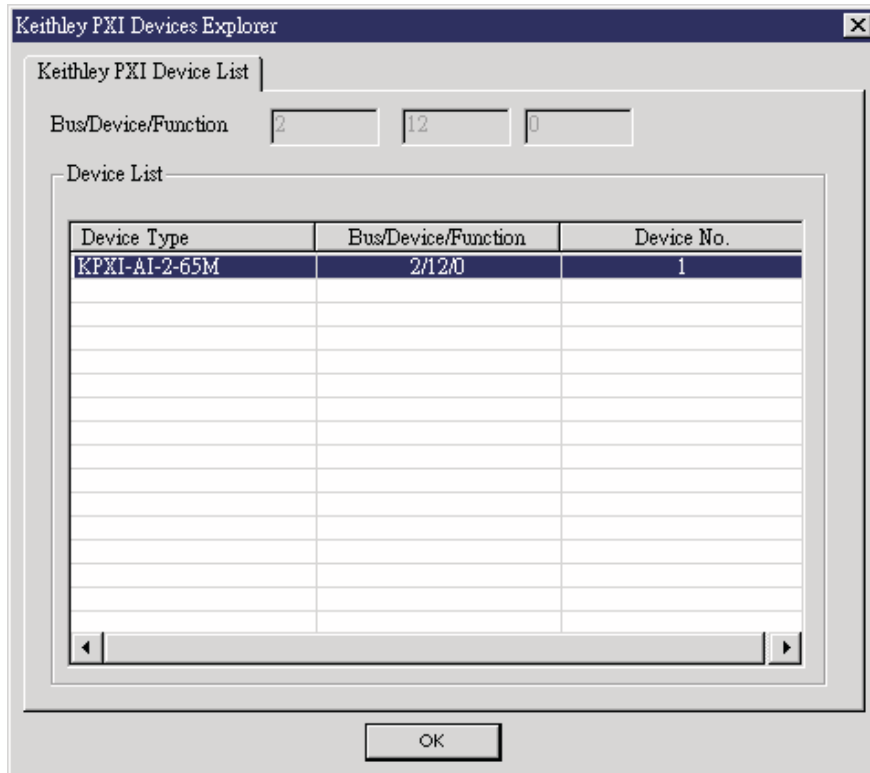

The *Device Browser* main window contains three columns, *Device Type*, *Location (Bus/Device/Function)* and *Device Number*.

Device Type: Type of KIDAQ board installed

Location (Bus/Device/Function): The location the device is plugged into

Device Number: Number of device at PXI bus (Starts from 1)

Using this utility, user can view all of the KIDAQ devices connected to your system and get the device number corresponding to the device plugged on a specified PXI slot.

## KIDAQ LabVIEW VIs Overview

This section briefly describes each VI in the KIDAQ LabVIEW driver. The setup program detects the system (Windows® XP/2000), and installs the correct platform drivers to the system. All applications developed with KIDAQ LabVIEW are compatible across Windows® XP/2000.

You can find the detailed description of each VI using any of the following ways:

- Select the **Show Help** command in the **Help** menu in LabVIEW. Then, when you put the mouse cursor on KIDAQ LabVIEW VI, LabVIEW will show the description of the VI.
- Refer to [Appendix D](#) of this document
- Contact Keithley Instruments via phone, email, or on the web at [www.keithley.com](http://www.keithley.com) for further information

KIDAQ LabVIEW VIs are grouped into the following LabVIEW palettes:

- **Analog Input VIs**
- **Analog Output VIs**
  - Advanced Analog Output VIs

- **Digital I/O VIs**
  - Advanced Digital I/O
- **Timer/Counter VIs**
  - Intermediate Timer/Counter VIs
  - Advanced Timer/Counter VIs
- **Calibration and Configuration VIs**
- **Error Handler VI**

## Analog Input VIs

**KI AI Acquire Waveform:** Acquires a specified number of samples at a specified sample rate from a single input channel and returns the acquired data.

**KI AI Acquire Waveforms:** Acquires data from the specified channels and samples the channels at the specified scan rate.

**KI AI Sample Channel:** Measures the signal attached to the specified channel and returns the measured data.

**KI AI Sample Channels:** Performs a single reading from each of the specified channels.

**KI AI Clear:** The KI AI Clear VI stops an acquisition associated with task ID in.

**KI AI Config:** Configures an analog input operation for a specified set of channels.

**KI AI Read:** Reads data from a buffered data acquisition.

**KI AI Single Scan:** Returns one scan of data directly from the board analog input channels for a non-buffered acquisition.

**KI AI Start:** Starts a buffered analog input operation.

## Analog Output VIs

**KI AO Generate Waveform:** Generates a timed and buffered waveform for the given output channel at the specified update rate.

**KI AO Generate Waveforms:** Generates timed and buffered waveforms for the given output channels at the specified update rate.

**KI AO Update Channel:** Writes a specified value to an analog output channel.

**KI AO Update Channels:** Writes values to each of the specified analog output channels.

**KI AO Clear:** The KI AO Clear VI stops an analog output generation associated with task ID.

**KI AO Config:** Configures a buffered analog output operation.

**KI AO Start:** Starts a buffered analog output operation.

**KI AO Wait:** waits until the waveform generation of the task completes before returning.

**KI AO Write:** writes data into the buffer for a buffered analog output operation.

### Advanced Analog Output VIs

**KI AO Trigger and Gate Config:** Configures the trigger conditions for analog output operations.

## Digital I/O VIs

**KI Read from Digital Line:** Reads the logical state of a digital line on a digital channel that you configure.

**KI Read from Digital Port:** Reads a digital channel that you configure.

**KI Write to Digital Line:** Sets the output logic state of a digital line to high or low on a digital channel that you specify.

**KI Write to Digital Port:** Outputs a decimal pattern to a digital channel that you specify.

**KI DIO Clear:** Stops an acquisition associated with task ID.

**KI DIO Config:** Creates the taskID, establishes the handshake parameters, and allocates a buffer to hold the scans.

**KI DIO Read:** Calls the VI to read data from the internal transfer buffer and returns the data read in pattern.

**KI DIO Start:** Starts a buffered digital I/O operation.

**KI DIO Write:** Writes digital output data to the internal transfer buffer.

### Advanced Digital I/O VIs

**KI DIO Port Config:** Configures a digital Channel and returns a taskID to be used with Port VIs.

## Timer/Counter VIs

**KI Count Events or Time:** Configures one or two counters to count external events.

**KI Generate Delayed Pulse:** Configures and starts a counter to generate a single pulse with the specified delay and pulse-width.

**KI Generate Pulse Train:** Configures the specified counter to generate a continuous pulse-train.

**KI Measure Pulse Width or Period:** Measures the pulse-width (length of time a signal is high or low) or period (length of time between adjacent rising or falling edges) of a TTL signal.

### Intermediate Timer/Counter VIs

**KI Continuous Pulse Generator Config:** Configures a counter to generate a continuous TTL pulse-train.

**KI Counter Divider Config:** Configures the specified counter to divide a signal.

**KI Counter Read:** Reads the counter or counters identified by task ID.

**KI Counter Start:** Starts the counters identified by task ID.

**KI Counter Stop:** Stops a count operation immediately or conditionally on an input error.

**KI Delayed Pulse Generator Config:** Configures a counter to generate a single pulse with the specified delay and pulse-width.

**KI Down Counter or Divider Config:** Configures the specified counter to count down or divide a signal.

**KI Event or Time Counter Config:** Configures one or two counters to count external events.

**KI UpDown Counter Config:** Configures one counter to count edges in the signal on the specified counter's SOURCE pin or the number of cycles of a specified internal timebase signal.

## Advanced Timer/Counter VIs

**KI ICTR Control:** This VI control counters on the KIDAQ devices that use 82C54 chip.

## Calibration and Configuration VIs

**KI KPXI-DAQ Series Calibrate and Digitizer Series calibrate:** calibrates Keithley PXI DAQ device.

**KI Route Signal:** routes an internal signal to the specified I/O connector or SSI bus line, or to enable clock sharing through the SSI bus clock line.

**KI SSI Control:** Connects or disconnects trigger and timing signals between DAQ devices along the Real-Time System Integration (SSI) bus.

## Error Handler VI

**KI Error Handler:** explains non-zero error codes and shows dialog box with information about error.

## Distribution of Applications

To install an application using KIDAQ LabVIEW on another computer, you also must install the necessary driver files and supporting libraries on the target machine. You can create an automatic installer to install your program and all of the files needed to run that program or you can manually install the program and program files. Whichever installation method you choose, you must install the following files:

**NOTE** *Do not replace any files on the target computer if the file on the target computer has a newer version than the file you are installing.*

## Windows XP/2000

### LLB files

kidaq\_pci.llb in **C:\Keithley\KI-DAQ\LLB**

### Required support DLLs

Pci-iv.dll in **C:\Windows\system32**. This file should be copied to the same system32 directory on the target machine. On Windows 2000 the Windows directory is named winnt instead of Windows.

### Driver files

The corresponding driver files in **C:\Windows\system32\drivers**, e.g. **ksdaq4M2.sys** for **KPXI-SDAQ-4-2M**. These files should be copied to:

- **Windows\system32\drivers** directory (for Windows XP).
- **Winnt\system32\drivers** directory (for Windows 2000).

The corresponding INF file in **\Windows\inf**, e.g. **ksdaq4M2.inf** for **KPXI-SDAQ-4-2M**. These files should be copied to:

- **Windows\inf** directory (for Windows XP).
- **Winnt\inf** directory (for Windows 2000).

The location of the device configuration utility is: **C:\Keithley\KI-DAQ\Util\configdrv**

---

# KIDAQ<sup>®</sup>-LabVIEW Compatible Function Reference

## In this appendix:

| Topic                                          | Page |
|------------------------------------------------|------|
| <b>Introduction</b> .....                      | D-2  |
| <b>Hardware support</b> .....                  | D-2  |
| KPXI-DIO series: .....                         | D-2  |
| KPXI-DAQ series: .....                         | D-2  |
| Digitizer series: .....                        | D-2  |
| <b>Analog input VIs</b> .....                  | D-3  |
| Easy analog input VIs .....                    | D-3  |
| Intermediate analog input VIs .....            | D-7  |
| <b>Analog output VIs</b> .....                 | D-21 |
| Easy analog output VIs .....                   | D-21 |
| Intermediate analog output VIs .....           | D-24 |
| Advanced analog output VIs .....               | D-32 |
| <b>Digital I/O VIs</b> .....                   | D-33 |
| Easy Digital I/O VIs .....                     | D-33 |
| Intermediate Digital I/O VIs .....             | D-37 |
| Advanced Digital I/O VIs .....                 | D-45 |
| <b>Counter VIs</b> .....                       | D-46 |
| Easy Counter VIs .....                         | D-46 |
| Intermediate Counter VIs .....                 | D-50 |
| Advanced Counter VIs .....                     | D-63 |
| <b>Calibration and Configuration VIs</b> ..... | D-67 |
| Calibration VIs .....                          | D-67 |
| Other Calibration and Configuration VIs .....  | D-68 |
| <b>Service VIs</b> .....                       | D-70 |
| <b>Error Codes</b> .....                       | D-71 |
| <b>AI Range Codes</b> .....                    | D-73 |
| <b>AI Data Format</b> .....                    | D-76 |

## Introduction

This function reference provides a detailed description of LabVIEW<sup>1</sup> compatible interfaces for Keithley Instruments PXI DAQ modules.

## Hardware support

Keithley Instruments will periodically upgrade KIDAQ LabVIEW to add support for new Keithley Instruments PXI data acquisition modules. This release of KIDAQ LabVIEW supports the following hardware:

### KPXI-DIO series:

- **KPXI-DIO-16-16:** 32 channels isolated Digital I/O card
- **KPXI-DIO-48:** 48-bit digital I/O card
- **KPXI-RDI-8-16:** 8 relay output and 16 isolated input card
- **KPXI-DIO-32-80M:** 40 Mbytes/sec Ultra-high speed 32 channels digital I/O module with bus mastering DMA transfer supporting scatter gather technology
- **KPXI-DIO-32-32:** 32 isolated channels DI & 32 isolated channels DO card
- **KPXI-DIO-64-0:** 64 isolated channels DI card
- **KPXI-DIO-0-64:** 64 isolated channels DO card

### KPXI-DAQ series:

- **KPXI-SDAQ-4-2M:** 2MHz 4 channels simultaneous A/D and 2 channels D/A output device with bus mastering DMA transfer capability
- **KPXI-SDAQ-4-500K:** 500kHz 4 channels simultaneous A/D and 2 channels D/A output device with bus mastering DMA transfer capability
- **KPXI-DAQ-64-3M:** 3MHz 64 channels multiplexed A/D and 2 channels D/A output device with bus mastering DMA transfer capability
- **KPXI-DAQ-64-500K:** 500kHz 64 channels multiplexed A/D and 2 channels D/A output device with bus mastering DMA transfer capability
- **KPXI-DAQ-64-250K:** 250kHz 64 channels multiplexed A/D and 2 channels D/A output device with bus mastering DMA transfer capability
- **KPXI-DAQ-96-3M:** 3MHz 96 channels multiplexed A/D device with bus mastering DMA transfer capability
- **KPXI-AO-4-1M:** High Performance 4 channels analog output Multi-function device with bus mastering DMA transfer capability
- **KPXI-AO-8-1M:** High Performance 8 channels analog output Multi-function device with bus mastering DMA transfer capability

### Digitizer series:

- **KPXI-AI-2-65M:** 130MHz or 2 channels simultaneous A/D digitizer with bus mastering DMA transfer capability

---

1. LabVIEW™ is a trademark of the National Instruments Corporation. All other trademarks are the property of their respective owners.



# Analog input VIs

Analog Input VIs (virtual instruments) are available in the Analog Input palette (Figure D-1).

Figure D-1  
Analog input palette

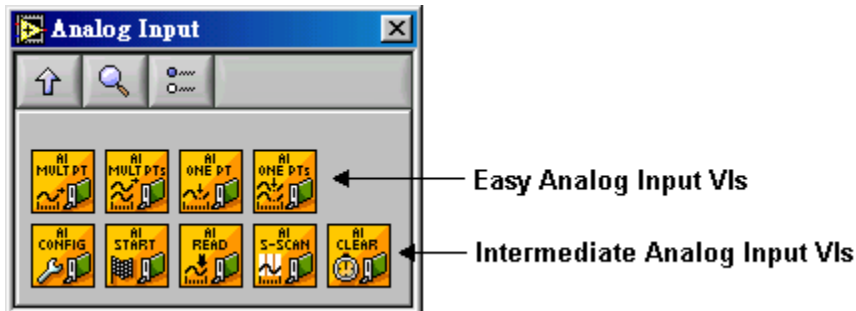

## Easy analog input VIs

### KI AI acquire waveform

This VI acquires a specified number of samples at a specified sample rate from a single input channel and returns the acquired data. This VI performs a timed measurement of a waveform on a single analog input channel. If an error occurs, a dialog box appears providing error information.

Table D-1  
KI AI acquire waveform

|            |                                                                                                                                                                                                                                                                                                                                                                                                                                                                                                                                                                                                                                                                |
|------------|----------------------------------------------------------------------------------------------------------------------------------------------------------------------------------------------------------------------------------------------------------------------------------------------------------------------------------------------------------------------------------------------------------------------------------------------------------------------------------------------------------------------------------------------------------------------------------------------------------------------------------------------------------------|
| <b>I16</b> | <b>device:</b> Number of the device (beginning from 1). The utility <i>Device Browser</i> can be used to get the information of current device configuration.                                                                                                                                                                                                                                                                                                                                                                                                                                                                                                  |
| <b>U16</b> | <b>sub type:</b> is the sub-type of the device you assigned to the Keithley Instruments PXI device during configuration.                                                                                                                                                                                                                                                                                                                                                                                                                                                                                                                                       |
| <b>abc</b> | <b>channel:</b> identifies the analog input channel you want to measure. The default input is channel 0. The valid channel for each Keithley Instruments PXI device is as follows: <ul style="list-style-type: none"> <li>• <b>KPXI-SDAQ-4-2M:</b> 0 through 3</li> <li>• <b>KPXI-SDAQ-4-500K:</b> 0 through 3</li> <li>• <b>KPXI-DAQ-64-3M:</b> 0 through 63</li> <li>• <b>KPXI-DAQ-64-500K:</b> 0 through 63</li> <li>• <b>KPXI-DAQ-64-250K:</b> 0 through 63</li> <li>• <b>KPXI-DAQ-96-3M:</b> 0 through 95</li> <li>• <b>KPXI-AO-4-1M:</b> 0 through 7</li> <li>• <b>KPXI-AO-8-1M:</b> 0 through 3</li> <li>• <b>KPXI-AI-2-65M:</b> 0 through 1</li> </ul> |
| <b>I32</b> | <b>number of samples:</b> is the number of samples the VI acquires. The default for this parameter is 1000 samples, except KPXI-AI-2-65M. For KPXI-AI-2-65M, the default value is 1024.                                                                                                                                                                                                                                                                                                                                                                                                                                                                        |
| <b>SGL</b> | <b>sample rate:</b> is the requested number of samples per second for the analog input. The default for this parameter is a rate of 1000 samples/second.                                                                                                                                                                                                                                                                                                                                                                                                                                                                                                       |

Table D-1 (continued)

**KI AI acquire waveform**

|                |                                                                                                                                                                                                                                         |
|----------------|-----------------------------------------------------------------------------------------------------------------------------------------------------------------------------------------------------------------------------------------|
| <b>SGL</b>     | <b>high limit:</b> is the maximum scaled data in Volts. The default input is 0. If both high limit and low limit are 0, high limit keeps the default settings.                                                                          |
| <b>SGL</b>     | <b>low limit:</b> is the minimum scaled data in Volts. The default input is 0. If both high limit and low limit are 0, low limit keeps the default settings.                                                                            |
| <b>U16</b>     | <b>input config:</b> defines the mode that the channel should be scanned.<br>0: No change (default input)<br>1: Differential (default setting)<br>2: Referenced single-ended<br>3: Nonreferenced single-ended                           |
| <b>[ SGL ]</b> | <b>waveform:</b> contains scaled analog input data.                                                                                                                                                                                     |
| <b>SGL</b>     | <b>actual sample period:</b> is the actual interval between samples, which is the inverse of the actual sample rate. The actual sample period can differ from the requested sample rate, depending on the capabilities of the hardware. |

**KI AI acquire waveforms**

Acquires data from the specified channels at the specified scan rate. This VI performs a timed measurement of multiple waveforms on the specified analog input channels. If an error occurs, a dialog box appears, giving you the error information.

Table D-2

**KI AI acquire waveforms**

|            |                                                                                                                                                                                             |
|------------|---------------------------------------------------------------------------------------------------------------------------------------------------------------------------------------------|
| <b>I16</b> | <b>device:</b> Number of the device (beginning from 1). The utility <b>Device Browser</b> can be used to get the information of current device configuration.                               |
| <b>U16</b> | <b>sub type:</b> is the sub-type of the device you assigned to the Keithley Instruments PXI device during configuration. Only the following series of devices need to specify the sub type. |

Table D-2 (continued)  
**KI AI acquire waveforms**







|              |                                                                                                                                                                                                                                                                                                                                                                                                                                                                                                                                                                                                                                                                                                                                                                                                                                                                                                                                                                                                                                                                                                                                                                                                                                                                                                                                                                                                                                                                                                                                                                                                                                                                                                                                                                                                                                                                                                                                                                                                                                                    |
|--------------|----------------------------------------------------------------------------------------------------------------------------------------------------------------------------------------------------------------------------------------------------------------------------------------------------------------------------------------------------------------------------------------------------------------------------------------------------------------------------------------------------------------------------------------------------------------------------------------------------------------------------------------------------------------------------------------------------------------------------------------------------------------------------------------------------------------------------------------------------------------------------------------------------------------------------------------------------------------------------------------------------------------------------------------------------------------------------------------------------------------------------------------------------------------------------------------------------------------------------------------------------------------------------------------------------------------------------------------------------------------------------------------------------------------------------------------------------------------------------------------------------------------------------------------------------------------------------------------------------------------------------------------------------------------------------------------------------------------------------------------------------------------------------------------------------------------------------------------------------------------------------------------------------------------------------------------------------------------------------------------------------------------------------------------------------|
| <p>[abc]</p> | <p><b>channels:</b> specifies the set of analog input channels you want to measure. The order of the channels in the scan list defines the order in which the channels are scanned. If x, y, and z refer to channels, you can specify a list of channels in a single element by "x,y,z". If x refers to the first channel in a consecutive channel range and y refers to the last channel, you can specify the range by "x:y". The default input is channel 0.</p> <p>The valid channel order for acquiring data is as follows:</p> <p><b>KPXI-SDAQ-4-2M:</b> numbers in channels must be within 0 and 3 and the continuous scan sequence is ascending with consecutive channels.</p> <p><b>KPXI-SDAQ-4-500K:</b> numbers in channels must be within 0 and 3 and the continuous scan sequence is ascending with consecutive channels.</p> <p><b>KPXI-DAQ-64-3M:</b> numbers in channels must be within 0 and 63 and there is no restriction of channel order setting; therefore you can set the channel order as you wish.</p> <p><b>KPXI-DAQ-64-500K:</b> numbers in channels must be within 0 and 63 and there is no restriction of channel order setting; therefore you can set the channel order as you wish.</p> <p><b>KPXI-DAQ-64-250K:</b> numbers in channels must be within 0 and 63 and there is no restriction of channel order setting; therefore you can set the channel order as you wish.</p> <p><b>KPXI-DAQ-96-3M:</b> numbers in channels must be within 0 and 95 and there is no restriction of channel order setting; therefore you can set the channel order as you wish.</p> <p><b>KPXI-AO-4-1M:</b> numbers in channels must be within 0 and 3 and the continuous scan sequence is ascending with consecutive channels.</p> <p><b>KPXI-AO-8-1M:</b> numbers in channels must be within 0 and 7 and the continuous scan sequence is ascending with consecutive channels.</p> <p><b>KPXI-AI-2-65M:</b> numbers in channels must be within 0 and 1 and the continuous scan sequence is ascending with consecutive channels.</p> |
| <p>[I32]</p> | <p><b>number of samples/ch:</b> is the number of samples per channel. The default is 1000 samples/ch, except KPXI-AI-2-65M. For KPXI-AI-2-65M, the default value is 1024 samples/ch.</p>                                                                                                                                                                                                                                                                                                                                                                                                                                                                                                                                                                                                                                                                                                                                                                                                                                                                                                                                                                                                                                                                                                                                                                                                                                                                                                                                                                                                                                                                                                                                                                                                                                                                                                                                                                                                                                                           |
| <p>[SGL]</p> | <p><b>scan rate:</b> is the requested number of scans per second. The default is 1000 scans/s. A scan is one sample/channel.</p>                                                                                                                                                                                                                                                                                                                                                                                                                                                                                                                                                                                                                                                                                                                                                                                                                                                                                                                                                                                                                                                                                                                                                                                                                                                                                                                                                                                                                                                                                                                                                                                                                                                                                                                                                                                                                                                                                                                   |
| <p>[SGL]</p> | <p><b>high limit:</b> is the maximum scaled data in Volts. The default input is 0. If both high limit and low limit are 0, high limit keeps the default settings.</p>                                                                                                                                                                                                                                                                                                                                                                                                                                                                                                                                                                                                                                                                                                                                                                                                                                                                                                                                                                                                                                                                                                                                                                                                                                                                                                                                                                                                                                                                                                                                                                                                                                                                                                                                                                                                                                                                              |
| <p>[SGL]</p> | <p><b>low limit:</b> is the minimum scaled data in Volts. The default input is 0. If both high limit and low limit are 0, low limit keeps the default settings.</p>                                                                                                                                                                                                                                                                                                                                                                                                                                                                                                                                                                                                                                                                                                                                                                                                                                                                                                                                                                                                                                                                                                                                                                                                                                                                                                                                                                                                                                                                                                                                                                                                                                                                                                                                                                                                                                                                                |
| <p>[U16]</p> | <p><b>input config:</b> defines the mode that the channel should be scanned.</p> <ul style="list-style-type: none"> <li>0: No change (default input)</li> <li>1: Differential (default setting)</li> <li>2: Referenced single-ended</li> <li>3: Nonreferenced single-ended</li> </ul>                                                                                                                                                                                                                                                                                                                                                                                                                                                                                                                                                                                                                                                                                                                                                                                                                                                                                                                                                                                                                                                                                                                                                                                                                                                                                                                                                                                                                                                                                                                                                                                                                                                                                                                                                              |
| <p>[SGL]</p> | <p><b>waveforms:</b> is a 2D array that contains analog input data in Volts.</p>                                                                                                                                                                                                                                                                                                                                                                                                                                                                                                                                                                                                                                                                                                                                                                                                                                                                                                                                                                                                                                                                                                                                                                                                                                                                                                                                                                                                                                                                                                                                                                                                                                                                                                                                                                                                                                                                                                                                                                   |
| <p>[SGL]</p> | <p><b>actual scan period:</b> is the actual interval between scans, which is the inverse of the actual scan rate. The actual scan period can differ from the requested scan rate, depending on the capabilities of the hardware.</p>                                                                                                                                                                                                                                                                                                                                                                                                                                                                                                                                                                                                                                                                                                                                                                                                                                                                                                                                                                                                                                                                                                                                                                                                                                                                                                                                                                                                                                                                                                                                                                                                                                                                                                                                                                                                               |

### KI AI sample channel

This VI performs a single, un-timed measurement of a channel. It measures the signal attached to the specified channel and returns the measured data (in Volts). If an error occurs, a dialog box appears, giving you the error information.

Table D-3

#### KI AI sample channel

|                                                                                     |                                                                                                                                                                                                                                                                                                                                                                                                                                                                                                          |
|-------------------------------------------------------------------------------------|----------------------------------------------------------------------------------------------------------------------------------------------------------------------------------------------------------------------------------------------------------------------------------------------------------------------------------------------------------------------------------------------------------------------------------------------------------------------------------------------------------|
|    | <b>device:</b> Number of the device (beginning from 1). The utility <b>Device Browser</b> can be used to get the information of current device configuration.                                                                                                                                                                                                                                                                                                                                            |
|    | <b>sub type:</b> is the sub-type of the device you assigned to the Keithley Instruments PXI device during configuration.                                                                                                                                                                                                                                                                                                                                                                                 |
|    | <b>channel:</b> identifies the analog input channel you want to measure. The default input is channel 0. The valid channel for each Keithley Instruments PXI device is as follows:<br><b>KPXI-SDAQ-4-2M:</b> 0 through 3<br><b>KPXI-SDAQ-4-500K:</b> 0 through 3<br><b>KPXI-DAQ-64-3M:</b> 0 through 63<br><b>KPXI-DAQ-64-500K:</b> 0 through 63<br><b>KPXI-DAQ-64-250K:</b> 0 through 63<br><b>KPXI-DAQ-96-3M:</b> 0 through 95<br><b>KPXI-AO-4-1M:</b> 0 through 3<br><b>KPXI-AO-8-1M:</b> 0 through 7 |
|   | <b>high limit:</b> is the maximum scaled data in Volts. The default input is 0. If both high limit and low limit are 0, high limit keeps the default setting.                                                                                                                                                                                                                                                                                                                                            |
|  | <b>low limit:</b> is the minimum scaled data in Volts. The default input is 0. If both high limit and low limit are 0, low limit keeps the default setting.                                                                                                                                                                                                                                                                                                                                              |
|  | <b>input config:</b> defines the mode that the channel should be scanned.<br>0: No change (default input)<br>1: Differential (default setting)<br>2: Referenced single-ended<br>3: Nonreferenced single-ended                                                                                                                                                                                                                                                                                            |
|  | <b>sample:</b> contains the scaled analog input data for the specified channel.                                                                                                                                                                                                                                                                                                                                                                                                                          |

### KI AI sample channels

This VI measures a single value from each of the specified analog input channels. If an error occurs, a dialog box appears, giving you the error information.

Table D-4

#### KI AI sample channels







|                                                                                     |                                                                                                                                                               |
|-------------------------------------------------------------------------------------|---------------------------------------------------------------------------------------------------------------------------------------------------------------|
|  | <b>device:</b> Number of the device (beginning from 1). The utility <b>Device Browser</b> can be used to get the information of current device configuration. |
|  | <b>sub type:</b> is the sub-type of the device you assigned to the Keithley Instruments PXI device during configuration.                                      |

Table D-4 (continued)  
**KI AI sample channels**

|                                                                                     |                                                                                                                                                                                                                                                                                                                                                                                                                                                                                                                                                                                                                                                                                                                                                                                                                                                                                                                                                                                                                                                                                                                                                                                                                                                                                                                                                                                                                                                                                                                                                                                                                                                                                                                                                                                                                                                                                                   |
|-------------------------------------------------------------------------------------|---------------------------------------------------------------------------------------------------------------------------------------------------------------------------------------------------------------------------------------------------------------------------------------------------------------------------------------------------------------------------------------------------------------------------------------------------------------------------------------------------------------------------------------------------------------------------------------------------------------------------------------------------------------------------------------------------------------------------------------------------------------------------------------------------------------------------------------------------------------------------------------------------------------------------------------------------------------------------------------------------------------------------------------------------------------------------------------------------------------------------------------------------------------------------------------------------------------------------------------------------------------------------------------------------------------------------------------------------------------------------------------------------------------------------------------------------------------------------------------------------------------------------------------------------------------------------------------------------------------------------------------------------------------------------------------------------------------------------------------------------------------------------------------------------------------------------------------------------------------------------------------------------|
|    | <p><b>channels:</b> specifies the set of analog input channels you want to measure. The order of the channels in the scan list defines the order in which the channels are scanned. If x, y, and z refer to channels, you can specify a list of channels in a single element by “x,y,z”. If x refers to the first channel in a consecutive channel range and y refers to the last channel, you can specify the range by “x:y”. The default input is channel 0.</p> <p>The valid channel order for acquiring data is as follows:</p> <p><b>KPXI-SDAQ-4-2M:</b> numbers in channels must be within 0 and 3 and the continuous scan sequence is ascending with consecutive channels.</p> <p><b>KPXI-SDAQ-4-500K:</b> numbers in channels must be within 0 and 3 and the continuous scan sequence is ascending with consecutive channels.</p> <p><b>KPXI-DAQ-64-3M:</b> numbers in channels must be within 0 and 63 and there is no restriction of channel order setting; therefore you can set the channel order as you wish.</p> <p><b>KPXI-DAQ-64-500K:</b> numbers in channels must be within 0 and 63 and there is no restriction of channel order setting; therefore you can set the channel order as you wish.</p> <p><b>KPXI-DAQ-64-250K:</b> numbers in channels must be within 0 and 63 and there is no restriction of channel order setting; therefore you can set the channel order as you wish.</p> <p><b>KPXI-DAQ-96-3M:</b> numbers in channels must be within 0 and 95 and there is no restriction of channel order setting; therefore you can set the channel order as you wish.</p> <p><b>KPXI-AO-4-1M:</b> numbers in channels must be within 0 and 3 and the continuous scan sequence is ascending with consecutive channels.</p> <p><b>KPXI-AO-8-1M:</b> numbers in channels must be within 0 and 7 and the continuous scan sequence is ascending with consecutive channels.</p> |
|   | <p><b>high limit:</b> is the maximum scaled data in Volts. The default input is 0. If both high limit and low limit are 0, high limit keeps the default setting.</p>                                                                                                                                                                                                                                                                                                                                                                                                                                                                                                                                                                                                                                                                                                                                                                                                                                                                                                                                                                                                                                                                                                                                                                                                                                                                                                                                                                                                                                                                                                                                                                                                                                                                                                                              |
|  | <p><b>low limit:</b> is the minimum scaled data in Volts. The default input is 0. If both high limit and low limit are 0, low limit keeps the default setting.</p>                                                                                                                                                                                                                                                                                                                                                                                                                                                                                                                                                                                                                                                                                                                                                                                                                                                                                                                                                                                                                                                                                                                                                                                                                                                                                                                                                                                                                                                                                                                                                                                                                                                                                                                                |
|  | <p><b>input config:</b> defines the mode that the channel should be scanned.</p> <ul style="list-style-type: none"> <li>0: No change (default input)</li> <li>1: Differential (default setting)</li> <li>2: Referenced single-ended</li> <li>3. Nonreferenced single-ended</li> </ul>                                                                                                                                                                                                                                                                                                                                                                                                                                                                                                                                                                                                                                                                                                                                                                                                                                                                                                                                                                                                                                                                                                                                                                                                                                                                                                                                                                                                                                                                                                                                                                                                             |
|  | <p><b>sample:</b> is a 1D array that contains scaled analog input data.</p>                                                                                                                                                                                                                                                                                                                                                                                                                                                                                                                                                                                                                                                                                                                                                                                                                                                                                                                                                                                                                                                                                                                                                                                                                                                                                                                                                                                                                                                                                                                                                                                                                                                                                                                                                                                                                       |

### Intermediate analog input VIs

#### KI AI clear

This VI stops an acquisition operation. Before beginning a new acquisition, you must call the KI AI Config VI.

Table D-5  
**KI AI clear**











|                                                                                     |                                                                                                                                                                                                  |
|-------------------------------------------------------------------------------------|--------------------------------------------------------------------------------------------------------------------------------------------------------------------------------------------------|
|  | <p><b>taskID in:</b> identifies the group and the I/O operation.</p>                                                                                                                             |
|  | <p><b>error in (no error):</b> describes error conditions occurring before the VI executes. If an error has already occurred, the VI returns the value of the error in cluster in error out.</p> |

Table D-5 (continued)

**KI AI clear**

|                                                                                   |                                                                                    |                                                                                                                                                                                                                               |
|-----------------------------------------------------------------------------------|------------------------------------------------------------------------------------|-------------------------------------------------------------------------------------------------------------------------------------------------------------------------------------------------------------------------------|
|                                                                                   |   | <b>status:</b> is TRUE if an error occurred. If status is TRUE, the VI does not perform any operations.                                                                                                                       |
|                                                                                   |   | <b>code:</b> is the error code number identifying an error. A value of 0 means no error, a negative value means a fatal error, and a positive value is a warning. Refer to <a href="#">Table D-52</a> for a code description. |
|                                                                                   |   | <b>source:</b> identifies where an error occurred. The source string is usually the name of the VI that produced the error.                                                                                                   |
|  |                                                                                    | <b>taskID out:</b> has the same value as taskID in.                                                                                                                                                                           |
|  |                                                                                    | <b>error out:</b> contains error information. If the error in cluster indicated an error, the error out cluster contains the same information. Otherwise, error out describes the error status of this VI.                    |
|                                                                                   |   | <b>status:</b> is TRUE if an error occurred. If status is TRUE, the VI does not perform any operations.                                                                                                                       |
|                                                                                   |   | <b>code:</b> is the error code number identifying an error. A value of 0 means no error, a negative value means a fatal error, and a positive value is a warning. Refer to <a href="#">Table D-52</a> for a code description. |
|                                                                                   |  | <b>source:</b> identifies where an error occurred. The source string is usually the name of the VI that produced the error.                                                                                                   |

**KI AI config**

Configures a buffered analog input operation, including configuring the hardware and allocating a buffer.

Table D-6

**KI AI config**













|                                                                                     |                                                                                                                                                                                                                                                                                                                                                                                                                                                      |                                                                                                                                                                                                                                                                                                              |
|-------------------------------------------------------------------------------------|------------------------------------------------------------------------------------------------------------------------------------------------------------------------------------------------------------------------------------------------------------------------------------------------------------------------------------------------------------------------------------------------------------------------------------------------------|--------------------------------------------------------------------------------------------------------------------------------------------------------------------------------------------------------------------------------------------------------------------------------------------------------------|
|    | <p><b>interchannel delay:</b> For devices with both scan and channel clocks (KPXI-DAQ series devices), you can use interchannel delay to specify the waiting time between sampling channels within a scan. Select a default interchannel delay automatically, giving the hardware time to settle between channels. The default value for interchannel delay is -1.0, which tells the AI Config VI to use the channel clock rate LabVIEW selects.</p> |                                                                                                                                                                                                                                                                                                              |
|    | <p><b>sub type:</b> is the sub-type of the device you assigned to the Keithley Instruments PXI device during configuration.</p>                                                                                                                                                                                                                                                                                                                      |                                                                                                                                                                                                                                                                                                              |
|    | <p><b>measurement mode structure:</b> This input is not used by Keithley Instruments PXI devices and is ignored.</p>                                                                                                                                                                                                                                                                                                                                 |                                                                                                                                                                                                                                                                                                              |
|                                                                                     |                                                                                                                                                                                                                                                                                                                                                                     | <p><b>measurement mode:</b> is not used</p>                                                                                                                                                                                                                                                                  |
|                                                                                     |                                                                                                                                                                                                                                                                                                                                                                     | <p><b>reserved:</b> is not used</p>                                                                                                                                                                                                                                                                          |
|  | <p><b>coupling &amp; input config:</b> is an array of clusters. Each array element contains the configuration for the channel or channels specified by the corresponding element of the channels array. KIDAQ LabVIEW uses only input config. The default for the coupling &amp; input config array is an empty array, which means the parameters keep their default settings.</p>                                                                   |                                                                                                                                                                                                                                                                                                              |
|                                                                                     |                                                                                                                                                                                                                                                                                                                                                                   | <p><b>coupling:</b> This input is not used by Keithley Instruments PXI devices and is ignored.</p>                                                                                                                                                                                                           |
|                                                                                     |                                                                                                                                                                                                                                                                                                                                                                   | <p><b>input config:</b> defines the mode that the channel should be scanned.<br/>                     0: No change (default input)<br/>                     1: Differential (default setting)<br/>                     2: Referenced single-ended<br/>                     3: Nonreferenced single-ended</p> |
|  | <p><b>input limits:</b> is an array of clusters. Each array element contains the expected signal limits for the channels specified by the corresponding element of channels. If there are fewer elements in this array than in channels, the VI uses the last array element for the rest of the channels. The default for the input limits array is an empty array, which means the input limits keep their default settings.</p>                    |                                                                                                                                                                                                                                                                                                              |
|                                                                                     |                                                                                                                                                                                                                                                                                                                                                                   | <p><b>high limit:</b> is the maximum scaled data in Volts. The default input is 0.</p>                                                                                                                                                                                                                       |
|                                                                                     |                                                                                                                                                                                                                                                                                                                                                                   | <p><b>low limit:</b> is the minimum scaled data in Volts. The default input is 0.</p>                                                                                                                                                                                                                        |
|  | <p><b>device:</b> Number of the device at PXI-bus (beginning from 1). The utility <b>Device Browser</b> can be used to get the information of current device configuration.</p>                                                                                                                                                                                                                                                                      |                                                                                                                                                                                                                                                                                                              |

Table D-6 (continued)

## KI AI config













|                                                                                     |                                                                                                                                                                                                                                                                                                                                                                                                                                                                                                                                                                                                                                                                                                                                                                                                                                                                                                                                                                                                                                                                                                                                                                                                                                                                                                                                                                                                                                                                                                                                                                                                                                                                                                                                                                                                                                                                                                                                                                                                                                                                                                                                                                             |
|-------------------------------------------------------------------------------------|-----------------------------------------------------------------------------------------------------------------------------------------------------------------------------------------------------------------------------------------------------------------------------------------------------------------------------------------------------------------------------------------------------------------------------------------------------------------------------------------------------------------------------------------------------------------------------------------------------------------------------------------------------------------------------------------------------------------------------------------------------------------------------------------------------------------------------------------------------------------------------------------------------------------------------------------------------------------------------------------------------------------------------------------------------------------------------------------------------------------------------------------------------------------------------------------------------------------------------------------------------------------------------------------------------------------------------------------------------------------------------------------------------------------------------------------------------------------------------------------------------------------------------------------------------------------------------------------------------------------------------------------------------------------------------------------------------------------------------------------------------------------------------------------------------------------------------------------------------------------------------------------------------------------------------------------------------------------------------------------------------------------------------------------------------------------------------------------------------------------------------------------------------------------------------|
| [abc]                                                                               | <p><b>channels:</b> specifies the set of analog input channels. The order of the channels in the scan list defines the order in which the channels are scanned. channels is an array of strings. You can use one channel entry per element or specify the entire scan list in a single element, or use any combination of these two methods. If x, y, and z refer to channels, you can specify a list of channels in a single element by "x,y,z". If x refers to the first channel in a consecutive channel range and y refers to the last channel, you can specify the range by "x:y".</p> <p>The valid channel order for acquiring data is as follows:</p> <p><b>KPXI-SDAQ-4-2M:</b> numbers in channels must be within 0 and 3 and the continuous scan sequence is ascending with consecutive channels.</p> <p><b>KPXI-SDAQ-4-500K:</b> numbers in channels must be within 0 and 3 and the continuous scan sequence is ascending with consecutive channels.</p> <p><b>KPXI-DAQ-64-3M:</b> numbers in channels must be within 0 and 63 and there is no restriction of channel order setting; therefore you can set the channel order as you wish.</p> <p><b>KPXI-DAQ-64-500K:</b> numbers in channels must be within 0 and 63 and there is no restriction of channel order setting; therefore you can set the channel order as you wish.</p> <p><b>KPXI-DAQ-64-250K:</b> numbers in channels must be within 0 and 63 and there is no restriction of channel order setting; therefore you can set the channel order as you wish.</p> <p><b>KPXI-DAQ-96-3M:</b> numbers in channels must be within 0 and 95 and there is no restriction of channel order setting; therefore you can set the channel order as you wish.</p> <p><b>KPXI-AO-4-1M:</b> numbers in channels must be within 0 and 7 and the continuous scan sequence is ascending with consecutive channels.</p> <p><b>KPXI-AO-8-1M:</b> numbers in channels must be within 0 and 3 and the continuous scan sequence is ascending with consecutive channels.</p> <p><b>KPXI-AI-2-65M:</b> numbers in channels must be within 0 and 1 and the continuous scan sequence is ascending with consecutive channels.</p> |
| I32                                                                                 | <p><b>buffer size:</b> is the number of scans you want the buffer to hold. The default for this parameter is 1000 scans, except KPXI-AI-2-65M. For KPXI-AI-2-65M, the default value is 1024 scans.</p>                                                                                                                                                                                                                                                                                                                                                                                                                                                                                                                                                                                                                                                                                                                                                                                                                                                                                                                                                                                                                                                                                                                                                                                                                                                                                                                                                                                                                                                                                                                                                                                                                                                                                                                                                                                                                                                                                                                                                                      |
| I16                                                                                 | <p><b>group:</b> is the number, from 0 to 15, that you assign to the specified set of channels. The default input and setting for group is 0. If you only have one acquisition for this device, leave this input unwired and use group 0.</p>                                                                                                                                                                                                                                                                                                                                                                                                                                                                                                                                                                                                                                                                                                                                                                                                                                                                                                                                                                                                                                                                                                                                                                                                                                                                                                                                                                                                                                                                                                                                                                                                                                                                                                                                                                                                                                                                                                                               |
|  | <p><b>error in (no error):</b> describes error conditions occurring before the VI executes. If an error has already occurred, the VI returns the value of the error in cluster in error out.</p>                                                                                                                                                                                                                                                                                                                                                                                                                                                                                                                                                                                                                                                                                                                                                                                                                                                                                                                                                                                                                                                                                                                                                                                                                                                                                                                                                                                                                                                                                                                                                                                                                                                                                                                                                                                                                                                                                                                                                                            |
|  | <p><b>status:</b> is TRUE if an error occurred. If status is TRUE, the VI does not perform any operations.</p>                                                                                                                                                                                                                                                                                                                                                                                                                                                                                                                                                                                                                                                                                                                                                                                                                                                                                                                                                                                                                                                                                                                                                                                                                                                                                                                                                                                                                                                                                                                                                                                                                                                                                                                                                                                                                                                                                                                                                                                                                                                              |
| I32                                                                                 | <p><b>code:</b> is the error code number identifying an error. A value of 0 means no error, a negative value means a fatal error, and a positive value is a warning. Refer to <a href="#">Table D-52</a> for a code description.</p>                                                                                                                                                                                                                                                                                                                                                                                                                                                                                                                                                                                                                                                                                                                                                                                                                                                                                                                                                                                                                                                                                                                                                                                                                                                                                                                                                                                                                                                                                                                                                                                                                                                                                                                                                                                                                                                                                                                                        |



Table D-6 (continued)  
**KI AI config**

|                                                                                   |                                                                                     |                                                                                                                                                                                                                               |
|-----------------------------------------------------------------------------------|-------------------------------------------------------------------------------------|-------------------------------------------------------------------------------------------------------------------------------------------------------------------------------------------------------------------------------|
|                                                                                   |    | <b>source:</b> identifies where an error occurred. The source string is usually the name of the VI that produced the error.                                                                                                   |
|  |                                                                                     | <b>number of buffers:</b> This input is not used by Keithley Instruments PXI devices and is ignored.                                                                                                                          |
|  |                                                                                     | <b>allocation mode:</b> This input is not used by Keithley Instruments PXI devices and is ignored.                                                                                                                            |
|  |                                                                                     | <b>number of AMUX boards:</b> This input is not used by Keithley Instruments PXI devices and is ignored.                                                                                                                      |
|  |                                                                                     | <b>taskID:</b> identifies the group and the I/O operation.                                                                                                                                                                    |
|  |                                                                                     | <b>number of channels:</b> is the total number of channels in the group.                                                                                                                                                      |
|  |                                                                                     | <b>error out:</b> contains error information. If the error in cluster indicated an error, the error out cluster contains the same information. Otherwise, error out describes the error status of this VI.                    |
|                                                                                   |    | <b>status:</b> is TRUE if an error occurred. If status is TRUE, the VI does not perform any operations.                                                                                                                       |
|                                                                                   |  | <b>code:</b> is the error code number identifying an error. A value of 0 means no error, a negative value means a fatal error, and a positive value is a warning. Refer to <a href="#">Table D-52</a> for a code description. |
|                                                                                   |  | <b>source:</b> identifies where an error occurred. The source string is usually the name of the VI that produced the error.                                                                                                   |

## KI AI Read

This VI reads specified number of scans of data from a buffered analog input acquisition.

KI AI Read is a polymorphic VI that you can configure to output the following kinds of data:

- 2-byte Binary Array (KPXI-AI-2-65M and KDAQ-DRVR series devices)([Table D-7](#))
- Scaled and 2-byte Binary Arrays (KPXI-AI-2-65M and KDAQ-DRVR series devices)([Table D-8](#))
- Scaled Array ([Table D-9](#))

Table D-7

### 2-byte binary array













|                                                                                     |                                                                                                                                                                                                                                                                                                                                                                                                                          |
|-------------------------------------------------------------------------------------|--------------------------------------------------------------------------------------------------------------------------------------------------------------------------------------------------------------------------------------------------------------------------------------------------------------------------------------------------------------------------------------------------------------------------|
|    | <b>conditional retrieval specification:</b> This input is not used by Keithley Instruments PXI devices and is ignored.                                                                                                                                                                                                                                                                                                   |
|    | <b>mode:</b> This input is not used by Keithley Instruments PXI devices and is ignored.                                                                                                                                                                                                                                                                                                                                  |
|    | <b>channel index:</b> This input is not used by Keithley Instruments PXI devices and is ignored.                                                                                                                                                                                                                                                                                                                         |
|    | <b>slope:</b> This input is not used by Keithley Instruments PXI devices and is ignored.                                                                                                                                                                                                                                                                                                                                 |
|   | <b>level:</b> This input is not used by Keithley Instruments PXI devices and is ignored.                                                                                                                                                                                                                                                                                                                                 |
|  | <b>hysteresis:</b> This input is not used by Keithley Instruments PXI devices and is ignored.                                                                                                                                                                                                                                                                                                                            |
|  | <b>skip count:</b> This input is not used by Keithley Instruments PXI devices and is ignored.                                                                                                                                                                                                                                                                                                                            |
|  | <b>offset:</b> This input is not used by Keithley Instruments PXI devices and is ignored.                                                                                                                                                                                                                                                                                                                                |
|  | <b>taskID in:</b> identifies the group and the I/O operation.                                                                                                                                                                                                                                                                                                                                                            |
|  | <b>number of scans to read:</b> is the number of scans the VI is to retrieve from the acquisition buffer. The default input is -1, which set number of scans to read equal to the value of the number of scans to acquire parameter when the KI AI Start was called. If number of scans to read is -1 and number of scans to acquire is 0, KIDAQ LabVIEW sets number of scans to read to be the half of the buffer size. |
|  | <b>time limit in sec:</b> is the time limit for the read operation. The default input is -1.0, which means KIDAQ LabVIEW calculates a time limit based on the value of number of scans to read and the scan rate. If the scan rate is unknown, the VI uses 1 second as the time limit. The resolution of the timeout clock is about 55 ms.                                                                               |
|  | <b>error in (no error):</b> describes error conditions occurring before the VI executes. If an error has already occurred, the VI returns the value of the error in cluster in error out.                                                                                                                                                                                                                                |
|  | <b>status:</b> is TRUE if an error occurred. If status is TRUE, the VI does not perform any operations.                                                                                                                                                                                                                                                                                                                  |

Table D-7 (continued)  
**2-byte binary array**















|                                                                                                                                                                                  |                                                                                                                                                                                                                                                                                                                                                                                                                 |                                                                                                                                                                                                                               |
|----------------------------------------------------------------------------------------------------------------------------------------------------------------------------------|-----------------------------------------------------------------------------------------------------------------------------------------------------------------------------------------------------------------------------------------------------------------------------------------------------------------------------------------------------------------------------------------------------------------|-------------------------------------------------------------------------------------------------------------------------------------------------------------------------------------------------------------------------------|
|                                                                                                                                                                                  |                                                                                                                                                                                                                                                                                                                                | <b>code:</b> is the error code number identifying an error. A value of 0 means no error, a negative value means a fatal error, and a positive value is a warning. Refer to <a href="#">Table D-52</a> for a code description. |
|                                                                                                                                                                                  |                                                                                                                                                                                                                                                                                                                                | <b>source:</b> identifies where an error occurred. The source string is usually the name of the VI that produced the error.                                                                                                   |
|                                                                                                 | <b>read/search position:</b> This input is not used by Keithley Instruments PXI devices and is ignored.<br>The starting point for the read is the position where the read mark points to. Initially, the read mark points to the beginning of the acquisition buffer. As you retrieve data from the buffer using this VI, KIDAQ LabVIEW increments the read mark to point to the next block of data to be read. |                                                                                                                                                                                                                               |
|                                                                                                                                                                                  |                                                                                                                                                                                                                                                                                                                                | <b>position:</b> This input is not used by Keithley Instruments PXI devices and is ignored.                                                                                                                                   |
|                                                                                                                                                                                  |                                                                                                                                                                                                                                                                                                                                | <b>read offset:</b> This input is not used by Keithley Instruments PXI devices and is ignored.                                                                                                                                |
|                                                                                                 | <b>scan backlog:</b> is the amount of data remaining in the buffer after this VI completes.                                                                                                                                                                                                                                                                                                                     |                                                                                                                                                                                                                               |
|                                                                                                | <b>number read:</b> is the number of scans returned. This number is identical to number of scans to read unless an error or timeout appears or the VI reaches the end of the data.                                                                                                                                                                                                                              |                                                                                                                                                                                                                               |
|                                                                                               | <b>taskID out:</b> has the same value as <i>taskID in</i> .                                                                                                                                                                                                                                                                                                                                                     |                                                                                                                                                                                                                               |
| <br>or<br> | <b>binary data:</b> is a 2D array that contains unscaled analog input data.                                                                                                                                                                                                                                                                                                                                     |                                                                                                                                                                                                                               |
|                                                                                               | <b>retrieval complete:</b> is TRUE when the acquisition finishes and no backlog data remains.                                                                                                                                                                                                                                                                                                                   |                                                                                                                                                                                                                               |
|                                                                                               | <b>error out:</b> contains error information. If the error in cluster indicated an error, the error out cluster contains the same information. Otherwise, error out describes the error status of this VI.                                                                                                                                                                                                      |                                                                                                                                                                                                                               |
|                                                                                               | <b>status:</b> is TRUE if an error occurred. If status is TRUE, the VI does not perform any operations.                                                                                                                                                                                                                                                                                                         |                                                                                                                                                                                                                               |
|                                                                                                                                                                                  |                                                                                                                                                                                                                                                                                                                              | <b>code:</b> is the error code number identifying an error. A value of 0 means no error, a negative value means a fatal error, and a positive value is a warning. Refer to <a href="#">Table D-52</a> for a code description. |
|                                                                                                                                                                                  |                                                                                                                                                                                                                                                                                                                              | <b>source:</b> identifies where an error occurred. The source string is usually the name of the VI that produced the error.                                                                                                   |

Table D-8  
Scaled and Binary Arrays















|                                                                                     |                                                                                                                                                                                                                                                                                                                                                                                                                          |
|-------------------------------------------------------------------------------------|--------------------------------------------------------------------------------------------------------------------------------------------------------------------------------------------------------------------------------------------------------------------------------------------------------------------------------------------------------------------------------------------------------------------------|
|    | <b>conditional retrieval specification:</b> This input is not used by Keithley Instruments PXI devices and is ignored.                                                                                                                                                                                                                                                                                                   |
|    | <b>mode:</b> This input is not used by Keithley Instruments PXI devices and is ignored.                                                                                                                                                                                                                                                                                                                                  |
|    | <b>channel index:</b> This input is not used by Keithley Instruments PXI devices and is ignored.                                                                                                                                                                                                                                                                                                                         |
|    | <b>slope:</b> This input is not used by Keithley Instruments PXI devices and is ignored.                                                                                                                                                                                                                                                                                                                                 |
|    | <b>level:</b> This input is not used by Keithley Instruments PXI devices and is ignored.                                                                                                                                                                                                                                                                                                                                 |
|    | <b>hysteresis:</b> This input is not used by Keithley Instruments PXI devices and is ignored.                                                                                                                                                                                                                                                                                                                            |
|    | <b>skip count:</b> This input is not used by Keithley Instruments PXI devices and is ignored.                                                                                                                                                                                                                                                                                                                            |
|   | <b>offset:</b> This input is not used by Keithley Instruments PXI devices and is ignored.                                                                                                                                                                                                                                                                                                                                |
|  | <b>taskID in:</b> Identifies the group and the I/O operation.                                                                                                                                                                                                                                                                                                                                                            |
|  | <b>number of scans to read:</b> is the number of scans the VI is to retrieve from the acquisition buffer. The default input is -1, which set number of scans to read equal to the value of the number of scans to acquire parameter when the KI AI Start was called. If number of scans to read is -1 and number of scans to acquire is 0, KIDAQ LabVIEW sets number of scans to read to be the half of the buffer size. |
|  | <b>time limit in sec:</b> is the time limit for the read operation. The default input is -1.0, which means KIDAQ LabVIEW calculates a time limit based on the value of number of scans to read and the scan rate. If the scan rate is unknown, the VI uses 1 second as the time limit. The resolution of the timeout clock is about 55 ms.                                                                               |
|  | <b>error in (no error):</b> describes error conditions occurring before the VI executes. If an error has already occurred, the VI returns the value of the error in cluster in error out.                                                                                                                                                                                                                                |
|  | <b>status:</b> is TRUE if an error occurred. If status is TRUE, the VI does not perform any operations.                                                                                                                                                                                                                                                                                                                  |
|  | <b>code:</b> is the error code number identifying an error. A value of 0 means no error, a negative value means a fatal error, and a positive value is a warning. Refer to <a href="#">Table D-52</a> for a code description.                                                                                                                                                                                            |
|  | <b>source:</b> Identifies where an error occurred. The source string is usually the name of the VI that produced the error.                                                                                                                                                                                                                                                                                              |

Table D-8 (continued)  
**Scaled and Binary Arrays**















|                                                                                                                                                                                |                                                                                                                                                                                                                                                                                                                                                                                                                                         |
|--------------------------------------------------------------------------------------------------------------------------------------------------------------------------------|-----------------------------------------------------------------------------------------------------------------------------------------------------------------------------------------------------------------------------------------------------------------------------------------------------------------------------------------------------------------------------------------------------------------------------------------|
|                                                                                               | <p><b>read/search position:</b> This input is not used by Keithley Instruments PXI devices and is ignored.<br/>                 The starting point for the read is the position where the read mark point to. Initially, the read mark points to the beginning of the acquisition buffer. As you retrieve data from the buffer using this VI, KIDAQ LabVIEW increments the read mark to point to the next block of data to be read.</p> |
|                                                                                               | <p><b>position:</b> This input is not used by Keithley Instruments PXI devices and is ignored.</p>                                                                                                                                                                                                                                                                                                                                      |
|                                                                                               | <p><b>read offset:</b> This input is not used by Keithley Instruments PXI devices and is ignored.</p>                                                                                                                                                                                                                                                                                                                                   |
|                                                                                               | <p><b>scan backlog:</b> is the amount of data remaining in the buffer after this VI completes.</p>                                                                                                                                                                                                                                                                                                                                      |
|                                                                                               | <p><b>number read:</b> is the number of scans returned. This number is identical to number of scans to read unless an error or timeout appears or the VI reaches the end of the data.</p>                                                                                                                                                                                                                                               |
|                                                                                               | <p><b>taskID out:</b> has the same value as <i>taskID in</i>.</p>                                                                                                                                                                                                                                                                                                                                                                       |
| <br>or<br> | <p><b>binary data:</b> is a 2D array that contains unscaled analog input data.</p>                                                                                                                                                                                                                                                                                                                                                      |
|                                                                                             | <p><b>scaled data:</b> is a 2D array that contains analog input data in Volts.</p>                                                                                                                                                                                                                                                                                                                                                      |
|                                                                                             | <p><b>retrieval complete:</b> is TRUE when the acquisition finishes and no backlog data remains.</p>                                                                                                                                                                                                                                                                                                                                    |
|                                                                                             | <p><b>error out:</b> contains error information. If the error in cluster indicated an error, the error out cluster contains the same information. Otherwise, error out describes the error status of this VI.</p>                                                                                                                                                                                                                       |
|                                                                                             | <p><b>status:</b> is TRUE if an error occurred. If status is TRUE, the VI does not perform any operations.</p>                                                                                                                                                                                                                                                                                                                          |
|                                                                                             | <p><b>code:</b> is the error code number identifying an error. A value of 0 means no error, a negative value means a fatal error, and a positive value is a warning. Refer to <a href="#">Table D-52</a> for a code description.</p>                                                                                                                                                                                                    |
|                                                                                             | <p><b>source:</b> identifies where an error occurred. The source string is usually the name of the VI that produced the error.</p>                                                                                                                                                                                                                                                                                                      |

Table D-9  
Scaled Array















|                                                                                     |                                                                                                                                                                                                                                                                                                                                                                                                                          |
|-------------------------------------------------------------------------------------|--------------------------------------------------------------------------------------------------------------------------------------------------------------------------------------------------------------------------------------------------------------------------------------------------------------------------------------------------------------------------------------------------------------------------|
|    | <b>conditional retrieval specification:</b> This input is not used by Keithley Instruments PXI devices and is ignored.                                                                                                                                                                                                                                                                                                   |
|    | <b>mode:</b> This input is not used by Keithley Instruments PXI devices and is ignored.                                                                                                                                                                                                                                                                                                                                  |
|    | <b>channel index:</b> This input is not used by Keithley Instruments PXI devices and is ignored.                                                                                                                                                                                                                                                                                                                         |
|    | <b>slope:</b> This input is not used by Keithley Instruments PXI devices and is ignored.                                                                                                                                                                                                                                                                                                                                 |
|    | <b>level:</b> This input is not used by Keithley Instruments PXI devices and is ignored.                                                                                                                                                                                                                                                                                                                                 |
|    | <b>hysteresis:</b> This input is not used by Keithley Instruments PXI devices and is ignored.                                                                                                                                                                                                                                                                                                                            |
|    | <b>skip count:</b> This input is not used by Keithley Instruments PXI devices and is ignored.                                                                                                                                                                                                                                                                                                                            |
|   | <b>offset:</b> This input is not used by Keithley Instruments PXI devices and is ignored.                                                                                                                                                                                                                                                                                                                                |
|  | <b>taskID in:</b> Identifies the group and the I/O operation.                                                                                                                                                                                                                                                                                                                                                            |
|  | <b>number of scans to read:</b> is the number of scans the VI is to retrieve from the acquisition buffer. The default input is -1, which set number of scans to read equal to the value of the number of scans to acquire parameter when the KI AI Start was called. If number of scans to read is -1 and number of scans to acquire is 0, KIDAQ LabVIEW sets number of scans to read to be the half of the buffer size. |
|  | <b>time limit in sec:</b> is the time limit for the read operation. The default input is -1.0, which means KIDAQ LabVIEW calculates a time limit based on the value of number of scans to read and the scan rate. If the scan rate is unknown, the VI uses 1 second as the time limit. The resolution of the timeout clock is about 55 ms.                                                                               |
|  | <b>error in (no error):</b> describes error conditions occurring before the VI executes. If an error has already occurred, the VI returns the value of the error in cluster in error out.                                                                                                                                                                                                                                |
|  | <b>status:</b> is TRUE if an error occurred. If status is TRUE, the VI does not perform any operations.                                                                                                                                                                                                                                                                                                                  |
|  | <b>code:</b> is the error code number identifying an error. A value of 0 means no error, a negative value means a fatal error, and a positive value is a warning. Refer to <a href="#">Table D-52</a> for a code description.                                                                                                                                                                                            |
|  | <b>source:</b> Identifies where an error occurred. The source string is usually the name of the VI that produced the error.                                                                                                                                                                                                                                                                                              |

Table D-9 (continued)

**Scaled Array**

|  |                                                                                                                                                                                                                                                                                                                                                                                                                |
|--|----------------------------------------------------------------------------------------------------------------------------------------------------------------------------------------------------------------------------------------------------------------------------------------------------------------------------------------------------------------------------------------------------------------|
|  | <b>read/search position:</b> This input is not used by Keithley Instruments PXI devices and is ignored.<br>The starting point for the read is the position where the read mark point to. Initially, the read mark points to the beginning of the acquisition buffer. As you retrieve data from the buffer using this VI, KIDAQ LabVIEW increments the read mark to point to the next block of data to be read. |
|  | <b>position:</b> This input is not used by Keithley Instruments PXI devices and is ignored.                                                                                                                                                                                                                                                                                                                    |
|  | <b>read offset:</b> This input is not used by Keithley Instruments PXI devices and is ignored.                                                                                                                                                                                                                                                                                                                 |
|  | <b>scan backlog:</b> is the amount of data remaining in the buffer after this VI completes.                                                                                                                                                                                                                                                                                                                    |
|  | <b>number read:</b> is the number of scans returned. This number is identical to number of scans to read unless an error or timeout appears or the VI reaches the end of the data.                                                                                                                                                                                                                             |
|  | <b>taskID out:</b> has the same value as taskID in.                                                                                                                                                                                                                                                                                                                                                            |
|  | <b>scaled data:</b> is a 2D array that contains analog input data in Volts.                                                                                                                                                                                                                                                                                                                                    |
|  | <b>retrieval complete:</b> is TRUE when the acquisition finishes and no backlog data remains.                                                                                                                                                                                                                                                                                                                  |
|  | <b>error out:</b> contains error information. If the error in cluster indicated an error, the error out cluster contains the same information. Otherwise, error out describes the error status of this VI.                                                                                                                                                                                                     |
|  | <b>status:</b> is TRUE if an error occurred. If status is TRUE, the VI does not perform any operations.                                                                                                                                                                                                                                                                                                        |
|  | <b>code:</b> is the error code number identifying an error. A value of 0 means no error, a negative value means a fatal error, and a positive value is a warning. Refer to <a href="#">Table D-52</a> for a code description.                                                                                                                                                                                  |
|  | <b>source:</b> identifies where an error occurred. The source string is usually the name of the VI that produced the error.                                                                                                                                                                                                                                                                                    |

**KI AI Single Scan**

This VI returns one scan of data from the analog input channels for a non-buffered acquisition.















Table D-10

**KI AI single scan**

|              |                                                               |
|--------------|---------------------------------------------------------------|
| Binary Array |                                                               |
|              | <b>taskID in:</b> identifies the group and the I/O operation. |

Table D-10 (continued)

## KI AI single scan

|                                                                                                                                                                                  |                                                                                                                                                                                                                               |
|----------------------------------------------------------------------------------------------------------------------------------------------------------------------------------|-------------------------------------------------------------------------------------------------------------------------------------------------------------------------------------------------------------------------------|
|                                                                                                 | <b>opcode:</b> This input is not used by Keithley Instruments PXI devices and is ignored.                                                                                                                                     |
|                                                                                                 | <b>time limit in sec:</b> This input is not used by Keithley Instruments PXI devices and is ignored.                                                                                                                          |
|                                                                                                 | <b>error in (no error):</b> describes error conditions occurring before the VI executes. If an error has already occurred, the VI returns the value of the error in cluster in error out.                                     |
|                                                                                                 | <b>status:</b> is TRUE if an error occurred. If status is TRUE, the VI does not perform any operations.                                                                                                                       |
|                                                                                                 | <b>code:</b> is the error code number identifying an error. A value of 0 means no error, a negative value means a fatal error, and a positive value is a warning. Refer to <a href="#">Table D-52</a> for a code description. |
|                                                                                                 | <b>source:</b> identifies where an error occurred. The source string is usually the name of the VI that produced the error.                                                                                                   |
|                                                                                                 | <b>data remaining:</b> This input is not used by Keithley Instruments PXI devices and is ignored.                                                                                                                             |
|                                                                                                | <b>taskID out:</b> has the same value as taskID in.                                                                                                                                                                           |
| <br>or<br> | <b>binary data:</b> contains the unscaled binary data in Volts. The array index represents the channel.                                                                                                                       |
|                                                                                               | <b>acquisition state:</b> This input is not used by Keithley Instruments PXI devices and is ignored                                                                                                                           |
|                                                                                               | <b>error out:</b> contains error information. If the error in cluster indicated an error, the error out cluster contains the same information. Otherwise, error out describes the error status of this VI.                    |
|                                                                                               | <b>status:</b> is TRUE if an error occurred. If status is TRUE, the VI does not perform any operations.                                                                                                                       |
|                                                                                               | <b>code:</b> is the error code number identifying an error. A value of 0 means no error, a negative value means a fatal error, and a positive value is a warning. Refer to <a href="#">Table D-52</a> for a code description. |
|                                                                                               | <b>source:</b> identifies where an error occurred. The source string is usually the name of the VI that produced the error.                                                                                                   |



**KI AI start**

Starts a buffered analog input operation. This VI sets the scan rate, the number of scans to acquire, the conversion clock source, and the trigger conditions. The VI then starts an acquisition.

Table D-11  
**KI AI start**











|                                                                                     |                                                                                                                                                                                                                                                                                                                                                                                                                                                                                                                                                                                                                                                                                  |
|-------------------------------------------------------------------------------------|----------------------------------------------------------------------------------------------------------------------------------------------------------------------------------------------------------------------------------------------------------------------------------------------------------------------------------------------------------------------------------------------------------------------------------------------------------------------------------------------------------------------------------------------------------------------------------------------------------------------------------------------------------------------------------|
|    | <b>taskID in:</b> identifies the group and the I/O operation.                                                                                                                                                                                                                                                                                                                                                                                                                                                                                                                                                                                                                    |
|    | <b>number of scans to acquire:</b> is the total number of scans to acquire. A scan is one point per channel. With the default input -1, the device acquires exactly one buffer of data. The buffer size input to the KI AI Config VI determines the size of the buffer. The number of total scans includes any pretrigger scans requested. If you set number of scans to acquire to 0, the device acquires data indefinitely into the buffer until you stop the acquisition with the KI AI Clear VI. In this case, the VI ignores the pretrigger scans input. For KPXI-AI-2-65M, the number of scans to acquire has to be equal to the buffer size input to the KI AI Config VI. |
|    | <b>scan rate:</b> is the number of scans/s to acquire. This is equivalent to the sampling rate per channel. The default for this parameter is 1000 scans/s. If you enter 0, the on-board internal clock is disabled and the external clock is used.                                                                                                                                                                                                                                                                                                                                                                                                                              |
|    | <b>error in (no error):</b> describes error conditions occurring before the VI executes. If an error has already occurred, the VI returns the value of the error in cluster in error out.                                                                                                                                                                                                                                                                                                                                                                                                                                                                                        |
|   | <b>status:</b> is TRUE if an error occurred. If status is TRUE, the VI does not perform any operations.                                                                                                                                                                                                                                                                                                                                                                                                                                                                                                                                                                          |
|  | <b>code:</b> is the error code number identifying an error. A value of 0 means no error, a negative value means a fatal error, and a positive value is a warning. Refer to <a href="#">Table D-52</a> for a code description.                                                                                                                                                                                                                                                                                                                                                                                                                                                    |
|  | <b>source:</b> identifies where an error occurred. The source string is usually the name of the VI that produced the error.                                                                                                                                                                                                                                                                                                                                                                                                                                                                                                                                                      |
|  | <b>edge or slope:</b><br>0: Do not change the default setting (default input).<br>1: Leading edge for digital trigger; positive slope for analog trigger.<br>2: Trailing edge for digital trigger; negative slope for analog trigger.                                                                                                                                                                                                                                                                                                                                                                                                                                            |
|  | <b>pretrigger scans:</b> is the number of scans you want to save in the buffer before the trigger. The default for this parameter is 0, which means no data before the trigger is saved.                                                                                                                                                                                                                                                                                                                                                                                                                                                                                         |
|  | <b>trigger type:</b> specifies the type of trigger to start or stop the acquisition.<br>0: No trigger (default input).<br>1: Analog trigger (default setting).<br>2: Digital trigger.<br>3: SSI digital start trigger (for KPXI-AI-2-65M, the signal is through PXI trigger bus 3) and analog trigger (for the applications need both start and stop triggers, e.g. middle trigger or pre-trigger mode of operation).<br>4: SSI digital start trigger (for KPXI-AI-2-65M, the signal is through PXI trigger bus 3) and digital trigger (for the applications need both start and stop triggers, e.g. middle trigger or pre-trigger mode of operation).                           |
|  | <b>number of buffers to acquire:</b> This input is not used by Keithley Instruments PXI devices and is ignored. There is always only one buffer.                                                                                                                                                                                                                                                                                                                                                                                                                                                                                                                                 |

Table D-11 (continued)

**KI AI start**





















|                                                                                     |                                                                                                                                                                                                                                                                                                                                                                                                                                                                                                                                                                                                                                                                                                                                                                                                                                                                                                                                                                                                                                                                                                                                         |
|-------------------------------------------------------------------------------------|-----------------------------------------------------------------------------------------------------------------------------------------------------------------------------------------------------------------------------------------------------------------------------------------------------------------------------------------------------------------------------------------------------------------------------------------------------------------------------------------------------------------------------------------------------------------------------------------------------------------------------------------------------------------------------------------------------------------------------------------------------------------------------------------------------------------------------------------------------------------------------------------------------------------------------------------------------------------------------------------------------------------------------------------------------------------------------------------------------------------------------------------|
|    | <p><b>scan clock source:</b> identifies the A/D clock source.</p> <p>0: Do not change the clock source setting (default input).</p> <p>1: An internal timebase is used (default setting).</p> <p>2: You supply a signal through the I/O connector 1 (for KPXI-DAQ series devices, the signal is from AF10/AF11 and for KPXI-AI-2-65M the signal is from CLK IN connector).</p> <p>3: You supply a signal through the I/O connector 2 (for KPXI-DAQ series devices and KPXI-AI-2-65M, the signal is from SSI cable).</p> <p>4: An internal timebase with double edged enabled (only available for KPXI-AI-2-65M).</p> <p>5: You supply a signal through the I/O connector 1 with double edged enabled (only available for KPXI-AI-2-65M).</p> <p>6: a signal from SSI cable with double edged enabled (only available for KPXI-AI-2-65M).</p> <p>7: external timebase from SSI cable (for KPXI-DAQ series devices, the timebase is 40MHz and for KPXI-AI-2-65M, the time base is 60 MHz).</p> <p>8: both conversion signal and external timebase from SSI cable (only available for KPXI-DAQ series devices. The timebase is 40MHz).</p> |
|    | <p><b>analog chan and level:</b> contains the following parameter.</p>                                                                                                                                                                                                                                                                                                                                                                                                                                                                                                                                                                                                                                                                                                                                                                                                                                                                                                                                                                                                                                                                  |
|   | <p><b>trigger channel:</b> specifies where the trigger comes from.</p> <p>When trigger type is 1 (analog trigger), the default for trigger channel is 0, i.e. analog input channel 0.</p> <p>When trigger type is 2 (digital trigger):</p> <p>0: external digital pin (default).</p> <p>1 : the signal from SSI cable.</p> <p>2: both start and stop trigger signals are from SSI cable (available for KPXI-DAQ series devices or KPXI-AI-2-65M).</p> <p>3~10: the signal is from PXI trigger bus 0 to 7. (only available for KPXI-AI-2-65M)</p> <p>11: the signal is PXI_START signal. (only available for KPXI-AI-2-65M)</p>                                                                                                                                                                                                                                                                                                                                                                                                                                                                                                          |
|  | <p><b>level:</b> level (measured in Volts) which analog source must cross for a trigger to occur. The default input for level is 0.0.</p>                                                                                                                                                                                                                                                                                                                                                                                                                                                                                                                                                                                                                                                                                                                                                                                                                                                                                                                                                                                               |
|  | <p><b>additional trig params:</b> cluster contains the following parameters:</p>                                                                                                                                                                                                                                                                                                                                                                                                                                                                                                                                                                                                                                                                                                                                                                                                                                                                                                                                                                                                                                                        |
|  | <p><b>hysteresis:</b> This input is not used by Keithley Instruments PXI devices and is ignored.</p>                                                                                                                                                                                                                                                                                                                                                                                                                                                                                                                                                                                                                                                                                                                                                                                                                                                                                                                                                                                                                                    |
|  | <p><b>coupling:</b> This input is not used by Keithley Instruments PXI devices and is ignored.</p>                                                                                                                                                                                                                                                                                                                                                                                                                                                                                                                                                                                                                                                                                                                                                                                                                                                                                                                                                                                                                                      |
|  | <p><b>delay:</b> specifies how long the device waits after a trigger occurs before sampling data. You express delay in seconds. The default input and setting are 0.0s (no delay).</p>                                                                                                                                                                                                                                                                                                                                                                                                                                                                                                                                                                                                                                                                                                                                                                                                                                                                                                                                                  |
|  | <p><b>skip count:</b> This input is not used by Keithley Instruments PXI devices and is ignored.</p>                                                                                                                                                                                                                                                                                                                                                                                                                                                                                                                                                                                                                                                                                                                                                                                                                                                                                                                                                                                                                                    |
|  | <p><b>time limit:</b> This input is not used by Keithley Instruments PXI devices and is ignored.</p>                                                                                                                                                                                                                                                                                                                                                                                                                                                                                                                                                                                                                                                                                                                                                                                                                                                                                                                                                                                                                                    |
|  | <p><b>taskID out:</b> has the same value as <i>taskID in</i>.</p>                                                                                                                                                                                                                                                                                                                                                                                                                                                                                                                                                                                                                                                                                                                                                                                                                                                                                                                                                                                                                                                                       |

Table D-11 (continued)  
**KI AI start**

|                                                                                     |                                                                                                                                                                                                                               |  |
|-------------------------------------------------------------------------------------|-------------------------------------------------------------------------------------------------------------------------------------------------------------------------------------------------------------------------------|--|
|    | <b>error out:</b> contains error information. If the error in cluster indicated an error, the error out cluster contains the same information. Otherwise, error out describes the error status of this VI.                    |  |
|    | <b>status:</b> is TRUE if an error occurred. If status is TRUE, the VI does not perform any operations.                                                                                                                       |  |
|    | <b>code:</b> is the error code number identifying an error. A value of 0 means no error, a negative value means a fatal error, and a positive value is a warning. Refer to <a href="#">Table D-52</a> for a code description. |  |
|    | <b>source:</b> identifies where an error occurred. The source string is usually the name of the VI that produced the error.                                                                                                   |  |
|    | <b>actual scan rate:</b> may differ slightly from the requested scan rate, depending on the hardware capabilities.                                                                                                            |  |
|    | <b>actual trigger params:</b> cluster may differ slightly from the requested trigger inputs, depending on the hardware capabilities. It contains the following parameters.                                                    |  |
|    | <b>actual level:</b> is the analog trigger level the VI used.                                                                                                                                                                 |  |
|   | <b>actual hysteresis:</b> This input is not used by Keithley Instruments PXI devices and is ignored.                                                                                                                          |  |
|  | <b>actual delay:</b> is the delay the VI used.                                                                                                                                                                                |  |

## Analog output VIs

### Easy analog output VIs

Analog Output VIs (virtual instruments) are available in the Analog Output palette ([Figure D-2](#)).

Figure D-2  
**Analog output palette**

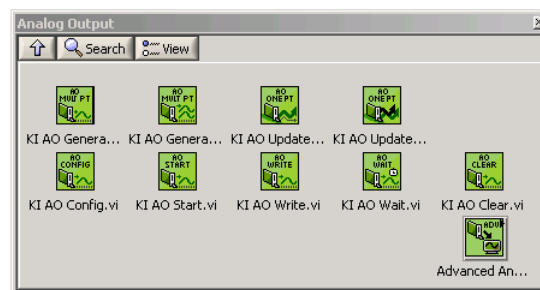









### KI AO generate waveform

Generates a timed and buffered waveform for the given output channel at the specified update rate. The KI AO Generate Waveform VI generates a waveform on a specified analog output channel. It does not return until the generation is complete.

**NOTE** This VI is not supported for Keithley KDIO Series devices.

Table D-12

**KI AO generate waveform**

|                                                                                     |                                                                                                                                                                                                                                                                                                                                                                             |
|-------------------------------------------------------------------------------------|-----------------------------------------------------------------------------------------------------------------------------------------------------------------------------------------------------------------------------------------------------------------------------------------------------------------------------------------------------------------------------|
|    | <b>device:</b> Number of the device (beginning from 1). The utility <b>Device Browser</b> can be used to get the information of current device configuration.                                                                                                                                                                                                               |
|    | <b>sub type:</b> is the sub-type of the device you assigned to the Keithley Instruments PXI device during configuration.                                                                                                                                                                                                                                                    |
|    | <b>channel:</b> identifies the analog output channel. The default input is channel 0. The valid channel for each Keithley Instruments PXI series device is as follows:<br><b>KPXI-SDAQ-4-500K/KPXI-SDAQ-4-2M/KPXI-DAQ-64-3M/KPXI-DAQ-64-500K/</b><br><b>KPXI-DAQ-64-250K/KPXI-DAQ-96-3M:</b> 0 or 1<br><b>KPXI-AO-4-1M:</b> 0 through 3<br><b>KPXI-AO-8-1M:</b> 0 through 7 |
|    | <b>high limit:</b> is the highest expected level of the signal in Volts you want to generate.                                                                                                                                                                                                                                                                               |
|    | <b>low limit:</b> is the lowest expected level of the signal in Volts you want to generate.                                                                                                                                                                                                                                                                                 |
|   | <b>reference source:</b> is the internal/external setting of the reference voltage for this channel.<br>0: Do not change the reference source setting (default input).<br>1: Internal (default setting).<br>2: External.                                                                                                                                                    |
|  | <b>update rate:</b> is the number of updates to generate per second. The default rate is 1000 update/s.                                                                                                                                                                                                                                                                     |
|  | <b>waveform:</b> is a 1D array that contains analog output data to be written the specified channel expressed in Volts. The data must be supplied.                                                                                                                                                                                                                          |

**KI AO generate waveforms**

Generates timed and buffered waveforms for the given output channels at the specified update rate. The KI AO Generate Waveforms VI generates waveforms on specified analog output channels. It does not return until the generation is complete.

**NOTE** This VI is not supported for Keithley KDIO Series devices.

Table D-13

**KI AO generate waveforms**









|                                                                                     |                                                                                                                                                               |
|-------------------------------------------------------------------------------------|---------------------------------------------------------------------------------------------------------------------------------------------------------------|
|  | <b>device:</b> Number of the device (beginning from 1). The utility <b>Device Browser</b> can be used to get the information of current device configuration. |
|  | <b>sub type:</b> is the sub-type of the device you assigned to the Keithley Instruments PXI device during configuration.                                      |

Table D-13 (continued)  
**KI AO generate waveforms**

|                                                                                   |                                                                                                                                                                                                                                                                                                                                                                                                                                                                                                          |
|-----------------------------------------------------------------------------------|----------------------------------------------------------------------------------------------------------------------------------------------------------------------------------------------------------------------------------------------------------------------------------------------------------------------------------------------------------------------------------------------------------------------------------------------------------------------------------------------------------|
|  | <b>channels:</b> Specifies the set of analog output channels you want to use. If x, y, and z refer to channels, you can specify a list of channels by separating the individual channels with commas (for example, x,y,z). If x refers to the first channel in a consecutive channel range and y refers to the last channel, you can specify the range by separating the first and last channels by a colon (for example, x:y). See KI AO generate waveform above for available channels on each module. |
|  | <b>high limit:</b> is the highest expected level of the signal in Volts you want to generate.                                                                                                                                                                                                                                                                                                                                                                                                            |
|  | <b>low limit:</b> is the lowest expected level of the signal in Volts you want to generate.                                                                                                                                                                                                                                                                                                                                                                                                              |
|  | <b>reference source:</b> is the internal/external setting of the reference voltage for this channel.<br>0: Do not change the reference source setting (default input).<br>1: Internal (default setting).<br>2: External.                                                                                                                                                                                                                                                                                 |
|  | <b>update rate:</b> is the number of updates to generate per second. The default rate is 1000 update/s.                                                                                                                                                                                                                                                                                                                                                                                                  |
|  | <b>waveforms:</b> is a 2D array that contains analog output data expressed in volts. You must supply this data. The channel order of the data must be the same channel order specified in channels. You must specify waveforms, where the first (top) dimension is the update number and the second (bottom) dimension is the channel number.                                                                                                                                                            |

**KI AO update channel**

Writes a single value to the specified analog output channel. If an error occurs, a dialog box appears, giving you the error information.

Table D-14  
**KI AO update channel**







|                                                                                     |                                                                                                                                                                                                                                                                                                                                                                        |
|-------------------------------------------------------------------------------------|------------------------------------------------------------------------------------------------------------------------------------------------------------------------------------------------------------------------------------------------------------------------------------------------------------------------------------------------------------------------|
|  | <b>device:</b> Number of the device (beginning from 1). The utility <b>Device Browser</b> can be used to get the information of current device configuration.                                                                                                                                                                                                          |
|  | <b>sub type:</b> is the sub-type of the device you assigned to the Keithley Instruments PXI device during configuration.                                                                                                                                                                                                                                               |
|  | <b>channel:</b> identifies the analog output channel. The default input is channel 0. The valid channel for each Keithley Instruments PXI device is as follows:<br><b>KPXI-SDAQ-4-500K/KPXI-SDAQ-4-2M/KPXI-DAQ-64-3M/KPXI-DAQ-64-500K/</b><br><b>KPXI-DAQ-64-250K/KPXI-DAQ-96-3MKI:</b> 0 or 1<br><b>KPXI-AO-4-1M:</b> 0 through 3<br><b>KPXI-AO-8-1M:</b> 0 through 7 |
|  | <b>high limit:</b> is the highest expected level of the signal in Volts you want to generate.                                                                                                                                                                                                                                                                          |
|  | <b>low limit:</b> is the lowest expected level of the signal in Volts you want to generate.                                                                                                                                                                                                                                                                            |







Table D-14 (continued)  
**KI AO update channel**

|                                                                                   |                                                                                                                                                                                                                          |
|-----------------------------------------------------------------------------------|--------------------------------------------------------------------------------------------------------------------------------------------------------------------------------------------------------------------------|
|  | <b>reference source:</b> is the internal/external setting of the reference voltage for this channel.<br>0: Do not change the reference source setting (default input).<br>1: Internal (default setting).<br>2: External. |
|  | <b>value:</b> contains the value to be written to the specified analog output channel expressed in the physical units of your signal. You must supply this data. All boards require Voltage for the physical unit.       |

### KI AO update channels

Writes values to each of the specified analog output channels. If an error occurs, a dialog box appears, giving you the error information.

Table D-15  
**KI AO update channels**

|                                                                                     |                                                                                                                                                                                                                                                                                                                                                                            |
|-------------------------------------------------------------------------------------|----------------------------------------------------------------------------------------------------------------------------------------------------------------------------------------------------------------------------------------------------------------------------------------------------------------------------------------------------------------------------|
|    | <b>device:</b> Number of the device (beginning from 1). The utility <b>Device Browser</b> can be used to get the information of current device configuration.                                                                                                                                                                                                              |
|    | <b>sub type:</b> is the sub-type of the device you assigned to the Keithley Instruments PXI device during configuration.                                                                                                                                                                                                                                                   |
|  | <b>channels:</b> Specifies the set of analog output channels you want to use. If x, y, and z refer to channels, you can specify a list of channels by "x,y,z". If x refers to the first channel in a consecutive channel range and y refers to the last channel, you can specify the range by "x:y". See KI AO update channel above for available channels on each module. |
|  | <b>high limit:</b> is the highest expected level of the signal in Volts you want to generate.                                                                                                                                                                                                                                                                              |
|  | <b>low limit:</b> is the lowest expected level of the signal in Volts you want to generate.                                                                                                                                                                                                                                                                                |
|  | <b>reference source:</b> is the internal/external setting of the reference voltage for this channel.<br>0: Do not change the reference source setting (default input).<br>1: Internal (default setting).<br>2: External.                                                                                                                                                   |
|  | <b>value:</b> is a 1D array that contains the analog output data expressed in the physical units of your signal. You must supply this data. All boards require Voltage for the physical unit.                                                                                                                                                                              |











## Intermediate analog output VIs

### KI AO clear

This VI stops an analog output generation associated with taskID in and releases associated internal resources, including buffers. Before beginning a new signal generation, you must call the KI AO Config VI.

**NOTE** This VI is not supported for Keithley KDIO Series devices.

Table D-16  
**KI AO clear**

|                                                                                     |                                                                                                                                                                                                                               |
|-------------------------------------------------------------------------------------|-------------------------------------------------------------------------------------------------------------------------------------------------------------------------------------------------------------------------------|
|    | <b>taskID in:</b> identifies the group and the I/O operation.                                                                                                                                                                 |
|    | <b>error in (no error):</b> describes error conditions occurring before the VI executes. If an error has already occurred, the VI returns the value of the error in cluster in error out.                                     |
|    | <b>status:</b> is TRUE if an error occurred. If status is TRUE, the VI does not perform any operations.                                                                                                                       |
|    | <b>code:</b> is the error code number identifying an error. A value of 0 means no error, a negative value means a fatal error, and a positive value is a warning. Refer to <a href="#">Table D-52</a> for a code description. |
|    | <b>source:</b> identifies where an error occurred. The source string is usually the name of the VI that produced the error.                                                                                                   |
|    | <b>taskID out:</b> has the same value as taskID in.                                                                                                                                                                           |
|    | <b>error out:</b> contains error information. If the error in cluster indicated an error, the error out cluster contains the same information. Otherwise, error out describes the error status of this VI.                    |
|  | <b>status:</b> is TRUE if an error occurred. If status is TRUE, the VI does not perform any operations.                                                                                                                       |
|  | <b>code:</b> is the error code number identifying an error. A value of 0 means no error, a negative value means a fatal error, and a positive value is a warning. Refer to <a href="#">Table D-52</a> for a code description. |
|  | <b>source:</b> identifies where an error occurred. The source string is usually the name of the VI that produced the error.                                                                                                   |

**KI AO Config**

Configures a buffered analog output operation, including configuring the hardware and allocating a buffer.

**NOTE** This VI is not supported for Keithley KDIO Series devices.

Table D-17  
**KI AO Config**



|                                                                                     |                                                                                                                                                                                                                                                                                                                                                                                                                                  |
|-------------------------------------------------------------------------------------|----------------------------------------------------------------------------------------------------------------------------------------------------------------------------------------------------------------------------------------------------------------------------------------------------------------------------------------------------------------------------------------------------------------------------------|
|  | <b>interchannel delay:</b> This input is not used by Keithley Instruments PXI devices and is ignored.                                                                                                                                                                                                                                                                                                                            |
|  | <b>sub type:</b> is the sub-type of the device you assigned to the Keithley Instruments PXI device during configuration.                                                                                                                                                                                                                                                                                                         |
|  | <b>limit settings:</b> is an array of clusters. Each array element contains the expected signal limits for the channels specified by the corresponding element of channels. If there are fewer elements in this array than in channels, the VI uses the last array element for the rest of the channels. The default for the limit settings array is an empty array, which means the limit settings keep their default settings. |

Table D-17 (continued)  
**KI AO Config**



















|                                                                                     |                                                                                     |                                                                                                                                                                                                                                                                                                                                                                                                                                                                                                                                                                                                                                                                                                                                                                                                                                                     |
|-------------------------------------------------------------------------------------|-------------------------------------------------------------------------------------|-----------------------------------------------------------------------------------------------------------------------------------------------------------------------------------------------------------------------------------------------------------------------------------------------------------------------------------------------------------------------------------------------------------------------------------------------------------------------------------------------------------------------------------------------------------------------------------------------------------------------------------------------------------------------------------------------------------------------------------------------------------------------------------------------------------------------------------------------------|
|                                                                                     |    | <b>high limit:</b> is the highest scaled data in Volts.                                                                                                                                                                                                                                                                                                                                                                                                                                                                                                                                                                                                                                                                                                                                                                                             |
|                                                                                     |    | <b>low limit:</b> is the lowest scaled data in Volts.                                                                                                                                                                                                                                                                                                                                                                                                                                                                                                                                                                                                                                                                                                                                                                                               |
|                                                                                     |    | <b>reference source:</b> is the internal/external setting of the reference voltage for this channel.<br>0: Do not change the reference source setting (default input).<br>1: Internal (default setting).<br>2: External.                                                                                                                                                                                                                                                                                                                                                                                                                                                                                                                                                                                                                            |
|    |                                                                                     | <b>device:</b> Number of the device (beginning from 1). The utility <b>Device Browser</b> can be used to get the information of current device configuration.                                                                                                                                                                                                                                                                                                                                                                                                                                                                                                                                                                                                                                                                                       |
|    |                                                                                     | <b>channels:</b> specifies the set of analog output channels. channels is an array of strings. If x, y, and z refer to channels, you can specify a list of channels in a single element by separating the individual channels by commas. For example, "x,y,z". If x refers to the first channel in a consecutive channel range and y refers to the last channel, you can specify the range by separating the first and last channels by a colon. For example, "x:y".<br>The valid channel order for data is as follows:<br><b>KPXI-SDAQ-4-500K/KPXI-SDAQ-4-2M/KPXI-DAQ-64-3M/KPXI-DAQ-64-500K/</b><br><b>KPXI-DAQ-64-250K/KPXI-DAQ-96-3M:</b> numbers in <b>channels</b> must be within 0 and 1<br><b>KPXI-AO-4-1M:</b> numbers in <b>channels</b> must be within 0 and 3<br><b>KPXI-AO-8-1M:</b> numbers in <b>channels</b> must be within 0 and 7 |
|  |                                                                                     | <b>buffer size:</b> is the number of updates you want the buffer to hold. The default for this parameter is 1000 scans.                                                                                                                                                                                                                                                                                                                                                                                                                                                                                                                                                                                                                                                                                                                             |
|  |                                                                                     | <b>group:</b> is the number, from 0 to 15, that you assign to the specified set of channels. The default input and setting for group is 0. If you only have one update operation for this device, leave this input unwired and use group 0.                                                                                                                                                                                                                                                                                                                                                                                                                                                                                                                                                                                                         |
|  |                                                                                     | <b>error in (no error):</b> describes error conditions occurring before the VI executes. If an error has already occurred, the VI returns the value of the error in cluster in error out.                                                                                                                                                                                                                                                                                                                                                                                                                                                                                                                                                                                                                                                           |
|                                                                                     |  | <b>status:</b> is TRUE if an error occurred. If status is TRUE, the VI does not perform any operations.                                                                                                                                                                                                                                                                                                                                                                                                                                                                                                                                                                                                                                                                                                                                             |
|                                                                                     |  | <b>code:</b> is the error code number identifying an error. A value of 0 means no error, a negative value means a fatal error, and a positive value is a warning. Refer to <a href="#">Table D-52</a> for a code description.                                                                                                                                                                                                                                                                                                                                                                                                                                                                                                                                                                                                                       |
|                                                                                     |  | <b>source:</b> identifies where an error occurred. The source string is usually the name of the VI that produced the error.                                                                                                                                                                                                                                                                                                                                                                                                                                                                                                                                                                                                                                                                                                                         |
|  |                                                                                     | <b>allocation mode:</b> This input is not used by Keithley Instruments PXI devices and is ignored.                                                                                                                                                                                                                                                                                                                                                                                                                                                                                                                                                                                                                                                                                                                                                  |
|  |                                                                                     | <b>taskID:</b> identifies the group and the I/O operation.                                                                                                                                                                                                                                                                                                                                                                                                                                                                                                                                                                                                                                                                                                                                                                                          |
|  |                                                                                     | <b>number of channels:</b> is the total number of channels in the group.                                                                                                                                                                                                                                                                                                                                                                                                                                                                                                                                                                                                                                                                                                                                                                            |



Table D-17 (continued)

**KI AO Config**

|                                                                                   |                                                                                                                                                                                                                               |
|-----------------------------------------------------------------------------------|-------------------------------------------------------------------------------------------------------------------------------------------------------------------------------------------------------------------------------|
|  | <b>error out:</b> contains error information. If the error in cluster indicated an error, the error out cluster contains the same information. Otherwise, error out describes the error status of this VI.                    |
|  | <b>status:</b> is TRUE if an error occurred. If status is TRUE, the VI does not perform any operations.                                                                                                                       |
|  | <b>code:</b> is the error code number identifying an error. A value of 0 means no error, a negative value means a fatal error, and a positive value is a warning. Refer to <a href="#">Table D-52</a> for a code description. |
|  | <b>source:</b> identifies where an error occurred. The source string is usually the name of the VI that produced the error.                                                                                                   |

**KI AO start**

Starts a buffered analog output operation. This VI sets the update rate, and then starts the generation.

**NOTE** This VI is not supported for Keithley KDIO Series devices.

Table D-18

**KI AO start**















|                                                                                     |                                                                                                                                                                                                                                                                                                                                                                                                                                  |
|-------------------------------------------------------------------------------------|----------------------------------------------------------------------------------------------------------------------------------------------------------------------------------------------------------------------------------------------------------------------------------------------------------------------------------------------------------------------------------------------------------------------------------|
|   | <b>taskID in:</b> identifies the group and the I/O operation.                                                                                                                                                                                                                                                                                                                                                                    |
|  | <b>update rate:</b> is the number of updates/s to generate. This is equivalent to the update rate per channel. The default for this parameter is 1000 updates/s. If you enter 0, the on-board internal clock is disabled and the external clock is used.                                                                                                                                                                         |
|  | <b>error in (no error):</b> describes error conditions occurring before the VI executes. If an error has already occurred, the VI returns the value of the error in cluster in error out.                                                                                                                                                                                                                                        |
|  | <b>status:</b> is TRUE if an error occurred. If status is TRUE, the VI does not perform any operations.                                                                                                                                                                                                                                                                                                                          |
|  | <b>code:</b> is the error code number identifying an error. A value of 0 means no error, a negative value means a fatal error, and a positive value is a warning. Refer to <a href="#">Table D-52</a> for a code description.                                                                                                                                                                                                    |
|  | <b>source:</b> identifies where an error occurred. The source string is usually the name of the VI that produced the error.                                                                                                                                                                                                                                                                                                      |
|  | <b>number of buffer iterations:</b> is the number of times KIDAQ LabVIEW has to generate the waveform from the output buffer. After generating the buffer the specified number of times, the generation stops. The default value is 1, which means KIDAQ LabVIEW generates the buffer only once. If you use a value of 0, KIDAQ LabVIEW generates the buffer continuously, until you stop the operation with the KI AO Clear VI. |
|  | <b>clock:</b><br>0: Do not change the default setting (default input).<br>1: Update clock 1 (default setting).                                                                                                                                                                                                                                                                                                                   |

Table D-18 (continued)

**KI AO start**

|                                                                                    |                                                                                                                                                                                                                               |
|------------------------------------------------------------------------------------|-------------------------------------------------------------------------------------------------------------------------------------------------------------------------------------------------------------------------------|
|   | <b>clock source:</b> specifies the source of the clock.<br>0: Do not change the clock source setting (default input).<br>1: Internal (default setting).<br>6: I/O connector.<br>7: SSI (RTSI) Connection.                     |
|   | <b>taskID out:</b> has the same value as taskID in.                                                                                                                                                                           |
|   | <b>error out:</b> contains error information. If the error in cluster indicated an error, the error out cluster contains the same information. Otherwise, error out describes the error status of this VI.                    |
|   | <b>status:</b> is TRUE if an error occurred. If status is TRUE, the VI does not perform any operations.                                                                                                                       |
|   | <b>code:</b> is the error code number identifying an error. A value of 0 means no error, a negative value means a fatal error, and a positive value is a warning. Refer to <a href="#">Table D-52</a> for a code description. |
|   | <b>source:</b> identifies where an error occurred. The source string is usually the name of the VI that produced the error.                                                                                                   |
|  | <b>actual update rate:</b> may differ slightly from the requested update rate, depending on the hardware capabilities.                                                                                                        |

**KI AO wait**

This VI waits until the waveform generation of the task completes before returning.

**NOTE** *This VI is not supported for Keithley KDIO Series devices.*

Table D-19

**KI AO wait**













|                                                                                     |                                                                                                                                                                                                                               |
|-------------------------------------------------------------------------------------|-------------------------------------------------------------------------------------------------------------------------------------------------------------------------------------------------------------------------------|
|  | <b>taskID in:</b> identifies the group and the I/O operation.                                                                                                                                                                 |
|  | <b>update rate:</b> is the number of updates/s to generate. This is equivalent to the update rate per channel. The default for this parameter is 1000 updates/s.                                                              |
|  | <b>error in (no error):</b> describes error conditions occurring before the VI executes. If an error has already occurred, the VI returns the value of the error in cluster in error out.                                     |
|  | <b>status:</b> is TRUE if an error occurred. If status is TRUE, the VI does not perform any operations.                                                                                                                       |
|  | <b>code:</b> is the error code number identifying an error. A value of 0 means no error, a negative value means a fatal error, and a positive value is a warning. Refer to <a href="#">Table D-52</a> for a code description. |
|  | <b>source:</b> identifies where an error occurred. The source string is usually the name of the VI that produced the error.                                                                                                   |
|  | <b>check every N updates:</b> informs the VI how often to check the status of the task to see if generation completes. This parameter default is to check every 5 updates.                                                    |

Table D-19 (continued)

**KI AO wait**

|                                                                                   |                                                                                                                                                                                                                               |
|-----------------------------------------------------------------------------------|-------------------------------------------------------------------------------------------------------------------------------------------------------------------------------------------------------------------------------|
|  | <b>taskID out:</b> has the same value as taskID in.                                                                                                                                                                           |
|  | <b>error out:</b> contains error information. If the error in cluster indicated an error, the error out cluster contains the same information. Otherwise, error out describes the error status of this VI.                    |
|  | <b>status:</b> is TRUE if an error occurred. If status is TRUE, the VI does not perform any operations.                                                                                                                       |
|  | <b>code:</b> is the error code number identifying an error. A value of 0 means no error, a negative value means a fatal error, and a positive value is a warning. Refer to <a href="#">Table D-52</a> for a code description. |
|  | <b>source:</b> identifies where an error occurred. The source string is usually the name of the VI that produced the error.                                                                                                   |

**KI AO write**

This VI writes data into the buffer for a buffered analog output operation. The data written into the buffer will then be generated (transferred from the buffer to the DAC) at the update rate specified in KI AO Start.

KI AO Write is a polymorphic VI that you can configure to output the following kinds of data:

- Binary Array
- Scaled Array

**NOTE** This VI is not supported for Keithley KDIO Series devices.

Table D-20

**KI AO write binary array**







|                                                                                     |                                                                                                                                                                                                                                                                                                                                                                                                                                                                                            |
|-------------------------------------------------------------------------------------|--------------------------------------------------------------------------------------------------------------------------------------------------------------------------------------------------------------------------------------------------------------------------------------------------------------------------------------------------------------------------------------------------------------------------------------------------------------------------------------------|
|  | <b>taskID in:</b> identifies the group and the I/O operation.                                                                                                                                                                                                                                                                                                                                                                                                                              |
|  | <b>binary data:</b> is a 2D array that contains unscaled analog output data. The channel order of the data must be the same as the channel order you specify in channels. You must specify waveforms, where the first (top) dimension is the update number and the second (bottom) dimension is the channel number. The length of the data array determines the number of updates the VI writes. When no data is wired, this VI is still useful for reporting update progress information. |
|  | <b>time limit in sec:</b> is the time limit for the output operation. The default input is -1.0, which means KIDAQ LabVIEW calculates a time limit based on the value of number of updates to generate and the update rate. If the update rate is unknown, the VI uses 1 second as the time limit. The resolution of the timeout clock is about 55 ms.                                                                                                                                     |
|  | <b>allow regeneration:</b> is not used by Keithley Instruments PXI devices and is ignored.                                                                                                                                                                                                                                                                                                                                                                                                 |
|  | <b>error in (no error):</b> describes error conditions occurring before the VI executes. If an error has already occurred, the VI returns the value of the error in cluster in error out.                                                                                                                                                                                                                                                                                                  |
|  | <b>status:</b> is TRUE if an error occurred. If status is TRUE, the VI does not perform any operations.                                                                                                                                                                                                                                                                                                                                                                                    |

Table D-20 (continued)  
**KI AO write binary array**











|                                                                                     |                                                                                                                                                                                                                               |
|-------------------------------------------------------------------------------------|-------------------------------------------------------------------------------------------------------------------------------------------------------------------------------------------------------------------------------|
|    | <b>code:</b> is the error code number identifying an error. A value of 0 means no error, a negative value means a fatal error, and a positive value is a warning. Refer to <a href="#">Table D-52</a> for a code description. |
|    | <b>source:</b> identifies where an error occurred. The source string is usually the name of the VI that produced the error.                                                                                                   |
|    | <b>taskID out:</b> has the same value as <i>taskID in</i> .                                                                                                                                                                   |
|    | <b>number of updates done:</b> is the number of updates the VI has generated; that is, the number of updates the VI has actually transferred from the buffer to the onboard FIFO.                                             |
|    | <b>number of buffers done:</b> is the number of times the VI has generated an entire buffer; that is, the number of times the VI has actually transferred all the data in the buffer to the onboard FIFO.                     |
|    | <b>generation complete:</b> is TRUE when the generation finishes.                                                                                                                                                             |
|    | <b>error out:</b> contains error information. If the error in cluster indicated an error, the error out cluster contains the same information. Otherwise, error out describes the error status of this VI.                    |
|   | <b>status:</b> is TRUE if an error occurred. If status is TRUE, the VI does not perform any operations.                                                                                                                       |
|  | <b>code:</b> is the error code number identifying an error. A value of 0 means no error, a negative value means a fatal error, and a positive value is a warning. Refer to <a href="#">Table D-52</a> for a code description. |
|  | <b>source:</b> identifies where an error occurred. The source string is usually the name of the VI that produced the error.                                                                                                   |

Table D-21  
**KI AO write binary array scaled array**

















|                                                                                     |                                                                                                                                                                                                                                                                                                                                                                                                                                                                                                   |
|-------------------------------------------------------------------------------------|---------------------------------------------------------------------------------------------------------------------------------------------------------------------------------------------------------------------------------------------------------------------------------------------------------------------------------------------------------------------------------------------------------------------------------------------------------------------------------------------------|
|  | <b>taskID in:</b> Identifies the group and the I/O operation.                                                                                                                                                                                                                                                                                                                                                                                                                                     |
|  | <b>scaled data:</b> is a 2D array that contains analog output data expressed in volts. The channel order of the data must be the same the channel order you specify in channels. You must specify waveforms, where the first (top) dimension is the update number and the second (bottom) dimension is the channel number. The length of the data array determines the number of updates the VI writes. When no data is wired, this VI is still useful for reporting update progress information. |
|  | <b>time limit in sec:</b> is the time limit for the output operation. The default input is -1.0, which means KIDAQ LabVIEW calculates a time limit based on the value of number of updates to generate and the update rate. If the update rate is unknown, the VI uses 1 second as the time limit. The resolution of the timeout clock is about 55 ms.                                                                                                                                            |
|  | <b>allow regeneration:</b> is not used by Keithley Instruments PXI devices and is ignored.                                                                                                                                                                                                                                                                                                                                                                                                        |

Table D-21 (continued)  
**KI AO write binary array scaled array**

|                                                                                     |                                                                                                                                                                                                            |                                                                                                                                                                                                                               |
|-------------------------------------------------------------------------------------|------------------------------------------------------------------------------------------------------------------------------------------------------------------------------------------------------------|-------------------------------------------------------------------------------------------------------------------------------------------------------------------------------------------------------------------------------|
|    | <b>error in (no error):</b> describes error conditions occurring before the VI executes. If an error has already occurred, the VI returns the value of the error in cluster in error out.                  |                                                                                                                                                                                                                               |
|                                                                                     |                                                                                                                           | <b>status:</b> is TRUE if an error occurred. If status is TRUE, the VI does not perform any operations.                                                                                                                       |
|                                                                                     |                                                                                                                           | <b>code:</b> is the error code number identifying an error. A value of 0 means no error, a negative value means a fatal error, and a positive value is a warning. Refer to <a href="#">Table D-52</a> for a code description. |
|                                                                                     |                                                                                                                           | <b>source:</b> Identifies where an error occurred. The source string is usually the name of the VI that produced the error.                                                                                                   |
|    | <b>taskID out:</b> has the same value as <i>taskID in</i> .                                                                                                                                                |                                                                                                                                                                                                                               |
|    | <b>number of updates done:</b> is the number of updates the VI has generated; that is, the number of updates the VI has actually transferred from the buffer to the onboard FIFO.                          |                                                                                                                                                                                                                               |
|    | <b>number of buffers done:</b> is the number of times the VI has generated an entire buffer; that is, the number of times the VI has actually transferred all the data in the buffer to the onboard FIFO.  |                                                                                                                                                                                                                               |
|                                                                                     |                                                                                                                          | <b>generation complete:</b> is TRUE when the generation finishes.                                                                                                                                                             |
|  | <b>error out:</b> contains error information. If the error in cluster indicated an error, the error out cluster contains the same information. Otherwise, error out describes the error status of this VI. |                                                                                                                                                                                                                               |
|                                                                                     |                                                                                                                         | <b>status:</b> is TRUE if an error occurred. If status is TRUE, the VI does not perform any operations.                                                                                                                       |
|                                                                                     |                                                                                                                         | <b>code:</b> is the error code number identifying an error. A value of 0 means no error, a negative value means a fatal error, and a positive value is a warning. Refer to <a href="#">Table D-52</a> for a code description. |
|                                                                                     |                                                                                                                         | <b>source:</b> identifies where an error occurred. The source string is usually the name of the VI that produced the error.                                                                                                   |

## Advanced analog output VIs

### KI AO Trigger and Gate Config

Configures the trigger conditions for analog output operations.

**NOTE** This VI is not supported for Keithley KDIO Series devices.

Table D-22

### KI AO Trigger and Gate Config

















|                                                                                     |                                                                                                                                                                                                                                                      |
|-------------------------------------------------------------------------------------|------------------------------------------------------------------------------------------------------------------------------------------------------------------------------------------------------------------------------------------------------|
|    | <b>taskID in:</b> identifies the group and the I/O operation.                                                                                                                                                                                        |
|    | <b>error in (no error):</b> describes error conditions occurring before the VI executes. If an error has already occurred, the VI returns the value of the error in cluster in error out.                                                            |
|    | <b>status:</b> is TRUE if an error occurred. If status is TRUE, the VI does not perform any operations.                                                                                                                                              |
|    | <b>code:</b> is the error code number identifying an error. A value of 0 means no error, a negative value means a fatal error, and a positive value is a warning. Refer to <a href="#">Table D-52</a> for a code description.                        |
|   | <b>source:</b> identifies where an error occurred. The source string is usually the name of the VI that produced the error.                                                                                                                          |
|  | <b>trigger or gate source:</b> specifies the source of trigger signal.<br>0: No change (default input).<br>1: None (default setting).<br>2: External WFDTRIG pin .<br>3: SSI (RTSI) pin .<br>5: ATCOUT (the output of the analog trigger circuitry). |
|  | <b>trigger or gate condition:</b> selects a rising or falling edge trigger.<br>0: No change (default input).<br>1: None (default setting).<br>2: Trigger on rising edge.<br>3: Trigger on falling edge.                                              |
|  | <b>trigger or gate source specification:</b> is not used by Keithley Instruments PXI devices and is ignored.                                                                                                                                         |
|  | <b>additional trig params:</b> cluster contains the following parameters:                                                                                                                                                                            |
|  | <b>delay:</b> specifies how long the device waits after a trigger occurs before waveform generates. You express delay in seconds. The default input and setting are 0.0s (no delay).                                                                 |
|  | <b>taskID out:</b> has the same value as <i>taskID in</i> .                                                                                                                                                                                          |
|  | <b>error out:</b> contains error information. If the error in cluster indicated an error, the error out cluster contains the same information. Otherwise, error out describes the error status of this VI.                                           |

Table D-22 (continued)  
**KI AO Trigger and Gate Config**

|                                                                                   |                                                                                   |                                                                                                                                                                                                                               |
|-----------------------------------------------------------------------------------|-----------------------------------------------------------------------------------|-------------------------------------------------------------------------------------------------------------------------------------------------------------------------------------------------------------------------------|
|                                                                                   |  | <b>status:</b> is TRUE if an error occurred. If status is TRUE, the VI does not perform any operations.                                                                                                                       |
|                                                                                   |  | <b>code:</b> is the error code number identifying an error. A value of 0 means no error, a negative value means a fatal error, and a positive value is a warning. Refer to <a href="#">Table D-52</a> for a code description. |
|                                                                                   |  | <b>source:</b> identifies where an error occurred. The source string is usually the name of the VI that produced the error.                                                                                                   |
|  |                                                                                   | <b>actual trigger params:</b> cluster may differ slightly from the requested trigger inputs, depending on the hardware capabilities. It contains the following parameters.                                                    |
|                                                                                   |  | <b>actual delay:</b> is the delay the VI used.                                                                                                                                                                                |

## Digital I/O VIs

Two classes of Digital I/O VIs are available in the Digital I/O palette: the Easy Digital I/O VIs, Intermediate Digital I/O VIs and Advanced Digital I/O VIs ([Figure D-3](#)).

Figure D-3  
**Digital I/O palette**

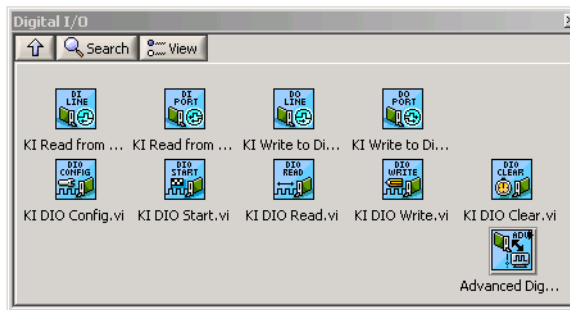

## Easy Digital I/O VIs

### KI Read from Digital Line







Reads the logical state of a digital line on a digital port. If an error occurs, a dialog box appears, giving you the error information.

**NOTE** When you call this VI on a digital I/O port that is part of an 8255 PPI and your iteration terminal is left at 0, the 8255 PPI goes through a configuration phase, where all the ports within the same PPI chip get reset to logic low, regardless of the data direction. The data

*direction on other ports, however, is maintained. To avoid this effect, connect a value other than 0 to the iteration terminal once you have configured the desired ports.*

Table D-23

**KI Read from Digital Line**

|                                                                                     |                                                                                                                                                                                                                                                                                                                                                                                                                                                                                          |
|-------------------------------------------------------------------------------------|------------------------------------------------------------------------------------------------------------------------------------------------------------------------------------------------------------------------------------------------------------------------------------------------------------------------------------------------------------------------------------------------------------------------------------------------------------------------------------------|
|    | <b>device:</b> Number of the device (beginning from 1). The utility <b>Device Browser</b> can be used to get the information of current device configuration.                                                                                                                                                                                                                                                                                                                            |
|    | <b>sub type:</b> is the sub-type of the device you assigned to the Keithley Instruments PXI device during configuration.                                                                                                                                                                                                                                                                                                                                                                 |
|    | <p><b>digital channel:</b> is the port number to read.<br/> <b>KPXI-DIO-16-16:</b> 1<br/> <b>KPXI-DIO-48:</b><br/> 0: P1A, 1: P1B, 2: P1C Lower, 3: P1C Upper<br/> 4: P2A, 5: P2B, 6: P2C Lower, 7: P2C Upper</p> <p><b>KPXI-RDI-8-16:</b> 1<br/> <b>KPXI-DIO-32-80M:</b> 3 (aux. input port)<br/> <b>KPXI-DIO-32-32:</b> 2 or 3<br/> <b>KPXI-DIO-64-0:</b> 1 or 2<br/> <b>KPXI-DIO-0-64:</b> 3<br/> <b>KPXI-DAQ series devices:</b><br/> 0: P1A, 1: P1B, 2: P1C Lower, 3: P1C Upper</p> |
|   | <b>Line:</b> is the individual port bit or line to be used for I/O.                                                                                                                                                                                                                                                                                                                                                                                                                      |
|  | <b>Line state:</b> is TRUE for high logic, and FALSE for low logic.                                                                                                                                                                                                                                                                                                                                                                                                                      |
|  | <b>Port width:</b> is the total width or the number of lines of the port in bits. For example, you can combine two 4-bit ports into an 8-bit port on a KPXI-DIO-48 device by setting port width to 8.                                                                                                                                                                                                                                                                                    |
|  | <b>iteration:</b> When iteration is 0 (default), KIDAQ LabVIEW re-configures the port. If iteration is greater than zero, KIDAQ LabVIEW uses the existing configuration, which improves performance. It can be used to optimize operation when you execute this VI in a loop.                                                                                                                                                                                                            |

**KI Read from Digital Port**

Reads a digital channel that you configure. If an error occurs, a dialog box appears, giving you the error information.

**NOTE** *When you call this VI on a digital I/O port that is part of an 8255 PPI and your iteration terminal is left at 0, the 8255 PPI goes through a configuration phase, where all the ports within the same PPI chip get reset to logic low, regardless of the data direction. The data direction on other ports, however, is maintained. To avoid this effect, connect a value other than 0 to the iteration terminal once you have configured the desired ports.*

Table D-24

**KI Read from Digital Port**







|                                                                                     |                                                                                                                                                               |
|-------------------------------------------------------------------------------------|---------------------------------------------------------------------------------------------------------------------------------------------------------------|
|  | <b>device:</b> Number of the device (beginning from 1). The utility <b>Device Browser</b> can be used to get the information of current device configuration. |
|  | <b>sub type:</b> is the sub-type of the device you assigned to the Keithley Instruments PXI device during configuration.                                      |



Table D-24 (continued)  
**KI Read from Digital Port**

|                                                                                    |                                                                                                                                                                                                                                                                                                                                                                                                                                                                                                                                                          |
|------------------------------------------------------------------------------------|----------------------------------------------------------------------------------------------------------------------------------------------------------------------------------------------------------------------------------------------------------------------------------------------------------------------------------------------------------------------------------------------------------------------------------------------------------------------------------------------------------------------------------------------------------|
|   | <p><b>digital channel:</b> is the port number to read.<br/> <b>KPXI-DIO-16-16:</b> 1</p> <p><b>KPXI-DIO-48:</b><br/>                     0: P1A, 1: P1B, 2: P1C Lower, 3: P1C Upper<br/>                     4: P2A, 5: P2B, 6: P2C Lower, 7: P2C Upper</p> <p><b>KPXI-RDI-8-16:</b> 1<br/> <b>KPXI-DIO-32-80M:</b> 3 (aux. input port)<br/> <b>KPXI-DIO-32-32:</b> 2 or 3<br/> <b>KPXI-DIO-64-0:</b> 1 or 2<br/> <b>KPXI-DIO-0-64:</b> 3</p> <p><b>KPXI-DAQ series devices:</b><br/>                     0: P1A, 1: P1B, 2: P1C Lower, 3: P1C Upper</p> |
|   | <p><b>pattern:</b> is the data the VI reads from the digital port.</p>                                                                                                                                                                                                                                                                                                                                                                                                                                                                                   |
|   | <p><b>port width:</b> is the total width or the number of lines of the port in bits. For example, you can combine two 4-bit ports into an 8-bit port on a KPXI-DIO-48 device by setting port width to 8.</p>                                                                                                                                                                                                                                                                                                                                             |
|  | <p><b>iteration:</b> When iteration is 0 (default), KIDAQ LabVIEW re-configures the port. If iteration is greater than zero, KIDAQ LabVIEW uses the existing configuration, which improves performance. It can be used to optimize operation when you execute this VI in a loop.</p>                                                                                                                                                                                                                                                                     |

**KI Write to Digital Line**

Sets the logic state of a digital line on a specified digital port. If an error occurs, a dialog box appears, giving you the error information.

**NOTE** *When you call this VI on a digital I/O port that is part of an 8255 PPI and your iteration terminal is left at 0, the 8255 PPI goes through a configuration phase, where all the ports within the same PPI chip get reset to logic low, regardless of the data direction. The data direction on other ports, however, is maintained. To avoid this effect, connect a value other than 0 to the iteration terminal once you have configured the desired ports.*

Table D-25  
**KI Write to Digital Line**







|                                                                                     |                                                                                                                                                                      |
|-------------------------------------------------------------------------------------|----------------------------------------------------------------------------------------------------------------------------------------------------------------------|
|  | <p><b>device:</b> Number of the device (beginning from 1). The utility <b>Device Browser</b> can be used to get the information of current device configuration.</p> |
|  | <p><b>sub type:</b> is the sub-type of the device you assigned to the Keithley Instruments PXI device during configuration.</p>                                      |

Table D-25 (continued)  
**KI Write to Digital Line**

|                                                                                     |                                                                                                                                                                                                                                                                                                                                                                                                                                                                                                                                                                                                          |
|-------------------------------------------------------------------------------------|----------------------------------------------------------------------------------------------------------------------------------------------------------------------------------------------------------------------------------------------------------------------------------------------------------------------------------------------------------------------------------------------------------------------------------------------------------------------------------------------------------------------------------------------------------------------------------------------------------|
|    | <p><b>digital channel:</b> is the port number to write.</p> <p><b>KPXI-DIO-16-16:</b> 0</p> <p><b>KPXI-DIO-48:</b><br/> 0: P1A, 1: P1B, 2: P1C Lower, 3: P1C Upper<br/> 4: P2A, 5: P2B, 6: P2C Lower, 7: P2C Upper</p> <p><b>KPXI-RDI-8-16:</b> 0</p> <p><b>KPXI-DIO-32-80M:</b> 1 (aux. output port)</p> <p><b>KPXI-DIO-32-32:</b> 0 (DO) or 1 (LED)</p> <p><b>KPXI-DIO-64-0:</b> 0 (LED)</p> <p><b>KPXI-DIO-0-64:</b> 0 (DO Low), 1 (DO High)</p> <p><b>KPXI-DIO-0-64:</b> 0 (DO Low), 1 (DO High), 2 (LED)</p> <p><b>KPXI-DAQ series devices:</b><br/> 0: P1A, 1: P1B, 2: P1C Lower, 3: P1C Upper</p> |
|    | <p><b>line:</b> is the individual port bit or line to be used for I/O.</p>                                                                                                                                                                                                                                                                                                                                                                                                                                                                                                                               |
|    | <p><b>line state:</b> is TRUE for high logic, and FALSE for low logic.</p>                                                                                                                                                                                                                                                                                                                                                                                                                                                                                                                               |
|  | <p><b>port width:</b> is the total width or the number of lines of the port in bits. For example, you can combine two 4-bit ports into an 8-bit port on a KPXI-DIO-48 device by setting port width to 8.</p>                                                                                                                                                                                                                                                                                                                                                                                             |
|  | <p><b>iteration:</b> When iteration is 0 (default), KIDAQ LabVIEW re-configures the port. If iteration is greater than zero, KIDAQ LabVIEW uses the existing configuration, which improves performance. It can be used to optimize operation when you execute this VI in a loop.</p>                                                                                                                                                                                                                                                                                                                     |

### KI Write to Digital Port

Writes a digital pattern to a digital port. If an error occurs, a dialog box appears, giving you the error information.

**NOTE** *When you call this VI on a digital I/O port that is part of an 8255 PPI when your iteration terminal is left at 0, the 8255 PPI goes through a configuration phase, where all the ports within the same PPI chip get reset to logic low, regardless of the data direction. The data direction on other ports, however, is maintained. To avoid this effect, connect a value other than 0 to the iteration terminal once you have configured the desired ports.*

Table D-26  
**KI Write to Digital Port**







|                                                                                     |                                                                                                                                                                      |
|-------------------------------------------------------------------------------------|----------------------------------------------------------------------------------------------------------------------------------------------------------------------|
|  | <p><b>device:</b> Number of the device (beginning from 1). The utility <b>Device Browser</b> can be used to get the information of current device configuration.</p> |
|  | <p><b>sub type:</b> is the sub-type of the device you assigned to the Keithley Instruments PXI device during configuration.</p>                                      |

Table D-26 (continued)  
**KI Write to Digital Port**

|                                                                                     |                                                                                                                                                                                                                                                                                                                                                                                                                                                                                                                                                                                                                                                                 |
|-------------------------------------------------------------------------------------|-----------------------------------------------------------------------------------------------------------------------------------------------------------------------------------------------------------------------------------------------------------------------------------------------------------------------------------------------------------------------------------------------------------------------------------------------------------------------------------------------------------------------------------------------------------------------------------------------------------------------------------------------------------------|
|    | <p><b>digital channel:</b> is the port number to write.</p> <p><b>KPXI-DIO-16-16:</b> 0</p> <p><b>KPXI-DIO-48:</b><br/>                 0: P1A, 1: P1B, 2: P1C Lower, 3: P1C Upper<br/>                 4: P2A, 5: P2B, 6: P2C Lower, 7: P2C Upper</p> <p><b>KPXI-RDI-8-16:</b> 0</p> <p><b>KPXI-DIO-32-80M:</b> 1 (aux. output port)</p> <p><b>KPXI-DIO-32-32:</b> 0 (DO) or 1 (LED)</p> <p><b>KPXI-DIO-64-0:</b> 0 (LED)</p> <p><b>KPXI-DIO-0-64:</b> 0 (DO Low), 1 (DO High)</p> <p><b>KPXI-DIO-0-64:</b> 0 (DO Low), 1 (DO High), 2 (LED)</p> <p><b>KPXI-DAQ series devices series:</b><br/>                 0: P1A, 1: P1B, 2: P1C Lower, 3: P1C Upper</p> |
|    | <p><b>pattern:</b> is the bit pattern writes to the digital port.</p>                                                                                                                                                                                                                                                                                                                                                                                                                                                                                                                                                                                           |
|    | <p><b>port width:</b> is the total width or the number of lines of the port in bits. For example, you can combine two 4-bit ports into an 8-bit port on a KPXI-DIO-48 device by setting port width to 8. If you are using channel names, port width is not needed and is ignored.</p>                                                                                                                                                                                                                                                                                                                                                                           |
|  | <p><b>iteration:</b> When iteration is 0 (default), KIDAQ LabVIEW re-configures the port. If iteration is greater than zero, KIDAQ LabVIEW uses the existing configuration, which improves performance. It can be used to optimize operation when you execute this VI in a loop.</p>                                                                                                                                                                                                                                                                                                                                                                            |

## Intermediate Digital I/O VIs

### KI DIO Clear

This VI stops a digital input or output acquisition. Before beginning a new acquisition, you must call the KI DIO Config VI.

**NOTE** This VI is not supported for KPXI-DAQ series devices.

Table D-27  
**KI DIO Clear**











|                                                                                     |                                                                                                                                                                                                  |                                                                                                                                                                                                                                      |
|-------------------------------------------------------------------------------------|--------------------------------------------------------------------------------------------------------------------------------------------------------------------------------------------------|--------------------------------------------------------------------------------------------------------------------------------------------------------------------------------------------------------------------------------------|
|  | <p><b>taskID in:</b> identifies the group and the I/O operation.</p>                                                                                                                             |                                                                                                                                                                                                                                      |
|  | <p><b>error in (no error):</b> describes error conditions occurring before the VI executes. If an error has already occurred, the VI returns the value of the error in cluster in error out.</p> |                                                                                                                                                                                                                                      |
|                                                                                     |                                                                                                               | <p><b>status:</b> is TRUE if an error occurred. If status is TRUE, the VI does not perform any operations.</p>                                                                                                                       |
|                                                                                     |                                                                                                               | <p><b>code:</b> is the error code number identifying an error. A value of 0 means no error, a negative value means a fatal error, and a positive value is a warning. Refer to <a href="#">Table D-52</a> for a code description.</p> |

Table D-27 (continued)

**KI DIO Clear**

|                                                                                   |                                                                                   |                                                                                                                                                                                                                               |
|-----------------------------------------------------------------------------------|-----------------------------------------------------------------------------------|-------------------------------------------------------------------------------------------------------------------------------------------------------------------------------------------------------------------------------|
|                                                                                   |  | <b>source:</b> identifies where an error occurred. The source string is usually the name of the VI that produced the error.                                                                                                   |
|  |                                                                                   | <b>taskID out:</b> has the same value as <i>taskID in</i> .                                                                                                                                                                   |
|  |                                                                                   | <b>error out:</b> contains error information. If the error in cluster indicated an error, the error out cluster contains the same information. Otherwise, error out describes the error status of this VI.                    |
|                                                                                   |  | <b>status:</b> is TRUE if an error occurred. If status is TRUE, the VI does not perform any operations.                                                                                                                       |
|                                                                                   |  | <b>code:</b> is the error code number identifying an error. A value of 0 means no error, a negative value means a fatal error, and a positive value is a warning. Refer to <a href="#">Table D-52</a> for a code description. |
|                                                                                   |  | <b>source:</b> identifies where an error occurred. The source string is usually the name of the VI that produced the error.                                                                                                   |

**KI DIO Config**

Configures a buffered digital I/O operation, including configuring the hardware and allocating a buffer. The VI only applies to KPXI-DIO-32-80M devices.

**NOTE** This VI is not supported for KPXI-DAQ series devices.

Table D-28

**KI DIO Config**







|                                                                                     |                                                                                     |                                                                                                                                                                                                      |
|-------------------------------------------------------------------------------------|-------------------------------------------------------------------------------------|------------------------------------------------------------------------------------------------------------------------------------------------------------------------------------------------------|
|  |                                                                                     | <b>device:</b> Number of the device (beginning from 1). The utility <b>Device Browser</b> can be used to get the information of current device configuration.                                        |
|  |                                                                                     | <b>sub type:</b> is the sub-type of the device you assigned to the Keithley Instruments PXI device during configuration.                                                                             |
|  |                                                                                     | <b>port list:</b> Specifies the set of digital ports, each of which is 8, 16 or 32 lines wide. The valid ports are as follows:<br>KPXI-DIO-32-80M<br>0 (digital output port), 2 (digital input port) |
|  |                                                                                     | <b>port width:</b> is the total width or the number of lines of the port in bits. port width is only valid for KPXI-DIO-32-80M which supports 8-bit, 16-bit and 32-bit of data acquisition           |
|  |                                                                                     | <b>group direction:</b> sets the direction for the group.<br>0: Do not change the group direction setting (default input).<br>1: Input (default setting).<br>2: Output.                              |
|  |                                                                                     | <b>error in (no error):</b> describes error conditions occurring before the VI executes. If an error has already occurred, the VI returns the value of the error in cluster in error out.            |
|                                                                                     |  | <b>status:</b> is TRUE if an error occurred. If status is TRUE, the VI does not perform any operations.                                                                                              |

Table D-28 (continued)  
**KI DIO Config**























|                                                                                     |                                                                                   |                                                                                                                                                                                                                                                                                                  |
|-------------------------------------------------------------------------------------|-----------------------------------------------------------------------------------|--------------------------------------------------------------------------------------------------------------------------------------------------------------------------------------------------------------------------------------------------------------------------------------------------|
|                                                                                     |  | <b>code:</b> is the error code number identifying an error. A value of 0 means no error, a negative value means a fatal error, and a positive value is a warning. Refer to <a href="#">Table D-52</a> for a code description.                                                                    |
|                                                                                     |  | <b>source:</b> identifies where an error occurred. The source string is usually the name of the VI that produced the error.                                                                                                                                                                      |
|    |                                                                                   | <b>number of scans/ updates:</b> specifies how much memory to allocate for the buffer. The default input for number of scans/updates is -1, which means KIDAQ LabVIEW leaves the current setting for number of scans/updates unchanged. The default setting for number of scans/updates is 1000. |
|    |                                                                                   | <b>group:</b> is the number the VI assigns to the set of ports, ranging from 0 to 15. The default input and setting for group is 0.                                                                                                                                                              |
|    |                                                                                   | <b>handshaking mode parameters:</b> affects the handshaking operation of KPXI-DIO-32-80M devices.                                                                                                                                                                                                |
|    |                                                                                   | <b>signal mode:</b> This input is not used by Keithley Instruments PXI devices and is ignored.                                                                                                                                                                                                   |
|    |                                                                                   | <b>edge mode:</b> This input is not used by Keithley Instruments PXI devices and is ignored.                                                                                                                                                                                                     |
|  |                                                                                   | <b>request polarity:</b> specifies active high or low handshaking request signals.<br>0: Do not change the request polarity setting (default input).<br>1: Active low requests (default setting).<br>2: Active high requests.                                                                    |
|  |                                                                                   | <b>acknowledge polarity:</b> specifies active high or low handshaking acknowledge signals.<br>0: Do not change the acknowledge polarity setting (default input).<br>1: Active low acknowledges (default setting).<br>2: Active high acknowledges.                                                |
|  |                                                                                   | <b>acknowledge modify mode:</b> This input is not used by Keithley Instruments PXI devices and is ignored.                                                                                                                                                                                       |
|  |                                                                                   | <b>acknowledge modify amount:</b> This input is not used by Keithley Instruments PXI devices and is ignored                                                                                                                                                                                      |
|  |                                                                                   | <b>hardware double-buffer mode:</b> This input is not used by Keithley Instruments PXI devices and is ignored.                                                                                                                                                                                   |
|  |                                                                                   | <b>terminator:</b> is TRUE if output port terminator is on and is FALSE if output port terminator is off. Terminator affects only KPXI-DIO-32-80M.                                                                                                                                               |
|  |                                                                                   | <b>burst handshaking enable:</b> is TRUE if burst handshaking mode is enabled and is FALSE if burst handshaking mode is disabled. burst handshaking enable affects only KPXI-DIO-32-80M.                                                                                                         |
|  |                                                                                   | <b>fifo control:</b> controls the DO FIFO. This parameter is only valid for KPXI-DIO-32-80M.                                                                                                                                                                                                     |

Table D-28 (continued)

**KI DIO Config**

|                                                                                   |                                                                                                                                                                                                                               |
|-----------------------------------------------------------------------------------|-------------------------------------------------------------------------------------------------------------------------------------------------------------------------------------------------------------------------------|
|  | <b>fifo wait enable:</b><br>TRUE: delay output data until FIFO is not almost empty<br>FALSE: digital output does not wait for FIFO is not almost empty.                                                                       |
|  | <b>threshold:</b> Is the programmable almost empty threshold of both PORTB FIFO and PORTA FIFO (if output port width is 32).                                                                                                  |
|  | <b>taskID:</b> identifies the group and the I/O operation.                                                                                                                                                                    |
|  | <b>error out:</b> contains error information. If the error in cluster indicated an error, the error out cluster contains the same information. Otherwise, error out describes the error status of this VI.                    |
|  | <b>status:</b> is TRUE if an error occurred. If status is TRUE, the VI does not perform any operations.                                                                                                                       |
|  | <b>code:</b> is the error code number identifying an error. A value of 0 means no error, a negative value means a fatal error, and a positive value is a warning. Refer to <a href="#">Table D-52</a> for a code description. |
|  | <b>source:</b> identifies where an error occurred. The source string is usually the name of the VI that produced the error.                                                                                                   |

**KI DIO Read**

Reads data from the internal buffer and returns the data read in pattern.

KI DIO Read is a polymorphic VI that you can configure to output the following kinds of data:

- U8 Array (with port width 8)
- U16 Array (with port width 16)
- U32 Array (with port width 32)

**NOTE** This VI is not supported for KPXI-DAQ series devices.

Table D-29

**KI DIO Read**



















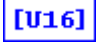

|                                                                                     |                                                                                                                                                                                                                                                                                                                                                                                                                                                                |
|-------------------------------------------------------------------------------------|----------------------------------------------------------------------------------------------------------------------------------------------------------------------------------------------------------------------------------------------------------------------------------------------------------------------------------------------------------------------------------------------------------------------------------------------------------------|
|  | <b>taskID in:</b> identifies the group and the I/O operation.                                                                                                                                                                                                                                                                                                                                                                                                  |
|  | <b>number of scans to read:</b> is the number of scans to retrieve from buffer. This parameter defaults to -1, which means leaving the number of scans to read setting unchanged. The default setting is equal to the size of the buffer, which you set by KI DIO Config VI. If number of scans to read is 0, you can check the scan backlog to determine how many scans have accumulated. The VI waits until the data is available or the time limit expires. |
|  | <b>read location:</b> This input is not used by Keithley Instruments PXI devices and is ignored. The starting point for the read is the position where the read mark points to. Initially, the read mark points to the beginning of the acquisition buffer. As you retrieve data from the buffer using this VI, the read mark is incremented to point to the next block of data to be read.                                                                    |
|  | <b>read offset:</b> This input is not used by Keithley Instruments PXI devices and is ignored.                                                                                                                                                                                                                                                                                                                                                                 |

Table D-29 (continued)  
**KI DIO Read**

|                                                                                                                                                                                                                                                                               |                                                                                     |                                                                                                                                                                                                                                                                                                                         |
|-------------------------------------------------------------------------------------------------------------------------------------------------------------------------------------------------------------------------------------------------------------------------------|-------------------------------------------------------------------------------------|-------------------------------------------------------------------------------------------------------------------------------------------------------------------------------------------------------------------------------------------------------------------------------------------------------------------------|
|                                                                                                                                                                                                                                                                               |    | <b>read mode:</b> This input is not used by Keithley Instruments PXI devices and is ignored.                                                                                                                                                                                                                            |
|                                                                                                                                                                                              |                                                                                     | <b>error in (no error):</b> describes error conditions occurring before the VI executes. If an error has already occurred, the VI returns the value of the error in cluster in error out.                                                                                                                               |
|                                                                                                                                                                                                                                                                               |    | <b>Status:</b> is TRUE if an error occurred. If status is TRUE, the VI does not perform any operations.                                                                                                                                                                                                                 |
|                                                                                                                                                                                                                                                                               |    | <b>code:</b> is the error code number identifying an error. A value of 0 means no error, a negative value means a fatal error, and a positive value is a warning. Refer to <a href="#">Table D-52</a> for a code description.                                                                                           |
|                                                                                                                                                                                                                                                                               |    | <b>Source:</b> identifies where an error occurred. The source string is usually the name of the VI that produced the error.                                                                                                                                                                                             |
|                                                                                                                                                                                              |                                                                                     | <b>time limit in sec:</b> timeout for data read. The default input is -1.0, which means KIDAQ LabVIEW calculates a time limit based on the value of number of scans to read and the scan rate. If the scan rate is unknown, the VI uses 1 second as the time limit. The resolution of the timeout clock is about 55 ms. |
|                                                                                                                                                                                                                                                                               |    | <b>taskID out:</b> has the same value as <i>taskID in</i> .                                                                                                                                                                                                                                                             |
| <br>or<br><br>or<br> |                                                                                     | <b>port data:</b> is a 1D array containing the digital data that the VI obtained from the internal buffer. Each element in this array is an 8-bit, 16-bit or 32-bit unsigned integer that represents a single port data.                                                                                                |
|                                                                                                                                                                                            |                                                                                     | <b>error out:</b> contains error information. If the error in cluster indicated an error, the error out cluster contains the same information. Otherwise, error out describes the error status of this VI.                                                                                                              |
|                                                                                                                                                                                                                                                                               |  | <b>Status:</b> is TRUE if an error occurred. If status is TRUE, the VI does not perform any operations.                                                                                                                                                                                                                 |
|                                                                                                                                                                                                                                                                               |  | <b>code:</b> is the error code number identifying an error. A value of 0 means no error, a negative value means a fatal error, and a positive value is a warning. Refer to <a href="#">Table D-52</a> for a code description.                                                                                           |
|                                                                                                                                                                                                                                                                               |  | <b>Source:</b> identifies where an error occurred. The source string is usually the name of the VI that produced the error.                                                                                                                                                                                             |
|                                                                                                                                                                                                                                                                               |  | <b>scan backlog:</b> is the amount of data in the buffer that remains unread after this VI completes.                                                                                                                                                                                                                   |
|                                                                                                                                                                                                                                                                               |  | <b>number read:</b> is the number of scans returned.                                                                                                                                                                                                                                                                    |
|                                                                                                                                                                                                                                                                               |  | <b>retrieval complete:</b> is TRUE when the total number of the scans you specified in the KI DIO Start VI has been read.                                                                                                                                                                                               |

**KI DIO Start**

Starts a buffered digital I/O operation.

**NOTE** This VI is not supported for KPXI-DAQ series devices.

Table D-30

**KI DIO Start**

















|                                                                                     |                                                                                                                                                                                                                                                                                                                                                                                                                                   |
|-------------------------------------------------------------------------------------|-----------------------------------------------------------------------------------------------------------------------------------------------------------------------------------------------------------------------------------------------------------------------------------------------------------------------------------------------------------------------------------------------------------------------------------|
|    | <b>taskID in:</b> identifies the group and the I/O operation.                                                                                                                                                                                                                                                                                                                                                                     |
|    | <b>number of scans /updates to acquire or generate:</b> is the total number of scans to acquire or generate. With the default input -1, the device acquires or generates exactly one buffer of data. The buffer size input to the KI DIO Config VI determines the size of the buffer. If number of scans/updates to acquire or generate is 0, the device acquires or generates data continuously until you stop the operation.    |
|    | <b>trigger type:</b> specifies the type of trigger.<br>0: Do not change (default input).<br>1: Start trigger. KIDAQ LabVIEW waits trigger signal to start DIO operation.                                                                                                                                                                                                                                                          |
|    | <b>trigger mode:</b> sets the trigger on or off.<br>0: Do not change (default input).<br>1: Off (default setting).<br>2: On.                                                                                                                                                                                                                                                                                                      |
|  | <b>trigger condition:</b> specifies when the digital operation triggers.<br>0: Do not change (default input).<br>1: Trigger on rising edge (default setting).<br>2: Trigger on falling edge.                                                                                                                                                                                                                                      |
|  | <b>error in (no error):</b> describes error conditions occurring before the VI executes. If an error has already occurred, the VI returns the value of the error in cluster in error out.                                                                                                                                                                                                                                         |
|  | <b>status:</b> is TRUE if an error occurred. If status is TRUE, the VI does not perform any operations.                                                                                                                                                                                                                                                                                                                           |
|  | <b>code:</b> is the error code number identifying an error. A value of 0 means no error, a negative value means a fatal error, and a positive value is a warning. Refer to <a href="#">Table D-52</a> for a code description.                                                                                                                                                                                                     |
|  | <b>source:</b> identifies where an error occurred. The source string is usually the name of the VI that produced the error.                                                                                                                                                                                                                                                                                                       |
|  | <b>handshake source:</b> determines the source of the conditions that perform a data transfer.<br>0: Do not change the handshake source setting (default input).<br>1: Internal clock.<br>2: I/O connector (default setting).<br>When handshake source is 1, the clock frequency control determines the clock rate.<br>When handshake source is 2, you must connect the handshake signal to the proper line on the I/O connector. |
|  | <b>clock frequency:</b> is the rate to which you want to handshake the data. This parameter is expressed in scans/s or updates/s. This parameter defaults to -1.0. The default setting is undefined.                                                                                                                                                                                                                              |
|  | <b>taskID out:</b> has the same value as <b>taskID in</b> .                                                                                                                                                                                                                                                                                                                                                                       |



Table D-30 (continued)  
**KI DIO Start**

|                                                                                   |                                                                                                                                                                                                            |                                                                                                                                                                                                                               |
|-----------------------------------------------------------------------------------|------------------------------------------------------------------------------------------------------------------------------------------------------------------------------------------------------------|-------------------------------------------------------------------------------------------------------------------------------------------------------------------------------------------------------------------------------|
|  | <b>error out:</b> contains error information. If the error in cluster indicated an error, the error out cluster contains the same information. Otherwise, error out describes the error status of this VI. |                                                                                                                                                                                                                               |
|                                                                                   |                                                                                                                           | <b>status:</b> is TRUE if an error occurred. If status is TRUE, the VI does not perform any operations.                                                                                                                       |
|                                                                                   |                                                                                                                           | <b>code:</b> is the error code number identifying an error. A value of 0 means no error, a negative value means a fatal error, and a positive value is a warning. Refer to <a href="#">Table D-52</a> for a code description. |
|                                                                                   |                                                                                                                           | <b>source:</b> identifies where an error occurred. The source string is usually the name of the VI that produced the error.                                                                                                   |

**KI DIO Write**

Writes digital output data to the internal transfer buffer. You can call the KI DIO Write VI after the transfer begins to retrieve the output status information.

**NOTE** This VI is not supported for KPXI-DAQ series devices.

Table D-31  
**KI DIO Write**



















|                                                                                                                                                                                                                                                                               |                                                                                                                                                                                                                                                                                                                                      |                                                                                                                                                                                                                               |
|-------------------------------------------------------------------------------------------------------------------------------------------------------------------------------------------------------------------------------------------------------------------------------|--------------------------------------------------------------------------------------------------------------------------------------------------------------------------------------------------------------------------------------------------------------------------------------------------------------------------------------|-------------------------------------------------------------------------------------------------------------------------------------------------------------------------------------------------------------------------------|
|                                                                                                                                                                                             | <b>taskID in:</b> identifies the group and the I/O operation.                                                                                                                                                                                                                                                                        |                                                                                                                                                                                                                               |
| <br>or<br><br>or<br> | <b>digital data:</b> is a 1D array containing digital output data. Each element in this array is an 8-bit, 16-bit and 32-bit unsigned integer that represents a single port data. If you call this VI with an empty array, you can examine buffer iterations and generation complete to retrieve the output progressing information. |                                                                                                                                                                                                                               |
|                                                                                                                                                                                            | <b>error in (no error):</b> describes error conditions occurring before the VI executes. If an error has already occurred, the VI returns the value of the error in cluster in error out.                                                                                                                                            |                                                                                                                                                                                                                               |
|                                                                                                                                                                                                                                                                               |                                                                                                                                                                                                                                                   | <b>status:</b> is TRUE if an error occurred. If status is TRUE, the VI does not perform any operations.                                                                                                                       |
|                                                                                                                                                                                                                                                                               |                                                                                                                                                                                                                                                   | <b>code:</b> is the error code number identifying an error. A value of 0 means no error, a negative value means a fatal error, and a positive value is a warning. Refer to <a href="#">Table D-52</a> for a code description. |
|                                                                                                                                                                                                                                                                               |                                                                                                                                                                                                                                                   | <b>source:</b> identifies where an error occurred. The source string is usually the name of the VI that produced the error.                                                                                                   |
|                                                                                                                                                                                            | <b>time limit in sec:</b> timeout for data write. The default input is -1.0, which means KIDAQ LabVIEW calculates a time limit based on the value of number of updates and the scan rate. If the scan rate is unknown, the VI uses 1 second as the time limit. The resolution of the timeout clock is about 55 ms.                   |                                                                                                                                                                                                                               |
|                                                                                                                                                                                            | <b>write location:</b> Determines where the write begins. Contains the following parameters.                                                                                                                                                                                                                                         |                                                                                                                                                                                                                               |

Table D-31 (continued)

**KI DIO Write**

|                                                                                     |                                                                                                                                                                                                                                                                                                                                                        |
|-------------------------------------------------------------------------------------|--------------------------------------------------------------------------------------------------------------------------------------------------------------------------------------------------------------------------------------------------------------------------------------------------------------------------------------------------------|
|    | <b>write offset:</b> The VI adds the value of write offset to the write mark to determine where the write begins. The default input is -1, which means leaving the write offset setting unchanged. This parameter defaults to a setting of 0.                                                                                                          |
|    | <b>write mode:</b> Setting write mode to 2 moves the write mark to the beginning of the buffer before the VI adds write offset to the write mark.<br>0: Do not change the write mode setting (default input).<br>1: Write at the write mark plus the write offset (default setting).<br>2: Write at the beginning of the buffer plus the write offset. |
|    | <b>taskID out:</b> has the same value as <i>taskID in</i> .                                                                                                                                                                                                                                                                                            |
|    | <b>error out:</b> contains error information. If the error in cluster indicated an error, the error out cluster contains the same information. Otherwise, error out describes the error status of this VI.                                                                                                                                             |
|    | <b>status:</b> is TRUE if an error occurred. If status is TRUE, the VI does not perform any operations.                                                                                                                                                                                                                                                |
|    | <b>code:</b> is the error code number identifying an error. A value of 0 means no error, a negative value means a fatal error, and a positive value is a warning. Refer to <a href="#">Table D-52</a> for a code description.                                                                                                                          |
|   | <b>source:</b> identifies where an error occurred. The source string is usually the name of the VI that produced the error.                                                                                                                                                                                                                            |
|  | <b>buffer iterations:</b> indicates the current number of complete iterations of the buffer.                                                                                                                                                                                                                                                           |
|  | <b>generation complete:</b> is TRUE when the number of updates to generate has finished.                                                                                                                                                                                                                                                               |

## Advanced Digital I/O VIs

### KI DIO Port Config

Configures a digital channel. You can use the task ID that this VI returns only in digital port VIs.

Table D-32

### KI DIO Port Config















|                                                                                     |                                                                                                                                                                                                                                                                                                                                                                                                                                                                                                                                                                                                            |
|-------------------------------------------------------------------------------------|------------------------------------------------------------------------------------------------------------------------------------------------------------------------------------------------------------------------------------------------------------------------------------------------------------------------------------------------------------------------------------------------------------------------------------------------------------------------------------------------------------------------------------------------------------------------------------------------------------|
|    | <b>device:</b> Number of the device (beginning from 1). The utility <b>Device Browser</b> can be used to get the information of current device configuration.                                                                                                                                                                                                                                                                                                                                                                                                                                              |
|    | <b>sub type:</b> is the sub-type of the device you assigned to the Keithley Instruments PXI device during configuration.                                                                                                                                                                                                                                                                                                                                                                                                                                                                                   |
|    | <p><b>digital channel:</b> is the port number to write.</p> <p><b>KPXI-DIO-16-16:</b> 0</p> <p><b>KPXI-DIO-48:</b><br/>0: P1A, 1: P1B, 2: P1C Lower, 3: P1C Upper<br/>4: P2A, 5: P2B, 6: P2C Lower, 7: P2C Upper</p> <p><b>KPXI-RDI-8-16:</b> 0</p> <p><b>KPXI-DIO-32-80M:</b> 1 (auxiliary output port)</p> <p><b>KPXI-DIO-32-32:</b> 0 (DO) or 1 (LED)</p> <p><b>KPXI-DIO-64-0:</b> 0 (LED)</p> <p><b>KPXI-DIO-0-64:</b> 0 (DO Low), 1 (DO High)</p> <p><b>KPXI-DIO-0-64:</b> 0 (DO Low), 1 (DO High), 2 (LED)</p> <p><b>KPXI-DAQ series devices:</b><br/>0: P1A, 1: P1B, 2: P1C Lower, 3: P1C Upper</p> |
|  | <b>port width:</b> is the total width or the number of lines of the port in bits. port width is only valid for KPXI-DIO-32-80M which supports 8-bit, 16-bit and 32-bit of data acquisition                                                                                                                                                                                                                                                                                                                                                                                                                 |
|  | <b>error in (no error):</b> describes error conditions occurring before the VI executes. If an error has already occurred, the VI returns the value of the error in cluster in error out.                                                                                                                                                                                                                                                                                                                                                                                                                  |
|  | <b>status:</b> is TRUE if an error occurred. If status is TRUE, the VI does not perform any operations.                                                                                                                                                                                                                                                                                                                                                                                                                                                                                                    |
|  | <b>code:</b> is the error code number identifying an error. A value of 0 means no error, a negative value means a fatal error, and a positive value is a warning. Refer to <a href="#">Table D-52</a> for a code description.                                                                                                                                                                                                                                                                                                                                                                              |
|  | <b>source:</b> identifies where an error occurred. The source string is usually the name of the VI that produced the error.                                                                                                                                                                                                                                                                                                                                                                                                                                                                                |
|  | <b>line direction map:</b> specifies the direction of each line in the port. If a bit is 0 in the line map, the line is an input line. If a bit is 1, the line is an output line. Set line direction map to -1 to make all the lines in a port output lines. Set line direction map to 0 to make all the lines in a port input lines. Port C (e.g. P1C, P2C, etc.) are the only ports on which you can configure lines for different directions. The least significant bit in the line map corresponds to line 0 in the port. The line direction map parameter defaults to 0.                              |
|  | <b>wired OR map:</b> is not used and ignored.                                                                                                                                                                                                                                                                                                                                                                                                                                                                                                                                                              |

Table D-32 (continued)  
**KI DIO Port Config**

|                                                                                   |                                                                                                                                                                                                                               |
|-----------------------------------------------------------------------------------|-------------------------------------------------------------------------------------------------------------------------------------------------------------------------------------------------------------------------------|
|  | <b>taskID out:</b> uniquely identifies the digital group. Use this value as the task ID to refer to this group in subsequent digital port VIs.                                                                                |
|  | <b>error out:</b> contains error information. If the error in cluster indicated an error, the error out cluster contains the same information. Otherwise, error out describes the error status of this VI.                    |
|  | <b>status:</b> is TRUE if an error occurred. If status is TRUE, the VI does not perform any operations.                                                                                                                       |
|  | <b>code:</b> is the error code number identifying an error. A value of 0 means no error, a negative value means a fatal error, and a positive value is a warning. Refer to <a href="#">Table D-52</a> for a code description. |
|  | <b>source:</b> identifies where an error occurred. The source string is usually the name of the VI that produced the error.                                                                                                   |

## Counter VIs

Six Counter VIs are contained in the Counter palette.

### Easy Counter VIs

#### KI Count Events or Time

Configures one or two counters to count external events. An external event is a high or low signal transition on the specified **GPTCn\_SRC** pin of the counter.

**NOTE** This VI is not supported for Keithley KDIO series devices.

Table D-33  
**KI Count Events or Time**











|                                                                                     |                                                                                                                                                               |
|-------------------------------------------------------------------------------------|---------------------------------------------------------------------------------------------------------------------------------------------------------------|
|  | <b>device:</b> Number of the device (beginning from 1). The utility <b>Device Browser</b> can be used to get the information of current device configuration. |
|  | <b>sub type:</b> is the sub-type of the device you assigned to the Keithley Instruments PXI device during configuration.                                      |
|  | <b>counter:</b> is an array of strings that specifies the counter(s) the VI controls.                                                                         |
|  | <b>counter size:</b> This input is not used by Keithley Instruments PXI devices and is ignored.                                                               |
|  | <b>start/restart:</b> is TRUE to configure and start the counter(s).                                                                                          |
|  | <b>stop:</b> is TRUE to stop the counter(s).                                                                                                                  |
|  | <b>source edge:</b> is the edge of the counter clock signal.<br>0: Count on low to high transition.<br>1: Count on high to low transition.                    |

Table D-33 (continued)  
**KI Count Events or Time**

|                                                                                   |                                                                                                                                                                                                                                                                                                   |
|-----------------------------------------------------------------------------------|---------------------------------------------------------------------------------------------------------------------------------------------------------------------------------------------------------------------------------------------------------------------------------------------------|
|  | <b>count:</b> is the value of the counter at the time it is read. If there are two counters assigned to the task ID, the value of the higher order counter is multiplied by 10000 hex, shifting it to the left 16 bits. The higher order counter is then added to the value of the lower counter. |
|  | <b>seconds till overflow:</b> This input is not used by Keithley Instruments PXI devices and is ignored.                                                                                                                                                                                          |
|  | <b>seconds since last call:</b> This input is not used by Keithley Instruments PXI devices and is ignored.                                                                                                                                                                                        |
|  | <b>seconds since start:</b> This input is not used by Keithley Instruments PXI devices and is ignored.                                                                                                                                                                                            |

**KI Generate Delayed Pulse**

Configures and starts a counter to generate a single pulse with the specified delay and pulse-width on the counter **GPTCn\_OUT** pin. A single pulse consists of a delay phase (phase 1), followed by a pulse phase (phase 2), and then returns to the phase 1 level.

**NOTE** This VI is not supported for Keithley KDIO series devices.

Table D-34  
**KI Generate Delayed Pulse**







|                                                                                     |                                                                                                                                                                                                                                                                                                                                 |
|-------------------------------------------------------------------------------------|---------------------------------------------------------------------------------------------------------------------------------------------------------------------------------------------------------------------------------------------------------------------------------------------------------------------------------|
|  | <b>device:</b> Number of the device (beginning from 1). The utility <b>Device Browser</b> can be used to get the information of current device configuration.                                                                                                                                                                   |
|  | <b>sub type:</b> is the sub-type of the device you assigned to the Keithley Instruments PXI device during configuration.                                                                                                                                                                                                        |
|  | <b>counter:</b> is an array of strings that specifies the counter(s) the VI controls.                                                                                                                                                                                                                                           |
|  | <b>pulse delays (s or cycles):</b> is the desired duration of the first phase of the pulse, phase 1. The unit is seconds if timebase source is 0 (internal) and cycles if timebase source is 1 (external). If pulse delay is 0.0 and timebase source is 0, the VI selects a minimum delay of three cycles of the timebase used. |
|  | <b>pulse-width (s or cycles):</b> is the desired duration of the second phase of the pulse, phase 2. The unit is seconds if timebase source is 0 (internal) and cycles if timebase source is 1 (external). If pulse-width is 0.0 and timebase source is 0, the VI selects a minimum width of three cycles of the timebase used. |
|  | <b>timebase source:</b> is the clock source. Timebase source is 0 to use an internal signal and 1 to use an external signal for the timebase.                                                                                                                                                                                   |

Table D-34 (continued)

**KI Generate Delayed Pulse**

|            |                                                                                                                                                                                                                                                                                                                                                                                                                                                                                                                                                                                                                                                                                                                                                                                                     |
|------------|-----------------------------------------------------------------------------------------------------------------------------------------------------------------------------------------------------------------------------------------------------------------------------------------------------------------------------------------------------------------------------------------------------------------------------------------------------------------------------------------------------------------------------------------------------------------------------------------------------------------------------------------------------------------------------------------------------------------------------------------------------------------------------------------------------|
| <b>U16</b> | <p><b>gate mode:</b> specifies how the counter <b>GPTCn_GATE</b> signal is used.</p> <p>0: Ungated/software start: ignore the gate source and start when the VI is called (default).</p> <p>1: Count while the gate signal is TTL high.</p> <p>2: Count while the gate signal is TTL low.</p> <p>3: Start counting on the rising edge of the TTL gate signal.</p> <p>4: Start counting on the falling edge of the TTL gate signal.</p> <p>5: Restart counting on each rising edge of the TTL gate signal.</p> <p>6: Restart counting on each falling edge of the TTL gate signal.</p> <p>Use gate mode 3 or 4 to generate one delayed pulse on the first gate edge after starting. Use gate mode 5 or 6 to generate a delayed pulse for each gate edge (i.e., retriggerable one-shot behavior).</p> |
| <b>U16</b> | <p><b>pulse polarity:</b> is the polarity of the second phase (phase 2) of the pulse.</p> <p>0: High pulse: phase 1 (the delay) is a low TTL level and phase 2 is a high level (default).</p> <p>1: Low pulse: phase 1 is a high TTL level and phase 2 is a low level.</p>                                                                                                                                                                                                                                                                                                                                                                                                                                                                                                                          |
| <b>U32</b> | <p><b>taskID of counter out:</b> is the task ID of the specified counter, which generates the delayed pulse.</p>                                                                                                                                                                                                                                                                                                                                                                                                                                                                                                                                                                                                                                                                                    |
| <b>DBL</b> | <p><b>actual delay (s or cycles):</b> is the achieved delay. It may differ from the desired delay because the hardware has limited resolution and range.</p>                                                                                                                                                                                                                                                                                                                                                                                                                                                                                                                                                                                                                                        |
|            | <p><b>actual width (s or cycles):</b> is the achieved pulse-width. It may differ from the desired width because the hardware has limited resolution and range.</p>                                                                                                                                                                                                                                                                                                                                                                                                                                                                                                                                                                                                                                  |

**KI Generate Pulse-Train**

Configures the specified counter to generate a continuous pulse-train on the GPTCn\_OUT pin. The signal has the prescribed frequency, duty cycle, and polarity. Each cycle of the pulse-train consist of a delay phase (phase 1) followed by a pulse phase (phase 2).

**NOTE** This VI is not supported for Keithley DIO series devices.











Table D-35

**KI Generate Pulse-Train**

|              |                                                                                                                                                                                                                                                                                                                                                          |
|--------------|----------------------------------------------------------------------------------------------------------------------------------------------------------------------------------------------------------------------------------------------------------------------------------------------------------------------------------------------------------|
| <b>I16</b>   | <p><b>device:</b> Number of the device (beginning from 1). The utility <b>Device Browser</b> can be used to get the information of current device configuration.</p>                                                                                                                                                                                     |
| <b>U16</b>   | <p><b>sub type:</b> is the sub-type of the device you assigned to the Keithley Instruments PXI device during configuration.</p>                                                                                                                                                                                                                          |
| <b>[abc]</b> | <p><b>counter:</b> is an array of strings that specifies the counter(s) the VI controls.</p>                                                                                                                                                                                                                                                             |
| <b>I32</b>   | <p><b>number of pulses:</b> is the number of pulses you want in the pulse-train. If the value is 0 (default), the VI generates a continuous pulse-train.</p>                                                                                                                                                                                             |
| <b>DBL</b>   | <p><b>frequency:</b> (Hz) is the desired repetition rate of the pulse-train.</p>                                                                                                                                                                                                                                                                         |
|              | <p><b>duty cycle:</b> is the desired ratio of the durations of phase 2 (phase two) of the pulse to the period of one cycle (1/frequency); default is 0.5. If duty cycle is 0.0 or 1.0, the VI computes the closest achievable duty cycle using a minimum period of three timebase cycles. A duty cycle very close to 0.0 or 1.0 may not be possible.</p> |

Table D-35 (continued)

**KI Generate Pulse-Train**

|                                                                                     |                                                                                                                                                                                                                                                                                                                                                                                                                                                                                                                                                                                                                                                                                       |
|-------------------------------------------------------------------------------------|---------------------------------------------------------------------------------------------------------------------------------------------------------------------------------------------------------------------------------------------------------------------------------------------------------------------------------------------------------------------------------------------------------------------------------------------------------------------------------------------------------------------------------------------------------------------------------------------------------------------------------------------------------------------------------------|
|    | <b>timebase:</b> is the frequency of the clock. If the value of timebase is 0 or 10000000, internal signal is used; otherwise, an external signal is used.                                                                                                                                                                                                                                                                                                                                                                                                                                                                                                                            |
|    | <b>gate mode:</b> specifies how the counter <i>GPTCn_GATE</i> signal is used.<br>0: ungated/software start: ignore the gate source and start when the VI is called. (default).<br>1: Count while the gate signal is TTL high.<br>2: Count while the gate signal is TTL low.<br>3: start (continuous) pulse-train on the rising edge of the TTL gate signal.<br>4: start (continuous) pulse-train on the falling edge of the TTL gate signal.<br>If number of pulses is 0 (continuous pulse-train), gate mode 3 or 4 generates one pulse per gate edge, which is the behavior of a retriggeable one shot. If number of pulses –1, gate mode 3 or 4 generates a continuous pulse-train. |
|    | <b>pulse polarity:</b> is the polarity of the second phase (phase 2) of the pulse.<br>0: High pulse: phase 1 (the delay) is a low TTL level and phase 2 is a high level (default).<br>1: Low pulse: phase 1 is a high TTL level and phase 2 is a low level.                                                                                                                                                                                                                                                                                                                                                                                                                           |
|    | <b>taskID of counter out:</b> is the task ID of the specified counter, which generates the pulse train.                                                                                                                                                                                                                                                                                                                                                                                                                                                                                                                                                                               |
|    | <b>taskID of counter -1 out:</b> this output is not used by Keithley Instruments PXI devices and is ignored.                                                                                                                                                                                                                                                                                                                                                                                                                                                                                                                                                                          |
|   | <b>actual parameters out:</b> is a cluster of lesser parameters. These parameters may differ from the desired parameters because the hardware has limited resolution and range.                                                                                                                                                                                                                                                                                                                                                                                                                                                                                                       |
|  | <b>frequency:</b> (Hz) is the achieved frequency.                                                                                                                                                                                                                                                                                                                                                                                                                                                                                                                                                                                                                                     |
|  | <b>duty cycle:</b> is the achieved duty cycled.                                                                                                                                                                                                                                                                                                                                                                                                                                                                                                                                                                                                                                       |
|  | <b>pulse delay:</b> is the achieved minimum delay to the gating pulse.                                                                                                                                                                                                                                                                                                                                                                                                                                                                                                                                                                                                                |
|  | <b>pulse-width:</b> is the achieved width of the gating pulse.                                                                                                                                                                                                                                                                                                                                                                                                                                                                                                                                                                                                                        |

**KI Measure Pulse-Width or Period**

Measures the pulse-width (length of time a signal is high or low) or period (length of time between adjacent rising or falling edges) of a TTL signal connected to the counter *GPTCn\_GATE* pin. The method used gates an internal timebase clock with the signal being measured. This VI is useful in measuring the period or frequency (1/period) of relatively low frequency signals, when many timebase cycles occur during the gate.

**NOTE** This VI is not supported for Keithley KDIO Series devices.

Table D-36

**KI Measure Pulse-Width or Period**











|                                                                                     |                                                                                                                                                               |
|-------------------------------------------------------------------------------------|---------------------------------------------------------------------------------------------------------------------------------------------------------------|
|  | <b>device:</b> Number of the device (beginning from 1). The utility <b>Device Browser</b> can be used to get the information of current device configuration. |
|-------------------------------------------------------------------------------------|---------------------------------------------------------------------------------------------------------------------------------------------------------------|

Table D-36 (continued)

**KI Measure Pulse-Width or Period**

|                                                                                     |                                                                                                                                                                                                                                                                                                                                                                                                                            |
|-------------------------------------------------------------------------------------|----------------------------------------------------------------------------------------------------------------------------------------------------------------------------------------------------------------------------------------------------------------------------------------------------------------------------------------------------------------------------------------------------------------------------|
|    | <b>sub type:</b> is the sub-type of the device you assigned to the Keithley Instruments PXI device during configuration.                                                                                                                                                                                                                                                                                                   |
|    | <b>counter:</b> is an array of strings that specifies the counter(s) the VI controls.                                                                                                                                                                                                                                                                                                                                      |
|    | <b>type of measurement:</b> identifies the type of pulse-width or period measurement to make. The following illustration demonstrates the various values for type of measurement.<br>0: Measure high pulse-width from rising to falling edge.<br>1: Measure low pulse-width from falling to rising edge.<br>2: Measure period between adjacent rising edges. (default)<br>3: Measure period between adjacent falling edges |
|    | <b>timebase:</b> is the frequency of the clock. If the value of timebase is 0 or 10000000, internal signal is used; otherwise, an external signal is used.                                                                                                                                                                                                                                                                 |
|    | <b>pulse-width/period (s) out:</b> is the measured pulse-width or period; it equals count/timebase and may be valid or invalid.                                                                                                                                                                                                                                                                                            |
|    | <b>time limit in sec:</b> is the period to wait for a valid measurement. If time limit is -1.0 (default), the time limit is set to five seconds or four times the range of the counter at the selected timebase ( $4 \times 65,536 / \text{timebase}$ ) in seconds.                                                                                                                                                        |
|   | <b>valid?:</b> is TRUE if counter has not underflowed (if <b>count ?4</b> ) or overflowed.                                                                                                                                                                                                                                                                                                                                 |
|  | <b>count:</b> is the value of the counter at the time it is read. For best accuracy, choose a timebase frequency that maximizes the count without overflowing it. If there are two counters assigned to the task ID, the value of the higher order counter is multiplied by 10000 hex, shifting it to the left 16 bits. The higher order counter is then added to the value of the lower counter.                          |
|  | <b>counter overflow?:</b> is TRUE if counter reaches TC. Overflow does not produce an error.                                                                                                                                                                                                                                                                                                                               |
|  | <b>timeout:</b> is TRUE if a valid reading is not within the prescribed or computed time limit. The timeout parameter does not produce an error.                                                                                                                                                                                                                                                                           |

**Intermediate Counter VIs****KI Continuous Pulse Generator Config**

Configures a counter to generate a continuous TTL pulse-train on its GPTCn\_OUT pin.

**NOTE** This VI is not supported for Keithley KDIO series devices.

Table D-37

**KI Continuous Pulse Generator Config**

|                                                                                     |                                                                                                                                                               |
|-------------------------------------------------------------------------------------|---------------------------------------------------------------------------------------------------------------------------------------------------------------|
|  | <b>device:</b> Number of the device (beginning from 1). The utility <b>Device Browser</b> can be used to get the information of current device configuration. |
|-------------------------------------------------------------------------------------|---------------------------------------------------------------------------------------------------------------------------------------------------------------|



Table D-37 (continued)  
**KI Continuous Pulse Generator Config**



















|                                                                                     |                                                                                                                                                                                                                                                                                                                                                                                                                                                                                                                                                                                                                                                         |
|-------------------------------------------------------------------------------------|---------------------------------------------------------------------------------------------------------------------------------------------------------------------------------------------------------------------------------------------------------------------------------------------------------------------------------------------------------------------------------------------------------------------------------------------------------------------------------------------------------------------------------------------------------------------------------------------------------------------------------------------------------|
|    | <b>sub type:</b> is the sub-type of the device you assigned to the Keithley Instruments PXI device during configuration.                                                                                                                                                                                                                                                                                                                                                                                                                                                                                                                                |
|    | <b>counter:</b> is the counter this VI controls.                                                                                                                                                                                                                                                                                                                                                                                                                                                                                                                                                                                                        |
|    | <b>error in (no error):</b> describes error conditions occurring before the VI executes. If an error has already occurred, the VI returns the value of the error in cluster in error out.                                                                                                                                                                                                                                                                                                                                                                                                                                                               |
|    | <b>status:</b> is TRUE if an error occurred. If status is TRUE, the VI does not perform any operations.                                                                                                                                                                                                                                                                                                                                                                                                                                                                                                                                                 |
|    | <b>code:</b> is the error code number identifying an error. A value of 0 means no error, a negative value means a fatal error, and a positive value is a warning. Refer to <a href="#">Table D-52</a> for a code description.                                                                                                                                                                                                                                                                                                                                                                                                                           |
|    | <b>source:</b> identifies where an error occurred. The source string is usually the name of the VI that produced the error.                                                                                                                                                                                                                                                                                                                                                                                                                                                                                                                             |
|    | <b>frequency:</b> (Hz) is the desired repetition rate of the pulse-train.                                                                                                                                                                                                                                                                                                                                                                                                                                                                                                                                                                               |
|   | <b>duty cycle:</b> is the desired ratio of the durations of phase 2 (phase two) of the pulse to the period of one cycle (1/frequency); default is 0.5. If duty cycle is 0.0 or 1.0, the VI computes the closest achievable duty cycle using a minimum period of three timebase cycles. A duty cycle very close to 0.0 or 1.0 may not be possible.                                                                                                                                                                                                                                                                                                       |
|  | <b>timebase:</b> is the frequency of the clock. If the value of timebase is 0 or 10000000 (10MHz), internal signal is used; otherwise, an external signal is used.                                                                                                                                                                                                                                                                                                                                                                                                                                                                                      |
|  | <b>gate mode:</b> specifies how the counter <i>GPTCn_GATE</i> signal is used.<br>0: Ungated/software start: ignore the gate source and start when Counter Start VI is called (default).<br>1: Count while the gate signal is TTL high after the Counter Start VI is called.<br>2: Count while the gate signal is TTL low after the Counter Start VI is called.<br>3: Start counting on the rising edge of the TTL gate signal after the Counter Start VI is called.<br>4: Start counting on the falling edge of the TTL gate signal after the Counter Start VI is called.<br>If gate mode is 3 or 4, the counter generates a single pulse on each edge. |
|  | <b>pulse polarity:</b> is the polarity of the second phase (phase 2) of the pulse.<br>0: High pulse: phase 1 (the delay) is a low TTL level and phase 2 is a high level (default).<br>1: Low pulse: phase 1 is a high TTL level and phase 2 is a low level.                                                                                                                                                                                                                                                                                                                                                                                             |
|  | <b>taskID:</b> is the task ID of the specified counter, which generates the pulse train.                                                                                                                                                                                                                                                                                                                                                                                                                                                                                                                                                                |
|  | <b>error out:</b> contains error information. If the error in cluster indicated an error, the error out cluster contains the same information. Otherwise, error out describes the error status of this VI.                                                                                                                                                                                                                                                                                                                                                                                                                                              |
|  | <b>status:</b> is TRUE if an error occurred. If status is TRUE, the VI does not perform any operations.                                                                                                                                                                                                                                                                                                                                                                                                                                                                                                                                                 |
|  | <b>code:</b> is the error code number identifying an error. A value of 0 means no error, a negative value means a fatal error, and a positive value is a warning. Refer to <a href="#">Table D-52</a> for a code description.                                                                                                                                                                                                                                                                                                                                                                                                                           |

Table D-37 (continued)

**KI Continuous Pulse Generator Config**

|                                                                                   |                                                                                   |                                                                                                                                                          |
|-----------------------------------------------------------------------------------|-----------------------------------------------------------------------------------|----------------------------------------------------------------------------------------------------------------------------------------------------------|
|                                                                                   |  | <b>source:</b> identifies where an error occurred. The source string is usually the name of the VI that produced the error.                              |
|  |                                                                                   | <b>actual frequency:</b> (Hz) is the achieved frequency. It may differ from the desired frequency because the hardware has limited resolution and range. |
|  |                                                                                   | <b>actual duty cycle:</b> is the achieved duty cycle. It may differ from the desired duty cycle because the hardware has limited resolution and range.   |

**KI Counter Divider Config**

Configures the specified counter to divide a signal on the counter GP\_TC\_CLK pin or on an internal timebase signal using a count value called the timebase divisor. The result is that the signal on the counter GP\_TC\_OUT pin is equal to the frequency of the input signal/timebase divisor.

This VI is not supported for Keithley KDAQ series devices.

Table D-38

**KI Counter Divider Config**



















|                                                                                     |                                                                                                                                                                                                                                                                                   |
|-------------------------------------------------------------------------------------|-----------------------------------------------------------------------------------------------------------------------------------------------------------------------------------------------------------------------------------------------------------------------------------|
|  | <b>device:</b> Number of the device (beginning from 1). The utility <b>Device Browser</b> can be used to get the information of current device configuration.                                                                                                                     |
|  | <b>sub type:</b> is the sub-type of the device you assigned to the Keithley Instruments PXI device during configuration.                                                                                                                                                          |
|  | <b>counter:</b> is the counter this VI controls.                                                                                                                                                                                                                                  |
|  | <b>gate mode:</b> specifies how the signal on the counter's GATE pin is used.<br>0: Ungated/software start: ignore the gate source and start when KI Counter Start VI is called (default).<br>1: Count while the gate signal is TTL high after the KI Counter Start VI is called. |
|  | <b>source edge:</b> This input is not used by Keithley Instruments PXI devices and is ignored.                                                                                                                                                                                    |
|  | <b>output:</b> This input is not used by Keithley Instruments PXI devices and is ignored.                                                                                                                                                                                         |
|  | <b>updown source:</b> specifies how the signal on the counter's UPDN pin is used.<br>0: software control: ignore the UPDN source and control by <b>updownctrl</b> (default).<br>1: hardware control.                                                                              |
|  | <b>updown control:</b> specifies the specified counter to count down or count up if <b>updown</b> source is configured to be software control.<br>0: count down (default).<br>1: count up.                                                                                        |

Table D-38 (continued)  
**KI Counter Divider Config**

|                                                                                     |                                                                                                                                                                                                                                  |
|-------------------------------------------------------------------------------------|----------------------------------------------------------------------------------------------------------------------------------------------------------------------------------------------------------------------------------|
|    | <b>timebase:</b> (Hz) is set to the frequency of the internal signal whose cycles are counted, or is set to <=0.0 (default) to count the rising edges of the signal on the counter GP_TC_CLK pin.                                |
|    | <b>timebase divisor:</b> is the count down or divide value. For example, if the input frequency is 24000000 Hz, timebase divisor is 240000, and the output is pulsed, the frequency of the counter's GP_TC_OUT signal is 100 Hz. |
|    | <b>error in (no error):</b> describes error conditions occurring before the VI executes. If an error has already occurred, the VI returns the value of the error in cluster in error out.                                        |
|    | <b>status:</b> is TRUE if an error occurred. If status is TRUE, the VI does not perform any operations.                                                                                                                          |
|    | <b>code:</b> is the error code number identifying an error. A value of 0 means no error, a negative value means a fatal error, and a positive value is a warning. Refer to <a href="#">Table D-52</a> for a code description.    |
|    | <b>source:</b> identifies where an error occurred. The source string is usually the name of the VI that produced the error.                                                                                                      |
|    | <b>taskID:</b> identifies the group and the I/O operation.                                                                                                                                                                       |
|   | <b>error out:</b> contains error information. If the error in cluster indicated an error, the error out cluster contains the same information. Otherwise, error out describes the error status of this VI.                       |
|  | <b>status:</b> is TRUE if an error occurred. If status is TRUE, the VI does not perform any operations.                                                                                                                          |
|  | <b>code:</b> is the error code number identifying an error. A value of 0 means no error, a negative value means a fatal error, and a positive value is a warning. Refer to <a href="#">Table D-52</a> for a code description.    |
|  | <b>source:</b> identifies where an error occurred. The source string is usually the name of the VI that produced the error.                                                                                                      |

**KI Counter Read**

Reads the counter or counters identified by task ID.

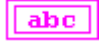
**NOTE** This VI is designed to read general purpose counter of Keithley KDAQ series devices.

Table D-39  
**KI Counter Read**













|                                                                                     |                                                                                                                                                                                           |
|-------------------------------------------------------------------------------------|-------------------------------------------------------------------------------------------------------------------------------------------------------------------------------------------|
|  | <b>taskID in:</b> identifies the group and the I/O operation.                                                                                                                             |
|  | <b>error in (no error):</b> describes error conditions occurring before the VI executes. If an error has already occurred, the VI returns the value of the error in cluster in error out. |
|  | <b>status:</b> is TRUE if an error occurred. If status is TRUE, the VI does not perform any operations.                                                                                   |

Table D-39 (continued)

**KI Counter Read**

|                                                                                     |                                                                                                                                                                                                                                                          |
|-------------------------------------------------------------------------------------|----------------------------------------------------------------------------------------------------------------------------------------------------------------------------------------------------------------------------------------------------------|
|    | <b>code:</b> is the error code number identifying an error. A value of 0 means no error, a negative value means a fatal error, and a positive value is a warning. Refer to <a href="#">Table D-52</a> for a code description.                            |
|    | <b>source:</b> identifies where an error occurred. The source string is usually the name of the VI that produced the error.                                                                                                                              |
|    | <b>counter list:</b> is the set of counters to read. Use this array only to read a subset of counters identified by task ID; otherwise, leave it empty. This input is only valid for KPXI-DAQ series devices.                                            |
|    | <b>taskID out:</b> has the same value as <i>taskID</i> in.                                                                                                                                                                                               |
|    | <b>count:</b> is the value of the counter at the time it is read.<br>If there are two counters assigned to the task ID, the value of the higher order counter is shifted to 16 bits to scale it, and then it is added to the value of the lower counter. |
|    | <b>error out:</b> contains error information. If the error in cluster indicated an error, the error out cluster contains the same information. Otherwise, error out describes the error status of this VI.                                               |
|    | <b>Status:</b> is TRUE if an error occurred. If status is TRUE, the VI does not perform any operations.                                                                                                                                                  |
|  | <b>Code:</b> is the error code number identifying an error. A value of 0 means no error, a negative value means a fatal error, and a positive value is a warning. Refer to <a href="#">Table D-52</a> for a code description.                            |
|  | <b>Source:</b> identifies where an error occurred. The source string is usually the name of the VI that produced the error.                                                                                                                              |
|  | <b>overflow:</b> This input is not used by Keithley Instruments PXI devices and is ignored.                                                                                                                                                              |

**KI Counter Start**

Starts the counters identified by task ID. This applies only to Keithley KDAQ series devices.

Table D-40

**KI Counter Start**











|                                                                                     |                                                                                                                                                                                                                               |
|-------------------------------------------------------------------------------------|-------------------------------------------------------------------------------------------------------------------------------------------------------------------------------------------------------------------------------|
|  | <b>taskID in:</b> identifies the group and the I/O operation.                                                                                                                                                                 |
|  | <b>error in (no error):</b> describes error conditions occurring before the VI executes. If an error has already occurred, the VI returns the value of the error in cluster in error out.                                     |
|  | <b>Status:</b> is TRUE if an error occurred. If status is TRUE, the VI does not perform any operations.                                                                                                                       |
|  | <b>Code:</b> is the error code number identifying an error. A value of 0 means no error, a negative value means a fatal error, and a positive value is a warning. Refer to <a href="#">Table D-52</a> for a code description. |

Table D-40 (continued)  
**KI Counter Start**

|                                                                                   |                                                                                   |                                                                                                                                                                                                                               |
|-----------------------------------------------------------------------------------|-----------------------------------------------------------------------------------|-------------------------------------------------------------------------------------------------------------------------------------------------------------------------------------------------------------------------------|
|                                                                                   |  | <b>Source:</b> identifies where an error occurred. The source string is usually the name of the VI that produced the error.                                                                                                   |
|  |                                                                                   | <b>counter list:</b> is the set of counters to read. Use this array only to read a subset of counters identified by task ID; otherwise, leave it empty. This input is only valid for Keithley KDAQ series devices.            |
|  |                                                                                   | <b>taskID out:</b> has the same value as <i>taskID</i> in.                                                                                                                                                                    |
|  |                                                                                   | <b>error out:</b> contains error information. If the error in cluster indicated an error, the error out cluster contains the same information. Otherwise, error out describes the error status of this VI.                    |
|                                                                                   |  | <b>Status:</b> is TRUE if an error occurred. If status is TRUE, the VI does not perform any operations.                                                                                                                       |
|                                                                                   |  | <b>Code:</b> is the error code number identifying an error. A value of 0 means no error, a negative value means a fatal error, and a positive value is a warning. Refer to <a href="#">Table D-52</a> for a code description. |
|                                                                                   |  | <b>Source:</b> identifies where an error occurred. The source string is usually the name of the VI that produced the error.                                                                                                   |

**KI Counter Stop**

Stops a count operation immediately or conditionally on an input error. This applies only to Keithley KDAQ series devices.

Table D-41  
**KI Counter Stop**











|                                                                                     |                                                                                     |                                                                                                                                                                                                                               |
|-------------------------------------------------------------------------------------|-------------------------------------------------------------------------------------|-------------------------------------------------------------------------------------------------------------------------------------------------------------------------------------------------------------------------------|
|  |                                                                                     | <b>taskID in:</b> identifies the group and the I/O operation.                                                                                                                                                                 |
|  |                                                                                     | <b>error in (no error):</b> describes error conditions occurring before the VI executes. If an error has already occurred, the VI returns the value of the error in cluster in error out.                                     |
|                                                                                     |  | <b>Status:</b> is TRUE if an error occurred. If status is TRUE, the VI does not perform any operations.                                                                                                                       |
|                                                                                     |  | <b>Code:</b> is the error code number identifying an error. A value of 0 means no error, a negative value means a fatal error, and a positive value is a warning. Refer to <a href="#">Table D-52</a> for a code description. |
|                                                                                     |  | <b>Source:</b> identifies where an error occurred. The source string is usually the name of the VI that produced the error.                                                                                                   |
|  |                                                                                     | <b>stop when:</b> This input is not used by Keithley Instruments PXI devices and is ignored.                                                                                                                                  |

Table D-41 (continued)

**KI Counter Stop**

|                                                                                   |                                                                                                                                                                                                                               |
|-----------------------------------------------------------------------------------|-------------------------------------------------------------------------------------------------------------------------------------------------------------------------------------------------------------------------------|
|  | <b>taskID out:</b> has the same value as <i>taskID in</i> .                                                                                                                                                                   |
|  | <b>error out:</b> contains error information. If the error in cluster indicated an error, the error out cluster contains the same information. Otherwise, error out describes the error status of this VI.                    |
|  | <b>Status:</b> is TRUE if an error occurred. If status is TRUE, the VI does not perform any operations.                                                                                                                       |
|  | <b>Code:</b> is the error code number identifying an error. A value of 0 means no error, a negative value means a fatal error, and a positive value is a warning. Refer to <a href="#">Table D-52</a> for a code description. |
|  | <b>source:</b> identifies where an error occurred. The source string is usually the name of the VI that produced the error.                                                                                                   |

**KI Delayed Pulse Generator Config**

Configures a counter to generate a single pulse with the specified delay and pulse-width on the counter GPTCn\_OUT pin.

**NOTE** This VI is not supported for Keithley KDIO Series devices.

Table D-42

**KI Delayed Pulse Generator Config**



















|                                                                                     |                                                                                                                                                                                                                                                                                                                                 |
|-------------------------------------------------------------------------------------|---------------------------------------------------------------------------------------------------------------------------------------------------------------------------------------------------------------------------------------------------------------------------------------------------------------------------------|
|  | <b>device:</b> Number of the device (beginning from 1). The utility <b>Device Browser</b> can be used to get the information of current device configuration.                                                                                                                                                                   |
|  | <b>sub type:</b> is the sub-type of the device you assigned to the Keithley Instruments PXI device during configuration.                                                                                                                                                                                                        |
|  | <b>counter:</b> is an array of strings that specifies the counter(s) the VI controls.                                                                                                                                                                                                                                           |
|  | <b>pulse delays (s or cycles):</b> is the desired duration of the first phase of the pulse, phase 1. The unit is seconds if timebase source is 0 (internal) and cycles if timebase source is 1 (external). If pulse delay is 0.0 and timebase source is 0, the VI selects a minimum delay of three cycles of the timebase used. |
|  | <b>pulse-width (s or cycles):</b> is the desired duration of the second phase of the pulse, phase 2. The unit is seconds if timebase source is 0 (internal) and cycles if timebase source is 1 (external). If pulse-width is 0.0 and timebase source is 0, the VI selects a minimum width of three cycles of the timebase used. |
|  | <b>timebase source:</b> is the clock source. Timebase source is 0 to use an internal signal and 1 to use an external signal (from <i>GPTCn_SRC</i> pin) for the timebase.                                                                                                                                                       |

Table D-42 (continued)  
**KI Delayed Pulse Generator Config**

|                                                                                     |                                                                                                                                                                                                                                                                                                                                                                                                                                                                                                                                                                                                                                                                                                        |
|-------------------------------------------------------------------------------------|--------------------------------------------------------------------------------------------------------------------------------------------------------------------------------------------------------------------------------------------------------------------------------------------------------------------------------------------------------------------------------------------------------------------------------------------------------------------------------------------------------------------------------------------------------------------------------------------------------------------------------------------------------------------------------------------------------|
|    | <p><b>gate mode:</b> specifies how the counter <i>GPTCn_GATE</i> signal is used.</p> <p>0: Ungated/software start: ignore the gate source and start when Counter Start VI is called (default)..</p> <p>1: Count while the gate signal is TTL high after the Counter Start VI is called.</p> <p>2: Count while the gate signal is TTL low after the Counter Start VI is called.</p> <p>3: Start counting on the rising edge of the TTL gate signal after the Counter Start VI is called.</p> <p>4: Start counting on the falling edge of the TTL gate signal after the Counter Start VI is called.</p> <p>Use gate mode 3 or 4 to generate one delayed pulse on the first gate edge after starting.</p> |
|    | <p><b>pulse polarity:</b> is the polarity of the second phase (phase 2) of the pulse.</p> <p>0: High pulse: phase 1 (the delay) is a low TTL level and phase 2 is a high level (default).</p> <p>1: Low pulse: phase 1 is a high TTL level and phase 2 is a low level.</p>                                                                                                                                                                                                                                                                                                                                                                                                                             |
|    | <p><b>error in (no error):</b> describes error conditions occurring before the VI executes. If an error has already occurred, the VI returns the value of the error in cluster in error out.</p>                                                                                                                                                                                                                                                                                                                                                                                                                                                                                                       |
|    | <p><b>status:</b> is TRUE if an error occurred. If status is TRUE, the VI does not perform any operations.</p>                                                                                                                                                                                                                                                                                                                                                                                                                                                                                                                                                                                         |
|    | <p><b>code:</b> is the error code number identifying an error. A value of 0 means no error, a negative value means a fatal error, and a positive value is a warning. Refer to <a href="#">Table D-52</a> for a code description.</p>                                                                                                                                                                                                                                                                                                                                                                                                                                                                   |
|   | <p><b>source:</b> identifies where an error occurred. The source string is usually the name of the VI that produced the error.</p>                                                                                                                                                                                                                                                                                                                                                                                                                                                                                                                                                                     |
|  | <p><b>taskID:</b> identifies the group and the I/O operation.</p>                                                                                                                                                                                                                                                                                                                                                                                                                                                                                                                                                                                                                                      |
|  | <p><b>error out:</b> contains error information. If the error in cluster indicated an error, the error out cluster contains the same information. Otherwise, error out describes the error status of this VI.</p>                                                                                                                                                                                                                                                                                                                                                                                                                                                                                      |
|  | <p><b>status:</b> is TRUE if an error occurred. If status is TRUE, the VI does not perform any operations.</p>                                                                                                                                                                                                                                                                                                                                                                                                                                                                                                                                                                                         |
|  | <p><b>code:</b> is the error code number identifying an error. A value of 0 means no error, a negative value means a fatal error, and a positive value is a warning. Refer to <a href="#">Table D-52</a> for a code description.</p>                                                                                                                                                                                                                                                                                                                                                                                                                                                                   |
|  | <p><b>source:</b> identifies where an error occurred. The source string is usually the name of the VI that produced the error.</p>                                                                                                                                                                                                                                                                                                                                                                                                                                                                                                                                                                     |
|  | <p><b>actual delay (s or cycles):</b> is the achieved delay. It may differ from the desired delay because the hardware has limited resolution and range.</p>                                                                                                                                                                                                                                                                                                                                                                                                                                                                                                                                           |
|  | <p><b>actual width (s or cycles):</b> is the achieved pulse-width. It may differ from the desired width because the hardware has limited resolution and range.</p>                                                                                                                                                                                                                                                                                                                                                                                                                                                                                                                                     |

### KI Down Counter or Divider Config

Configures the specified counter to count down or divide a signal on the counter **GPTCn\_SRC** pin or on an internal timebase signal using a count value called the timebase divisor. The result is that the signal on the counter **GPTCn\_OUT** pin is equal to the frequency of the input signal/timebase divisor.

**NOTE** This VI is not supported for Keithley KDIO Series devices.

Table D-43

### KI Down Counter or Divider Config

















|                                                                                     |                                                                                                                                                                                                                                                                                                                                                                                                                                                                                                                                                                           |
|-------------------------------------------------------------------------------------|---------------------------------------------------------------------------------------------------------------------------------------------------------------------------------------------------------------------------------------------------------------------------------------------------------------------------------------------------------------------------------------------------------------------------------------------------------------------------------------------------------------------------------------------------------------------------|
|    | <b>device:</b> Number of the device (beginning from 1). The utility <b>Device Browser</b> can be used to get the information of current device configuration.                                                                                                                                                                                                                                                                                                                                                                                                             |
|    | <b>sub type:</b> is the sub-type of the device you assigned to the Keithley Instruments PXI device during configuration.                                                                                                                                                                                                                                                                                                                                                                                                                                                  |
|    | <b>counter:</b> is an array of strings that specifies the counter(s) the VI controls.                                                                                                                                                                                                                                                                                                                                                                                                                                                                                     |
|    | <b>timebase:</b> (Hz) is set to the frequency of the internal signal whose cycles are counted, or is set to <=0.0 (default) to count the rising edges of the signal on the counter <b>GPTCn_SRC</b> pin.                                                                                                                                                                                                                                                                                                                                                                  |
|    | <b>timebase divisor:</b> is the count down or divide value. For example, if the input frequency is 10000000 Hz, timebase divisor is 100000, and the output is pulsed, the frequency of the counter's <b>GPTCn_OUT</b> signal is 100 Hz.                                                                                                                                                                                                                                                                                                                                   |
|  | <b>gate mode:</b> specifies how the counter <b>GPTCn_GATE</b> signal is used.<br>0: Ungated/software start: ignore the gate source and start when Counter Start VI is called (default).<br>1: Count while the gate signal is TTL high after the Counter Start VI is called.<br>2: Count while the gate signal is TTL low after the Counter Start VI is called.<br>3: Start counting on the rising edge of the TTL gate signal after the Counter Start VI is called.<br>4: Start counting on the falling edge of the TTL gate signal after the Counter Start VI is called. |
|  | <b>source edge:</b> is the edge of the counter clock signal.<br>0: Count on low to high transition.<br>1: Count on high to low transition.                                                                                                                                                                                                                                                                                                                                                                                                                                |
|  | <b>output:</b> is the behavior of the output signal when counter reaches TC.<br>0: High pulse lasting one cycle of the source or timebase signal (default).<br>1: Low pulse lasting one cycle of the source or timebase signal.<br>2: High toggle lasting until the next TC.<br>3: Low toggle lasting until the next TC.<br>The effect of output modes 0 and 1 is to divide-down the source of timebase frequency by the timebase divisor. The effect of output modes 2 and 3 is to divide the frequency by twice the timebase divisor.                                   |
|  | <b>error in (no error):</b> describes error conditions occurring before the VI executes. If an error has already occurred, the VI returns the value of the error in cluster in error out.                                                                                                                                                                                                                                                                                                                                                                                 |
|  | <b>status:</b> is TRUE if an error occurred. If status is TRUE, the VI does not perform any operations.                                                                                                                                                                                                                                                                                                                                                                                                                                                                   |
|  | <b>code:</b> is the error code number identifying an error. A value of 0 means no error, a negative value means a fatal error, and a positive value is a warning. Refer to <a href="#">Table D-52</a> for a code description.                                                                                                                                                                                                                                                                                                                                             |



Table D-43 (continued)  
**KI Down Counter or Divider Config**

|                                                                                   |                                                                                   |                                                                                                                                                                                                                               |
|-----------------------------------------------------------------------------------|-----------------------------------------------------------------------------------|-------------------------------------------------------------------------------------------------------------------------------------------------------------------------------------------------------------------------------|
|                                                                                   |  | <b>source:</b> identifies where an error occurred. The source string is usually the name of the VI that produced the error.                                                                                                   |
|  |                                                                                   | <b>taskID:</b> identifies the group and the I/O operation.                                                                                                                                                                    |
|  |                                                                                   | <b>error out:</b> contains error information. If the error in cluster indicated an error, the error out cluster contains the same information. Otherwise, error out describes the error status of this VI.                    |
|                                                                                   |  | <b>status:</b> is TRUE if an error occurred. If status is TRUE, the VI does not perform any operations.                                                                                                                       |
|                                                                                   |  | <b>code:</b> is the error code number identifying an error. A value of 0 means no error, a negative value means a fatal error, and a positive value is a warning. Refer to <a href="#">Table D-52</a> for a code description. |
|                                                                                   |  | <b>source:</b> identifies where an error occurred. The source string is usually the name of the VI that produced the error.                                                                                                   |

**KI Event or Time Counter Config**

Configures one or two counters to count external events. An external event is a high or low signal transition on the specified **GPTCn\_SRC** pin of the counter.

**NOTE** This VI is not supported for Keithley KDIO Series devices.

Table D-44  
**KI Event or Time Counter Config**

















|                                                                                     |                                                                                                                                                                                                                                                                                                                                                                                                                                                                                                                                                                                                      |
|-------------------------------------------------------------------------------------|------------------------------------------------------------------------------------------------------------------------------------------------------------------------------------------------------------------------------------------------------------------------------------------------------------------------------------------------------------------------------------------------------------------------------------------------------------------------------------------------------------------------------------------------------------------------------------------------------|
|  | <b>device:</b> Number of the device (beginning from 1). The utility <b>Device Browser</b> can be used to get the information of current device configuration.                                                                                                                                                                                                                                                                                                                                                                                                                                        |
|  | <b>sub type:</b> is the sub-type of the device you assigned to the Keithley Instruments PXI device during configuration.                                                                                                                                                                                                                                                                                                                                                                                                                                                                             |
|  | <b>counter:</b> is an array of strings that specifies the counter(s) the VI controls.                                                                                                                                                                                                                                                                                                                                                                                                                                                                                                                |
|  | <b>count limit:</b> this input is not used by Keithley Instruments PXI devices and is ignored.                                                                                                                                                                                                                                                                                                                                                                                                                                                                                                       |
|  | <p><b>gate mode:</b> specifies how the counter <b>GPTCn_GATE</b> signal is used.</p> <p>0: Ungated/software start: ignore the gate source and start when Counter Start VI is called (default).</p> <p>1: Count while the gate signal is TTL high after the Counter Start VI is called.</p> <p>2: Count while the gate signal is TTL low after the Counter Start VI is called.</p> <p>3: Start counting on the rising edge of the TTL gate signal after the Counter Start VI is called.</p> <p>4: Start counting on the falling edge of the TTL gate signal after the Counter Start VI is called.</p> |
|  | <b>counter size:</b> is not used by Keithley Instruments PXI devices and is ignored.                                                                                                                                                                                                                                                                                                                                                                                                                                                                                                                 |

Table D-44 (continued)  
**KI Event or Time Counter Config**

|                                                                                     |                                                                                                                                                                                                                       |                                                                                                                                                                                                                               |
|-------------------------------------------------------------------------------------|-----------------------------------------------------------------------------------------------------------------------------------------------------------------------------------------------------------------------|-------------------------------------------------------------------------------------------------------------------------------------------------------------------------------------------------------------------------------|
|    | <b>error in (no error):</b> describes error conditions occurring before the VI executes. If an error has already occurred, the VI returns the value of the error in cluster in error out.                             |                                                                                                                                                                                                                               |
|                                                                                     |                                                                                                                                      | <b>status:</b> is TRUE if an error occurred. If status is TRUE, the VI does not perform any operations.                                                                                                                       |
|                                                                                     |                                                                                                                                      | <b>code:</b> is the error code number identifying an error. A value of 0 means no error, a negative value means a fatal error, and a positive value is a warning. Refer to <a href="#">Table D-52</a> for a code description. |
|                                                                                     |                                                                                                                                      | <b>source:</b> identifies where an error occurred. The source string is usually the name of the VI that produced the error.                                                                                                   |
|    | <b>source edge:</b> is the edge of the counter clock signal.<br>0: Count on low to high transition.<br>1: Count on high to low transition.                                                                            |                                                                                                                                                                                                                               |
|    | <b>event source/timebase:</b> (Hz) is set to the frequency of the internal signal whose cycles are counted, or is set to <=0.0 (default) to count the rising edges of the signal on the counter <i>GPTCn_SRC</i> pin. |                                                                                                                                                                                                                               |
|    | <b>taskID:</b> identifies the group and the I/O operation.                                                                                                                                                            |                                                                                                                                                                                                                               |
|  | <b>error out:</b> contains error information. If the error in cluster indicated an error, the error out cluster contains the same information. Otherwise, error out describes the error status of this VI.            |                                                                                                                                                                                                                               |
|                                                                                     |                                                                                                                                    | <b>status:</b> is TRUE if an error occurred. If status is TRUE, the VI does not perform any operations.                                                                                                                       |
|                                                                                     |                                                                                                                                    | <b>code:</b> is the error code number identifying an error. A value of 0 means no error, a negative value means a fatal error, and a positive value is a warning. Refer to <a href="#">Table D-52</a> for a code description. |
|                                                                                     |                                                                                                                                    | <b>source:</b> identifies where an error occurred. The source string is usually the name of the VI that produced the error.                                                                                                   |















### KI Pulse-Width or Period Measurement Config

Configures the specified counter to measure the pulse-width or period of a TTL signal connected to its *GPTCn\_GATE* pin.

**NOTE** This VI is not supported for Keithley KDIO Series devices.

Table D-45

### KI Pulse-Width or Period Measurement Config

|                                                                                     |                                                                                                                                                                                                                                                                                                                                                                                                                            |
|-------------------------------------------------------------------------------------|----------------------------------------------------------------------------------------------------------------------------------------------------------------------------------------------------------------------------------------------------------------------------------------------------------------------------------------------------------------------------------------------------------------------------|
|    | <b>device:</b> Number of the device (beginning from 1). The utility <b>Device Browser</b> can be used to get the information of current device configuration.                                                                                                                                                                                                                                                              |
|    | <b>sub type:</b> is the sub-type of the device you assigned to the Keithley Instruments PXI device during configuration.                                                                                                                                                                                                                                                                                                   |
|    | <b>counter:</b> is an array of strings that specifies the counter(s) the VI controls.                                                                                                                                                                                                                                                                                                                                      |
|    | <b>timebase:</b> (Hz) is set to the frequency of the internal signal whose cycles are counted, or is set to <=0.0 (default) to count the rising edges of the signal on the counter <i>GPTCn_SRC</i> pin.                                                                                                                                                                                                                   |
|    | <b>type of measurement:</b> identifies the type of pulse-width or period measurement to make. The following illustration demonstrates the various values for type of measurement.<br>0: Measure high pulse-width from rising to falling edge.<br>1: Measure low pulse-width from falling to rising edge.<br>2: Measure period between adjacent rising edges. (default)<br>3: Measure period between adjacent falling edges |
|  | <b>error in (no error):</b> describes error conditions occurring before the VI executes. If an error has already occurred, the VI returns the value of the error in cluster in error out.                                                                                                                                                                                                                                  |
|  | <b>status:</b> is TRUE if an error occurred. If status is TRUE, the VI does not perform any operations.                                                                                                                                                                                                                                                                                                                    |
|  | <b>code:</b> is the error code number identifying an error. A value of 0 means no error, a negative value means a fatal error, and a positive value is a warning. Refer to <a href="#">Table D-52</a> for a code description.                                                                                                                                                                                              |
|  | <b>source:</b> identifies where an error occurred. The source string is usually the name of the VI that produced the error.                                                                                                                                                                                                                                                                                                |
|  | <b>taskID:</b> identifies the group and the I/O operation.                                                                                                                                                                                                                                                                                                                                                                 |
|  | <b>error out:</b> contains error information. If the error in cluster indicated an error, the error out cluster contains the same information. Otherwise, error out describes the error status of this VI.                                                                                                                                                                                                                 |
|  | <b>status:</b> is TRUE if an error occurred. If status is TRUE, the VI does not perform any operations.                                                                                                                                                                                                                                                                                                                    |
|  | <b>code:</b> is the error code number identifying an error. A value of 0 means no error, a negative value means a fatal error, and a positive value is a warning. Refer to <a href="#">Table D-52</a> for a code description.                                                                                                                                                                                              |
|  | <b>source:</b> identifies where an error occurred. The source string is usually the name of the VI that produced the error.                                                                                                                                                                                                                                                                                                |

## KI UpDown Counter Config

Configures one counter to count edges in the signal on the specified counter's SOURCE pin or the number of cycles of a specified internal timebase signal.

Table D-46

### KI UpDown Counter Config



















|                                                                                     |                                                                                                                                                                                                                                                                                |
|-------------------------------------------------------------------------------------|--------------------------------------------------------------------------------------------------------------------------------------------------------------------------------------------------------------------------------------------------------------------------------|
|    | <b>device:</b> Number of the device (beginning from 1). The utility <b>Device Browser</b> can be used to get the information of current device configuration.                                                                                                                  |
|    | <b>sub type:</b> is the sub-type of the device you assigned to the Keithley Instruments PXI device during configuration.                                                                                                                                                       |
|    | <b>counter:</b> is the counter this VI controls.                                                                                                                                                                                                                               |
|    | <b>gate mode:</b> specifies how the signal on the counter's GATE pin is used.<br>0: Ungated/software start: ignore the gate source and start when Counter Start VI is called (default).<br>1: Count while the gate signal is TTL high after the KI Counter Start VI is called. |
|    | <b>source edge:</b> This input is not used by Keithley Instruments PXI devices and is ignored.                                                                                                                                                                                 |
|    | <b>output:</b> This input is not used by Keithley Instruments PXI devices and is ignored.                                                                                                                                                                                      |
|  | <b>updown source:</b> specifies how the signal on the counter's UPDN pin is used.<br>0: software control: ignore the UPDN source and control by updown control (default).<br>1: hardware control.                                                                              |
|  | <b>updown control:</b> specifies the specified counter to count down or count up if updown source is configured to be software control.<br>0: count down (default).<br>1: count up.                                                                                            |
|  | <b>timebase:</b> (Hz) is set to the frequency of the internal signal whose cycles are counted, or is set to <=0.0 (default) to count the rising edges of the signal on the counter SOURCE pin.                                                                                 |
|  | <b>error in (no error):</b> describes error conditions occurring before the VI executes. If an error has already occurred, the VI returns the value of the error in cluster in error out.                                                                                      |
|  | <b>status:</b> is TRUE if an error occurred. If status is TRUE, the VI does not perform any operations.                                                                                                                                                                        |
|  | <b>code:</b> is the error code number identifying an error. A value of 0 means no error, a negative value means a fatal error, and a positive value is a warning. Refer to <a href="#">Table D-52</a> for a code description.                                                  |
|  | <b>source:</b> identifies where an error occurred. The source string is usually the name of the VI that produced the error.                                                                                                                                                    |
|  | <b>count:</b> is the count value.                                                                                                                                                                                                                                              |
|  | <b>taskID:</b> identifies the group and the I/O operation.                                                                                                                                                                                                                     |

Table D-46 (continued)  
**KI UpDown Counter Config**

|                                                                                   |                                                                                                                                                                                                            |                                                                                                                                                                                                                               |
|-----------------------------------------------------------------------------------|------------------------------------------------------------------------------------------------------------------------------------------------------------------------------------------------------------|-------------------------------------------------------------------------------------------------------------------------------------------------------------------------------------------------------------------------------|
|  | <b>error out:</b> contains error information. If the error in cluster indicated an error, the error out cluster contains the same information. Otherwise, error out describes the error status of this VI. |                                                                                                                                                                                                                               |
|                                                                                   |                                                                                                                           | <b>status:</b> is TRUE if an error occurred. If status is TRUE, the VI does not perform any operations.                                                                                                                       |
|                                                                                   |                                                                                                                           | <b>code:</b> is the error code number identifying an error. A value of 0 means no error, a negative value means a fatal error, and a positive value is a warning. Refer to <a href="#">Table D-52</a> for a code description. |
|                                                                                   |                                                                                                                           | <b>source:</b> identifies where an error occurred. The source string is usually the name of the VI that produced the error.                                                                                                   |

## Advanced Counter VIs

### KI ICTR Control

This VI control counters on the Keithley Instruments PXI devices that use 82C54 chip. Control operations include starting, stopping, and setting the state of active acquisitions.

**NOTE** This VI is not supported for Keithley KDAQ series devices.

Table D-47  
**KI ICTR Control**





|                                                                                     |                                                                                                                                                                                                                                                                                                                                              |
|-------------------------------------------------------------------------------------|----------------------------------------------------------------------------------------------------------------------------------------------------------------------------------------------------------------------------------------------------------------------------------------------------------------------------------------------|
|  | <b>device:</b> Number of the device (beginning from 1). The utility <b>Device Browser</b> can be used to get the information of current device configuration.                                                                                                                                                                                |
|  | <b>sub type:</b> is the sub-type of the device you assigned to the Keithley Instruments PXI device during configuration.                                                                                                                                                                                                                     |
|  | <b>counter:</b> is the counter this VI controls.<br>KPXI-DIO-48: 0, 1 or 2                                                                                                                                                                                                                                                                   |
|  | control code:<br>0: Setup mode 0 – Toggle output from low to high on TC (default).<br>1: Setup mode 1 – Programmable one-shot.<br>2: Setup mode 2 – Rate generator.<br>3: Setup mode 3 – Square wave rate demerara.<br>4: Setup mode 4 – Software-triggered strobe.<br>5: Setup mode 5 – Hardware-triggered strobe.<br>6: Read.<br>7: Reset. |

Table D-47 (continued)

**KI ICTR Control**

|            |                                                                                                                                                                                                                                                                                                                                                                                                                                                                                                                                                                                                                                                                                                                                                                                                                                              |
|------------|----------------------------------------------------------------------------------------------------------------------------------------------------------------------------------------------------------------------------------------------------------------------------------------------------------------------------------------------------------------------------------------------------------------------------------------------------------------------------------------------------------------------------------------------------------------------------------------------------------------------------------------------------------------------------------------------------------------------------------------------------------------------------------------------------------------------------------------------|
| <b>U16</b> | <p><b>count:</b> is the period between output pulses. If control code is 0, 1, 4, or 5, count can be 0 through 65,535 in binary counter operation and 0 through 9,999 in binary-coded decimal (BCD) counter operation. If control code is 2 or 3, count can be 2 through 65,535 and 0 in binary counter operation and 2 through 9,999 and 0 in BCD counter operation.</p> <p><b>Setup mode 0: Toggle output from low to high on terminal count.</b><br/>In this mode, as shown in the figure below, the output goes low after the mode set operation, and the counter begins to count down while the gate input is high. When terminal count is reached, the output goes high and remains high until the selected counter is set to a different mode.</p>  |
|------------|----------------------------------------------------------------------------------------------------------------------------------------------------------------------------------------------------------------------------------------------------------------------------------------------------------------------------------------------------------------------------------------------------------------------------------------------------------------------------------------------------------------------------------------------------------------------------------------------------------------------------------------------------------------------------------------------------------------------------------------------------------------------------------------------------------------------------------------------|

Table D-47 (continued)  
**KI ICTR Control**







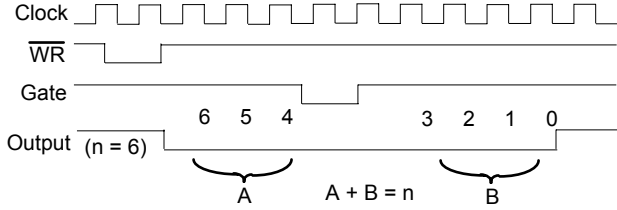



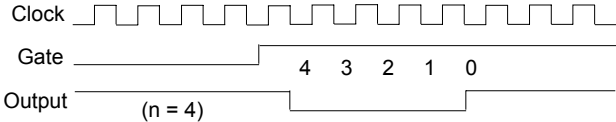
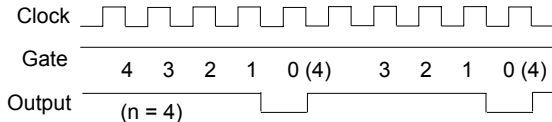
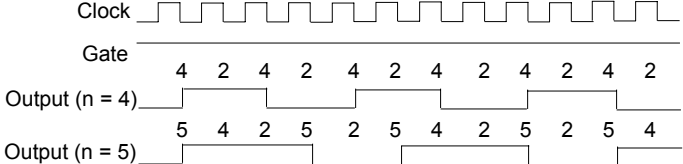
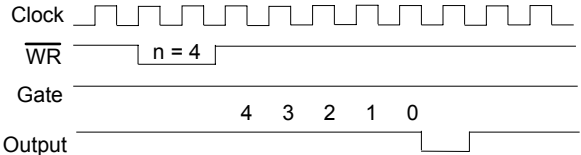
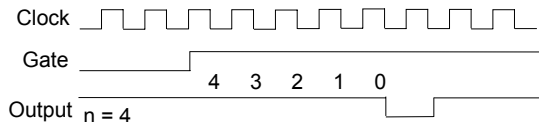



|                                                                                     |                                                                                                                                                                                                                                                                                                                                                                                                                                                                                                                                                                                                                                                                                                                                                                                                                                                                                                                                                                                                                                                                                                                                                                                                                                                                                                                                                                                                                                                                                                                                                                                                                                                                                                                                                                       |
|-------------------------------------------------------------------------------------|-----------------------------------------------------------------------------------------------------------------------------------------------------------------------------------------------------------------------------------------------------------------------------------------------------------------------------------------------------------------------------------------------------------------------------------------------------------------------------------------------------------------------------------------------------------------------------------------------------------------------------------------------------------------------------------------------------------------------------------------------------------------------------------------------------------------------------------------------------------------------------------------------------------------------------------------------------------------------------------------------------------------------------------------------------------------------------------------------------------------------------------------------------------------------------------------------------------------------------------------------------------------------------------------------------------------------------------------------------------------------------------------------------------------------------------------------------------------------------------------------------------------------------------------------------------------------------------------------------------------------------------------------------------------------------------------------------------------------------------------------------------------------|
|                                                                                     | <p><b>count:</b> (continued)</p> <p><b>Setup mode 1: Programmable one-shot</b><br/>                 In this mode, as shown in the figure below, the <b>Output</b> goes low following the rising edge of <b>Gate</b> input <b>and</b> the falling edge of the clock. The <b>Output</b> and goes high on terminal count.</p>  <p><b>Setup mode 2: Rate generator</b><br/>                 In this mode, the output goes low for one period of the clock input. <b>count</b> indicates the period from one output pulse to the next.</p>  <p><b>Setup mode 3: Square wave rate generator</b><br/>                 In this mode, the output stays high for one half of the <b>count</b> clock pulses and stays low for the other half.</p>  <p><b>Setup mode 4: Software-triggered strobe</b><br/>                 In this mode, the output is initially high, and the counter begins to count down while the gate input is high. On terminal count, the output goes low for one clock pulse, then goes high again. The following diagram shows the SOFT_TRIG mode timing diagram.</p>  <p><b>Setup mode 5: Hardware-triggered strobe</b><br/>                 This mode is similar to Setup mode 4 except that the gate input is used as a trigger to start counting. The following diagram shows the HARD_TRIG mode timing diagram.</p>  |
|  | <p><b>output state:</b> is only valid when control code is 7 (reset).<br/>                 0: Low (default input).<br/>                 1: High.</p>                                                                                                                                                                                                                                                                                                                                                                                                                                                                                                                                                                                                                                                                                                                                                                                                                                                                                                                                                                                                                                                                                                                                                                                                                                                                                                                                                                                                                                                                                                                                                                                                                  |

Table D-47 (continued)

**KI ICTR Control**

|                                                                                     |                                                                                                                                                                                                                               |
|-------------------------------------------------------------------------------------|-------------------------------------------------------------------------------------------------------------------------------------------------------------------------------------------------------------------------------|
|    | <b>binary or bcd:</b> controls whether the counter operates as a 16-bit binary counter or as a 4-decade BCD counter.<br>0: <i>BinBcd</i> .<br>1: 16-bit binary counter (default input)                                        |
|    | <b>Keithley Instruments PXI extensions:</b> additional features for Keithley Instruments PXI devices.                                                                                                                         |
|    | <b>clock source:</b> defines the clock source for the timer/counter.<br>0: ECK1 (default input)<br>1: COU n-1<br>2: CK1<br>3: COU 10                                                                                          |
|    | <b>error in (no error):</b> describes error conditions occurring before the VI executes. If an error has already occurred, the VI returns the value of the error in cluster in error out.                                     |
|    | <b>status:</b> is TRUE if an error occurred. If status is TRUE, the VI does not perform any operations.                                                                                                                       |
|    | <b>code:</b> is the error code number identifying an error. A value of 0 means no error, a negative value means a fatal error, and a positive value is a warning. Refer to <a href="#">Table D-52</a> for a code description. |
|  | <b>source:</b> identifies where an error occurred. The source string is usually the name of the VI that produced the error.                                                                                                   |
|  | <b>read value:</b> When you set control code to 6 (read), read value returns the value the VI read from the counter.                                                                                                          |
|  | <b>taskID:</b> has the same value as <i>taskID in</i> .                                                                                                                                                                       |
|  | <b>error out:</b> contains error information. If the error in cluster indicated an error, the error out cluster contains the same information. Otherwise, error out describes the error status of this VI.                    |
|  | <b>status:</b> is TRUE if an error occurred. If status is TRUE, the VI does not perform any operations.                                                                                                                       |
|  | <b>code:</b> is the error code number identifying an error. A value of 0 means no error, a negative value means a fatal error, and a positive value is a warning. Refer to <a href="#">Table D-52</a> for a code description. |
|  | <b>source:</b> identifies where an error occurred. The source string is usually the name of the VI that produced the error.                                                                                                   |



# Calibration and Configuration VIs

## Calibration VIs

### KI KPXI-DAQ series devices and Digitizer Series Calibrate

Use this VI to calibrate KPXI-DAQ series devices and Digitizer Series device and to select a set of calibration constants to be used by KIDAQ LabVIEW.

**NOTE** This VI is not supported for Keithley KDIO devices.

Table D-48

### KI KPXI-DAQ series devices and Digitizer Series Calibrate













|                                                                                     |                                                                                                                                                                                                                                                                                                                                                                                                                           |
|-------------------------------------------------------------------------------------|---------------------------------------------------------------------------------------------------------------------------------------------------------------------------------------------------------------------------------------------------------------------------------------------------------------------------------------------------------------------------------------------------------------------------|
|    | <b>taskID in:</b> identifies the group and the I/O operation.                                                                                                                                                                                                                                                                                                                                                             |
|    | <b>error in (no error):</b> describes error conditions occurring before the VI executes. If an error has already occurred, the VI returns the value of the error in cluster in error out.                                                                                                                                                                                                                                 |
|    | <b>status:</b> is TRUE if an error occurred. If status is TRUE, the VI does not perform any operations.                                                                                                                                                                                                                                                                                                                   |
|    | <b>code:</b> is the error code number identifying an error. A value of 0 means no error, a negative value means a fatal error, and a positive value is a warning. Refer to <a href="#">Table D-52</a> for a code description.                                                                                                                                                                                             |
|  | <b>Source:</b> identifies where an error occurred. The source string is usually the name of the VI that produced the error.                                                                                                                                                                                                                                                                                               |
|  | <b>operation:</b> determines the operation the VI performs.<br>0: No change (default input).<br>1: Set default load area (default setting).<br>2: Self-calibrate.<br>Setting the default load area, or value 1, does not perform a calibration; it sets the default load area to the area specified by calibration constants.<br>Self-calibrate, or value 2, performs a calibration using the internal voltage reference. |
|  | <b>calibration constants:</b> specifies which set of calibration constants KIDAQ LabVIEW uses.<br>0: No change (default input).<br>1: Factory EEPROM area, i.e. Bank 0 (default setting).<br>2: EEPROM Bank 0 area.<br>3: EEPROM Bank 1 area.<br>4: EEPROM Bank 2 area.<br>5: EEPROM Bank 3 area.                                                                                                                         |
|  | <b>reference voltage:</b> this input is not used by Keithley Instruments PXI devices and is ignored.                                                                                                                                                                                                                                                                                                                      |
|  | <b>taskID out:</b> has the same value as <i>taskID in</i> .                                                                                                                                                                                                                                                                                                                                                               |
|  | <b>error out:</b> contains error information. If the error in cluster indicated an error, the error out cluster contains the same information. Otherwise, error out describes the error status of this VI.                                                                                                                                                                                                                |
|  | <b>status:</b> is TRUE if an error occurred. If status is TRUE, the VI does not perform any operations.                                                                                                                                                                                                                                                                                                                   |

Table D-48 (continued)

**KI KPXI-DAQ series devices and Digitizer Series Calibrate**

|                                                                                   |                                                                                                                                                                                                                               |
|-----------------------------------------------------------------------------------|-------------------------------------------------------------------------------------------------------------------------------------------------------------------------------------------------------------------------------|
|  | <b>code:</b> is the error code number identifying an error. A value of 0 means no error, a negative value means a fatal error, and a positive value is a warning. Refer to <a href="#">Table D-52</a> for a code description. |
|  | <b>source:</b> identifies where an error occurred. The source string is usually the name of the VI that produced the error.                                                                                                   |

**Other Calibration and Configuration VIs****KI Route Signal**

Use this VI to route an internal signal to the specified I/O connector or SSI bus line, or to enable clock sharing through the SSI bus clock line.

**NOTE** This VI is not supported for Keithley KDIO devices.

Table D-49

**KI Route Signal**















|                                                                                     |                                                                                                                                                                                                                                                                                                                                                                                                                                                                                                                                                                                       |
|-------------------------------------------------------------------------------------|---------------------------------------------------------------------------------------------------------------------------------------------------------------------------------------------------------------------------------------------------------------------------------------------------------------------------------------------------------------------------------------------------------------------------------------------------------------------------------------------------------------------------------------------------------------------------------------|
|    | <b>taskID in:</b> identifies the group and the I/O operation.                                                                                                                                                                                                                                                                                                                                                                                                                                                                                                                         |
|   | <b>error in (no error):</b> describes error conditions occurring before the VI executes. If an error has already occurred, the VI returns the value of the error in cluster in error out.                                                                                                                                                                                                                                                                                                                                                                                             |
|  | <b>status:</b> is TRUE if an error occurred. If status is TRUE, the VI does not perform any operations.                                                                                                                                                                                                                                                                                                                                                                                                                                                                               |
|  | <b>code:</b> is the error code number identifying an error. A value of 0 means no error, a negative value means a fatal error, and a positive value is a warning. Refer to <a href="#">Table D-52</a> for a code description.                                                                                                                                                                                                                                                                                                                                                         |
|  | <b>source:</b> identifies where an error occurred. The source string is usually the name of the VI that produced the error.                                                                                                                                                                                                                                                                                                                                                                                                                                                           |
|  | <p><b>signal name:</b> allows you to select the SSI line. The valid signal name for KPXI-DAQ series devices are as follows:</p> <ul style="list-style-type: none"> <li>0 : Do not change signal name (default input).</li> <li>1 : AI conversion.</li> <li>2 : AO update.</li> <li>3 : AI trigger.</li> <li>4 : AO trigger.</li> <li>19 : SSI Clock.</li> </ul> <p>The valid signal names for KPXI-AI-2-65M are the following:</p> <ul style="list-style-type: none"> <li>0 : Do not change signal name (default input).</li> <li>3 : AI trigger.</li> <li>19 : SSI Clock.</li> </ul> |
|  | <b>signal name line number:</b> this input is not used by Keithley Instruments PXI devices and is ignored.                                                                                                                                                                                                                                                                                                                                                                                                                                                                            |

Table D-49 (continued)

**KI Route Signal**

|                                                                                     |                                                                                                                                                                                                                                                                                                                                                                                                                                                                                                                                                                                                                                                                                                                                                                                                                                                                                                                                                                        |
|-------------------------------------------------------------------------------------|------------------------------------------------------------------------------------------------------------------------------------------------------------------------------------------------------------------------------------------------------------------------------------------------------------------------------------------------------------------------------------------------------------------------------------------------------------------------------------------------------------------------------------------------------------------------------------------------------------------------------------------------------------------------------------------------------------------------------------------------------------------------------------------------------------------------------------------------------------------------------------------------------------------------------------------------------------------------|
|    | <p><b>signal source:</b> is the signal that KIDAQ LabVIEW routes to the location designated in signal name. There is only one valid signal source for most signal names. The valid signal source for KPXI-DAQ series devices are the following:<br/>                 0 : Do not change signal source (default input).<br/>                 1 : None (default setting).<br/>                 2 : AI Start Trigger.<br/>                 3 : AI Stop Trigger.<br/>                 4 : AI Convert.<br/>                 7 : AO Update.<br/>                 8 : AO Start Trigger.<br/>                 21 : Board Clock<br/>                 The valid signal sources for KPXI-AI-2-65M devices are the following:<br/>                 0 : Do not change signal source (default input).<br/>                 1 : None (default setting).<br/>                 2 : AI Start Trigger.<br/>                 3 : AI Stop Trigger.<br/>                 21 : Board Clock</p> |
|    | <p><b>signal source line number:</b> this input is not used by Keithley Instruments PXI devices and is ignored.</p>                                                                                                                                                                                                                                                                                                                                                                                                                                                                                                                                                                                                                                                                                                                                                                                                                                                    |
|    | <p><b>taskID out:</b> has the same value as <i>taskID in</i>.</p>                                                                                                                                                                                                                                                                                                                                                                                                                                                                                                                                                                                                                                                                                                                                                                                                                                                                                                      |
|  | <p><b>error out:</b> contains error information. If the error in cluster indicated an error, the error out cluster contains the same information. Otherwise, error out describes the error status of this VI.</p>                                                                                                                                                                                                                                                                                                                                                                                                                                                                                                                                                                                                                                                                                                                                                      |
|  | <p><b>status:</b> is TRUE if an error occurred. If status is TRUE, the VI does not perform any operations.</p>                                                                                                                                                                                                                                                                                                                                                                                                                                                                                                                                                                                                                                                                                                                                                                                                                                                         |
|  | <p><b>code:</b> is the error code number identifying an error. A value of 0 means no error, a negative value means a fatal error, and a positive value is a warning. Refer to <a href="#">Table D-52</a> for a code description.</p>                                                                                                                                                                                                                                                                                                                                                                                                                                                                                                                                                                                                                                                                                                                                   |
|  | <p><b>Source:</b> identifies where an error occurred. The source string is usually the name of the VI that produced the error.</p>                                                                                                                                                                                                                                                                                                                                                                                                                                                                                                                                                                                                                                                                                                                                                                                                                                     |

**KI SSI Control**

Connects or disconnects trigger and timing signals between DAQ devices along the Real-Time System Integration (SSI) bus.

**NOTE** This VI is not supported for Keithley KDIO Series devices.

Table D-50

**KI SSI Control**









|                                                                                     |                                                                      |
|-------------------------------------------------------------------------------------|----------------------------------------------------------------------|
|  | <p><b>taskID in:</b> identifies the group and the I/O operation.</p> |
|-------------------------------------------------------------------------------------|----------------------------------------------------------------------|

Table D-50 (continued)

**KI SSI Control**

|                                                                                     |                                                                                                                                                                                                                                                                                                                                                                                                                                                                                               |
|-------------------------------------------------------------------------------------|-----------------------------------------------------------------------------------------------------------------------------------------------------------------------------------------------------------------------------------------------------------------------------------------------------------------------------------------------------------------------------------------------------------------------------------------------------------------------------------------------|
|    | <p><b>board signal:</b> allows you to select the SSI line. The valid signal name for KPXI-DAQ series devices are as follows:</p> <ul style="list-style-type: none"> <li>0 : AI conversion.</li> <li>1 : AO update.</li> <li>2 : AI trigger.</li> <li>3 : AO trigger.</li> <li>4 : Board Clock.</li> <li>5 : AI Start</li> </ul> <p>The valid signal name for KPXI-AI-2-65M are the following:</p> <ul style="list-style-type: none"> <li>2 : AI trigger.</li> <li>4 : Board Clock.</li> </ul> |
|    | <p><b>trigger line:</b> this input is not used by Keithley Instruments PXI devices and is ignored.</p>                                                                                                                                                                                                                                                                                                                                                                                        |
|    | <p><b>direction:</b></p> <ul style="list-style-type: none"> <li>1 : The board transmits the signal to the bus.</li> </ul>                                                                                                                                                                                                                                                                                                                                                                     |
|    | <p><b>control code:</b></p> <ul style="list-style-type: none"> <li>0 : Do not change the control code setting (default input).</li> <li>1 : Clear.</li> <li>2 : Connect (default input).</li> <li>3 : Disconnect.</li> <li>4 : Construct the trigger line <b>usemap</b> only.</li> </ul>                                                                                                                                                                                                      |
|  | <p><b>device out:</b> has the same value as device.</p>                                                                                                                                                                                                                                                                                                                                                                                                                                       |
|  | <p><b>status:</b> This input is not used by KPXI-DAQ series devices and is ignored.</p>                                                                                                                                                                                                                                                                                                                                                                                                       |
|  | <p><b>trigger line usemap:</b> provides a list of free and busy SSI trigger lines. If trigger line <i>i</i> is not busy, <b>trigger line usemap[i]</b> shows a value of 0. If <b>trigger line <i>i</i></b> is busy, the VI sets <b>trigger line usemap[i]</b> to the device number of the device driving the line. Making only a receive connection to trigger line <i>i</i> does not set the [<i>i</i>]<b>th</b> element of trigger line <b>usemap</b>.</p>                                  |

## Service VIs

**KI Error Handler**

The KI Error Handler VI explains a non-zero error codes and shows dialog box with information about error. An error code equaling 0 (zero) means no error occurred.

Table D-51

**KI Error Handler**









|                                                                                     |                                                                                                                                                                                                  |
|-------------------------------------------------------------------------------------|--------------------------------------------------------------------------------------------------------------------------------------------------------------------------------------------------|
|  | <p><b>error in (no error):</b> describes error conditions occurring before the VI executes. If an error has already occurred, the VI returns the value of the error in cluster in error out.</p> |
|  | <p><b>status:</b> is TRUE if an error occurred. If status is TRUE, the VI does not perform any operations.</p>                                                                                   |

Table D-51 (continued)  
**KI Error Handler**

|                                                                                   |                                                                                                                                                                                                                               |
|-----------------------------------------------------------------------------------|-------------------------------------------------------------------------------------------------------------------------------------------------------------------------------------------------------------------------------|
|  | <b>code:</b> is the error code number identifying an error. A value of 0 means no error, a negative value means a fatal error, and a positive value is a warning. Refer to <a href="#">Table D-52</a> for a code description. |
|  | <b>source:</b> identifies where an error occurred. The source string is usually the name of the VI that produced the error.                                                                                                   |
|  | <b>error out:</b> contains error information. If the error in cluster indicated an error, the error out cluster contains the same information. Otherwise, error out describes the error status of this VI.                    |
|  | <b>status:</b> is TRUE if an error occurred. If status is TRUE, the VI does not perform any operations.                                                                                                                       |
|  | <b>code:</b> is the error code number identifying an error. A value of 0 means no error, a negative value means a fatal error, and a positive value is a warning. Refer to <a href="#">Table D-52</a> for a code description. |
|  | <b>source:</b> identifies where an error occurred. The source string is usually the name of the VI that produced the error.                                                                                                   |

## Error Codes

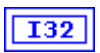
The Error Codes for KIDAQ LabVIEW VIs are contained in [Table D-52](#).

Table D-52  
 Error Codes: KIDAQ LabVIEW VIs

| Code   | Name                        | Description                                                        |
|--------|-----------------------------|--------------------------------------------------------------------|
| 0      | NoError                     | No error occurred                                                  |
| -10006 | badLineError                | The line is invalid                                                |
| -10007 | badChanError                | The value of AI/AO channel or DI/O port is invalid.                |
| -10008 | badGroupError               | The group is invalid.                                              |
| -10009 | badCounterError             | The value of input terminal <b>Ctr</b> is out of range.            |
| -10010 | badCountError               | The value of input terminal <b>State</b> is out of range.          |
| -10012 | badRangeError               | The specified A/D or D/A voltage value is out of range.            |
| -10019 | badClkFrequencyError        | The frequency is invalid.                                          |
| -10025 | limitsOutOfRangeError       | The value of AI range is invalid.                                  |
| -10026 | badBufferSpecificationError | The requested number of buffers or the buffer size is not allowed. |
| -10027 | badDAQEventError            | The DAQ events could not be opened.                                |
| -10041 | badTaskIDError              | The specified task ID is invalid.                                  |

Table D-52 (continued)  
Error Codes: KIDAQ LabVIEW VIs

| Code   | Name                    | Description                                                                                                                                                                                    |
|--------|-------------------------|------------------------------------------------------------------------------------------------------------------------------------------------------------------------------------------------|
| -10081 | badPretrigCountError    | The pretrigger sample count is invalid.                                                                                                                                                        |
| -10083 | badTrigModeError        | The trigger mode is invalid.                                                                                                                                                                   |
| -10084 | badTrigCountError       | The trigger count is invalid.                                                                                                                                                                  |
| -10086 | badExtRefError          | The external reference is invalid.                                                                                                                                                             |
| -10087 | badTrigTypeError        | The trigger type is invalid.                                                                                                                                                                   |
| -10088 | badTrigLevelError       | The trigger level is invalid.                                                                                                                                                                  |
| -10089 | badTotalCountError      | The DMA or interrupt transfer size is larger than the memory allocated in driver.                                                                                                              |
| -10100 | badPortWidthError       | The requested digital port width is not a multiple of the hardware port width or is not attainable by the DAQ hardware.                                                                        |
| -10121 | gpctrBadCtrNumberError  | Invalid <b>counterNumber</b> used.                                                                                                                                                             |
| -10122 | gpctrBadParamValueError | Invalid <b>paramValue</b> used.                                                                                                                                                                |
| -10240 | noDriverError           | Open device driver failed.                                                                                                                                                                     |
| -10242 | functionNotFoundError   | The function is not supported by this type of card.                                                                                                                                            |
| -10341 | badConnectError         | The SSI signal/line cannot be connected as specified.                                                                                                                                          |
| -10370 | badScanListError        | The scan list is invalid.                                                                                                                                                                      |
| -10401 | unknownDeviceError      | The specified device is not a Keithley Instruments PXI device, the driver does not support the device.                                                                                         |
| -10402 | deviceNotFoundError     | No device is located in the specified slot or the device number is invalid.                                                                                                                    |
| -10409 | groupBusyError          | The specified group is in use.                                                                                                                                                                 |
| -10411 | counterBusyError        | The specified counter is in use.                                                                                                                                                               |
| -10444 | memFullError            | Fail to allocate a driver internal use memory.                                                                                                                                                 |
| -10604 | activeWriteError        | Once data generation has started, only the transfer buffers originally written to may be updated.                                                                                              |
| -10608 | noTransferInProgError   | No transfer is in progress for the specified resource.                                                                                                                                         |
| -10609 | transferInProgError     | A transfer is already in progress for the specified resource, or the operation is not allowed because the device is in the process of performing transfers, possibly with different resources. |

Table D-52 (continued)  
 Error Codes: KIDAQ LabVIEW VIs

| Code   | Name                          | Description                                                                                                                                                                  |
|--------|-------------------------------|------------------------------------------------------------------------------------------------------------------------------------------------------------------------------|
| -10612 | badLineDirError               | The specified line does not support the specified transfer direction.                                                                                                        |
| -10613 | badChanDirError               | The specified channel does not support the specified transfer direction, or you have performed an operation on a digital port or line configured for the opposite direction. |
| -10618 | badClkSrcError                | The specified source signal cannot be assigned to the clock resource.                                                                                                        |
| -10621 | badTrigError                  | The specified trigger signal cannot be assigned to the trigger resource.                                                                                                     |
| -10629 | invalidOpModeError            | The specified operating mode is invalid, or the resources have not been configured for the specified operating mode.                                                         |
| -10631 | noInfiniteModeError           | Continuous input or output transfers are not allowed in the current operating mode, or continuous operation is not allowed for this type of device.                          |
| -10634 | noContTransferInProgressError | No continuous (double buffered) transfer is in progress.                                                                                                                     |
| -10636 | noContWithSynchError          | You cannot start a continuous (double-buffered) operation with a synchronous function call.                                                                                  |
| -10681 | badChanRangeError             | All channels of this board must have the same range.                                                                                                                         |
| -10697 | rateNotSupportedError         | The value of input terminal <b>SampleRate</b> is invalid.                                                                                                                    |
| -10800 | timeOutError                  | The operation could not complete within the time limit.                                                                                                                      |
| -10801 | calibrationError              | An error occurred during the calibration process.                                                                                                                            |
| -10810 | internalDriverError           | An unexpected error occurred inside the driver when performing this given operation.                                                                                         |
| -10849 | Unable to open a file         | Fail to open a data file for storing input data.                                                                                                                             |
| -10856 | osError                       | An unexpected error occurred from the operating system while performing the given operation.                                                                                 |

## AI Range Codes

The Analog Input Range for Keithley Instruments PXI devices are contained in [Table D-53](#) and [Table D-54](#):

Table D-53  
**Analog Input Range**

| Item | Range                |
|------|----------------------|
| 1    | Bipolar -10V to +10V |

Table D-53 (continued)

**Analog Input Range**

| Item | Range                        |
|------|------------------------------|
| 2    | Bipolar -5V to +5V           |
| 3    | Bipolar -2.5V to +2.5V       |
| 4    | Bipolar -1.25V to +1.25V     |
| 5    | Bipolar -0.625V to +0.625V   |
| 6    | Bipolar -0.3125V to +0.3125V |
| 7    | Bipolar -0.5V to +0.5V       |
| 8    | Bipolar -0.05V to +0.05V     |
| 9    | Bipolar -0.005V to +0.005V   |
| 10   | Bipolar -1V to +1V           |
| 11   | Bipolar -0.1V to +0.1V       |
| 12   | Bipolar -0.01V to +0.01V     |
| 13   | Bipolar -0.001V to +0.001V   |
| 14   | Unipolar 0 to +20V           |
| 15   | Unipolar 0 to +10V           |
| 16   | Unipolar 0 to +5V            |
| 17   | Unipolar 0 to +2.5V          |
| 18   | Unipolar 0 to +1.25V         |
| 19   | Unipolar 0 to +1V            |
| 20   | Unipolar 0 to +0.1V          |
| 21   | Unipolar 0 to +0.01V         |
| 22   | Unipolar 0 to +0.001V        |
| 23   | Bipolar -2V to +2V           |
| 24   | Bipolar -0.25V to +0.25V     |
| 25   | Bipolar -0.2V to +0.2V       |
| 26   | Unipolar 0 to +4V            |
| 27   | Unipolar 0 to +2V            |



Table D-53 (continued)

**Analog Input Range**

| Item | Range               |
|------|---------------------|
| 28   | Unipolar 0 to +0.5V |
| 29   | Unipolar 0 to +0.4V |

Table D-54

**Valid analog input ranges (specified by module)**

| Model                                                                      | Range                                                                   |
|----------------------------------------------------------------------------|-------------------------------------------------------------------------|
| KPXI-SDAQ-4-500K<br>KPXI-SDAQ-4-2M<br>KPXI-DAQ-64-500K<br>KPXI-DAQ-64-250K | 1, 2, 3, 4, 15, 16, 17, 18                                              |
| KPXI-DAQ-64-3M<br>KPXI-DAQ-96-3M                                           | 1, 2, 3, 4, 7, 8, 10, 15, 16, 17, 19, 20,<br>23, 24, 25, 26, 27, 28, 29 |
| KPXI-AO-4-1M<br>KPXI-AO-8-1M                                               | 1, 15                                                                   |
| KPXI-AI-2-65M                                                              | 2, 10                                                                   |

## AI Data Format

Table D-55  
Analog Input data format (by Model)

| Model                                | AI Data Format                                                                                                                                                                  |
|--------------------------------------|---------------------------------------------------------------------------------------------------------------------------------------------------------------------------------|
| KPXI-SDAQ-4-2M                       | 16-bit signed integer data:<br>D13 D12 D11 ..... D1 D0 b1 b0<br><br>Where:<br>D13, D12, ... , D0 : A/D converted data<br>b1, b0 : Simultaneous Digital Input data.              |
| KPXI-SDAQ-4-500K                     | 16-bit unsigned integer data:<br>D15 D14 D13 ..... D1 D0<br><br>Where:<br>D15, D14, ... , D0 : A/D converted data                                                               |
| KPXI-DAQ-64-3M                       | 16-bit signed integer data:<br>D11 D10 D9 ..... D1 D0 b3 b2 b1 b0<br><br>Where:<br>D11, D10, ... , D0 : A/D converted data<br>b3, b2, b1, b0 : Simultaneous Digital Input data. |
| KPXI-DAQ-96-3M                       | 16-bit signed integer data:<br>D11 D10 D9 ..... D1 D0 b3 b2 b1 b0<br><br>Where:<br>D11, D10, ... , D0 : A/D converted data<br>b3, b2, b1, b0 : not used.                        |
| KPXI-DAQ-64-500K<br>KPXI-DAQ-64-250K | 16-bit signed integer data:<br>D15 D14 D13 ..... D1 D0<br><br>Where:<br>D15, D14, ... , D0 : A/D converted data                                                                 |
| KPXI-AO-4-1M<br>KPXI-AO-8-1M         | 16-bit signed integer data:<br>D13 D12 D11 ..... D1 D0 b1 b0<br><br>Where<br>D13, D12, ... , D0 : A/D converted data<br>b1, b0 : AI Auto-scan Channel.                          |
| KPXI-AI-2-65M                        | 16-bit unsigned integer data:<br>b15 b14 D13 D12 D11 ..... D1D0<br><br>Where:<br>D13, D12, ... , D0 : A/D converted data<br>b14 : Over-voltage indicator                        |

**Model No.** \_\_\_\_\_ **Serial No.** \_\_\_\_\_ **Date** \_\_\_\_\_

**Name and Telephone No.** \_\_\_\_\_

**Company** \_\_\_\_\_

List all control settings, describe problem and check boxes that apply to problem. \_\_\_\_\_

\_\_\_\_\_

Intermittent                       Analog output follows display                       Particular range or function bad; specify

IEEE failure                       Obvious problem on power-up                       Batteries and fuses are OK

Front panel operational    All ranges or functions are bad                       Checked all cables

Display or output (check one)

Drifts                       Unable to zero                       Unstable

Overload                       Will not read applied input

Calibration only                       Certificate of calibration required                       Data required

(attach any additional sheets as necessary)

Show a block diagram of your measurement including all instruments connected (whether power is turned on or not).  
Also, describe signal source.

Where is the measurement being performed? (factory, controlled laboratory, out-of-doors, etc.) \_\_\_\_\_

What power line voltage is used? \_\_\_\_\_ Ambient temperature? \_\_\_\_\_ °F

Relative humidity? \_\_\_\_\_ Other? \_\_\_\_\_

Any additional information. (If special modifications have been made by the user, please describe.)

\_\_\_\_\_

**Be sure to include your name and telephone number on this service form.**



Specifications are subject to change without notice.  
All Keithley trademarks and trade names are the property of Keithley Instruments, Inc.  
All other trademarks and trade names are the property of their respective companies.



A G R E A T E R M E A S U R E O F C O N F I D E N C E

**Keithley Instruments, Inc.**

**Corporate Headquarters** • 28775 Aurora Road • Cleveland, Ohio 44139 • 440-248-0400 • Fax: 440-248-6168 • 1-888-KEITHLEY • [www.keithley.com](http://www.keithley.com)