

The Marconi communication test set 2955 series has a common fault – the 10MHz oscillator is prone to failure. Shows as a breaking up of the display and general lockup. It is not a good idea to use your unit if it is showing this symptom as it can corrupt the eeprom, see below – here is one way to fix it.

Courtesy Bob Blumfelds VK6JBN

de Mark Webster VK2BAK

---

The fault you mention sounds like the 10mhz ref oscillator on the crt board is intermittent. This is an extremely common fault.

It's a small grey box located towards the rear of the long crt pcb. There is a blue multiturn pot directly above it. That sets the frequency. It will lock the unit up if it fails during warmup or operation. It supplies all the timing signals for the 2955 including the display. Best way to fix it is remove and install a new 10mhz reference oscillator. The original oscillator is not easily sourced and they are getting too old. I fitted a 10mhz Vectron oven which fits nicely onto the side of the case directly behind the crt pcb. There is 12v on the crt board as the original oven uses 5v. You will require a transistor, a couple of resistors and a cap to "pullup" the level of the oscillator signal to 2v p-p which the Marconi needs to work. If the level is low then the unit won't start on power up. You won't obviously need to do that if you source an oven with a high level output. I suppose another way is to find a good hp oscillator on ebay.

Also don't use the unit too often as the intermittent timing signals will screw the cal data in the eeprom and you will need a new board. Symptoms of that is unusual readings in the sinad, frequency etc when no signals are applied. Also levels out will be unusual too! This happened to another set I fixed up and I ended up buying a second hand controller board to fix it. *[email to VK2BAK]*

PHASE LOCKED LOOP

INTERNAL STANDARD

VIDEO AMP

FROM  
AB1  
PLO

EXT 1MHz  
RFAN  
PALCA

FROM  
AB1  
PLO6

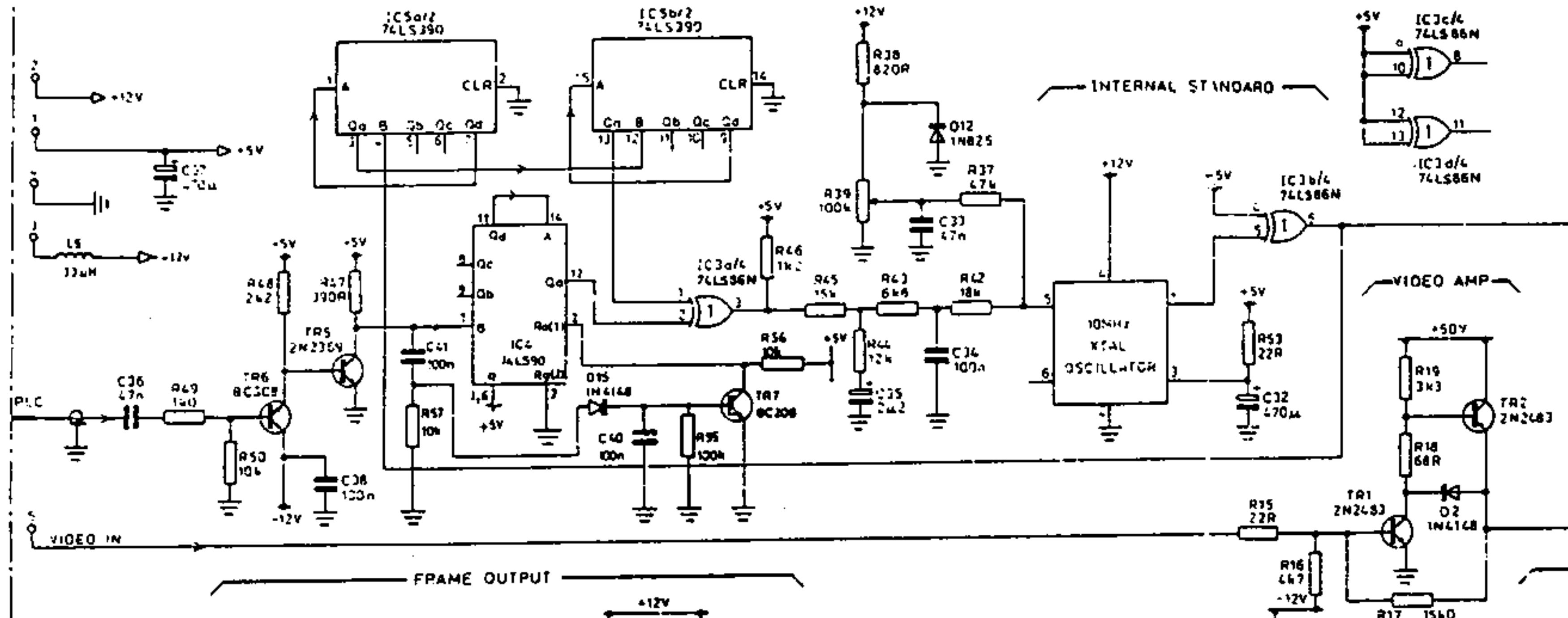

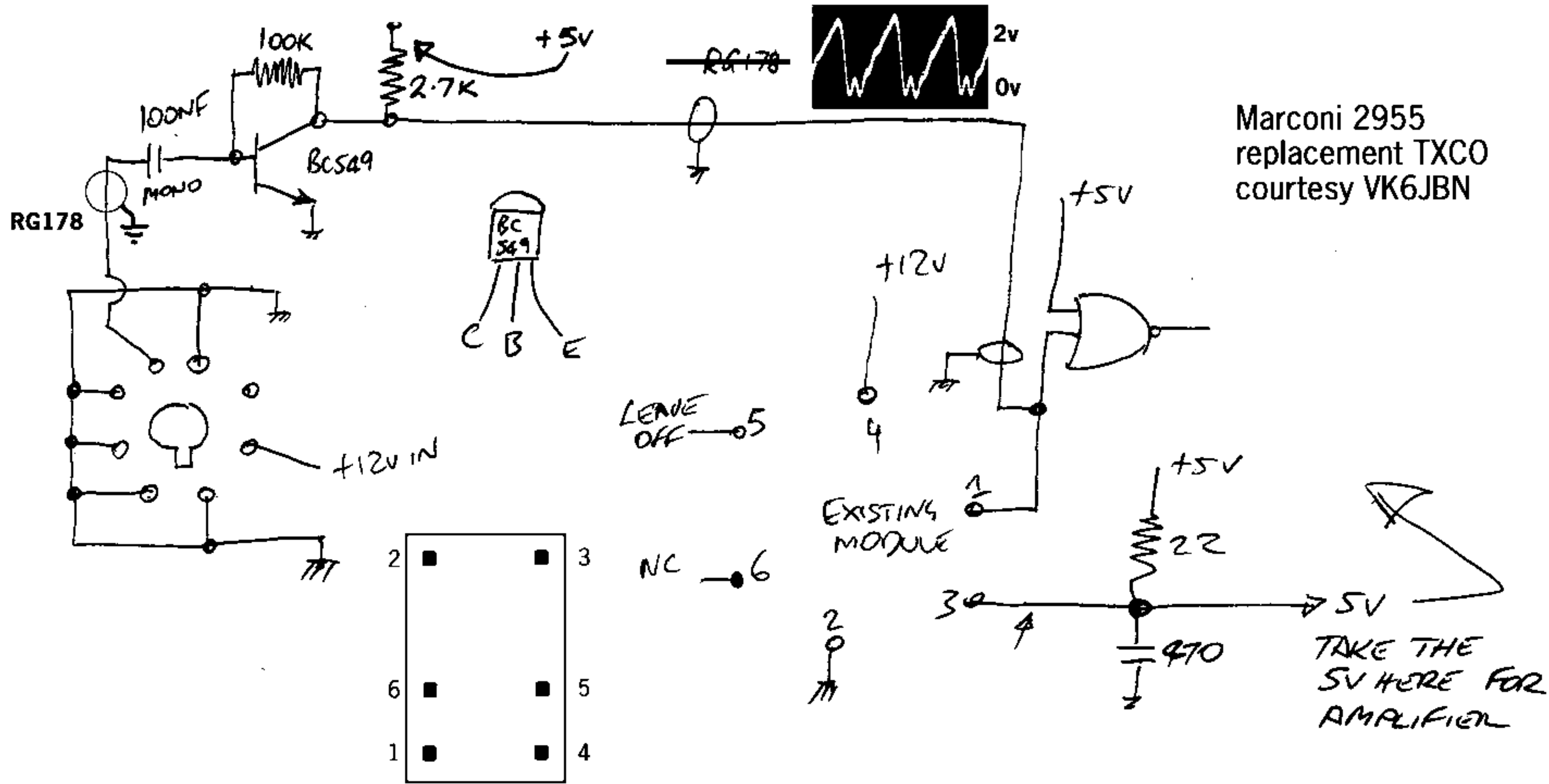

Marconi 2955  
replacement TXCO  
courtesy VK6JBN

TAKE THE  
5V HERE FOR  
AMPLIFIER

+5V<sub>3</sub>

OUT<sub>1</sub>

PM14

+12V<sub>4</sub>

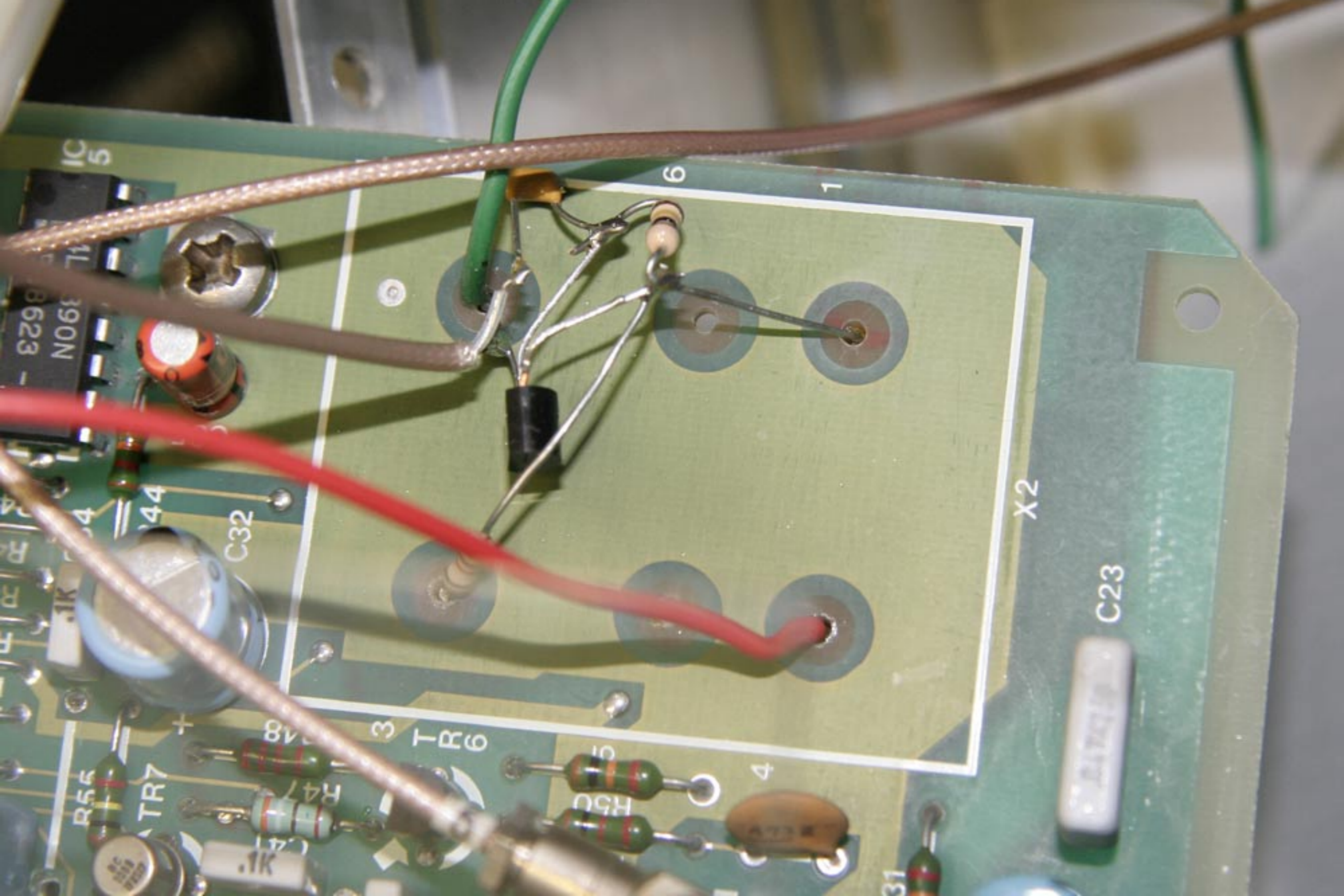

IC 5

8623 -  
N068 T11

6

1

C32

X2

C23

TR7

R50

R47

4

R55

31

**DANGER**  
HIGH VOLTAGES EXPOSED BE

USE SCREW ON XTRAL OVERVIEW

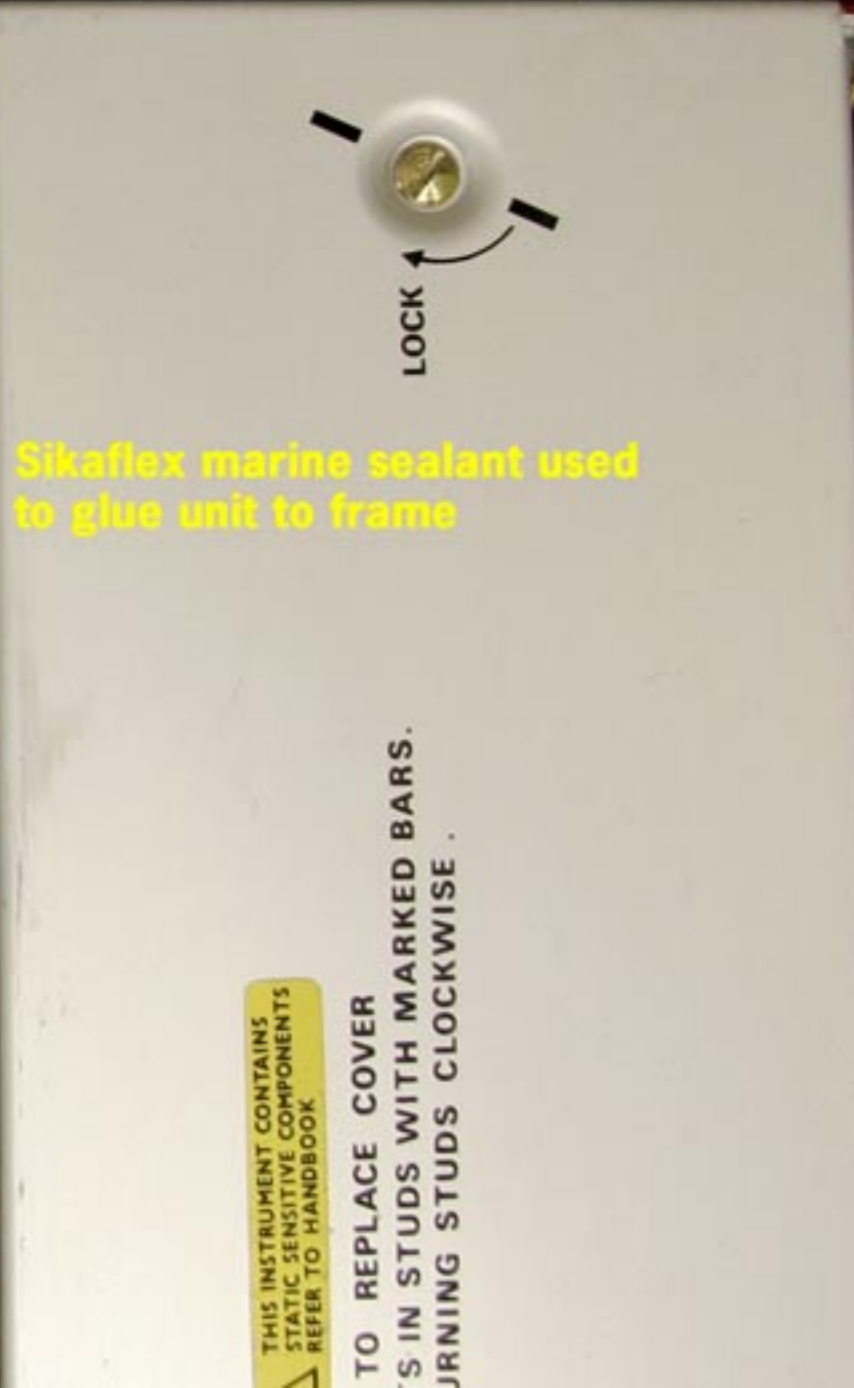

THIS INSTRUMENT CONTAINS  
STATIC SENSITIVE COMPONENTS  
REFER TO HANDBOOK

TO REPLACE COVER  
S IN STUDS WITH MARKED BARS.  
TURNING STUDS CLOCKWISE.

820-41721

teklonix

in sync with GPS fx standard

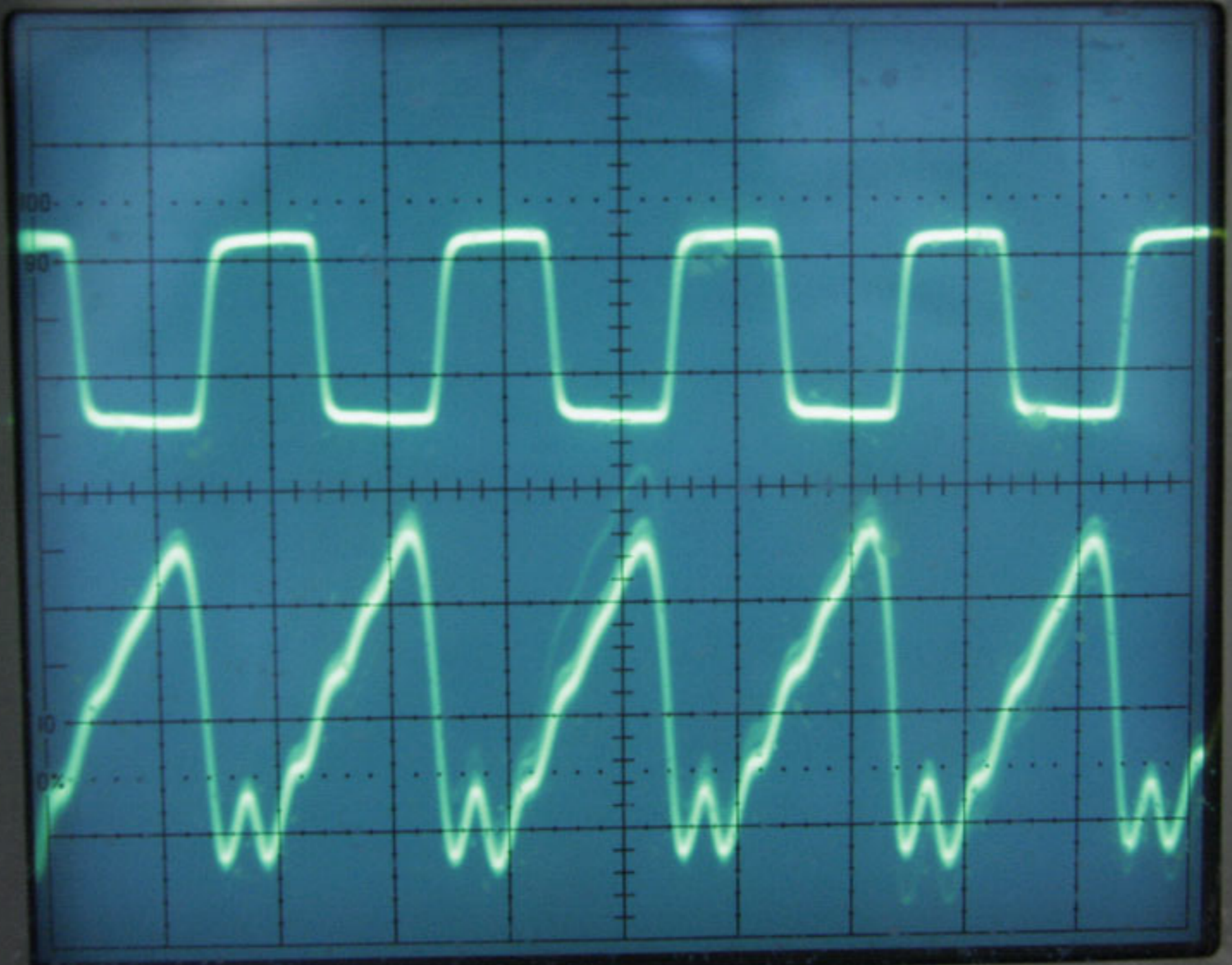

2

IN

TRACE

BEA

PROBE

50

10

PD

# TEST REPORT

DSO-2100 USB

DATE = 30/05/2007      TIME = 10:05:48

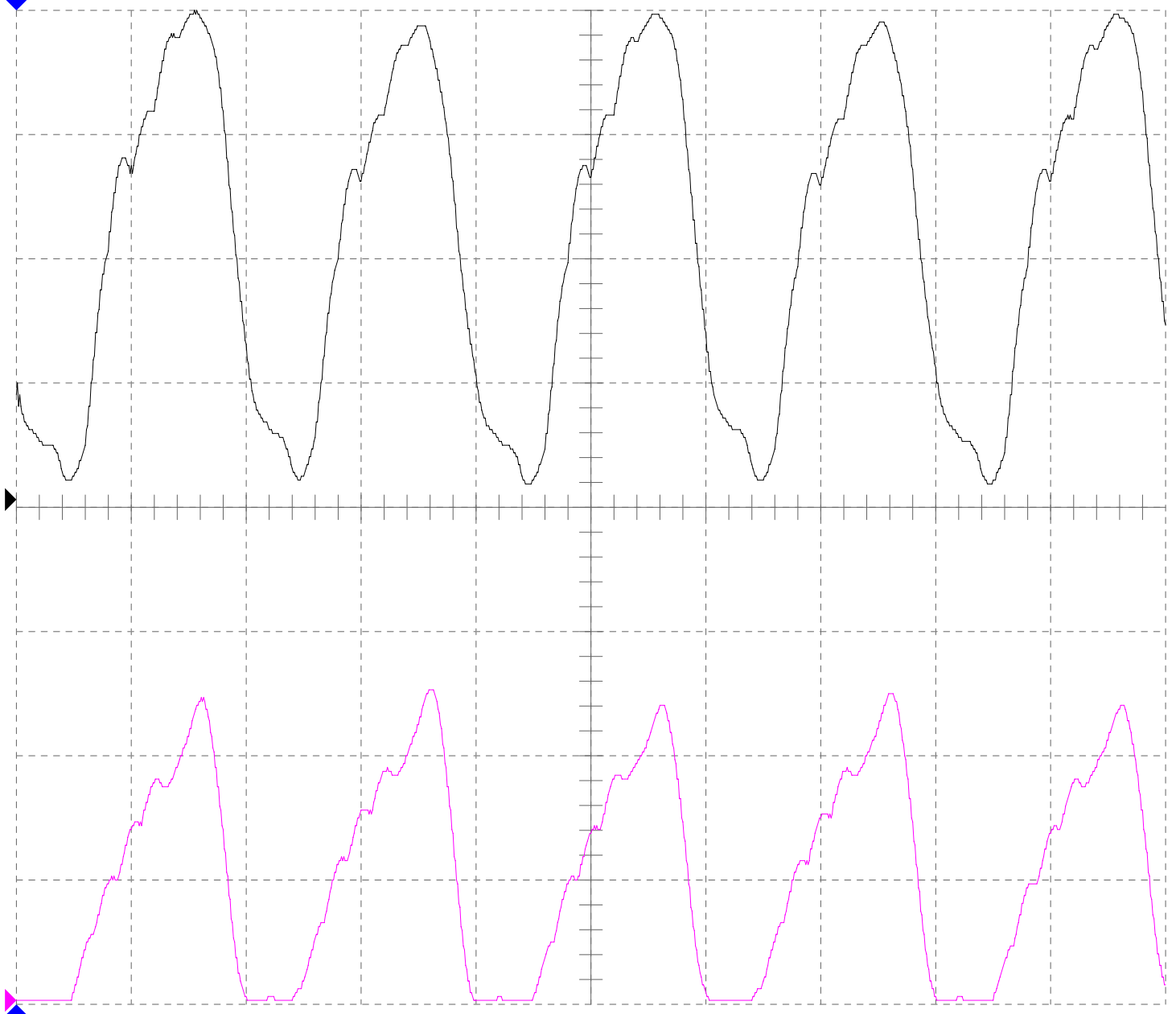

**CH1 :** [REDACTED]

**CH2 :** [REDACTED]

SAMPLING RATE = 100MS/s

TIME DIV = 50 ns/div

CH1 VOLT DIV = 1V/div

Input Coupling = DC

CH2 VOLT DIV = 1V/div

Input Coupling = DC

**Note :** 

---

---

---

---



