

# Do I need a PPM100 Partial Pressure Monitor for my SRS RGA?

<b>Introduction .....</b>	<b>2</b>
<b>What is the PPM100 controller? .....</b>	<b>3</b>
<b>How does the PPM100 interface to the SRS RGA? .....</b>	<b>4</b>
<b>What does the PPM100 controller do? .....</b>	<b>5</b>
Partial Pressure Monitor and Control .....	5
Leak Test Analysis .....	5
Mass Spec Display .....	6
RGA Control .....	7
Analog I/O Ports .....	8
Capacitance Manometer readings (CM1-4) .....	8
Data Logging (Charts and Tables) .....	9
Vacuum Process Control .....	10
Computer Interfaces (RS-232, GPIB and USB) .....	10
Internet Access .....	11
<b>Who should consider the PPM100? .....</b>	<b>13</b>
<b>Do I still need RGA Windows? .....</b>	<b>16</b>
<b>PPM100 Specifications .....</b>	<b>17</b>

# Introduction

If you are planning to purchase an SRS RGA, or even if you already own one, you might want to consider the addition of a PPM100 Partial Pressure Monitor to your vacuum setup.

The PPM100 was designed based on recommendations from vacuum users with a broad range of partial pressure measurement requirements. The PPM100 is most suitable for RGA users who ...

- ... require analog I/O capabilities.
- ... require process control capabilities.
- ... perform repetitive vacuum processes.
- ... demand high reliability (i.e. mission-critical applications.)
- ... need access to RGA data over the world wide web
- ... operate in process environments incompatible with PCs
- ... require uninterrupted 24/7 access to partial pressure data
- ... require a compact and mobile partial pressure measurement setup.
- ... prefer a traditional standalone RGA controller box over a PC.
- ... do not wish to deal with computers, software upgrades and system crashes

If any of the above requirements applies to you, please read the rest of this application note to familiarize yourself with: (1) the main features and specifications of the PPM100 controller, (2) the advantages of operating any SRS RGA with a stand-alone PPM100 controller (i.e. as compared to a PC/RGA Windows interface), and (3) the cases in which RGA Windows is still recommended.

# What is the PPM100 controller?

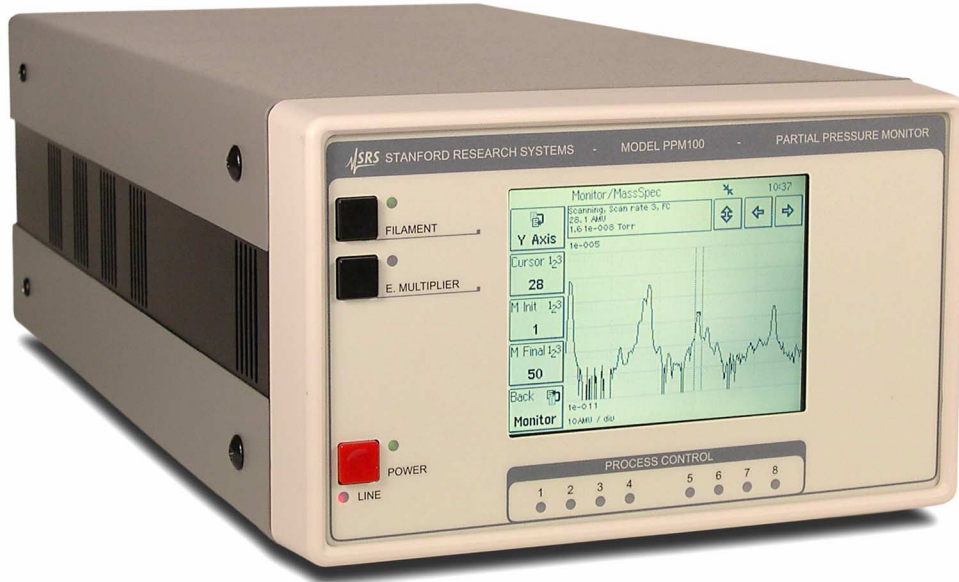

Figure 1. Front panel of the PPM100 controller with its touchscreen/LCD display and RGA control buttons.

The PPM100 Partial Pressure Monitor is a standalone, fully-programmable, microprocessor-based vacuum system controller that when connected to any SRS RGA100/200/300 residual gas analyzer can continuously monitor and display **partial pressures** of up to eight individual gas components. It includes a touchscreen/LCD front-panel display, pressure vs. time and analog-scan graphing, built-in relays for vacuum system control and several multipurpose (analog and digital) I/O ports. RS-232, USB and GPIB computer interfaces are standard in all controllers. An Embedded Web Server (EWS), with a standard Ethernet connector, connects the PPM100 to the World Wide Web.

# How does the PPM100 interface to the SRS RGA?

A very important feature of the PPM100 controller is that it eliminates the requirement to connect the SRS RGA to a host PC computer. The RGA is instead connected directly to the PPM100 controller through its standard RGA-RS232 serial interface port and all data is displayed on the front panel of the controller.

**Warning!** PPM100 is not compatible with third-party residual gas analyzers

A menu-driven user-interface allows the PPM100 operator to easily program all required RGA Setup parameters from the controller's front panel- i.e. no RGA Windows software interface is required.

Note that the PPM100 is a standalone instrument - there is no need to connect the controller itself to an external computer to access its full performance and functionality.

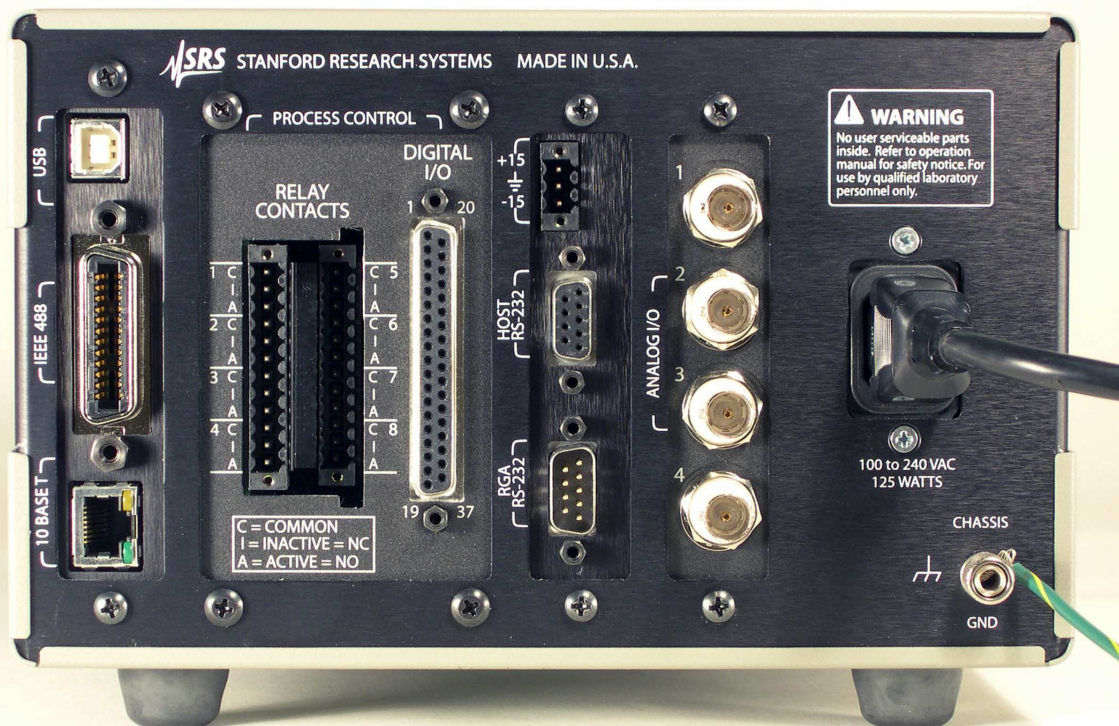

Figure 2. Back panel of the PPM100 controller. Connect the SRS RGA to the RGA RS-232 (DB-9) connector using a standard serial communication cable.

# What does the PPM100 controller do?

## Partial Pressure Monitor and Control

PPM100 can monitor and display up to eight independent RGA partial pressures on its front panel LCD. Each partial pressure reading has its own (1) mass, (2) detector, (3) scan rate and (4) alarm settings. The Partial Pressure Display mode of operation is primarily used to generate single gas data for leak testing applications, and to track changes in the concentrations of up to eight independent components of a gas mixture as a function of time. The partial pressure readings can also be linked to alarms, process control relays and both digital and analog output signals.

Monitor				11:22
PP1 2 <b>7.10-08</b> Hydrogen	PP2 4 <b>2.09-09</b> Helium	PP3 18 <b>2.56-07</b> <b>Alarm High</b> Water	PP4 28 <b>3.95-06</b> Nitrogen	
PP5 32 <b>7.80-07</b> <b>Alarm High</b> Oxygen	PP6 40 <b>6.02-08</b> <b>Alarm Low</b> Argon	PP7 43 <b>2.24-09</b> Pump oil	PP8 44 <b>9.91-09</b> CO2	
<b>Pressure</b>	<b>Analog I/O</b>	<b>MassSpec</b>	<b>Back</b>	<b>Help</b>

Figure 3. The partial pressure Monitor Display mode of the PPM100 shows partial pressure readings, and alarm status, for up to eight individual gas species.

## Leak Test Analysis

The PPM100 can be used to leak test components attached to the vacuum system. Use leak trend graphs to detect leaks as partial pressure transients while spraying the vacuum system components with a tracer gas such as helium or argon. A stamp-sized 'Signal vs. time' plot of the most recent partial pressures for the selected mass is displayed on the front panel. A small instantaneous partial pressure reading is also included next to the plot.

When 'Audio Leak Trend' is selected, a repetitive audio signal whose frequency is proportional to the partial pressure readings provides a means to "hear" pressure transients, eliminating the need to look at the front panel display while searching for leaks.

In order to provide optimum data acquisition rates at the mass of interest, all other partial pressure readings and displays are disabled while in this display mode.

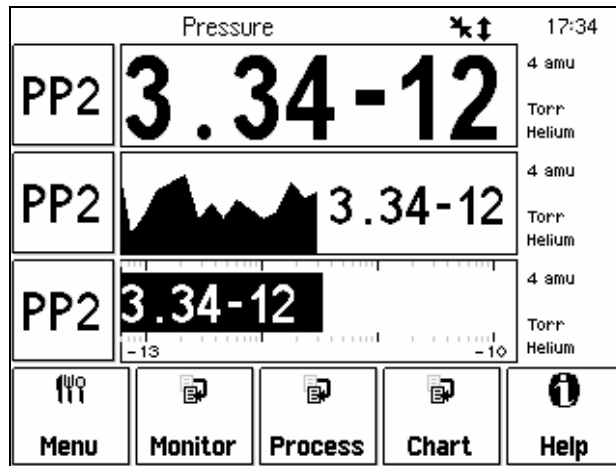

*Figure 4.* Leak trend Display Mode. Use this graphical mode to Leak test components of your vacuum system. PP2 data bar is set to Leak trend, and three display modes are available on the same screen to visualize leak rates during testing.

## Mass Spec Display

A Scan Display mode is available to graph RGA Mass Spectra directly on the front panel of the controller. During analog scanning the quadrupole mass spectrometer is stepped at fixed mass increments (i.e. 0.1 amu) through a user-specified mass range. The ion current is measured after each mass-increment step and transmitted to the PPM100 for display. Analog scanning simplifies the detection of mass peaks for component gas identification, and provides a direct measure of the mass resolution of the quadrupole mass spectrometer.

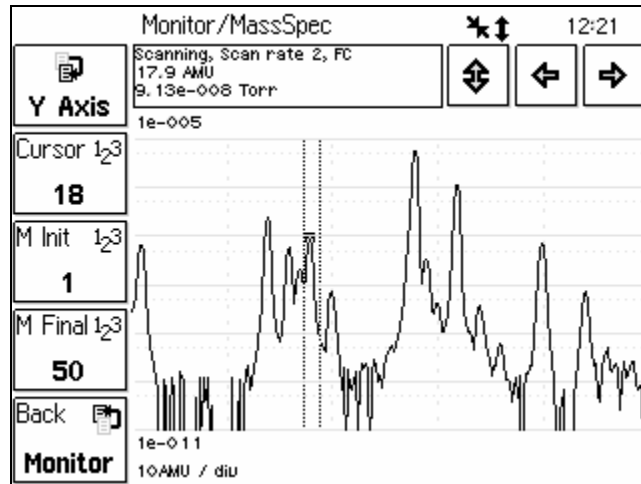

Figure 5. The Mass Spec Display mode of the PPM100 shows complete RGA Mass spectra and includes a cursor for fast peak identification.

## RGA Control

The PPM100 includes a FILAMENT button on its front panel for manual activation of filament emission as required for partial pressure measurements. Press the E. MULTIPLIER button at any time to activate the electron multiplier detector during analog scans. All RGA ionizer settings are easily configured from the touchscreen/LCD user interface.

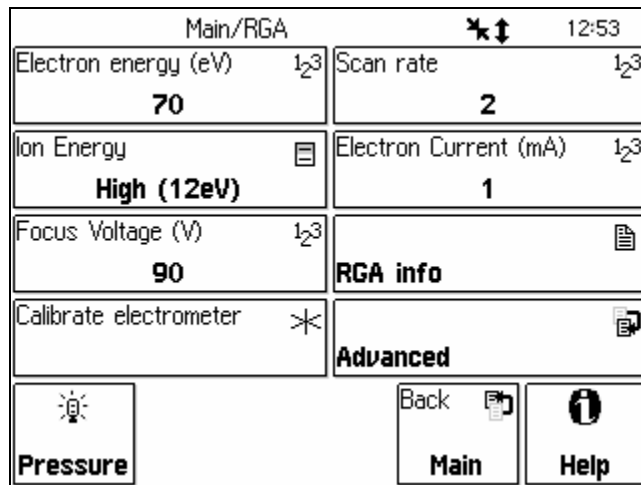

Figure 6. RGA Setup parameters are easily set from the front panel.

## Analog I/O Ports

The PPM100 controller has four analog input/output ports. Their range is  $\pm 12$  V with 14 bit input resolution and 12-bit output resolution. The update rate is 2 Hz. Each port is individually configurable as an input or an output for complete I/O flexibility.



AnalogIO				11:54
AN1 <b>-0.257 V</b> Temp ADC input	AN2 <b>-0.274 V</b> Dose Valve Manual out	AN3 <b>+8.735 V</b> CM 10Torr ADC input	AN4 <b>+4.450 V</b> Argon buff PP6 out	
CM1 DISPLAY OFF Temp Off	CM2 DAC OUTPUT Dose Valve Off	CM3 8.74 Torr CM 10Torr Linear	CM4 DAC OUTPUT Argon buff Off	
 <b>Pressure</b>		 <b>Back</b>	 <b>Help</b>	

Figure 7. The AnalogIO Display mode of the PPM100 (w/CM readings disabled) shows the voltage levels at the analog I/O ports.

Use analog I/O ports as inputs to read voltages from vacuum system instruments such as capacitance manometers, analog output third-party gauges, mass flow controllers, turbo pump controllers, etc.

Analog output levels can be programmed manually from the front panel, remotely through the computer interface, or they can be linked to partial pressure readings for closed-loop control of gas composition. Use analog I/O ports as outputs to control auxiliary vacuum equipment such as heaters, actuators, ion sources, programmable logic controllers, dosing valves and throttle controllers.

## Capacitance Manometer readings (CM1-4)

The PPM100 controller can display pressure as measured by standard capacitance manometers (CMs). Up to four independent CM readings can be monitored simultaneously. Pressure readings are updated at 2 Hz. The PPM100 precisely measures the 0 to 10 Vdc linear output signal from the CM to determine pressure. Full-scale ranges up to 1000 Torr are supported by the controller.

For added convenience, the PPM100 also supplies an auxiliary (AUX)  $\pm 15$  V, 100 mA power output. This is usually sufficient to power up a couple of standard (i.e. non-heated) capacitance manometers.



**Tip!** The CM pressure display mode can also be applied to display pressures from third-party vacuum gauges with analog outputs linked to the log of the total pressure.

## Data Logging (Charts and Tables)

All PPM100 controllers include Data Logging capabilities. When Data Logging is enabled, data from *all* partial pressure measurements and *all* analog inputs are stored in a circular memory buffer at the rate specified by a user-programmable logging interval.

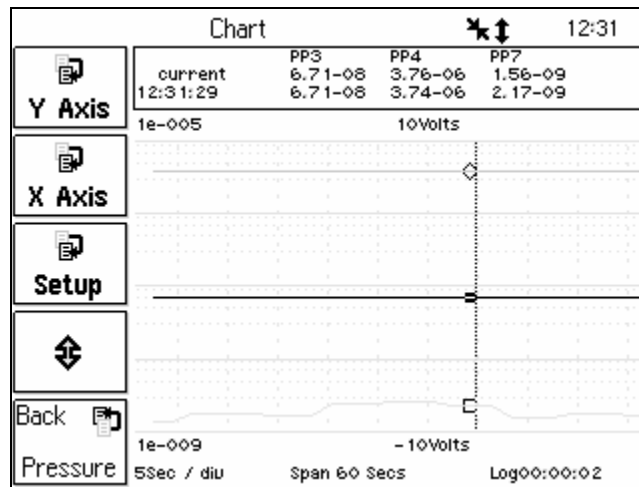





*Figure 8.* Data Logging (Chart) Display mode of the PPM100. Both Graph and Table display modes are shown side-to-side. The signal-vs-time display allows you to monitor pump-down and venting cycles and follow the time behavior of your system.

The logged data can be accessed through the touchscreen LCD. Both table and chart (P vs. Time) displays are available. The chart display includes convenient graphical tools such as (1) cursor, (2) zoom, (3) (x, y)-axis scaling (manual and auto), and (4) cursor readings. Users can switch rapidly between current and logged readings for the pressures or analog signals of interest. The data log can also be accessed remotely through the computer interface, or through the world wide web when using the embedded web server.

Typical applications of the Data Logging capabilities include capturing pump-down or venting curves for vacuum system characterization, monitoring mass-flow controller signals during deposition processes, and tracking temperatures and other time dependent variables during bakeouts or heat treatments.

## Vacuum Process Control

Eight channels of process control are standard in the PPM100 controller.

Process			13:21
ROUGH VALVE 1	FORE VALVE 2	GATE VALVE 3	FORE STATUS 4
CLOSED <b>Inactive</b> <b>Manual</b>	OPEN <b>Inactive</b> <b>Manual</b>	CLOSED <b>Inactive</b> <b>Auto</b>	OK <b>Inactive</b> <b>Manual</b>
VENT VALVE 5	Channel 6 6	Channel 7 7	Channel 8 8
VENTING <b>Inactive</b> <b>Manual</b>	<b>Inactive</b> <b>Manual</b>	<b>Inactive</b> <b>Manual</b>	<b>Inactive</b> <b>Manual</b>
 <b>Pressure</b>	 <b>History</b>	 <b>Overview</b>	Back  <b>Pressure</b>  <b>Help</b>

*Figure 9.* Process Control Display mode of the PPM100. Eight process control channels bring additional power and versatility to the PPM100.

Each channel has a relay closure output and corresponding opto-isolated TTL output signal, that may be linked to a variety of input sources with intuitive user-programmable rules. Each individual channel can be linked to any partial pressure or analog input, the system clock, gauge status or a TTL input trigger signal. The Process Control module also includes several opto-isolated TTL level inputs, used to remotely control filament on/off, degas on/off, E. MULT. On/Off, keypad lockout, datalogging reset and touchscreen enable/disable functions.

Manual override is available for all process control channels, making it possible to manually control channel relays and TTL output levels directly from the front panel. Manual relay control makes it possible to use the PPM100 as a standalone controller capable of manually or automatically managing the operation of any standard vacuum system.

All process control events are automatically time-stamped and recorded in memory (Event Logging) so they can be reviewed at any time. Use the History button on the Process Control panel to access the Process Control Event Log at any time.

## Computer Interfaces (RS-232, GPIB and USB)

PPM100 includes standard RS-232, GPIB and USB communication ports. A host computer connected to the instrument can easily configure, diagnose and operate the PPM100 controller using simple ASCII commands. An intuitive and

complete Remote Command Set facilitates integration of all controller functions into any processing or diagnostic software. The same command set is shared by the RS232, USB and GPIB interfaces.

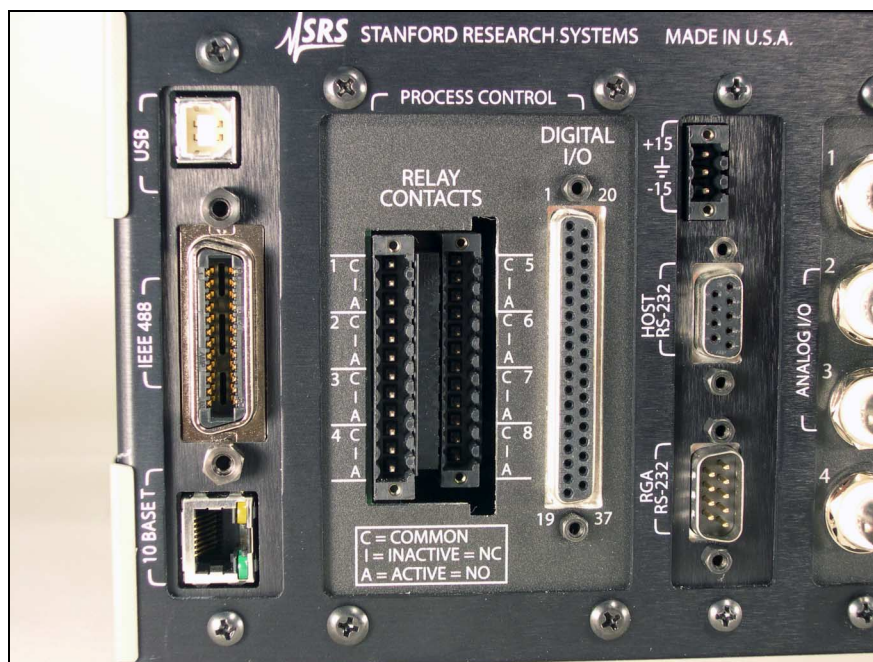

*Figure 10.* Back panel of PPM100. Computer interface ports on the back panel of the PPM100 include: (1) HOST RS232, (2) GPIB, (3) USB, and (4) 10 BASE-T Ethernet port (for embedded web server)

**Tip!** Computer interfacing is only required for: (1) Computer monitor/control of the PPM100 and vacuum system, (2) Remote access to data-logs and history lists, (3) calibration data uploads, and (4) firmware upgrades (for controller and web server).

The PPM100 itself is a standalone instrument - there is no need to connect the controller to an external computer to access its full performance and functionality. All instrument functions and parameters are manually accessible and easily modified through its menu-driven user interface.

## Internet Access

An Embedded Web Server (EWS) connects the PPM100 to the World Wide Web. The EWS is a TCP/IP compatible web server that resides inside the PPM100 box, continuously gathering data from the instrument. When connected to an ethernet network with an Internet gateway, the EWS can deliver PPM100 data to a user anywhere on the world wide web using a standard browser. Users can monitor their vacuum system gas composition from anywhere in the world. E-mail notification can notify a client list of potential or real system problems.

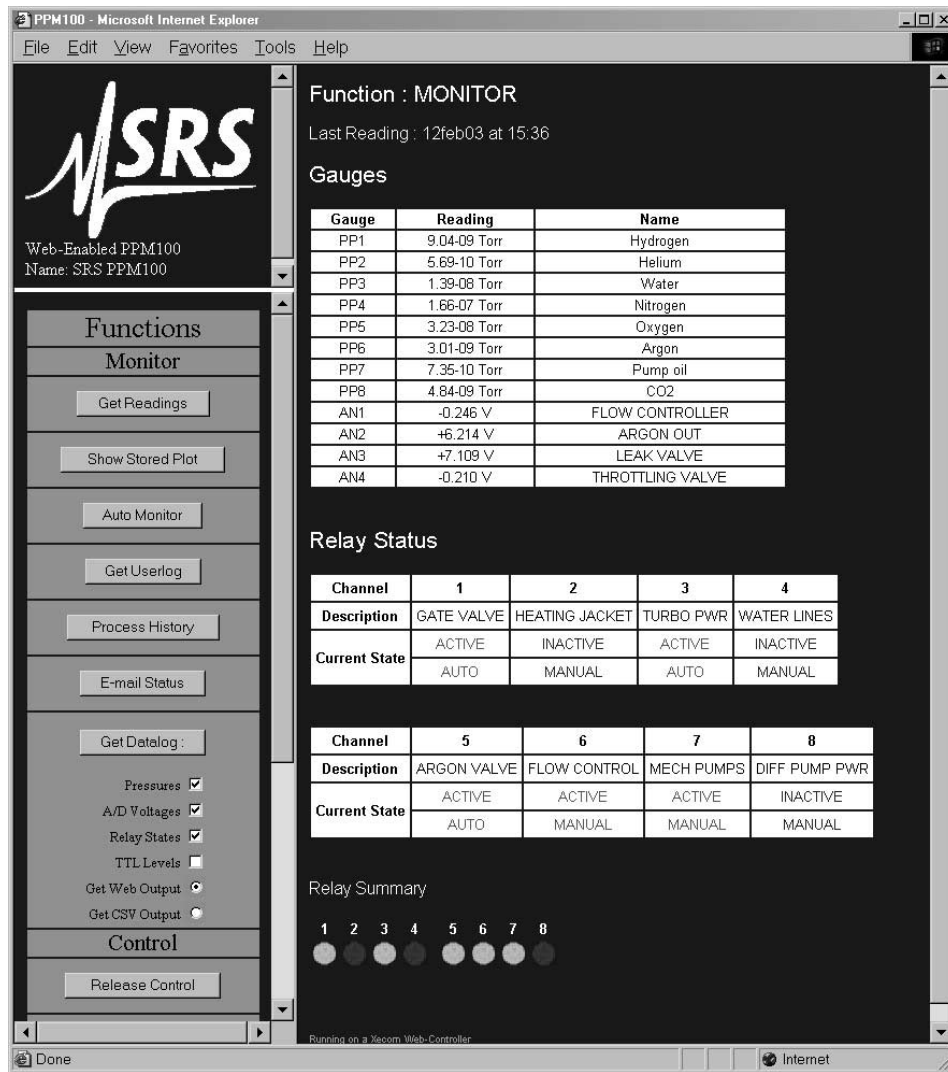

Figure 11. Sample of the PPM100 web page.

The EWS provides the most convenient way to access PPM100 data from a computer without writing custom serial or GPIB based software. Display modes supported include: analog-scans, pressure-versus-time, tables, etc. The EWS can also be configured to allow access to process control functions, so that any vacuum system can be monitored and controlled from anywhere in the world.

**Tip!** Use the web interface to track your vacuum system from your office or from home without having to pay periodic visits to your lab. Use the control capabilities to turn heating jackets on/off or activate/deactivate valves, pumps and gauges from the comfort of your office.

## Who should consider the PPM100?

### ◆ RGA users who require auxiliary Analog I/O capabilities.

Process vacuum applications often require monitoring analog signals from multiple electronic sources such as capacitance manometers, third-party gauges with analog outputs, mass flow controllers, turbo pump controllers, thermometers, etc. The PPM100 analog input ports provide the simplest way to collect and log data from up to four auxiliary vacuum instruments in parallel with its RGA partial pressure readings.

PPM100 can also provide Analog OUT signals linked to partial pressures of individual gases for applications requiring feedback-loop control of gas composition. Use analog OUT signals to control auxiliary vacuum equipment such as heaters, actuators, ion sources, programmable logic controllers and dosing valves and throttles.

Note! Analog I/O is not supported by the RGA Windows software provided with the SRS RGA.

A good example of a vacuum application requiring multiple inputs is the Temperature Programmed Desorption (TPD) procedures that are common during surface science experiments. The only viable alternative to the Analog I/O capabilities of the PPM100 would be to interface the RGA directly to a personal computer, fitted with an "A/D and D/A" board and to write specialized software to integrate the RGA readings with the analog I/O signals of interest.

### ◆ RGA users who need Process Control Capabilities.

PPM100 provides one of the simplest and most reliable ways to build process control and interlocking capabilities into a vacuum system setup. Use the 8 channels of process control to make mission-critical decisions based on (1) logic levels, (2) analog signal levels, (3) time, (4) system status, and/or (5) partial pressure readings during your process. All this without any need for computer programming/interfaces or additional hardware.

The only viable alternative to the Process Control capabilities of the PPM100 would be to interface the RGA directly to a computer, fitted with a "Logic I/O and Relay" board and to write specialized software to link the RGA and analog readings to the Logic and Relay ports.

### ◆ RGA Users who perform repetitive vacuum processes.

PPM100 is ideally suited for repetitive processes where the partial pressure limits and interlocking requirements during execution of the vacuum procedure are well

understood. Fast response, reliability and standalone operation make the PPM100 an ideal alternative to the PC/RGA Windows interface. Alarms can immediately announce out-of-range conditions for critical gas components of a gas mixture, while process control channels and rules can be used to protect the system from catastrophic events without any need for human intervention.

#### ◆ **RGA Users with high reliability requirements**

The reliability of the PPM100 as a partial pressure monitor/controller far exceeds any PC Computer/RGA Windows based setup. As a standalone instrument, PPM100 continues to collect data day-in and day-out without interruption, without sharing CPU time with any other software applications and without being susceptible to PC operating system crashes.

If uninterrupted datalogging is a requirement in your process, you should seriously consider the PPM100 as an upgrade for the PC/RGA Windows setup.

#### ◆ **RGA users who require access to RGA data over the World Wide Web**

The Embedded Web Server (EWS) available for the PPM100 provides the most convenient way to access RGA data through the Internet. The EWS can also be configured to allow access to process control functions, so that any vacuum system can be monitored and controlled from anywhere in the world.

Use the web interface to monitor your vacuum system from your office or from home without having to pay periodic visits to your lab and while waiting for your system to pump down. Use the control capabilities to turn heating jackets on/off or activate/deactivate valves or pumps and gauges from the comfort of your office.

Note! Web access is not supported by the RGA Windows software package provided with the SRS RGA.

As an added convenience, the PPM100 includes an e-mail notification system, that can be easily programmed to notify RGA/PPM100 users of important vacuum system events by sending e-mail messages to a user-specified address.

#### ◆ **RGA users in process environments incompatible with PCs**

PC computers are often incompatible with process environments, and alternative solutions such as remote interfacing or industrial PCs are often technically incompatible or prohibitively expensive. Desktops are often too large, and laptops are generally considered too delicate for the process floor. The standalone PPM100 solves all of the above problems with a small, rugged, reliable and rack mountable package.

#### ◆ **RGA users who require 24/7 access to partial pressure data**

PPM100 provides 24/7 access to your RGA data. If your application requires uninterrupted access to gas composition information from your vacuum system, carefully consider a PPM100 for your RGA setup.

For example, surface scientists are used to keeping a watchful eye on their vacuum system's RGA spectra throughout system pumpdowns and during sample handling. Displaying the RGA data with a standalone PPM100, frees the experiment's computer(s) for critical (i.e. experiment related) data acquisition functions and minimizes the possibility of missing important "vacuum events" while RGA data is not being displayed on the computer's screen.

◆ **RGA users who require a compact and mobile measurement setup**

PPM100 offers a very compact, rugged and rack mountable package. Its size can only be compared to a much more delicate laptop PC.

Vacuum engineers and technicians, requiring mobile, RGA-based, diagnostic systems should seriously consider the PPM100 as a compact and rugged substitute for the PC/RGA Windows setup. For example, *a PPM100/RGA system provides an excellent portable "leak detection" setup.*

◆ **RGA users who have PC interfacing requirements beyond RS232**

The SRS RGA offers only one interface option- RS232 at 28.8 Kbaud rate.

If your interfacing requirements involve GPIB, USB or ethernet , or you simply need a more flexible RS232 setup, consider a PPM100 as a bridge between your RGA and your process computers.

◆ **RGA users who demand a traditional standalone controller box**

Standalone partial pressure display units, which connect directly to RGA mass spectrometers, have been available since the early days of mass spectrometry and are still the preferred display option for many vacuum users.

◆ **RGA users who do not wish to deal with computers, software upgrades and system crashes.**

There is a modern trend to dedicate a PC to every new instrument or sensor in the lab. However, PCs cannot generally be regarded as friendly or reliable in process environments. If you are not interested in dealing with: (1) system crashes, (2) software incompatibilities, (3) hardware incompatibilities, (4) boot-up times, (5) software upgrades, (6) operating system upgrades, (7) software development, (8) computer interfaces, etc, you should consider the PPM100 as an upgrade to your RGA/RGA Windows setup.

## Do I still need RGA Windows?

◆ **PPM100 is not a complete substitute for RGA Windows.**

RGA Windows offers several RGA data display options that are not feasible in a standalone, monochrome display unit as the PPM110. Obvious examples include: bigger screen, color-coded gas traces, fast display update, scan logging, deeper data buffers and hard disk data storage.

RGA Windows is still sometimes required to perform RGA tuning operations such as: (1) mass axis calibration, (2) sensitivity calibration, and (3) E. MULT. gain adjustment. However, RGA users must keep in mind that these procedures are rarely required during routine vacuum measurements.

◆ **PPM100 is not recommended for very fast data acquisition applications**

RGA users interested in fast data acquisition rates (i.e. such as fast-TPD, or laser desorption experiments) must still rely in the faster PC/RGA Windows setup for data acquisition. Consult the factory for specific details.



# PPM100 Specifications

Specifications apply after 1 hour of warm-up

## General

Interfaces	RS-232 (std.), USB (std), GPIB (std) or Ethernet interface with embedded web server.
Power	90 to 264 VAC, 47 to 63 Hz, 240 W
Operating temperature	0°C to 40°C, non-condensing Less than 90% humidity
Weight/Dimensions	15 lbs. / 8.5"x5.25"x16" (WHD)
Warranty	One year parts and labor

## Display

Type	Back-lit, touchscreen LCD (4.7" diag)
Resolution	320 x 240 pixels
Modes	Numeric, bargraph, P vs. T
Units	Torr, mbar, bar, Pa and micron
Numeric resolution	3 digit mantissa plus exponent
Update rate	2 samples per second

## Electrical (20°C to 30°C)

### Analog I/O

Ports	4 configurable analog ports
Range	±12 Vdc
Resolution	14-bit (In), 12-bit (Out)
Update rate	2 Hz
Connector	BNC

## Gauges (Total Pressure)

### Capacitance Manometer

Number of gauges	Simultaneous readout of up to four capacitance manometers using the auxiliary inputs.
Auxiliary power output	±15 Vdc, 100 mA (for CM power)

### Process Control

Number of channels	8 channels with programmable setpoint, polarity, hysteresis, delay, audio signal and text messages.
Input signals	Total pressure (CM gauge), partial pressure (RGA), voltage (I/O ports), time (internal clock), TTL and gauge status.
Output signals	Relay and TTL level
Relays	SPDT, form C, 5A/250VAC/30VDC, resistive load
TTL outputs	Active low, opto-isolated
Manual control	All channels can be operated from front panel.
Remote TTL control	7 opto-isolated TTL channels (Fil on/off, Degas on/off, Fil lockout, Control keypad lockout, data logging time reset, touchscreen enable/disable, remote enable/disable)