

Operation and Service Manual

# **SIM Prototype Kits**

---

**SIM9B1 & SIM9B2**



**Stanford Research Systems**

---

Revision 1.0 • April 3, 2009

---

## Certification

Stanford Research Systems certifies that this product met its published specifications at the time of shipment.

## Warranty

This Stanford Research Systems product is warranted against defects in materials and workmanship for a period of one (1) year from the date of shipment.

## Service

For warranty service or repair, this product must be returned to a Stanford Research Systems authorized service facility. Contact Stanford Research Systems or an authorized representative before returning this product for repair.

Information in this document is subject to change without notice.

Copyright © Stanford Research Systems, Inc., 2009. All rights reserved.

Stanford Research Systems, Inc.  
1290-D Reamwood Avenue  
Sunnyvale, CA 94089 USA  
Phone: (408) 744-9040 • Fax: (408) 744-9049  
**www.thinkSRS.com • e-mail: info@thinkSRS.com**

Printed in U.S.A.

Document number 9-01642-903



*SIM9B1 & SIM9B2 SIM Prototype Kits*

---

# Contents

---

<b>General Information</b>	<b>iii</b>
Service and warranty . . . . .	iii
Preparation for use . . . . .	iii
Symbols . . . . .	iv
Specifications . . . . .	v
<b>1 SIM Mechanical Interface</b>	<b>1-1</b>
1.1 Exterior Specifications . . . . .	1-2
1.2 Main PCB . . . . .	1-3
1.3 Daughter Boards . . . . .	1-3
1.4 Blank Panels . . . . .	1-7
1.5 Bill of Materials . . . . .	1-10
<b>2 Circuit Guidelines</b>	<b>2-1</b>
2.1 Connector Specification . . . . .	2-2
2.2 Connector Pin-out . . . . .	2-2
2.3 Special Topics . . . . .	2-3



---

## General Information

---

The SIM9B1 and SIM9B2 Prototyping Kits, part of Stanford Research Systems' Small Instrumentation Modules family, offers users a convenient path to integrating custom circuits into an existing SIM900 Mainframe system.

Two models are available. SIM9B1 is a single-wide blank module, while SIM9B2 is a double-wide blank module. In their as-delivered form from the factory, these are immediately usable as empty-slot fillers for the SIM900 Mainframe. For users wishing to populate these with custom circuits, the following chapters provide details on the mechanical and electrical interfaces.









## Service and Warranty

While the SIM9B1 and SIM9B2 are provided with the intention of user customization, Stanford Research Systems is unable to provide *any* service or repair of customized modules. Warranty coverage for these products extends *only* for unmodified products, and covers defects in materials and workmanship.

## Preparation for use

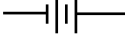
The SIM9B1 and SIM9B2 modules are designed to be used inside the SIM900 Mainframe. Do not turn on the power to the SIM900 until the module is fully inserted into the mainframe and locked in place.

### Symbols you may Find on SRS Products

Symbol	Description
	Alternating current
	Caution - risk of electric shock
	Frame or chassis terminal
	Caution - refer to accompanying documents
	Earth (ground) terminal
	Battery
	Fuse
	On (supply)
	Off (supply)

## Specifications

Interface	Serial (RS-232) through SIM interface
Connectors	DB-15 (male) SIM interface
Weight	1.2 lbs (SIM9B1), 1.4 lbs (SIM9B2)
Dimensions	1.5" W × 3.6" H × 7.0" D (SIM9B1), 3.0" W × 3.6" H × 7.0" D (SIM9B2)





---

# 1 SIM Mechanical Interface

---

There are two basic design options for a SIM prototype module: single-wide (SIM9B1) or double-wide (SIM9B2). The exterior mechanical interfaces for both sizes are fixed, and will only briefly be reviewed here. Of greater interest to the SIM designer are the internal mechanical interfaces for mounting the main PCB, locating the 15-pin D connector, and so on.

## In This Chapter

<b>1.1</b>	<b>Exterior Specifications</b> . . . . .	<b>1-2</b>
<b>1.2</b>	<b>Main PCB</b> . . . . .	<b>1-3</b>
1.2.1	Fixed component locations . . . . .	1-3
1.2.2	Clearance . . . . .	1-3
<b>1.3</b>	<b>Daughter Boards</b> . . . . .	<b>1-3</b>
1.3.1	Single-wide, SIM9B1 . . . . .	1-3
1.3.2	Double-wide, SIM9B2 . . . . .	1-6
<b>1.4</b>	<b>Blank Panels</b> . . . . .	<b>1-7</b>
<b>1.5</b>	<b>Bill of Materials</b> . . . . .	<b>1-10</b>

## 1.1 Exterior Specifications

*all units are inches*

The overall depth of a SIM module is 7.000, the overall height is 3.600. The single-wide module is 1.460 wide, while the double-wide is 2.960 wide. The slots in the Mainframe are on a 1.500 pitch.

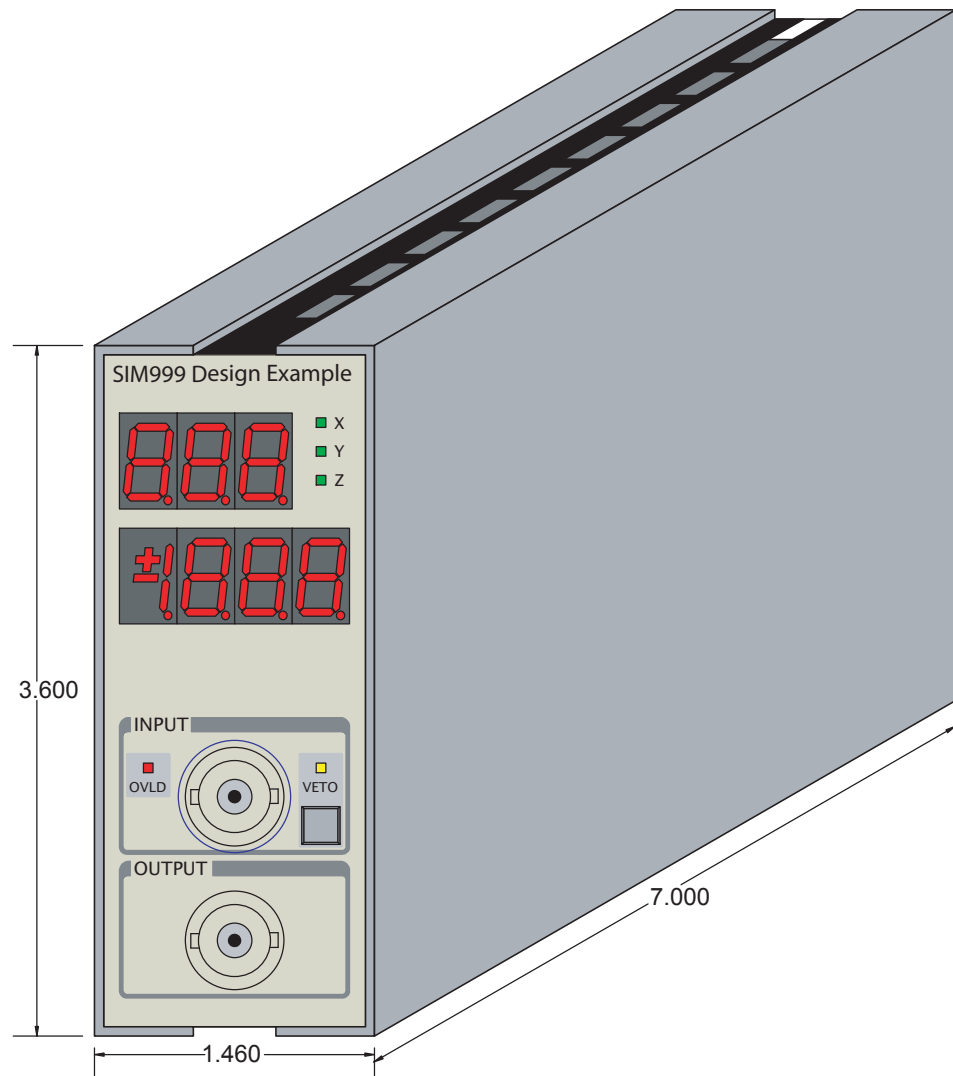

Figure 1.1: Isometric sketch of a generic single-wide SIM module.

The backmost bottom ventilation slot is used as a catch for the Mainframe retention latch. Towards the end of the inwards travel as a module is inserted, the latch is deflected down by the module center bracket. This part of the module bracket is an unpainted, bright nickel plated patch which will establish chassis ground before any pins on the DB-15 connector mate. Once the module is fully inserted,

the latch is captured in the slot. The latch might extend slightly into the interior volume of the module, perhaps as much as 0.025.

## 1.2 Main PCB

If installing a custom printed circuit board (PCB), the module hardware has fixed mounting points for holding the board and its key component, the DB-15 connector. Figure 1.2 gives the dimensions and key locations for “full size” PCB installation in either the single-wide SIM9B1 or the double-wide SIM9B2.

Figure 1.3 provides orientation for the mounting of the PCB and DB-15 connector inside the module.

### 1.2.1 Fixed component locations

Figure 1.2 gives coordinates for all key components on the main PCB. The four mounting holes on the board are fixed relative to the module brackets, and lie on a square with  $x = 2.031$  &  $4.656$  and  $y = 0.188$  &  $3.008$ . The DB-15 connector *must* be located with pin-1 at  $(x = 0.391, y = 0.398)$  and placed on the bottom side of the board to properly align with the module rear panel.

### 1.2.2 Clearance

The clearance from the top side of the main PCB (the “component” side) to the interior wall of the module outer skin is nominally 0.252. This gives room for most surface mount components. Bulky through-hole components need to be mounted on the bottom side of the PCB (the “wire” side).

Beneath each mounting hole is a steel tab from the module bracket (see hashed blocks in Figure 1.2). This tab extends 0.156 inwards from the center of the mounting hole, and  $\pm 0.188$  to either side of the center. You must not place any components on the bottom side of the board where they will interfere with these tabs.

## 1.3 Daughter Boards

Most user prototype circuits will fit entirely on a single main PCB. In cases where either complexity or performance requires additional circuit boards, this section documents several mounting and interface options.

### 1.3.1 Single-wide, SIM9B1

The single-wide module bracket has symmetric mounting tabs to hold two parallel PCB's: the main PCB (with the rear panel DB-15)

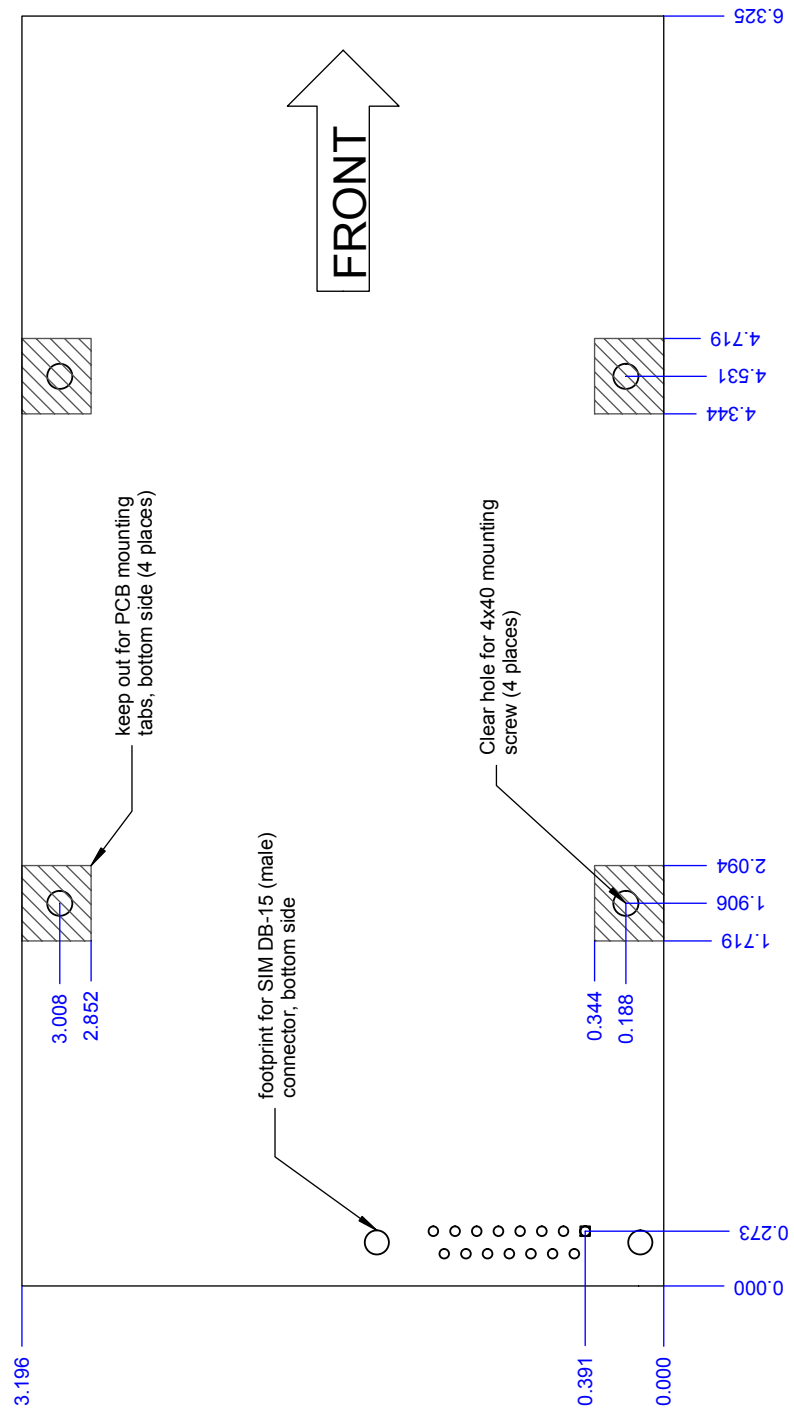

Figure 1.2: Layout dimensions for main PCB.

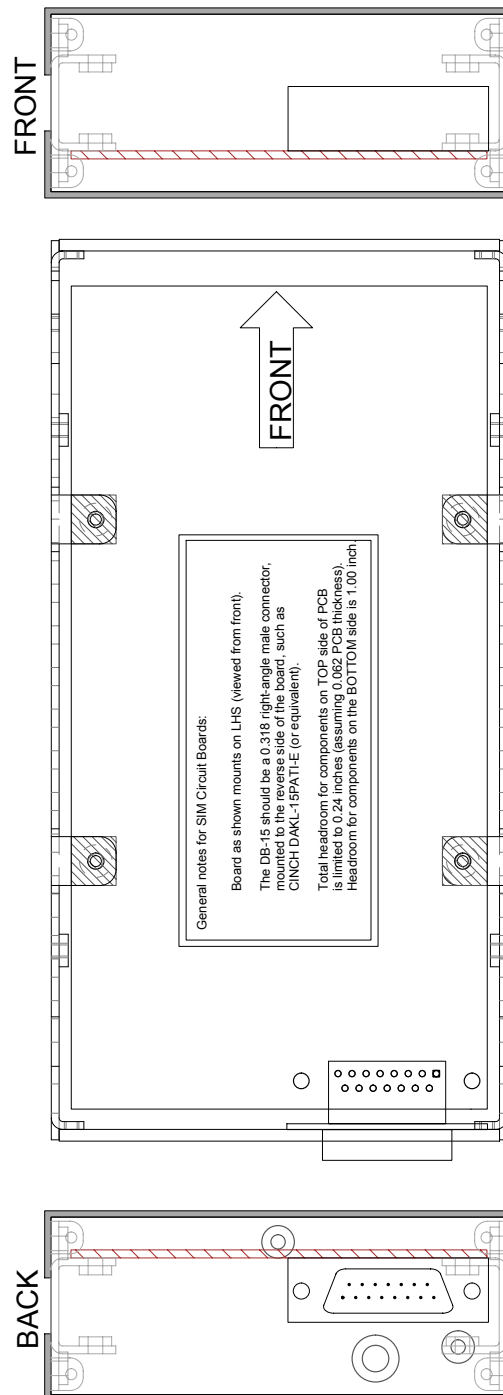

Figure 1.3: Configuration of main PCB in assembled module.

on one side, and a daughter board on the opposite side. The face-to-face separation between the boards is 0.736 (Figure 1.4).

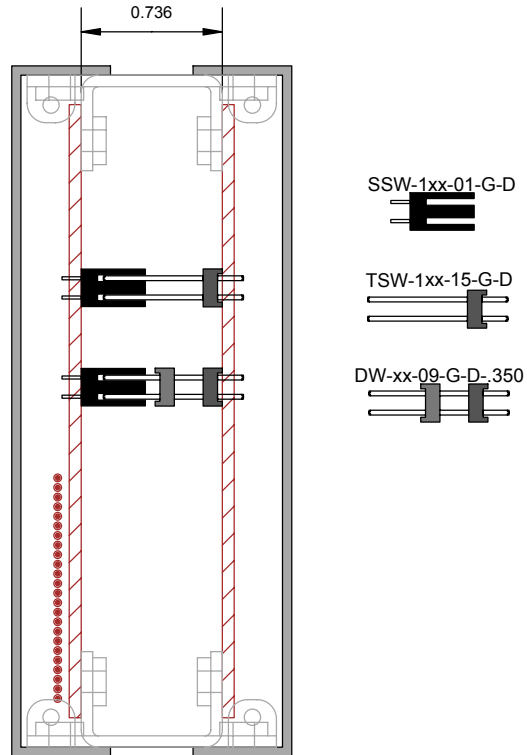

Figure 1.4: Single-wide module with daughter board. Two header options are shown.

Two possible interconnect schemes are also suggested in the figure, both based on SAMTEC 0.100 headers. The upper scheme uses a dual-inline (DIL) header with extra long pins (option 15 in the part number), while the lower one uses a “board stacker” header (a second polymer block holds the pins stable). This second option will likely cost more, but the pins will be more stable for the blind mating of the two boards.

### 1.3.2 Double-wide, SIM9B2

The double-wide module bracket has unique top and bottom parts, with board-mounting tabs only on the module left-hand side (for supporting the main PCB). The suggested method for mounting is to use a set of 0.625 female-female threaded standoffs to support a daughter board to the interior side of the main board tabs (see Figure 1.5). Long mounting screws are used on the main PCB (5/16 min. length) to come *through* the PEM nut and into the standoff; the daughter board is then screwed to the interior side of the standoffs.

Be careful when removing the screws holding the main PCB; these will be “jammed” by the combined threads of the PEM nut and standoff. The daughter board might need to be removed first, and then the standoff loosened, before removing the main PCB, so as to not strip the screws.

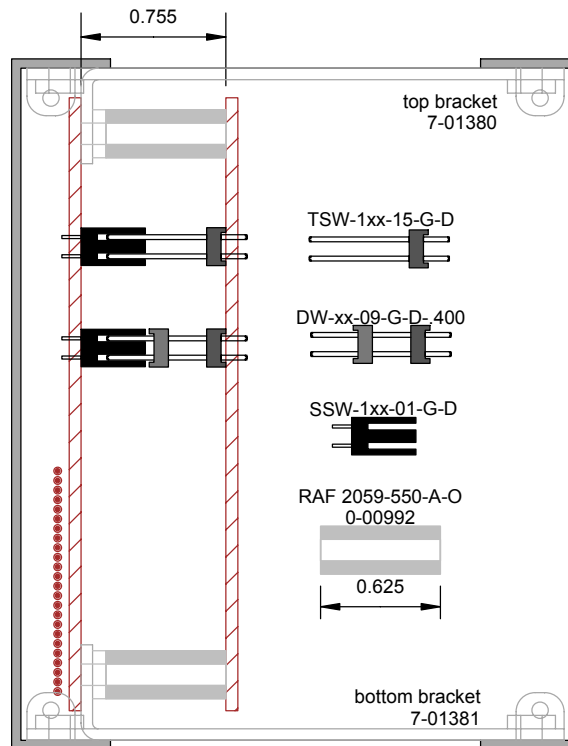

Figure 1.5: Double-wide module with daughter board. Two header options are shown. If a larger board-to-board gap is needed, substitute 0-993 (11/16 standoff) in place of 0-992 (5/8 standoff), and TSW-1xx-17 for TSW-1xx-15 (longer header); this will change the gap from 0.755 to 0.817.

The same two interconnect schemes are possible as before; using the PEM hardware, the face-to-face board separation is slightly greater than the single-wide case. For the double-wide, this gap is 0.755.

Other schemes, such as transverse daughter boards, are possible.

## 1.4 Blank Panels

The prototype kits, SIM9B1 and SIM9B2, are each provided with two blank front panels. Users can modify these parts to accommodate connectors such as BNC or D-connectors, to interface custom circuitry with external signals.

While it is also possible to modify the rear panels for user connections, SRS recommends minimizing this practice for custom modules. Additional blank front and rear panels are available.



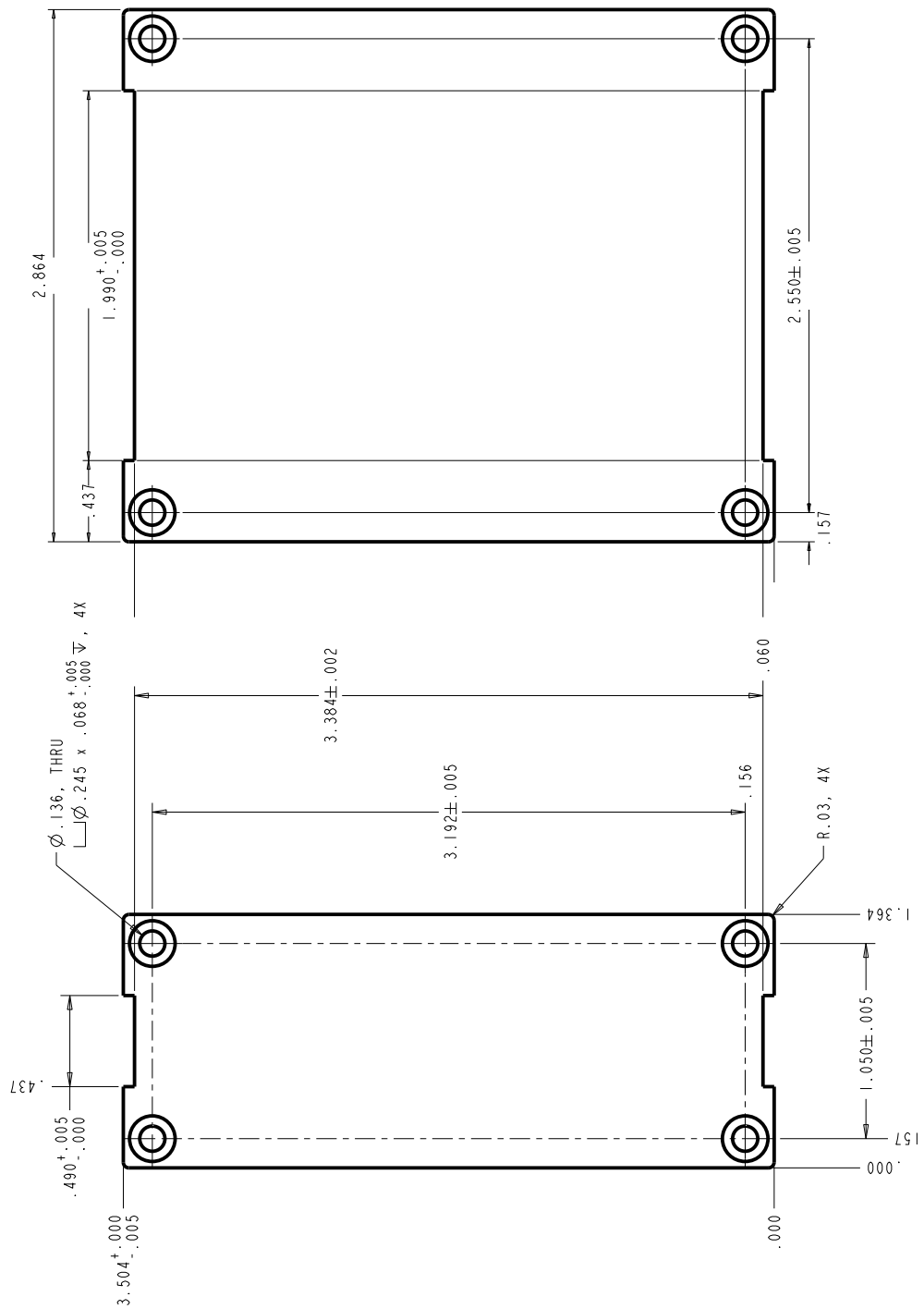

Figure 1.6: Single-wide and double-wide blank front panels.

## 1.5 Bill of Materials

The complete list of components for assembling a SIM9B1 or SIM9B2 are tabulated below.

Table 1.1: Items for single-wide BOM.

Item	Q/ea	Reference	SRS P/N	Value	comment
1	4	PCB mounting	0-00187	4-40×1/4PP	(not included)
2	4	PCB mounting	0-00096	#4 split wash	(not included)
3	2	DB-15 mounting	0-00835	4-40×3/8PF	Undercut
4	4	Front panel mounting	0-00148	4-40×1/8,PS	slotted; Phillips will NOT fit
5	4	Rear panel mounting	0-00515	4-40×1/8PP	
6	8	Module cover mounting	0-00371	4-40×3/16P	Black undercut flathead Phillips
7	1	DB-15 connector	1-00367	DB-15	Male, RA, 0.318 footprint
8	1	Front panel, SIM9B1	7-02082		Module front panel
9	1	Rear panel, SIM9B1	7-02083		Module rear panel
10	2	SIM 1× bracket	7-00933		single-wide top/bottom bracket
11	2	SIM module cover	7-00932		
12	4	Foot	0-00188	SR550foot	

Table 1.2: Items for double-wide BOM.

Item	Q/ea	Reference	SRS P/N	Value	comment
1	4	PCB mounting	0-00259	4-40×1/2PP	(not included)
2	4	PCB mounting	0-00096	#4 split wash	(not included)
3	2	DB-15 mounting	0-00835	4-40×3/8PF	Undercut
4	4	Front panel mounting	0-00148	4-40×1/8,PS	slotted; Phillips will NOT fit
5	4	Rear panel mounting	0-00515	4-40×1/8PP	
6	8	Module cover mounting	0-00371	4-40×3/16PF	Black undercut flathead Phillips
7	1	DB-15 connector	1-00367	DB-15	Male, RA, 0.318 footprint
8	1	Front panel, SIM9B2	7-02085		Module front panel
9	1	Rear panel, SIM9B2	7-02086		Module rear panel
10	1	SIM 2× top brkt	7-01380		double-wide top bracket
11	1	SIM 2× btm brkt	7-01381		double-wide bottom bracket
12	2	SIM module cover	7-00932		
13	4	Foot	0-00188	SR550foot	

---

## 2 Circuit Guidelines for SIM Designs

---

While the function-specific aspects of each SIM's circuitry will in general be unique, all modules must conform to the same *interface* specification for compatibility with the SIM Mainframe.

### In This Chapter

<b>2.1</b>	<b>Connector Specification</b>	<b>2-2</b>
<b>2.2</b>	<b>Connector Pin-out</b>	<b>2-2</b>
<b>2.3</b>	<b>Special Topics</b>	<b>2-3</b>
2.3.1	Grounding	2-3
2.3.2	Power	2-3
2.3.3	Timing reference	2-4
2.3.4	Asynchronous communications	2-5
2.3.5	Status	2-5

## 2.1 Connector Specification

All SIM modules have a 15-pin D connector as their primary interface to the “rest of the world.” This section describes that interface.

The connector is a “0.318 footprint” right-angle PCB-mounted DSub-15 male, Cinch part number DAKL-15PATI-E (SRS stock number 1-00367). For serial communication, the SIM acts as Data Communications Equipment (DCE), while the Mainframe acts as Data Terminal Equipment (DTE) towards the SIM.

## 2.2 Connector Pin-out

Pin	Signal	Direction Src ⇒ Dest	Description
1	SIGNAL_GND	MF ⇒ SIM	Reference only; should carry no current
2	-STATUS	SIM ⇒ MF	Status/service request (GND=asserted, +5V=idle)
3	RTS	MF ⇒ SIM	HW Handshake (+5V=talk; GND=stop)
4	CTS	SIM ⇒ MF	HW Handshake (+5V=talk; GND=stop)
5	-REF_10MHZ	MF ⇒ SIM	10 MHz reference clk (complement of pin-12)
6	-5V	MF ⇒ SIM	Power supply (typ. for fast electronics)
7	-15V	MF ⇒ SIM	Power supply (typ. for quiet electronics)
8	PS_RTN	MF ⇒ SIM	Power supply return (GND)
9	CHASSIS_GND		Chassis ground
10	TXD	MF ⇒ SIM	Async data (start bit="0"=+5V; "1"=GND)
11	RXD	SIM ⇒ MF	Async data (start bit="0"=+5V; "1"=GND)
12	+REF_10MHZ	MF ⇒ SIM	10 MHz reference clk (complement of pin-5)
13	+5V	MF ⇒ SIM	Power supply (typ. for fast electronics)
14	+15V	MF ⇒ SIM	Power supply (typ. for quiet electronics)
15	+24V	MF ⇒ SIM	Power supply (typ. for maximum power)

The serial data signals (RXD, TXD, CTS, RTS) follow standard RS-232 polarity conventions, but are implemented as 0, +5V HC logic levels. The SIM900 Mainframe defaults all slots to 9600 baud, but a wide range of baud rates is available under program control—users should consult the SIM900 Mainframe documentation for further details.

The -STATUS signal is terminated with a 100kΩ pull-up resistor in the Mainframe. If a module has *no* microcontroller intelligence on-board, it can either drive -STATUS with a gate or open-collector to indicate a single-bit message (such as overload), or can hard-wire -STATUS to GND as a simple presence detect function. In any case, the precise meaning of -STATUS is SIM module specific. Pulses on -STATUS must be at least 10 μs duration to guarantee detection by the Mainframe.

## 2.3 Special Topics

Special topics on grounding, power supplies, timebase, and communications are discussed here. Depending on the custom application, users may find some parts of this section helpful.

### 2.3.1 Grounding

The SIM interface dedicates 3 of the 15 pins to ground, and within the SIM Mainframe all three of these pins are tied common to the Mainframe's ground. When plugged into an internal slot in the mainframe, only the contact resistance across the DB-15 connector will separate these grounds, but when connected to a 15-pin cable the difference can be more significant. The suggested uses for these pins are:

- PS\_RTN is intended to carry the bulk of the return current for a module. At the least, all the fast digital circuitry (including any oscillator and microcontroller) should return to this pin.
- CHASSIS\_GND should be tied to the external chassis of the SIM module. In most modules, CHASSIS\_GND and PS\_RTN will be tied together in the module as well, making this pin appear somewhat redundant. In a high-power or high-speed module, where PS\_RTN might “bounce” around a bit, having the separate CHASSIS\_GND wire may help keep the module chassis from bouncing around too much.

There might also be a safety issue here, but generally we expect SIM modules to be low voltage, low power (read: safe) instruments.

- SIGNAL\_GND is the “clean” ground. Broadly, there are two uses for it, depending on the application. First, SIGNAL\_GND can be dedicated as an unburdened zero-volts reference potential for single-ended signals. A second and loosely related use is as an analog ground net for quiet circuitry. The only distinction between these two uses is the DC ohmic drop in SIGNAL\_GND due to the returned analog current.

### 2.3.2 Power

The SIM interface provides 5 distinct supply voltages to the modules:  $\pm 5V$ ,  $\pm 15V$ , and  $+24V$ . The connectors are specified for up to 5 amps on a pin, but good design should be well below that level. Within the Mainframe, each voltage is separately decoupled with a large ferrite bead and a  $4.7\mu F$  tantalum capacitor; between any pair of slots, these components will act as a pi-filter to partially isolate

conducted noise between modules. The SRS reference design for modules calls for mirroring this bead/capacitor network right at the DB-15 connector, but this is application specific. Unused supplies can be left unconnected within the module.

- +5V: This is the main digital supply to a module. The microcontroller and associated logic are intended to be powered from here. Note, however, this supply is independently regulated from the SIM Mainframe internal VCC supply (separate 3-terminal regulators). If a module requires a small amount of +5 V, it might be good to generate it locally with a linear regulator down from +15 V. The +5 V supply is created in the Mainframe with a 5-amp linear regulator; these 5 amps must be shared among the assorted modules. A “good” design will use less than 0.5 A of +5 V, but if you need more, it’s available.
- –5 V: This supply is primarily for high-speed applications, either to provide symmetric  $\pm 5$  V for fast amplifiers, or as a  $V_{EE}$  supply for fast ECL logic. This supply has a total of 3 amps capacity.
- $\pm 15$  V: These are intended as the quiet supplies for analog circuitry. They are both produced with 3 A linear regulators in the Mainframe. If your design will present a significant AC load from either of these supplies, you should be careful to adequately bypass.
- +24 V: Unlike the other 4 supplies, +24 V is *not* generated by the Mainframe DC-to-DC power supply. Rather, it is passed through directly from the universal-input switching supply that provides primary power for the Mainframe. The present Mainframe design has a 4.5 A +24 V supply. Since it does not come from the DC-to-DC supply, the +24 V is by far the most efficient supply available to the modules, and any significant power circuits should be operated from it if possible. Since it does not come from a linear regulator, though, it has the worst ripple of any of the supplies. The cooling fan in the Mainframe is also operated from this supply.

SIM modules do not require the Mainframe for operation: the user should be able to provide DC power to the 15-pin connector. To keep this option as viable as possible, module designers may want to consider minimizing the number of distinct supply voltages used.

### 2.3.3 Timing reference

The  $\pm$ REF.10MHZ signals are complementary 0–5V square waves provided by the SIM Mainframe for clock synchronization. The

two motivations for providing these signals are (1) to distribute a known good timebase from the Mainframe to timing-sensitive modules, such as function generators, and (2) to avoid drifting beat-note effects between free-running oscillators in different modules at (nominally) the same frequency. Remember that all SIM modules must be able to work independent of the Mainframe, so a good design will not *require* the REF\_10MHZ signals for operation. Custom user applications may deviate from this design rule, if operation in the SIM900 Mainframe is always assured.

For custom designs that depend on the REF\_10MHZ signals for operation, users should be careful that the signals are enabled on the SIM900 Mainframe. Switch 2 on the rear-panel DIP switch should be in the “on” position to guarantee distribution of the  $\pm$ REF\_10MHZ signals.

Since a module could be operated at the end of a cable from the Mainframe, keeping the load on +REF\_10MHZ and -REF\_10MHZ balanced will minimize the common-mode 10 MHz power appearing on the cable.

#### 2.3.4 Asynchronous communications

SIM modules communicate with a user’s computer through the SIM Mainframe using an RS-232 style asynchronous protocol. UART hardware built into most microcontrollers provides the actual bit-shifting function, while hardware flow control is implemented in firmware. Unlike true RS-232, signal levels are 0 & +5 V; signal *polarity*, however, follows the RS-232 convention.

A special device-clear signal can be sent from the Mainframe to a module by asserting the  $\langle$ break $\rangle$  signal After Reset or device-clear, communications should default to 9600/8/N/1/RTS-CTS.

#### 2.3.5 Status

The -STATUS signal is a one-bit “out-of-band” message that a SIM module can send to the Mainframe to indicate that some pre-defined event has occurred. Modules manufactured by SRS typically implement the IEEE-488.2 status model; for these modules the -STATUS signal is controlled by the Status Byte register.

Module designers are free to re-define -STATUS to reflect any appropriate single-bit message, such as Overload or Triggered. See page 2-2 for discussion of driving the -STATUS signal.