

User's Manual

Model SR844 RF Lock-In Amplifier



1290-D Reamwood Avenue
Sunnyvale, California 94089
Phone: (408) 744-9040 • Fax: (408) 744-9049
email: infor@thinkSRS.com • www.thinkSRS.com

Copyright © 1997, 2007, 2013 by SRS, Inc.
All Rights Reserved.

Revision 2.8 (11/2013)

Certification

Stanford Research Systems certifies that this product met its published specifications at the time of shipment. Stanford Research Systems further certifies that its calibration measurements are traceable to the United States National Institute of Standards and Technology (NIST).

Warranty

This Stanford Research Systems product is warranted against defects in materials and workmanship for a period of one (1) year from the date of shipment.

Service

For warranty service or repair, this product must be returned to a Stanford Research Systems authorized service facility. Contact Stanford Research Systems or an authorized representative before returning this product for repair.

Information in this document is subject to change without notice.

Copyright © Stanford Research Systems, Inc., 1997, 2007, 2013. All rights reserved.

Stanford Research Systems, Inc.
1290-D Reamwood Avenue
Sunnyvale, California 94089

Printed in U.S.A.

Safety and Preparation For Use

WARNING! Dangerous voltages, capable of causing injury or death, are present in this instrument. Use extreme caution whenever the instrument cover is removed. Do not remove the cover while the unit is plugged into a live outlet.

Caution This instrument may be damaged if operated with the LINE VOLTAGE SELECTOR set for the wrong AC line voltage or if the wrong fuse is installed.

Line Voltage Selection The SR844 operates from a 100V, 120V, 220V, or 240V nominal AC power source having a line frequency of 50 or 60 Hz. Before connecting the power cord to a power source, verify that the LINE VOLTAGE SELECTOR card, located in the rear panel fuse holder, is set so that the correct AC input voltage value is visible.

Conversion to other AC input voltages requires a change in the fuse holder voltage card position and fuse value. Disconnect the power cord, open the fuse holder cover door and pull the fuse-pull lever to remove the fuse. Remove the small printed circuit board and select the operating voltage by orienting the printed circuit board so that the desired voltage is visible when the circuit board is pushed firmly into its slot. Push the fuse-pull lever back into its normal position and insert the correct fuse into the fuse holder.

Line Fuse Verify that the correct line fuse is installed before connecting the line cord. For 100V/120V, use a 1 Amp fuse and for 220V/240V, use a 1/2 Amp fuse.

Line Cord The SR844 has a detachable, three-wire power cord for connection to the power source and to a protective ground. The exposed metal parts of the instrument are connected to the outlet ground to protect against electrical shock. Always use an outlet which has a properly connected protective ground.









Service Do not attempt to service or adjust this instrument unless another person, capable of providing first aid or resuscitation, is present.

Do not install substitute parts or perform any unauthorized modifications to this instrument. Contact the factory for instructions on how to return the instrument for authorized service and adjustment.

Fan The fans in the SR844 are required to maintain proper operation. Do not block the vents in the chassis or the unit may not operate properly.

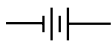
Warning! **Regarding Use With Photomultipliers and Other Detectors**
The front end amplifier of this instrument is easily damaged if a photomultiplier is used improperly with the amplifier. When left completely unterminated, a cable connected to a PMT can charge to several hundred volts in a relatively short time. If this cable is connected to the inputs of the SR844 the stored charge may damage the front-end op amps. To avoid this problem, always connect the PMT output to the SR844 input before turning the PMT on.

Symbols that may be found on SRS products

Symbol	Description
	Alternating current
	Caution - risk of electric shock
	Frame or chassis terminal
	Caution - refer to accompanying documents
	Earth (ground) terminal
	Battery
	Fuse
	On (supply)
	Off (supply)

Contents

General Information

Safety and Preparation For Use	i
Contents	iii
Specifications	v

Chapter 1 Getting Started

Quick Start	1-3
The Basic Lock-In	1-5
X, Y, R, θ and dBm	1-9
Outputs, Offsets and Expands	1-12
Storing and Recalling Setups	1-18
Aux Outputs and Inputs	1-19

Chapter 2 SR844 Basics

What is a Lock-In Amplifier?	2-3
The Functional SR844	2-8
RF Signal Input Path	2-9
Reference Channel	2-10
I.F. Section	2-11
Inside the DSP	2-12
Analog Outputs and Scaling	2-15
What is Dynamic Reserve ?	2-17
Sources of Error	2-19
Using the SR844 as a Double Lock-In	2-22
Noise Measurements	2-23
Intrinsic (Random) Noise Sources	2-24
External Noise Sources	2-25

Chapter 3 Operation

Overview	3-3
Signal Input	3-8
Time Constants	3-11
Sensitivity	3-13
CH1 Display and Output	3-15
CH2 Display and Output	3-20
Reference Section	3-26
Save and Recall	3-30
Interface	3-31
Scan and Rel	3-33
Auto Functions	3-40
Shift Functions	3-41

Chapter 4 Programming

Index of Commands	4-2
Introduction	4-7
Command Syntax	4-10
Status Register Definitions	4-31
Example Program	4-34

Chapter 5 Testing

Getting Ready	5-3
Self Test	5-5
Amplitude Response	5-7
Phase Response	5-9
Frequency Accuracy	5-11
Ref Out Amplitude	5-13
DC Outputs and Inputs	5-15
Input Noise	5-17
SR844 Performance Test Record	5-19

Chapter 6 Circuitry

Service	6-3
Circuit Board Locations	6-4
Circuit Descriptions	6-6
Parts Lists	6-25
Schematic Diagrams	6-80

Specifications

Specifications apply after 30 minutes of warm-up. All specifications are with output filtering enabled (6, 12, 18 or 24 dB/oct) and 2F detection OFF, unless stated otherwise.

Signal Input	
Voltage Input	single-ended BNC.
Input Impedance	50 Ω or 1 M Ω 30 pF.
Damage Threshold	± 5 V (DC+AC)
Bandwidth	25 kHz to 200 MHz.
Full Scale Sensitivity	100 nV to 1V rms in a 1-3-10 sequence.
Gain Accuracy	
< 50 MHz	± 0.25 dB
< 200 MHz	± 0.50 dB
Gain Stability	0.2%/ $^{\circ}$ C
Coherent Pickup	Low Noise Wide Reserve, Sensitivity < 30 mV.
f < 10 MHz	< 100 nV (typical)
f < 50 MHz	< 2.5 μ V (typical)
f < 200 MHz	< 25 μ V (typical)
Input Noise: 50 Ω Input	
100 kHz < f < 100 MHz	2 nV/ $\sqrt{\text{Hz}}$ (typical), < 4 nV/ $\sqrt{\text{Hz}}$ (max).
25 kHz < f < 200 MHz	< 5 nV/ $\sqrt{\text{Hz}}$ (typical), < 8 nV/ $\sqrt{\text{Hz}}$ (max).
Input Noise: 1 M Ω Input	
25 kHz < f < 200 MHz	5 nV/ $\sqrt{\text{Hz}}$ (typical), < 8 nV/ $\sqrt{\text{Hz}}$ (max).
Dynamic Reserve	> 60 dB (expand off)

Reference	
External Reference Input	25 kHz to 200 MHz.
Impedance	50 Ω or 10 k Ω 40 pF.
Level	0.7 Vpp digital or 0 dBm sinusoidal signal.
Pulse Width	> 2 ns at any frequency.
Threshold Setting	Automatic, set to midpoint of waveform extrema.
Acquisition Time	< 10 s (auto-ranging, any frequency). < 1 s (within same octave).
Internal Reference Oscillator	25 kHz to 200 MHz.
Frequency Resolution	3 digits.
Frequency Accuracy	± 0.1 in the 3rd digit.
Phase Noise	-90 dBc/Hz at f=100 MHz, $\Delta f=100$ Hz.
Reference Outputs	Phase locked to either Internal or External reference.
Front Panel Ref Out	25 kHz to 200 MHz square wave, 1.0 Vpp nominal into 50 Ω .
Rear Panel TTL Out	25 kHz to 1.5 MHz, 0 to +5 V nominal, ≥ 3 V into 50 Ω .
Harmonic Detect	Detect at 50 kHz $\leq 2 \times$ Reference ≤ 200 MHz.
Phase Resolution	0.02 $^{\circ}$
Absolute Phase Error	
< 50 MHz	< 2.5 $^{\circ}$
< 100 MHz	< 5.0 $^{\circ}$
< 200 MHz	< 10.0 $^{\circ}$

Reference	
Relative Phase Error, Orthogonality	< 2.5°
Phase Noise	0.005° rms at 100 MHz, 100 ms time constant.
Phase Drift	
< 10 MHz	< 0.1°/°C
< 100 MHz	< 0.25°/°C
< 200 MHz	< 0.5°/°C

Demodulator	
Zero Stability	Digital displays have no zero drift. Analog outputs have < 5ppm/°C drift for all dynamic reserve settings.
Filtering	
Time Constants	100 μs to 30 ks with 6, 12, 18 or 24 dB/octave roll-off.
None	10 to 20 μs update rate (X and Y outputs), 60 μs (R and θ outputs).
Harmonic Rejection	
Odd Harmonics	-10 dBc @ 3×Ref, -14 dBc @ 5×Ref, etc.
Other Harmonics and Sub-harmonics	< -40 dBc
Spurious Responses	-10 dBc @ Ref ± 2×IF -23 dBc @ Ref ± 4×IF < -30 dBc otherwise.

Displays			
	Channel 1	Channel 2	Reference
Type	4½ digit LED	4½ digit LED	4½ digit LED
Displayed Quantities	X	Y	Reference Frequency
	R [Volts]	θ [degrees]	Reference Phase
	R [dBm]	Y-noise [Volts]	Aux Output Voltages
	X-noise	Y-noise [dBm]	Offsets in % of Full Scale
	AUX IN 1	AUX IN 2	IF Frequency
			Elapsed Settling Time
Ratio	The signal may be ratioed with respect to AUX IN 1 or 2. The ratio is applied to both X and Y before computation of R, R[dBm], X-noise, Y-noise [V, dBm] and so affects all of these quantities. The ratio input is normalized to 1 V and has a dynamic range > 100.		
Expand	The CH1 and CH2 displays and outputs may be expanded by ×10 or ×100.		

CH1 and CH2 Outputs	
Connectors	Front Panel BNC.
Voltage Range	±10V full scale proportional to X, Y or CH1, CH2 displayed quantity. ±11V full scale for phase
Update Rate	
X, Y	48 to 96 kHz
R, θ , Aux Inputs	12 to 24 kHz
X Noise, Y Noise	512 Hz

Aux Inputs and Outputs	
Connectors	Rear Panel BNC.
Inputs	2
Type	Differential with 1 M Ω input impedance on both signal and shield.
Range	±10V
Resolution	1/3 mV
Bandwidth	3 kHz
Outputs	2
Range	±10V
Resolution	1 mV

Environmental Conditions	
Operating	Temperature: +10°C to +40°C (Specifications apply over +18°C to +28°C) Relative Humidity: <90% Non-condensing
Non-Operating	Temperature: -25°C to +65°C Relative Humidity: <95% Non-condensing

General	
Furnished Accessories	Power Cord Operating Manual
Interfaces	IEEE-488.2 and RS232 interfaces standard. All instrument functions can be controlled and read through either interface.
Power	70 Watts, 100/120/220/240 VAC, 50/60 Hz.
Dimensions	17" W x 5.25" H x 19.5" D
Weight	23 lb.
Warranty	One year parts and labor on materials and workmanship.

Chapter 1

Getting Started

The tutorials in this chapter are designed to acquaint the first time user with the SR844 RF Lock-In Amplifier. The functions and features of the SR844 are grouped together into several short tutorials. You may choose to do the tutorials selectively depending on your level of experience and your measurement needs. Do not be concerned that your measurements do not agree exactly with the printed values in the manual; the focus of these exercises is to learn how to use the instrument.

For all of the tutorials it is expected that you have installed the instrument with the line voltage setting appropriate to the AC power available. If you have not done so, please see the section *Line Voltage Selection* under **Safety and Preparation for Use** (page i) before proceeding further.

The experimental procedures are detailed in two columns. The left column lists the actual steps to be performed. The right column is an explanation of each step. The front panel **Keys**, **Knob** and **READOUTS** are denoted in special fonts. Indicators are shown in **Bold** and connectors in CAPITALS.

In This Chapter

Quick Start	1-3
The Basic Lock-In	1-5
X, Y, R, θ and dBm	1-9
Outputs, Offsets and Expands	1-12
Storing and Recalling Setups	1-18
Aux Outputs and Inputs	1-19

Quick Start

This section will lead you through the most basic setup and use of the SR844 RF lock-in amplifier. You *must* have selected the line voltage (page i) and connected AC power in order to proceed further.

For this section you will need one BNC cable.

1	Disconnect all cables from the SR844. Check that the power cord is connected.	
2	Turn the power on while holding down the Setup key.	If the Setup key is pressed during power-on, the instrument performs power-on tests and returns to its factory preset settings.
3	Wait until the power-on tests are completed.	<p>The instrument first displays <i>SR844</i> followed by the unit's serial number (CH1 and CH2 displays) and the firmware revision number (Reference display).</p> <p>Several tests are performed after this. The message <i>DATA TEST PASS</i> follows a read/write test to the processor RAM. <i>BATT TEST PASS</i> refers to a test of the battery-backed-up memory. <i>PROG TEST PASS</i> follows a test of the instrument program ROM. <i>DSP TEST PASS</i> refers to the Digital Signal Processor (DSP). <i>RCAL STD SET</i> is shorthand for Recall Standard Setup (factory defaults). Normally, the Setup button is not pressed during power-up and the last message will instead be <i>RCAL USER SET</i>, which means that the previous User's setup has been recalled.</p>
4	If any of the tests <i>FAIL</i> , try power-on once more with the Setup button held down. If the test <i>FAILs</i> again, note the ROM version and Serial Number and contact either the factory or your local representative.	
5	Connect REF OUT on the front panel to the SIGNAL IN with the BNC cable.	The SR844 defaults to the internal oscillator set at 1.00 MHz. The reference mode is indicated by the INTERNAL LED . In this mode the SR844 generates a reference signal at the selected frequency and detects input signals in phase and in quadrature with this reference. A 1.0 Vpp square wave reference signal is available at REF OUT.

1-4 Quick Start

	<p>At 1 MHz, a quarter wavelength is roughly 50 meters of BNC cable. Your BNC cable is probably a lot shorter than this, so the signal input is close to being in phase with the reference.</p>
6 Check the readings on the front panel displays.	<p>Press CH1 Display to select R [dBm]. The R[dBm] display on CH1 should read +5.6 to +9.6 dBm.</p>

The Basic Lock-In

This measurement is designed to use the internal oscillator to explore some of the basic lock-in operations. You should already be familiar with the fundamentals of lock-in detection. See Chapter 2 for a discussion of the basics of lock-in measurements.

Specifically, you will measure the amplitude of the reference oscillator at various frequencies, sensitivities, time constants and phases. You will need a BNC cable for this section.

<p>1 Disconnect all cables from the SR844.</p> <p>If the power is off, turn it on. Wait for self-tests to complete.</p>	<p>Turn on the unit.</p>
<p>2 Press Shift then Recall (PRESET) to restore factory presets.</p>	<p>We will start with the unit in its factory preset configuration.</p> <p>The factory preset configuration is Internal Reference mode (shown by the INTERNAL LED) at 1.00 MHz, shown on the Reference display.</p> <p>The time constant is 100 ms (shown by the time constant indicators 1, ×100 and ms above the Time Constant Up/Down keys) and the sensitivity is 1 V rms (the indicators are below the Sensitivity Up/Down keys).</p>
<p>3 Connect REF OUT on the front panel to the SIGNAL IN with the BNC cable.</p>	<p>The SR844 reference output (1.0 Vpp nominal square wave into 50 Ω) is within the unit's measurement range (1 Vrms) so we can connect it directly to the input. The SR844 input impedance is set to 50 Ω (shown by the 50 Ω indicator) which is appropriate for the REF OUT.</p> <p>The BNC cable has a small phase shift at 1 MHz (the free-space wavelength is 300 m), so the input signal should be mostly X (in-phase) with a small Y (quadrature) component.</p> <p>The CH1 Display is set to X and should show something close to 0.54 V. The CH2 display is set to Y and should show less than ±0.05 V.</p>

1-6 The Basic Lock-In

	<p>Remember, the signal is a 0.5 Vpk (1.0 Vpp) square wave. A square wave is composed of signals at all odd harmonics. The SR844 is a square wave detecting lock-in and detects all of the odd harmonics of the fundamental. The amplitude of the fundamental (at 1.00 MHz) is $4/\pi \times \text{Vpk}$. The contribution from all odd harmonics is</p> $1 + (1/3)^2 + (1/5)^2 + (1/7)^2 + \dots \approx 1.19$ <p>The detected amplitude is $4/\pi \times 0.5 \text{ Vpk} \times 1.19$ or 0.759 Vpk. The SR844 reads the signal in units of Vrms (0.707 \times Vpk) or 0.537 Vrms.</p> <p>The CH1 display may not read exactly 0.54 V for a number of reasons:</p> <ul style="list-style-type: none"> • The REF OUT amplitude is only a <i>nominal</i> specification. • The basic accuracy of the unit is ± 0.25 dB (3%). • Since the phase may not be exactly 0°, $X=R\cos\theta$ is slightly less than R (amplitude).
<p>4 Press Shift then Phase to perform AutoPhase.</p>	<p>This adjusts the reference phase inside the instrument. (The phase at which the signal is detected changes, but Ref Out remains unchanged.) This should set the value of Y (on the CH2 display) to zero.</p>
<p>5 Press Phase.</p>	<p>Display the reference phase. It should be close to zero.</p>
<p>6 Press the +90° key.</p>	<p>This adds 90° to the reference phase. The value of X should drop to near zero, while Y changes to about -0.54 V (negative of the previous X reading).</p>
<p>7 Use the knob to adjust the reference phase until Y is zero and X is equal to the positive amplitude.</p>	<p>While the reference phase is being displayed, the knob can be used to change it. The adjustment described should result in the phase returning to nearly zero again.</p> <p>In general, the knob is used to adjust the quantity displayed in the Reference display (if it can be changed). The keys below the display are used to select the desired quantity.</p>

8	Press Freq.	Now the display shows the reference frequency, still <i>1.00 MHz</i> .
9	Rotate the knob left to get to <i>999 kHz</i> and <i>998 kHz</i> . Rotate the knob right to get to <i>1.01 MHz</i> and <i>1.02 MHz</i> .	The internal frequency may be adjusted with 3-digit resolution. The actual frequency is within 1 count in the 4th digit of the displayed frequency. For example, when set to 4.56 MHz, the actual frequency is within 0.001 MHz of 4.56 MHz.
10	Use the knob to adjust the frequency to <i>96 kHz</i> .	The X reading should vary less than 10%.
11	Press Sensitivity Down .	The sensitivity changes to 300 mV (indicated below the Sensitivity Down key). The OVL indicators in the CH1 and CH2 displays indicate that the readings may be invalid due to an overload condition. OVL indicators in the Input, Time Constant and Sensitivity areas are used to pinpoint the source of the overload.
12	Press Shift then Sensitivity Up to perform AutoSensitivity.	This adjusts the sensitivity so that the measured magnitude, R, is a sizable percentage of full scale. The instrument should end up on the 1 V scale and the displays showing their previous values.
13	Disconnect the cable at the SIGNAL IN connector.	Watch the CH1 display bargraph drop down to zero. The time constant is 100 ms, the bargraph falls quickly but not instantaneously.
14	Reconnect the cable to SIGNAL IN.	Watch the CH1 bargraph come back up.
15	Press Time Constant Down six times until the time constant is 100 μ s.	The Time Constant is adjusted using the left hand pair of keys in the Time Constant area. The indicated time constant should be 1, x100, μs . The CH1 and CH2 values remain nearly unchanged but may be noisy in the last digit.
16	Disconnect the cable at the SIGNAL IN connector, then reconnect it.	The bargraph falls and rises nearly instantaneously.
17	Press Time Constant Up until the time constant is 3 s.	The indicated time constant should be 3, x1,s . The CH1 and CH2 displays remain nearly unchanged.
18	Disconnect the cable at the SIGNAL IN connector. Wait until the CH1 reading drops to zero.	The bargraph falls slowly.

1-8 The Basic Lock-In

19 Reconnect the cable to SIGNAL IN.	The bargraph rises slowly. In fact, with a filter slope of 12 dB/oct, it takes about 5 time constants to get to within 1% of the final reading. In this case, this takes more than 15 s.
20 Press Slope/Oct DOWN until 24 dB is selected.	<p>The filter slope is adjusted using the right hand pair of keys in the Time Constant area. The filter rolloff can be 6, 12, 18 or 24 dB/oct.</p> <p>With 24 dB/oct rolloff, it takes about 12 time constants to get within 1% of the final reading.</p> <p>Remember, both the time constant and filter slope affect the output settling time.</p>
21 Press Slope/Oct UP until NO FILTER is selected.	No filtering is also available. In this case, the demodulator outputs are amplified but not filtered. The high output bandwidth in this case requires that the outputs be taken from the CH1 or CH2 OUTPUT from the front panel and not from the displays.
22 Press Slope/Oct DOWN until 12 dB is selected.	12 dB/oct works well in most situations.

X, Y, R, θ and dBm

This measurement is designed to use the internal oscillator and an external signal source to explore some of the signal types. You will need a synthesized signal generator cable of providing 200 mVrms (0 dBm) sine waves at 100 kHz into a 50 Ω load (the DS335 from Stanford Research Systems will suffice), and BNC cables.

Specifically you will display the lock-in outputs when measuring a signal that has a frequency close to, but not equal to, the internal reference frequency.

Note: The last few items in this section require that the signal generator have a Sync output; if you are using a signal generator that has a single output only, you can split the output using a BNC Tee (or a power splitter or a directional coupler).

1	Disconnect all cables from the SR844. If the power is off, turn it on. Wait for self-tests to complete.	Turn on the unit.
2	Press Shift then Recall (PRESET) to restore factory presets.	The factory preset configuration is: 1 Vrms sensitivity. 100 ms, 12 dB/oct time constant. Internal Reference at 1.00 MHz. Signal Input 50 Ω .
3	Use the knob to adjust the SR844 reference frequency to 100 kHz.	We are using a low reference frequency so that the intrinsic frequency difference between the SR844 and the signal generator has a smaller absolute value.
4	Press Sensitivity Down . Press Time Constant Down twice until the time constant is 10 ms.	The SR844 sensitivity should now be 300 mVrms. We need a shorter time constant to measure the output signal.
5	Turn on the external signal generator and set the frequency to 100 kHz exactly, and the amplitude to 200 mVrms, 0 dBm, or 600 mVpp into 50 Ω . The exact value doesn't really matter. Low-frequency signal generators may have waveform selection (select sine wave) and DC offset (set it to zero). If the signal generator offers modulation, make sure it's off.	While not phase-locked, the signal generator and SR844 should be at very nearly the same frequency; the slight frequency difference will be manifested as a changing relative phase.

1-10 X, Y, R, θ and dBm

6	Connect the signal generator output to the SR844 SIGNAL IN connector with a BNC cable.	The CH1 and CH2 readings should both vary between positive and negative values in a correlated fashion that reflects the changing relative phase between the two instruments.
7	Adjust the signal generator frequency if necessary to better match the signal generator frequency to the SR844.	The extent of adjustment should be less than 10 Hz.
8	Adjust the signal generator frequency in steps of 1 Hz (or less) until the CH1 and CH2 readings oscillate with a period of a few seconds.	The CH1 and CH2 display bargraphs should now oscillate slowly.
9	Press CH1 Display once to select R [V].	R is the signal amplitude and is independent of reference phase ($R = \sqrt{x^2 + y^2}$). The reading of R does not oscillate.
10	Press CH1 Display to select R [dBm].	The R[dBm] display on CH1 should read within a few dB of 0 dBm (0.224 Vrms) depending upon the amplitude setting of the signal generator.
11	Adjust the signal generator amplitude to half the original amplitude (100 mVrms, -6 dBm, or 300 mVpp).	The R[dBm] display should drop by 6 dBm.
12	Press CH1 Display several times until R [V] is selected once again.	The Display key cycles through the available choices.
13	Press CH2 Display to select θ .	CH2 now shows the signal phase θ . The phase is changing linearly with a rate equal to the frequency difference between the signal generator and the SR844. The readout and bargraph ramp linearly and smoothly from -180° to $+180^\circ$ (or vice-versa) once each period. When displaying θ , the bargraph on the CH2 display is scaled from -180° (extreme left) to $+180^\circ$ (extreme right).
14	Press the Source key (above REF OUT).	Switch the SR844 to External Reference Mode. Since there is no external reference input connected yet, the Reference Display should read about 19 kHz (the internal oscillator pulls to its lowest frequency) and the red OUT OF RANGE and UNLOCK indicators should be lit.

<p>15 Connect the Sync output of the signal generator to the REF IN connector of the SR844 with a BNC cable.</p> <p><i>Note:</i> If you are using a signal generator with a single output, split the output using a BNC Tee, or a power splitter or 10 to 20 dB directional coupler. (If you use a directional coupler the straight-through output should go to REF IN and the coupled output should go to SIGNAL IN.) You may need to adjust the signal generator amplitude to provide the SR844 with enough signal to lock, and you may need to adjust the SR844 sensitivity so that the signal amplitude, R, is a sizable fraction of the full scale range.</p>	<p>The SR844 locks to the signal generator frequency, and the R and θ displays are both stable. Check that the UNLOCK error indicator (above the knob) is off.</p> <p>If the REF IN signal is noisy or too small, the SR844 may not be able to lock. The reference signal should be greater than 0.6 Vpp. If the signal generator Sync output cannot drive 50 Ω to a large enough amplitude, try changing the Reference Input Impedance to 10 kΩ by pressing the Ref Z-In key.</p>
<p>16 Change the signal generator frequency to 1.00 MHz.</p>	<p>The SR844 UNLOCK error indicator comes on briefly, then goes off to indicate that the SR844 has locked to the new frequency. The new frequency should be correctly displayed in the Reference display.</p> <p>The displayed value of R should not change (depending upon the amplitude flatness of the signal generator and the accuracy of the SR844). The value of θ may change a few degrees depending upon the signal generator Sync phase and cable lengths.</p>

Outputs, Offsets and Expands

This measurement is designed to use the internal oscillator to explore some of the basic lock-in outputs. You will need BNC cables and a digital voltmeter (DVM).

Specifically, you will measure the amplitude of the reference oscillator and provide analog outputs proportional to the measurement. The effect of offsets and expands on the displayed values and the analog outputs will be explored.

<p>1 Disconnect all cables from the Lock-In.</p> <p>If the power is off, turn it on. Wait for self-tests to complete.</p>	<p>Turn on the unit.</p>
<p>2 Press Shift then Recall (PRESET) to restore factory presets.</p>	<p>The factory preset configuration is: 1 Vrms sensitivity. 100 ms, 12 dB/oct time constant. Internal Reference at 1.00 MHz. Signal Input 50 Ω.</p>
<p>3 Connect REF OUT on the front panel to the SIGNAL IN with the BNC cable.</p>	<p>The SR844 reference output (1.0 Vpp nominal square wave into 50 Ω) is within the unit's measurement range (1 Vrms) so we can connect it directly to the input. The SR844 input impedance is set to 50 Ω (shown by the 50 Ω indicator) which is appropriate for the REF OUT.</p> <p>The CH1 Display is set to X and should show something close to 0.54 V. The CH2 display is set to Y and should show less than ±0.05 V.</p> <p>Remember, the signal is a 0.5 Vpk (1.0 Vpp) square wave. A square wave is composed of signals at all odd harmonics. The SR844 is a square wave detecting lock-in and detects all of the odd harmonics of the fundamental. The amplitude of the fundamental (at 1.00 MHz) is $4/\pi \times V_{pk}$. The contribution from all odd harmonics is</p> $1 + (1/3)^2 + (1/5)^2 + (1/7)^2 + \dots \approx 1.19$ <p>The detected amplitude is $4/\pi \times 0.5 \text{ Vpk} \times 1.19$ or 0.759 Vpk. The SR844 reads the signal in units of Vrms (0.707 x Vpk) or 0.537 Vrms.</p>

	<p>The CH1 display may not read exactly 0.54 V for a number of reasons:</p> <ul style="list-style-type: none"> • The Ref Out amplitude is only a <i>nominal</i> specification. • The basic accuracy of the unit is ± 0.25 dB (3%). • Since the phase may not be exactly 0°, $X=R\cos\theta$ is slightly less than R (amplitude).
<p>4 Connect the CH1 OUTPUT to the DVM. Set the DVM to read DC Volts, on the 20 Vdc scale.</p>	<p>The CH1 output is preset to X as indicated by the X LED above the CH1 OUTPUT. The output voltage is given by the formula:</p> $(X/\text{Sensitivity} - X_{\text{offset}}) \times \text{Expand} \times 10V$ <p>In this case $X \cong 0.54$ Vrms, Sensitivity = 1.0 Vrms, $X_{\text{offset}} = 0$, Expand = 1 (no output expand), so we expect the DC output voltage to be about 5.4 V. The DVM should read about this value (depending upon the exact X reading).</p>
<p>5 Press CH1 Offset Auto (this key is two keys left of the CH1 OUTPUT connector).</p>	<p>X, Y and R may all be offset and expanded independently.</p> <p>Since Channel 1 is displaying X, the Offset (On/Off, Auto and Modify) and Expand keys below the Channel 1 Display set the offset and expand for X. The <i>display selection</i> determines which quantity the Offset and Expand keys operate on.</p> <p>Offset Auto automatically adjusts the offset of the displayed quantity to make the result zero. In this case, X is offset to zero. (Y is also offset to zero. See below for an explanation of X and Y offsets.)</p> <p>The offset affects both the displayed value of X and the CH1 analog output (X). Thus, after the auto offset function is performed, both the displayed value of X and the DVM should show readings very close to zero.</p> <p>The XYOffs indicator in the Channel 1 Display has turned on to indicate that the display quantity is affected by XY offsets.</p> <p>Offsets are useful for making relative measurements or to cancel the contribution from an unwanted phase coherent signal. In analog lock-ins, offsets</p>

were generally used to remove DC output errors from the lock-in itself. The SR844 demodulator is digital and has no DC output errors, however, it does have some coherent pickup at high frequencies, which can be canceled using offsets.

Important!

Xoffset and Yoffset are applied to the X and Y demodulator outputs directly. R and θ are computed from the *offset* values of X and Y. Offsetting X or Y *changes* the measurement of R and θ .

In addition, changing the Reference Phase will modify the values of Xoffset and Yoffset. Think of (Xoffset, Yoffset) as a signal vector relative to the Reference (internal or external) which cancels an actual signal at the input. This cancellation is preserved even when the detection phase (Reference Phase) is changed. This is done by circularly rotating the *values* of Xoffset and Yoffset by minus the Reference Phase. This preserves the phase relationship between (Xoffset, Yoffset) and the signal input.

Since the vector (Xoffset, Yoffset) is used to cancel a real signal at the input, Xoffset and Yoffset are always turned on and off together. Turning either X or Y offset on (or off) turns on (or off) *both* offsets. Auto offsetting either X or Y performs auto offset on *both* X and Y. These statements are true even if only one of the quantities X or Y is currently being displayed.

<p>6 Press Phase to display the Reference Phase in the Reference Display.</p> <p>Press the +90° key.</p> <p>Press the Zero key to return the phase to zero.</p>	<p>Since auto offset has set (Xoffset, Yoffset) to cancel the signal input, changing the Reference Phase does not affect the X and Y readings.</p> <p>X and Y remain zero even as the phase is changed. This allows phase coherent signals at the input to be completely canceled. For example, to cancel coherent pickup, turn the experimental signal off while leaving all of the signal cabling in place, perform auto offset X (or Y) and then turn on the experimental signal and proceed normally. The effects of the coherent pickup are removed <i>at the input</i>. The amplitude and phase of the experimental signal are now measured normally.</p>
--	---

<p>7 Press CH1 Offset Modify.</p>	<p>The offset of the CH1 display quantity is shown on the Reference display. The reading is in percent of full scale. In this case, the Xoffset should be about -54% (of 1 Vrms).</p> <p>Note! The entered offset percentage <i>does not change</i> when the sensitivity is changed. However, it does change if the reference phase is changed (see above).</p>
<p>8 Use the knob to adjust the offset until the X display is 0.1 V.</p>	<p>The displayed value of X should be close to 0.1 Vrms. The offset should be about 44% and the CH1 output voltage (see the formula in step 4 above) should be</p> $(0.54 \text{ V}/1.0 \text{ V} - 0.44) \times 1 \times 10\text{V} = 1.0 \text{ V}$ <p>or nearly so.</p>
<p>9 Press CH1 Expand.</p>	<p>With an expand of ×10, the display has one more digit of resolution (100 mV full scale). The Expand indicator turns on at the bottom of the Channel 1 display to indicate that the displayed quantity has been expanded. The output voltage should now be</p> $(0.54 \text{ V}/1.0 \text{ V} - 0.44) \times 10 \times 10\text{V} = 10 \text{ V}$ <p>or nearly so.</p> <p>The expand allows the output gain to be increased by 10 or 100. To use output Expand, it is necessary to have a display reading that is less than 10% or 1% of the full scale sensitivity. This can be achieved using offsets if necessary.</p> <p>The maximum output is limited to 110% of the display full scale (Sensitivity ÷ Expand). Any greater output will turn on the OVLD indicator above the CH1 OUTPUT connector. The OVLD indicator within the CH1 display will also turn on.</p> <p>With offset and expand, the output voltage gain and offset can be programmed to provide control of feedback signals with proper bias and gain for a variety of situations.</p> <p>Offsets add and subtract from the display. Expand increases the resolution of the display and the gain of the analog output.</p>

1-16 Outputs, Offsets and Expands

10 Press CH1 Output to select DISPLAY .	<p>This key toggles the CH1 analog output function between the selected display quantity and X. In other words, it is possible to have a signal proportional to X on the analog output while the display shows R (or some other quantity).</p> <p>In this case, with the display set to X, X remains the CH1 analog output quantity and the DVM reads the same.</p>
11 Press CH1 Display once to select R(V) .	<p>This selects R (Volts) as the CH1 display quantity. Since the CH1 Output is set to DISPLAY, R is now also the CH1 analog output.</p> <p>Remember that Xoffset and Yoffset are applied directly to the demodulator outputs, the value of R is computed from the <i>offset</i> values of X and Y. The XYOffs indicator in the CH1 display indicates that the displayed value is affected by XY offsets.</p> <p>At the present time, Y is offset to zero and X is offset to 100 mV. The resultant R is 100 mV and the CH1 display should read about 0.1 V. Expand is off since the display quantity R has not been expanded.</p> <p>The CH1 analog output should be</p> $(0.1 \text{ V}/1.0 \text{ V} - 0.0) \times 1 \times 10\text{V} = 1 \text{ V}$ <p>or 10% of full scale.</p> <p>The Channel 1 Offset and Expand keys now set the offset and expand for R.</p>
12 Press CH1 Output to select X .	<p>The CH1 analog output returns to X. The offset and expand for X are still in effect, even though R is the displayed quantity. Thus, the DVM reads 10 V.</p> <p>The CH1 display is unchanged. It still shows R and 0.1 V.</p>
13 Press CH1 Offset On/Off.	<p>This turns Roffset on. The ROffs indicator within the CH1 display turns on to show that the displayed quantity is affected by Roffset. (The XYOffs indicator within the CH1 display means that XY offsets are on and also affect the CH1 displayed quantity.)</p>
14 Press CH1 Offset Modify.	<p>The offset of the CH1 display quantity, R(V), is shown on the Reference display. The reading is in percent of full scale.</p>

<p>15 Use the knob to adjust the offset until the CH1 display is 0.0 V.</p>	<p>The offset should be about -10%. (R was 0.1 V or 10% of full scale).</p> <p>Pressing Expand will increase the resolution of the R measurement. The R offset and expand do <i>not</i> affect either X or Y. Note that the DVM still reads 10 V for the X output.</p>
<p>16 Press CH1 Offset On/Off again.</p>	<p>This turns off the R offset. The CH1 ROffs indicator turns off and the displayed R returns to 0.1 V. The XYOffs indicator remains on because XY offsets are still on.</p>
<p>17 Press Display four times to return to X display.</p>	<p>The CH1 display returns to showing X with Xoffset and Expand on.</p>
<p>18 Press Expand twice to turn Expand off.</p>	<p>Turn off X expand. The Expand key cycles through none, x10 and x100.</p>
<p>19 Press CH1 Offset On/Off once.</p>	<p>Turn off X offset. This also turns off Y offset. The XYOffs indicators turn off and the displays show the original measurement of the REF OUT signal.</p> <p>This completes this exercise. For more information see Chapter 3, <i>CH1 Display and Output</i>.</p>

Storing and Recalling Setups

The SR844 can store 9 complete instrument setups in non-volatile memory.

<p>1 Press Shift then Recall (PRESET) to restore factory presets.</p>	<p>This restores the SR844 to its factory presets.</p> <p>The factory preset configuration is: 1 Vrms sensitivity. 100 ms, 12 dB/oct time constant. Internal Reference at 1.00 MHz. Signal Input 50 Ω.</p>
<p>2 Press Sensitivity Down twice. Press Time Constant Up twice.</p>	<p>Change the lock-in setup so that we have a different setup to save.</p> <p>These keypresses select 100 mV sensitivity and 1 s time constant.</p>
<p>3 Press Save.</p>	<p>The CH1 and CH2 displays show <i>SAVE n</i> where n is a number from 1 to 9.</p>
<p>4 Use the knob to select setup number 3.</p>	<p>The knob selects the setup number (shown in the CH2 display).</p>
<p>5 Press Save again.</p>	<p>The second time Save is pressed completes the operation. The message <i>DONE</i> is appears briefly in the Reference display. Any other key pressed at this time aborts the Save.</p> <p>The current setup is now saved as setup number 3.</p>
<p>6 Press Shift then Recall to restore factory presets.</p>	<p>The sensitivity and time constant revert to 1 V and 100 ms respectively. Now let's recall the setup that we just saved.</p>
<p>7 Press Recall.</p>	<p>The CH1 and CH2 displays show <i>RCAL n</i> where n is a number from 1 to 9.</p>
<p>8 Use the knob to select setup number 3.</p>	<p>The knob selects the setup number.</p>
<p>9 Press Recall again.</p>	<p>The second time Recall is pressed completes the operation. The message <i>DONE</i> is appears briefly in the Reference display. Any other key pressed at this time aborts the Recall.</p> <p>The time constant and sensitivity should have reverted back to their saved values of 100 mV and 1 s respectively.</p>

Aux Outputs and Inputs

This measurement is designed to illustrate the use of the Aux Outputs and Inputs on the rear panel. You will need BNC cables and a digital voltmeter (DVM).

Specifically, you will set the Aux Output voltages and measure them with the DVM. These outputs will then be connected to the Aux Inputs to simulate external DC voltages which the lock-in can measure.

1	Press Shift then Recall to restore factory presets.	This restores the SR844 to its factory presets.
2	Connect AUX OUT 1 on the rear panel to the DVM. Set the DVM to read DC Volts, either auto-ranging or on the 20 Vdc scale.	The Aux Outputs can provide programmable DC voltages between -10.5 and 10.5 Volts. The outputs may be set from the front panel, or via the computer interface.
3	Press AuxOut once or until the Reference Display shows the level of AUX OUT 1, as shown by the AxOut1 indicator beneath the display.	Show the level of AUX OUT 1 on the Reference display. The default value is 0.000 V.
4	Use the knob to adjust the level to 10.000 V.	Change the output to 10 V. The DVM should read very close to 10.000 V.
5	Use the knob to adjust the level to -5.000 V.	Change the output to -5 V. The DVM should read very close to -5.000 V. The auxiliary outputs are useful for controlling other parameters in an experiment, such as pressure, temperature, wavelength, etc. The AuxOut voltages may be set remotely over the GPIB or RS-232 interface.
6	Press CH1 Display four times or until AUX IN 1 is selected.	Pressing Display cycles the CH1 Display through the five available quantities. AUX IN 1 shows the voltage at AUX IN 1. The two Aux inputs can each read an analog voltage in the ± 10.5 V range. These inputs may be used for monitoring and measuring other parameters in an experiment, such as pressure, temperature, position, etc. The Aux In voltages may be read remotely over the GPIB or RS-232 interface.
7	Disconnect AUX OUT 1 from the DVM.	We will use AUX OUT 1 to provide an analog voltage to measure.
8	Connect AUX OUT 1 to AUX IN 1 on the rear panel.	The CH1 display shows the voltage at AUX IN 1 (close to -5.000 V).

1-20 Aux Outputs and Inputs

9 Use the knob to adjust AUX OUT 1 to -6.500 V.	The CH1 display should now read close to -6.500 V.
---	--

Besides reading basic DC voltages, the Aux In voltages may be used to normalize the signal. In Ratio mode, the X and Y signals are multiplied by $(1.000\text{V}/\text{AUX IN 1})$ or $(1.000\text{V}/\text{AUX IN 2})$ prior to time constant filtering. Ratio mode is fully explained in Chapter 3, *CH 1 Display and Output*.

Another application of the AUX IN voltages is to provide a second demodulation, sometimes known as the *Double Lock-In Technique*. This is described in Chapter 2.

The displays may be stored in the internal data buffers at a programmable sampling rate. This allows storage of not only the lock-in outputs (X, Y, R or θ) but also the values of the AUX IN voltages. See Chapter 4, *Data Storage*, for more information.

Chapter 2

SR844 Basics

In This Chapter

What is a Lock-In Amplifier ?	2-3	Ratio	2-13
Why Use a Lock-in Amplifier ?	2-3	Time Constant Filters	2-13
What is Phase-Sensitive Detection ?	2-3	R, θ , dBm Computation	2-14
Units	2-4	Output Select	2-14
RMS or Peak ?	2-4	The Host Processor	2-14
Degrees or Radians ?	2-4		
Volts or dBm ?	2-5	Analog Outputs and Scaling	2-15
What About Signals at Other Frequencies ?	2-5	CH1 and CH2 Outputs	2-15
What About DC Offset and Drift ?	2-6	Output Scales	2-15
Where Does the Reference Come From ?	2-6	Output Offset and Expand	2-15
		Display Scales	2-16
The Functional SR844	2-8	What is Dynamic Reserve ?	2-17
RF Signal Input Path	2-9	Wide and Close Reserves	2-17
Input Impedance	2-9	Sources of Error	2-19
200 MHz Low Pass Filter	2-9	Spurious Responses	2-19
20 dB Attenuator	2-9	Square Wave Response	2-19
20 kHz High Pass Filter	2-9	IF Sidebands	2-19
20 dB Gain	2-9	Coherent Pickup	2-20
Reference Channel	2-10	Using the SR844 as a Double Lock-In	2-22
Auto-Threshold Comparator	2-10	Noise Measurements	2-23
Phase Locked Loop and Divider Chain	2-10	How Does a Lock-in Measure Noise ?	2-23
20 MHz Reference/ Synthesizer	2-10	Noise Estimation	2-23
X and Y Reference Generator	2-10	Intrinsic (Random) Noise Sources	2-25
IF Section	2-11	Johnson Noise	2-25
180 kHz Low Pass Filter	2-11	Shot Noise	2-25
Gain Stages	2-11	1/f Noise	2-25
Anti-Aliasing Filter	2-11	Total Noise	2-25
16-Bit ADC	2-11	External Noise Sources	2-26
Inside the DSP	2-12	Capacitive coupling	2-26
Inputs	2-12	Inductive coupling	2-27
Demodulators	2-12	Resistive coupling or Ground Loops	2-27
Phase Adjust	2-12	Microphonics	2-28
Offsets	2-13		

What is a Lock-In Amplifier ?

Lock-In amplifiers are used to detect and measure very small AC signals — all the way down to a few nanovolts. Accurate measurements may be made even when the small signal is obscured by noise sources many thousands of times larger.

Lock-in amplifiers use a technique known as phase sensitive detection to single out the component of the signal at a specific reference frequency *and* phase. Noise signals at frequencies other than the reference frequency are rejected and do not affect the measurement.

Why Use a Lock-in Amplifier ?

Let's consider an example. Suppose the signal is a 1 μV sine wave at 10 MHz. Clearly some amplification is required. A good low noise amplifier will have about 3 $\text{nV}/\sqrt{\text{Hz}}$ of input noise. If the amplifier bandwidth is 200 MHz and the gain is 1000, then we can expect our output to be 1 mV of signal and 43 mV of broadband noise (3 $\text{nV}/\sqrt{\text{Hz}} \times \sqrt{200 \text{ MHz}} \times 1000$). We won't have much luck measuring the output signal unless we single out the frequency of interest.

Now try following the amplifier with a phase sensitive detector (PSD). The PSD can detect the signal at 10 MHz with a bandwidth as narrow as 0.01 Hz (or even narrower if you have the patience to wait for several time constants). Using a 1 Hz detection bandwidth, the output noise will be only 3 μV (3 $\text{nV}/\sqrt{\text{Hz}} \times \sqrt{1 \text{ Hz}} \times 1000$) which is considerable less than the amplified signal of 1 mV. The signal to noise ratio is now 300 and accurate measurement is possible.

What is Phase-Sensitive Detection ?

Lock-in measurements require a frequency reference. Typically an experiment is excited at a fixed frequency (from an oscillator or function generator) and the lock-in amplifier detects the response from the experiment at the reference frequency. Suppose the reference signal is a square wave at frequency ω_R . This might be the sync output from a function generator. If the sine output from the function generator is used to excite the experiment, the response might be $V_I \sin(\omega_R t + \theta_I)$ where V_I is the signal amplitude.

The lock-in amplifier multiplies the signal by the reference $V_R \sin(\omega_R t + \theta_R)$ using a mixer. (*Note:* The SR844 uses a more complicated reference signal for reasons discussed below, but the principle is the same.) The mixer generates the product of its two inputs as its output V_{MI} .

$$V_{MI} = V_I V_R \sin(\omega_R t + \theta_I) \sin(\omega_R t + \theta_R) \quad (2-1)$$

$$= \frac{1}{2} V_I V_R \cos(\theta_R - \theta_I) + \frac{1}{2} V_I V_R \sin(2\omega_R t + \theta_R + \theta_I) \quad (2-2)$$

Since the two inputs to the mixer are at *exactly* the same frequency, the first term in the mixer output is at DC. The second term is at a frequency $2\omega_R$, which is at a high frequency and can be readily removed using a low pass filter. After filtering

$$V_{MI+FILT} = \frac{1}{2} V_I V_R \cos(\theta_R - \theta_I) \quad (2-3)$$

which is proportional to the cosine of the phase difference between the input and the reference. Hence the term phase sensitive detection.

In order to measure V_I using Eqn (2-3), the phase difference between the signal and reference, $\theta_R - \theta_I$, must be stable and known. The SR844 solves this problem by using two mixers, with the reference inputs 90° out of phase. The reference input to the second mixer is $V_R \sin(\omega_R t + \theta_R - \pi/2)$ and the output of the second mixer is

$$V_{M2} = \frac{1}{2} V_I V_R \cos(\theta_R - \theta_I - \pi/2) + \frac{1}{2} V_I V_R \sin(2\omega_R t + \theta_R + \theta_I - \pi/2) \quad (2-4)$$

After filtering,

$$V_{M2+FILT} = \frac{1}{2} V_I V_R \cos(\theta_R - \theta_I - \pi/2) \quad (2-5)$$

$$= \frac{1}{2} V_I V_R \sin(\theta_R - \theta_I) \quad (2-6)$$

The amplitude and phase of the input signal can be determined from the two mixer outputs, Eqn (2-3) and (2-6). These computations are handled by the DSP chip in the SR844.

$$\text{Amplitude } R = (2/V_R) \times \sqrt{ (V_{M1+FILT})^2 + (V_{M2+FILT})^2 } \quad (2-7)$$

$$\text{Phase } \theta_R - \theta_I = \tan^{-1}(V_{M2+FILT}/V_{M1+FILT}) \quad (2-8)$$

$$\text{In-Phase Component } X = R \cos(\theta_R - \theta_I) \quad (2-9)$$

$$\text{Quadrature Component } Y = R \sin(\theta_R - \theta_I) \quad (2-10)$$

Units

RMS or Peak ?

Lock-in amplifiers as a general rule measure the input signal in Volts rms. When the SR844 displays a magnitude of 1 V (rms), the sine component of the input signal at the reference frequency has an amplitude of 1 Vrms or 2.8 Vpk-pk. This is important to remember whenever the input signal is *not* a sine wave. For example, if the signal input is a square wave with a 1 Vpk (2 Vpk-pk) amplitude, the sine component at the fundamental frequency has a peak amplitude of $4/\pi \times 1$ Vpk. The lock-in displays the rms amplitude (Vpk/ $\sqrt{2}$) or 0.9 Vrms.

Degrees or Radians ?

In this discussion, frequencies have been referred to as f [Hz] and ω [radian/sec].

$$\omega = 2\pi f \quad (2-19)$$

This is because it is customary to measure frequency in Hertz, while the math is most convenient using ω . For purposes of measurement, the SR844 reports frequency in kHz and MHz. The equations used to explain the calculations are often written using ω to simplify the expressions.

Phase is always reported in degrees. Again, the equations are usually written as if θ were in radians.

Volts or dBm ?

The SR844 permits users to display some output quantities in either Vrms or dBm. The quantities that may be displayed in dBm are R (amplitude of the input signal) and Y-noise. Note that X and Y may only be displayed in Volts — they are the components of the input signal in rectangular coordinates and may be both positive and negative. Any conversion to dBm would be artificial, and possibly misleading. The SR844 assumes 50 Ω while computing dBm, so that the R[dBm] quantity indicates the power that would be dissipated if the input voltage were applied to a 50 Ω load. This is only accurate if the signal load is actually 50 Ω . When using the 1 M Ω signal input, this is unlikely to be the true power in the signal.

What About Signals at Other Frequencies ?

In the above calculation we assumed that the input signal was at the reference frequency, which is *always* the case for the signal of interest in a lock-in measurement. However, there is always noise, and often times spurious signals at other frequencies. It is instructive to follow such a signal through a mixer.

The signal input is $V_X \sin(\omega_X t + \theta_X)$ and the reference input is $V_R \sin(\omega_R t + \theta_R)$ as before. Then the mixer output is

$$\begin{aligned} V_{MX} &= \frac{1}{2} V_X V_R \cos((\omega_R - \omega_X)t + \theta_R - \theta_X) \\ &\quad + \frac{1}{2} V_X V_R \sin((\omega_R + \omega_X)t + \theta_R + \theta_X) \end{aligned} \quad (2-11)$$

The second term will always be a high frequency term and will not pass through the low pass filter. Whether the first term makes it through or not depends upon the filter bandwidth compared to the frequency difference between the spurious signal and the reference. For $(\omega_R - \omega_X)$ much greater than the filter bandwidth,

$$V_{MX+FILT} \cong 0 \quad (2-12)$$

We see that the output low pass filter directly determines the bandwidth of the lock-in amplifier. The relationship between the filter time constant and the low-pass filter bandwidth is

$$\Delta F_{LP} = 1 / (2\pi \tau) \quad (2-13)$$

Here ΔF_{LP} is the bandwidth of the low-pass filter and τ is the instrument time constant. Since frequencies both above and below the reference frequency can mix down into the low-pass filter bandwidth, the measurement bandwidth at the reference frequency is twice the low-pass filter bandwidth.

$$\Delta F_{INPUT} = 2 \Delta F_{LP} \quad (2-14)$$

$$= 1 / (\pi \tau) \quad (2-15)$$

Signals closer than ΔF_{LP} to the reference frequency will appear at the output and obscure the output from the actual signal. For ω_X very close to the reference frequency, the filtered output is

$$V_{MX+FILT} = \frac{1}{2} V_X V_R \cos((\omega_R - \omega_X)t + \theta_R - \theta_X) \quad (2-16)$$

The filtered output of the second mixer is

$$V_{M2X+FILT} = \frac{1}{2} V_X V_R \sin((\omega_R - \omega_X)t + \theta_R - \theta_X) \quad (2-17)$$

Spurious signals very close to the reference frequency are detected by a lock-in amplifier; the phase appears to rotate slowly at the difference frequency.

What About DC Offset and Drift ?

The classic lock-in described above suffers from a serious drawback, namely DC drift. For weak input signals, typical of many lock-in measurements, the DC output of the mixers may be very small. This voltage can be less than the input offset of even a very good DC amplifier. Furthermore, there is the DC output offset of the mixer itself. While it is possible to null these offsets once, or even periodically, these offsets drift over time and temperature making it very difficult to make measurements with the sensitivity and accuracy demanded of lock-in amplifiers.

The solution used in the SR844 is to chop the mixer reference signals. This means that the mixer reference signals reverse their polarity at the chop frequency. A signal at the reference frequency generates a mixer output that also changes sign at the chop frequency. Thus, the mixer output is at the chop frequency and not at DC. While its amplitude may still be small, the post-mixer amplifier can now be AC coupled, eliminating problems of DC offset and drift completely. The chop frequency in the SR844 is derived from the reference frequency, and is in the range of 2 – 12 kHz. This is fast enough to permit measurement time constants of 1 ms or even 100 μ s, yet is always slow compared to the signal frequency.

The recovery of the signal amplitude and phase from the chopped signals is a little more complicated than equations (2-7) and (2-8) above. In effect, chopping the reference puts the mixer outputs at an IF (intermediate frequency) equal to the chop frequency. The mixer is followed by an IF filter (the relevant mixer outputs are between 2 and 12 kHz) and IF amplifier. The demodulation of the low frequency IF signal is easily handled by the digital signal processor.

Where Does the Reference Come From ?

The lock-in reference frequency must be the same as the signal frequency, i.e. $\omega_R = \omega_I$. Not only do the frequencies have to be the same, but the phase between the signals cannot change with time, otherwise $\cos(\theta_R - \theta_I)$ will change and the detector outputs will not be stable. In other words, the lock-in reference needs to be phase-locked to the signal one is trying to detect.

It is common to provide the lock-in amplifier with a reference signal taken from the experiment. This external reference signal is connected to the front panel reference input labeled REF IN. In this case the user is responsible for the external reference being phase-locked to the signal of interest.

The SR844 contains a phase-locked loop that locks to the external reference and generates reference signals with the correct amplitude, frequency and phase for both the in-phase and quadrature mixers. Since the SR844 tracks the external reference, changes in the external reference do not affect the measurement. Furthermore, the measurements made by the SR844 are independent of the amplitude of the external reference, with one exception. The phase relationship between the external reference and the internally generated signals depends slightly on the amplitude of the external reference.

It is not necessary to provide an external reference to the SR844. The SR844 contains a digital frequency synthesizer that may be used as an internal reference source. This is a convenient feature in those cases where an external generator is not available. To use the internal source, the front panel REF OUT must be used to excite the experiment appropriately. REF IN is left unconnected. The mixer reference signals are generated from the synthesizer.

It should be noted that high-frequency mixers operate by using the reference (or local oscillator) signal to switch pairs of diodes or transistors on and off. Consequently it is more accurate to view the mixer operation as multiplication by a square wave rather than multiplication by a sine wave. In fact, the reference signal provided to the mixers in the SR844 is a square wave.

The Functional SR844

The functional block diagram of the SR844 RF Lock-In Amplifier is shown below. A short description of each block follows .

SR844 Block Diagram

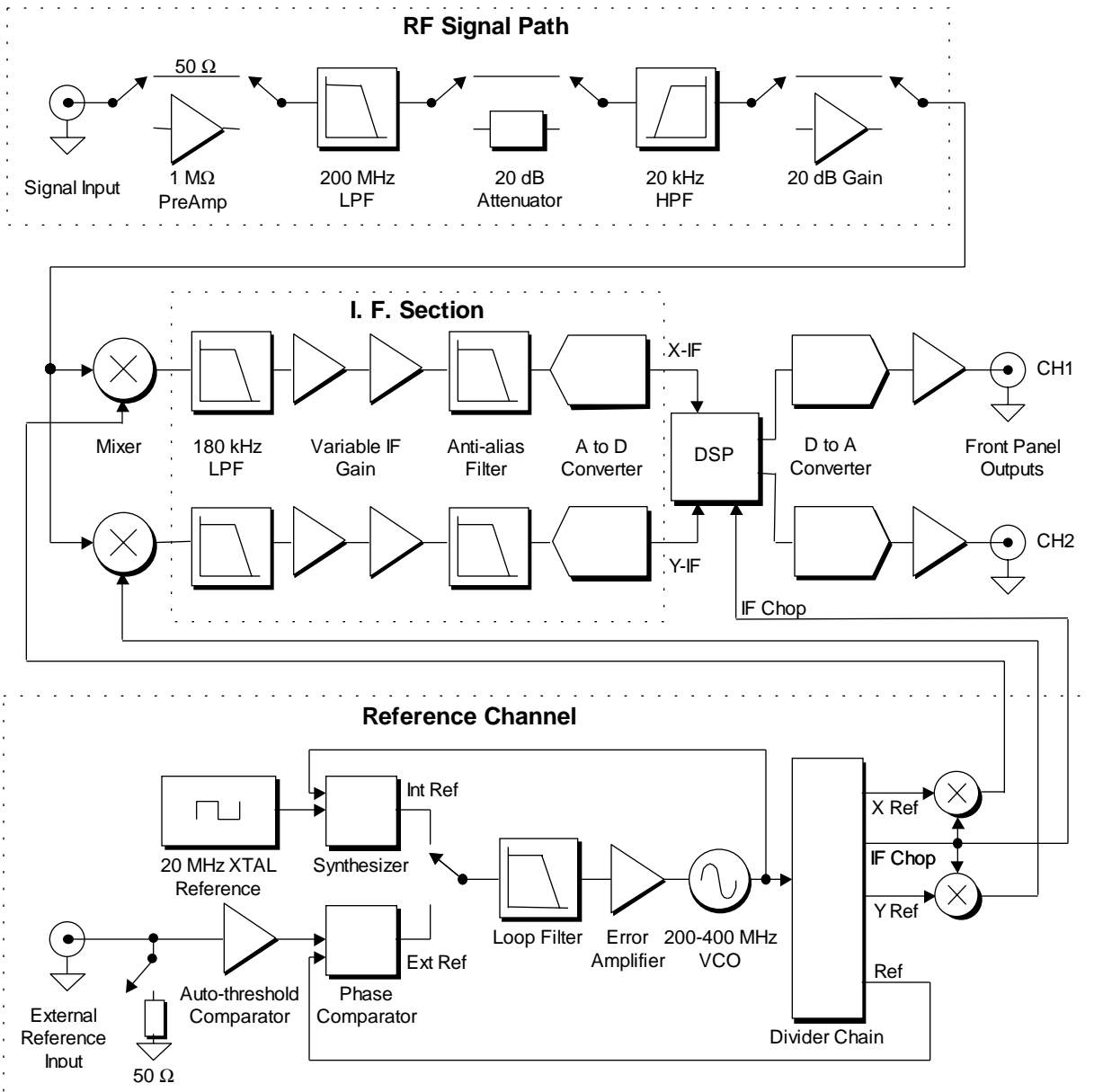

RF Signal Input Path

The path the input signal takes from the front panel input to the two mixers depends on the chosen input impedance and wide (RF) reserve. The SR844 accepts input signals in the range 25 kHz to 200 MHz, with signal levels up to 1 V_{rms} (+13 dBm). (The damage threshold is 5 V DC+AC.)

Input Impedance

For signal sources with 50 Ω source impedance, the 50 Ω input provides input matching; it also provides lower input noise. When using 50 Ω or other small source impedances, the 50 Ω input is preferred.

If the 1 MΩ || 30 pF input impedance is selected, the signal is buffered by a FET-input preamp with a nominal gain of x2 (+6 dB). The 1 MΩ input should only be used if the source impedance is much greater than 50 Ω.

Important!

The bandwidth of the 1 MΩ input is limited by its 30 pF input capacitance and the source impedance. The source impedance (R) and the input capacitance (30 pF) form a simple low-pass filter at $f_c = 1/2\pi RC$. Signals at frequencies greater than f_c are attenuated at the input and not measured accurately by the SR844. Even a 50 Ω source impedance forms a 106 MHz filter at the 1 MΩ input!

200 MHz Low Pass Filter

This passive filter removes signal components above 200 MHz that could interfere with the operation of the SR844.

20 dB Attenuator

This attenuator provides 20 dB (x10) of input signal attenuation. This is useful in cases where the real or interfering signals are large. At high sensitivities (near 1 V), the attenuator is required to scale the actual signal to prevent mixer overload. At lower sensitivities (100 mV and below), the attenuator is used to provide wide (RF) dynamic reserve by preventing overloads later in the signal path. While using the attenuator deteriorates the noise performance of the instrument, it improves the dynamic reserve.

20 kHz High Pass Filter

This filter provides a block to DC and line frequency signals that could interfere with signal measurement.

20 dB Gain

This gain stage can be used to boost low-level signals above the mixer noise floor in situations where the interfering signals are not too strong. This gain is required for sensitive measurements (below 100 μV). It is also used when less wide (RF) dynamic reserve is needed.

Reference Channel

The SR844 accepts sinusoidal and digital signals as external reference inputs, including low duty-cycle pulse trains. The nominal input levels are 0 dBm sine or 0.7 V_{pp} pulse. Larger levels are acceptable. The reference input may be terminated in either 50Ω or 10 kΩ||40 pF.

Auto-Threshold Comparator

The auto-threshold circuit detects the maximum and minimum voltages of the waveform and sets the threshold level to the mean of these two voltages. The SR844 uses the positive transitions through the threshold voltage as its phase reference.

Phase Locked Loop and Divider Chain

The Phase Comparator, Loop Filter, Error Amplifier, VCO and Divider Chain form a classic Phase Locked Loop (PLL). When the output edges of the Divider Chain coincide with the output edges of the Auto-Threshold Comparator, the loop is phase-locked.

In the SR844, the VCO always runs between 200 and 400 MHz. The divider chain does successive divide by 2 all the way down to 24.4 to 48.8 kHz. In this way, any frequency within the SR844 operating range can be generated by selecting the appropriate tap from the chain. In addition, the IF (chopping) frequency is generated synchronously by dividing the lowest frequency tap (24–49 kHz) by 3, 4, 12 or 16. The chopping frequency is between 2–3 kHz for time constants of 1 ms and above, and between 8–12 kHz for 100 and 300 μs time constants as well as No Filter.

20 MHz Reference/ Synthesizer

In internal reference mode, these components replace the external reference input to the phase locked loop discussed above. The synthesizer chip is a phase comparator that can be programmed to lock when the two inputs (the VCO and the 20 MHz crystal reference) are phase-locked at a particular frequency ratio (for example, VCO/194 = 20 MHz/17). The frequency in internal mode is set by programming the appropriate ratio into the synthesizer chip.

Important!

The SR844 provides 3 digits of resolution in setting the internal mode frequency. Because of the nature of the fractional arithmetic involved it is not possible to generate the exact frequencies with such a simple configuration. However, the frequency error is less than 0.1 in the 3rd digit. For example, entering an internal frequency of 267 kHz on the front panel results in a frequency between 266.9 and 267.1 kHz.

X and Y Reference Generator

The divider chain generates the X and Y square wave reference signals, 90° out of phase at the reference frequency. These signals are mixed with the IF chopping signal to produce the chopped reference signals to the X (in-phase) and Y (quadrature) mixers. The IF chopping signal is passed to the Digital Signal Processor (DSP) to provide the IF reference.

IF Section

The mixer outputs contain the in-phase and quadrature components of the input signal, [shifted to the IF (chopping) frequency (2–12 kHz)] as well as unwanted high-frequency mixer outputs and contributions from interfering signals and input noise. The IF section has identical signal paths for the in-phase and quadrature signals.

180 kHz Low Pass Filter

This passive filter eliminates much of the high-frequency mixer output, principally in order to keep RF out of the subsequent low-frequency amplifier and filter stages. This filter removes the $2f_{\text{ref}}$ mixer output for most reference frequencies.

Gain Stages

A variable IF gain section provides the gain necessary to detect very weak signals. The instrument sets the variable gain appropriate to the IF (close) dynamic reserve mode and overall sensitivity.

Anti-Aliasing Filter

Digital sampling causes aliasing, where analog signals at high frequencies appear as digital signals at low frequencies. In general, if the signal is sampled at F_s , any input signal at a frequency above $F_s/2$ will be aliased into the interval $[0, F_s/2]$. The purpose of the anti-aliasing filter is to remove any IF signals above $F_s/2$ before digitization.

The anti-aliasing filter is a 7th order active Cauer filter with a corner at 18 kHz. This filter is removed when no output filtering is selected.

16-Bit ADC

The analog-to-digital converters (ADCs) digitize the IF outputs for the digital signal processor (DSP) for further processing. The sampling rate varies between 48–96 kHz. The sampling clock comes from the divider chain in the reference channel and is synchronous with the reference frequency.

Inside the DSP

Much of the signal processing in the SR844 occurs inside the Digital Signal Processor (DSP).

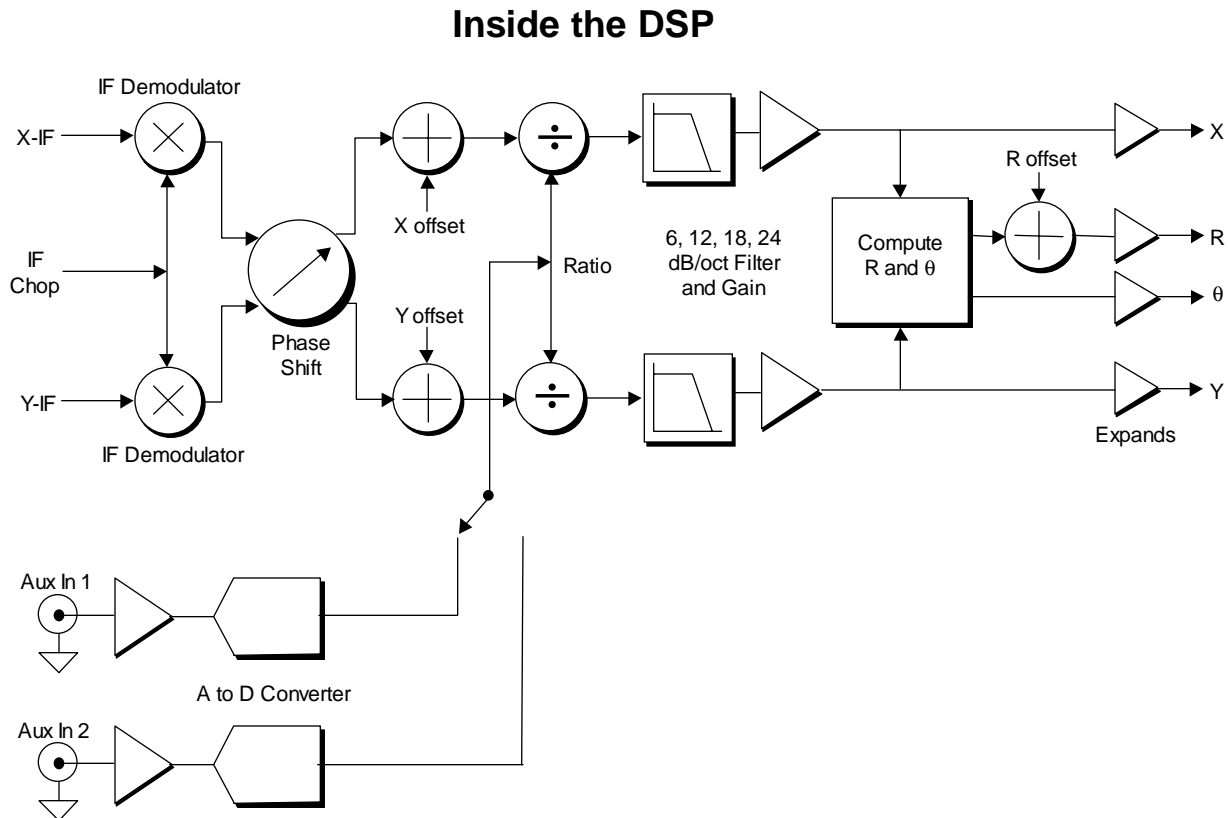

Inputs

The DSP receives the digitized X-IF and Y-IF signals from the IF section. In addition there is an IF chop signal that allows the DSP to demodulate the X-IF and Y-IF signals at the correct IF frequency.

Demodulators

The two data streams are multiplied by a digital IF chop waveform which converts the X-IF and Y-IF signals back to DC. The advantage of demodulating inside the DSP is to eliminate the DC output errors of analog mixers.

Phase Adjust

The two demodulated signals are subject to a matrix rotation that selects the detection phase (reference phase set by the user) and compensates for phase delays internal to the instrument. These phase-rotated signals are hereafter referred to as X and Y.

Offsets

User entered offsets can be added to X and Y. These offsets are added *before* taking ratios, filtering and computing R and θ .

Offsets are useful for making relative measurements or to cancel the contribution from an unwanted phase coherent signal. In analog lock-ins, offsets were generally used to remove DC output errors from the mixer outputs. The SR844 demodulator is digital and has no DC output errors, however, it does have coherent pickup at high frequencies, which can be canceled using offsets.

Important!

Xoffset and Yoffset are applied to the X and Y before other processing occurs. R and θ are computed from the *offset* values of X and Y. Adding offsets to X or Y *changes* the value of R and θ .

In addition, changing the Reference Phase will modify the values of Xoffset and Yoffset. Think of (Xoffset, Yoffset) as a signal vector relative to the Reference (internal or external) which cancels an actual signal at the input. This cancellation is preserved even when the detection phase (Reference Phase) is changed. This is done by circularly rotating the values of Xoffset and Yoffset by minus the Reference Phase. This preserves the phase relationship between (Xoffset, Yoffset) and the signal input.

Since the vector (Xoffset, Yoffset) is used to cancel a real signal at the input, Xoffset and Yoffset are always turned on and off together. Turning *either* offset on (or off) turns on (or off) *both* offsets. Auto offsetting either X or Y performs auto offset on *both* quantities. These statements are true even if only one of the quantities X or Y is currently being displayed.

Ratio

If ratio mode has been selected, the reciprocal of the appropriate input (1.0 V/AUX IN 1 or 1.0 V/AUX IN 2) is computed, and *both* X and Y are multiplied by this quantity. Since the value of R is computed after the ratio, R is also scaled by the ratio.

Another application of the Aux Input voltages is to provide a second demodulation, sometimes known as the *Double Lock-In Technique*. This is described in the next section.

Time Constant Filters

The signals are filtered by a chain of simple low-pass filter/amplifiers. Using 1, 2, 3 or 4 stages provides the selected rolloff of 6, 12, 18 or 24 dB/octave. Distributing the gain among the filters allows near-optimum signal recovery without causing internal overloads or losing bits of resolution. The appropriate filtered X and Y are used for all subsequent computations.

The individual filters are the digital equivalent of an RC low-pass filter, although being digital they can easily incorporate gain. The numerical coefficients of the filter are chosen to provide the selected time constant and a gain appropriate to the sensitivity. Since the filters are digital, very long time constants (up to 30 ks) are easily achievable.

Selecting No Filter removes the filtering operations while leaving just gain. This mode is useful when the highest possible analog output bandwidth is required from the X and Y

outputs. In this case, the 18 kHz anti-aliasing filter in front of the IF analog-to-digital converters is also removed. The output time constant is around 20-40 μ s in this case.

R, θ , dBm Computation

The DSP computes R[Volts] and θ from X and Y, and R[dBm] from R[Volts].

Output Select

Two quantities are selected for the front panel CH1 and CH2 analog outputs. These outputs may be expanded (by 10 or 100) before being sent to the output digital-to-analog converters. The outputs are buffered to ± 10 V.

The output update rate for X and Y is between 48 and 96 kHz for time constant filter slopes of 6 and 12 dB/oct as well as No Filter. The X and Y update rate for 18 and 24 dB/oct filtering is 4 times slower, or 12-24 kHz. The update rate for R and θ is also 12-24 kHz.

Two quantities are also selected for the front panel displays. Each of these may be expanded (by 10 or 100) before being sent to the host processor for display and storage.

The Host Processor

The host processor provides the interface between the front panel, the instrument configuration, the DSP and the remote ports (GPIB and RS-232). The host processor receives the front panel output values from the DSP and displays them and sends the data to the remote ports. The host also computes X-noise and Y-noise from the X and Y data.

Analog Outputs and Scaling

CH1 and CH2 Outputs

The SR844 has two analog outputs, CH1 and CH2, on the front panel. These outputs can be configured to output voltages proportional to the CH1 and CH2 displays or X and Y.

X and Y are the traditional outputs of an analog lock-in. The output voltage is proportional to the X and Y components of the signal with low-pass output filtering, offset, ratio and expand. In this case, a different quantity (R or θ for example) may be shown on the displays.

If the outputs are set to **DISPLAY**, the output voltage is proportional to the quantity shown on the corresponding display. The CH1 display can show X, R, R[dBm], Xnoise or AUX IN 1. The CH2 display can show Y, θ , Ynoise, Ynoise[dBm] or AUX IN 2. Offset, ratio and expand may be applied to many of these quantities.

Output Scales

The sensitivity of the lock-in is the rms amplitude of an input sine (at the reference frequency) which results in a full scale DC output. Full scale means 10 Vdc at the CH1 or CH2 analog output. The overall gain (input to output) of the amplifier is then 10 V/sensitivity. This gain is distributed between RF gain (before the mixer), IF gain (after the mixer) and DC gain (in the DSP). Changing the dynamic reserve at a given sensitivity changes the gain distribution while keeping the overall gain constant.

The SR844 considers 10 Vdc to be full scale for any output proportional to simply X, Y or R. Values of X, Y and R are always rms values. Noise is also measured in rms Volts and Xnoise and Ynoise are scaled the same as X and Y.

Phase is a quantity which ranges from -180° to $+180^\circ$ regardless of the sensitivity. When CH2 outputs a voltage proportional to θ , the output scale is $18^\circ/\text{V}$ or $180^\circ = 10 \text{ V}$.

Outputs proportional to quantities measured in dBm (R[dBm] and Ynoise[dBm]) have an output scale which is independent of sensitivity. The output is $\pm 10 \text{ V} = \pm 200 \text{ dBm}$ or 20 dBm/V .

Output Offset and Expand

The SR844 has the ability to offset the X, Y and R outputs. This is useful when measuring deviations in the signal around some nominal value. The offset can be set so that the output is offset to zero. Further changes in the output can then be read directly from the display or output voltages. The offset is specified as percentage of full scale and the percentage does *not* change when the sensitivity is changed. Offsets may be set up to $\pm 110\%$ of full scale. For dBm displays, the offset range is $\pm 110\%$ of 200 dBm or $\pm 220 \text{ dB}$.

The measured phase may be offset by adjusting the Reference phase.

The X, Y, R and θ outputs may also be expanded. This simply takes the output (minus its offset) and multiplies by an expansion factor. Thus, a signal which is only 10% of full scale can be expanded to provide 10 V of output rather than only 1 V. The normal use for

expand is to expand the measurement resolution around some value which is not zero. For example, suppose a signal has nominal value of 0.9 mV and we want to measure small deviations, say 10 μ V or so, in the signal. The sensitivity of the lock-in needs to be 1 mV to accommodate the nominal signal. If the offset is set to -90% of full scale, the nominal 0.9 mV signal will result in a zero output. The 10 μ V deviations in the signal only provide 100 mV of output. If the output is expanded by 10, these small deviations are magnified by 10 and provide 1 V of output.

The SR844 can expand the output by 10 or 100 provided the expanded output does not exceed full scale. In the above example, the 10 μ V deviations can be expanded by 100 times before they exceed full scale (1 mV sensitivity).

Outputs proportional to quantities measured in dBm (R[dBm] and Ynoise[dBm]) may also be expanded. The expanded output scales are 2 dB/V and 0.2 dB/V for x10 and x100 expands.

The phase output may also be expanded on CH2. The expanded output scales are 1.8 $^\circ$ /V and 0.18 $^\circ$ /V for x10 and x100 expands. The phase output can *not* be offset. Instead use the Reference phase to adjust the detection phase to yield a measured phase of zero.

Display Scales

Offsets *are* reflected in the displayed values. For example, if CH1 is displaying X, the X offset is applied to the displayed value. When X is offset to zero, the displayed value will drop to zero also. Any display which is showing a quantity which is affected by XY offsets will display a highlighted **XYOffs** indicator below the value. If the quantity is affected by an R offset, the **ROffs** indicator will be on. Note that both indicators may be on at the same time.

Output expands do *not* increase the displayed values. Expand increases the resolution of the displayed value (not the *size* of the displayed signal). When X is expanded, the display is shown with more digits but has the same non-expanded value. Any display which is expanded will display a highlighted **Expand** indicator below the value.

What is Dynamic Reserve ?

Dynamic reserve is an important concept for lock-in amplifiers. It is a measure of how much noise, or interfering signals at frequencies other than the reference, the instrument can withstand while still accurately measuring the desired signal at the reference frequency. More dynamic reserve is better. The traditional definition of dynamic reserve is the ratio of the largest tolerable noise signal (at the input) to the full scale signal, expressed in dB. For example, if full scale is $1\mu\text{V}$, then a dynamic reserve of 60 dB means noise as large as 1 mV (1000 times greater than $1\mu\text{V}$) can be tolerated at the input without overload.

Unfortunately, the word ‘tolerable’ allows some latitude in usage. Even without causing overloads, large interfering signals can cause distortion and DC output errors in analog components that can affect the measurement. For this discussion, dynamic reserve is defined as follows:

The dynamic reserve of a lock-in amplifier at a given full-scale input voltage is the ratio (in dB) of the Largest Interfering Signal to the full-scale input voltage. The Largest Interfering Signal is defined as the amplitude of the largest interfering signal (not at the reference frequency) that can be applied to the input before the lock-in cannot measure a signal with its specified accuracy.

While dynamic reserve is quoted as a single number, the actual reserve depends upon the frequency of the interfering signal. The reason for this has to do with the fact that a lock-in amplifier applies (1) gain and (2) bandwidth-narrowing to the input signal, and it does so in several stages. Depending on their frequency, different interfering signals are rejected at different points. An interfering signal several MHz from the reference produces a mixer output at several MHz; this signal is rejected by the IF low-pass filter immediately following the mixer. An interfering signal 50 kHz from the reference is rejected by the anti-aliasing filter before the A-D converter (see the following section for a detailed functional description). A close-by interfering signal is rejected by the time-constant filters in the DSP. *Note:* What about an interfering signal at 6 Hz offset, when the time-constant is only 3 ms ? 3 ms corresponds to a bandwidth of about $330\text{ s}^{-1} \cong 50\text{ Hz}$, this signal is within the instrument bandwidth and by definition is *not* an interfering signal.

Wide and Close Reserves

The fact that gain and bandwidth-narrowing occur in several stages leads to the question of how best to allocate the gain between the different stages. At one extreme, one could imagine all the gain to be in the DSP (digital signal processor), which wins with regard to dynamic reserve since interfering signals suffer no amplification and are least likely to cause overloads or distortion. The drawback to this is that the signal could get lost in the noise at the A-to-D converter or mixer. (In analog lock-ins, the DSP gain was replaced by output DC gain, which caused substantial problems with DC offset and drift). The other extreme is to put the maximum gain as close to the signal input as possible; this approach wins on noise performance, but has poor dynamic reserve. Since the interfering signals see lots of gain, a relatively small interfering signal could cause an overload.

Recognizing that different experimental situations call for different gain-allocation strategies, the SR844 provides multiple dynamic reserve modes separately for both the RF signal gain (before the mixer) and the IF gain (after the mixer).

Wide Reserve or RF reserve, allocates the RF signal gain before the mixer. See Chapter 3, *Signal Input*, for a table of RF gain vs Wide Reserve. The Wide Reserve should be set to accommodate *all* interfering signals within the 20 kHz - 200 MHz bandwidth of the RF input. High reserve applies minimum RF gain preventing large interfering signals from causing amplifier overloads. Low Noise provides maximum RF gain and the best output signal-to-noise and is less susceptible to coherent pick-up. Normal is in between.

Close Reserve or IF reserve, allocates the IF gain after the mixer and before the DSP. The Close Reserve should be set to accommodate interfering signals closer to the reference frequency than the IF bandwidth (180 kHz). High reserve applies the minimum IF gain preventing overloads before the DSP. Low Noise provides the maximum IF gain and the best output signal to noise. Normal is once again somewhere in between. The maximum allowable IF gain is proportional to $(\text{sensitivity} \times \text{RF gain})^{-1}$ - up to a maximum of 50 dB. Choosing the Wide Reserve sets the RF gain (see Chapter 3, *Signal Input*) and thus determines the maximum allowable IF gain. The minimum IF gain is 1.

After selecting the Wide (RF) and Close (IF) reserve modes, the DSP supplies the remainder of the gain required for the correct output scaling.

Important!

As a general rule, try to use Low Noise reserve modes if possible. Only increase the reserve if overloads occur. This will provide the best output signal-to-noise and have the least coherent pickup (see below).

Some sensitivity settings do not have three different gain allocations available. For example, the 1 V sensitivity can only be achieved by a single gain allocation. Sensitivity settings below 10 μV require all of the available gain. In these cases two, and sometimes all three, of the reserve modes actually use the same gain allocation. The dynamic reserve of these identical gain allocations is, of course, the same.

Note that the 1 V_{rms} input specification should never be exceeded in a measurement situation. This means that when the sensitivity is 1 V_{rms}, there is no room left for interfering signals, and the dynamic reserve is zero!

Sources of Error

Spurious Responses

It is useful to consider the signal in the frequency domain. Fourier's theorem states that any signal can be represented as an infinite sum of sine waves, each with different frequency, amplitude and phase. In the frequency domain, a signal is described in terms of its individual frequency components. This is in contrast to the time domain description, where the signal is described by its value at each point in time, just like one would see on an oscilloscope. The SR844 circuitry is linear, which means that the signal at any point is the sum of the signals due to each frequency component. For the purpose of analysis the individual frequency components may be treated independently.

The SR844 multiplies the signal by a (chopped) square wave at the reference frequency. All components of the input signal are multiplied by the reference frequency simultaneously. Signal and noise at the reference frequency give rise to (chopped) DC. In general other frequency components give rise to mixer outputs at other frequencies, and are not detected. There are a few exceptions, which constitute the spurious response of the instrument. It is good for a user to be aware of and understand these limitations.

Spurious responses are outputs due to signals at frequencies *other* than the reference frequency. These outputs are indistinguishable from the output due to a signal *at* the reference frequency.

Square Wave Response

The first class of spurious responses are harmonics of the reference frequency. Recall that the mixer multiplies the input signal by the lock-in reference, which is really a square wave. A square wave at the reference frequency may be written as

$$\sin(\omega_R t) + (1/3) \sin(3\omega_R t) + (1/5) \sin(5\omega_R t) + \dots \quad (2-18)$$

The lock-in is detecting signals at all odd harmonics of the reference simultaneously. An input signal at $3\omega_R$ yields an output 1/3 as large as a signal at ω_R . This -10 dB response at the third harmonic is a fundamental limitation of the technique employed in the SR844.

When the input signal is also a square wave (at the reference frequency), all of the odd harmonics of the signal coincide with the harmonics of the reference and are detected. In the frequency domain, this is simply multiplying eqn. 2-18 by itself and keeping those resultant terms which are at DC. Thus, the contribution from all odd harmonics is

$$1 + (1/3)^2 + (1/5)^2 + (1/7)^2 + \dots \approx 1.2$$

The amplitude of the fundamental sine component of a square wave is $4/\pi$ x the peak amplitude of the square wave. The detected amplitude is $4/\pi$ x peak x 1.2 or 1.53 x peak. The SR844 reads the signal in units of V_{rms} (0.707 x 1.53 x peak) or 1.08 x peak (V_{rms}).

IF Sidebands

The second class of spurious responses are chopping sidebands at $\omega_R \pm 2N\omega_C$, where ω_C is the chopping frequency (IF) and N is an integer. To understand these spurious responses, we need to understand a little more about how chopping works. The chopping operation

consists of multiplying a signal by a square wave of amplitude 1 and frequency ω_C . Half of the time the output equals the input. The other half of the time the output is the negative of the input. Assuming that all chopping operations are properly synchronized, we can take a signal, chop it, and chop it again and recover the original signal.

Now let's take a reference signal at ω_1 ($\omega_1 \approx \omega_C$), chop it and put it into the mixer reference input, where it gets multiplied by the signal input. Without chopping, the mixer output would have a DC output proportional to the signal input. With chopping, the DC output is multiplied by ± 1 at the chopping frequency. If we now chop this output we can recover the DC output. However, the chopping operations are not ideal and signals at frequencies other than the reference can cause DC outputs from the final chopping operation. The spurious responses are typically -10 dB at a frequency offset of $\pm 2f_C$, dropping to -30 dB at $\pm 6f_C$ and -42 dB at $\pm 12f_C$ where f_C is in the range of 2-12 kHz.

Coherent Pickup

At the high reference frequencies used by the SR844, a small amount of reference signal pickup occurs in the RF signal path. This is called coherent pickup. Since the pickup is phase coherent with the reference frequency it is detected by the SR844 as if it was a real signal input. Measuring signals which are smaller than the instrument's own coherent pickup requires care and the use of offsets.

The typical amount of coherent pickup in the SR844 is shown below.

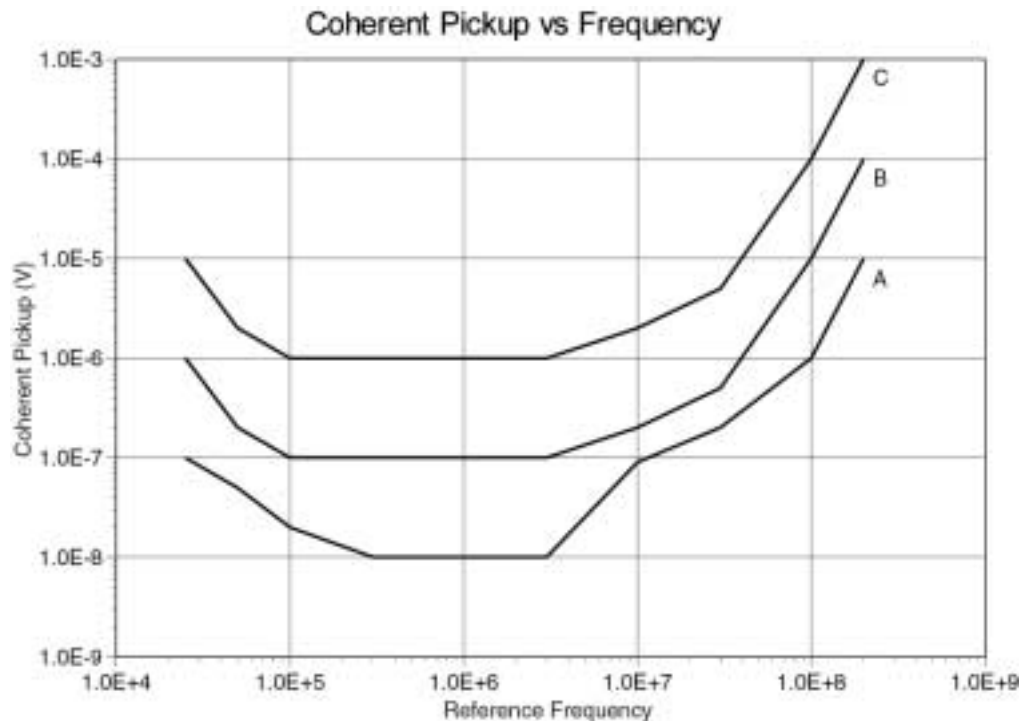

The level of coherent pickup (three curves above) is dependent on the RF input gain. The choice of Wide (RF) reserve and Sensitivity determines the RF gain and thus, the level of coherent pickup. The following table shows which curve to use.

Wide Reserve	50 Ω Sig Z-In			1 MΩ Sig Z-In		
	HIGH	NORMAL	LOW NOISE	HIGH	NORMAL	LOW NOISE
Sensitivity						
1 V	C	C	C	C	C	C
300 mV	C	C	C	C	C	C
100 mV	C	B	B	C	C	B
30 mV	C	B	B	C	B	B
10 mV	C	B	A	B	B	A
3 mV	C	B	A	B	B	A
1 mV	C	B	A	B	A	A
300 μV	B	A	A	B	A	A
100 μV	B	A	A	B	A	A
30 μV	B	A	A	A	A	A
10 μV	A	A	A	A	A	A
3 μV	A	A	A	A	A	A
1 μV	A	A	A	A	A	A
300 nV	A	A	A	A	A	A
100 nV	A	A	A	A	A	A

Clearly the Low Noise reserve setting should be used whenever possible. For sensitive measurements, the Low Noise reserve can provide 60 dB or more of dynamic reserve while minimizing the coherent pickup.

Another source of coherent pickup is in the experimental setup itself. The signal and reference cables and grounds are very important, especially at higher reference frequencies.

The X and Y offsets can be used to cancel the coherent pickup as long as the pickup remains stable during the experiment.

Using the SR844 as a Double Lock-In

The ratio feature of the SR844 can be used to provide a second stage of demodulation. Consider the following application: you have an experiment providing a signal at 100 MHz. Because the environment is noisy and RF interference is everywhere, you arrange the experiment so that the signal of interest is modulated at a low frequency, say on/off at 100 Hz. This could be a laser beam with a 100 MHz pulse rate going through a light chopper spinning at 100 Hz. The problem is to measure the modulated component of the 100 MHz signal.

One solution is to use a 100 MHz power meter to measure the signal, and put its 100 Hz output into a traditional low-frequency lock-in such as an SR830 and measure the 100 Hz component. Or you could put the signal into an SR844 and make a narrowband measurement at 100 MHz, using a 1 ms time constant, and take the 100 Hz analog output and look at it with either an oscilloscope or a low-frequency lock-in. Or you could have the SR844 detect *both* the 100 MHz and 100 Hz signals as follows: put the 100 Hz reference signal into the SR844's AUX IN 1 input, turn on ratio mode, and have the SR844 make the measurement for you directly, say with a 1 s time constant.

The key to this technique, sometimes referred to as a double lock-in, is putting in a bipolar square wave into AUX IN 1. Remember that the DSP is dividing the incoming data by AUX IN 1, and then low-pass filtering the result. If AUX IN 1 is ± 1 V, the DSP is effectively demodulating the 100 Hz output and averaging it.

In order to get accurate measurements of the 100 Hz modulated component of the 100 MHz signal, it is important that any unmodulated 100 MHz signal be rejected. You can do this by turning off the 100 MHz modulation and adjusting the DC offset of the AUX IN 1 square wave until the SR844 reading is nulled. In the above example, simply turn off the light chopper and pass the beam 100% of the time. If the AUX IN 1 signal comes from a source that allows independent phase adjustment without disturbing the experiment, you can also perform the following test: change the *phase* of the AUX IN 1 source by 180° — if the signal is properly nulled, the instrument reading will change sign but stay at the same value.

While the use of AUX IN 1 for demodulation can be a handy technique, it does suffer from two limitations. First, the AUX IN 1 input is bandwidth limited to about 3 kHz (minimum sampling rate is 12 kHz), so the modulation signal into AUX IN 1 should be considerably slower than this, say up to a few hundred Hz. Second, there is no phase adjustment on the ratio input. Remember, the X and Y outputs are *both* modulated at the *same* phase of the 100 Hz modulation. In the above example, they both turn on and off together with the light chopper. If the ratio input is 90° out of phase with the this modulation, the result is zero on *both* X and Y.

In general, using a low-frequency lock-in amplifier is preferred. However, in many instances, the SR844 provides a convenient solution for both modulation frequencies.

Noise Measurements

Lock-in amplifiers can be used to measure noise. Noise measurements are usually used to characterize components and detectors.

The SR844 measures input signal noise *at* the reference frequency. Many noise sources have a frequency dependence which the lock-in can measure.

How Does a Lock-in Measure Noise ?

Remember that the lock-in detects signals close to the reference frequency. How close? Input signals within the detection bandwidth set by the time constant and filter rolloff appear at the output at a frequency $f=f_{\text{SIG}}-f_{\text{REF}}$. Input noise near the reference frequency appears as noise at the output with a bandwidth of DC to the detection bandwidth.

For Gaussian noise, the equivalent noise bandwidth (ENBW) of a low-pass filter is the bandwidth of a perfect rectangular filter which passes the same amount of noise as the real filter. The ENBW is determined by the time constant and slope as shown below.

Slope [dB/octave]	ENBW for Time Constant T
6	$1/(4T)$
12	$1/(8T)$
18	$3/(32T)$
24	$5/(64T)$

Noise Estimation

The noise is simply the standard deviation (root of the mean of the squared deviations) of the measured X or Y. This formula, while mathematically exact, is not suited to providing a real-time output proportional to the measured noise. Therefore the SR844 uses a simplified algorithm to estimate the X or Y noise.

The moving average of X is computed over some past history, and subtracted from the present value X to get the deviation. The Mean Average Deviation (MAD) is computed as a moving average of the absolute value of the deviations. For Gaussian noise, the MAD is related to the RMS deviation by a constant factor. The MAD is scaled by this factor and by the ENBW to obtain noise in units of Volts/ $\sqrt{\text{Hz}}$. X and Y noise are displayed in units of Volts/ $\sqrt{\text{Hz}}$. The average reading is independent of the time constant and slope but the variations or noisiness in the reading is not. For more stable readings, use longer time constants.

In the SR844 the X and Y noise are computed in the host processor; the MAD algorithm is used because it requires less computation and is a moving average. The X and Y data values are sampled (from the DSP) at a 512 Hz rate; the moving average and MAD are then updated. The moving averages have an exponential time constant that varies between 10 to 80 times the filter time constant. Shorter averaging times settle quickly but fluctuate a lot and yield a poor estimate of the noise, while longer averaging times yield better noise estimates but take a long time to settle to a steady answer.

The SR844 performs the noise calculations all the time, whether or not X or Y noise is being displayed. Thus, as soon as X noise is displayed, the value shown is up to date and no extra

settling time is required. If the sensitivity (or other measurement parameter) is changed, then the noise estimate will need to settle to the correct value.

Intrinsic (Random) Noise Sources

Random noise finds its way into experiments in a variety of ways. Good experimental design can reduce these noise sources and improve the measurement stability and accuracy.

There are a variety of intrinsic noise sources which are present in all electronic signals. These sources are physical in origin.

Johnson Noise

Every resistor generates a noise voltage across its terminals due to thermal fluctuations in the electron density within the resistor itself. These fluctuations give rise to an open-circuit noise voltage

$$V_{\text{NOISE(rms)}} = \sqrt{4kTR\Delta f} \quad (2-20)$$

where k is Boltzmann's constant ($1.38 \times 10^{-23} \text{ JK}^{-1}$), T is the absolute temperature (typically 300 K), R is the resistance in ohms and Δf is the measurement bandwidth in Hz.

The amount of noise measured by the lock-in is determined by the measurement bandwidth. In a lock-in the equivalent noise bandwidth (ENBW) of the time constant filters sets the measurement bandwidth. The ENBW is determined by the time constant and slope as shown previously.

The Johnson noise of a 50 Ω input on the SR844 is simply

$$V_{\text{NOISE(rms)}} = 0.91 \text{ nV} \times \sqrt{\text{ENBW}}$$

Shot Noise

Electric current has noise due to the finite nature of the charge carriers. There is always some non-uniformity in the electron flow which generates noise in the current. This noise is called shot noise. This can appear as voltage noise when current is passed through a resistor. The shot noise or current noise is given by

$$I_{\text{NOISE(rms)}} = \sqrt{2qI_{\text{RMS}}\Delta f} \quad (2-21)$$

where q is the electron charge ($1.6 \times 10^{-19} \text{ C}$), I_{RMS} is the rms current and Δf is the measurement bandwidth.

1/f Noise

Every 68 Ω resistor, no matter what it is made of, has the same Johnson noise. However there is additional noise, aside from the Johnson noise, which arises from resistance fluctuations due to the current flowing through the resistor. This noise has spectral power density inversely proportional to the frequency, hence the name. The amount of 1/f noise is dependent on the resistor material and even manufacturing details. For carbon composition resistors this noise is typically 0.3 $\mu\text{V/V}$ per decade of frequency, while for leaded metal film resistors 0.01 $\mu\text{V/V}$ is more typical. These numbers are for low resistance values 10–1000 Ω , the $\mu\text{V/V}$ numbers are worse for large resistances.

Total Noise

All of these noise sources are incoherent. The total random noise is the square root of the sum of the squares of all the incoherent noise sources.

External Noise Sources

In addition to the intrinsic noise sources discussed in the previous section, there are a variety of external noise sources within the laboratory.

Many noise sources are asynchronous, i.e. they are not related to the reference and do not occur at the reference frequency or its harmonics. Examples include lighting fixtures, motors, cooling units, radios and computer screens. These noise sources affect the measurement by increasing the required dynamic reserve or time constant.

Some noise sources, however, are related to the reference and, if picked up in the signal path, will add or subtract from the actual signal and cause errors in the measurement. Typical sources of synchronous noise are ground loops between the experiment, detector and lock-in, and electronic pick-up from the reference oscillator or experimental apparatus and cables.

Many of these noise sources can be reduced with good laboratory practice and experiment design. There are several ways in which noise sources are coupled into the signal path.

Capacitive coupling

An RF or AC voltage from a nearby piece of apparatus can couple to a detector via a stray capacitance. Although C_{STRAY} may be very small, the coupled noise may still exceed a weak experimental signal. This is especially damaging if the coupled noise is synchronous (i.e. at the reference frequency).

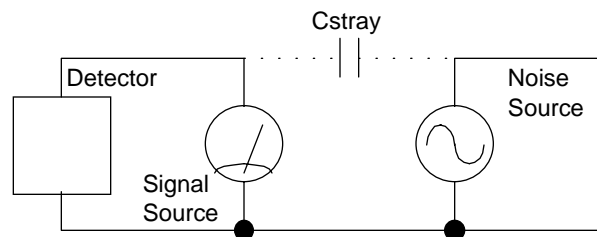

We can estimate the noise current caused by a stray capacitance by

$$I = C_{\text{STRAY}} \times (dV/dt) = \omega \cdot C_{\text{STRAY}} \cdot V_{\text{NOISE}} \quad (2-22)$$

where $\omega/2\pi$ is the noise frequency, V_{NOISE} is the noise amplitude, and C_{STRAY} is the stray capacitance. This type of coupling is especially damaging since it is proportional to frequency and the SR844 operates at very high frequencies.

For example, if the noise source is a computer clock line, $\omega/2\pi$ might be 33 MHz and V_{NOISE} might be 5 V/2. C_{STRAY} can be crudely estimated using a parallel plate equivalent capacitor, perhaps 0.1 cm^2 at a distance of 10 cm, which yields $C_{\text{STRAY}} \cong 10^{-15} \text{ F}$. The resulting noise current is $0.5 \text{ } \mu\text{A}$, or $25 \text{ } \mu\text{V}$ across $50 \text{ } \Omega$.

If the noise source is at the reference frequency, then the problem is much worse. The lock-in rejects noise at other frequencies, but pick-up at the reference signal appears as signal !

Cures for capacitive coupling include:

- Removing or turning off the noise source.
- Keep the noise source far from the experiment (reducing C_{STRAY}). Do not bring signal cables close to the noise source or reference cables.
- Designing the experiment with low-impedance detectors (so that noise current generates small voltages).
- Installing capacitive shielding by placing both the experiment and detector in a metal box.

Inductive coupling

An AC current in a nearby piece of apparatus can couple to the experiment via a magnetic field. A changing current in a nearby circuit gives rise to a changing magnetic field, which induces an EMF ($d\Phi_B/dt$) in the loop connecting the detector to the experiment. This is like a transformer with the experiment–detector loop as the secondary winding.

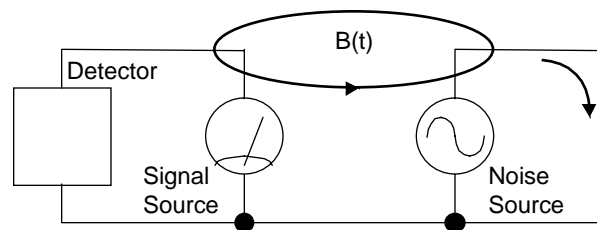

Cures for inductively coupled noise include:

- Removing or turning off the interfering noise source.
- Reducing the area of the pick-up loop by using twisted pairs or coaxial cables.
- Using magnetic shielding to prevent the magnetic field from crossing the area of the experiment.

Resistive coupling or Ground Loops

Currents flowing through ground connections can give rise to noise voltages. This is especially a problem with reference frequency ground currents.

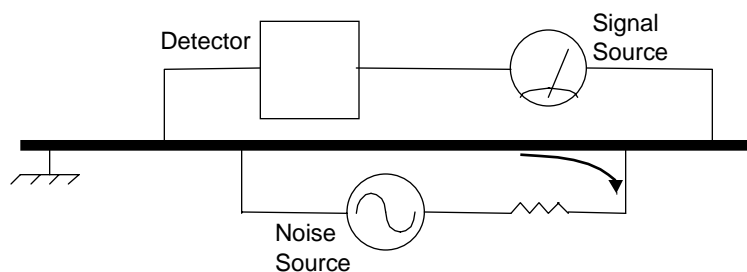

In this illustration, the detector is measuring the signal relative to a ground far from the rest of the experiment. The detector senses the signal plus the voltage due to the noise source's ground return passing through the finite resistance of the ground between the experiment and the detector. The detector and the experiment are grounded at different places which, in this case, are at different potentials.

Cures for ground loop problems include:

- Grounding everything to the same physical point.
- Using a heavy ground bus to reduce the resistance of ground connections.
- Removing sources of large ground currents from the ground bus used for small signals.

Microphonics

Not all sources of noise are electrical in origin. Mechanical noise can be translated into electrical noise by microphonic effects. Physical changes in the experiment or cables (due to vibrations, for example) can result in electrical noise at the lower end of the SR844's operating frequency range.

For example, consider a coaxial cable connecting a detector to the lock-in. The capacitance of the cable is a function of its geometry. Mechanical vibrations in the cable translate into a capacitance that varies in time at the vibration frequency. Since the cable is governed by $Q = C \cdot V$. Taking the components of this equation at the vibration frequency, we have $Q_v = C_v \cdot V_0 + C_0 \cdot V_v$. We can also use $V_v = R \cdot I_v = j\omega Q_v$, where R is the load resistance on the cable, and solve for V_v

$$V_v = -C_v \cdot V_0 / [C_0 + j(\omega R)] \quad (2-23)$$

This assumes a DC voltage (V_0) present on the cable. In general a cable subject to vibration acts as a mixer, generating signal components at the sum and difference of the vibration frequency and any electrical signal frequency.

Some ways to minimize microphonic signals are:

- Eliminate mechanical vibrations near the experiment.
- Tie down cables carrying sensitive signals so they do not move.
- Use a low noise cable that is designed to reduce microphonic effects.

Chapter 3

Operation

In This Chapter

Overview	3-3	CH1 Display and Output	3-15
Power	3-3	CH2 Display and Output	3-21
Reset	3-3	Reference Section	3-27
Keys	3-4	Save and Recall	3-31
Key-Click On/Off	3-4	Interface	3-32
Keypad Test	3-4	Scan and Rel	3-34
Knob	3-4	Overview	3-34
Local Lockout	3-5	Using Frequency Scans	3-35
Front Panel Display Test	3-5	Storing and Using Rel Values	3-36
Display Off Operation	3-5	Scan and Rel Example	3-39
Front Panel Connectors	3-5	Rels without Scan	3-40
Rear Panel Connectors	3-6	Auto Functions	3-41
Factory Preset Values	3-7	Shift Functions	3-42
Signal Input	3-8		
Time Constants	3-11		
Sensitivity	3-13		

Overview

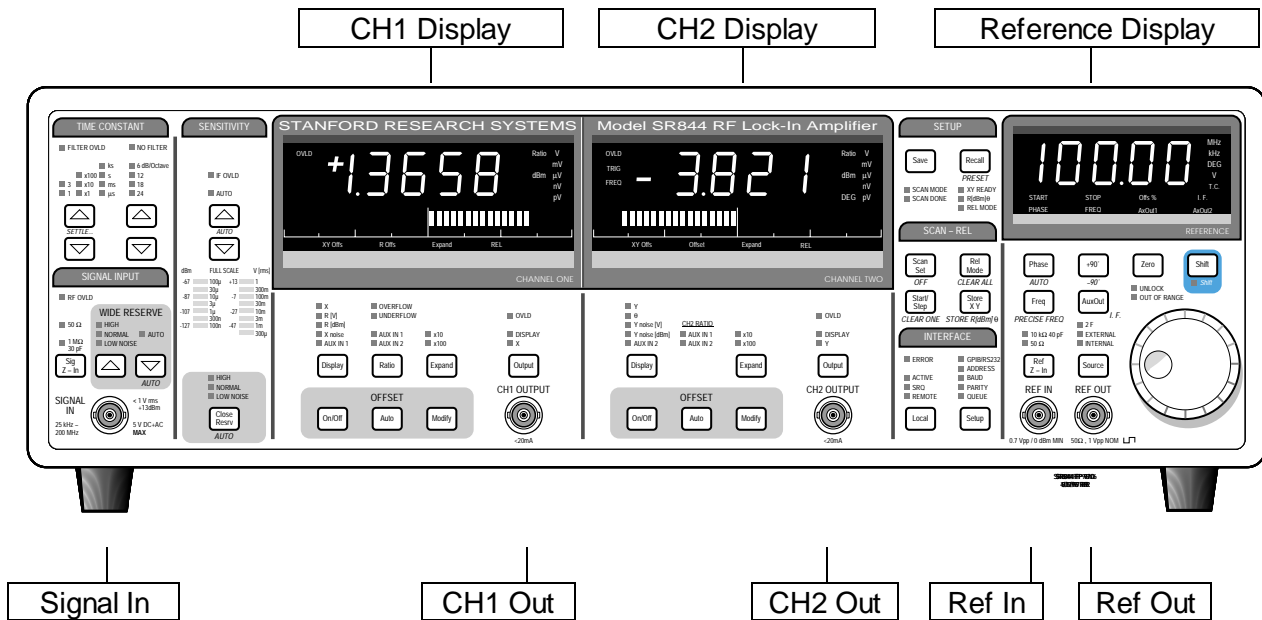

Power

The power switch is on the rear panel. The SR844 is turned on by pushing the switch up. The serial number (5 digits) is shown on the CH1 and CH2 displays and the REFERENCE display shows the firmware version. The following internal tests are performed.

DATA	Performs a read/write test to the processor RAM.
BATT	The nonvolatile backup memory is tested. Instrument settings are stored in nonvolatile memory and are retained when the power is turned off.
PROG	Checks the processor ROM.
DSP	Checks the digital signal processor (DSP).
RCAL	If the backup memory check passes, then the instrument returns to the settings in effect when the power was last turned off (<i>RCAL USER</i> is displayed). If there is a memory error, then the stored settings are lost and the factory preset values are used (<i>RCAL STD</i>)

Reset

The SR844 may be set to the factory preset settings at any time by pressing Shift–Recall (Shift then Recall).

To completely reset the unit, hold down the Setup key while the power is turned on. The unit will ignore previous setups and use the factory preset settings.

Keys

The keys are grouped and labeled according to function. In the manual, keys are referred to in **This Font**. A complete description of the keys follows later in this chapter.

Legends printed in blue below some keys are shift key functions. Just like on a calculator, the Shift key combinations are sequential, e.g. press **Shift** followed by **Recall** to PRESET the instrument to its factory default setup. Sequential keypresses are designated with a – sign, e.g. **Shift–Recall**.

Simultaneous keypresses are reserved for a few test functions and are designated with a + sign, e.g. **Local+Setup**.

Invalid keypresses cause the SR844 to produce an audible error tone.

Key-Click On/Off

Press **TimeConstUp+TimeConstDown** (both keys simultaneously) to toggle the key-click on and off.

Keypad Test

To test the keypad, press the **Ref Z-In+Source** keys together. The CH1 and CH2 displays will read *Pad Code*, and a number of LED indicators will be turned on. The LED's indicate which keys have not yet been pressed. Press all of the keys on the front panel, one at a time. As each key is pressed, the key code is displayed on the REFERENCE display, and the LED nearest that key turns off. When all of the keys have been pressed, the display will return to normal. To return to normal operation without pressing all the keys, simply turn the knob.

Knob

The knob is used to adjust parameters in the Reference Display. The following parameters may be adjusted:

- Reference Frequency (Internal Reference Mode)
- Reference Phase
- Auxiliary Output Voltages
- Interface parameters (GPIB or RS-232)
- Active Remote Interface
- All Offsets
- Manual Scan parameters
- Save/Recall memory location
- Scrolling the Remote Interface Queue display

Local Lockout

The front panel keys and the knob may be disabled by remote interface command (GPIB or RS-232). Attempts to change the settings from the front panel will display the message *LOCL LOUT* indicating that local control is locked out by the remote interface. Note that the factory preset values leave the front panel keys *enabled* even during remote operation. Local/Remote operation is discussed more fully later in this chapter (see the **Local** key), and in Chapter 4, *Interface Commands*.

Front Panel Display Test

To test the front panel displays press **Local** and **Setup** together. Some of the front panel LED's will turn on. Note that the instrument is still operational; only the display is in test mode. Press **+90°** to increase the number of illuminated LED's and **Phase** to decrease the number. Use the knob to move the selected LED's across the panel. Make sure that every LED can be turned on. Pressing **Zero** shows a text message on the display. Press any key other than **Phase**, **+90°**, or **Zero** to exit this test mode.

Display Off Operation

Enter the Display Test mode as explained above. Press **Phase** until no LED's are lit. The SR844 is still operating, output voltages are updated and the unit responds to interface commands. To change a setting press any key other than **Phase**, **+90°** or **Zero** (**Local** or **AuxOut** are good choices) to exit the test mode, change the desired parameter, and then re-enter Display Test mode.

Front Panel Connectors

There are five BNC connectors on the front panel.

SIGNAL INPUT	The measurement range of the SR844 is up to 1 Vrms (+13 dBm), over the frequency range 25 kHz to 200 MHz. Do not exceed the damage threshold of ±5V DC+AC.
CH1 OUTPUT	The CH1 output provides a ±10V analog output proportional to either X or the CH1 displayed quantity.
CH2 OUTPUT	The CH2 output provides a ±10V analog output proportional to either Y or the CH2 displayed quantity.
REFERENCE INPUT	The SR844 accepts sinusoidal and digital signals as external reference inputs, including low-duty cycle pulse trains. The signal should be a 0 dBm sine wave or a 0.7 to 5 Vpp pulse. The reference input may be terminated in either 50 Ω or 10 kΩ, 40 pF.

REFERENCE OUT	The reference out signal is phase coherent with the reference signal internal to the SR844. It is a square wave, nominally 1 V _{pp} into 50 Ω. In external reference mode, this signal is phase-locked to the external reference input, while in internal mode it is derived from a frequency synthesizer and locked to an internal 20 MHz crystal oscillator.
----------------------	---

Important!

The shields of all the connectors are connected to the instrument ground and thereby to chassis ground. **Do not under any circumstance attempt to apply voltage to the connector shields.**

Rear Panel Connectors

The rear panel has six BNC connectors, the power entry module and connectors for the GPIB and RS-232 remote interfaces.

Power Entry Module	The power entry module is used to fuse the AC line voltage input, select the line voltage, and block high-frequency noise from entering or exiting the instrument. Refer to the beginning of the manual under <i>Safety and Preparation for Use</i> for instructions on selecting the correct line voltage and fuse.
RS-232	The RS-232 connector is configured as a DCE (transmit on pin 3, receive on pin 2). The baud rate and parity are set with the Setup key. To connect the SR844 to a standard PC/compatible serial port, which is a DTE, use a straight-through serial cable.
IEEE-488 (GPIB)	The 24-pin IEEE-488 connector allows a computer to control the SR844 via the IEEE-488 (GPIB) instrument bus. The address of the instrument is set with the Setup key. The default address is 8.

From left to right, the BNC connectors are

TRIG IN	This TTL input may be used to trigger internal data storage and/or to start data acquisition. Data storage is available only via the remote interfaces. If Trigger Start is selected, then a rising edge will start data storage. If the sample rate is also Triggered, then samples are recorded at the first and every subsequent trigger. The maximum sample rate is 512 Hz with a 2 ms trigger to sample latency.
TTL OUT	This output is a TTL output (0–5 V nominal) at the reference frequency. It is only available for reference frequencies below 1.56 MHz. This output can drive a 50 Ω load.
AUX OUT 1	This is an auxiliary DC output voltage. The range is ±10.5 V and the resolution is 1 mV. The output impedance is <1 Ω and the current is limited to 10 mA.

AUX OUT 2	A second auxiliary DC output voltage, identical to AUX OUT 1.
AUX IN 1	This is an auxiliary DC/low-frequency input voltage which can be digitized by the SR844. The range is ± 10.5 V and the resolution is 16 bits (approx. 0.3 mV). The input impedance is 1 M Ω and the bandwidth is limited to about 3 kHz. The SR844 can report this voltage just like a digital voltmeter, or the voltage can be used to normalize the signal in ratio mode.
AUX IN 2	A second auxiliary DC/low-frequency input voltage, identical to AUX IN 1.

Factory Preset Values

The factory preset values may be set by pressing Shift–Recall, or by sending the *RST command over either remote interface. The factory preset values are:

Reference/ Phase	
Reference Source	Internal
Internal Frequency	1.00 MHz
Input Impedance	50 Ω
Reference Display	Frequency
Reference Phase	0°

Scan/ Rel	
Scan Start	100 kHz
Scan Stop	100 MHz
Number of Steps	4
Scan Mode	Off
Rel Values	Not Set
Rel Mode	Off

RF Signal Input	
Input Impedance	50 Ω
Wide Reserve	Normal

Aux Outputs	
AUX OUT 1	0.000 V
AUX OUT 2	0.000 V

Gain /Time Constant	
Sensitivity	1 Vrms
Close Reserve	Normal
Time Constant	100 ms
Filter dB/oct	12 dB

Remote Interfaces	
Output to	GPIB
GPIB Address	8
RS-232 Baud Rate	9600
Parity	None
Override Remote	On

Output/ Offset	
CH1 Output	X
CH2 Output	Y
CH1 Display	X
CH2 Display	Y
All Offsets	0.00 %
All Expands	$\times 1$
Ratio Mode	Off

Other	
Alarms	On
Key-Click	On
Status Enable Registers	Cleared
Save/ Recall Memories	Cleared

Data Storage	
Sample Rate	1 Hz
Scan Mode	Loop
Trigger Starts	No

Signal Input

The keys in this section operate on the RF signal input of the instrument, before the signal is mixed down to the IF (Intermediate Frequency, 2-12 kHz). Refer to the Chapter 2, *The Functional SR844*, for more information.

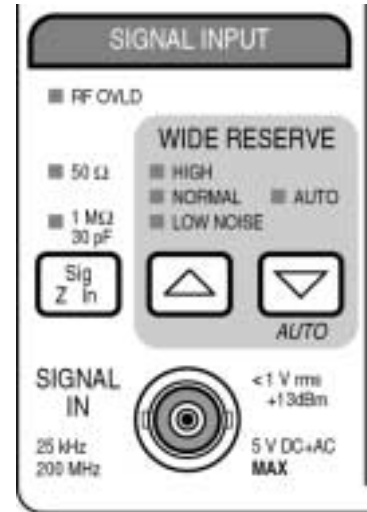

<p>Sig Z-In</p>	<p>This key selects the input impedance of the SR844 Signal Input, either 50 Ω or 1 MΩ. The indicators above the key show the current selection.</p> <p>In 50 Ω mode, the SR844 input is matched to a 50 Ω source. This is the appropriate setting for signal sources capable of driving a 50 Ω load. It is highly recommended to use 50 ohm cables in this mode, since an impedance mismatch will cause a reflection of power at the location of the mismatch, resulting in a discrepancy between the signal emanating from the source and that measured by the SR844.</p> <p>The 1 MΩ setting is appropriate for high-impedance sources, or for situations where a standard 10X scope probe is used to measure the voltage at a test point. In this setting, the input signal is buffered by a pre-amplifier before going through the RF attenuator and gain stages to the mixers.</p> <p>Important!</p> <p>The 1 MΩ input should only be used if the source impedance is much greater than 50 Ω. The bandwidth of the 1 MΩ input is limited by its 30 pF input capacitance and the source impedance. The source impedance (R) and the input capacitance (30 pF) form a simple low-pass filter at $f_c = 1/2\pi RC$. Signals at frequencies greater than f_c are attenuated at the input and are not measured accurately by the SR844.</p>
<p>Wide Dynamic Reserve</p>	<p>Wideband Dynamic Reserve or RF reserve, allocates the RF signal gain before the mixer. The Wide Reserve should be set to accommodate <i>all</i> interfering signals within the 20 kHz - 200 MHz bandwidth of the RF input. High reserve applies minimum RF gain preventing large interfering signals from causing amplifier overloads. Low Noise provides maximum RF gain and the best output signal-to-noise and is less susceptible to coherent pick-up. Normal is somewhere in between.</p> <p>The overall gain is achieved with a combination of RF gain (before the mixers), IF gain (after the mixers) and DSP gain (in the output filters). Changing the sensitivity changes the overall gain while changing the dynamic reserves (Wide and Close) affects the allocation of gain between RF, IF and DSP gains. See the discussion in Chapter 2, <i>Dynamic Reserve</i>, for more information.</p>

	<p>Important! The Wide Reserve setting and the sensitivity determine the amount of internal coherent pickup. See the discussion in Chapter 2 on <i>Dynamic Reserve</i> and <i>Coherent Pickup</i> for more information.</p>
Wide Resrv Up/Down	<p>These keys set the Wideband Dynamic Reserve mode to either High, Normal or Low Noise. The current setting is indicated by the LEDs above the keys.</p> <p>The Low Noise mode selects the maximum RF gain allowed at the current sensitivity. Low Noise provides the best possible signal-to-noise and the least coherent pickup and should be used whenever possible.</p> <p>The instrument selects RF attenuation or gain depending on the Wide Reserve mode and the instrument sensitivity (see below).</p>
AUTO [Shift-Wide ResrvDown]	<p>This key sequence selects the Wideband Dynamic Reserve mode automatically. This function will execute <i>once</i> when the keys are pressed. A tone sounds when the function is complete. The reserve will not continue to change even if the input signal changes substantially. To adjust for the changed conditions, it may be necessary to perform the Auto function again, or make manual changes. The AUTO indicator is on while this function executes.</p>
RF OVLD	<p>The RF OVLD indicator shows that the RF input is overloaded. This overload occurs in the RF signal path before the mixers. If RF OVLD is on, try a higher wide reserve or a larger sensitivity.</p>

RF Attenuation (–20 dB) or Gain (+20 dB) for different combinations of Wide Dynamic Reserve and Sensitivity is shown in the table below. 0 dB means that the signal goes straight into the mixer with neither attenuation nor gain. Note that at sensitivities below 30 μV, the full dynamic reserve of the instrument is available even at +20 dB gain, so there is no reason to switch in attenuation. Also, at minimum sensitivity (1 V rms) attenuation is always required to prevent the mixer from overloading.

Sig Z-In	50 Ω			1 MΩ		
	WIDE RESERVE	NORMAL	LOW NOISE	WIDE RESERVE	NORMAL	LOW NOISE
Sensitivity						
1 V	–20 dB	–20 dB	–20 dB	–20 dB	–20 dB	–20 dB
300 mV	–20 dB	–20 dB	–20 dB	–20 dB	–20 dB	–20 dB
100 mV	–20 dB	0 dB	0 dB	–20 dB	–20 dB	0 dB
30 mV	–20 dB	0 dB	0 dB	–20 dB	0 dB	0 dB
10 mV	–20 dB	0 dB	+20 dB	0 dB	0 dB	+20 dB
3 mV	–20 dB	0 dB	+20 dB	0 dB	0 dB	+20 dB
1 mV	–20 dB	0 dB	+20 dB	0 dB	+20 dB	+20 dB
300 μV	0 dB	+20 dB	+20 dB	0 dB	+20 dB	+20 dB
100 μV	0 dB	+20 dB	+20 dB	0 dB	+20 dB	+20 dB
30 μV	0 dB	+20 dB	+20 dB	+20 dB	+20 dB	+20 dB
10 μV	+20 dB	+20 dB	+20 dB	+20 dB	+20 dB	+20 dB
3 μV	+20 dB	+20 dB	+20 dB	+20 dB	+20 dB	+20 dB

3-10 Signal Input

Sig Z-In	50 Ω			1 M Ω			
	WIDE RESERVE	HIGH	NORMAL	LOW NOISE	HIGH	NORMAL	LOW NOISE
1 μ V	+20 dB	+20 dB	+20 dB	+20 dB	+20 dB	+20 dB	+20 dB
300 nV	+20 dB	+20 dB	+20 dB	+20 dB	+20 dB	+20 dB	+20 dB
100 nV	+20 dB	+20 dB	+20 dB	+20 dB	+20 dB	+20 dB	+20 dB

Time Constants

The keys in this section operate on the signal output of the instrument, after the signal is mixed down to DC. Refer to Chapter 2, *Inside the DSP*, for more information.

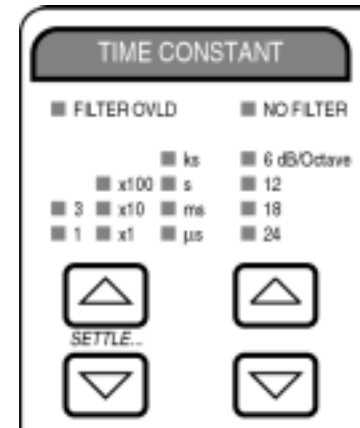

<p>Time Constant</p>	<p>The output low-pass filter directly determines the bandwidth of the lock-in amplifier. The relationship between the filter time constant, τ, and the low-pass filter bandwidth, $f_{-3\text{ dB}}$ is shown in the table below.</p> <p>A lock-in output signal at f_o is due to an interfering input signal at $f_{\text{ref}} \pm f_o$. This output signal is attenuated by the output low-pass filter. Signals whose f_o is greater than ΔF_{LP} are attenuated while signals closer than ΔF_{LP} to the reference frequency will appear at the output (and obscure the output from the actual signal).</p>																									
<p>Time Constant Up/Down</p>	<p>The left hand UP/DOWN keys in this section select the output filter time constant. The time constant of the SR844 may be set from 100 μs to 30 ks in 1-3-10 steps. The time constant is indicated by a set of indicators, (1x, 3x), (1, 10, 100), and (μs, ms, s, ks).</p>																									
<p>Filter Slope</p>	<p>0 to 4 stages of output low-pass filtering may be selected. These provide up to 24 dB/octave of attenuation for AC signals at the output.</p> <p>Each filter stage contributes 6 dB/octave of roll-off in the output filter response. Using a higher slope can decrease the required time constant and make a measurement faster. Note that the frequency response of a <i>single</i> filter stage is such that the -3 dB point is at an output frequency $f_o = 1/2\pi\tau$, where τ is the time constant. With 3 poles, the filter response at $f_o = 1/2\pi\tau$ will be -9 dB. The correct -3 dB points for more than one filter stage are given in the following table</p> <table border="1" data-bbox="423 1339 1300 1535"> <thead> <tr> <th>Slope</th> <th>Poles</th> <th>$f_{-3\text{ dB}}$</th> <th>$f_{-3\text{ dB}} [\tau=1\text{ ms}]$</th> <th>$f_{-3\text{ dB}} [\tau=3\text{ ms}]$</th> </tr> </thead> <tbody> <tr> <td>6 dB/oct</td> <td>1</td> <td>$1.000/2\pi\tau$</td> <td>159 Hz</td> <td>53.1 Hz</td> </tr> <tr> <td>12 dB/oct</td> <td>2</td> <td>$0.644/2\pi\tau$</td> <td>102 Hz</td> <td>34.2 Hz</td> </tr> <tr> <td>18 dB/oct</td> <td>3</td> <td>$0.510/2\pi\tau$</td> <td>81.2 Hz</td> <td>27.1 Hz</td> </tr> <tr> <td>24 dB/oct</td> <td>4</td> <td>$0.435/2\pi\tau$</td> <td>69.2 Hz</td> <td>23.1 Hz</td> </tr> </tbody> </table> <p>Important! The filter slope also determines the output update rate for the X (CH1) and Y (CH2) analog outputs. X and Y update at 48-96 kHz with 6 or 12 dB/oct slope and 12-24 kHz with 18 or 24 dB/oct slope. The update rate for R and θ remains 12-24 kHz regardless of filter slope.</p>	Slope	Poles	$f_{-3\text{ dB}}$	$f_{-3\text{ dB}} [\tau=1\text{ ms}]$	$f_{-3\text{ dB}} [\tau=3\text{ ms}]$	6 dB/oct	1	$1.000/2\pi\tau$	159 Hz	53.1 Hz	12 dB/oct	2	$0.644/2\pi\tau$	102 Hz	34.2 Hz	18 dB/oct	3	$0.510/2\pi\tau$	81.2 Hz	27.1 Hz	24 dB/oct	4	$0.435/2\pi\tau$	69.2 Hz	23.1 Hz
Slope	Poles	$f_{-3\text{ dB}}$	$f_{-3\text{ dB}} [\tau=1\text{ ms}]$	$f_{-3\text{ dB}} [\tau=3\text{ ms}]$																						
6 dB/oct	1	$1.000/2\pi\tau$	159 Hz	53.1 Hz																						
12 dB/oct	2	$0.644/2\pi\tau$	102 Hz	34.2 Hz																						
18 dB/oct	3	$0.510/2\pi\tau$	81.2 Hz	27.1 Hz																						
24 dB/oct	4	$0.435/2\pi\tau$	69.2 Hz	23.1 Hz																						
<p>Slope Up/Down</p>	<p>The right hand UP/DOWN keys in this section select the output low-pass filter slope (number of poles) in the time constant filter.</p>																									

3-12 Time Constants

<p>NO FILTER</p>	<p>To choose no output filtering, press the UP key until the NO FILTER indicator is on. The time constant indicators turn off in this case.</p> <p>No Filter bypasses the IF and output filters to provide the fastest response time of the instrument. This mode should be used with caution because these bypassed filters provide most of the instrument's spurious frequency rejection. In No Filter mode, the SR844 is acting more like a tuned receiver than a lock-in amplifier. No Filter mode is provided for those users who need the faster response time and are not concerned with limiting the detection bandwidth.</p> <p>Important!</p> <p>The update rate for the X and Y analog outputs is 48-96 kHz, depending upon the reference frequency. The update rate is fastest at the upper end of each octave, where the data is sampled at about 10 μs per point. The e^{-1} response time of the instrument is approximately 2 sample periods, or about 20 μs best case. The update rate for R and θ remains 12-24 kHz even in the No Filter mode.</p> <p>In addition to the update rate, the instrument has a latency of 3 sample periods.</p> <p>The recommended operating frequencies for the fastest response time are shown in the following table.</p> <table border="1" data-bbox="347 863 1284 972"> <tr> <td>46 kHz</td> <td>92 kHz</td> <td>180 kHz</td> <td>370 kHz</td> <td>740 kHz</td> <td>1.4 MHz</td> <td>2.9 MHz</td> </tr> <tr> <td>5.9 MHz</td> <td>11 MHz</td> <td>23 MHz</td> <td>47 MHz</td> <td>95 MHz</td> <td>190MHz</td> <td></td> </tr> </table>	46 kHz	92 kHz	180 kHz	370 kHz	740 kHz	1.4 MHz	2.9 MHz	5.9 MHz	11 MHz	23 MHz	47 MHz	95 MHz	190MHz	
46 kHz	92 kHz	180 kHz	370 kHz	740 kHz	1.4 MHz	2.9 MHz									
5.9 MHz	11 MHz	23 MHz	47 MHz	95 MHz	190MHz										
<p>Settle... [Shift-Time ConstUp]</p>	<p>This key sequence shows the elapsed time (in units of the current Time Constant) in the Reference Display. The display increments from the time the key sequence is pressed. It is a useful aid in making measurements with very long time constants where the user can wait a specified number of time constants before recording a measurement. Elapsed times are displayed from 0.01 to 99.99 time constants.</p>														
<p>FILTER OVLD</p>	<p>The FILTER OVLD indicator shows that an overload has occurred in the DSP output filters. Try increasing the time constant or filter slope. Another solution is to use a larger full scale sensitivity.</p>														

Sensitivity

The keys in this section select the overall sensitivity of the instrument (Output/Input). The IF dynamic reserve is also selected in this section. Refer to Chapter 2, *What is Dynamic Reserve*, for more information.

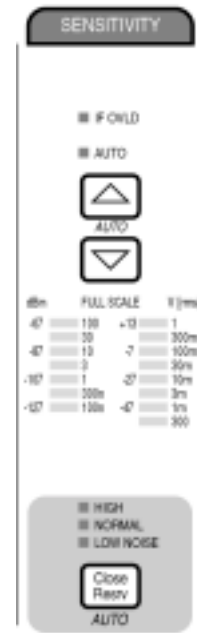

Sensitivity	The overall analog gain (output/input) is 10 VDC output divided by the full scale AC signal input and ranges from 10 to 10 ⁸ . The overall gain is achieved with a combination of RF signal gain (before the mixers), IF gain (after the mixers) and DSP gain (in the output filters). Changing the sensitivity changes the overall gain while changing the dynamic reserves (Wide and Close) affects the allocation of gain between RF, IF and DSP gains. See the discussion in Chapter 2, <i>What is Dynamic Reserve</i> , for more information.
Sens Up/Down	These keys select the full scale sensitivity of the instrument. The full scale sensitivity ranges from 100 nVrms (-127 dBm) to 1 Vrms (+13 dBm) in 1-3-10 steps (10 dB). The sensitivity is indicated below the Up/Down keys. Note that the dBm measurements are calculated assuming a 50 Ω source, and will be incorrect for the 1 MΩ input.
AUTO [Shift-SensUp]	This key sequence automatically adjusts the sensitivity based on the detected signal magnitude, the instrument reserve settings and any overload conditions. This function executes <i>once</i> when the keys are pressed. A tone sounds when the function is complete. The sensitivity will not continue to change even if there is a substantial change in the input signal. In the case of a substantial signal change, it may be necessary to perform the Auto Sensitivity function again, or adjust the sensitivity/reserve manually. It is common for users to make changes in the reserve and/or sensitivity after the unit has completed the Auto Sensitivity function. Auto Sensitivity takes more time to complete at larger time constants. The AUTO indicator is on while Auto Sensitivity is in progress. Auto Sensitivity will not execute if the time constant is greater than 1 s.
Close Dynamic Reserve	Close Reserve or IF reserve, allocates the IF gain after the mixer and before the DSP. The Close Reserve should be set to accommodate interfering signals closer to the reference frequency than the IF bandwidth (180 kHz). High reserve applies minimum IF gain preventing overloads before the DSP. Low Noise provides maximum IF gain and the best output signal to noise. Normal is somewhere in between.

3-14 Sensitivity

	<p>The overall gain is achieved with a combination of RF gain (before the mixers), IF gain (after the mixers) and DSP gain (in the output filters). Changing the sensitivity changes the overall gain while changing the dynamic reserves (Wide and Close) affects the allocation of gain between RF, IF and DSP gains. See the discussion in Chapter 2, <i>What is Dynamic Reserve</i>, for more information.</p>
Close Resrv	<p>This key cycles through the three Close (IF) Dynamic Reserve modes, High, Normal or Low Noise.</p> <p>The Low Noise mode selects the maximum IF gain allowed at the current sensitivity and wide reserve. Low Noise provides the best possible output signal-to-noise and should be used whenever possible.</p>
AUTO [Shift- Close Reserve]	<p>This key sequence automatically selects the Close Dynamic Reserve mode. This function will execute <i>once</i> when the keys are pressed. A tone sounds when the function is complete. The reserve will not continue to change even if the input signal changes substantially. To adjust for the changed conditions, it may be necessary to perform the Auto function again, or make manual changes. The AUTO indicator is on while this function executes.</p>
IF OVLD	<p>The IF OVLD indicator shows that the IF section is overloaded. This overload occurs after the mixers and is caused by input signals close to the reference frequency (within ~180 kHz with No Filter and within ~18 kHz with 6-24 dB/oct filtering). If IF OVLD is on, try a higher close reserve or a larger sensitivity.</p>

CH1 Display and Output

The keys in this section select the Channel 1 display quantity and analog CH1 OUTPUT, as well as offsets, expands and ratios.

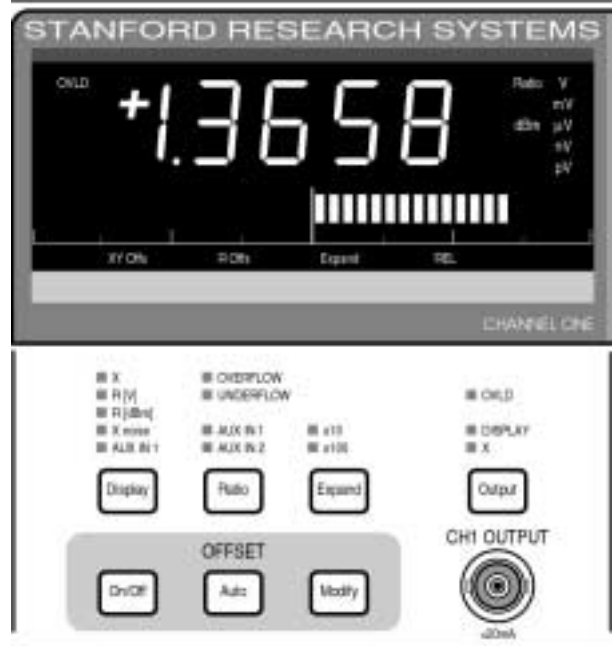

Display This key selects the Channel 1 Display quantity. Channel 1 may display X [Volts], R [Volts], R [dBm], Xnoise [Volts], or AUX IN 1 [Volts]. The displayed quantity appears on a 4½ digit display and also on the accompanying bar-graph display. An indicator shows the currently displayed quantity.

Quantity	Description
X	This is the component of the input signal in-phase with the reference. The reference phase may be adjusted; see the section on Reference Phase later in this chapter for more information.
R [V]	This is the magnitude of the input signal, measured in Volts. Note that R is computed from the filtered values of X and Y, so that a signal with constant R and rapidly-varying phase (compared to the time constant) will give an incorrect value for R.
R [dBm]	This is the magnitude of the input signal, measured in dBm. The conversion from Volts to dBm assumes a 50 Ω load.
Xnoise	This is the input signal noise at the reference frequency, and is derived from the X measurements. This quantity is discussed in greater detail in Chapter 2, <i>Noise Measurements</i> .
AUX IN 1	This is the voltage applied to the rear panel AUX IN 1.

Key features and parameters for the various displayed quantities are shown below.

Quantity [Unit]	Display Range	Bar Graph Range	Ratio	Offset	Expand	Max Output Update Period
X [Volts]	±110% f.s.	±f.s.	Yes	±110% f.s.	Yes	22 μs, <i>Note 2</i>
R [Volts]	±110% f.s.	±f.s.	Yes	±110% f.s.	Yes	88 μs, <i>Note 2</i>
R [dBm]	±220 dBm	±200 dBm	<i>Note 1</i>	±110% of 200 dBm	Yes	88 μs, <i>Note 2</i>
Xnoise [Volts]	±110% f.s.	±f.s.	<i>Note 1</i>	No	Yes	1.953 ms, <i>Note 3</i>
AUX IN 1 [Volts]	±10 V	±10 V	No	No	No	88 μs, <i>Note 2</i>

Note 1 If ratio mode has been selected, the reciprocal of the appropriate input (1.0V/AUX IN 1 or 1.0V/AUX IN 2) is computed, and *both* X and Y are multiplied by this quantity. Since the value of R is computed after the ratio, R is also scaled by the ratio. R[dBm] will show an offset, and Xnoise will be scaled in the same proportion as X.

Note 2 This shows the worst-case output update rate for the CH1 analog output. The update rate is fastest at the high end of an octave band. See the IF frequency display in the Reference Section for more details.

The X output updates 4 times slower when 18 and 24 dB/oct filtering is used.

The digital display is always updated at a 2 Hz rate. The bar-graphs are updated at 64 Hz. Display quantities may be read out via remote interface or stored in the internal data buffers (see Chapter 4, *Data Storage*) at a maximum rate of 512 Hz.

Note 3 The noise is computed at 512 Hz for all time constants ≤ 30 ms. For longer time constants the noise is updated 25.6 times per time constant.

Offset

User entered offsets can be added to X and Y. These offsets are added *before* taking ratios, output time-constant filtering, and computing R and θ .

Offsets are useful for making relative measurements or to cancel the contribution from an unwanted phase coherent signal. In analog lock-ins, offsets were generally used to remove DC output errors from the mixer outputs. The SR844 demodulator is digital and has no DC output errors, however, the SR844 does have coherent pickup at high frequencies, which can be canceled using offsets.

Important points about offsets:

- Xoffset and Yoffset are applied to X and Y before ratios, filtering and expands. R and θ are computed from the *offset* values of X and Y. Adding offsets to X or Y *changes* the value of R and θ .

	<ul style="list-style-type: none"> • In addition, changing the Reference Phase will modify the values of Xoffset and Yoffset. Think of (Xoffset, Yoffset) as a signal vector relative to the Reference (internal or external) which cancels an actual signal at the input. This cancellation is preserved even when the detection phase (Reference Phase) is changed. This is done by circularly rotating the <i>values</i> of Xoffset and Yoffset by minus the Reference Phase. This preserves the phase relationship between (Xoffset, Yoffset) and the signal input. • Since the vector (Xoffset, Yoffset) is used to cancel a real signal at the input, Xoffset and Yoffset are always turned on and off together. Turning either offset on turns on <i>both</i> offsets. Auto offsetting either X or Y performs auto offset on <i>both</i> quantities. These statements are true even if only one of the quantities X or Y is currently being displayed.
On/Off	<p>This key turns the Offset On or Off for the current CH1 display quantity. As indicated in the table above, X, R[V] and R[dBm] may be offset, while Xnoise and AUX IN 1 may not. This key has no effect if the currently displayed quantity is Xnoise or AUX IN 1. When Offset is turned On, the offset value last used for the current display quantity is applied.</p> <p>Turning Xoffset on and off also turns on and off Yoffset. The XYOffs indicator in the display indicates that the displayed quantity is affected by X and Y offsets.</p> <p>Xoffset and Yoffset are applied <i>before</i> R and θ are calculated. Thus, the XYOffs indicator will be on if the display is showing R and XY offsets are on.</p> <p>R Offsets (V or dBm) are simply added to the displayed quantities. The displayed value of R is simply $R(\text{display}) = R(\text{computed from offset X and Y}) + R\text{offset}$. The ROffs indicator in the display indicates that the displayed value of R has an Roffset applied. The R[dBm] offset simply adds or subtracts a number of dB from the display.</p> <p>The Offsets can be set by pressing the Modify key and then using the knob, or using the Auto key. The Offsets can also be set from the remote interface.</p>
Auto	<p>This key sets the Offset for the displayed quantity equal to the negative of its current displayed value, so that the display, with offset applied, is equal to zero. The Offset is turned On if it is not already On. This key has no effect for quantities that may not be offset.</p> <p>Important! If the display is X, Auto performs Auto Offset for both X <i>and</i> Y and turns on both X <i>and</i> Y offsets. This is true even if the CH2 display is <i>not</i> displaying Y at the time.</p>
Modify	<p>When Modify is pressed, the Offset of the currently displayed quantity appears on the Reference Display (above the knob), even if the Offset is Off. Press Phase, Freq or AuxOut to return the Reference Display to its previous state.</p> <p>The Offset is displayed as a percentage of Full Scale. For R[dBm] full scale is 200 dBm regardless of the sensitivity. The knob may be used to modify the offset. Turn the Offset on to apply the displayed offset.</p>

Important!

- Except for R[dBm], the offset is specified as a percentage of full scale sensitivity. Changing the sensitivity requires the offsets be changed to offset the same input signal.
- Changing the Reference Phase will modify the values of Xoffset and Yoffset. (Xoffset, Yoffset) is a signal vector relative to the Reference (internal or external) which cancels an actual signal at the input. This cancellation is preserved even when the detection phase (Reference Phase) is changed. This is done by circularly rotating the *values* of Xoffset and Yoffset by minus the Reference Phase. This preserves the phase relationship between (Xoffset, Yoffset) and the signal input.

Ratio

Ratio mode divides both X *and* Y by the input voltage AUX IN 1 or AUX IN 2. The ratio input is normalized to 1.000 Volt, so that ratioing by an Aux Input that is a steady 1.000 V is exactly the same as having the ratio mode Off. The useful range of the Aux Inputs, when in ratio mode, is from about 0.1 Volt to 10 Volts. Both positive and negative voltages are permitted.

The Ratio key selects the ratio mode. The ratio mode may be Off, divide by **AUX IN 1** or **AUX IN 2**. The **AUX IN 1** and **AUX IN 2** indicators above the Ratio key show the ratio mode if it is on. Both indicators are off when ratio mode is Off. The instrument has a single ratio mode, which applies to *both* X and Y. The CH2 **AUX IN 1** and **AUX IN 2** indicators follow the CH1 indicators.

In Ratio Mode, the non-ratioed quantities are not available.

When the ratio mode is on, the ratio is performed *after* X and Y offsets are applied and *before* the output time constant filters. This allows the offsets to cancel a signal at the input before applying the ratio.

R and θ are computed from ratioed X and Y. Thus, R is ratioed the same as X and Y. The ratio shows up as a dBm offset in R[dBm]. Xnoise is computed from the ratioed X. For example, if the ratio mode is **AUX IN 2** and the AUX IN 2 input is a steady 2 volts, X and R[V] will be 1/2 their non-ratioed values, R[dBm] will be down by 6 dB and Xnoise will also be down a factor of 2. Ratio is not applied to AUX IN 1.

Note that the effects of ratio mode on Xnoise may be several. A steady Aux Input will linearly scale the Xnoise as just mentioned. If the variations of the Aux Input are positively correlated with signal variations, as might be expected in situations where the input signal is dependent on the Aux Input, then Xnoise in ratio mode may be much lower than the non-ratioed value. If the variations of the Aux Input are uncorrelated with signal variations, or negatively correlated, then the Xnoise in ratio mode may be greater than the non-ratioed value.

**OVERFLOW
UNDER-
FLOW**

The **OVERFLOW** indicator shows that the ratio Aux Input exceeds the input range (± 10.5 V). The ratioed outputs are no longer correct in this case.

	<p>Dividing the signal by an Aux Input less than 1.0 V is equivalent to multiplying the signal by a value greater than 1.0. Small Aux Inputs can cause the ratioed outputs to overload. The UNDERFLOW indicator is on whenever the ratio Aux Input falls below ± 50 mV.</p> <p>In both cases it is necessary to change the setup. In general, the Aux Input ratio signal should be conditioned to be close to ± 1 V.</p>
<p>Expand</p>	<p>This key selects the Output Expand for the current CH1 display quantity. This function expands the display quantity by $\times 1$ (no expand), x10 or x100 and expands both the display and on the corresponding analog CH1 OUTPUT. The Expand for the displayed quantity is shown by x10 and x100 indicators above the Expand key. Neither indicator is on when the expand is $\times 1$.</p> <p>Expand amplifies the CH1 analog output by $\times 10$ or $\times 100$. If the output overloads, the OVLD indicator above the output BNC turns on.</p> <p>The <i>value</i> shown on the display remains the same, but is shown with greater resolution; 1 extra digit at $\times 10$, or 2 digits at $\times 100$. The Expand indicator within the display is on whenever the display is expanded. Expanding a quantity can cause the display to overload, indicated by OVLD within the display.</p> <p>Expand is an output function and has no effect on the internal values used for computation, i.e. expanding X will <i>not</i> affect R and θ. Expand is applied <i>after</i> offsets and ratios.</p> <p>The typical use of the Expand function is in conjunction with the Offset function, to magnify variations of the measured quantity about a nominal value. Remember, in order to expand a quantity it must be less than 10% ($\times 10$) or 1% ($\times 100$) of full scale.</p> <p><i>Example:</i> Suppose the X component of the input is 12.345 mV. The SR844 is set to 100 mV sensitivity with Offset, Ratio and Expand off. The CH1 display reads X=12.34 mV. The analog CH1 OUTPUT is 1.234 V (10 V is full scale). The offset is now turned On and set to -10%. Since the offset is a percentage of 100 mV full scale, the offset is -10 mV and the display now reads 2.34 mV. The XYOffs indicator within the display turns on. The analog CH1 OUTPUT is now 0.234 V. If Expand is turned on at x10, the display will read 2.345 mV (extra resolution) and the analog CH1 OUTPUT will be 2.345 V (amplified).</p>
<p>Output</p>	<p>This key switches the analog CH1 OUTPUT between the DISPLAY quantity and X.</p> <p>When set to Display, the analog CH1 OUTPUT provides a signal proportional to the Display quantity (as selected by the Display key). An output of ± 10 V corresponds to \pmfull scale on the display. The CH1 output has the same offset/ratio/expand that is applied to the display.</p> <p>When set to X, the CH1 analog CH1 OUTPUT provides a signal proportional to X. An output of ± 10 V corresponds to \pmfull scale sensitivity. The output has the offset/ratio/expand that was selected for X, either from the front panel keys or via remote interface. Note that if the Output is set to X and the Display is set to <i>another</i> quantity, their Expands may be different, and there is <i>no</i> indication of the output expand for the analog output X.</p> <p>You cannot have different offset/ratio/expand for X on the display and X on the analog output. But you <i>can</i> have different offset/expand for R (on display) and X (analog out).</p>

3-20 CH1 Display and Output

OVLD

There are 2 overload indicators for CH1.
--

The OVLD indicator above the CH1 OUTPUT BNC indicates that the analog output is overloaded (greater than ± 10.5 V).
--

The OVLD indicator within the CH1 display indicates that the display has overloaded. The normal range of the display is $\pm 110\%$ of full scale (without expand). Expand decreases the range of the display by 10 or 100.
--

CH2 Display and Output

The keys in this section select the Channel 2 display quantity and analog CH2 OUTPUT, as well as offsets, expands and ratios.



Display This key selects the Channel 2 Display quantity. Channel 2 may display Y [Volts], θ [Degrees], Ynoise [Volts], Ynoise [dBm], or AUX IN 2 [Volts]. The displayed quantity appears on a 4½ digit display and also on the accompanying bar-graph display. An indicator shows the currently displayed quantity.

Quantity	Description
Y	This is the component of the input signal in quadrature with the reference. The reference phase may be adjusted; see the section on Reference Phase later in this chapter for more information.
θ [Deg]	This is the phase of the input signal, measured in Degrees.
Ynoise [Volts]	This is the input signal noise at the reference frequency, and is derived from the Y measurements. This quantity is discussed in greater detail in Chapter 2, <i>Noise Measurements</i> .
Ynoise [dBm]	This is the same quantity as above, converted into dBm. The dBm computation assumes a 50 Ω load.
AUX IN 2	This is the voltage applied to the rear panel AUX IN 2.

3-22 CH2 Display and Output

Key features and parameters for the various displayed quantities are shown below.

Quantity [Unit]	Display Range	Bar Graph Range	Ratio	Offset	Expand	Max Sample Period
Y [Volts]	±110% f.s.	±f.s.	Yes	±110% f.s.	Yes	22 μs, <i>Note 4</i>
θ [Deg]	±180°	±180°	<i>Note 2</i>	<i>Note 3</i>	Yes	88 μs, <i>Note 4</i>
Ynoise [Volts]	±110% f.s.	±f.s.	<i>Note 1</i>	No	Yes	1.953 ms, <i>Note 5</i>
Ynoise [dBm]	±220 dBm	±200 dBm	<i>Note 1</i>	No	No	1.953 ms, <i>Note 5</i>
AUX IN 2 [Volts]	±10 V	±10 V	No	No	No	88 μs, <i>Note 4</i>

Note 1 If ratio mode has been selected, the reciprocal of the appropriate input (1.0V/AUX IN 1 or 1.0V/AUX IN 2) is computed, and *both* X and Y are multiplied by this quantity. θ is computed from Y/X and is unchanged by the ratio. Ynoise will be scaled in the same proportion as Y.

Note 2 If ratio mode has been selected, the reciprocal of the appropriate input (1.0VAUX IN 1 or 1.0V/AUX IN 2) is computed, and *both* X and Y are multiplied by this quantity. θ is computed from Y/X and, except for sign, is unchanged by the ratio. The phase will change by 180° if the ratio input is negative.

Note 3 The detection phase may be modified by adjusting the Reference Phase; this can be used to adjust or null the displayed phase of the input signal, but it also modifies X and Y (and their offsets). There is no separate phase offset adjustment.

Note 4 This shows the worst-case output sample rate for the CH2 analog output. The sample rate is fastest at the high end of an octave band. See IF frequency display in the Reference Section for more details.

The X output updates 4 times slower when 18 and 24 dB/oct filtering is used.

The digital display is always updated at a 2 Hz rate. The bar-graphs are updated at 64 Hz. Display quantities may be read out via remote interface or stored in the internal data buffers (see Chapter 4, *Data Storage*) at a maximum rate of 512 Hz.

Note 5 The noise is computed at 512 Hz for all time constants ≤ 30 ms. For longer time constants the noise is updated 25.6 times per time constant.

Offset User entered offsets can be added to X and Y. These offsets are added *before* taking ratios, output time-constant filtering, and computing R and θ.

Offsets are useful for making relative measurements or to cancel the contribution from an unwanted phase coherent signal. In analog lock-ins, offsets were generally used to remove DC output errors from the mixer outputs. The SR844 demodulator is digital and has no DC output errors, however, it does have coherent pickup at high frequencies, which can be canceled using offsets.

Important points about offsets:

- Xoffset and Yoffset are applied to X and Y before ratios, filtering and expands. R and θ are computed from the *offset* values of X and Y. Adding offsets to X or Y *changes* the value of R and θ .
- In addition, changing the Reference Phase will modify the values of Xoffset and Yoffset. Think of (Xoffset, Yoffset) as a signal vector relative to the Reference (internal or external) which cancels an actual signal at the input. This cancellation is preserved even when the detection phase (Reference Phase) is changed. This is done by circularly rotating the *values* of Xoffset and Yoffset by minus the Reference Phase. This preserves the phase relationship between (Xoffset, Yoffset) and the signal input.
- Since the vector (Xoffset, Yoffset) is used to cancel a real signal at the input, Xoffset and Yoffset are always turned on and off together. Turning either offset on turns on *both* offsets. Auto offsetting either X or Y performs auto offset on *both* quantities. These statements are true even if only one of the quantities X or Y is currently being displayed.
- Use the Reference Phase controls to adjust the measured and displayed phase of the input signal. This is discussed in the section on Reference Phase later in this chapter. Note that reference phase adjustment is *not* equivalent to having an offset adjustment on the displayed phase. This will change the measured values of X and Y.

On/Off	<p>This key turns the Offset On or Off for the current CH2 display quantity. As indicated in the table above, Y is the only CH2 display quantity which may be offset. This key has no effect if the currently displayed quantity is not Y. When Yoffset is turned On, the Yoffset value last used is applied.</p> <p>Turning Yoffset on and off also turns on and off Xoffset. The XYOffs indicator in the display indicates that the displayed quantity is affected by X and Y offsets.</p> <p>Xoffset and Yoffset are applied <i>before</i> R and θ are calculated. Thus, the XYOffs indicator will be on if the display is showing θ and XYoffsets are on.</p> <p>The Offsets can be set by pressing the Modify key and then using the knob, or using the Auto key. The Offsets can also be set from the remote interface.</p>
Auto	<p>This key sets the Yoffset equal to the negative of its current displayed value, so that the display, with Yoffset applied, is equal to zero. The Yoffset is turned On if it is not already On. This key has no effect for CH2 displays other than Y.</p> <p>Important! If the display is Y, Auto performs Auto Offset for both X <i>and</i> Y and turns on both X <i>and</i> Y offsets. This is true even if the CH1 display is <i>not</i> displaying X at the time.</p>

<p>Modify</p>	<p>When Modify is pressed, the Yoffset appears on the Reference Display (above the knob), even if the Offset is Off. This key has no effect if the display is not Y. Press Phase, Freq or AuxOut to return the Reference Display to its previous state.</p> <p>The Offset is displayed as a percentage of Full Scale. The knob may be used to modify the offset. Turn the Offset on to apply the displayed offset.</p> <p>Important!</p> <ul style="list-style-type: none"> • The offset is specified as a percentage of full scale sensitivity. Changing the sensitivity requires the offsets be changed to offset the same input signal. • Changing the Reference Phase will modify the values of Xoffset and Yoffset. (Xoffset, Yoffset) is a signal vector relative to the Reference (internal or external) which cancels an actual signal at the input. This cancellation is preserved even when the detection phase (Reference Phase) is changed. This is done by circularly rotating the <i>values</i> of Xoffset and Yoffset by minus the Reference Phase. This preserves the phase relationship between (Xoffset, Yoffset) and the signal input.
<p>Ratio</p>	<p>Ratio mode divides both <i>X</i> and <i>Y</i> by the input voltage AUX IN 1 or AUX IN 2. The ratio input is normalized to 1.000 Volt, so that ratioing by an Aux Input that is a steady 1.000 V is exactly the same as having the ratio mode Off. The useful range of the Aux Inputs, when in ratio mode, is from about 0.1 Volt to 10 Volts. Both positive and negative voltages are permitted.</p> <p>The SR844 has a single ratio mode that is common to both channels. The control for the ratio mode is the Ratio key in the Channel 1 Display section. The instrument's ratio mode will be applied to the currently displayed Channel 2 quantity as shown by the AUX IN 1 and AUX IN 2 indicators. As shown in the table above, ratioing may be applied to Y, Ynoise [Volts] and Ynoise [dBm], but may not be applied to θ and AUX IN 2.</p> <p>If the instrument is in Ratio Mode, the non-ratioed quantities are not available.</p> <p>When the ratio mode is on, the ratio is performed <i>after</i> X and Y offsets are applied and <i>before</i> the output time-constant filters. This allows the offsets to cancel a signal at the input before applying the ratio.</p> <p>R and θ are computed from ratioed X and Y. If the ratioing input is negative, the signs of X and Y will both be changed, and the phase θ will differ by 180° from the non-ratioed value. Ynoise is computed from the ratioed Y. For example, if the ratio mode is AUX IN 2 and the AUX IN 2 input is a steady 2 volts, Y will be ½ its non-ratioed value, θ will be unchanged and Ynoise will also be down a factor of 2.</p> <p>Note that the effects of ratio mode on Ynoise may be several. A steady Aux Input will linearly scale the Ynoise as just mentioned. If the variations of the Aux Input are positively correlated with signal variations, as might be expected in situations where the input signal is dependent on the Aux Input, then Ynoise in ratio mode may be much lower than the non-ratioed value. If the variations of the Aux Input are uncorrelated with signal variations, or negatively correlated, then the Ynoise in ratio mode may be greater than the non-ratioed value.</p>

<p>OVERFLOW</p> <p>UNDER-FLOW</p>	<p>The OVERFLOW indicator shows that the ratio Aux Input exceeds the input range (± 10.5 V). The ratioed outputs are no longer correct in this case.</p> <p>Dividing the signal by an Aux Input less than 1.0 V is equivalent to multiplying the signal by a value greater than 1.0. Small Aux Inputs can cause the ratioed outputs to overload. The UNDERFLOW indicator is on whenever the ratio Aux Input falls below ± 50 mV.</p> <p>In both cases it is necessary to change the setup. In general, the Aux Input ratio signal should be conditioned to be close to ± 1 V.</p>
<p>Expand</p>	<p>This key selects the Output Expand for the current CH2 display quantity. This function expands the display quantity by $\times 1$ (no expand), x10 or x100 and expands both the display and on the corresponding analog CH2 OUTPUT. The Expand for the displayed quantity is shown by x10 and x100 indicators above the Expand key. Neither indicator is on when the expand is $\times 1$.</p> <p>Expand amplifies the CH2 analog output by $\times 10$ or $\times 100$. If the output overloads, the OVLD indicator above the output BNC turns on.</p> <p>The <i>value</i> shown on the display remains the same, but is shown with greater resolution; 1 extra digit at $\times 10$, or 2 digits at $\times 100$. The Expand indicator within the display is on whenever the display is expanded. Expanding a quantity can cause the display to overload, indicated by OVLD within the display.</p> <p>Expand is an output function and has no effect on the internal values used for computation, i.e. expanding Y will <i>not</i> affect R and θ. Expand is applied <i>after</i> offsets and ratios.</p> <p>The typical use of the Expand function is in conjunction with the Offset function, to magnify variations of the measured quantity about a nominal value. Remember, in order to expand a quantity it must be less than 10% ($\times 10$) or 1% ($\times 100$) of full scale.</p> <p><i>Example:</i> Suppose the Y component of the input is 12.345 mV. The SR844 is set to 100 mV sensitivity with Offset, Ratio and Expand off. The CH2 display reads Y=12.34 mV. The analog CH2 OUTPUT is 1.234 V (10 V is full scale). The offset is now turned On and set to -10%. Since the offset is a percentage of 100 mV full scale, the offset is -10 mV and the display now reads 2.34 mV. The XYOffs indicator within the display turns on. The analog CH2 OUTPUT is now 0.234 V. If Expand is turned on at $\times 10$, the display will read 2.345 mV (extra resolution) and the analog CH2 OUTPUT will be 2.345 V (amplified).</p>
<p>Output</p>	<p>This key switches the analog CH2 OUTPUT between the DISPLAY quantity and Y.</p> <p>When set to DISPLAY, the analog CH2 OUTPUT provides a signal proportional to the Display quantity (as selected by the Display key). An output of ± 10 V corresponds to \pmfull scale on the display. The CH2 output has the same offset/ratio/expand that is applied to the display.</p> <p>When set to Y, the CH2 analog CH2 OUTPUT provides a signal proportional to Y. An output of ± 10 V corresponds to \pmfull scale sensitivity. The output has the offset/ratio/expand that was selected for Y, either from the front panel keys or via remote interface. Note that if the Output is set to Y and the Display is set to <i>another</i> quantity, their Expands may be different, and there is <i>no</i> indication of the output expand for the analog output Y.</p>

3-26 CH2 Display and Output

You cannot have different offset/ratio/expand for Y on the display and Y on the analog output. But you *can* have different expand for θ (on display) and Y (analog out).

OVLD

There are 2 overload indicators for CH2.

The **OVLD** indicator above the CH2 OUTPUT BNC indicates that the analog output is overloaded (greater than ± 10.5 V).

The **OVLD** indicator within the CH2 display indicates that the display has overloaded. The normal range of the display is $\pm 110\%$ of full scale (without expand). Expand decreases the range of the display by 10 or 100.

Reference Section

The Reference Section of the front panel contains the Reference Display, connectors for the External Reference Input and for the Reference Out, and several keys and indicators. The knob is also located here. The display and keys are discussed below.

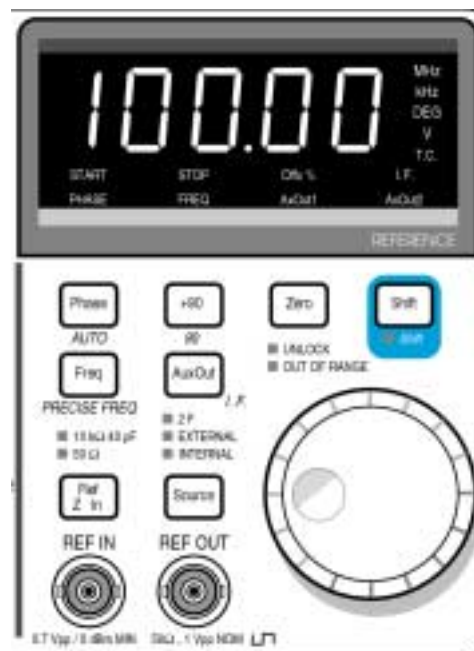

Reference Display

The Reference Display is a 4-½ digit LED display that shows the following features:

Key	Display	Knob Adjust?	Description
Phase	Reference Phase	Yes	The detection phase relative to the reference (deg).
Freq	Reference Frequency	Only in Internal Reference Mode	The detection frequency.
PRECISE FREQ	Precise Reference Frequency	Only in Internal Reference Mode	Displays the reference frequency on the Channel 2 and Reference Displays with extra precision.
I.F.	IF Frequency	Only in Internal Reference Mode	The IF (chop frequency) used in the SR844, provided for information.
AuxOut	AUX OUT 1, 2	Yes	The rear panel Aux Output voltages.
CH1/CH2 Offset Modify	Offset	Yes	The offset (% f.s.) for the CH1 or CH2 display quantity.
SETTLE...	Elapsed Time	No	Time constants elapsed.
Scan Set	Scan Start	Yes	The start frequency for manual scanning. <i>Note 1</i>
Scan Set	Scan Stop	Yes	The stop frequency for manual scanning. <i>Note 1</i>
Scan Set	Scan Steps	Yes	The number of frequency steps for manual scanning. <i>Note 1</i>

Note 1 See the description of Scan and Rel later in this chapter for more details.

<p>Freq</p>	<p>This key displays the reference frequency. If the reference mode is EXTERNAL, then the measured external reference frequency is displayed. Measurements are made 6–12 times a second and the display is updated at 5.7 Hz. The display will be erroneous if the instrument is UNLOCKed or the frequency is OUT OF RANGE. Indicators on the front panel show both of these error conditions. In external reference mode, the knob serves no function with this display.</p> <p>In INTERNAL reference mode, the internal reference frequency is displayed. The internal reference frequency is adjusted using the knob. The SR844 offers 3 digits of resolution in specifying the internal reference frequency, and 4 digits of accuracy. For example, frequencies of 1.23 and 1.24 MHz may be selected. When 1.23 MHz is selected, the actual reference frequency will be in the range 1.229 to 1.231 MHz.</p> <p>Use PRECISE FREQ to display the frequency with more resolution (in either reference mode).</p>
<p>PRECISE FREQ [Shift–Freq]</p>	<p>This key sequence shows the reference frequency with 6 or 7 digits of resolution using the CH2 and Reference displays together. Read the two displays as if they were one single display. The FREQ indicator within the CH2 display turns on whenever the Precise Frequency is displayed.</p> <p>To cancel this display mode, choose another reference display (Freq or Phase for example).</p> <p>While the internal reference frequency is set to 3 digits resolution, the actual frequency generated in internal mode may be slightly different (within ± 1 in the 4th digit).</p>
<p>I.F. [Shift–AuxOut]</p>	<p>This key sequence shows the IF frequency on the Reference Display. See Chapter 2, <i>Sources of Error</i>, for more information about the IF (chop frequency). This display is provided as a user convenience. The instrument has weak spurious responses at offsets of $\pm 2 \times \text{IF}$, $\pm 4 \times \text{IF}$, etc. from the reference frequency. Some users may wish to set up their experiments to avoid specific IF frequencies.</p> <p>When the reference is in internal mode and the IF frequency is displayed, the knob may be used to adjust the internal <i>reference</i> frequency while showing the IF frequency.</p> <p>Important!</p> <p>The SR844 covers the operating frequency range in octaves bands. Users can check the IF frequency to determine whether the instrument is at the high end of an octave band or the low end of the next band. At the high end of an octave, the IF frequency will be close to 3 kHz (12 kHz for time constants $\leq 300 \mu\text{s}$), while at the low end it will be close to 2 kHz (8 kHz for time constants $\leq 300 \mu\text{s}$). The IF frequency affects the output update rate for the analog CH1 and CH2 OUTPUTs. The fastest update rates occur at the high end of each octave band (where the IF is the highest).</p>
<p>AuxOut</p>	<p>This key shows the two rear panel Aux output values. Pressing AuxOut alternates between AUX OUT 1 and AUX OUT 2. The selected output is indicated by AxOut1 or AxOut2 within the display. The knob is used to adjust the selected output voltage within the range ± 10.500 Volts.</p>
<p>Phase</p>	<p>This key shows the phase, relative to the reference, currently being used for signal detection. The phase is displayed in degrees (-179.99° to $+180.00^\circ$). The knob is used to adjust the phase. See below for more details.</p>

	<p>The SR844 is calibrated such that an input signal that is in phase with the rising edge of the External Reference input is measured as having $X=R$, $Y=0$ and $\theta=0^\circ$ when the Reference Phase is set to 0°. If the unit is in Internal Reference mode, there is no external reference signal; in this case an input signal in phase with REF OUT yields $X=R$, $Y=0$ and $\theta=0^\circ$.</p> <p>The Reference Phase may be changed to detect the signal at any phase relative to the reference. The Reference Phase control is applied inside the DSP (a simple coordinate rotation), which means that changing the Reference Phase does not change any of the RF, IF or reference signals inside the SR844. The phase control is applied before the output time-constant filtering.</p>
+90°	This key adds 90° to the Reference Phase. 360° is subtracted from the phase if necessary to keep it within range -179.99° to $+180.00^\circ$. This key essentially exchanges the measured in-phase (X) and quadrature (Y) components of the signal.
-90° [Shift+ +90°]	This key adds -90° to the Reference Phase. 360° is added to the phase if necessary to keep it within range -179.99° to $+180.00^\circ$. This key essentially exchanges the measured in-phase (X) and quadrature (Y) components of the signal.
Zero	This key resets the Reference Phase to 0° .
AUTO [Shift-Phase]	<p>This key sequence automatically selects a Reference Phase that matches the phase of the input signal. This results in a measured phase of the input signal that is close to zero. Note that if the measured phase of the input signal is not settled or is noisy at the time Shift-Phase is pressed, the measured phase will not settle to exactly 0°.</p> <p>Auto phase is executed once at the time the keys are pressed. The Reference Phase will not track changes in the phase of the input signal. However the R function always provides the magnitude of the input signal, even as the phase moves, as long as the phase moves slowly compared to the measurement time constant.</p>
Reference Mode	<p>In EXTERNAL Reference mode, the SR844 locks to the signal present on the External Reference Input.</p> <p>In INTERNAL Reference mode, the SR844 generates the reference frequency using an internal synthesizer. It is recommended to leave the External Reference input disconnected when the unit is in internal mode.</p> <p>REF OUT</p> <p>In both reference modes, REF OUT provides a 1 Vpp signal (into 50 Ω) in phase with the reference. This signal can be used to provide the modulation necessary in the experiment.</p>
Source	This key sets the Reference mode of the SR844, either EXTERNAL or INTERNAL . The selected mode is shown by indicators above the key.
2F [Shift-Source]	<p>This key sequence toggles 2F harmonic detection. 2F mode is shown by the indicator above the EXTERNAL and INTERNAL indicators.</p> <p>2F detection is available for both External and Internal Reference modes. In both cases, the displayed frequency is the 2F detection frequency. The frequency of the REF OUT signal is at F or half of the displayed detection frequency. In External mode, the frequencies of REF IN and REF OUT are both F.</p>

Important!

The 2F detection frequency is limited to 50 kHz to 200 MHz. This corresponds to a REF IN and REF OUT frequency range of 25 kHz to 100 MHz.

The absolute phase in 2F mode is not specified. However, the relative phase accuracy generally applies.

Ref Z-In	This key selects the impedance of the External Reference Input (REF IN), either 50 Ω or 10 kΩ 40 pF . The reference signal should be 0 dBm (sine) or 0.7 Vpp (pulse) for proper locking. The SR844 will lock to other amplitudes with possible degradation in phase accuracy and jitter.
OUT OF RANGE	This indicator is on whenever the External Reference input is out of the operating frequency range (25 kHz to 200 MHz) or is not detected at the input due to insufficient amplitude or non-periodic pulse shape. This only applies in External Reference mode.
UNLOCK	This indicator is on whenever the SR844 is not locked. In External Reference mode, this occurs when the REF IN frequency is changing or unstable. In Internal Reference mode, this occurs when the internal reference frequency is changed. The internal synthesizer requires time to lock to the new frequency.

Save and Recall

Nine setups of the SR844 may be saved in non-volatile memory (setup buffers 1-9). The stored setups include all front panel instrument settings, as well as the remote interface configurations. The Scan parameters used for manual scans are saved. The Rel mode data (frequencies, configurations and stored Rel values) are *not* stored. The stored setups *do not* include any signal history or overload conditions, nor do they include the internal data buffers.

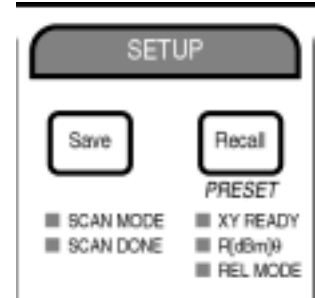

Save	<p>Pressing Save once displays <i>SAVE n</i> where <i>n</i> is the last used setup buffer. A new setup buffer (1–9) may be selected using the knob. The Reference display shows <i>YES</i> if buffer <i>n</i> is in use and <i>NO</i> if it is empty.</p> <p>A second press of the Save key will save the current instrument setup in the chosen setup buffer. A confirmation message <i>SAVE n DONE</i> is displayed briefly.</p> <p>Any other keypress will abort the save process and display the message <i>SAVE NOT DONE</i>.</p>
Recall	<p>Pressing Recall once displays <i>RCAL n</i> where <i>n</i> is the last used setup buffer. Another setup buffer (1–9) may be selected using the knob. The Reference display shows <i>YES</i> if buffer <i>n</i> is in use and <i>NO</i> if it is empty.</p> <p>A second press of the Recall key will recall the instrument setup from the chosen setup buffer. A confirmation message <i>RCAL n DONE</i> is displayed if the recall operation is successful. <i>RCAL DATA ERR</i> is displayed if no setup was previously saved in the selected buffer.</p> <p>Any other keypress will abort the recall process and display the message <i>RCAL NOT DONE</i>.</p> <p>If a remote command is received before the second Recall keypress, the remote command is processed normally and the instrument continues to wait for either knob input or the second Recall keypress.</p> <p>Important!</p> <ul style="list-style-type: none"> • The recall operation will clear the internal data buffers (see Chapter 4, <i>Data Storage</i>). • Recall does not affect the stored Rel mode information (see Scan and Rel later in this chapter). Thus an instrument configuration may be saved at one frequency and recalled at another frequency, without affecting stored Rel values. • Interface setup parameters are not changed.
PRESET [Shift–Recall]	<p>This key sequence restores the instrument to its factory defaults (see earlier in this chapter).</p>

Interface

The SR844 can be interfaced to a host computer via RS232 or GPIB. The keys in this section configure the interface for proper operation with the host. These parameters must be set *before* attempting to interface the instrument to the host computer.



Setup

The Setup key cycles through the remote interface configuration parameters. Indicators above the Setup key indicate which parameter is being shown. The value or setting of the parameter is displayed on the Reference Display and is adjusted using the knob. See Chapter 4, *Introduction*, for more information about setting the correct interface.

Parameter	Configuration Notes																																																																								
GPIB/RS232	The SR844 outputs data to only one interface at a time. Commands may be received over both interfaces but responses are directed only to the selected interface. Use the knob to select either <i>GPIB</i> or <i>R232</i> for the output interface.																																																																								
ADDRESS	Use the knob to select a GPIB address for the SR844.																																																																								
BAUD	Use the knob to select a RS232 baud rate from 300 to 19200 baud.																																																																								
PARITY	Use the knob to select <i>EVEN</i> , <i>ODD</i> or <i>NONE</i> for the RS232 parity.																																																																								
QUEUE	<p>The last 256 characters received by the SR844 may be displayed to help find programming errors. Setup Queue will display 6 hexadecimal characters at a time (2 each on the Channel 1, Channel 2 and Reference displays). Turn the knob CCW to move farther back in the buffer and CW to move towards the most recently received characters. A period ‘.’ is displayed to indicate the ends of the buffer. All characters are changed to upper-case, spaces are removed, and command delimiters are changed to linefeeds (0A).</p> <p>The table below shows the hexadecimal equivalents of all of the characters recognized by the SR844.</p> <table border="1"> <thead> <tr> <th>Hex</th> <th>ASCII</th> <th>Hex</th> <th>ASCII</th> <th>Hex</th> <th>ASCII</th> </tr> </thead> <tbody> <tr> <td>0A</td> <td>linefeed</td> <td>39</td> <td>9</td> <td>4D</td> <td>M</td> </tr> <tr> <td>2A</td> <td>*</td> <td>3B</td> <td>;</td> <td>4E</td> <td>N</td> </tr> <tr> <td>2B</td> <td>+</td> <td>3F</td> <td>?</td> <td>4F</td> <td>O</td> </tr> <tr> <td>2C</td> <td>,</td> <td>41</td> <td>A</td> <td>50</td> <td>P</td> </tr> <tr> <td>2D</td> <td>-</td> <td>42</td> <td>B</td> <td>51</td> <td>Q</td> </tr> <tr> <td>2E</td> <td>.</td> <td>43</td> <td>C</td> <td>52</td> <td>R</td> </tr> <tr> <td>30</td> <td>0</td> <td>44</td> <td>D</td> <td>53</td> <td>S</td> </tr> <tr> <td>31</td> <td>1</td> <td>45</td> <td>E</td> <td>54</td> <td>T</td> </tr> <tr> <td>32</td> <td>2</td> <td>46</td> <td>F</td> <td>55</td> <td>U</td> </tr> <tr> <td>33</td> <td>3</td> <td>47</td> <td>G</td> <td>56</td> <td>V</td> </tr> <tr> <td>34</td> <td>4</td> <td>48</td> <td>H</td> <td>57</td> <td>W</td> </tr> </tbody> </table>	Hex	ASCII	Hex	ASCII	Hex	ASCII	0A	linefeed	39	9	4D	M	2A	*	3B	;	4E	N	2B	+	3F	?	4F	O	2C	,	41	A	50	P	2D	-	42	B	51	Q	2E	.	43	C	52	R	30	0	44	D	53	S	31	1	45	E	54	T	32	2	46	F	55	U	33	3	47	G	56	V	34	4	48	H	57	W
Hex	ASCII	Hex	ASCII	Hex	ASCII																																																																				
0A	linefeed	39	9	4D	M																																																																				
2A	*	3B	;	4E	N																																																																				
2B	+	3F	?	4F	O																																																																				
2C	,	41	A	50	P																																																																				
2D	-	42	B	51	Q																																																																				
2E	.	43	C	52	R																																																																				
30	0	44	D	53	S																																																																				
31	1	45	E	54	T																																																																				
32	2	46	F	55	U																																																																				
33	3	47	G	56	V																																																																				
34	4	48	H	57	W																																																																				

	35	5	49	I	58	X
	36	6	4A	J	59	Y
	37	7	4B	K	5A	Z
	38	8	4C	L		
LOCAL	<p>Remote interface commands can put the SR844 into either the Remote state or the Local Lockout state. It is possible to configure the unit over the remote interface so that the front panel is inoperative in these states. See in Chapter 4, <i>Interface Commands</i>, for information on how to do this. Note that the factory preset values are such that the front panel is <i>not</i> disabled by Remote commands.</p> <p>Attempts to change the settings from the front panel will display the message <i>LOCL LOUT</i> indicating that local control is locked out by the remote interface.</p> <p>If the unit is in the Remote state and the front panel is locked-out, the Local key will return the unit to the Local state and re-enable the front panel. In the Local Lockout state, even the Local key is locked out. It is not possible to distinguish between the Remote and Local Lockout states from the front panel indicators, since the REMOTE indicator is on in both cases. If the Local key does not return the unit to the Local state, the unit is probably in the Local Lockout state. There are three ways to get out of the Local Lockout state. One is to turn the power off and back on with the Setup key pressed; this restores the factory preset values. The other two methods are by remote commands and are discussed in greater detail in Chapter 4, <i>Interface Commands</i>. <i>LOCL0</i> takes the unit out of the Local Lockout state, while <i>OVRM1</i> enables the front panel regardless of Remote or Local Lockout state.</p>					
REMOTE	This indicator shows that the SR844 has been put into either the Remote or Local Lockout state by receipt of a remote command. Front panel control may not be allowed.					
SRQ	This indicator is on when a GPIB service request is generated by the SR844. This indicator remains on until a serial poll is completed. See Chapter 4, <i>Status Register Definitions</i> , for more information.					
ACTIVE	This indicator flashes when there is activity (receive or transmit) on either remote interface.					
ERROR	This indicator flashes when there is a remote interface error, such as an illegal command, or a out-of-range parameter.					

Scan and Rel

Overview

Scans

The SR844 offers the facility of doing a manual frequency scan covering up to 11 frequency points. This facility is available *only* in the Internal Reference mode. Frequency scans are a convenient method for making repeated measurements over a set of frequencies. For example, measurements of device noise or frequency response using REF OUT as the signal source.

The set of scan frequencies are specified by a start frequency, a stop frequency and the number of points. The start frequency and stop frequency may be anywhere within the operating range of the instrument, 25 kHz – 200 MHz. The SR844 will select the frequency points by interpolating geometrically between the start and stop frequencies. The following equation gives the frequencies F_i for $i=0$ to $N-1$, where $N \geq 2$ is the number of points.

$$F_i = F_{start} \times \left[\frac{F_{stop}}{F_{start}} \right]^{\frac{i}{N-1}}$$

Here F_{start} and F_{stop} are the start and stop frequencies respectively. The geometric interpolation is appropriate for wide frequency intervals, and is close to linear for narrow frequency intervals. The interpolated frequencies are rounded to the resolution of the internal frequency source.

The **SCAN MODE** indicator is on while a scan is in progress. Use the **Scan Set** key to setup a scan. Scan setup is not permitted while a scan is in progress. Use the **Start/Step** key to start a scan and to step through the frequencies. To stop a scan without going through all the frequencies, use **OFF** (Shift–Scan Set).

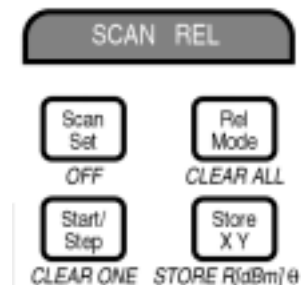

Rel

At each scan frequency, a stored measurement setup, or Rel Configuration (sensitivity, reserve, etc.), can be recalled. In addition, stored offsets (Rel Values) may be applied to the signal. XY Rel Values are stored X and Y offsets. Rθ Rels are stored R[dBm] and θ offsets. Rel Values can be stored for each scan frequency.

To store Rel Values at the current scan frequency:

- Use the **Store XY** key to Auto Offset X and Y and store the offsets as XY Rel offset values. The **XY READY** indicator is on when XY Rel Values have been stored at the current scan frequency. This also stores the Rel Configuration (sensitivity, reserve, etc.).
- Use **STORE R[dBm]θ** (Shift–Store XY) to Auto Offset R[dBm] and Auto Phase the reference and store the results as R[dBm] and θ Rel offset values. The **R[dBm]θ** indicator is on when R[dBm]θ Rel Values have been stored at the current scan frequency. This also stores the Rel Configuration (sensitivity, reserve, etc.).

Use the Rel Mode key to toggle **REL MODE** on and off.

In **SCAN MODE** with **REL MODE** on, the instrument automatically recalls the stored Rel Configuration and Rel Values at each scan frequency. The **REL** indicator within the CH1 and CH2 displays is on whenever the recalled Rel Configuration and Rel Values are in effect.

If the current scan frequency does not have any stored Rel Values (as indicated by **XY READY** or **R[dBm]θ**), the current configuration and offsets remain in effect. The **REL** indicator is off in this case.

The stored XY Rel Values are applied as X and Y offsets (adjusted for the current phase). The stored R[dBm] Rel Value is applied as the R[dBm] offset. The stored θ Rel Value is applied as the Reference Phase (there is no phase offset). Offset indicators within the CH1 and CH2 displays are turned on as appropriate (as well as the **REL** indicator).

After the Rel Configuration and Rel Values are recalled, the instrument setup can be modified using the front panel or remote interface. Once the configuration is modified, the **REL** indicator turns off indicating that the current configuration is not the recalled Rel Configuration. Toggle **REL MODE** off and back on to recall the stored Rel Configuration once again.

When **REL MODE** is off, stored Rel Configurations and Rel Values are ignored (the configuration and offsets currently in effect are *still* applied to the measurement).

Use the CLEAR ALL key (Shift–Rel Mode) to clear *all* stored Rel Configurations and Values and CLEAR ONE (Shift–Start/Step) to clear the Rels at the *current* scan frequency only.

Scan and Rel parameters are stored in non-volatile memory and recalled at power on. They are *not* stored with the 9 available stored setups.

Using Frequency Scans

This section discusses the operation of the frequency Scan Mode. The Scan Mode can be used in conjunction with Rel Mode as described in the following section.

Scan Set	<p>This key accesses the scan frequency parameters. Successive keypresses are used to cycle through the Start and Stop frequencies and Number of Points on the Reference Display. The knob is used at each stage to modify the current parameter.</p> <p>Changing the scan parameters is <i>not</i> permitted if a scan is in progress (SCAN MODE indicator on). In such a case the knob has no effect. There are three scan parameters:</p>	
	Parameter	Description
Start		The start frequency, F_{start} , is shown on the Reference Display, along with the START indicator within the display. Use the knob to select a start frequency in the range 25 kHz – 200 MHz.
Stop		The stop frequency F_{stop} , is shown on the Reference Display, along with the STOP indicator within the display. Use the knob to select a stop frequency in the range 25 kHz – 200 MHz.
Number of Points		The number of points, N, is shown on the Reference Display. There is no indicator shown in the display. Use the knob to select from 2 to 11 steps. The number of points includes both the start and stop frequencies, so the

	number of interpolated points is $N - 2$.										
	Completing the scan parameter setup procedure does <i>not</i> start a scan. The frequency reference remains unchanged (Internal or External reference mode) after all scan parameters have been set.										
Start/Step	<p>This key is used to step through the scan frequencies. If no scan has been setup, the factory preset values are used, namely Start = 100 kHz, Stop = 100 MHz, N = 4, which gives interpolated frequencies of 1 MHz and 10 MHz.</p> <p>The SR844 <i>must</i> be in Internal Reference mode to perform a scan. Start/Step has no effect unless the unit is in Internal Reference mode.</p> <p>Successive presses of Start/Step perform the following functions.</p> <table border="1"> <thead> <tr> <th>Keypress</th> <th>Description</th> </tr> </thead> <tbody> <tr> <td>1st</td> <td>If a scan is not in progress, pressing the Start/Step key will begin one, if the SR844 is in Internal reference mode. The frequency is set to the Start frequency, F_{start} , and the SCAN MODE indicator is turned on.</td> </tr> <tr> <td>2nd ... Nth</td> <td>Subsequent keypresses step to the next scan frequency, F_i. When the frequency reaches the Stop frequency, F_{stop} ,the SCAN DONE indicator turns on.</td> </tr> <tr> <td>N+1st</td> <td>Another keypress exits the Scan Mode while remaining at the Stop frequency. The SCAN MODE and SCAN DONE indicators both turn off.</td> </tr> <tr> <td>N+2nd</td> <td>The next keypress begins another scan, just like the 1st keypress above.</td> </tr> </tbody> </table> <p>Important! During a frequency scan, changing some front panel parameters will exit Scan Mode. These are (1) changing the internal frequency and (2) switching to External Reference mode.</p>	Keypress	Description	1st	If a scan is not in progress, pressing the Start/Step key will begin one, if the SR844 is in Internal reference mode. The frequency is set to the Start frequency, F_{start} , and the SCAN MODE indicator is turned on.	2nd ... Nth	Subsequent keypresses step to the next scan frequency, F_i . When the frequency reaches the Stop frequency, F_{stop} ,the SCAN DONE indicator turns on.	N+1st	Another keypress exits the Scan Mode while remaining at the Stop frequency. The SCAN MODE and SCAN DONE indicators both turn off.	N+2nd	The next keypress begins another scan, just like the 1st keypress above.
Keypress	Description										
1st	If a scan is not in progress, pressing the Start/Step key will begin one, if the SR844 is in Internal reference mode. The frequency is set to the Start frequency, F_{start} , and the SCAN MODE indicator is turned on.										
2nd ... Nth	Subsequent keypresses step to the next scan frequency, F_i . When the frequency reaches the Stop frequency, F_{stop} ,the SCAN DONE indicator turns on.										
N+1st	Another keypress exits the Scan Mode while remaining at the Stop frequency. The SCAN MODE and SCAN DONE indicators both turn off.										
N+2nd	The next keypress begins another scan, just like the 1st keypress above.										
OFF [Shift– Scan Set]	This key sequence terminates Scan Mode. The SCAN MODE and SCAN DONE indicators are turned off. It has no effect if SCAN MODE is off.										

Storing and Using Rel Values

This section discusses the storage of Rel Values at the scan frequencies. The Scan and Rel features work together in a straightforward manner. First, use the Scan keys to specify the frequency scan (Start, Stop and N) as described previously. Then, use Start/Step to step through the scan frequencies while using the Store keys to store Rel Configurations and Values at each frequency. Changing scan parameters clears all stored Rel.

XY Rel Values are actually stored X and Y offsets. R0 Rel Values are stored offsets for R[dBm] and stored settings of the reference phase. Rel Values are stored along with the current measurement configuration. This is because offsets are generally valid only for a specific configuration and are not

appropriate for different configurations. **Using stored Rel Values at a scan frequency will also recall the stored measurement configuration.**

The measurement configuration includes:

- Signal Z-In
- Wide Reserve
- Phase (if R θ Rel Values are stored)
- Time Constant Slope (but not the Time Constant)
- Sensitivity
- Close Reserve
- Ratio

Other parameters, such as Display, Expand and AUX OUT values are not included.

Press Rel Mode to turn **REL MODE** on. In this mode, stored Rel Configurations and Values are automatically recalled at the current scan frequency (if previously stored, as indicated by **XY READY** or **R[dBm] θ**). When a Rel Configuration is recalled, the **REL** indicators within the CH1 and CH2 displays are turned on. The **XYOffs** and **ROffs** indicators within the displays are turned on and off as appropriate.

After a Rel Configuration is recalled, changing the measurement configuration or modifying offsets causes the **REL** indicators to turn off. This does not alter the stored Rel Values or Configuration, it merely indicates that the current configuration is *not* the same as the stored configuration. It also does not alter the offsets currently in use. Use Rel Mode to toggle **REL MODE** off and back on to recall the stored Rel Values and Configuration once again.

Changing frequency scan parameters clears *all* stored Rel Values. Use the CLEAR ALL key (Shift–Rel Mode) to clear *all* stored Rel Configurations and Values and CLEAR ONE (Shift–Start/Step) to clear the Rels at the *current* scan frequency only.

The Rel Values are saved when the instrument power is turned off. They are *not* stored with the 9 available stored setups.

Store XY	<p>Performs Auto Offset on both X and Y and stores the XY offsets as XY Rel Values at the current scan frequency. X and Y displays and outputs are offset to zero. Any previously stored XY Rel Values are replaced. The current measurement configuration is also saved. Previously stored Rθ Rel Values are discarded if they were stored with a measurement configuration which differs from the current one.</p> <p>The XY READY indicator turns on indicating that XY Rel Values are stored for this scan frequency.</p>
Store R[dBm] θ [Shift–Store XY]	<p>Performs Auto Phase and Auto Offset on R[dBm] and stores the R[dBm] offset and reference phase as Rθ Rel Values at the current scan frequency. R[dBm] and θ displays are offset to zero. Any previously stored Rθ Rel Values are replaced. The current measurement configuration is also saved. Previously stored XY Rel Values are discarded if they were stored with a measurement configuration which differs from the current one.</p> <p>The R[dBm]θ indicator turns on indicating that Rθ Rel Values are stored for this scan frequency.</p>

XY READY R[dBm]θ	These indicators are on if there are XY or Rθ Rel Values stored for the current scan frequency. They do not imply that these Rel Values are being applied to the current measurement.
Rel Mode	<p>This key toggles REL MODE.</p> <p>In SCAN MODE with REL MODE on, the instrument automatically recalls the stored Rel Configuration and Rel Values at <i>each</i> scan frequency (if previously stored, as indicated by XY READY or R[dBm]θ). The REL indicator within the CH1 and CH2 displays is on whenever the recalled Rel Configuration and Rel Values are in effect.</p> <p>If the current scan frequency does not have any stored Rel Values (as indicated by XY READY or R[dBm]θ), the current configuration and offsets remain in effect. The REL indicator is off in this case.</p> <p>The stored XY Rel Values are applied as X and Y offsets (adjusted for the current phase). The stored R[dBm] Rel Value is applied as the R[dBm] offset. The stored θ Rel Value is applied as the Reference Phase (there is no phase offset). Offset indicators within the CH1 and CH2 displays are turned on as appropriate (as well as the REL indicator).</p> <p>Turning REL MODE off does not change the current measurement. The current measurement configuration <i>remains</i> in effect. As long as REL MODE is off, stored Rel Values and Configurations are not recalled at any other scan frequencies.</p>
CLEAR ALL [Shift–Rel Mode]	This key sequence discards <i>all</i> stored Rel Values and Configurations.
CLEAR ONE [Shift–Start/ Step]	This key sequence discards the stored Rel Values and Configurations at the <i>current</i> scan frequency.
Any key that changes the instrument configuration	All keys in the SIGNAL INPUT and SENSITIVITY sections as well as Slope Up/Down , Ratio , Recall , Preset , Ref Z-In , Ref Source change the measurement configuration and turn the REL indicators off. This does not affect REL MODE .
Start/Step	This key is used to step through the scan frequencies. If REL MODE is on, stored Rel Configurations and Values (if previously stored) will be applied.

Scan and Rel Example

In this example we will make transfer function measurements of a device-under-test, or DUT, using the SR844 REF OUT signal in Internal Reference mode. For this example, we assume that the DUT attenuates the REF OUT signal. We will make measurements at several frequencies using the Scan Mode. We will use Rel Mode to store the measured values when the DUT is by-passed (using STORE R[dBm] θ).

First, we set the frequency scan parameters to select the scan frequencies. Then we step through the scan with the DUT by-passed, storing Rel Configurations and Values at each frequency (using STORE R[dBm] θ). This measures the DUT input. Next we pass the signal through the DUT and step through the frequency scan again. This measures the transfer response of the DUT directly in dB and degrees.

If the DUT amplifies the signal, we would need to make the scan with the DUT in the signal path *first*, storing Rel Values and Configurations. The second scan by-passes the DUT and measures the transfer response (negate both the dB and phase readings). The order is determined by which configuration (through the DUT or by-pass the DUT) has the larger output signal. This determines the required measurement configuration at each frequency.

1	Connect the REF OUT signal (appropriately attenuated and terminated) to the input of the DUT. The DUT output should be connected to the SIGNAL IN of the SR844. Now by-pass the DUT, leave as much of the apparatus in place as possible. It is important to use the same cabling for both setups (by-pass and through the DUT) in order to preserve phase delays through the system.
2	Set the frequency scan parameters using the Scan Set key and knob as described previously in the section <i>Using Frequency Scans</i> . Press CLEAR ALL [Shift– Rel Mode] to discard any previously stored Rel Values.
3	Press Start/Step once to begin/continue the frequency scan.
4	Adjust the instrument configuration to measure the signal appropriately. Set the displays to show R[dBm] on CH1 and θ on CH2. This measures the DUT input.
5	Press STORE R[dBm] θ . This saves the signal phase and the measured value of R[dBm] as well as the measurement configuration to be used in the next scan.
6	Repeat steps 3–5 until the Scan is done.
7	Now pass the signal through the DUT.
8	Press Start/Step once more to turn Scan Mode off at the Stop frequency.
9	Press Rel Mode to turn on REL MODE and use the stored Rel Values. The next scan will display R[dBm] and phase relative to the original scan taken with the DUT by-passed. This is exactly the transfer function we started out to measure.
10	Press Start/Step once to begin/continue the frequency scan.
11	When the measurement is stable, note the readings. In dB and degrees, these give the value of the transfer function of the DUT at the current frequency.
12	Repeat steps 10–11 until the Scan is done.

Rels without Scan

This section discusses the storage of Rel Values when the unit is *not* in Scan mode. This is useful for external reference configurations or for frequency points that are not in a log series. Up to 11 different Rel Configurations may be stored (at 11 different frequencies).

To store Rel Values at the current frequency:

- Use the **Store XY** key to Auto Offset X and Y and store the offsets as XY Rel offset values. The **XY READY** indicator is on when XY Rel Values have been stored at the current frequency. This also stores the Rel Configuration (sensitivity, reserve, etc.).
- Use **STORE R[dBm]θ** (**Shift–Store XY**) to Auto Offset R[dBm] and Auto Phase the reference and store the results as R[dBm] and θ Rel offset values. The **R[dBm]θ** indicator is on when R[dBm]θ Rel Values have been stored at the current frequency. This also stores the Rel Configuration (sensitivity, reserve, etc.).

Use the Rel Mode key to toggle **REL MODE** on and off.

With **REL MODE** on, the instrument automatically recalls the stored Rel Configuration and Rel Values whenever the frequency is within 1% of a frequency for which a Rel Configuration and Values has been stored. The **REL** indicator within the CH1 and CH2 displays is on whenever the recalled Rel Configuration and Rel Values are in effect.

If the current frequency does not have any stored Rel Values (as indicated by **XY READY** or **R[dBm]θ**), the current configuration and offsets remain in effect. The **REL** indicator is off in this case.

The stored XY Rel Values are applied as X and Y offsets (adjusted for the current phase). The stored R[dBm] Rel Value is applied as the R[dBm] offset. The stored θ Rel Value is applied as the Reference Phase (there is no phase offset). Offset indicators within the CH1 and CH2 displays are turned on as appropriate (as well as the **REL** indicator).

After the Rel Configuration and Rel Values are recalled, the instrument setup can be modified using the front panel or remote interface. Once the configuration is modified, the **REL** indicator turns off indicating that the current configuration is not the recalled Rel Configuration. Toggle **REL MODE** off and back on to recall the stored Rel Configuration once again.

When **REL MODE** is off, stored Rel Configurations and Rel Values are ignored (the configuration and offsets currently in effect are *still* applied to the measurement).

- Pressing **CLEAR ALL** clears *all* stored Rel Configurations, both those stored with a scan and those stored at specific frequencies.
- Pressing the **CLEAR ONE** clears the Rel Configuration stored with the *current* frequency (if any).
- The Rel Configurations are indexed by frequency with a 1% tolerance band. Rels stored at 90.0MHz will be recalled whenever the frequency falls between 89.1MHz (-1%) and 90.9MHz (+1%).
- You should familiarize yourself with the preceding sections before using the Rels without Scan.

Auto Functions

Wide Reserve	Shift–WideResrv Down	Select the Wideband Dynamic Reserve mode automatically. This function will execute <i>once</i> when the keys are pressed. A tone sounds when the function is complete. The reserve will not continue to change even if the input signal changes substantially. To adjust for the changed conditions, it may be necessary to perform the Auto function again, or make manual changes. The Wide Reserve AUTO indicator is on while this function executes.
Close Reserve	Shift–CloseResrv	Select the Close Dynamic Reserve mode automatically. This function will execute <i>once</i> when the keys are pressed. A tone sounds when the function is complete. The reserve will not continue to change even if the input signal changes substantially. To adjust for the changed conditions, it may be necessary to perform the Auto function again, or make manual changes. The Sensitivity AUTO indicator is on while this function executes.
Sensitivity	Shift–SensUp	Automatically adjust the sensitivity based on the detected signal magnitude, instrument reserve settings and overload conditions. This function executes <i>once</i> when the keys are pressed. A tone sounds when the function is complete. The sensitivity will not continue to change even if there is a substantial change in the input signal. In the case of a substantial signal change, it may be necessary to perform the Auto Sensitivity function again, or adjust the sensitivity/reserve manually. Auto Sensitivity takes more time to complete at larger time constants. The Sensitivity AUTO indicator is on while Auto Sensitivity is in progress. Auto Sensitivity will not execute if the time constant is greater than 1 s.
Phase	Shift–Phase	Select the Reference Phase that matches the phase of the input signal. A tone sounds when the function is complete. This results in a measured phase of the input signal that is close to zero. If the measured phase of the input signal is not settled or is noisy at the time Shift-Phase is pressed, the measured phase may not settle to 0°. Auto phase is executed once at the time the keys are pressed. The Reference Phase will not track changes in the phase of the input signal. However the R function always provides the magnitude of the input signal, even as the phase moves, as long as the phase moves slowly compared to the measurement time constant.
Offset	CH1 or CH2 Offset Auto	This key sets the Offset for the displayed quantity equal to the negative of its current value, so that the display, with offset applied, is equal to zero. The Offset is turned On if it is not already On. This key has no effect for quantities that may not be offset. Important! If the display is X or Y, Auto Offset is performed on both X <i>and</i> Y and turns on both X <i>and</i> Y offsets. This is true even if the other display is <i>not</i> displaying X or Y at the time.

Shift Functions

Some keys have shift functions labeled in blue below the key.

SETTLE...	Shift–Time Constant Up	This key sequence causes the Reference Display to show the elapsed time (in units of the current Time Constant).
PRESET	Shift–Recall	This key sequence restores the instrument to its factory defaults (see earlier in this chapter).
–90°	[Shift– +90°]	This key sequence changes the reference phase by –90°.
I.F.	[Shift– AuxOut]	<p>This key sequence shows the IF frequency on the Reference Display. See Chapter 2, <i>Sources of Error</i>, for more information about the IF (chop frequency). This display is provided as a user convenience. The instrument has weak spurious responses at offsets of $\pm 2 \times \text{IF}$, $\pm 4 \times \text{IF}$, etc. from the reference frequency. Some users may wish to set up their experiments to avoid specific IF frequencies.</p> <p>When the reference is in internal mode and the IF frequency is displayed, the knob may be used to adjust the internal reference frequency while showing the IF frequency.</p> <p>Important! The SR844 covers the operating frequency range in octave bands. Users can check the IF frequency to determine whether the instrument is at the high end of an octave band or the low end of the next band. At the high end of an octave, the IF frequency will be close to 3 kHz (12 kHz for time constants $\leq 300 \mu\text{s}$), while at the low end it will be close to 2 kHz (8 kHz for time constants $\leq 300 \mu\text{s}$). The IF frequency affects the output update rate for the analog CH1/CH2 OUTPUTs. The fastest update rates occur at the high end of each octave band (where the IF is the highest).</p>
PRECISE FREQ	[Shift– Freq]	<p>This key sequence shows the reference frequency with 6 or 7 digits resolution using the CH2 and Reference displays together. Read the two displays as if they were one single display. While the internal reference frequency is set to 3 digits resolution, the actual frequency generated in internal mode may be slightly different (within ± 1 in the 4th digit).</p> <p>To cancel this display mode, choose another reference display (Freq or Phase for example).</p>
Null	[Shift–Shift]	A second keypress cancels the first Shift if it is pressed by mistake.
OFF	[Shift– Scan Set]	This key sequence terminates Scan Mode. It has no effect if SCAN MODE is off.
CLEAR ALL	[Shift–Rel Mode]	This key sequence discards <i>all</i> stored Rel Configurations and Values.

CLEAR ONE	[Shift– Start/ Step]	This key sequence discards the stored Rel Configurations and Values at the <i>current</i> frequency.
STORE R[dBm]θ	[Shift– Store XY]	<p>Performs Auto Phase and Auto Offset on R[dBm] and stores the R[dBm] offset and reference phase as Rθ Rel Values at the current scan frequency. R[dBm] and θ displays are offset to zero. Any previously stored Rθ Rel Values are replaced. If the current measurement configuration differs from the previously stored configuration, it is also replaced. Previously stored XY Rel Values are discarded if they were stored with a measurement configuration which differs from the current one.</p> <p>The R[dBm]θ indicator turns on indicating that Rθ Rel Values are stored for this scan frequency.</p>
2F Mode	[Shift–Source]	<p>This key sequence toggles 2F harmonic detection. 2F mode is shown by the indicator above the EXTERNAL and INTERNAL indicators.</p> <p>2F detection is available for both External and Internal Reference modes. In both cases, the displayed frequency is the 2F detection frequency. The frequency of the REF OUT signal is at F or half of the displayed detection frequency. In External mode, the frequencies of REF IN and REF OUT are both F.</p> <p>Important! The 2F detection frequency is limited to 50 kHz to 200 MHz. This corresponds to a REF IN and REF OUT frequency range of 25 kHz to 100 MHz.</p> <p>The absolute phase in 2F mode is not specified. However, the relative phase accuracy generally applies.</p>

Chapter 4

Remote Operation

In This Chapter

Index of Commands	4-2
Introduction	4-7
Communicating With GPIB	4-7
Communicating With RS232	4-7
Indicators	4-7
Queues	4-7
Command Format	4-8
Command Synchronization	4-8
Example Program	4-9
Command Syntax	4-10
Output Interface (RS232 or GPIB)	4-10
Reference and Phase Commands	4-11
Signal Input Commands	4-12
Gain and Time Constant Commands	4-13
Display and Output Commands	4-15
Aux Input and Output Commands	4-17
Setup Commands	4-18
Auto Functions	4-20
Scan and Rel Functions	4-21
Data Storage	4-22
Data Storage Commands	4-24
Data Transfer Commands	4-25
Interface Commands	4-29
Status Reporting Commands	4-30
Status Register Definitions	4-31
Using Serial Poll	4-32
Using *STB?	4-33
Using Status Enable Registers	4-33
Service Requests (SRQ)	4-33
Example Program	4-34
Using Microsoft C with the GPIB interface	4-34

Index of Commands

Variables	
ch	output channel (1=CH1, 2=CH2)
i, j, k, l, m, n, q	integers
f	real number frequency in Hz
x, y, z	real numbers
Syntax	
(?)	required for queries only - illegal for set
var	always required
{var}	required for sets only - illegal for query
[var]	optional for set and query

Reference and Phase		
FMOD(?) {i}	4-11	Set (Query) the Reference Mode to External (0) or Internal (1).
HARM(?) {i}	4-11	Set (Query) the 2F detect Mode to Off (0) or On (1).
FREQ(?) {f}	4-11	Set (Query) the Reference Frequency to f Hz. Set allowed only in Internal Reference mode.
FRAQ?	4-11	Query the Reference Frequency to 6 or 7 digits precision in Hz.
FRIQ?	4-11	Query the IF frequency. Returns an integer number of Hz.
PHAS(?) {x}	4-11	Set (Query) the Reference Phase to x degrees.
APHS	4-20	Perform AutoPhase function.
REFZ(?) {i}	4-11	Set (Query) the Reference Input impedance to 50 Ω (0) or 10 k Ω (1).
Signal Input		
WRSV(?) {i}	4-12	Set (Query) the Wide Reserve Mode to High Reserve (0), Normal (1), or Low Noise (2).
AWRS	4-20	Automatically set Wide Reserve Mode.
INPZ(?) {i}	4-12	Set (Query) the Signal Input Impedance to 50 Ω (0) or 1 M Ω (1).
Gain and Time Constant		
SENS(?) {i}	4-13	Set (Query) the Sensitivity to 100 nV (0) through 1 V (14) rms full-scale.
AGAN	4-20	Perform Auto Sensitivity.
CRSV(?) {i}	4-13	Set (Query) the Close Dynamic Reserve Mode to High Reserve (0), Normal (1) or Low Noise (2).
ACRS	4-20	Automatically set Close Reserve Mode.
OFLT(?) {i}	4-13	Set (Query) the Time Constant to 100 μ s (0) through 30 ks (17).
OFSL(?) {i}	4-13	Set (Query) the Time Constant Filter Slope to 6 (i=1), 12 (2), 18 (3), 24 (4) dB/oct, or NoFilter Mode (i=0).
SETL(?)	4-14	Reset Elapsed Time counter to zero, return elapsed T.C.'s.

Display and Output		
DDEF(?)ch{,q}	4-15	Set (Query) the CH1 (ch=1) display to X (q=0), R[V] (1), R[dBm] (2), Xn (3), AuxIn1 (4) or CH2 (ch=2) to Y (q=0), θ (1), Yn[V] (2), Yn[dBm] (3), AuxIn2 (4).
DRAT(?) {i}	4-15	Set (Query) the Ratio Mode to Off (0), \div AuxIn1 (1), \div AuxIn2 (2).
FPOP(?)ch{,i}	4-15	Set (Query) the CH1/CH2 analog output to Display (0) or X/Y (1).
DOFF(?) ch,q{,x}	4-15	Set (Query) the CH1/CH2 Offset for X, R[V], R[dBm] or Y to x % full scale.
AOFF ch,q	4-20	Auto Offset CH1/CH2 for X, R[V], R[dBm] or Y.
DEXP(?) ch,q{,i}	4-16	Set (Query) the Expand for X, R[V], R[dBm], Xn, Y, θ , Yn [V] to $\times 1$ (i=0), $\times 10$ (1), $\times 100$ (2).
Aux Input and Output		
AUXI? i	4-17	Query the value of Aux Input i (1 or 2).
AUXO(?)i{x}	4-17	Set (Query) the value of Aux Output i (1 or 2) to x Volts.
Setup		
OUTX(?) {i}	4-18	Set (Query) the Output Interface to RS-232 (0) or GPIB (1).
OVRM(?) {i}	4-18	Set (Query) the GPIB Override Remote mode to Off (0) or On (1).
KCLK(?) {i}	4-18	Set (Query) the Keyclick to Off (0) or On (1).
ALRM(?) {i}	4-18	Set (Query) the Alarms to Off (0) or On (1).
SSET i	4-18	Save current settings to Buffer i (1–9).
RSET i	4-18	Recall settings from Buffer i (1–9).
KNOB i	4-18	Execute i knob adjustments.
KEYP i	4-18	Press key i.
Auto Functions		
AWRS	4-20	Automatically set Wideband Reserve Mode.
ACRS	4-20	Automatically set Close-In Reserve Mode
AGAN	4-20	Perform AutoGain to set the Sensitivity.
APHS	4-20	Perform AutoPhase to get X=maximum positive and Y=0.
AOFF ch,q	4-20	AutoOffset X, R[V], R[dBm] only.
Scan and Rel		
SSTR(?) {f}	4-21	Set (Query) the Scan Start Frequency to f Hz.
SFIN(?) {f}	4-21	Set (Query) the Scan Stop Frequency to f Hz.
SSTP(?) {i}	4-21	Set (Query) the Scan Number of Points to $2 \leq i \leq 11$.
SMOD(?) {i}	4-21	Set (Query) the current Scan Point ($1 \leq i \leq N$) or Off (0).
RSTO i	4-21	Store XY (1), or R[dBm] θ (2) Rel Values.
RRDY? i	4-21	Query Rels Ready XY (1) or R[dBm] θ (2) returns 0 (no) or 1 (yes).
RCLR	4-21	Clear all stored Rel Values and Configurations.
RMOD(?) {i}	4-21	Query Rel/Lock on (1) or off (0).

4-4 Index of Commands

Data Storage		
SRAT(?) {i}	4-24	Set (Query) the Data Sample Rate to 62.5 mHz (0) through 512 Hz (13) or Trigger (14).
SEND(?) {i}	4-24	Set (Query) the End of Scan mode to One-Shot (0) or Loop (1).
TRIG	4-24	Sample trigger command. Same as trigger input.
TSTR(?) {i}	4-24	Set (Query) the Trigger Starts Scan mode to No (0) or Yes (1).
STRT	4-24	Start or continue a scan.
PAUS	4-24	Pause during a scan. Does not reset a paused or done scan.
REST	4-24	Reset the scan. All stored data is lost.
Data Transfer		
OUTP?i	4-25	Query the value of X (1), Y (2), R[V] (3), R[dBm] (4) or θ (5).
OUTR?ch	4-25	Query the value of Display ch (1,2).
SNAP?i, j {, k, l, m, n}	4-25	Query the value of 2 to 6 parameters simultaneously.
SPTS?	4-26	Query the number of points stored in the Display buffer.
TRCA? ch, j, k	4-26	Read $k \geq 1$ points starting at bin $j \geq 0$ from Display ch (1,2) buffer in ASCII floating point.
TRCB? ch, j, k	4-26	Read $k \geq 1$ points starting at bin $j \geq 0$ from Display ch (1,2) buffer in IEEE binary floating point.
TRCL? ch, j, k	4-27	Read $k \geq 1$ points starting at bin $j \geq 0$ from Display ch (1,2) buffer in non-normalized binary floating point.
FAST(?) {i}	4-28	Set (Query) Fast Data Transfer mode to Off (0) or On(1). Fast mode will transfer binary X and Y every sample during a scan over GPIB.
STRD	4-28	Start a Scan after 0.5 s delay. Use with Fast Data Transfer mode.
Interface		
*RST	4-29	Reset the SR844 to its default configuration.
PRST	4-29	Power-On reset of SR844.
*IDN?	4-29	Read the SR844 device identification string.
LOCL(?) {i}	4-29	Set (Query) the Local/Remote state to Local (0), Remote (1) or Local Lockout (2).
OVRM(?) {i}	4-29	Set (Query) the Override Remote mode to Off (0) or On (1).
Status		
*CLS	4-30	Clear all status bytes.
*STB?[i]	4-30	Query the Serial Poll Status Byte. If i is included only bit i is queried.
*SRE(?) [i,] {j}	4-30	*SREj sets the Serial Poll Enable Register to the decimal value j (0–255). *SREi, j sets bit i (0–7) to j (0,1). *SRE? queries the entire register. *SRE?i queries bit i.
*ESR?[i]	4-30	Query the Standard Event Status Byte. If i is included only bit i is queried.
*ESE(?) [i,] {j}	4-30	*ESEj sets the Standard Event Status Enable Register to decimal value j (0–255). *ESEi, j sets bit i (0–7) to j (0,1). *ESE? queries the entire register. *ESE?i queries bit i.
*PSC(?) {i}	4-30	Set (Query) the Power-On Status Clear bit to Set (1) or Clear (0).

ERRS?[i]	4-30	Query the Error Status Byte. If i is included only bit i is queried.
ERRE(?) [i,] {j}	4-30	ERREj sets the Error Status Enable Register to decimal value j (0–255). ERREi, j sets bit i (0–7) to j (0,1). ERRE? queries the entire register. ERRE?i queries bit i.
LIAS?[i]	4-30	Query the LIA Status Register. If i is included only bit i is queried.
LIAE(?) [i,] {j}	4-30	LIAEj sets the LIA Status Enable Register to decimal value j (0–65535). LIAEi, j sets bit i (0–15) to j (0,1). LIAE? queries the entire register. LIAE?i queries bit i.

Serial Poll Status: *STB?, *SRE		
bit	name	set when...
0	SCN	No data is being stored.
1	IFC	No command in progress.
2	ERR	Enabled bit in Error status set.
3	LIA	Enabled bit in LIA status set.
4	MAV	Interface output buffer not empty.
5	ESB	Enabled bit in Standard Event status set.
6	SRQ	Service Request has occurred.
7	—	unused

Error Status: ERRS?, ERRE		
bit	name	set when...
0	—	unused
1	BAK	Battery backup failed.
2	RAM	RAM memory test failed.
3	FPG	FPGA test failed.
4	ROM	ROM memory test failed.
5	GPB	GPIB Fast Data Transfer aborted.
6	DSP	DSP test failed.
7	MTH	Internal math error occurred.

Standard Event Status: *ESR?, *ESE		
bit	name	set when...
0	RXQ	Input queue overflows.
1	—	unused
2	TXQ	Output queue overflows.
3	—	
4	EXE	Command execution error occurs.
5	CMD	Illegal command received.
6	URQ	Any key-press or knob rotation.
7	PON	Power-on.

LIA Status: LIAS?, LIAE		
bit	name	set when...
0	ULK	Reference unlocked.
1	FRQ	Ext Ref frequency out of range.
2	—	unused
3	TRG	Data storage triggered.
4	INP	Signal Input overloads.
5	RSV	IF amplifier overloads.
6	FLT	Time constant filter overloads.
7	CHG	Ref frequency changed by >1%.
8	CH1	CH1 display or front panel ovld.
9	CH2	CH2 display or front panel ovld.
10	OAX	Aux input overflows.
11	UAX	Aux input underflows.

Introduction

The SR844 RF Lock-In Amplifier may be remotely programmed via either the RS232 or GPIB (IEEE-488) interfaces. Any computer supporting one of these interfaces may be used to program the SR844. Both interfaces are receiving at all times, however, the SR844 will send responses to only one interface. Specify the output interface with the OUTX command at the start of every program.



Important!

Use the OUTX command at the beginning of every program to direct the SR844 responses to the correct interface.

Communicating With GPIB

The SR844 supports the IEEE-488.1 (1978) interface standard. It also supports the required common commands of the IEEE-488.2 (1987) standard. Before attempting to communicate with the SR844 over the GPIB interface, the SR844's Device Address must be set with the Setup key.

Communicating With RS232

The SR844 is configured as a DCE (transmit on pin 3, receive on pin 2) device and supports CTS/DTR hardware handshaking. The CTS signal (pin 5) is an output indicating that the SR844 is ready, while the DTR signal (pin 20) is an input that is used to control the SR844's data transmission. If desired, the handshake pins may be ignored and a simple 3 wire interface (pins 2, 3 and 7) may be used. The RS232 interface Baud Rate and Parity are set with the Setup key. The RS232 word length is always 8 bits.

Indicators

To assist in programming, the SR844 has four interface status indicators located in the INTERFACE section of the front panel.

The **ACTIVE** indicator flashes whenever a character is received or transmitted over either interface.

The **ERROR** indicator flashes when an error, such as illegal command, or parameter out of range, has been detected.

The **REMOTE** indicator is on whenever the SR844 is in the Remote state (front panel may be locked out).

The **SRQ** indicator is on when the SR844 generates a service request. **SRQ** stays on until a GPIB serial poll is completed.

Queues

To help find program errors, the SR844 can display its receive buffer on the displays. Use the Setup key to access the Queue display. The last 256 characters received by the SR844 may be displayed in hexadecimal format. See the Chapter 3, *Interface*, for a complete description.

Command Format

Communication with the SR844 uses ASCII characters. Commands may be in either UPPER or lower case and may contain any number of embedded SPACE characters. A command to the SR844 consists of a four character command mnemonic with optional ?, arguments if necessary, and a command terminator. The command, arguments and terminator may be separated by spaces. The terminator must be a linefeed <LF> or carriage return <CR> on RS232, or a linefeed <LF> or EOI on GPIB. No command processing occurs until a terminator is received. Commands function identically on GPIB and RS232 whenever possible. Command mnemonics beginning with an asterisk '*' are IEEE-488.2 (1987) defined common commands. These commands also function identically on RS232. Commands may require one or more parameters. Multiple parameters are separated by commas (,).

Multiple commands may be sent on one command line by separating them with semicolons (;).

There is no need to wait between commands. The SR844 has a 256 character input buffer and processes commands in the order received. If the buffer fills up, the SR844 will hold off handshaking on the GPIB and attempt to hold off handshaking on RS232. Similarly, the SR844 has a 256 character output buffer to store output until the host computer is ready to receive it. If either buffer overflows, both buffers are cleared and an error reported.

The present value of a particular parameter may be determined by querying the SR844 for its value. A query is formed by appending a question mark '?' to the command mnemonic and omitting the desired parameter from the command. Values returned by the SR844 are sent as a string of ASCII characters terminated by a carriage return <CR> on RS232 and by a line-feed <LF> on GPIB. If multiple query commands are sent on one command line (separated by semicolons, of course), the answers will be returned individually, each with a terminator.

Examples of Commands

FMOD 1 <LF>	Set Reference Mode to Internal
FREQ 27E5 <LF>	Set the internal reference frequency to 27E5 Hz (2.7 MHz)
*IDN? <LF>	Query the device identification
STRT <LF>	Start internal data storage
OUTP? 1 <LF>	Query the value of X

Command Synchronization

IFC (Interface Ready, bit 1) in the Serial Poll status signals that the SR844 is ready to receive and execute a command. When a command is received, this bit is cleared, indicating that command execution is in progress. No other commands will be processed until this command is completed. Commands received during this time are stored in the buffer to be processed later. Only GPIB serial polling will generate a response while a command is in progress. When all pending commands have executed, the IFC bit is set again. By checking IFC with serial polls, a host computer can ensure that all previously sent commands have finished before sending a new command.

Since most commands execute very quickly, the host computer does not need to continually check the IFC bit. Commands may be sent one after another and they will be processed immediately.

However, some commands, such as reset and auto-function commands, may require a long time to execute. In addition, the host program may need to check that these operations executed without error. In these cases, after the command is sent, the status should be queried.

When using the GPIB interface, serial polling may be used to check the IFC bit in the Serial Poll status while an operation is in progress. After the IFC bit becomes set, signaling the completion of the command, then the ERR or ESB bits may be checked to verify successful completion of the command.

If the RS232 interface is used, or serial polling is not available, then the *STB? query command may be used to read the Serial Poll status word. However, *STB? **never** returns the IFC bit set (since *STB? is itself a command).

Since the SR844 processes one command at a time, status queries will not be processed until the previous operation is finished. Thus a response to a status query in itself signals that the previous command is finished. The query response may then be checked for various errors.

Example Program

An example program is included at the end of this chapter. This program is a good reference for writing your own programs to control the SR844.

Command Syntax

The four letter mnemonic (shown in CAPS) in each command sequence specifies the command. The rest of the sequence consists of parameters. Parameters shown in { } and [] are not always required. Generally, parameters in { } are required to set a value in the SR844 and parameters in [] are optional in both set and query commands. Multiple parameters are separated by commas. Multiple commands may be sent on one command line by separating them with semicolons (;).

The present value of a parameter may be determined by sending a query command. Commands that may be queried have a question mark in parentheses (?) after the mnemonic. Commands that may ONLY be queried have a ? after the mnemonic. Commands that MAY NOT be queried have no ?. A query is formed by including the question mark ? after the command mnemonic and omitting the queried parameter from the command. The query parameters shown in { } are NOT sent with a query. The query returns the value of these parameters. Values are returned as a string of ASCII characters (unless otherwise noted).

Do **not** send () or { } or [] as part of the command.

For example, the command AUXO (?) i { , x } is used as follows.

AUXO 1,1.234	Set AUX OUT 1 to 1.234 V
AUXO? 1	Query the current setting of AUX OUT 1

Variables are defined as follows.

ch	output channel (1=CH1, 2=CH2)
i, j, k, l, m, n, q	integers
x, y, z	real numbers
f	real number frequency in Hz
s	text string

All numeric variables may be expressed in integer, floating point or exponential formats (i.e., the number five can be either 5, 5.0, or 0.5E1). Strings are sent as a sequence of ASCII characters.

Output Interface (RS232 or GPIB)

All responses are directed only to the selected output interface. Use the OUTX command at the beginning of every program to select the correct interface.

Reference and Phase Commands

FMOD(?) { i }	The FMOD command sets or queries the Reference Mode. The parameter <i>i</i> selects Internal (<i>i</i> =1) or External (<i>i</i> =0) reference.
HARM(?) { i }	<p>The HARM command sets or queries 2F detect mode. The parameter <i>i</i> selects OFF, (detect at F, <i>i</i>=0) or ON, (detect at 2F, <i>i</i>=1).</p> <p>The 2F detect frequency is limited to 50 kHz to 200 MHz. The HARM 1 command will generate an error if the Reference Mode is Internal and the reference frequency is below 50 kHz. The HARM 1 command will result in an OUT OF RANGE indication if the Reference Mode is External and the REF IN frequency is below 25 kHz.</p>
FREQ(?) { f }	<p>The FREQ command sets or queries the detection (reference) frequency. When 2F mode is Off, the detection frequency is the same as REF IN and REF OUT. When 2F mode is On, the detection frequency is twice REF IN and REF OUT.</p> <p>The FREQ? query will return the detection frequency in Internal or External mode. In Internal mode the frequency is returns the displayed reference frequency (3 digit resolution), whereas in External mode frequency is returned to the measurement resolution (6 or 7 digits). The instrument measures the frequency at 6–12 times a second.</p> <p>The FREQ <i>f</i> command sets the frequency of the internal reference oscillator. This command is allowed only if the Reference Mode is Internal. The parameter <i>f</i> is a real number that specifies the frequency in Hz. The value of <i>f</i> will be rounded to the nearest available internal frequency. The value of <i>f</i> must be in the range $2.5E4 \leq f \leq 2.0E8$ (2F Off) and $5.0E4 \leq f \leq 2.0E8$ (2F On)</p>
FREQ?	The FREQ? command queries the reference frequency. The frequency is returned with the measurement resolution (6 or 7 digits) in <i>both</i> External and Internal mode.
FRIQ?	<p>The FRIQ? command queries the IF frequency. The returned value is an integer with units of Hz.</p> <p>The IF frequency will be in the range of approximately 2–3 kHz, for all time constants 1 ms and longer. The SR844 uses a higher IF, approximately 8–12 kHz, for faster time constants.</p>
PHAS(?) { x }	The PHAS command sets or queries the detection phase, in degrees, relative to the reference. The parameter <i>x</i> is the phase (real number of degrees) and may be specified from $-360 \leq x \leq 360$. The value specified is rounded to 0.01° and adjusted to the interval [-179.99 , 180.00].
APHS	The APHS command performs the Auto Phase function. This command is the same as pressing Shift–Phase. This command adjusts the reference phase so that the current measurement has a Y value of zero and an X value equal to the signal magnitude, R.
REFZ(?) { i }	The REFZ command sets or queries the Reference Input impedance. The parameter <i>i</i> selects 50 Ω (<i>i</i> =0) or 10 kΩ (<i>i</i> =1).

Signal Input Commands

WRSV(?) { i }	The WRSV command sets or queries the Wide Reserve Mode of the instrument. The parameter <i>i</i> selects High Reserve (<i>i</i> =0), Normal (<i>i</i> =1), or Low Noise (minimum wide reserve) (<i>i</i> =2).
AWRS	The AWRS command performs the Auto Wide Reserve function. This command is the same as pressing Shift–WideReserveDown . AWRS automatically sets the Wide Reserve Mode of the instrument to the minimum reserve without overload.
INPZ(?) { i }	The INPZ command sets or queries the Signal Input impedance. The parameter <i>i</i> selects 50 Ω (<i>i</i> =0) or 1 M Ω (<i>i</i> =1).

Gain and Time Constant Commands

SENS (?) { i }	<p>The SENS command sets or queries the Sensitivity. The parameter <i>i</i> selects a sensitivity from the table below.</p> <table border="1" data-bbox="500 373 881 720"> <thead> <tr> <th>i</th> <th>Sensitivity</th> </tr> </thead> <tbody> <tr><td>0</td><td>100 nVrms / -127 dBm</td></tr> <tr><td>1</td><td>300 nVrms / -117 dBm</td></tr> <tr><td>2</td><td>1 μVrms / -107 dBm</td></tr> <tr><td>3</td><td>3 μVrms / -97 dBm</td></tr> <tr><td>4</td><td>10 μVrms / -87 dBm</td></tr> <tr><td>5</td><td>30 μVrms / -77 dBm</td></tr> <tr><td>6</td><td>100 μVrms / -67 dBm</td></tr> <tr><td>7</td><td>300 μVrms / -57 dBm</td></tr> </tbody> </table> <table border="1" data-bbox="938 373 1320 678"> <thead> <tr> <th>i</th> <th>Sensitivity</th> </tr> </thead> <tbody> <tr><td>8</td><td>1 mVrms / -47 dBm</td></tr> <tr><td>9</td><td>3 mVrms / -37 dBm</td></tr> <tr><td>10</td><td>10 mVrms / -27 dBm</td></tr> <tr><td>11</td><td>30 mVrms / -17 dBm</td></tr> <tr><td>12</td><td>100 mVrms / -7 dBm</td></tr> <tr><td>13</td><td>300 mVrms / +3 dBm</td></tr> <tr><td>14</td><td>1 Vrms / +13 dBm</td></tr> </tbody> </table>	i	Sensitivity	0	100 nVrms / -127 dBm	1	300 nVrms / -117 dBm	2	1 μ Vrms / -107 dBm	3	3 μ Vrms / -97 dBm	4	10 μ Vrms / -87 dBm	5	30 μ Vrms / -77 dBm	6	100 μ Vrms / -67 dBm	7	300 μ Vrms / -57 dBm	i	Sensitivity	8	1 mVrms / -47 dBm	9	3 mVrms / -37 dBm	10	10 mVrms / -27 dBm	11	30 mVrms / -17 dBm	12	100 mVrms / -7 dBm	13	300 mVrms / +3 dBm	14	1 Vrms / +13 dBm						
i	Sensitivity																																								
0	100 nVrms / -127 dBm																																								
1	300 nVrms / -117 dBm																																								
2	1 μ Vrms / -107 dBm																																								
3	3 μ Vrms / -97 dBm																																								
4	10 μ Vrms / -87 dBm																																								
5	30 μ Vrms / -77 dBm																																								
6	100 μ Vrms / -67 dBm																																								
7	300 μ Vrms / -57 dBm																																								
i	Sensitivity																																								
8	1 mVrms / -47 dBm																																								
9	3 mVrms / -37 dBm																																								
10	10 mVrms / -27 dBm																																								
11	30 mVrms / -17 dBm																																								
12	100 mVrms / -7 dBm																																								
13	300 mVrms / +3 dBm																																								
14	1 Vrms / +13 dBm																																								
AGAN	<p>The AGAN command performs the Auto Sensitivity function. This command is the same as pressing Shift–SensUp. AGAN automatically sets the Sensitivity of the instrument.</p> <p>This function may take some time if the time constant is long. This function does nothing if the time constant is greater than 1 s. Check the Interface Ready bit (bit 1) in the Serial Poll Status to determine when the command is finished.</p>																																								
CRSV (?) { i }	<p>The CRSV command sets or queries the Close Dynamic Reserve Mode. The parameter <i>i</i> selects High Reserve (<i>i</i>=0), Normal (<i>i</i>=1), or Low Noise (minimum close reserve) (<i>i</i>=2).</p>																																								
ACRS	<p>The ACRS command performs the Auto Close Reserve function. This command is the same as pressing Shift–CloseResrv.</p>																																								
OFLT (?) { i }	<p>The OFLT command sets or queries the time constant. The parameter <i>i</i> selects a time constant below.</p> <table border="1" data-bbox="500 1308 808 1675"> <thead> <tr> <th>i</th> <th>time constant</th> </tr> </thead> <tbody> <tr><td>0</td><td>100 μs</td></tr> <tr><td>1</td><td>300 μs</td></tr> <tr><td>2</td><td>1 ms</td></tr> <tr><td>3</td><td>3 ms</td></tr> <tr><td>4</td><td>10 ms</td></tr> <tr><td>5</td><td>30 ms</td></tr> <tr><td>6</td><td>100 ms</td></tr> <tr><td>7</td><td>300 ms</td></tr> <tr><td>8</td><td>1 s</td></tr> </tbody> </table> <table border="1" data-bbox="865 1308 1174 1675"> <thead> <tr> <th>i</th> <th>time constant</th> </tr> </thead> <tbody> <tr><td>9</td><td>3 s</td></tr> <tr><td>10</td><td>10 s</td></tr> <tr><td>11</td><td>30 s</td></tr> <tr><td>12</td><td>100 s</td></tr> <tr><td>13</td><td>300 s</td></tr> <tr><td>14</td><td>1 ks</td></tr> <tr><td>15</td><td>3 ks</td></tr> <tr><td>16</td><td>10 ks</td></tr> <tr><td>17</td><td>30 ks</td></tr> </tbody> </table>	i	time constant	0	100 μ s	1	300 μ s	2	1 ms	3	3 ms	4	10 ms	5	30 ms	6	100 ms	7	300 ms	8	1 s	i	time constant	9	3 s	10	10 s	11	30 s	12	100 s	13	300 s	14	1 ks	15	3 ks	16	10 ks	17	30 ks
i	time constant																																								
0	100 μ s																																								
1	300 μ s																																								
2	1 ms																																								
3	3 ms																																								
4	10 ms																																								
5	30 ms																																								
6	100 ms																																								
7	300 ms																																								
8	1 s																																								
i	time constant																																								
9	3 s																																								
10	10 s																																								
11	30 s																																								
12	100 s																																								
13	300 s																																								
14	1 ks																																								
15	3 ks																																								
16	10 ks																																								
17	30 ks																																								
OFSL (?) { i }	<p>The OFSL command sets or queries the Time Constant Filter Slope. The parameter <i>i</i> selects 6 dB/oct (<i>i</i>=1), 12dB/oct (<i>i</i>=2), 18dB/oct (<i>i</i>=3), or 24 dB/oct (<i>i</i>=4). This command also sets the No Filter mode, with parameter <i>i</i>=0.</p>																																								

4-14 Gain and Time Constant

SETL (?)	The SETL command resets the Elapsed Time counter to zero, while the SETL? query returns the Elapsed Time as a real number, in units of the current Time Constant, since either the last SETL command or since the Settle... key was pressed. The SETL? query does not reset the Elapsed Time counter.
------------	--

Display and Output Commands

Many of the commands in this section use the parameters *ch* for Channel and *q* for Quantity as specified in the following table.

Channel 1 (ch=1)		Channel 2 (ch=2)	
q	display	q	display
0	X	0	Y
1	R [Volts rms]	1	θ
2	R [dBm]	2	Y noise [Volts]
3	X noise	3	Y noise [dBm]
4	AUX IN 1	4	AUX IN 2

DDEF(?) ch { , q }	The DDEF command selects the CH1 and CH2 displays. The parameter <i>ch</i> selects Channel 1 or Channel 2 and is required. The DDEF <i>ch</i> , <i>q</i> command sets display <i>ch</i> to quantity <i>q</i> as listed above.																				
DRAT(?) { i }	<p>The DRAT command sets or queries the instrument ratio mode. The signal may be divided by either of the Aux Inputs. This scaling is applied before the Time Constant filters and applies to X, Y, R, Xnoise and Ynoise.</p> <p>The DRAT <i>i</i> command sets the ratio mode as listed below.</p> <table border="1"> <thead> <tr> <th>i</th> <th>Ratio</th> </tr> </thead> <tbody> <tr> <td>0</td> <td>none</td> </tr> <tr> <td>1</td> <td>÷ AUX IN 1</td> </tr> <tr> <td>2</td> <td>÷ AUX IN 2</td> </tr> </tbody> </table>	i	Ratio	0	none	1	÷ AUX IN 1	2	÷ AUX IN 2												
i	Ratio																				
0	none																				
1	÷ AUX IN 1																				
2	÷ AUX IN 2																				
FPOP(?) ch { , i }	<p>The FPOP command sets or queries the front panel (CH1 and CH2) output sources. The parameter <i>ch</i> selects Channel 1 or Channel 2 and is required. The FPOP <i>ch</i> , <i>i</i> command sets the analog output <i>ch</i> to quantity <i>i</i> as shown below.</p> <table border="1"> <thead> <tr> <th colspan="2">Channel 1 (ch=1)</th> <th colspan="2">Channel 2 (ch=2)</th> </tr> <tr> <th>i</th> <th>output quantity</th> <th>i</th> <th>output quantity</th> </tr> </thead> <tbody> <tr> <td>0</td> <td>CH1 display</td> <td>0</td> <td>CH2 display</td> </tr> <tr> <td>1</td> <td>X</td> <td>1</td> <td>Y</td> </tr> </tbody> </table>	Channel 1 (ch=1)		Channel 2 (ch=2)		i	output quantity	i	output quantity	0	CH1 display	0	CH2 display	1	X	1	Y				
Channel 1 (ch=1)		Channel 2 (ch=2)																			
i	output quantity	i	output quantity																		
0	CH1 display	0	CH2 display																		
1	X	1	Y																		
DOFF(?) ch , q { , x }	<p>The DOFF command sets or queries the Offset for the quantity specified by <i>ch</i> , <i>q</i> in the table below. The offset <i>x</i> is specified in % of full scale. The allowed ranges for <i>x</i> are specified in the table below.</p> <table border="1"> <thead> <tr> <th>ch,q</th> <th>quantity</th> <th>x</th> <th>unit</th> </tr> </thead> <tbody> <tr> <td>1 , 0</td> <td>X</td> <td>-110 to +110</td> <td>% of full scale</td> </tr> <tr> <td>1 , 1</td> <td>R[V]</td> <td>-110 to +110</td> <td>% of full scale</td> </tr> <tr> <td>1 , 2</td> <td>R[dBm]</td> <td>-110 to +110</td> <td>% of 200 dBm</td> </tr> <tr> <td>2 , 0</td> <td>Y</td> <td>-110 to +110</td> <td>% of full scale</td> </tr> </tbody> </table>	ch,q	quantity	x	unit	1 , 0	X	-110 to +110	% of full scale	1 , 1	R[V]	-110 to +110	% of full scale	1 , 2	R[dBm]	-110 to +110	% of 200 dBm	2 , 0	Y	-110 to +110	% of full scale
ch,q	quantity	x	unit																		
1 , 0	X	-110 to +110	% of full scale																		
1 , 1	R[V]	-110 to +110	% of full scale																		
1 , 2	R[dBm]	-110 to +110	% of 200 dBm																		
2 , 0	Y	-110 to +110	% of full scale																		

4-16 Display and Output

	<p>Specifying any other quantity in the offset commands will result in an error.</p> <p>Important! Setting an offset to 0 turns that offset <i>off</i>. Setting an offset to a non-zero value sets the offset value <i>and</i> turns the offset on.</p> <p>Remember, X and Y offsets turn on and off <i>together</i>. Always set <i>both</i> X and Y offsets together making sure that the second offset which is set is non-zero.</p> <p>Querying the offset of a quantity that has offset turned off will return zero.</p>
AOFF ch, q	<p>The AOFF ch, q command automatically offsets the chosen quantity to zero. The quantity is specified by its display channel ch and quantity q as per the table above. Both parameters ch and q are required. This command is equivalent to pressing the Auto Offset key.</p> <p>Important! Remember, Auto Offset X or Y performs Auto Offset on both X <i>and</i> Y.</p>
DEXP (?) ch, q { , i }	<p>The DEXP command sets or queries the output Expand of the display quantity specified by ch, q (see table above). The parameter i specifies No Expand (0), ×10 (1) or ×100 (2).</p> <p>The following quantities may be expanded: X, R[V], R[dBm], Xnoise, Y, θ, and Ynoise [Volts]. Specifying any other quantity in the DEXP command will result in an error.</p>

Aux Input and Output Commands

AUXI? <i>i</i>	The AUXI? command queries the Aux Input values. The parameter <i>i</i> (1 or 2) selects an Aux Input and is required. The Aux Input voltages are returned in units of Volts. The resolution is 1/3 mV. This is a query only command.
AUXO(?) <i>i</i> { , <i>x</i> }	The AUXO command sets or queries the Aux Output voltage. The parameter <i>i</i> (1 or 2) selects an Aux Output and is required. The parameter <i>x</i> is the output voltage (real number of Volts) and is limited to $-10.500 \leq x \leq 10.500$.

Setup Commands

OUTX(?) { i }	<p>The OUTX command sets the output interface to RS232 (i=0) or GPIB (i=1).</p> <p>The OUTX i command should be sent before any query commands to direct the responses to the interface in use.</p>
OVRM(?) { i }	<p>The OVRM command sets or queries the GPIB Override Remote mode. The parameter i selects Off (i=0) or On (i=1).</p> <p>The default mode is Override Remote On. In this mode the front panel is <i>always</i> active, regardless of the Remote or Local Lockout state. (A remote command will <i>always</i> put the SR844 into one of these states and illuminate the REMOTE indicator, except for LOCL0.)</p> <p>To lock-out the front panel, use the OVRM0 command. Then in the Remote state only the Local key is active. If the unit is in Local Lockout, the entire front panel will be disabled. To reactivate the front panel, issue OVRM1 or LOCL0. In the Remote state, pressing the Local key will also reactivate the front panel.</p>
KCLK(?) { i }	The KCLK command sets or queries the key click On (i=1) or Off (i=0) state.
ALRM(?) { i }	The ALRM command sets or queries the alarm On (i=1) or Off (i=0) state.
SSET i	The SSET i command saves the instrument setup in setting buffer i (1≤i≤9). The setting buffers are retained when the power is turned off.
RSET i	The RSET i command recalls the instrument setup from setting buffer i (1≤i≤9). Interface parameters are not changed when a setting buffer is recalled with the RSET command. If setting i has not been saved prior to the RSET i command, then an error will result.
KNOB i	<p>The KNOB i command executes the equivalent of i knob adjustments. This command is primarily provided to allow a remote program to do anything that can be accomplished using the front panel. However, since the actions of the knob are context sensitive, it is poor programming practice to use the KNOB command when another functional command is available.</p> <p>The parameter i is a signed integer between -32767 and 32767.</p>
KEYP i	The KEYP command executes the equivalent of a single front panel keypress. Although this command is primarily provided to allow the remote program to force the reference display to show a particular quantity, such as frequency or offset, it allows a remote program to do anything that can be accomplished using the front panel keys. However, since the actions of the keys are context sensitive, it is poor programming practice to use the KEYP command (e.g. KEYP3) when another functional command (e.g. OFSL2) is available. The following table lists the available keycodes.

i	Key	i	Key
0	Time Constant Up	29	CH2 Offset Auto
1	Time Constant Down	32	CH2 Offset Modify
2	Slope Down (up arrow !)	33	Save Settings
3	Slope Up	34	Recall Settings
4	Sensitivity Up	35	Start/Step
5	Sensitivity Down	36	Scan Set
8	Wide Reserve Up	37	Rel Mode
9	Signal Z-In	40	Store XY
10	Wide Reserve Down	41	Local
12	Close Reserve	42	Setup
13	CH1 Offset Modify	43	Phase
16	CH1 Display	44	+90°
17	Ratio	45	Phase Zero
18	CH1 Expand	48	Shift
19	CH1 Output	49	Freq
20	CH1 Offset On/Off	50	Ref Z-In
21	CH1 Offset Auto	51	Ref Source
24	CH2 Display	57	Aux Out
26	CH2 Expand	59	Key Click On/Off
27	CH2 Output	60	LED Test Mode
28	CH2 Offset On/Off	61	Keypad Test Mode

The shift keys are available by adding 64 to the corresponding standard key codes

i	Key	i	Key
64	Settle	101	Clear All
68	Auto Sensitivity	104	Store R[dBm]θ
74	Auto Wide Reserve	107	Auto Phase
76	Auto Close Reserve	108	-90°
98	Preset	113	Precise Freq
99	Clear One	115	2F Mode On/Off
100	Scan Off	121	IF Frequency

Auto Functions

AWRS	The AWRS command performs the Auto Wide Reserve function. This command is the same as pressing Shift–WideReserveDown . AWRS automatically sets the Wide Reserve Mode of the instrument to the minimum reserve without overload.										
ACRS	The ACRS command performs the Auto Close Reserve function. This command is the same as pressing Shift–CloseResrv .										
AGAN	<p>The AGAN command performs the Auto Sensitivity function. This command is the same as pressing Shift–SensUp. AGAN automatically sets the Sensitivity of the instrument.</p> <p>This function may take some time if the time constant is long. This function does nothing if the time constant is greater than one second. Check the Interface Ready bit (bit 1) in the Serial Poll Status to determine when the command is finished.</p>										
APHS	The APHS command performs the Auto Phase function. This command is the same as pressing Shift–Phase . This command adjusts the reference phase so that the current measurement has a Y value of zero and an X value equal to the signal magnitude, R.										
AOFF <i>ch, q</i>	<p>The AOFF <i>ch, q</i> command automatically offsets the chosen quantity to zero. The quantity is specified by its display channel <i>ch</i> and quantity <i>q</i> as per the table above. Both parameters <i>ch</i> and <i>q</i> are required. This command is equivalent to pressing the Auto Offset key.</p> <table border="1" data-bbox="423 1062 699 1255"> <thead> <tr> <th>ch,q</th> <th>Quantity</th> </tr> </thead> <tbody> <tr> <td>1,0</td> <td>X</td> </tr> <tr> <td>1,1</td> <td>R[V]</td> </tr> <tr> <td>1,2</td> <td>R[dBm]</td> </tr> <tr> <td>2,0</td> <td>Y</td> </tr> </tbody> </table> <p>Important! Remember, Auto Offset X or Y performs Auto Offset on both X and Y.</p>	ch,q	Quantity	1,0	X	1,1	R[V]	1,2	R[dBm]	2,0	Y
ch,q	Quantity										
1,0	X										
1,1	R[V]										
1,2	R[dBm]										
2,0	Y										

Scan and Rel Functions

SSTR(?) {f}	The SSTR command sets and queries the Scan Start Frequency. The parameter f is a real number of Hz. The Start Frequency may not be set while a scan is in progress.
SFIN(?) {f}	The SFIN command sets and queries the Scan Stop Frequency. The parameter f is a real number of Hz. The Stop Frequency may not be set while a scan is in progress.
SSTP(?) {i}	The SSTP command sets and queries the Number of Scan Points. The parameter i is $2 \leq i \leq 11$. The Number of Points may not be set while a scan is in progress.
SMOD(?) {i}	The SMOD command sets and queries the current scan point. SMOD i moves to point i ($1 \leq i \leq N$) in the scan where N=Number of Scan Points. Use SMOD to move from scan frequency to scan frequency (in any order). SMOD 0 exits Scan Mode.
RSTO i	The RSTO command stores XY (i=1) or R[dBm] θ (i=2) Rel Values along with the measurement configuration at the current frequency.
RRDY? i	The RRDY command queries whether any Rel Values are stored for the current frequency. The parameter i selects XY (i=1) or R[dBm] θ (i=2). RRDY? i returns 0 (no Rel Values) or 1 (Rel Values stored).
RCLR	The RCLR command clears <i>all</i> stored Rel Values and Configurations.
RMOD(?) {i}	The RMOD command sets and queries REL MODE Off (i=0) or On (i=1).

Data Storage

Introduction

The SR844 can store up to 16383 points from both the Channel 1 and Channel 2 displays in an internal data buffer. The data buffer is *not* retained when the power is turned off. The data buffer is accessible only via the remote interfaces.

Configure the displays to show the desired quantity (with appropriate ratio, offset and expand). The data buffer stores the quantities which are displayed. Only quantities which are displayed on the CH1 or CH2 displays can be stored. Frequency, for example, cannot be stored.

Data Points and Bins

Data points stored in the buffer are sometimes referred to by their bin position within the buffer. The oldest data point is bin 0, the next is bin 1, etc. A buffer with N points is numbered from 0 to N-1.

Sample Rate

The sample rate can be varied from 512 Hz down to 62.5 mHz (one point every 16 seconds). The sample rate sets how often points are added to the storage buffer. Both displays are sampled at the same rate and at the same times.

In addition to the internal sample rates, sampling can be triggered by a remote TRIG command or by the rear panel TTL trigger input. In this mode, one sample is taken within 2 ms of receipt of each trigger. Triggers occurring at a rate faster than 512 Hz will be ignored.

Storage Time

The buffer holds 16383 samples taken at the sample rate. The entire storage time is 16383 divided by the sample rate.

End of Scan

When the buffer becomes full, data storage can either stop or continue.

The first case is called one-shot (data points are stored for a single buffer length). At the end of the buffer, data storage stops and an audible alarm sounds.

The second case is called loop. In this case, data storage continues at the end of the buffer. The data buffer will store 16383 points and start storing at the beginning again. The most recent 16383 points will be contained in the buffer. Once the buffer has looped around, the oldest point (at any time) is bin 0 and the most recent point is bin 16382.

The default mode is loop.

Starting and Stopping a Scan

The `STRT`, `STRD`, `PAUS` and `REST` commands are used to control data storage. Basically, the `STRT` command starts data storage after a reset or pause. The `PAUS` command pauses data storage but does not reset the buffer. The `REST` command stops data storage and resets the buffer data.

Aliasing Effects

In any sampled data stream, it is possible to sample a high frequency signal such that it will appear to be a much lower frequency. This is called aliasing.

Aliasing occurs whenever the signal being sampled contains components at frequencies greater than $1/2$ the sample rate.

Generally, the highest possible sample rate should be used given the desired storage time. The lock-in time constant and filter slope should be chosen to attenuate signals at frequencies higher than $1/2$ the sample rate as much as possible.

Data Storage Commands

SRAT(?) {i}	<p>The SRAT command sets or queries the Data Sample Rate. The parameter i selects the sample rate as shown below.</p> <table border="1" data-bbox="427 380 768 680"> <thead> <tr> <th>i</th> <th>sample rate</th> </tr> </thead> <tbody> <tr><td>0</td><td>62.5 mHz (16 s)</td></tr> <tr><td>1</td><td>125 mHz (8 s)</td></tr> <tr><td>2</td><td>250 mHz (4 s)</td></tr> <tr><td>3</td><td>500 mHz (2 s)</td></tr> <tr><td>4</td><td>1 Hz</td></tr> <tr><td>5</td><td>2 Hz</td></tr> <tr><td>6</td><td>4 Hz</td></tr> </tbody> </table> <table border="1" data-bbox="824 380 1166 716"> <thead> <tr> <th>i</th> <th>sample rate</th> </tr> </thead> <tbody> <tr><td>7</td><td>8 Hz</td></tr> <tr><td>8</td><td>16 Hz</td></tr> <tr><td>9</td><td>32 Hz</td></tr> <tr><td>10</td><td>64 Hz</td></tr> <tr><td>11</td><td>128 Hz</td></tr> <tr><td>12</td><td>256 Hz</td></tr> <tr><td>13</td><td>512 Hz</td></tr> <tr><td>14</td><td>Trigger</td></tr> </tbody> </table>	i	sample rate	0	62.5 mHz (16 s)	1	125 mHz (8 s)	2	250 mHz (4 s)	3	500 mHz (2 s)	4	1 Hz	5	2 Hz	6	4 Hz	i	sample rate	7	8 Hz	8	16 Hz	9	32 Hz	10	64 Hz	11	128 Hz	12	256 Hz	13	512 Hz	14	Trigger
i	sample rate																																		
0	62.5 mHz (16 s)																																		
1	125 mHz (8 s)																																		
2	250 mHz (4 s)																																		
3	500 mHz (2 s)																																		
4	1 Hz																																		
5	2 Hz																																		
6	4 Hz																																		
i	sample rate																																		
7	8 Hz																																		
8	16 Hz																																		
9	32 Hz																																		
10	64 Hz																																		
11	128 Hz																																		
12	256 Hz																																		
13	512 Hz																																		
14	Trigger																																		
SEND(?) {i}	<p>The SEND command sets or queries the End of Scan mode. The parameter i selects one-shot (0) or loop (1). If loop mode is used, be sure to pause data storage before reading the data to avoid confusion about which data point is most recent.</p>																																		
TRIG	<p>The TRIG command is the software trigger command. This command has the same effect as a trigger at the rear panel TRIG IN. If the Data Sample Rate is set to Trigger (SRAT14), then receipt of this command causes data to be sampled and stored to both the Channel 1 and Channel 2 buffers within 2 ms (actually on the next 512 Hz clock tick). The command is ignored if the Data Sample Rate is set to an internal rate, or if the buffers are full, or if the command is received before a previous TRIG command has completed.</p>																																		
TSTR(?) {i}	<p>The TSTR command sets or queries the Trigger Scan Mode to On (1) or Off (0). When Trigger Scan Mode is On (i=1), an external or software trigger starts the scan. This mode is only applicable for fixed data sample rates set by SRAT 0-13.</p>																																		
STRT	<p>The STRT command starts or resumes data storage. STRT is ignored if storage is already in progress.</p>																																		
PAUS	<p>The PAUS command pauses data storage. If storage is already paused or reset then this command is ignored.</p>																																		
REST	<p>The REST command resets the data buffers. The REST command can be sent at any time – any storage in progress, paused or not, will be reset. This command will erase the data buffer!</p>																																		

Data Transfer Commands

OUTP? i	<p>The OUTP? i command reads the value of X, Y, R or θ. The parameter i selects X (1), Y (2), R [V] (3), R [dBm] (4) or θ (5). Values are returned as ASCII floating point numbers with units of Volts, dBm or degrees. The units are <i>not</i> part of the returned string. For example, the response might be $-1.0103E-6$. This command is a query only command.</p> <p>Important! The returned value <i>does</i> have Offsets and Ratio applied. However, Expand is <i>not</i> applied (compare OUTR?ch below).</p>																						
OUTR? ch	<p>The OUTR? i command reads the value of the CH1 or CH2 display. The parameter ch selects the display (ch=1 or ch=2). Values are returned as ASCII floating point numbers with units of the display. For example the response might be $-1.0103E-6$. This command is a query only command.</p> <p>The response has Ratio, Offset and Expand applied, just like the display.</p>																						
SNAP? i, j {, k, l, m, n}	<p>The SNAP? command returns the values of up to six parameters at a single instant. For example, SNAP? is a way to query values of X and Y (or R and θ) recorded at the same instant. This is important when the time constant is very short. Using the OUTP? or OUTR? command will result in time delays between reading X and Y (or R and θ) which may be greater than the time constant.</p> <p>The SNAP? command requires <i>at least two</i> and at most six parameters. The parameters i, j, k, l, m, n select the parameters below.</p> <table border="1" data-bbox="500 1098 1092 1514"> <thead> <tr> <th>i, j, k, l, m, n</th> <th>parameter</th> </tr> </thead> <tbody> <tr> <td>1</td> <td>X</td> </tr> <tr> <td>2</td> <td>Y</td> </tr> <tr> <td>3</td> <td>R [V]</td> </tr> <tr> <td>4</td> <td>R [dBm]</td> </tr> <tr> <td>5</td> <td>θ</td> </tr> <tr> <td>6</td> <td>AUX IN 1</td> </tr> <tr> <td>7</td> <td>AUX IN 2</td> </tr> <tr> <td>8</td> <td>Reference Frequency</td> </tr> <tr> <td>9</td> <td>CH1 display</td> </tr> <tr> <td>10</td> <td>CH2 display</td> </tr> </tbody> </table> <p>The requested values are returned in a single ASCII string with the values in the order requested, separated by commas. For example, the SNAP?1, 2, 8, 6 will return the values of X, Y, Freq, and AUX IN 1. These values will be returned in a single string such as</p> <p style="text-align: center;">$0.9514E-3, -1.2271E-5, 2.770E7, -3.219$</p> <p>The first value is X [V], the second is Y [V], the third is F_{REF} [Hz] and the last is AUX IN 1 [V].</p>	i, j, k, l, m, n	parameter	1	X	2	Y	3	R [V]	4	R [dBm]	5	θ	6	AUX IN 1	7	AUX IN 2	8	Reference Frequency	9	CH1 display	10	CH2 display
i, j, k, l, m, n	parameter																						
1	X																						
2	Y																						
3	R [V]																						
4	R [dBm]																						
5	θ																						
6	AUX IN 1																						
7	AUX IN 2																						
8	Reference Frequency																						
9	CH1 display																						
10	CH2 display																						

	<p>The values of X and Y are recorded at a single instant, as are the values of R[V] and θ. Thus reading (X,Y) or (R,θ) yields a snapshot of the input signal. A SNAP? measurement of X, Y, R and θ may give R,θ measured at a time up to 84 μs before the X,Y measurement.</p> <p>R[dBm] and the Aux Inputs are computed with a maximum interval of 84 μs. A SNAP? measurement of X, Y, and AUX IN 1 will give AUX IN 1 measured at a time up to 84 μs before the X,Y measurement.</p> <p>The reference frequency is computed 6-12 times a second.</p> <p>The SNAP? command is a query only command. It is used to record various parameters simultaneously, not to transfer data quickly.</p> <p>Important! The returned values of X, Y, R and RdBm have Offset and Ratio applied, but <i>not</i> Expand, just like OUTP?i. The values of the CH1 and CH2 display have Offset, Ratio <i>and</i> Expand applied, just like OUTR?ch.</p>
SPTS?	<p>The SPTS? command queries the number of points currently stored in the buffer. The same number of points are stored from each display. If the buffer is reset, then 0 is returned. Remember, SPTS? returns N where N is the number of points – the points are numbered from 0 (oldest) to N-1 (most recent). The SPTS? command can be sent at any time, even while storage is in progress. It is a query only command.</p>
TRCA? ch, j, k	<p>The TRCA? command queries the points stored in the Display ch buffer. The values are returned as ASCII floating point numbers in the units of the display. Multiple points are separated by commas and the final point is followed by a terminator. For example, the response for two points might be</p> <p style="text-align: center;">-1.2345E-6, +0.1234E-6,</p> <p>The parameter ch selects the display buffer (1 or 2) and is required. Points are read from the buffer starting at bin j ($j \geq 0$). A total of k bins are read ($k \geq 1$). To read a single point, set $k=1$. Both j and k are required. If $j+k$ exceeds the number of stored points (as returned by the SPTS? query), then an error occurs.</p> <p>Important! If data storage is set to Loop mode, be sure to pause data storage before reading any data. This is because the points are indexed relative to the oldest point, which is continually changing.</p>
TRCB? ch, j, k	<p>The TRCB? command queries the points stored in the Display ch buffer. The values are returned as IEEE format binary floating point numbers (in the units of the display). There are four bytes per point. Multiple points are not separated by any delimiter. The bytes can be read directly into a floating point array (in most programming languages).</p> <p>The parameter ch selects the display buffer (1 or 2) and is required. Points are read from the buffer starting at bin j ($j \geq 0$). A total of k bins are read ($k \geq 1$). To read a single point, set $k=1$. Both j and k are required. If $j+k$ exceeds the number of stored points (as returned by the SPTS? query), then an error occurs.</p>

When using the GPIB interface, <EOI> is sent with the final byte. The points must be read using a binary transfer (see your GPIB interface card software manual). Make sure that the software is configured to not terminate upon receipt of a <CR> or <LF>.

Important!

- If data storage is set to Loop mode, be sure to pause data storage before reading any data. This is because the points are indexed relative to the oldest point, which is continually changing.
- Do not query the Interface Ready status bit after sending the TRCB? command. This bit will *not* be set until the transfer is complete.

When using the RS232 interface the points must be read as binary bytes (no checking for linefeeds, carriage returns or other control characters). Most serial interface drivers are designed for ASCII text only and will not work here. In addition, the data transfer does not pause between bytes. The receiving interface must always be ready to receive the next byte. In general, using binary transfers on the RS232 interface *is not* recommended.

TRCL? ch, j, k

The TRCL? command queries the points stored in the Display ch buffer. The values are returned in non-normalized floating point format in the units of the trace. There are four bytes per point. Multiple points are not separated by any delimiter. The bytes *cannot* be read directly into a floating point array.

Each point consists of four bytes. Byte 0 is the LSB and is transmitted first. Byte 3 is the MSB. The format is illustrated below.

16 bits		16 bits	
0	exp	mantissa	
byte3	byte2	byte1	byte0

The mantissa is a signed 16 bit integer (–32768 to +32767). The exponent is a signed integer whose value ranges from 0 to 248 (thus byte 3 is always zero). The value of the data point is

$$\text{value} = \text{mantissa} \times 2^{[\text{exponent} - 124]}$$

The data within the SR844 is stored in this format, so data transfers using this format is *faster* than IEEE floating point format. If transfer speed is important, then the TRCL? command should be used.

The parameter ch selects the display buffer (1 or 2) and is required. Points are read from the buffer starting at bin j (j ≥ 0). A total of k bins are read (k ≥ 1). To read a single point, set k=1. Both j and k are required. If j+k exceeds the number of stored points (as returned by the SPTS? query), then an error occurs.

When using the GPIB interface, <EOI> is sent with the final byte. The points must be read using a binary transfer (see your GPIB interface card software manual). Make sure that the software is configured to not terminate upon receipt of a <CR> or <LF>.

	<p>Important!</p> <ul style="list-style-type: none"> • If data storage is set to Loop mode, be sure to pause data storage before reading any data. This is because the points are indexed relative to the oldest point, which is continually changing. • Do not query the Interface Ready status bit after sending the TRCL? command. This bit will not be set until the transfer is complete. <p>When using the RS232 interface the points must be read as binary bytes (no checking for linefeeds, carriage returns or other control characters). Most serial interface drivers are designed for ASCII text only and will not work here. In addition, the data transfer does not pause between bytes. The receiving interface must always be ready to receive the next byte. In general, using binary transfers on the RS232 interface <i>is not</i> recommended.</p>
<p>FAST(?) { i }</p>	<p>The FAST command sets the Fast Data Transfer mode on and off. The parameter <i>i</i> selects On (1) or Off (0). In the Fast Data Transfer mode, the values of <i>X</i> and <i>Y</i> are automatically transmitted over the GPIB interface whenever data is sampled and stored. The fast transfer mode is <i>not available over RS232</i>. The sample rate sets the frequency of data transfers (512 Hz maximum). It is important that the receiving interface be able to keep up with the transfers.</p> <p>Offsets, Ratios and Expands are included in the values of <i>X</i> and <i>Y</i>. The values of <i>X</i> and <i>Y</i> are transferred as signed integers, 2 bytes long (16 bits). <i>X</i> is sent first, followed by <i>Y</i>, for a total of four bytes per sample. The values range from -32768 to +32767. The value of ±29788 represents ±full scale (i.e. sensitivity/expand).</p> <p>Important!</p> <ul style="list-style-type: none"> • At fast sample rates, it is important that the receiving interface be able to keep up. If the SR844 finds that the GPIB interface is not ready to receive a point, then the fast transfer mode is <i>turned off</i> and GPB bit in the Error Status Register is set. • The transfer mode should be turned on (using FAST1) <i>before</i> storage is started. Then use the STRD command (see below) to start data storage. After sending the STRD command, immediately make the SR844 a talker and the controlling interface a listener. Remember, the first transfer will occur with the very first point.
<p>STRD</p>	<p>After using FAST1 to turn on Fast Data Transfer, use the STRD command to start the data storage. STRD starts data storage after a delay of 0.5 s. This delay allows the controlling interface to place itself in the read mode before the first data points are transmitted.</p> <p>Do <i>not</i> use the STRT command to start the scan. See the programming examples at the end of this section.</p>

Interface Commands

*RST	<p>The *RST command resets the SR844 to its default configuration. The communications setup is not changed. All other modes and settings are set to their default conditions and values. This command takes some time to complete. This command resets any data scan in progress. Data stored in the buffers will be lost.</p>
PRST	<p>The PRST command does a power-on reset. In addition to resetting the configuration, the DSP and programmable logic are re-loaded, and the communication ports are reset. This command takes about 5 seconds to complete; no new commands will be recognized in the meantime.</p> <p>The next command (after IFC ready becomes set again) should be OUTX i.</p>
*IDN?	<p>The *IDN? query returns the SR844's device identification string. This string is in the format</p> <pre style="text-align: center;">Stanford_Research_Systems , SR844 , s/n00111 , ver1.00</pre> <p>In this example, the serial number is 00111 and the firmware version is 1.00</p>
LOCL (?) {i}	<p>The LOCL command sets or queries the local/remote state. The SR844 is put into the Local (i=0), Remote (i=1) or Local Lockout (i=2) state. These states duplicate the GPIB local/remote states. In the Local state both remote command execution and keyboard input are allowed. In the Remote state remote command execution is allowed, but the keyboard and knob are locked out, except for the Local key which returns the SR844 to the Local state. In the Local Lockout state the entire front panel is locked out, including the Local key.</p> <p>The REMOTE indicator is on in the Remote and Local Lockout states.</p> <p>The Override Remote mode (below) must be set to Off in order for the front panel to be locked out. If Override Remote is On, then the front panel is active even in the Remote and Local Lockout states.</p> <p>The LOCL? query returns 1 or 2 for the Remote and Local Lockout states. The unit cannot return 0 (Local state) since receipt of the LOCL? query will put the unit into the Remote state.</p>
OVRM (?) {i}	<p>The OVRM command sets or queries the Override Remote mode. The parameter i selects Off (0) or On (1).</p> <p>The default mode is Override Remote On. In this mode the front panel is <i>always</i> active, regardless of the Remote or Local Lockout state. (The REMOTE indicator still indicates Remote or Local Lockout.)</p> <p>To lock-out the front panel, use the OVRM0 command. In the Remote state, only the Local key is active. Pressing the Local key will reactivate the front panel. If the unit is in Local Lockout, the entire front panel will be disabled (including the Local key). To reactivate the front panel, issue OVRM1 or LOCL0.</p>

Status Reporting Commands

The Status Registers are defined in the following section.

*CLS	The *CLS command clears all status registers. The status enable registers are <i>not</i> cleared.
*STB? [i]	The *STB? command queries the value of the Serial Poll Status register. The value is returned as a decimal number from 0 – 255. The *STB?i command queries the value (0 or 1) of bit i (0–7). Reading this register has no effect on its value. This command cannot be used to read status bit 1 (command execution in progress). Use serial poll to determine command execution status.
*SRE(?) [i,] {j}	The *SREj command sets the Serial Poll Enable register to the decimal value j (0–255). The *SREi, j command set bit i (0–7) to j (0 or 1). The *SRE? command queries the value (0–255) of the Serial Poll Enable register. The *SRE?i command queries the value (0 or 1) of bit i.
*ESR? [i]	The *ESR? command queries the value of the Standard Event Status register. The value is returned as a decimal number from 0 – 255. The *ESR?i command queries the value (0 or 1) of bit i (0–7). Reading the entire register will clear it, while reading bit i will only clear bit i.
*ESE(?) [i,] {j}	The *ESEj command sets the Standard Event Enable register to the decimal value j (0–255). The *ESEi, j command sets bit i (0–7) to j (0 or 1). The *ESE? command queries the value (0–255) of the Standard Event Enable register. The *ESE?i command queries the value (0 or 1) of bit i.
*PSC(?) {i}	The *PSC command sets the value of the Power-On Status Clear bit. If i=1 the power-on status clear bit is set and all status registers and enable registers are cleared on power-on. If i=0, the bit is cleared and the status enable registers maintain their values at power-off. This allows a service request to be generated at power-on.
ERRS? [i]	The ERRS? command queries the value of the Error Status register. The value is returned as a decimal number from 0 – 255. The ERRS?i command queries the value (0 or 1) of bit i (0–7). Reading the entire register will clear it, while reading bit i will only clear bit i.
ERRE(?) [i,] {j}	The ERREj command sets the Error Status Enable register to the decimal value j (0–255). The ERREi, j command sets bit i (0–7) to j (0 or 1). The ERRE? command queries the value (0–255) of the Error Status Enable register. The ERRE?i command queries the value (0 or 1) of bit i.
LIAS? [i]	The LIAS? command queries the value of the Lock-In (LIA) Status register. The value is returned as a decimal number (0 – 65535). The LIAS?i command queries the value (0 or 1) of bit i (0–15). Reading the entire register will clear it, while reading bit i will only clear bit i.
LIAE(?) [i,] {j}	The LIAEj command sets the Lock-In (LIA) Status Enable register to the decimal value j (0–65535). The LIAEi, j command sets bit i (0–15) to j (0 or 1). The LIAE? command queries the value (0–65535) of the LIA Status Enable register. The LIAE?i command queries the value (0 or 1) of bit i.

Status Register Definitions

The SR844 reports on its status by means of four status registers: the Serial Poll Status, the Standard Event Status, the LIA Status and the Error Status.

The status bits are set to 1 when an event has occurred or a state is present, as described in the tables below.

Serial Poll Status Register: *STB?, *SRE		
bit	name	set when
0	SCN	No data storage is in progress. Paused storage is still considered to be in progress.
1	IFC	No command execution is in progress (Interface Ready).
2	ERR	An enabled bit in the Error status register has been set.
3	LIA	An enabled bit in the LIA status register has been set.
4	MAV	The interface output buffer is not empty.
5	ESB	An enabled bit in the Standard Event status register has been set.
6	SRQ	A service request has occurred.
7	unused	

Standard Event Status Register: *ESR?, *ESE		
bit	name	set when
0	RXQ	Input queue overflows. This occurs when too many characters are received at once and causes the queues to be cleared.
1	—	unused
2	TXQ	Output queue overflows. This occurs when too many characters are waiting to be transmitted and causes the queues to be cleared.
3	—	unused
4	EXE	Command execution error occurs.
5	CMD	Illegal command is received.
6	URQ	Any key-press or knob rotation.
7	PON	Power-on.
Bits in this register remain set until cleared by reading them or by the *CLS command.		

LIA (Lock-In Amplifier) Status Register: LIAS?, LIAE		
bit	name	set when
0	ULK	A reference unlock is detected.
1	FRQ	The reference frequency is out of range.
2	—	unused
3	TRG	Data storage is triggered.
4	INP	The signal input overloads.
5	RSV	The IF amplifier overloads.
6	FLT	A time constant filter overloads.
7	CHG	Reference frequency changed by more than 1%.
8	CH1	Channel 1 display or output overloads.
9	CH2	Channel 2 display or output overloads.
10	OAX	Either Aux Input overloads.
11	UAX	Ratio input underflows.
12	—	unused
13	—	unused
14	—	unused
15	—	unused

Bits in this register remain set until cleared by reading them or by the *CLS command.

Error Status Register: ERRS?, ERRE		
bit	name	set when
0	—	unused
1	BAK	Battery backup has failed.
2	RAM	The RAM memory test failed.
3	FPG	FPGA test failed.
4	ROM	The ROM memory test failed.
5	GPB	GPIB Fast Data Transfer mode is aborted.
6	DSP	The DSP test failed.
7	MTH	An internal math error occurred.

Bits in this register remain set until cleared by reading them or by the *CLS command.

Using Serial Poll

Except for SRQ, a bit in the Serial Poll Status register is *not* cleared by serial polling. When reading the status using a serial poll, the SRQ bit signals that the SR844 is requesting service. The SRQ bit will be set (1) the first time the SR844 is polled following a service request. The serial poll automatically clears the service request. Subsequent polls will return SRQ cleared (0) until another service request occurs. Polling the status byte and reading it with *STB? can return different values for SRQ. When polled, SRQ indicates a service request has occurred. When read with *STB?, SRQ indicates that an enabled Serial Poll Status bit is set.

Using *STB?

A bit in the Serial Poll Status register is *not* cleared by reading the register using *STB?. The bit stays set as long as the status condition exists. This is true even for SRQ. SRQ will be set whenever the same bit in the Serial Poll Status register and Serial Poll Enable register is set. This is independent of whether a serial poll has occurred to clear the service request.

Using Status Enable Registers

The ERR, LIA and ESB bits are set whenever any bit in both their respective *status* register and *enable* register is set. Use the *ESE, ERRE and LIAE commands to set status enable register bits. This allows status bits in the Error, LIA and Standard Event Status registers to set bits in the Serial Poll register where they can be serial polled or cause a service request.

The ERR, LIA and ESB bits are not cleared until ALL enabled status bits in the Error, LIA and Standard Event *status* registers are cleared. The status registers can be cleared by reading them, or by using the *CLS command.

Service Requests (SRQ)

A GPIB Service Request (SRQ) will be generated whenever an enabled bit in the Serial Poll Status register becomes set. Use *SRE to enable bits in the Serial Poll Status by setting the corresponding bits in the Serial Poll Enable register. A service request is only generated when an enabled Serial Poll Status bit becomes set (changes from 0 to 1). An enabled status bit which becomes set and remains set will generate a *single* SRQ. If another service request from the same status bit is desired, the requesting status bit must first be cleared. In the case of ERR, LIA and ESB bits, this means clearing the enabled bits in the ERR, LIA and ESB status registers (by reading them). Multiple enabled bits in these status registers will generate a single SRQ. Another SRQ (from ERR, LIA or ESB) can only be generated after clearing the ERR, LIA or ESB bits in the Serial Poll Status register. To clear these bits, *all* enabled bits in the ERR, LIA or ESB status bytes must be cleared.

The host computer should respond to the SRQ by performing a serial poll to each device to determine which is requesting service (as indicated by SRQ set). Bit 6 (SRQ) will be reset by the serial poll.

For example, to generate a request when a RSV overload occurs, bit 5 in the LIA Status Enable register needs to be set (LIAE32 or LIAE5, 1 command) and bit 3 in the Serial Poll Enable register must be set (*SRE8) command. When a reserve overload occurs, bit 5 in the LIA Status is set. Since bit 5 in the LIA Status Enable register is also set, bit 3 (LIA) in the Serial Poll Status also gets set. Since bit 3 in the Serial Poll Enable register is also set, an SRQ is generated. Bit 6 (SRQ) in the Serial Poll Status is set. Further RSV overloads will not generate another SRQ until the RSV overload status bit is cleared. The RSV status bit is cleared by reading the LIA Status register (LIAS? query). Presumably the host is alerted to the overload via the SRQ, performs a serial poll to clear the SRQ, does something to try to remedy the situation (change gain, experimental parameters, etc.) and then clears the RSV status bit by reading the LIA Status register. A subsequent RSV overload will then generate another SRQ.

Example Program

Using Microsoft C with the GPIB interface

To successfully interface the SR844 to a PC via the GPIB interface, the instrument, interface card and interface drivers must all be configured properly. To configure the SR844, the GPIB address must be set with the **Setup** key. The default address is 8; use this address unless a conflict occurs with other instruments in your system. The SR844 will be set to GPIB address 8 whenever a reset is performed (power on with the **Setup** key down).



Make sure that you follow all of the instructions for installing the GPIB card. The GPIB card cannot be simply unpacked and put into your computer. To configure the card, you may need to set jumpers and switches on the card to set the I/O address and interrupt levels. Refer to your manual for more information.

Capital Equipment Corp. CEC488 GPIB Card

The CEC488 card contains its low level drivers in ROM. The card address needs to be set so as not to conflict with other devices in your computer. The software interface uses a header file and a link library. There is no initialization required for the drivers.

Use the TEST488 program to test the card installation. Use TRTEST to communicate directly from the keyboard with the SR844. If TRTEST doesn't work, then your programs will not run.

The example is written using the CEC library routines.

National Instruments GPIB Card

You must run the program "IBCONF" to configure the resident GPIB driver for your GPIB card. Please refer to the National Instruments manual for more information. For example, the following options should be set with IBCONF:

Device Name:	SR844
Device Address:	8
EOS Character:	0Ah (linefeed)
Terminate Read on EOS:	Yes

Once all the hardware and GPIB drivers are configured, use "IBIC". Use "IBWRT" and "IBRD" to send to and receive from the SR844. If you cannot talk to the SR844 via "IBIC", then your programs will not run.

To modify the example to use a National Instruments card, modify the routines where indicated.

Other GPIB cards

You need to setup and configure your card according to your manual. The example program points out the routines which are interface dependent. Your card should have functions equivalent to those used in the example.

```

// *****
// Example program using Microsoft C v7.0 and
// the Capital Equipment Corp CEC488 interface card.
// To use another interface card, modify the GPIB subroutines
// where indicated.

// The SR844 is assumed to be at address 8 (default).

// Link this object file with ieee488.lib provided by CEC
// (or the library for your GPIB card).

// *****
// Connect the REF OUT to the SIGNAL IN
// *****

#include <stdio.h>
#include <stdlib.h>
#include <string.h>
#include <conio.h>
#include <math.h>
#include <ieee-c.h>           // This is the CEC header file
                             // Use the .h file for your interface card.
                             // send(), enter(), transmit(), rarray(), tarray(),
                             // spoll(), initialize(), settimetype() are routines
                             // defined in ieee-c.h.

// *****
#define      sr844 8          // address of SR844

int          status, length; // CEC routines use these
char         recv[80];       // global GPIB receive string
char         cmd[80];        // global GPIB command string

int          FastBuf[1600];  // Fast Transfer Mode buffer (2 ints per point, X&Y)
int          rLiaBuf[1600];  // LIA float buffer (ch1) (2 ints per point)
int          pLiaBuf[1600];  // LIA float buffer (ch2) (2 ints per point)
float        rfBuf[800];     // IEEE binary buffer (ch1) (1 float per point)
float        pfBuf[800];     // IEEE binary buffer (ch2) (1 float per point)
char         rAscBuf[10][20]; // ASCII string buffer (ch1)
char         pAscBuf[10][20]; // ASCII string buffer (ch2)

double fscale[15] = {1.0E-7, 3.0E-7, 1.0E-6, 3.0E-6, 1.0E-5, 3.0E-5, 1.0E-4, 3.0E-4,
                    1.0E-3, 3.0E-3, 1.0E-2, 3.0E-2, 1.0E-1, 3.0E-1, 1.0};
int          sens;          // array of full scale sensitivities in Volts
                             // sensitivity number [0-14]

// *****
// Subroutines at the end of this listing
// *****
// GPIB interface subroutines
// You may need to modify these for your interface card!

void TxGpib (int, char *);  // transmit string to device
void GetGpib (int);         // receive string from device
void TxSr844 (char *);     // transmit string to SR844, wait for IFC
void GetSr844 (char *);    // transmit query string to SR844 (wait for IFC),
                             // and get receive string
void WaitIFC (void);       // wait for IFC status in SR844 (command complete)

// *****

void GetSpace (void);      // pause and wait for space bar
double xLIA (int,int);    // translate LIA float data to real values
double xBin (int,int);    // translate IEEE binary data

```

4-36 Example Program

```
void main (void) {
    // *****
    // You can see the commands received by the SR844 using the [Setup] key
    // to show the receive queue on the displays. The hex values of the received
    // characters will be shown.
    // *****

    int nPts,nCount,i,j,test;
    double xval, yval, rval, pval;
    double chlval, ch2val;

    printf ("\nSR844 Example Program\n");

    // ***** Initialize your GPIB card here *****
    initialize (21,0);

    // ***** Set the SR844 output interface to GPIB! *****
    TxSr844 ("*CLS"); // Clear all status registers.
    TxSr844 ("OUTX1"); // Direct SR844 responses to GPIB interface.

    // ***** Set the Standard Event Enable register to catch EXE and CMD
    // Command errors will set the ESB bit in the Serial Poll Status
    TxSr844 ("*ESE48"); // set bits 4 and 5

    // ***** Check communication by querying the SR844 IDN string
    GetSr844 ("*IDN?");
    printf ("[GPIB IDN] = %s\n", recv);

    printf ("Reset SR844...");
    TxSr844 ("*RST"); // Reset the SR844 to the default state.
    printf ("done\n"); // Communication parameters are unchanged.

    TxSr844("REST"); // Reset data buffers.
    TxSr844("SRAT10; SEND0"); // Set sample rate (64 Hz), stop at end.
    TxSr844("DDEF1,0; DDEF2,0"); // Buffers store CH1 (X) and CH2 (Y) displays

    printf ("Initialization done ... Change settings here if desired.");
    GetSpace (); // Pause to change setup.

    // *****
    // ***** Read outputs normally *****

    // Read values sequentially. If the outputs are changing rapidly, the values
    // of X,Y,R and phase may not agree.
    // OUTP does not include the output expand.
    GetSr844 ("OUTP?1"); xval = atof(recv); // read X
    GetSr844 ("OUTP?2"); yval = atof(recv); // read Y
    GetSr844 ("OUTP?3"); rval = atof(recv); // read R
    GetSr844 ("OUTP?5"); pval = atof(recv); // read phase

    printf ("OUTP? :\n");
    printf (" X Y R Phase \n");
    printf (" %14.6E %14.6E %14.6E %14.6E\n", xval, yval, rval, pval);

    // *****
    // Read display values (including expands). These values are read sequentially.
    GetSr844 ("OUTR?1"); chlval = atof(recv); // read CH1 display (with expand)
    GetSr844 ("OUTR?2"); ch2val = atof(recv); // read CH2 display (with expand)

    printf ("OUTR? :\n");
    printf (" CH1 CH2 \n");
    printf (" %14.6E %14.6E\n", chlval, ch2val);

    // *****
    // Read X,Y,R,phase simultaneously. These values agree much better for rapidly
    // changing outputs.
    GetSr844 ("SNAP?1,2,3,5"); // Read X,Y,R,phase at same time.
    // Result is a string with 4 values separated
    // by commas.
    sscanf (recv,"%lf,%lf,%lf,%lf",&xval,&yval,&rval,&pval);

    printf ("SNAP? :\n");
}
```

```

printf ("      X              Y              R              Phase \n");
printf ("      %14.6E      %14.6E      %14.6E      %14.6E\n", xval, yval, rval, pval);

GetSpace ();

// *****
// ***** Fast Data Transfer mode test *****

printf("FastAcqData"); // Acquire and transfer data simultaneously

settimeout (11000); // Turn off timeout for SR844 or set the timeout longer
// than the total acquisition time. The timeout measures
// the time to complete a transfer,
// not the time since the most recent byte is received.

TxSr844("FAST1; STRD"); // Turn FAST mode data transfer ON,
// then start scan using the STRD start acquisition
// after 0.5s.
// The STRD command MUST be used if the data transfer
// is to be started by this program! Do NOT use STRT!

// Take data for 10 seconds and then stop.
// 10 seconds of data at 64 Hz sample rate has
// 640 points.
// Each point consists of X(2 bytes) and Y(2 bytes)
// for a total of 4*(64*10) bytes.

transmit ("MLA TALK 8", &status); // make sr844 the talker right away

j=0; // total bytes received
for (i=0; i<10; i++) { // get 64 points (256 bytes) 10 times
    rarray ((char *)(FastBuf+128*i), 64*4, &nCount, &status);
    // rarray receives bytes from the interface and puts them into the
    // FastBuf[] array. Each transfer moves 64 points (64*4 bytes).
    // The actual number of bytes transferred is in nCount.

    printf ("."); j+=nCount;
    // update progress to screen, increment total byte count
}
// Depending upon the system, you may need to transfer all
// of the desired points at once
// to avoid missing data between transfers.
// Fast mode will abort if the SR844 finds the host not ready to receive data.

TxSr844("PAUS; FAST0"); // Pause the data storage, turn off FAST mode
settimeout (5000); // Set timeout shorter again

nPts = j/4; // Number of points (bytes/4) received
printf("%d bytes.(%d pts).", j, nPts);
if (j==2560) printf ("OK"); else printf ("NOT OK"); // 2560 = 4*(64*10) bytes

// ***** Print first 10 points received *****
GetSr844 ("SENS?"); sens=atoi(recv); // Get sensitivity setting
printf (".fs=%8.1EV\n", fscale[sens]);

printf (" n      X              Y              R              Phase \n");
for (i=0; i<10; i++) {
    printf ("%3d      %14.6E      %14.6E      %14.6E      %14.6E\n", i, xBin(3,i),
        xBin(4,i), xBin(1,i), xBin(2,i));
    // xBin converts the received integer X and Y data
    // into real X, Y, R, phase based upon the sensitivity
}

GetSpace (); // pause

```

4-38 Example Program

```
// ***** Acquire data, then transfer data *****
// ***** Acquire data, then transfer data *****

printf("AcquireData.");
test = 0; // Keep track of errors in variable test

TxSr844 ("REST"); // Reset buffers
TxSr844 ("STRT"); // Start data storage

j = 0;
do {
    GetSr844 ("SPTS?");
    i = atoi(recv); // Read how many points taken so far?
    if (i/64 > j) {printf ("."); j++;} // Show progress every 64 points
}
while (i<640); // Until 640 points taken (10 seconds)

TxSr844 ("PAUS"); // Pause acquisition

GetSr844("SPTS?"); // How many points in buffer?
nPts = atoi(recv);
printf ("SPTS=%d.",nPts);

// ***** Read all points in IEEE float format *****
printf("IEEE.");

sprintf(cmd,"TRCB?1,0,%d",nPts); // (CH1, start at bin 0, all points)
TxGpib (sr844,cmd); // Send cmd and don't wait for IFC ready!
transmit ("MLA TALK 8", &status); // Make sr844 the talker
rarray ((char *)rfBuf, nPts*4, &nCount, &status);
// Read directly into a FLOAT array rfBuf, 4 bytes per point

if ( nCount != nPts*4 ) {
    printf ("\nERROR: expected %d bytes, received %d bytes",nPts*4,nCount);
    test=1; GetSpace ();
}
else printf ("1.",nCount); // CH1 ok

sprintf(cmd,"TRCB?2,0,%d",nPts); // (CH2, start at bin 0, all points)
TxGpib (sr844,cmd); // Send cmd and don't wait for IFC ready!
transmit ("MLA TALK 8", &status); // Make sr844 the talker
rarray ((char *)pfBuf, nPts*4, &nCount, &status);
// Read directly into a FLOAT array pfBuf, 4 bytes per point

if ( nCount != nPts*4 ) {
    printf ("\nERROR: expected %d bytes, received %d bytes",nPts*4,nCount);
    test=1; GetSpace ();
}
else printf ("2.",nCount); // CH2 ok

// ***** Read all points in LIA float format *****
printf("LiaFlt.");

sprintf(cmd,"TRCL?1,0,%d",nPts); // (CH1, starting with bin 0, all points)
TxGpib (sr844,cmd); // Send cmd and don't wait for IFC ready!
transmit ("MLA TALK 8", &status); // Make sr844 the talker
rarray ((char *)rLiaBuf, nPts*4, &nCount, &status);
// Read into int array rLiaBuf, 2 ints or 4 bytes per point

if ( nCount != nPts*4 ) {
    printf ("\nERROR: expected %d bytes, received %d bytes",nPts*4,nCount);
    test=1; GetSpace ();
}
else printf ("1.",nCount); // CH1 ok

sprintf(cmd,"TRCL?2,0,%d",nPts); // (CH2, starting with bin 0, all points)
TxGpib (sr844,cmd); // Send cmd and don't wait for IFC ready!
transmit ("MLA TALK 8", &status); // Make sr844 the talker
rarray ((char *)pLiaBuf, nPts*4, &nCount, &status);
// Read into int array pLiaBuf, 2 ints or 4 bytes per point

if ( nCount != nPts*4 ) {
    printf ("\nERROR: expected %d bytes, received %d bytes",nPts*4,nCount);
```

```

        test=1; GetSpace ();
    }
    else printf ("2.",nCount);          // CH2 ok

    if (test==0) printf ("OK");        // All transfers finished ok

    // ***** Read first 10 points in ASCII *****
    printf(".ASCII.", nPts);

    for (i=0; i<10; i++) {
        sprintf (cmd, "TRCA?1,%d,1", i); // (CH1, starting with bin i, 1 point)
        GetSr844 (cmd);                  // Get string from SR844
        strcpy (rAscBuf[i], recv);       // Copy to string array rAscBuf

        sprintf (cmd, "TRCA?2,%d,1", i); // (CH2, starting with bin i, 1 point)
        GetSr844 (cmd);                  // Get string from SR844
        strcpy (pAscBuf[i], recv);       // Copy to string array rAscBuf
    }
    printf ("\n");

    // ***** Print first 10 points *****
    // for Ch1
    printf ("CH1:  n      ASCII              IEEE              LIA\n");
    for (i=0; i<10; i++ ) {
        printf ("      %3d  %14s  %14.6E  %14.6E\n", i, rAscBuf[i], rfBuf[i],
                xLIA(1,i) );
        // xLIA translates LIA float format into IEEE floating point.
        // Data in rfBuf is already IEEE floats.
    }

    // for Ch2
    printf ("CH2:  n      ASCII              IEEE              LIA\n");
    for (i=0; i<10; i++ ) {
        printf ("      %3d  %14s  %14.6E  %14.6E\n", i, pAscBuf[i], pfBuf[i],
                xLIA(2,i) );
    }

    GetSpace ();                        // pause

    TxSr844 ("REST"); // Reset scan, clear buffers
}

// *****
// Subroutines
// *****
void TxGpib (int address, char *command) {
    // Routine to transmit the string command to a GPIB address.
    // Modify this routine for your GPIB interface.

    send (address, command, &status); // send() is the CEC routine to send
                                        // a string to and address.
                                        // Sets status=0 if result is ok.

    if (status != 0) {
        // Handle transmit errors here
        printf ("\nCommand = %s\n", command);
        printf ("Error at device %d : status = %d\n", address, status);
        GetSpace ();
    }
}
}

```

4-40 Example Program

```
// *****
void GetGpib (int address) {
    // Routine to get an answer from a GPIB address.
    // Modify this routine for your GPIB interface.

    char temp[80];

    enter (temp,80,&length,address,&status);
        // enter() is the CEC routine to enter
        // a string from an address.
        // Sets status=0 if result is ok.
        // 80 is maximum string length.
        // Actual received length is stored in &length.

    if (status != 0) {
        // Handle receive errors here
        printf ("\nError at device %d : status = %d\n", address, status);
        GetSpace ();
    }

    strcpy (recv, temp); // Set global receive string
}
// *****
void WaitIFC (void) {
    // Serial poll the SR844 until IFC (bit 1) is set (command done).
    // Modify for your GPIB interface.
    char stb;

    do {spoll (sr844,&stb,&status);} while (!(stb&2));
        // spoll() is the CEC serial poll routine.
        // The value of the Serial Poll register is
        // stored in stb.
        // Test bit 1 (IFC) until set.

    if (stb&32) {
        // If ESB bit set (bit 5 in Serial Poll)
        // there must be a command error in the Standard Event Status!
        // Handle command errors here.
        TxGpib (sr844, "*ESR?"); // Clear the Standard Event Status
        GetGpib (sr844); // by reading it.

        printf ("\nEXE error\n");
        GetSpace ();
    }
}
// *****
void TxSr844 (char *command) {
    // Send command to the SR844 and wait until command executes
    // (IFC set in the Serial Poll register).

    TxGpib (sr844, command); // Send command to SR844 address
    WaitIFC (); // Wait until IFC set again, ok to continue
}
// *****
void GetSr844 (char *getcmd) {
    // Query the SR844 for a response.
    // getcmd is the query command string.

    TxSr844 (getcmd); // Send query command, wait for command to execute.
    GetGpib (sr844); // Get response into global receive string (recv).
}
}
```

```

// *****
void GetSpace (void) {
    // Wait for space bar pressed.

    char ch;

    while ( kbhit() ) getch();// Clear keyboard buffer.
    printf ("\n<Space> to continue, <Q> to quit >");
    do {
        ch = (char) getch();
        if ( (ch=='q')||(ch=='Q') ) exit(0);    // exit
    }
    while (ch != ' ');        // Until space bar
    printf ("\n");
}
// *****
double xBin (int quant, int index)
{
    // Returns double result from FAST mode array (integer X and Y data).
    // See FAST command description for more details.
    // quant selects X, Y, R or Phase to be returned

    double x,y;

    x = (double)FastBuf[2*index]/29788.0;    // 29788 is full scale
    y = (double)FastBuf[2*index+1]/29788.0;

    x = x * fscale[sens];    // CONVERT to voltage
    y = y * fscale[sens];    // by multiplying by full scale input voltage.

    switch (quant) {
        case 1: return (sqrt(x*x + y*y));    // Compute R from X and Y
        case 2: return (atan2(y,x) * 57.2958); // Compute theta from X and Y
        case 3: return (x);
        case 4: return (y);
        default: return (0.0);
    }
}
// *****
double xLIA (int chan, int index)
{
    // Returns double result from LIA float arrays.
    // See TRCL command description for more details.

    int mant,exp;
    double val;

    if ( chan==1 ) {
        // channel 1
        mant = rLiaBuf[2*index];    // First comes the mantissa (16 bits)
        exp = rLiaBuf[2*index+1] - 124; // Then the binary exponent (16 bits)
        // offset by 124
        val = (double) mant * pow(2.0,(double) exp);
    }

    if ( chan==2 ) {
        // channel 2
        mant = pLiaBuf[2*index];    // First comes the mantissa (16 bits)
        exp = pLiaBuf[2*index+1] - 124; // Then the binary exponent (16 bits)
        // offset by 124
        val = (double) mant * pow(2.0,(double) exp);
    }

    return (val);
}
// *****

```

Chapter 5

Performance Tests

In This Chapter

Getting Ready	5-3
Introduction	5-3
Serial Number	5-3
Firmware Revision	5-3
Preset	5-3
Warm-Up	5-3
Test Record	5-3
Necessary Equipment	5-3
Front Panel Display Test	5-4
Keypad Test	5-4
If A Test Fails	5-4
1. Self Tests	5-5
2. Amplitude Response	5-7
3. Phase Response	5-9
4. Frequency Accuracy	5-11
5. Ref Out Amplitude	5-13
6. DC Outputs and Inputs	5-15
7. Input Noise	5-17
SR844 Performance Test Record	5-19

Getting Ready

Introduction

The performance tests described in this section are designed to verify with a high degree of confidence that the unit is performing correctly.

Serial Number

If you need to contact Stanford Research Systems, please have the serial number of your unit available. The 5-digit serial number is printed on a label affixed to the rear panel. The serial number is also displayed on the CH1 and CH2 displays when the unit is powered on.

Firmware Revision

The firmware revision code is shown on the Reference display when the unit is powered on.

Preset

Throughout this chapter it will be necessary to preset the lock-in to a known state, the factory preset state. To do this, press **Shift** then **Recall**.

Warm-Up

The lock-in should be turned on and allowed to warm up for at least an hour before any tests are performed. The self-test does not require any warm-up period.

Test Record

Make a copy of the SR844 Performance Test Record at the end of this chapter. Fill in the results of the tests on this record. This record will allow you to determine whether the tests pass or fail, and also to preserve a record of the tests.

Necessary Equipment

The following equipment is necessary to complete the performance tests. The suggested equipment or its equivalent be used.

RF Synthesizer

Frequency Range	10 kHz to 200 MHz
Frequency Accuracy	better than 5 ppm
Amplitude Accuracy	1.0 dB
Amplitude	capable of at least +10 dBm output
Recommended	Marconi 2023

Power Splitter

Mini-Circuits ZFRSC-2050 or equivalent

Feed-Through Attenuators

Mini-Circuits CAT-3 or equivalent

Mini-Circuits CAT-20 or equivalent

DC Voltmeter

Range	20V, 4 1/2 digits
Accuracy	0.005%
Recommended	Fluke 8840A

Terminations

50 Ω

BNC Cables

Various lengths

Front Panel Display Test

To test the front panel displays press **Local** and **Setup** keys together. Some of the front panel LED's will turn on. Press **+90°** to increase the number of illuminated LED's and **Phase** to decrease the number. Use the knob to move the selected LED's across the panel. Make sure that every LED can be turned on. Press any key other than **+90°**, **Phase** or **Zero** to exit this test mode. Note that the instrument is still operational; only the display is in test mode.

Keypad Test

To test the keypad, press the **Ref Z-In+Source** keys together. The CH1 and CH2 displays will read *Pad Code*, and a number of LED indicators will be turned on. The LED's indicate which keys have not yet been pressed. Press all of the keys on the front panel, one at a time. As each key is pressed, the key code is displayed on the Reference display, and the LED nearest that key turns off. When all of the keys have been pressed, the display will return to normal. To return to normal operation without pressing all the keys, simply turn the knob.

If A Test Fails

If a test fails, you should check the settings and connections of any external equipment and, if possible, verify its operation using a DVM, scope, or other test equipment. After checking the setup, repeat the test from the beginning to make sure that the test was performed correctly.

If the test continues to fail, contact Stanford Research Systems for instructions. Make sure you have the unit's serial number and firmware revision code in hand. Have the test record with you also.

1. Self Tests

The self-tests check the lock-in hardware. These are functional tests and do not relate to the specifications. These tests should be checked before any of the performance tests.

Setup

No external setup is required for this test.

Procedure

- 1) Turn the SR844 power switch off. Then turn the unit on while holding down the Setup key. Check the results of the DATA, BATT, PROG and DSP tests.

DATA Performs a read/write test to the processor RAM.

BATT The nonvolatile backup memory is tested. Instrument settings are stored in nonvolatile memory and are retained when the power is turned off.

PROG Checks the processor ROM.

DSP Checks the digital signal processor (DSP).

The results are displayed on the Reference display (*PASS* or *FAIL*).

- 2) This completes the functional hardware tests. Enter the results of this test in the test record at the end of this chapter.

2. Amplitude Response

This test measures the amplitude response vs. frequency. Due to the high frequencies involved, a test of this type is difficult to perform without specialized (and expensive) test equipment along with complex test procedures beyond the scope of this manual. Instead, this test is designed to use a simpler procedure which, if passed, verifies the functionality of the SR844. If the unit passes this test, then it is very probable that the unit meets its stated accuracy. This test is *not* intended to *verify* the accuracy of the SR844.

Setup

We will use the RF synthesizer (Marconi 2023 or equivalent) to provide both the external reference signal and the input signal. Use an RF 2-way power splitter (Mini-Circuits ZFRSC-2050 or equivalent) to split the synthesizer output into 2 signals. Connect identical cables to the splitter outputs. Connect the 2 splitter outputs as follows:

- One to REF IN through a feed-through 3 dB attenuator (Mini-Circuits CAT-3 or equivalent).
- One to SIGNAL IN through a feed-through 3 dB attenuator (Mini-Circuits CAT-3 or equivalent). We will need 2 feed-through 20 dB attenuators (Mini-Circuits CAT-20 or equivalent) for portions of this test.

Set the RF synthesizer to:

Frequency: 100.0 kHz
Amplitude: +9.0 dBm
Modulation: OFF

The synthesizer output +9.0 dBm, the splitter (-6 dB) and the feed-through 3 dB attenuators provide each input with 0 dBm signals. This is the nominal signal level for the REF IN and a good reference level for the SIGNAL IN as well.

The synthesizer output amplitude accuracy is ± 0.8 dB. The attenuators and splitters have a typical accuracy of about ± 0.5 dB. Depending upon the number of attenuators used in the signal path, the total error in the signal input is between ± 1.8 dB and ± 2.8 dB. Coupled with the SR844 accuracy, the worst case error in the reading may be as large as ± 2.3 and ± 3.8 dB (0.25 dB less below 50 MHz). This is typical of RF measurements. Your measurements will typically be quite a bit more accurate.

Procedure

- 1) Press Shift then Recall to restore the factory preset instrument settings.
- 2) Press the keys in the following sequence:

Source

Switch to **EXTERNAL** Reference mode.

CH1 Display twice

Set the CH1 display to **R[dBm]**.

5-8 Performance Tests

Wide Reserve Down

Select **LOW NOISE** Wide Reserve.

Close Resrv once

Select **LOW NOISE** Close Reserve.

Sensitivity Down once

Select **300 mV** sensitivity.

- 3) Amplitude response is checked at various frequencies. For each frequency in the table below, perform steps 3.1 through 3.2.

Test Frequencies
100 kHz
300 kHz
1 MHz
3 MHz
10 MHz
30 MHz
100 MHz
200 MHz

- 3.1) Set the RF synthesizer to the frequency in the table.
- 3.2) Wait for the SR844 **UNLOCK** indicator to turn off.
- 3.3) Wait for the CH1 reading to stabilize. Record the CH1 reading (dBm).
- 4) Add one 20 dB attenuator at the SIGNAL IN. The total attenuation at the SIGNAL IN is now -23 dB. Press the following key sequence:

Sensitivity Down twice

Select **30 mV** sensitivity.

- 5) Repeat step 3 at this sensitivity.
- 6) Add another 20 dB attenuator at the SIGNAL IN. The total attenuation at the SIGNAL IN is now -43 dB. Press the following key sequence:

Sensitivity Down twice

Select **3 mV** sensitivity.

- 7) Repeat step 3 at this sensitivity.
- 8) This completes the amplitude response test. Enter the results of this test into the test record at the end of this chapter.

3. Phase Response

This test measures the phase response vs. frequency. Due to the high frequencies involved, a test of this type is difficult to perform without specialized (and expensive) test equipment along with complex test procedures beyond the scope of this manual. Instead, this test is designed to use a simpler procedure which, if passed, verifies the functionality of the SR844. If the unit passes this test, then it is very probable that the unit meets its stated accuracy. This test is *not* intended to *verify* the accuracy of the SR844.

Setup

We will use the RF synthesizer (Marconi 2023 or equivalent) to provide both the external reference signal and the input signal. Use an RF 2-way power splitter (Mini-Circuits ZFRSC-2050 or equivalent) to split the synthesizer output into 2 signals. Connect *identical* short cables to the splitter outputs. Connect the 2 splitter outputs as follows:

- One to REF IN through a feed-through 3 dB attenuator (Mini-Circuits CAT-3 or equivalent).
- One to SIGNAL IN through a feed-through 3 dB attenuator (Mini-Circuits CAT-3 or equivalent).

Set the RF synthesizer to:

Frequency: 100.0 kHz
Amplitude: +9.0 dBm
Modulation: OFF

The synthesizer output +9.0 dBm, the splitter (-6 dB) and the feed-through 3 dB attenuators provide each input with 0 dBm signals. This is the nominal signal level for the REF IN and a good reference level for the SIGNAL IN as well.

At high frequencies the difference in path length between the two signals contributes large amounts of phase shift. For example, even 1" of difference between the signal path and the external reference path contributes 6° of phase shift. In addition, the phase imbalance of the splitter may be as high as 3°. Take care to make the two signal paths as identical as possible. The results of this test are almost entirely determined by the experimental setup. You should be able to achieve 10° phase matching without difficulty. If you are unable to achieve this level of matching, try a different setup using different components and cables.

Procedure

- 1) Press Shift then Recall to restore the factory preset instrument settings.
- 2) Press the keys in the following sequence:

Source

Switch to **EXTERNAL** Reference mode.

CH1 Display once

Set the CH1 display to **R[V]**.

5-10 Performance Tests

CH2 Display once
Set the CH2 display to θ (degrees).

Sensitivity Down once
Select **300 mV** sensitivity.

- 3) Phase response is checked at various frequencies. For each frequency in the table below, perform steps 3.1 through 3.2.

Test Frequencies
100 kHz
300 kHz
1 MHz
3 MHz
10 MHz
30 MHz
100 MHz

- 3.1) Set the RF synthesizer to the frequency in the table.
- 3.2) Wait for the SR844 **UNLOCK** indicator to turn off.
- 3.3) Wait for the CH2 reading to stabilize. Record the CH2 reading (degrees).
- 4) This completes the phase response test. Enter the results of this test into the test record at the end of this chapter.

4. Frequency Accuracy

This test measures the frequency accuracy of the SR844. This tests the accuracy of the frequency counter inside the unit. The counter is used only in External Reference mode.

Setup

We will use the RF synthesizer (Marconi 2023 or equivalent) to provide the external reference signal. Connect the synthesizer output to REF IN.

Set the RF synthesizer to:

Frequency: 1.9993 MHz
Amplitude: 0.0 dBm
Modulation: OFF

Procedure

- 1) Press Shift then Recall to restore the factory preset instrument settings.
- 2) Press the keys in the following sequence:

Source

Switch to **EXTERNAL** Reference mode.

Shift then Freq (Precise Freq)

Display the Precise Frequency on the CH2 and Reference displays.

- 3) For each frequency in the table below, repeat steps 3.1 through 3.3.

Test Frequencies
1.9993 MHz
1.9997 MHz

- 3.1) Set the RF synthesizer to the frequency in the table.
 - 3.2) Wait a few until the SR844 **UNLOCK** indicator is off.
 - 3.3) Record the frequency reading shown on the CH1 and Reference displays. The most significant 3 digits are on the CH1 display. The least significant 3 digits are on the Reference display. There are a total of 6 digits in the frequency reading.
- 4) This completes the Frequency Accuracy test. Enter the results of this test in the test record at the end of this chapter.

5. Ref Out Amplitude

This test measures the amplitude and frequency response of the front panel REF OUT signal.

Setup

We will use the SR844 to measure the REF OUT signal amplitude. Connect the REF OUT to the SIGNAL IN with a cable. The REF OUT signal is nominally a square wave with amplitude 1.0 V_{pp} into 50 Ω. At high frequencies, the waveform becomes more sinusoidal leading to a change in the amplitude of the fundamental (as measured by the SR844) at higher frequencies.

Procedure

- 1) Press **Shift** then **Recall** to restore the factory preset instrument settings.
- 2) Press the keys in the following sequence:

CH1 Display twice
Set the CH1 display to **R[dBm]**.

- 3) REF OUT amplitude is checked at various frequencies. For each frequency in the table below, perform steps 3.1 through 3.2.

Test Frequencies
100 kHz
300 kHz
1 MHz
3 MHz
10 MHz
30 MHz
100 MHz
200 MHz

- 3.1) Use the knob to set the reference frequency (Reference display) to the value in the table.
- 3.2) Wait for the SR844 **UNLOCK** indicator to turn off.
- 3.3) Wait for the CH1 reading to stabilize. Record the CH1 reading (dBm).
- 4) This completes the Ref Out Amplitude test. Enter the results of this test in the test record at the end of this chapter.

6. DC Outputs and Inputs

This test measures the DC accuracy of the DC outputs and inputs of the SR844.

Setup

We will use the digital voltmeter (DVM) to measure the DC outputs of the lock-in. Then we will use one of the outputs to generate a voltage to measure on the DC inputs.

Connect a 50 Ω termination to the SIGNAL IN.

Procedure

- 1) Press **Shift** then **Recall** to restore the factory preset instrument settings.
- 2) For the CH1 and CH2 outputs, repeat steps 2.1 through 2.4:
 - 2.1) Connect the CH1 (or CH2) output to the DVM. Set the DVM to the 20 Vdc range.
 - 2.2) Press CH1 (or CH2) **Offset On/Off** to turn **XYOffs** on.
 - 2.3) Press CH1 (or CH2) **Offset Modify** to see the offset in the Reference display.
 - 2.4) For each of the offsets in the table below, repeat steps 2.4.1 and 2.4.2:

Offset [%]
-100.00
-50.00
0.00
50.00
100.00

- 2.4.1) Use the knob to set the offset to the value in the table.
- 2.4.2) Record the DVM reading.
- 3) For the AUX OUT 1 and AUX OUT 2 outputs, repeat steps 3.1 through 3.3:
 - 3.1) Connect AUX OUT 1 (or AUX OUT 2) to the DVM. Set the DVM to the 20 Vdc range.
 - 3.2) Press **AuxOut** once or twice until the **AxOut1** (or **AxOut2**) setting shows on the Reference display.
 - 3.3) For each of the output voltages in the table below, repeat steps 3.3.1 and 3.3.2:

Output Voltage [V]
-10.00
-5.00
0.00
5.00
10.00

- 3.3.1) Use the knob to adjust the Aux Output level (Reference display) to the value from the table.
- 3.3.2) Record the DVM reading.
- 4) Press **AuxOut** once or twice to show **AxOut1** on the Reference display.
- 5) For AUX IN 1 and AUX IN 2 repeat steps 5.1 through 5.3:
 - 5.1) Connect AUX OUT 1 to AUX IN 1 (or AUX IN 2).
 - 5.2) Press CH1 (or CH2) Display until the display shows **AUX IN 1** (or **AUX IN 2**).
 - 5.3) For the same table of voltages as in 3.3 above repeat steps 5.3.1 and 5.3.2:
 - 5.3.1) Use the knob to adjust AUX OUT 1 (Reference display) to the voltage in the above table.
 - 5.3.2) Record the value of AUX IN 1 (or AUX IN 2) from the CH1 (or CH2) display.
- 6) This completes the DC outputs and inputs test. Enter the results of this test in the test record at the end of the Chapter.

7. Input Noise

This test measures the SR844 input noise.

Setup

Connect a 50 Ω termination to the signal input.

Procedure

- 1) Press Shift then Recall to restore the factory preset instrument settings.
- 2) Press the keys in the following sequence:
 - Sensitivity Down until
the sensitivity is **300 nV**.
 - CH1 Display three times
Set the CH1 display to **Xnoise**.
 - Close Reserve once until
LOW NOISE is selected.
- 3) Wait until the CH1 display stabilizes. Record the value of the CH1 display ($\text{nV}/\sqrt{\text{Hz}}$).
- 4) This completes the noise test. Enter the results of this test in the test record at the end of this chapter.

SR844 Performance Test Record	
Serial Number:	Tested By:
Firmware Revision:	Date:
Equipment Used:	

1. Self Tests		
Test	Pass	Fail
Data		
Batt		
Prog		
DSP		

2. Amplitude Response				
Sensitivity	Frequency	Lower Limit	CH1 Reading (dBm)	Upper Limit
300 mV	100 kHz	-2.0 dBm		+2.0 dBm
	300 kHz	-2.0 dBm		+2.0 dBm
	1 MHz	-2.0 dBm		+2.0 dBm
	3 MHz	-2.0 dBm		+2.0 dBm
	10 MHz	-2.0 dBm		+2.0 dBm
	30 MHz	-2.0 dBm		+2.0 dBm
	100 MHz	-2.25 dBm		+2.25 dBm
	200 MHz	-2.25 dBm		+2.25 dBm
Sensitivity	Frequency	Lower Limit	CH1 Reading (dBm)	Upper Limit
30 mV	100 kHz	-22.5 dBm		-17.5 dBm
	300 kHz	-22.5 dBm		-17.5 dBm
	1 MHz	-22.5 dBm		-17.5 dBm
	3 MHz	-22.5 dBm		-17.5 dBm
	10 MHz	-22.5 dBm		-17.5 dBm
	30 MHz	-22.5 dBm		-17.5 dBm
	100 MHz	-22.75 dBm		-17.25 dBm
	200 MHz	-22.75 dBm		-17.25 dBm
Sensitivity	Frequency	Lower Limit	CH1 Reading (dBm)	Upper Limit
3 mV	100 kHz	-43.0 dBm		-37.0 dBm
	300 kHz	-43.0 dBm		-37.0 dBm
	1 MHz	-43.0 dBm		-37.0 dBm
	3 MHz	-43.0 dBm		-37.0 dBm
	10 MHz	-43.0 dBm		-37.0 dBm
	30 MHz	-43.0 dBm		-37.0 dBm
	100 MHz	-43.25 dBm		-36.75 dBm
	200 MHz	-43.25 dBm		-36.75 dBm

3. Phase Response				
Sensitivity	Frequency	Lower Limit	CH2 Reading (deg)	Upper Limit
300 mV	100 kHz	-6.0°		+6.0°
	300 kHz	-6.0°		+6.0°
	1 MHz	-6.0°		+6.0°
	3 MHz	-6.0°		+6.0°
	10 MHz	-6.0°		+6.0°
	30 MHz	-8.0°		+8.0°
	100 MHz	-10.0°		+10.0°

4. Frequency Accuracy			
Synthesizer Frequency	Lower Limit	Precise Frequency Reading	Upper Limit
1.9993 MHz	1.99925 MHz		1.99935 MHz
1.9997 MHz	1.99965 MHz		1.99975 MHz

5. Ref Out Amplitude Accuracy and Flatness			
Frequency	Lower Limit	CH1 Reading (dBm)	Upper Limit
100 kHz	+5.6 dBm		+9.6 dBm
300 kHz	+5.6 dBm		+9.6 dBm
1 MHz	+5.6 dBm		+9.6 dBm
3 MHz	+4.6 dBm		+8.6 dBm
10 MHz	+3.6 dBm		+7.6 dBm
30 MHz	+2.6 dBm		+6.6 dBm
100 MHz	+1.6 dBm		+5.6 dBm
200 MHz	-2.5 dBm		+2.5 dBm

6. DC Outputs and Inputs				
Output	Offset	Lower Limit	DVM Reading (V)	Upper Limit
CH1	-100.00%	-10.010 V		-9.990 V
	-50.00%	-5.010 V		-4.990 V
	0.00%	-0.005 V		0.005 V
	+50.00%	+4.990 V		+5.010 V
	+100.0%	+9.990 V		+10.010 V
Output	Offset	Lower Limit	DVM Reading (V)	Upper Limit
CH2	-100.00%	-10.010 V		-9.990 V
	-50.00%	-5.010 V		-4.990 V
	0.00%	-0.005 V		0.005 V
	+50.00%	+4.990 V		+5.010 V
	+100.0%	+9.990 V		+10.010 V

6. DC Outputs and Inputs (continued)				
Output	Voltage	Lower Limit	DVM Reading (V)	Upper Limit
AUX OUT 1	-10.000 V	-10.010 V		-9.990 V
	-5.000 V	-5.010 V		-4.990 V
	0.000 V	-0.005 V		0.005 V
	+5.000 V	+4.990 V		+5.010 V
	+10.000 V	+9.990 V		+10.010 V
Output	Voltage	Lower Limit	DVM Reading (V)	Upper Limit
AUX OUT 2	-10.000 V	-10.010 V		-9.990 V
	-5.000 V	-5.010 V		-4.990 V
	0.000 V	-0.005 V		0.005 V
	+5.000 V	+4.990 V		+5.010 V
	+10.000 V	+9.990 V		+10.010 V
Input	Voltage	Lower Limit	CH1 Reading (V)	Upper Limit
AUX IN 1	-10.000 V	-10.020 V		-9.980 V
	-5.000 V	-5.020 V		-4.980 V
	0.000 V	-0.020 V		0.020 V
	+5.000 V	+4.980 V		+5.020 V
	+10.000 V	+9.980 V		+10.020 V
Input	Voltage	Lower Limit	CH2 Reading (V)	Upper Limit
AUX IN 2	-10.000 V	-10.020 V		-9.980 V
	-5.000 V	-5.020 V		-4.980 V
	0.000 V	-0.020 V		0.020 V
	+5.000 V	+4.980 V		+5.020 V
	+10.000 V	+9.980 V		+10.020 V

7. Input Noise			
Frequency	Sensitivity	CH1 Reading (nV)	Upper Limit
1.000 MHz	300 nV		2.5 nV

Chapter 6

Circuitry, Parts Lists and Schematics

In This Chapter

Service	6-3
Circuit Board Locations	6-4
Circuit Descriptions	6-6
844C: CPU/Power Supply Board	6-6
844S: Display Board	6-8
844K: Keypad Board	6-9
84RTO: Rear Panel and TTL Out Board	6-9
84MBD: Motherboard	6-10
84SIG: Signal Input Board	6-12
84CMX: Chop and Mix Board	6-13
84IFN: I.F. and Noise Board	6-15
84XRF: External Reference Board	6-17
84DVC: Divider Chain Board	6-20
84DSP: Digital Signal Processing Board	6-22
Parts Lists	6-25
CPU and Power Supply (844C) Board	6-26
Front and Rear Panel (844S, 844K, 84RTO) Board	6-31
Motherboard (84MBD)	6-38
Signal Input (84SIG) Board	6-47
Mixer (84CMX) Board	6-51
IF Amplifier (84IFN) Board	6-55
Reference (84XRF) Board	6-64
Divider Chain (84DVC) Board	6-70
Digital Signal Processor (84DSP) Board	6-76
Final Assembly and Miscellaneous	6-79
Schematic Diagrams	6-80

Service



Do not attempt to service or adjust this instrument unless another person, capable of providing first aid or resuscitation, is present.

Always disconnect the power cord and wait at least two minutes before opening the unit. Dangerous power supply voltages may be present even after the unit has been unplugged.

This unit is to be serviced by qualified personnel only. There are no user-serviceable parts inside.

Check the LED at the front right corner of the CPU and power supply board. The unit is safe only if the LED is off. If the LED is on, do not attempt any service on the unit.

Do not install substitute parts or perform any unauthorized modifications to this instrument.

For warranty service or repair, this product must be returned to a Stanford Research Systems authorized service facility. Contact Stanford Research Systems or an authorized representative before returning this product for repair.

Circuit Board Locations

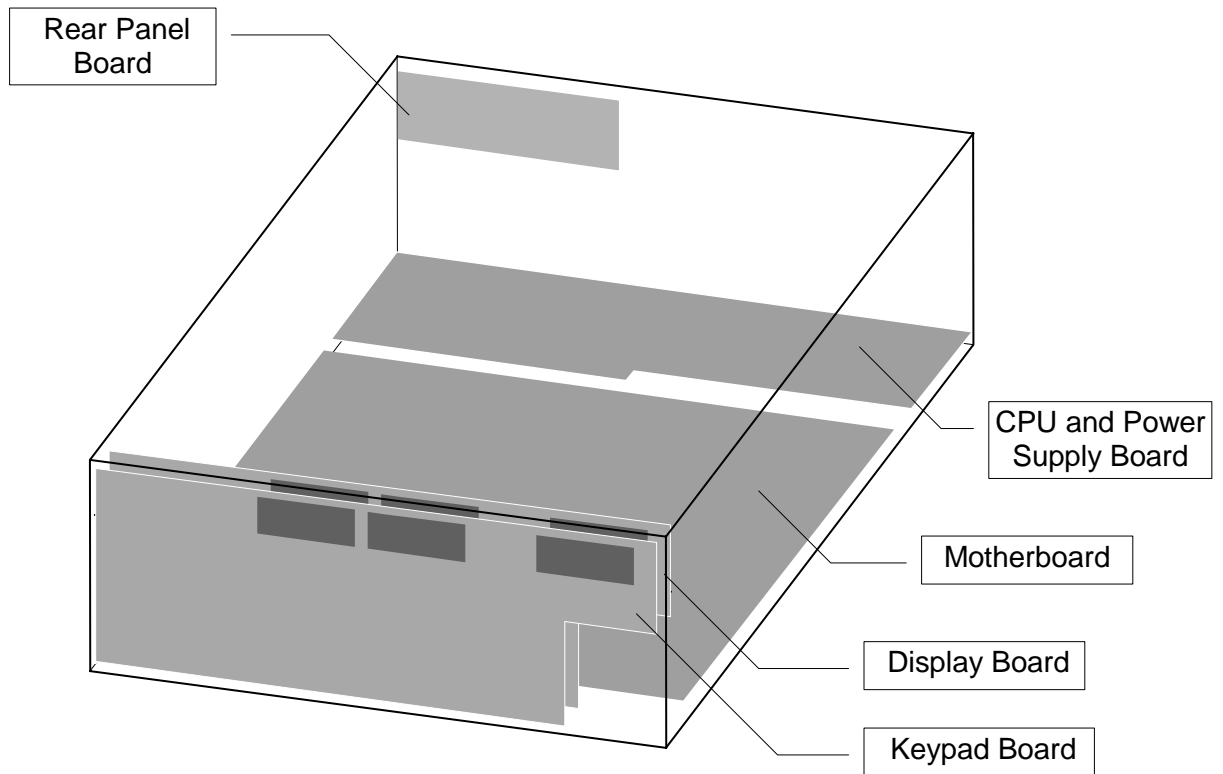

Circuit Boards

The SR844 has five main printed circuit boards shown above.

- The CPU/Power Supply board (844C) contains the host processor, interfaces and power supply.
- The Keypad board (844K) holds the front panel indicators and keypad.
- The Display board (844S) holds the digital readout displays.
- The Rear Panel board (844RTO) holds the rear panel BNC connectors.
- The Motherboard (844MBD) holds 6 daughter boards and the actual lock-in circuitry. See the next page for the locations of the daughter boards.

Daughter Boards

There are 6 small daughter boards mounted to the Motherboard.

- Signal Input (84SIG); RF input amplifier and attenuator
- Mixer (84CMX); RF mixers
- IF Amplifier (84IFN); 2 channels of IF filtering and gain, includes ADC.
- Reference (84XRF); external reference input and PLL.
- Divider (84DVC); reference frequency divider chain.
- Digital Signal Processor (84DSP); processing and DC analog inputs and outputs.
This board is mounted on the bottom of the Motherboard.

These boards overlap in some cases. Do not attempt to remove a daughter board until all boards which are above it are removed. The locations are shown below.

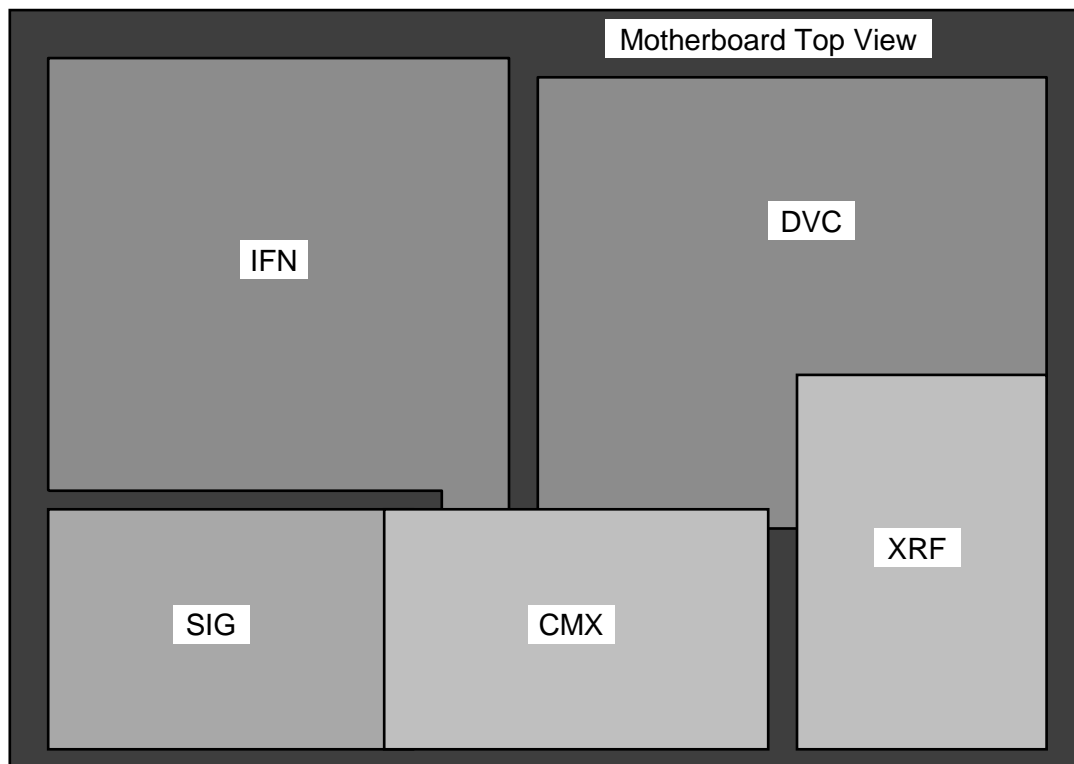

Circuit Descriptions

A description of the circuitry on each board follows. The parts lists and schematics for each board follow the circuit descriptions.

844C: CPU/Power Supply Board

This board is located at the rear of the instrument. The two sections of this board are (a) the CPU and (b) the Power Supply.

Document Number	Sheet	Schematic
CPU-1	1	CPU
CPU-2	2	Address and Data Buffers
CPU-3	3	System ROM
CPU-4	4	System RAM
CPU-5	5	System Decode
CPU-6	6	System I/O
CPU-7	7	System Interfaces
CPU-8	8	System Interconnect
CPU-9	9	Unregulated Supplies
CPU-10	10	Power Supplies

CPU-1... CPU-8: CPU System

The host processor in the SR844 is an 80C186 microprocessor (U101) running at 12 MHz. This processor runs the front panel interfaces (keypad, display and knob), controls the instrument settings, and runs the remote interfaces (GPIB and RS-232). In addition the '186 performs numerous instrument calculations, such as computing calibration values that are then downloaded to the DSP, doing offset and phase calculations, and also computing miscellaneous functions such as Xnoise and Ynoise.

U201–U203 are latches for the '186 address lines. U204–U205 are bidirectional latches for the '186 data lines. In addition U210 and U209 are gated latches for address and data respectively that are only enabled for communication to the motherboard, ie when $-\text{PCS4}$ is low. These separate gated outputs $\text{XA1}–\text{XA6}$ and $\text{XD0}–\text{XD7}$ reduce the microprocessor noise on the instrument circuit boards. U207, U208 and U211 perform basic gating so as to generate read/write/select strobes for memory ($-\text{LO_WR}$, $-\text{HI_WR}$), for the motherboard ($-\text{XWR}$, $-\text{XRD}$) and for other interfaces ($-\text{SYS_WR}$, $-\text{SYS_RD}$, $-\text{SYS_DS}$). The $-\text{XDT/R}$ line controls the direction of data to/from the motherboard.

U303 and U304 are the system boot ROMs, which contain the '186 program code and all the instrument calibration data. The boards are built for normal ROM based operation, however JP303 allows conversion of the board to emulator operation. U401 and U402 are the system RAM, battery backed up by BT701. When power is on, Q701 is on and D701 is reverse-biased, which disconnects the battery from the memory chips, leaving

them powered through Q701. Actually the battery isn't completely disconnected, the reverse leakage current through D701 trickle charges the battery when the unit is on !

Port addresses are decoded by U501 (display writes), U213A(keypad and knob reads), U212C (GPIB) and U207C (RS232).

The data bus is connected to the front panel connector JP602 through bi-directional latches U614 and U615. The data bus is 'read' only for the keypad, it is 'write' for all the display control. (Reading the knob doesn't require the data bus).

The knob is read as follows. The knob has 4 phases, with combinations of (KNOBA, KNOBB) = (0 , 0), (0 , 1), (1 , 1), (1 , 0) for the 4 phases. By reading the state of the knob every time the knob changes phase, the '186 can keep track of the knob position and the direction of travel. U610A clocks falling edges of KNOBA, while U610B clocks rising edges. Either event causes the corresponding -Q to go low, which generates a knob interrupt (-KNOB_INT = low) via U602A and U901F. Similarly a rising or falling edge on KNOBB generates a knob interrupt. The processor responds to the knob interrupt by reading the knob state, which also clears the flip-flops U610 and U611.

The knob interrupt and GPIB interrupt are gated together by U208D and U901A to form a system interrupt SYS_INT. By issuing a status read -STAT_RD, the processor can determine the source of the interrupt and at the same time read the knobs.

The speaker is controlled by signals TIMER1 from the '186, which is a square wave that sets the frequency of sound to be produced, and SPKR_EN, which turns the speaker on and off. These signals are combined in U602B; if SPKR_EN is high, the output of U602B turns switch Q705 on/off at the frequency of TIMER1. The speaker LS701 is a piezoelectric element which forms the load on this switch.

U902 is a GPIB controller, which is connected to the GPIB connector JP902 through line driver chips U903 and U904. U905 is a UART, it is connected to the RS232 connector JP903 through buffers U705 and U906. These ports have a clock separate from the processor clock; the oscillator circuit uses a 3.6864 MHz crystal X902 and an inverter U701D. JP1000 is the expansion connector for communication between the '186 and the instrument motherboard.

CPU-9 & CPU-10: Power Supply

The power transformer T1 has two primary coils and three secondaries. The primaries can be connected in different ways for different AC line voltages, selection is done by a small card in the power entry module.

The secondaries are hooked up in full-wave rectifier bridges to generate +34V, $\pm 21V$, +11V, $\pm 10V$, all unregulated. There are seven regulators attached to the heatsink at the center of the board. U3 generates +5V for the CPU ('186) circuitry and for the front panel display. U4 generates +5V for the instrument, ie the motherboard and boards mounted on the motherboard. U10 generates +8V for the instrument. U5 generates -7.7V for the instrument (primarily the ECL circuitry). U6 and U8 generate $\pm 12V$ for

the fan and the RS232 port. U9 generates +25V for the instrument. All the instrument power goes out on JP4 to the motherboard 84MBD.

The power reset circuit works as follows. On power-up C7 is initially discharged, which means `-PWR_RESET` is low when U612 has enough voltage to operate. Q3 turns on quickly and shuts Q4 off, leaving C4 to be charged up (it takes about 200 ms) by R6. At this point `-PWR_RESET` goes high and the power-up cycle is complete. At power-down, C7 is initially charged, which means `-PWR_RESET` is high. When the power is shut off, +5V_P falls faster than C9 can discharge, as a result of which the base of Q3 is pulled below 0V momentarily, shutting off Q3. But +5V_P is still above 4.3V, which allows Q4 to turn on and discharges C7. This causes `-PWR_RESET` to go low well before the voltage has dropped below the circuit's operating point.

844S: Display Board

The front panel is assembled as a sandwich. The front panel metal is in front, then the conductive rubber keypad with all the keys, then the 844K Keypad board with the key contacts and shorter LEDs, and at the back the 844S Display board. 844S contains the logic for driving the front panel LEDs (on the back of the board) and the taller LEDs (on the front of the board).

Document Number	Sheet	Schematic
844S1	1	Display Drivers
844S2	2	Display LEDs

Data lines, control signals and power all come from the CPU/Power Supply board 844C on connector JP4.

LED's are addressed using multiplexed row/column addressing. The eight columns are turned on in rotation by signals STRB0-STRB7. If row #R is on when column #C is on, then the LED at (#R, #C) is illuminated. Each strobe lasts approximately 2 ms. At the beginning of each strobe, data words are written for all the rows. The clocks ODD and EVEN write the rows for the 7 segment displays (EVEN0-EVEN7 and ODD0-ODD7), while clocks LED_CLK0 and LED_CLK1 write the rows for the individual and bar-graph LEDs (LED0-LED29).

On each cycle, the current strobe word is stored in register U7. One bit is low at a time. If Q5 is low, transistor Q1C is turned on through N1.5. The rest of the transistors in arrays Q1 and Q2 are kept off by the remaining high bits in U7. Q1C's collector sources current into all LED's on column STRB4 that have their row turned on.

On each cycle, the control bits for rows LED0-LED7 are stored in register U9. If output Q2 (U9.18) is high, the corresponding transistor in U2 is turned on through N5.2. The collector of that transistor sinks current from line LED1 through the LED at row #1 and the currently active column. N9.2 is a current-limiting resistor. The other LED rows are similar.

U0 is a retriggerable monostable multivibrator. While triggered, the output \bar{Q} keeps the strobe and LED row registers enabled. If no strobe comes in 6 ms, the multivibrator returns to quiescent state, with \bar{Q} high, and all registers are disabled. With registers disabled, all row and column transistors are off. This serves as a protection mechanism, since neither the transistors nor LED's are rated for continuous operation. Without this protection, an error that caused the '186 to hang could also burn out the front panel.

The front panel keys are addressed by an extension of the row/column scheme used for LEDs. The same 8 columns are used (STRB0–STRB7) and there are 6 key rows KEY0–KEY6. If the key at column STRB3, row KEY2 is closed (button pressed), the line KEY2 is driven high during the STRB3 cycle. In this way reading the keys once each cycle allows the host '186 processor to determine which keys are pressed. U1 is an input latch read once during each column strobe. The latch inputs are the KEY rows mentioned. N13 is an array of pull-down resistors that ensures that the KEYS are read as zero when they are not activated.

JP5 is the knob connector. The knob is an optical encoder that is read directly by the host '186 processor. It requires no support circuitry on 844S.

Connectors J1 and J2 distribute the strobe, LED row, and Key row signals to the 844K Keypad board.

844K: Keypad Board

This board is sandwiched between the 844S Display board and the front panel metal, as described in the preceding section. The Keypad board contains mini-LED's and keypad contacts that all have to be mounted close to the front panel metal. The keys and LED's are addressed by a column/row scheme described in the preceding section. All row and column lines come from 844S on connectors J6 and J7.

84RTO: Rear Panel and TTL Out Board

The Rear Panel Board 84RTO consists of two pieces, the larger of which is soldered directly to the BNC connectors on the rear panel. The smaller is a detachable daughter card that contains the drivers for the TTL output drivers.

Interconnect Board

This is the larger board mentioned above. Five of the six BNCs are wired directly from the BNC connector to ribbon cable connector J876. The interconnect board also has decoupling capacitors between the BNC shields and chassis ground.

For the TTL output, power and signals from J876 are wired to the daughter card attached to J877. The TTL output from the daughter card is connected to the rear panel BNC out J874. Note that on this board, the ground for the TTL output circuitry is not connected

to the ground for the rest of the circuitry. This avoids undesirable contamination of the DC signals.

Daughter Card

Comparators U870 and U871 reconstitute both the TTL output signal (TTL1) and a signal at twice the frequency (TTL2) from low-level inputs TL1± and TL2± from the divider chain 84DVC. The low-level signals are ±200 mV. TTL2 is used to clock output registers U872 and U873 which are wired all 16 lines in parallel in order to be able to drive a 50Ω load. N872, N873 provide current-limiting and short-circuit protection on the outputs, as does R872.

84MBD: Motherboard

The motherboard 84MBD occupies the front half of the instrument. Besides providing power supplies and interconnects for the various other circuit boards, the motherboard contains the following circuitry: (a) the Platform Interface, which is the interface between the host '186 processor and the rest of the instrument, (b) the Synthesizer, used in internal reference mode (c) the Range Select circuitry.

Document Number	Sheet	Schematic
MBDMAIN	1	84MBD Main
MBDXRF	2	84XRF Power, Connectors
MBDDVC	3	84DVC Power, Connectors
MBDCMX	4	84CMX Power, Connectors
MBDSIG	5	84SIG Power, Connectors
MBDIFN	6	84IFN Power, Connectors
MBDDSP	7	84DSP Power, Connectors
MPLAT	8	Platform Interface
MSYNT	9	Synthesizer
MRNGS	10	Range Select

Power Supplies

Regulated (-7.7V, +5V, +8V, +25V) and Unregulated (±17V nom.) power comes in from the CPU/Power Supply board 844C on connector J4. Most of the power is re-regulated and distributed to the various boards. Distribution of input power is shown on page MBDMAIN, while the (secondary) regulators are grouped along with the interconnect to the board they service on separate pages.

Power supplies are decoupled from each other with capacitors and either beads, inductors or resistors. Separate circuit sections generally have independently regulated power. FR47 is a small surface-mount bead with 47Ω impedance at 100 MHz, FR95 is a bigger surface-mount bead with 95Ω impedance at 100 MHz.

Interconnects

Cable connections on the motherboard are shown on page MBDMAIN, while the dual-in-line interconnects to daughter boards are shown separately on successive pages.

MPLAT: Platform Interface

The address (BA0–BA4), data (BD0–BD7) and control (BC2–BC6) lines from the ‘186 host processor come from the CPU/Power Supply board 844C on connector J3. U800 buffers the data lines, while U801 and U804A buffer the address lines. The address lines (and data lines, actually) are gated by –PCS4 port select strobe on 844C, so gating of U801 is not necessary. The addresses are decoded by U802 (read strobe) and U803 (write strobe). Some of these decoded-address strobes are used to select registers while others are used for clear, load and clock pulses directly.

The two input (read) latches are U808, which reads the range bits determined in the Range Select section, and U809, which reads the various status (error, overload) bits. Most of the inputs and the data bus are accessible on test points that are labelled on the board.

There are four output (write) registers. U807 is a latch that writes range select and loop filter bits to the Range Select section in internal reference mode. U810–812 are the registers that set the control bits for all the various boards. The signal control bits are in U810, the I.F. control bits are in U812, and the rest of the control bits are distributed among the registers. The digital outputs go through resistors for isolation. Many output bits have test points either on the motherboard or at their destination on another board.

Programmable chip U813 latches the various status bits, so that a transient error can be caught and read by the host ‘186.

MSYNT: Synthesizer

U821 is a 20MHz crystal TTL oscillator. Its output is gated by U822B and used as the reference for the synthesizer chip U820. This chip divides the reference input and the F input by different integers and generates error pulses on pins R and V (the signals are INTUP and INTDN) if the edges of the divided-down signals don’t match up precisely. These signals are used as feedback in a phase-locked loop so as to lock the F input to the 20 MHz reference. The actual frequency of F depends on the divisors programmed into the synthesizer chip. The F input lines come from the VCO on 84XRF, they are terminated by R820 and AC coupled into the synthesizer. The programming inputs SY0–SY2 come from the Platform interface above. The outputs INTUP and INTDN go to the Loop Filter on 84XRF. An auxiliary output –INT . LOCK is returned to the Platform Interface after filtering; this signal goes low when the synthesizer is not phase-locked.

The 20 MHz clock signal from U821 is buffered by U822A and attenuated by R823/C823. This signal is sent to 84DSP for use as the DSP clock.

MRNGS: Range Select

The SR844 operates in 13 octave ranges, from 25 kHz to 200 MHz. The ranges and the associated bit values are defined in a table in the description of 84DVC below. In internal reference mode, the host '186 processor knows what the instrument frequency and range should be and writes the range to the up/down counter U849 directly. In addition it writes the loop filter bits ILF0 and ILF1 (U848.10, U848.11). In external mode the range is determined on the fly by the hardware as follows. VTUN2 is an input from the 84XRF board that is equal to half the VCO tuning voltage. It is typically about 1.0V at the bottom of an octave (VCO at 200 MHz) and about 9.0V at the top of the octave (VCO at 400 MHz). VTUN2 is compared against set points P840 and P842 by comparators U840A and U840B. If VTUN2 is too low, then the circuit should try to establish phase-lock on the next lower octave. In this case the LOWER input to U848 goes high, causing a down clock to be sent to counter U849, which decreases the range by 1. Similarly if VTUN2 is too high, -RAISE goes low, and an up clock is sent to U849, which increases the range by 1. R849/C849 delays the clock by 10ns to ensure that the Down/Up control U849.5 is established before the clock edge arrives at U849.14. In addition U852A generates an 80µs long pulse that disables further range transitions for the 80µs duration. The trigger input to U852.2 is the clock pulse, buffered by U851B and delayed 90ns by R851/C851. Were it not for the 90ns delay, the disable pulse from U852 would shut off the clock pulse too soon; this delay ensures that the clock to U849 is not a runt pulse.

U848 also writes the loop filter bits to 84XRF; these bits are determined by internal logic from the range bits when the unit is in external mode, while the ILF0-1 bits written by the host are used directly in internal mode. U848 also accepts RISING and -FALLING as inputs from the phase comparator on 84XRF; if either is active the instrument is not phase-locked and the unlock output UNLL is set high. Further, the range switching clock is disabled if it would cause the range to go outside the endpoints (2,14). If a range switch is necessary and the range is already at one of the endpoints, the out-of-range output OORL is set. UNLL and OORL are latched within U848, they are cleared by -LCHCLR after the host '186 processor has read the status register.

Comparator U840D compares VTUN2 against a mid-range setpoint to establish whether the VCO frequency (and by inference the reference frequency) are in the upper or lower half of an octave. This determines bit RANGR4 (low in lower half of octave, high in upper half). In normal operation CALSEL and CALRNG4 are both low, and RANGR4 is the inverse of the comparator output. In internal mode and certain other special situations, the host '186 processor can override the hardware setting of this bit by writing CALSEL high, in which case RANGR4 is equal to the value written for CALRNG4. These bits, CALSEL and CALRNG4 are written to register U850 along with the range and loop filter bits.

84SIG: Signal Input Board

The 84SIG board is located on the left-hand side front of the instrument. This board contains the RF input signal circuitry, including attenuation, filtering and gain. The input to the board is the raw signal provided by the user on the front panel signal input.

The output is the conditioned signal (after attenuation, filtering and gain) that goes to the mixers on 84CMX.

Relay S102 selects the signal path corresponding to the chosen input impedance. The 50 Ω signal path goes through a 2dB input matching attenuator, R102–104. The 1M Ω signal path goes through a preamplifier consisting of an AC-coupled JFET Q108 followed by an amplifier U120. P108 is used to adjust the bias of Q108 for minimum distortion.

Between S102 and S140 is a 5-pole Cauer passive low-pass filter with a cutoff frequency of about 220 MHz. The filter components are C132–138 and L132–133.

Relay S140 switches the signal between a straight-through path and one containing 20 dB attenuation (R140–142). Note that S140 and S150 are not under direct user control, rather they are set by the instrument depending on the user–selected wide reserve, close reserve and sensitivity.

Between S140 and S150 is a 3-pole passive high-pass filter with a cutoff of about 20kHz, using C144–147 and L144–145. The legs with R187, R188 provide compensation at low and high frequencies respectively.

Relay S150 switches the signal between a straight-through path and one containing 20 dB gain (U150). The components R150–151 and C150 provide impedance matching to the amplifier.

The output signal goes to the mixers on 84CMX via connector J011.

There is also overload detection on this board, with two sense inputs. One input senses the preamplifier output via R164 and C164, the other senses the mixer input via R160 and C160. The two sense inputs share peak–detecting capacitors and comparators. D172, D173 charge C171 to the maximum of either sense signal, while D170, D171 charge C170 to the minimum of either sense signal. All signals and the comparator thresholds are referred to +7.5VDC nominal, which is generated by U156. C170 and C171 are monitored by the two halves of U170, a FET-input dual comparator. U180 combines the comparator outputs so that OVLD2 goes low when either comparator’s threshold is exceeded.

OVLD2 goes to the platform interface on the motherboard 84MBD; this is also where the relay control bits SI0–SI2 come from.

84CMX: Chop and Mix Board

The 84CMX board is located midway across the front of the instrument. It contains the Chop and Mix sections.

Document Number	Sheet	Schematic
CMXM	1	Mixers
CMXC	2	Chop Circuit

CMXC: Chop Circuit

This section generates the chopped Local Oscillator signals that are used by the Mixer section to downconvert the input signal from the Reference frequency (25kHz – 200MHz) to the Intermediate Frequency (I. F. : 2 – 3 kHz and 8 – 12 kHz).

U713 generates the appropriate chopping signal by dividing down the 49–98 kHz divider chain output. The division is performed as follows :

RANG4C	TCMIN	Divisor	Comment
0	0	12	Bottom half of octave and long time constant, I.F. = 2–3 kHz
0	1	3	Bottom half of octave and short time constant, I.F. = 8–12 kHz
1	0	16	Top half of octave and long time constant, I.F. = 2–3 kHz
1	1	4	Top half of octave and short time constant, I.F. = 8–12 kHz

The chop output U713.15 is a symmetric square wave. It is buffered by U714 and then converted to ECL levels by the network R714–716. The other output of U713 is a sync output which is high for a length of time equal to one data sample period; this signal allows the DSP to ensure that the demodulation it applies is in phase with the chopping waveform.

U707 is used to synchronize the ECL chop waveform to the 6–12 MHz divider chain output. U705 buffers the Reference Frequency output from the divider chain. These two signals are XOR'ed by U708; when the chop (A) input is low the Q output of U708 is equal to the reference frequency (B) input. When the chop (A) input is high, the Q output is the inverse of the B input. Thus the output of U708 is a signal at the reference frequency that has been chopped at the I.F.

U702 buffers the divider chain output at twice the reference frequency (2FR). The outputs are wired to the flip-flops U709 and U710 with opposite phase, so that U709 clocks on a rising edge of 2FR while U710 clocks on a falling edge of 2FR. This is a 180° phase difference at twice the reference frequency, which is 90° phase difference at the reference frequency. Since the D inputs to U709 and U710 are the same except for one being the inverse of the other, the outputs of U709 and U710 are identical except for a 90° phase shift – which is exactly what is required for in-phase and quadrature mixing. These are the local oscillator signals that are fed to the mixer section (XDRV±, YDRV±). These signals return back to the chop section (XRET±, YRET±) for termination.

CMXM: Mixers

The inputs to the mixer section are (1) the conditioned input signal from the Signal board 84SIG, and (2,3) the Local oscillator inputs from the Chop section above. The outputs of this section are filtered I.F. signals, MIXX and MIXY for the In-Phase and Quadrature channels respectively. The operation of the In-Phase channel X mixer is described below; the operation of the Quadrature or Y channel is identical.

The local oscillator signals $XDRV_{\pm}$ are a balanced Q , $-Q$ pair of signals at ECL levels. They are attenuated by R764, Y764 and R765, Y765 before being AC coupled to the Local Oscillator inputs U760.10 and U760.11.

The conditioned signal from 84SIG is split between the two mixers and attenuated by R740 and R760. The split lines are AC-coupled to the mixer's RF inputs, U760.6 and U760.7. R761 is the signal termination; in addition the tantalum capacitors F760–761 are necessary for proper signal termination at low frequencies. R790–791 are also part of the matched attenuator, the DC blocking capacitor C790 is required because the amplifier U150 on 84SIG adds a DC bias to the signal.

The mixer generates the product of the signal on its RF inputs and the signal on its LO inputs. In general the low frequency component of the product is the desired I.F. signal, while the high frequency components at $2 \times F_{REF}$ and other multiples are undesired and need to be filtered out. The capacitor network Z762, C762 and Z763, C763 provide a small amount of filtering between the mixer front end and its built-in preamplifier. R762 squelches a resonance between the self-resonant frequencies of Z762 and C762. The built-in preamplifier is set to a gain of 2 by X769 and Y769, the Common node for the preamplifier is biased to $\frac{1}{2}$ of the supply voltage by R769 and R770, and the capacitors Z769 – E769 hold the common node stable. R768 controls the operating current of the mixer.

The amplified mixer output is filtered before going to the I.F. board 84IFN. L770–L771 and C770–C774 constitute a 2-stage low-pass filter, the first stage being a 3rd order Causer filter with cutoff at 180 kHz, while the second stage is a 2nd order filter with cutoff at 2 MHz. Together the filter provides good rejection of the $2 \times F_{REF}$ mixer outputs out to 400 MHz and beyond. F770 provides a DC block since the mixer is not ground-referenced.

84IFN: I.F. and Noise Board

This board is mounted just above the left rear portion of the motherboard 84MBD. This board contains the I.F. amplifiers, anti-aliasing filters and A-to-D converters. There are two each of these signal path circuits, one for the X or In-Phase channel, one for the Y or Quadrature channel. The X channel is described below; operation of the Y channel is identical. There is also a noise generator and overload detector on this board.

Document Number	Sheet	Schematic
IFN1	2	IF Amplifiers and Anti-Aliasing Filters
IFN2	3	Noise, ADC and Overload

IFN1: I.F. Amplifiers

The inputs to this circuit are MIX.X, the filtered I.F. output from the mixer on 84CMX, and GND.X, the ground on 84CMX to which MIX.X is referenced. U400 is a differential amplifier with $\times 4$ gain that converts the differential inputs to a single-ended signal referenced to local ground and also boosts the signal above the noise level of succeeding

amplifier stages. As with subsequent amplifier stages, a small capacitor in the feedback loop provides weak roll-off for high-frequency signals.

U401 is a programmable amplifier stage, the gain of $\times 1$, $\times 3$, $\times 10$, $\times 30$ corresponds to control bit values $[IF1, IF0] = [0, 0], [0, 1], [1, 0], [1, 1]$ respectively. U403A is a programmable amplifier stage, its gain $\times 1$, $\times 10$ corresponds to bit $IF2 = 0, 1$ respectively. U403B is another $\times 1$, $\times 10$ stage identical to U403A; it is controlled by bit $IF3$. The inputs to U403A and U403B are both AC-coupled to eliminate unwanted amplification of DC offsets from preceding stages.

The IF bits are set by the instrument depending on the front panel settings. All Op amps in this section and in the anti-aliasing filter have independent decoupled power supplies.

IFN1: Anti-Aliasing Filter (AAF)

Op amps U406–U408 constitute a 7th order Cauer low-pass filter with cutoff at 18 kHz. This serves as an anti-aliasing filter. C422 is the filter termination. The filter output is buffered by U410.

Switch U409A selects between (a) the AAF output and (b) the unfiltered output direct from U403B. The latter is used when the user has selected NoFilter on the front panel. The AAF is always connected to U403B, but the unfiltered line is disconnected by switch U405A when not in use, in order to eliminate cross-talk.

U410A is a summing amplifier that sums the filtered/unfiltered signal with noise. The option to turn the noise off with U409B is not available to the user. The addition of out-of-band noise serves to improve the linearity and resolution of the measurement, without adding noise within the measurement bandwidth. The output of U410A $DET.X$ is ready for digitizing and goes directly to the A-to-D converter.

IFN2: A-to-D Converter

U478 is a 2-channel A-to-D converter. Besides the conditioned signals $DET.X$ and $DET.Y$ above, this I.C. requires control signals from the DSP board 84DSP. $CONVERT$ is a short pulse that triggers the data sampling and conversion process, $ADC.CLK$ is a train of 18 clocks that reads the data out of U478. The output data is a serial bit stream, MSB first, for each of the X and Y channels. These bit streams, $SER.X$ and $SER.Y$ go to the DSP board 84DSP for further (digital) processing.

IFN2: Overload Detector

U480 is a quad comparator used to check that the A-to-D signal inputs $DET.X$ and $DET.Y$ are within ± 2.5 V. The comparator outputs $OVL.D.X$ and $OVL.D.Y$ are TTL levels that go low when the A-to-D is overloaded. The 2.5 V thresholds are generated from the A-to-D RefOut of 2.75 V by op amps U479A,B.

IFN2: Noise Generator

The noise of a 90.9K resistor (R470) at room temperature is $38\text{nV}/\sqrt{\text{Hz}}$. U470 and U471 amplify this to about $0.8\text{mV}/\sqrt{\text{Hz}}$. U472 and U473 constitute a 5th order Cauer low-pass filter with cutoff around 1.0kHz. C479 is the termination for this filter. The filter output is buffered by U474.

This narrow-band noise at DC is converted to narrow-band at $F_s/2$ (that is, half the sampling frequency) by multiplying the DC noise by ± 1 at frequency $F_s/2$. To achieve this U475A and U475B generate [DC noise $\times 1$] and [DC noise $\times -1$] respectively. U476A switches back and forth between the two at $F_s/2$; its output is buffered by U474B. NOISE is summed with the output of the anti-aliasing filter as mentioned above.

The inputs 24K49D \pm and NOI . CLK are required to generate the $F_s/2$ clock. 24K49D \pm are low-level signals at $F_s/2$ coming from the divider chain; they are converted to a TTL level signals by comparator U591. N591 sets the nominal operating voltage of the comparator inputs to 2.5V, while Z591–592 allow the inputs to be shifted to this level. NOI . CLK is a short TTL pulse, also at F_s , coming from the DSP board. U477A synchronizes the edges of 24K– (the comparator output) to the NOI . CLK pulse. The output of U477A drives switch U476A mentioned above, so that it switches between [$\pm 1 \times \text{DC noise}$] at $F_s/2$.

The RC networks (R497–498, C480–481) and (R574–575, C482–483) provide additional roll-off at both high and low frequencies.

84XRF: External Reference Board

The 84XRF board is located on the right-hand side front of the instrument. The circuitry associated with the external reference input is found on this board. There are four functional blocks found on this board :

Document Number	Sheet	Schematic
XREFI	2	Reference Input
XPHSC	3	Phase Comparator
XPLLF	4	Phase-Locked Loop Filter
XVCO	5	Voltage Controlled Oscillator

XREFI: Reference Input

The input to this section is the raw signal provided by the user on the front panel external reference input. The output is a matched pair of signals (Q and $-Q$) at the same frequency and phase, but converted to a digital ECL square wave.

R213 is the optional 50Ω termination, which is switched into the circuit when relay S210 is closed. The coil for S210 is driven by Q210, whose input $-\text{REF}50$ comes from the

platform interface section of the motherboard 84MBD. Components R210–212 and C210 are an input matching network.

Half of U216 (U216A) is used as a very fast buffer. The input network R214–215, C213–214, Z214–215 provides DC blocking, overvoltage protection to 50V, and current limiting. The several parallel paths in this network ensure that there is a suitable signal path at all input frequencies. R217–218 provide a DC path to ground for the buffer input, and also define the input resistance in the high-impedance case. C215 and R216 are to prevent unwanted oscillations. P216 controls the quiescent current drawn by U216; the voltage measured across JP216 should be 50.6 mV, but this is not critical.

The buffered signal drives two diode-capacitor pairs through R221. D220 charges C220 to the maximum value of the signal waveform, this value is buffered by follower U220A. Similarly C221 is charged to the signal minimum, and this voltage is buffered by U220B. R222 and R223 are bleed resistors that drain charge off C220 and C221 respectively, enabling the capacitors to track decreases in signal amplitude. N220 is a voltage divider; the voltage at node N220.2 is filtered by Z220–222 and has a value that is the mean of the signal maximum and the signal minimum. This voltage is buffered by U230 and is the threshold voltage used to define the edge, or phase zero point, of the reference input waveform. Remember that U216A is AC coupled, so the extrema and threshold may not be the same voltages as are on the raw input signal.

The other half of U216 (U216B) is an operational transconductance amplifier (OTA) that operates as a difference amplifier. The voltage at U216.8 is proportional to the difference between the buffered signal on U216.3 and the threshold on U216.2. The components R233, Z231, L230 and Z230 constitute a reverse filter that prevents high-frequency signals from going back from U216 to U230.

U234 is an ECL comparator set to a threshold of nominally zero volts. Note that the zero threshold is the same point on the waveform at which the signal is equal to *its* threshold value (mean of the signal extrema). R240 and N234 provide 30mV hysteresis, with C234 providing a fast boost to the hysteresis. P234 is provided to null any accumulated offsets in the threshold level; it is adjusted so that a sine-wave input gives an output waveform with 50% duty cycle.

The outputs of U234 go to the phase comparator.

XPHSC: Phase Comparator

The inputs to the phase comparator are ECL square waves at the reference frequency, one Q/–Q pair from U234 above, and the other from the divider chain on 84DVC. These signals are buffered by U300 and U302, the outputs being correctly referenced to local ground. U304 is the phase comparator, the U and –U lines go active when the U304.6 lags U304.7, while the D/–D lines go active when U304.6 leads U304.7. One pair of outputs, –U/–D, go to the loop filter below, while the other pair is used for sensing unlock.

U310 is configured as a differential amplifier with $\times 10$ gain. The idea is that when the circuit is phase-locked, both U and D are at ECL low and the diff amp output U310.6 is nominally zero. When unlocked, any activity on U or D causes U310.6 to deviate from

zero. C308–310 provide some input filtering, since the output of U304 can be much faster than U310 is able to handle.

The output of U310 goes into a dual comparator which generates error signals (RISING and –FALLING) whenever U310.6 goes outside the range $\pm 0.3V$ nominal. This corresponds to a phase excursion of $\pm 10^\circ$ nominal. Typically RISING goes high when the VCO frequency is going up, and –FALLING goes low when the VCO frequency is going down. In either case the unit is not phase-locked. P313 is used to adjust the threshold to 0.6V total range. P310 is used to adjust the LF357 offset so that its output is centered wrt the comparator thresholds when the unit is phase-locked. N316 converts the comparator output voltages to TTL levels and C316–317 provide some necessary filtering to reduce the unlock sensitivity at low frequencies. The RISING and –FALLING outputs go to the Range Select section on the motherboard 84MBD.

XPLLF: Phase-Locked Loop Filter

This circuit implements a Type II second order loop filter with differential inputs; there are numerous analog multiplexers to select the correct signal path depending on the loop comparison frequency and the internal or external reference mode.

There are four signal paths in the feedback arms of the filter and two paths in the input arms. The paths are selected depending on the control bits LF1,0 as shown below

LF1	LF0	Comparison Frequency Range	Upper Input Arm	Upper Feedback Arm	Lower Input Arm	Lower Feedback Arm
0	0	25kHz – 100kHz	N342C,D	C352	N342B,A	C363
0	1	100kHz – 800kHz	N342C,D	E351	N342B,A	E362
1	0	800kHz – 6.25MHz	N340C,D	E350	N340B,A	E360
1	1	6.25MHz – 200MHz	N340C,D	E348	N340B,A	E358

The comparison frequency is the frequency at which the phase comparator operates. In external mode, the phase comparator U304 (above) operates at the external reference frequency, and the LF1, 0 bits can be directly found from the table above. In internal mode the phase comparator is inside the synthesizer chip and operates at a divided down frequency which is always below 2 MHz. Consequently the LF bits may be any of [00, 01, 10] depending on the programming of the synthesizer registers. Note that it is possible for three successive internal frequencies to have three different settings of the LF bits ! (The synthesizer chip is on the motherboard 84MBD.)

Resistor networks R370–R375 convert the TTL levels of INTUP and INTDN (from the synthesizer) into ECL levels; this guarantees that the inputs of U344 are always $\leq -0.8V$ in both external and internal modes, which in turn permits the use of polarized feedback capacitors. The Zener diode pairs D340–347 protect the multiplexers U340A and U341A from overload transients during range switching.

The loop filter output U344.6 is the VCO tuning voltage VTUNE; it goes to the VCO. In addition, a copy equal to half the tuning voltage, VTUN2, is generated by U345 and is

used for sensing the tuning voltage. VTUN2 goes to the Range Select section of the motherboard 84MBD.

P364 is used to null out offsets in the phase-locked loop. Any imbalance in the phase comparators U and D levels requires the PLL to run at a compensating phase offset. P364 is tuned till the PLL has zero phase offset.

XVCO: Voltage Controlled Oscillator

The input to this circuit is the tuning voltage VTUNE from the previous section. This signal is filtered by R380–381, C380–381 and clamped by D381 ($\geq -0.4V$) before it is fed into the VCO U381. Note that the input network also provides some reverse filtering to keep high frequency signals out of U344. The output of U381 is nominally +10dBm between 200 and 400 MHz. The VCO output is split, one pair of signals goes to the divider chain on 84DVC, the other pair goes to the synthesizer on 84MBD. The baluns T385, T386 convert the single-ended VCO output into differential signals.

84DVC: Divider Chain Board

The 84DVC board is mounted just above the right rear portion of the motherboard. This board contains the divider chain. Since the SR844 operates synchronously, all instrument operations are clocked by signals derived from the reference frequency. The divider chain takes the VCO output (200 – 400 MHz) and uses flip-flops and counters to generate clock signals at (100 – 200 MHz), (50 – 100 MHz) all the way down to (24.4 – 48.8 kHz). The 84DVC board also contains multiplexers for selecting the appropriate tap for various circuit functions and associated logic. The Reference Out driver is also located on this board.

Document Number	Sheet	Schematic
DVCE	2	Divider Chain, Multiplexed and Fixed Outputs
DVCR	3	Power and Multiplexer Control Bits

DVCE: Divider Chain

400D± are the differential inputs from the VCO; these signals are AC coupled into buffer U601. One pair of outputs goes through a delay line J601/J602 direct to one input of the 2F multiplexer U624. The other output goes down the divider chain, buffer U603 then ÷2 counter U604. As with subsequent stages, the outputs of U604 go to several multiplexers in addition to going down the divider chain. This output is buffered by U605 and divided by ÷2 counter U606. Another buffer U607 delivers the signal (now 50–100 MHz) to a 3-stage counter U608, the ÷8 output of this counter is in the range 6–12 MHz. This signal is buffered by U611A and converted to TTL by comparator U638. The TTL signal goes into 12-stage counter U643, which generates all the remaining clocks down to 24.4 – 48.8 kHz.

DVCR: Multiplexer Control Bits

Appropriate taps are taken from the divider chain depending on the range (octave) within which the reference frequency lies, and also depending on whether the instrument is in 2nd harmonic mode or not. The multiplexer control bits are derived from the 5 inputs : RANGE0 – RANGE3 and MODE2F, all of which come from the motherboard 84MBD. The control bits are generated using gates U642 and programmable logic chips U640, U651. TTL bits are buffered with 1.0K resistors for isolation, while bits for ECL multiplexers are converted from TTL to ECL levels using resistor networks such as N660 and N661. The nomenclature for the control bits is as follows, letter S is used for ECL bits and T for TTL bits, the first number (25 in S25S0, for example) denotes which chip the control bit goes to (25 means U625) and the trailing number (0 in the example) denotes which control bit, 0 being the LSB, 2 the MSB, and 3 is the gate/enable on chips that require it. T44T3 is a TTL control bit going to the gate of U644.

The range bits are defined as shown in the following table: note that RANGE0 is the Most Significant Bit (MSB). The frequencies in the table are the *detection* frequency in both normal and 2F modes, this is the *same* as the reference frequency in normal mode and is *twice* the reference frequency in 2F mode.

Range	2	3	4	5	6	7	8	9	10	11	12	13	14
RANG0	0	0	0	0	0	0	1	1	1	1	1	1	1
RANG1	0	0	1	1	1	1	0	0	0	0	1	1	1
RANG2	1	1	0	0	1	1	0	0	1	1	0	0	1
RANG3	0	1	0	1	0	1	0	1	0	1	0	1	0
Low Freq	25 kHz	48.8 kHz	97.6 kHz	195 kHz	390 kHz	781 kHz	1.56 MHz	3.12 MHz	6.25 MHz	12.5 MHz	25 MHz	50 MHz	100 MHz
High Freq	48.8 kHz	97.6 kHz	195 kHz	390 kHz	781 kHz	1.56 MHz	3.12 MHz	6.25 MHz	12.5 MHz	25 MHz	50 MHz	100 MHz	200 MHz

DVCE: Multiplexed Outputs

U613 and U619 are a cascaded pair of multiplexers, the output of which is at the detection frequency F_D . This output is buffered by U616 and goes to the Chop circuit on 84CMX.

U618 is a multiplexer whose output is at the reference frequency F_R . This output is synchronized with a $2 \times F_R$ clock in U620 and U622. The output of U620 goes to the phase-locked loop circuit on 84XRF, while the output of U622 goes to the Reference Out circuit. U650 is a current-feedback amplifier with some feedback resistors included in the package. R658, R659 make the part into a differential amplifier. R655, R678 and R679 form an attenuator that also provides reverse termination. The output goes directly to the front panel BNC connector Ref Out.

The low-frequency inputs to U618 come from U643 and TTL multiplexer U649. The signals are converted from TTL to ECL levels using resistor networks R654/R674/R694 and R648/R668/R688. Similarly the low-frequency inputs to U619 come from U643 and TTL multiplexer U645.

U624 and U625 form a multiplexer to select $2 \times F_R$. On any range only one of these multiplexers is active, the other chip's output is held ECL-low. The two outputs are combined by OR gates U626, U627. The output of U626 clocks the flip-flops U620, U622 mentioned above, while the output of U627 goes through some delay lines to buffer U629 and thence to the Chop circuit on 84CMX. The low-frequency inputs to U625 come from TTL multiplexer U644.

U649 and U644 also provide signals at F_R and $2 \times F_R$ respectively for the rear panel TTL out circuit. The TTL output is active only for ranges 2–7, ie below 1.56 MHz. Above this RANGR0 is high, which gates U648 off. Otherwise the TTL output is active and U648 generates complementary Q , \bar{Q} signals which are attenuated to $\pm 200\text{mV}$ by N648, N649 and then sent to the 84RTO board where the output drivers are located.

DVCE: Fixed Outputs

Other circuit functions require synchronous signals that are held to a specific octave regardless of the operating frequency. U611C drives a 6–12 MHz signal to the Chop circuit on 84CMX for the purpose of synchronizing the Chop (I.F.) waveform.

Fixed taps from U643 are buffered by U647 and U648. The 24–49 kHz tap is required both by the Chop circuit on 84CMX and by the noise circuit on 84IFN. The 49–98 kHz tap is required both by the Chop circuit on 84CMX and by the FPGA on 84DSP. The latter is used to generate all the clocks and control signals required for data sampling, which occurs at 49–98 kHz.

84DSP: Digital Signal Processing Board

This board is mounted *underneath* the motherboard 84MBD. This board contains the following sections (a) the DSP chip (b) the FPGA (c) the Auxiliary Input A-to-D converter (d) the Auxiliary Output D-to-A converter (e) the Front Panel Output D-to-A converter.

DSP Chip

U900 is the DSP chip. The DSP is connected to the host '186 processor (on the CPU board 844C) by means of the data bus D0–D7 and the DSP control lines DSP0–DSP7. All of these signals come through the platform interface on the motherboard. The DSP also does parallel I/O over its own data bus 56D0–56D15 using control lines 56D16–56D18. These control lines are the read and write strobes and a low-order address bit that is used to distinguish X and Y data. In addition the DSP receives the SYNCD input from the Chop section of 84CMX and RANG4D from the Range Select section of the motherboard. The former is used to ensure that demodulation (that is, conversion of the I.F. signal to DC) within the DSP is in phase with the Chop waveform applied to the Local Oscillator signals on 84CMX. The latter distinguishes upper half and lower half of each octave, and is required so that the DSP uses the correct demodulation waveform. Pin PC8 (U900.33) is connected to the Timer input U900.39 enabling the DSP timer to make measurements of the Data Sampling period, and

indirectly the reference frequency. The DSP clock is fixed frequency 20 MHz, it comes from the Synthesizer section of the motherboard and is buffered by U910. The operations performed within the DSP are described in Chapter 2, Inside the DSP.

FPGA

U904 is the FPGA (Field Programmable Gate Array). This chip performs the following functions (a) conversion of parallel data on the DSP data bus to and from serial data on the A-to-D and D-to-A data lines (b) generation of all timing clocks and pulses required for operation of the A-to-D's, D-to-A's, DSP data sampling, and the noise circuit on 84IFN. This chip is programmed over the instrument data bus D0–D7 each time the instrument is powered up; the data bus is not used by the FPGA otherwise. U908 and U910 buffer the outputs from the FPGA, and N908–N911 provide isolation.

The FPGA has four clock inputs :

[1] 6M+ is a synchronous (to the reference frequency and data sampling) clock that is recovered from low-level inputs 6M12D± by comparator U905. These low-level (± 200 mV) inputs come from the divider chain 84DVC. R905, Z905 provide termination to the input lines. Because the input is always at high frequency, no hysteresis is required.

[2] 49K– is a synchronous clock which defines the instrument sampling rate; it is recovered from low-level inputs 49K98D± (also from 84DVC) by comparator U938. R938 provides hysteresis; no line termination is required.

[3] CCLK (U904.73) comes from the host '186 processor via the platform interface and is only used for programming the FPGA.

[4] ICLKDSP is a buffered 20MHz clock identical to the DSP clock; it is presently unused.

Auxiliary Input

The Auxiliary inputs AUXI0–AUXI3 are differential lines (two for each input) coming from the rear panel BNCs, via connector J2 on the motherboard. U907A,B are two differential amplifiers with $\times 0.25$ gain that convert the differential ± 10 V inputs into single-ended signals within the A-to-D converters' input range. U909 is a two-channel A-to-D converter, its control signals are generated by the FPGA, and its serial bitstream outputs (MSB first) go to the FPGA where they are converted to parallel data and read by the DSP.

Auxiliary Output

U914 is a dual D-to-A converter, its control signals and serial input data are written directly by the host '186 via the platform interface. R914 and Z913 filter the channel 2 output with a time constant of $47\mu\text{s}$. The filtered output is amplified by U915A so as to provide outputs spanning ± 10 V. The channel 1 circuitry is identical. The outputs go to the rear panel BNCs via connector J2 on the motherboard.

Front Panel Output

The front panel output data (both channels) is written by the DSP to the FPGA once every data sample period. The FPGA converts the parallel data to serial and sends the serial data to dual D-to-A converter U920 along with the appropriate control signals. R928 and Z923 filter the Channel 2 (Y) output with a $4.7\mu\text{s}$ time constant. The filtered output is amplified by U915C so as to provide outputs spanning $\pm 10\text{V}$. The outputs go to the front panel via connectors J5 (X) and J6 (Y) on the motherboard.

Parts Lists

Parts lists for all of the circuit boards are listed in the following sections. Schematic diagrams follow the parts lists at the end of this manual.

CPU and Power Supply (844C) Board Parts List

CPU and Power Supply Board Assembly			
Ref. No.	SRS Part No.	Value	Component Description
BT701	6-00001-612	BR-2/3A 2PIN PC	Battery
C 1	5-00477-509	5600U	Capacitor, Electrolytic, 50V, 20%, Rad
C 2	5-00478-520	33000U	Capacitor, Electrolytic, 16V, 20%, Rad
C 3	5-00228-526	15000U	Capacitor, Electrolytic, 35V, 20%, Rad
C 4	5-00228-526	15000U	Capacitor, Electrolytic, 35V, 20%, Rad
C 5	5-00478-520	33000U	Capacitor, Electrolytic, 16V, 20%, Rad
C 6	5-00478-520	33000U	Capacitor, Electrolytic, 16V, 20%, Rad
C 7	5-00225-548	.1U AXIAL	Capacitor, Ceramic, 50V,+80/-20% Z5U AX
C 9	5-00038-509	10U	Capacitor, Electrolytic, 50V, 20%, Rad
C 10	5-00038-509	10U	Capacitor, Electrolytic, 50V, 20%, Rad
C 12	5-00038-509	10U	Capacitor, Electrolytic, 50V, 20%, Rad
C 16	5-00127-524	2.2U	Capacitor, Tantalum, 50V, 20%, Rad
C 17	5-00127-524	2.2U	Capacitor, Tantalum, 50V, 20%, Rad
C 18	5-00127-524	2.2U	Capacitor, Tantalum, 50V, 20%, Rad
C 19	5-00192-542	22U MIN	Cap, Mini Electrolytic, 50V, 20% Radial
C 20	5-00127-524	2.2U	Capacitor, Tantalum, 50V, 20%, Rad
C 23	5-00192-542	22U MIN	Cap, Mini Electrolytic, 50V, 20% Radial
C 24	5-00127-524	2.2U	Capacitor, Tantalum, 50V, 20%, Rad
C 26	5-00192-542	22U MIN	Cap, Mini Electrolytic, 50V, 20% Radial
C 27	5-00127-524	2.2U	Capacitor, Tantalum, 50V, 20%, Rad
C 28	5-00192-542	22U MIN	Cap, Mini Electrolytic, 50V, 20% Radial
C 29	5-00127-524	2.2U	Capacitor, Tantalum, 50V, 20%, Rad
C 34	5-00193-542	2.2U MIN	Cap, Mini Electrolytic, 50V, 20% Radial
C 36	5-00127-524	2.2U	Capacitor, Tantalum, 50V, 20%, Rad
C 101	5-00177-501	30P	Capacitor, Ceramic Disc, 50V, 10%, SL
C 102	5-00215-501	20P	Capacitor, Ceramic Disc, 50V, 10%, SL
C 103	5-00028-507	100P	Capacitor, Ceramic Disc, 250V, 10%, Y5P
C 903	5-00022-501	.001U	Capacitor, Ceramic Disc, 50V, 10%, SL
C 907	5-00012-501	330P	Capacitor, Ceramic Disc, 50V, 10%, SL
C 908	5-00012-501	330P	Capacitor, Ceramic Disc, 50V, 10%, SL
C 909	5-00178-501	62P	Capacitor, Ceramic Disc, 50V, 10%, SL
C 910	5-00178-501	62P	Capacitor, Ceramic Disc, 50V, 10%, SL
C 1001	5-00225-548	.1U AXIAL	Capacitor, Ceramic, 50V,+80/-20% Z5U AX
C 1002	5-00225-548	.1U AXIAL	Capacitor, Ceramic, 50V,+80/-20% Z5U AX
C 1003	5-00225-548	.1U AXIAL	Capacitor, Ceramic, 50V,+80/-20% Z5U AX
C 1004	5-00225-548	.1U AXIAL	Capacitor, Ceramic, 50V,+80/-20% Z5U AX
C 1006	5-00225-548	.1U AXIAL	Capacitor, Ceramic, 50V,+80/-20% Z5U AX
C 1007	5-00225-548	.1U AXIAL	Capacitor, Ceramic, 50V,+80/-20% Z5U AX
C 1008	5-00225-548	.1U AXIAL	Capacitor, Ceramic, 50V,+80/-20% Z5U AX
C 1009	5-00225-548	.1U AXIAL	Capacitor, Ceramic, 50V,+80/-20% Z5U AX
C 1010	5-00225-548	.1U AXIAL	Capacitor, Ceramic, 50V,+80/-20% Z5U AX
C 1012	5-00225-548	.1U AXIAL	Capacitor, Ceramic, 50V,+80/-20% Z5U AX
C 1013	5-00225-548	.1U AXIAL	Capacitor, Ceramic, 50V,+80/-20% Z5U AX
C 1014	5-00225-548	.1U AXIAL	Capacitor, Ceramic, 50V,+80/-20% Z5U AX
C 1015	5-00225-548	.1U AXIAL	Capacitor, Ceramic, 50V,+80/-20% Z5U AX
C 1016	5-00225-548	.1U AXIAL	Capacitor, Ceramic, 50V,+80/-20% Z5U AX
C 1017	5-00225-548	.1U AXIAL	Capacitor, Ceramic, 50V,+80/-20% Z5U AX

CPU and Power Supply Board Assembly			
Ref. No.	SRS Part No.	Value	Component Description
C 1018	5-00225-548	.1U AXIAL	Capacitor, Ceramic, 50V,+80/-20% Z5U AX
C 1019	5-00225-548	.1U AXIAL	Capacitor, Ceramic, 50V,+80/-20% Z5U AX
C 1021	5-00225-548	.1U AXIAL	Capacitor, Ceramic, 50V,+80/-20% Z5U AX
C 1022	5-00225-548	.1U AXIAL	Capacitor, Ceramic, 50V,+80/-20% Z5U AX
C 1023	5-00100-517	2.2U	Capacitor, Tantalum, 35V, 20%, Rad
C 1024	5-00225-548	.1U AXIAL	Capacitor, Ceramic, 50V,+80/-20% Z5U AX
C 1026	5-00100-517	2.2U	Capacitor, Tantalum, 35V, 20%, Rad
C 1030	5-00225-548	.1U AXIAL	Capacitor, Ceramic, 50V,+80/-20% Z5U AX
C 1031	5-00225-548	.1U AXIAL	Capacitor, Ceramic, 50V,+80/-20% Z5U AX
C 1035	5-00225-548	.1U AXIAL	Capacitor, Ceramic, 50V,+80/-20% Z5U AX
C 1036	5-00225-548	.1U AXIAL	Capacitor, Ceramic, 50V,+80/-20% Z5U AX
C 1037	5-00225-548	.1U AXIAL	Capacitor, Ceramic, 50V,+80/-20% Z5U AX
C 1040	5-00225-548	.1U AXIAL	Capacitor, Ceramic, 50V,+80/-20% Z5U AX
C 1041	5-00225-548	.1U AXIAL	Capacitor, Ceramic, 50V,+80/-20% Z5U AX
C 1042	5-00100-517	2.2U	Capacitor, Tantalum, 35V, 20%, Rad
C 1043	5-00225-548	.1U AXIAL	Capacitor, Ceramic, 50V,+80/-20% Z5U AX
C 1044	5-00225-548	.1U AXIAL	Capacitor, Ceramic, 50V,+80/-20% Z5U AX
C 1047	5-00225-548	.1U AXIAL	Capacitor, Ceramic, 50V,+80/-20% Z5U AX
D 2	3-00391-301	MBR360	Diode
D 3	3-00391-301	MBR360	Diode
D 4	3-00391-301	MBR360	Diode
D 5	3-00391-301	MBR360	Diode
D 6	3-00391-301	MBR360	Diode
D 9	3-00391-301	MBR360	Diode
D 15	3-00391-301	MBR360	Diode
D 16	3-00001-301	1N4001	Diode
D 18	3-00001-301	1N4001	Diode
D 19	3-00001-301	1N4001	Diode
D 30	3-00391-301	MBR360	Diode
D 31	3-00391-301	MBR360	Diode
D 32	3-00391-301	MBR360	Diode
D 33	3-00391-301	MBR360	Diode
D 34	3-00221-301	1N4004	Diode
D 35	3-00221-301	1N4004	Diode
D 36	3-00221-301	1N4004	Diode
D 37	3-00221-301	1N4004	Diode
D 401	3-00004-301	1N4148	Diode
D 701	3-00203-301	1N5711	Diode
DS1	3-00011-303	RED	LED, T1 Package
JP4	1-00171-130	34 PIN ELH	Connector, Male
JP602	1-00171-130	34 PIN ELH	Connector, Male
JP603	1-00109-130	4 PIN DI	Connector, Male
JP604	1-00109-130	4 PIN DI	Connector, Male
JP902	1-00160-162	IEEE488/STAND.	Connector, IEEE488, Standard, R/A, Femal
JP903	1-00016-160	RS232 25 PIN D	Connector, D-Sub, Right Angle PC, Female
JP1000	1-00170-130	26 PIN ELH	Connector, Male
L 0	6-00055-630	FB43-1801	Ferrite Beads
L 1	6-00055-630	FB43-1801	Ferrite Beads
L 2	6-00055-630	FB43-1801	Ferrite Beads
L 3	6-00055-630	FB43-1801	Ferrite Beads

6-28 Parts Lists

CPU and Power Supply Board Assembly			
Ref. No.	SRS Part No.	Value	Component Description
LS701	6-00096-600	MINI	Misc. Components
N 101	4-00587-425	10KX7	Resistor Network SIP 1/4W 2% (Common)
N 102	4-00334-425	10KX5	Resistor Network SIP 1/4W 2% (Common)
N 200	4-00852-420	82X8	Resistor Network, DIP, 1/4W,2%,8 Ind
N 201	4-00852-420	82X8	Resistor Network, DIP, 1/4W,2%,8 Ind
PC1	7-00635-701	SR844 CPU	Printed Circuit Board
Q 3	3-00021-325	2N3904	Transistor, TO-92 Package
Q 4	3-00021-325	2N3904	Transistor, TO-92 Package
Q 401	3-00026-325	2N5210	Transistor, TO-92 Package
Q 701	3-00022-325	2N3906	Transistor, TO-92 Package
Q 702	3-00021-325	2N3904	Transistor, TO-92 Package
Q 705	3-00022-325	2N3906	Transistor, TO-92 Package
R 3	4-00034-401	10K	Resistor, Carbon Film, 1/4W, 5%
R 4	4-00032-401	100K	Resistor, Carbon Film, 1/4W, 5%
R 5	4-00034-401	10K	Resistor, Carbon Film, 1/4W, 5%
R 6	4-00046-401	2.0M	Resistor, Carbon Film, 1/4W, 5%
R 7	4-00305-401	4.3K	Resistor, Carbon Film, 1/4W, 5%
R 30	4-00474-402	910	Resistor, Carbon Comp, 1/2W, 5%
R 31	4-00474-402	910	Resistor, Carbon Comp, 1/2W, 5%
R 32	4-00474-402	910	Resistor, Carbon Comp, 1/2W, 5%
R 33	4-00067-401	3.9K	Resistor, Carbon Film, 1/4W, 5%
R 34	4-00067-401	3.9K	Resistor, Carbon Film, 1/4W, 5%
R 35	4-00067-401	3.9K	Resistor, Carbon Film, 1/4W, 5%
R 36	4-00067-401	3.9K	Resistor, Carbon Film, 1/4W, 5%
R 37	4-00034-401	10K	Resistor, Carbon Film, 1/4W, 5%
R 38	4-00034-401	10K	Resistor, Carbon Film, 1/4W, 5%
R 39	4-00682-407	2.37K	Resistor, Metal Film, 1/8W, 1%, 50PPM
R 40	4-00310-407	6.19K	Resistor, Metal Film, 1/8W, 1%, 50PPM
R 41	4-00918-407	5.36K	Resistor, Metal Film, 1/8W, 1%, 50PPM
R 42	4-00682-407	2.37K	Resistor, Metal Film, 1/8W, 1%, 50PPM
R 43	4-00107-402	10	Resistor, Carbon Comp, 1/2W, 5%
R 44	4-00107-402	10	Resistor, Carbon Comp, 1/2W, 5%
R 45	4-00762-407	158	Resistor, Metal Film, 1/8W, 1%, 50PPM
R 46	4-00176-407	3.01K	Resistor, Metal Film, 1/8W, 1%, 50PPM
R 47	4-00022-401	1.0M	Resistor, Carbon Film, 1/4W, 5%
R 48	4-00471-401	82	Resistor, Carbon Film, 1/4W, 5%
R 49	4-00471-401	82	Resistor, Carbon Film, 1/4W, 5%
R 50	4-00471-401	82	Resistor, Carbon Film, 1/4W, 5%
R 401	4-00034-401	10K	Resistor, Carbon Film, 1/4W, 5%
R 402	4-00305-401	4.3K	Resistor, Carbon Film, 1/4W, 5%
R 601	4-00034-401	10K	Resistor, Carbon Film, 1/4W, 5%
R 701	4-00088-401	51K	Resistor, Carbon Film, 1/4W, 5%
R 702	4-00130-407	1.00K	Resistor, Metal Film, 1/8W, 1%, 50PPM
R 703	4-00034-401	10K	Resistor, Carbon Film, 1/4W, 5%
R 704	4-00034-401	10K	Resistor, Carbon Film, 1/4W, 5%
R 712	4-00130-407	1.00K	Resistor, Metal Film, 1/8W, 1%, 50PPM
R 713	4-00056-401	22	Resistor, Carbon Film, 1/4W, 5%
R 901	4-00034-401	10K	Resistor, Carbon Film, 1/4W, 5%
R 911	4-00022-401	1.0M	Resistor, Carbon Film, 1/4W, 5%
R 912	4-00062-401	270	Resistor, Carbon Film, 1/4W, 5%

CPU and Power Supply Board Assembly			
Ref. No.	SRS Part No.	Value	Component Description
R 913	4-00130-407	1.00K	Resistor, Metal Film, 1/8W, 1%, 50PPM
SO101	1-00108-150	PLCC 68 TH	Socket, THRU-HOLE
SO303	1-00156-150	32 PIN 600 MIL	Socket, THRU-HOLE
SO304	1-00156-150	32 PIN 600 MIL	Socket, THRU-HOLE
SW1	2-00039-218	SR810/830	Switch, Panel Mount, Power, Rocker
T 1	1-00152-116	11 PIN, WHITE	Header, Amp, MTA-156
U 3	3-00112-329	7805	Voltage Reg., TO-220 (TAB) Package
U 4	3-00112-329	7805	Voltage Reg., TO-220 (TAB) Package
U 5	3-00784-340	LT1185	Integrated Circuit (Thru-hole Pkg)
U 6	3-00346-329	7812	Voltage Reg., TO-220 (TAB) Package
U 8	3-00330-329	7912	Voltage Reg., TO-220 (TAB) Package
U 9	3-00149-329	LM317T	Voltage Reg., TO-220 (TAB) Package
U 10	3-00785-340	TL750M08CKC	Integrated Circuit (Thru-hole Pkg)
U 101	3-00354-340	80C186-12	Integrated Circuit (Thru-hole Pkg)
U 201	3-00537-340	74HC373	Integrated Circuit (Thru-hole Pkg)
U 202	3-00537-340	74HC373	Integrated Circuit (Thru-hole Pkg)
U 203	3-00537-340	74HC373	Integrated Circuit (Thru-hole Pkg)
U 204	3-00387-340	74HC245	Integrated Circuit (Thru-hole Pkg)
U 205	3-00387-340	74HC245	Integrated Circuit (Thru-hole Pkg)
U 207	3-00045-340	74HC32	Integrated Circuit (Thru-hole Pkg)
U 208	3-00165-340	74HC08	Integrated Circuit (Thru-hole Pkg)
U 209	3-00387-340	74HC245	Integrated Circuit (Thru-hole Pkg)
U 210	3-00537-340	74HC373	Integrated Circuit (Thru-hole Pkg)
U 211	3-00045-340	74HC32	Integrated Circuit (Thru-hole Pkg)
U 212	3-00045-340	74HC32	Integrated Circuit (Thru-hole Pkg)
U 213	3-00038-340	74HC139	Integrated Circuit (Thru-hole Pkg)
U 401	3-00551-341	128KX8-70	STATIC RAM, I.C.
U 402	3-00551-341	128KX8-70	STATIC RAM, I.C.
U 501	3-00037-340	74HC138	Integrated Circuit (Thru-hole Pkg)
U 601	3-00467-340	74HCT74	Integrated Circuit (Thru-hole Pkg)
U 602	3-00348-340	74HC20	Integrated Circuit (Thru-hole Pkg)
U 608	3-00401-340	74HCT244	Integrated Circuit (Thru-hole Pkg)
U 610	3-00467-340	74HCT74	Integrated Circuit (Thru-hole Pkg)
U 611	3-00467-340	74HCT74	Integrated Circuit (Thru-hole Pkg)
U 612	3-00039-340	74HC14	Integrated Circuit (Thru-hole Pkg)
U 614	3-00539-340	74HCT245	Integrated Circuit (Thru-hole Pkg)
U 615	3-00539-340	74HCT245	Integrated Circuit (Thru-hole Pkg)
U 701	3-00051-340	74HCU04	Integrated Circuit (Thru-hole Pkg)
U 705	3-00110-340	MC1489	Integrated Circuit (Thru-hole Pkg)
U 901	3-00155-340	74HC04	Integrated Circuit (Thru-hole Pkg)
U 902	3-00645-340	NAT9914BPD	Integrated Circuit (Thru-hole Pkg)
U 903	3-00078-340	DS75160A	Integrated Circuit (Thru-hole Pkg)
U 904	3-00079-340	DS75161A	Integrated Circuit (Thru-hole Pkg)
U 905	3-00247-340	SCN2641	Integrated Circuit (Thru-hole Pkg)
U 906	3-00109-340	MC1488	Integrated Circuit (Thru-hole Pkg)
X 101	6-00068-620	24.000 MHZ	Crystal
X 902	6-00037-620	3.6864 MHZ	Crystal
Z 0	0-00158-000	60MM 24V	Hardware, Misc.
Z 0	0-00186-021	6-32X1-3/8PP	Screw, Panhead Phillips
Z 0	0-00187-021	4-40X1/4PP	Screw, Panhead Phillips

6-30 Parts Lists

CPU and Power Supply Board Assembly			
Ref. No.	SRS Part No.	Value	Component Description
Z 0	0-00231-043	#4 SHOULDER	Washer, nylon
Z 0	0-00246-043	#8 X 1/16	Washer, nylon
Z 0	0-00316-003	PLTFM-28	Insulators
Z 0	0-00477-021	8-32X1/2	Screw, Panhead Phillips
Z 0	0-00772-000	1.5" WIRE	Hardware, Misc.
Z 0	1-00087-131	2 PIN JUMPER	Connector, Female
Z 0	5-00262-548	.01U AXIAL	Capacitor, Ceramic, 50V,+80/-20% Z5U AX
Z 0	7-00501-720	SR830-8	Fabricated Part

Front and Rear Panel (844S, 844K, 84RTO) Board Parts List

This section includes the Keypad, Display and Rear Panel boards as well as the front and rear panel hardware.

Front and Rear Panel Assembly			
Ref. No.	SRS Part No.	Value	Component Description
B 1	3-00546-340	HDSP-4830	Integrated Circuit (Thru-hole Pkg)
B 2	3-00546-340	HDSP-4830	Integrated Circuit (Thru-hole Pkg)
B 3	3-00546-340	HDSP-4830	Integrated Circuit (Thru-hole Pkg)
B 4	3-00546-340	HDSP-4830	Integrated Circuit (Thru-hole Pkg)
B 5	3-00546-340	HDSP-4830	Integrated Circuit (Thru-hole Pkg)
B 6	3-00546-340	HDSP-4830	Integrated Circuit (Thru-hole Pkg)
B 7	3-00546-340	HDSP-4830	Integrated Circuit (Thru-hole Pkg)
B 8	3-00546-340	HDSP-4830	Integrated Circuit (Thru-hole Pkg)
B 9	3-00770-340	HDSP-4850	Integrated Circuit (Thru-hole Pkg)
B 10	3-00770-340	HDSP-4850	Integrated Circuit (Thru-hole Pkg)
C 1	5-00225-548	.1U AXIAL	Capacitor, Ceramic, 50V,+80/-20% Z5U AX
C 2	5-00219-529	.01U	Cap, Monolythic Ceramic, 50V, 20%, Z5U
C 3	5-00219-529	.01U	Cap, Monolythic Ceramic, 50V, 20%, Z5U
C 4	5-00219-529	.01U	Cap, Monolythic Ceramic, 50V, 20%, Z5U
C 5	5-00219-529	.01U	Cap, Monolythic Ceramic, 50V, 20%, Z5U
C 6	5-00219-529	.01U	Cap, Monolythic Ceramic, 50V, 20%, Z5U
C 7	5-00219-529	.01U	Cap, Monolythic Ceramic, 50V, 20%, Z5U
C 8	5-00219-529	.01U	Cap, Monolythic Ceramic, 50V, 20%, Z5U
C 9	5-00219-529	.01U	Cap, Monolythic Ceramic, 50V, 20%, Z5U
C 10	5-00219-529	.01U	Cap, Monolythic Ceramic, 50V, 20%, Z5U
C 11	5-00219-529	.01U	Cap, Monolythic Ceramic, 50V, 20%, Z5U
C 12	5-00219-529	.01U	Cap, Monolythic Ceramic, 50V, 20%, Z5U
C 13	5-00219-529	.01U	Cap, Monolythic Ceramic, 50V, 20%, Z5U
C 14	5-00219-529	.01U	Cap, Monolythic Ceramic, 50V, 20%, Z5U
C 15	5-00219-529	.01U	Cap, Monolythic Ceramic, 50V, 20%, Z5U
C 16	5-00219-529	.01U	Cap, Monolythic Ceramic, 50V, 20%, Z5U
C 17	5-00219-529	.01U	Cap, Monolythic Ceramic, 50V, 20%, Z5U
C 18	5-00225-548	.1U AXIAL	Capacitor, Ceramic, 50V,+80/-20% Z5U AX
C 19	5-00041-509	220U	Capacitor, Electrolytic, 50V, 20%, Rad
C 870	5-00363-552	10P	Capacitor, Chip (SMT1206), 50V, 5%, NPO
C 871	5-00363-552	10P	Capacitor, Chip (SMT1206), 50V, 5%, NPO
C 880	5-00219-529	.01U	Cap, Monolythic Ceramic, 50V, 20%, Z5U
C 881	5-00219-529	.01U	Cap, Monolythic Ceramic, 50V, 20%, Z5U
C 882	5-00219-529	.01U	Cap, Monolythic Ceramic, 50V, 20%, Z5U
C 883	5-00219-529	.01U	Cap, Monolythic Ceramic, 50V, 20%, Z5U
C 885	5-00219-529	.01U	Cap, Monolythic Ceramic, 50V, 20%, Z5U
C 890	5-00134-529	100P	Cap, Monolythic Ceramic, 50V, 20%, Z5U
C 891	5-00134-529	100P	Cap, Monolythic Ceramic, 50V, 20%, Z5U
C 894	5-00134-529	100P	Cap, Monolythic Ceramic, 50V, 20%, Z5U
D 0	3-00013-306	RED	LED, Rectangular
D 1	3-00013-306	RED	LED, Rectangular
D 2	3-00013-306	RED	LED, Rectangular
D 3	3-00175-306	YELLOW	LED, Rectangular
D 4	3-00175-306	YELLOW	LED, Rectangular
D 5	3-00175-306	YELLOW	LED, Rectangular

6-32 Parts Lists

Front and Rear Panel Assembly			
Ref. No.	SRS Part No.	Value	Component Description
D 11	3-00175-306	YELLOW	LED, Rectangular
D 13	3-00547-310	RED COATED	LED, Coated Rectangular
D 15	3-00547-310	RED COATED	LED, Coated Rectangular
D 20	3-00547-310	RED COATED	LED, Coated Rectangular
D 21	3-00547-310	RED COATED	LED, Coated Rectangular
D 22	3-00547-310	RED COATED	LED, Coated Rectangular
D 23	3-00547-310	RED COATED	LED, Coated Rectangular
D 24	3-00547-310	RED COATED	LED, Coated Rectangular
D 25	3-00175-306	YELLOW	LED, Rectangular
D 30	3-00175-306	YELLOW	LED, Rectangular
D 31	3-00175-306	YELLOW	LED, Rectangular
D 32	3-00175-306	YELLOW	LED, Rectangular
D 33	3-00175-306	YELLOW	LED, Rectangular
D 34	3-00175-306	YELLOW	LED, Rectangular
D 35	3-00013-306	RED	LED, Rectangular
D 40	3-00547-310	RED COATED	LED, Coated Rectangular
D 41	3-00547-310	RED COATED	LED, Coated Rectangular
D 42	3-00547-310	RED COATED	LED, Coated Rectangular
D 43	3-00175-306	YELLOW	LED, Rectangular
D 50	3-00547-310	RED COATED	LED, Coated Rectangular
D 51	3-00547-310	RED COATED	LED, Coated Rectangular
D 52	3-00547-310	RED COATED	LED, Coated Rectangular
D 53	3-00547-310	RED COATED	LED, Coated Rectangular
D 54	3-00547-310	RED COATED	LED, Coated Rectangular
D 55	3-00547-310	RED COATED	LED, Coated Rectangular
D 60	3-00175-306	YELLOW	LED, Rectangular
D 61	3-00175-306	YELLOW	LED, Rectangular
D 63	3-00175-306	YELLOW	LED, Rectangular
D 64	3-00175-306	YELLOW	LED, Rectangular
D 65	3-00175-306	YELLOW	LED, Rectangular
D 70	3-00547-310	RED COATED	LED, Coated Rectangular
D 71	3-00547-310	RED COATED	LED, Coated Rectangular
D 72	3-00547-310	RED COATED	LED, Coated Rectangular
D 73	3-00547-310	RED COATED	LED, Coated Rectangular
D 74	3-00175-306	YELLOW	LED, Rectangular
D 75	3-00175-306	YELLOW	LED, Rectangular
D 80	3-00004-301	1N4148	Diode
D 81	3-00004-301	1N4148	Diode
D 82	3-00004-301	1N4148	Diode
D 83	3-00004-301	1N4148	Diode
D 84	3-00004-301	1N4148	Diode
D 85	3-00004-301	1N4148	Diode
D 86	3-00004-301	1N4148	Diode
D 87	3-00004-301	1N4148	Diode
D 116	3-00575-311	GREEN MINI	LED, Subminiature
D 117	3-00575-311	GREEN MINI	LED, Subminiature
D 118	3-00575-311	GREEN MINI	LED, Subminiature
D 119	3-00575-311	GREEN MINI	LED, Subminiature
D 120	3-00575-311	GREEN MINI	LED, Subminiature
D 121	3-00575-311	GREEN MINI	LED, Subminiature

Front and Rear Panel Assembly			
Ref. No.	SRS Part No.	Value	Component Description
D 122	3-00575-311	GREEN MINI	LED, Subminiature
D 123	3-00575-311	GREEN MINI	LED, Subminiature
D 124	3-00576-311	RED MINI	LED, Subminiature
D 125	3-00575-311	GREEN MINI	LED, Subminiature
D 126	3-00575-311	GREEN MINI	LED, Subminiature
D 216	3-00576-311	RED MINI	LED, Subminiature
D 217	3-00576-311	RED MINI	LED, Subminiature
D 221	3-00769-311	YELLOW MINI	LED, Subminiature
D 222	3-00576-311	RED MINI	LED, Subminiature
D 223	3-00575-311	GREEN MINI	LED, Subminiature
D 224	3-00575-311	GREEN MINI	LED, Subminiature
D 225	3-00769-311	YELLOW MINI	LED, Subminiature
D 317	3-00575-311	GREEN MINI	LED, Subminiature
D 319	3-00575-311	GREEN MINI	LED, Subminiature
D 320	3-00575-311	GREEN MINI	LED, Subminiature
D 321	3-00575-311	GREEN MINI	LED, Subminiature
D 322	3-00575-311	GREEN MINI	LED, Subminiature
D 323	3-00575-311	GREEN MINI	LED, Subminiature
D 324	3-00575-311	GREEN MINI	LED, Subminiature
D 416	3-00575-311	GREEN MINI	LED, Subminiature
D 417	3-00575-311	GREEN MINI	LED, Subminiature
D 418	3-00575-311	GREEN MINI	LED, Subminiature
D 419	3-00575-311	GREEN MINI	LED, Subminiature
D 420	3-00575-311	GREEN MINI	LED, Subminiature
D 421	3-00575-311	GREEN MINI	LED, Subminiature
D 422	3-00575-311	GREEN MINI	LED, Subminiature
D 423	3-00575-311	GREEN MINI	LED, Subminiature
D 424	3-00575-311	GREEN MINI	LED, Subminiature
D 425	3-00576-311	RED MINI	LED, Subminiature
D 516	3-00575-311	GREEN MINI	LED, Subminiature
D 517	3-00575-311	GREEN MINI	LED, Subminiature
D 518	3-00575-311	GREEN MINI	LED, Subminiature
D 519	3-00575-311	GREEN MINI	LED, Subminiature
D 520	3-00575-311	GREEN MINI	LED, Subminiature
D 521	3-00575-311	GREEN MINI	LED, Subminiature
D 522	3-00575-311	GREEN MINI	LED, Subminiature
D 523	3-00575-311	GREEN MINI	LED, Subminiature
D 524	3-00575-311	GREEN MINI	LED, Subminiature
D 525	3-00576-311	RED MINI	LED, Subminiature
D 616	3-00576-311	RED MINI	LED, Subminiature
D 617	3-00575-311	GREEN MINI	LED, Subminiature
D 618	3-00575-311	GREEN MINI	LED, Subminiature
D 619	3-00575-311	GREEN MINI	LED, Subminiature
D 620	3-00575-311	GREEN MINI	LED, Subminiature
D 621	3-00575-311	GREEN MINI	LED, Subminiature
D 622	3-00575-311	GREEN MINI	LED, Subminiature
D 623	3-00575-311	GREEN MINI	LED, Subminiature
D 626	3-00769-311	YELLOW MINI	LED, Subminiature
D 716	3-00576-311	RED MINI	LED, Subminiature
D 717	3-00575-311	GREEN MINI	LED, Subminiature

6-34 Parts Lists

Front and Rear Panel Assembly			
Ref. No.	SRS Part No.	Value	Component Description
D 718	3-00575-311	GREEN MINI	LED, Subminiature
D 719	3-00576-311	RED MINI	LED, Subminiature
D 720	3-00575-311	GREEN MINI	LED, Subminiature
D 721	3-00575-311	GREEN MINI	LED, Subminiature
D 722	3-00575-311	GREEN MINI	LED, Subminiature
D 723	3-00575-311	GREEN MINI	LED, Subminiature
D 724	3-00575-311	GREEN MINI	LED, Subminiature
D 725	3-00575-311	GREEN MINI	LED, Subminiature
D 726	3-00575-311	GREEN MINI	LED, Subminiature
DO26	3-00575-311	GREEN MINI	LED, Subminiature
DO16	3-00575-311	GREEN MINI	LED, Subminiature
DO17	3-00575-311	GREEN MINI	LED, Subminiature
DO18	3-00575-311	GREEN MINI	LED, Subminiature
DO19	3-00575-311	GREEN MINI	LED, Subminiature
DO20	3-00575-311	GREEN MINI	LED, Subminiature
DO21	3-00576-311	RED MINI	LED, Subminiature
DO23	3-00575-311	GREEN MINI	LED, Subminiature
DO24	3-00575-311	GREEN MINI	LED, Subminiature
DO25	3-00575-311	GREEN MINI	LED, Subminiature
J 1	1-00202-131	36 PIN SI SOCK	Connector, Female
J 2	1-00202-131	36 PIN SI SOCK	Connector, Female
J 3	1-00203-131	12 PIN SI SOCK	Connector, Female
J 4	1-00203-131	12 PIN SI SOCK	Connector, Female
J 5	1-00203-131	12 PIN SI SOCK	Connector, Female
J 6	1-00204-130	36 PIN SI	Connector, Male
J 7	1-00204-130	36 PIN SI	Connector, Male
J 8	1-00205-130	12 PIN SI	Connector, Male
J 9	1-00205-130	12 PIN SI	Connector, Male
J 10	1-00205-130	12 PIN SI	Connector, Male
J 870	1-00073-120	INSL	Connector, BNC
J 871	1-00073-120	INSL	Connector, BNC
J 872	1-00073-120	INSL	Connector, BNC
J 873	1-00073-120	INSL	Connector, BNC
J 874	1-00073-120	INSL	Connector, BNC
J 875	1-00073-120	INSL	Connector, BNC
J 876	1-00170-130	26 PIN ELH	Connector, Male
J 877	1-00332-130	14 PIN ELH	Connector, Male
J 878	1-00331-131	14 PIN DI SSW	Connector, Female
JP4	1-00171-130	34 PIN ELH	Connector, Male
JP5	1-00138-130	5 PIN SI	Connector, Male
L 870	4-01577-461	15 - 1/2W	Thick Film, 5%, 200 ppm, Chip Resistor
L 871	4-00942-462	15	Thin Film, 1%, 50 ppm, MELF Resistor
N 1	4-00468-420	300X8	Resistor Network, DIP, 1/4W,2%,8 Ind
N 2	4-00468-420	300X8	Resistor Network, DIP, 1/4W,2%,8 Ind
N 3	4-00468-420	300X8	Resistor Network, DIP, 1/4W,2%,8 Ind
N 4	4-00835-420	47X8	Resistor Network, DIP, 1/4W,2%,8 Ind
N 5	4-00468-420	300X8	Resistor Network, DIP, 1/4W,2%,8 Ind
N 6	4-00468-420	300X8	Resistor Network, DIP, 1/4W,2%,8 Ind
N 7	4-00468-420	300X8	Resistor Network, DIP, 1/4W,2%,8 Ind
N 8	4-00468-420	300X8	Resistor Network, DIP, 1/4W,2%,8 Ind

Front and Rear Panel Assembly			
Ref. No.	SRS Part No.	Value	Component Description
N 9	4-00469-420	10X8	Resistor Network, DIP, 1/4W,2%,8 Ind
N 10	4-00246-421	47X3	Res. Network, SIP, 1/4W,2% (Isolated)
N 11	4-00421-420	220X7	Resistor Network, DIP, 1/4W,2%,8 Ind
N 12	4-00421-420	220X7	Resistor Network, DIP, 1/4W,2%,8 Ind
N 13	4-00263-425	1.0KX7	Resistor Network SIP 1/4W 2% (Common)
N 872	4-00247-425	100X9	Resistor Network SIP 1/4W 2% (Common)
N 873	4-00247-425	100X9	Resistor Network SIP 1/4W 2% (Common)
PC1	7-00608-701	SR844 KEYPAD	Printed Circuit Board
PC2	7-00609-701	SR844 DISPLAY	Printed Circuit Board
PC3	7-00792-701	SR844 RP	Printed Circuit Board
PC4	7-00794-701	SR844 SHIELD	Printed Circuit Board
Q 1	3-00264-340	MPQ3467	Integrated Circuit (Thru-hole Pkg)
Q 2	3-00264-340	MPQ3467	Integrated Circuit (Thru-hole Pkg)
R 1	4-00142-407	100K	Resistor, Metal Film, 1/8W, 1%, 50PPM
R 870	4-01181-462	4.64K	Thin Film, 1%, 50 ppm, MELF Resistor
R 871	4-01181-462	4.64K	Thin Film, 1%, 50 ppm, MELF Resistor
R 872	4-01213-462	10.0K	Thin Film, 1%, 50 ppm, MELF Resistor
T 0	6-00166-610	SR844	Transformer
U 0	3-00199-340	74HC4538	Integrated Circuit (Thru-hole Pkg)
U 1	3-00401-340	74HCT244	Integrated Circuit (Thru-hole Pkg)
U 2	3-00064-340	CA3081	Integrated Circuit (Thru-hole Pkg)
U 3	3-00064-340	CA3081	Integrated Circuit (Thru-hole Pkg)
U 4	3-00064-340	CA3081	Integrated Circuit (Thru-hole Pkg)
U 5	3-00064-340	CA3081	Integrated Circuit (Thru-hole Pkg)
U 6	3-00064-340	CA3081	Integrated Circuit (Thru-hole Pkg)
U 7	3-00548-340	74HCT574	Integrated Circuit (Thru-hole Pkg)
U 8	3-00548-340	74HCT574	Integrated Circuit (Thru-hole Pkg)
U 9	3-00548-340	74HCT574	Integrated Circuit (Thru-hole Pkg)
U 10	3-00548-340	74HCT574	Integrated Circuit (Thru-hole Pkg)
U 11	3-00548-340	74HCT574	Integrated Circuit (Thru-hole Pkg)
U 12	3-00548-340	74HCT574	Integrated Circuit (Thru-hole Pkg)
U 13	3-00548-340	74HCT574	Integrated Circuit (Thru-hole Pkg)
U 14	3-00289-340	HDSP-H107	Integrated Circuit (Thru-hole Pkg)
U 15	3-00288-340	HDSP-H101	Integrated Circuit (Thru-hole Pkg)
U 16	3-00288-340	HDSP-H101	Integrated Circuit (Thru-hole Pkg)
U 17	3-00288-340	HDSP-H101	Integrated Circuit (Thru-hole Pkg)
U 18	3-00288-340	HDSP-H101	Integrated Circuit (Thru-hole Pkg)
U 19	3-00289-340	HDSP-H107	Integrated Circuit (Thru-hole Pkg)
U 20	3-00288-340	HDSP-H101	Integrated Circuit (Thru-hole Pkg)
U 21	3-00288-340	HDSP-H101	Integrated Circuit (Thru-hole Pkg)
U 22	3-00288-340	HDSP-H101	Integrated Circuit (Thru-hole Pkg)
U 23	3-00288-340	HDSP-H101	Integrated Circuit (Thru-hole Pkg)
U 24	3-00289-340	HDSP-H107	Integrated Circuit (Thru-hole Pkg)
U 25	3-00288-340	HDSP-H101	Integrated Circuit (Thru-hole Pkg)
U 26	3-00288-340	HDSP-H101	Integrated Circuit (Thru-hole Pkg)
U 27	3-00288-340	HDSP-H101	Integrated Circuit (Thru-hole Pkg)
U 28	3-00288-340	HDSP-H101	Integrated Circuit (Thru-hole Pkg)
U 870	3-00781-360	NJM360	Integrated Circuit (Surface Mount Pkg)
U 871	3-00781-360	NJM360	Integrated Circuit (Surface Mount Pkg)
U 872	3-00751-360	74HC574	Integrated Circuit (Surface Mount Pkg)

6-36 Parts Lists

Front and Rear Panel Assembly			
Ref. No.	SRS Part No.	Value	Component Description
U 873	3-00751-360	74HC574	Integrated Circuit (Surface Mount Pkg)
Z 0	0-00014-002	6J4	Power_Entry Hardware
Z 0	0-00025-005	3/8"	Lugs
Z 0	0-00043-011	4-40 KEP	Nut, Kep
Z 0	0-00048-011	6-32 KEP	Nut, Kep
Z 0	0-00079-031	4-40X3/16 M/F	Standoff
Z 0	0-00097-040	#6 FLAT	Washer, Flat
Z 0	0-00104-043	#4 NYLON	Washer, nylon
Z 0	0-00125-050	3" #18	Wire #18 UL1007 Stripped 3/8x3/8 No Tin
Z 0	0-00127-050	4" #18	Wire #18 UL1007 Stripped 3/8x3/8 No Tin
Z 0	0-00130-050	5-5/8" #18	Wire #18 UL1007 Stripped 3/8x3/8 No Tin
Z 0	0-00149-020	4-40X1/4PF	Screw, Flathead Phillips
Z 0	0-00195-020	6-32X3/8PF	Screw, Flathead Phillips
Z 0	0-00209-021	4-40X3/8PP	Screw, Panhead Phillips
Z 0	0-00210-020	4-40X5/16PF	Screw, Flathead Phillips
Z 0	0-00212-021	6-32X2PP	Screw, Panhead Phillips
Z 0	0-00241-021	4-40X3/16PP	Screw, Panhead Phillips
Z 0	0-00256-043	#6 SHOULDER	Washer, nylon
Z 0	0-00299-000	1/8" ADHES TAPE	Hardware, Misc.
Z 0	0-00377-004	SR760/830/780	Knobs
Z 0	0-00378-004	CAP 760/830/780	Knobs
Z 0	0-00386-003	BNC BUSHING	Insulators
Z 0	0-00418-000	CLIP, CABLE	Hardware, Misc.
Z 0	0-00481-000	BUMPER/CORD WRP	Hardware, Misc.
Z 0	0-00483-000	FAN GUARD III	Hardware, Misc.
Z 0	0-00485-057	GROMMET	Grommet
Z 0	0-00486-000	CABLE	Hardware, Misc.
Z 0	0-00491-005	#10 SOLDER	Lugs
Z 0	0-00492-026	6-32X1/2FP BLK	Screw, Black, All Types
Z 0	0-00500-000	554808-1	Hardware, Misc.
Z 0	0-00517-000	BINDING POST	Hardware, Misc.
Z 0	0-00525-050	8-1/4" #18	Wire #18 UL1007 Stripped 3/8x3/8 No Tin
Z 0	0-00536-032	31894	Termination
Z 0	0-00665-063	4-40X3/16	Screw, Nylon
Z 0	0-00696-043	3/8X5/8 .032THK	Washer, nylon
Z 0	1-00132-171	34 COND	Cable Assembly, Ribbon
Z 0	1-00141-171	5 PIN SIL	Cable Assembly, Ribbon
Z 0	1-00153-113	11 PIN,18AWG/OR	Connector, Amp, MTA-156
Z 0	1-00252-171	34 COND	Cable Assembly, Ribbon
Z 0	1-00313-169	SR844 4" COAX	Cable Assembly, Custom
Z 0	1-00314-169	6.5" COAX	Cable Assembly, Custom
Z 0	1-00333-171	26 COND	Cable Assembly, Ribbon
Z 0	1-00334-169	26/16-10 IDC	Cable Assembly, Custom
Z 0	1-00335-169	6.25" COAX	Cable Assembly, Custom
Z 0	1-00344-130	3 PIN SI ZW	Connector, Male
Z 0	1-00345-130	3 PIN SI TLW	Connector, Male
Z 0	1-00347-169	SR844 3" COAX	Cable Assembly, Custom
Z 0	2-00034-220	ENA1J-B20	SOFTPOT
Z 0	4-00681-436	SG240	Thermistor, ICL (Inrush Current Limiter)
Z 0	6-00004-611	1A 3AG	Fuse

Front and Rear Panel Assembly			
Ref. No.	SRS Part No.	Value	Component Description
Z 0	7-00124-720	TRANSCOVER2-MOD	Fabricated Part
Z 0	7-00499-735	SR830-4/-5	Injection Molded Plastic
Z 0	7-00706-720	SR844-1	Fabricated Part
Z 0	7-00707-709	SR844-2	Lexan Overlay
Z 0	7-00709-740	SR844-5	Keypad, Conductive Rubber
Z 0	7-00790-720	SR844-10	Fabricated Part
Z 0	7-00791-709	SR844-12	Lexan Overlay
Z 0	7-00798-720	SR844-13	Fabricated Part
Z 0	9-00267-917	GENERIC	Product Labels
Z 872	5-00315-527	.1UF	Capacitor, Ceramic SMT1206, 50V, 20% Z5U
Z 873	5-00315-527	.1UF	Capacitor, Ceramic SMT1206, 50V, 20% Z5U
Z 874	5-00315-527	.1UF	Capacitor, Ceramic SMT1206, 50V, 20% Z5U

Motherboard (84MBD) Parts List

This section includes the components mounted on the Motherboard itself.

Motherboard Assembly			
Ref. No.	SRS Part No.	Value	Component Description
C 800	5-00382-552	390P	Capacitor, Chip (SMT1206), 50V, 5%, NPO
C 807	5-00298-568	.01U	Cap, Ceramic 50V SMT (1206) +/-10% X7R
C 813	5-00367-552	22P	Capacitor, Chip (SMT1206), 50V, 5%, NPO
C 820	5-00375-552	100P	Capacitor, Chip (SMT1206), 50V, 5%, NPO
C 821	5-00375-552	100P	Capacitor, Chip (SMT1206), 50V, 5%, NPO
C 824	5-00382-552	390P	Capacitor, Chip (SMT1206), 50V, 5%, NPO
C 849	5-00367-552	22P	Capacitor, Chip (SMT1206), 50V, 5%, NPO
C 851	5-00379-552	220P	Capacitor, Chip (SMT1206), 50V, 5%, NPO
C 852	5-00298-568	.01U	Cap, Ceramic 50V SMT (1206) +/-10% X7R
E 21	5-00260-544	470U	Cap, Mini Electrolytic, 25V, 20%, Radial
E 23	5-00260-544	470U	Cap, Mini Electrolytic, 25V, 20%, Radial
E 26	5-00260-544	470U	Cap, Mini Electrolytic, 25V, 20%, Radial
E 29	5-00260-544	470U	Cap, Mini Electrolytic, 25V, 20%, Radial
E 35	5-00260-544	470U	Cap, Mini Electrolytic, 25V, 20%, Radial
E 37	5-00260-544	470U	Cap, Mini Electrolytic, 25V, 20%, Radial
E 44	5-00260-544	470U	Cap, Mini Electrolytic, 25V, 20%, Radial
E 45	5-00260-544	470U	Cap, Mini Electrolytic, 25V, 20%, Radial
E 50	5-00260-544	470U	Cap, Mini Electrolytic, 25V, 20%, Radial
E 51	5-00260-544	470U	Cap, Mini Electrolytic, 25V, 20%, Radial
E 65	5-00260-544	470U	Cap, Mini Electrolytic, 25V, 20%, Radial
E 67	5-00260-544	470U	Cap, Mini Electrolytic, 25V, 20%, Radial
E 826	5-00260-544	470U	Cap, Mini Electrolytic, 25V, 20%, Radial
F 3	5-00318-569	2.2U/T35	Cap, Tantalum, SMT (all case sizes)
F 4	5-00318-569	2.2U/T35	Cap, Tantalum, SMT (all case sizes)
F 5	5-00470-569	2.2U/T16	Cap, Tantalum, SMT (all case sizes)
F 9	5-00470-569	2.2U/T16	Cap, Tantalum, SMT (all case sizes)
F 10	5-00318-569	2.2U/T35	Cap, Tantalum, SMT (all case sizes)
F 11	5-00318-569	2.2U/T35	Cap, Tantalum, SMT (all case sizes)
F 20	5-00470-569	2.2U/T16	Cap, Tantalum, SMT (all case sizes)
F 22	5-00318-569	2.2U/T35	Cap, Tantalum, SMT (all case sizes)
F 28	5-00319-569	10U/T35	Cap, Tantalum, SMT (all case sizes)
F 35	5-00470-569	2.2U/T16	Cap, Tantalum, SMT (all case sizes)
F 44	5-00470-569	2.2U/T16	Cap, Tantalum, SMT (all case sizes)
F 45	5-00470-569	2.2U/T16	Cap, Tantalum, SMT (all case sizes)
F 50	5-00470-569	2.2U/T16	Cap, Tantalum, SMT (all case sizes)
F 51	5-00470-569	2.2U/T16	Cap, Tantalum, SMT (all case sizes)
F 54	5-00471-569	10U/T16	Cap, Tantalum, SMT (all case sizes)
F 55	5-00470-569	2.2U/T16	Cap, Tantalum, SMT (all case sizes)
F 58	5-00318-569	2.2U/T35	Cap, Tantalum, SMT (all case sizes)
F 59	5-00318-569	2.2U/T35	Cap, Tantalum, SMT (all case sizes)
F 60	5-00318-569	2.2U/T35	Cap, Tantalum, SMT (all case sizes)
F 61	5-00318-569	2.2U/T35	Cap, Tantalum, SMT (all case sizes)
F 62	5-00318-569	2.2U/T35	Cap, Tantalum, SMT (all case sizes)
F 63	5-00318-569	2.2U/T35	Cap, Tantalum, SMT (all case sizes)
F 64	5-00318-569	2.2U/T35	Cap, Tantalum, SMT (all case sizes)

Motherboard Assembly			
Ref. No.	SRS Part No.	Value	Component Description
F 67	5-00470-569	2.2U/T16	Cap, Tantalum, SMT (all case sizes)
F 75	5-00318-569	2.2U/T35	Cap, Tantalum, SMT (all case sizes)
F 76	5-00318-569	2.2U/T35	Cap, Tantalum, SMT (all case sizes)
F 77	5-00318-569	2.2U/T35	Cap, Tantalum, SMT (all case sizes)
F 78	5-00318-569	2.2U/T35	Cap, Tantalum, SMT (all case sizes)
F 79	5-00318-569	2.2U/T35	Cap, Tantalum, SMT (all case sizes)
F 80	5-00318-569	2.2U/T35	Cap, Tantalum, SMT (all case sizes)
F 81	5-00318-569	2.2U/T35	Cap, Tantalum, SMT (all case sizes)
F 82	5-00318-569	2.2U/T35	Cap, Tantalum, SMT (all case sizes)
F 83	5-00318-569	2.2U/T35	Cap, Tantalum, SMT (all case sizes)
F 84	5-00318-569	2.2U/T35	Cap, Tantalum, SMT (all case sizes)
F 85	5-00318-569	2.2U/T35	Cap, Tantalum, SMT (all case sizes)
F 86	5-00318-569	2.2U/T35	Cap, Tantalum, SMT (all case sizes)
F 87	5-00318-569	2.2U/T35	Cap, Tantalum, SMT (all case sizes)
F 88	5-00319-569	10U/T35	Cap, Tantalum, SMT (all case sizes)
F 89	5-00319-569	10U/T35	Cap, Tantalum, SMT (all case sizes)
F 90	5-00318-569	2.2U/T35	Cap, Tantalum, SMT (all case sizes)
F 91	5-00318-569	2.2U/T35	Cap, Tantalum, SMT (all case sizes)
F 92	5-00318-569	2.2U/T35	Cap, Tantalum, SMT (all case sizes)
F 93	5-00318-569	2.2U/T35	Cap, Tantalum, SMT (all case sizes)
F 94	5-00318-569	2.2U/T35	Cap, Tantalum, SMT (all case sizes)
F 95	5-00318-569	2.2U/T35	Cap, Tantalum, SMT (all case sizes)
F 96	5-00318-569	2.2U/T35	Cap, Tantalum, SMT (all case sizes)
F 97	5-00318-569	2.2U/T35	Cap, Tantalum, SMT (all case sizes)
F 800	5-00471-569	10U/T16	Cap, Tantalum, SMT (all case sizes)
F 826	5-00470-569	2.2U/T16	Cap, Tantalum, SMT (all case sizes)
F 830	5-00318-569	2.2U/T35	Cap, Tantalum, SMT (all case sizes)
F 831	5-00318-569	2.2U/T35	Cap, Tantalum, SMT (all case sizes)
F 832	5-00470-569	2.2U/T16	Cap, Tantalum, SMT (all case sizes)
F 833	5-00470-569	2.2U/T16	Cap, Tantalum, SMT (all case sizes)
J 2	1-00328-130	16 PIN ELH	Connector, Male
J 3	1-00170-130	26 PIN ELH	Connector, Male
J 4	1-00171-130	34 PIN ELH	Connector, Male
J 5	1-00307-141	STRAIGHT JACK	SMB Connector
J 6	1-00307-141	STRAIGHT JACK	SMB Connector
J 10	1-00302-131	6 PIN DIF CES	Connector, Female
J 12	1-00304-131	10 PIN DIF CES	Connector, Female
J 13	1-00304-131	10 PIN DIF CES	Connector, Female
J 14	1-00304-131	10 PIN DIF CES	Connector, Female
J 16	1-00301-131	4 PIN DIF CES	Connector, Female
J 17	1-00301-131	4 PIN DIF CES	Connector, Female
J 20	1-00305-131	14 PIN DIF CES	Connector, Female
J 21	1-00301-131	4 PIN DIF CES	Connector, Female
J 30	1-00305-131	14 PIN DIF CES	Connector, Female
J 31	1-00303-131	8 PIN DIF CES	Connector, Female
J 33	1-00304-131	10 PIN DIF CES	Connector, Female
J 40	1-00303-131	8 PIN DIF CES	Connector, Female
J 41	1-00303-131	8 PIN DIF CES	Connector, Female
J 42	1-00304-131	10 PIN DIF CES	Connector, Female
J 43	1-00302-131	6 PIN DIF CES	Connector, Female

6-40 Parts Lists

Motherboard Assembly			
Ref. No.	SRS Part No.	Value	Component Description
J 44	1-00301-131	4 PIN DIF CES	Connector, Female
J 45	1-00301-131	4 PIN DIF CES	Connector, Female
J 61	1-00305-131	14 PIN DIF CES	Connector, Female
J 62	1-00301-131	4 PIN DIF CES	Connector, Female
J 63	1-00301-131	4 PIN DIF CES	Connector, Female
J 64	1-00301-131	4 PIN DIF CES	Connector, Female
J 65	1-00301-131	4 PIN DIF CES	Connector, Female
J 66	1-00303-131	8 PIN DIF CES	Connector, Female
J 67	1-00301-131	4 PIN DIF CES	Connector, Female
J 68	1-00301-131	4 PIN DIF CES	Connector, Female
J 69	1-00301-131	4 PIN DIF CES	Connector, Female
J 70	1-00304-131	10 PIN DIF CES	Connector, Female
J 71	1-00302-131	6 PIN DIF CES	Connector, Female
J 90	1-00306-131	40 PIN DIF CES	Connector, Female
J 91	1-00304-131	10 PIN DIF CES	Connector, Female
J 92	1-00305-131	14 PIN DIF CES	Connector, Female
J 93	1-00301-131	4 PIN DIF CES	Connector, Female
J 94	1-00305-131	14 PIN DIF CES	Connector, Female
L 1	6-00243-609	15UH	Inductor, Fixed, SMT
L 2	6-00237-631	FR95	Ferrite bead, SMT
L 3	6-00237-631	FR95	Ferrite bead, SMT
L 4	6-00237-631	FR95	Ferrite bead, SMT
L 7	6-00237-631	FR95	Ferrite bead, SMT
L 8	6-00237-631	FR95	Ferrite bead, SMT
L 10	6-00237-631	FR95	Ferrite bead, SMT
L 11	6-00237-631	FR95	Ferrite bead, SMT
L 20	6-00236-631	FR47	Ferrite bead, SMT
L 23	6-00236-631	FR47	Ferrite bead, SMT
L 24	6-00236-631	FR47	Ferrite bead, SMT
L 26	6-00236-631	FR47	Ferrite bead, SMT
L 29	6-00243-609	15UH	Inductor, Fixed, SMT
L 33	6-00236-631	FR47	Ferrite bead, SMT
L 35	6-00236-631	FR47	Ferrite bead, SMT
L 40	6-00236-631	FR47	Ferrite bead, SMT
L 41	6-00236-631	FR47	Ferrite bead, SMT
L 44	6-00236-631	FR47	Ferrite bead, SMT
L 45	6-00236-631	FR47	Ferrite bead, SMT
L 46	6-00236-631	FR47	Ferrite bead, SMT
L 47	6-00237-631	FR95	Ferrite bead, SMT
L 50	6-00236-631	FR47	Ferrite bead, SMT
L 51	6-00237-631	FR95	Ferrite bead, SMT
L 54	6-00243-609	15UH	Inductor, Fixed, SMT
L 55	6-00243-609	15UH	Inductor, Fixed, SMT
L 58	6-00236-631	FR47	Ferrite bead, SMT
L 59	6-00236-631	FR47	Ferrite bead, SMT
L 60	6-00236-631	FR47	Ferrite bead, SMT
L 61	6-00236-631	FR47	Ferrite bead, SMT
L 64	6-00236-631	FR47	Ferrite bead, SMT
L 65	6-00237-631	FR95	Ferrite bead, SMT
L 67	6-00237-631	FR95	Ferrite bead, SMT

Motherboard Assembly			
Ref. No.	SRS Part No.	Value	Component Description
L 75	6-00236-631	FR47	Ferrite bead, SMT
L 84	6-00236-631	FR47	Ferrite bead, SMT
L 85	6-00236-631	FR47	Ferrite bead, SMT
L 88	6-00236-631	FR47	Ferrite bead, SMT
L 89	6-00236-631	FR47	Ferrite bead, SMT
L 800	6-00236-631	FR47	Ferrite bead, SMT
L 825	6-00243-609	15UH	Inductor, Fixed, SMT
L 826	6-00236-631	FR47	Ferrite bead, SMT
L 832	6-00236-631	FR47	Ferrite bead, SMT
N 71	4-00910-463	1.0KX4D	Resistor network, SMT, Leadless
N 75	4-00903-425	47X5	Resistor Network SIP 1/4W 2% (Common)
N 800	4-00908-463	270X4D	Resistor network, SMT, Leadless
N 801	4-00908-463	270X4D	Resistor network, SMT, Leadless
N 802	4-00910-463	1.0KX4D	Resistor network, SMT, Leadless
N 803	4-00910-463	1.0KX4D	Resistor network, SMT, Leadless
N 804	4-00911-463	4.7KX4D	Resistor network, SMT, Leadless
N 805	4-00909-463	470X4D	Resistor network, SMT, Leadless
N 806	4-00910-463	1.0KX4D	Resistor network, SMT, Leadless
N 807	4-00910-463	1.0KX4D	Resistor network, SMT, Leadless
N 808	4-00910-463	1.0KX4D	Resistor network, SMT, Leadless
N 809	4-00910-463	1.0KX4D	Resistor network, SMT, Leadless
N 810	4-00910-463	1.0KX4D	Resistor network, SMT, Leadless
N 840	4-00911-463	4.7KX4D	Resistor network, SMT, Leadless
N 841	4-00911-463	4.7KX4D	Resistor network, SMT, Leadless
N 842	4-00911-463	4.7KX4D	Resistor network, SMT, Leadless
N 852	4-00910-463	1.0KX4D	Resistor network, SMT, Leadless
N 853	4-00910-463	1.0KX4D	Resistor network, SMT, Leadless
N 854	4-00910-463	1.0KX4D	Resistor network, SMT, Leadless
N 855	4-00910-463	1.0KX4D	Resistor network, SMT, Leadless
P 840	4-00879-441	2.0K	Pot, Multi-Turn Trim, 3/8" Square Top Ad
P 841	4-00879-441	2.0K	Pot, Multi-Turn Trim, 3/8" Square Top Ad
P 842	4-00879-441	2.0K	Pot, Multi-Turn Trim, 3/8" Square Top Ad
PC1	7-00585-701	SR844 MOTHER	Printed Circuit Board
R 20	4-01430-461	9.1	Thick Film, 5%, 200 ppm, Chip Resistor
R 24	4-01407-461	1	Thick Film, 5%, 200 ppm, Chip Resistor
R 27	4-01445-461	39	Thick Film, 5%, 200 ppm, Chip Resistor
R 28	4-01053-462	215	Thin Film, 1%, 50 ppm, MELF Resistor
R 29	4-01053-462	215	Thin Film, 1%, 50 ppm, MELF Resistor
R 30	4-01175-462	4.02K	Thin Film, 1%, 50 ppm, MELF Resistor
R 31	4-01511-461	22K	Thick Film, 5%, 200 ppm, Chip Resistor
R 32	4-01470-461	430	Thick Film, 5%, 200 ppm, Chip Resistor
R 33	4-01407-461	1	Thick Film, 5%, 200 ppm, Chip Resistor
R 36	4-01445-461	39	Thick Film, 5%, 200 ppm, Chip Resistor
R 37	4-01445-461	39	Thick Film, 5%, 200 ppm, Chip Resistor
R 38	4-01445-461	39	Thick Film, 5%, 200 ppm, Chip Resistor
R 40	4-01407-461	1	Thick Film, 5%, 200 ppm, Chip Resistor
R 41	4-01431-461	10	Thick Film, 5%, 200 ppm, Chip Resistor
R 42	4-01407-461	1	Thick Film, 5%, 200 ppm, Chip Resistor
R 46	4-01430-461	9.1	Thick Film, 5%, 200 ppm, Chip Resistor
R 54	4-01419-461	3.3	Thick Film, 5%, 200 ppm, Chip Resistor

6-42 Parts Lists

Motherboard Assembly			
Ref. No.	SRS Part No.	Value	Component Description
R 55	4-01428-461	7.5	Thick Film, 5%, 200 ppm, Chip Resistor
R 56	4-01419-461	3.3	Thick Film, 5%, 200 ppm, Chip Resistor
R 57	4-01431-461	10	Thick Film, 5%, 200 ppm, Chip Resistor
R 58	4-01419-461	3.3	Thick Film, 5%, 200 ppm, Chip Resistor
R 59	4-01419-461	3.3	Thick Film, 5%, 200 ppm, Chip Resistor
R 60	4-01430-461	9.1	Thick Film, 5%, 200 ppm, Chip Resistor
R 61	4-01430-461	9.1	Thick Film, 5%, 200 ppm, Chip Resistor
R 62	4-01053-462	215	Thin Film, 1%, 50 ppm, MELF Resistor
R 63	4-01150-462	2.21K	Thin Film, 1%, 50 ppm, MELF Resistor
R 64	4-01150-462	2.21K	Thin Film, 1%, 50 ppm, MELF Resistor
R 65	4-01053-462	215	Thin Film, 1%, 50 ppm, MELF Resistor
R 68	4-01407-461	1	Thick Film, 5%, 200 ppm, Chip Resistor
R 69	4-01455-461	100	Thick Film, 5%, 200 ppm, Chip Resistor
R 70	4-01455-461	100	Thick Film, 5%, 200 ppm, Chip Resistor
R 71	4-01455-461	100	Thick Film, 5%, 200 ppm, Chip Resistor
R 72	4-01455-461	100	Thick Film, 5%, 200 ppm, Chip Resistor
R 73	4-01455-461	100	Thick Film, 5%, 200 ppm, Chip Resistor
R 74	4-01050-462	200	Thin Film, 1%, 50 ppm, MELF Resistor
R 75	4-01053-462	215	Thin Film, 1%, 50 ppm, MELF Resistor
R 76	4-01059-462	249	Thin Film, 1%, 50 ppm, MELF Resistor
R 77	4-01124-462	1.18K	Thin Film, 1%, 50 ppm, MELF Resistor
R 78	4-01423-461	4.7	Thick Film, 5%, 200 ppm, Chip Resistor
R 79	4-01407-461	1	Thick Film, 5%, 200 ppm, Chip Resistor
R 81	4-01407-461	1	Thick Film, 5%, 200 ppm, Chip Resistor
R 82	4-01053-462	215	Thin Film, 1%, 50 ppm, MELF Resistor
R 83	4-01053-462	215	Thin Film, 1%, 50 ppm, MELF Resistor
R 84	4-01150-462	2.21K	Thin Film, 1%, 50 ppm, MELF Resistor
R 85	4-01150-462	2.21K	Thin Film, 1%, 50 ppm, MELF Resistor
R 86	4-01407-461	1	Thick Film, 5%, 200 ppm, Chip Resistor
R 87	4-01407-461	1	Thick Film, 5%, 200 ppm, Chip Resistor
R 88	4-01407-461	1	Thick Film, 5%, 200 ppm, Chip Resistor
R 89	4-01407-461	1	Thick Film, 5%, 200 ppm, Chip Resistor
R 90	4-01053-462	215	Thin Film, 1%, 50 ppm, MELF Resistor
R 91	4-01053-462	215	Thin Film, 1%, 50 ppm, MELF Resistor
R 92	4-01150-462	2.21K	Thin Film, 1%, 50 ppm, MELF Resistor
R 93	4-01150-462	2.21K	Thin Film, 1%, 50 ppm, MELF Resistor
R 94	4-00950-462	18.2	Thin Film, 1%, 50 ppm, MELF Resistor
R 95	4-00950-462	18.2	Thin Film, 1%, 50 ppm, MELF Resistor
R 96	4-00950-462	18.2	Thin Film, 1%, 50 ppm, MELF Resistor
R 97	4-00950-462	18.2	Thin Film, 1%, 50 ppm, MELF Resistor
R 99	4-01181-462	4.64K	Thin Film, 1%, 50 ppm, MELF Resistor
R 800	4-01465-461	270	Thick Film, 5%, 200 ppm, Chip Resistor
R 802	4-01053-462	215	Thin Film, 1%, 50 ppm, MELF Resistor
R 803	4-01053-462	215	Thin Film, 1%, 50 ppm, MELF Resistor
R 804	4-01053-462	215	Thin Film, 1%, 50 ppm, MELF Resistor
R 805	4-01053-462	215	Thin Film, 1%, 50 ppm, MELF Resistor
R 806	4-01053-462	215	Thin Film, 1%, 50 ppm, MELF Resistor
R 813	4-01181-462	4.64K	Thin Film, 1%, 50 ppm, MELF Resistor
R 814	4-01181-462	4.64K	Thin Film, 1%, 50 ppm, MELF Resistor
R 815	4-01181-462	4.64K	Thin Film, 1%, 50 ppm, MELF Resistor

Motherboard Assembly			
Ref. No.	SRS Part No.	Value	Component Description
R 820	4-01455-461	100	Thick Film, 5%, 200 ppm, Chip Resistor
R 821	4-01181-462	4.64K	Thin Film, 1%, 50 ppm, MELF Resistor
R 822	4-01471-461	470	Thick Film, 5%, 200 ppm, Chip Resistor
R 823	4-01471-461	470	Thick Film, 5%, 200 ppm, Chip Resistor
R 824	4-01511-461	22K	Thick Film, 5%, 200 ppm, Chip Resistor
R 826	4-01431-461	10	Thick Film, 5%, 200 ppm, Chip Resistor
R 830	4-01035-462	140	Thin Film, 1%, 50 ppm, MELF Resistor
R 832	4-01431-461	10	Thick Film, 5%, 200 ppm, Chip Resistor
R 840	4-01146-462	2.00K	Thin Film, 1%, 50 ppm, MELF Resistor
R 841	4-01405-462	1.00M	Thin Film, 1%, 50 ppm, MELF Resistor
R 842	4-01405-462	1.00M	Thin Film, 1%, 50 ppm, MELF Resistor
R 843	4-01557-461	1.8M	Thick Film, 5%, 200 ppm, Chip Resistor
R 848	4-01181-462	4.64K	Thin Film, 1%, 50 ppm, MELF Resistor
R 849	4-01471-461	470	Thick Film, 5%, 200 ppm, Chip Resistor
R 851	4-01470-461	430	Thick Film, 5%, 200 ppm, Chip Resistor
R 852	4-01511-461	22K	Thick Film, 5%, 200 ppm, Chip Resistor
SP0	3-00112-329	7805	Voltage Reg., TO-220 (TAB) Package
U 20	3-00112-329	7805	Voltage Reg., TO-220 (TAB) Package
U 22	3-00710-360	78L08	Integrated Circuit (Surface Mount Pkg)
U 24	3-00764-329	7905.2	Voltage Reg., TO-220 (TAB) Package
U 28	3-00765-329	LT317A	Voltage Reg., TO-220 (TAB) Package
U 34	3-00764-329	7905.2	Voltage Reg., TO-220 (TAB) Package
U 42	3-00112-329	7805	Voltage Reg., TO-220 (TAB) Package
U 43	3-00715-329	79M05	Voltage Reg., TO-220 (TAB) Package
U 48	3-00112-329	7805	Voltage Reg., TO-220 (TAB) Package
U 49	3-00764-329	7905.2	Voltage Reg., TO-220 (TAB) Package
U 54	3-00112-329	7805	Voltage Reg., TO-220 (TAB) Package
U 55	3-00715-329	79M05	Voltage Reg., TO-220 (TAB) Package
U 60	3-00149-329	LM317T	Voltage Reg., TO-220 (TAB) Package
U 61	3-00141-329	LM337T	Voltage Reg., TO-220 (TAB) Package
U 63	3-00712-360	79L05	Integrated Circuit (Surface Mount Pkg)
U 66	3-00764-329	7905.2	Voltage Reg., TO-220 (TAB) Package
U 76	3-00141-329	LM337T	Voltage Reg., TO-220 (TAB) Package
U 80	3-00149-329	LM317T	Voltage Reg., TO-220 (TAB) Package
U 81	3-00141-329	LM337T	Voltage Reg., TO-220 (TAB) Package
U 84	3-00714-329	78M12	Voltage Reg., TO-220 (TAB) Package
U 85	3-00716-329	79M12	Voltage Reg., TO-220 (TAB) Package
U 90	3-00149-329	LM317T	Voltage Reg., TO-220 (TAB) Package
U 91	3-00141-329	LM337T	Voltage Reg., TO-220 (TAB) Package
U 94	3-00714-329	78M12	Voltage Reg., TO-220 (TAB) Package
U 95	3-00716-329	79M12	Voltage Reg., TO-220 (TAB) Package
U 800	3-00746-360	74HC245	Integrated Circuit (Surface Mount Pkg)
U 801	3-00750-360	74HC573	Integrated Circuit (Surface Mount Pkg)
U 802	3-00743-360	SN74HC138D	Integrated Circuit (Surface Mount Pkg)
U 803	3-00743-360	SN74HC138D	Integrated Circuit (Surface Mount Pkg)
U 804	3-00741-360	74HC04	Integrated Circuit (Surface Mount Pkg)
U 805	3-00663-360	74HC08	Integrated Circuit (Surface Mount Pkg)
U 807	3-00750-360	74HC573	Integrated Circuit (Surface Mount Pkg)
U 808	3-00750-360	74HC573	Integrated Circuit (Surface Mount Pkg)
U 809	3-00750-360	74HC573	Integrated Circuit (Surface Mount Pkg)

6-44 Parts Lists

Motherboard Assembly			
Ref. No.	SRS Part No.	Value	Component Description
U 810	3-00747-360	74HC273	Integrated Circuit (Surface Mount Pkg)
U 811	3-00747-360	74HC273	Integrated Circuit (Surface Mount Pkg)
U 812	3-00747-360	74HC273	Integrated Circuit (Surface Mount Pkg)
U 813	3-00844-361	SR844 U813	GAL/PAL, SMT
U 820	3-00560-360	MC145191F	Integrated Circuit (Surface Mount Pkg)
U 821	6-00238-621	20.000MHZ OSC8	Crystal Oscillator
U 822	3-00782-360	74HC02	Integrated Circuit (Surface Mount Pkg)
U 824	3-00709-360	78L05	Integrated Circuit (Surface Mount Pkg)
U 830	3-00602-360	78L12	Integrated Circuit (Surface Mount Pkg)
U 832	3-00112-329	7805	Voltage Reg., TO-220 (TAB) Package
U 840	3-00727-360	LM339	Integrated Circuit (Surface Mount Pkg)
U 848	3-00845-361	SR844 U848	GAL/PAL, SMT
U 849	3-00171-340	74HC191	Integrated Circuit (Thru-hole Pkg)
U 850	3-00745-360	74HC175	Integrated Circuit (Surface Mount Pkg)
U 851	3-00782-360	74HC02	Integrated Circuit (Surface Mount Pkg)
U 852	3-00754-360	74LS123	Integrated Circuit (Surface Mount Pkg)
U 853	3-00749-360	74HC541	Integrated Circuit (Surface Mount Pkg)
U 854	3-00749-360	74HC541	Integrated Circuit (Surface Mount Pkg)
V 22	4-01461-461	180	Thick Film, 5%, 200 ppm, Chip Resistor
V 23	4-01461-461	180	Thick Film, 5%, 200 ppm, Chip Resistor
V 36	4-01461-461	180	Thick Film, 5%, 200 ppm, Chip Resistor
V 37	4-01461-461	180	Thick Film, 5%, 200 ppm, Chip Resistor
Z 0	0-00043-011	4-40 KEP	Nut, Kep
Z 0	0-00104-043	#4 NYLON	Washer, nylon
Z 0	0-00209-021	4-40X3/8PP	Screw, Panhead Phillips
Z 0	0-00210-020	4-40X5/16PF	Screw, Flathead Phillips
Z 0	0-00231-043	#4 SHOULDER	Washer, nylon
Z 0	0-00299-000	1/8" ADHES TAPE	Hardware, Misc.
Z 0	0-00447-007	TO-220	Heat Sinks
Z 0	0-00619-031	4-40X11/16 M/F	Standoff
Z 0	0-00651-003	SR844-11	Insulators
Z 0	0-00661-040	.016 FLAT	Washer, Flat
Z 0	0-00662-031	4-40X5/16 M/F	Standoff
Z 0	0-00663-031	4-40X7/16 M/F	Standoff
Z 0	1-00143-101	TEST JACK	Vertical Test Jack
Z 0	7-00754-720	SR844-8	Fabricated Part
Z 0	7-00755-720	SR844-9	Fabricated Part
Z 0	7-00803-720	SR844-14	Fabricated Part
Z 1	5-00315-527	.1UF	Capacitor, Ceramic SMT1206, 50V, 20% Z5U
Z 3	5-00315-527	.1UF	Capacitor, Ceramic SMT1206, 50V, 20% Z5U
Z 6	5-00315-527	.1UF	Capacitor, Ceramic SMT1206, 50V, 20% Z5U
Z 7	5-00315-527	.1UF	Capacitor, Ceramic SMT1206, 50V, 20% Z5U
Z 8	5-00315-527	.1UF	Capacitor, Ceramic SMT1206, 50V, 20% Z5U
Z 10	5-00315-527	.1UF	Capacitor, Ceramic SMT1206, 50V, 20% Z5U
Z 20	5-00315-527	.1UF	Capacitor, Ceramic SMT1206, 50V, 20% Z5U
Z 21	5-00315-527	.1UF	Capacitor, Ceramic SMT1206, 50V, 20% Z5U
Z 22	5-00315-527	.1UF	Capacitor, Ceramic SMT1206, 50V, 20% Z5U
Z 23	5-00315-527	.1UF	Capacitor, Ceramic SMT1206, 50V, 20% Z5U
Z 24	5-00315-527	.1UF	Capacitor, Ceramic SMT1206, 50V, 20% Z5U
Z 25	5-00315-527	.1UF	Capacitor, Ceramic SMT1206, 50V, 20% Z5U

6-46 Parts Lists

Motherboard Assembly			
Ref. No.	SRS Part No.	Value	Component Description
Z 804	5-00315-527	.1UF	Capacitor, Ceramic SMT1206, 50V, 20% Z5U
Z 805	5-00315-527	.1UF	Capacitor, Ceramic SMT1206, 50V, 20% Z5U
Z 807	5-00315-527	.1UF	Capacitor, Ceramic SMT1206, 50V, 20% Z5U
Z 808	5-00315-527	.1UF	Capacitor, Ceramic SMT1206, 50V, 20% Z5U
Z 809	5-00315-527	.1UF	Capacitor, Ceramic SMT1206, 50V, 20% Z5U
Z 810	5-00315-527	.1UF	Capacitor, Ceramic SMT1206, 50V, 20% Z5U
Z 811	5-00315-527	.1UF	Capacitor, Ceramic SMT1206, 50V, 20% Z5U
Z 812	5-00315-527	.1UF	Capacitor, Ceramic SMT1206, 50V, 20% Z5U
Z 813	5-00315-527	.1UF	Capacitor, Ceramic SMT1206, 50V, 20% Z5U
Z 820	5-00315-527	.1UF	Capacitor, Ceramic SMT1206, 50V, 20% Z5U
Z 821	5-00315-527	.1UF	Capacitor, Ceramic SMT1206, 50V, 20% Z5U
Z 822	5-00315-527	.1UF	Capacitor, Ceramic SMT1206, 50V, 20% Z5U
Z 823	5-00315-527	.1UF	Capacitor, Ceramic SMT1206, 50V, 20% Z5U
Z 824	5-00315-527	.1UF	Capacitor, Ceramic SMT1206, 50V, 20% Z5U
Z 825	5-00315-527	.1UF	Capacitor, Ceramic SMT1206, 50V, 20% Z5U
Z 826	5-00315-527	.1UF	Capacitor, Ceramic SMT1206, 50V, 20% Z5U
Z 831	5-00315-527	.1UF	Capacitor, Ceramic SMT1206, 50V, 20% Z5U
Z 832	5-00315-527	.1UF	Capacitor, Ceramic SMT1206, 50V, 20% Z5U
Z 833	5-00315-527	.1UF	Capacitor, Ceramic SMT1206, 50V, 20% Z5U
Z 834	5-00315-527	.1UF	Capacitor, Ceramic SMT1206, 50V, 20% Z5U
Z 848	5-00315-527	.1UF	Capacitor, Ceramic SMT1206, 50V, 20% Z5U
Z 850	5-00315-527	.1UF	Capacitor, Ceramic SMT1206, 50V, 20% Z5U
Z 851	5-00315-527	.1UF	Capacitor, Ceramic SMT1206, 50V, 20% Z5U
Z 853	5-00315-527	.1UF	Capacitor, Ceramic SMT1206, 50V, 20% Z5U
Z 854	5-00315-527	.1UF	Capacitor, Ceramic SMT1206, 50V, 20% Z5U

Signal Input (84SIG) Board Parts List

Signal Input Assembly			
Ref. No.	SRS Part No.	Value	Component Description
C 108	5-00055-512	.15U	Cap, Stacked Metal Film 50V 5% -40/+85c
C 114	5-00385-552	680P	Capacitor, Chip (SMT1206), 50V, 5%, NPO
C 120	5-00469-512	.56U	Cap, Stacked Metal Film 50V 5% -40/+85c
C 121	5-00298-568	.01U	Cap, Ceramic 50V SMT (1206) +/-10% X7R
C 122	5-00469-512	.56U	Cap, Stacked Metal Film 50V 5% -40/+85c
C 132	5-00363-552	10P	Capacitor, Chip (SMT1206), 50V, 5%, NPO
C 133	5-00355-552	2.2P	Capacitor, Chip (SMT1206), 50V, 5%, NPO
C 134	5-00355-552	2.2P	Capacitor, Chip (SMT1206), 50V, 5%, NPO
C 135	5-00363-552	10P	Capacitor, Chip (SMT1206), 50V, 5%, NPO
C 136	5-00363-552	10P	Capacitor, Chip (SMT1206), 50V, 5%, NPO
C 137	5-00340-552	7.5P	Capacitor, Chip (SMT1206), 50V, 5%, NPO
C 138	5-00340-552	7.5P	Capacitor, Chip (SMT1206), 50V, 5%, NPO
C 144	5-00055-512	.15U	Cap, Stacked Metal Film 50V 5% -40/+85c
C 145	5-00387-552	1000P	Capacitor, Chip (SMT1206), 50V, 5%, NPO
C 146	5-00055-512	.15U	Cap, Stacked Metal Film 50V 5% -40/+85c
C 147	5-00387-552	1000P	Capacitor, Chip (SMT1206), 50V, 5%, NPO
C 150	5-00469-512	.56U	Cap, Stacked Metal Film 50V 5% -40/+85c
C 151	5-00385-552	680P	Capacitor, Chip (SMT1206), 50V, 5%, NPO
C 160	5-00468-512	.056U	Cap, Stacked Metal Film 50V 5% -40/+85c
C 164	5-00468-512	.056U	Cap, Stacked Metal Film 50V 5% -40/+85c
C 170	5-00374-552	82P	Capacitor, Chip (SMT1206), 50V, 5%, NPO
C 171	5-00374-552	82P	Capacitor, Chip (SMT1206), 50V, 5%, NPO
C 172	5-00363-552	10P	Capacitor, Chip (SMT1206), 50V, 5%, NPO
C 173	5-00367-552	22P	Capacitor, Chip (SMT1206), 50V, 5%, NPO
C 174	5-00298-568	.01U	Cap, Ceramic 50V SMT (1206) +/-10% X7R
C 180	5-00379-552	220P	Capacitor, Chip (SMT1206), 50V, 5%, NPO
C 186	5-00385-552	680P	Capacitor, Chip (SMT1206), 50V, 5%, NPO
C 190	5-00385-552	680P	Capacitor, Chip (SMT1206), 50V, 5%, NPO
C 196	5-00385-552	680P	Capacitor, Chip (SMT1206), 50V, 5%, NPO
CX171	5-00363-552	10P	Capacitor, Chip (SMT1206), 50V, 5%, NPO
CX176	5-00363-552	10P	Capacitor, Chip (SMT1206), 50V, 5%, NPO
D 101	3-00763-313	MMD914	Diode, SMT
D 102	3-00763-313	MMD914	Diode, SMT
D 103	3-00763-313	MMD914	Diode, SMT
D 170	3-00609-301	BAR10	Diode
D 171	3-00609-301	BAR10	Diode
D 172	3-00609-301	BAR10	Diode
D 173	3-00609-301	BAR10	Diode
F 100	5-00471-569	10U/T16	Cap, Tantalum, SMT (all case sizes)
F 114	5-00319-569	10U/T35	Cap, Tantalum, SMT (all case sizes)
F 150	5-00318-569	2.2U/T35	Cap, Tantalum, SMT (all case sizes)
F 186	5-00318-569	2.2U/T35	Cap, Tantalum, SMT (all case sizes)
F 190	5-00318-569	2.2U/T35	Cap, Tantalum, SMT (all case sizes)
F 194	5-00318-569	2.2U/T35	Cap, Tantalum, SMT (all case sizes)
F 196	5-00318-569	2.2U/T35	Cap, Tantalum, SMT (all case sizes)
J 10	1-00293-130	6 PIN DI ZW 08	Connector, Male
J 11	1-00330-130	8 PIN DIF CLT	Connector, Male

6-48 Parts Lists

Signal Input Assembly			
Ref. No.	SRS Part No.	Value	Component Description
J 12	1-00308-131	10 PIN DIF CLH	Connector, Female
J 14	1-00294-130	10 PIN DI ZW 08	Connector, Male
J 16	1-00292-130	4 PIN DI ZW 08	Connector, Male
J 17	1-00292-130	4 PIN DI ZW 08	Connector, Male
J 111	1-00307-141	STRAIGHT JACK	SMB Connector
J 120	1-00326-131	2 PIN SIF CES	Connector, Female
JP100	1-00329-131	3 PIN SIF - CES	Connector, Female
JP101	1-00329-131	3 PIN SIF - CES	Connector, Female
JP102	1-00329-131	3 PIN SIF - CES	Connector, Female
JP103	1-00329-131	3 PIN SIF - CES	Connector, Female
JP104	1-00329-131	3 PIN SIF - CES	Connector, Female
L 101	6-00236-631	FR47	Ferrite bead, SMT
L 102	6-00236-631	FR47	Ferrite bead, SMT
L 132	6-00234-609	43NH - SMT 10T	Inductor, Fixed, SMT
L 133	6-00235-609	28NH - SMT 8T	Inductor, Fixed, SMT
L 144	6-00278-601	270UH	Inductor
L 145	6-00240-601	4.7UH	Inductor
L 150	6-00278-601	270UH	Inductor
L 151	6-00240-601	4.7UH	Inductor
L 186	6-00236-631	FR47	Ferrite bead, SMT
L 190	6-00236-631	FR47	Ferrite bead, SMT
L 196	6-00236-631	FR47	Ferrite bead, SMT
N 180	4-00911-463	4.7KX4D	Resistor network, SMT, Leadless
P 108	4-00617-441	100K	Pot, Multi-Turn Trim, 3/8" Square Top Ad
PC1	7-00753-701	SR844 SIG INPUT	Printed Circuit Board
Q 101	3-00601-360	MMBT3904LT1	Integrated Circuit (Surface Mount Pkg)
Q 102	3-00601-360	MMBT3904LT1	Integrated Circuit (Surface Mount Pkg)
Q 103	3-00601-360	MMBT3904LT1	Integrated Circuit (Surface Mount Pkg)
Q 108	3-00766-360	MMBFJ310	Integrated Circuit (Surface Mount Pkg)
R 102	4-01084-462	453	Thin Film, 1%, 50 ppm, MELF Resistor
R 103	4-00930-462	11.3	Thin Film, 1%, 50 ppm, MELF Resistor
R 104	4-01084-462	453	Thin Film, 1%, 50 ppm, MELF Resistor
R 106	4-00992-462	49.9	Thin Film, 1%, 50 ppm, MELF Resistor
R 107	4-01084-462	453	Thin Film, 1%, 50 ppm, MELF Resistor
R 108	4-01405-462	1.00M	Thin Film, 1%, 50 ppm, MELF Resistor
R 109	4-01575-461	10M	Thick Film, 5%, 200 ppm, Chip Resistor
R 110	4-01405-462	1.00M	Thin Film, 1%, 50 ppm, MELF Resistor
R 111	4-01406-461	0	Thick Film, 5%, 200 ppm, Chip Resistor
R 112	4-00993-462	51.1	Thin Film, 1%, 50 ppm, MELF Resistor
R 113	4-01070-462	324	Thin Film, 1%, 50 ppm, MELF Resistor
R 114	4-01407-461	1	Thick Film, 5%, 200 ppm, Chip Resistor
R 120	4-00992-462	49.9	Thin Film, 1%, 50 ppm, MELF Resistor
R 121	4-01070-462	324	Thin Film, 1%, 50 ppm, MELF Resistor
R 122	4-00960-462	23.2	Thin Film, 1%, 50 ppm, MELF Resistor
R 123	4-01117-462	1.00K	Thin Film, 1%, 50 ppm, MELF Resistor
R 124	4-01117-462	1.00K	Thin Film, 1%, 50 ppm, MELF Resistor
R 125	4-00942-462	15	Thin Film, 1%, 50 ppm, MELF Resistor
R 126	4-01084-462	453	Thin Film, 1%, 50 ppm, MELF Resistor
R 128	4-01407-461	1	Thick Film, 5%, 200 ppm, Chip Resistor
R 140	4-01001-462	61.9	Thin Film, 1%, 50 ppm, MELF Resistor

Signal Input Assembly			
Ref. No.	SRS Part No.	Value	Component Description
R 141	4-01059-462	249	Thin Film, 1%, 50 ppm, MELF Resistor
R 142	4-01001-462	61.9	Thin Film, 1%, 50 ppm, MELF Resistor
R 150	4-01009-462	75	Thin Film, 1%, 50 ppm, MELF Resistor
R 151	4-01423-461	4.7	Thick Film, 5%, 200 ppm, Chip Resistor
R 152	4-01406-461	0	Thick Film, 5%, 200 ppm, Chip Resistor
R 153	4-01059-462	249	Thin Film, 1%, 50 ppm, MELF Resistor
R 154	4-01059-462	249	Thin Film, 1%, 50 ppm, MELF Resistor
R 156	4-01511-461	22K	Thick Film, 5%, 200 ppm, Chip Resistor
R 157	4-01511-461	22K	Thick Film, 5%, 200 ppm, Chip Resistor
R 158	4-01001-462	61.9	Thin Film, 1%, 50 ppm, MELF Resistor
R 160	4-01059-462	249	Thin Film, 1%, 50 ppm, MELF Resistor
R 161	4-01059-462	249	Thin Film, 1%, 50 ppm, MELF Resistor
R 162	4-01505-461	12K	Thick Film, 5%, 200 ppm, Chip Resistor
R 164	4-01084-462	453	Thin Film, 1%, 50 ppm, MELF Resistor
R 165	4-01505-461	12K	Thick Film, 5%, 200 ppm, Chip Resistor
R 170	4-01575-461	10M	Thick Film, 5%, 200 ppm, Chip Resistor
R 171	4-01348-462	255K	Thin Film, 1%, 50 ppm, MELF Resistor
R 172	4-01305-462	90.9K	Thin Film, 1%, 50 ppm, MELF Resistor
R 173	4-01108-462	806	Thin Film, 1%, 50 ppm, MELF Resistor
R 174	4-01124-462	1.18K	Thin Film, 1%, 50 ppm, MELF Resistor
R 175	4-01305-462	90.9K	Thin Film, 1%, 50 ppm, MELF Resistor
R 176	4-01355-462	301K	Thin Film, 1%, 50 ppm, MELF Resistor
R 177	4-01575-461	10M	Thick Film, 5%, 200 ppm, Chip Resistor
R 180	4-01117-462	1.00K	Thin Film, 1%, 50 ppm, MELF Resistor
R 184	4-01059-462	249	Thin Film, 1%, 50 ppm, MELF Resistor
R 185	4-00960-462	23.2	Thin Film, 1%, 50 ppm, MELF Resistor
R 186	4-01407-461	1	Thick Film, 5%, 200 ppm, Chip Resistor
R 187	4-01117-462	1.00K	Thin Film, 1%, 50 ppm, MELF Resistor
R 188	4-01431-461	10	Thick Film, 5%, 200 ppm, Chip Resistor
R 190	4-01407-461	1	Thick Film, 5%, 200 ppm, Chip Resistor
R 194	4-01471-461	470	Thick Film, 5%, 200 ppm, Chip Resistor
R 196	4-01407-461	1	Thick Film, 5%, 200 ppm, Chip Resistor
S 102	3-00422-335	RG2ET-DC5V	Relay
S 140	3-00422-335	RG2ET-DC5V	Relay
S 150	3-00422-335	RG2ET-DC5V	Relay
U 120	3-00721-360	CLC409AJE	Integrated Circuit (Surface Mount Pkg)
U 150	3-00569-360	MAR6SM	Integrated Circuit (Surface Mount Pkg)
U 156	3-00729-360	LM741C	Integrated Circuit (Surface Mount Pkg)
U 170	3-00720-340	CA3290E	Integrated Circuit (Thru-hole Pkg)
U 180	3-00782-360	74HC02	Integrated Circuit (Surface Mount Pkg)
U 186	3-00602-360	78L12	Integrated Circuit (Surface Mount Pkg)
U 190	3-00711-360	78L15	Integrated Circuit (Surface Mount Pkg)
U 194	3-00709-360	78L05	Integrated Circuit (Surface Mount Pkg)
U 196	3-00711-360	78L15	Integrated Circuit (Surface Mount Pkg)
W 164	4-01024-462	107	Thin Film, 1%, 50 ppm, MELF Resistor
Z 0	1-00143-101	TEST JACK	Vertical Test Jack
Z 101	5-00315-527	.1UF	Capacitor, Ceramic SMT1206, 50V, 20% Z5U
Z 102	5-00315-527	.1UF	Capacitor, Ceramic SMT1206, 50V, 20% Z5U
Z 114	5-00315-527	.1UF	Capacitor, Ceramic SMT1206, 50V, 20% Z5U
Z 120	5-00315-527	.1UF	Capacitor, Ceramic SMT1206, 50V, 20% Z5U

6-50 Parts Lists

Signal Input Assembly			
Ref. No.	SRS Part No.	Value	Component Description
Z 156	5-00315-527	.1UF	Capacitor, Ceramic SMT1206, 50V, 20% Z5U
Z 157	5-00315-527	.1UF	Capacitor, Ceramic SMT1206, 50V, 20% Z5U
Z 160	5-00315-527	.1UF	Capacitor, Ceramic SMT1206, 50V, 20% Z5U
Z 164	5-00315-527	.1UF	Capacitor, Ceramic SMT1206, 50V, 20% Z5U
Z 170	5-00315-527	.1UF	Capacitor, Ceramic SMT1206, 50V, 20% Z5U
Z 180	5-00315-527	.1UF	Capacitor, Ceramic SMT1206, 50V, 20% Z5U
Z 186	5-00315-527	.1UF	Capacitor, Ceramic SMT1206, 50V, 20% Z5U
Z 190	5-00315-527	.1UF	Capacitor, Ceramic SMT1206, 50V, 20% Z5U
Z 191	5-00315-527	.1UF	Capacitor, Ceramic SMT1206, 50V, 20% Z5U
Z 194	5-00315-527	.1UF	Capacitor, Ceramic SMT1206, 50V, 20% Z5U
Z 196	5-00315-527	.1UF	Capacitor, Ceramic SMT1206, 50V, 20% Z5U

Mixer (84CMX) Board Parts List

Mixer Assembly			
Ref. No.	SRS Part No.	Value	Component Description
C 714	5-00367-552	22P	Capacitor, Chip (SMT1206), 50V, 5%, NPO
C 742	5-00385-552	680P	Capacitor, Chip (SMT1206), 50V, 5%, NPO
C 743	5-00385-552	680P	Capacitor, Chip (SMT1206), 50V, 5%, NPO
C 750	5-00467-512	.018U	Cap, Stacked Metal Film 50V 5% -40/+85c
C 751	5-00379-552	220P	Capacitor, Chip (SMT1206), 50V, 5%, NPO
C 752	5-00379-552	220P	Capacitor, Chip (SMT1206), 50V, 5%, NPO
C 753	5-00467-512	.018U	Cap, Stacked Metal Film 50V 5% -40/+85c
C 754	5-00389-552	1500P	Capacitor, Chip (SMT1206), 50V, 5%, NPO
C 762	5-00385-552	680P	Capacitor, Chip (SMT1206), 50V, 5%, NPO
C 763	5-00385-552	680P	Capacitor, Chip (SMT1206), 50V, 5%, NPO
C 770	5-00467-512	.018U	Cap, Stacked Metal Film 50V 5% -40/+85c
C 771	5-00379-552	220P	Capacitor, Chip (SMT1206), 50V, 5%, NPO
C 772	5-00379-552	220P	Capacitor, Chip (SMT1206), 50V, 5%, NPO
C 773	5-00467-512	.018U	Cap, Stacked Metal Film 50V 5% -40/+85c
C 774	5-00389-552	1500P	Capacitor, Chip (SMT1206), 50V, 5%, NPO
C 790	5-00468-512	.056U	Cap, Stacked Metal Film 50V 5% -40/+85c
E 720	5-00260-544	470U	Cap, Mini Electrolytic, 25V, 20%, Radial
E 721	5-00260-544	470U	Cap, Mini Electrolytic, 25V, 20%, Radial
E 747	5-00041-509	220U	Capacitor, Electrolytic, 50V, 20%, Rad
E 748	5-00030-520	2200U	Capacitor, Electrolytic, 16V, 20%, Rad
E 749	5-00030-520	2200U	Capacitor, Electrolytic, 16V, 20%, Rad
E 767	5-00041-509	220U	Capacitor, Electrolytic, 50V, 20%, Rad
E 768	5-00030-520	2200U	Capacitor, Electrolytic, 16V, 20%, Rad
E 769	5-00030-520	2200U	Capacitor, Electrolytic, 16V, 20%, Rad
E 780	5-00481-521	100U	Capacitor, Electrolytic, 25V, 20%, Rad
E 781	5-00030-520	2200U	Capacitor, Electrolytic, 16V, 20%, Rad
E 782	5-00030-520	2200U	Capacitor, Electrolytic, 16V, 20%, Rad
F 740	5-00470-569	2.2U/T16	Cap, Tantalum, SMT (all case sizes)
F 741	5-00470-569	2.2U/T16	Cap, Tantalum, SMT (all case sizes)
F 749	5-00471-569	10U/T16	Cap, Tantalum, SMT (all case sizes)
F 750	5-00471-569	10U/T16	Cap, Tantalum, SMT (all case sizes)
F 760	5-00470-569	2.2U/T16	Cap, Tantalum, SMT (all case sizes)
F 761	5-00470-569	2.2U/T16	Cap, Tantalum, SMT (all case sizes)
F 769	5-00471-569	10U/T16	Cap, Tantalum, SMT (all case sizes)
F 770	5-00471-569	10U/T16	Cap, Tantalum, SMT (all case sizes)
J 11	1-00325-130	8 PIN DI MTMM	Connector, Male
J 12	1-00299-130	10 PIN DI MTSW	Connector, Male
J 13	1-00298-130	10 PIN DI ZW 10	Connector, Male
J 15	1-00285-130	4 PIN DI MTLW	Connector, Male
J 70	1-00298-130	10 PIN DI ZW 10	Connector, Male
J 71	1-00296-130	6 PIN DI ZW 10	Connector, Male
J 72	1-00285-130	4 PIN DI MTLW	Connector, Male
J 73	1-00287-130	10 PIN DI MTLW	Connector, Male
J 74	1-00286-130	8 PIN DI MTLW	Connector, Male
J 731	1-00329-131	3 PIN SIF - CES	Connector, Female
J 732	1-00329-131	3 PIN SIF - CES	Connector, Female
J 733	1-00329-131	3 PIN SIF - CES	Connector, Female

6-52 Parts Lists

Mixer Assembly			
Ref. No.	SRS Part No.	Value	Component Description
J 734	1-00329-131	3 PIN SIF - CES	Connector, Female
JP746	1-00326-131	2 PIN SIF CES	Connector, Female
JP747	1-00326-131	2 PIN SIF CES	Connector, Female
JP764	1-00326-131	2 PIN SIF CES	Connector, Female
JP765	1-00326-131	2 PIN SIF CES	Connector, Female
JP791	1-00326-131	2 PIN SIF CES	Connector, Female
L 720	6-00237-631	FR95	Ferrite bead, SMT
L 723	6-00237-631	FR95	Ferrite bead, SMT
L 750	6-00239-603	47UH	Inductor, Axial
L 751	6-00240-601	4.7UH	Inductor
L 770	6-00239-603	47UH	Inductor, Axial
L 771	6-00240-601	4.7UH	Inductor
L 780	6-00236-631	FR47	Ferrite bead, SMT
N 714	4-00910-463	1.0KX4D	Resistor network, SMT, Leadless
PC1	7-00749-701	SR844 CHOP&MIX	Printed Circuit Board
R 714	4-01181-462	4.64K	Thin Film, 1%, 50 ppm, MELF Resistor
R 715	4-01150-462	2.21K	Thin Film, 1%, 50 ppm, MELF Resistor
R 716	4-01162-462	2.94K	Thin Film, 1%, 50 ppm, MELF Resistor
R 720	4-01433-461	12	Thick Film, 5%, 200 ppm, Chip Resistor
R 721	4-01433-461	12	Thick Film, 5%, 200 ppm, Chip Resistor
R 740	4-00960-462	23.2	Thin Film, 1%, 50 ppm, MELF Resistor
R 741	4-01020-462	97.6	Thin Film, 1%, 50 ppm, MELF Resistor
R 742	4-01407-461	1	Thick Film, 5%, 200 ppm, Chip Resistor
R 743	4-01407-461	1	Thick Film, 5%, 200 ppm, Chip Resistor
R 744	4-01059-462	249	Thin Film, 1%, 50 ppm, MELF Resistor
R 745	4-01059-462	249	Thin Film, 1%, 50 ppm, MELF Resistor
R 746	4-01084-462	453	Thin Film, 1%, 50 ppm, MELF Resistor
R 747	4-01084-462	453	Thin Film, 1%, 50 ppm, MELF Resistor
R 748	4-01129-462	1.33K	Thin Film, 1%, 50 ppm, MELF Resistor
R 749	4-01181-462	4.64K	Thin Film, 1%, 50 ppm, MELF Resistor
R 750	4-01181-462	4.64K	Thin Film, 1%, 50 ppm, MELF Resistor
R 754	4-01181-462	4.64K	Thin Film, 1%, 50 ppm, MELF Resistor
R 760	4-00960-462	23.2	Thin Film, 1%, 50 ppm, MELF Resistor
R 761	4-01020-462	97.6	Thin Film, 1%, 50 ppm, MELF Resistor
R 762	4-01407-461	1	Thick Film, 5%, 200 ppm, Chip Resistor
R 763	4-01407-461	1	Thick Film, 5%, 200 ppm, Chip Resistor
R 764	4-01059-462	249	Thin Film, 1%, 50 ppm, MELF Resistor
R 765	4-01059-462	249	Thin Film, 1%, 50 ppm, MELF Resistor
R 766	4-01084-462	453	Thin Film, 1%, 50 ppm, MELF Resistor
R 767	4-01084-462	453	Thin Film, 1%, 50 ppm, MELF Resistor
R 768	4-01129-462	1.33K	Thin Film, 1%, 50 ppm, MELF Resistor
R 769	4-01181-462	4.64K	Thin Film, 1%, 50 ppm, MELF Resistor
R 770	4-01181-462	4.64K	Thin Film, 1%, 50 ppm, MELF Resistor
R 774	4-01181-462	4.64K	Thin Film, 1%, 50 ppm, MELF Resistor
R 790	4-01053-462	215	Thin Film, 1%, 50 ppm, MELF Resistor
R 791	4-01053-462	215	Thin Film, 1%, 50 ppm, MELF Resistor
R 792	4-01084-462	453	Thin Film, 1%, 50 ppm, MELF Resistor
T 709	6-00055-630	FB43-1801	Ferrite Beads
T 710	6-00055-630	FB43-1801	Ferrite Beads
T 740	6-00055-630	FB43-1801	Ferrite Beads

Mixer Assembly			
Ref. No.	SRS Part No.	Value	Component Description
T 760	6-00055-630	FB43-1801	Ferrite Beads
U 702	3-00736-360	MC100EL11D	Integrated Circuit (Surface Mount Pkg)
U 705	3-00737-360	MC100EL16D	Integrated Circuit (Surface Mount Pkg)
U 707	3-00738-360	MC100EL51D	Integrated Circuit (Surface Mount Pkg)
U 708	3-00735-360	MC100EL07D	Integrated Circuit (Surface Mount Pkg)
U 709	3-00738-360	MC100EL51D	Integrated Circuit (Surface Mount Pkg)
U 710	3-00738-360	MC100EL51D	Integrated Circuit (Surface Mount Pkg)
U 713	3-00841-361	SR844 U713	GAL/PAL, SMT
U 714	3-00749-360	74HC541	Integrated Circuit (Surface Mount Pkg)
U 740	3-00717-360	AD831	Integrated Circuit (Surface Mount Pkg)
U 760	3-00717-360	AD831	Integrated Circuit (Surface Mount Pkg)
W 700	4-01024-462	107	Thin Film, 1%, 50 ppm, MELF Resistor
W 702	4-01024-462	107	Thin Film, 1%, 50 ppm, MELF Resistor
W 703	4-01024-462	107	Thin Film, 1%, 50 ppm, MELF Resistor
W 704	4-01024-462	107	Thin Film, 1%, 50 ppm, MELF Resistor
W 705	4-01024-462	107	Thin Film, 1%, 50 ppm, MELF Resistor
W 706	4-01024-462	107	Thin Film, 1%, 50 ppm, MELF Resistor
W 707	4-01024-462	107	Thin Film, 1%, 50 ppm, MELF Resistor
W 708	4-01024-462	107	Thin Film, 1%, 50 ppm, MELF Resistor
W 709	4-01024-462	107	Thin Film, 1%, 50 ppm, MELF Resistor
W 710	4-01024-462	107	Thin Film, 1%, 50 ppm, MELF Resistor
X 700	4-00993-462	51.1	Thin Film, 1%, 50 ppm, MELF Resistor
X 702	4-00993-462	51.1	Thin Film, 1%, 50 ppm, MELF Resistor
X 703	4-00993-462	51.1	Thin Film, 1%, 50 ppm, MELF Resistor
X 704	4-00993-462	51.1	Thin Film, 1%, 50 ppm, MELF Resistor
X 705	4-00993-462	51.1	Thin Film, 1%, 50 ppm, MELF Resistor
X 706	4-00993-462	51.1	Thin Film, 1%, 50 ppm, MELF Resistor
X 707	4-00993-462	51.1	Thin Film, 1%, 50 ppm, MELF Resistor
X 708	4-00993-462	51.1	Thin Film, 1%, 50 ppm, MELF Resistor
X 709	4-00993-462	51.1	Thin Film, 1%, 50 ppm, MELF Resistor
X 710	4-00993-462	51.1	Thin Film, 1%, 50 ppm, MELF Resistor
X 745	4-00993-462	51.1	Thin Film, 1%, 50 ppm, MELF Resistor
X 749	4-00993-462	51.1	Thin Film, 1%, 50 ppm, MELF Resistor
X 765	4-00993-462	51.1	Thin Film, 1%, 50 ppm, MELF Resistor
X 769	4-00993-462	51.1	Thin Film, 1%, 50 ppm, MELF Resistor
Y 700	4-00993-462	51.1	Thin Film, 1%, 50 ppm, MELF Resistor
Y 702	5-00315-527	.1UF	Capacitor, Ceramic SMT1206, 50V, 20% Z5U
Y 703	4-00993-462	51.1	Thin Film, 1%, 50 ppm, MELF Resistor
Y 704	4-00993-462	51.1	Thin Film, 1%, 50 ppm, MELF Resistor
Y 705	4-00993-462	51.1	Thin Film, 1%, 50 ppm, MELF Resistor
Y 706	4-00993-462	51.1	Thin Film, 1%, 50 ppm, MELF Resistor
Y 707	4-00993-462	51.1	Thin Film, 1%, 50 ppm, MELF Resistor
Y 708	4-00993-462	51.1	Thin Film, 1%, 50 ppm, MELF Resistor
Y 709	4-00993-462	51.1	Thin Film, 1%, 50 ppm, MELF Resistor
Y 710	4-00993-462	51.1	Thin Film, 1%, 50 ppm, MELF Resistor
Y 744	4-00993-462	51.1	Thin Film, 1%, 50 ppm, MELF Resistor
Y 749	4-00993-462	51.1	Thin Film, 1%, 50 ppm, MELF Resistor
Y 764	4-00993-462	51.1	Thin Film, 1%, 50 ppm, MELF Resistor
Y 769	4-00993-462	51.1	Thin Film, 1%, 50 ppm, MELF Resistor
Z 0	0-00478-055	1.5"X#30 BLK	Wire, Other

6-54 Parts Lists

Mixer Assembly			
Ref. No.	SRS Part No.	Value	Component Description
Z 0	0-00479-055	1.5"X#30 ORA	Wire, Other
Z 0	1-00143-101	TEST JACK	Vertical Test Jack
Z 700	5-00315-527	.1UF	Capacitor, Ceramic SMT1206, 50V, 20% Z5U
Z 702	4-00993-462	51.1	Thin Film, 1%, 50 ppm, MELF Resistor
Z 703	5-00315-527	.1UF	Capacitor, Ceramic SMT1206, 50V, 20% Z5U
Z 704	5-00315-527	.1UF	Capacitor, Ceramic SMT1206, 50V, 20% Z5U
Z 705	5-00315-527	.1UF	Capacitor, Ceramic SMT1206, 50V, 20% Z5U
Z 706	5-00315-527	.1UF	Capacitor, Ceramic SMT1206, 50V, 20% Z5U
Z 707	5-00315-527	.1UF	Capacitor, Ceramic SMT1206, 50V, 20% Z5U
Z 708	5-00315-527	.1UF	Capacitor, Ceramic SMT1206, 50V, 20% Z5U
Z 709	5-00315-527	.1UF	Capacitor, Ceramic SMT1206, 50V, 20% Z5U
Z 710	5-00315-527	.1UF	Capacitor, Ceramic SMT1206, 50V, 20% Z5U
Z 713	5-00315-527	.1UF	Capacitor, Ceramic SMT1206, 50V, 20% Z5U
Z 721	5-00315-527	.1UF	Capacitor, Ceramic SMT1206, 50V, 20% Z5U
Z 722	5-00315-527	.1UF	Capacitor, Ceramic SMT1206, 50V, 20% Z5U
Z 723	5-00315-527	.1UF	Capacitor, Ceramic SMT1206, 50V, 20% Z5U
Z 725	5-00315-527	.1UF	Capacitor, Ceramic SMT1206, 50V, 20% Z5U
Z 727	5-00315-527	.1UF	Capacitor, Ceramic SMT1206, 50V, 20% Z5U
Z 728	5-00315-527	.1UF	Capacitor, Ceramic SMT1206, 50V, 20% Z5U
Z 729	5-00315-527	.1UF	Capacitor, Ceramic SMT1206, 50V, 20% Z5U
Z 730	5-00315-527	.1UF	Capacitor, Ceramic SMT1206, 50V, 20% Z5U
Z 740	5-00315-527	.1UF	Capacitor, Ceramic SMT1206, 50V, 20% Z5U
Z 741	5-00315-527	.1UF	Capacitor, Ceramic SMT1206, 50V, 20% Z5U
Z 742	5-00315-527	.1UF	Capacitor, Ceramic SMT1206, 50V, 20% Z5U
Z 743	5-00315-527	.1UF	Capacitor, Ceramic SMT1206, 50V, 20% Z5U
Z 744	5-00315-527	.1UF	Capacitor, Ceramic SMT1206, 50V, 20% Z5U
Z 745	5-00315-527	.1UF	Capacitor, Ceramic SMT1206, 50V, 20% Z5U
Z 747	5-00315-527	.1UF	Capacitor, Ceramic SMT1206, 50V, 20% Z5U
Z 748	5-00315-527	.1UF	Capacitor, Ceramic SMT1206, 50V, 20% Z5U
Z 749	5-00315-527	.1UF	Capacitor, Ceramic SMT1206, 50V, 20% Z5U
Z 760	5-00315-527	.1UF	Capacitor, Ceramic SMT1206, 50V, 20% Z5U
Z 761	5-00315-527	.1UF	Capacitor, Ceramic SMT1206, 50V, 20% Z5U
Z 762	5-00315-527	.1UF	Capacitor, Ceramic SMT1206, 50V, 20% Z5U
Z 763	5-00315-527	.1UF	Capacitor, Ceramic SMT1206, 50V, 20% Z5U
Z 764	5-00315-527	.1UF	Capacitor, Ceramic SMT1206, 50V, 20% Z5U
Z 765	5-00315-527	.1UF	Capacitor, Ceramic SMT1206, 50V, 20% Z5U
Z 767	5-00315-527	.1UF	Capacitor, Ceramic SMT1206, 50V, 20% Z5U
Z 768	5-00315-527	.1UF	Capacitor, Ceramic SMT1206, 50V, 20% Z5U
Z 769	5-00315-527	.1UF	Capacitor, Ceramic SMT1206, 50V, 20% Z5U

IF Amplifier (84IFN) Board Parts List

If Amplifier Assembly			
Ref. No.	SRS Part No.	Value	Component Description
C 400	5-00148-545	1000P	Capacitor, Monolythic Ceramic, COG, 1%
C 401	5-00148-545	1000P	Capacitor, Monolythic Ceramic, COG, 1%
C 402	5-00367-552	22P	Capacitor, Chip (SMT1206), 50V, 5%, NPO
C 403	5-00367-552	22P	Capacitor, Chip (SMT1206), 50V, 5%, NPO
C 404	5-00374-552	82P	Capacitor, Chip (SMT1206), 50V, 5%, NPO
C 405	5-00374-552	82P	Capacitor, Chip (SMT1206), 50V, 5%, NPO
C 406	5-00366-552	18P	Capacitor, Chip (SMT1206), 50V, 5%, NPO
C 407	5-00375-552	100P	Capacitor, Chip (SMT1206), 50V, 5%, NPO
C 408	5-00375-552	100P	Capacitor, Chip (SMT1206), 50V, 5%, NPO
C 409	5-00379-552	220P	Capacitor, Chip (SMT1206), 50V, 5%, NPO
C 410	5-00057-512	.22U	Cap, Stacked Metal Film 50V 5% -40/+85c
C 411	5-00366-552	18P	Capacitor, Chip (SMT1206), 50V, 5%, NPO
C 412	5-00379-552	220P	Capacitor, Chip (SMT1206), 50V, 5%, NPO
C 413	5-00469-512	.56U	Cap, Stacked Metal Film 50V 5% -40/+85c
C 414	5-00366-552	18P	Capacitor, Chip (SMT1206), 50V, 5%, NPO
C 415	5-00379-552	220P	Capacitor, Chip (SMT1206), 50V, 5%, NPO
C 416	5-00149-545	.01U	Capacitor, Monolythic Ceramic, COG, 1%
C 417	5-00149-545	.01U	Capacitor, Monolythic Ceramic, COG, 1%
C 418	5-00149-545	.01U	Capacitor, Monolythic Ceramic, COG, 1%
C 419	5-00149-545	.01U	Capacitor, Monolythic Ceramic, COG, 1%
C 420	5-00149-545	.01U	Capacitor, Monolythic Ceramic, COG, 1%
C 421	5-00149-545	.01U	Capacitor, Monolythic Ceramic, COG, 1%
C 422	5-00149-545	.01U	Capacitor, Monolythic Ceramic, COG, 1%
C 423	5-00389-552	1500P	Capacitor, Chip (SMT1206), 50V, 5%, NPO
C 470	5-00382-552	390P	Capacitor, Chip (SMT1206), 50V, 5%, NPO
C 471	5-00382-552	390P	Capacitor, Chip (SMT1206), 50V, 5%, NPO
C 472	5-00298-568	.01U	Cap, Ceramic 50V SMT (1206) +/-10% X7R
C 473	5-00382-552	390P	Capacitor, Chip (SMT1206), 50V, 5%, NPO
C 474	5-00382-552	390P	Capacitor, Chip (SMT1206), 50V, 5%, NPO
C 475	5-00468-512	.056U	Cap, Stacked Metal Film 50V 5% -40/+85c
C 476	5-00468-512	.056U	Cap, Stacked Metal Film 50V 5% -40/+85c
C 477	5-00468-512	.056U	Cap, Stacked Metal Film 50V 5% -40/+85c
C 478	5-00468-512	.056U	Cap, Stacked Metal Film 50V 5% -40/+85c
C 479	5-00468-512	.056U	Cap, Stacked Metal Film 50V 5% -40/+85c
C 480	5-00298-568	.01U	Cap, Ceramic 50V SMT (1206) +/-10% X7R
C 481	5-00382-552	390P	Capacitor, Chip (SMT1206), 50V, 5%, NPO
C 482	5-00385-552	680P	Capacitor, Chip (SMT1206), 50V, 5%, NPO
C 483	5-00375-552	100P	Capacitor, Chip (SMT1206), 50V, 5%, NPO
C 484	5-00298-568	.01U	Cap, Ceramic 50V SMT (1206) +/-10% X7R
C 485	5-00298-568	.01U	Cap, Ceramic 50V SMT (1206) +/-10% X7R
C 486	5-00298-568	.01U	Cap, Ceramic 50V SMT (1206) +/-10% X7R
C 487	5-00298-568	.01U	Cap, Ceramic 50V SMT (1206) +/-10% X7R
C 488	5-00382-552	390P	Capacitor, Chip (SMT1206), 50V, 5%, NPO
C 500	5-00148-545	1000P	Capacitor, Monolythic Ceramic, COG, 1%
C 501	5-00148-545	1000P	Capacitor, Monolythic Ceramic, COG, 1%
C 502	5-00367-552	22P	Capacitor, Chip (SMT1206), 50V, 5%, NPO
C 503	5-00367-552	22P	Capacitor, Chip (SMT1206), 50V, 5%, NPO

6-56 Parts Lists

If Amplifier Assembly			
Ref. No.	SRS Part No.	Value	Component Description
C 504	5-00374-552	82P	Capacitor, Chip (SMT1206), 50V, 5%, NPO
C 505	5-00374-552	82P	Capacitor, Chip (SMT1206), 50V, 5%, NPO
C 506	5-00366-552	18P	Capacitor, Chip (SMT1206), 50V, 5%, NPO
C 507	5-00375-552	100P	Capacitor, Chip (SMT1206), 50V, 5%, NPO
C 508	5-00375-552	100P	Capacitor, Chip (SMT1206), 50V, 5%, NPO
C 509	5-00379-552	220P	Capacitor, Chip (SMT1206), 50V, 5%, NPO
C 510	5-00057-512	.22U	Cap, Stacked Metal Film 50V 5% -40/+85c
C 511	5-00366-552	18P	Capacitor, Chip (SMT1206), 50V, 5%, NPO
C 512	5-00379-552	220P	Capacitor, Chip (SMT1206), 50V, 5%, NPO
C 513	5-00469-512	.56U	Cap, Stacked Metal Film 50V 5% -40/+85c
C 514	5-00366-552	18P	Capacitor, Chip (SMT1206), 50V, 5%, NPO
C 515	5-00379-552	220P	Capacitor, Chip (SMT1206), 50V, 5%, NPO
C 516	5-00149-545	.01U	Capacitor, Monolythic Ceramic, COG, 1%
C 517	5-00149-545	.01U	Capacitor, Monolythic Ceramic, COG, 1%
C 518	5-00149-545	.01U	Capacitor, Monolythic Ceramic, COG, 1%
C 519	5-00149-545	.01U	Capacitor, Monolythic Ceramic, COG, 1%
C 520	5-00149-545	.01U	Capacitor, Monolythic Ceramic, COG, 1%
C 521	5-00149-545	.01U	Capacitor, Monolythic Ceramic, COG, 1%
C 522	5-00149-545	.01U	Capacitor, Monolythic Ceramic, COG, 1%
C 523	5-00389-552	1500P	Capacitor, Chip (SMT1206), 50V, 5%, NPO
F 420	5-00318-569	2.2U/T35	Cap, Tantalum, SMT (all case sizes)
F 421	5-00318-569	2.2U/T35	Cap, Tantalum, SMT (all case sizes)
F 422	5-00318-569	2.2U/T35	Cap, Tantalum, SMT (all case sizes)
F 423	5-00318-569	2.2U/T35	Cap, Tantalum, SMT (all case sizes)
F 424	5-00318-569	2.2U/T35	Cap, Tantalum, SMT (all case sizes)
F 425	5-00318-569	2.2U/T35	Cap, Tantalum, SMT (all case sizes)
F 426	5-00318-569	2.2U/T35	Cap, Tantalum, SMT (all case sizes)
F 427	5-00318-569	2.2U/T35	Cap, Tantalum, SMT (all case sizes)
F 430	5-00318-569	2.2U/T35	Cap, Tantalum, SMT (all case sizes)
F 431	5-00318-569	2.2U/T35	Cap, Tantalum, SMT (all case sizes)
F 432	5-00318-569	2.2U/T35	Cap, Tantalum, SMT (all case sizes)
F 433	5-00318-569	2.2U/T35	Cap, Tantalum, SMT (all case sizes)
F 434	5-00318-569	2.2U/T35	Cap, Tantalum, SMT (all case sizes)
F 435	5-00318-569	2.2U/T35	Cap, Tantalum, SMT (all case sizes)
F 436	5-00318-569	2.2U/T35	Cap, Tantalum, SMT (all case sizes)
F 437	5-00318-569	2.2U/T35	Cap, Tantalum, SMT (all case sizes)
F 478	5-00471-569	10U/T16	Cap, Tantalum, SMT (all case sizes)
F 479	5-00471-569	10U/T16	Cap, Tantalum, SMT (all case sizes)
F 480	5-00318-569	2.2U/T35	Cap, Tantalum, SMT (all case sizes)
F 481	5-00318-569	2.2U/T35	Cap, Tantalum, SMT (all case sizes)
F 482	5-00318-569	2.2U/T35	Cap, Tantalum, SMT (all case sizes)
F 483	5-00318-569	2.2U/T35	Cap, Tantalum, SMT (all case sizes)
F 484	5-00318-569	2.2U/T35	Cap, Tantalum, SMT (all case sizes)
F 485	5-00318-569	2.2U/T35	Cap, Tantalum, SMT (all case sizes)
F 486	5-00318-569	2.2U/T35	Cap, Tantalum, SMT (all case sizes)
F 487	5-00318-569	2.2U/T35	Cap, Tantalum, SMT (all case sizes)
F 488	5-00471-569	10U/T16	Cap, Tantalum, SMT (all case sizes)
F 489	5-00318-569	2.2U/T35	Cap, Tantalum, SMT (all case sizes)
F 490	5-00318-569	2.2U/T35	Cap, Tantalum, SMT (all case sizes)
F 491	5-00318-569	2.2U/T35	Cap, Tantalum, SMT (all case sizes)

If Amplifier Assembly			
Ref. No.	SRS Part No.	Value	Component Description
F 492	5-00318-569	2.2U/T35	Cap, Tantalum, SMT (all case sizes)
F 493	5-00318-569	2.2U/T35	Cap, Tantalum, SMT (all case sizes)
F 494	5-00318-569	2.2U/T35	Cap, Tantalum, SMT (all case sizes)
F 495	5-00318-569	2.2U/T35	Cap, Tantalum, SMT (all case sizes)
F 496	5-00318-569	2.2U/T35	Cap, Tantalum, SMT (all case sizes)
F 497	5-00318-569	2.2U/T35	Cap, Tantalum, SMT (all case sizes)
F 498	5-00471-569	10U/T16	Cap, Tantalum, SMT (all case sizes)
F 499	5-00318-569	2.2U/T35	Cap, Tantalum, SMT (all case sizes)
F 520	5-00318-569	2.2U/T35	Cap, Tantalum, SMT (all case sizes)
F 521	5-00318-569	2.2U/T35	Cap, Tantalum, SMT (all case sizes)
F 522	5-00318-569	2.2U/T35	Cap, Tantalum, SMT (all case sizes)
F 524	5-00318-569	2.2U/T35	Cap, Tantalum, SMT (all case sizes)
F 525	5-00318-569	2.2U/T35	Cap, Tantalum, SMT (all case sizes)
F 526	5-00318-569	2.2U/T35	Cap, Tantalum, SMT (all case sizes)
F 527	5-00318-569	2.2U/T35	Cap, Tantalum, SMT (all case sizes)
F 530	5-00318-569	2.2U/T35	Cap, Tantalum, SMT (all case sizes)
F 531	5-00318-569	2.2U/T35	Cap, Tantalum, SMT (all case sizes)
F 532	5-00318-569	2.2U/T35	Cap, Tantalum, SMT (all case sizes)
F 534	5-00318-569	2.2U/T35	Cap, Tantalum, SMT (all case sizes)
F 535	5-00318-569	2.2U/T35	Cap, Tantalum, SMT (all case sizes)
F 536	5-00318-569	2.2U/T35	Cap, Tantalum, SMT (all case sizes)
F 537	5-00318-569	2.2U/T35	Cap, Tantalum, SMT (all case sizes)
J 15	1-00301-131	4 PIN DIF CES	Connector, Female
J 40	1-00290-130	8 PIN DI TSW 07	Connector, Male
J 41	1-00290-130	8 PIN DI TSW 07	Connector, Male
J 42	1-00281-130	10 PIN DI	Connector, Male
J 43	1-00289-130	6 PIN DI TSW 07	Connector, Male
J 44	1-00288-130	4 PIN DI TSW 07	Connector, Male
J 45	1-00288-130	4 PIN DI TSW 07	Connector, Male
L 400	6-00236-631	FR47	Ferrite bead, SMT
L 401	6-00236-631	FR47	Ferrite bead, SMT
N 400	4-00911-463	4.7KX4D	Resistor network, SMT, Leadless
N 500	4-00911-463	4.7KX4D	Resistor network, SMT, Leadless
N 591	4-00911-463	4.7KX4D	Resistor network, SMT, Leadless
PC0	7-00586-701	SR844 IF&NOISE	Printed Circuit Board
R 400	4-01001-462	61.9	Thin Film, 1%, 50 ppm, MELF Resistor
R 401	4-01001-462	61.9	Thin Film, 1%, 50 ppm, MELF Resistor
R 402	4-01059-462	249	Thin Film, 1%, 50 ppm, MELF Resistor
R 403	4-01059-462	249	Thin Film, 1%, 50 ppm, MELF Resistor
R 404	4-01175-462	4.02K	Thin Film, 1%, 50 ppm, MELF Resistor
R 405	4-01150-462	2.21K	Thin Film, 1%, 50 ppm, MELF Resistor
R 406	4-01305-462	90.9K	Thin Film, 1%, 50 ppm, MELF Resistor
R 407	4-01181-462	4.64K	Thin Film, 1%, 50 ppm, MELF Resistor
R 408	4-01181-462	4.64K	Thin Film, 1%, 50 ppm, MELF Resistor
R 409	4-01053-462	215	Thin Film, 1%, 50 ppm, MELF Resistor
R 410	4-01146-462	2.00K	Thin Film, 1%, 50 ppm, MELF Resistor
R 411	4-01181-462	4.64K	Thin Film, 1%, 50 ppm, MELF Resistor
R 412	4-01053-462	215	Thin Film, 1%, 50 ppm, MELF Resistor
R 413	4-01009-462	75	Thin Film, 1%, 50 ppm, MELF Resistor
R 414	4-01153-462	2.37K	Thin Film, 1%, 50 ppm, MELF Resistor

6-58 Parts Lists

If Amplifier Assembly			
Ref. No.	SRS Part No.	Value	Component Description
R 415	4-01213-462	10.0K	Thin Film, 1%, 50 ppm, MELF Resistor
R 416	4-01167-462	3.32K	Thin Film, 1%, 50 ppm, MELF Resistor
R 417	4-01175-462	4.02K	Thin Film, 1%, 50 ppm, MELF Resistor
R 418	4-01020-462	97.6	Thin Film, 1%, 50 ppm, MELF Resistor
R 419	4-01150-462	2.21K	Thin Film, 1%, 50 ppm, MELF Resistor
R 420	4-01146-462	2.00K	Thin Film, 1%, 50 ppm, MELF Resistor
R 421	4-01181-462	4.64K	Thin Film, 1%, 50 ppm, MELF Resistor
R 422	4-01175-462	4.02K	Thin Film, 1%, 50 ppm, MELF Resistor
R 423	4-01084-462	453	Thin Film, 1%, 50 ppm, MELF Resistor
R 424	4-00960-462	23.2	Thin Film, 1%, 50 ppm, MELF Resistor
R 425	4-01175-462	4.02K	Thin Film, 1%, 50 ppm, MELF Resistor
R 426	4-01181-462	4.64K	Thin Film, 1%, 50 ppm, MELF Resistor
R 427	4-01150-462	2.21K	Thin Film, 1%, 50 ppm, MELF Resistor
R 428	4-01146-462	2.00K	Thin Film, 1%, 50 ppm, MELF Resistor
R 429	4-01181-462	4.64K	Thin Film, 1%, 50 ppm, MELF Resistor
R 430	4-01175-462	4.02K	Thin Film, 1%, 50 ppm, MELF Resistor
R 431	4-01084-462	453	Thin Film, 1%, 50 ppm, MELF Resistor
R 432	4-00960-462	23.2	Thin Film, 1%, 50 ppm, MELF Resistor
R 433	4-01175-462	4.02K	Thin Film, 1%, 50 ppm, MELF Resistor
R 434	4-01181-462	4.64K	Thin Film, 1%, 50 ppm, MELF Resistor
R 435	4-01305-462	90.9K	Thin Film, 1%, 50 ppm, MELF Resistor
R 436	4-01120-462	1.07K	Thin Film, 1%, 50 ppm, MELF Resistor
R 437	4-01053-462	215	Thin Film, 1%, 50 ppm, MELF Resistor
R 438	4-01059-462	249	Thin Film, 1%, 50 ppm, MELF Resistor
R 439	4-00993-462	51.1	Thin Film, 1%, 50 ppm, MELF Resistor
R 440	4-01133-462	1.47K	Thin Film, 1%, 50 ppm, MELF Resistor
R 441	4-01461-461	180	Thick Film, 5%, 200 ppm, Chip Resistor
R 442	4-01129-462	1.33K	Thin Film, 1%, 50 ppm, MELF Resistor
R 443	4-01133-462	1.47K	Thin Film, 1%, 50 ppm, MELF Resistor
R 444	4-01124-462	1.18K	Thin Film, 1%, 50 ppm, MELF Resistor
R 445	4-01053-462	215	Thin Film, 1%, 50 ppm, MELF Resistor
R 446	4-00942-462	15	Thin Film, 1%, 50 ppm, MELF Resistor
R 447	4-01053-462	215	Thin Film, 1%, 50 ppm, MELF Resistor
R 448	4-01124-462	1.18K	Thin Film, 1%, 50 ppm, MELF Resistor
R 449	4-01124-462	1.18K	Thin Film, 1%, 50 ppm, MELF Resistor
R 450	4-01124-462	1.18K	Thin Film, 1%, 50 ppm, MELF Resistor
R 451	4-01124-462	1.18K	Thin Film, 1%, 50 ppm, MELF Resistor
R 452	4-01053-462	215	Thin Film, 1%, 50 ppm, MELF Resistor
R 453	4-01117-462	1.00K	Thin Film, 1%, 50 ppm, MELF Resistor
R 454	4-01117-462	1.00K	Thin Film, 1%, 50 ppm, MELF Resistor
R 455	4-00960-462	23.2	Thin Film, 1%, 50 ppm, MELF Resistor
R 456	4-01124-462	1.18K	Thin Film, 1%, 50 ppm, MELF Resistor
R 457	4-00942-462	15	Thin Film, 1%, 50 ppm, MELF Resistor
R 458	4-01070-462	324	Thin Film, 1%, 50 ppm, MELF Resistor
R 459	4-01471-461	470	Thick Film, 5%, 200 ppm, Chip Resistor
R 460	4-01471-461	470	Thick Film, 5%, 200 ppm, Chip Resistor
R 470	4-01305-462	90.9K	Thin Film, 1%, 50 ppm, MELF Resistor
R 471	4-01305-462	90.9K	Thin Film, 1%, 50 ppm, MELF Resistor
R 472	4-01305-462	90.9K	Thin Film, 1%, 50 ppm, MELF Resistor
R 473	4-01305-462	90.9K	Thin Film, 1%, 50 ppm, MELF Resistor

If Amplifier Assembly			
Ref. No.	SRS Part No.	Value	Component Description
R 474	4-01070-462	324	Thin Film, 1%, 50 ppm, MELF Resistor
R 475	4-01305-462	90.9K	Thin Film, 1%, 50 ppm, MELF Resistor
R 476	4-01305-462	90.9K	Thin Film, 1%, 50 ppm, MELF Resistor
R 477	4-01305-462	90.9K	Thin Film, 1%, 50 ppm, MELF Resistor
R 478	4-01305-462	90.9K	Thin Film, 1%, 50 ppm, MELF Resistor
R 479	4-01305-462	90.9K	Thin Film, 1%, 50 ppm, MELF Resistor
R 480	4-01129-462	1.33K	Thin Film, 1%, 50 ppm, MELF Resistor
R 481	4-01305-462	90.9K	Thin Film, 1%, 50 ppm, MELF Resistor
R 482	4-01037-462	147	Thin Film, 1%, 50 ppm, MELF Resistor
R 483	4-01175-462	4.02K	Thin Film, 1%, 50 ppm, MELF Resistor
R 484	4-01037-462	147	Thin Film, 1%, 50 ppm, MELF Resistor
R 485	4-00960-462	23.2	Thin Film, 1%, 50 ppm, MELF Resistor
R 486	4-01175-462	4.02K	Thin Film, 1%, 50 ppm, MELF Resistor
R 487	4-01133-462	1.47K	Thin Film, 1%, 50 ppm, MELF Resistor
R 488	4-01129-462	1.33K	Thin Film, 1%, 50 ppm, MELF Resistor
R 489	4-01150-462	2.21K	Thin Film, 1%, 50 ppm, MELF Resistor
R 490	4-01153-462	2.37K	Thin Film, 1%, 50 ppm, MELF Resistor
R 491	4-01117-462	1.00K	Thin Film, 1%, 50 ppm, MELF Resistor
R 492	4-01129-462	1.33K	Thin Film, 1%, 50 ppm, MELF Resistor
R 493	4-01162-462	2.94K	Thin Film, 1%, 50 ppm, MELF Resistor
R 494	4-01133-462	1.47K	Thin Film, 1%, 50 ppm, MELF Resistor
R 495	4-01129-462	1.33K	Thin Film, 1%, 50 ppm, MELF Resistor
R 496	4-01141-462	1.78K	Thin Film, 1%, 50 ppm, MELF Resistor
R 497	4-01175-462	4.02K	Thin Film, 1%, 50 ppm, MELF Resistor
R 498	4-01305-462	90.9K	Thin Film, 1%, 50 ppm, MELF Resistor
R 500	4-01001-462	61.9	Thin Film, 1%, 50 ppm, MELF Resistor
R 501	4-01001-462	61.9	Thin Film, 1%, 50 ppm, MELF Resistor
R 502	4-01059-462	249	Thin Film, 1%, 50 ppm, MELF Resistor
R 503	4-01059-462	249	Thin Film, 1%, 50 ppm, MELF Resistor
R 504	4-01175-462	4.02K	Thin Film, 1%, 50 ppm, MELF Resistor
R 505	4-01150-462	2.21K	Thin Film, 1%, 50 ppm, MELF Resistor
R 506	4-01305-462	90.9K	Thin Film, 1%, 50 ppm, MELF Resistor
R 507	4-01181-462	4.64K	Thin Film, 1%, 50 ppm, MELF Resistor
R 508	4-01181-462	4.64K	Thin Film, 1%, 50 ppm, MELF Resistor
R 509	4-01053-462	215	Thin Film, 1%, 50 ppm, MELF Resistor
R 510	4-01146-462	2.00K	Thin Film, 1%, 50 ppm, MELF Resistor
R 511	4-01181-462	4.64K	Thin Film, 1%, 50 ppm, MELF Resistor
R 512	4-01053-462	215	Thin Film, 1%, 50 ppm, MELF Resistor
R 513	4-01009-462	75	Thin Film, 1%, 50 ppm, MELF Resistor
R 514	4-01153-462	2.37K	Thin Film, 1%, 50 ppm, MELF Resistor
R 515	4-01213-462	10.0K	Thin Film, 1%, 50 ppm, MELF Resistor
R 516	4-01167-462	3.32K	Thin Film, 1%, 50 ppm, MELF Resistor
R 517	4-01175-462	4.02K	Thin Film, 1%, 50 ppm, MELF Resistor
R 518	4-01020-462	97.6	Thin Film, 1%, 50 ppm, MELF Resistor
R 519	4-01150-462	2.21K	Thin Film, 1%, 50 ppm, MELF Resistor
R 520	4-01146-462	2.00K	Thin Film, 1%, 50 ppm, MELF Resistor
R 521	4-01181-462	4.64K	Thin Film, 1%, 50 ppm, MELF Resistor
R 522	4-01175-462	4.02K	Thin Film, 1%, 50 ppm, MELF Resistor
R 523	4-01084-462	453	Thin Film, 1%, 50 ppm, MELF Resistor
R 524	4-00960-462	23.2	Thin Film, 1%, 50 ppm, MELF Resistor

6-60 Parts Lists

If Amplifier Assembly			
Ref. No.	SRS Part No.	Value	Component Description
R 525	4-01175-462	4.02K	Thin Film, 1%, 50 ppm, MELF Resistor
R 526	4-01181-462	4.64K	Thin Film, 1%, 50 ppm, MELF Resistor
R 527	4-01150-462	2.21K	Thin Film, 1%, 50 ppm, MELF Resistor
R 528	4-01146-462	2.00K	Thin Film, 1%, 50 ppm, MELF Resistor
R 529	4-01181-462	4.64K	Thin Film, 1%, 50 ppm, MELF Resistor
R 530	4-01175-462	4.02K	Thin Film, 1%, 50 ppm, MELF Resistor
R 531	4-01084-462	453	Thin Film, 1%, 50 ppm, MELF Resistor
R 532	4-00960-462	23.2	Thin Film, 1%, 50 ppm, MELF Resistor
R 533	4-01175-462	4.02K	Thin Film, 1%, 50 ppm, MELF Resistor
R 534	4-01181-462	4.64K	Thin Film, 1%, 50 ppm, MELF Resistor
R 535	4-01305-462	90.9K	Thin Film, 1%, 50 ppm, MELF Resistor
R 536	4-01120-462	1.07K	Thin Film, 1%, 50 ppm, MELF Resistor
R 537	4-01053-462	215	Thin Film, 1%, 50 ppm, MELF Resistor
R 538	4-01059-462	249	Thin Film, 1%, 50 ppm, MELF Resistor
R 539	4-00993-462	51.1	Thin Film, 1%, 50 ppm, MELF Resistor
R 540	4-01133-462	1.47K	Thin Film, 1%, 50 ppm, MELF Resistor
R 541	4-01461-461	180	Thick Film, 5%, 200 ppm, Chip Resistor
R 542	4-01129-462	1.33K	Thin Film, 1%, 50 ppm, MELF Resistor
R 543	4-01133-462	1.47K	Thin Film, 1%, 50 ppm, MELF Resistor
R 544	4-01124-462	1.18K	Thin Film, 1%, 50 ppm, MELF Resistor
R 545	4-01053-462	215	Thin Film, 1%, 50 ppm, MELF Resistor
R 546	4-00942-462	15	Thin Film, 1%, 50 ppm, MELF Resistor
R 547	4-01053-462	215	Thin Film, 1%, 50 ppm, MELF Resistor
R 548	4-01124-462	1.18K	Thin Film, 1%, 50 ppm, MELF Resistor
R 549	4-01124-462	1.18K	Thin Film, 1%, 50 ppm, MELF Resistor
R 550	4-01124-462	1.18K	Thin Film, 1%, 50 ppm, MELF Resistor
R 551	4-01124-462	1.18K	Thin Film, 1%, 50 ppm, MELF Resistor
R 552	4-01053-462	215	Thin Film, 1%, 50 ppm, MELF Resistor
R 553	4-01117-462	1.00K	Thin Film, 1%, 50 ppm, MELF Resistor
R 554	4-01117-462	1.00K	Thin Film, 1%, 50 ppm, MELF Resistor
R 555	4-00960-462	23.2	Thin Film, 1%, 50 ppm, MELF Resistor
R 556	4-01124-462	1.18K	Thin Film, 1%, 50 ppm, MELF Resistor
R 557	4-00942-462	15	Thin Film, 1%, 50 ppm, MELF Resistor
R 558	4-01070-462	324	Thin Film, 1%, 50 ppm, MELF Resistor
R 570	4-01153-462	2.37K	Thin Film, 1%, 50 ppm, MELF Resistor
R 571	4-01153-462	2.37K	Thin Film, 1%, 50 ppm, MELF Resistor
R 572	4-01124-462	1.18K	Thin Film, 1%, 50 ppm, MELF Resistor
R 573	4-01181-462	4.64K	Thin Film, 1%, 50 ppm, MELF Resistor
R 574	4-01150-462	2.21K	Thin Film, 1%, 50 ppm, MELF Resistor
R 575	4-01505-461	12K	Thick Film, 5%, 200 ppm, Chip Resistor
R 576	4-01117-462	1.00K	Thin Film, 1%, 50 ppm, MELF Resistor
R 577	4-01213-462	10.0K	Thin Film, 1%, 50 ppm, MELF Resistor
R 578	4-01213-462	10.0K	Thin Film, 1%, 50 ppm, MELF Resistor
R 579	4-01505-461	12K	Thick Film, 5%, 200 ppm, Chip Resistor
R 580	4-01505-461	12K	Thick Film, 5%, 200 ppm, Chip Resistor
R 581	4-01477-461	820	Thick Film, 5%, 200 ppm, Chip Resistor
R 582	4-01477-461	820	Thick Film, 5%, 200 ppm, Chip Resistor
R 583	4-01117-462	1.00K	Thin Film, 1%, 50 ppm, MELF Resistor
R 584	4-01117-462	1.00K	Thin Film, 1%, 50 ppm, MELF Resistor
R 585	4-00993-462	51.1	Thin Film, 1%, 50 ppm, MELF Resistor

If Amplifier Assembly			
Ref. No.	SRS Part No.	Value	Component Description
R 586	4-00993-462	51.1	Thin Film, 1%, 50 ppm, MELF Resistor
R 587	4-01477-461	820	Thick Film, 5%, 200 ppm, Chip Resistor
R 588	4-01477-461	820	Thick Film, 5%, 200 ppm, Chip Resistor
R 589	4-01455-461	100	Thick Film, 5%, 200 ppm, Chip Resistor
R 590	4-01455-461	100	Thick Film, 5%, 200 ppm, Chip Resistor
R 591	4-01505-461	12K	Thick Film, 5%, 200 ppm, Chip Resistor
R 592	4-01167-462	3.32K	Thin Film, 1%, 50 ppm, MELF Resistor
U 400	3-00731-360	5534	Integrated Circuit (Surface Mount Pkg)
U 401	3-00731-360	5534	Integrated Circuit (Surface Mount Pkg)
U 402	3-00752-360	4052	Integrated Circuit (Surface Mount Pkg)
U 403	3-00730-360	5532	Integrated Circuit (Surface Mount Pkg)
U 404	3-00753-360	4053	Integrated Circuit (Surface Mount Pkg)
U 405	3-00643-360	DG211BDY	Integrated Circuit (Surface Mount Pkg)
U 406	3-00818-360	LM833	Integrated Circuit (Surface Mount Pkg)
U 407	3-00818-360	LM833	Integrated Circuit (Surface Mount Pkg)
U 408	3-00818-360	LM833	Integrated Circuit (Surface Mount Pkg)
U 409	3-00753-360	4053	Integrated Circuit (Surface Mount Pkg)
U 410	3-00730-360	5532	Integrated Circuit (Surface Mount Pkg)
U 470	3-00729-360	LM741C	Integrated Circuit (Surface Mount Pkg)
U 471	3-00729-360	LM741C	Integrated Circuit (Surface Mount Pkg)
U 472	3-00724-360	LF353	Integrated Circuit (Surface Mount Pkg)
U 473	3-00724-360	LF353	Integrated Circuit (Surface Mount Pkg)
U 474	3-00726-360	LF412	Integrated Circuit (Surface Mount Pkg)
U 475	3-00724-360	LF353	Integrated Circuit (Surface Mount Pkg)
U 476	3-00753-360	4053	Integrated Circuit (Surface Mount Pkg)
U 477	3-00742-360	74HC74	Integrated Circuit (Surface Mount Pkg)
U 478	3-00757-360	PCM1750U	Integrated Circuit (Surface Mount Pkg)
U 479	3-00724-360	LF353	Integrated Circuit (Surface Mount Pkg)
U 480	3-00727-360	LM339	Integrated Circuit (Surface Mount Pkg)
U 481	3-00709-360	78L05	Integrated Circuit (Surface Mount Pkg)
U 482	3-00712-360	79L05	Integrated Circuit (Surface Mount Pkg)
U 483	3-00709-360	78L05	Integrated Circuit (Surface Mount Pkg)
U 484	3-00712-360	79L05	Integrated Circuit (Surface Mount Pkg)
U 500	3-00731-360	5534	Integrated Circuit (Surface Mount Pkg)
U 501	3-00731-360	5534	Integrated Circuit (Surface Mount Pkg)
U 503	3-00730-360	5532	Integrated Circuit (Surface Mount Pkg)
U 504	3-00753-360	4053	Integrated Circuit (Surface Mount Pkg)
U 506	3-00818-360	LM833	Integrated Circuit (Surface Mount Pkg)
U 507	3-00818-360	LM833	Integrated Circuit (Surface Mount Pkg)
U 508	3-00818-360	LM833	Integrated Circuit (Surface Mount Pkg)
U 509	3-00753-360	4053	Integrated Circuit (Surface Mount Pkg)
U 510	3-00730-360	5532	Integrated Circuit (Surface Mount Pkg)
U 591	3-00728-360	LM393	Integrated Circuit (Surface Mount Pkg)
V 420	4-01461-461	180	Thick Film, 5%, 200 ppm, Chip Resistor
V 421	4-01461-461	180	Thick Film, 5%, 200 ppm, Chip Resistor
V 422	4-01461-461	180	Thick Film, 5%, 200 ppm, Chip Resistor
V 423	4-01461-461	180	Thick Film, 5%, 200 ppm, Chip Resistor
V 424	4-01461-461	180	Thick Film, 5%, 200 ppm, Chip Resistor
V 425	4-01461-461	180	Thick Film, 5%, 200 ppm, Chip Resistor
V 426	4-01461-461	180	Thick Film, 5%, 200 ppm, Chip Resistor

6-62 Parts Lists

If Amplifier Assembly			
Ref. No.	SRS Part No.	Value	Component Description
V 427	4-01461-461	180	Thick Film, 5%, 200 ppm, Chip Resistor
V 430	4-01461-461	180	Thick Film, 5%, 200 ppm, Chip Resistor
V 431	4-01461-461	180	Thick Film, 5%, 200 ppm, Chip Resistor
V 432	4-01461-461	180	Thick Film, 5%, 200 ppm, Chip Resistor
V 433	4-01461-461	180	Thick Film, 5%, 200 ppm, Chip Resistor
V 434	4-01461-461	180	Thick Film, 5%, 200 ppm, Chip Resistor
V 435	4-01461-461	180	Thick Film, 5%, 200 ppm, Chip Resistor
V 436	4-01461-461	180	Thick Film, 5%, 200 ppm, Chip Resistor
V 437	4-01461-461	180	Thick Film, 5%, 200 ppm, Chip Resistor
V 481	4-01461-461	180	Thick Film, 5%, 200 ppm, Chip Resistor
V 482	4-01461-461	180	Thick Film, 5%, 200 ppm, Chip Resistor
V 483	4-01461-461	180	Thick Film, 5%, 200 ppm, Chip Resistor
V 485	4-01461-461	180	Thick Film, 5%, 200 ppm, Chip Resistor
V 491	4-01461-461	180	Thick Film, 5%, 200 ppm, Chip Resistor
V 492	4-01461-461	180	Thick Film, 5%, 200 ppm, Chip Resistor
V 493	4-01461-461	180	Thick Film, 5%, 200 ppm, Chip Resistor
V 495	4-01461-461	180	Thick Film, 5%, 200 ppm, Chip Resistor
V 520	4-01461-461	180	Thick Film, 5%, 200 ppm, Chip Resistor
V 521	4-01461-461	180	Thick Film, 5%, 200 ppm, Chip Resistor
V 522	4-01461-461	180	Thick Film, 5%, 200 ppm, Chip Resistor
V 524	4-01461-461	180	Thick Film, 5%, 200 ppm, Chip Resistor
V 525	4-01461-461	180	Thick Film, 5%, 200 ppm, Chip Resistor
V 526	4-01461-461	180	Thick Film, 5%, 200 ppm, Chip Resistor
V 527	4-01461-461	180	Thick Film, 5%, 200 ppm, Chip Resistor
V 530	4-01461-461	180	Thick Film, 5%, 200 ppm, Chip Resistor
V 531	4-01461-461	180	Thick Film, 5%, 200 ppm, Chip Resistor
V 532	4-01461-461	180	Thick Film, 5%, 200 ppm, Chip Resistor
V 534	4-01461-461	180	Thick Film, 5%, 200 ppm, Chip Resistor
V 535	4-01461-461	180	Thick Film, 5%, 200 ppm, Chip Resistor
V 536	4-01461-461	180	Thick Film, 5%, 200 ppm, Chip Resistor
V 537	4-01461-461	180	Thick Film, 5%, 200 ppm, Chip Resistor
Z 0	1-00143-101	TEST JACK	Vertical Test Jack
Z 400	5-00315-527	.1UF	Capacitor, Ceramic SMT1206, 50V, 20% Z5U
Z 401	5-00315-527	.1UF	Capacitor, Ceramic SMT1206, 50V, 20% Z5U
Z 402	5-00315-527	.1UF	Capacitor, Ceramic SMT1206, 50V, 20% Z5U
Z 403	5-00315-527	.1UF	Capacitor, Ceramic SMT1206, 50V, 20% Z5U
Z 404	5-00315-527	.1UF	Capacitor, Ceramic SMT1206, 50V, 20% Z5U
Z 405	5-00315-527	.1UF	Capacitor, Ceramic SMT1206, 50V, 20% Z5U
Z 406	5-00315-527	.1UF	Capacitor, Ceramic SMT1206, 50V, 20% Z5U
Z 407	5-00315-527	.1UF	Capacitor, Ceramic SMT1206, 50V, 20% Z5U
Z 408	5-00315-527	.1UF	Capacitor, Ceramic SMT1206, 50V, 20% Z5U
Z 409	5-00315-527	.1UF	Capacitor, Ceramic SMT1206, 50V, 20% Z5U
Z 410	5-00315-527	.1UF	Capacitor, Ceramic SMT1206, 50V, 20% Z5U
Z 411	5-00315-527	.1UF	Capacitor, Ceramic SMT1206, 50V, 20% Z5U
Z 412	5-00315-527	.1UF	Capacitor, Ceramic SMT1206, 50V, 20% Z5U
Z 413	5-00315-527	.1UF	Capacitor, Ceramic SMT1206, 50V, 20% Z5U
Z 414	5-00315-527	.1UF	Capacitor, Ceramic SMT1206, 50V, 20% Z5U
Z 479	5-00315-527	.1UF	Capacitor, Ceramic SMT1206, 50V, 20% Z5U
Z 480	5-00315-527	.1UF	Capacitor, Ceramic SMT1206, 50V, 20% Z5U
Z 481	5-00315-527	.1UF	Capacitor, Ceramic SMT1206, 50V, 20% Z5U

If Amplifier Assembly			
Ref. No.	SRS Part No.	Value	Component Description
Z 482	5-00315-527	.1UF	Capacitor, Ceramic SMT1206, 50V, 20% Z5U
Z 483	5-00315-527	.1UF	Capacitor, Ceramic SMT1206, 50V, 20% Z5U
Z 484	5-00315-527	.1UF	Capacitor, Ceramic SMT1206, 50V, 20% Z5U
Z 485	5-00315-527	.1UF	Capacitor, Ceramic SMT1206, 50V, 20% Z5U
Z 486	5-00315-527	.1UF	Capacitor, Ceramic SMT1206, 50V, 20% Z5U
Z 490	5-00315-527	.1UF	Capacitor, Ceramic SMT1206, 50V, 20% Z5U
Z 491	5-00315-527	.1UF	Capacitor, Ceramic SMT1206, 50V, 20% Z5U
Z 492	5-00315-527	.1UF	Capacitor, Ceramic SMT1206, 50V, 20% Z5U
Z 493	5-00315-527	.1UF	Capacitor, Ceramic SMT1206, 50V, 20% Z5U
Z 494	5-00315-527	.1UF	Capacitor, Ceramic SMT1206, 50V, 20% Z5U
Z 495	5-00315-527	.1UF	Capacitor, Ceramic SMT1206, 50V, 20% Z5U
Z 502	5-00315-527	.1UF	Capacitor, Ceramic SMT1206, 50V, 20% Z5U
Z 503	5-00315-527	.1UF	Capacitor, Ceramic SMT1206, 50V, 20% Z5U
Z 506	5-00315-527	.1UF	Capacitor, Ceramic SMT1206, 50V, 20% Z5U
Z 507	5-00315-527	.1UF	Capacitor, Ceramic SMT1206, 50V, 20% Z5U
Z 591	5-00315-527	.1UF	Capacitor, Ceramic SMT1206, 50V, 20% Z5U
Z 592	5-00315-527	.1UF	Capacitor, Ceramic SMT1206, 50V, 20% Z5U

Reference (84XRF) Board Parts List

Reference Assembly			
Ref. No.	SRS Part No.	Value	Component Description
C 201	5-00298-568	.01U	Cap, Ceramic 50V SMT (1206) +/-10% X7R
C 202	5-00387-552	1000P	Capacitor, Chip (SMT1206), 50V, 5%, NPO
C 205	5-00387-552	1000P	Capacitor, Chip (SMT1206), 50V, 5%, NPO
C 210	5-00366-552	18P	Capacitor, Chip (SMT1206), 50V, 5%, NPO
C 213	5-00387-552	1000P	Capacitor, Chip (SMT1206), 50V, 5%, NPO
C 214	5-00367-552	22P	Capacitor, Chip (SMT1206), 50V, 5%, NPO
C 215	5-00355-552	2.2P	Capacitor, Chip (SMT1206), 50V, 5%, NPO
C 216	5-00298-568	.01U	Cap, Ceramic 50V SMT (1206) +/-10% X7R
C 220	5-00379-552	220P	Capacitor, Chip (SMT1206), 50V, 5%, NPO
C 221	5-00379-552	220P	Capacitor, Chip (SMT1206), 50V, 5%, NPO
C 230	5-00366-552	18P	Capacitor, Chip (SMT1206), 50V, 5%, NPO
C 234	5-00313-552	1P	Capacitor, Chip (SMT1206), 50V, 5%, NPO
C 299	5-00262-548	.01U AXIAL	Capacitor, Ceramic, 50V, +80/-20% Z5U AX
C 300	5-00363-552	10P	Capacitor, Chip (SMT1206), 50V, 5%, NPO
C 301	4-01084-462	453	Thin Film, 1%, 50 ppm, MELF Resistor
C 302	4-01084-462	453	Thin Film, 1%, 50 ppm, MELF Resistor
C 303	5-00363-552	10P	Capacitor, Chip (SMT1206), 50V, 5%, NPO
C 308	5-00382-552	390P	Capacitor, Chip (SMT1206), 50V, 5%, NPO
C 309	5-00382-552	390P	Capacitor, Chip (SMT1206), 50V, 5%, NPO
C 310	5-00382-552	390P	Capacitor, Chip (SMT1206), 50V, 5%, NPO
C 316	5-00387-552	1000P	Capacitor, Chip (SMT1206), 50V, 5%, NPO
C 317	5-00387-552	1000P	Capacitor, Chip (SMT1206), 50V, 5%, NPO
C 340	5-00298-568	.01U	Cap, Ceramic 50V SMT (1206) +/-10% X7R
C 341	5-00298-568	.01U	Cap, Ceramic 50V SMT (1206) +/-10% X7R
C 342	5-00382-552	390P	Capacitor, Chip (SMT1206), 50V, 5%, NPO
C 343	5-00298-568	.01U	Cap, Ceramic 50V SMT (1206) +/-10% X7R
C 344	5-00382-552	390P	Capacitor, Chip (SMT1206), 50V, 5%, NPO
C 345	5-00057-512	.22U	Cap, Stacked Metal Film 50V 5% -40/+85c
C 346	5-00298-568	.01U	Cap, Ceramic 50V SMT (1206) +/-10% X7R
C 347	5-00306-568	.033U	Cap, Ceramic 50V SMT (1206) +/-10% X7R
C 352	5-00057-512	.22U	Cap, Stacked Metal Film 50V 5% -40/+85c
C 353	5-00382-552	390P	Capacitor, Chip (SMT1206), 50V, 5%, NPO
C 354	5-00298-568	.01U	Cap, Ceramic 50V SMT (1206) +/-10% X7R
C 355	5-00382-552	390P	Capacitor, Chip (SMT1206), 50V, 5%, NPO
C 356	5-00057-512	.22U	Cap, Stacked Metal Film 50V 5% -40/+85c
C 357	5-00298-568	.01U	Cap, Ceramic 50V SMT (1206) +/-10% X7R
C 358	5-00306-568	.033U	Cap, Ceramic 50V SMT (1206) +/-10% X7R
C 363	5-00057-512	.22U	Cap, Stacked Metal Film 50V 5% -40/+85c
C 366	5-00298-568	.01U	Cap, Ceramic 50V SMT (1206) +/-10% X7R
C 380	5-00379-552	220P	Capacitor, Chip (SMT1206), 50V, 5%, NPO
C 381	5-00387-552	1000P	Capacitor, Chip (SMT1206), 50V, 5%, NPO
C 387	5-00387-552	1000P	Capacitor, Chip (SMT1206), 50V, 5%, NPO
C 388	5-00057-512	.22U	Cap, Stacked Metal Film 50V 5% -40/+85c
D 220	3-00762-313	MMD6263	Diode, SMT
D 221	3-00762-313	MMD6263	Diode, SMT
D 340	3-00783-313	MMBZ5226	Diode, SMT
D 341	3-00783-313	MMBZ5226	Diode, SMT

Reference Assembly			
Ref. No.	SRS Part No.	Value	Component Description
D 342	3-00783-313	MMBZ5226	Diode, SMT
D 343	3-00783-313	MMBZ5226	Diode, SMT
D 344	3-00783-313	MMBZ5226	Diode, SMT
D 345	3-00783-313	MMBZ5226	Diode, SMT
D 346	3-00783-313	MMBZ5226	Diode, SMT
D 347	3-00783-313	MMBZ5226	Diode, SMT
D 381	3-00762-313	MMD6263	Diode, SMT
E 208	5-00260-544	470U	Cap, Mini Electrolytic, 25V, 20%, Radial
E 330	5-00260-544	470U	Cap, Mini Electrolytic, 25V, 20%, Radial
E 332	5-00260-544	470U	Cap, Mini Electrolytic, 25V, 20%, Radial
E 348	5-00044-509	47U	Capacitor, Electrolytic, 50V, 20%, Rad
E 350	5-00038-509	10U	Capacitor, Electrolytic, 50V, 20%, Rad
E 351	5-00040-509	1.0U	Capacitor, Electrolytic, 50V, 20%, Rad
E 358	5-00044-509	47U	Capacitor, Electrolytic, 50V, 20%, Rad
E 360	5-00038-509	10U	Capacitor, Electrolytic, 50V, 20%, Rad
E 362	5-00040-509	1.0U	Capacitor, Electrolytic, 50V, 20%, Rad
F 200	5-00470-569	2.2U/T16	Cap, Tantalum, SMT (all case sizes)
F 201	5-00470-569	2.2U/T16	Cap, Tantalum, SMT (all case sizes)
F 204	5-00470-569	2.2U/T16	Cap, Tantalum, SMT (all case sizes)
F 205	5-00470-569	2.2U/T16	Cap, Tantalum, SMT (all case sizes)
F 206	5-00318-569	2.2U/T35	Cap, Tantalum, SMT (all case sizes)
F 207	5-00318-569	2.2U/T35	Cap, Tantalum, SMT (all case sizes)
F 322	5-00470-569	2.2U/T16	Cap, Tantalum, SMT (all case sizes)
F 330	5-00470-569	2.2U/T16	Cap, Tantalum, SMT (all case sizes)
F 331	5-00318-569	2.2U/T35	Cap, Tantalum, SMT (all case sizes)
F 332	5-00470-569	2.2U/T16	Cap, Tantalum, SMT (all case sizes)
F 365	5-00470-569	2.2U/T16	Cap, Tantalum, SMT (all case sizes)
F 368	5-00318-569	2.2U/T35	Cap, Tantalum, SMT (all case sizes)
F 369	5-00470-569	2.2U/T16	Cap, Tantalum, SMT (all case sizes)
F 388	5-00318-569	2.2U/T35	Cap, Tantalum, SMT (all case sizes)
J 20	1-00300-130	14 PIN DI ZW 10	Connector, Male
J 21	1-00295-130	4 PIN DI ZW 10	Connector, Male
J 30	1-00300-130	14 PIN DI ZW 10	Connector, Male
J 31	1-00297-130	8 PIN DI ZW 10	Connector, Male
J 32	1-00286-130	8 PIN DI MTLW	Connector, Male
J 33	1-00298-130	10 PIN DI ZW 10	Connector, Male
J 34	1-00286-130	8 PIN DI MTLW	Connector, Male
J 210	1-00241-141	RT ANGLE JACK	SMB Connector
JP216	1-00326-131	2 PIN SIF CES	Connector, Female
JP220	1-00326-131	2 PIN SIF CES	Connector, Female
JP234	1-00326-131	2 PIN SIF CES	Connector, Female
JP310	1-00326-131	2 PIN SIF CES	Connector, Female
JP313	1-00326-131	2 PIN SIF CES	Connector, Female
JP383	1-00326-131	2 PIN SIF CES	Connector, Female
L 200	6-00236-631	FR47	Ferrite bead, SMT
L 201	6-00236-631	FR47	Ferrite bead, SMT
L 203	6-00236-631	FR47	Ferrite bead, SMT
L 207	6-00236-631	FR47	Ferrite bead, SMT
L 230	6-00243-609	15UH	Inductor, Fixed, SMT
L 322	6-00236-631	FR47	Ferrite bead, SMT

6-66 Parts Lists

Reference Assembly			
Ref. No.	SRS Part No.	Value	Component Description
L 330	6-00236-631	FR47	Ferrite bead, SMT
L 332	6-00236-631	FR47	Ferrite bead, SMT
L 388	6-00242-609	1UH	Inductor, Fixed, SMT
N 220	4-00911-463	4.7KX4D	Resistor network, SMT, Leadless
N 234	4-00908-463	270X4D	Resistor network, SMT, Leadless
N 304	4-00906-463	100X4D	Resistor network, SMT, Leadless
N 306	4-00909-463	470X4D	Resistor network, SMT, Leadless
N 316	4-00911-463	4.7KX4D	Resistor network, SMT, Leadless
N 340	4-00909-463	470X4D	Resistor network, SMT, Leadless
N 342	4-00909-463	470X4D	Resistor network, SMT, Leadless
P 216	4-00326-441	200	Pot, Multi-Turn Trim, 3/8" Square Top Ad
P 234	4-00012-441	20K	Pot, Multi-Turn Trim, 3/8" Square Top Ad
P 310	4-00012-441	20K	Pot, Multi-Turn Trim, 3/8" Square Top Ad
P 313	4-00879-441	2.0K	Pot, Multi-Turn Trim, 3/8" Square Top Ad
P 364	4-00012-441	20K	Pot, Multi-Turn Trim, 3/8" Square Top Ad
PC1	7-00752-701	SR844 EXT REF	Printed Circuit Board
Q 210	3-00601-360	MMBT3904LT1	Integrated Circuit (Surface Mount Pkg)
R 206	4-01457-461	120	Thick Film, 5%, 200 ppm, Chip Resistor
R 210	4-01024-462	107	Thin Film, 1%, 50 ppm, MELF Resistor
R 211	4-01477-461	820	Thick Film, 5%, 200 ppm, Chip Resistor
R 212	4-01117-462	1.00K	Thin Film, 1%, 50 ppm, MELF Resistor
R 213	4-00913-453	49.9 FP	Resistor, 2W, 1%
R 214	4-01167-462	3.32K	Thin Film, 1%, 50 ppm, MELF Resistor
R 215	4-01167-462	3.32K	Thin Film, 1%, 50 ppm, MELF Resistor
R 216	4-01461-461	180	Thick Film, 5%, 200 ppm, Chip Resistor
R 217	4-01167-462	3.32K	Thin Film, 1%, 50 ppm, MELF Resistor
R 218	4-01175-462	4.02K	Thin Film, 1%, 50 ppm, MELF Resistor
R 219	4-01053-462	215	Thin Film, 1%, 50 ppm, MELF Resistor
R 220	4-01084-462	453	Thin Film, 1%, 50 ppm, MELF Resistor
R 221	4-00993-462	51.1	Thin Film, 1%, 50 ppm, MELF Resistor
R 222	4-01557-461	1.8M	Thick Film, 5%, 200 ppm, Chip Resistor
R 223	4-01557-461	1.8M	Thick Film, 5%, 200 ppm, Chip Resistor
R 230	4-00993-462	51.1	Thin Film, 1%, 50 ppm, MELF Resistor
R 231	4-01035-462	140	Thin Film, 1%, 50 ppm, MELF Resistor
R 232	4-01431-461	10	Thick Film, 5%, 200 ppm, Chip Resistor
R 233	4-01445-461	39	Thick Film, 5%, 200 ppm, Chip Resistor
R 234	4-01162-462	2.94K	Thin Film, 1%, 50 ppm, MELF Resistor
R 235	4-01471-461	470	Thick Film, 5%, 200 ppm, Chip Resistor
R 236	4-01431-461	10	Thick Film, 5%, 200 ppm, Chip Resistor
R 240	4-01447-461	47	Thick Film, 5%, 200 ppm, Chip Resistor
R 241	4-01084-462	453	Thin Film, 1%, 50 ppm, MELF Resistor
R 300	4-01471-461	470	Thick Film, 5%, 200 ppm, Chip Resistor
R 301	4-01471-461	470	Thick Film, 5%, 200 ppm, Chip Resistor
R 302	4-01471-461	470	Thick Film, 5%, 200 ppm, Chip Resistor
R 303	4-01471-461	470	Thick Film, 5%, 200 ppm, Chip Resistor
R 304	4-01020-462	97.6	Thin Film, 1%, 50 ppm, MELF Resistor
R 310	4-01213-462	10.0K	Thin Film, 1%, 50 ppm, MELF Resistor
R 311	4-01213-462	10.0K	Thin Film, 1%, 50 ppm, MELF Resistor
R 312	4-01117-462	1.00K	Thin Film, 1%, 50 ppm, MELF Resistor
R 313	4-01213-462	10.0K	Thin Film, 1%, 50 ppm, MELF Resistor

Reference Assembly			
Ref. No.	SRS Part No.	Value	Component Description
R 314	4-01348-462	255K	Thin Film, 1%, 50 ppm, MELF Resistor
R 315	4-01213-462	10.0K	Thin Film, 1%, 50 ppm, MELF Resistor
R 316	4-01405-462	1.00M	Thin Film, 1%, 50 ppm, MELF Resistor
R 317	4-01405-462	1.00M	Thin Film, 1%, 50 ppm, MELF Resistor
R 332	4-01455-461	100	Thick Film, 5%, 200 ppm, Chip Resistor
R 340	4-01117-462	1.00K	Thin Film, 1%, 50 ppm, MELF Resistor
R 341	4-01117-462	1.00K	Thin Film, 1%, 50 ppm, MELF Resistor
R 347	4-01428-461	7.5	Thick Film, 5%, 200 ppm, Chip Resistor
R 349	4-01447-461	47	Thick Film, 5%, 200 ppm, Chip Resistor
R 351	4-01470-461	430	Thick Film, 5%, 200 ppm, Chip Resistor
R 352	4-01146-462	2.00K	Thin Film, 1%, 50 ppm, MELF Resistor
R 357	4-01511-461	22K	Thick Film, 5%, 200 ppm, Chip Resistor
R 358	4-01428-461	7.5	Thick Film, 5%, 200 ppm, Chip Resistor
R 360	4-01447-461	47	Thick Film, 5%, 200 ppm, Chip Resistor
R 362	4-01470-461	430	Thick Film, 5%, 200 ppm, Chip Resistor
R 363	4-01146-462	2.00K	Thin Film, 1%, 50 ppm, MELF Resistor
R 364	4-01511-461	22K	Thick Film, 5%, 200 ppm, Chip Resistor
R 365	4-01053-462	215	Thin Film, 1%, 50 ppm, MELF Resistor
R 366	4-01150-462	2.21K	Thin Film, 1%, 50 ppm, MELF Resistor
R 367	4-01150-462	2.21K	Thin Film, 1%, 50 ppm, MELF Resistor
R 368	4-01150-462	2.21K	Thin Film, 1%, 50 ppm, MELF Resistor
R 369	4-01053-462	215	Thin Film, 1%, 50 ppm, MELF Resistor
R 370	4-01181-462	4.64K	Thin Film, 1%, 50 ppm, MELF Resistor
R 371	4-01181-462	4.64K	Thin Film, 1%, 50 ppm, MELF Resistor
R 372	4-01150-462	2.21K	Thin Film, 1%, 50 ppm, MELF Resistor
R 373	4-01150-462	2.21K	Thin Film, 1%, 50 ppm, MELF Resistor
R 374	4-01162-462	2.94K	Thin Film, 1%, 50 ppm, MELF Resistor
R 375	4-01162-462	2.94K	Thin Film, 1%, 50 ppm, MELF Resistor
R 380	4-00993-462	51.1	Thin Film, 1%, 50 ppm, MELF Resistor
R 381	4-01117-462	1.00K	Thin Film, 1%, 50 ppm, MELF Resistor
R 382	4-00950-462	18.2	Thin Film, 1%, 50 ppm, MELF Resistor
R 383	4-01084-462	453	Thin Film, 1%, 50 ppm, MELF Resistor
R 384	4-01406-461	0	Thick Film, 5%, 200 ppm, Chip Resistor
R 385	4-00950-462	18.2	Thin Film, 1%, 50 ppm, MELF Resistor
R 386	4-00950-462	18.2	Thin Film, 1%, 50 ppm, MELF Resistor
R 387	4-01445-461	39	Thick Film, 5%, 200 ppm, Chip Resistor
S 210	3-00196-335	HS-212S-5	Relay
T 385	6-00055-630	FB43-1801	Ferrite Beads
T 386	6-00055-630	FB43-1801	Ferrite Beads
U 206	3-00713-360	79L12	Integrated Circuit (Surface Mount Pkg)
U 216	3-00732-360	OPA660	Integrated Circuit (Surface Mount Pkg)
U 220	3-00726-360	LF412	Integrated Circuit (Surface Mount Pkg)
U 230	3-00731-360	5534	Integrated Circuit (Surface Mount Pkg)
U 234	3-00718-360	AD96685BR	Integrated Circuit (Surface Mount Pkg)
U 300	3-00734-360	MC100EL05D	Integrated Circuit (Surface Mount Pkg)
U 302	3-00734-360	MC100EL05D	Integrated Circuit (Surface Mount Pkg)
U 304	3-00740-360	MCK12140D	Integrated Circuit (Surface Mount Pkg)
U 310	3-00725-360	LF357	Integrated Circuit (Surface Mount Pkg)
U 316	3-00728-360	LM393	Integrated Circuit (Surface Mount Pkg)
U 322	3-00709-360	78L05	Integrated Circuit (Surface Mount Pkg)

6-68 Parts Lists

Reference Assembly			
Ref. No.	SRS Part No.	Value	Component Description
U 330	3-00709-360	78L05	Integrated Circuit (Surface Mount Pkg)
U 332	3-00712-360	79L05	Integrated Circuit (Surface Mount Pkg)
U 340	3-00753-360	4053	Integrated Circuit (Surface Mount Pkg)
U 341	3-00753-360	4053	Integrated Circuit (Surface Mount Pkg)
U 342	3-00753-360	4053	Integrated Circuit (Surface Mount Pkg)
U 343	3-00752-360	4052	Integrated Circuit (Surface Mount Pkg)
U 344	3-00660-360	OP27GS	Integrated Circuit (Surface Mount Pkg)
U 345	3-00729-360	LM741C	Integrated Circuit (Surface Mount Pkg)
U 381	6-00244-625	Q3500C-0204T	Voltage Controlled Crystal Oscillator
U 388	3-00602-360	78L12	Integrated Circuit (Surface Mount Pkg)
V 322	4-01461-461	180	Thick Film, 5%, 200 ppm, Chip Resistor
V 332	4-01461-461	180	Thick Film, 5%, 200 ppm, Chip Resistor
W 300	4-01024-462	107	Thin Film, 1%, 50 ppm, MELF Resistor
W 302	4-01024-462	107	Thin Film, 1%, 50 ppm, MELF Resistor
X 234	4-00993-462	51.1	Thin Film, 1%, 50 ppm, MELF Resistor
X 300	4-00993-462	51.1	Thin Film, 1%, 50 ppm, MELF Resistor
X 302	5-00363-552	10P	Capacitor, Chip (SMT1206), 50V, 5%, NPO
Y 234	4-00993-462	51.1	Thin Film, 1%, 50 ppm, MELF Resistor
Y 300	4-00993-462	51.1	Thin Film, 1%, 50 ppm, MELF Resistor
Y 302	5-00363-552	10P	Capacitor, Chip (SMT1206), 50V, 5%, NPO
Z 0	0-00478-055	1.5"X#30 BLK	Wire, Other
Z 0	0-00479-055	1.5"X#30 ORA	Wire, Other
Z 0	1-00143-101	TEST JACK	Vertical Test Jack
Z 201	5-00315-527	.1UF	Capacitor, Ceramic SMT1206, 50V, 20% Z5U
Z 203	5-00315-527	.1UF	Capacitor, Ceramic SMT1206, 50V, 20% Z5U
Z 206	5-00315-527	.1UF	Capacitor, Ceramic SMT1206, 50V, 20% Z5U
Z 207	5-00315-527	.1UF	Capacitor, Ceramic SMT1206, 50V, 20% Z5U
Z 208	5-00315-527	.1UF	Capacitor, Ceramic SMT1206, 50V, 20% Z5U
Z 214	5-00315-527	.1UF	Capacitor, Ceramic SMT1206, 50V, 20% Z5U
Z 215	5-00315-527	.1UF	Capacitor, Ceramic SMT1206, 50V, 20% Z5U
Z 220	5-00315-527	.1UF	Capacitor, Ceramic SMT1206, 50V, 20% Z5U
Z 221	5-00315-527	.1UF	Capacitor, Ceramic SMT1206, 50V, 20% Z5U
Z 222	5-00315-527	.1UF	Capacitor, Ceramic SMT1206, 50V, 20% Z5U
Z 230	5-00315-527	.1UF	Capacitor, Ceramic SMT1206, 50V, 20% Z5U
Z 231	5-00315-527	.1UF	Capacitor, Ceramic SMT1206, 50V, 20% Z5U
Z 232	5-00315-527	.1UF	Capacitor, Ceramic SMT1206, 50V, 20% Z5U
Z 234	5-00315-527	.1UF	Capacitor, Ceramic SMT1206, 50V, 20% Z5U
Z 300	5-00315-527	.1UF	Capacitor, Ceramic SMT1206, 50V, 20% Z5U
Z 301	5-00315-527	.1UF	Capacitor, Ceramic SMT1206, 50V, 20% Z5U
Z 302	5-00315-527	.1UF	Capacitor, Ceramic SMT1206, 50V, 20% Z5U
Z 303	5-00315-527	.1UF	Capacitor, Ceramic SMT1206, 50V, 20% Z5U
Z 304	5-00315-527	.1UF	Capacitor, Ceramic SMT1206, 50V, 20% Z5U
Z 305	5-00315-527	.1UF	Capacitor, Ceramic SMT1206, 50V, 20% Z5U
Z 310	5-00315-527	.1UF	Capacitor, Ceramic SMT1206, 50V, 20% Z5U
Z 322	5-00315-527	.1UF	Capacitor, Ceramic SMT1206, 50V, 20% Z5U
Z 323	5-00315-527	.1UF	Capacitor, Ceramic SMT1206, 50V, 20% Z5U
Z 324	5-00315-527	.1UF	Capacitor, Ceramic SMT1206, 50V, 20% Z5U
Z 325	5-00315-527	.1UF	Capacitor, Ceramic SMT1206, 50V, 20% Z5U
Z 326	5-00315-527	.1UF	Capacitor, Ceramic SMT1206, 50V, 20% Z5U
Z 327	5-00315-527	.1UF	Capacitor, Ceramic SMT1206, 50V, 20% Z5U

Reference Assembly			
Ref. No.	SRS Part No.	Value	Component Description
Z 330	5-00315-527	.1UF	Capacitor, Ceramic SMT1206, 50V, 20% Z5U
Z 331	5-00315-527	.1UF	Capacitor, Ceramic SMT1206, 50V, 20% Z5U
Z 332	5-00315-527	.1UF	Capacitor, Ceramic SMT1206, 50V, 20% Z5U
Z 333	5-00315-527	.1UF	Capacitor, Ceramic SMT1206, 50V, 20% Z5U
Z 334	5-00315-527	.1UF	Capacitor, Ceramic SMT1206, 50V, 20% Z5U
Z 340	5-00315-527	.1UF	Capacitor, Ceramic SMT1206, 50V, 20% Z5U
Z 341	5-00315-527	.1UF	Capacitor, Ceramic SMT1206, 50V, 20% Z5U
Z 342	5-00315-527	.1UF	Capacitor, Ceramic SMT1206, 50V, 20% Z5U
Z 343	5-00315-527	.1UF	Capacitor, Ceramic SMT1206, 50V, 20% Z5U
Z 349	5-00315-527	.1UF	Capacitor, Ceramic SMT1206, 50V, 20% Z5U
Z 350	5-00315-527	.1UF	Capacitor, Ceramic SMT1206, 50V, 20% Z5U
Z 351	5-00315-527	.1UF	Capacitor, Ceramic SMT1206, 50V, 20% Z5U
Z 352	5-00315-527	.1UF	Capacitor, Ceramic SMT1206, 50V, 20% Z5U
Z 353	5-00315-527	.1UF	Capacitor, Ceramic SMT1206, 50V, 20% Z5U
Z 360	5-00315-527	.1UF	Capacitor, Ceramic SMT1206, 50V, 20% Z5U
Z 364	5-00315-527	.1UF	Capacitor, Ceramic SMT1206, 50V, 20% Z5U
Z 365	5-00315-527	.1UF	Capacitor, Ceramic SMT1206, 50V, 20% Z5U
Z 388	5-00315-527	.1UF	Capacitor, Ceramic SMT1206, 50V, 20% Z5U

Divider Chain (84DVC) Board Parts List

Divider Chain Assembly			
Ref. No.	SRS Part No.	Value	Component Description
C 600	5-00375-552	100P	Capacitor, Chip (SMT1206), 50V, 5%, NPO
C 601	5-00375-552	100P	Capacitor, Chip (SMT1206), 50V, 5%, NPO
C 632	5-00367-552	22P	Capacitor, Chip (SMT1206), 50V, 5%, NPO
C 659	5-00366-552	18P	Capacitor, Chip (SMT1206), 50V, 5%, NPO
C 660	5-00387-552	1000P	Capacitor, Chip (SMT1206), 50V, 5%, NPO
C 661	5-00387-552	1000P	Capacitor, Chip (SMT1206), 50V, 5%, NPO
C 662	5-00387-552	1000P	Capacitor, Chip (SMT1206), 50V, 5%, NPO
C 663	5-00387-552	1000P	Capacitor, Chip (SMT1206), 50V, 5%, NPO
C 664	5-00387-552	1000P	Capacitor, Chip (SMT1206), 50V, 5%, NPO
C 665	5-00387-552	1000P	Capacitor, Chip (SMT1206), 50V, 5%, NPO
C 666	5-00387-552	1000P	Capacitor, Chip (SMT1206), 50V, 5%, NPO
C 667	5-00387-552	1000P	Capacitor, Chip (SMT1206), 50V, 5%, NPO
C 668	5-00387-552	1000P	Capacitor, Chip (SMT1206), 50V, 5%, NPO
C 669	5-00387-552	1000P	Capacitor, Chip (SMT1206), 50V, 5%, NPO
C 670	5-00387-552	1000P	Capacitor, Chip (SMT1206), 50V, 5%, NPO
C 671	5-00387-552	1000P	Capacitor, Chip (SMT1206), 50V, 5%, NPO
C 672	5-00387-552	1000P	Capacitor, Chip (SMT1206), 50V, 5%, NPO
C 673	5-00387-552	1000P	Capacitor, Chip (SMT1206), 50V, 5%, NPO
C 674	5-00387-552	1000P	Capacitor, Chip (SMT1206), 50V, 5%, NPO
C 675	5-00387-552	1000P	Capacitor, Chip (SMT1206), 50V, 5%, NPO
C 676	5-00387-552	1000P	Capacitor, Chip (SMT1206), 50V, 5%, NPO
C 677	5-00387-552	1000P	Capacitor, Chip (SMT1206), 50V, 5%, NPO
C 678	5-00387-552	1000P	Capacitor, Chip (SMT1206), 50V, 5%, NPO
C 679	5-00387-552	1000P	Capacitor, Chip (SMT1206), 50V, 5%, NPO
D 624	3-00763-313	MMD914	Diode, SMT
J 7	1-00327-130	10 PIN ELH	Connector, Male
J 32	1-00303-131	8 PIN DIF CES	Connector, Female
J 34	1-00303-131	8 PIN DIF CES	Connector, Female
J 60	1-00307-141	STRAIGHT JACK	SMB Connector
J 61	1-00282-130	14 PIN DI	Connector, Male
J 62	1-00288-130	4 PIN DI TSW 07	Connector, Male
J 63	1-00288-130	4 PIN DI TSW 07	Connector, Male
J 64	1-00288-130	4 PIN DI TSW 07	Connector, Male
J 65	1-00288-130	4 PIN DI TSW 07	Connector, Male
J 66	1-00290-130	8 PIN DI TSW 07	Connector, Male
J 67	1-00288-130	4 PIN DI TSW 07	Connector, Male
J 68	1-00288-130	4 PIN DI TSW 07	Connector, Male
J 69	1-00288-130	4 PIN DI TSW 07	Connector, Male
J 74	1-00303-131	8 PIN DIF CES	Connector, Female
J072	1-00301-131	4 PIN DIF CES	Connector, Female
J073	1-00304-131	10 PIN DIF CES	Connector, Female
L 650	6-00236-631	FR47	Ferrite bead, SMT
L 651	6-00236-631	FR47	Ferrite bead, SMT
L 666	6-00236-631	FR47	Ferrite bead, SMT
L 667	6-00236-631	FR47	Ferrite bead, SMT
N 640	4-00910-463	1.0KX4D	Resistor network, SMT, Leadless

Divider Chain Assembly			
Ref. No.	SRS Part No.	Value	Component Description
N 641	4-00910-463	1.0KX4D	Resistor network, SMT, Leadless
N 646	4-00910-463	1.0KX4D	Resistor network, SMT, Leadless
N 647	4-00916-463	47X4D	Resistor network, SMT, Leadless
N 648	4-00910-463	1.0KX4D	Resistor network, SMT, Leadless
N 649	4-00916-463	47X4D	Resistor network, SMT, Leadless
N 650	4-00910-463	1.0KX4D	Resistor network, SMT, Leadless
N 651	4-00910-463	1.0KX4D	Resistor network, SMT, Leadless
N 660	4-00911-463	4.7KX4D	Resistor network, SMT, Leadless
N 661	4-00917-463	3.9KX4D	Resistor network, SMT, Leadless
N 664	4-00911-463	4.7KX4D	Resistor network, SMT, Leadless
N 665	4-00917-463	3.9KX4D	Resistor network, SMT, Leadless
N 668	4-00910-463	1.0KX4D	Resistor network, SMT, Leadless
N 672	4-00911-463	4.7KX4D	Resistor network, SMT, Leadless
N 673	4-00917-463	3.9KX4D	Resistor network, SMT, Leadless
N 676	4-00910-463	1.0KX4D	Resistor network, SMT, Leadless
O 611	4-01059-462	249	Thin Film, 1%, 50 ppm, MELF Resistor
O 612	4-01059-462	249	Thin Film, 1%, 50 ppm, MELF Resistor
P 650	4-00326-441	200	Pot, Multi-Turn Trim, 3/8" Square Top Ad
PC1	7-00750-701	SR844 DVC	Printed Circuit Board
R 600	4-01150-462	2.21K	Thin Film, 1%, 50 ppm, MELF Resistor
R 601	4-01084-462	453	Thin Film, 1%, 50 ppm, MELF Resistor
R 602	4-01084-462	453	Thin Film, 1%, 50 ppm, MELF Resistor
R 603	4-01150-462	2.21K	Thin Film, 1%, 50 ppm, MELF Resistor
R 604	4-01181-462	4.64K	Thin Film, 1%, 50 ppm, MELF Resistor
R 605	4-00978-462	35.7	Thin Film, 1%, 50 ppm, MELF Resistor
R 606	4-00978-462	35.7	Thin Film, 1%, 50 ppm, MELF Resistor
R 607	4-00942-462	15	Thin Film, 1%, 50 ppm, MELF Resistor
R 608	4-00942-462	15	Thin Film, 1%, 50 ppm, MELF Resistor
R 609	4-01117-462	1.00K	Thin Film, 1%, 50 ppm, MELF Resistor
R 610	4-01117-462	1.00K	Thin Film, 1%, 50 ppm, MELF Resistor
R 611	4-01084-462	453	Thin Film, 1%, 50 ppm, MELF Resistor
R 612	4-01084-462	453	Thin Film, 1%, 50 ppm, MELF Resistor
R 613	4-01181-462	4.64K	Thin Film, 1%, 50 ppm, MELF Resistor
R 614	4-01150-462	2.21K	Thin Film, 1%, 50 ppm, MELF Resistor
R 615	4-01150-462	2.21K	Thin Film, 1%, 50 ppm, MELF Resistor
R 616	4-01084-462	453	Thin Film, 1%, 50 ppm, MELF Resistor
R 617	4-01084-462	453	Thin Film, 1%, 50 ppm, MELF Resistor
R 620	4-01084-462	453	Thin Film, 1%, 50 ppm, MELF Resistor
R 621	4-01084-462	453	Thin Film, 1%, 50 ppm, MELF Resistor
R 622	4-01084-462	453	Thin Film, 1%, 50 ppm, MELF Resistor
R 623	4-01084-462	453	Thin Film, 1%, 50 ppm, MELF Resistor
R 624	4-01150-462	2.21K	Thin Film, 1%, 50 ppm, MELF Resistor
R 625	4-01471-461	470	Thick Film, 5%, 200 ppm, Chip Resistor
R 626	4-01117-462	1.00K	Thin Film, 1%, 50 ppm, MELF Resistor
R 629	4-01084-462	453	Thin Film, 1%, 50 ppm, MELF Resistor
R 630	4-01084-462	453	Thin Film, 1%, 50 ppm, MELF Resistor
R 632	4-01406-461	0	Thick Film, 5%, 200 ppm, Chip Resistor
R 638	4-01150-462	2.21K	Thin Film, 1%, 50 ppm, MELF Resistor
R 639	4-01150-462	2.21K	Thin Film, 1%, 50 ppm, MELF Resistor
R 647	4-01181-462	4.64K	Thin Film, 1%, 50 ppm, MELF Resistor

6-72 Parts Lists

Divider Chain Assembly			
Ref. No.	SRS Part No.	Value	Component Description
R 648	4-01181-462	4.64K	Thin Film, 1%, 50 ppm, MELF Resistor
R 649	4-01181-462	4.64K	Thin Film, 1%, 50 ppm, MELF Resistor
R 650	4-01181-462	4.64K	Thin Film, 1%, 50 ppm, MELF Resistor
R 651	4-01181-462	4.64K	Thin Film, 1%, 50 ppm, MELF Resistor
R 652	4-01181-462	4.64K	Thin Film, 1%, 50 ppm, MELF Resistor
R 653	4-01181-462	4.64K	Thin Film, 1%, 50 ppm, MELF Resistor
R 654	4-01181-462	4.64K	Thin Film, 1%, 50 ppm, MELF Resistor
R 655	4-00993-462	51.1	Thin Film, 1%, 50 ppm, MELF Resistor
R 656	4-01084-462	453	Thin Film, 1%, 50 ppm, MELF Resistor
R 657	4-01084-462	453	Thin Film, 1%, 50 ppm, MELF Resistor
R 658	4-01070-462	324	Thin Film, 1%, 50 ppm, MELF Resistor
R 659	4-01001-462	61.9	Thin Film, 1%, 50 ppm, MELF Resistor
R 667	4-01150-462	2.21K	Thin Film, 1%, 50 ppm, MELF Resistor
R 668	4-01150-462	2.21K	Thin Film, 1%, 50 ppm, MELF Resistor
R 669	4-01150-462	2.21K	Thin Film, 1%, 50 ppm, MELF Resistor
R 670	4-01150-462	2.21K	Thin Film, 1%, 50 ppm, MELF Resistor
R 671	4-01150-462	2.21K	Thin Film, 1%, 50 ppm, MELF Resistor
R 672	4-01150-462	2.21K	Thin Film, 1%, 50 ppm, MELF Resistor
R 673	4-01150-462	2.21K	Thin Film, 1%, 50 ppm, MELF Resistor
R 674	4-01150-462	2.21K	Thin Film, 1%, 50 ppm, MELF Resistor
R 676	4-01070-462	324	Thin Film, 1%, 50 ppm, MELF Resistor
R 678	4-01423-461	4.7	Thick Film, 5%, 200 ppm, Chip Resistor
R 679	4-01084-462	453	Thin Film, 1%, 50 ppm, MELF Resistor
R 687	4-01162-462	2.94K	Thin Film, 1%, 50 ppm, MELF Resistor
R 688	4-01162-462	2.94K	Thin Film, 1%, 50 ppm, MELF Resistor
R 689	4-01162-462	2.94K	Thin Film, 1%, 50 ppm, MELF Resistor
R 690	4-01162-462	2.94K	Thin Film, 1%, 50 ppm, MELF Resistor
R 691	4-01162-462	2.94K	Thin Film, 1%, 50 ppm, MELF Resistor
R 692	4-01162-462	2.94K	Thin Film, 1%, 50 ppm, MELF Resistor
R 693	4-01162-462	2.94K	Thin Film, 1%, 50 ppm, MELF Resistor
R 694	4-01162-462	2.94K	Thin Film, 1%, 50 ppm, MELF Resistor
T 600	6-00055-630	FB43-1801	Ferrite Beads
T 620	6-00055-630	FB43-1801	Ferrite Beads
T 622	6-00055-630	FB43-1801	Ferrite Beads
U 601	3-00736-360	MC100EL11D	Integrated Circuit (Surface Mount Pkg)
U 603	3-00737-360	MC100EL16D	Integrated Circuit (Surface Mount Pkg)
U 604	3-00573-360	MC10EL32D	Integrated Circuit (Surface Mount Pkg)
U 605	3-00737-360	MC100EL16D	Integrated Circuit (Surface Mount Pkg)
U 606	3-00573-360	MC10EL32D	Integrated Circuit (Surface Mount Pkg)
U 607	3-00737-360	MC100EL16D	Integrated Circuit (Surface Mount Pkg)
U 608	3-00733-360	MC10EL34D	Integrated Circuit (Surface Mount Pkg)
U 611	3-00266-340	MC10H116	Integrated Circuit (Thru-hole Pkg)
U 613	3-00739-360	MC100EL57D	Integrated Circuit (Surface Mount Pkg)
U 616	3-00737-360	MC100EL16D	Integrated Circuit (Surface Mount Pkg)
U 618	3-00268-340	MC10H164	Integrated Circuit (Thru-hole Pkg)
U 619	3-00268-340	MC10H164	Integrated Circuit (Thru-hole Pkg)
U 620	3-00738-360	MC100EL51D	Integrated Circuit (Surface Mount Pkg)
U 622	3-00738-360	MC100EL51D	Integrated Circuit (Surface Mount Pkg)
U 624	3-00739-360	MC100EL57D	Integrated Circuit (Surface Mount Pkg)
U 625	3-00739-360	MC100EL57D	Integrated Circuit (Surface Mount Pkg)

Divider Chain Assembly			
Ref. No.	SRS Part No.	Value	Component Description
U 626	3-00734-360	MC100EL05D	Integrated Circuit (Surface Mount Pkg)
U 627	3-00734-360	MC100EL05D	Integrated Circuit (Surface Mount Pkg)
U 629	3-00737-360	MC100EL16D	Integrated Circuit (Surface Mount Pkg)
U 638	3-00781-360	NJM360	Integrated Circuit (Surface Mount Pkg)
U 640	3-00842-361	SR844 U640	GAL/PAL, SMT
U 641	3-00749-360	74HC541	Integrated Circuit (Surface Mount Pkg)
U 642	3-00663-360	74HC08	Integrated Circuit (Surface Mount Pkg)
U 643	3-00761-340	74AC4040N	Integrated Circuit (Thru-hole Pkg)
U 644	3-00744-360	74HC151	Integrated Circuit (Surface Mount Pkg)
U 645	3-00744-360	74HC151	Integrated Circuit (Surface Mount Pkg)
U 646	3-00741-360	74HC04	Integrated Circuit (Surface Mount Pkg)
U 647	3-00741-360	74HC04	Integrated Circuit (Surface Mount Pkg)
U 648	3-00782-360	74HC02	Integrated Circuit (Surface Mount Pkg)
U 649	3-00744-360	74HC151	Integrated Circuit (Surface Mount Pkg)
U 650	3-00722-360	HFA1114	Integrated Circuit (Surface Mount Pkg)
U 651	3-00843-361	SR844 U651	GAL/PAL, SMT
U 652	3-00748-360	74HC540	Integrated Circuit (Surface Mount Pkg)
W 601	4-01024-462	107	Thin Film, 1%, 50 ppm, MELF Resistor
W 602	4-01024-462	107	Thin Film, 1%, 50 ppm, MELF Resistor
W 603	4-01024-462	107	Thin Film, 1%, 50 ppm, MELF Resistor
W 604	4-01024-462	107	Thin Film, 1%, 50 ppm, MELF Resistor
W 605	4-01024-462	107	Thin Film, 1%, 50 ppm, MELF Resistor
W 606	4-01024-462	107	Thin Film, 1%, 50 ppm, MELF Resistor
W 607	4-01024-462	107	Thin Film, 1%, 50 ppm, MELF Resistor
W 608	4-01024-462	107	Thin Film, 1%, 50 ppm, MELF Resistor
W 609	4-01024-462	107	Thin Film, 1%, 50 ppm, MELF Resistor
W 610	4-01024-462	107	Thin Film, 1%, 50 ppm, MELF Resistor
W 611	4-01024-462	107	Thin Film, 1%, 50 ppm, MELF Resistor
W 613	4-01024-462	107	Thin Film, 1%, 50 ppm, MELF Resistor
W 618	4-01468-461	360	Thick Film, 5%, 200 ppm, Chip Resistor
W 619	4-01468-461	360	Thick Film, 5%, 200 ppm, Chip Resistor
W 624	4-01024-462	107	Thin Film, 1%, 50 ppm, MELF Resistor
W 625	4-01024-462	107	Thin Film, 1%, 50 ppm, MELF Resistor
W 626	4-01024-462	107	Thin Film, 1%, 50 ppm, MELF Resistor
W 627	4-01024-462	107	Thin Film, 1%, 50 ppm, MELF Resistor
X 600	4-00993-462	51.1	Thin Film, 1%, 50 ppm, MELF Resistor
X 601	4-00993-462	51.1	Thin Film, 1%, 50 ppm, MELF Resistor
X 602	4-00993-462	51.1	Thin Film, 1%, 50 ppm, MELF Resistor
X 603	4-00993-462	51.1	Thin Film, 1%, 50 ppm, MELF Resistor
X 604	4-00993-462	51.1	Thin Film, 1%, 50 ppm, MELF Resistor
X 605	4-00993-462	51.1	Thin Film, 1%, 50 ppm, MELF Resistor
X 606	4-00993-462	51.1	Thin Film, 1%, 50 ppm, MELF Resistor
X 607	4-00993-462	51.1	Thin Film, 1%, 50 ppm, MELF Resistor
X 608	4-00993-462	51.1	Thin Film, 1%, 50 ppm, MELF Resistor
X 609	4-00993-462	51.1	Thin Film, 1%, 50 ppm, MELF Resistor
X 610	4-00993-462	51.1	Thin Film, 1%, 50 ppm, MELF Resistor
X 613	4-00993-462	51.1	Thin Film, 1%, 50 ppm, MELF Resistor
X 618	4-01020-462	97.6	Thin Film, 1%, 50 ppm, MELF Resistor
X 619	4-01020-462	97.6	Thin Film, 1%, 50 ppm, MELF Resistor
X 620	4-00993-462	51.1	Thin Film, 1%, 50 ppm, MELF Resistor

6-74 Parts Lists

Divider Chain Assembly			
Ref. No.	SRS Part No.	Value	Component Description
X 624	4-00993-462	51.1	Thin Film, 1%, 50 ppm, MELF Resistor
X 625	4-00993-462	51.1	Thin Film, 1%, 50 ppm, MELF Resistor
X 626	4-00993-462	51.1	Thin Film, 1%, 50 ppm, MELF Resistor
X 627	4-00993-462	51.1	Thin Film, 1%, 50 ppm, MELF Resistor
Y 600	4-00993-462	51.1	Thin Film, 1%, 50 ppm, MELF Resistor
Y 601	4-00993-462	51.1	Thin Film, 1%, 50 ppm, MELF Resistor
Y 602	4-00993-462	51.1	Thin Film, 1%, 50 ppm, MELF Resistor
Y 603	4-00993-462	51.1	Thin Film, 1%, 50 ppm, MELF Resistor
Y 604	4-00993-462	51.1	Thin Film, 1%, 50 ppm, MELF Resistor
Y 605	4-00993-462	51.1	Thin Film, 1%, 50 ppm, MELF Resistor
Y 606	4-00993-462	51.1	Thin Film, 1%, 50 ppm, MELF Resistor
Y 607	4-00993-462	51.1	Thin Film, 1%, 50 ppm, MELF Resistor
Y 608	4-00993-462	51.1	Thin Film, 1%, 50 ppm, MELF Resistor
Y 609	4-00993-462	51.1	Thin Film, 1%, 50 ppm, MELF Resistor
Y 610	4-00993-462	51.1	Thin Film, 1%, 50 ppm, MELF Resistor
Y 613	4-00993-462	51.1	Thin Film, 1%, 50 ppm, MELF Resistor
Y 620	4-00993-462	51.1	Thin Film, 1%, 50 ppm, MELF Resistor
Y 624	4-00993-462	51.1	Thin Film, 1%, 50 ppm, MELF Resistor
Y 625	4-00993-462	51.1	Thin Film, 1%, 50 ppm, MELF Resistor
Y 626	4-00993-462	51.1	Thin Film, 1%, 50 ppm, MELF Resistor
Y 627	4-00993-462	51.1	Thin Film, 1%, 50 ppm, MELF Resistor
Z 0	0-00478-055	1.5"X#30 BLK	Wire, Other
Z 0	0-00479-055	1.5"X#30 ORA	Wire, Other
Z 0	1-00143-101	TEST JACK	Vertical Test Jack
Z 600	5-00315-527	.1UF	Capacitor, Ceramic SMT1206, 50V, 20% Z5U
Z 601	5-00315-527	.1UF	Capacitor, Ceramic SMT1206, 50V, 20% Z5U
Z 602	5-00315-527	.1UF	Capacitor, Ceramic SMT1206, 50V, 20% Z5U
Z 603	5-00315-527	.1UF	Capacitor, Ceramic SMT1206, 50V, 20% Z5U
Z 604	5-00315-527	.1UF	Capacitor, Ceramic SMT1206, 50V, 20% Z5U
Z 605	5-00315-527	.1UF	Capacitor, Ceramic SMT1206, 50V, 20% Z5U
Z 606	5-00315-527	.1UF	Capacitor, Ceramic SMT1206, 50V, 20% Z5U
Z 607	5-00315-527	.1UF	Capacitor, Ceramic SMT1206, 50V, 20% Z5U
Z 608	5-00315-527	.1UF	Capacitor, Ceramic SMT1206, 50V, 20% Z5U
Z 609	5-00315-527	.1UF	Capacitor, Ceramic SMT1206, 50V, 20% Z5U
Z 610	5-00315-527	.1UF	Capacitor, Ceramic SMT1206, 50V, 20% Z5U
Z 611	5-00315-527	.1UF	Capacitor, Ceramic SMT1206, 50V, 20% Z5U
Z 613	5-00315-527	.1UF	Capacitor, Ceramic SMT1206, 50V, 20% Z5U
Z 614	5-00315-527	.1UF	Capacitor, Ceramic SMT1206, 50V, 20% Z5U
Z 618	5-00315-527	.1UF	Capacitor, Ceramic SMT1206, 50V, 20% Z5U
Z 619	5-00315-527	.1UF	Capacitor, Ceramic SMT1206, 50V, 20% Z5U
Z 624	5-00315-527	.1UF	Capacitor, Ceramic SMT1206, 50V, 20% Z5U
Z 625	5-00315-527	.1UF	Capacitor, Ceramic SMT1206, 50V, 20% Z5U
Z 626	5-00315-527	.1UF	Capacitor, Ceramic SMT1206, 50V, 20% Z5U
Z 627	5-00315-527	.1UF	Capacitor, Ceramic SMT1206, 50V, 20% Z5U
Z 632	5-00315-527	.1UF	Capacitor, Ceramic SMT1206, 50V, 20% Z5U
Z 640	5-00315-527	.1UF	Capacitor, Ceramic SMT1206, 50V, 20% Z5U
Z 641	5-00315-527	.1UF	Capacitor, Ceramic SMT1206, 50V, 20% Z5U
Z 642	5-00315-527	.1UF	Capacitor, Ceramic SMT1206, 50V, 20% Z5U
Z 643	5-00315-527	.1UF	Capacitor, Ceramic SMT1206, 50V, 20% Z5U
Z 644	5-00315-527	.1UF	Capacitor, Ceramic SMT1206, 50V, 20% Z5U

Divider Chain Assembly			
Ref. No.	SRS Part No.	Value	Component Description
Z 646	5-00315-527	.1UF	Capacitor, Ceramic SMT1206, 50V, 20% Z5U
Z 647	5-00315-527	.1UF	Capacitor, Ceramic SMT1206, 50V, 20% Z5U
Z 648	5-00315-527	.1UF	Capacitor, Ceramic SMT1206, 50V, 20% Z5U
Z 649	5-00315-527	.1UF	Capacitor, Ceramic SMT1206, 50V, 20% Z5U
Z 650	5-00315-527	.1UF	Capacitor, Ceramic SMT1206, 50V, 20% Z5U
Z 651	5-00315-527	.1UF	Capacitor, Ceramic SMT1206, 50V, 20% Z5U
Z 652	5-00315-527	.1UF	Capacitor, Ceramic SMT1206, 50V, 20% Z5U
Z 653	5-00315-527	.1UF	Capacitor, Ceramic SMT1206, 50V, 20% Z5U
Z 660	5-00315-527	.1UF	Capacitor, Ceramic SMT1206, 50V, 20% Z5U
Z 661	5-00315-527	.1UF	Capacitor, Ceramic SMT1206, 50V, 20% Z5U
Z 663	5-00315-527	.1UF	Capacitor, Ceramic SMT1206, 50V, 20% Z5U
Z 664	5-00315-527	.1UF	Capacitor, Ceramic SMT1206, 50V, 20% Z5U
Z 665	5-00315-527	.1UF	Capacitor, Ceramic SMT1206, 50V, 20% Z5U
Z 666	5-00315-527	.1UF	Capacitor, Ceramic SMT1206, 50V, 20% Z5U
Z 667	5-00315-527	.1UF	Capacitor, Ceramic SMT1206, 50V, 20% Z5U
Z 668	5-00315-527	.1UF	Capacitor, Ceramic SMT1206, 50V, 20% Z5U
Z 671	5-00315-527	.1UF	Capacitor, Ceramic SMT1206, 50V, 20% Z5U
Z 673	5-00315-527	.1UF	Capacitor, Ceramic SMT1206, 50V, 20% Z5U
Z 676	5-00315-527	.1UF	Capacitor, Ceramic SMT1206, 50V, 20% Z5U
Z 678	5-00315-527	.1UF	Capacitor, Ceramic SMT1206, 50V, 20% Z5U
Z 679	5-00315-527	.1UF	Capacitor, Ceramic SMT1206, 50V, 20% Z5U
Z 680	5-00315-527	.1UF	Capacitor, Ceramic SMT1206, 50V, 20% Z5U
Z 682	5-00315-527	.1UF	Capacitor, Ceramic SMT1206, 50V, 20% Z5U
Z 684	5-00315-527	.1UF	Capacitor, Ceramic SMT1206, 50V, 20% Z5U
Z 685	5-00315-527	.1UF	Capacitor, Ceramic SMT1206, 50V, 20% Z5U
Z 686	5-00315-527	.1UF	Capacitor, Ceramic SMT1206, 50V, 20% Z5U
Z 687	5-00315-527	.1UF	Capacitor, Ceramic SMT1206, 50V, 20% Z5U
Z 688	5-00315-527	.1UF	Capacitor, Ceramic SMT1206, 50V, 20% Z5U
Z 692	5-00315-527	.1UF	Capacitor, Ceramic SMT1206, 50V, 20% Z5U

Digital Signal Processor (84DSP) Board Parts List

The DSP board is mounted on the bottom of the Motherboard.

Digital Signal Processor Assembly			
Ref. No.	SRS Part No.	Value	Component Description
C 900	5-00382-552	390P	Capacitor, Chip (SMT1206), 50V, 5%, NPO
C 901	5-00382-552	390P	Capacitor, Chip (SMT1206), 50V, 5%, NPO
C 902	5-00298-568	.01U	Cap, Ceramic 50V SMT (1206) +/-10% X7R
C 903	5-00298-568	.01U	Cap, Ceramic 50V SMT (1206) +/-10% X7R
C 904	5-00298-568	.01U	Cap, Ceramic 50V SMT (1206) +/-10% X7R
C 905	5-00298-568	.01U	Cap, Ceramic 50V SMT (1206) +/-10% X7R
C 908	5-00379-552	220P	Capacitor, Chip (SMT1206), 50V, 5%, NPO
C 909	5-00379-552	220P	Capacitor, Chip (SMT1206), 50V, 5%, NPO
C 912	5-00379-552	220P	Capacitor, Chip (SMT1206), 50V, 5%, NPO
C 913	5-00379-552	220P	Capacitor, Chip (SMT1206), 50V, 5%, NPO
C 914	5-00375-552	100P	Capacitor, Chip (SMT1206), 50V, 5%, NPO
C 916	5-00375-552	100P	Capacitor, Chip (SMT1206), 50V, 5%, NPO
C 924	5-00375-552	100P	Capacitor, Chip (SMT1206), 50V, 5%, NPO
C 926	5-00375-552	100P	Capacitor, Chip (SMT1206), 50V, 5%, NPO
F 903	5-00471-569	10U/T16	Cap, Tantalum, SMT (all case sizes)
F 906	5-00471-569	10U/T16	Cap, Tantalum, SMT (all case sizes)
F 930	5-00470-569	2.2U/T16	Cap, Tantalum, SMT (all case sizes)
F 950	5-00471-569	10U/T16	Cap, Tantalum, SMT (all case sizes)
F 951	5-00471-569	10U/T16	Cap, Tantalum, SMT (all case sizes)
F 952	5-00471-569	10U/T16	Cap, Tantalum, SMT (all case sizes)
F 953	5-00471-569	10U/T16	Cap, Tantalum, SMT (all case sizes)
F 954	5-00471-569	10U/T16	Cap, Tantalum, SMT (all case sizes)
F 955	5-00471-569	10U/T16	Cap, Tantalum, SMT (all case sizes)
F 960	5-00318-569	2.2U/T35	Cap, Tantalum, SMT (all case sizes)
F 961	5-00318-569	2.2U/T35	Cap, Tantalum, SMT (all case sizes)
J 90	1-00291-130	40 PIN DI TSW07	Connector, Male
J 91	1-00281-130	10 PIN DI	Connector, Male
J 92	1-00282-130	14 PIN DI	Connector, Male
J 93	1-00288-130	4 PIN DI TSW 07	Connector, Male
J 94	1-00282-130	14 PIN DI	Connector, Male
L 950	6-00236-631	FR47	Ferrite bead, SMT
L 970	6-00243-609	15UH	Inductor, Fixed, SMT
N 900	4-00912-463	10KX4D	Resistor network, SMT, Leadless
N 901	4-00912-463	10KX4D	Resistor network, SMT, Leadless
N 902	4-00912-463	10KX4D	Resistor network, SMT, Leadless
N 903	4-00912-463	10KX4D	Resistor network, SMT, Leadless
N 904	4-00905-463	82X4D	Resistor network, SMT, Leadless
N 905	4-00911-463	4.7KX4D	Resistor network, SMT, Leadless
N 907	4-00912-463	10KX4D	Resistor network, SMT, Leadless
N 908	4-00907-463	220X4D	Resistor network, SMT, Leadless
N 909	4-00907-463	220X4D	Resistor network, SMT, Leadless
N 910	4-00905-463	82X4D	Resistor network, SMT, Leadless
N 911	4-00905-463	82X4D	Resistor network, SMT, Leadless
PC1	7-00751-701	SR844 DSP	Printed Circuit Board
R 900	4-01213-462	10.0K	Thin Film, 1%, 50 ppm, MELF Resistor

Digital Signal Processor Assembly			
Ref. No.	SRS Part No.	Value	Component Description
R 901	4-01213-462	10.0K	Thin Film, 1%, 50 ppm, MELF Resistor
R 904	4-01133-462	1.47K	Thin Film, 1%, 50 ppm, MELF Resistor
R 906	4-01405-462	1.00M	Thin Film, 1%, 50 ppm, MELF Resistor
R 907	4-01405-462	1.00M	Thin Film, 1%, 50 ppm, MELF Resistor
R 908	4-01348-462	255K	Thin Film, 1%, 50 ppm, MELF Resistor
R 909	4-01348-462	255K	Thin Film, 1%, 50 ppm, MELF Resistor
R 910	4-01405-462	1.00M	Thin Film, 1%, 50 ppm, MELF Resistor
R 911	4-01405-462	1.00M	Thin Film, 1%, 50 ppm, MELF Resistor
R 912	4-01348-462	255K	Thin Film, 1%, 50 ppm, MELF Resistor
R 913	4-01348-462	255K	Thin Film, 1%, 50 ppm, MELF Resistor
R 914	4-01471-461	470	Thick Film, 5%, 200 ppm, Chip Resistor
R 915	4-01471-461	470	Thick Film, 5%, 200 ppm, Chip Resistor
R 916	4-01117-462	1.00K	Thin Film, 1%, 50 ppm, MELF Resistor
R 917	4-01455-461	100	Thick Film, 5%, 200 ppm, Chip Resistor
R 918	4-01175-462	4.02K	Thin Film, 1%, 50 ppm, MELF Resistor
R 919	4-01133-462	1.47K	Thin Film, 1%, 50 ppm, MELF Resistor
R 920	4-01117-462	1.00K	Thin Film, 1%, 50 ppm, MELF Resistor
R 921	4-01455-461	100	Thick Film, 5%, 200 ppm, Chip Resistor
R 922	4-01175-462	4.02K	Thin Film, 1%, 50 ppm, MELF Resistor
R 923	4-01133-462	1.47K	Thin Film, 1%, 50 ppm, MELF Resistor
R 928	4-01447-461	47	Thick Film, 5%, 200 ppm, Chip Resistor
R 929	4-01447-461	47	Thick Film, 5%, 200 ppm, Chip Resistor
R 930	4-01133-462	1.47K	Thin Film, 1%, 50 ppm, MELF Resistor
R 931	4-01455-461	100	Thick Film, 5%, 200 ppm, Chip Resistor
R 932	4-01175-462	4.02K	Thin Film, 1%, 50 ppm, MELF Resistor
R 933	4-01133-462	1.47K	Thin Film, 1%, 50 ppm, MELF Resistor
R 934	4-01133-462	1.47K	Thin Film, 1%, 50 ppm, MELF Resistor
R 935	4-01455-461	100	Thick Film, 5%, 200 ppm, Chip Resistor
R 936	4-01175-462	4.02K	Thin Film, 1%, 50 ppm, MELF Resistor
R 937	4-01133-462	1.47K	Thin Film, 1%, 50 ppm, MELF Resistor
R 938	4-01511-461	22K	Thick Film, 5%, 200 ppm, Chip Resistor
R 939	4-01511-461	22K	Thick Film, 5%, 200 ppm, Chip Resistor
R 940	4-01175-462	4.02K	Thin Film, 1%, 50 ppm, MELF Resistor
U 900	3-00611-360	DSP56002FC-40	Integrated Circuit (Surface Mount Pkg)
U 904	3-00760-361	XC5202PC84-6	GAL/PAL, SMT
U 905	3-00781-360	NJM360	Integrated Circuit (Surface Mount Pkg)
U 907	3-00726-360	LF412	Integrated Circuit (Surface Mount Pkg)
U 908	3-00749-360	74HC541	Integrated Circuit (Surface Mount Pkg)
U 909	3-00757-360	PCM1750U	Integrated Circuit (Surface Mount Pkg)
U 910	3-00749-360	74HC541	Integrated Circuit (Surface Mount Pkg)
U 914	3-00756-360	PCM1700U	Integrated Circuit (Surface Mount Pkg)
U 915	3-00723-360	LF347	Integrated Circuit (Surface Mount Pkg)
U 920	3-00756-360	PCM1700U	Integrated Circuit (Surface Mount Pkg)
U 938	3-00781-360	NJM360	Integrated Circuit (Surface Mount Pkg)
Z 0	1-00143-101	TEST JACK	Vertical Test Jack
Z 900	5-00315-527	.1UF	Capacitor, Ceramic SMT1206, 50V, 20% Z5U
Z 907	5-00315-527	.1UF	Capacitor, Ceramic SMT1206, 50V, 20% Z5U
Z 908	5-00315-527	.1UF	Capacitor, Ceramic SMT1206, 50V, 20% Z5U
Z 909	5-00315-527	.1UF	Capacitor, Ceramic SMT1206, 50V, 20% Z5U
Z 910	5-00315-527	.1UF	Capacitor, Ceramic SMT1206, 50V, 20% Z5U

6-78 Parts Lists

Digital Signal Processor Assembly			
Ref. No.	SRS Part No.	Value	Component Description
Z 911	5-00315-527	.1UF	Capacitor, Ceramic SMT1206, 50V, 20% Z5U
Z 912	5-00315-527	.1UF	Capacitor, Ceramic SMT1206, 50V, 20% Z5U
Z 913	5-00315-527	.1UF	Capacitor, Ceramic SMT1206, 50V, 20% Z5U
Z 915	5-00315-527	.1UF	Capacitor, Ceramic SMT1206, 50V, 20% Z5U
Z 917	5-00315-527	.1UF	Capacitor, Ceramic SMT1206, 50V, 20% Z5U
Z 918	5-00315-527	.1UF	Capacitor, Ceramic SMT1206, 50V, 20% Z5U
Z 919	5-00315-527	.1UF	Capacitor, Ceramic SMT1206, 50V, 20% Z5U
Z 920	5-00315-527	.1UF	Capacitor, Ceramic SMT1206, 50V, 20% Z5U
Z 921	5-00315-527	.1UF	Capacitor, Ceramic SMT1206, 50V, 20% Z5U
Z 922	5-00315-527	.1UF	Capacitor, Ceramic SMT1206, 50V, 20% Z5U
Z 923	5-00315-527	.1UF	Capacitor, Ceramic SMT1206, 50V, 20% Z5U
Z 925	5-00315-527	.1UF	Capacitor, Ceramic SMT1206, 50V, 20% Z5U
Z 930	5-00315-527	.1UF	Capacitor, Ceramic SMT1206, 50V, 20% Z5U
Z 931	5-00315-527	.1UF	Capacitor, Ceramic SMT1206, 50V, 20% Z5U
Z 932	5-00315-527	.1UF	Capacitor, Ceramic SMT1206, 50V, 20% Z5U
Z 933	5-00315-527	.1UF	Capacitor, Ceramic SMT1206, 50V, 20% Z5U
Z 934	5-00315-527	.1UF	Capacitor, Ceramic SMT1206, 50V, 20% Z5U
Z 935	5-00315-527	.1UF	Capacitor, Ceramic SMT1206, 50V, 20% Z5U
Z 936	5-00315-527	.1UF	Capacitor, Ceramic SMT1206, 50V, 20% Z5U
Z 937	5-00315-527	.1UF	Capacitor, Ceramic SMT1206, 50V, 20% Z5U
Z 938	5-00315-527	.1UF	Capacitor, Ceramic SMT1206, 50V, 20% Z5U
Z 939	5-00315-527	.1UF	Capacitor, Ceramic SMT1206, 50V, 20% Z5U
Z 940	5-00315-527	.1UF	Capacitor, Ceramic SMT1206, 50V, 20% Z5U
Z 941	5-00315-527	.1UF	Capacitor, Ceramic SMT1206, 50V, 20% Z5U
Z 942	5-00315-527	.1UF	Capacitor, Ceramic SMT1206, 50V, 20% Z5U
Z 943	5-00315-527	.1UF	Capacitor, Ceramic SMT1206, 50V, 20% Z5U
Z 944	5-00315-527	.1UF	Capacitor, Ceramic SMT1206, 50V, 20% Z5U
Z 945	5-00315-527	.1UF	Capacitor, Ceramic SMT1206, 50V, 20% Z5U
Z 950	5-00315-527	.1UF	Capacitor, Ceramic SMT1206, 50V, 20% Z5U
Z 951	5-00315-527	.1UF	Capacitor, Ceramic SMT1206, 50V, 20% Z5U
Z 960	5-00315-527	.1UF	Capacitor, Ceramic SMT1206, 50V, 20% Z5U
Z 961	5-00315-527	.1UF	Capacitor, Ceramic SMT1206, 50V, 20% Z5U
Z 962	5-00315-527	.1UF	Capacitor, Ceramic SMT1206, 50V, 20% Z5U
Z 963	5-00315-527	.1UF	Capacitor, Ceramic SMT1206, 50V, 20% Z5U
Z 970	5-00315-527	.1UF	Capacitor, Ceramic SMT1206, 50V, 20% Z5U
Z 971	5-00315-527	.1UF	Capacitor, Ceramic SMT1206, 50V, 20% Z5U
Z 972	5-00315-527	.1UF	Capacitor, Ceramic SMT1206, 50V, 20% Z5U

Final Assembly and Miscellaneous Parts List

These parts are used in the final assembly, to put together the above sub-assemblies in a finished unit.

Final Assembly and Miscellaneous			
Ref. No.	SRS Part No.	Value	Component Description
U 303	3-00639-342	256KX8-120	EPROM/PROM, I.C.
U 304	3-00639-342	256KX8-120	EPROM/PROM, I.C.
Z 0	0-00045-013	4-40 MINI	Nut, Mini
Z 0	0-00179-000	RIGHT FOOT	Hardware, Misc.
Z 0	0-00180-000	LEFT FOOT	Hardware, Misc.
Z 0	0-00185-021	6-32X3/8PP	Screw, Panhead Phillips
Z 0	0-00187-021	4-40X1/4PP	Screw, Panhead Phillips
Z 0	0-00204-000	REAR FOOT	Hardware, Misc.
Z 0	0-00241-021	4-40X3/16PP	Screw, Panhead Phillips
Z 0	0-00248-026	10-32X3/8TRUSSP	Screw, Black, All Types
Z 0	0-00315-021	6-32X7/16 PP	Screw, Panhead Phillips
Z 0	0-00415-031	4-40X1/2 M/F	Standoff
Z 0	0-00641-031	4-40X3/16 M/F	Standoff
Z 0	3-00744-360	74HC151	Integrated Circuit (Surface Mount Pkg)
Z 0	7-00147-720	BAIL	Fabricated Part
Z 0	7-00508-720	SR830-16	Fabricated Part
Z 0	7-00509-720	SR830-17	Fabricated Part
Z 0	7-00708-709	SR844-4	Lexan Overlay

Schematic Diagrams