

# User Manual



## **3066 & 3086** **3 GHz Real Time Spectrum Analyzer** **071-0501-01**

This document supports firmware version 2.2.



Copyright © Sony/Tektronix Corporation. All rights reserved.

Copyright © Tektronix, Inc. All rights reserved.

Tektronix products are covered by U.S. and foreign patents, issued and pending. Information in this publication supercedes that in all previously published material. Specifications and price change privileges reserved.

Printed in Japan.

Sony/Tektronix Corporation, P.O.Box 5209, Tokyo Int'l, Tokyo 100-31 Japan

Tektronix, Inc., P.O. Box 1000, Wilsonville, OR 97070-1000

TEKTRONIX and TEK are registered trademarks of Tektronix, Inc.

MS-DOS and Microsoft are registered trademarks of Microsoft Corporation.

Windows, Windows 95 and Excel are trademarks of Microsoft Corporation.

## WARRANTY

Tektronix warrants that the products that it manufactures and sells will be free from defects in materials and workmanship for a period of one (1) year from the date of shipment. If a product proves defective during this warranty period, Tektronix, at its option, either will repair the defective product without charge for parts and labor, or will provide a replacement in exchange for the defective product.

In order to obtain service under this warranty, Customer must notify Tektronix of the defect before the expiration of the warranty period and make suitable arrangements for the performance of service. Customer shall be responsible for packaging and shipping the defective product to the service center designated by Tektronix, with shipping charges prepaid. Tektronix shall pay for the return of the product to Customer if the shipment is to a location within the country in which the Tektronix service center is located. Customer shall be responsible for paying all shipping charges, duties, taxes, and any other charges for products returned to any other locations.

This warranty shall not apply to any defect, failure or damage caused by improper use or improper or inadequate maintenance and care. Tektronix shall not be obligated to furnish service under this warranty a) to repair damage resulting from attempts by personnel other than Tektronix representatives to install, repair or service the product; b) to repair damage resulting from improper use or connection to incompatible equipment; c) to repair any damage or malfunction caused by the use of non-Tektronix supplies; or d) to service a product that has been modified or integrated with other products when the effect of such modification or integration increases the time or difficulty of servicing the product.

**THIS WARRANTY IS GIVEN BY TEKTRONIX IN LIEU OF ANY OTHER WARRANTIES, EXPRESS OR IMPLIED. TEKTRONIX AND ITS VENDORS DISCLAIM ANY IMPLIED WARRANTIES OF MERCHANTABILITY OR FITNESS FOR A PARTICULAR PURPOSE. TEKTRONIX' RESPONSIBILITY TO REPAIR OR REPLACE DEFECTIVE PRODUCTS IS THE SOLE AND EXCLUSIVE REMEDY PROVIDED TO THE CUSTOMER FOR BREACH OF THIS WARRANTY. TEKTRONIX AND ITS VENDORS WILL NOT BE LIABLE FOR ANY INDIRECT, SPECIAL, INCIDENTAL, OR CONSEQUENTIAL DAMAGES IRRESPECTIVE OF WHETHER TEKTRONIX OR THE VENDOR HAS ADVANCE NOTICE OF THE POSSIBILITY OF SUCH DAMAGES.**



## Service Options

Tektronix provides service to cover repair under warranty as well as other services that are designed to meet your specific service needs. Advancing technology has brought incredible change to the power of measurement instruments. Manufacturing methods and calibration techniques have been revolutionized, making the service challenge tougher than ever. By using Tektronix as your service provider you make use of our technology and product knowledge, our world-wide logistics infrastructure, and our ISO9000 approved service centers. Tektronix technicians are trained on the latest products and are equipped with the most current information on product improvements and upgrades for optimum product performance.

**Warranty Repair Service.** Tektronix technicians provide warranty service at most Tektronix service locations worldwide. The warranty period for this product can be found behind the title page in this manual.

**Calibration and Repair Service.** Tektronix offers calibrations, non-warranty repair, and support for customers performing their own service. Where appropriate, calibrations are compliant to ANSI/NCSL Z-540/ISO GUIDE 25 and ISO9000 Quality Systems. If you prefer to perform your own service, Tektronix supports repair to the replaceable-part level through providing for circuit board exchange. All services can be purchased through a variety of agreements to fit your specific requirements.

For more information, regarding service offerings or service locations worldwide, please see the Tektronix product catalog or visit us on our Customer Services World Center web site at:

<http://www.tek.com/Measurement/Service>.



# Table of Contents

|                                     |             |
|-------------------------------------|-------------|
| <b>General Safety Summary</b> ..... | <b>xv</b>   |
| <b>Service Safety Summary</b> ..... | <b>xvii</b> |
| <b>Preface</b> .....                | <b>xix</b>  |

## Getting Started

|  |            |
|--|------------|
| <b>Product Overview</b> .....                  | <b>1-1</b> |
| Features .....                                 | 1-1        |
| Targets .....                                  | 1-2        |
| The difference between the 3066 and 3086 ..... | 1-3        |
| <b>Architecture</b> .....                      | <b>1-5</b> |
| 3 GHz Down Converter .....                     | 1-6        |
| Analog Front End .....                         | 1-6        |
| A/D converter .....                            | 1-6        |
| Digital Down Converter .....                   | 1-6        |
| FIFO .....                                     | 1-6        |
| FFT Processor .....                            | 1-7        |
| Digital Trigger Comparator .....               | 1-7        |
| Data Memory .....                              | 1-7        |
| Controller .....                               | 1-7        |
| ISA/PCI Bus .....                              | 1-7        |
| CPU Board .....                                | 1-8        |
| TFT Display .....                              | 1-8        |
| The 3086 Only .....                            | 1-8        |
| <b>Installation and Power On</b> .....         | <b>1-9</b> |
| Unpacking and Inspection .....                 | 1-9        |
| Installation .....                             | 1-9        |
| Action During Abnormal Operation .....         | 1-14       |
| Adjusting the Display Tilt Angle .....         | 1-14       |
| Calibration and Functional Checks .....        | 1-16       |
| Backing Up User Files .....                    | 1-18       |

## Operating Basics

|   |             |
|---|-------------|
| <b>Interface Maps</b> .....                 | <b>2-1</b>  |
| Front Panel .....                           | 2-2         |
| Rear Panel .....                            | 2-4         |
| Display Screen Configuration .....          | 2-5         |
| General Display Information in a View ..... | 2-6         |
| Status/Setup Display .....                  | 2-7         |
| <b>Menu Operations</b> .....                | <b>2-11</b> |
| Displaying Menus .....                      | 2-11        |
| Menu Item Information .....                 | 2-14        |
| Selection and Numeric Input .....           | 2-16        |

|   |             |
|---|-------------|
| <b>Tutorial</b> .....                                 | <b>2-19</b> |
| Preparations .....                                    | 2-19        |
| Setup .....   | 2-20        |
| Applying Power .....                                  | 2-20        |
| Configuration with Basic Configuration Patterns ..... | 2-22        |
| Measuring a Digital Modulated Signal .....            | 2-25        |
| Making Changes to Hardware Settings .....             | 2-27        |
| View Definitions and Layout .....                     | 2-31        |
| Averaging and Compared Display .....                  | 2-36        |
| Search and Zoom .....                                 | 2-38        |
| Delta Markers .....                                   | 2-41        |
| Trigger and Mask Pattern .....                        | 2-44        |
| Spectrum Time-series Variation .....                  | 2-50        |
| EVM (Error Vector Magnitude) Analysis .....           | 2-52        |
| Power Measurement .....                               | 2-55        |
| Turning Off the Power .....                           | 2-58        |
| <b>Menu Functions</b> .....                           | <b>2-59</b> |
| Setup Sequence .....                                  | 2-59        |
| CONFIG Menu .....                                     | 2-60        |
| SETUP (Standard) Menu .....                           | 2-64        |
| SETUP (CDMA) Menu .....                               | 2-68        |
| Waveform View Menu .....                              | 2-70        |
| Analog View Menu .....                                | 2-74        |
| FSK View Menu .....                                   | 2-76        |
| Spectrogram View Menu .....                           | 2-77        |
| Waterfall View Menu .....                             | 2-79        |
| CDMAWaveform View Menu .....                          | 2-80        |
| CDMAPolar View Menu .....                             | 2-83        |
| CDMATime View Menu .....                              | 2-86        |
| Polar View .....                                      | 2-88        |
| EyeDiagram View Menu .....                            | 2-91        |
| SymbolTable View Menu .....                           | 2-92        |
| EVM View Menu .....                                   | 2-93        |
| Average Menu .....                                    | 2-94        |
| SaveLoad Menu .....                                   | 2-95        |
| File Access Menu .....                                | 2-96        |
| Print Menu .....                                      | 2-97        |

## Reference

|  |            |
|--|------------|
| <b>Input and Memory Modes</b> .....                      | <b>3-1</b> |
| Setting a Basic Patterns .....                           | 3-1        |
| Establishing a Mode Manually .....                       | 3-2        |
| IQ, Wideband, RF, and Baseband Modes .....               | 3-3        |
| Scalar, Frequency, Dual, and Zoom Modes .....            | 3-4        |
| Summary of Modes .....                                   | 3-6        |
| <b>Frequency and Span</b> .....                          | <b>3-7</b> |
| Setting Limits and Restrictions .....                    | 3-7        |
| Setting the Frequency and Span .....                     | 3-8        |
| Setting the Frequency Using the Markers and Search ..... | 3-8        |
| Buffering the Input Value .....                          | 3-9        |



|  |             |
|--|-------------|
| <b>Reference Level</b> .....   | <b>3-11</b> |
| Setting the Reference Level .....                                    | 3-12        |
| <b>Time and Frequency Domains</b> .....                              | <b>3-13</b> |
| Setting the Parameters .....   | 3-13        |
| About FFT Points .....   | 3-14        |
| About FFT Windows .....  | 3-14        |
| <b>Frame Period and Real Time</b> .....                              | <b>3-17</b> |
| Setting the Frame Period .....                                       | 3-17        |
| Frame Period and REALTIME Acquisition .....                          | 3-17        |
| <b>Acquisition and Block Size</b> .....                              | <b>3-21</b> |
| Setting the Block Size .....   | 3-21        |
| Starting/Stopping Data Acquisition .....                             | 3-21        |
| Acquisition Mode .....   | 3-22        |
| Block Size .....   | 3-22        |
| Physical and Logical Frames .....                                    | 3-23        |
| <b>Displaying the Data</b> .....                                     | <b>3-27</b> |
| Defining a View .....  | 3-27        |
| Specifying the Data Source and Display Format .....                  | 3-27        |
| Specify the Layout on the Screen .....                               | 3-28        |
| <b>Scale and Bin</b> .....   | <b>3-31</b> |
| Using Auto Scale .....   | 3-31        |
| Changing the Scale Manually .....                                    | 3-32        |
| Number of Bins .....   | 3-34        |
| <b>Marker Operations and Search</b> .....                            | <b>3-35</b> |
| Marker Characteristics .....   | 3-35        |
| Moving the Primary Marker .....                                      | 3-36        |
| Searching the Spectrum .....   | 3-37        |
| Operating the Delta Marker .....                                     | 3-38        |
| Contents of Read Out .....   | 3-40        |
| <b>Switching the Display Frame</b> .....                             | <b>3-41</b> |
| Switching Display Frames in a Two-dimensional View .....             | 3-42        |
| Switching the Linked Frames .....                                    | 3-43        |
| Changing the Marker Frame Position in a Three-dimensional View ..... | 3-45        |
| Marker Movement in a Time Domain Three-dimensional View .....        | 3-46        |
| <b>Trigger</b> .....   | <b>3-47</b> |
| Data Acquisition Timing .....  | 3-47        |
| Trigger Source .....   | 3-50        |
| Trigger Domain .....   | 3-50        |
| Trigger Mode .....   | 3-51        |
| Trigger Count .....  | 3-55        |
| Trigger Parameters .....   | 3-57        |
| Data Display Timing .....  | 3-58        |
| <b>Creating a Trigger Mask Pattern</b> .....                         | <b>3-59</b> |
| Trigger Register .....   | 3-60        |
| Restrictions on Creation .....                                       | 3-60        |
| Condition of Trigger Generation .....                                | 3-60        |
| Draw Line .....  | 3-60        |
| Pattern Creation Procedure Example .....                             | 3-61        |
| Moving the Baseline .....  | 3-64        |

|  |              |
|--|--------------|
| <b>Analyzing an Analog Modulated Signal</b> .....                | <b>3-65</b>  |
| Setting Requirements .....                                       | 3-65         |
| Selecting Analog Modulation Analysis .....                       | 3-65         |
| Display .....  | 3-66         |
| <b>Displaying and Analyzing a Digital Modulated Signal</b> ..... | <b>3-67</b>  |
| Setting Requirements .....                                       | 3-67         |
| Selecting Digital Modulated Signal Analysis .....                | 3-67         |
| Supported Modulation Systems .....                               | 3-69         |
| Process Flow .....   | 3-69         |
| Constellation and Vector Displays .....                          | 3-71         |
| EYE Diagram Display .....  | 3-72         |
| Symbol Table Display .....                                       | 3-74         |
| Error Vector Analysis Display .....                              | 3-75         |
| <b>Analyzing an FSK Digital Modulated Signal</b> .....           | <b>3-77</b>  |
| Setting Requirements .....                                       | 3-77         |
| Placing the Analyzer in the FSK Signal Analysis Mode .....       | 3-77         |
| Display .....  | 3-78         |
| <b>Power Measurement</b> .....                                   | <b>3-79</b>  |
| Setting Requirements .....                                       | 3-79         |
| Power Measurement and Marker Operations .....                    | 3-80         |
| Using an Averaged Waveform .....                                 | 3-80         |
| Noise Measurement .....  | 3-81         |
| Power Measurement .....  | 3-82         |
| C/N and C/No Measurements .....                                  | 3-83         |
| ACP (Adjacent Channel Leakage Power) Measurement .....           | 3-84         |
| OBW (Occupied Bandwidth) Measurement .....                       | 3-86         |
| Band Power Marker Operations .....                               | 3-87         |
| <b>CDMA Analysis</b> .....                                       | <b>3-91</b>  |
| Evaluation of Demodulation Precision and Waveform Quality .....  | 3-92         |
| Evaluation of Spurious .....                                     | 3-95         |
| Time Characteristic Evaluation .....                             | 3-100        |
| <b>Zoom</b> .....  | <b>3-105</b> |
| Data Available for Zoom .....                                    | 3-105        |
| Running Zoom .....   | 3-106        |
| Setting the Frequency Using the Search Function .....            | 3-107        |
| Zoom Range .....   | 3-107        |
| Zoom Process .....   | 3-108        |
| <b>Average and Peak Hold</b> .....                               | <b>3-109</b> |
| Mechanism .....  | 3-110        |
| Averaging Mode .....   | 3-112        |
| Example of View Averaging Function Operating Procedure .....     | 3-113        |
| Example of the UTILITY Averaging Function .....                  | 3-114        |
| <b>Saving and Loading a File</b> .....                           | <b>3-115</b> |
| Available Files .....  | 3-115        |
| Configuration File (.CFG) .....                                  | 3-115        |
| Data File (*.IQ, *.AP) .....                                     | 3-116        |
| <b>File Operations</b> .....                                     | <b>3-119</b> |
| Inputting and Outputting a File .....                            | 3-119        |
| Selecting the Drive .....  | 3-120        |
| Moving the Directory .....                                       | 3-121        |

|   |              |
|---|--------------|
| Selecting a File .....                                    | 3-121        |
| Saving a File .....                                       | 3-121        |
| Loading a File .....                                      | 3-122        |
| Copying a File .....                                      | 3-122        |
| Deleting a File .....                                     | 3-123        |
| Creating the Directory .....                              | 3-123        |
| Deleting a Directory .....                                | 3-123        |
| Inputting a Directory or File Name .....                  | 3-124        |
| <b>Data File Format .....</b>                             | <b>3-125</b> |
| File Structure .....                                      | 3-125        |
| File Header .....   | 3-126        |
| Data Block .....  | 3-130        |
| Correction Data Block .....                               | 3-135        |
| <b>Access to Windows 95 .....</b>                         | <b>3-137</b> |
| Expansion Slots .....                                     | 3-137        |
| Connecting the Mouse and Keyboard .....                   | 3-138        |
| Access to Windows 95 .....                                | 3-139        |
| <b>Setting the Date and Time .....</b>                    | <b>3-141</b> |
| <b>Hardcopy .....</b>                                     | <b>3-143</b> |
| Outputting Data to the Printer .....                      | 3-143        |
| Outputting the Hardcopy to a Disk .....                   | 3-145        |
| <b>Outputting Spectrum Data in Text Form .....</b>        | <b>3-147</b> |
| Restrictions on Use .....                                 | 3-147        |
| Output Format .....                                       | 3-147        |
| Text Output Procedure .....                               | 3-148        |
| <b>Displaying the Version and Self Test Results .....</b> | <b>3-151</b> |

## Appendices

|  |            |
|--|------------|
| <b>Appendix A: Options and Accessories .....</b>   | <b>A-1</b> |
| Options .....                                      | A-1        |
| Standard Accessories .....                         | A-3        |
| Optional Accessories .....                         | A-3        |
| <b>Appendix B: Specifications .....</b>            | <b>B-1</b> |
| Electrical Characteristics .....                   | B-1        |
| Physical Characteristics .....                     | B-12       |
| Environmental Characteristics .....                | B-13       |
| <b>Appendix C: Default Settings .....</b>          | <b>C-1</b> |
| Basic Pattern Configuration Default Settings ..... | C-1        |
| Resetting to Default Settings .....                | C-7        |
| <b>Appendix D: Inspection and Cleaning .....</b>   | <b>D-1</b> |
| <b>Appendix E: Repacking for Shipment .....</b>    | <b>E-1</b> |
| <b>Appendix F: Mouse Operations .....</b>          | <b>F-1</b> |
| Overview .....                                     | F-1        |
| Setting .....                                      | F-2        |
| Mouse Operations .....                             | F-3        |
| Operations with Keyboard .....                     | F-9        |
| Caution in Turning Off the Power .....             | F-9        |
| External PC Application .....                      | F-10       |

|   |            |
|---|------------|
| <b>Appendix G: Data Storage Utility (Option 1S)</b> .....         | <b>G-1</b> |
| Overview .....  | G-1        |
| Restrictions .....  | G-2        |
| Storing Data .....  | G-3        |
| Loading Data .....  | G-5        |
| <b>Appendix H: cdmaOne Analysis (3066 Option 15)</b> .....        | <b>H-1</b> |
| About cdmaOne Analysis .....                                      | H-1        |
| Operation Examples .....  | H-3        |
| View Menu Functions .....   | H-8        |
| <b>Appendix I: W-CDMA/cdmaOne Analysis (3086 Option 16)</b> ..... | <b>I-1</b> |
| About W-CDMA Analysis .....                                       | I-1        |
| Operation Examples .....  | I-3        |
| View Menu Functions .....   | I-8        |
| <b>Appendix J: CCDF Analysis (Option 20)</b> .....                | <b>J-1</b> |
| About CCDF Analysis .....   | J-2        |
| Operation Examples .....  | J-3        |
| View Menu Functions .....   | J-5        |

## Index

# List of Figures

|   |      |
|---|------|
| <b>Figure 1–1: Signal processing system block diagram</b> .....                     | 1–5  |
| <b>Figure 1–2: AC connector (rear panel)</b> .....                                  | 1–9  |
| <b>Figure 1–3: Mouse connector location (rear panel)</b> .....                      | 1–11 |
| <b>Figure 1–4: Power switch location</b> .....                                      | 1–11 |
| <b>Figure 1–5: New clock settings dialog box</b> .....                              | 1–12 |
| <b>Figure 1–6: Display of result of self test at power on</b> .....                 | 1–13 |
| <b>Figure 1–7: System initial screen</b> .....                                      | 1–13 |
| <b>Figure 1–8: Angular adjustment of tilt display</b> .....                         | 1–15 |
| <b>Figure 1–9: Display of UNCAL</b> .....   | 1–16 |
| <b>Figure 1–10: Running the self gain calibration</b> .....                         | 1–17 |
| <br>  |      |
| <b>Figure 2–1: Front panel map (left part)</b> .....                                | 2–2  |
| <b>Figure 2–2: Front panel map (right part)</b> .....                               | 2–3  |
| <b>Figure 2–3: Rear panel map</b> .....   | 2–4  |
| <b>Figure 2–4: Display screen configuration</b> .....                               | 2–5  |
| <b>Figure 2–5: View general display information</b> .....                           | 2–6  |
| <b>Figure 2–6: Status display areas</b> .....                                       | 2–7  |
| <b>Figure 2–7: Setup display area</b> .....   | 2–8  |
| <b>Figure 2–8: Menu display area and keys</b> .....                                 | 2–11 |
| <b>Figure 2–9: CONFIG menu keys</b> .....   | 2–12 |
| <b>Figure 2–10: SETUP menu keys</b> .....   | 2–12 |
| <b>Figure 2–11: VIEW keys</b> .....   | 2–13 |
| <b>Figure 2–12: Examples of top menu items display</b> .....                        | 2–14 |
| <b>Figure 2–13: Lower menu item display examples</b> .....                          | 2–15 |
| <b>Figure 2–14: Menu items requiring selection or numeric input</b> .....           | 2–16 |
| <b>Figure 2–15: Drop-down list for selecting an item</b> .....                      | 2–16 |
| <b>Figure 2–16: Side menu item for numeric setting</b> .....                        | 2–17 |
| <b>Figure 2–17: Increment/decrement keys</b> .....                                  | 2–18 |
| <b>Figure 2–18: Number of steps display</b> .....                                   | 2–18 |
| <b>Figure 2–19: Cable connection</b> .....  | 2–20 |
| <b>Figure 2–20: Power switch</b> .....  | 2–21 |
| <b>Figure 2–21: System initial screen</b> .....                                     | 2–21 |
| <b>Figure 2–22: Display of the CONFIG:MODE key and the associated submenu</b> ..... | 2–22 |
| <b>Figure 2–23: Control of the start and stop of measurement</b> .....              | 2–23 |

|  |      |
|--|------|
| Figure 2–24: Spectrum measurement with a span of 3 GHz .....                       | 2–23 |
| Figure 2–25: Status display area .....   | 2–24 |
| Figure 2–26: Four-view display for digital modulation analysis .....               | 2–25 |
| Figure 2–27: Measuring the digital modulated signal – Span 3 GHz .                 | 2–26 |
| Figure 2–28: Location of the SETUP:FREQ key .....                                  | 2–27 |
| Figure 2–29: Freq side menu item available for numeric input .....                 | 2–28 |
| Figure 2–30: Numeric input keypad .....  | 2–28 |
| Figure 2–31: Setup display areas .....   | 2–30 |
| Figure 2–32: Views resulting from changes to the frequency and span settings ..... | 2–30 |
| Figure 2–33: Displaying the CONFIG:VIEW key and its associated submenus .....      | 2–31 |
| Figure 2–34: Selecting the Waterfall view .....                                    | 2–32 |
| Figure 2–35: Making changes to view D .....  | 2–33 |
| Figure 2–36: Four-view display layout .....  | 2–34 |
| Figure 2–37: VIEW keys (view control keys) .....                                   | 2–34 |
| Figure 2–38: View B display (1-view display) .....                                 | 2–35 |
| Figure 2–39: Averaging and compared waveform display .....                         | 2–37 |
| Figure 2–40: Signal acquisition in the Zoom mode .....                             | 2–39 |
| Figure 2–41: Example of using zoom .....   | 2–40 |
| Figure 2–42: Moving the markers by search .....                                    | 2–42 |
| Figure 2–43: Example measurement using the delta markers .....                     | 2–43 |
| Figure 2–44: Preparations for creation of the trigger mask pattern .               | 2–45 |
| Figure 2–45: Creating a single trigger area using the delta markers .              | 2–47 |
| Figure 2–46: Creating two trigger areas using the delta markers ...                | 2–47 |
| Figure 2–47: Checking that the trigger has been generated .....                    | 2–49 |
| Figure 2–48: Acquiring the signal using a trigger mask .....                       | 2–49 |
| Figure 2–49: Example of changing the display frame .....                           | 2–51 |
| Figure 2–50: Digital modulation signal EVM analysis .....                          | 2–54 |
| Figure 2–51: Signal process and display blocks .....                               | 2–59 |
| <br>   |      |
| Figure 3–1: Signal process flow .....  | 3–3  |
| Figure 3–2: Use of data memory .....   | 3–4  |
| Figure 3–3: Relationship between the frequency and span settings ..                | 3–10 |
| Figure 3–4: Overload indicator .....   | 3–11 |
| Figure 3–5: Window process of time domain data .....                               | 3–15 |
| Figure 3–6: Time and frequency domain frame period .....                           | 3–18 |
| Figure 3–7: Checking that real time has been set .....                             | 3–18 |
| Figure 3–8: Relationship between the block size and frames .....                   | 3–23 |

|   |      |
|---|------|
| Figure 3–9: Indexes to physical frames (for frequency, dual, and zoom modes) .....              | 3–24 |
| Figure 3–10: Checking that VECTOR has been set .....  | 3–25 |
| Figure 3–11: VIEW keys (view control keys) .....  | 3–28 |
| Figure 3–12: One-view display .....   | 3–29 |
| Figure 3–13: Two-view display .....   | 3–29 |
| Figure 3–14: Four-view display (1x4 display) .....  | 3–30 |
| Figure 3–15: Four-view display (2x2 display) .....  | 3–30 |
| Figure 3–16: Scaling control .....  | 3–32 |
| Figure 3–17: Marker read-out position .....   | 3–36 |
| Figure 3–18: Display frames .....   | 3–41 |
| Figure 3–19: Switching linked frames .....  | 3–43 |
| Figure 3–20: Marker and frames .....  | 3–44 |
| Figure 3–21: Coordinates for the time domain, three-dimensional waterfall display .....         | 3–46 |
| Figure 3–22: Data acquisition timing .....  | 3–48 |
| Figure 3–23: Trigger generation display .....   | 3–49 |
| Figure 3–24: Acquiring and displaying data in the Auto mode .....                               | 3–52 |
| Figure 3–25: Trigger mode and data memory (except the Auto mode) .....                          | 3–52 |
| Figure 3–26: Acquiring and displaying data in the Quick mode .....                              | 3–53 |
| Figure 3–27: Acquiring and displaying data in the Timeout mode ..                               | 3–53 |
| Figure 3–28: Acquiring and displaying data in the Interval mode ...                             | 3–54 |
| Figure 3–29: Acquiring and displaying data in the Quick Interval mode .....                     | 3–54 |
| Figure 3–30: Three-dimensional view display effect resulting from setting a trigger count ..... | 3–56 |
| Figure 3–31: Specifying the trigger generation timing by polarity ..                            | 3–57 |
| Figure 3–32: Example of a created trigger pattern .....   | 3–59 |
| Figure 3–33: First example of a trigger pattern with a shifted baseline .....                   | 3–64 |
| Figure 3–34: Second example of a trigger pattern created with a shifted baseline .....          | 3–64 |
| Figure 3–35: Display examples of analog signal demodulation .....                               | 3–66 |
| Figure 3–36: Digital modulation signal flow .....   | 3–70 |
| Figure 3–37: Vector and constellation display examples .....                                    | 3–71 |
| Figure 3–38: Vector and EYE diagram display examples .....                                      | 3–73 |
| Figure 3–39: Symbol table display example .....   | 3–74 |
| Figure 3–40: EVM view display example (B) to (D) .....  | 3–75 |

|   |       |
|---|-------|
| Figure 3–41: 1/4 $\pi$ QPSK constellation display example and error vector .....                            | 3–76  |
| Figure 3–42: Example display of FSK modulation signal demodulation .....                                    | 3–78  |
| Figure 3–43: Noise measurement example .....  | 3–81  |
| Figure 3–44: Power measurement example .....  | 3–82  |
| Figure 3–45: C/N (left) and C/No (right) measurement examples ...   | 3–83  |
| Figure 3–46: ACP measurement example .....  | 3–85  |
| Figure 3–47: OBW measurement example .....  | 3–86  |
| Figure 3–48: Power measurement band power marker .....  | 3–87  |
| Figure 3–49: ACP measurement band power marker .....  | 3–88  |
| Figure 3–50: Band power marker used for the occupied bandwidth (OBW) measurement .....                      | 3–89  |
| Figure 3–51: CDMA — Analysis with the EVM/Rho basic configuration pattern .....                             | 3–92  |
| Figure 3–52: CDMA Analysis with the spurious basic pattern (30 MHz span) .....                              | 3–95  |
| Figure 3–53: CDMA Analysis with the spurious basic pattern (5 MHz span) .....                               | 3–96  |
| Figure 3–54: Default specified line (when RBW = 30 k) .....   | 3–97  |
| Figure 3–55: Default specified line (when RBW = 1 M) .....  | 3–97  |
| Figure 3–56: CDMA Analysis with the time domain basic pattern ..  | 3–100 |
| Figure 3–57: Default mask area .....  | 3–101 |
| Figure 3–58: CDMA Analysis with the time domain basic pattern (rising/falling characteristic display) ..... | 3–103 |
| Figure 3–59: Unzoomed and zoomed spectra .....  | 3–105 |
| Figure 3–60: Zoom mode process .....  | 3–108 |
| Figure 3–61: Example of concurrent display of a spectrum and its averaged waveform .....                    | 3–109 |
| Figure 3–62: Mechanism of averaging in a view .....   | 3–110 |
| Figure 3–63: Mechanism of the averaging process that uses the utility average function .....                | 3–111 |
| Figure 3–64: Menu item with which the file can be saved or loaded .   | 3–119 |
| Figure 3–65: File process display .....   | 3–119 |
| Figure 3–66: File process menu .....  | 3–120 |
| Figure 3–67: File copy process .....  | 3–122 |
| Figure 3–68: Data file structure .....  | 3–125 |
| Figure 3–69: Adding dummy frames .....  | 3–127 |
| Figure 3–70: Data block structure .....   | 3–130 |
| Figure 3–71: Expansion slots .....  | 3–137 |



|   |              |
|---|--------------|
| <b>Figure 3-72: Displaying the Windows 95 accessory menu</b> .....                                      | <b>3-139</b> |
| <b>Figure 3-73: Date/Time Properties dialog box</b> .....   | <b>3-141</b> |
| <b>Figure 3-74: Installing the printer driver</b> .....   | <b>3-144</b> |
| <b>Figure 3-75: Copying data to the clipboard and pasting it to an application</b> .....                | <b>3-148</b> |
| <b>Figure 3-76: Example of pasting text data and creating a graph</b> ....                              | <b>3-149</b> |
| <b>Figure 3-77: Version information and self test results display (View of upper left corner)</b> ..... | <b>3-152</b> |
| <br>  |              |
| <b>Figure F-1: Interface for mouse operations</b> .....   | <b>F-2</b>   |
| <b>Figure F-2: Correspondence between front panel buttons and front panel interface keys</b> .....      | <b>F-4</b>   |
| <b>Figure F-3: Operating the menu items (top level item)</b> .....                                      | <b>F-5</b>   |
| <b>Figure F-4: Operating the menu items (7 items in lower level)</b> .....                              | <b>F-6</b>   |
| <b>Figure F-5: Selecting menus using the mouse</b> .....  | <b>F-7</b>   |
| <b>Figure F-6: Moving the markers and selecting a frame</b> .....                                       | <b>F-8</b>   |
| <b>Figure G-1: Automatic data storage in the block mode</b> .....                                       | <b>G-4</b>   |
| <b>Figure G-2: Automatic data storage in the roll mode</b> .....  | <b>G-5</b>   |
| <b>Figure H-1: Code-domain power spectrogram (View B)</b> .....   | <b>H-4</b>   |
| <b>Figure H-2: Constellation (View C)</b> .....   | <b>H-4</b>   |
| <b>Figure H-3: Code-domain power (View D)</b> .....   | <b>H-5</b>   |
| <b>Figure H-4: Analyzing a transient signal</b> .....   | <b>H-7</b>   |
| <b>Figure I-1: Code-domain power spectrogram (View B)</b> .....   | <b>I-4</b>   |
| <b>Figure I-2: Symbol constellation (View C)</b> .....  | <b>I-4</b>   |
| <b>Figure I-3: Code-domain power (View D)</b> .....   | <b>I-5</b>   |
| <b>Figure I-4: Symbol power (View D)</b> .....  | <b>I-5</b>   |
| <b>Figure I-5: Analyzing a transient signal</b> .....   | <b>I-7</b>   |
| <b>Figure J-1: CCDF calculation process</b> .....   | <b>J-2</b>   |
| <b>Figure J-2: CCDF measurement (View G)</b> .....  | <b>J-4</b>   |
| <b>Figure J-3: CCDFView display (View H)</b> .....  | <b>J-4</b>   |

# List of Tables

|  |       |
|--|-------|
| Table 2–1: Display status .....                            | 2–7   |
| Table 2–2: Setup display items .....                       | 2–9   |
| Table 2–3: CONFIG menu table .....                         | 2–60  |
| Table 2–4: SETUP (Standard) menu table .....               | 2–64  |
| Table 2–5: SETUP (CDMA) menu table .....                   | 2–68  |
| Table 2–6: Waveform view menu table .....                  | 2–70  |
| Table 2–7: Analog view menu table .....                    | 2–74  |
| Table 2–8: FSK view menu table .....                       | 2–76  |
| Table 2–9: Spectrogram view menu table .....               | 2–77  |
| Table 2–10: Waterfall view menu table .....                | 2–79  |
| Table 2–11: CDMAWaveform view menu table .....             | 2–80  |
| Table 2–12: CDMAPolar view menu table .....                | 2–83  |
| Table 2–13: CDMATime view menu table .....                 | 2–86  |
| Table 2–14: Polar view menu table .....                    | 2–88  |
| Table 2–15: Polar view menu table .....                    | 2–91  |
| Table 2–16: Polar view menu table .....                    | 2–92  |
| Table 2–17: EVM view menu table .....                      | 2–93  |
| Table 2–18: Average menu table .....                       | 2–94  |
| Table 2–19: SaveLoad menu table .....                      | 2–95  |
| Table 2–20: File Access menu table .....                   | 2–96  |
| Table 2–21: Print menu table .....                         | 2–97  |
|  |       |
| Table 3–1: Summary of modes .....                          | 3–6   |
| Table 3–2: Summary of modes .....                          | 3–7   |
| Table 3–3: Reference level setting range .....             | 3–12  |
| Table 3–4: FFT window and band pass filter .....           | 3–16  |
| Table 3–5: Minimum frame period .....                      | 3–19  |
| Table 3–6: Block size selections .....                     | 3–22  |
| Table 3–7: Number of bins .....                            | 3–34  |
| Table 3–8: Maximum trigger count .....                     | 3–55  |
| Table 3–9: Effects of Pos on different trigger modes ..... | 3–57  |
| Table 3–10: Setting data display timing .....              | 3–58  |
| Table 3–11: Modulating Systems .....                       | 3–69  |
| Table 3–12: CDMA analysis items .....                      | 3–91  |
| Table 3–13: Zoom range .....                               | 3–107 |

|   |              |
|---|--------------|
| <b>Table 3–14: Files available in this system</b>                                 | <b>3–115</b> |
| <b>Table 3–15: Data formats and file load</b>                                     | <b>3–117</b> |
| <b>Table 3–16: Possible combinations of data types</b>                            | <b>3–131</b> |
| <b>Table 3–17: Frame size</b>   | <b>3–132</b> |
| <b>Table 3–18: Order of bins in frequency domain</b>                              | <b>3–132</b> |
| <b>Table 3–19: Functions available with a keyboard</b>                            | <b>3–138</b> |
| <br>  |              |
| <b>Table A–1: Options</b>   | <b>A–1</b>   |
| <b>Table A–2: Standard accessories</b>  | <b>A–3</b>   |
| <b>Table A–3: Optional accessories</b>  | <b>A–3</b>   |
| <b>Table B–1: Input/memory mode related</b>                                       | <b>B–1</b>   |
| <b>Table B–2: Trigger related</b>   | <b>B–2</b>   |
| <b>Table B–3: Marker/Zoom Related</b>   | <b>B–2</b>   |
| <b>Table B–4: Display/View related</b>  | <b>B–3</b>   |
| <b>Table B–5: Frequency standard related</b>                                      | <b>B–4</b>   |
| <b>Table B–6: Controller/Data storage related</b>                                 | <b>B–4</b>   |
| <b>Table B–7: IQ input related (3086 only)</b>                                    | <b>B–5</b>   |
| <b>Table B–8: Wideband input related (3086 only)</b>                              | <b>B–6</b>   |
| <b>Table B–9: RF input related</b>  | <b>B–7</b>   |
| <b>Table B–10: Baseband input related</b>   | <b>B–8</b>   |
| <b>Table B–11: Digital demodulation related</b>                                   | <b>B–9</b>   |
| <b>Table B–12: Frame time related</b>   | <b>B–10</b>  |
| <b>Table B–13: Frame update time related</b>                                      | <b>B–11</b>  |
| <b>Table B–14: Power requirements</b>   | <b>B–12</b>  |
| <b>Table B–15: Physical</b>   | <b>B–12</b>  |
| <b>Table B–16: Environmental</b>  | <b>B–13</b>  |
| <b>Table B–17: Certifications and compliances</b>                                 | <b>B–14</b>  |
| <b>Table C–1: Default settings for basic configuration pattern<br/>(Standard)</b> | <b>C–1</b>   |
| <b>Table C–2: Default settings for basic configuration pattern (CDMA)</b>         | <b>C–3</b>   |
| <b>Table D–1: External inspection check list</b>                                  | <b>D–1</b>   |
| <b>Table F–1: Mapping between keypad keys and keyboard keys</b>                   | <b>F–9</b>   |
| <b>Table H–1: cdmaOne parameters</b>  | <b>H–1</b>   |
| <b>Table H–2: CodeSpectrogram view menu table</b>                                 | <b>H–8</b>   |
| <b>Table H–3: CodePolar view menu table</b>                                       | <b>H–10</b>  |
| <b>Table H–4: CodePower view menu table</b>                                       | <b>H–12</b>  |
| <b>Table I–1: W-CDMA parameters</b>   | <b>I–1</b>   |
| <b>Table I–2: CodeWSpectrogram view menu table</b>                                | <b>I–8</b>   |
| <b>Table I–3: CodeWPolar view menu table</b>                                      | <b>I–10</b>  |

|   |             |
|---|-------------|
| <b>Table I-4: CodeWPower view menu table</b> .....  | <b>I-12</b> |
| <b>Table J-1: CCDF view menu table</b> .....        | <b>J-5</b>  |
| <b>Table J-2: CCDFView display menu table</b> ..... | <b>J-7</b>  |

# General Safety Summary

Review the following safety precautions to avoid injury and prevent damage to this product or any products connected to it. To avoid potential hazards, use this product only as specified.

*Only qualified personnel should perform service procedures.*

## To Avoid Fire or Personal Injury

**Use Proper Power Cord.** Use only the power cord specified for this product and certified for the country of use.

**Ground the Product.** This product is grounded through the grounding conductor of the power cord. To avoid electric shock, the grounding conductor must be connected to earth ground. Before making connections to the input or output terminals of the product, ensure that the product is properly grounded.

**Observe All Terminal Ratings.** To avoid fire or shock hazard, observe all ratings and markings on the product. Consult the product manual for further ratings information before making connections to the product.

**Do Not Operate Without Covers.** Do not operate this product with covers or panels removed.

**Avoid Exposed Circuitry.** Do not touch exposed connections and components when power is present.

**Do Not Operate With Suspected Failures.** If you suspect there is damage to this product, have it inspected by qualified service personnel.

**Do Not Operate in Wet/Damp Conditions.**

**Do Not Operate in an Explosive Atmosphere.**

**Provide Proper Ventilation.** Refer to the manual's installation instructions for details on installing the product so it has proper ventilation.

## Symbols and Terms

**Terms in this Manual.** These terms may appear in this manual:



---

**WARNING.** Warning statements identify conditions or practices that could result in injury or loss of life.

---



---

**CAUTION.** Caution statements identify conditions or practices that could result in damage to this product or other property.

---

**Terms on the Product.** These terms may appear on the product:

DANGER indicates an injury hazard immediately accessible as you read the marking.

WARNING indicates an injury hazard not immediately accessible as you read the marking.

CAUTION indicates a hazard to property including the product.

**Symbols on the Product.** The following symbols may appear on the product:



WARNING  
High Voltage



Protective Ground  
(Earth) Terminal



CAUTION  
Refer to Manual



Double  
Insulated

# Service Safety Summary

Only qualified personnel should perform service procedures. Read this *Service Safety Summary* and the *General Safety Summary* before performing any service procedures.

**Do Not Service Alone.** Do not perform internal service or adjustments of this product unless another person capable of rendering first aid and resuscitation is present.

**Disconnect Power.** To avoid electric shock, disconnect the mains power by means of the power cord or, if provided, the power switch.

**Use Care When Servicing With Power On.** Dangerous voltages or currents may exist in this product. Disconnect power, remove battery (if applicable), and disconnect test leads before removing protective panels, soldering, or replacing components.

To avoid electric shock, do not touch exposed connections.





# Preface

## About This Manual

This manual describes the 3066 and 3086 3 GHz Real Time Spectrum Analyzers

The manual contains the following:

**Section 1: Getting Started.** Contains the product overview and describes the architecture, installation, and calibration of the analyzer.

**Section 2: Operating Basics.** Gives brief description of the functions of the front and rear panels and the menu items. Also, describes the basic menu operations.

This section also provides the tutorials for beginners which explain the step-by-step procedures in which measurements are made using a signal generator. After installation, you can use these tutorials to quickly master how to operate the analyzer and the outline of its functions by performing the steps.

**Section 3: Reference.** Describes the basic concept of the process and how to operate specific applications. This section also details the combined procedure of front panel key operations and menu operations.

**Appendices.** Lists the options and accessories, specifications, and default settings of the analyzer. This section also describes how to store and repackage it for shipment and how to use the optional software.

First time users should complete the installation as described in Section 1, *Getting Started*, then perform the steps shown in Section 2, *Tutorial*.

This system uses Windows 95 as the operating system. This manual does not describe common use of Windows 95. Refer to your Windows 95 related manuals as necessary.

## Conventions

This manual uses the following conventions:

- Front-panel button and control labels are printed in the manual in upper case text. For example, ROLL, BLOCK, PRINT. If it is part of a procedure, the button or control label is printed in boldface. For example, “Press **BLOCK**”.
- To easily find buttons on the front panel, the area name label is printed together with the button by concatenating with a colon (:), as in SETUP:MAIN, VIEW:SCALE, etc. For example, “Press CONFIG:**MODE** key”.
- Menu and on-screen form titles are printed in the manual in the same case (initial capitals) as they appear on the instrument screen. For example, Source, Format. If it is part of a procedure, the menu title is shown in boldface. For example, “Press the **Trigger...** side key”.
- A list of keys, controls, and/or menu items separated by an arrow symbol (→) indicates the order in which to perform the listed tasks. For example:  
Select CONFIG:**MODE**→**More...**→**CDMA**→**Spurious**.

## Contacting Tektronix

|                       |   |
|-----------------------|---|
| Product Support       | For application-oriented questions about a Tektronix measurement product, call toll free in North America:<br>1-800-TEK-WIDE (1-800-835-9433 ext. 2400)<br>6:00 a.m. – 5:00 p.m. Pacific time<br><br>Or contact us by e-mail:<br>tm_app_supp@tek.com<br><br>For product support outside of North America, contact your local Tektronix distributor or sales office. |
| Service Support       | Contact your local Tektronix distributor or sales office. Or visit our web site for a listing of worldwide service locations.<br><br><a href="http://www.tek.com">http://www.tek.com</a>  |
| For other information | In North America:<br>1-800-TEK-WIDE (1-800-835-9433)<br>An operator will direct your call.  |
| To write us           | Tektronix, Inc.<br>P.O. Box 1000<br>Wilsonville, OR 97070-1000  |

# Getting Started



# Product Overview

The 3066 and 3086 are real time spectrum analyzers equipped with a 3 GHz down converter for analyzing radio frequency (RF) signals.

The analyzer can obtain time domain and frequency domain data simultaneously through a new architecture. It can perform the spectrum, analog modulation, and digital modulation analysis in the frequency band from DC to 3 GHz with the span set from 100 Hz to 3 GHz. The analyzer displays the results in color.

## Features

The analyzer has the following features:

- Measurement frequency range: DC to 3 GHz
- Measurement span: 100 Hz to 3 GHz
- Complete real time frequency analysis
- Concurrent process of real time frequency and modulation analysis
- Concurrent collection, analysis, and display of frequency and time domain data
- Ability to display eleven types of analysis results:
  - Spectrum display (frequency vs. level or phase)
  - Spectrogram display (frequency vs. level, or phase vs. time)
  - Waterfall display (time vs. modulation factor, phase, or frequency)
  - Analog demodulation display (time vs. modulation factor, phase, or frequency)
  - FSK modulation view (time vs. frequency)
  - Constellation/vector display (digital demodulation)
  - EYE diagram display
  - Symbol table display
  - EVM/Rho analysis display
  - Spurious analysis display
  - Time characteristics analysis display

- Abundant trigger functions:
  - Real time frequency selection trigger (frequency domain mask trigger)
  - Level trigger
  - External trigger
  - Free run
- Power measurements: Noise, Power, C/N, C/No, ACP, and OBW
- Analysis of digital modulation signals  
(3066: up to 6 MHz span, 3086: up to 30 MHz span)
- CDMA analysis for the IS-95 and T-53 standards
- Digital zooming (frequency enlargement by a factor of 2 to 1000)
- Self contained with a 12.1 inch, full-color TFT display and sturdy cabinet

## Targets

The analyzer is capable of performing complete real time analysis for the following usages:

- Power measurements: Noise, C/N, C/No, Power, ACP, and OBW
- CDMA analysis (IS-95 and T-53): Rho, Spurious, and Time characteristics
- Digital modulation analysis
- Analog modulation analysis
- Variation analysis in PLL frequency: Jitter in reference oscillator of a mobile telephone, localization of a radio set, HD read-out jitter, etc.
- Analysis of momentary noise: Mixed noise, measurement EMI measurement, etc.
- Multi-path measurement: Measurement of electric wave environment
- Electric wave interference: Radar interference
- Analysis of electric waves: Analyzing electric waves received from foreign countries

## The difference between the 3066 and 3086

The 3066 and 3086 functions are the same, except that the 3086 has the following two input modes:

- Wideband input mode: Processes 50 MHz to 3 GHz signals with maximum 30 MHz span in the vector mode.
- IQ input mode: Inputs the I and Q signals directly from the rear panel connectors.

The descriptions in this manual apply to both the 3066 and the 3086, unless otherwise noted.





# Architecture

Figure 1-1 contains the signal processing system block diagram for the analyzer.

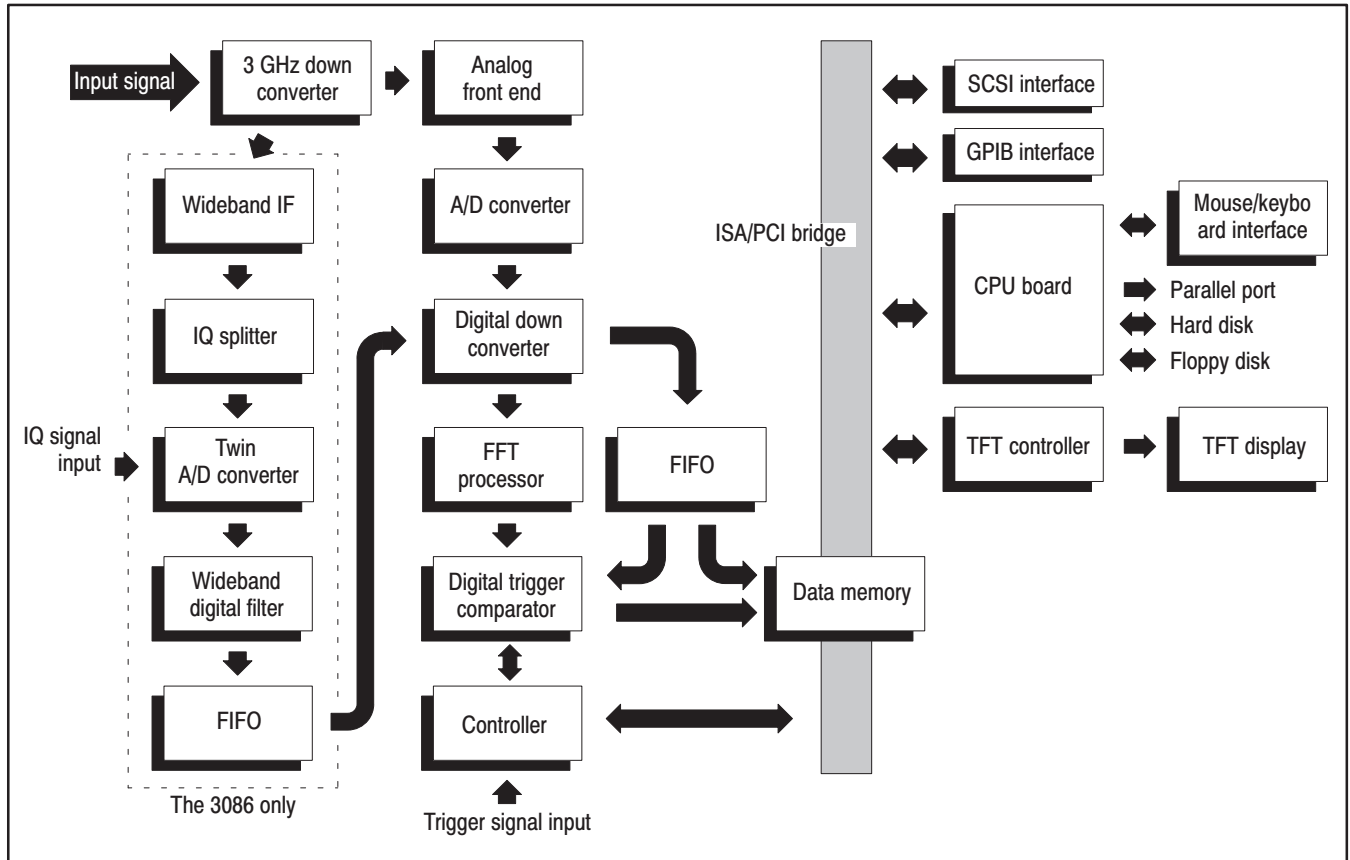


Figure 1-1: Signal processing system block diagram

## 3 GHz Down Converter

Converts the RF signal, input at the front-panel RF INPUT, into a 10 MHz IF signal. The signal output from the 3 GHz down converter is sent to the succeeding block, i.e., analog front end. This down converter is equipped with the voltage reference and reference clock generator at the periphery.

## Analog Front End

This block conditions the A/D conversion signal by using the low-noise amplifier and high-precision attenuator, and anti-aliasing filter.

## A/D converter

The output from the analog front end block enters the A/D converter via the fine-tuning attenuator, the anti-aliasing filter, and the driver amplifier. The sampling rate of this converter is 25.6 MHz, and its resolution is 12 bits.

This A/D converter is equipped with the offset-regulating D/A converter, voltage reference, and reference clock generator at the periphery.

## Digital Down Converter

Performs span and center frequency setting, which are required for flexible spectrum analysis. This converter consists of two main stages. The first stage converts the 0 to 10 MHz real signal into the complex signal of  $\pm 5$  MHz. The second stage converts the frequency to set any center frequency.

A thinning-out filter is provided between stages to implement span changes by thinning out the sampling rate. This filter consists of an FIR filter of a maximum of 503 taps and four-stage comb filters. The factor of the FIR filter can be set at a high precision of 20 bits, and it implements relatively sharp thinning-out filtering with less spurious emission.

## FIFO

Upon receiving the data stream from the digital down converter, this block divides the data into frames, and writes the data into data memory. The FIFO sends these frames to the digital trigger comparator at the same time.

## FFT Processor

Performs 1,024- or 256-point complex FFT at high speed. This block consists of the FFT calculation DSP, output buffer, and timing control circuit. To obtain the capability of performing 1,024-point complex FFT at 12,500 times/s, this processor has a unique parallel structure. This capability of calculation enables realtime analysis to be available in up to 5 MHz span.

The input data is subjected to a window process to keep from missing parts of the spectrum. For the window type, you have three options of Blackman-Harris, Hamming, and rectangular. To guarantee the continuity of data, the windows show view of the spectrum span which overlap by 50% or more for real-time spans of 5 MHz or less.

## Digital Trigger Comparator

This block has the realtime digital trigger mechanism to monitor the occurrence of a specific event on the spectrum. Trigger conditions are produced by editing a mask pattern on the Amplitude vs. Frequency Display screen. The mask pattern can be obtained also by making changes to acquired data.

Since the trigger comparator is continuously in operation at the maximum rate, the phenomenon will not be missed even when a low rate of frame update has been set in the block mode. The pre-trigger and post-trigger positions can be set optionally; the phenomenon before and after the trigger event can be measured.

## Data Memory

This is a 16 Mbyte, high-rate SRAM block that stores spectrum data. For 1,024-point analysis, this memory contains 4,000 frames; for 256-point analysis, it contains 16,000 frames. This memory is accessed from the system controller via the ISA/PC bridge.

## Controller

Controls the signal processing system hardware.

## ISA/PCI Bus

The ISA/PCI bus is used to link the system components.

## CPU Board

This system controller board is equipped with a Intel PENTIUM MMX CPU. For the system controller, Windows 95 is used as the OS to achieve control between the user interface and hardware.

This analyzer is equipped with a 2.1 G-byte hard disk, a 3.5 inch floppy disk, and expansion slots. It supports the following interfaces as standards:

- GPIB interface
- SCSI interface
- Centronics interface
- Keyboard/mouse interface

Windows 95 application software can be run by connecting the mouse and keyboard to the analyzer.

Any interface board can be specified for the remaining expansion slot.

## TFT Display

A 12.1 inch XGA TFT-LCD module is used. This color display has a sufficient resolution for multi-windows, and can display eleven formats (views). You can select up to eight formats and display four of them together.

## The 3086 Only

|                                |  |
|--------------------------------|--|
| <b>Wideband IF</b>             | Amplifies and filters the IF signal converted through 3 GHz down converter. The bandwidth is 30 MHz.   |
| <b>IQ Splitter</b>             | Splits the signal processed in the wideband IF block to the I and Q components. Also, you can input the I and Q signals directly from the rear panel connectors. |
| <b>Twin A/D Converter</b>      | Converts the analog I and Q signals separated by the IQ splitter to the digital quantity, respectively.  |
| <b>Wideband Digital Filter</b> | This filter thins out the sampling clock to change the span.   |
| <b>FIFO</b>                    | Stores the data from the wideband digital filter and outputs them to the digital down converter, synchronizing with the data stream from the analog front end.   |

# Installation and Power On

Before beginning the installation, be sure to read *General Safety Summary* and *Service Safety Summary* starting on page xv.

## Unpacking and Inspection

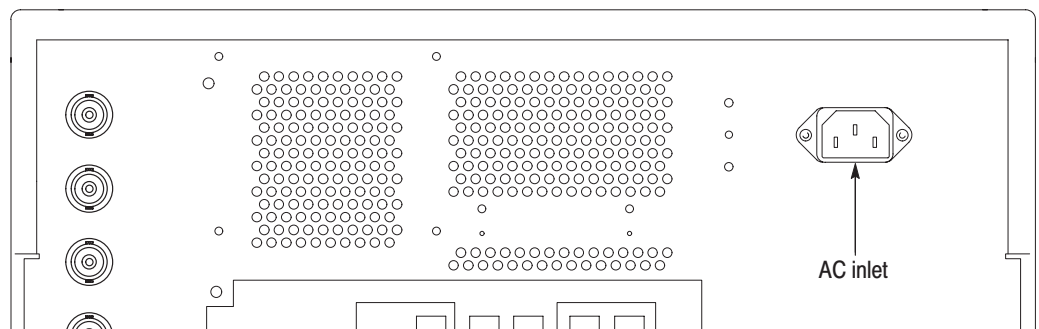
This product is packed in a corrugated fiberboard container for delivery. Before opening the container, check that it has no scratches or damage on its surfaces.

After opening the container, check that all accessories are found inside. For the listing of the accessories, refer to *Standard Accessories* on page A-3. If you find one or more damaged or defective components, contact your local Tektronix Field Office or representative.

It is recommended that the container and packing material be stored in a safe place. They may become necessary when you need to repack the product to transport it.

## Installation

- Power Supply** The analyzer operates with a power supply frequency of 47 to 66 Hz and an AC power supply voltage of 90 to 250 V. Before plugging the cord in the outlet, be sure that the power supply voltage is proper.
- Power Cord** Insert the supplied power cord into the rear panel AC connector (see Figure 1-2).



**Figure 1-2: AC connector (rear panel)**

.Plug the power cord into a three-wire outlet that has a protective ground line. The metallic section on the surface of the analyzer is connected to the power supply protective ground terminal through the power cord ground line. To prevent electrical shocks, be sure to insert the plug into an outlet that has a protective ground terminal.



---

**CAUTION.** *Placing the front panel power switch in the STAND-BY position does not disconnect power from the product. To disconnect power, unplug the power cord from the outlet.*

---

### Heat Radiation

This analyzer has two exhaust fans on its rear panel. Air enters the cabinet through the air intakes on the side, and exhausts through the exhaust fan on the rear panel.



---

**CAUTION.** *To prevent overheating, leave 5 cm or more space at both sides of and behind the analyzer.*

---

### Software

This analyzer is shipped with its software installed.

For instructions on installing a printer or driver, refer to page 3–143.

### Connecting the Mouse

Connect the standard mouse to the rear panel connector before turning the analyzer power on (See Figure 1–3).



---

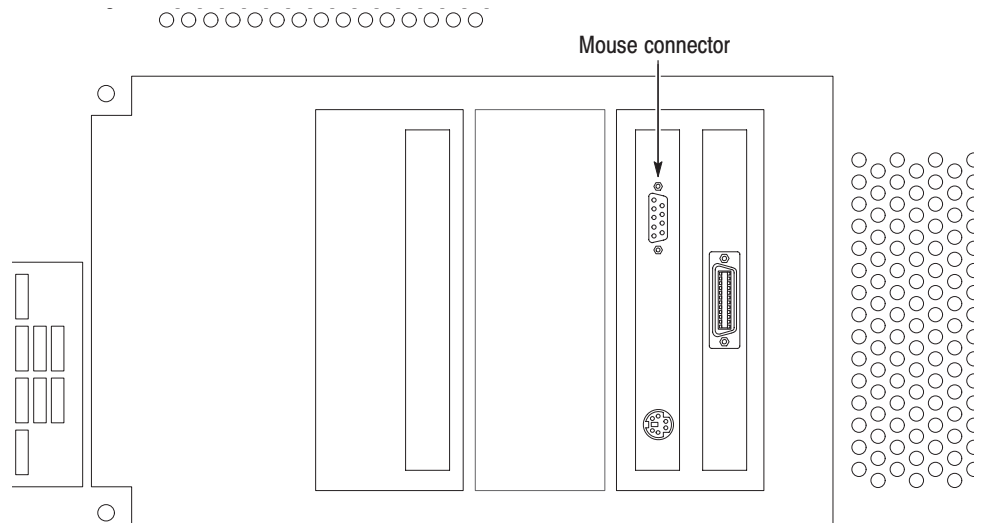
**CAUTION.** *To avoid damaging the analyzer, make sure that the power is off before connecting the mouse. If the power is on, turn off the Power Switch on the front panel and wait until the power shuts off completely.*

---

For the normal analyzer operation, the mouse is not necessary. You can use it in these cases:

- When you want to operate with a mouse instead of the front panel (Refer to Appendix F for the mouse operations).
- When Windows 95 displays a dialog box for maintaining the operating system (for example, changing the time).

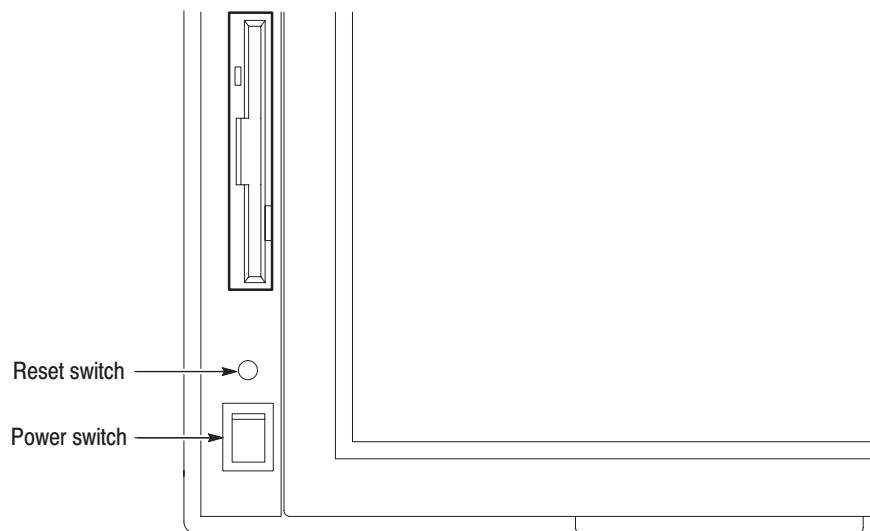
For more information about using the mouse, refer to page 3–138.



**Figure 1-3: Mouse connector location (rear panel)**

**Turning On the Power**

To turn on the power to the analyzer, turn on the Power switch located at the bottom left corner of the front panel. When you turn on the power, Windows 95 is booted and the system software is subsequently started.



**Figure 1-4: Power switch location**

**When the New clock settings dialog box appears.** If Windows 95 displays the “New clock settings” dialog box at power-on (see Figure 1–5), press the OK button with the mouse to start the analyzer application.



**Figure 1-5: New clock settings dialog box**

For the date and time setting procedure, refer to page 3–141.

**Self Test** After you turn on the power, this analyzer performs a pass/fail test for each of the digital circuits by using the self test routine. Upon completion, it displays the result on the monitor display as shown in Figure 1–6. If the test fails in any item, contact your Tektronix Field Office or representative.

Subsequently, the initial screen in Figure 1–7 appears.

**Shutting Down** When you place the Power Switch on the front panel in the STAND-BY position, the internal software detects the condition of the Power Switch and shuts down the system before powering off the analyzer. You need not terminate the application software of the analyzer or Windows 95 before the shutdown.



---

**CAUTION.** When powering on or off the power, be sure to use the Power Switch on the front panel. While the power cord remains unplugged from the AC outlet, or no voltage is being supplied to the AC outlet, be sure to keep the Power Switch in the STAND-BY position.

---



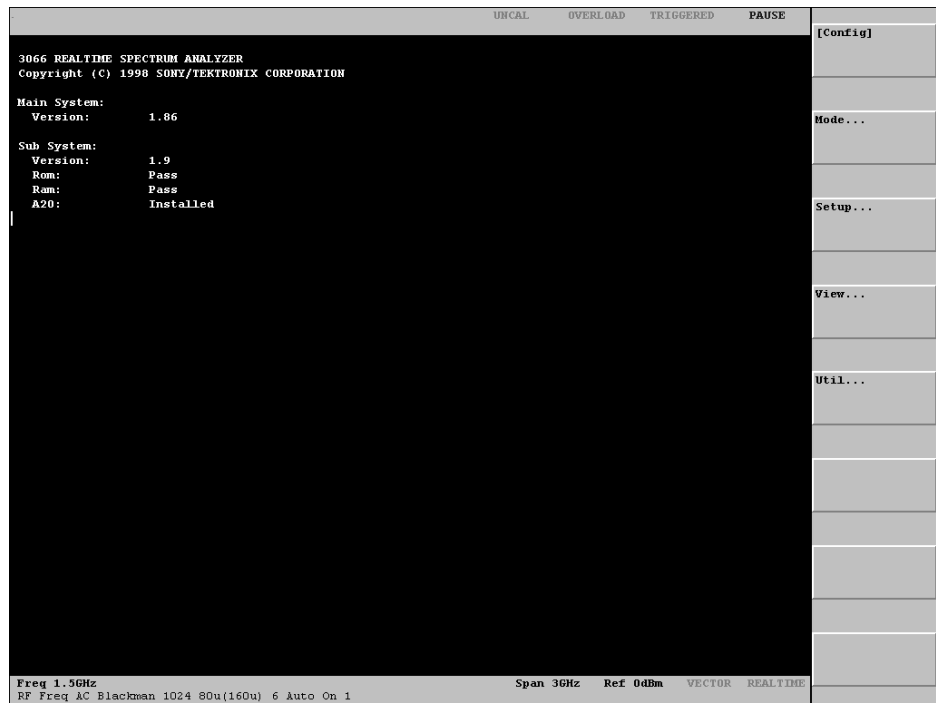


Figure 1-6: Display of result of self test at power on

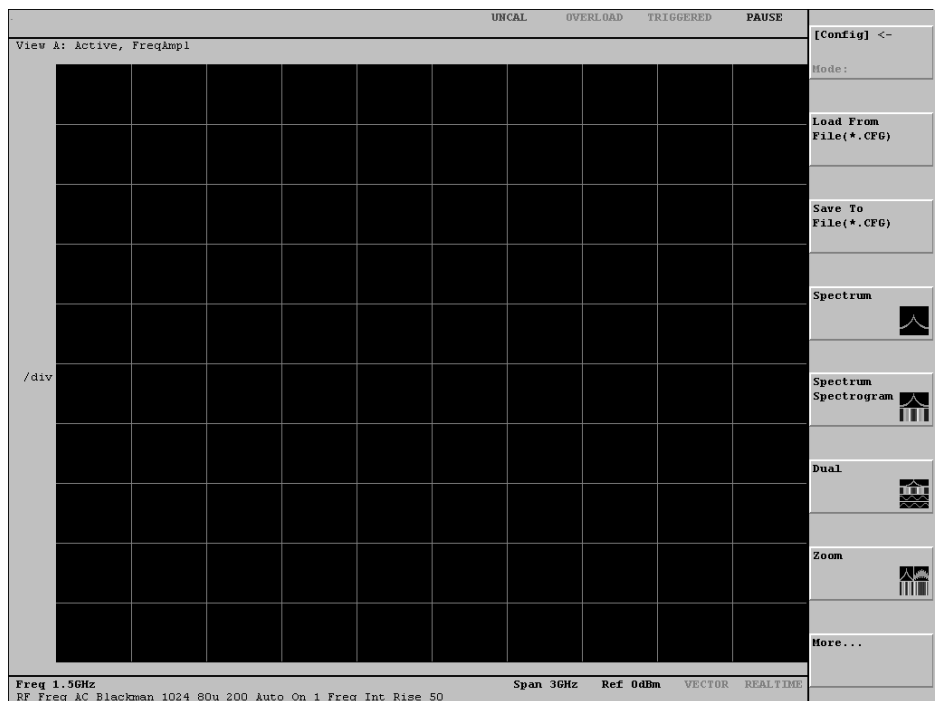


Figure 1-7: System initial screen

## Action During Abnormal Operation

Note the following when operating the Power Switch on the front panel.

If normal operation of the basic software is no longer enabled, the power cannot be shut off by returning the Power Switch on the front panel to STAND-BY from ON.

If the system is abnormal, check that the Power Switch on the front panel is ON. Subsequently, press the Reset Switch above the Power Switch (see Figure 1–4) to reboot the system. Then, place the Power Switch in the STAND-BY position.

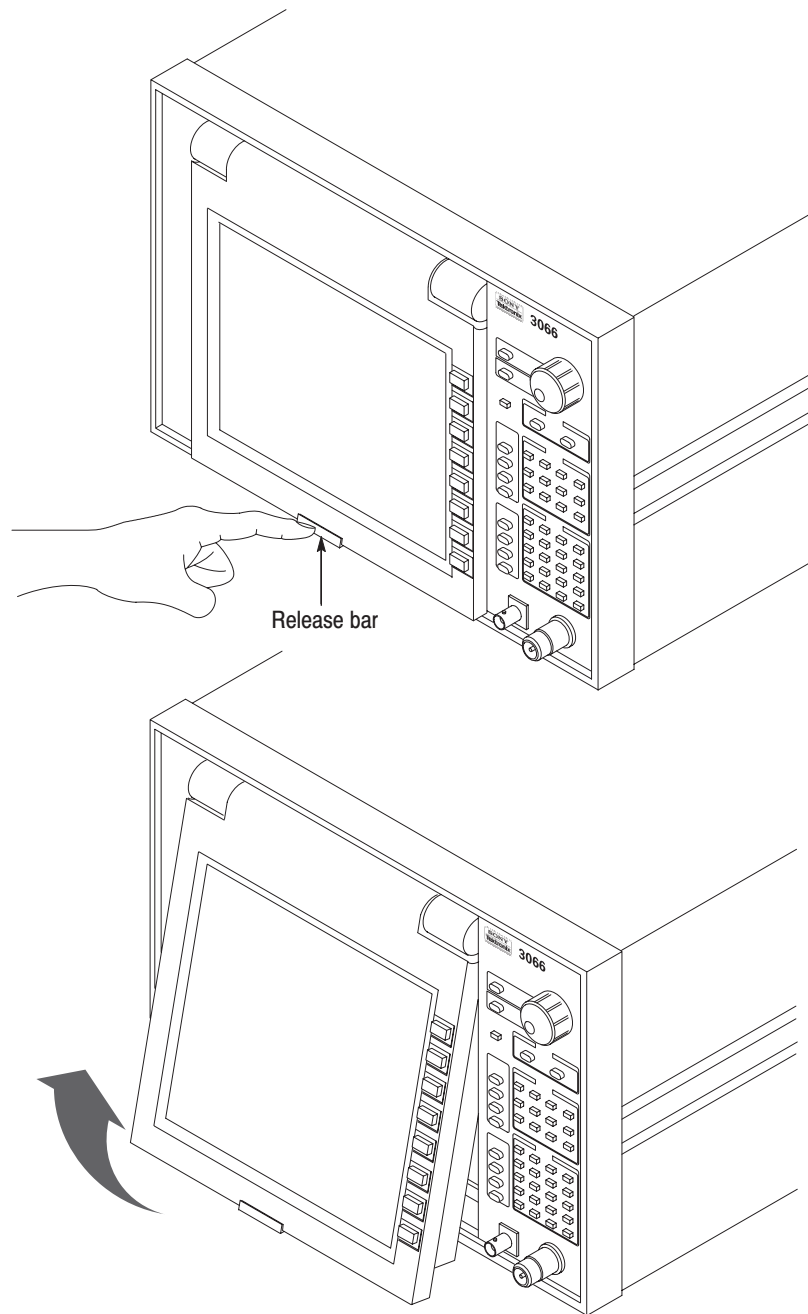
If the Reset Switch operation does not result in normal operation of the system, place the Power Switch in the STAND-BY position. Then, unplug the power cable once from the rear panel. Wait 10 seconds or more. Then, connect the power cable again and turn on the Power Switch.

## Adjusting the Display Tilt Angle

You can adjust the tilt angle of the display, as appropriate for the lighting conditions in the room and the level of your eyes.

When you press the release bar at the bottom of the display, the bottom of the display slightly pops up toward you. While holding the bottom of the display at its bottom, pull it up toward you until you find the optimal viewing angle.

When returning the display into the main cabinet, continue to press the bottom of the display until you hear a click.



**Figure 1-8: Angular adjustment of tilt display**

## Calibration and Functional Checks

To guarantee the operation of the analyzer, perform the following processes:

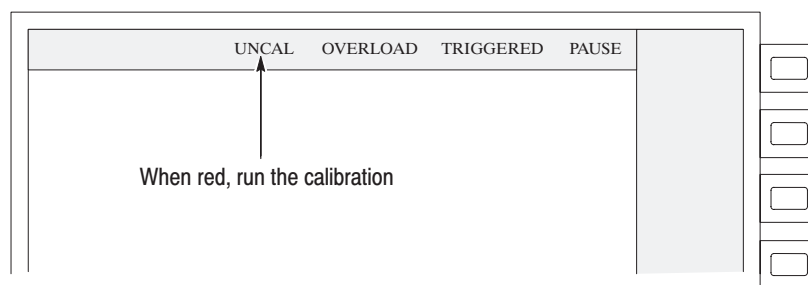
- Self gain calibration
- Functional check (by service personnel only)

### Self Gain Calibration

The calibration routine calibrates the amplifier gain based on the signal generator within the analyzer. This calibration should be run when the analyzer is started or during operation.

Allow the analyzer to warm up for 20 minutes before you perform this calibration. The warm-up period allows the analyzer electrical performance to become stable before you run the calibration.

During operation, when the ambient temperature varies by  $\pm 3$  °C or more relative to the temperature at the previous calibration, UNCAL is displayed in red in the hardware status display area (see Figure 1–9). This means that you should run the calibration.



**Figure 1-9: Display of UNCAL**

When UNCAL is displayed in red, run the calibration using the following procedure:

---

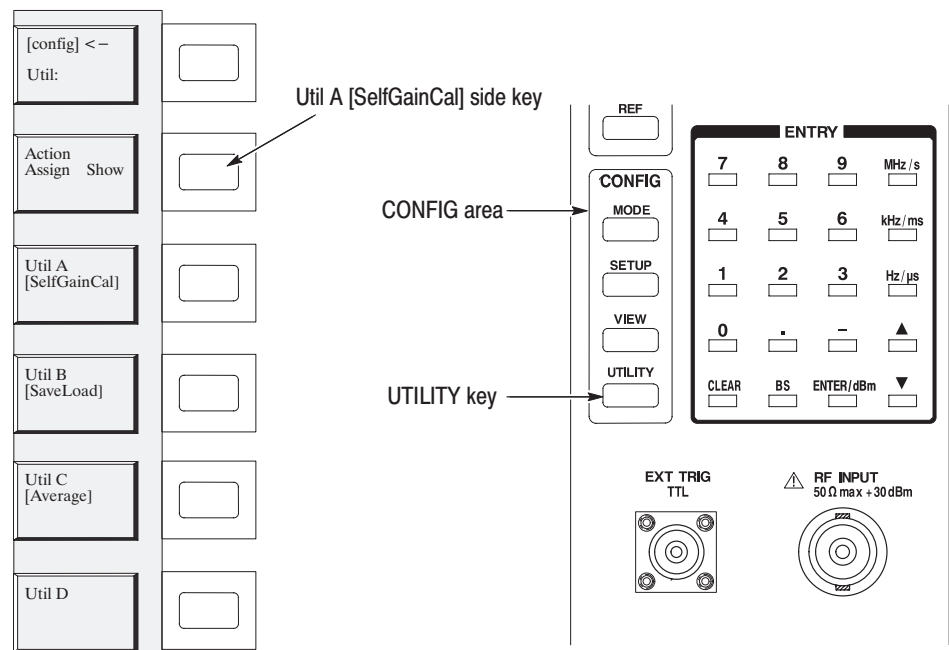
**NOTE.** *If the calibration is run while signal acquisition is in progress, the acquisition stops.*

---

1. Press the **UTILITY** key in the front panel CONFIG area (see Figure 1–10).
2. Press the **Util A [SelfGainCal]** side key.
3. Press the **Gain Cal** side key.

The calibration runs. It takes several seconds to complete the process.

4. If you press **AutoGainCal** side key and select **On**, the calibration will run automatically after data acquisition when the analyzer is in uncal state.



**Figure 1–10: Running the self gain calibration**

### **IQ Offset Calibration (3086 only)**

The IQ offset calibration compensates the IQ signal offset between the signal source and the analyzer when inputting the IQ signals directly from the rear panel connectors.

---

**NOTE.** Set the level of the *I* and *Q* input signals to zero before doing the following procedure.

---

1. Press the **UTILITY** key in the front panel CONFIG area (see Figure 1–10).
2. Press the **Util A [SelfGainCal]** side key.
3. Set the level of the external IQ input signal to zero.
4. Press the **IQ Offset Cal** side key.

The calibration runs. It takes several seconds to complete the process.

### **Functional Check**

The electrical characteristics listed in Appendix B, *Specifications*, in this manual may be checked only by service personnel. If you need a characteristics check, contact your Tektronix Field Office or representative.

### **When an Error Occurs**

When an error occurs during the calibration, contact your Tektronix Field Office or representative.

## **Backing Up User Files**

You should back up your user files on a regular basis. Use the Windows Back Up tool to back up files stored on the hard disk. The Back Up tool is located in the System Tools folder in the Accessories folder. Start the tool and determine which files and folders you want to back up. Use the Windows online help for information on using the Back Up tool.

In particular, you should frequently back up your user-generated files. For the analyzer, the user-generated files consist of configuration and data files, which have these extensions:

- Configuration files: .CFG, .TRG
- Data files: .AP, .IQ, .APT, .IQT

# Operating Basics







## Interface Maps

This section lists the names of the front- and rear-panel components and their functions. Following the descriptions of the menu operations, this section also gives brief descriptions of the menu item functions.

## Front Panel

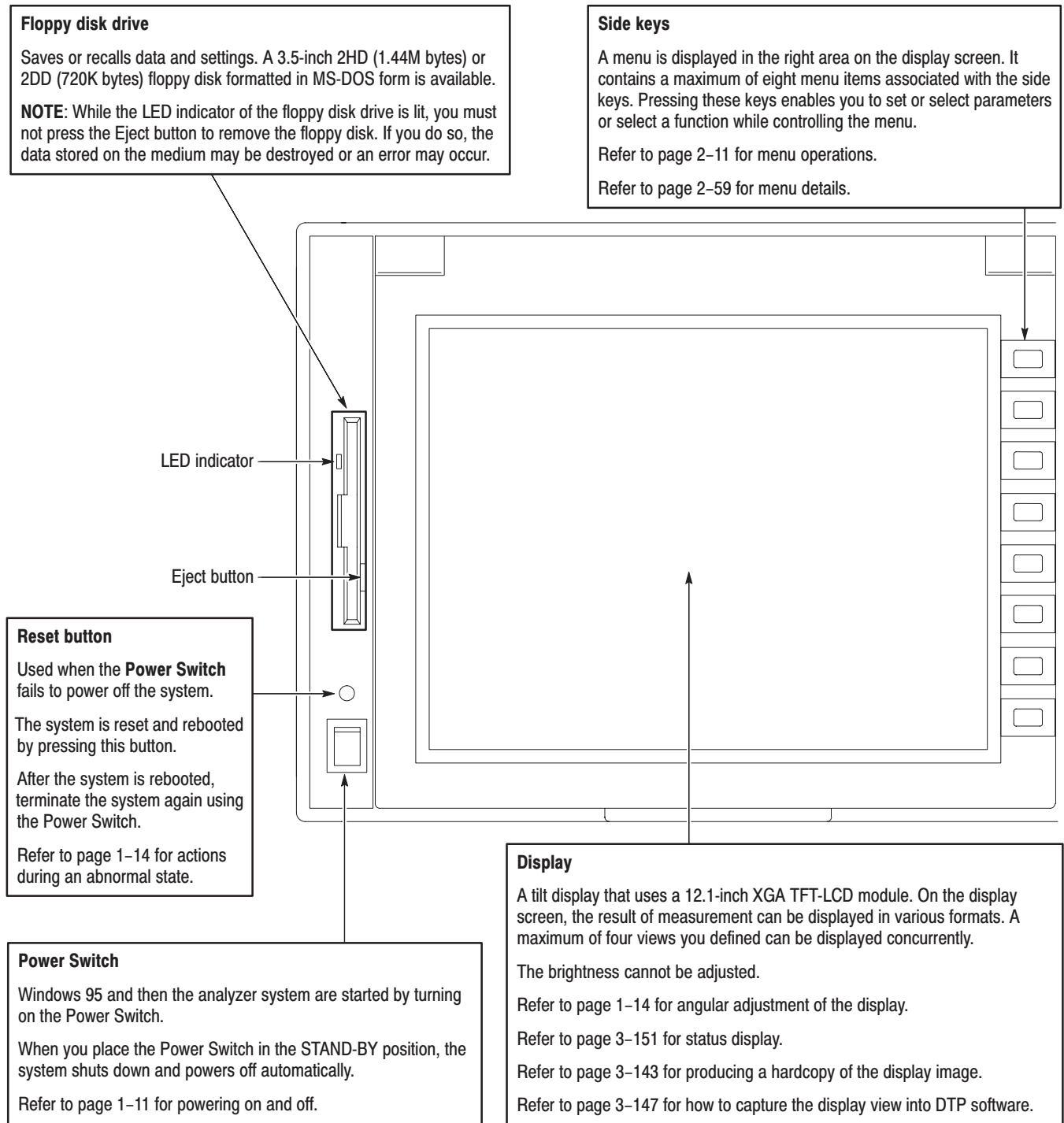


Figure 2-1: Front panel map (left part)

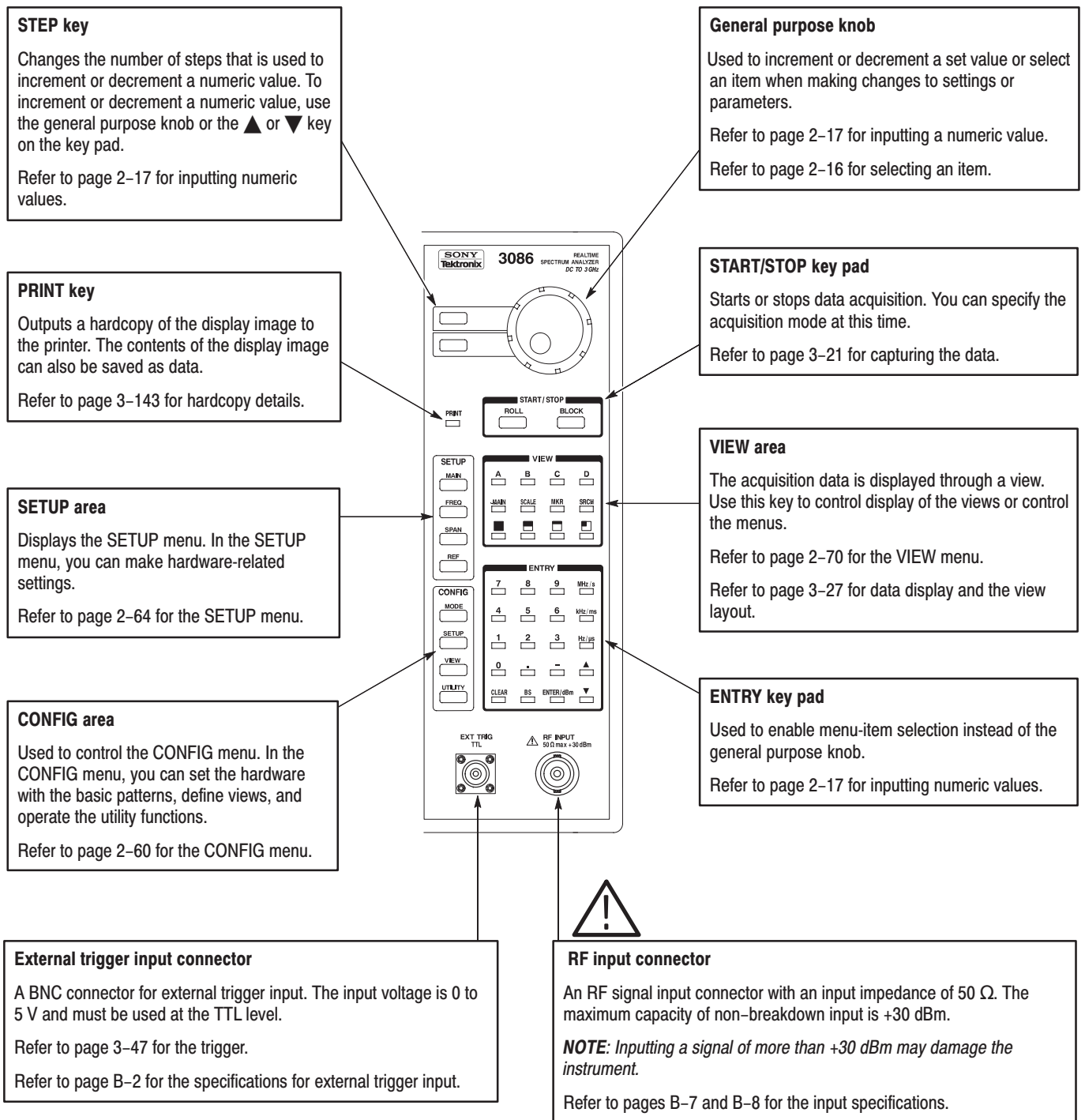


Figure 2-2: Front panel map (right part)

## Rear Panel

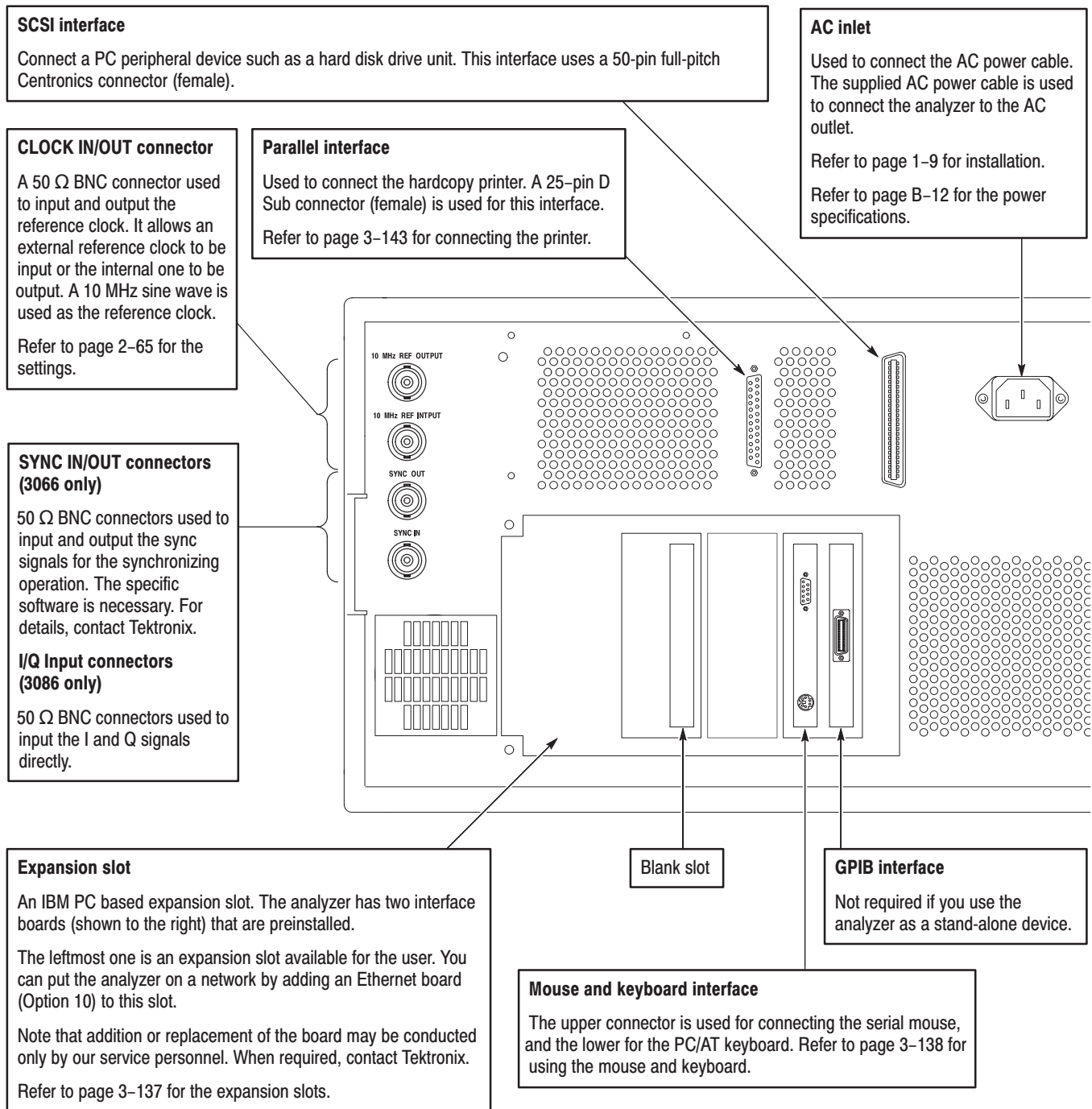
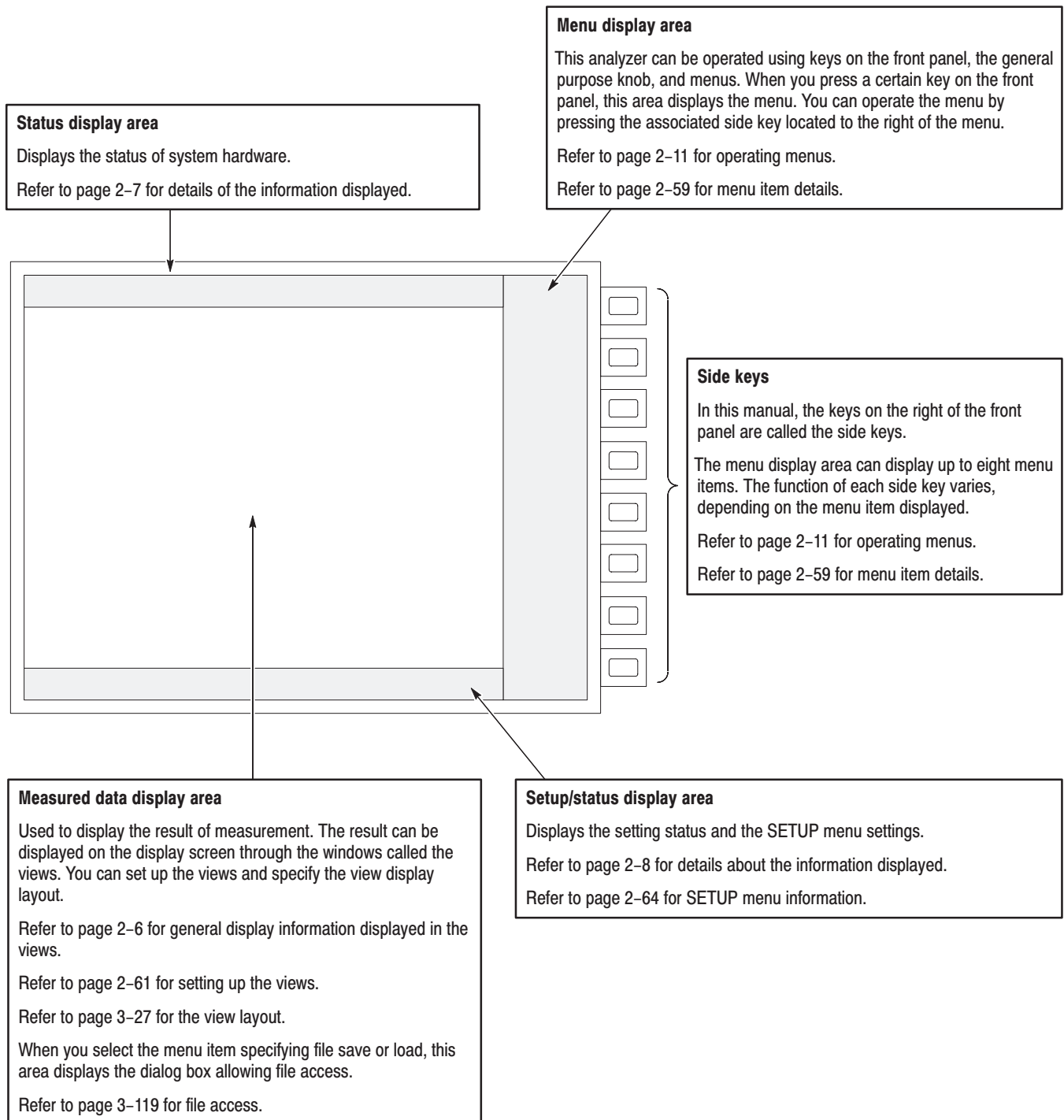


Figure 2-3: Rear panel map

## Display Screen Configuration



**Figure 2-4: Display screen configuration**

## General Display Information in a View

The display information depends on the view and the display format selected. This section details the general information that is displayed in all the views.

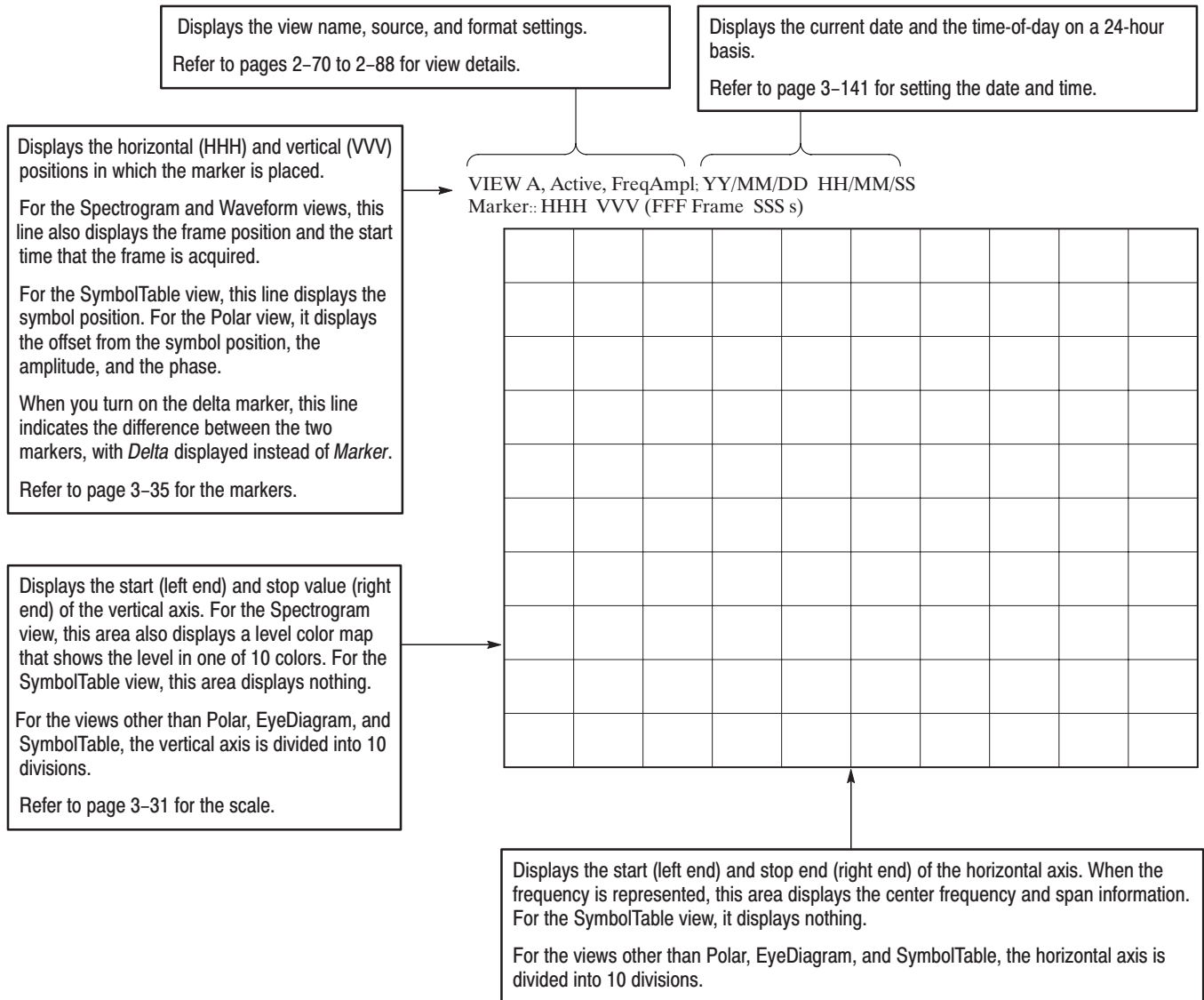


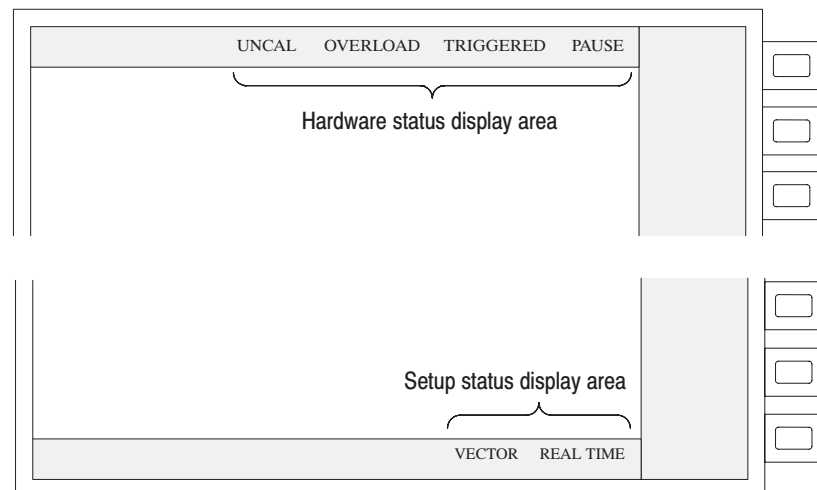
Figure 2-5: View general display information

## Status/Setup Display

This section shows the status display areas on the display screen and lists their details.

### Status Display

The status display areas on the display screen show the six status items listed in Table 2–1. Status messages are displayed in red or blue. Those displayed in red are warning messages.



**Figure 2–6: Status display areas**

**Table 2–1: Display status**

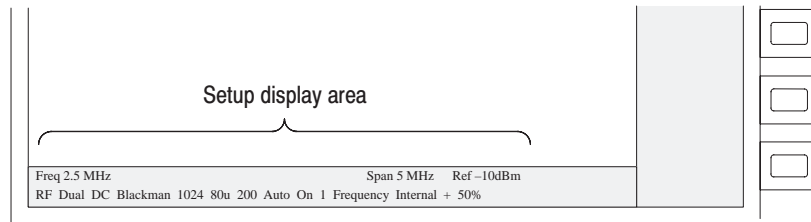
| Items     | Display color | Descriptions  |
|-----------|---------------|---|
| UNCAL     | Gray          | Indicates that the calibration is required.   |
|           | Red           | If this field turns red, run the calibration (refer to page 1–16).  |
| OVERLOAD  | Gray          | Displays the input level. If this field turns red, this indicates an overvoltage input state. Use the analyzer only while the OVERLOAD field is gray. |
|           | Red           | If overvoltage input occurs, lower the input level or change the hardware reference level setting (refer to page 3–11).                               |
| TRIGGERED | Grey          | When the trigger is generated, this field turns blue.   |
|           | Blue          | Refer to page 3–47 for the trigger.   |
| PAUSE     | Gray          | While data capture is at a stop, this field turns blue.   |
|           | Blue          | Refer to page 3–21 for stopping and starting data acquisition.  |

**Table 2-1: Display status (cont.)**

| Items    | Display color | Descriptions  |
|----------|---------------|---|
| VECTOR   | Gray          | When the span is set to acquire one-frame data by one scan, this field turns blue. In the Base-band mode, it always turns blue. In the RF mode, it turns blue when the span is set to 6 MHz or less.  |
|          | Blue          | Refer to page 3-23 for frames and scanning. Refer to page 3-7 for span setting.   |
| REALTIME | Gray          | When the realtime mode is set, this field turns blue. Realtime is implemented only when the analysis has been set so that there is no loss in time during data acquisition. In the Zoom mode, the realtime mode has always been set. Otherwise, the mode depends on the frame period setting. |
|          | Blue          | Refer to page 3-17 for realtime setting.  |

**Setup Display**

The setup display area on the display screen displays the 17 settings listed in Table 2-2. All display items in this area are identical to those set through the SETUP menu. Refer to page 3-22 for the SETUP menu.



**Figure 2-7: Setup display area**



**Table 2-2: Setup display items**

| Display items                          | Menu items                         |
|--|------------------------------------|
| <b>From left to right on upper row</b> |                                    |
| Frequency                              | SETUP: Freq,Span,Ref...→Freq       |
| Span                                   | SETUP: Freq,Span,Ref...→Span       |
| Reference level                        | SETUP: Freq,Span,Ref...→Ref        |
| <b>From left to right on lower row</b> |                                    |
| Input mode                             | SETUP: Input Mode                  |
| Memory mode                            | SETUP: Memory Mode                 |
| Input coupling                         | SETUP: Input,FFT...→Input Coupling |
| FFT window                             | SETUP: Input,FFT...→FFT Window     |
| FFT points                             | SETUP: Input,FFT...→FFT Points     |
| Frame period                           | SETUP: Frame Period                |
| Block size                             | SETUP: Block Size                  |
| Trigger mode                           | SETUP: Trigger...→Mode             |
| Trigger count                          | SETUP: Trigger...→Count            |
| Trigger count value                    | SETUP: Trigger...→Times            |
| Trigger domain                         | SETUP: Trigger...→Domain           |
| Trigger source                         | SETUP: Trigger...→Source           |
| Trigger polarity                       | SETUP: Trigger...→Slope            |
| Trigger position                       | SETUP: Trigger...→Pos              |

\* Each arrow (→) indicates that the one pointed to is at the next lower level.



# Menu Operations

This section describes basic operations of the menus on this analyzer and how to select the desired menu item and input numeric values. Refer to *Menu Functions* on page 2–59 for menu function details.

## Displaying Menus

A menu continually remains displayed at the right end on the display screen. You can select and display the desired one of the following three menus by using keys on the control panel located to the right of the front panel:

- CONFIG menu
- SETUP menu
- VIEW menu (varies depending on the view type)

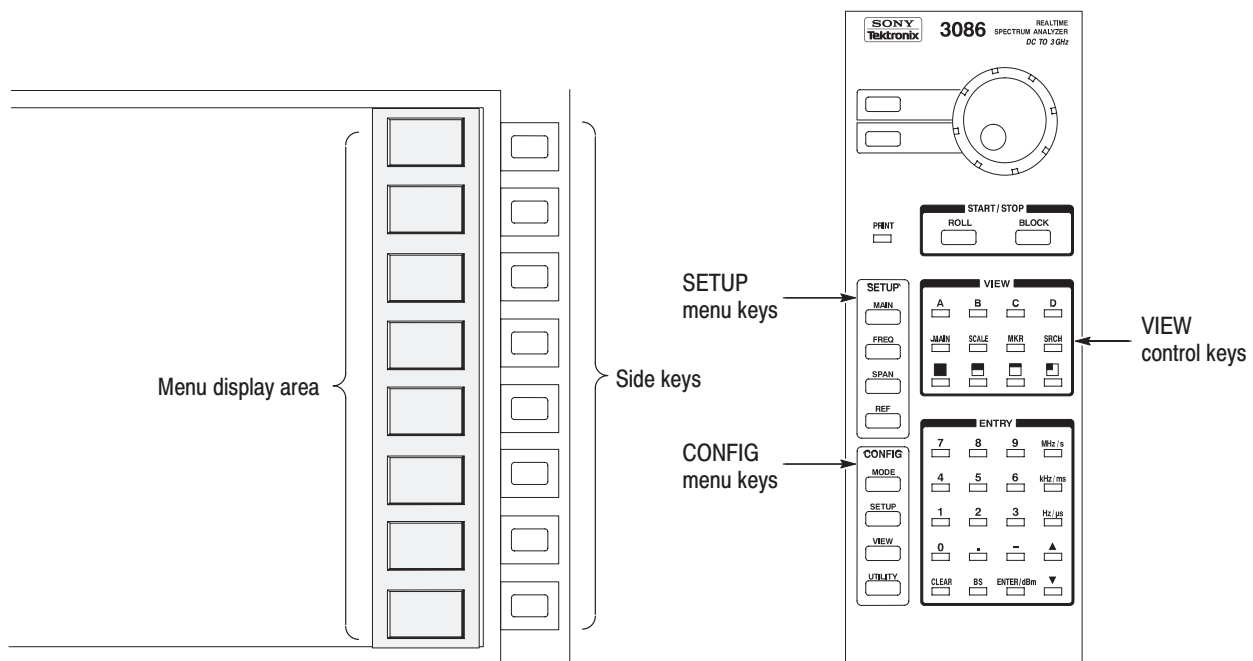
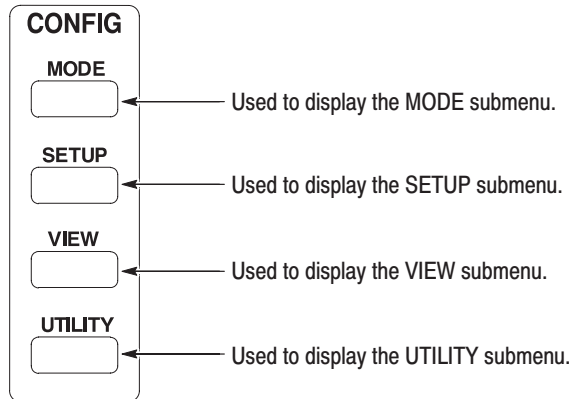


Figure 2–8: Menu display area and keys

**CONFIG** Figure 2–9 shows the CONFIG menu keys. When you press any of these, the submenu associated with the key in the CONFIG area, that is, the particular menu at the lower level, is displayed. These four keys are shortcut keys to the submenus. You can return to the top level of the CONFIG menu by pressing the top side key.

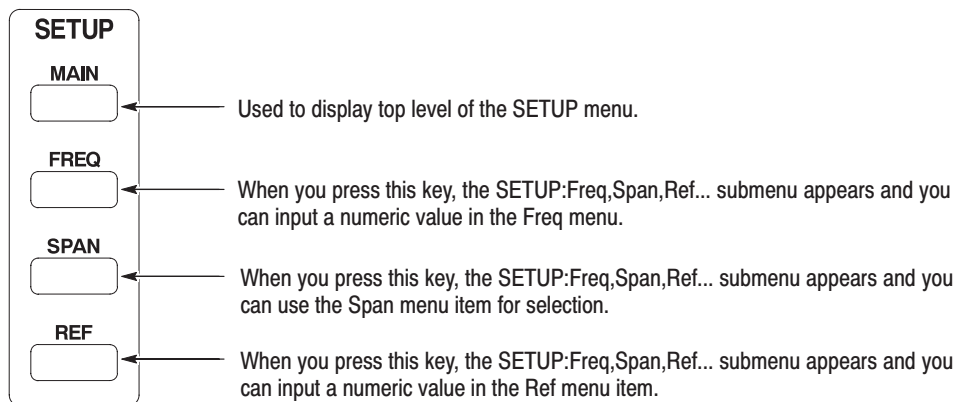
See page 3–19 for details about the CONFIG menu.



**Figure 2-9: CONFIG menu keys**

**SETUP** Figure 2–10 shows the SETUP menu keys. The top level of the SETUP menu is displayed by pressing the MAIN key. When you press one of the lower three keys, the particular submenu of the SETUP menu is displayed. That is, they are shortcut keys to the submenus.

Refer to *SETUP (Standard) Menu* on page 2–64 and *SETUP (CDMA) Menu* on page 2–68 for details of the SETUP menu.

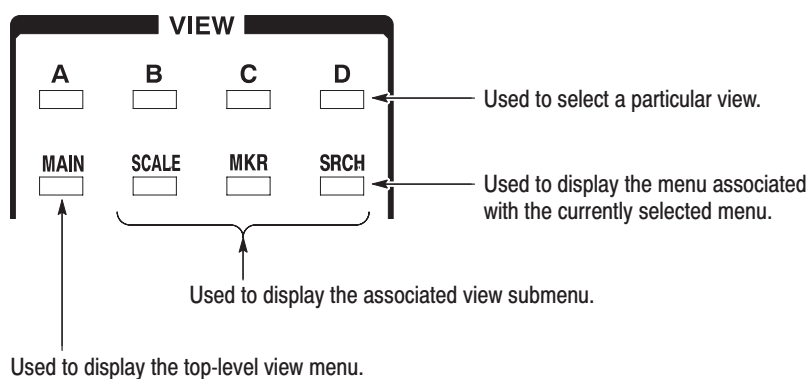


**Figure 2-10: SETUP menu keys**

**VIEW** The VIEW menu allows you to make settings for each associated view. When displaying the VIEW menu, you must select the view using the key associated with the specified alphabetical letter. For example, to use the markers for View B, display the VIEW menu using the following procedure:

1. Press the **B** key.
2. Press the **MKR** key.

The MKR submenu of the view menu associated with View B is displayed.



**Figure 2-11: VIEW keys**

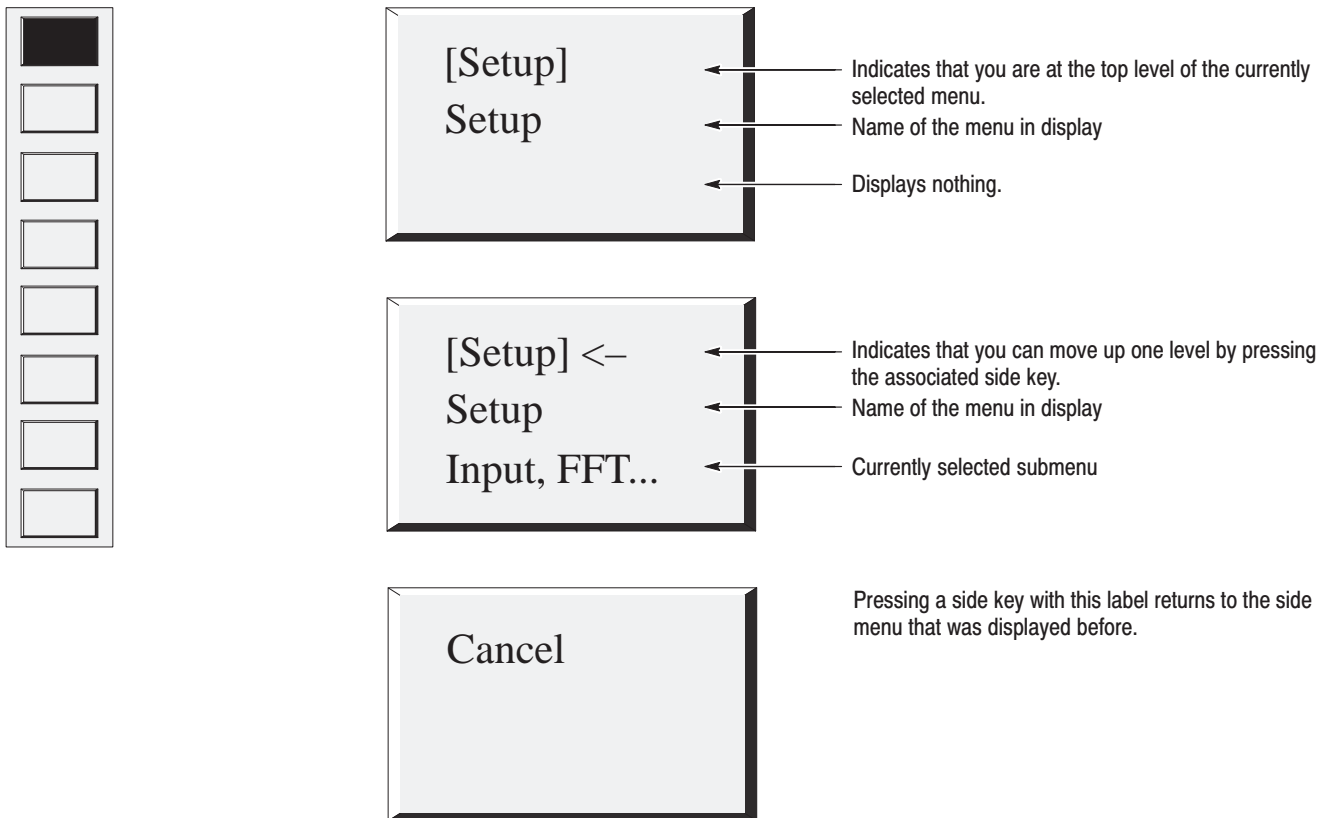
See page 2-61 for details of the VIEW menu.

## Menu Item Information

Each menu displayed may include up to eight menu items associated with the side keys on the right side of the display.

The menu item displayed at the top of the eight menu items, displays two or three items of information as shown in Figures 2–12 and 2–13.

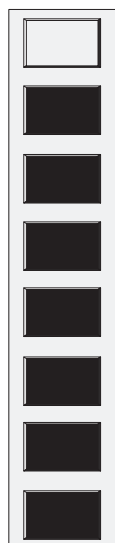
You can use the top menu item to return to the immediately upper level within the menu hierarchy. You can return to the top-level menu display by pressing the side key (to the right of the display) once or twice. If you are at the top level of a menu, the system displays information as shown in the upper illustration in Figure 2–12. If you are at a submenu, the system displays information as shown in the lower illustration.



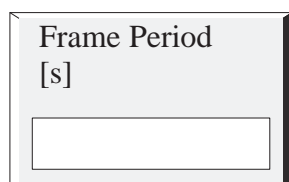
**Figure 2-12: Examples of top menu items display**

The second through eighth menu items in the displayed menu are used to set or select a menu item or to move to a submenu. Figure 2–13 shows many of the menu items.

**NOTE.** If a setting for a menu item is not allowed or is disabled, its label remains gray.



If the label is followed by "...", you can move to the lower-level submenu by pressing the associated side key.

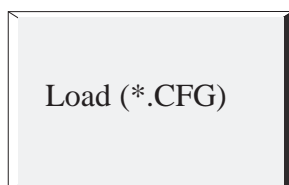


The parameter or option values are displayed together with the menu item label. You can press the associated side key to select an option or to input a value.

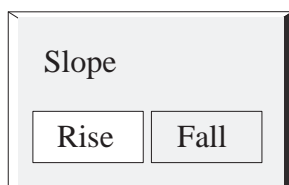
See page 3-15 for how to select an item or to input a value.



When you press the associated side key, the function indicated with the label runs. In this example, the maximum span is set in the Span menu item.



When you press the associated side key, the File Access menu appears. You can save or load a file through this menu.



Toggle menu items switch between the two displayed options when you press the associated side key.

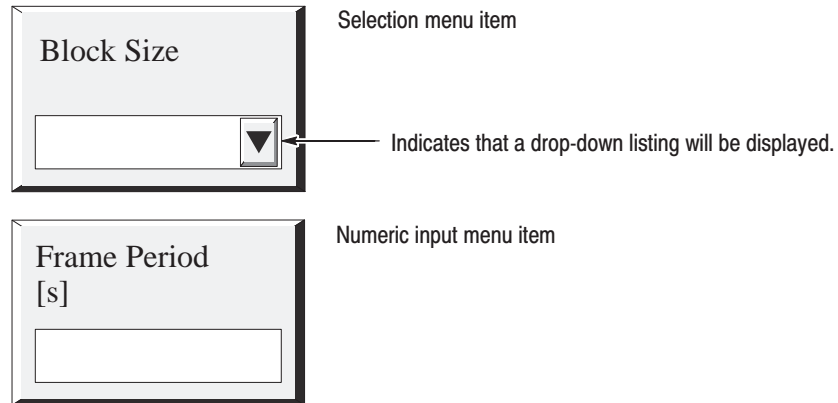


Menu items without labels do not cause any response.

**Figure 2-13: Lower menu item display examples**

## Selection and Numeric Input

Figure 2–14 shows the configurations of a menu item that requires selection or numeric input.



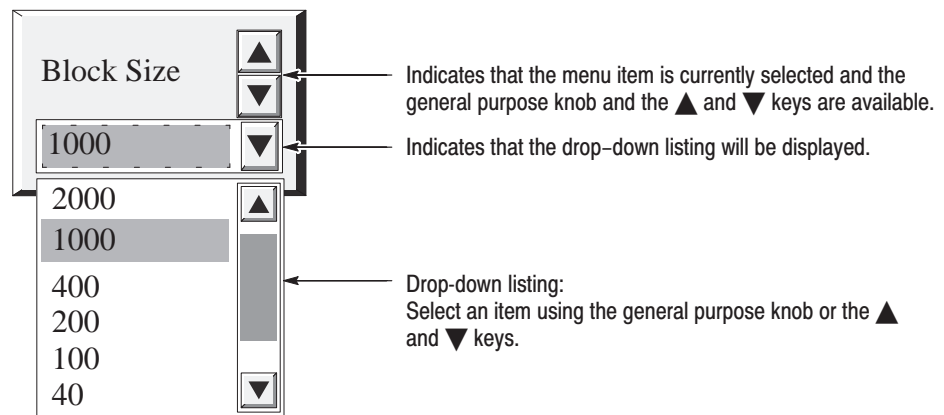
**Figure 2-14: Menu items requiring selection or numeric input**

### Selecting an Item

Use the following procedures to select an item:

1. Press the associated side key.

The menu item changes to the display as shown below:



**Figure 2-15: Drop-down list for selecting an item**

2. Turn the general purpose knob to move the blue item within the drop-down listing, and select an item. Alternatively, you can use the ▲ and ▼ keys for the selection.



3. Press the side key again to finish the selection. You can also use the **ENTER/dBm** key in the keypad

The selected item is immediately reflected in the analyzer settings or views.

To cancel the selection, press the **CLEAR** key in the keypad.

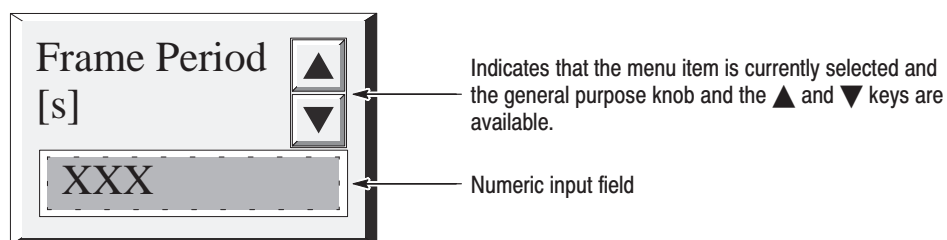
If the setting field is blue even if the drop-down list is not displayed, the general purpose knob and the ▲ and ▼ keys are available for selection. In this case, the selection is established without pressing the side key after selection.

## Numeric Input

Use the following procedures to input a numeric value.

1. Press the associated side key.

The menu item changes to the display as shown below:



**Figure 2-16: Side menu item for numeric setting**

2. To change the numeric value, you can type in the new value or increment or decrement the current value.

**Numeric Input.** Input the new value using the following procedure. Use the ENTRY area keys (in the keypad).

- a. Type a value with the numeric keys.

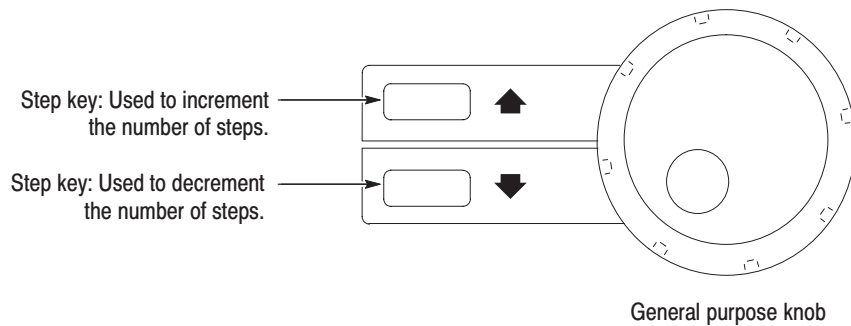
You can delete a digit using the **BS** or a selection with the **CLEAR** key.

- b. Press the Unit key to establish the input.

The new values are immediately reflected in the analyzer settings or views.

**Increment/decrement.** Increment or decrement the displayed value using the following procedure:

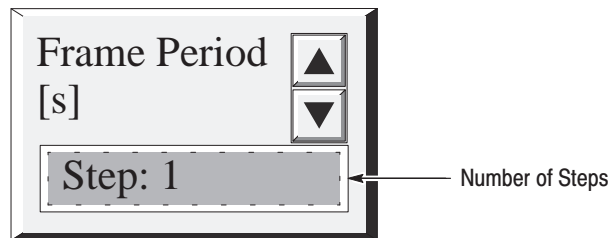
- c. Use **Step** keys to the left of the general purpose knob to change the number of steps for increment or decrement.



**Figure 2-17: Increment/decrement keys**

Pressing a Step key causes the value to change in the numeric input field. The number-of-steps setting is 1 in the example illustrated below. It is changed by pressing a Step key repeatedly.

Set the desired number of steps while observing the display.



**Figure 2-18: Number of steps display**

- d. Increment or decrement the numeric value by turning the general purpose knob or pressing the ▲ and ▼ keys.

When necessary, repeat steps c and d to increment or decrement to obtain a desired value more quickly.

The established values are immediately reflected in the analyzer settings or views.

# Tutorial

This section can help you learn operations of this system. It describes basic procedures, such as applying power, displaying the results of measurements, and powering off the analyzer. This section uses default settings as far as possible. The following procedures are contained in this section:

- Connecting the hardware components and powering up
- Configuring basic patterns
  - Measuring the spectrum
  - Measuring the digital modulated signal
- Making changes to the hardware settings
- Viewing definitions and layout
- Using averaging and compared displays
- Using Search and Zoom
- Using delta markers
- Using Trigger and mask patterns
- Measuring time-series variations in spectrum
- Using EVM (Error Vector Magnitude) analysis
- Measuring noise and power
- Powering down

These procedures assume that the installation described on page 1–9 has already been completed.

Many of the examples in this tutorial require connection of a digital modulated signal.

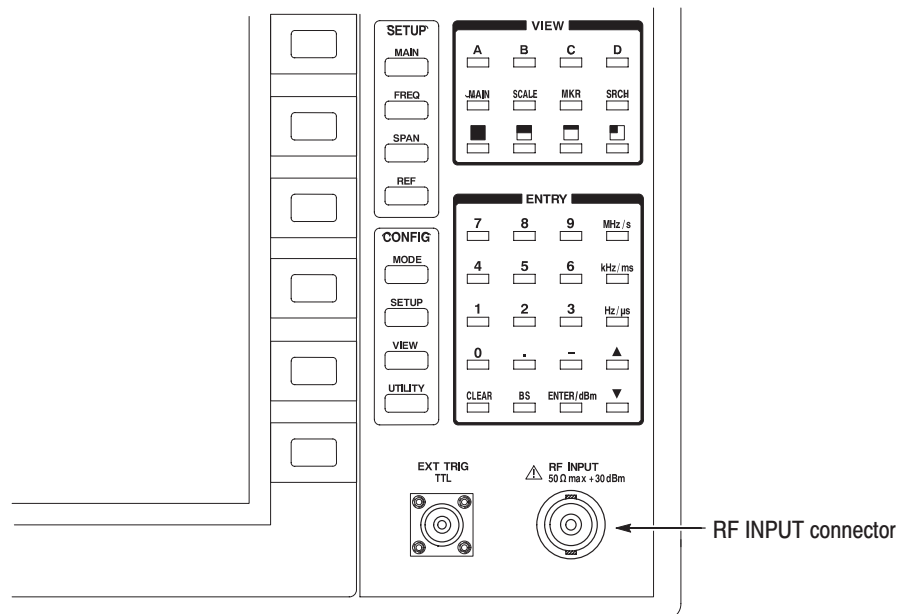
## Preparations

Prepare the following equipment for use in the examples:

- Digital modulated signal generator  
Recommended signal generator: Rohde & Schwartz SMIQ
- One 50  $\Omega$  coaxial cable

## Setup

1. Connect the standard mouse to the rear panel connector of the analyzer. Refer to *Connecting the Mouse* on page 1–10.
2. Connect the signal generator output to the RF INPUT connector on the front panel (see Figure 2–19).



**Figure 2–19: Cable connection**

3. Set the signal generator as follows:
  - Center frequency: 800 MHz
  - Modulation: PDC modulation system  
Symbol rate: 21 kHz  
Filter: Root Raised Cosine  
 $\alpha$ /BT: 0.5
  - Output level: –10 dBm

## Applying Power

1. Power up the signal generator.
2. To power up the analyzer, place the **Power Switch** in the ON position. See Figure 2–20.

3. The analyzer should boot up with the initial screen shown in Figure 2–21. Now, the preparations to operate the analyzer are complete.

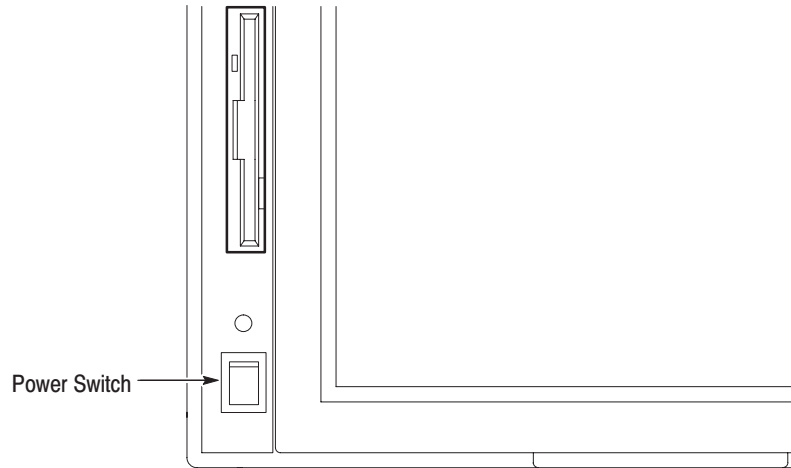


Figure 2-20: Power switch

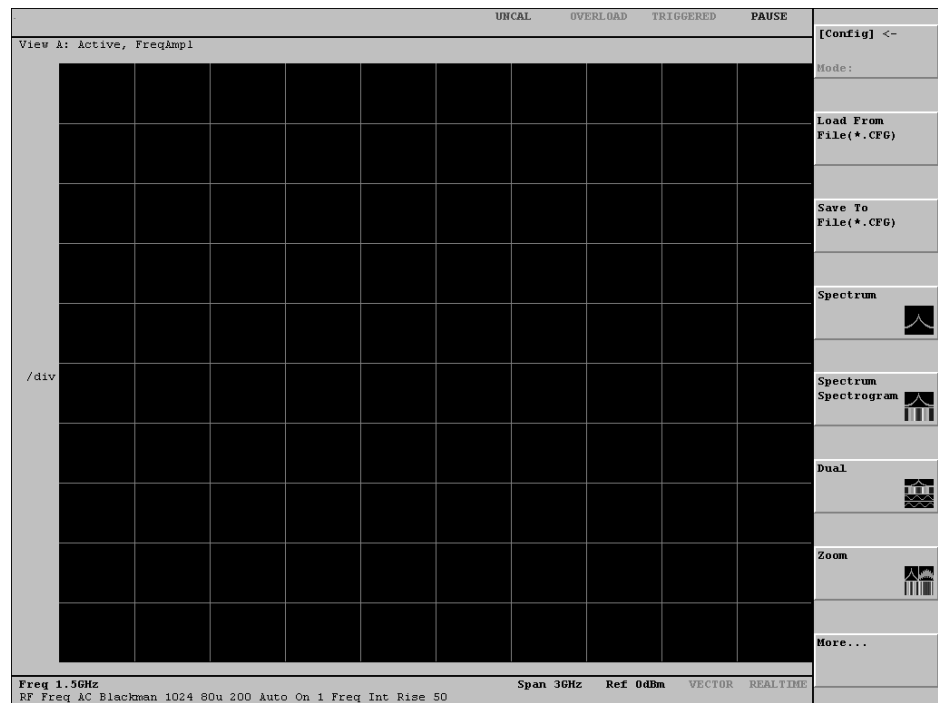


Figure 2-21: System initial screen

## Configuration with Basic Configuration Patterns

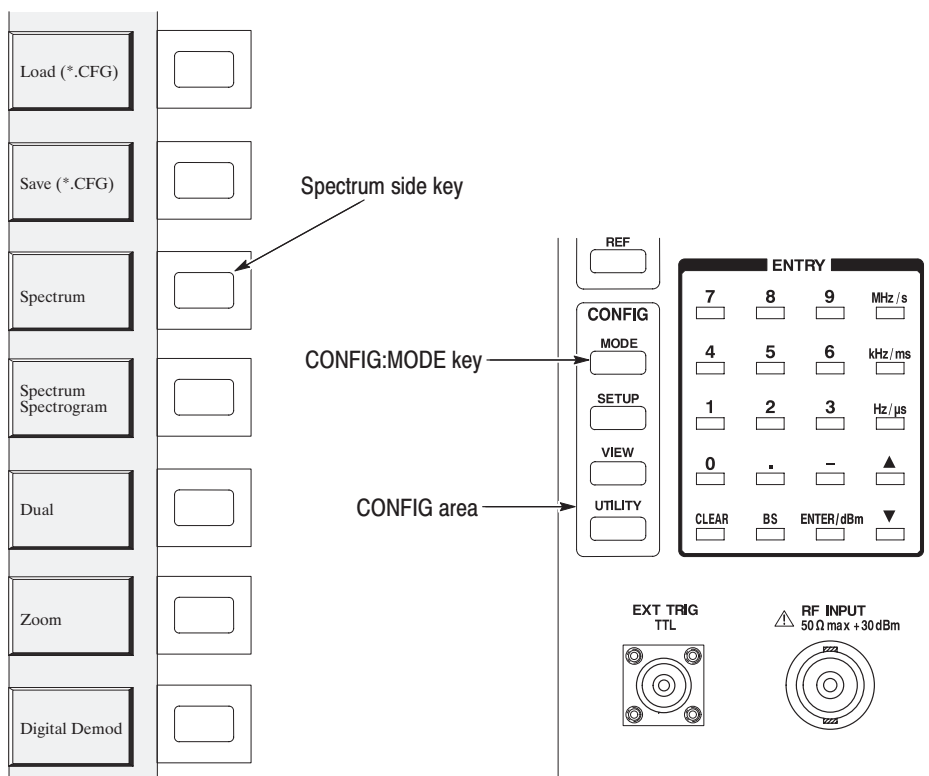
This section describes the easy way to measure the spectrum.

### Measuring the Spectrum

Follow these steps to quickly measure the spectrum of the input signal.

1. Press the **MODE** key in the CONFIG area (see Figure 2–22).

When you press the CONFIG:MODE key, the CONFIG:MODE menu is displayed at the right side of the screen.



**Figure 2-22: Display of the CONFIG:MODE key and the associated submenu**

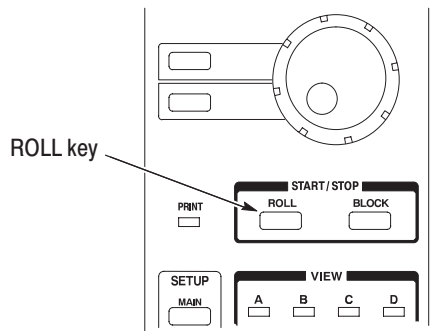
2. Press the **Spectrum** side key.

This key selects measurement of the spectrum with a default span of 3 GHz and a center frequency of 1.5 GHz. The view in Figure 2–21 is unchanged because you need to start acquiring data on the input signal.

**Starting and Stopping Measurement (Roll Mode)**

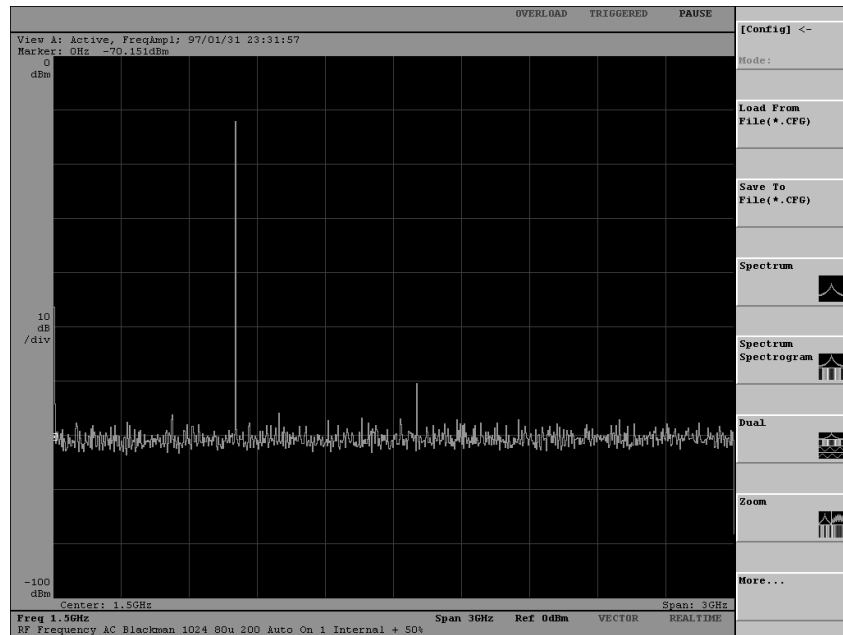
The Roll mode acquires data continuously and simultaneously displays current measurements of the displayed signal.

- 3. Press the **ROLL** key on the front panel.



**Figure 2-23: Control of the start and stop of measurement**

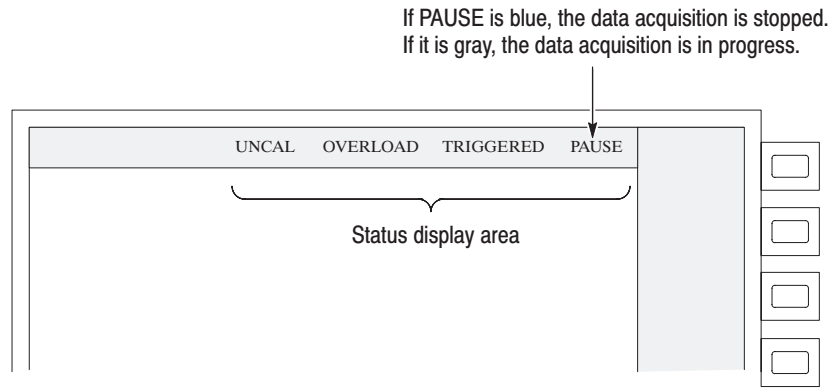
Figure 2-24 shows an example of the spectrum display.



**Figure 2-24: Spectrum measurement with a span of 3 GHz**

4. Stop the measurement by pressing the **ROLL** key.

If PAUSE is in blue in the status display area ( see Figure 2–25), the measurement is currently stopped. If it is in gray, the measurement is in progress.



**Figure 2-25: Status display area**

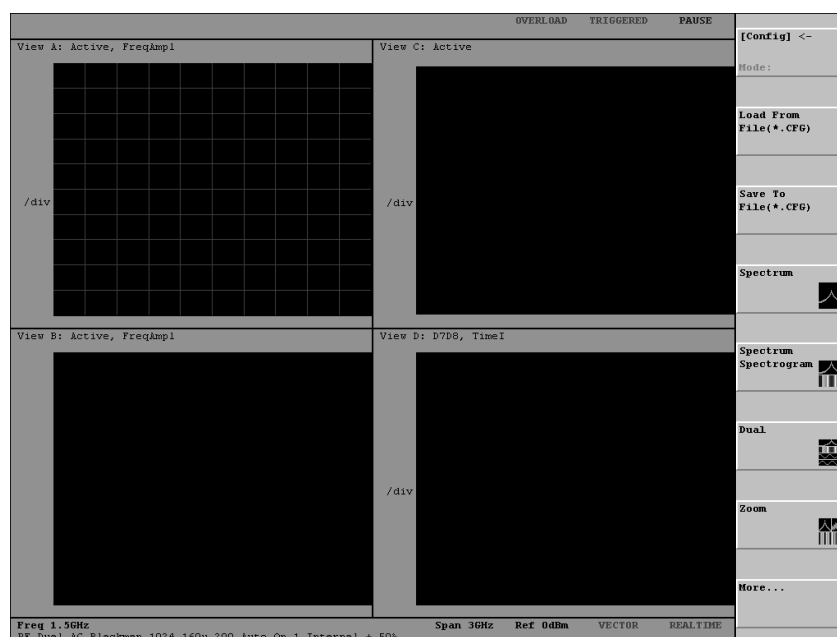


## Measuring a Digital Modulated Signal

Now, measure a digital modulated signal.

5. Press the **MODE** key in the CONFIG area again (see Figure 2–22).
6. Press the **Digital Demod** side key in the menu.

The display view changes as shown in Figure 2–26. The analyzer is set to a span of 3 GHz and a center frequency of 1.5 GHz. It now displays the spectrum, spectrogram, vector (constellation), and EYE pattern in the four views.



**Figure 2–26: Four-view display for digital modulation analysis**

### Starting and Stopping the Measurement

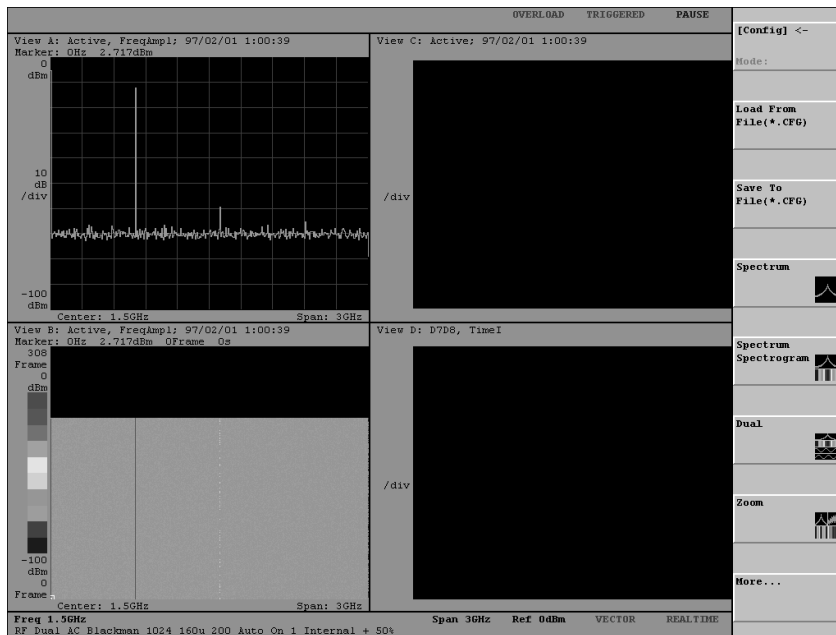
Now, acquire a signal in the BLOCK mode. This mode acquires the data in blocks before display of the measurement result.

**7. Press the BLOCK key.**

Note that the block mode is not yet active because of the current settings. The analyzer continues to use the roll mode to acquire the signal. Real-time acquisition is disabled since the span setting is too great (3 GHz).

Figure 2–27 shows the current view.

The display in this example contains neither the vector nor the EYE pattern. This is because the span is too great (3 GHz) and the digital modulated signal cannot be captured alone. These views can be obtained by specifying a proper center frequency and span.



**Figure 2–27: Measuring the digital modulated signal – Span 3 GHz**

In the next example, you will acquire the signal in the block mode by setting a proper center frequency and span.

## Making Changes to Hardware Settings

In this section, you learn how to make changes to the hardware settings through the SETUP menu.

For the previous views, the default center frequency and span settings were used for measurement. You can change the center frequency and span using the keys in the SETUP area and the SETUP menu.

### Changing the Center Frequency

The center frequency is initially set to the default value 1.5 GHz. Change it to 800 MHz.

1. Press the **FREQ** key in the SETUP area (see Figure 2–28).

The Freq, Span, Ref... submenu is displayed in the menu display area.

Note that numeric input in the Freq menu item is already available for adjustment.

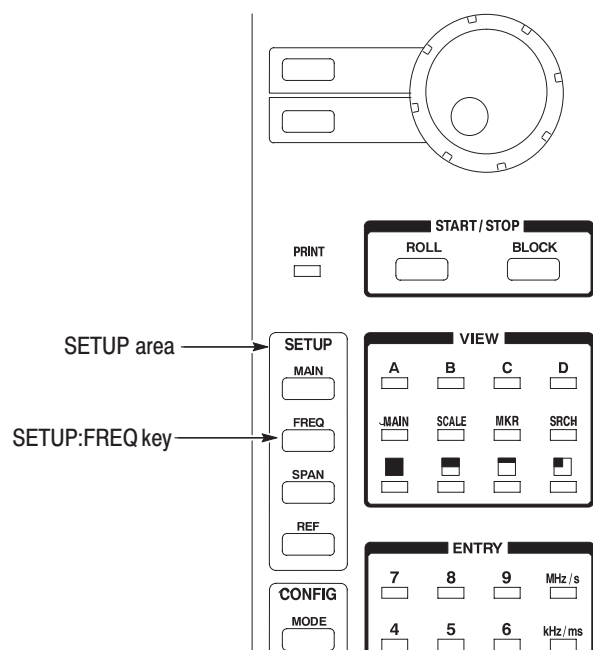
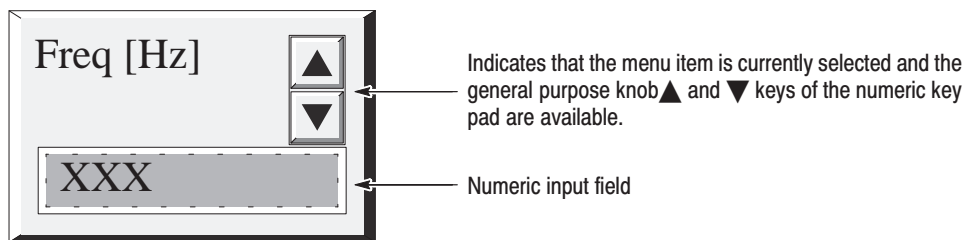


Figure 2–28: Location of the SETUP:FREQ key



**Figure 2-29: Freq side menu item available for numeric input**

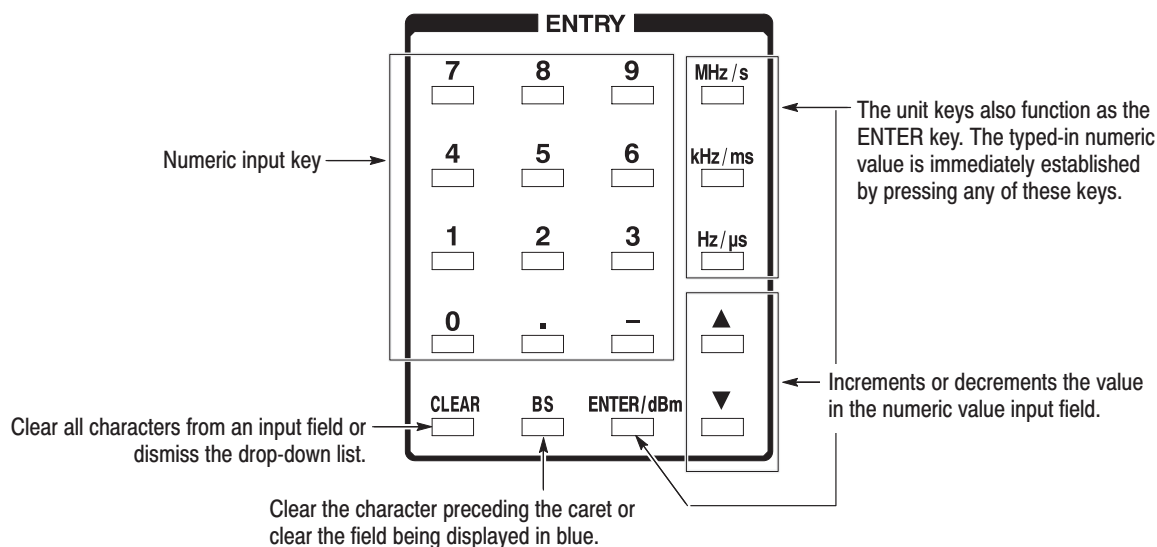
2. Input the new center frequency 800 MHz: In the ENTRY area, press the key **8 0 0 MHz/s** in order.

**NOTE.** When you input 800 MHz in this state, the display returns to 1.5 GHz. You must go on and set the span before the new center frequency (800 MHz) can be used. For details, Refer to Buffering the Input Values on page 3–9.

The **MHz/s**, **kHz/ms**, **Hz/μs**, and **ENTER/dBm** keys function in the same manner as the **ENTER** key. They establish the numeric value you typed in. When you press any of these keys, the hardware is immediately set up with the values you selected.

If you type in an erroneous digit, correct it using the **BS** or **CLEAR** key.

You can also change the numeric value using the general purpose knob or the **▲** and **▼** keys in the ENTRY area.



**Figure 2-30: Numeric input keypad**

## Changing the Span

The currently displayed menu indicates that the span is set to the default value 3 GHz. Change it to 100 kHz.

3. Press the **Span** side key.

A drop-down list appears to select the desired item.

4. Select **100k** using the general purpose knob.

5. Press the **Span** side key again.

The hardware is set up immediately with the new value.

---

**NOTE.** After the span has been changed, the relationship between the span and the frequency input in Step 2 falls within the allowable range. Now the 800 MHz center frequency, input previously, is displayed for the Freq menu item.

---

## Starting and Stopping the Measurement (Block Mode)

With the center frequency and span set to appropriate values, you can now use the block mode to acquire data. This mode displays the result of measurement after the data has been acquired in blocks.

6. Press the **BLOCK** key on the front panel.

Unlike the roll mode, the block mode requires a longer time to display the data. This is because, the data is displayed only after enough is acquired to fill the specified block size. After one block of data has been captured, the data acquisition is displayed.

Make sure that REALTIME is displayed in blue in the setting status display area at the bottom of the display (see Figure 2–31). This indicates that the data is being acquired in real time. The settings allowing real-time acquisition of the data depend on the frame period and span settings. Refer to *Frame Period and Realtime* on 3–17 for details.

Also check that the PAUSE display is gray in the hardware status display area (see Figure 2–31) indicating the acquisition of data.

Figure 2–32 shows the measurement result using the new center frequency and span. Note that the display scale has automatically changed in accordance with the center frequency and span settings.

You now have a proper vector view and EYE diagram. Try changing the span setting. This modifies the two views, especially the Polar view located at the top right corner on the display. It has a mechanism to demodulate the digital modulated signal. If the span is too great or small, the modulated signal cannot be analyzed.

Try changing the frequency in fine increments using the general purpose knob. Note how the display diagram changes.

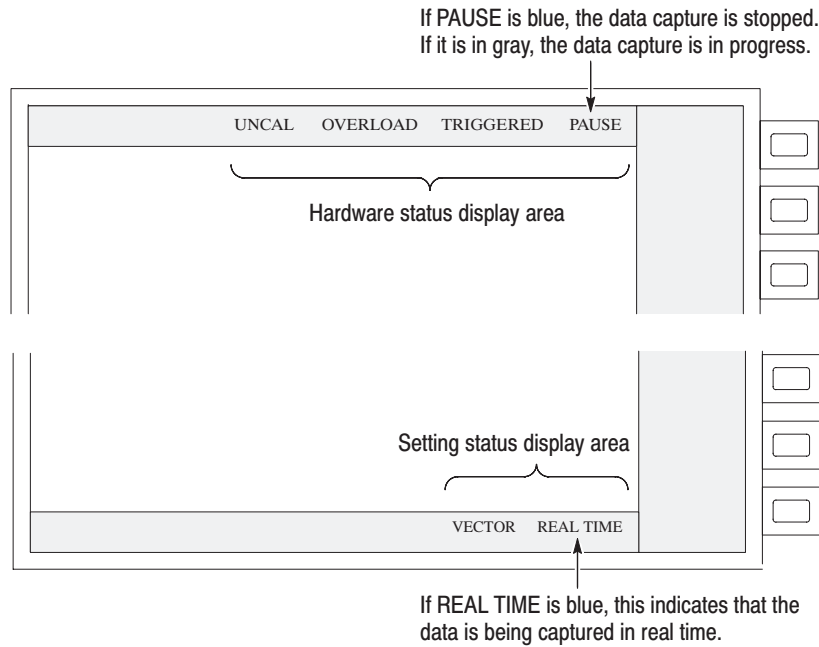


Figure 2-31: Setup display areas

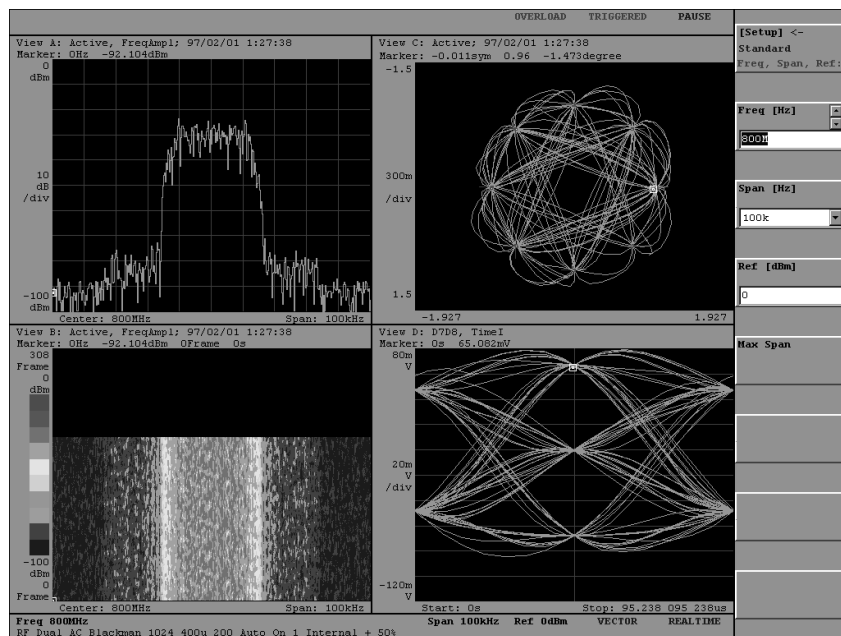


Figure 2-32: Views resulting from changes to the frequency and span settings

## View Definitions and Layout

In this section, you learn how to define a view or a window used to display the result of measurement.

The view is a window used to display the result of measurement. This system allows you to define up to four views. You can specify how the result is displayed in each of the defined views.

In the subsequent sections, you modify the view located at the bottom right corner on the screen to the waterfall display.

### Checking the View Definitions

Four views of A to D are already defined in the basic pattern settings. First, you check their definitions.

1. Press the **VIEW** key in the CONFIG area (see Figure 2–33).

The display area shows the menu used to set the format of the four views (see Figure 2–33).

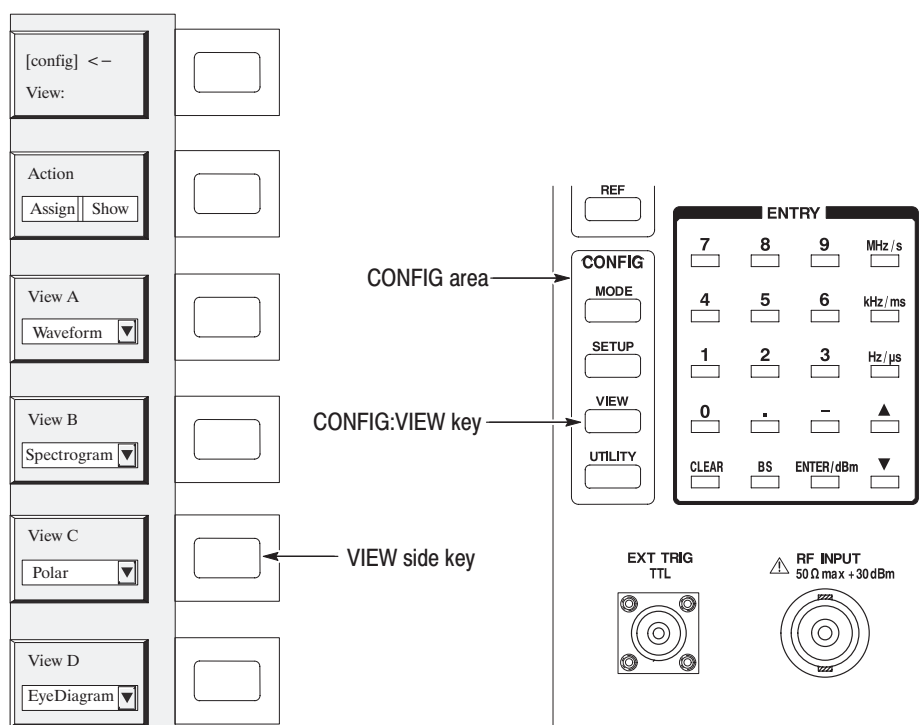


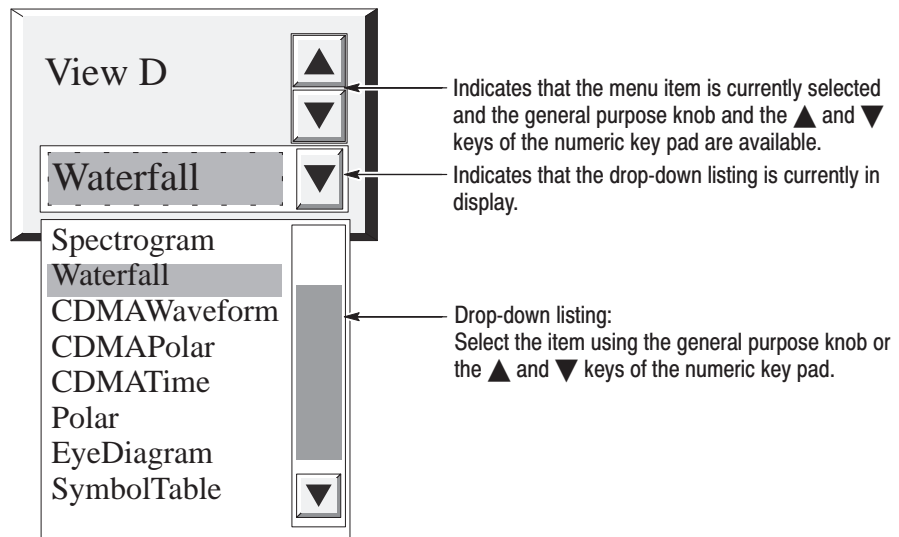
Figure 2–33: Displaying the CONFIG:VIEW key and its associated submenus

**Redefining a View** Change the view definition in the View D from Eye diagram to Waterfall.

2. Redefine View D.

- a. Press the **View D** side key.

A drop-down listing appears to select the desired item (see Figure 2–34).



**Figure 2-34: Selecting the Waterfall view**

- b. Select **Waterfall** from the drop-down listing by turning the general purpose knob.
- c. Press the **View D** side key again.

Figure 2–35 shows an example of the views using the new settings.



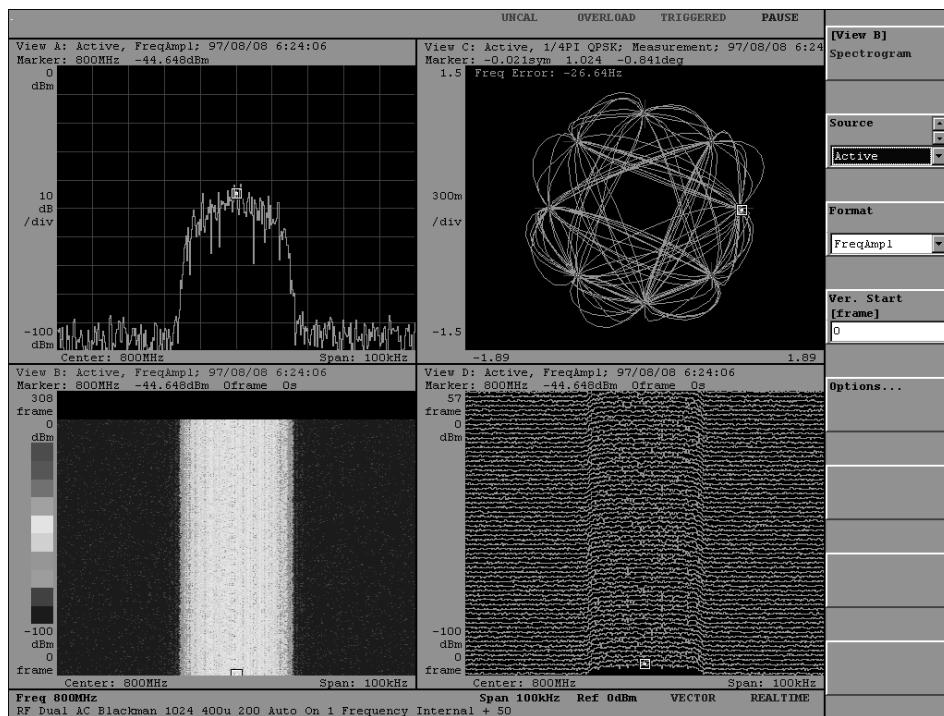
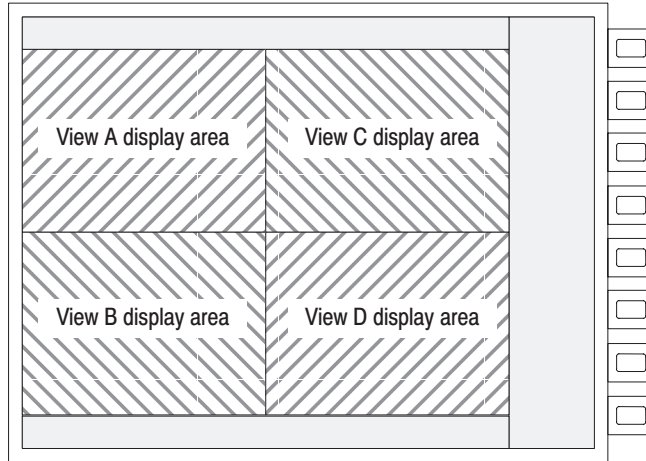


Figure 2-35: Making changes to view D

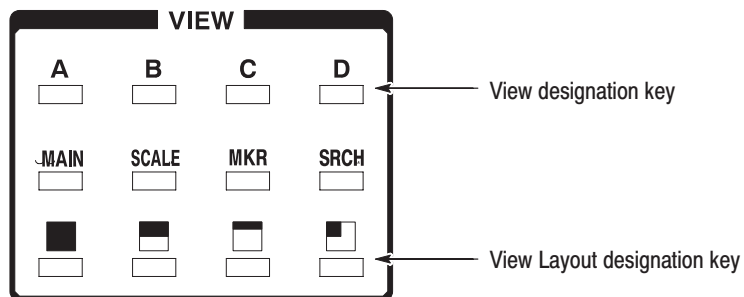
**View Layout** The views are placed in predefined positions on the display screen. At present, they are placed in the two-by-two layout as shown in Figure 2–36. If a view is not defined, the appropriate area is empty.



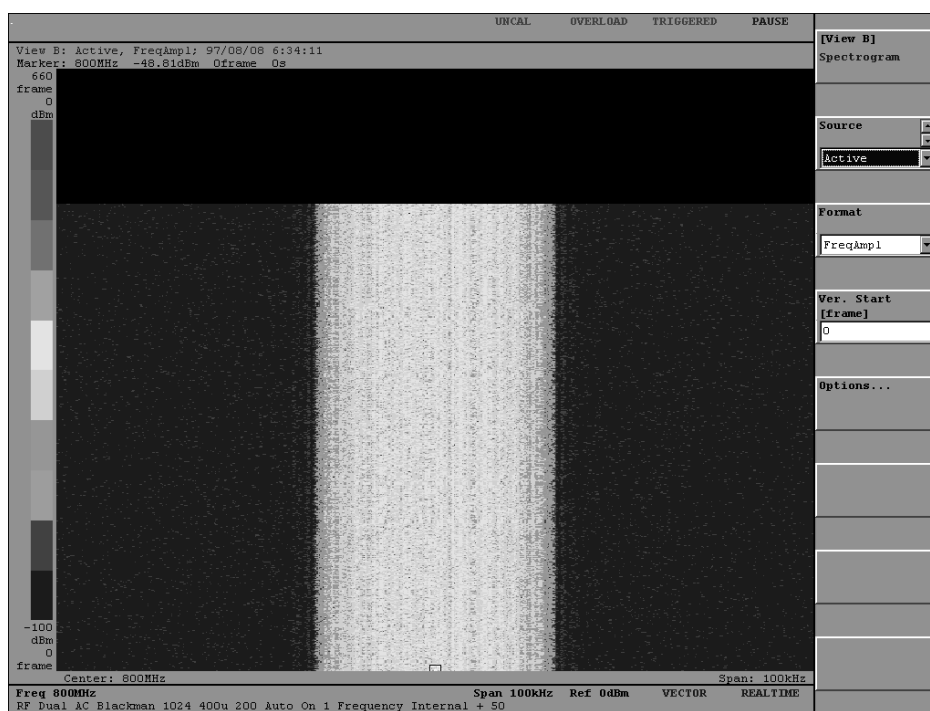
**Figure 2-36: Four-view display layout**

3. Modify the View B display layout.
  - a. Press the ■ key in the VIEW area (see Figure 2–37).
  - b. Press the **B** key in the VIEW area (see Figure 2–37).




View B is displayed fully on the display screen. See Figure 2–38.



**Figure 2-37: VIEW keys (view control keys)**



**Figure 2-38: View B display (1-view display)**

- c. Press the **A** to **D** keys sequentially in the VIEW area.
- d. Try pressing the , , and  keys and the **A** to **D** keys in various combinations to see the possible view configurations.

## Averaging and Compared Display

In this section, you learn how to compare averaged and non-averaged waveforms. The Waveform views are capable of averaging the data and displaying two waveforms concurrently.

### Setting Up the Averaging

The Waveform view is predefined for View A. Modify the input source of this view to enable the averaging process.

4. Modify the View A source.
  - a. Press the **VIEW:A** key.
  - b. Press the **VIEW:MAIN** key.
  - c. Press the **Source** side key.
  - d. Select **Average** by turning the general purpose knob.

Now, the averaging settings are complete.

### Setting Up the Compared Display

You can display two waveforms for comparison.

5. Make settings to display the averaged and the non-averaged waveforms concurrently.
  - a. Press the **Trace2...** side key.
  - b. Press the **Source** side key.
  - c. Select **Active** by turning the general purpose knob.

### Acquiring and Displaying the Signals

The averaging function in the Waveform view does not work in the block mode.

6. Press the **ROLL** key on the front panel.

The displayed spectrum is for the non-averaged waveform.

Observe the View A display. A green and a yellow trace should now be displayed. The green trace represents the averaged waveform and the yellow one the non-averaged waveform.

In Figure 2–39, the white trace represents the non-averaged waveform and the grayish trace the averaged waveform.

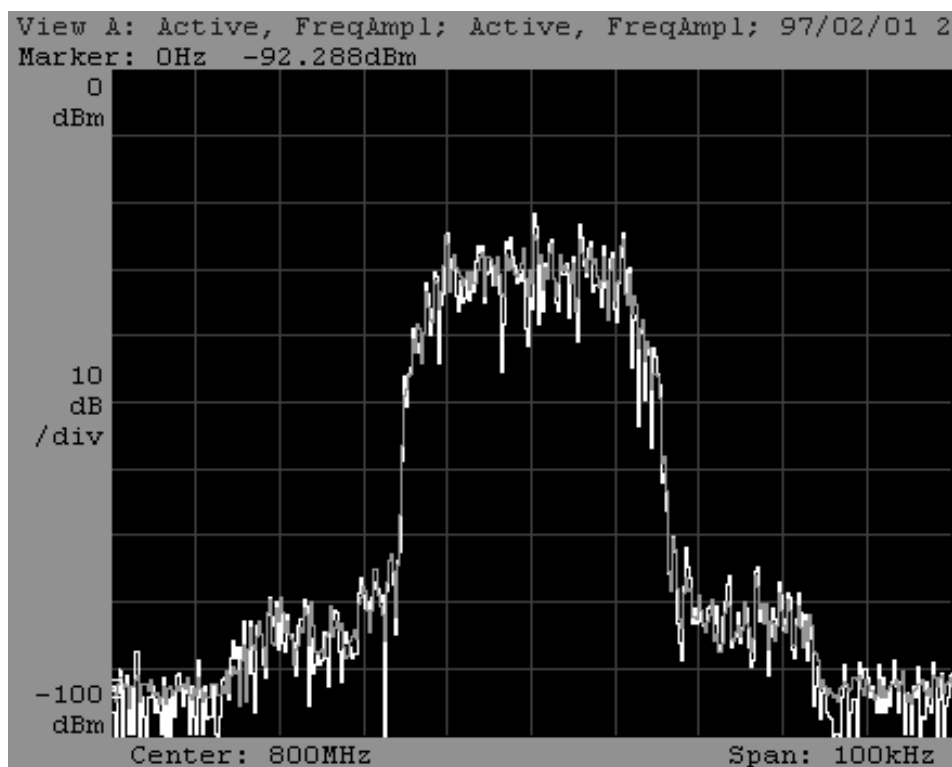


Figure 2–39: Averaging and compared waveform display

## Search and Zoom

In this section, you learn to use the Zoom and Search functions. Zoom enlarges a specific section of the obtained spectrum and displays it. The Zoom function of this analyzer remakes the frequency domain data, with a specific frequency and span, based on the time domain data. Therefore, it is capable of enlarging the view by a factor of up to 1000 without sacrificing the precision of observation.

### Setting the Zoom Mode

To enlarge the display, you must first acquire the waveform in the Zoom mode.

1. Place the analyzer in the Zoom mode.
  - a. Press the **CONFIG:MODE** key.

Where **CONFIG:MODE** represents the **MODE** key within the **CONFIG** area. This format is used hereafter.

- b. Press the **Zoom** side key.

The analyzer is now in the Zoom mode. The center frequency and span settings are still unchanged. Check them with the menus.

2. Press the **SETUP:FREQ** key.

With the Freq and Span menu items, make sure that the center frequency and span settings are 800 MHz and 100 kHz. If you changed these settings previously they will not be reset when you change acquisition or display modes. To set Freq and Span follow the steps listed on pages 2–9 and 2–11.

### Capturing the Signal

The Zoom function requires the block mode.

3. Press the **BLOCK** key on the front panel to capture the signal.

Figure 2–40 shows an example of the signal acquired in the Zoom mode.

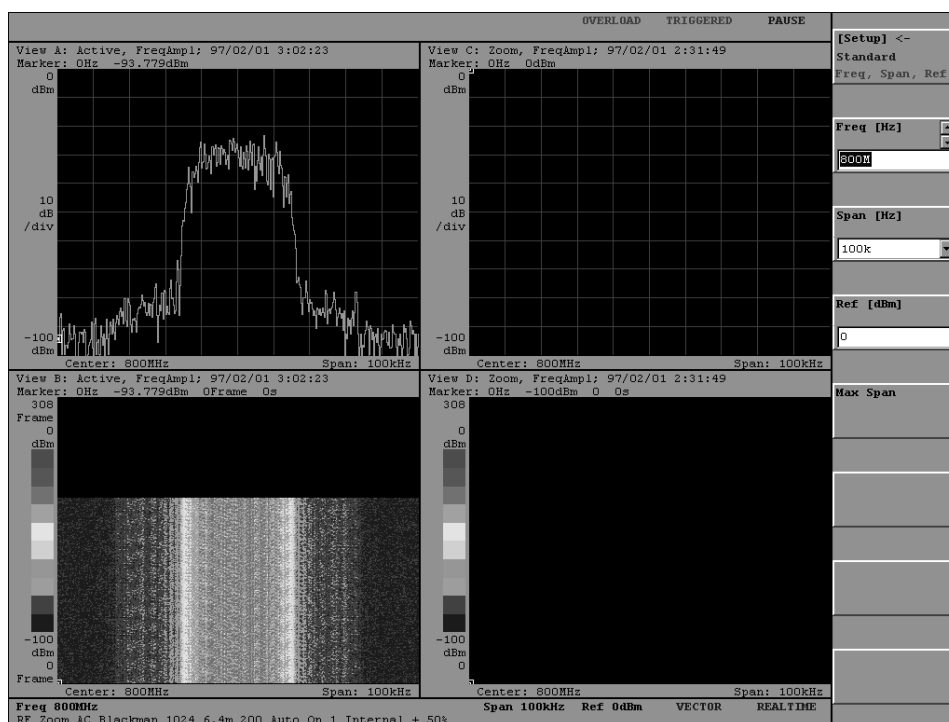


Figure 2–40: Signal acquisition in the Zoom mode

### Searching for the Spectrum

Define a new center frequency and enlargement factor for the acquired waveform. First, the search function is used to search for the spectrum with the maximum intensity to use for the center frequency.

4. Using the search function, search for the peak spectrum.
  - a. Press the VIEW:A key.
  - b. Press the VIEW:SRCH key.

A marker (□) is positioned at the maximum peak spectrum. This frequency becomes the center frequency.

**Run Zoom** Use Zoom around the center frequency found with the search function.

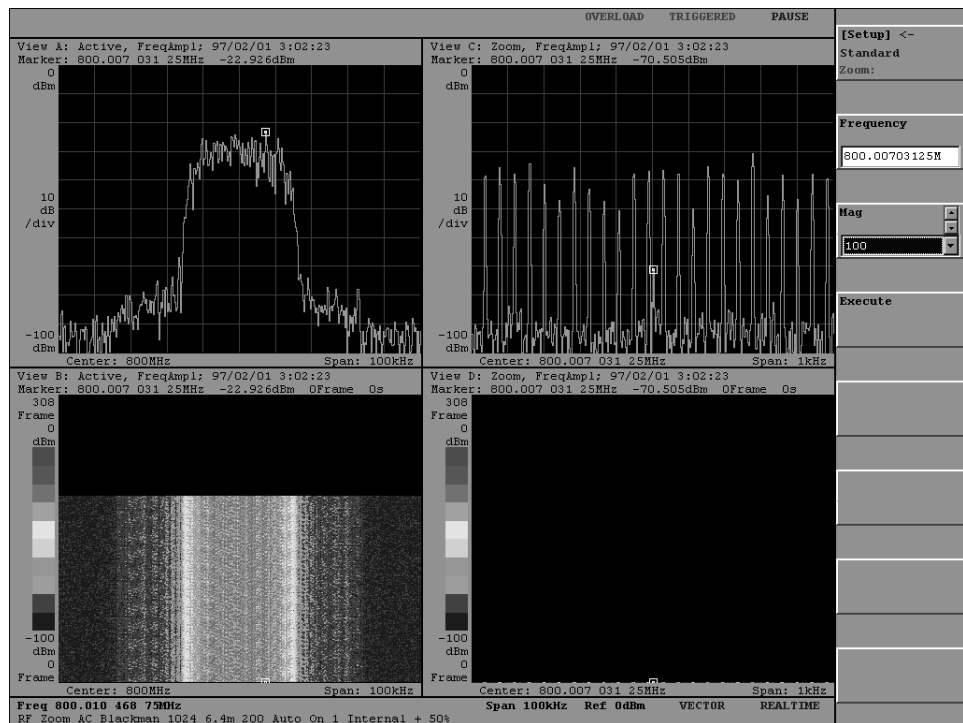
5. Run Zoom.
  - a. Press the SETUP:MAIN key.
  - b. Press the **Zoom...** side key.

Note that the Frequency menu item contains the new frequency resulting from the search.

- c. Press the **Mag** side key. Turn the general purpose knob to set the enlargement factor to 100.
- d. Press the **Execute** side key.

The enlarged view is displayed in Views C and D. Figure 2–41 is a zoom display example. In View D, the number of displayed frames is  $[(\text{block size})/(\text{enlargement factor}) - 1]$  (In this case,  $200/100 - 1 = 1$ ).

You can repeat steps c to d to view different zoom factors.




**Figure 2-41: Example of using zoom**



## Delta Markers

In this section, you learn how to operate the delta markers. Delta markers let you accurately measure the difference between two frequencies.

A comb spectrum waveform can be observed in View C in Figure 2–42. Measure the difference between the frequencies of adjacent spectrum peaks.

1. For better visibility, change View C to a single view display.
  - a. Press the VIEW:C key.
  - b. Press the VIEW:  key.

View C changes to single view display. See Figure 2–42.

### Searching for the Spectrum

For simplification, we measure the interval between the peak spectrum with the maximum power and the adjacent peak to its the right.

2. Position the delta markers at the maximum peak spectrum.
  - Press the VIEW:SRCH key.

The delta markers ( $\square$  and  $\diamond$ ) are both positioned at the maximum peak spectrum. Figure 2–42 shows an example. By rotating the general purpose knob, the peak spectra to the right or left are found and the markers are positioned there.

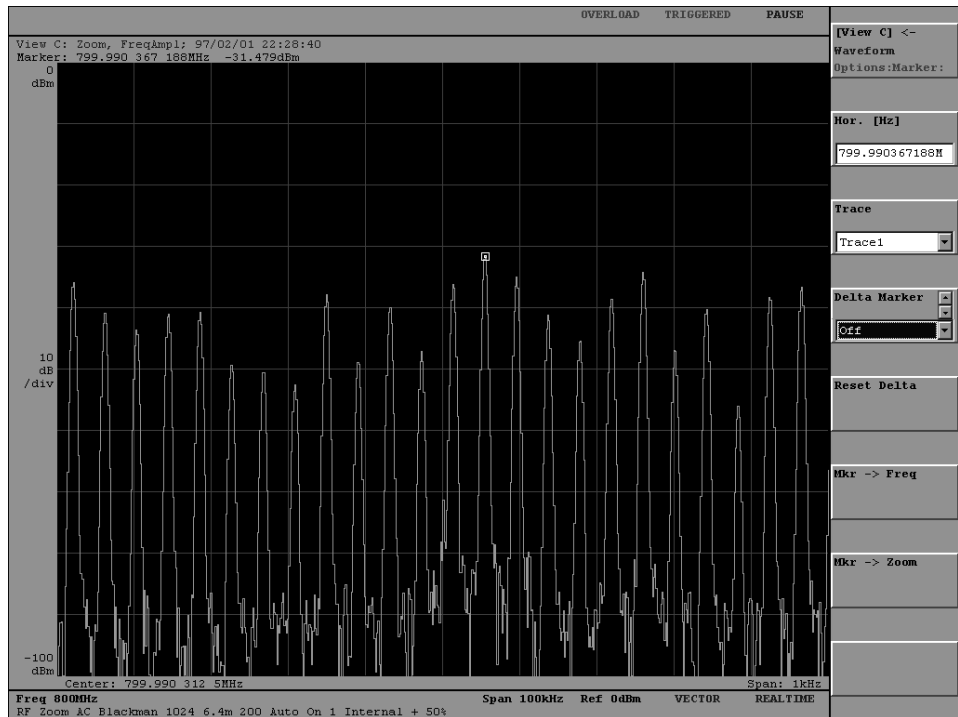


Figure 2-42: Moving the markers by search

### Operating the Delta Markers

Position the delta markers for a measurement.

3. Operate the delta markers.
  - a. Press the VIEW:MKR key.
  - b. Press the **Delta Marker** side key and select **On**.  
The delta markers turn on.
  - c. Press the **Reset Delta** side key.  
The  $\diamond$  marker displays and moves to the  $\square$  position.

4. Measure the spectrum interval.
  - a. Press the **Hor.** side key.
  - b. While turning the general purpose knob, position only the  $\square$  marker on to the adjacent peak.

At the top left corner, the view shows the differences in frequency and power. These values are the result of the delta marker measurement. See Figure 2-43.

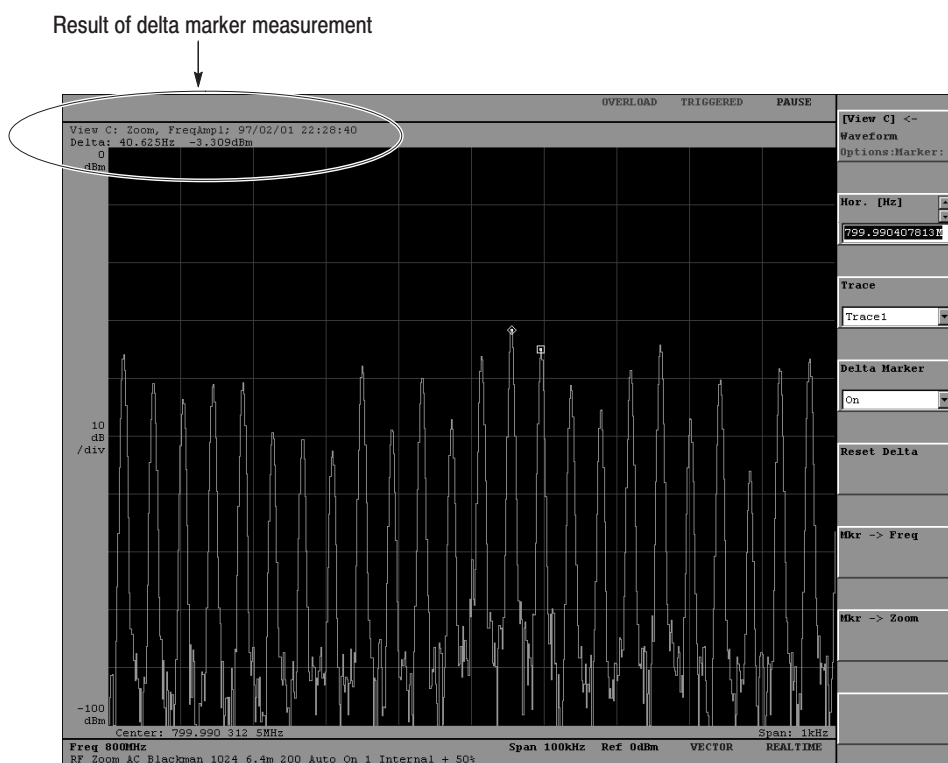


Figure 2-43: Example measurement using the delta markers


## Trigger and Mask Pattern

In this section, you learn how to create the trigger mask and cause the trigger. You can create a trigger mask in an internal trigger register and cause a two-dimensional trigger of the frequency and level.

Modulation ON/OFF of the signal generator is used to cause the trigger. For simplicity, we make changes to the analyzer settings.

### Preparation for Creating the Mask Pattern

Select the correct configuration for triggered acquisition.

1. Change to the basic configuration.
  - a. Press the **CONFIG:MODE** key.
  - b. Press the **Spectrum/Spectrogram** side key.
2. Make sure that the frequency and span are 800 MHz and 100 kHz, respectively.
3. Press the **VIEW:A** key and then the **VIEW: ** key.
4. Set the generator modulation off.
5. Press the **BLOCK** key on the analyzer front panel to acquire the signal by in the block mode.

The waveform as shown in Figure 2–44 is observed.

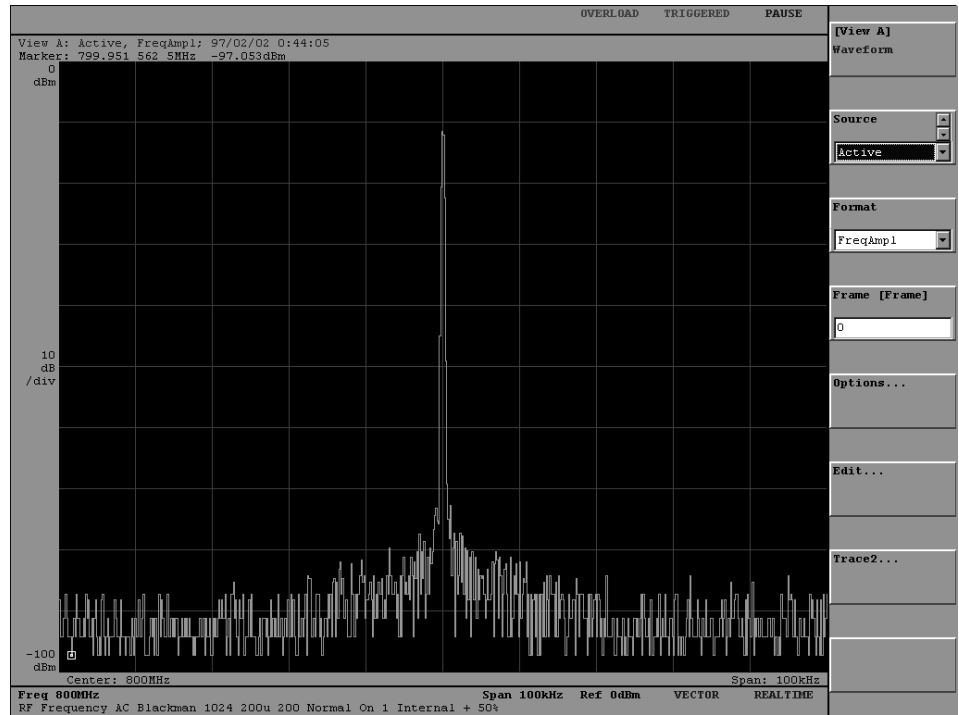


Figure 2-44: Preparations for creation of the trigger mask pattern

**Creating the Trigger Mask**

Create the trigger mask pattern while observing the waveform in View A in Figure 2–44. The trigger should be generated when the signal generator modulation is turned on. For this purpose, a trigger area is created on each side of the peak spectrum. This setting generates the trigger when the spectrum enters either of the areas.

6. Create a trigger area to the left of the peak spectrum (see Figure 2–45).
  - a. Press the **VIEW:A** key.
  - b. Press the **VIEW:MAIN** key.
  - c. Press the **Edit...** side key.

Position the marker at the bottom left corner of the area.

- d. Press the **Hor.** side key. Then, position the marker horizontally using the general purpose knob.
- e. Press the **Ver.** side key. Position the marker vertically using the general purpose knob.

You can fine-tune the marker position by repeating steps d and e. Adjust the amount of marker shift by pressing the two step keys located to the left of the general purpose knob.

Position the marker at the bottom right corner of the area.

- f. Press the **Reset Delta** side key.
- g. Position the marker vertically and horizontally in the manner of Steps d and e.
- h. Press the **Draw** side key.

Now, the trigger area has been created to the left of the peak spectrum. See Figure 2–45.

Next, create the mask area to the right of the peak spectrum using the technique learned in the previous steps.

7. Create the trigger area to the right of the peak spectrum (see Figure 2–46).
  - Create the area as you did in steps d to h.

Now, the desired trigger masks are complete. The created trigger masks are saved in the internal trigger register.

---

**NOTE.** In Figures 2–45 to 2–48, the colorless areas are shown in white for visibility.

---

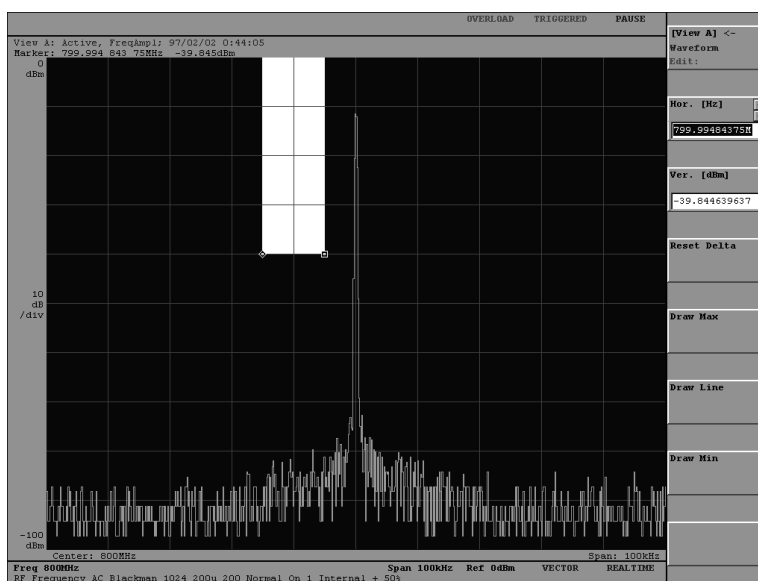


Figure 2-45: Creating a single trigger area using the delta markers

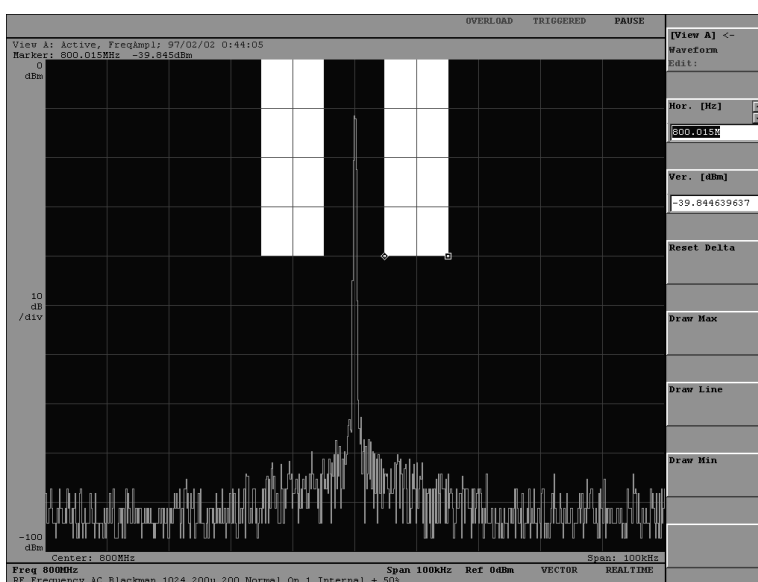



Figure 2-46: Creating two trigger areas using the delta markers

**Checking the Trigger Conditions**

Return to the two-view display and check trigger settings.

8. Press the VIEW:  key to return to the two-view display.
9. Check the trigger conditions.
  - a. Press the SETUP:MAIN key.
  - b. Press the **Trigger...** side key.
  - c. Press the **Mode** side key.

Normal trigger mode should be selected in the Mode menu item. Creating the trigger mask pattern causes the Normal trigger mode to be set automatically.

This completes the trigger preparations.

**Causing the Trigger**

Acquiring data using the trigger mask settings.

10. Press the **BLOCK** key.

PAUSE in the status display area changes to gray from blue. This indicates that the analyzer has begun to acquire the signal.

11. Turn on signal generator modulation.

TRIGGERED in the status display area turns blue (see Figure 2–47). Subsequently, PAUSE turns blue. This indicates that the trigger has been generated and the acquisition has completed. The new view is shown in Figure 2–48.

As shown in the spectrogram in View B, the signal modulation was turned on almost at the middle of a block, which is the trigger point. The generator modulated signal began to enter the trigger area at this point.

Using the **Slope** side key, set the trigger polarity to negative. Press the **BLOCK** key, and then turn off the signal generator modulation. This causes the trigger to be generated again.

Using the **Pos** side key, change the trigger position setting. Then, cause another trigger. The trigger position changes in the spectrogram display.



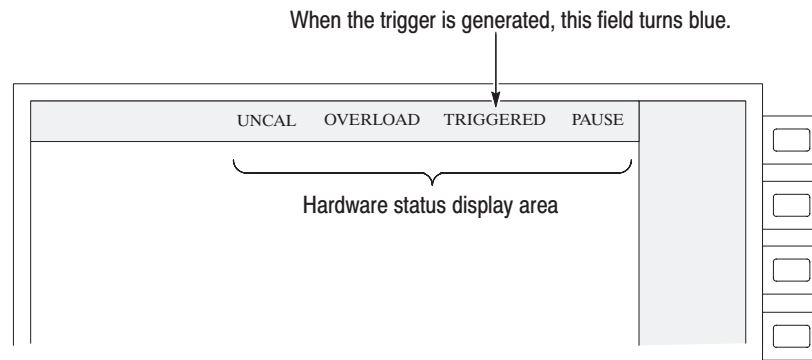


Figure 2-47: Checking that the trigger has been generated

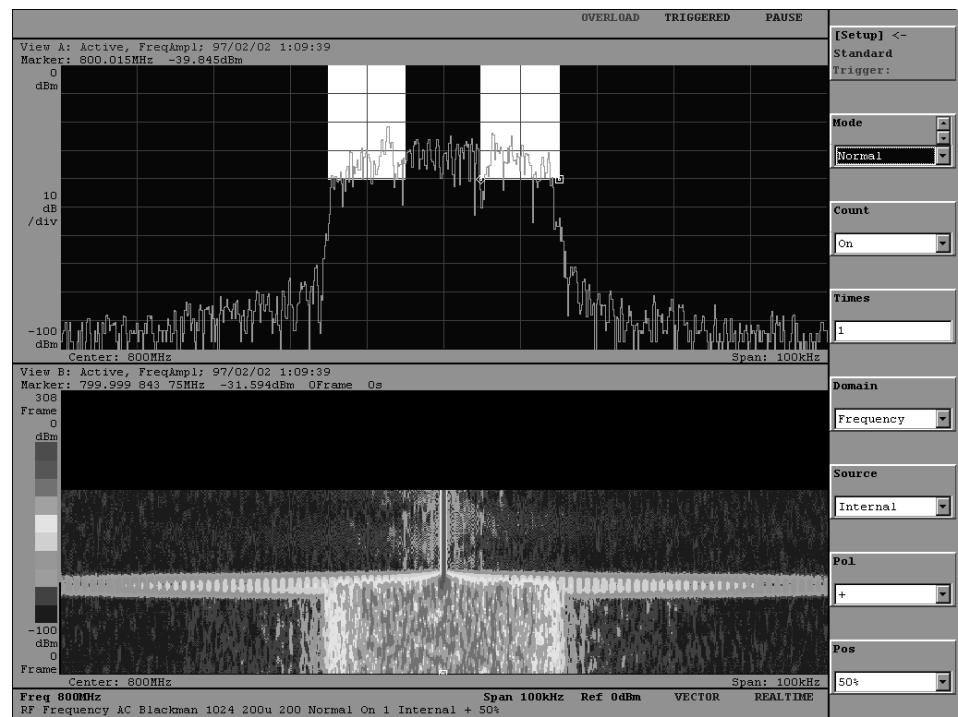


Figure 2-48: Acquiring the signal using a trigger mask

## Spectrum Time-series Variation

In this section, you examine the variation by displaying the spectrum waveforms of the respective frames one after another. This technique lets you examine detailed signal variation as time-series variation of the spectrum waveform.

The data that has been acquired using the trigger function is used below (see Figure 2–48 on page 2–49).

### Changing the Contents of the Display Frames Consecutively

The spectrum in View A is from the data acquired in Frame 0. View B contains a time-series view of 200-frame (default) data.

Seeing View B, you notice that the spectrum varies drastically when the modulation is started. To examine a detailed view of this portion, move the frame to this changing point.

**12.** Change the contents of View A.

- a.** Press the **VIEW:A** key.
- b.** Press the **VIEW:MAIN** key.
- c.** Press the **Frame** side key.
- d.** Turn the general purpose knob.

While you are turning the general purpose knob, the contents displayed in View A vary. Notice that the marker of View B is also moving.

While observing View B, move the marker in View A to the portion in which the spectrum varies drastically. The data of the frame in which this marker is positioned is displayed in View A (see Figure 2–49).

This way, you can observe time-series variation of spectrum waveforms in detail while turning the general purpose knob.

When you move the marker in the reverse direction, that is, toward the frame, the display view in View A varies. Press the **VIEW:B** and **VIEW:MRK** keys and the **Ver.** side key in order. Then, turn the general purpose knob.

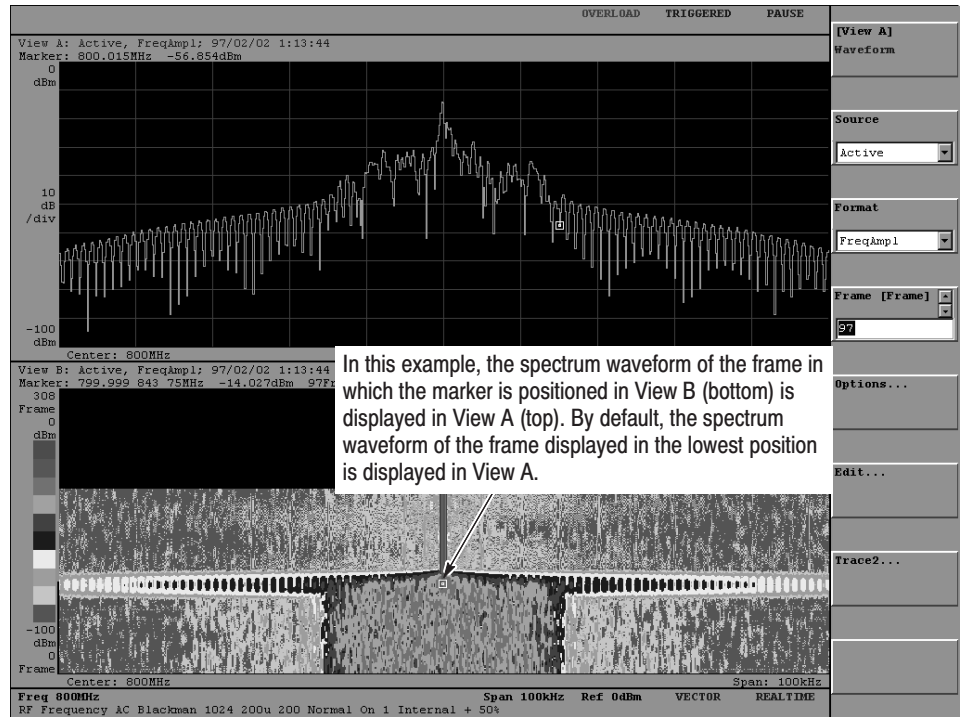


Figure 2-49: Example of changing the display frame

## EVM (Error Vector Magnitude) Analysis

In this section, you learn how to use the EVM views and information presented in it. For a digital modulated signal, EVM views can be used to measure the error of an actual signal relative to the ideal signal.

Return the hardware settings to the defaults. All settings except the following are returned to the defaults by configuring the settings with the basic pattern:

- Input mode
- Center frequency
- Span
- Reference level

### Preparations

Make settings used to measure digital modulation signals. Selecting the Default Demod side key will reset most hardware settings to default values. A few settings, such as center frequency and span are not reset.

**13.** Press the CONFIG:MODE key.

**14.** Select **More...** and press the **Digital Demod** side key.

Now, the basic pattern used to measure the digital modulation signal has been set.

**15.** Check these parameter settings because they are not reset to default. If one or more of them is improper, correct them. To do so, press the SETUP:FREQ key to display the menu. Then, set each of the following values by pressing the associated side key.

- Center frequency: 800 MHz
- Span: 100 kHz

Change the view layout. To perform the EVM measurement, use the digital modulation function in the Polar view. Display the Polar view and the three EVM views.

16. Press the **CONFIG:VIEW** key.
17. In the View **A** to **D** side keys, change the view definitions to the following views:
  - View A: Polar
  - View B: EVM (Format: EVM)
  - View C: EVM (Format: Mag Error)
  - View D: EVM (Format: Phase Error)
18. For each view, change the EVM view display format to the one shown in parentheses above.

The EVM view display format is EVM by default.

- a. Press the **VIEW:C** key. Then, press the **VIEW:MAIN** key.
- b. Select *Mag Error* in the **Format** menu item.
- c. Press the **VIEW:D** key.
- d. Select **Phase Error** in the **Format** menu item.

Now, the preparations for the measurement are complete.

### Measuring the Error

19. Press either the **ROLL** or **BLOCK** key on the front panel to acquire the signal.

Now, you have obtained the views shown in Figure 2–50.

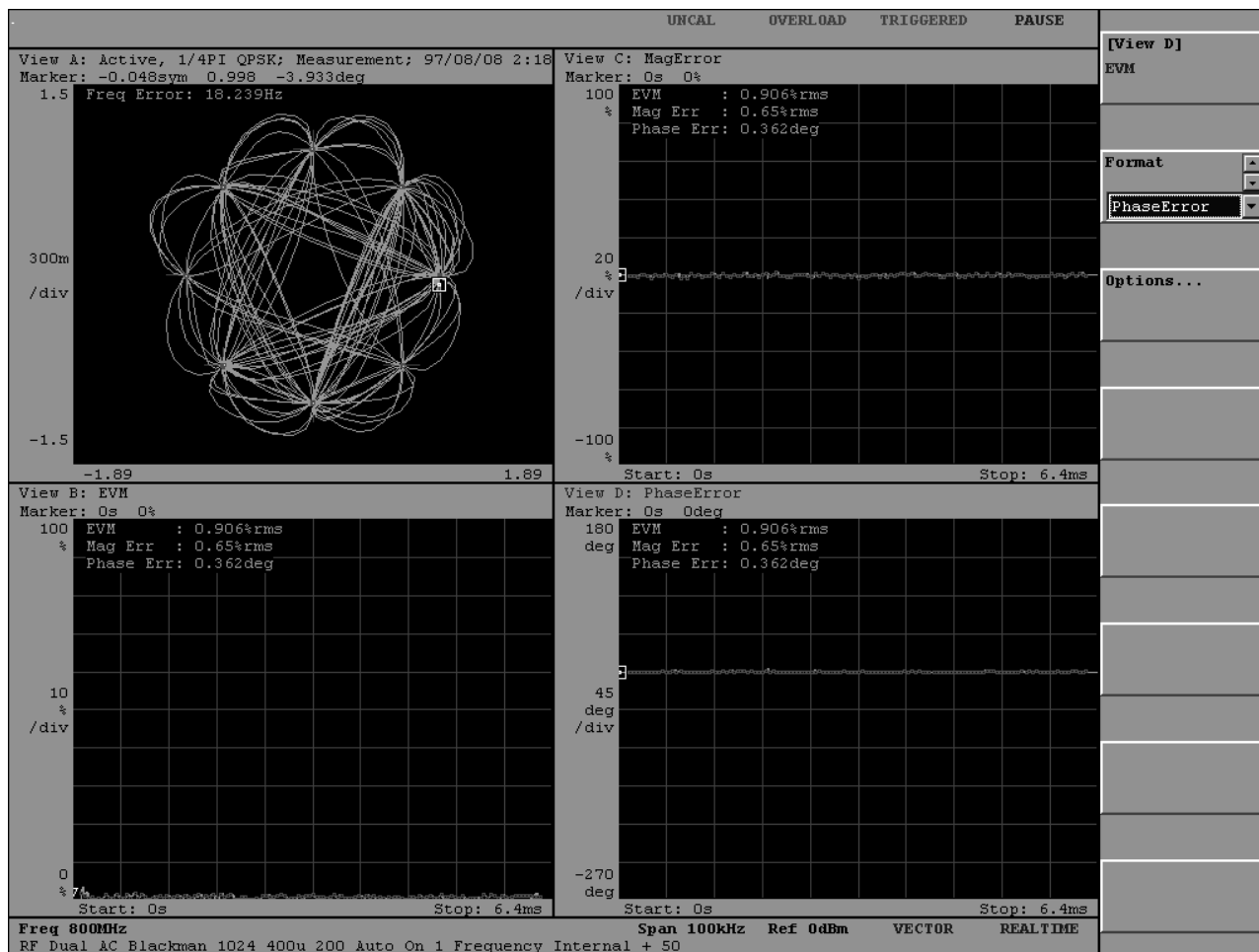


Figure 2-50: Digital modulation signal EVM analysis

Each of Views B to D displays the following information:

- EVM (% RMS): Error vector
- Mag Error (% RMS): Amplitude error
- Phase Error (% RMS): Phase error

The vector error, the amplitude error, the root-mean-square of the phase error, and Rho ( $\rho$  meter) are displayed at the top left of Views B to D.

The measurement signal is actually displayed in green. In Views B to C, the vertical axis represents the error magnitude, and the horizontal axis the time. The green trace displayed in each view represents the error.

## Power Measurement

This section describes the Power, C/No, ACP, and OBW measurement procedures. All of the following power measurements can be performed on the displayed spectrum:

|       |  |
|-------|--|
| Noise | Noise per frequency (dBm/Hz)                         |
| Power | Power of the specified frequency domain (dBm)        |
| C/N   | Proportion of carrier to noise (dB)                  |
| C/No  | Proportion of carrier to noise per frequency (dB/Hz) |
| ACP   | Leakage power of adjacent channel (dB)               |
| OBW   | Occupied bandwidth                                   |

This section describes the Power, C/No, ACP, and OBW measurement procedures.

### Preparations

You can use Waveform views to perform the power measurement. First, return all settings to the defaults. Then, display the four Waveform views on the screen.

1. Press the **CONFIG:MODE** key.
2. Press the **Spectrum** side key.

All settings except the following are returned to the defaults by configuring the settings with the basic pattern:

- Input mode
  - Center frequency
  - Span
  - Reference level
3. Check the parameter settings below. If one or more of them is wrong, correct them. To do so, press the **SETUP:FREQ** key to display the menu. Then, set each of the following values while holding down the associated side key:
    - Center frequency: 800 MHz
    - Span: 1 MHz

Redefine the views.

4. Press the **CONFIG:VIEW** key.
5. Define all of Views A to D as Waveform views.

6. Press the **ROLL** or **BLOCK** key on the front panel to capture the signal.

Now, the preparations for measurement are complete.

### Power Measurement

With the center at 800.25 MHz, measure the power of the 50 kHz wide noise. You can measure the power using the band power marker.

7. Perform the Power measurement in View A.
  - a. Press the View:**A** and VIEW:**MRK** keys in order.
  - b. Select **Power** from the **Measurement** menu item.
8. Set the band power marker center frequency to 800.25 MHz. Set the frequency bandwidth to 50 kHz.
  - a. Press the **Band Power Markers...** side key.
  - b. Input 800.25 MHz in the **Center** menu item.
  - c. Input 50 kHz in the **Width** menu item.

The measured result (dBm) is displayed at the top left corner of View A.

### C/No Measurement

Using the primary marker, measure the spectrum power at 800 MHz, the carrier signal frequency. Then, with the center at 800.25 MHz, measure 50 kHz wide noise power using the band power marker. C/No is the ratio between the carrier signal strength and the noise power per frequency.

9. Perform the C/No measurement in the View B.
  - a. Press the View:**B** and VIEW:**MRK** keys in order.
  - b. Select **C/No** from the **Measurement** menu item.
10. Move the primary marker to the 800 MHz position.
  - a. Input 800 MHz in the **Hor.** menu item.
11. Set the band power marker center frequency to 800.25 MHz. Set the frequency bandwidth to 50 kHz.
  - a. Press the **Band Power Markers...** side key.
  - b. Input 800.25 MHz in the **Center** menu item.
  - c. Input 50 kHz using the **Width** menu item.

The measured result (dBm/Hz) is displayed at the top left corner of the View B.



## ACP Measurement

The ACP measurement measures the ratio between the power leaked by the carrier signal and the power of the carrier signal (adjacent channel leakage power). This measurement uses three band power markers (Upper, Center, and Lower) specialized for the ACP measurement.

Place the Center band power marker in the center of the carrier and then set the channel bandwidth. Now, you can measure the carrier signal power. The channel bandwidth of the Upper and Lower band power markers is identical to that of the Center band power marker. You set the spacing of the upper and lower markers from the center marker using the channel spacing (SP) parameter.

The parameters you must set for this measurement are the center frequency, frequency bandwidth, and channel spacing. For more information, refer to page 3–88

12. Perform the ACP measurement in View C.
  - a. Press the **VIEW:C** and **VIEW:MRK** keys in order.
  - b. Select **ACP** from the **Measurement** menu item.
13. Determine the frequency bandwidth and channel spacing.
  - a. Press the **ACP...** side key.
  - b. Input 50 kHz for the frequency bandwidth in the **BW** menu item.
  - c. Input 250 kHz for the channel spacing in the **SP** menu item.
14. Determine the Center power marker frequency position.
  - a. Select **Center** from the **Band Power Marker** menu item.
  - b. Press the top side key to return to the higher-level menu.
  - c. Input 800 MHz in the **Hor.** menu item.

The Upper and Lower measurement results (dB) are displayed at the top left corner of the View C.

In this condition, only the Center band power marker is displayed in the view. Only one of the three markers can be displayed at a time. Use the following steps to select the marker you want to display:

15. Select the desired band power marker.
  - a. Press the **ACP...** side key.
  - b. Select Upper, Center, or Lower from the **Band Power Marker** menu item.

## OBW Measurement

The OBW (occupied bandwidth) measurement determines the frequency bandwidth of the power range so that the power ratio is obtained between the whole power and the span frequency setting range.

Set the power ratio for this measurement.

**16.** Perform the OBW measurement in View D.

- a.** Press the **VIEW:D** and **VIEW:MRK** keys in order.
- b.** Select **OBW** from the **Measurement** menu item.

**17.** Set 98% for the power proportion.

- Input 98% in the **OBW** menu item.

The band power marker is displayed as well as the frequency bandwidth (dB) at the top left corner of the View D. The range of this marker indicates the calculated frequency bandwidth.

This band power marker cannot be changed. The band power marker center frequency is always the center frequency set for the analyzer.

## Turning Off the Power

After completion of your measurements, turn off the power.

**18.** Press the **Power Switch** (at the bottom left corner of the front panel) to select the **STAND-BY** position.

The Windows 95 shutdown process runs and powers down the analyzer.

**19.** Turn off the power to the signal generator.

You have completed the Tutorial.

# Menu Functions

This section provides tables showing the hierarchy of the menu functions and a description of each function.

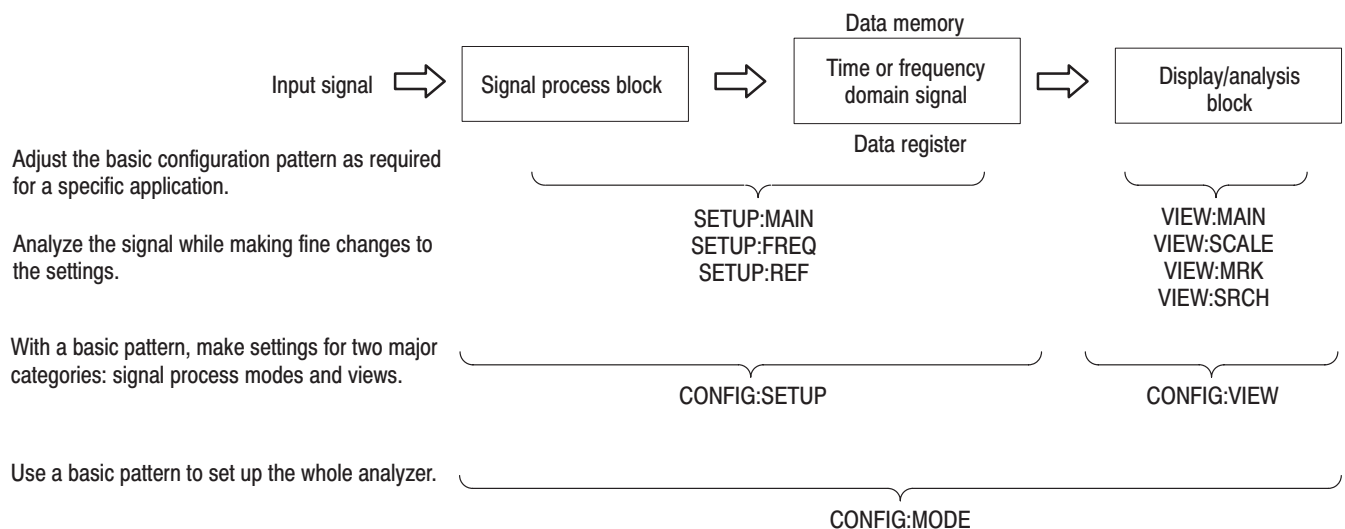
## Setup Sequence

Power up the analyzer. The Windows 95 operating system boots up and the initial screen appears. The analyzer is now ready for measurement.

Figure 2–51 shows the major flow from input to display of a signal. It also includes hierarchical descriptions about what process blocks can be operated using the menus displayed with the front panel keys.

Use the following procedure for setups and operations:

1. Set a basic pattern configuration using the **CONFIG:MODE** menu.
2. Set the signal process mode using the **CONFIG:SETUP** menu. Alternatively, change the display format and the number of views using the **CONFIG:VIEW**.
3. Using the **SETUP:MAIN** or **VIEW:MAIN** menus, change the settings in detail before or during measurement. For example, change the frequency or span or the display scale. You can also operate the markers or create the trigger mask pattern.



**Figure 2–51: Signal process and display blocks**

## CONFIG Menu

Table 2-3: CONFIG menu table

| Top Level | Subordinate level, options and descriptions  |  |
|-----------|--|--|
| Mode...   | <p>The CONFIG:MODE menu lets you configure the hardware and software using a basic pattern.</p> <p>Many settings are required to display information after signal input. The analyzer initially contains settings that are used most frequently. For this configuration, basic patterns are used to configure the signal process and display systems.</p> <p>NOTE: By default, with basic patterns the frequency is set to 1.5 GHz and a span to 3 GHz. After changing these settings, you cannot enter the proper modes until you set the span to the proper values.</p> <p>Refer to Setup... below and page 3-1 for mode details. Refer to Appendix C for details of the basic pattern default settings.</p> |  |
|           | Load (*.CFG)   | Loads the instrument settings from a file and configures the analyzer.   |
|           | Save (*.CFG)   | Saves the current instrument settings in the specified file. This function enables you to create many basic patterns. It also allows you to save patterns that may be used frequently; you can later load them from the file to set up the analyzer.   |
|           | Spectrum   | Performs the configuration required to observe the spectrum.   |
|           | Spectrum Spectrogram   | Performs the configuration required to display the spectrum and spectrogram.   |
|           | Dual   | Performs the configuration required for a Dual mode process.   |
|           | Zoom   | Performs the configuration required for a Zoom process.  |
|           | CDMA   | Performs the configuration for the CDMA analysis. Select one of the following measurement standards of IS-95 and T-53.   |
|           | EVM/Rho  | Performs measurement, analysis and display of the EVM (Error Vector Magnitude), Rho ( $\rho$ meter), frequency error, and origin offset error.   |
|           | Spurious   | Perform measurement, analysis and display of the power, OBW (occupied bandwidth) and spurious characteristics.   |
|           | Time Domain  | Perform measurement, analysis and display of the time characteristic for the burst signal.   |
|           | Digital Demod  | Performs the configuration required to observe a digital modulated signal.   |
|           | cdmaOne Fwd Link   | Performs the configuration required to observe cdmaOne forward link signals specified in "TIA/EIA IS-95-A" (1995.5 TIA/EIA). 3066 with option 15 and 3086 with option 16 only. Refer to <i>Appendix H: cdmaOne Analysis</i> .  |
|           | W-CDMA Down Link   | Performs the configuration required to observe W-CDMA down link signals specified in "Specifications for W-CDMA Mobile Communication System Experiment Version 1.1" (1998.3 NTT Mobile Communications Network Inc.). 3086 with option 16 only. Refer to <i>Appendix I: W-CDMA/cdmaOne Analysis</i> . |
|           | CCDF   | Performs the configuration for the CCDF (Complementary Cumulative Distribution Function) measurement. Option 20 only. Refer to <i>Appendix J: CCDF Analysis</i> .  |

Table 2-3: CONFIG menu table (cont.)

| Top Level | Subordinate level, options and descriptions  |  |   |
|-----------|--|--|---|
| Setup...  | Setup  | None   | Loads the standard SETUP program or CDMA SETUP program.   |
|           |  | Standard   | NOTE: Use this setting unchanged in usual operation.  |
|           |  | CDMA   | If you select Standard or CDMA, the SETUP program is loaded. If you select None, the SETUP menu will be unavailable for setting.  |
| View...   | You can configure each view. The View E to H side keys are displayed by pressing the <b>More...</b> side key.  |  |   |
|           | Action   | Assign   | With pressing a View side key, you can select the view type, such as Waveform and Analog, described below.  |
|           |  | Show   | With pressing a View side key, the view menu is displayed. Refer to the following sections for each view menu.  |
|           | View A to H  | None   | Specifies that no information is displayed in a view.   |
|           |  | Waveform   | Displays a spectrum whose horizontal axis represents the frequency or time and whose vertical axis represents the amplitude, phase, I, or Q.<br><br>The Waveform view can average the spectrum waveform. It can also display two waveforms concurrently. This view is useful when you observe two waveforms while comparing them. |
|           |  | Analog   | Demodulates an AM, FM, or PM signal and displays the result. The horizontal axis represents the time, and the vertical axis the frequency (FM), amplitude (AM), or phase (PM).  |
|           |  | FSK  | Demodulates an FSK (frequency shift keying) modulated signal and displays the result. The horizontal axis represents the time, and the vertical axis the modulating level, phase, or amplitude.   |
|           |  | Spectrogram  | Enables frame-by-frame time-series display along the vertical axis. In each spectrum, the horizontal axis represents the frequency and the colors the amplitude or phase. This is the color spectrogram display.  |
|           |  | Waterfall  | Enables frame-by-frame time-series diagram along the vertical axis. In each spectrum, the horizontal axis represents the frequency or time, and the vertical axis the amplitude, phase, I, or Q. This is called waterfall display.  |
|           |  | CDMAWaveform   | This view has basically the same functions as the Waveform view, except for the functions for analyzing the signal according to IS-95 and T-53.   |
| CDMAPolar |  | This view has basically the same functions as the Polar view, except for the functions for analyzing the signal according to IS-95 and T-53. |   |
| CDMATime  | Displays a spectrum whose horizontal axis represents the time and whose vertical axis represents the amplitude. This view has the spurious measurement functions for IS-95 and T-53. |  |   |

Table 2-3: CONFIG menu table (cont.)

| Top Level  | Subordinate level, options and descriptions |  |
|------------|---|--|
|            | Polar                                       | Displays a demodulated signal in polar coordinates (horizontal and vertical axes are I and Q, respectively, in rectangular coordinates). This view is useful in observing the phase and amplitude of a digitally modulated signal. This is called a constellation display. |
|            | EyeDiagram                                  | Enables EYE diagram display. The signal demodulated for the Polar view is used as the input source. The horizontal axis represents the time and the vertical axis the amplitude, phase, I, or Q. This view must always be used together with the Polar or CDMA Polar view. |
|            | SymbolTable                                 | Displays a digital pattern with numeric values. The signal demodulated for the Polar or CDMA Polar view is used as the input source. This view must always be used together with the Polar or CDMA Polar view.   |
|            | EVM   | Displays an error vector magnitude (EVM). The signal demodulated for the Polar or CDMA Polar view is used as the input source. This view must always be used together with the Polar or CDMA Polar view.   |
|            | CodeSpectrogram                             | 3066 with option 15 and 3086 with option 16 only.<br>Refer to <i>Appendix H: cdmaOne Analysis</i> .  |
|            | CodePolar                                   |  |
|            | CodePower                                   |  |
|            | CodeWSpectrogram                            | 3086 with option 16 only.<br>Refer to <i>Appendix I: W-CDMA/cdmaOne Analysis</i> .   |
|            | CodeWPolar                                  |  |
|            | CodeWPower                                  |  |
|            | CCDF  | Option 20 only.<br>Refer to <i>Appendix J: CCDF Analysis</i> .   |
|            | CCDFView                                    |  |
| Options... | Style                                       | Selects a view layout of One by One, One by Two, One by Four, or Two by Two.   |
|            | Background Color                            | Selects a background color of the waveform display area. The color is black or white.  |
|            | Marker Link                                 | Determines whether the markers in all views move in unison or separately.  |

Table 2-3: CONFIG menu table (cont.)

| Top Level | Subordinate level, options and descriptions  |   |   |
|-----------|--|---|---|
| Util...   | Selects the utility menu. The Util E to H side keys are displayed by pressing the <b>More...</b> side key. |   |   |
|           | Action   | Assign  | With pressing a Util side key, you can assign a utility program to the Util D to G key. |
|           |  | Show  | With pressing a Util side key, the utility menu is displayed.                           |
|           | Util A [SelfGainCal]   | Controls the self gain calibration. Refer to <i>Self Gain Calibration</i> on page 1-16 for details on performing the calibration. |   |
|           | Util B [SaveLoad]  | Controls saving or loading data to/from a file. Refer to <i>SaveLoad Menu</i> on page 2-95 for details on the menu.               |   |
|           | Util C [Average]   | Controls averaging. Refer to <i>Average Menu</i> on page 2-94 for details on the menu.  |   |
|           | Util D to G  | Not used. You can select only None currently.   |   |
|           | Util H [Remote]  | Refer to the 3066 and 3086 Programmer Manual for details on the remote control.   |   |

## SETUP (Standard) Menu

The SETUP menu is changed according to the selection with CONFIG:SETUP→Setup. When you select Standard, the menu shown in Table 2-4 appears.

The SETUP menu settings are displayed in the setup display area at the bottom on the display screen (refer to page 2-8).

**Table 2-4: SETUP (Standard) menu table**

| Top level  | Subordinate level, options and descriptions          |  |  |
|------------|--|--|--|
| Input, FFT | Sets up the input, memory and hardware FFT analyzer. |  |  |
|            | Input Mode   | IQ (3086 only)   | Refer to “Input and Memory Modes” on page 3-1 for details.   |
|            |  | Wideband (3086 only)   |  |
|            |  | RF   |  |
|            |  | Baseband   |  |
|            | Memory Mode  | Frequency  | Refer to “Input and Memory Modes” on page 3-1 for details.   |
|            |  | Dual   |  |
|            |  | Zoom   |  |
|            | Input Coupling                                       | Selects the input coupling for the RF INPUT connector on the front panel. This item is displayed only in the Baseband mode. In the RF mode, the AC coupling is set automatically.<br>This menu item is not displayed in RF mode.   |  |
|            |  | AC   | AC coupling. Only AC components of the input signal are processed with DC components removed.            |
|            |  | GND  | Used to display the GND level.   |
|            |  | DC   | Specifies that the original input signal is used, as it is, for the measurement.                         |
|            | FFT Window   | Blackman   | Selects Blackman, Hamming, or Rect for the FFT window. Refer to page 3-13 for details of the FFT window. |
|            |  | Hamming  |  |
|            |  | Rect   |  |
| FFT Points | 256  | Sets the number of FFT sampling points per frame to either 1,024 (default) or 256 points. For 1,024 points, the high-resolution mode results; for 256 points, the high-speed measurement mode results. For the Dual and Zoom modes, only the setting of 1,024 points is effective. |  |
|            | 1024   | The frame length depends on the number of points defined here. For time domain data, this value is also used for sampling.<br>Refer to page 3-13 for FFT. See Table 3-5 on page 3-19 for the frame length.<br>This menu item is not displayed in Dual and Zoom mode.               |  |



Table 2-4: SETUP (Standard) menu table (cont.)

| Top level          | Subordinate level, options and descriptions  |   |   |
|--------------------|--|---|---|
| Freq, Span, Ref... | The center frequency, span, and reference level are directly accessible using the SETUP:FREQ, SETUP:SPAN, and SETUP:REF keys, respectively.<br>If you change the mode from Baseband to RF, or vice versa, these settings will change to the defaults.  |   |   |
|                    | Freq   | Inputs the center frequency of the span. You must set the value so that the value [frequency $\pm$ (span/2)] does not exceed the frequency range available for the analyzer.<br>Refer to page 3-7 for details on the center frequency.  |   |
|                    | Span   | 3G/2G/1G/<br>500M/200M/100M/<br>50M/30M/20M/10M/<br>6M/5M/2M/1M/<br>500k/200k/100k/<br>50k/20k/10k/<br>5k/2k/1k/<br>500/200/100<br>Selects a predefined span. In the Baseband mode, you can select a span between 100 Hz and 10 MHz in 1-2-5 steps. In the RF mode, you can select between 100 Hz and 3 GHz in 1-2-5 steps. In the IQ and Wideband modes of the 3086, you can select 30 MHz, 20 MHz, or 10 MHz.<br>The maximum span is set by pressing the Max Span side key. Refer to page 3-7 for span details. |   |
|                    | Ref  | Sets the reference level, which must be greater than the maximum level of the input signal. If an overload occurs, the measured data will be valid.   |   |
|                    | Max Span   | Set the maximum span.   |   |
|                    | Reference Osc  | Internal  | Selects either Internal or External for the reference clock. If you select External, the reference clock input through the 10 MHz REF INPUT connector on the rear panel is used. Use the 10 MHz sine wave for the reference clock.                    |
|                    |  | External  | If you select Internal, the internal reference clock (10 MHz sine wave) is output through the 10 MHz REF OUTPUT connector on the rear panel. If you select External, the externally input reference clock will be output also through this connector. |
|                    | Frequency Offset   | The frequency on the displayed screen is the sum of the frequency actually processed by the analyzer and its frequency offset. This setting is required, for example, when a down converter is connected externally. It does not influence the frequency processed in the analyzer. Usually, set this value to 0.   |   |
| Reference Offset   | The reference level displayed on the screen is the sum of the reference level actually processed by the analyzer and its reference offset. This setting is required, for example, when an attenuator is connected externally. It does not influence the reference level processed in the analyzer. Usually, set this value to 0. |   |   |
| Frame Period       | Sets the frame period for the block mode.<br>The frame period setting is effective only in the Frequency or Dual mode. In Zoom mode, this setting is ignored, and frames are continuous in the temporal aspect. Thus, this menu item is not displayed in the Zoom mode. See Table 3-5 on page 3-19 for frame period details.     |   |   |
| Block Size         | 4000/2000/1000/<br>400/200/100/<br>40/20/10  | In the block mode, the block size specifies the number of frames used to acquire the data. When you press the BLOCK key, the data is captured in the frames corresponding to the block size specified here and then displayed. Refer to page 3-21 for details on the relationship between the block size and mode.  |   |

Table 2-4: SETUP (Standard) menu table (cont.)

| Top level  | Subordinate level, options and descriptions  |   |
|------------|--|---|
| Trigger... | Sets up the trigger. The trigger function is available only for the block mode. Refer to page 3-47 for details on the trigger. |   |
|            | Mode   | Sets the trigger mode. There are four trigger modes:  |
|            | Auto   | Causes the data to be acquired in one of the following conditions, without relating to trigger generation:<br><br>If you have turned on the trigger count, the following takes place. When you press the BLOCK key on the front panel, the data is acquired the number of times specified with the trigger count (Times). If you have turned Off the count, the data acquisition will repeat until you will press the BLOCK key on the front panel.   |
|            | Normal   | Waits for a trigger event and performs data acquisition.<br><br>If you have turned on the trigger count, the following takes place. When you press the BLOCK key on the front panel, this function then waits for a trigger. The data is acquired the number of times specified with the trigger count (Times). If you have turned off the trigger count, the data acquisition will repeat while waiting trigger generation. This continues until you press the BLOCK key on the front panel.<br><br>If you press the Draw Max, Draw Line, Draw Min, or Draw Horizontal side key in the Edit... submenu when creating the trigger mask pattern in the Waveform view, the trigger mode is automatically set to Normal. |
|            | Quick  | Same as the Normal mode, except that the data is displayed after all blocks are acquired.   |
|            | Delayed  | Causes data acquisition to stop the specified elapsed time after the trigger event is generated. The other settings are the same as Normal.   |
|            | Timeout  | When the trigger event does not occur within the specified time, the data acquisition is stopped. If the signal suddenly disappears, you can examine the contents of the data just before the signal disappeared. Effective only when the trigger source is set to Internal.  |
|            | Interval   | Acquires block data at the specified time interval.   |
|            | Quick Interval   | Same as the Interval mode, except that the data is displayed after all blocks are acquired.   |
|            | Count  | Off<br>On   |
|            | Times  | Sets the trigger count. This setting is effective only when Count has been set to On. The maximum trigger count depends on the number of FFT points, the memory mode, and the block size.   |

Table 2-4: SETUP (Standard) menu table (cont.)

| Top level      | Subordinate level, options and descriptions  |  |
|----------------|--|--|
|                | Domain   | <p>Specifies the domain in which the trigger functions. You can select either the Frequency or Time domain.</p> <p>If Format has been set to FreqAmpl in the Waveform view, the Domain setting can be set automatically to Frequency during creation of the trigger mask pattern. To do so, press the Draw Max, Draw Line, Draw Min, or Draw Horizontal side key in the Edit... submenu.</p> <p>If Format has been set to TimeAmpl in the Waveform view, the Domain setting is set automatically to Time in the above condition.</p> |
|                | Source   | Selects the trigger source used for trigger generation. If you select Internal, the trigger mask pattern stored in the internal register will be used for trigger generation. If you select External, the trigger signal input through the EXT TRIG connector on the front panel will be used for trigger generation. Refer to page 3-59 for details of the trigger mask pattern.  |
|                | Slope  | Sets the polarity.   |
|                | Rise   | If the trigger source is Internal, the internal trigger occurs when the signal enters the white area within the trigger mask pattern area. If the source is External, the trigger signal rising edge is used.  |
|                | Fall   | When the signal exits from the trigger mask pattern, the internal trigger occurs. If the trigger source is External, the trigger signal falling edge is used.  |
|                | Pos  | Selects the trigger position in 1% steps between 0 and 100 %. The trigger position represents the ratio of the number of frames preceding the trigger generation to that of one-block captured data. If the block size is 1,000 frames and the trigger position 10 %, for example, 100 frames are acquired before the trigger generation. In this case, 900 frames are acquired after it.  |
|                | Timeout  | Sets the timeout for the Timeout trigger mode. The range is 0 to 60 s.   |
|                | Delayed  | Sets the delay time for the Delayed trigger mode. The range is 0 to 60 s.  |
|                | Interval   | Sets the time interval for the Interval and Quick Interval trigger mode. The range is 1 to 3600 s.   |
| <b>Zoom...</b> | <p>Displayed only if the analyzer has been set to the Zoom mode.</p> <p>Zoom redraws the data within the frequency domain with a new center frequency, with respect to the data acquired in the Zoom mode. When a difficult-to-reproduce frequency phenomenon is acquired, for example, Zoom is useful to enlarge the appropriate section. Refer to page 3-105 for details on the Zoom mode.</p> |  |
|                | Frequency  | <p>Sets the center frequency, which must be in the frequency range of the acquired data. You can also set the center frequency using the following procedure in the view menu: Options...→Marker→Mkr→Freq side key. (Refer to pages 2-70 to 2-93 for the view menu.)</p> <p>Because this item is linked to the marker, you can set the frequency in the current marker position. Conversely, when a numeric value is input in this item, the marker moves to this frequency position.</p>  |
|                | Mag  | Selects the magnification of the span.   |
|                | Execute  | Executes Zoom. You can repeat the execution while varying the above settings.  |

## SETUP (CDMA) Menu

The SETUP menu settings are displayed in the setup display area at the bottom on the display screen (refer to page 2–8).

**Table 2–5: SETUP (CDMA) menu table**

| Top level          | Subordinate level, options and descriptions   |  |
|--------------------|---|--|
| Freq, Span, Ref... | <p>The channel, span, and reference level are directly accessible using the SETUP:FREQ, SETUP:SPAN, and SETUP:REF keys, respectively.</p> <p>If you change the mode from Baseband to RF, or vice versa, these settings will change to the defaults.</p> |  |
|                    | Standard  | <p>IS-95</p> <p>T-53</p> <p>Selects either IS-95 or T-53 standard.</p>   |
|                    | Channel   | <p>Selects a channel number to set the frequency to measure. The frequency specified by channel is the center frequency for the 5 MHz span setting, but it is not used for the 30 MHz span setting.</p> <p>For IS-95, you can select 1 to 777 for the channel number. Channels 1 and 777 correspond to 825.03 and 848.31 MHz, respectively. The frequency difference between two adjacent channels is 0.03 MHz.</p> <p>For T-53, you can select 1 to 1199 for the channel number. Channels 1 and 1199 correspond to 915.0125 and 888.9875 MHz, respectively. The frequency difference between two adjacent channels is 0.0125 MHz.</p> |
|                    | Span  | <p>3G/2G/1G/<br/>500M/200M/100M/<br/>50M/30M/20M/10M/<br/>6M/5M/2M/1M/<br/>500k/200k/100k/<br/>50k/20k/10k/<br/>5k/2k/1k/<br/>500/200/100</p> <p>Selects a predefined span. In the Baseband mode, you can select a span between 100 Hz and 10 MHz in 1-2-5 steps. In the RF mode, you can select between 100 Hz and 3 GHz in 1-2-5 steps. In the IQ and Wideband modes of the 3086, you can select 30 MHz, 20 MHz, or 10 MHz.</p> <p>The maximum span is set by pressing the Max Span side key. Refer to page 3–7 for span details.</p>  |
|                    | Ref   | <p>Sets the reference level, which must be greater than the maximum level of the input signal. If an overload occurs, the measured data will not be valid.</p>   |
|                    | Max Span  | <p>Sets the maximum span.</p>  |
|                    | Reference Osc   | <p>Internal</p> <p>External</p> <p>Selects either Internal or External for the reference clock. If you select External, the reference clock input through the 10 MHz REF INPUT connector on the rear panel is used. Use the 10 MHz sine wave for the reference clock.</p> <p>If you select Internal, the internal reference clock (10 MHz sine wave) is output through the 10 MHz REF OUTPUT connector on the rear panel. If you select External, the externally input reference clock will be output also through this connector.</p>   |

Table 2-5: SETUP (CDMA) menu table (cont.)

| Top level                         | Subordinate level, options and descriptions   |   |
|-----------------------------------|---|---|
| <b>30MHz Span</b>                 | Sets the span to 30 MHz in the IS-95 mode.  |   |
| <b>50MHz Span</b>                 | Sets the span to 50 MHz in the T-53 mode.   |   |
| <b>5MHz Span<br/>Auto Trig.</b>   | Sets the span to 5 MHz and the trigger mode to Auto.  |   |
| <b>5MHz Span<br/>Normal Trig.</b> | Sets the span to 5 MHz and the trigger mode to Normal.  |   |
| <b>Block Size</b>                 | 4000/2000/1000/<br>400/200/100/<br>40/20/10   | In the block mode, it specifies the number of frames used to acquire the data. When you press the BLOCK key, the data is captured in the frames corresponding to the block size specified here and then displayed. See page 3-21 for details on the relationship between the block size and mode. |
| <b>Trigger...</b>                 | Set the trigger parameters. The trigger menu items and their functions are the same as the those in the SETUP (Standard). Refer to page 2-66 for the trigger menu and their descriptions. Refer to page 3-47 for trigger details. |   |
| <b>Trigger Level</b>              | When the 5MHz Span Normal Trig. is selected, you can set the time domain trigger level from -40 dB to 0 dB for the input trigger signal.  |   |

## Waveform View Menu

Table 2–6 summarizes the structure of the waveform view menu.

**Table 2–6: Waveform view menu table**

| Top level     | Subordinate level, options and descriptions  |   |
|---------------|--|---|
| <b>Source</b> | Specifies the input data used for the view. You can select one of the following items:   |   |
|               | None   | Specifies no input source. The display area in the view is empty.   |
|               | Active   | Specifies the data memory for the input source. This is the same as displaying the acquisition data on the display screen.  |
|               | Average  | The averaged data is the input source. If you select this item, the Format and Frame menu items will disappear and the Average Type and Num Average menu items will appear.   |
|               | Zoom   | Specifies that the Zoomed data is the input source. If you want to use the Zoom mode, select the Zoom. For Zoom, refer to pages 3–4 and 3–105.  |
|               | D1 to D8   | Specifies a data register of D1 to D8 for the input source.<br><br>The data averaged with the UTILITY Average function is written into the data register. To display the averaged data or compare the currently captured spectrum and the averaged spectrum, use a data register as the input source.<br><br>Refer to page 3–109 for averaging.   |
|               | D1D2 to D7D8   | Specifies the register pair for the input source.<br><br>The digital modulated signal demodulated with the CDMA Polar or Polar view (refer to page 2–83 and 2–88, respectively) is written into the register pair. If you want to display the spectrum of the modulated digital modulated signal, use a register pair as the input source.<br><br>Refer to page 3–67 for demodulating a digital modulated signal. |
|               | File (*.IQ)  | Specifies the IQ-formatted, saved data file for the input source.   |
|               | File (*.AP)  | Specifies the AP-formatted, saved data file for the input.  |
| <b>Format</b> | Defines the physical units specified for the horizontal and vertical axes. You can select one of the items below. If you select Average for the Source, FreqAmpl will be selected automatically and this Format menu will disappear. |   |
|               | FreqAmpl   | Shows the waveform, with the frequency (span) along the horizontal axis and with the amplitude along the vertical axis. For displaying a usual spectrum, select this format.  |
|               | FreqPhase  | Shows the waveform, with the frequency (span) along the horizontal axis and with the phase along the vertical axis.   |
|               | FreqI  | Shows the waveform, with the frequency (span) along the horizontal axis and with I (In-Phase) along the vertical axis.  |
|               | FreqQ  | Shows the waveform, with the frequency (span) along the horizontal axis and with Q (Quadrature-Phase) along the vertical axis.  |
|               | TimeAmpl   | Shows the waveform, with the time along the horizontal axis and with the amplitude along the vertical axis.   |
|               | TimePhase  | Shows the waveform, with the time along the horizontal axis and with the phase along the vertical axis.   |

Table 2-6: Waveform view menu table (cont.)

| Top level           | Subordinate level, options and descriptions   |   |
|---------------------|---|---|
|                     | TimeI   | Shows the waveform, with the time along the horizontal axis and with I (In-Phase) along the vertical axis.  |
|                     | TimeQ   | Shows the waveform, with the time along the horizontal axis and with Q (Quadrature-phase) along the vertical axis.  |
| <b>Frame</b>        | Specifies a frame to display. The frame is set to 0 by default, which always contains the latest written data. Refer to page 3-17 for frame details.<br><br>If you select Average in Source, the Frame menu item disappears.  |   |
| <b>Average Type</b> | This specifies the Average mode. It is displayed only when you select Average for the Source.   |   |
|                     | RMSExpo   | Performs averaging with the exponential function RMS (root-mean-square). This mode decreases the influence by the older data exponentially.   |
|                     | RMS   | Performs averaging with the RMS (root-mean-square).   |
|                     | PeakHold  | Holds the peak value.   |
| <b>Num Average</b>  | If you set the averaging mode to RMS, the average is obtained only for the frame specified with Num Average before switching to the fixed display. If you select RMSExpo in the averaging mode, Num Average will be used for weighted setting of the old data. The Num Average item is displayed only when you select Average for the Source.<br><br>Refer to page 3-109 for averaging details. |   |
| <b>Options...</b>   | Scale...  | Sets up the horizontal and vertical axes.   |
|                     | Hor. Scale  | Sets the horizontal axis scale.   |
|                     | Hor. Start  | Sets the horizontal axis start value.   |
|                     | Ver. Scale  | Sets the vertical axis scale.   |
|                     | Ver. Start  | Sets the vertical axis start value.   |
|                     | Auto Scale  | Performs the auto scale, which automatically sets the start values and scales of the horizontal and vertical axes for the waveform.   |
|                     | Marker...   | Operates the markers. Refer to page 3-35 for how to use the markers.  |
|                     | Hor.  | Inputs the horizontal position and moves the □ marker. By default, it is positioned at the horizontal axis start point.   |
|                     | Trace   | Selects either Trace1 or Trace2 for the waveform on which you operate the markers. Trace2 specifies the waveform that is associated with the Source set with the submenu.   |
|                     | Delta Marker  | Turns On or Off the delta marker.   |
|                     | Reset Delta   | Moves the ◇ to the □ marker position.   |
|                     | Mkr->Freq   | Sets the center frequency, to the frequency of the spectrum in the current marker position. When you press this side key, the Freq,Span,Ref...->Freq setting in the SETUP menu changes to the frequency in the current marker position. |
|                     | Measurement   | Perform the power measurement. Select one of the power measurement items: Noise, Power, C/N, C/No, ACP and OBW.   |

Table 2-6: Waveform view menu table (cont.)

| Top level    | Subordinate level, options and descriptions   |  |
|--------------|---|--|
|              | Band Power Markers...   | This menu item is displayed only when you select the Power, C/N or C/No in the Measurement menu item. You can operate the band power marker using the parameters: Center, Width, Right and Left.                       |
|              | ACP...  | This menu item is displayed only when you select ACP in the Measurement menu item. You can perform operation specific for the ACP measurement.   |
|              | OBW   | This menu item is displayed only when you select OBW in the Measurement menu item. Set the ratio between the power in the specified band region and the power in the whole region specified by span.                   |
| Search...    | Searches for the peak spectrum and positions the <input type="checkbox"/> marker there.   |  |
|              | Peak  | Searches the peak spectrum and moves the marker there. Rotate the general purpose knob clockwise to search the peak rightward, and vice versa.   |
|              | Max   | Searches for the maximum peak spectrum and moves the marker there.   |
|              | Separation  | Sets the minimum horizontal distance relative to full-scale (100 %) to separate two peaks.   |
|              | Trace   | Selects either Trace1 or Trace2 for the waveform on which you operate the markers. Trace2 specifies the waveform that is associated with the Source set with the submenu.  |
|              | Delta Marker  | Turns On or Off the delta marker.  |
|              | Reset Delta   | Moves the <input type="checkbox"/> to the <input type="checkbox"/> marker position.  |
|              | Mkr->Freq   | Sets the center frequency to the frequency at the current marker position. When you press this side key, the Freq,Span,Ref...->Freq setting in the SETUP menu changes to the frequency at the current marker position. |
| Copy To...   | Copies the waveform data in display to one of the locations below. This copy function is effective only for data captured in the vector mode. |  |
|              | Clipboard   | Converts the waveform data in display into the text form and copies to the Windows clipboard. The text data can be passed from the clipboard to an application in your PC. Refer to page 3-147 for details.            |
|              | Text File   | Converts the waveform data in display into the text form and copies it to a text file. Refer to page 3-147 for details.  |
|              | D1 to D8  | Copies the waveform data in display to any of the D1 to D8 text registers. This function can be used to save the data temporarily.   |
| Copy From... | This menu item is displayed only when you set a data register D1 to D8 in the Source menu item.   |  |
| Position     | Specify the frame position to be displayed after a trigger event.   |  |



Table 2-6: Waveform view menu table (cont.)

| Top level | Subordinate level, options and descriptions   |   |
|-----------|---|---|
| Edit...   | <p>Creates the trigger mask pattern in the view displaying a waveform.</p> <p>To create the trigger mask pattern, use the □ and ◇ markers. You can use Hor., Ver., and Reset Delta to operate the markers. The created mask patterns are saved in an internal trigger register. Refer to page 3-59 for the procedures to create the mask pattern.</p> |   |
|           | Hor.  | Inputs the horizontal position to moves the □.  |
|           | Ver.  | Inputs the vertical position to moves the □.  |
|           | Reset Delta   | <p>Places the ◇ in the □ marker position.</p> <p>Only the □ marker can move freely . The ◇ marker cannot move freely although it can be placed in the □ position. When you press the Rest Delta side key, the ◇ marker moves to the □ position. In this case, the ◇ marker will remain there even if you move the □ marker again.</p>   |
|           | Draw Max  | Fills the area below the maximum line (reference level).  |
|           | Draw Line   | Fills the area below the currently set draw line and the line connecting the □ and ◇ marker position. The draw line is set with Draw Max or Draw Min.   |
|           | Draw Min  | Fills the area below the minimum line (i.e., the level 70 dB lower than the reference level).   |
|           | Draw Horizontal   | <p>Fills the area below the horizontal line containing the marker position.</p> <p>When you press one of the four side keys, changes are automatically made to the following settings:</p> <ul style="list-style-type: none"> <li>■ Trigger mode: Set to Normal.</li> <li>■ Trigger domain: <ul style="list-style-type: none"> <li>■ Set to Time if Format has been set to TimeAmpl in the current Waveform view.</li> <li>■ Set to Frequency if Format has been set to FreqAmpl in the current Waveform view.</li> </ul> </li> </ul> |
| Trace2... | Displays two waveforms concurrently.  |   |
|           | Source  | Refer to Source on page 2-70.   |
|           | Format  | Refer to Format on page 2-70.   |
|           | Frame   | Refer to Frame on page 2-71.  |

## Analog View Menu

Table 2–7 summarizes the structure of the Analog view menu.

**Table 2–7: Analog view menu table**

| Top level         | Subordinate level, options and descriptions   |   |  |
|-------------------|---|---|--|
| <b>Source</b>     | Specifies the data input used for the view. You can select one of the following items:  |   |  |
|                   | None  | Specifies no input source. The display area in the view is empty.   |  |
|                   | Active  | Specifies the data memory as the input source. This is the same as displaying the acquisition data on the display screen.   |  |
|                   | Zoom  | Specifies that the Zoomed data is input as the input source. If you want to use the Zoom mode, select this item. For Zoom, refer to pages 3–4 and 3–105.  |  |
|                   | D1D2 to D7D8  | Specify the register pair for the input source.<br><br>The digital modulated signal demodulated with the CDMA Polar or Polar view (refer to page 2–83 and 2–88, respectively) is written into the register pair. If you want to display the spectrum of the digital modulated signal, use a register pair as the input source.<br><br>Refer to page 3–67 for demodulating a digital modulated signal. |  |
|                   | File (*.IQ)   | Specifies IQ-formatted, saved data file for the input source.   |  |
|                   | File (*.AP)   | Specifies the AP-formatted, saved data file for the input source.   |  |
| <b>Format</b>     | Specifies the method of signal modulation. With the built-in demodulator, this analyzer can display the demodulated signal. Refer to page 3–65.           |   |  |
|                   | AM  | Demodulates the amplitude-modulated signal. The horizontal axis represents the time, and the vertical axis the modulating factor.   |  |
|                   | PM  | Demodulates the phase-modulated signal. The horizontal axis represents the time, and the vertical axis the phase.   |  |
|                   | FM  | Demodulates the frequency-modulated signal. The horizontal axis represents the time, and the vertical axis the frequency.   |  |
| <b>Frame</b>      | Specifies a frame to be displayed. The frame is set to 0 by default, which always contains the latest written data. Refer to page 3–17 for frame details. |   |  |
| <b>Options...</b> | Scale...  | Selects the vertical and horizontal axes. Refer to page 2–71 and 3–31 for details.  |  |
|                   | Marker...   | Operates the markers. Refer to page 3–35 for how to operate the markers.  |  |
|                   |   | Hor.  | Inputs the horizontal position to moves the □ marker. By default, the marker is positioned at the start point on the horizontal axis.  |
|                   |   | Delta Marker  | Turns On or Off the delta marker.  |
|                   |   | Reset Delta   | Places the ◇ in the □ marker position.<br><br>Only the □ marker can move freely . The ◇ marker cannot move freely although it can be placed in the □ position. When you press the Rest Delta side key, the ◇ marker moves to the □ position. In this case, the ◇ marker will remain there even if you move the □ marker again. |

Table 2-7: Analog view menu table (cont.)

| Top level  | Subordinate level, options and descriptions   |   |
|------------|---|---|
| Search...  | Searches for the peak spectrum and positions the □ marker there.  |   |
|            | Peak  | Searches the peak spectrum and moves the marker there. Rotate the general purpose knob clockwise to search the peak rightward, and vice versa.  |
|            | Max   | Searches for the maximum peak spectrum and moves the marker there.  |
|            | Min   | Searches for the minimum peak spectrum and moves the marker there.  |
|            | Separation  | Sets the minimum horizontal distance relative to full-scale (100 %) to separate two peaks.  |
|            | Delta Marker  | Turns On or Off the delta marker.   |
|            | Reset Delta   | Moves the ◇ to the □ marker position.   |
| Copy To... | Copies the waveform data in display to one of the locations below. This copy function is effective only for data captured in the vector mode. |   |
|            | Clipboard   | Converts the waveform data in display into the text form and copies to the Windows clipboard. The text data can be passed from the clipboard to an application in your PC. Refer to page 3-147 for details. |
|            | Text File   | Converts the waveform data in display into the text form and copies it to a text file. Refer to page 3-147 for details.   |
|            | D1 to D8  | Copies the waveform data in display to any of the D1 to D8 text registers. This function can be used to save the data temporarily.  |

## FSK View Menu

Table 2–8 summarizes the structure of the FSK view menu.

**Table 2–8: FSK view menu table**

| Top level  | Subordinate level, options and descriptions  |   |   |
|------------|--|---|---|
| Source     | Specifies the input used for the view. Refer to page 2–74 for details.   |   |   |
| Frame      | Specifies a frame to be displayed. The frame is set to 0, which always contains the latest written data. Refer to page 3–17 for frame details. |   |   |
| Options... | Scale...   | Selects the vertical and horizontal axes. Refer to page 2–71 and 3–31 for details.  |   |
|            | Marker...  | Operates the markers. Refer to page 2–74 and 3–35 for how to operate the markers.   |   |
|            | Search...  | Searches for the peak spectrum and positions the □ marker there.  |   |
|            |  | Peak  | Searches the peak spectrum and moves the marker there. Rotate the general purpose knob clockwise to search the peak rightward, and vice versa.  |
|            |  | Max   | Searches for the maximum peak spectrum and moves the marker there.  |
|            |  | Min   | Searches for the minimum peak spectrum and moves the marker there.  |
|            |  | Separation  | Sets the minimum horizontal distance relative to full-scale (100 %) to separate two peaks.  |
|            |  | Delta Marker  | Turns On or Off the delta marker.   |
|            | Reset Delta  | Moves the ◇ to the □ marker position.   |   |
|            | Copy To...   | Copies the waveform data in display to one of the locations below. This copy function is effective only for data captured in the vector mode. |   |
|            |  | Clipboard   | Converts the waveform data in display into the text form and copies to the Windows clipboard. The text data can be passed from the clipboard to an application in your PC. Refer to page 3–147 for details. |
|            |  | Text File   | Converts the waveform data in display into the text form and copies it to a text file. Refer to page 3–147 for details.   |
| D1 to D8   |  | Copies the waveform data in display to any of the D1 to D8 text registers. This function can be used to save the data temporarily.            |   |

## Spectrogram View Menu

Table 2–9 summarizes the structure of the Spectrogram view menu.

**Table 2–9: Spectrogram view menu table**

| Top level         | Subordinate level, options and descriptions   |  |  |
|-------------------|---|--|--|
| <b>Source</b>     | Specifies the input data used for the view.   |  |  |
|                   | None  | Specifies no input source. The display area in the view will be empty.   |  |
|                   | Active  | Specifies the data memory for the input source. This is the same as displaying the acquires data, on the display screen.                       |  |
|                   | Zoom  | Specifies that the Zoomed data as the input source. If you want to use the Zoom mode, select this Zoom item.                                   |  |
|                   | File (*.IQ)   | Specifies the IQ-formatted, saved data file for the input source.  |  |
|                   | File (*.AP)   | Specifies the AP-formatted, saved data file for the input source.  |  |
| <b>Format</b>     | FreqAmpl  | The horizontal axis represents the span and the vertical axis the amplitude or phase. Only FreqAmpl and FreqPhase are available for selection. |  |
|                   | FreqPhase   |  |  |
| <b>Ver. Start</b> | Specifies the beginning frame of the vertical axis. The frame is set to 0 by default, which contains the latest data. Refer to page 3–17 for frame details. |  |  |
| <b>Options...</b> | Scale...  | Sets the horizontal, vertical and color axes.  |  |
|                   |   | Hor. Scale   | Sets the scale of the horizontal axis.   |
|                   |   | Hor. Start   | Sets the start value of the horizontal axis.   |
|                   |   | Ver. Scale   | Sets the scale of the vertical axis. The value is a multiple of the number of basic frames (1 to 16). The number of basic frames varies with the view display format. Refer to page 3–33 for the number of basic frames. |
|                   |   | Ver. Start   | Sets the start value of the vertical axis. Because the vertical axis represents frames, input the frame number to begin the display. Refer to page 3–17 for frame details.   |
|                   |   | Color Scale  | Inputs the width of the level represented in colors.   |
|                   |   | Color Start  | Inputs the start value of the level represented in colors.<br><br>The level is represented in 10 colors from blue (minimum) to red (maximum). The level below the minimum is represented in black.                       |
|                   |   | Auto Scale   | Performs the auto scale, which automatically sets the start values and scales of the horizontal and vertical axes and level to view the whole waveform.  |

Table 2-9: Spectrogram view menu table (cont.)

| Top level    | Subordinate level, options and descriptions                                    |  |  |
|--------------|--|--|--|
| Marker...    | Operates the markers. Refer to page 3-35 for how to use the markers.           |  |  |
|              | Hor.   | Inputs the horizontal position to moves the □ marker. By default, it is positioned at the start point on the horizontal axis.  |  |
|              | Ver.   | Inputs the frame number as the vertical position to moves the □ marker. By default, the marker is positioned in frame 0.   |  |
|              | Delta Marker   | Turns On or Off the delta marker.  |  |
|              | Reset Delta  | Moves the ◇ to the □ position.   |  |
|              | Mkr->Freq  | Sets the center frequency to the frequency at the current marker position. When you press this side key, the Freq,Span,Ref...->Freq setting in the SETUP menu changes to the frequency at the current marker position. |  |
|              | Search...  | Searches for the peak spectrum in the current frame and positions the □ marker there.  |  |
|              |  | Peak   | Searches the peak spectrum and moves the marker there. Rotate the general purpose knob clockwise to search the peak rightward, and vice versa. |
|              |  | Max  | Searches for the maximum peak spectrum and moves the marker there.   |
|              |  | Separation   | Sets the minimum horizontal distance relative to full-scale (100 %) to separate two peaks.   |
|              |  | Ver.   | Inputs the frame number as the vertical position to moves the □ marker. By default, the marker is positioned in frame 0.                       |
| Delta Marker |  | Turns On or Off the delta marker.  |  |
| Reset Delta  |  | Moves the ◇ to the □ position.   |  |
| Mkr->Freq    |  | Sets the center frequency to the frequency at the current marker position. When you press this side key, the Freq,Span,Ref...->Freq setting in the SETUP menu changes to the frequency at the current marker position. |  |
| Ver. Mag     | Sets the number of vertical pixels to display one frame. The range is 1 to 10. |  |  |

## Waterfall View Menu

Table 2–10 summarizes the structure of the Waterfall view menu.

**Table 2–10: Waterfall view menu table**

| Top level         | Subordinate level, options and descriptions   |   |
|-------------------|---|---|
| <b>Source</b>     | Specifies the input data used for the view. Refer to page 2–70 for details.   |   |
| <b>Format</b>     | Defines the attributes for the horizontal and vertical axes. Refer to page 2–70 for details.  |   |
| <b>Ver. Start</b> | Specifies the start frame of the vertical axis. The frame is set to 0 by default, which contains the latest data. Refer to page 3–17 for frame details. |   |
| <b>Options...</b> | Scale...  | Sets up the horizontal and vertical axes.   |
|                   | Hor. Scale  | Sets the horizontal axis.   |
|                   | Hor. Start  | Sets the horizontal axis start value.   |
|                   | Ver. Scale  | Sets the start value of the vertical axis. Because the vertical axis represents frames, input the number of frames to be displayed. Refer to page 3–17 for frame details.   |
|                   | Ver. Start  | Sets the start value of the vertical axis. Because the vertical axis represents frames, input the frame number. The frame number begins with 0. See page 3–17 for frame details.                                  |
|                   | Height Scale  | Assigns the vertical axis scale for Height.   |
|                   | Height Start  | Assigns the start value to Height.  |
|                   | Auto Scale  | Performs the auto scale, which automatically sets the start values and scales of the horizontal, vertical axes and Height to view the whole waveform.   |
|                   | Marker...   | Operates the marker. Refer to page 2–78 and 3–35 for details.   |
|                   | Search...   | Searches for the peak spectrum in the current frame and positions the <input type="checkbox"/> marker there. Refer to page 2–78 for detail.<br><br>You can specify the frame by operating the markers vertically. |
| Height            | Represents the vertical axis scale indicating the amplitude level of a one-frame spectrum. The Height value is in increments of pixels.                 |   |
| Gap               | Specifies the interval between frames displaying the spectrum.  |   |

## CDMAWaveform View Menu

Table 2–11 summarizes the structure of the CDMAWaveform view menu.

**NOTE.** The CDMAWaveform view is used to perform the measurement in accordance with the IS-95 and T-53 standards.

**Table 2–11: CDMAWaveform view menu table**

| Top level           | Subordinate level, options and descriptions  |  |
|---------------------|--|--|
| <b>Source</b>       | Specifies the input data used for the view. For the details, refer to 2–70.  |  |
| <b>Format</b>       | Defines the attributes for the horizontal and vertical axes. For the details, refer to 2–70.   |  |
| <b>Frame</b>        | Specifies the frame to be displayed. The frame is set to 0 by default, which always contains the latest written data. Refer to page 3–17 for frame details.<br><br>If you select Average in Source, the frame selection disappears.  |  |
| <b>Compression</b>  | This menu item is displayed only when you select register of D1 to D8 for Source. It is related only to the display. If the number of data points per pixel is 2 or more, you can select one of the following:   |  |
|                     | Sample   | Samples the data at regular intervals to display.  |
|                     | MinMax   | Connects the maximum and minimum values of the associated data items in the display of each pixel position. The data line in each point is also connected by straight lines. |
|                     | Max  | Selects the maximum value as the display data point.   |
|                     | Min  | Selects the minimum value as the display data point.   |
| <b>Average Type</b> | Specifies the Average mode. For details, refer to page 2–71.   |  |
| <b>Num Average</b>  | If you set the averaging mode to RMS, the average is obtained only for the frame specified with Num Average before switching to the fixed display. If you select RMSEpo in the averaging mode, Num Average will be used for weighted setting of the old data. The Num Average item is displayed only when you select Average for the Source.<br><br>Refer to page 3–109 for averaging details. |  |



Table 2-11: CDMAWaveform view menu table (cont.)

| Top level  | Subordinate level, options and descriptions |  |  |
|------------|---|--|--|
| Options... | Scale...                                    | Scales the horizontal and vertical axes. Refer to 2-71 for detail.   |  |
|            | Marker...                                   | Operates the markers. Refer to page 3-35 for how to use the markers.   |  |
|            |   | Hor.   | Inputs the horizontal position and moves the □ marker. By default, it is positioned at the horizontal axis start point.  |
|            |   | Spurious   | This view detects eight spurious signals. Spurious places the marker on the detected spurious positions.<br><br>When you press the Spurious side key, the Up and Down keys appear on the menu item. Each time you press the Up arrow key, the marker moves from a spurious position to the next stronger one. Each time you press the Down arrow key, the marker moves from a spurious position to the next weaker one.<br><br>This function is useful to examine the spurious position and intensity when you have set to something other than Spurious in the Measurement menu item. |
|            |   | Delta Marker   | Turns On or Off the delta marker.  |
|            |   | Reset Delta  | Moves the ◇ to the □ marker position.  |
|            | Search...                                   | Searches for the peak spectrum and positions the □ marker there.   |  |
|            |   | Peak   | Searches the peak spectrum and moves the marker there. Rotate the general purpose knob clockwise to search the peak rightward, and vice versa.   |
|            |   | Max  | Searches for the maximum peak spectrum and moves the marker there.   |
|            |   | Min  | Searches for the minimum peak spectrum and moves the marker there.   |
|            |   | Separation   | Sets the minimum horizontal distance relative to full-scale (100 %) to separate two peaks.   |
|            |   | Delta Marker   | Turns On or Off the delta marker.  |
|            |   | Reset Delta  | Moves the ◇ to the □ marker position.  |
|            | Mask...                                     | Used to make PASS/FAIL decision for the displayed waveform. The defaults are the values meeting the IS-95 standard. The values of this Specified Mask Line can be changed.<br><br>Refer to <i>Creating the Trigger Mask Pattern</i> on page 3-59, for the shape of and the settings for the specified mask line. |  |
|            | Copy To...                                  | Copies the waveform data in display to one of the following locations. This copy function is effective only for data captured in the vector mode.  |  |
|            |   | Clipboard  | Converts the waveform data in display into the text form and copies to the Windows clipboard. The text data can be passed from the clipboard to an application in your PC. Refer to page 3-147 for details.  |
|            |   | Text File  | Converts the waveform data in display into the text form and copies it to a text file. Refer to page 3-147 for details.  |

**Table 2-11: CDMAWaveform view menu table (cont.)**

| Top level                     | Subordinate level, options and descriptions  |  |
|-------------------------------|--|--|
|                               |  | D1 to D8<br>Copies the waveform data in display to any of the D1 to D8 text registers. This function can be used to save the data temporarily.   |
|                               | Copy From...   | This menu item is displayed only when you have specified one of data registers D1 to D8 for the Source. The data in the specified text file (Text File) is copied to this register.  |
|                               | Position   | Specifies the frame position in which the waveform is displayed after a trigger event. The frame for which the trigger has been generated is displayed by setting the trigger position (Pos) and Position to the same frame. By default, both settings are identical.  |
| <b>RBW</b>                    | This view displays the waveform of the in-band power that was calculated with the default RBW (resolution bandwidth) (30 kHz). You can set RBW to 30K (Hz), 1M (Hz), or Off. For the Off setting, the initial input signal is displayed as is. |  |
| <b>Measurement</b>            | The measured value is displayed at the top left corner of the view. Select one of the following for its mode:  |  |
|                               | Off  | Displays no measurement value.   |
|                               | Power  | Displays Power (in-band power) and OBW (occupied bandwidth). For OBW, the default power ratio between the carrier frequency domain and the whole span area is set to 99% by default, which is the value specified in the IS-95 or T-53 standard. It can be changed with Measurement Option...→OBW. Refer to page 3-86 for the OBW measurement concept. Refer to page 3-82 for the Power measurement concept. |
|                               | Spurious   | In addition to Power and OBW above, the eight detected spurious signal power and frequency positions are displayed.  |
| <b>Measurement Options...</b> | You can change the following measurement parameters:   |  |
|                               | OBW  | Specifies the power ratio between the current frequency area and the whole span area that is used to calculate OBW (occupied bandwidth). By default, 99% is set as specified in IS-95 and T-53.  |
|                               | Separation   | Specifies the ratio (%) of the frequency resolution to the span frequency. This resolution is used to distinguish two adjacent peak spectrums as being independent spurious signals for the spurious search.   |
|                               | Threshold  | Specifies the threshold level to detect a spurious position. The threshold level must be specified as a relative level from the reference.   |
|                               | Sorted by  | Specifies the order of the number tags assigned to the eight detected spurious signal. If you select Level, the tags will be numbered in level order. If you select Frequency, they will be numbered in frequency order.   |
|                               | Spurious Search  | If you turn Off this parameter with the number tag displayed, the tag display position will not change during all subsequent measurements. This setting is useful to observe time-dependent changes of the detected spurious signal. Usually, keep it On throughout the spurious measurement.  |
|                               | Standard   | Selects either IS-95 or T-53 standard.   |
|                               | Channel  | Displays the Specified Mask Line of the specified channel. The channel matches the one you specify in SETUP (CDMA)→Freq,Span,Ref...  |

## CDMAPolar View Menu

Table 2–12 summarizes the structure of the view menu when you define CDMAPolar for a view.

---

**NOTE.** *The CDMAPolar view is used to perform the measurement in accordance with the IS-95 and T-53 standards. In other cases, use the Polar view. The difference between the Polar and CDMAPolar view functions is only the function to measure a signal according to the IS-95 and T-53 standards.*

---

**Table 2–12: CDMAPolar view menu table**

| Top level          | Subordinate level, options and descriptions   |  |
|--------------------|---|--|
| <b>Source</b>      | Specifies the input data used for the view.   |  |
|                    | None  | Specifies no input source. The display area in the view will be empty.                                   |
|                    | Active  | Specifies the data memory for the input source. This is the same as displaying the acquired data, as is. |
|                    | Zoom  | Specifies the Zoomed data for the input source.  |
|                    | File(*.IQ)  | Specifies the IQ-formatted, saved data file for the input source.  |
| <b>Frame</b>       | Specifies a frame to be displayed. The frame is set to 0 by default, which always contains the latest written data. Refer to page 3–17 for frame details. |  |
| <b>Standard...</b> | Sets the modulating system, symbol rate, filter, and $\alpha$ /BT according to the standard digital modulating system settings.                           |  |
|                    | NADC  | Configures the modulating system according to NADC (North American Digital Cellular).                    |
|                    | PDC   | Configures the modulating system according to PDC (Personal Digital Cellular System).                    |
|                    | PHS   | Configures the modulating system according to PHS (Personal Handy Phone System).                         |
|                    | TETRA   | Configures the modulating system according to TETRA (Trans-European Trunked Radio).                      |
|                    | GSM   | Configures the modulating system according to GSM (Global System for Mobile Communication).              |
|                    | CDPD  | Configures the modulating system according to CDPD (Cellular Digital Packet Data).                       |
|                    | IS95  | Configures the modulating system according to IS-95.   |

Table 2-12: CDMA Polar view menu table (cont.)

| Top level          | Subordinate level, options and descriptions  |   |  |
|--------------------|--|---|--|
| Manual Setup...    | Sets the modulating system, symbol rate, filter, and $\alpha$ /BT manually.  |   |  |
|                    | Modulation   | Selects the modulating system required to demodulate the digital modulated signal.  |  |
|                    |  | 1/4 PI_QPSK   | Specifies 1/4 $\pi$ Shift QPSK (Quadrature Phase Shift Keying) modulation. |
|                    |  | BPSK  | Specifies BPSK (Binary Phase Shift Keying) modulation.                     |
|                    |  | QPSK  | Specifies QPSK (Quadrature Phase Shift Keying) modulation.                 |
|                    |  | 8PSK  | Specifies 8PSK (Phase Shift Keying) modulation.                            |
|                    |  | 16QAM   | Specifies 16QAM (Quadrature Amplitude Modulation) modulation.              |
|                    |  | 64QAM   | Specifies 64QAM (Quadrature Amplitude Modulation) modulation.              |
|                    |  | GMSK  | Specifies GMSK (Gaussian-filtered Minimum Shift Keying) modulation.        |
|                    | CDMA_OQPSK   | Specifies CDMA OQPSK (Offset QPSK) which is used in the IS-95 standard.   |  |
|                    | Symbol Rate  | Inputs the symbol rate required to demodulate the digital modulated signal.<br>There is the following relationship between the symbol and bit rates:<br>$\text{Symbol rate} = \frac{\text{Bit rate} \times 1 \text{ state}}{\text{Number of bits}}$ |  |
| Measurement Filter | Selects the filter required to demodulate the digital modulated signal. You can select either None (no filter) or RootRaisedCosine. Refer to page 3-69, for details. |   |  |
| Reference Filter   | Selects None (no filter), RaisedCosine, or Gaussian for the filter required to create reference data. Refer to <i>Processing Flow</i> on page 3-69 for detail.       |   |  |
| Alpha/BT           | Inputs the $\alpha$ /BT value.   |   |  |
| Auto Carrier       | Determines whether to search the carrier automatically.  |   |  |
|                    | Off  | Sets the carrier frequency to the value with the Carrier (Hz) button which appears by pressing the Off button.  |  |
|                    | On   | Searches the carrier automatically, and displays the frequency error relative to center frequency on screen at Freq Err.  |  |
| Burst...           | Sets the burst search parameters.  |   |  |
|                    | Search   | Specifies whether to search burst (On) or not (Off).  |  |
|                    | Block Size   | Specifies the frame range to search a burst from the frame specified with Frame (refer to 2-83 page). The range is 1 to 20 frames.  |  |
|                    | Number Frames  | Specifies the number of frames to be analyzed. When the burst exceeds one frame, set this parameter to 2.   |  |
|                    | Offset   | Specifies the first data point to be analyzed relative to the beginning of burst within the range of -1024 to +1024. For example, when you set it to -100, the measurement is made from the hundredth data point before the beginning of burst.     |  |
|                    | Threshold  | Sets the threshold to detect the rising edge of burst. The range is -100 dB to 0 dB relative to the maximum data value.   |  |

Table 2–12: CDMAPolar view menu table (cont.)

| Top level  | Subordinate level, options and descriptions |   |   |
|------------|---|---|---|
| Options... | Display                                     | The polar view can display either a measurement data or a reference reference, which has been demodulated and modulated in this view. To display measurement data, select Measure, to display reference signal, select Reference. Refer to <i>Processing Flow</i> on page 3–69 for detail.  |   |
|            | Format                                      | Selects the display format.   |   |
|            |   | Vector  | Displays a data in vector format that represents symbol-to-symbol movements using a vector. |
|            |   | Constellation   | Displays a data in constellation format that represents only symbols.                       |
|            | Time Marker                                 | Inputs the time to moves the <input type="checkbox"/> marker.   |   |
|            | Measurement Destination                     | Selects the register pair used to write the data resulting after the signal passes through the Measurement filter. Refer to <i>Reference Destination</i> below for the selections.  |   |
|            | Reference Destination                       | Selects the register pair used to write the data resulting after the signal passes through the Measurement filter, demodulating mechanism, and Reference filter.<br>Refer to <i>Process Flow</i> on page 3–69, for the demodulating and modulating mechanism.   |   |
|            |   | None  | Specifies no output source.   |
| D1D2-D7D8  |   | Specify a register pair for the output source. Use this setting as the default as possible as you can.<br><br>A pair of data registers (D1 to D8) is called a register pair. The possible combinations are D1D2, D3D4, D5D6, and D7D8. They are mainly used to write the I and Q component data of a digitally modulated signal.<br><br>NOTE: For register pairs, two of the D1 to D8 data registers are combined for use. For example, if the D1D2 register pair is used for observation of the digital modulated signal although the Average function is using the D1 register, the resulting display will be unpredictable.<br><br>If these two functions are in use concurrently, do not use the same register for the two functions. |   |

## CDMATime View Menu

This view displays the structure of the CDMATime view menu.

---

**NOTE.** The CDMATime view is used to perform the measurement in accordance with the IS-95 and T-53 standards.

---



---

**NOTE.** For the CDMA time characteristic measurement, use the **Measure** side key rather than the front panel **ROLL** or **BLOCK** key.

---

If you use the **ROLL** or **BLOCK** key for the measurement, neither averaging nor mask decision takes place although the measurement can be performed. In this case, the horizontal axis in the CDMATime view represents the time in the block mode or the frequency in the roll mode.

---

**Table 2-13: CDMATime view menu table**

| Top level               | Subordinate level, options and descriptions   |  |
|-------------------------|---|--|
| <b>Source</b>           | Specifies the input data used for the view.   |  |
|                         | None  | Specifies no input source. The display area in the view will be empty.                                       |
|                         | Active  | Specifies the data memory for the input source. This is the same as displaying the acquired data, as is.     |
|                         | Zoom  | Specifies that the Zoomed data as the input source. If you want to use the Zoom mode, select this Zoom item. |
|                         | File (*.IQ)   | Specifies the IQ-formatted, saved data file for the input source.  |
|                         | File (*.AP):  | Specifies the AP-formatted, saved data file for the input source.  |
| <b>Block</b>            | <p>Specifies the block position to be displayed. By default, the contents of Block 0 position are displayed. In the block mode, data is acquired in the number of specified frames as one block, which is specified in SETUP (CDMA)→Block Size. If the data has been acquired in two or more blocks, you specify this block position to display the data captured in the specified block position. The block containing the latest acquired data is defined as Block 0.</p> <p>The relationship between the blocks and display is similar to that between the frames and the display in the frequency domain. Refer to page 3-21 for details.</p> |  |
| <b>Trace1 (Raw)</b>     | If set to On, the acquisition data is displayed by a green trace. If set to Off, this display disappears.   |  |
| <b>Trace2 (Average)</b> | If set to On, the averaged waveform is displayed in yellow. If set to Off, this display disappears. This menu item appears when the you use the Measure or Measure Data side menu for the measurement.  |  |

Table 2-13: CDMA Time view menu table (cont.)

| Top level           | Subordinate level, options and descriptions  |   |   |
|---------------------|--|---|---|
| Options...          | Scale...   | Scales the horizontal and vertical axes.  |   |
|                     |  | Hor. Scale  | Sets the horizontal axis scale.   |
|                     |  | Hor. Start  | Sets the horizontal axis start value.   |
|                     |  | Ver. Scale  | Sets the vertical axis scale.   |
|                     |  | Ver. Start  | Sets the vertical axis start value.   |
|                     |  | Rising Edge   | Enlarges the waveform around the rising edge.   |
|                     |  | Falling Edge  | Enlarges the waveform around the falling edge.  |
|                     | Marker...  | Full Scale  | Returns the usual display state when the rising or falling edge waveform is in enlarged display.                        |
|                     |  | Operates the markers. Refer to page 3-35 for how to use the markers.  |   |
|                     |  | Hor.  | Inputs the horizontal position and moves the □ marker. By default, it is positioned at the horizontal axis start point. |
|                     |  | Delta Marker  | Turns On or Off the delta marker.   |
|                     | Search...  | Reset Delta   | Moves the ◇ to the □ marker position.   |
|                     |  | Searches for the peak spectrum and positions the □ marker there. The search menu is the same as in the CDMAWaveform view. Refer to page 2-81. |   |
| Mask...             | Used to make PASS/FAIL decision for the averaged waveform (Trace2). The defaults are the values specified in the IS-95 and T-53 standards. The values of this mask can be changed.   |   |   |
|                     | Refer to page 3-59, for the shape of and the settings for the mask.  |   |   |
| Num Average         | Specifies the averaging count. The default is 100 (specified in the IS-95 standard). Be sure to use the Measure side menu for the measurement.   |   |   |
| <b>Measure</b>      | <p>This function measures the CDMA time characteristic for the input signal by pressing the Measure side key. For the time characteristic, data is acquired 100 times by default, and the averaged waveform is displayed, as Trace2, in yellow. The PASS/FAIL decision is made by comparing the averaged waveform with the mask settings.</p> <p>You can specify the averaging count with Option...→Num Average. The IS-95 standard requires that the values from 100 measurements be averaged.</p> <p>To abort the measurement after you press this side key, press the front panel CLR key. For example, if you press the Measure side key twice consecutively and press the CLR key only once, the current measurement is aborted. The measurement responding to the second Measure side key operation begins immediately after this. In this case, press the CLR key again to abort the second measurement. To abort the measurement sequence completely, press the CLR side key repeatedly until the number of times you pressed the Measure side key is reached.</p> |   |   |
| <b>Measure Data</b> | <p>This function measures the CDMA time characteristic for the data already contained in memory. This side menu is used, for example, when you loaded the data from a file.</p> <p>Specifying the averaging count and aborting the measurement (sequence) are the same as for the Measure side menu.</p>   |   |   |

## Polar View

Table 2–14 summarizes the structure of the Polar view menu when you defined Polar for a view.

**Table 2–14: Polar view menu table**

| Top level          | Subordinate level, options and descriptions   |  |
|--------------------|---|--|
| <b>Source</b>      | Specifies the input data used for the view.   |  |
|                    | None  | Specifies no input source. The display area in the view will be empty.                                   |
|                    | Active  | Specifies the data memory for the input source. This is the same as displaying the acquired data, as is. |
|                    | Zoom  | Specifies the Zoomed data for the input source.  |
|                    | File(*.IQ)  | Specifies the IQ-formatted, saved data file for the input source.  |
| <b>Frame</b>       | Specifies a frame to be displayed. The frame is set to 0 by default, which always contains the latest written data. Refer to page 3–17 for frame details. |  |
| <b>Standard...</b> | Sets the modulating system, symbol rate, filter, and $\alpha$ /BT according to the standard digital modulating system settings.                           |  |
|                    | NADC  | Configures the modulating system according to NADC (North American Digital Cellular).                    |
|                    | PDC   | Configures the modulating system according to PDC (Personal Digital Cellular System).                    |
|                    | PHS   | Configures the modulating system according to PHS (Personal Handy Phone System).                         |
|                    | TETRA   | Configures the modulating system according to TETRA (Trans-European Trunked Radio).                      |
|                    | GSM   | Configures the modulating system according to GSM (Global System for Mobile Communication).              |
| CDPD               | Configures the modulating system according to CDPD (Cellular Digital Packet Data).  |  |



Table 2-14: Polar view menu table (cont.)

| Top level        | Subordinate level, options and descriptions  |   |  |
|------------------|--|---|--|
| Manual Setup...  | Sets the modulating system, symbol rate, filter, and $\alpha$ /BT manually.  |   |  |
|                  | Modulation   | Selects the modulating system required to demodulate the digital modulated signal.  |  |
|                  |  | 1/4 PI_QPSK   | Specifies 1/4 $\pi$ Shift QPSK (Quadrature Phase Shift Keying) modulation. |
|                  |  | BPSK  | Specifies BPSK (Binary Phase Shift Keying) modulation.                     |
|                  |  | QPSK  | Specifies QPSK (Quadrature Phase Shift Keying) modulation.                 |
|                  |  | 8PSK  | Specifies 8PSK (Phase Shift Keying) modulation.                            |
|                  |  | 16QAM   | Specifies 16QAM (Quadrature Amplitude Modulation) modulation.              |
|                  |  | 64QAM   | Specifies 64QAM (Quadrature Amplitude Modulation) modulation.              |
|                  |  | GMSK  | Specifies GMSK (Gaussian-filtered Minimum Shift Keying) modulation.        |
|                  | CDMA_OQPSK   | Specifies CDMA OQPSK (Offset QPSK) which is used in the IS-95 standard.   |  |
|                  | Symbol Rate  | Inputs the symbol rate required to demodulate the digital modulated signal.<br>There is the following relationship between the symbol and bit rates:<br>$\text{Symbol rate} = \frac{\text{Bit rate} \times 1 \text{ state}}{\text{Number of bits}}$ |  |
|                  | Measurement Filter   | Selects the filter required to demodulate the digital modulated signal. You can select either None (no filter) or RootRaisedCosine. Refer to page 3-69, for details.  |  |
| Reference Filter | Selects None (no filter), RaisedCosine, or Gaussian for the filter required to create reference data. Refer to <i>Processing Flow</i> on page 3-69 for detail. |   |  |
| Alpha/BT         | Inputs the $\alpha$ /BT value.   |   |  |
| Auto Carrier     | Determines whether to search the carrier automatically.  |   |  |
|                  | Off  | Sets the carrier frequency to the value with the Carrier (Hz) button which appears by pressing the Off button.  |  |
|                  | On   | Searches the carrier automatically, and displays the frequency error relative to center frequency on screen at Freq Err.  |  |
| Burst...         | Sets the burst search parameters.  |   |  |
|                  | Search   | Specifies whether to search burst (On) or not (Off).  |  |
|                  | Block Size   | Specifies the frame range to search a burst from the frame specified with Frame (refer to 2-83 page). The range is 1 to 20 frames.  |  |
|                  | Number Frames  | Specifies the number of frames to be analyzed. When the burst exceeds one frame, set this parameter to 2.   |  |
|                  | Offset   | Specifies the first data point to be analyzed relative to the beginning of burst within the range of -1024 to +1024. For example, when you set it to -100, the measurement is made from the hundredth data point before the beginning of burst.     |  |
|                  | Threshold  | Sets the threshold to detect the rising edge of burst. The range is -100 dB to 0 dB relative to the maximum data value.   |  |

Table 2-14: Polar view menu table (cont.)

| Top level  | Subordinate level, options and descriptions |  |   |
|------------|---|--|---|
| Options... | Display                                     | The polar view can display either measurement data or a reference signal, which has been demodulated and modulated in this view. To display measurement data, select Measure, to display the reference signal, select Reference. Refer to <i>Processing Flow</i> on page 3-69 for detail.  |   |
|            | Format                                      | Selects the display format.  |   |
|            |   | Vector   | Displays a data in vector format that represents symbol-to-symbol movements using a vector. |
|            |   | Constellation  | Displays data in constellation format that represents only symbols.                         |
|            | Time Marker                                 | Inputs the time to move the <input type="checkbox"/> marker.   |   |
|            | Measurement Destination                     | Selects the register pair used to write the data resulting after the signal passes through the Measurement filter. See the next subsection, "Reference Destination" for the selections.  |   |
|            | Reference Destination                       | Selects the register pair used to write the data resulting after the signal passes through the Measurement filter, demodulating mechanism, and Reference filter.<br>Refer to page 3-69, for the demodulating and modulating mechanism.   |   |
| None       |   | Specifies no output source.  |   |
| D1D2-D7D8  |   | Specify a register pair for the output source. Use default settings when possible.<br><br>A pair of data registers (D1 to D8) is called a register pair. The possible combinations are D1D2, D3D4, D5D6, and D7D8. They are mainly used to write the I and Q component data of a digitally modulated signal.<br><br>NOTE: For register pairs, two of the D1 to D8 data registers are combined for use. For example, if the D1D2 register pair is used for observation of the digital modulated signal and the Average function is using the D1 register, the resulting display will be unpredictable.<br><br>If these two functions are in use concurrently, do not use the same register for the two functions. |   |

## EyeDiagram View Menu

Table 2–15 summarizes the structure of the EyeDiagram view menu.

**Table 2–15: Polar view menu table**

| Top level         | Subordinate level, options and descriptions   |   |
|-------------------|---|---|
| <b>Source</b>     | Specifies the input used for the view.  |   |
|                   | Measurement   | Defines Measurement (register pair) as the input source. This input source is the measurement signal that is output from the Polar or CDMAPolar view (i.e., measurement data).  |
|                   | Reference   | Defines Reference (register pair) as the input source. This input source is the ideal signal that is output from the Polar or CDMAPolar view (i.e., reference data).<br><br>Refer to page 3–69 for processing a digital modulated signal.<br><br>Refer to page 2–90 for output of the Polar and CDMAPolar view (Measurement Destination and Reference Destination). |
| <b>Format</b>     | Selects the digital format. To specify the horizontal axis, use Eye Length. The default length is set to two symbols.   |   |
|                   | I   | Enables Eye diagram display, with the I data defined along the vertical axis.   |
|                   | Q   | Enables Eye diagram display, with the Q data defined along the vertical axis.   |
|                   | Trellis   | Enables Eye diagram display, with the phase defined along the vertical axis.  |
| <b>Options...</b> | Scale...  |   |
|                   | Ver. Scale  | Sets the vertical axis scale.   |
|                   | Ver. Start  | Sets the vertical axis start value.   |
|                   | Auto Scale  | Performs the auto scale, which automatically sets the start values and scales of the horizontal and vertical axes to display the whole waveform.  |
|                   | Time Marker   | Inputs the time to move the <input type="checkbox"/> marker.  |
| <b>Eye Length</b> | Inputs the length of the symbol to be displayed. The time length required for symbol-to-symbol movement is defined as 1. This is the scale setting for the horizontal axis. |   |

## SymbolTable View Menu

Table 2–16 summarizes the structure of the SymbolTable view menu.

**Table 2–16: Polar view menu table**

| Top level                | Subordinate level, options and descriptions  |   |
|--------------------------|--|---|
| <b>Source</b>            | Specifies the input used for the view.   |   |
|                          | Measurement  | Defines Measurement (register pair) as the input source. This input source is the measurement signal that is output from the Polar or CDMAPolar view (i.e., Measurement data).  |
|                          | Reference  | Defines Reference (register pair) as the input source. This input source is the ideal signal that is output from the Polar or CDMAPolar view (i.e., Reference data).<br><br>See page 3–69 for processing a digital modulated signal.<br><br>See page 3–41 for output of the Polar view (Measurement Destination and Reference Destination). |
| <b>Radix</b>             | Selects the notation of numeric values displayed. You can select the hexadecimal (Hex), octal (Oct), or binary (Bin) notation. |   |
| <b>Rotate</b>            | Changes the numeric value start position. This setting is unavailable for the $1/4 \pi$ QPSK or GMSK modulating system.        |   |
| <b>Symbol</b>            | Sets the symbol position to place the $\square$ marker. The range is 0 to the number of symbols – 1.                           |   |
| <b>Copy To Clipboard</b> | Copies the data in displayed form to the clipboard. You can paste the data from the clipboard into the application software.   |   |

## EVM View Menu

Table 2–17 summarizes the structure of the EVM view menu.

**Table 2–17: EVM view menu table**

| Top level         | Subordinate level, options and descriptions  |   |  |
|-------------------|--|---|--|
| <b>Format</b>     | Specifies the display format.  |   |  |
|                   | EVM  | Displays the error vector magnitude, whose vertical axis represents the percentage of error vector magnitude, and whose horizontal axis represents the time.  |  |
|                   | Mag Error  | Displays the amplitude error, whose vertical axis represents the percentage of amplitude error, and whose horizontal axis represents the time.  |  |
|                   | Phase Error  | Displays the phase error, whose vertical axis represents the percentage of phase error, and whose horizontal axis represents the time.  |  |
| <b>Mask Area</b>  | Specifies the left and right area on screen to exclude from calculating EVM. The range is 0 to 50 % relative to full-scale. 0 % excludes no area and 50 % does whole area. For example, 10 % specifies that 10 % area from both left and right edges are excluded. |   |  |
| <b>Options...</b> | Scale...   | Scales the horizontal and vertical axes. The scale menu is the same as in the Waveform view. Refer to page 2–71.  |  |
|                   | Marker...  | Operates the primary and delta markers. Refer to page 3–35 on using the markers.  |  |
|                   |  | Symbol  | Sets the symbol position to place the □ marker. The range is 0 to the number of symbols – 1.   |
|                   |  | Delta Marker  | Turns On or Off the delta marker.  |
|                   |  | Mkr->Freq   | Sets the center frequency to the frequency at the current marker position. When you press this side key, the Freq,Span,Ref...->Freq setting in the SETUP menu changes to the frequency at the current marker position. |
|                   | Search...  | Searches the peak spectrum and positions the marker there.  |  |
|                   |  | Max   | Searches the maximum peak spectrum and moves the marker there.   |
|                   |  | Min   | Searches the minimum peak spectrum and moves the marker there.   |
|                   | Copy To...   | Copies the waveform data in the display to the destination below. By copying the data to the clipboard or a text file, you can reproduce the waveform using PC application software. Refer to page 3–147 for details. This function is available only for the data acquired in the Vector mode. |  |
|                   |  | Clipboard   | Converts the waveform data in the display into text form data and copies it to the Windows clipboard.  |
|                   |  | Test File   | Converts the waveform data in the display into text form data and writes it to a file.   |
|                   |  | D1 to D8  | Copies the waveform data in the display to any of the D1 to D8 text registers. This function can be used to save the data temporarily.   |

## Average Menu

You can call the Average menu from the CONFIG:UTILITY menu. To call the Average menu, press the Util C [Average] side key in the CONFIG:UTILITY menu.

**Table 2-18: Average menu table**

| Top level            | Subordinate level, options and descriptions   |   |
|----------------------|---|---|
| <b>Source</b>        | Selects the input source.   |   |
|                      | None  | Specifies no input source and disables the source selection.  |
|                      | Active  | Specifies the active data as the input source. The active data means the acquired data.<br>You can select Active only when the analyzer is active in the roll mode. If you select Active, the averaging process will run while acquiring the data. Thus, you can use this function for comparison (through the view), with a non-averaged spectrum for example. |
|                      | Zoom  | Specifies the Zoomed data as the input source. If you want to average the Zoomed data, acquire the signal in Zoom mode and then execute the Zoom function.  |
|                      | File(*.IQ)  | Specifies the IQ-formatted, saved data for the input source.  |
|                      | File(*.AP)  | Specifies the AP-formatted, saved data for the input source.  |
| <b>Begin Frame</b>   | Selects the frame to begin the process.   |   |
| <b>End Frame</b>     | Selects the frame to end the process.<br><br>With the beginning and end of the frames specified, only the frames in this data range are averaged. The frame number specified may be 0 to (block size - 1). It may be 0 to (trigger count x block size - 1) if you have set the trigger. |   |
| <b>Destination</b>   | Specifies the destination for the result of the process. This destination is always one of the D1 to D8 data registers. The default is D1.  |   |
| <b>Mkr-&gt;Frame</b> | Sets the frame in the marker position to End Frame.   |   |
| <b>RMS</b>           | Performs the averaging process with the RMS (root-mean-square).   |   |
| <b>PeakHold</b>      | Performs the peak hold.   |   |

## SaveLoad Menu

You can call the SaveLoad menu from the CONFIG:UTILITY menu.  
To call the Save Load menu, press the Util B [SaveLoad] side key in the CONFIG:UTILITY menu.

Refer to page 3–115 for details of saving and loading a file.

**Table 2–19: SaveLoad menu table**

| Top level      | Subordinate level, options and descriptions  |  |
|----------------|--|--|
| <b>Save...</b> | Saves the contents of the data memory to a file.   |  |
|                | Source   | Specifies the data to be saved. Only the data written in the data memory can be saved. If the data has been Zoomed, the resulting Zoomed data can also be saved.   |
|                | Begin Frame  | Selects the frame to begin the save.   |
|                | End Frame  | Selects the frame to end the save.<br><br>With the beginning and end frames specified, only the frames of this data range are saved. The frame number specified may be 0 to (block size – 1). It may be 0 to (trigger count x block size – 1) if you have set the trigger. |
|                | All Frames   | Specifies that the data in all frames is saved.  |
|                | Mkr->Frame   | Sets the frame in the marker position to End Frame.  |
|                | Save To File (*.IQ)  | Saves the data to a file in IQ format.   |
|                | Save To File (*.AP)  | Saves the data to a file in AP format. All data saved in AP format is unavailable for modulation analysis or Zoom.   |
| <b>Load...</b> | Loads data from the file and writes it into the data memory. At this time, the mode, frequency, or span setting is not set for the analyzer. |  |
|                | Load From File (*.IQ)  | Loads the data from the file that contains it in IQ format.<br><br>This function cannot load the data saved in AP format. The AP format file may be specified only in the Source menu item in each view. Refer to page 3–116 for details.                                  |

## File Access Menu

The File Access menu is called from the File (\*.XXX) menu item of any of the other menus. It is then displayed together with the screen used for file operations. File extension XXX indicates CFG, IQ, or AP.

Refer to page 3–119 for details about file operations.

**Table 2–20: File Access menu table**

| Top level            | Subordinate level, options and descriptions   |   |
|----------------------|---|---|
| <b>Cancel</b>        | Returns to the menu calling the File Access menu.   |   |
| <b>OK</b>            | Once you have selected a drive, directory, or file in the following menu items, press the OK side key to perform the specified file operation.<br><br>Upon completion of the file process, you return to the menu calling the File Access menu. |   |
| <b>File</b>          | Selects a file.   |   |
| <b>Dir</b>           | Selects a directory. The directory selection is established by pressing the Expand Dir side key.  |   |
| <b>Expand Dir</b>    | Lists the files of the selected directory or shows the directory listing.   |   |
| <b>Drive</b>         | Selects a drive.  |   |
| <b>Name Entry...</b> | This inputs the file name or directory name.  |   |
|                      | Position  | Press this side key and use the general purpose knob to move the caret within the file name input field.  |
|                      | Delete Char   | Press this side key to delete the character placed in the caret position within the input field. When the caret is not displayed, the last character is deleted each time you press this side key.  |
|                      | A B C D E F G<br>H...   | When you press the side key, you receive a submenu in which a character is assigned to each side key. When you press the side key again, the character on the side key label is input.<br><br>The same rule also applies to the four menu items below this menu item. |
|                      | I J K L M N O<br>P...   |   |
|                      | Q R S T U V W<br>X...   |   |
|                      | Y Z 0 1 2 3 4 5...  |   |
| 6 7 8 9 . _ \ :...   |   |   |
| <b>Operation...</b>  | Performs the file operation. When you press this side key, the submenus appear that let you select a drive, directory, and file.  |   |
|                      | Copy File...  | Copies a file.  |
|                      | Delete File...  | Deletes a file.   |
|                      | Create Dir...   | Creates a new directory.  |
|                      | Delete Dir...   | Deletes a directory.  |



## Print Menu

The Print menu performs a hardcopy of the screen display. For the detail, refer to *Hardcopy* on page 3–143.

**Table 2–21: Print menu table**

| <b>Top level</b>                 | <b>Subordinate level, options and descriptions</b> |
|----------------------------------|--|
| <b>Cancel</b>                    | Returns to the menu previously displayed.          |
| <b>Printer</b>                   | Selects a printer.                                 |
| <b>Print To Printer</b>          | Performs a hardcopy.                               |
| <b>Save To File<br/>(* .BMP)</b> | Saves the hardcopy to a file.                      |



# Reference



# Input and Memory Modes

There are four modes to process the input signal: IQ, Wideband, RF, and Baseband (IQ and Wideband are for the 3086 only). There are also four modes to process the input signal and write the result into the data memory: Scalar, Frequency, Dual, and Zoom.

These modes must be established before all the other settings. If the current input or memory mode is switched, the old settings except some items are replaced by the defaults.

This section describes how to establish the mode, and then describes the individual modes.

## Setting a Basic Patterns

You can use the CONFIG:MODE menu to set a basic configuration pattern for the analyzer.

1. Press the CONFIG:MAIN key.
2. Press the desired side key corresponding to a mode setting or necessary analysis.

To enter the Frequency mode, press the **Spectrum** or **Spectrum Spectrogram** side key. To enter the Dual mode, press the **Dual** side key. To enter into the Zoom mode, press the **Zoom** side key.

To perform digital signal analysis press **More...→Digital Demod**. To perform CDMA analysis, press **More...→CDMA** and then select one of the three options.

Once you have performed any of the above operations, the settings are made using the basic configuration pattern, and the views are displayed on the screen.

## Establishing a Mode Manually

To establish an input or memory mode manually, use the following procedure. For a basic pattern, the input mode defaults to RF. To set the IQ, Wideband (the 3086 only), or Baseband, do the following steps:

1. Select the input mode.
  - a. Press the **SETUP:MAIN** key.
  - b. Press the **Input Mode** side key.
  - c. For the 3066, select **RF** or **Baseband** using the general purpose knob.  
For the 3086, select **IQ**, **Wideband**, **RF**, or **Baseband** using the general purpose knob.
2. Select the memory mode.
  - a. Press the **Memory Mode** side key.
  - b. Select **Frequency**, **Dual**, or **Zoom** using the general purpose knob.

Scalar mode selection is unavailable. If you set the span to 10 MHz or more, the analyzer is automatically set to the Scalar mode. Refer to *Frequency and Span* on page 3–7 for setting the span.

## IQ, Wideband, RF, and Baseband Modes

---

**NOTE.** *The Wideband and IQ modes are for the 3086 only.*

---

Figure 3–1 shows the rough process flow from inputting signal to writing into the data memory.

The RF and Wideband modes can process up to 3 GHz signals using the 3 GHz down converter. Since the Baseband mode does not use this converter, it can only process DC to 10 MHz signals. The IQ mode inputs I and Q signals directly from the rear panel connectors.

The Baseband mode can process data within a span of up to 5 or 10 MHz per frame. The RF mode can only process data within a span of up to 5 MHz. The Wideband and IQ modes extend the range up to 30 MHz. See Table 3–1 on page 3–6 for the relationship between mode and span.

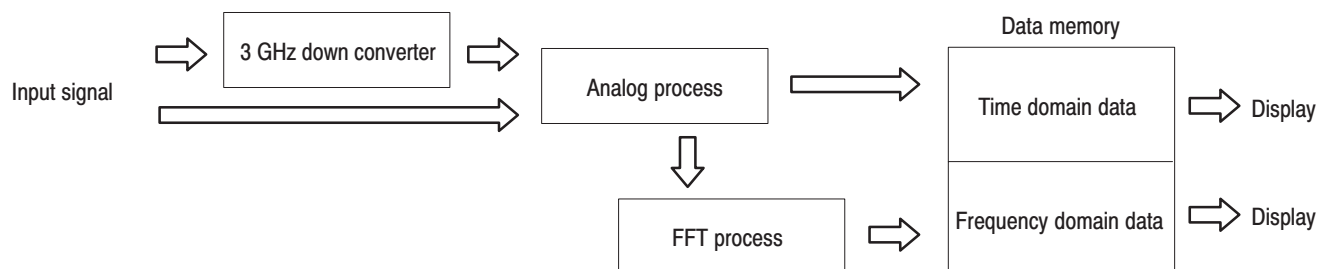
The data is acquired in one logical frame by one scan with a span of up to 5 or 10 MHz in the Baseband mode, a span of up to 5 MHz in the RF mode, and a span of up to 30 MHz in the Wideband and IQ modes. If you set a span beyond these settings, the data is acquired in one frame by two or more scans. This way, the analyzer is configured to process data within a span of up to 3 GHz. If you set the span to 3 GHz, the analyzer will acquire the data by configuring one logical frame with 600 physical frames, that is 600 scans.

---

**NOTE.** *One scan represents one physical frame within the data memory. One logical frame represents the data length to be displayed. In the realtime acquisition, there is a one-to-one correspondence between physical and logical frames. In this case, the logical frame is equivalent to the physical frame.*

*Refer to Physical and Logical Frames on page 3–23.*

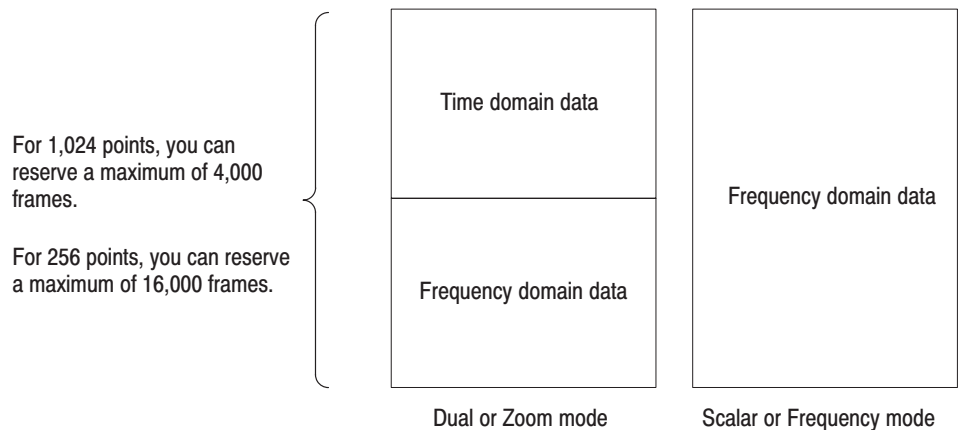
---



**Figure 3–1: Signal process flow**

## Scalar, Frequency, Dual, and Zoom Modes

The Frequency, Dual, and Zoom modes are available for setting process hardware settings, depending on the use of the frame or data memory. For the data memory, you can reserve a maximum of 4,000 (for 1,024 FFT points) or 16,000 frames (for 256 FFT points).



**Figure 3-2: Use of data memory**

In the Dual or Zoom mode, the data for the frequency domain and that for the time domain are written into the memory at the same time. The block size (number of frames) available for each is reduced to half (see page 3-2).

In the Frequency mode, only frequency domain signals are written into every frame (refer to *RF and Baseband Modes* on page 3-3). This mode enables the analyzer to capture signals of twice the length possible in the Dual or Zoom mode.

The Dual and Zoom modes differ in how you set the frame period. The Dual mode allows you to set any frame period. For the Zoom mode, frames are used with a consecutive periods in time for sue in the Zoom process. The Zoom mode limits the range of valid frame periods.

In addition, the Dual and Zoom modes are different in the subsequent process after the signal is written into the memory. In the Zoom mode, any signal captured once can be redisplayed after changing have been made in its center frequency and span ranges.



The RF mode is switched to the Scalar by setting the span to 10 MHz or larger. In this mode, while the time domain data is displayed in the view, the contents in display disappears even if the Dual or Zoom mode has been established. When you return the span to 6 MHz or less, the initial established mode returns and the display resumes. The Scalar mode is similar to the Frequency mode. They differ in their use of frames and in their span range. The Scalar mode is not available in the Baseband mode.

Usually, you should observe signals in the 3 GHz span. If you want to observe detailed phenomena around a particular center frequency, use the Frequency or Dual mode. To examine more detailed frequency phenomena, use the Zoom mode.

## Summary of Modes

Table 3–1 summarizes the relationship between the modes and span settings.

**Table 3–1: Summary of modes**

| Mode                  |                        | Max. span | Frame period                      | F/T write <sup>3</sup> | Zoom     |
|-----------------------|------------------------|-----------|-----------------------------------|------------------------|----------|
| IQ <sup>1</sup>       | Zoom only              | 30 MHz    | Consecutively<br>(disable to set) | F and T                | Enabled  |
| Wideband <sup>1</sup> |                        |           |                                   |                        |          |
| RF                    | Scalar                 | 3 GHz     | Optionally set                    | F only                 | Disabled |
|                       | Frequency <sup>2</sup> | 6 MHz     | Optionally set                    | F only                 | Disabled |
|                       | Dual <sup>2</sup>      | 6 MHz     | Optionally set                    | F and T                | Disabled |
|                       | Zoom <sup>2</sup>      | 5 MHz     | Consecutively<br>(disable to set) | F and T                | Enabled  |
| Baseband              | Frequency              | 10 MHz    | Optionally set                    | F only                 | Disabled |
|                       | Dual                   | 10 MHz    | Optionally set                    | F and T                | Disabled |
|                       | Zoom                   | 5 MHz     | Consecutively<br>(disable to set) | F and T                | Enabled  |

<sup>1</sup> **The 3086 only.**

<sup>2</sup> **The mode is switched to Scalar by setting the span to 10 MHz or larger.**

<sup>3</sup> **F and T represent the frequency and time domain data, respectively.**

Make the following settings as required:

### Scalar mode.

- Acquiring signals in a wide range of 10 MHz to 3 GHz

### Frequency mode.

- Acquiring data in the 5 to 10 MHz span for a long time

### Dual mode.

- Analyzing analog modulation
- Analyzing digital modulation
- Acquiring signals in real time (depending on the frame period)

### Zoom mode.

- Capturing signals in real time
- Enlarge a particular frequency area on the screen

# Frequency and Span

Before or during measurement, you can change the frequency and span settings freely as long as they are allowed by the acquisition mode and measurement processing selected.

## Setting Limits and Restrictions

The upper limit of the span depends on the mode as shown in Table 3–2.

**Table 3–2: Summary of modes**

| Mode                  |           | Max. span | Default span   | Range           | Default frequency |
|-----------------------|-----------|-----------|----------------|-----------------|-------------------|
| IQ <sup>1</sup>       | Zoom only | 30 MHz    | 30 MHz         | 50 MHz to 3 GHz | 1.5 GHz           |
| Wideband <sup>1</sup> |           |           |                |                 |                   |
| RF                    | Scalar    | 3 GHz     | 3 GHz          | 10 MHz to 3 GHz | 1.5 GHz           |
|                       | Frequency | 6 MHz     | – <sup>2</sup> |                 |                   |
|                       | Dual      |           |                |                 |                   |
|                       | Zoom      | 5 MHz     |                |                 |                   |
| Baseband              | Frequency | 10 MHz    | 10 MHz         | DC to 10 MHz    | 5 MHz             |
|                       | Dual      | 10 MHz    | 5 MHz          |                 |                   |
|                       | Zoom      | 5 MHz     | 5 MHz          |                 |                   |

<sup>1</sup> **The 3086 only.**

<sup>2</sup> **The default is the Scalar mode. If you set the span to 6 MHz or less, the mode changes to the appropriate mode.**

When you set the span to 10 MHz or larger for the RF Frequency, RF Dual, or RF Zoom mode, the Scalar mode is entered automatically.

The value of (center frequency + span/2) must not exceed 3 GHz in the RF mode. It must not exceed 5 or 10 MHz (depending on the memory mode) in the Baseband mode. Similarly, the value of (center frequency – span/2) must not be below 10 MHz in the RF mode. It must not be below 0 Hz in the Baseband mode. See Figure 3–3.

## Setting the Frequency and Span

You can use shortcut keys to quickly set the center frequency and span.

### Setting the Center Frequency.

1. Press the **SETUP:FREQ** key.
2. Use the general purpose knob to increment or decrement the numeric value. Alternatively, use the **ENTRY** key pad to input it.

### Setting the Span.

1. Press the **SETUP:SPAN** key.
2. Use the general purpose knob to select the desired span from the drop-down listing.

You can make frequent changes to the center frequency and span settings. To do so, keep the associated menus open during setting. When the menu is kept open, press the **FREQ** side key instead of **SETUP:FREQ** and the **Span** side key instead of **SETUP:SPAN**. Then, you can set a numeric value or select a predefined value.

## Setting the Frequency Using the Markers and Search

You can position the marker in the peak spectrum using the search function. Then, you can set the frequency at the marker position to the center frequency.

1. Press the key associated with the view (**VIEW:A** to **D**) in which the spectra to search are displayed.
2. Press the **VIEW:SRCH** key.

The marker is positioned at the maximum peak spectrum. Rotating the general purpose knob clockwise searches the peak spectrum rightward and places the marker there, and vice versa.

3. Press the **Mkr->Freq** side key to set the marker frequency position to the center frequency.

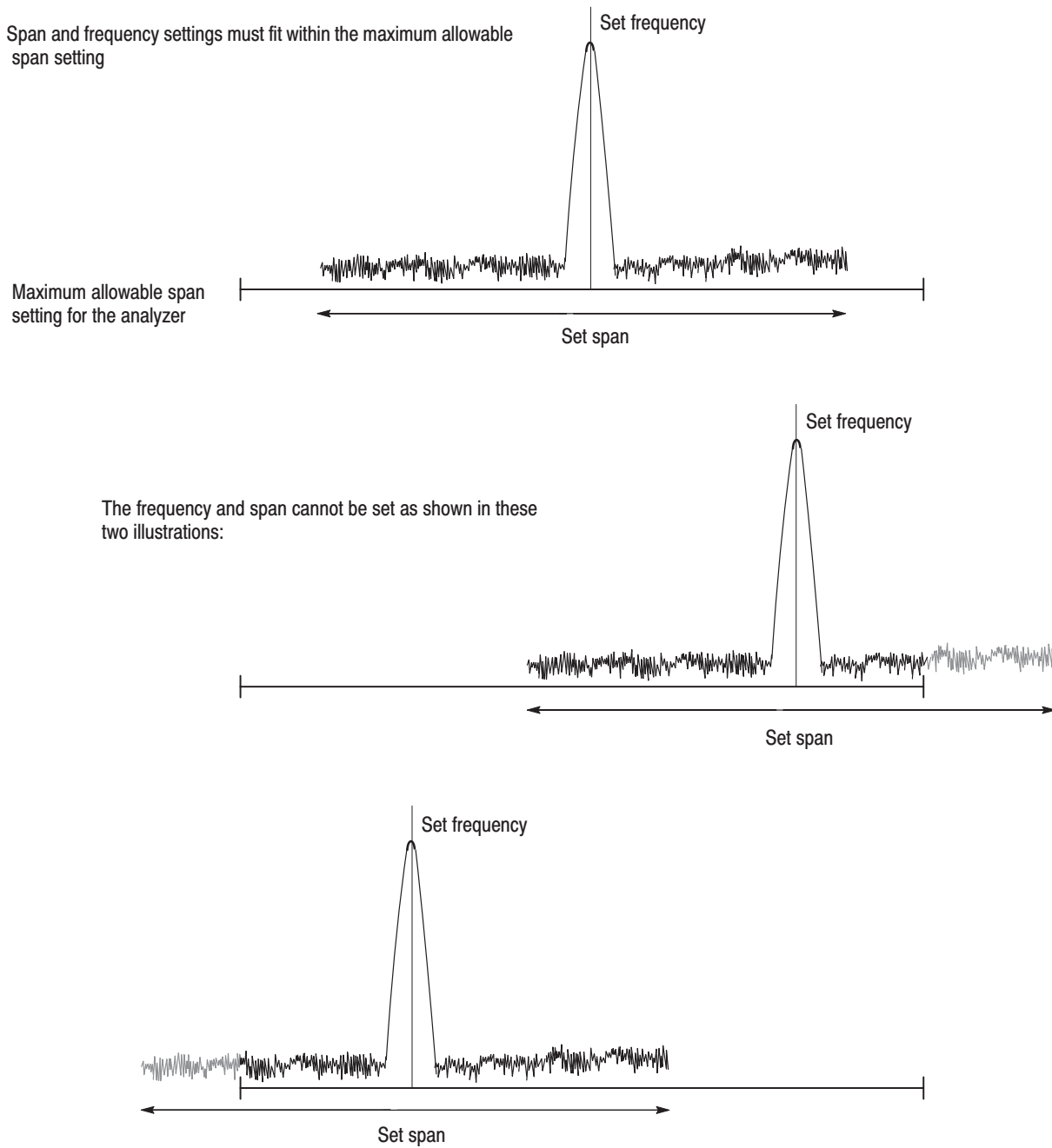
Unless you ensure that the span setting, which extends on either side of the new center frequency, is still valid, the frequency you set using this procedure may not take effect. See the following topic, *Buffering the Input Value*.

## Buffering the Input Value

Suppose that the frequency and span have been set to 1.5 and 3 GHz, respectively. If you attempt to change the frequency to 800 MHz, the value displayed in the Freq menu item returns to the initial value, 1.5 GHz. This is because you attempted to input a value that is inhibited as shown in Figure 3–3. The previously input 800 MHz frequency is saved and displayed in the Freq menu item when you select a valid span, such as 200 MHz.

Most settings immediately affect the hardware. The frequency and span settings are written into the buffer. For possible combination of settings, they are then reflected directly to the hardware. If you attempt to input a value that is not allowed, it is buffered but not set in the hardware. If you change another parameter and the combination is permitted, the buffered value takes effect and is reflected to the hardware.

This buffering is made in frequency, span and frame period settings.

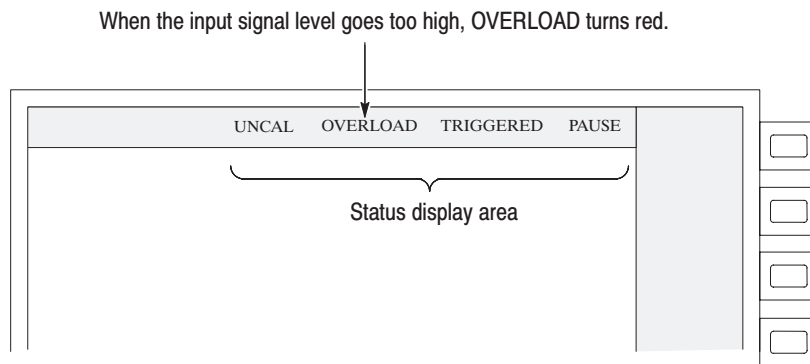


**Figure 3-3: Relationship between the frequency and span settings**

# Reference Level

Set the reference level, depending on the input signal level. If the input signal level goes too high or the reference level setting is too low for the default (0 dBm), an input overload may occur.

When an overload occurs, OVERLOAD turns red in the status display area on the screen. Refer to *Status Display* on page 2-7 for the status display.



**Figure 3-4: Overload indicator**

Changing the reference level actually changes the attenuator setting for the internal amplifier. If you continue to operate the analyzer after an overload has occurred, the internal DAC will not work for acquired signals, resulting in a corrupt data display.

The OVERLOAD indicator is updated each time one physical frame is acquired. Because the indicator is for only the current frame, you could miss an overload condition when you have set a long span in the RF mode. In a long span, two or more physical frames are used by one scan; when a high-level signal occurs, OVERLOAD turns red momentarily and then disappears. If you have made settings so that one scan uses one physical frame, a similar phenomenon may result when a single-shot signal occurs.

## Setting the Reference Level

You can use shortcut keys to set the reference level.

1. Press the **SETUP:REF** key.
2. Use the general purpose knob to increment or decrement the numeric value.  
The setting limits are as follows:

**Table 3-3: Reference level setting range**

| Mode                 | Setting range  |
|----------------------|----------------|
| IQ (3086 only)       | -50 to +30 dBm |
| Wideband (3086 only) |                |
| RF                   |                |
| Baseband             | -30 to +30 dBm |



# Time and Frequency Domains

This analyzer is equipped with a hardware fast Fourier transform (FFT) analyzer. This enables concurrent measurement of time and frequency domain data.

The following two FFT parameters are available:

- FFT points
- FFT window

## Setting the Parameters

Use the following procedure to set the parameters:

1. Press the **SETUP:MAIN** key. The **SETUP:MAIN** menu is displayed.
2. Press the **Input,FFT...** side key. The **Input, FFT...** submenu is displayed.

### **FFT points.**

3. Select the number of FFT points.
  - a. Press the **FFT Points** side key.
  - b. Turn the general purpose knob to select either **1,024** or **256**.

### **FFT window.**

4. Select the FFT window.
  - a. Press the **FFT Window** side key.
  - b. Turn the general purpose knob to select the FFT window.

Refer to *About FFT Window* on page 3–14 for FFT window types.

## About FFT Points

You can select either 256 or 1,024 for the number of FFT points. The Dual and Zoom modes allow you to select only 1,024 points. If you set this value to 256 and switch the mode to Dual or Zoom, the analyzer automatically switches it to 1,024.

The number of points set here is the number of sampling points in one physical frame for the frequency and time domain.

If the number of points is small, you can observe the time-dependent spectrum variation more exactly in the spectrogram or waterfall view. If the number of points is large, the signal-to-noise (SN) ratio and the frequency resolution will be improved.

Refer to *Frame Period and Realtime* on page 3–17 for frame details.

## About FFT Windows

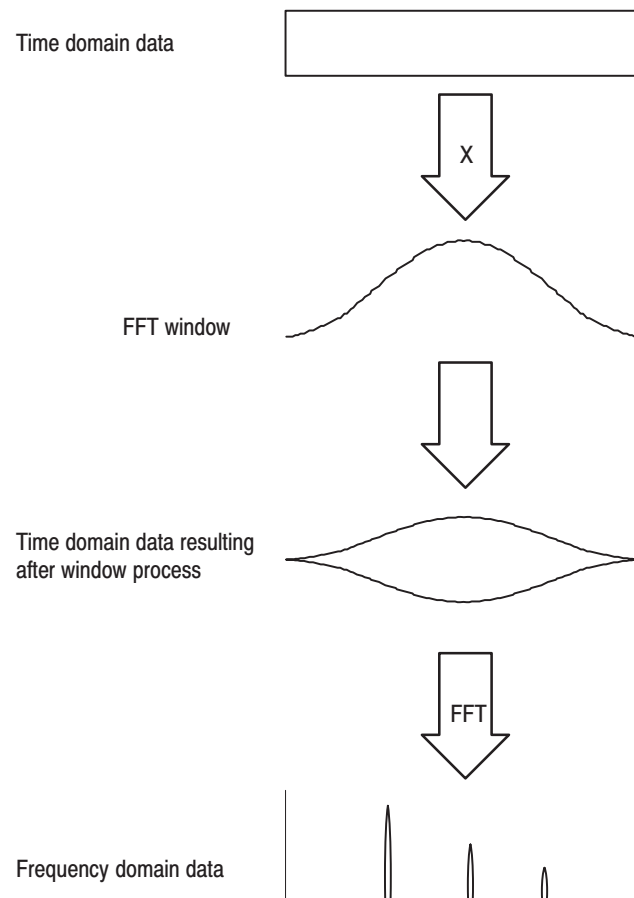
Figure 3–5 outlines how the frequency domain data is generated from the time domain data.

The FFT window serves as the band pass filter located between the time and frequency domain data. The FFT frequency resolution and amplitude accuracy of each frequency component depend on the window shape.

The analyzer supports three FFT windows: Rectangular, Hamming, and Blackman-Harris. See Table 3–4.

Generally, the frequency resolution and the amplitude accuracy of a window are mutually contradictory. For ordinary measurement, select a window that enables the desired frequency component to be separated. Using such a window minimizes the leakage error and maximizes the amplitude accuracy, with each frequency component separate.

To select the optimum window, first select the window that maximizes the frequency resolution (Rectangular window). Then, sequentially switch to windows with less frequency resolution (Blackman-Harris). Use the last window that still passes the frequency component to be separated. Suitable frequency resolution and amplitude accuracy are obtained by using the window immediately before the one from which the frequency component cannot be separated.

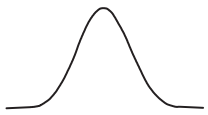
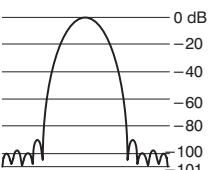

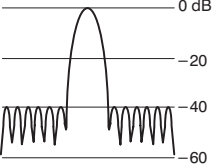

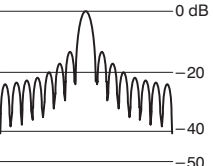


**Figure 3-5: Window process of time domain data**

Consider the following characteristics when selecting the FFT window (see Table 3-4) :

- Reducing the main lobe width of the window improves the frequency resolution.
- Reducing the side lobe level relative to the main lobe decreases the leakage error and improves the amplitude accuracy of the frequency component.

**Table 3-4: FFT window and band pass filter**

| Window type   | Bandpass filter   | -3 dB Band width | Maximum side lobe |
|---|---|------------------|-------------------|
|  <p>Blackman-Harris Window</p> |  | 1.28             | -94 dB            |
|  <p>Hamming Window</p>         |  | 1.28             | -43 dB            |
|  <p>Rectangular Window</p>     |  | 0.89             | -13 dB            |

# Frame Period and Real Time

The frame period settings are important when acquiring data in the real-time block mode. This section describes how to set the frame period and describes the relationship between the frame period and real time.

Note that Zoom does not allow you to set the frame period because it uses a fixed frame period.

## Setting the Frame Period

1. Press the **SETUP:MAIN** key. The **SETUP:MAIN** menu is displayed.
2. Press the **Frame Period** side key.
3. Use the general purpose knob to increase or decrease the current value. Alternatively, use the numeric key pad to input the numeric value.

## Frame Period and REALTIME Acquisition

Figure 3–6 shows the frame period concept, which is effective only in the block mode. In (1) of Figure 3–6, the frame period is set so that the frames overlap in time. If this frame period is the minimum, you can observe the time-dependent frequency variation in more detail on the spectrum waveform. You can set the frame period so that it continues or discontinues in the temporal aspect.

In the roll mode, the display takes place each time the signal is written into a frame; the frame period is not valid.

Table 3–5 lists the default minimum frame period. The minimum frame period depends on the number of FFT points and the span.

In the Dual mode, default settings are made so that the frame period is minimized. In the Zoom mode, the frame period continuing in the temporal aspect is set. If settings are made so that the frame period continues or overlaps in the temporal aspect, the data acquisition is achieved in real time in the block mode. In this case, **REALTIME** turns blue in the status display area on the screen (see Figure 3–7).

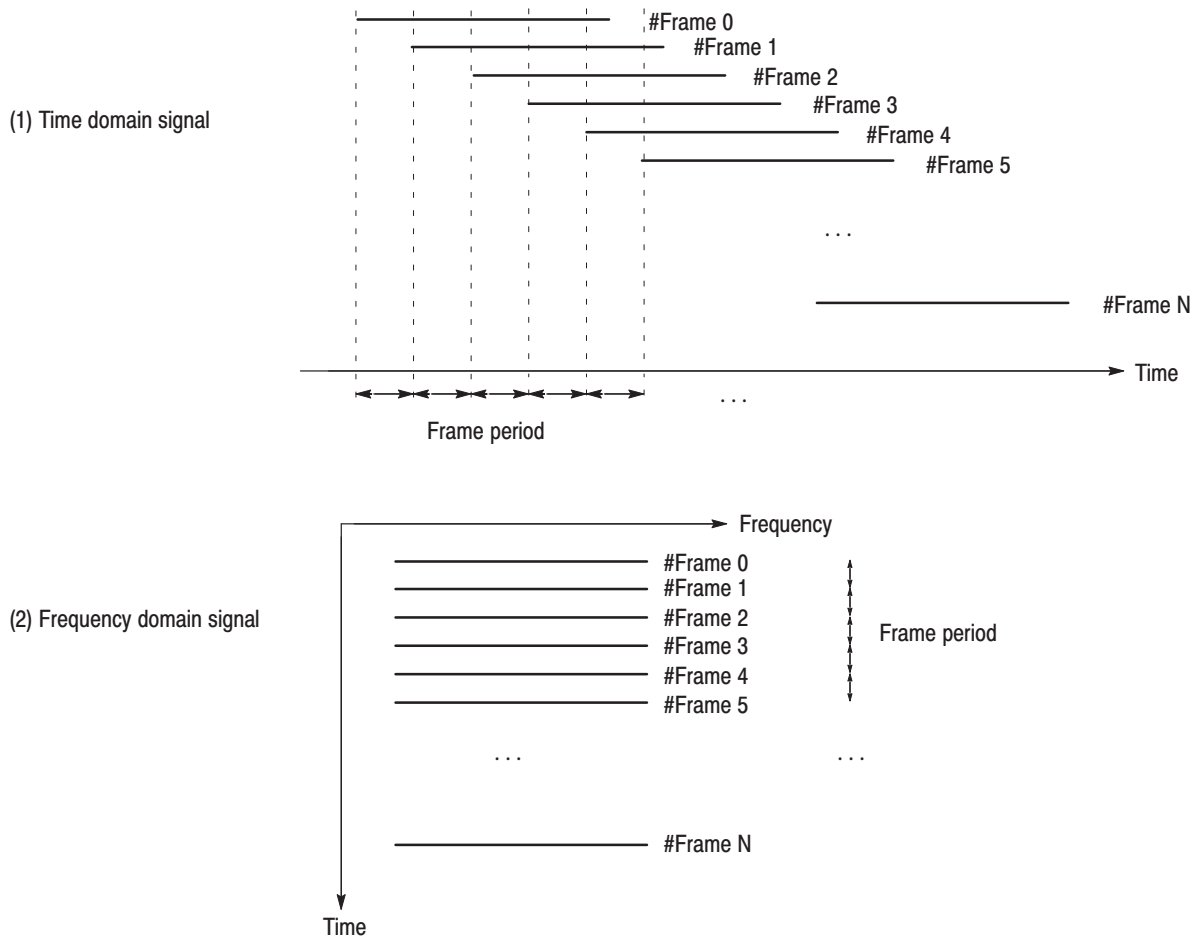


Figure 3-6: Time and frequency domain frame period

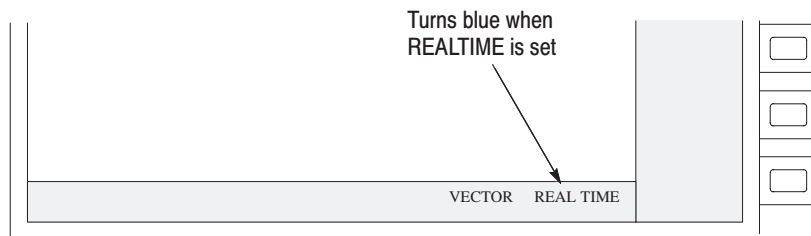


Figure 3-7: Checking that real time has been set

**NOTE.** If the span is set to 10 MHz in the Baseband mode and the frame period to 80  $\mu$ s, the data can be acquired in real time. The RF mode allows the data to be acquired in real time only when the span is set to 6 MHz or less.

**Table 3-5: Minimum frame period**

| FFT points                            | Span             | Frame length | Minimum frame period |
|---------------------------------------|------------------|--------------|----------------------|
| 256                                   | 10 MHz and 6 MHz | 20 $\mu$ s   | 20 $\mu$ s           |
|                                       | 5 MHz            | 40 $\mu$ s   |                      |
|                                       | 2 MHz            | 80 $\mu$ s   |                      |
|                                       | 1 MHz            | 160 $\mu$ s  |                      |
|                                       | 500 kHz          | 320 $\mu$ s  |                      |
|                                       | 200 kHz          | 800 $\mu$ s  | 200 $\mu$ s          |
|                                       | 100 kHz          | 1.6 ms       |                      |
|                                       | 50 kHz           | 3.2 ms       |                      |
|                                       | 20 kHz           | 8 ms         | 2 ms                 |
|                                       | 10 kHz           | 16 ms        |                      |
|                                       | 5 kHz            | 32 ms        |                      |
|                                       | 2 kHz            | 80 ms        | 20 ms                |
|                                       | 1 kHz            | 160 ms       |                      |
|                                       | 500 Hz           | 320 ms       |                      |
|                                       | 200 Hz           | 800 ms       | 50 ms                |
| 100 Hz                                | 1.6 s            | 100 ms       |                      |
| 1024 (RF and Base-band modes)         | 10 MHz           | 80 $\mu$ s   | 80 $\mu$ s           |
|                                       | 5 MHz            | 160 $\mu$ s  |                      |
|                                       | 2 MHz            | 320 $\mu$ s  |                      |
|                                       | 1 MHz            | 640 $\mu$ s  |                      |
|                                       | 500 kHz          | 1.28 ms      |                      |
|                                       | 200 kHz          | 3.2 ms       | 200 $\mu$ s          |
|                                       | 100 kHz          | 6.4 ms       |                      |
|                                       | 50 kHz           | 12.8 ms      |                      |
|                                       | 20 kHz           | 32 ms        | 2 ms                 |
|                                       | 10 kHz           | 64 ms        |                      |
|                                       | 5 kHz            | 128 ms       |                      |
|                                       | 2 kHz            | 320 ms       | 20 ms                |
|                                       | 1 kHz            | 640 ms       |                      |
|                                       | 500 Hz           | 1.28 s       |                      |
|                                       | 200 Hz           | 3.2 s        | 50 ms                |
| 100 Hz                                | 6.4 s            | 100 ms       |                      |
| 1024 (the 3086 Wideband and IQ modes) | 30 MHz           | 25 $\mu$ s   | 25 $\mu$ s           |
|                                       | 20 MHz           | 25 $\mu$ s   | 25 $\mu$ s           |
|                                       | 10 MHz           | 50 $\mu$ s   | 50 $\mu$ s           |





# Acquisition and Block Size

To acquire and display a signal, you can use either the roll or block mode. For the block mode, you need to set the block size. This section describes how to set up these modes and gives information about acquisition. It then describes the relationship between the frame period and real-time acquisition.

## Setting the Block Size

1. Press the **SETUP:MAIN** key. The **SETUP:MAIN** menu is displayed.
2. Press the **Block Size** side key.
3. Turn the general purpose knob to select the block size.

## Starting/Stopping Data Acquisition

**Roll Mode.** Press the **ROLL** key on the front panel to start the data acquisition in the roll mode. When you press the **ROLL** key again, the acquisition stops.

---

**NOTE.** *The trigger cannot be used in the roll mode.*

---

**Block Mode.** Press the **BLOCK** key on the front panel to start the data acquisition in the block mode. If the trigger has been set, the data acquisition starts when the trigger condition is satisfied.

In the block mode, the acquisition stops upon completion of acquisition of one block. If the trigger has been set, the acquisition stops after the specified number of blocks is acquired. Refer to *Trigger* page 3–47 for trigger details.

If you press the **BLOCK** key again while the data acquisition is in progress, the acquisition stops and only the acquired frame data is displayed. One-block data may be acquired in this way.

---

**NOTE.** *Unless the span is set to 6 MHz or less in the RF mode, the roll mode operates when you press the **BLOCK** key. Whenever you press the **BLOCK** key in the Baseband mode, the block mode operates.*

---

## Acquisition Mode

The block mode is used to display the processed data after writing it into the data memory. In this mode, the data acquisition stops after acquiring one block of data.

In the roll mode the captured data is written into the data memory frame by frame while being displayed. Thus, the data acquisition and display repeat until you press the **ROLL** key again.

In the roll mode, data continued in the temporal aspect is difficult to reproduce because the signal is displayed while being acquired. In addition, if a setting operation is in process or another application is running on this analyzer, an error frame may be generated unless the frame period is small. The frame period also depends on the number of views displayed and the contents displayed.

In the block mode, frames can be set to continue in the temporal aspect to contain time intervals between them or to overlap in the temporal aspect. This depends on the frame period setting.

## Block Size

In the block mode, the system acquires the data for the frames corresponding to the specified block size. The block size depends on the number of FFT points as listed in Table 3–6. The default is 20 for the CDMA EVM/Rho and Time Domain settings, or 200 for the other settings.

**Table 3–6: Block size selections**

| Mode      | FFT points | Block size   |
|-----------|------------|--|
| Frequency | 256        | 10, 20, 40, 100, 200, 400, 1000, 2000, 4000, 8000, 16000 |
| Frequency | 1024       | 10, 20, 40, 100, 200, 400, 1000, 2000, 4000              |
| Dual      |            | 10, 20, 40, 100, 200, 400, 1000, 2000                    |
| Zoom      |            |  |

Figure 3–8 shows the relationship between the block size and frames.



**Figure 3–8: Relationship between the block size and frames**

When the trigger count takes effect, the (block size  $\times$  trigger count) data is written into the memory. Note that you may not set the trigger count exceeding the maximum number of blocks.

The block size takes effect only in the block mode. In the roll mode, the block size you have set is ignored and the maximum block size is always used.

## Physical and Logical Frames

Any area reserved in memory is called a physical frame, while any frame in the display is called a logical frame. In any mode other than Scalar, data is written into one physical frame by one scan and this frame is displayed as one logical frame. In the Scalar mode, two or more physical frames are used by one scan (one logical frame).

The physical frame length (represented by the number of FFT points) corresponding to the block size is reserved in the data memory. They are reserved continuously in the memory and managed by software by indexing from the logical frames to the physical frames. See Figure 3–9.

Frame 0 indexes the physical frame that contains the latest written data. The frame index is updated each time data is written into a physical frame.

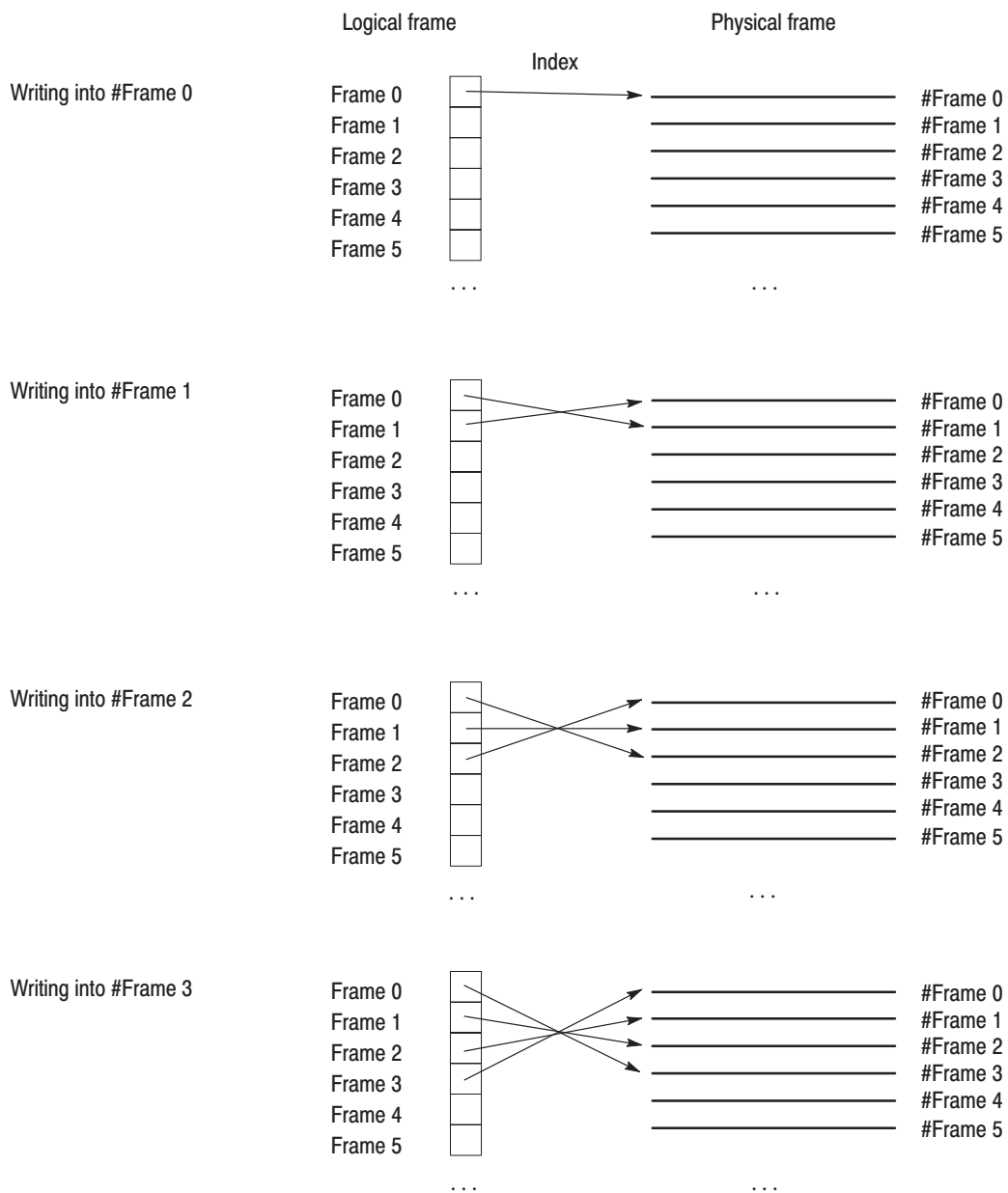


Figure 3-9: Indexes to physical frames (for frequency, dual, and zoom modes)

The display settings are made using this logical frame. A two-dimensional view displays the data that was written into frame 0, by default. A three-dimensional view always displays frame 0 on the lowest line.

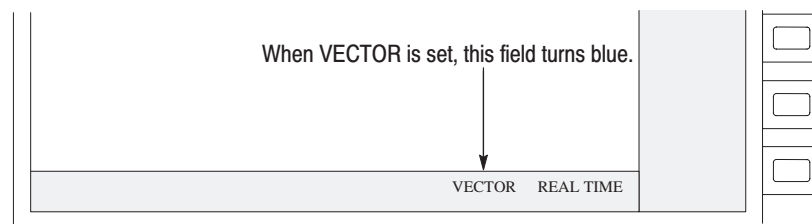
In the Scalar mode, one logical frame consists of two or more physical frames. Because a time gap occurs between physical frames during a signal scan, the time domain data will not be valid. Even if an unusual frequency phenomenon occurs during a time gap, it will not be reflected in the frequency domain data.

---

**NOTE.** *In the real time acquisition, there is one-to-one correspondence between physical and logical frames. The roll mode uses real time acquisition, so the physical frame is equivalent to the logical frame.*

---

In the Dual and Zoom modes, physical and logical frames are in a one-to-one correspondence, and the time domain data can be acquired and displayed. Once this data is acquired, it can be subjected to analog and digital modulation analyses. After the one-to-one correspondence is established, the VECTOR field on the status display line turns blue (see Figure 3–10).



**Figure 3–10: Checking that VECTOR has been set**

The one-to-one correspondence between physical and logical frames is also kept in the Frequency mode. The time domain data, however, is not written into the memory in this mode in order to enable the frequency domain data to be measured for a possible maximum time.



# Displaying the Data

You can display the acquired data on the display screen using the four views. The view is a window used to display the acquired data. You can define up to four views at the same time in the analyzer. They are named Views A, B, C, and D.

- You can specify the data display format for each of the views.
- You can specify the layout of the four views on the screen.

## Defining a View

To define a view, use this procedure:

1. Press the **CONFIG:VIEW** key on the front panel.

The **CONFIG:VIEW** menu is displayed.

2. Press any of the side keys of Views A to D. Then, turn the general purpose knob to select the desired view.

The selectable views are Waveform, Analog, FSK, Spectrogram, Waterfall, Polar, EyeDiagram, SymbolTable, and EVM. They are also CDMAWaveform, CDMAPolar and CDMATime that are specific for CDMA analysis.

You can define one to four views and display them concurrently on the display screen.

## Specifying the Data Source and Display Format

You can specify the input to the view and how to display the input data. For example, to specify the input data (data source) and display format for View A, perform the following steps:

1. Press the **VIEW:A** and **VIEW:MAIN** keys on the front panel.

The view menu is displayed.

2. Press the **Source** side key. Then, select the data source using the general purpose knob.

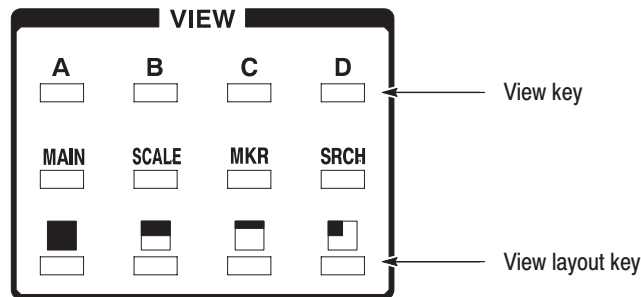
The data source selections depend on the view.

3. Press the **Format** side key and use the general purpose knob to select the display format.

The display format selections vary depending on the view.

## Specify the Layout on the Screen

Once you have specified the display format for the views, specify how they are placed on the screen. You can display one, two, or four of the defined views at one time. To do so, use the VIEW key on the front panel. (See Figure 3–11.)



**Figure 3–11: VIEW keys (view control keys)**

You can use the view layout specifying keys to define the view display layout.

- One-view display
- Two-view display
- Four-view display (1x4 or 2x2 display configuration)


---

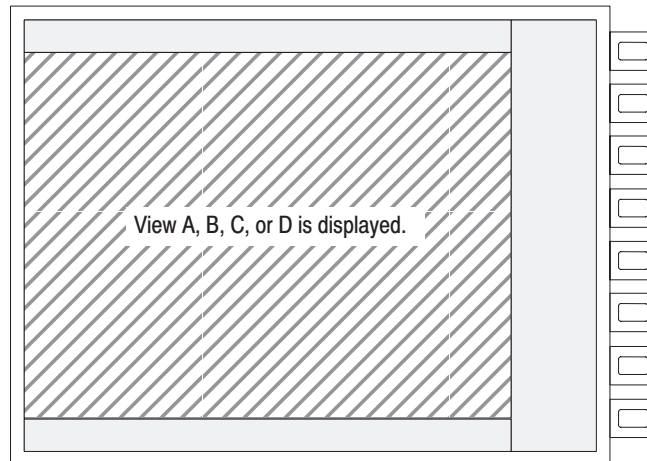
**NOTE.** If you have specified **None** for **Source** in a view menu, the display in this menu will be empty.

---




**One View Display**

You enter the one-view mode by pressing the  key in the VIEW area. One view is displayed on the screen. Then, use the view specifying key (**A**, **B**, **C**, or **D** key) to display the associated view.

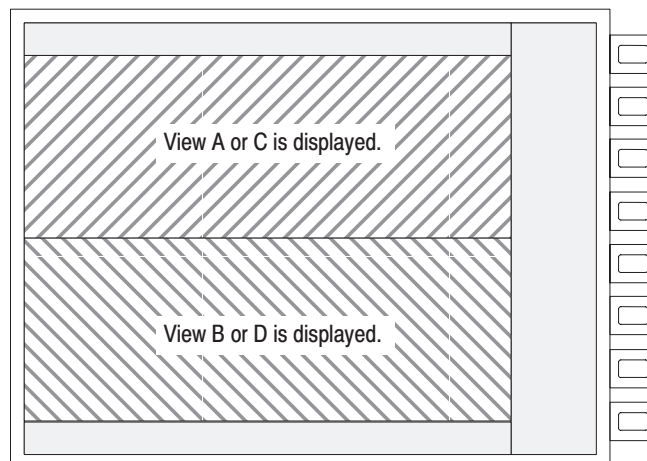


**Figure 3-12: One-view display**

**Two View Display**

You enter the two-view display mode by pressing the  key in the VIEW area. As shown in Figure 3-13, two views can be displayed concurrently in the two areas that are vertically partitioned on the display screen.


The upper and lower areas are as shown in Figure 4-13. Use the view specifying keys (**A**, **B**, **C**, and **D** keys) to display the desired view. Any undefined view appears empty.




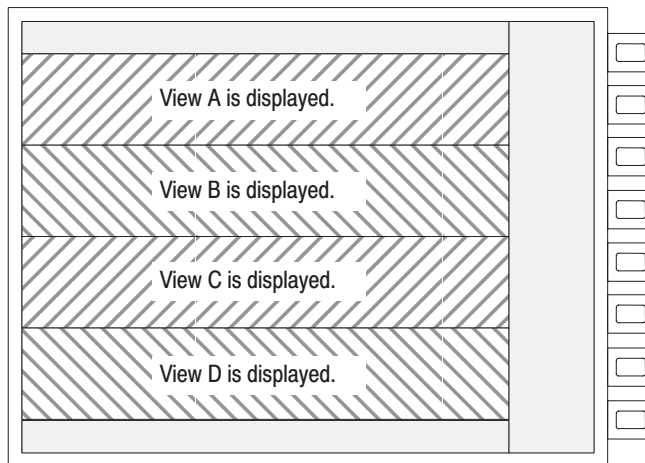
**Figure 3-13: Two-view display**

**Four-view Display**

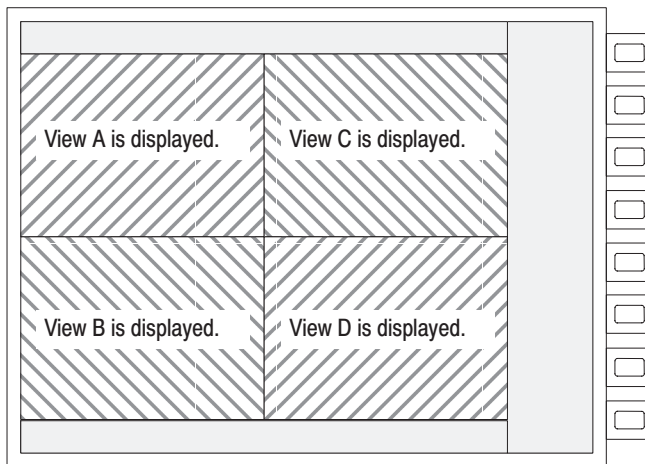
Four views can be displayed concurrently on the screen in either of the two types of configurations.

You enter the 1x4 display mode by pressing the  key in the VIEW area. As shown in Figure 3–14, four views can be displayed concurrently in the four areas vertically partitioned on the screen.

You enter the 2x2 display mode by pressing the  key in the VIEW area. As shown in Figure 3–15, four views can be displayed concurrently in the four areas partitioned in the two by two configuration. Any undefined view is empty.



**Figure 3–14: Four-view display (1x4 display)**



**Figure 3–15: Four-view display (2x2 display)**

## Scale and Bin

The horizontal and vertical axes in each view are defined automatically by the settings in the SETUP menu. In most cases, you do not need to change the scale settings. However, you may need to use the auto-scale function depending on the display.

Scaling is not supported for the Polar, CDMAPolar and SymbolTable displays.

### Using Auto Scale

The auto-scale function calculates the optimum scale from the acquired waveform and redraws the display. The roll mode allows use of this function even while the data is being acquired.

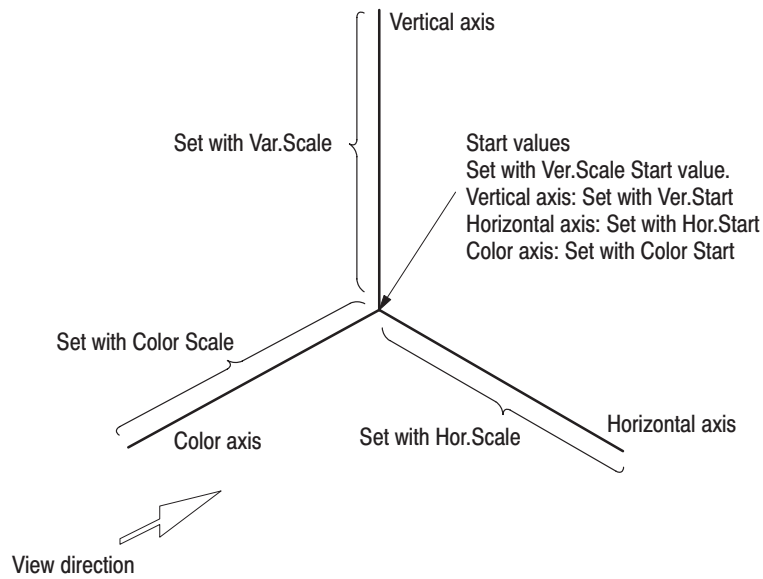
1. Select the view that you want to auto scale. For example, to select View A, press the **VIEW:A** key.
2. Press the **VIEW:SCALE** key.
3. Press the **Auto Scale** side key.

## Changing the Scale Manually

You can change the axis scale in the following way:

1. Select the view for which you want to change the scale. For example, to select View B, press the **VIEW:B** key.
2. Press the **VIEW:SCALE** key.

The Scale... submenu is displayed. Set the scale for each axis using the side keys defined in Figure 3–16.



**Figure 3–16: Scaling control**

### Special axis settings

- In the EYE diagram view, the horizontal axis represents the time indicating the symbol length. In this case, set a multiple of the symbol time length using the Eye Length side key in the view menu.
- In the Spectrogram view, the vertical axis represents the number of frames. The vertical axis is predefined as representing the number of basic frames. In this case, set a multiple of the number of basic frames using the Ver.Scale side key. Stop the data acquisition before changing the scale. If the data acquisition is active after the scale change, the setting returns to the axis setting used for the initial basic frames.

The number of basic frames is as follows:

One-view display: 660

Two-view display: 308

Four-view display (1x4 layout): 132

Four-view display (2x2 layout): 308

- In the Waterfall view, the spectrum for each piece of frame data is compressed to display vertically. Use Height to specify the width of the vertical axis representing each frame. Use Gap to specify the frame-to-frame interval. The value can be set in increments of pixels. Set the start value of this height and width using the Height Start and Height Scale side keys, respectively.

---

**NOTE.** For the frequency area in the waterfall display, the horizontal axis start value applies only to the frame 0 data. Note that the start value varies from frame to frame. For details, refer to Movement of the Markers in the Three-dimensional View in the Time Domain on page 3-46.

---

## Number of Bins

The number of bins varies with the span setting, but does not vary with the scale.

**Table 3-7: Number of bins**

| Mode                        | Span           | Number of bins |
|-----------------------------|----------------|----------------|
| IQ, Wideband<br>(3086 only) | 10 MHz, 20 MHz | 501            |
|                             | 30 MHz         | 751            |
| RF, Baseband                | 2 MHz or less  | 641            |
|                             | 6 MHz          | 481            |
| Baseband                    | 5 MHz, 10 MHz  | 801            |

The number of bins is effective for any mode other than Scalar. In the Scalar mode, the number of bins does not pertain because two or more physical frames are used for display.

The frequency band width of each bin is determined as follows:

$$\text{Frequency Bandwidth} = \frac{\text{Set Span}}{\text{Number of Bins}}$$

# Marker Operations and Search

A marker moves along the waveform and indicates the exact value of the data point at the current marker position. Two types of markers can be used. One is called merely the marker and is represented with a  $\square$  on the screen. The other is called the delta ( $\Delta$ ) marker and is displayed with a  $\square$  and  $\diamond$  on the screen.

The primary marker is used to measure absolute values such as the frequency, time, amplitude level, and phase at the current marker position. It is also called the absolute marker.

The delta marker is used to measure relative values such as the time, frequency, and phase difference and the amplitude level by obtaining the differences between the two markers. The delta marker is also called the relative marker.

You can use the markers to create the trigger mask pattern and to switch the frame to be displayed. Refer to *Creating the Trigger Mask Pattern* on page 3–59 for trigger mask pattern. Refer to *Switching the Display Frame* on page 3–41 for switching the frame to be displayed.

## Marker Characteristics

When you move the marker in a view, the markers in all views in the display with the same unit for the horizontal axis, move concurrently. This rule applies regardless of whether the view is three- or two-dimensional.

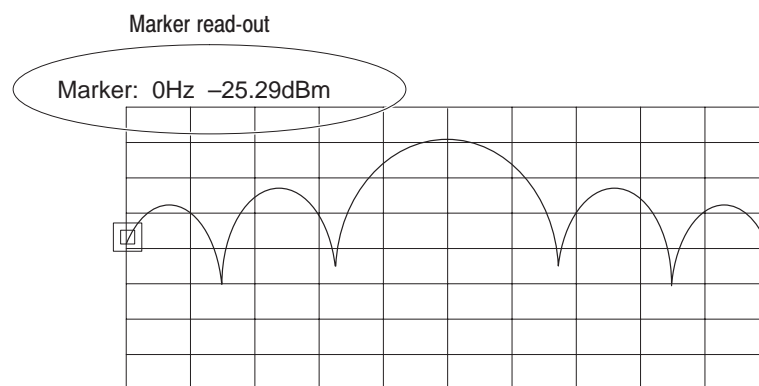
Once you move the marker vertically in a three-dimensional view, the display frames in all two-dimensional views in display vary according the marker movement. Refer to *Switching the Display Frame* on page 3–41 for details.

## Moving the Primary Marker

To move the primary marker, you can input a numeric value, use the general purpose knob, or use the search function.

The marker search function is disabled in three-dimensional displays, such as color spectrogram or waterfall display. The search function is not supported for Polar, CDMA Polar, EyeDiagram, and SymbolTable view.

When the marker is used, it is continuously displayed. The read-out of the marker position is displayed in the top left position outside the display area (see Figure 3–17).



**Figure 3–17: Marker read-out position**

1. Press one of the **VIEW:A** to **VIEW:D** keys (the one associated with the desired view). The desired view menu is displayed.
2. Press the **VIEW:MKR** key to display the menu used for marker operations.
3. Move the marker in either of the following ways:

### **Numeric Input.**

- a. Press the **Hor.** side key. Then, input the numeric value to move the marker horizontally. If the **Ver.** menu item is displayed, you can also move the marker horizontally by pressing the **Ver.** side key and inputting the numeric value.



**General Purpose Knob.**

- b. Press the **Hor.** side key. Then, turn the general purpose knob to move the marker horizontally. If the **Ver.** menu item is displayed, you can also move the marker vertically by pressing the **Ver.** side key and turning the general purpose knob.

The vertical movement of the marker is permitted in a three-dimensional display such as a color spectrogram or waterfall display.

In the Polar, EyeDiagram, or SymbolTable view, the Time Marker side key is displayed instead of the Hor. or Ver. side key.

4. Read the marker read-out.

## Searching the Spectrum

You can search the displayed waveform for the maximum value and position the marker there.

1. Press the **VIEW:SRCH** key.

The analyzer searches the maximum peak spectrum and positions the marker there. Rotate the general purpose knob clockwise to search peak rightward, and vice versa.

2. Read the marker read-out.

The contents of the read-out depends on the nature of the displayed waveform. For example, if the vertical and horizontal axes represent the phase and time, the phase and time components at the marker position are read out. If the horizontal and vertical axes represent the frequency and the amplitude level respectively, their components in the marker position are read out.

## Operating the Delta Marker

The delta marker has many controls including on/off and reset.

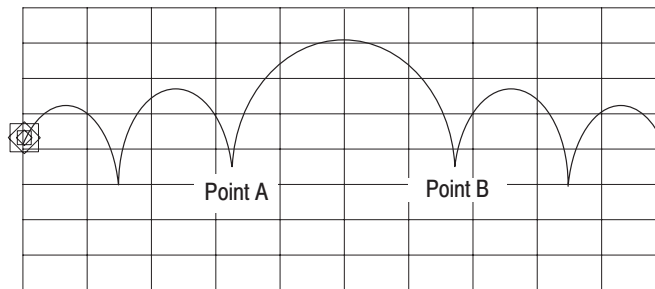
You can place the  $\diamond$  marker only in the  $\square$  marker position, but you cannot move it freely. When you press the **Reset Delta** side key, the  $\diamond$  moves to the  $\square$  position. Even if you move the  $\square$  again, the  $\diamond$  remains there.

Operate the delta marker using the following procedures:

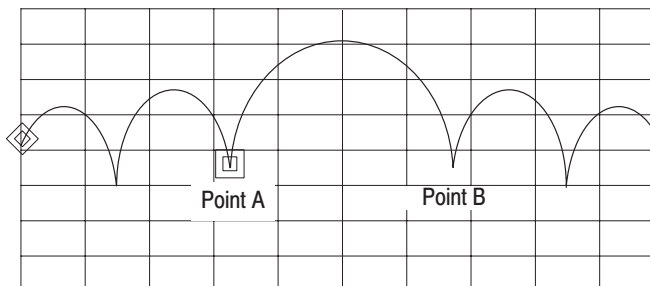
1. Press one of the VIEW:A to D keys (the one associated with the desired view).
2. Press the VIEW:MKR key to display the menu used for marker operations.
3. Select **On** using the **Delta Marker** side key.

The Marker label in the top left position outside the display area changes to the Delta label.

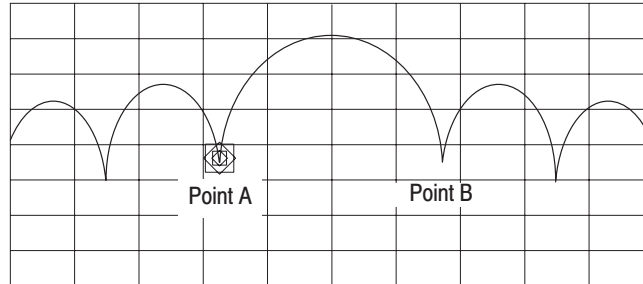
Delta: 0Hz 0.0dBm



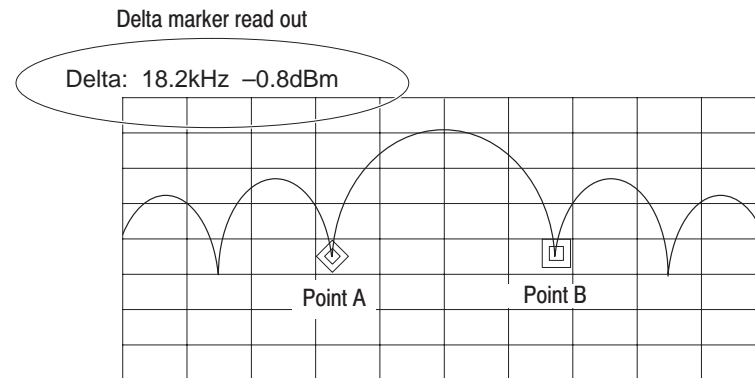
4. Move the  $\square$  marker to the desired position (Point A).



5. Press the **Reset Delta** side key to move the  $\diamond$  marker to the  $\square$  marker position.



6. Move the  $\square$  marker to the desired position (Point B). The  $\diamond$  marker remains there.



The  $\diamond$  marker is positioned at Point A, and the  $\square$  marker at Point B.

7. Read the marker read-out.

## Contents of Read Out

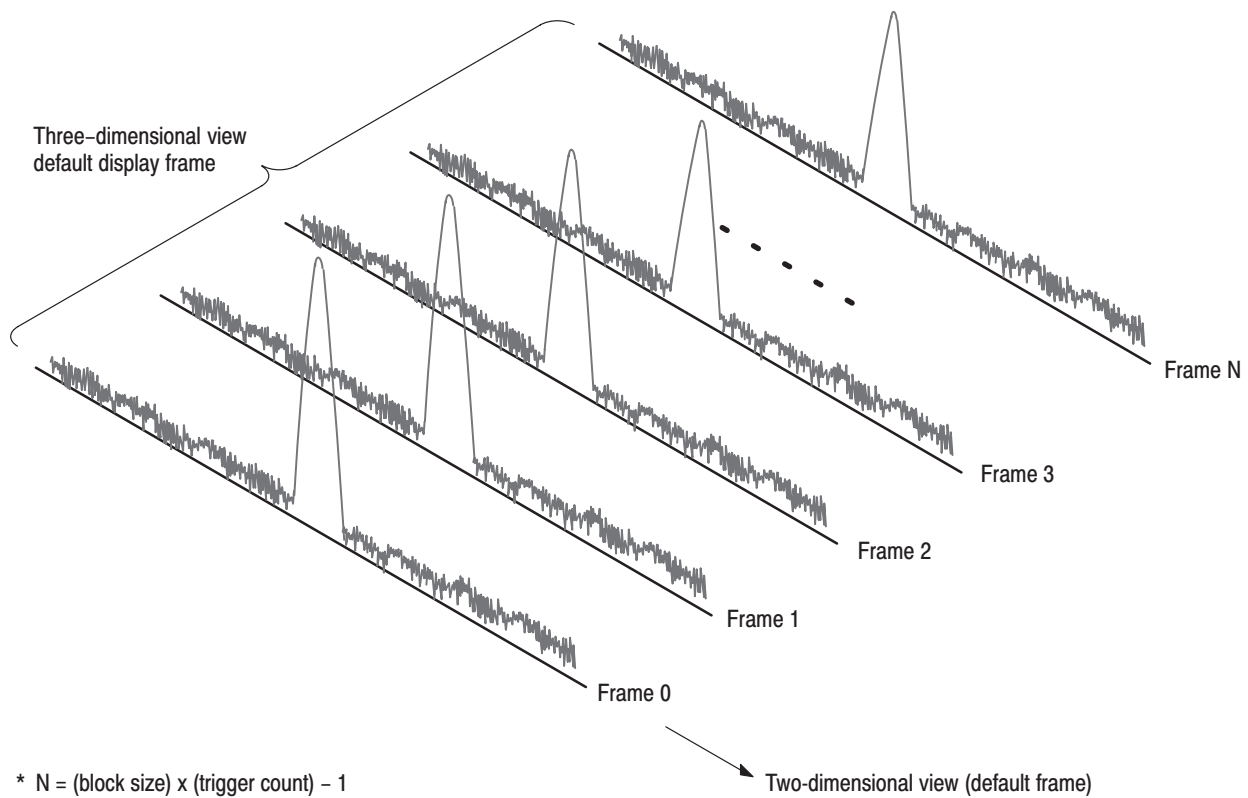
In the Polar and CDMA Polar view, the symbol position, amplitude, and phase at the marker position is read out. When calculating the amplitude, the distance to the most distant position in which the symbol of the ideal signal should be positioned is assumed to be 1. The symbol position is displayed in floating point value. It only indicates a position exceeding the symbol, and the fractional part of the value is not pertinent.

In the SymbolTable view, the symbol position in which the digit at the marker position is recognized, is read out.

# Switching the Display Frame

Two or more frames are displayed at a time in a three-dimensional view, such as a color spectrogram or waterfall view. Only one frame is displayed in a two-dimensional display (default: frame 0). You can display this frame while changing its view settings.

If two or more views are in display, switching the display frame in a view causes the display frames in all the other views to be switched. This allows you to observe a piece of data from various standpoints.



**Figure 3-18: Display frames**

## Switching Display Frames in a Two-dimensional View

Use the following procedure to switch the frame to be displayed:

1. Display the view menu for the view is to be switched.

For example, if you want to switch the display frame of View C, display this view using the following procedures:

- a. Press the VIEW:C key.
- b. Press the VIEW:MAIN key.

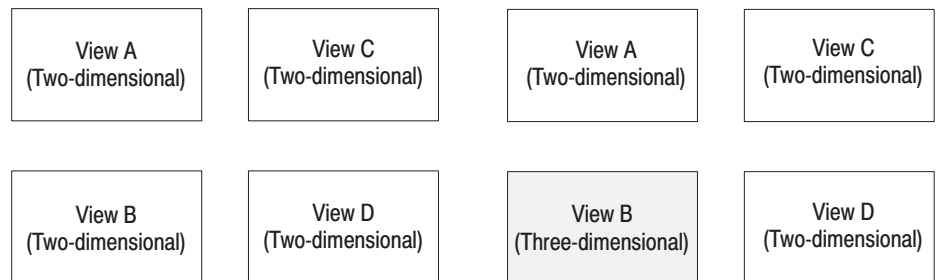
2. Press the **Frame** side key and then input the desired frame number.

Change the frame number continuously by turning the general purpose knob. In this way, you can continuously display the time-dependent variation in a waveform.

The input range is 0 to (number of blocks – 1) unless the trigger count has been enabled. It is 0 to (trigger count × number of blocks – 1) if the trigger count has been enabled.

## Switching the Linked Frames

If two or more two-dimensional views are in display, switching the frame in a view causes the display frames in all the other two-dimensional views to be switched. The frame position of the marker in each three-dimensional view is also switched.



If all of Views A to D are two-dimensional, all display frames of Views B to D are also switched from 0 to 100 when the display frame of View A is switched from 0 to 100.

If only View B is three-dimensional and all the others are two-dimensional, the display frames of Views C and D are also switched when the display frame of View A is switched.

At this time, the frame position of the marker displayed in View B moves together with the display frame of View A.

(A)

(B)

**Figure 3-19: Switching linked frames**

When you switch the marker frame position in a three-dimensional view, the display frames in the other two-dimensional views are switched accordingly.

If time-dependent variation appears in a three-dimensional view in a certain area, use of the above function helps you observe time-dependent variation in detail in the spectrum within this area.

The marker linking function also works among the Polar, EyeDiagram, and SymbolTable views.

This data and the primary marker are displayed in every view. Any two-dimensional view always displays the frame in the marker position. Therefore, when the marker position changes in a certain view, the display frame and marker position change accordingly in all the other views.

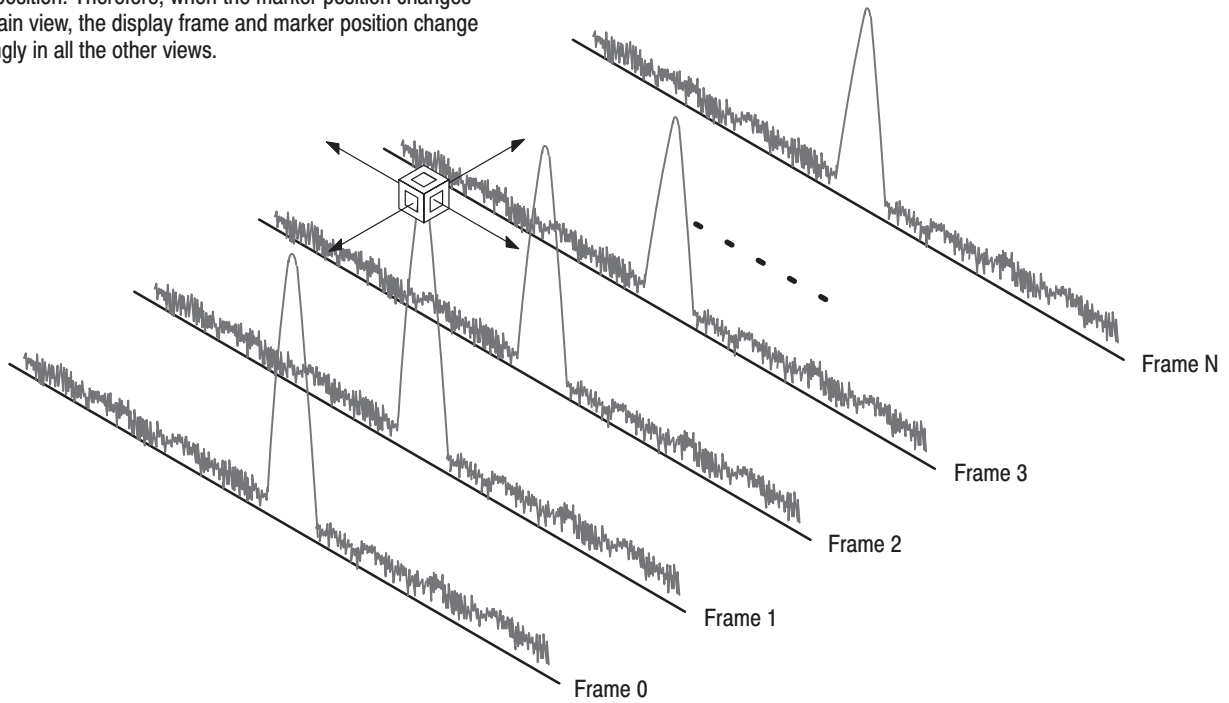


Figure 3-20: Marker and frames



## Changing the Marker Frame Position in a Three-dimensional View

1. Select the three-dimensional view and display the Marker menu. For example, if View B is three-dimensional, operate the keys as follows:
  - a. Press the VIEW:**B** key.
  - b. Press the VIEW:**MKR** key.
2. Press the **Ver.** side key and then change the value.

When you change the numeric value continuously using the general purpose knob, the display frame in the two-dimensional view continuously changes accordingly. Use this technique to observe time-dependent variation in detail in the spectrum waveform.

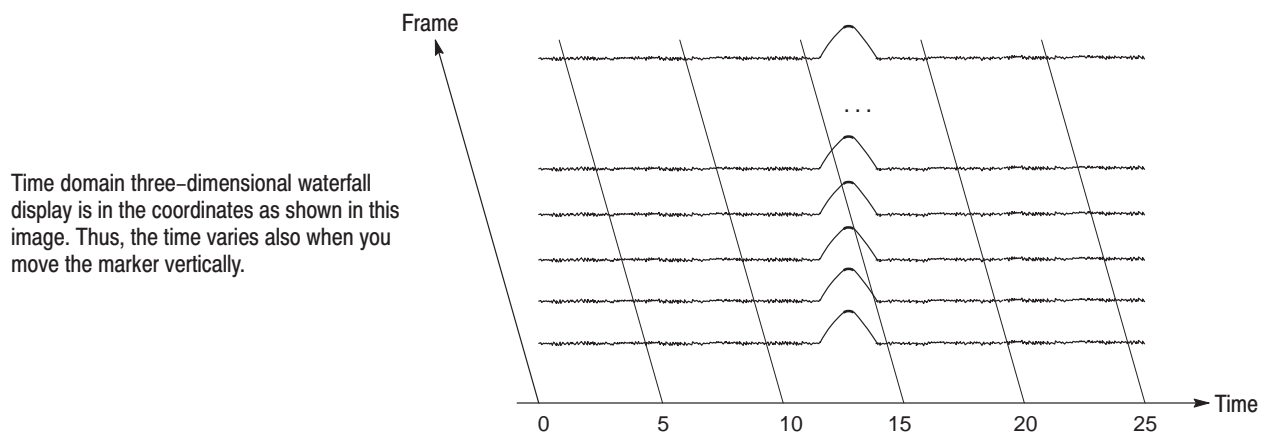
## Marker Movement in a Time Domain Three-dimensional View

In the time domain, the start time varies from frame to frame. Refer to *Frame Period and Realtime* on page 3–17 for details.

The horizontal axis represents the time, and the start time at the left end is 0 in time domain waterfall display. This rule applies only to frame 0. For Frame 1, the start time is equal to the last frame period. For Frame 2, the frame time is  $-(\text{frame period} \times 2)$ . That is, the start time for frame N is as follows:

$$-(\text{Frame Period} \times \text{Frame } N)$$

When you move the primary marker vertically in time-domain waterfall display, the time varies. You can examine the relative difference in time between two phenomena by using the delta marker.



**Figure 3-21: Coordinates for the time domain, three-dimensional waterfall display**

# Trigger

The analyzer processes the input signal and writes it into the data memory independently of the trigger. The trigger only specifies the data acquisition stop timing and the frame display range. This section describes the trigger functions.

## Data Acquisition Timing

When you press the **BLOCK** key on the front panel, the analyzer begins to acquire the signal and write it into the data memory.

Once the trigger condition has been satisfied, the analyzer then writes the required number of frames, stops the acquisition, and displays the signal data.

---

**NOTE.** *The trigger is the means by which the data acquired in a certain condition is held in the memory and displayed. Actually, the analyzer continually processes signals and writes the data into the memory even if no trigger event has occurred.*

---

Figure 3–22 shows the data that is acquired before and after a trigger event. When you press the **BLOCK** key, the analyzer begins to write the data into the data memory. When the trigger occurs, the data is written into  $(100 - \text{Pos})$  frames before the process stops. The frames to be displayed finally are those corresponding to the Pos percent setting and those corresponding to  $(100 - \text{Pos})$  frames acquired after the trigger generation.

For example, if you set the number of blocks to 400 and Pos to 30%, the normal trigger mode will display 120 frames before the trigger point and the 280 frames after the trigger point.

If the period between when you press the **BLOCK** key and when the trigger event occurs is too short, the data for the frames you specified with Pos may not be fully acquired. In this case, the size of the resulting display data does not fill the total number of blocks.

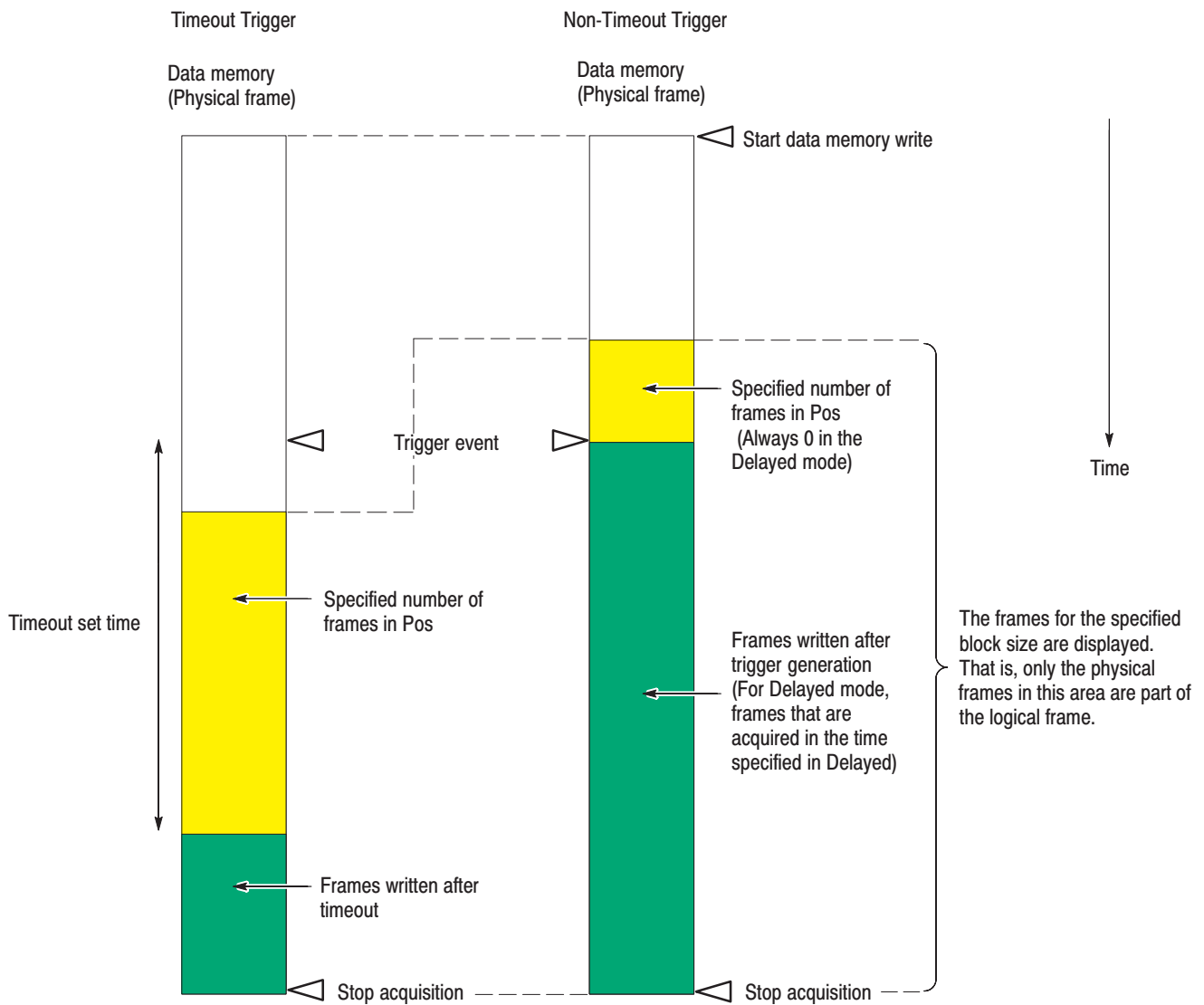
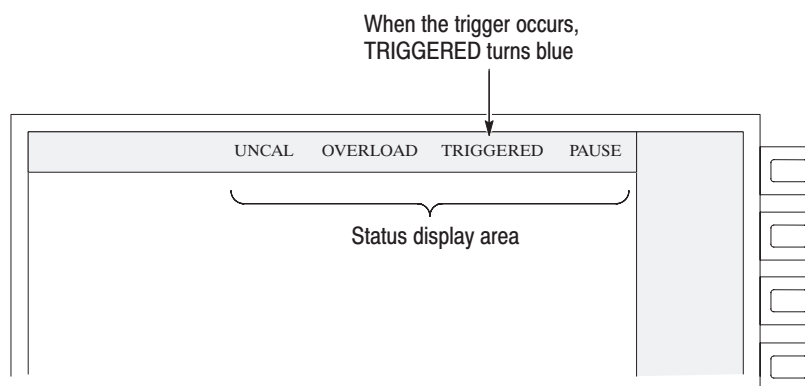


Figure 3-22: Data acquisition timing

If you press the **BLOCK** key again immediately after pressing it, the data acquisition will stop before a trigger has been generated. The data acquired in the data memory is still displayed in this case. From TRIGGERED in the status display field, you can determine whether the data was acquired before or after the trigger. If the data is acquired after the trigger event is displayed, this field turns blue.



**Figure 3-23: Trigger generation display**

If the trigger is generated and you press the **BLOCK** key again before the data acquisition stops, the acquisition will stop after filling the current frame. As a result, the data may be written into a frame that contains an area smaller than one block.

Refer to *Physical and Logical Frames* on page 3-23 for physical and logical frames.

## Trigger Source

There are two trigger sources: external and internal. The external trigger choice accepts the trigger signal through the front panel EXT TRIG connector. The internal trigger choice uses the trigger mask pattern to detect a trigger event.

### Setting.

1. Press the **SETUP:MAIN** key to display the SETUP:MAIN menu.
2. Press the **Trigger...** side key to display the submenu.
3. Press the **Source** side key to select either the **Internal** or **External** trigger source.

For the internal trigger, the trigger register is used. It must contain your trigger mask pattern. Refer to *Creating the Trigger Mask Pattern* on page 3–59.

For the external trigger, the signal input from the front panel EXT TRIG connector is used. In this case, you can specify either the input pulse rising or falling edge as the trigger event.

## Trigger Domain

The analyzer can cause the trigger in the time or frequency domain. The trigger domain is set automatically in the following condition:

- If the Format has been set to FreqAmpl in the Waveform view, the trigger domain is automatically set to the frequency domain when you press the Draw Max, Draw Line, Draw Mini, or Draw Horizontal side key for creating the trigger mask.
- If the Format has been set to TimeAmpl in the Waveform view, the trigger domain is automatically set to the time domain by the same operation.

**Setting.** To set the domain manually, specify it as follows:

Press the **Domain** side key to specify the domain to which you want to cause the trigger.

For the time domain, select **Time**. For the frequency domain, select **Frequency**.

## Trigger Mode

The trigger mode specifies how to acquire and display the data before and after trigger generation. There are eight trigger modes: Auto, Normal, Quick, Delayed, Timeout, Interval, Quick Interval, and Never.

**Setting** To set the trigger mode, press the **Mode** side key and select the trigger mode.

**Auto.** Acquires and displays one block of data when you press the **BLOCK** key. This takes place regardless of whether the trigger is generated, and repeats until you press the **BLOCK** key again (see Figure 3–24). The data is repeatedly written into the data memory within the same block.

Pressing the **BLOCK** key when the trigger count is on causes the data acquisition and display to repeat, until the specified trigger count is reached. The data from each trigger is written into different blocks in the data memory (see Figure 3–25).

**Normal.** Acquires the data as described in *Data Acquisition Timing* on page 3–47. Even if you press the **BLOCK** key, the analyzer waits for a trigger event.

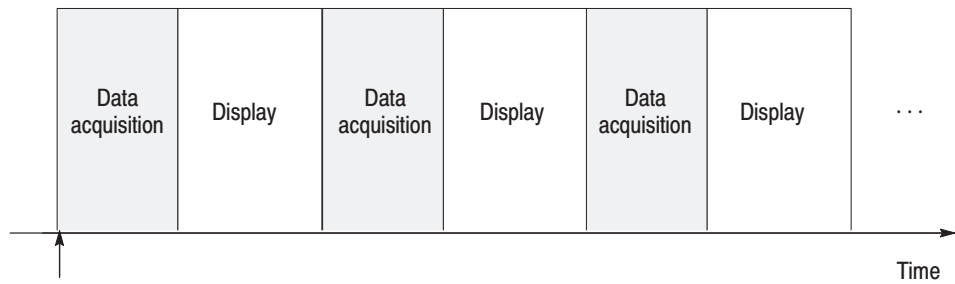
If the trigger count is on, the wait for trigger generation and the data acquisition will repeat until the specified trigger count is reached. The data from each trigger is written into different blocks in the data memory (see Figure 3–25).

In the Waveform view, you can set the trigger mode automatically to Normal when you press the Draw Max, Draw Line, Draw Mini, or Draw Horizontal side key in the Edit... submenu for creating the trigger mask pattern.

**Quick.** Works in the same manner as the Normal mode, except that the data is displayed after all blocks are acquired (see Figure 3–26). You can get phenomena which are missed during data display in the Normal mode.

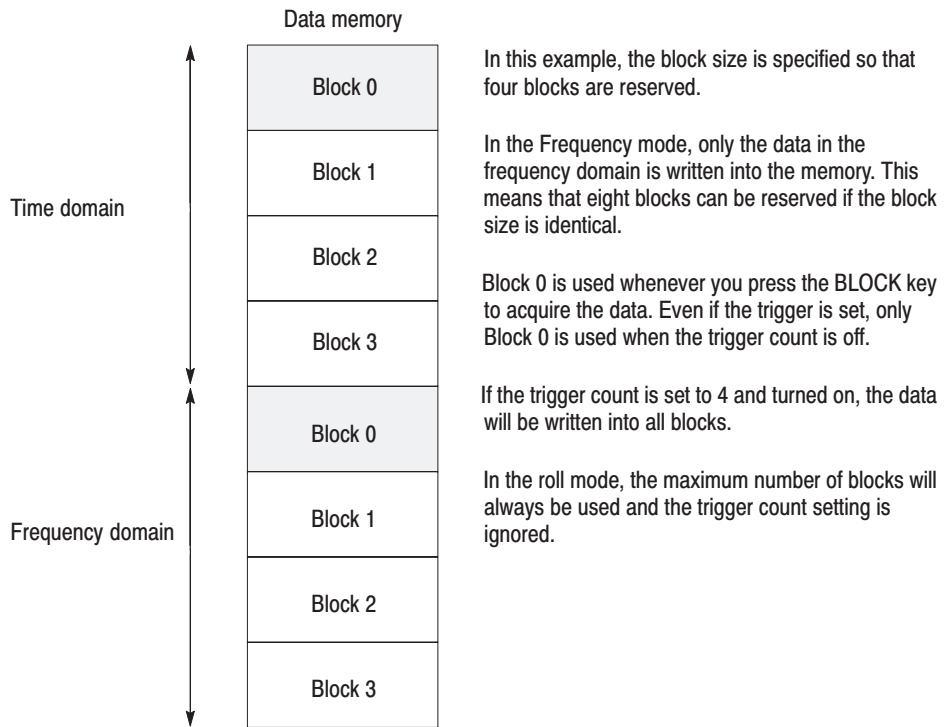
**Delayed.** Works in the same manner as the Normal mode, except that you can set the end point of the data acquisition to the specified time after the trigger event is generated.

The Delayed time can be set with Trigger...→Delayed.



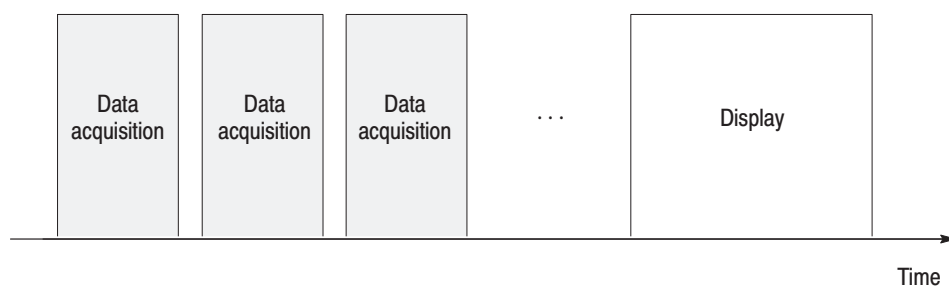
For the Auto mode, the point at which you press the BLOCK key.  
 For the Normal mode, the point at which the trigger occurs after you press the BLOCK key.

**Figure 3-24: Acquiring and displaying data in the Auto mode**



**Figure 3-25: Trigger mode and data memory (except the Auto mode)**

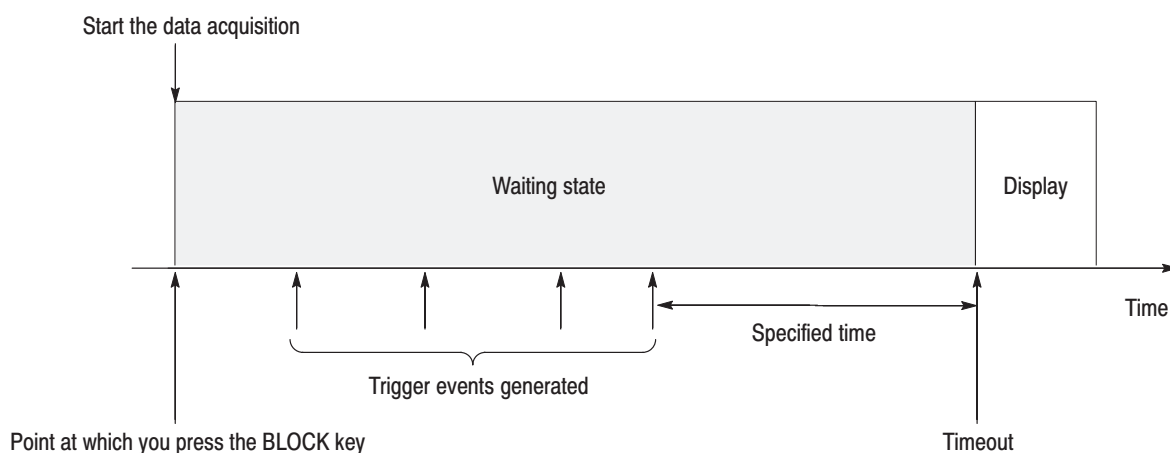




**Figure 3-26: Acquiring and displaying data in the Quick mode**

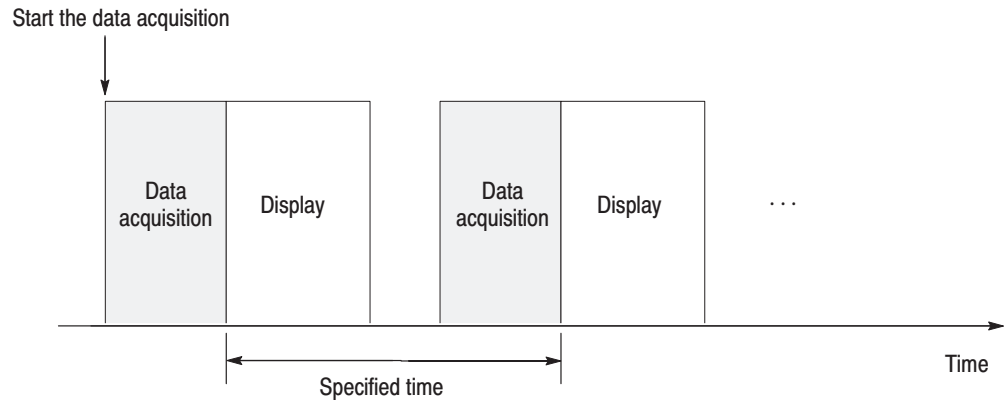
**Timeout.** Captures the data if no trigger event occurs for the predefined time. If trigger events occur in this mode, the waiting state continues as shown in Figure 3-27. The data in the blocks preceding and succeeding the timeout is displayed according to the settings. The trigger conditions, such as the trigger position and trigger count, are effective in this mode. This mode is effective when using the internal trigger source.

You can set the timeout with Trigger...→Timeout.



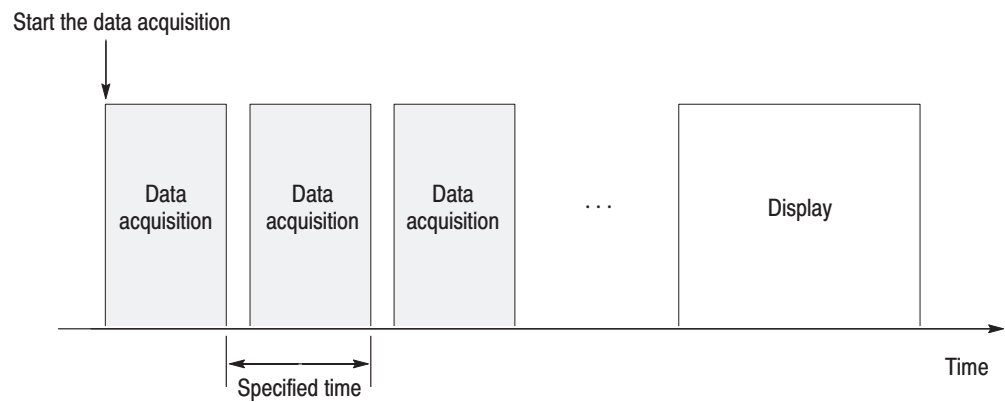
**Figure 3-27: Acquiring and displaying data in the Timeout mode**

**Interval.** Acquires block data at the specified time interval (see Figure 3–28). You can set the interval with Trigger...→Interval.



**Figure 3–28: Acquiring and displaying data in the Interval mode**

**Quick Interval.** Works in the same manner as the Interval mode, except that the data is displayed after all blocks are acquired (see Figure 3–29). You can get phenomena which are missed during data display in the Interval mode.



**Figure 3–29: Acquiring and displaying data in the Quick Interval mode**

**Never.** Disables trigger settings.

## Trigger Count

The trigger count specifies how many times the data acquisition should repeat. This function may operate in one of the following way depending on the trigger mode:

- When you press the **BLOCK** key, the data acquisition repeats the specified number of times before stopping. This takes place independently of the trigger condition.
- When you press the **BLOCK** key, a wait state for trigger generation occurs after each attempt. The data acquisition repeats the specified number of times before stopping.

Refer to page 3–21 for the descriptions of block mode and trigger count.

The maximum trigger count depends on the FFT points and memory mode settings as listed in Table 3–8.

**Table 3–8: Maximum trigger count**

| Memory Mode | FFT points | Maximum trigger count (fraction part rounded down) |
|-------------|------------|--|
| Frequency   | 256        | 16,000 for set block size                          |
| Frequency   | 1024       | 4,000 for set block size                           |
| Dual        |            | 2,000 for set block size                           |
| Zoom        |            |  |

**NOTE.** *Trigger is effective only in the block mode.*

### Setting.

1. Press the **Count** side key and set the trigger count **On** or **Off**.
2. Press the **Times** side key and input the trigger count value.

Figure 3–30 shows the example of three dimensional view.

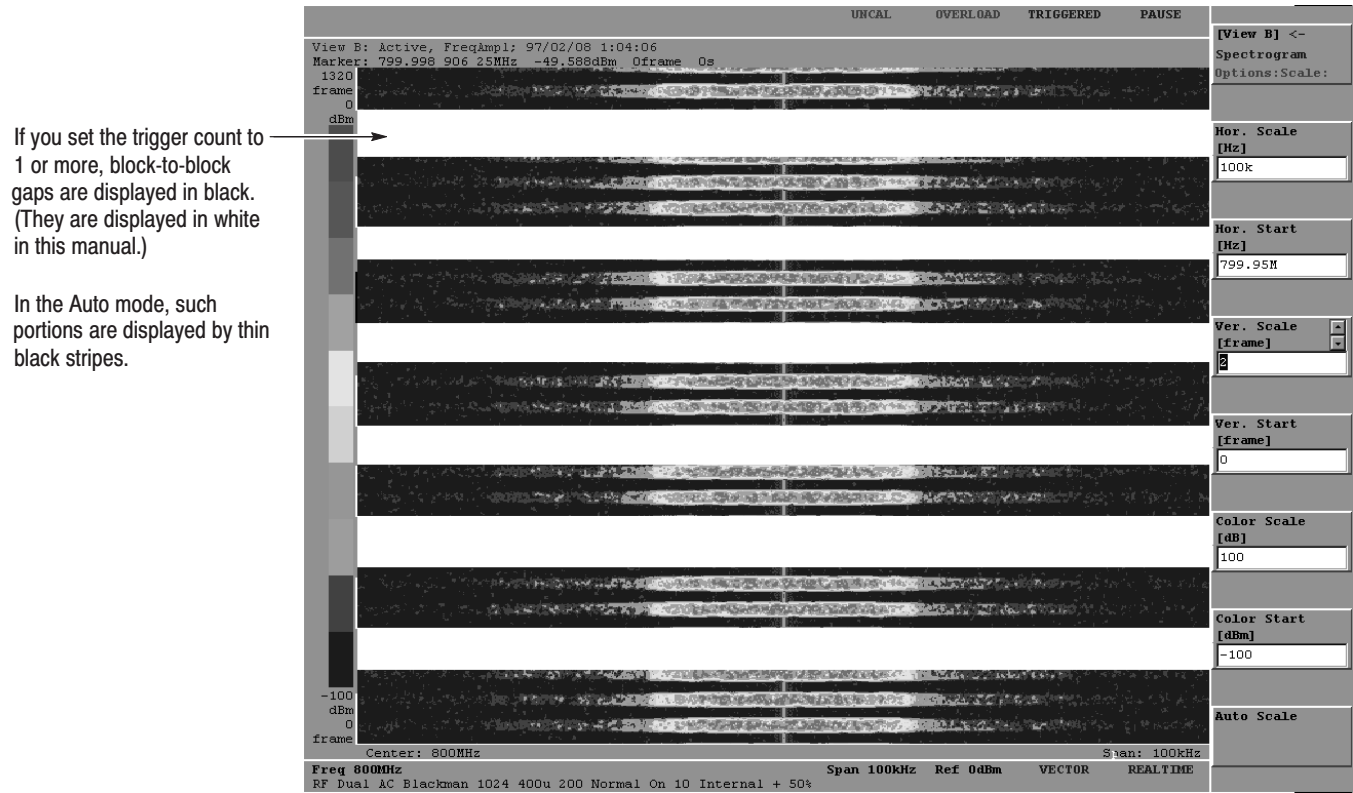


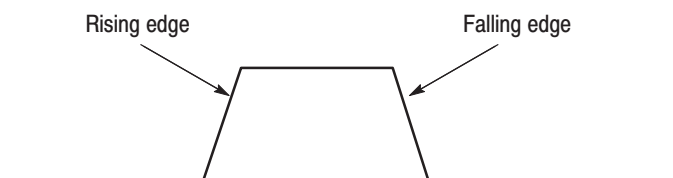
Figure 3-30: Three-dimensional view display effect resulting from setting a trigger count

## Trigger Parameters

The parameters slope and Pos control trigger timing and pre- and post-trigger acquisition.

**Slope.** When you set the trigger source to External, you can specify the trigger timing using the signal slope. Select either the rising or falling edge of the input trigger pulse as shown in Figure 3–31.

3. Press the **Pol** side key to select either **Rise** or **Fall**.



**Figure 3–31: Specifying the trigger generation timing by polarity**

When you set the trigger source to Internal, you can control whether the trigger is generated when the signal enters the mask area (Rise) or leaves the mask area (Fall).

**Pos.** The data is displayed as described in Table 3–9. See Figure 3–22 for details.

4. Press the **Pos** side key to specify the position in %.

**Table 3–9: Effects of Pos on different trigger modes**

| Trigger mode | Descriptions  |
|--------------|---|
| Normal       | For example, if Pos is set to 40%, the range from 40% before the trigger point to 60% after it, will be displayed as one block.                               |
| Timeout      | For example, if Pos is set to 80%, the range from 80% before the trigger point to 20% after it will be displayed as one block.                                |
| Delayed      | Pos is regarded as 100 % (Pos setting is disabled). The acquisition ends within the specified Delay time after the trigger point, and that data is displayed. |

## Data Display Timing

In a two-dimensional view, such as Waveform or Polar view, the frame where the latest data has been acquired is always displayed by default (frame 0 data). However, the data that you desire to observe may be stored previously in another frame.

You can specify an arbitrary frame and display its data. Even in this case, it is not easy to find those frames (refer to page 3–41).

The views in Table 3–10 allow you to specify the frame to be displayed, by setting the trigger position using relative position (%) from the trigger event.

**Table 3–10: Setting data display timing**

| <b>View</b>  | <b>Menu path for setting</b> |
|--------------|------------------------------|
| Waveform     | Options...→Position          |
| CDMAWaveform | Options...→Position          |
| CDMATime     | Options...→Position          |
| CDMAPolar    | Options...→Position          |
| Polar        | Options...→Position          |

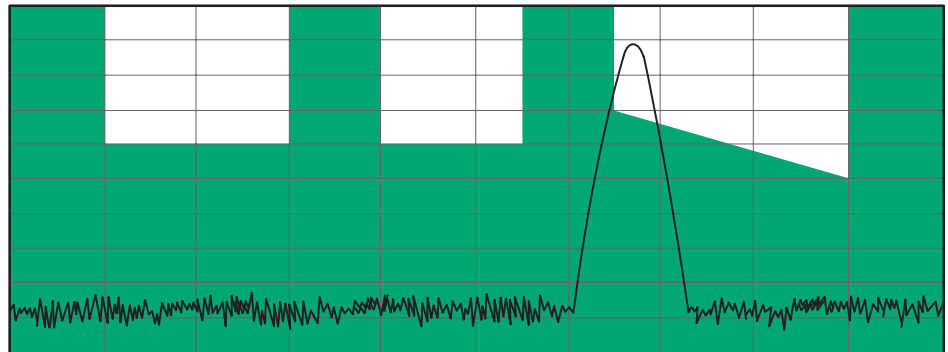
## Creating a Trigger Mask Pattern

The trigger mask pattern is a two-dimensional mask pattern. For a frequency domain signal, this pattern is used to cause a trigger event with the frequency and amplitude level. For a time domain signal, it is used to cause the trigger event with the time and amplitude level.

Figure 3–32 shows an example of a mask pattern. It contains blue and achromatic areas (shown white) on the display area. When the spectrum exceeds a boundary between two types of areas, this causes the trigger.

You can create a trigger mask pattern by operating the marker in the spectrum display. The pattern you create is saved in the internal trigger register.

Refer to *Trigger* on page 3–47 for other trigger settings.



**Figure 3–32: Example of a created trigger pattern**

## Trigger Register

The trigger register has areas that store the time and frequency domain trigger mask patterns. That is, you can store two different domain patterns in different areas within a single trigger register.

If you attempt to cause the trigger in the frequency domain when the trigger register contains both domain patterns in the trigger register, only the frequency domain pattern will be used. If you attempt to cause the trigger in the time domain in the same condition, only the time domain pattern will be used.

Note that an attempt to cause the trigger in the frequency domain results in failure if the trigger register contains only the time domain pattern.

## Restrictions on Creation

You can create the trigger mask pattern only in the Waveform view.

You can cause the trigger in a two-dimensional space of the frequency or time and amplitude. Therefore, you must select either FreqAmpl or TimeAmpl in the Format menu item.

## Condition of Trigger Generation

The trigger mask pattern contains blue and achromatic areas. You can set the trigger to occur when the spectrum enters an achromatic area from the blue area, or vice versa.

## Draw Line

In a Waveform view, there are several baselines: the maximum line (reference level), minimum line (70 dB lower than the reference level), and the horizontal line where the primary marker (□) is positioned. The draw line is used to link one of these baselines to the □ and ◇ marks. You can create the trigger mask pattern by filling the area below the linked line.

Refer to the following topic for a trigger mask procedure.



## Pattern Creation Procedure Example

You use the edit marker when creating a trigger mask pattern. You can operate the edit marker almost in the same manner as the delta marker. The difference is that you can also move it vertically. Refer to *Operating the Delta Marker* on page 3–38 for details of how to operate the delta marker.

**1.** Select the view.

For example, if you have defined View B for the Waveform view, press the **VIEW:B** key.

You do not need to keep a waveform (such as a spectrum) displayed in the Waveform view. However, if you use a view containing a waveform, this will help you create a pattern meeting the measurement conditions.

**2.** Display the menu used for operations.

**a.** Press the **VIEW:MAIN** key.

**b.** Press the **Edit...** side key.

The required menu is displayed.

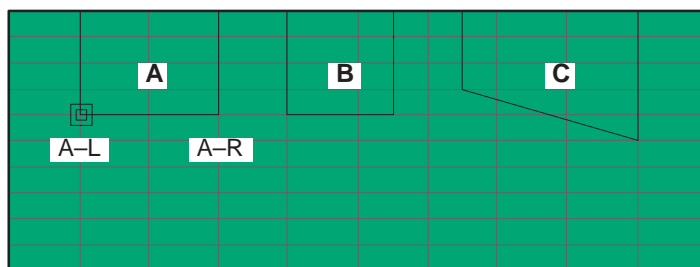
**3.** Create the mask pattern.

To create the pattern shown in Figure 3–32, first create achromatic area A.

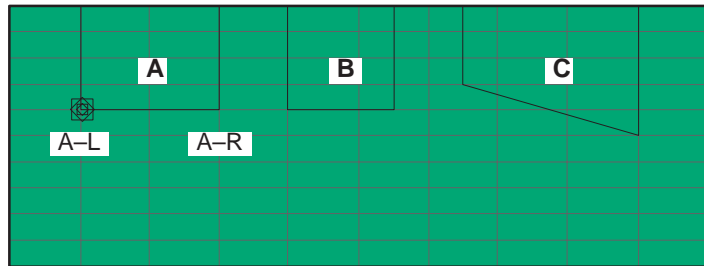
**a.** Press the **Draw Max** side key.

Position the edit marker at both corners at the bottom of area A by using the **Hor.**, **Ver.**, and **Reset Delta** side keys.

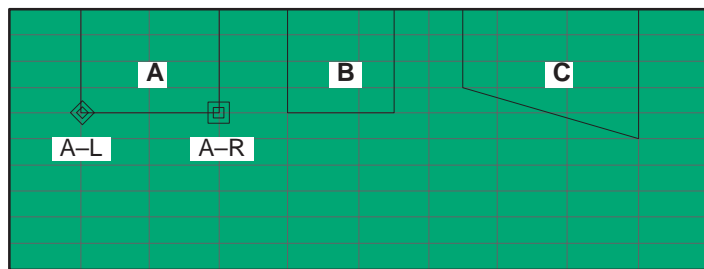
**b.** Position the  in A–L using the **Hor.** and **Ver.** side keys.



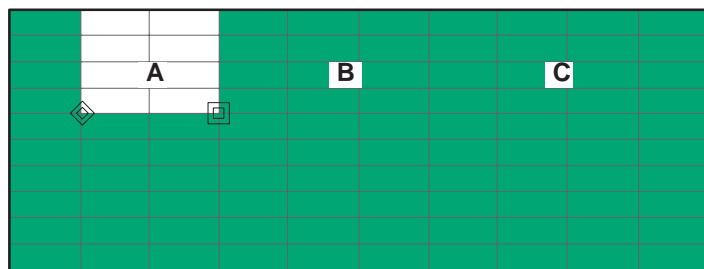
- c. Place the  $\diamond$  on the  $\square$  using the **Reset Delta** side key.



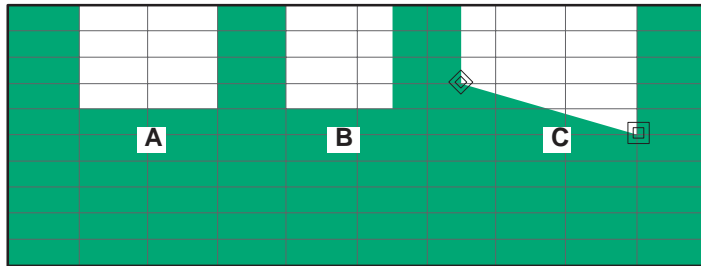
- d. Position the  $\square$  in A-R using the **Hor.** and **Ver.** side keys.



- e. Press the **Draw Line** side key. The white area is created as shown below.



- f. Using steps from b to e, move the edit marker to create areas B and C.



The trigger mask pattern you created is written into the internal trigger register.

## Moving the Baseline

You can create a mask pattern as shown in Figure 3–33 or 3–34. To create it, you move the trigger mask baseline between the reference level and the level 70 dB lower than the reference level. Use one of the following operations to move the baseline, then perform the steps under step 3 on page 3–61.

- To place the baseline at the reference level, press the **Draw Max** side key.
- To place the baseline at the level 70 dBm lower than the reference level, press the **Draw Min** side key.
- To place the baseline between the reference level and the level 70 dB lower than the reference level, press the **Draw Horizontal** side key with the edit marker (□) in the specified position. You can move the edit marker using the Hor. and Ver. side keys before pressing the Reset Delta side key.

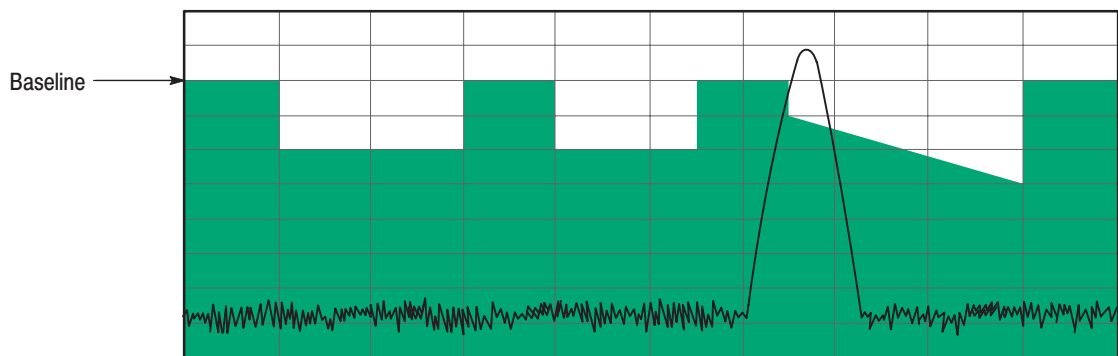


Figure 3–33: First example of a trigger pattern with a shifted baseline

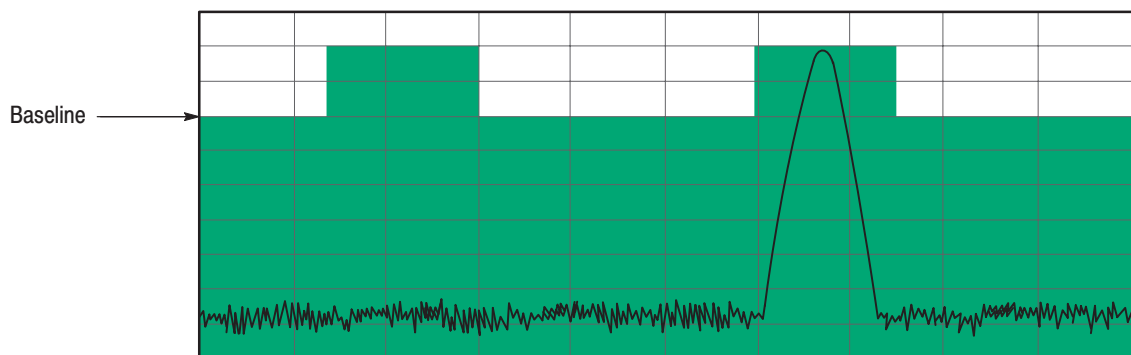


Figure 3–34: Second example of a trigger pattern created with a shifted baseline

# Analyzing an Analog Modulated Signal

To analyze an analog modulated signal, use the Analog view. This view is capable of demodulating and displaying PM (phase modulation), AM (amplitude modulation), and FM (frequency modulation) signals.

## Setting Requirements

Because analysis of an analog modulated signal requires time domain data, place the analyzer in the Dual or Zoom mode.

## Selecting Analog Modulation Analysis

When displaying a signal, select the modulating system.

1. Press the **CONFIG:MODE** key.
2. Press the **Dual**, **Zoom**, or **More...→Digital Demod** side keys.
3. Set a proper frequency and span (refer to page 3–7).

If you set a proper span, the analyzer will recognize the analog modulation and the signal will be displayed. It is important that the span be set as close to the band width as possible and be fine-tuned.

4. Define the view.
  - a. Press the **CONFIG:VIEW** key.
  - b. Press one of the **VIEW A** to **D** side keys.
  - c. Turn the general purpose knob to select Analog.

If you want to define two or more Analog views, repeat steps a through c.

5. Select the modulating system.
  - a. Select the view you selected. For example, if you have defined View B as the Analog view, press the **VIEW:B** key.
  - b. Press the **Format** side key.
  - c. Turn the general purpose knob to select **AM**, **PM**, or **FM**.

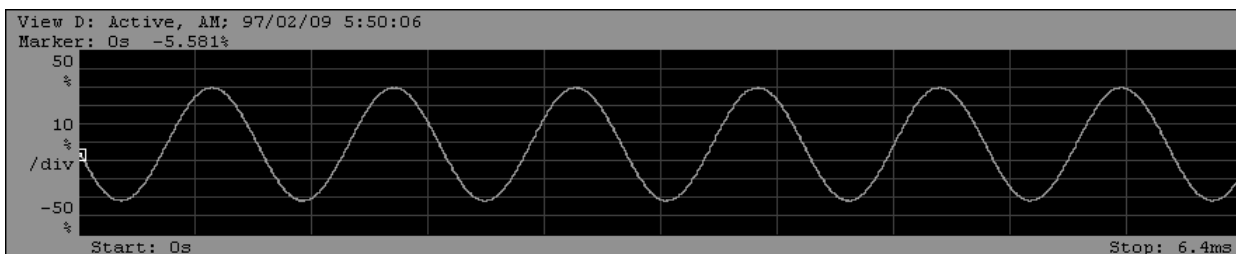
Now, the preparations to demodulate and display the analog signal are complete.

## Display

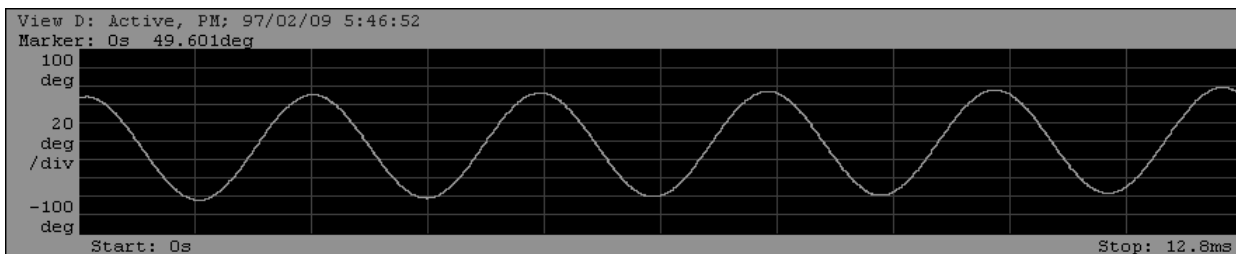
The horizontal axis represents the time in all AM, PM, and FM demodulation displays. By default, the time duration matches the frame length (see Table 3–5 on page 3–19).

The vertical axis represents the modulation factor (%) in AM modulation display, the phase in PM demodulation display, or the frequency in FM demodulation display.

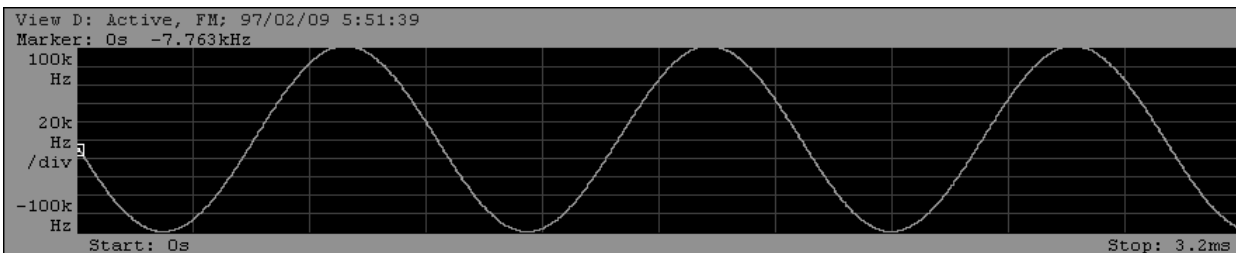
Figure 3–35 shows three display examples. In certain conditions, the Analog view cannot finely display the whole waveform when the default scale settings are used. In this case, use the auto scale function (refer to page 3–31).



AM signal demodulation display example



PM signal demodulation display example



FM signal demodulation display example

**Figure 3–35: Display examples of analog signal demodulation**

# Displaying and Analyzing a Digital Modulated Signal

To analyze a digital modulated signal, you have the following options:

- Constellation or vector display in the Polar or CDMAPolar view
- EYE diagram display in the EyeDiagram view
- Symbol table display in the SymbolTable view
- Error vector analysis display in the EVM view

The Polar and CDMAPolar views are capable of demodulating a digitally modulated signal. Usually, the EyeDiagram, SymbolTable, and EVM views use the input source processed by the Polar or CDMAPolar view demodulation.

The CDMAPolar view is to used for measurement according to the IS-95 and T-53 standards. Throughout this section, references to the Polar view apply to both the Polar and CDMAPolar views.

## Setting Requirements

Because observation of a digital modulated signal requires time domain data, place the analyzer in the Dual or Zoom mode.

If you display the EyeDiagram, SymbolTable or EVM view, be sure to display the Polar or CDMAPolar view also.

## Selecting Digital Modulated Signal Analysis

1. Press the CONFIG:MODE key.
2. Press the More...→Digital Demod side key.
3. Select the view.

In steps 1 and 2 above, the Waveform, Spectrogram, Polar, and EyeDiagram views are set by default. If you perform a digital modulation analysis, set the SymbolTable view instead of the Waveform or Spectrogram view when necessary.

For example, define Views A to D as the Polar, EyeDiagram, EVM (Format: EVM), and EVM (Format: Phase Error) views, respectively.

- a. Press the CONFIG:VIEW key.

- b. Select **Polar**, **EyeDiagram**, **EVM** and **EVM** using the View **B** to **D** side keys.

Set the format in each EVM view. The format of the EVM view is EVM by default. Change the format in the View D.

- c. Press the **VIEW:D** key, and then the **VIEW:MAIN** key.
  - d. Press the **Format** side key to select the **Phase Error**.
4. Set a proper frequency and span (refer to page 3–7).

If you do not set a proper span, the analyzer will not recognize the digital modulation and the signal will not be displayed. It is important that the span be set as close to the band width as possible and be fine-tuned.

5. Select the modulating system or set the modulation parameters.
- a. Select the Polar view. Because you have defined View B as the Polar view, press the **VIEW:B** key.

Select the modulating system.

- b. Select the **Standard Setup...** side key.
- c. Press the side key from the menu to select the modulating system. The implemented standard modulation systems are described in *Supported Modulation Systems* in this section.

Set the modulation parameters manually.

- d. Press the **Manual Setup...** side key.
- e. Press the **Modulation** side key to select the modulating signal.
- f. Press the **Symbol Rate** side key to input the symbol rate.
- g. Press the **Measurement Filter** side key to select either **None** (no filter) or **RootRaisedCosine** as the measurement filter.
- h. Press the **Reference Filter** side key to select **None** (no filter), **RaisedCosine**, or **Gaussian** as the Reference filter.
- i. Press the **Alpha/BT** side key to input the  $\alpha$ /BT value.

Now, the settings are complete. The spectrum, vector, EYE diagram, EVM and Phase Error are displayed. Then, press the **ROLL** or **BLOCK** key to acquire and display the data.



## Supported Modulation Systems

The standard modulation systems are supported for the Polar view. For non-standard cases, you can specify the modulating system, symbol rate, filter, or  $\alpha$ /BT.

**Table 3–11: Modulating Systems**

| Modulation system       | Modulation     | Symbol rate | Filter           | $\alpha$ /BT |
|-------------------------|----------------|-------------|------------------|--------------|
| NADC                    | 1/4 $\pi$ QPSK | 24.3 kHz    | RootRaisedCosine | 0.35         |
| PDC                     | 1/4 $\pi$ QPSK | 21 kHz      | RootRaisedCosine | 0.5          |
| PHS                     | 1/4 $\pi$ QPSK | 192 kHz     | RootRaisedCosine | 0.5          |
| TETRA                   | 1/4 $\pi$ QPSK | 18 kHz      | RootRaisedCosine | 0.35         |
| GMS                     | GMSK           | 270.833 kHz | None             | 0.3          |
| CDPD                    | GMSK           | 19.2 kHz    | None             | 0.5          |
| IS-95/T-53 <sup>1</sup> | CDMA_OQPSK     | 1.2288 MHz  | RootRaisedCosine | 0.2          |

<sup>1</sup> IS-95 and T-53 can be set only in the CDMAPolar view.

## Process Flow

The Polar view is capable of demodulating and modulating digital modulated signals. Input of the data obtained with the Polar view allows the EYE diagram display to be in the EyeDiagram view, symbol display to be in the SymbolTable view, and error vector analysis display to be in EVM view. For this reason, the Polar view must always be kept in display in order to use these three views.

Figure 3–36 outlines the digital modulated signal process taking place in the Polar view.

The RF digital modulated signal input to the Polar view first passes the filter, then enters the demodulating mechanism. The filtered signal is displayed, as Measurement data, in the constellation or vector form. This is based on the additional information obtained with the modulating mechanism. As the Measurement Data, this data and additional information are written into the register pair for input to other views.

After the input data passes through the demodulating mechanism, the digital data is obtained. Further, it is digitally modulated again by the modulating mechanism. After passing through the filter, the data is written into the register pair as the Reference Data together with the additional information obtained with the modulating mechanism. Because this signal has been internally modulated, it can be regarded as the ideal signal (Reference data). The Polar, EyeDiagram, or SymbolTable view can also display the Reference data instead of the Measurement data.

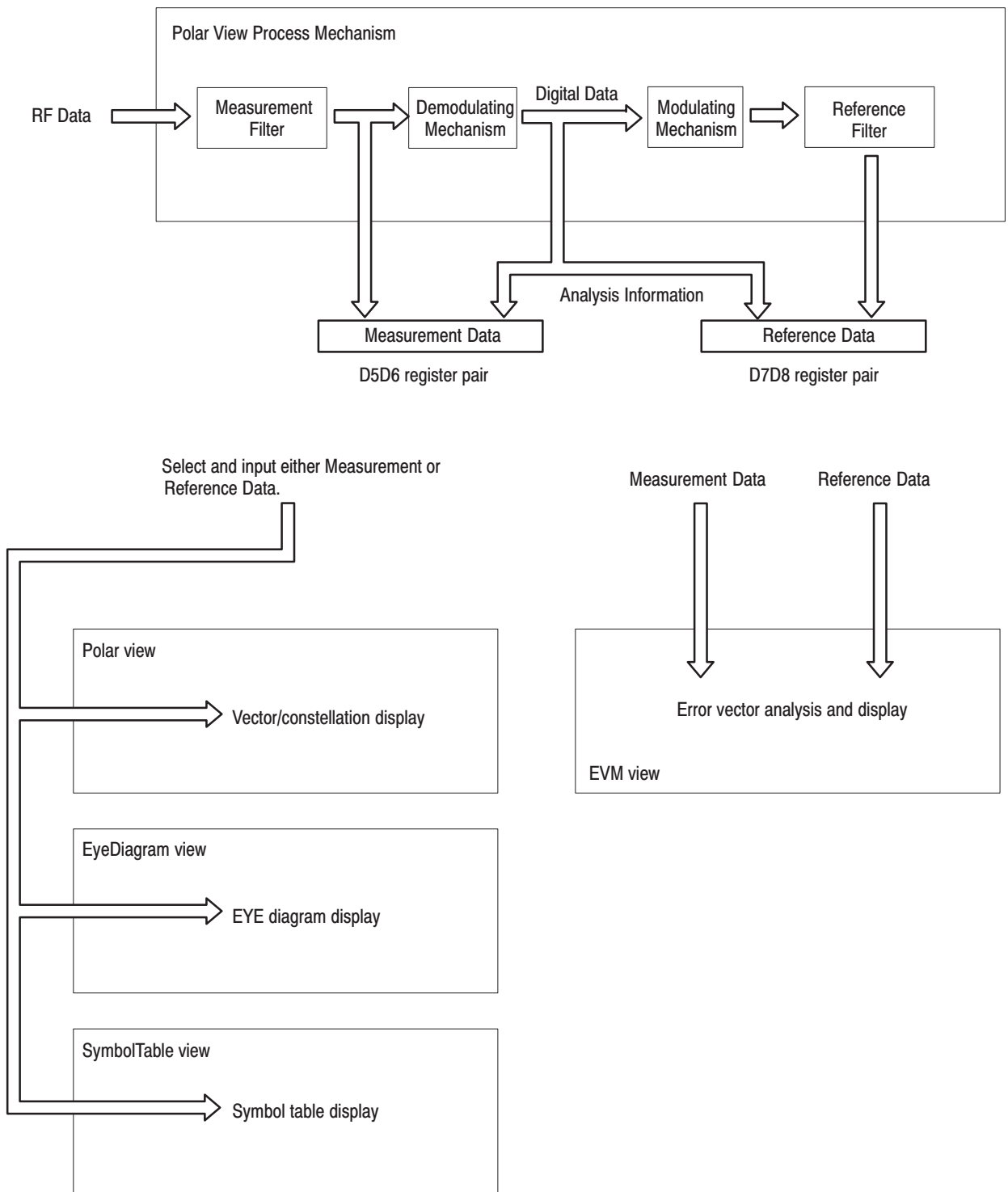


Figure 3-36: Digital modulation signal flow

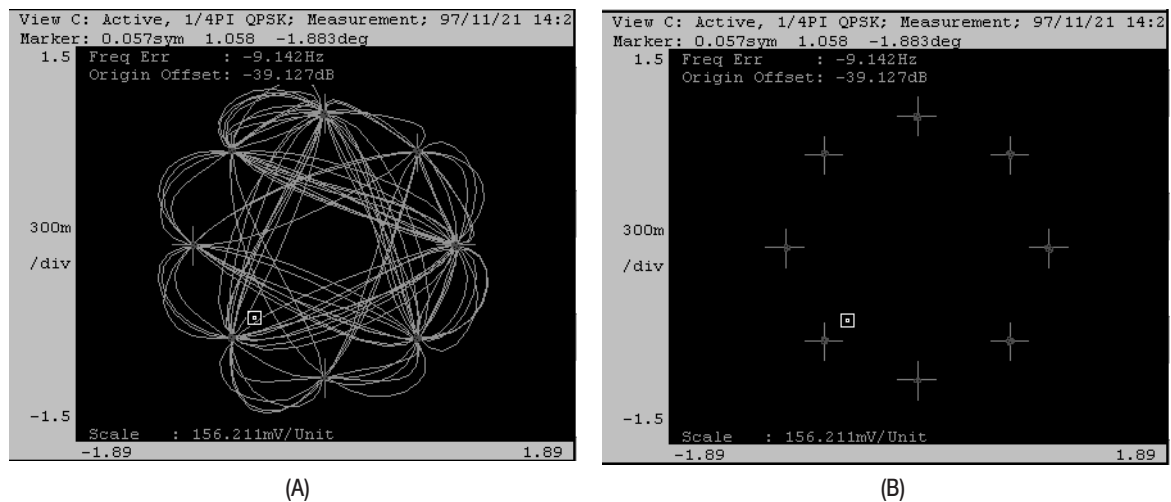
## Constellation and Vector Displays

The Polar view displays the digital modulated signal in the vector or constellation form. To select the vector form, select **Format** → **Vector**. To select the constellation form, select **Format** → **Constellation**.

The vector display uses the polar coordinates or IQ diagram to display signals represented by the phase and amplitude. Figure 3–37 (A) is an example showing a vector display of the signal that was subjected to  $1/4 \pi$  QPSK modulation. The red points show the measurement symbol positions. The green trace shows the locus of shifts between symbols. Each point through which multiple concentrated traces pass corresponds to the symbol of the measurement signal. You can estimate the error vector size by comparing such points with the red points. The cross hairs show the symbol positions of the ideal signal.

Figure 3–37 (B) shows a constellation display example. Like the vector display, the constellation displays the signal in the polar coordinates or IQ diagram. However, the constellation displays only the measurement signal symbols in red without displaying the symbol-to-symbol locus.

Note that the symbol is not displayed in the vector form in the CDMA Polar view.



**Figure 3–37: Vector and constellation display examples**

The Freq Error field is displayed at the top left corner. It indicates the value obtained by subtracting the currently set center frequency from the measurement setting carrier frequency. To make the center frequency of the analyzer match the measurement signal carrier frequency, set the center frequency to the value of (Current Frequency + Freq Error).

The OriginOffset indicates the shift of the origin of the polar coordinate for the ideal signal from that for the measurement signal. All the signal and measurement data displayed in the Polar view are used only after origin shift has been corrected.

To obtain the numerical errors from the ideal digital modulated signal, use the EVM view (refer to page 3–75).

The Polar view can display the ideal signal in addition to the measurement data. For the measurement signal, select **Display**→**Measurement** in the Polar view menu. For the ideal signal, select **Display**→**Reference**.

## EYE Diagram Display

The EyeDiagram view inputs the signal processed in the Polar view and displays the EYE diagram.

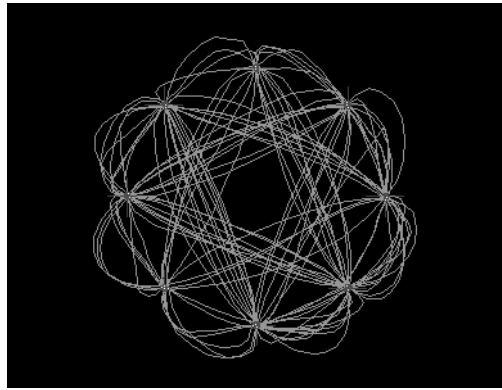
The EYE diagram represents symbol-to-symbol transitions by time and the amplitude or phase. The vector is spread to the time and amplitude or phase, and folded back to a specific symbol position. This allows the symbol-to-symbol shift locus to be represented as an EYE diagram.

Figure 3–38 shows an example of the vector display of a signal subjected to  $1/4\pi$  QPSK modulation (A) and EYE diagram display examples (B to D). Examples (B) to (D) show the one-, two-, and four-symbol transition lengths, respectively. Each point through which multiple concentrated lines pass shows a symbol.

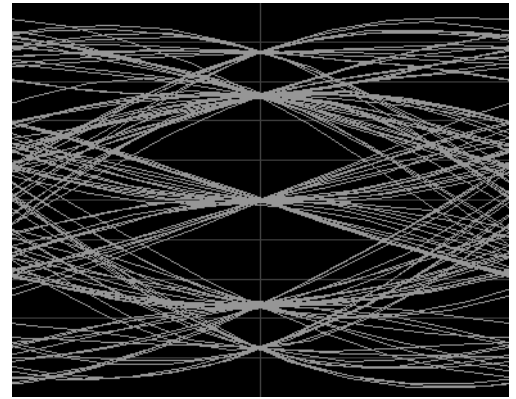
Like the vector and constellation displays, if the actual signal deviates from the ideal symbol position, the symbol position will shift, disordering the EYE diagram.

You can use Eye Length in the EyeDiagram view to set the symbol transition length.

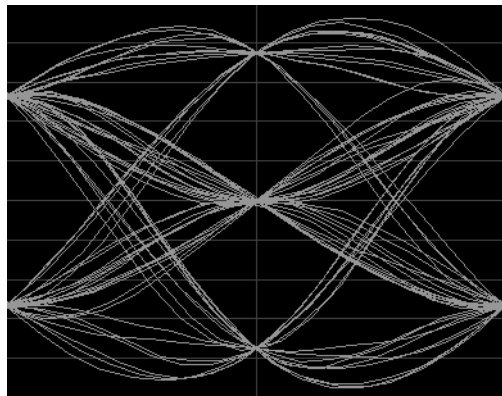
The EyeDiagram view can also display the ideal signal in addition to the measurement data. For the measurement signal, select **Source**→**Measurement**. For the ideal signal, select **Source**→**Reference**. You can obtain the size of the disorder in the EYE diagram by turning the general purpose knob clockwise or counterclockwise. To obtain the errors numerically that are from the ideal digital modulated signal, use the EVM view (refer to page 3–75).



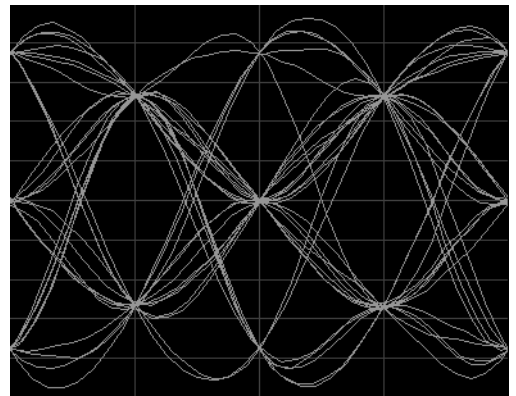
(A)



(B)



(C)



(D)

**Figure 3-38: Vector and EYE diagram display examples**

## Symbol Table Display

The SymbolTable view inputs the signal processed in the Polar view and displays the completely demodulated digital data in a bit string form.

The bit strings can be represented in binary, octal, or hexadecimal notation. You can select one of them using the Radix side key in the SymbolTable view menu. For the BPSK, QPSK, 8 PSK, or QAM modulating system, the start position of digits is merely a relative symbol position, and you can therefore change it. Press the **Rotate** side key in the menu to change the relative start position.

Figure 3–39 shows an example of a bit pattern symbol table obtained by demodulating the signal that was subjected to  $1/4 \pi$  QPSK modulation.

The SymbolTable view can also display the ideal signal in addition to the measurement data. For the measurement signal, select **Source**→**Measurement**. For the ideal signal, select **Source**→**Reference**. Basically, there are no differences between their bit strings.

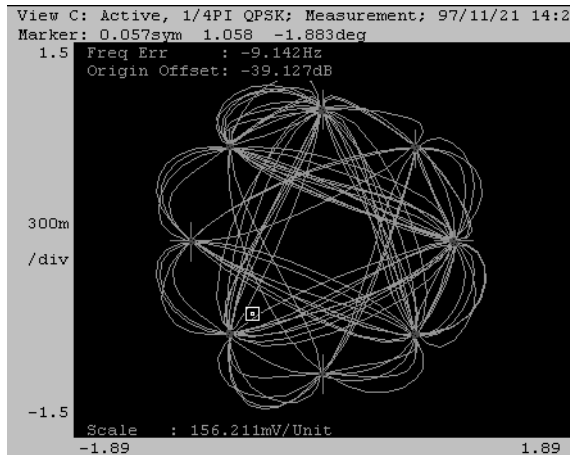
```

0: 00000010 00100001 11110011 00111011 11010101
20: 01100111 00000000 10101101 11111100 00010011
40: 11110111 10010111 11001110 10001111 01011000
60: 11011100 00101101 00110111 00010001 01001101
80: 10011000 01010010 10101110 00010000 00011011
100: 10011111 10100110 10111110 00101000 01111011
120: 00001110 11100101 11011001 10100011 00101010
140: 00110101 00000011 01000001 11110100 01111011
160: 11000110 11100111 01101001 10101100 10001010
180: 00010100 11000011 10000101 01110110 11100000
200: 11001001 10111101 01001010 01110000 01000010
220: 11011110 01110001 00111010 11011001 01100001
240: 00101000 10
    
```

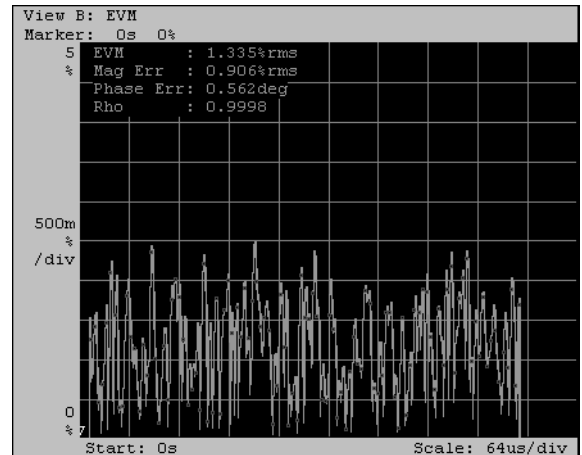
**Figure 3–39: Symbol table display example**

## Error Vector Analysis Display

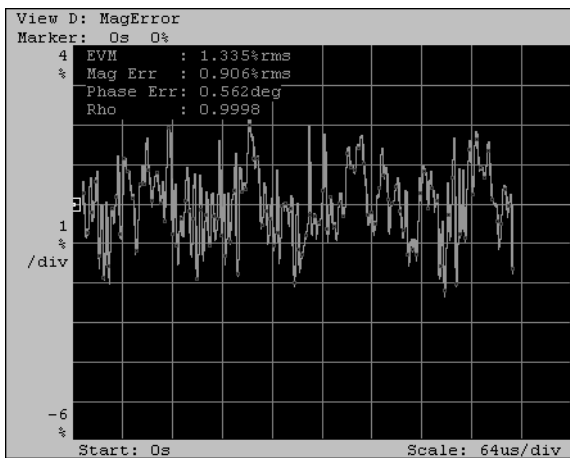
The EVM view inputs both the measurement signal and ideal signal, which has been processed in the Polar view, to display the difference as error magnitude. With the EVM view, you can obtain the numeric errors in each data point.



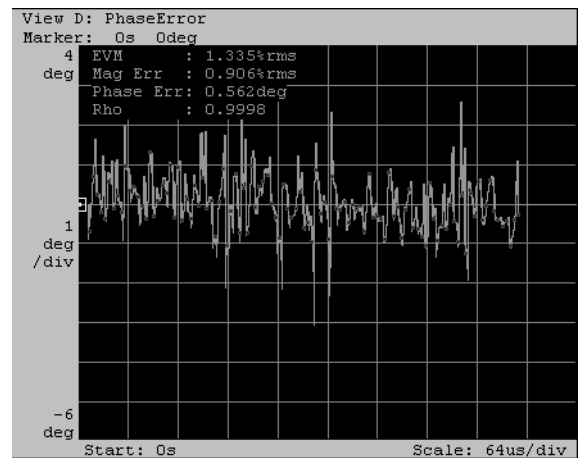
(A) Vector display



(B) EVM display



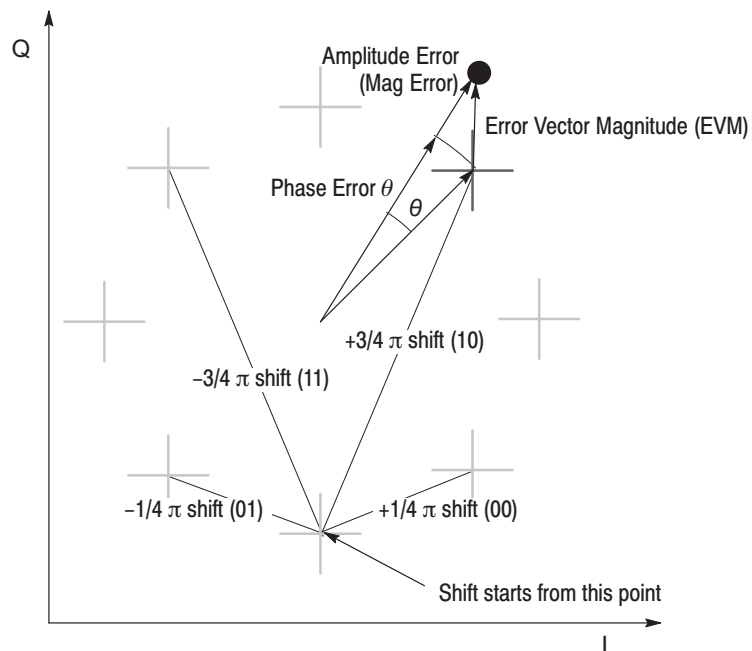
(C) Mag Error display



(D) Phase Error display

**Figure 3–40: EVM view display example (B) to (D)**

Figure 3–41 shows a constellation display example that is based on  $1/4 \pi$  QPSK modulating system. For this modulating system, the bit pattern is determined by shifts from the individual positions. For example, suppose that the actual signal has shifted to the ● position from the ideal symbol position. In this case, you can evaluate the quality of the modulation signal as an error in the radial (amplitude) direction, an error in the phase direction, and the total error vector.



**Figure 3-41: 1/4 π QPSK constellation display example and error vector**

The EVM view has the three display formats, which correspond to the errors described above. In each of these three display formats, the following error information is commonly displayed:

- Mag Error (% RMS): Root-mean-square of the amplitude error
- Phase error (deg): Root-mean-square of the phase error
- EVM (% RMS): Root-mean-square of the EVM (Error Vector Magnitude)
- Rho: ρ meter

The Rho (ρ meter) indicates the waveform distortion, which is represented with the following equation.

$$\rho (Rho) = \frac{\left| \sum_{k=1}^M R_k Z_k^* \right|^2}{\sum_{k=1}^M |R_k|^2 \sum_{k=1}^M |Z_k|^2}$$

Where,  $R_k$  is the ideal IQ signal point data represented by the complex number, and the  $Z_k$  is the measurement IQ signal point data represented by the complex number.



# Analyzing an FSK Digital Modulated Signal

The analyzer can demodulate and display an FSK (Frequency Shift Keying) signal using the FSK view.

## Setting Requirements

Because observation of an FSK modulated signal requires time domain data, place the analyzer in the Dual or Zoom mode.

## Placing the Analyzer in the FSK Signal Analysis Mode

1. Press the CONFIG:MODE key.
2. Press the **Dual**, **Zoom**, or **More...→Digital Demod** side key.
3. Set a proper frequency and span (refer to page 3–7).

If you set a proper span, the analyzer will be able to recognize the digital modulation and the signal will be displayed. It is important that the span be set as close to the band width as possible and be fine-tuned.

4. Redefine the view.
  - a. Press the CONFIG:VIEW key.
  - b. Press one of the VIEW A to D side keys. Then, turn the general purpose knob to select **FSK**.

If you want to define more FSK views, repeat step b.

Now, the preparations to demodulate and display the FSK signal are complete.

## Display

The FSK view displays the demodulated signal with the time along the horizontal axis and with the frequency along the vertical axis. Figure 3–42 shows an example of a demodulated FSK modulated signal.

The modulated signal is displayed with the time along the horizontal axis and with the frequency along the vertical axis. By default, the horizontal axis scale is set to the frame length (see Table 3–5 on page 3–19) and the vertical axis scale to the span. In certain conditions, the FSK view cannot finely display the whole waveform with the default scale settings. In this case, use the auto scale function (refer to page 3–31).

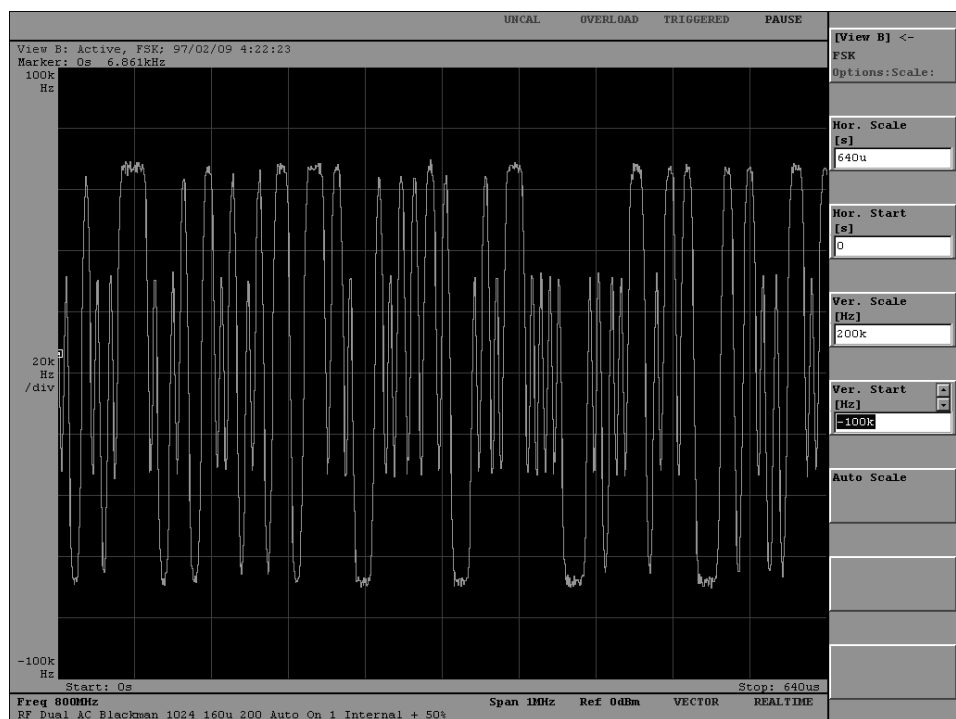


Figure 3–42: Example display of FSK modulation signal demodulation

# Power Measurement

The following power measurements are available:

|              |  |
|--------------|--|
| <b>Noise</b> | Noise per frequency (dBm/Hz)                         |
| <b>Power</b> | Power of the specified frequency domain (dBm)        |
| <b>C/N</b>   | Proportion of carrier to noise (dB)                  |
| <b>C/No</b>  | Proportion of carrier to noise per frequency (dB/Hz) |
| <b>ACP</b>   | Leakage power of adjacent channel (dB)               |
| <b>OWB</b>   | Occupied bandwidth                                   |

## Setting Requirements

The following restrictions are imposed on the power measurements:

- Only Blackman-Harris (default) is enabled for the FFT window.

Select **Input, FFT...→FFT Window→Blackman** from the SETUP menu. Refer to *Time And Frequency Domains* on page 3–13 for the FFT window.

The result from each power measurement is displayed at the top left corner in the Waveform view. The result is not displayed if you have set an FFT window other than Blackman-Harris.

- Measurement can be performed for data captured in the vector mode.

Refer to *Physical and Logical Frames* on page 3–23 for the vector mode.

- Measurement is enabled only for the Waveform view.
- You must use an averaged waveform in any power measurement.

## Power Measurement and Marker Operations

To perform power measurement, you must use the marker and special markers called power markers.

Refer to *Marker Operations And Search* on page 3–35 for instructions on using the marker. The power per frequency measured only with the marker is calculated by the frequency bandwidth per bin. Refer to *Number of Bins* on page 3–34 for the frequency bandwidth per bin.

There are three band-power markers. Refer to *Band Power Marker Operations* on page 3–87 for their operation.

## Using an Averaged Waveform

You must use an averaged waveform in any power measurement, although this may not appear in the following operation descriptions. Select **Source**→**Average** in the Waveform view. Refer to *Averaging and Peak Hold* on page 3–109 for averaging details.

## Noise Measurement

The Noise measurement measures the noise per frequency (dBm/Hz) readout. The value of the vertical component at the marker position is divided by the bandwidth of the bin.

Perform the noise measurement using the following steps:

1. Measure the spectrum and display it in the Waveform view.
2. Select **Options...** → **Marker...** → **Measurement** → **Noise** from the Waveform view menu.
3. Move the marker to the desired data point.
4. Read the measured value displayed at the top left corner on the view.
5. When necessary, press the **ROLL** or **BLOCK** key to acquire the signal while measuring the noise.

Figure 3–43 shows a noise measurement example.

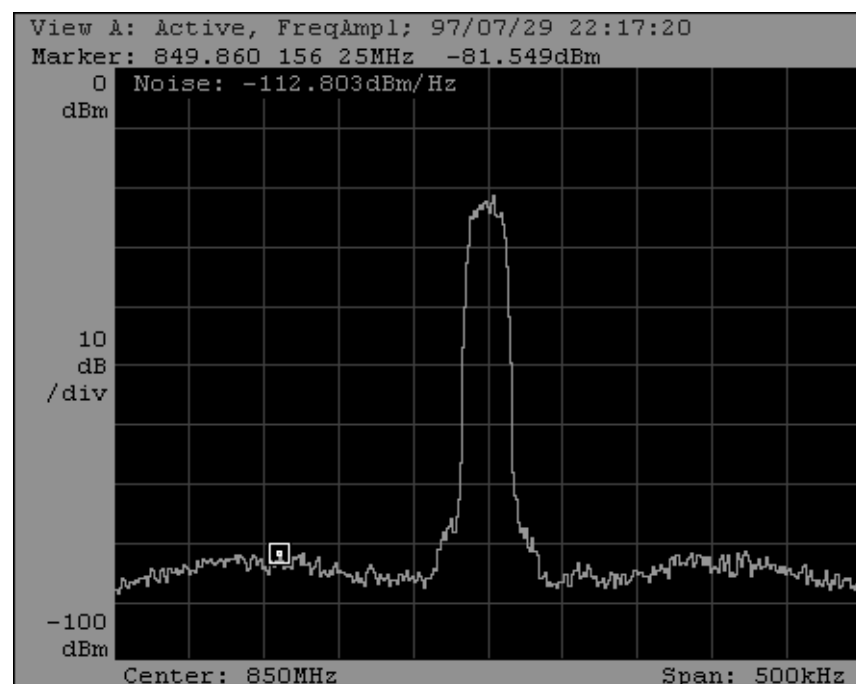


Figure 3–43: Noise measurement example

## Power Measurement

The Power measurement measures the power (dBm) of the specified frequency region. To specify the frequency region, use the band power marker that appears when you select **Power**.

Perform the power measurement using the following procedures:

1. Measure the spectrum and display it in the Waveform view.
2. Select **Options...**→**Marker...**→**Measurement**→**Power** from the Waveform view menu.
3. Use the band power markers to bracket the desired frequency domain as shown in Figure 3–44.
4. Read the measured value displayed at the top left corner on the view.
5. When necessary, press the **ROLL** or **BLOCK** key to acquire the signal while measuring Power.

Figure 3–44 shows a power measurement example about the specified frequency domain.

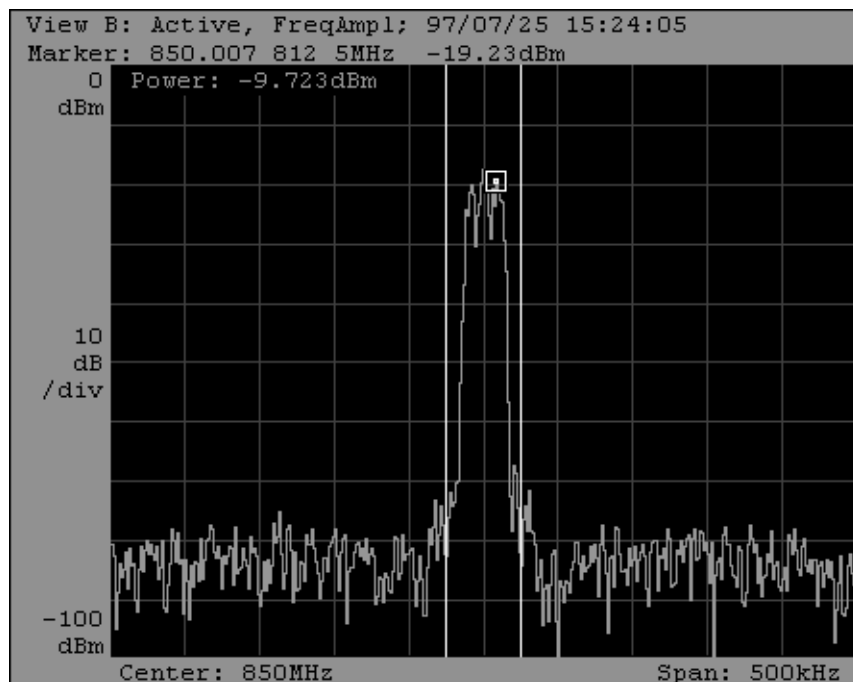


Figure 3–44: Power measurement example

## C/N and C/No Measurements

The C/N measurement measures the power proportion (dB) of the carrier to the noise. The C/No measurement measures the power proportion (dB/Hz) of carrier to the noise per frequency.

For the carrier signal measurement, use the marker. For the noise measurement, use the band power marker that appears when you select C/N or C/No.

Perform the measurement using the following procedures:

1. Measure the spectrum and display it in the Waveform view.
2. Select the following from the Waveform view:  
For the C/N measurement, **Options...**→**Marker...**→**Measurement**→**C/N**  
For the C/No measurement, **Options...**→**Marker...**→**Measurement**→**C/No**
3. Move the marker to move to the desired frequency position on the carrier signal. When necessary, use the marker search function.
4. Use the band power marker to select a noise frequency region.
5. Read the measured value displayed at the top left corner on the view.
6. When necessary, press the **ROLL** or **BLOCK** key to acquire the signal while measuring C/N or C/No.

The left view in Figure 3–45 shows a C/N measurement example. The right one shows a C/No measurement example.

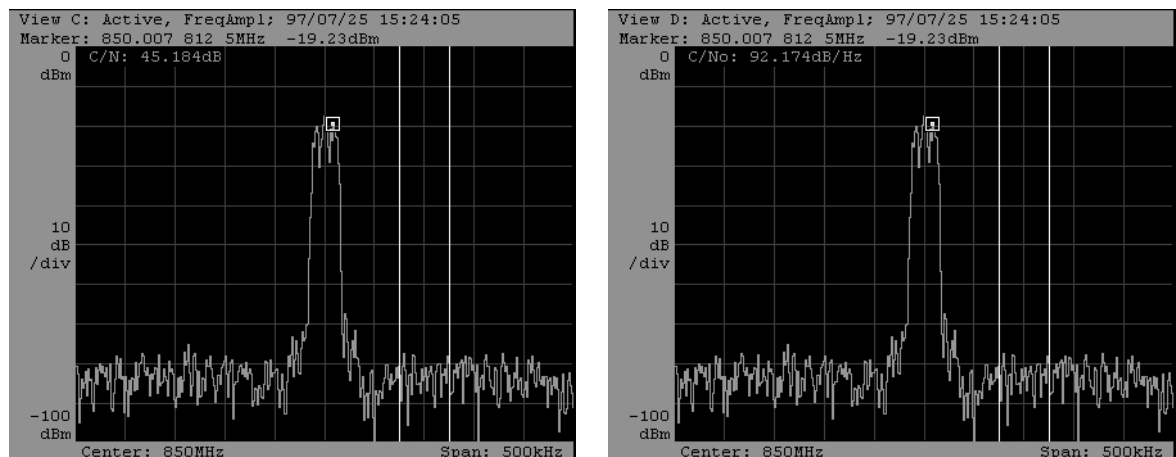


Figure 3–45: C/N (left) and C/No (right) measurement examples

## ACP (Adjacent Channel Leakage Power) Measurement

The ACP measurement measures the power proportion (dB) of a signal appearing in a frequency region adjacent to the carrier signal frequency (the carrier signal).

If you select ACP, you can operate three band power markers specialized for ACP measurement: Center, Upper, and Lower. The Center marker measures the carrier signal power. The Upper and Lower markers measure the power that appears on the upper and lower adjacent channels. They depend on the three parameters: Fc, Bw, and Sp.

Perform the measurement using the following procedure:

1. Measure the spectrum and display it in the Waveform view.
2. Select **Options...→Marker...→Measurement→ACP**.
3. Use the markers by selecting **Options...→Marker...→ACP...**
  - a. Determine the carrier signal center frequency (Fc).
    - Select **Options...→Marker...→ACP...→Band Power Markers→Center**.
    - Move the Center marker to the carrier signal center frequency (Fc) in the same manner as for the marker.
  - b. Input the frequency bandwidth (Bw) in the **Options...→Marker...→ACP...→BW** item.

The band power marker is displayed clearly in the Waveform view. Fine-tune the measurement area by repeating steps a and b.

- c. Input the channel spacing (Sp) from Fc in the **Options...→Marker...→ACP...→SP** item.

Now the measurement begins. You can display the Upper and Lower band power markers by selecting **Options...→Marker...→ACP...→Band Power Markers→Upper** and **Lower**, respectively.

Now you can view the channel position and bandwidth although the measurement works without displaying these markers.

4. Read the measured value displayed at the top left corner on the view.

ACP Lower (dB) indicates the power proportion of the high frequency adjacent channel signal to the carrier signal.

ACP Upper (dB) indicates the power proportion of the low frequency adjacent channel signal to the carrier signal.



5. When necessary, press the **ROLL** or **BLOCK** key to acquire the signal while measuring the ACP.

Figure 3–46 shows an ACP measurement example.

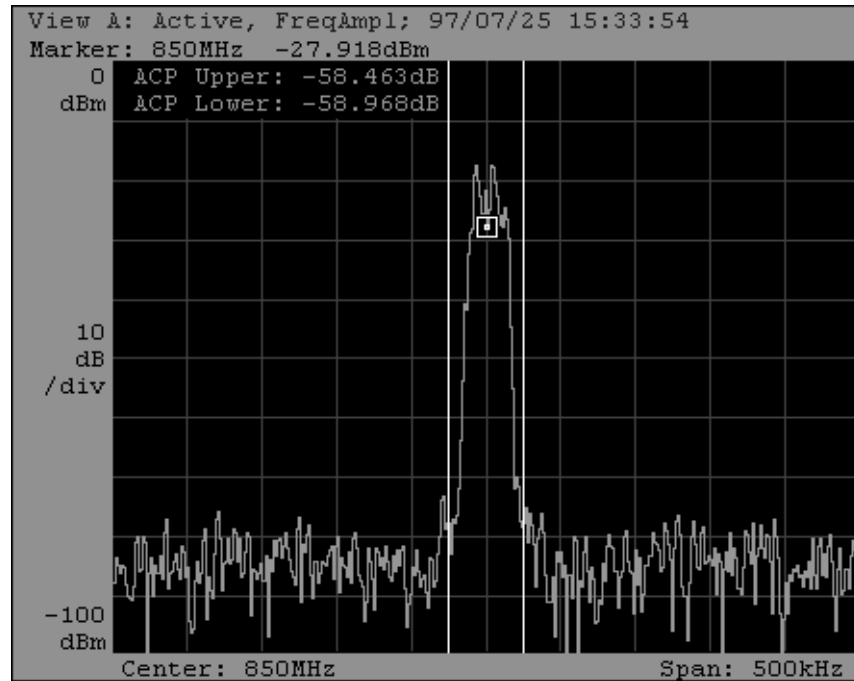


Figure 3–46: ACP measurement example

## OBW (Occupied Bandwidth) Measurement

The OBW measurement obtains the frequency bandwidth so that the power proportion of the carrier signal to the entire power of the span frequency region equals the specified proportion (OBW). For this measurement, you input only the proportion (Pr) although it displays the band power markers.

Perform the measurement using the following procedure:

1. Measure the spectrum and display it in the Waveform view.
2. Select **Options...→Marker...→Measurement→OBW** from the Waveform view menu.
3. Input the desired proportion (Pr) in the **Options...→Marker...→OBW** item.
4. A band power marker is displayed in the view. Its center indicates the current center frequency of the instrument. When necessary, change the input value in step 3.
5. Read the measured value displayed at the top left corner on the view.
6. When necessary, press the **ROLL** or **BLOCK** key to acquire the signal while measuring the OBW.

Figure 3–47 shows an OBW measurement example.

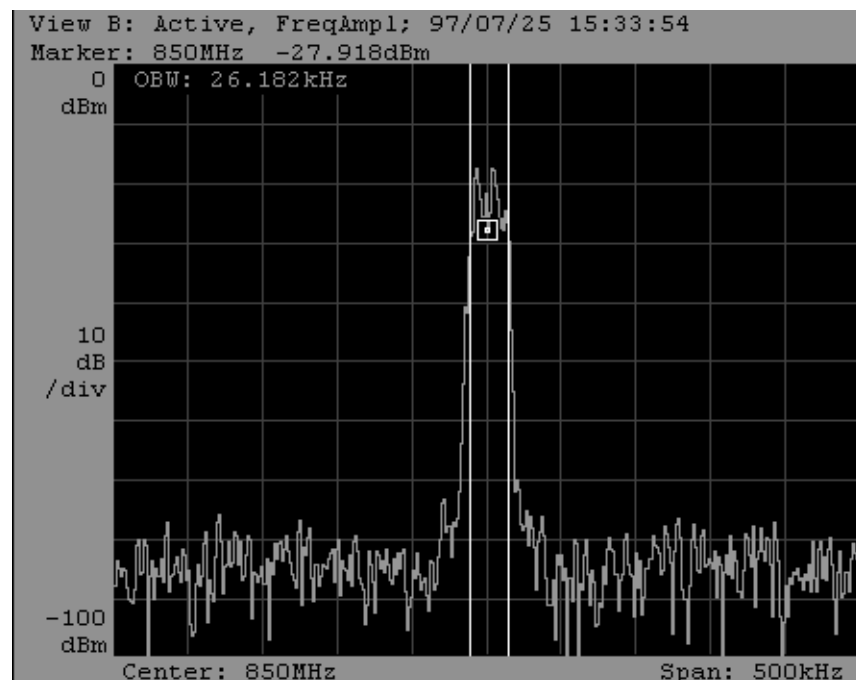


Figure 3–47: OBW measurement example

## Band Power Marker Operations

The power measurement uses special markers called band power markers in addition to the frequency marker. The following three band power markers are available. Their operations depend on the measurement type.

- Power, C/N, and C/No measurements: Power measurement band power marker
- ACP measurement: ACP measurement band power marker
- OBW measurement: OBW measurement band power marker

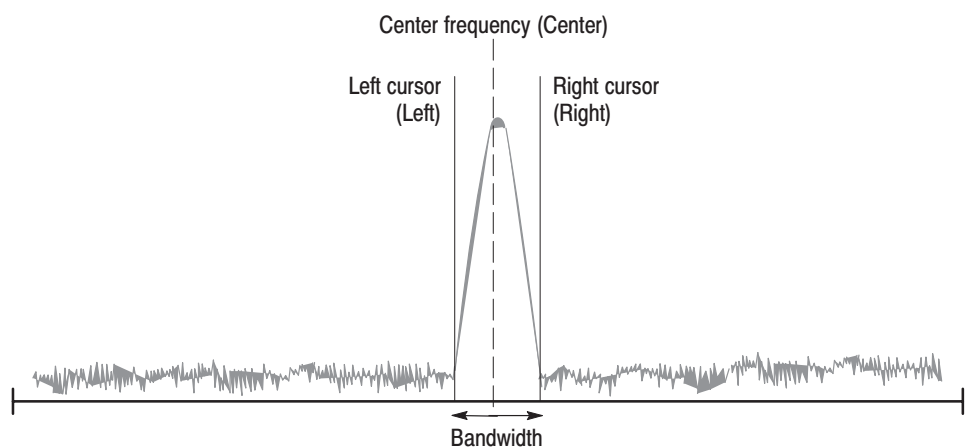
### Power, C/N, and C/No Measurements

These markers are used to determine the frequency bandwidth. See Figure 3–48. Two vertical cursors appear. Set the four related parameters and operate the cursor. When operating it, use one of the following methods or both methods combined.

Determine the center frequency (Center) and frequency bandwidth (Width).

1. Input the center frequency in the **Options...→Marker...→Band Power Markers→Center**.
2. Input the bandwidth in the **Options...→Marker...→Band Power Markers→Width**.

If you set the bandwidth to 0, the power for one bin width will be used for calculation.



**Figure 3–48: Power measurement band power marker**

Now, the marker position has been determined.

Determine the right (Right) and left (Left) cursor positions.

1. Input the frequency position of the right cursor in the **Options...→Marker...→Band Power Markers→Right**.
2. Input the frequency position of the left cursor in the **Options...→Marker...→Band Power Markers→Left**.

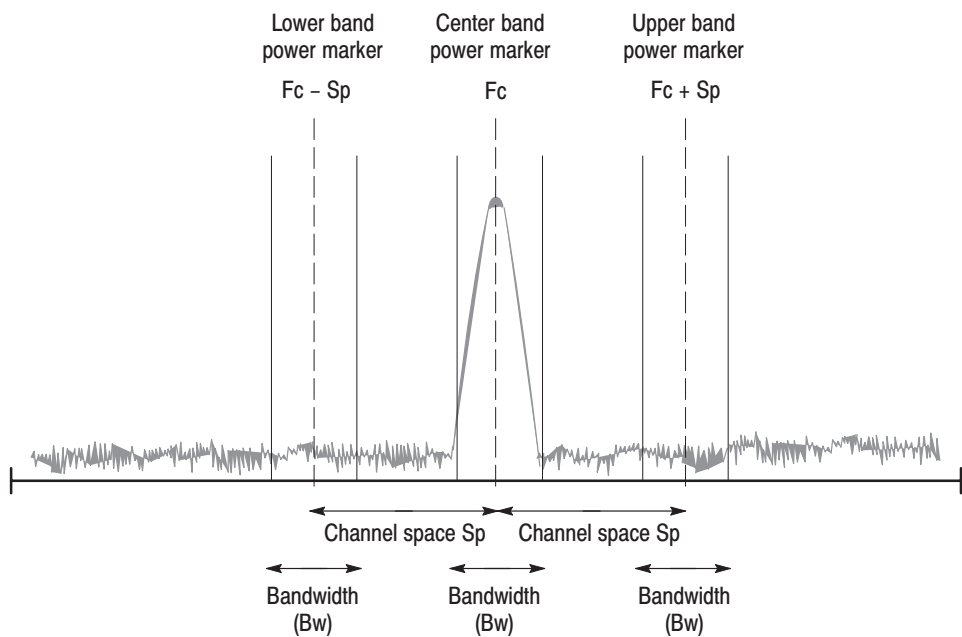
Now, the marker position has been determined.

## ACP Measurement

The three band power markers are used to obtain the power proportion of the upper and lower adjacent frequency channels to the carrier signal. These markers are called the Upper, Center, and Lower band power markers, respectively. See Figure 3-49.

The band power markers are set using the following three parameters:

- Center frequency:  $F_c$
- Bandwidth:  $B_w$
- Channel spacing:  $S_p$



**Figure 3-49: ACP measurement band power marker**

Determine these parameters using the following procedures:

1. Determine the carrier signal center frequency ( $F_c$ ).
  - a. Select **Options...→Marker...→ACP...→Band Power Markers→Center**.
  - b. Move the Center marker to the carrier signal center frequency ( $F_c$ ) in the same manner as for the marker.
2. Input the center frequency ( $B_w$ ) in the **Options...→Marker...→ACP...→BW** item.
3. Input the channel spacing from  $F_c$  ( $S_p$ ) in the **Options...→Marker...→ACP...→SP** item.

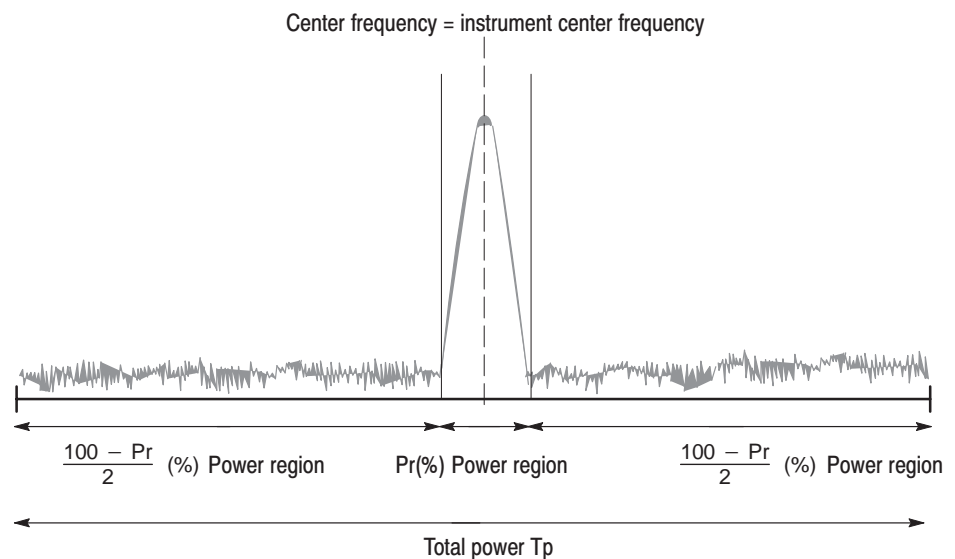
Now, all marker positions have been determined.

Only one on the three band power markers, Upper, Center and Left, can be displayed at a time. To display a marker, select with **Options...→Marker...→ACP...→Band Power Markers**.

### OBW Measurement

This marker is used to determine the frequency bandwidth with two vertical cursors. It cannot be operated directly.

Suppose that the power of the area represented by the instrument frequency span ( $F_s$ ) is  $T_p$  and that the instrument center frequency is  $F_c$ . See Figure 3-50.



**Figure 3-50: Band power marker used for the occupied bandwidth (OBW) measurement**

Obtain the power region  $X_p$  for which the proportion to  $S_p$  equals the value set in **Options...→Marker...→OBW**.

$$X_p = \frac{Pr \times Tp}{100}$$

From  $X_p$ , obtain the frequency bandwidth with the center in  $F_s$ . Display the cursor in the view.

Do the following procedures:

1. Align the carrier signal center frequency in the center frequency position of the instrument.
2. Input the proportion ( $Pr$ ) in the **Options...→Marker...→OBW**.

The instrument executes the calculation and displays the cursor in the view. At the same time, the frequency bandwidth occupied by the marker is displayed at the top left corner on the view.

# CDMA Analysis

The analyzer can perform analysis for a signal that a mobile station transmits to the base station. It can actually perform the analyses listed in Table 3–12 with respect to the measurement items specified in the IS-95 and T-53 standards.

**Table 3–12: CDMA analysis items**

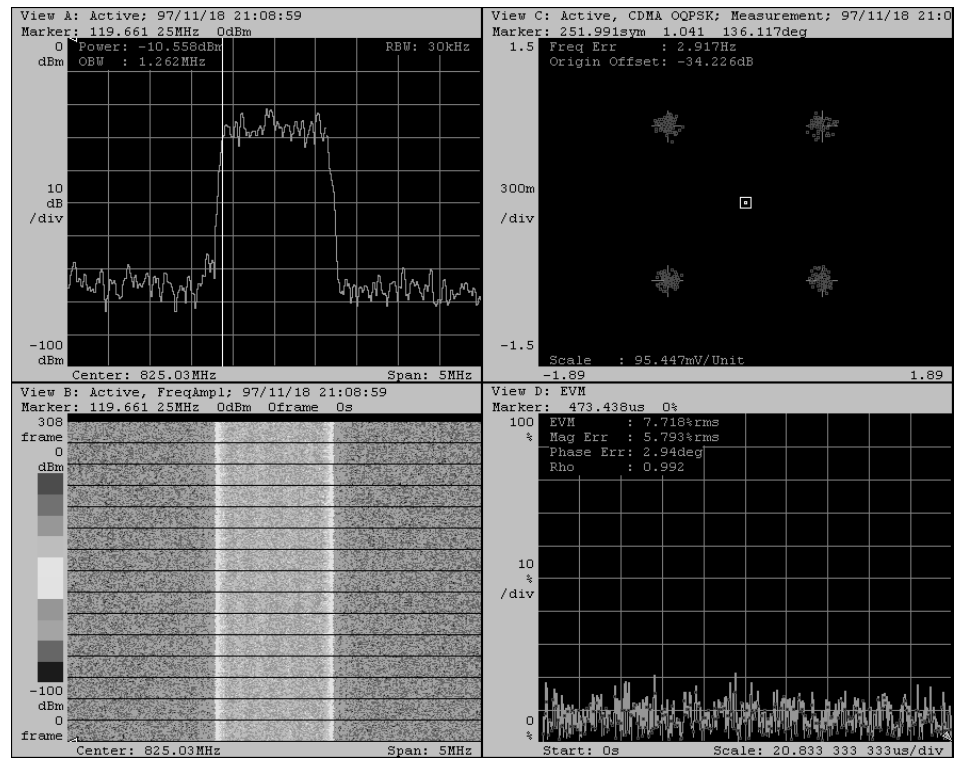
| <b>Classification</b>   | <b>Items to be analyzed</b>  | <b>Remarks</b>                 |
|---|--|--------------------------------|
| Channel analysis<br>(Evaluation of demodulation precision and waveform quality)   | In-band power<br>Burst waveform<br>F error<br>EVM and Rho ( $\rho$ ) | 5 MHz span                     |
| In-band analysis<br>(Evaluation of spurious)                                      | Spurious<br>(30 kHz and 1 MHz RBW)<br>OBW                            | 30 or 5 MHz                    |
| Time characteristic analysis<br>(Evaluation of rising and falling characteristic) | Power Specified Line<br>Average power<br>Rising and falling edges    | 1.6 ms wide<br>25 $\mu$ s wide |

This section describes each type of analysis.

## Evaluation of Demodulation Precision and Waveform Quality

Figure 3–51 shows the result of a channel analysis that is performed in the four views.

The first subsection describes the displayed information. The second subsection gives the measurement procedures.



**Figure 3–51: CDMA — Analysis with the EVM/Rho basic configuration pattern**

### Displayed Information

View A shows the plot of the in-band power values within the specified RBW (resolution band width) by using the CDMAWaveform view. Power (in-band power) and OBW (occupied bandwidth) are displayed at the top left corner of the view. The RBW value is preset to the default (30 kHz). If necessary, it can be switched to 1 MHz.

Refer to *Power Measurement* on page 3–79 for detail about the definitions of OBW (occupied bandwidth) and Power (in-band power). Note that the CDMA analysis uses the parameters defined in IS-95 and T-53 for the measurement.

View B displays the signal acquisition status for confirmation by using the Spectrum view.



View C displays the frequency and origin offset errors by using the CDMA Polar view while demodulating the input signal. This view also displays the symbol positions with red points. Also, it can display the symbol-to-symbol trace in the vector display mode.

Refer to *Process Flow* on page 3–69 for the demodulation function description.

**View D:** After compensating the origin offset from the signal demodulated in the CDMA Polar view, View D displays the following modulation quality information at the top left corner of the view using the EVM view.

- EVM (% RMS): Root-mean-square of EVM (error vector magnitude)
- Mag Error (% RMS): Root-mean-square of amplitude error
- Phase Error (deg): Root-mean-square of phase error
- Rho:  $\rho$  meter

The IS-95 and T-53 standards specify that the  $\rho$  meter value shall be 0.995 or larger. Refer to *Error Vector Analysis Display* on page 3–75 for details of the above information.

The green trace represents the EVM between the ideal and measured signals. The red points represent symbols of the measured signal. The view display can be switched to Mag Error or Phase Error.

## Measurement Procedure

1. Press the CONFIG:MODE key.
2. Press the More...→CDMA→EVM/Rho side keys in order.

Now, the basic settings are complete.

3. Press the SETUP:MAIN key.
4. Select the channel as necessary.
  - a. Press the Freq,Span,Ref... side key.
  - b. Press the Standard side key and select IS-95 or T53.
  - c. Press the Channel side key to select or type the channel number.

For IS-95, you can select 1 to 777 for the channel number. Channels 1 and 7 correspond to 825.03 and 848.31 MHz, respectively. The frequency difference between two adjacent channels is 0.03 MHz.

For T-53, you can select 1 to 1199 for the channel number. Channels 1 and 7 correspond to 915.0125 and 888.9875 MHz, respectively. The frequency difference between two adjacent channels is 0.0125 MHz.

5. Select the relationship between the span and the trigger:

For a continuous input signal, press the **5M Span Auto Trig.** side key.  
For a burst input signal, press the **5M Span Normal Trig.** side key.

If you select 5M Span Normal Trig. although the input signal is continuous, the measurement may be disabled because no trigger can be generated. If you do not know whether a continuous or burst signal is input, first select 5M Span Auto Trig. If the display condition is unstable, select 5M Span Normal Trig. because a burst signal is a high probability.

6. Press the **BLOCK** key to initiate the measurement.

The signal is displayed in each view together with the measurement values.

#### **Setting RBW to 1 MHz.**

Measure OBW and Power with View A at a resolution bandwidth of 1 MHz.

1. Press the **VIEW:A** and **MAIN** keys in order.
2. Press the **RBW** side key to select **1M**.

#### **Switching the error display to Mag or Phase Error.**

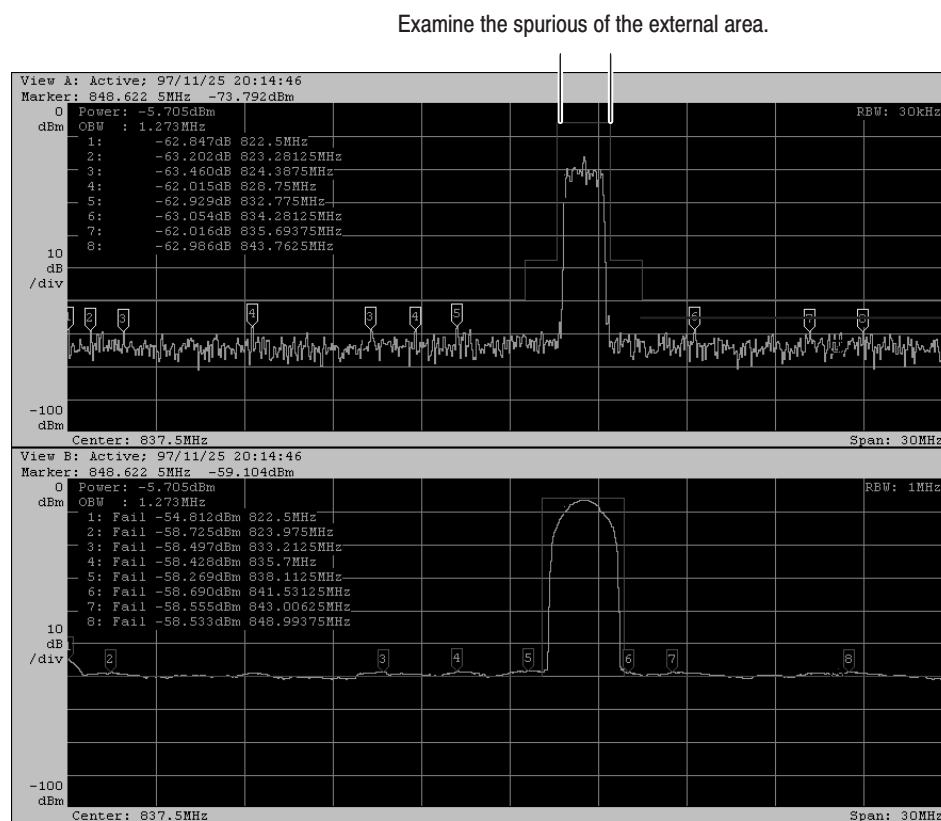
Switch the error display with View D to Mag Error or Phase Error:

1. Press the **VIEW:A** and **MAIN** keys in order.
2. Press the **Format** side key to select either **Mag Error** or **Phase Error**.
3. If necessary, press the **Option...→Scale...→Auto Scale** side keys to adjust the scale.

## Evaluation of Spurious

Figure 3–52 shows the two views that display the result obtained from an in-band analysis. By default, Views A and B display the same measured result with the same settings.

The first subsection describes the displayed information. The second subsection details the measurement procedure.



**Figure 3–52: CDMA Analysis with the spurious basic pattern (30 MHz span)**

### Displayed Information

The CDMAWaveform view is used for Views A and B. In Figure 3–52, the RBW for View B is set to 1 M.

With the RBW (resolution band width) set to 30 kHz or 1 MHz, the in-band power values were calculated from the input signal. The waveform displayed in the view was produced by plotting these values in each frequency position. The red line is the Specified Line from IS-95 and T-53. The displayed spectrum must be inside this line. When you set the view menu RBW menu item off, the input signal itself is displayed but the Specified Line disappears.

The Power (in-band power) and OBW (occupied bandwidth) values for the input signal are listed at the top left corner of the view.

Refer to *Power Measurement* on page 3–79 for detail about the definitions of OBW (occupied bandwidth) and Power (in-band power).

Each number enclosed in yellow lines, called a number tag, indicates a spurious signal position. The eight strongest spurious signals can be selected and numbered in frequency or level order. The selection is made by searching the signals that are outside the red base line with the strongest area (see Figure 3–52). Information about each spurious signal having the number tag is displayed in each view in the following format:

Number: Fail information signal-intensity (dB or dBm)  
frequency-position

The Number corresponds to the number of the number tag. If a spurious signal is beyond the Specified Line, Fail is displayed. Otherwise, empty display results.

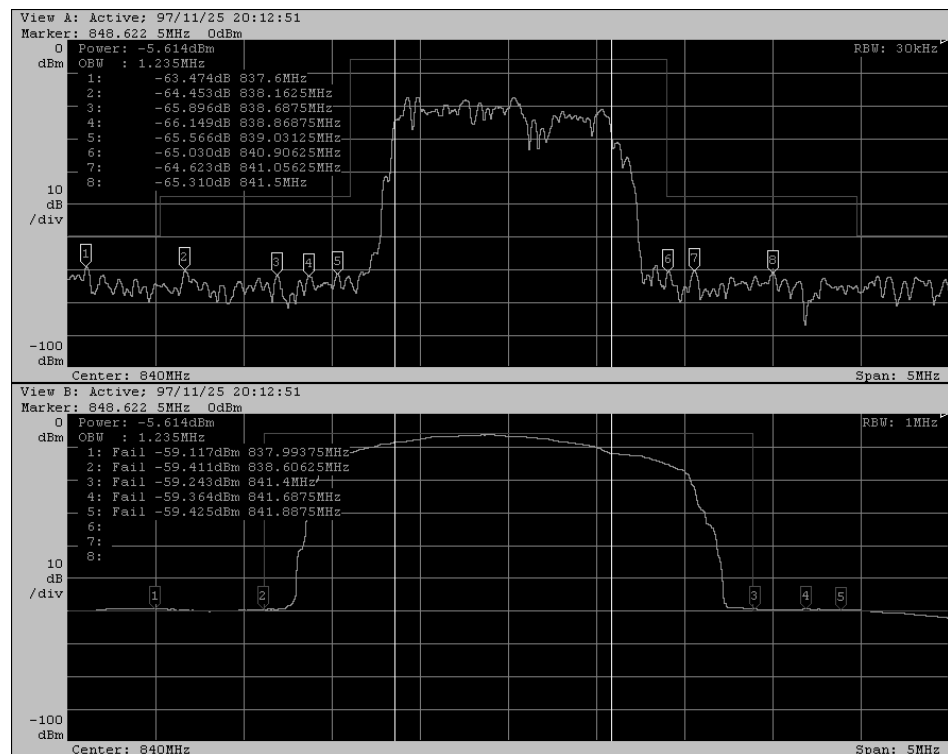
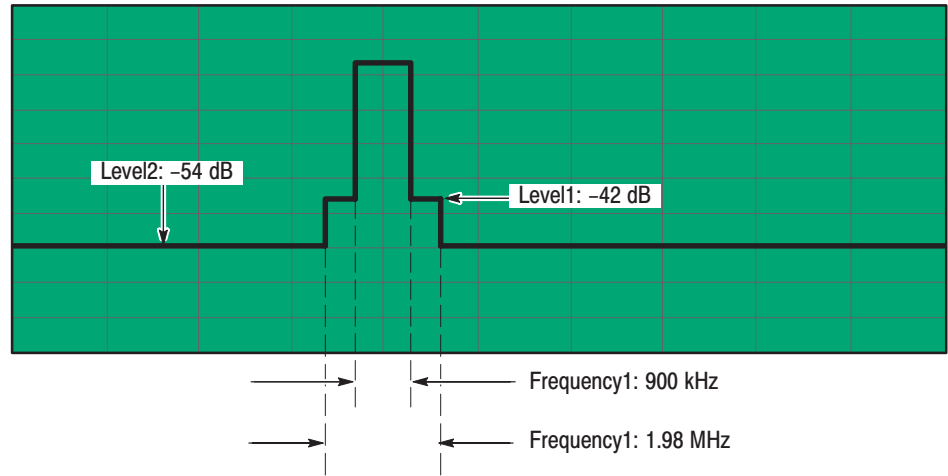


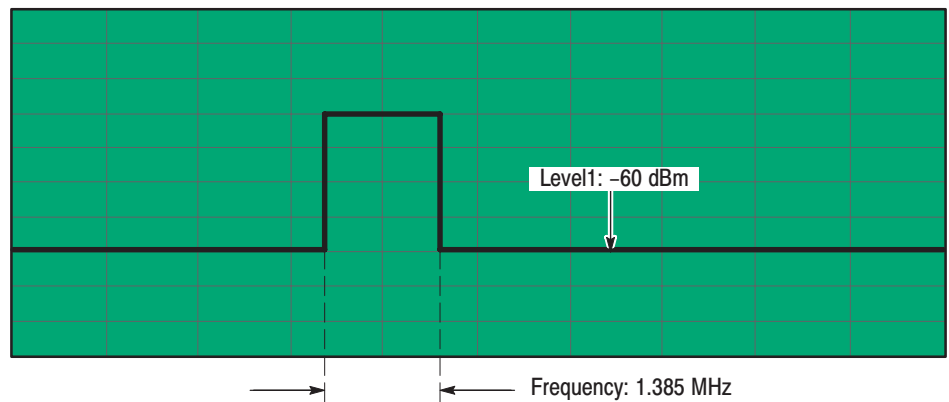
Figure 3–53: CDMA Analysis with the spurious basic pattern (5 MHz span)

**Specified Line Settings**

By default, the specified lines are set as shown in Figures 3–54 and 3–55. The values agree with those specified in the IS-95 and T-53 standards. You can view and set the specified line parameters by selecting **Options...→Mask...**



**Figure 3–54: Default specified line (when RBW = 30 k)**



**Figure 3–55: Default specified line (when RBW = 1 M)**

## Measurement Procedure

1. Press the **CONFIG:MODE** key.
2. Press the **More...→CDMA→Spurious** side keys in order.

Now, the basic settings are complete.

3. Press the **SETUP:MAIN** key.
4. Select the channel as necessary.
  - a. Press the **Freq, Span, Ref...** side key.
  - b. Press the **Standard** side key and select IS-95 or T53.
  - c. Press the **Channel** side key to select or type the channel number.

For IS-95, you can select 1 to 777 for the channel number. Channels 1 and 777 correspond to 825.03 and 848.31 MHz, respectively. The difference in frequency between channels is 0.03 MHz.

For T-53, you can select 1 to 1199 for the channel number. Channels 1 and 7 correspond to 915.0125 and 888.9875 MHz, respectively. The frequency difference between two adjacent channels is 0.0125 MHz.

5. Select the relationship between the span and the trigger.
  - a. Press the **30M Span, 5M Span Auto Trig.,** or **5M Span Normal Trig.** side button.

If you want to observe spurious signals in a wide range, select 30MHz Span. In this setting, since no signals can be acquired in the block mode, the measurement is performed as for the Auto trigger setting.

For 5MHz Span, the block mode takes effect. For a continuous input signal, press the 5M Span Auto Trig. side key. For a burst input signal, press the 5M Span Normal Trig. side key.

When the 5M Span Normal Trig. is selected, you may not perform the measurement since a trigger event can not be generated. If you do not know whether a continuous or burst signal is input, first select **5M Span Auto Trig.** If the display condition is unstable, select **5M Span Normal Trig.** because it will likely be a burst signal.

6. Perform the measurement by pressing the **ROLL** key if you have set **30Hz Span** or by pressing the **BLOCK** key if you have set **5MHz Span,**

### Changing the resolution bandwidth.

You can switch RBW (resolution bandwidth) between **1 MHz** and **Off**. If you set it to **Off**, the usual signal strength spectrum is displayed.

1. Select either **1M** or **Off** in the RBW side menu.
2. Press the **BLOCK** key to initiate the measurement.

### Sorting the number tags in frequency order.

By default, the number tags are numbered in spurious strength order. They can be renumbered in frequency order.

1. Select **Measurement Options...→Sorted by→Frequency**.
2. Perform the measurement by pressing the **ROLL** key if you have set **30Hz Span**, or pressing the **BLOCK** key if you have set **5MHz Span**,

### Performing the measurement, with the number tag display fixed.

By default, the spurious signal is searched for and the number tags are updated each time the measurement is performed. With the number tag display fixed, you can evaluate time-dependent changes of the spurious.

1. Select **Measurement Option...→Spurious Search→Off**.
2. Perform the measurement by pressing the **ROLL** key if you have set **30Hz Span**, or pressing the **BLOCK** key if you have set **5MHz Span**,

## Time Characteristic Evaluation

Figure 3–56 shows the two views that display the result obtained from in-band analysis.

The first subsection describes the displayed information. The second subsection gives the measurement procedures.

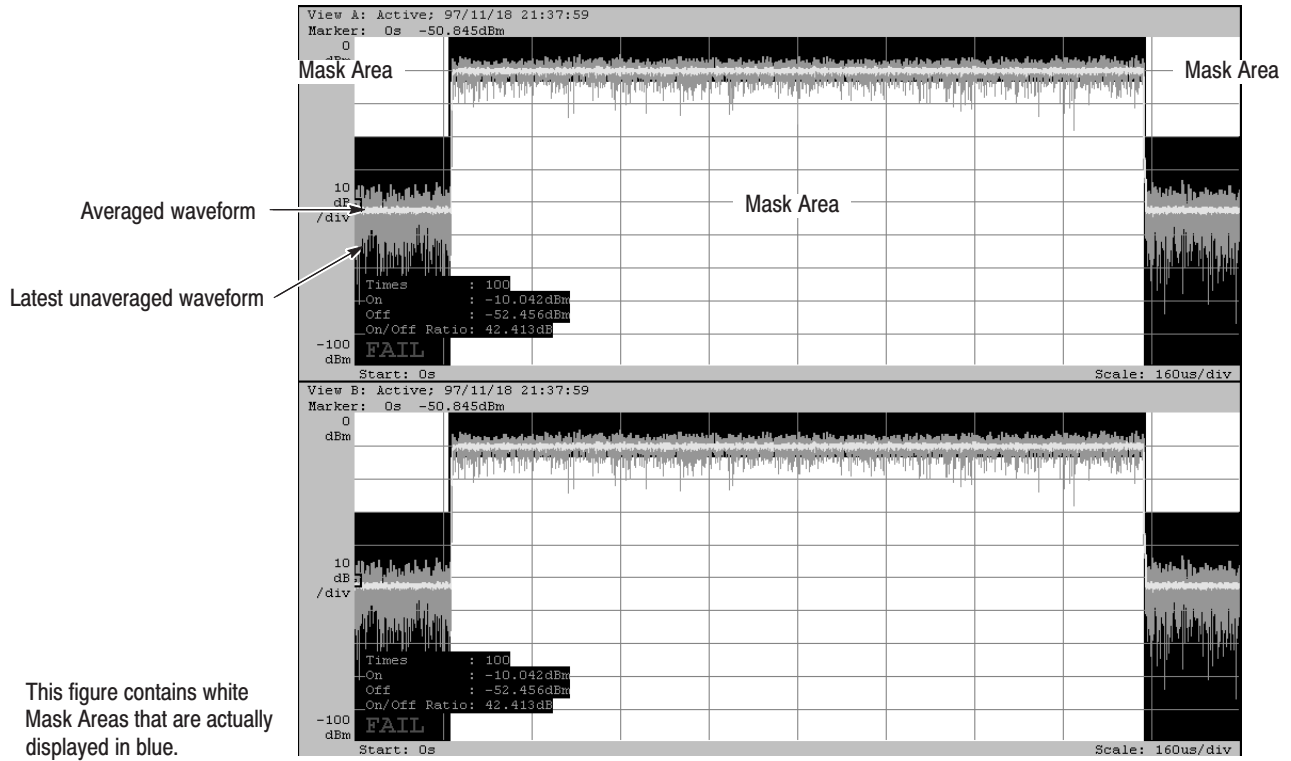


Figure 3–56: CDMA Analysis with the time domain basic pattern



## Displayed Information

The CDMAWaveform view is used for Views A and B. With the signal strength along the vertical axis and with the time along the horizontal axis, the same contents are displayed in both views by default. This display is used to measure the burst signal rising and falling time characteristics according to the IS-95 and T-53 standards.

The green waveform was obtained by one scan, while the yellow one was averaged by 100 scans. When an averaged signal enters a mask area that is blue, this results in an error. FAIL is displayed in red at the bottom left corner of the view.

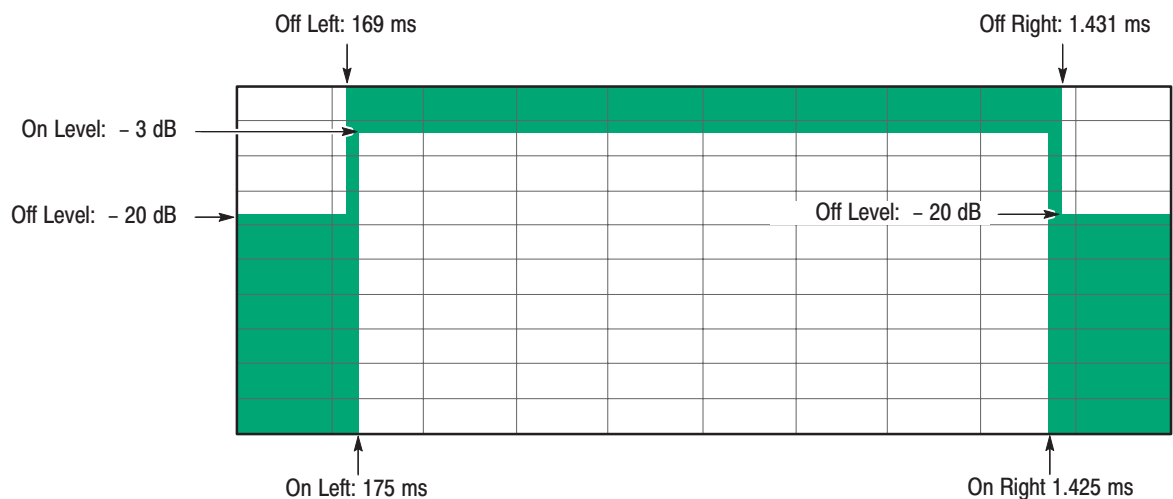
The following information is also displayed at the bottom left corner of the view:

|              |  |
|--------------|--|
| Times        | Averaging count  |
| On           | Burst signal intensity (averaged waveform)   |
| Off          | Intensity resulting when the burst signal is off (averaged waveform)                                       |
| On/Off Ratio | Proportion of the signal strength resulting when the burst signal is on, to that resulting when it is off. |

See Figure 3–57. This view can enlarge the burst signal rising and falling characteristic. The operating procedure is detailed in *Measurement Procedure* described on page 3–102.

## Mask Settings

By default, the mask area is set as shown in Figure 3–57. The values satisfy those specified in IS-95 and T-53. You can view and set the mask parameters by selecting **Options...→Mask...** in the CDMATime view menu.



**Figure 3–57: Default mask area**

## Measurement Procedure

1. Press the **CONFIG:MODE** key.
2. Press the **More...→CDMA→Time Domain** side keys in order.

Now, the basic settings are complete.

3. Press the **ROLL** key to make sure that the input signal is a burst.

Since you evaluate the signal rising and falling characteristics in this measurement, the burst signal must be active. This step checks that a signal suitable for the measurement is being input. If it is obvious that the signal is suitable for the measurement, skip this step.

4. Press the **Measure** side key to perform the measurement.

The same result is obtained by pressing the **Measure** side key in any **CDMATime** view.

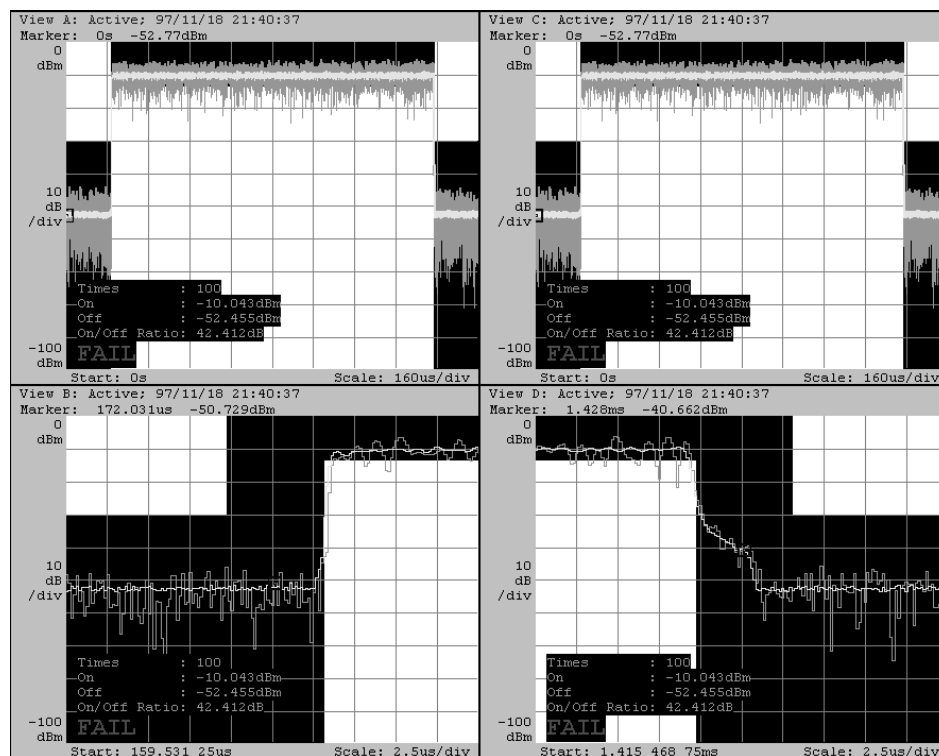
When you press the **Measure** side key, the [nnn/100] display appears. By default, nnn is incremented from 0 to 100. This indicates that the signal is acquired 100 times while being averaged. After the [100/100] display appears, the view displays the latest acquisition signal in green and the averaged waveform in yellow. At the same time, the averaged waveform is compared with the mask for the **PASS/FAIL** test. The result is displayed at the bottom left corner of the view.

IS-95 specifies that the averaging count is 100. This value is the default. You can set another value through the **Num Average** menu item.

To stop the measurement before completion, press the **CLR** key on the front panel. This operation aborts the measurement.

### Analyze the detailed rising and falling characteristics.

The signal rising and falling characteristic are critical to the time characteristic measurement. For example, the rising and falling waveforms can be enlarged in two of the four views shown in Figure 3–58.



**Figure 3–58: CDMA Analysis with the time domain basic pattern (rising/falling characteristic display)**

1. Press the CONFIG:VIEW key.
2. Select **CDMATime** for Views C and D.

Now, the four views contain the same display.

3. Change the View B display.
  - a. Press the VIEW:B key. Then, press the VIEW:MAIN key.
  - b. Press **Option...→Scale...→Rising Edge** side key.

View B changes to the one shown at the bottom left corner in Figure 3–58.

4. Change the View D display.
  - a. Press the VIEW:D and VIEW:MAIN keys in order.
  - b. Press **Option...**→**Scale...**→**Falling Edge** side key.

View D changes to the one shown at the bottom right corner in Figure 3-58.

# Zoom

Zoom enables you to observe details of a spectrum around a particular frequency by enlarging the acquired spectrum waveform in the specified span.

View A in Figure 3–59 displays the spectrum of the signal acquired in the Zoom mode. View B in the figure displays the spectrum resulting from the Zoom process. In this example, the signal acquired with a center frequency of 800 MHz and a span of 100 kHz enlarges by a factor of 100 around a center frequency of about 800 MHz.

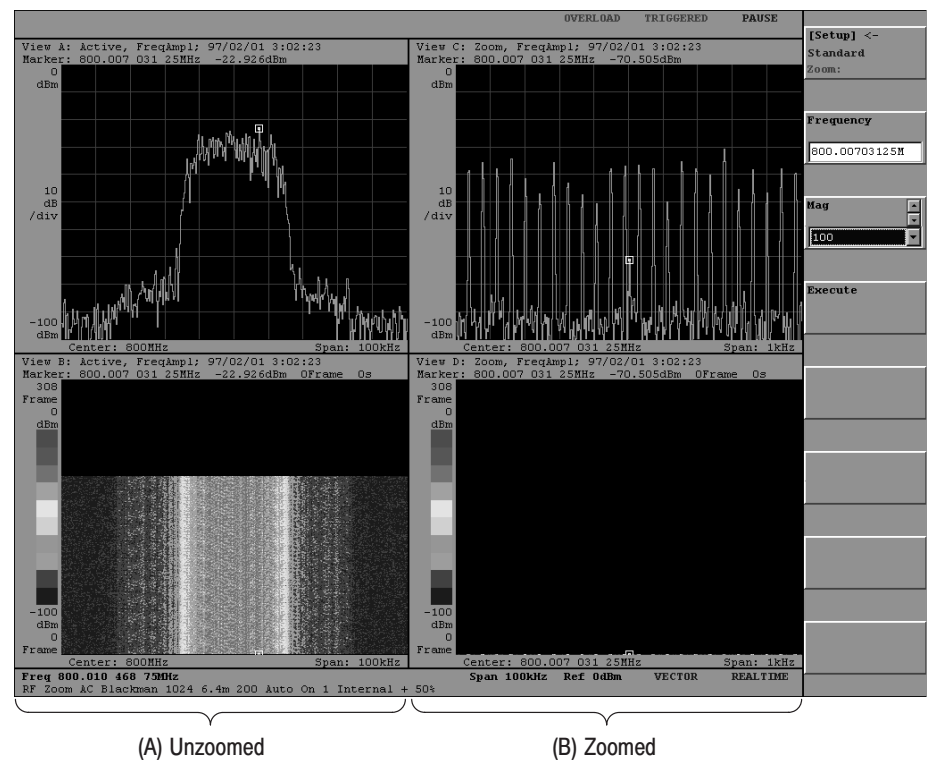


Figure 3–59: Unzoomed and zoomed spectra

## Data Available for Zoom

All data available for display in the Waveform, Analog, FSK, Waterfall, or Spectrogram views is available for Zoom. When Zoom runs, the waveform enlarges by the specified factor along the time and frequency axes.

## Running Zoom

To perform zooming, use the following procedure:

1. Set the analyzer to Zoom mode.

If you do not use basic patterns, do the following settings:

- a. Press the **SETUP:MAIN** key.
- b. Press the **Memory Mode** side key and then press **Zoom**.

2. Set the center frequency, span, reference level, and other parameters as necessary.
3. Set the Unzoomed view.

For example, if you display an unzoomed spectrum in View A, use the following procedures:

- a. Press the **CONFIG:VIEW** key. Then, press the **View A** side key to select Waveform.

4. Set the zoomed view.

For example, if you display the zoomed spectrum in View C, use the following procedures:

- a. Press the **CONFIG:VIEW** key. Then, press the **View C** side key to select Waveform.
- b. Press the **VIEW:C** key. Then, press the **VIEW:MAIN** key.
- c. Press the **Source** side key to select **Zoom**.

5. Press the **BLOCK** key to start the data acquisition.

After one-block of data has been captured, the acquisition is completed and View A displays the spectrum of the acquisition signal.

6. Run Zoom.
  - a. Press the **SETUP:MAIN** key.
  - b. Press the **Zoom...** side key in the menu.
  - c. Press the **Frequency** side key to input the center frequency used after zooming.
  - d. Select the **Mag** side key to select the magnification. The span equals (Unzoomed span / magnification).
  - e. Run Zoom by pressing the **Execute** side key.

Now, the enlarged spectrum is displayed in View C.

If necessary, repeat step 6 while changing the center frequency and magnification.

## Setting the Frequency Using the Search Function

You can position a marker at the peak spectrum using the search function, and then set the frequency at the marker position to the center frequency for Zoom.

1. Press the key associated with the view that contains the spectrum to be searched.
2. Press the VIEW:SRCH key.

The marker is positioned at the maximum peak spectrum. Rotating the general purpose knob clockwise searches the peak spectrum rightward and positions the marker there, and vice versa.

The frequency at the marker position is immediately set in SETUP:Zoom...→ **Frequency**. If necessary, change the Zoom center frequency by fine-tuning the marker position.

## Zoom Range

The Zoom range depends on the block size (number of frames) and the span settings. If you press the **BLOCK** key during data acquisition, the resulting written data does not reach the set block size. In this case, the block size depends on the number of written frames and the span. The magnification is as follows:

**Table 3-13: Zoom range**

| Mode                        | Span                 | Magnification                            |
|-----------------------------|----------------------|--|
| IQ, Wideband<br>(3086 only) | 10MHz, 20MHz, 30 MHz | 2 to the number of frames in 2-5-10 step |
| RF, Baseband                | 5 MHz                | 2 to the number of frames in 2-5-10 step |
|                             | Other than 5 MHz     | 2 to the number of frames in 2-4-10 step |

When running Zoom, one physical frame is remade using the physical frame in the time domain for the magnification. Therefore, the number of frames that can be displayed in the Spectrogram and Waveform views equal to  $(1/\text{magnification} - 1)$ .

---

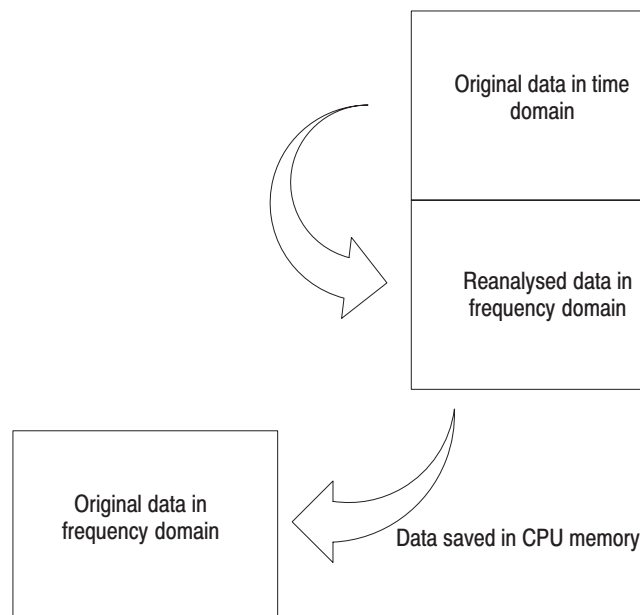
**NOTE.** For a three-dimensional view, one frame of those resulting from Zoom will not contain the data available for display. Therefore, the number of frames available for display will equal to (total number of frames – 1).

---

## Zoom Process

The zooming function of this analyzer remakes the frequency domain data, with a new frequency, from the time domain data acquired in the Zoom mode. For example, suppose that a signal was observed with a center frequency of 5 MHz and a span of 1 MHz. The Zoom mode reanalyzes exactly the same signal with a center frequency of 2.5 MHz and a span of 100 kHz, and displays the result on the screen. Therefore, you can set the span to 1/1,000 to 1/2, with high precision and without causing amplitude or phase distortion. This differs from enlargement by simple division scale or interpolation. In addition, while making changes to the center frequency and span settings, you can repeat zooming the data acquired once.

When Zoom runs, the original data in the frequency domain is saved in CPU memory. You can redisplay the original data in the frequency domain.



**Figure 3-60: Zoom mode process**



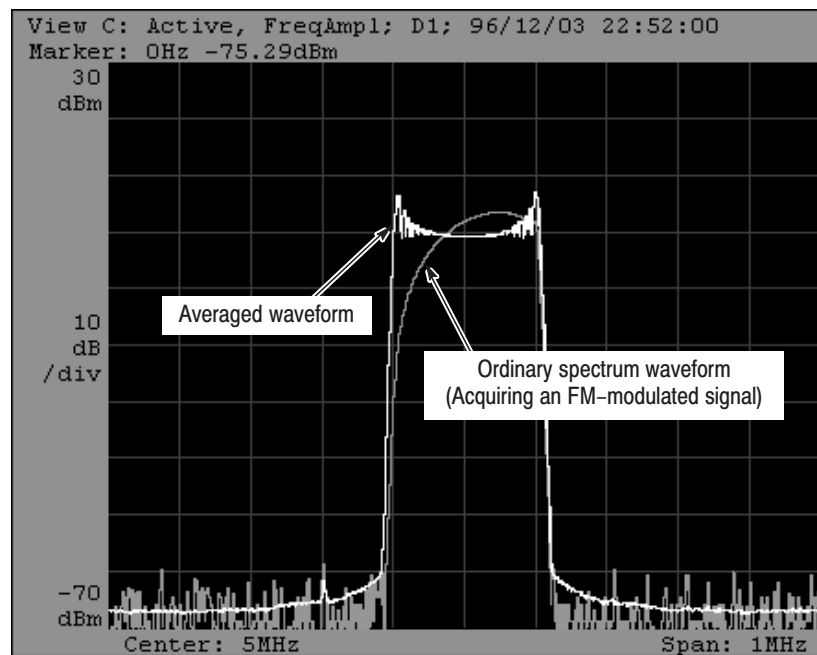
# Average and Peak Hold

The Waveform view can display the data while averaging. This enables you to make comparison between a spectrum waveform and its averaged waveform or observe spectrum shifts from the average or maximum value.

The UTILITY also has an independent averaging function that is capable of averaging the data stored in memory or in a file in the specified range.

The averaging function includes the average function, which performs the averaging process, and the peak hold function, which extracts the maximum value. The average function averages the frame-to-frame data on each of the bins. This decreases random noises which increases the S/N ratio. The peak hold function extracts the maximum value from the frame-to-frame data contained in the frequency domain.

Figure 3–61 shows an example that shows a spectrum and the result from the peak hold process.

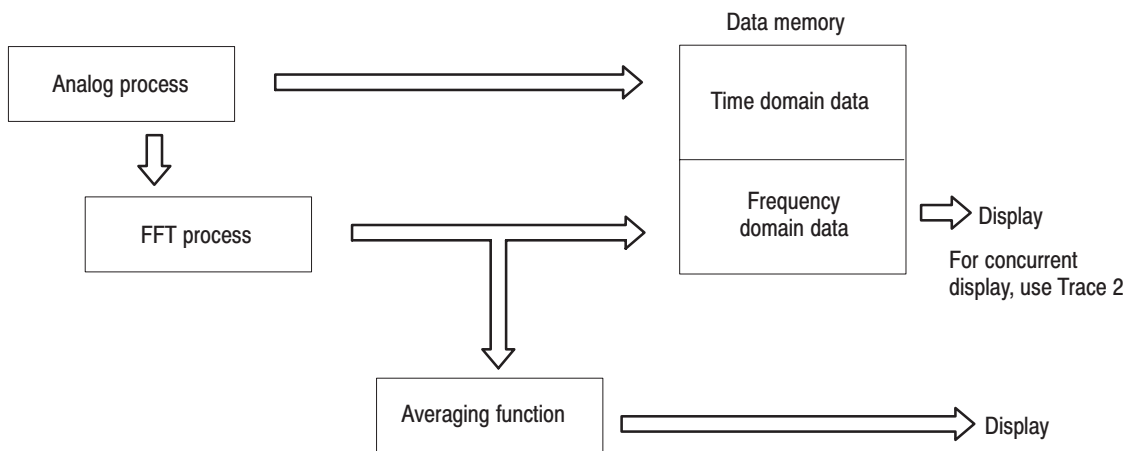


**Figure 3–61: Example of concurrent display of a spectrum and its averaged waveform**

## Mechanism

There are two ways of averaging. One is selecting **Average** for the input source in the Waveform view. The other is using the averaging function, which can be called through the CONFIG:UTILITY menu.

The averaging function available for the Waveform view performs the process while acquiring the signal. Figure 3–62 shows the mechanism. Averaging operates only when you are acquiring the data in the roll mode. In the block mode, the averaging function is disabled and ordinary data acquisition and display take place.



**Figure 3–62: Mechanism of averaging in a view**

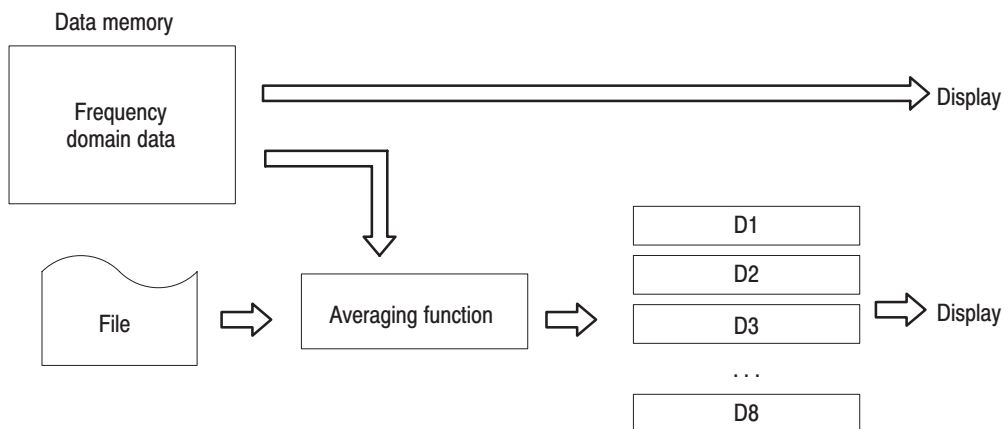
### Using the UTILITY Average Function

The average function available from CONFIG:UTILITY can process data while waveform acquisition is at a stop. Therefore, the data to process is in a file or in the data memory.

This analyzer contains memory areas called registers, including eight data registers that store the acquisition data.

You can use data registers D1 to D8 to hold the results the averaging function. This setting allows the frequency domain signal to be written into any of the D1 to D8 registers while performing averaging or peak-holding (see Figure 3–63).

The average data written in a data register can be displayed alone on the screen through a view. It can also displayed together with the contents of the original data memory or file before averaging.



**Figure 3–63: Mechanism of the averaging process that uses the utility average function**

## Averaging Mode

Three averaging modes are available.

**PeakHold.** Peak hold mode displays the maximum value only.

$$X(p)_n = x(p)_n \quad \text{for : } n = 1$$

$$X(p)_n = \max(X(p)_{n-1}, x(p)_n) \quad \text{for : } n \geq 2$$

**RMS.** Root-mean-square

$$X(p)_n = x(p)_n \quad \text{for : } n = 1$$

$$X(p)_n = \frac{X(p)_{n-1} + x(p)_n}{2} \quad \text{for : } 2 \leq n \leq \text{NumAverage}$$

For the view averaging function, the average for the frames that are set in the 1 to Num Average range is performed. For the averaging function through the UTILITY menu, the average is obtained over the frames in the range specified in Begin and End Frames.

**RMSExpo.** Exponential function root-mean-square

$$X(p)_n = x(p)_n \quad \text{for : } n = 1$$

$$X(p)_n = \frac{X(p)_{n-1} + x(p)_n}{2} \quad \text{for : } 2 \leq n \leq \text{NumAverage}$$

$$X(p)_n = \frac{(\text{NumAverage}-1) \times X(p)_{n-1} + x(p)_n}{\text{NumAverage}} \quad \text{for : } n > \text{NumAverage}$$

Where,

$X(p)_n$ : Display data for the nth frame

$x(p)_n$ : Active data for the nth frame

$P$ : Frame point

$\text{NumAverage}$ : Weighted average

The influence of older data decreases, and that of later data increases.

The averaging function through the UTILITY menu does not support the RMSExpo mode.

## Example of View Averaging Function Operating Procedure

### Setting the View.

1. Set the view.

For example, to display the ordinary spectrum and its averaged data concurrently in the View A, do the following procedures:

- a. Press the CONFIG:VIEW key. Then, select **Waveform** from the **View A** side key.
- b. Press the VIEW:A and VIEW:MAIN keys in order.
- c. Press the **Source** side key to select **Average**.
- d. Make the necessary settings to **Average Type** and **Num Average**.
- e. Press the **Trace2...** side key to display the submenu. Then, select **Active** using the **Source** side key.

### Process.

2. Press the **ROLL** key to capture the signal.

The ordinary spectrum and its averaged data are displayed concurrently in the View A.

The averaging process does not work in the block mode. In this mode, when you press the **BLOCK** key, the acquisition data is displayed without being averaged. To average the signal acquired in the block mode, use the procedures explained below.

## Example of the UTILITY Averaging Function

Suppose that the data memory already contains the written data, which can be acquired in the block mode. If you use the roll mode, stop the data acquisition before executing the process.

### Average Process.

1. After calling the averaging function, set up and run it.

- a. Press the **CONFIG:UTILITY** key.
- b. Press the **Util C [Average]** side key.
- c. Press the **Source** side key to select **Active**.

The contents of the data memory are processed in this case. To process the contents of a file, select either **File (\*.IQ)** or **File (\*.AP)**.

- d. Input the frame numbers in **Begin Frame** and **End Frame** to define the frame range to process.

If you press the **All Frame** side key, 0 and (total number of frames – 1) are set in **Begin Frame** and **End Frame**, respectively. If you press the **Mkr->Frame** side key, the number of the frame in the marker position is set in **End Frame**.

- e. Press the **Destination** side key to select one of the D1 to D8 data registers for the destination.
- f. Press the **RMS** (root-mean-square) side key or **PeakHold** (Peak hold) side key to execute the process.

When you press the **RMS** or **PeakHold** side key, the side key turns white, indicating that the process is in execution. Wait until the key returns to the initial color (gray), indicating that the process is complete.

### Setting the View.

2. Display the contents of the data register.

- a. For example, to define Waveform for View A, press the **CONFIG:VIEW** key, and then select **Waveform** using the **View A** side key.
- b. Press the **View A** and **VIEW:MAIN** keys in order.
- c. Press the **Source** side key to select the data register you set in step 1.e.

Now, the result of the averaging process is displayed.

# Saving and Loading a File

You can save or load the settings or data on the hard disk or a floppy disk. These tasks are performed using the Save and Load menus.

## Available Files

This analyzer can save and load any file with one of the extensions listed in Table 3–14.

**Table 3–14: Files available in this system**

| Extension | Description  |
|-----------|--|
| .CFG      | A configuration file, which is used to save the current settings.  |
| .IQ       | A file used to save IQ-formatted data. I stands for in-phase. Q stands for quadrature phase, which is orthogonal to I. When data is written into the data memory, the IQ format is always used. This data can be saved into the file as it is. |
| .AP       | A file used to save AP-formatted data. A and P stand for amplitude and phase, respectively. The contents of the data memory are converted into the AP format from the IQ format before being saved.  |

## Configuration File (.CFG)

The configuration file contains the settings in all menus as data. You can save the current configuration and settings in this kind of file. You can also load the contents of this file to restore the saved instrument settings.

**Save** Save the settings in a file.

1. Press the CONFIG:MODE key.
2. Press the **Save (\*.CFG)** side key.

The file access menu and screen appear. Select the destination drive and directory for save. Set the file name (not including the extension) and save the file. Refer to page 3–119 for detail about file operations.

**Load** Load the file and set up the analyzer.

1. Press the CONFIG:MODE key.
2. Press the **Load (\*.CFG)** side key.

The file access menu and screen appear. Select the drive and directory in which the file is located, and load it. Refer to page 3–119 for detail about file operations.

## Data File (\*.IQ, \*.AP)

This file is used to transfer IQ- or AP-formatted data between the data memory and a file.

**Save** You can save the data residing in the data memory using the Save Data function in the UTILITY. When the data is saved, part of the setting information is saved to allow the data to be displayed normally when being loaded.

1. Display the Save Load menu.
  - a. Press the CONFIG:UTILITY key.
  - b. Press the **Util B [Save Load]** side key.
  - c. Press the **Save...** side key.
2. Select the data you want to save.
  - a. Press the **Source** side key. Then, select the data source.

If you select **Active**, the data in the data memory is selected to be saved. If the data has been Zoomed, you can save the Zoomed result by selecting **Zoom**.

3. Select the frame range you want to save.

Define the beginning and ending frames in **Begin Frame** and **End Frame**. If you press **All Frames** side key, all frames containing the written data are selected. If you press the **Mkr -> Frame** side keys, the frames from 0 to the one in the marker position will be saved.



#### 4. Save the data.

- a. Press the **File (\*.IP)** or **File (\*.AP)** side key.

The File Access menu appears. Specify the device, directory, and file name before beginning the save operation. Refer to page 3–119 for detail about file operations.

If you press the **File (\*.AP)** side key, the data in the specified frame range is saved in IQ format. If you press the **File (\*.AP)** side key, this data is saved in AP format.

The analyzer uses the IQ format to write data into the memory. The IQ-formatted data is represented with the horizontal and vertical axes, but not represented with the I and Q axes of the IQ diagram. The AP-formatted data is calculated from the IQ-formatted data, and is the data represented in the polar coordinates. It takes more time to save the AP-formatted data to save the IQ-formatted data.

**Load** There are two ways to load data.

**Specifying the view Source menu item.** Specify the data file in the view Source menu item using File (\*.IQ) or File (\*.AP). The data listed in Table 3–15 is available in a view.

The data loaded in this way cannot be Zoomed. The data saved in AP format is unavailable for modulation analysis.

**Table 3–15: Data formats and file load**

| Format | View (Source)   |        |           |             |              |                         |                | Average |
|--------|-----------------|--------|-----------|-------------|--------------|-------------------------|----------------|---------|
|        | [CDMA] Waveform | Analog | Waterfall | Spectrogram | [CDMA] Polar | EyeDiagram/ SymbolTable | CDMATime       |         |
| IQ     | ○               | ○      | ○         | ○           | ○            | × <sup>1</sup>          | ○ <sup>2</sup> | ○       |
| AP     | ○               | ○      | ○         | ○           | ×            | ×                       | ×              | ○       |

<sup>1</sup> Does not enable direct input but enables file data display through the Polar view.

<sup>2</sup> The CDMATime view can not read data unless it has not been acquired with block size set to 20.

**Using the SaveLoad function.**

1. Display the SaveLoad menu.
  - a. Press the CONFIG:UTILITY key.
  - b. Press the **Util B [Save Load]** side key.
  - c. Press the **Load...** side key.
2. Select the data you want to load.
  - a. Press the **Load From File (\*.IQ)** side key. Then, select the IQ-formatted file.

Once you have selected the file, the IQ-formatted data saved in the file is loaded in the memory.

---

**NOTE.** *You cannot load AP-formatted data in the data memory of this analyzer.*

---

3. Specify **Active** in the **Source** menu item in the view to display the contents of the data memory in the view.

In this way, you can enlarge the display with the Zoom function if the data has been acquired in the Zoom mode.

# File Operations

You can save the settings or data on the hard disk or a floppy disk. You can also load the settings or data stored in the files. You do these through menus.

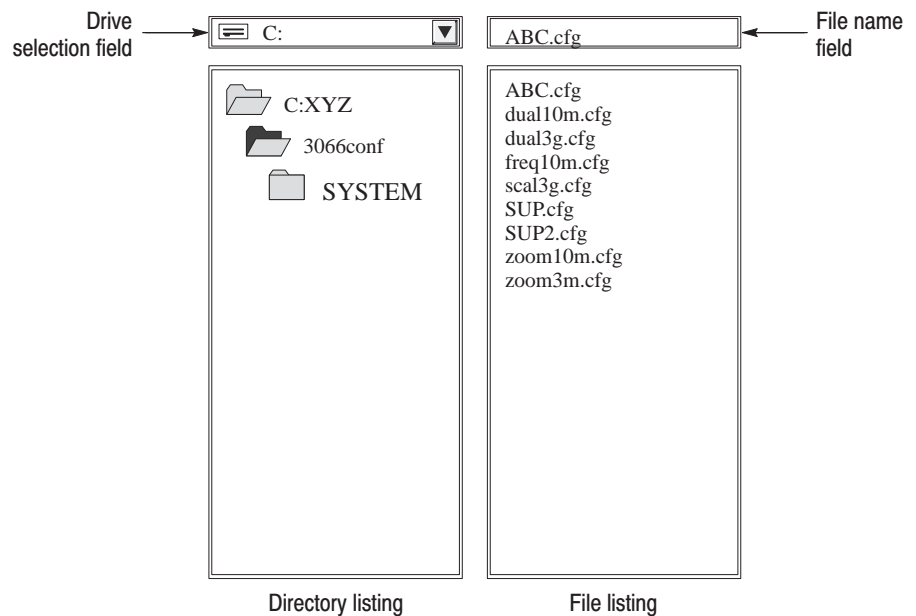
## Inputting and Outputting a File

File input and output are enabled in the CONFIG and VIEW menus. Figure 3–64 shows the menu items appearing during file saving or loading.



**Figure 3–64: Menu item with which the file can be saved or loaded**

When you press the associated side menu key, the File Access menu used for file operations and the dialog as shown in Figure 3–65 are displayed on the screen.



**Figure 3–65: File process display**

|              |   |
|--------------|---|
| Cancel       | Returns to the previous displayed menu without processing                       |
| OK           | Begin the save, load, or other operation  |
| File         | Select a file from the file listing   |
| Dir          | Select a directory from the directory listing                                   |
| Expand Dir   | Display the file listing located in the directory you selected above step       |
| Drive        | Select the drive in the drive selection field                                   |
| Name Entry.. | Edit the characters in the file name entry field in the subdirectory            |
| Operation... | Open the subdirectory to copy or delete a file, or create or delete a directory |

**Figure 3-66: File process menu**

## Selecting the Drive

1. Press the **Drive** side key. This allows you to select a drive in the drive selection field.
2. Select a directory using the general purpose knob or the ▲ or ▼ key on the ENTRY key pad.

---

## Moving the Directory

1. If necessary, select a drive. Refer to *Selecting the Drive* in this section.
2. Press the **Dir** side key. This allows you to select a directory from the directory listing.
3. Select a directory using the general purpose knob or the ▲ or ▼ key on the ENTRY key pad.
4. Press the **Expand Dir** side key. The files under the directory you selected are displayed.
5. If the directory hierarchy is deep, repeat steps 2 through 4.

## Selecting a File

1. If necessary, move the directory. Refer to *Moving the Directory* in this section.
2. Press the **File** side key. This allows you to select a file from the file listing.
3. Select a directory using the general purpose knob or the ▲ or ▼ key on the ENTRY key pad. The file name you selected is displayed in the file name field.

## Saving a File

### Rewriting an existing file:

1. Select a desired file using the procedures in *Selecting a File*.
2. Press the **OK** side key.

### Creating a new file:

3. Press the **Name Entry...** key. The submenu is displayed.
4. Input the file name. For detail, refer to *Inputting the Directory or File Name* on page 3-124.
5. Press the **OK** side key.

---

**NOTE.** *The instrument automatically adds the extension to the file. You do not need to input the extension. If you input an improper extension, the instrument replaces it with the proper one.*

---

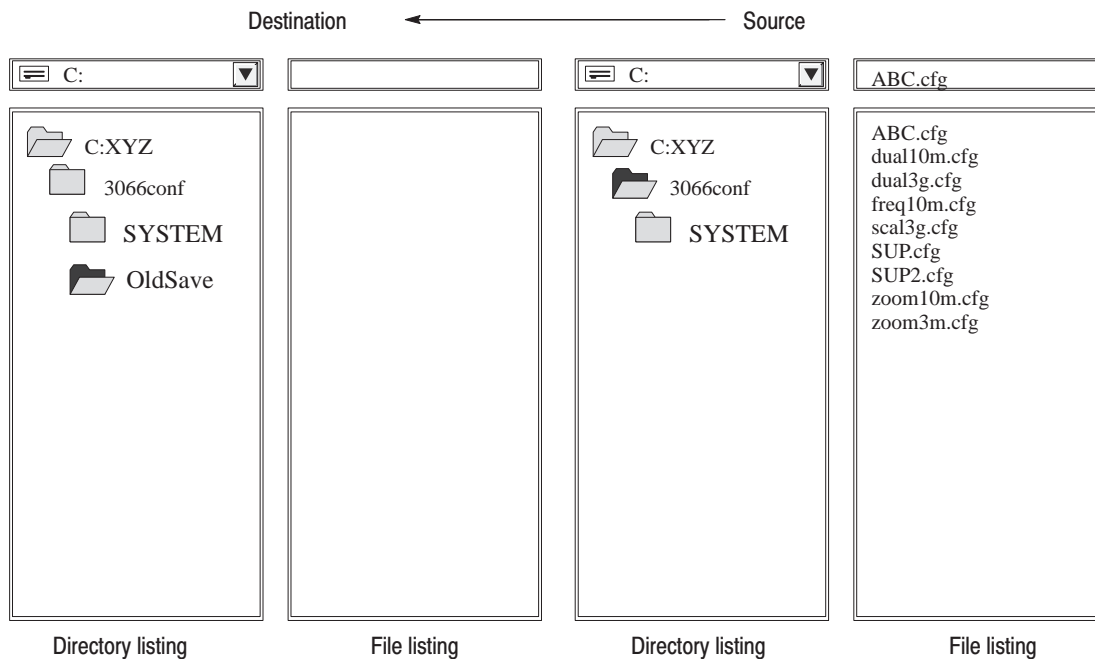
## Loading a File

1. Select a file using the procedures in *Selecting a File*.
2. Press the **OK** side key.

## Copying a File

Figure 3–67 shows the Copy File menu.

1. Open the destination directory. Refer to *Moving the Directory* for the procedure.
2. Select a source file.
  - a. Press the **Operation...** and **Copy File...** side keys in order. The new menu and file process dialog appear.
  - b. Select a file using the procedure in *Selecting a File* on page 3–121.
3. Press the **Copy File** side key.
4. Press the uppermost side key twice to return to the top-level menu.



**Figure 3–67: File copy process**

## Deleting a File

1. Press the **Operation...→Delete File...** side keys in order. The new menu appears.
2. Select a file using the procedure described in *Selecting a File* on page 3–121.
3. Press the **Delete File** side key to delete the file.
4. Press the uppermost side key twice to return to the highest-level menu.

## Creating the Directory

1. Press the **Operation...→Create Dir...** side keys in order. The new menu appears.
2. If necessary, move the directory. Refer to *Moving the Directory* on page 3–121.
3. Input the directory name using the procedure described in *Inputting the Directory or File Name* on page 3–124.
4. Press the **Create Dir** side key to create the directory.
5. Press the uppermost side key twice to return to the top-level menu.

## Deleting a Directory

1. Press the **Operation...→Delete Dir...** side keys. The new menu appears.
2. If necessary, move the directory. Refer to *Moving the Directory* on page 3–121.
3. Press the **Delete Dir** side key to delete the directory.
4. Press the uppermost side key twice to return to the top-level menu.

---

**NOTE.** *Directories containing one or more files cannot be deleted.*

---

## Inputting a Directory or File Name

**Renaming and Using a File.** When you select a file from the file listing, the file is displayed in the file name field. To create a new file by changing this file name, use the following procedure:

1. Select a file using the procedures described in *Selecting a File* on page 3–121.
2. Press the **Name Entry...** side key.
3. Press the **Position** side key to position the caret at the character you want to change. To insert a character, position the caret immediately after the where you want the new character.
4. If you change a character, press the **Delete Char** side key to delete the character at the caret position.
5. Press the side key associated with the menu item in which the characters are displayed.
6. All characters are displayed in side menu items. Press the associated side key.
7. If necessary, repeat steps 3 to 6.

**Inputting a New Name.** If the file name is not in displayed in the file name field or you want to input a new file name, use the following procedure:

1. Select a file using the procedures described in *Selecting a File* on page 3–121.  
  
If characters are displayed in the file name field, press the **Delete Char** side key repeatedly until they are all deleted.
2. Press the side key associated with the menu item containing the characters you want.
3. Each character is displayed in each side menu item. Press the associated side key.

To change a character, press the **Position** side key and then turn the general purpose knob to position the caret at the character you want to change.

To delete a character, press the **Delete Char** side key. The character at the caret position is deleted. While the caret is in a position where nothing exists, the **Delete Char** side key functions as the Backspace key.



# Data File Format

This section describes the structure of data files (\*.AP, \*.IQ).

## File Structure

In the frequency domain mode, the analyzer makes only frequency domain data files. In the dual domain mode, the analyzer makes frequency domain data files and time domain data files (“T” is added to the end of frequency domain file name) simultaneously.

The data file normally consists of three blocks (see Figure 3–68).

Data file (\*.AP, \*.IQ)

|                                       |
|---------------------------------------|
| File header (text format)             |
| Data block (binary format)            |
| Correction data block (binary format) |

**Figure 3–68: Data file structure**

When logging data continuously, a data block is added every data acquisition, and the date and time are added to the end of data file in the text format.

The data file is normally made after a data acquisition completes. But when logging data, the analyzer acquires data and add the data block to the file repeatedly. So, at the time the analyzer creates the file header, it does not know when it will acquire the last frame. Therefore, the analyzer adds the date and time to the end of file when the logging completes. Check if the date and time are added. If so, use them instead of DateTime in the file header. Refer to *DateTime* on page 3–129 for the format of date and time.

Also, when logging data, the analyzer does not know the number of valid frames (ValidFrames; refer to page 3–128) at the time it creates the file header. Then the analyzer writes “ValidFrames=0” supposedly. Check the value of ValidFrames in the file header. If it is zero, obtain the true value by investigating the file size. In this case, Correction data block is always added.

The details on each block are described below.

## File Header

The following is an example of the file header. The analyzer always writes “xxxxxType” at the beginning of header, where x is a decimal digit. For other items, no special order is observed, and some new items may be added.

```
40425Type=3066IQ
FrameReverse=Off
FramePadding=Before
InputMode=Wideband
MemoryMode=Zoom
FFTWindows=Blackman
FFTPoints=1024
Bins=501
MaxInputLevel=0
LevelOffset=0
CenterFrequency=82.31875M
FrequencyOffset=0
Span=20M
BlockSize=40
ValidFrames=40
FramesPeriod=25u
UnitPeriod=12.5u
FrameLength=25u
DataTime=98/08/25@12:00:44
GainOffset=-78.1656611311994
ZoomGainOffset=-54.0765278004965
MultiFrames=1
MultiAddr=0
```

The first numbers show a length of header. The first character “4” in the example indicates that the length of header is expressed by the four bytes after the second character. In this case,

$$\text{Length of header} = 1 \text{ (1}^{\text{st}} \text{ byte)} + 4 \text{ ( 2}^{\text{nd}} \text{ to 5}^{\text{th}} \text{ bytes)} + 0425 = 430 \text{ bytes}$$

The data block starts from the 431<sup>th</sup> byte.

**Type.** Shows a type of data. The analyzer has the following four types of data.

3066IQ expresses the data block contains I and Q data in the frequency domain.

3066IQT expresses the data block contains I and Q data in the time domain.

3066AP expresses the data block contains amplitude and phase data in the frequency domain.

3066APT expresses the data block contains amplitude and phase data in the time domain.

**FrameReverse.** Shows the frame order in a data block.

Off indicates the last frame in the data block is the latest acquired frame.

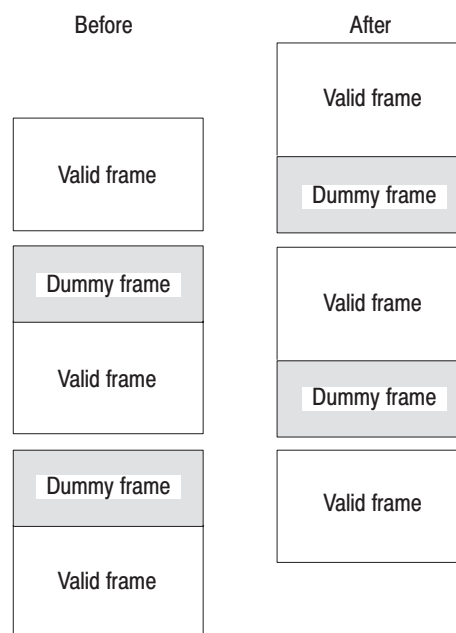
On indicates the first frame in the data block is the latest acquired frame.

Files of the 3066 version 1.27 or before do not have FrameReverse. Handle these files with FrameReverse=On. In the 3066 version 1.42 or later, FrameReverse is always Off.

**FramePadding.** When acquired frames do not fill the data block, the analyzer adds dummy frames. Such a case occurs, for example, when the analyzer stops a data acquisition after a trigger event before it fill a pre-trigger area in the data block with frames.

Before adds a dummy frame before a valid frame, but not in the first frame.

After adds a dummy frame after a valid frame, but not in the last frame.



**Figure 3-69: Adding dummy frames**

Files of the 3066 version 1.43 or before do not have FramePadding. Handle these files with FramePadding=After. In the 3066 version 1.6 or later, FramePadding is always Before.

**InputMode.** Shows the input mode when the analyzer acquired the data.

Files of the 3066 version 1.87 or before do not have InputMode. This parameter is needed only when 3086 retrieves the data into its memory.

**MemoryMode.** Shows the memory mode when the analyzer acquired the data.

Files of the 3066 version 1.87 or before do not have MemoryMode. This parameter is needed only when 3086 retrieves the data into its memory.

**FFTWindow.** Shows the FFT window setting when the analyzer acquired the data.

**FFTPoints.** Shows the FFT points setting when the analyzer acquired the data.

Files of the 3066 version 1.27 or before do not have FFTWindow. Determine the value from Bins below.

**Bins.** Shows the number of bins. When the value is 121, 161, or 201, one frame has 256 bin data. When 481, 501, 641, 751, or 801, it has 1024 bin data (refer to *Frame Data* on page 3–132). This information is the same as “bins” in the frame header (refer to *Frame Header* on page 3–130).

**MaxInputLevel.** Shows the reference level in dBm when the analyzer acquired the data.

**LevelOffset.** Shows the level offset in dB when the analyzer acquired the data.

**CenterFrequency.** Shows the center frequency in Hz when the analyzer acquired the data.

**FrequencyOffset.** Shows the frequency offset in Hz when the analyzer acquired the data.

**Span.** Shows the span in Hz when the analyzer acquired the data.

**BlockSize.** Shows the block size when the analyzer acquired the data.

**ValidFrames.** Shows the number of frames in the data block. This value divided by MultiFrames (described below) represents the number of frames that are scanned and synthesized into one frame.

**FramePeriod.** Shows the frame period setting in second. The actual period is obtained by multiplying UnitPeriod (described below) by the difference of “ticks” of each frame (refer to page 3–132).

**UnitPeriod.** Shows the unit time of time stamp “ticks” of each frame (refer to page 3–132).

**FrameLength.** This shows the time necessary to acquire one frame.

**DateTime.** Shows the time when the analyzer acquired the last frame in a data block. It is recommended to change “@” to “ ” (space). Files may have many “@” characters.

**GainOffset.** Shows the gain offset. It is used for calculating the amplitude (refer to page 3–135).

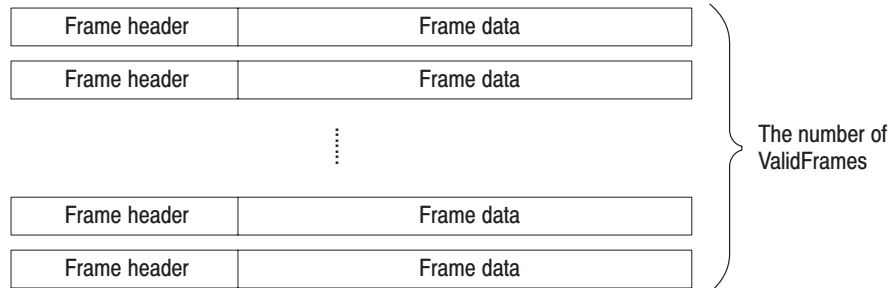
**ZoomGainOffset.** Shows the gain offset for zooming. This parameter is used only when the 3086 zooms data. (Not used to calculate amplitude in the data file.)

**MultiFrames.** Shows the number of scans for creating one frame in the multi-frame mode. For example, when MultiFrames=20, scanning 20 times with the span of 5 MHz make the span of 100 MHz.

**MultiAddr.** Shows the last frame address in the multi-frame mode. The range is 0 to MultiFrames –1. MultiFrames –1 indicates that the data ends just at the end of scans.

## Data Block

The data block contains pairs of frame header and frame data by ValidFrames in number (refer to page 3–128). The frame order is determined by FrameReverse (refer to page 3–127).



**Figure 3–70: Data block structure**

### Frame Header

The frame header is defined as the following structure.

```
structframeHeader_st {
    short dataShift;
    short validA;
    short validP;
    short validI;
    short validQ;
    short bins;
    short frameError;
    short triggered;
    short overLoad;
    short lastFrame;
    unsigned long ticks;
};
```

The following is the detail on each item.

**short dataShift.** Shows the exponential part of data. The range is 0 to 15. For example, 5 represents  $2^5$ . It is used to calculate I and Q values (refer to *Calculation of Data* on page 3–134).

**short validA, short validP, short validI, short validQ.** These parameters indicate whether the data type is amplitude, phase, I, or Q, respectively. Table 3–16 shows possible combinations of these values.

0 indicates that data is not written in the file.

–1 indicates that data is written in the file.

**Table 3–16: Possible combinations of data types**

| validA | validP | validI | validQ |
|--------|--------|--------|--------|
| 0      | 0      | 0      | 0      |
| –1     | 0      | 0      | 0      |
| 0      | –1     | 0      | 0      |
| –1     | –1     | 0      | 0      |
| 0      | 0      | –1     | 0      |
| 0      | 0      | 0      | –1     |
| 0      | 0      | –1     | –1     |

**short bins.** Shows the number of bins. It is the same as Bins in the file header.

**short frameError.** Indicates whether data acquisition completes within FramePeriod in the file header.

0 indicates that the data acquisition completed within FramePeriod.

–1 indicates that the data acquisition was beyond FramePeriod.

**short triggered.** Indicates whether the frame is before or after the trigger.

0 indicates that the frame is before the trigger (pre-trigger).

–1 indicates that the frame is after the trigger (post-trigger).

**short overLoad.** Indicates whether an input overload occurred.

0 indicates that the MaxInputLevel value in the file header was proper.

–1 indicates that the MaxInputLevel value in the file header was too low.

**short lastFrame.** The analyzer can divide its memory such as 100 frames  $\times$  40 blocks. “lastFrame” indicates the last frame in a block.

0 indicates that the frame is not the last in the block.

-1 indicates that the frame is the last in the block.

**unsigned long ticks.** Shows a time stamp with the unit time of UnitPeriod in the file header (not FramePeriod).

### Frame Data

A frame contains either pairs of amplitude and phase data or pairs of I and Q data. In the case of amplitude data only, the format is the same as in the case of pairs. The frame size depends on Bins in the file header (or bins in the frame header) as listed in Table 3–17.

**Table 3–17: Frame size**

| Value of Bins           | Number of data per frame |
|-------------------------|--------------------------|
| 121, 161, 201           | 256 bins per frame       |
| 481, 501, 641, 751, 801 | 1024 bins per frame      |

**Order of Bins.** The time domain data line from zero methodically. But the frequency domain data line from the center frequency data and dummy data are inserted in the middle part as listed in Table 3–17.

**Table 3–18: Order of bins in frequency domain**

| Number of bins | Order of bins  |
|----------------|--|
| 121            | 60, 61, 62, ..., 118, 119, 120, <135 dummy data>, 0, 1, 2, ..., 57, 58, 59       |
| 161            | 80, 81, 82, ..., 158, 159, 160, <95 dummy data>, 0, 1, 2, ..., 77, 78, 79        |
| 201            | 100, 101, 102, ..., 198, 199, 200, <55 dummy data>, 0, 1, 2, ..., 97, 98, 99     |
| 481            | 240, 241, 242, ..., 478, 479, 480, <543 dummy data>, 0, 1, 2, ..., 237, 238, 239 |
| 501            | 250, 251, 252, ..., 498, 499, 500, <523 dummy data>, 0, 1, 2, ..., 247, 248, 249 |
| 641            | 320, 321, 322, ..., 638, 639, 640, <383 dummy data>, 0, 1, 2, ..., 317, 318, 319 |
| 751            | 375, 376, 377, ..., 748, 749, 750, <273 dummy data>, 0, 1, 2, ..., 372, 373, 374 |
| 801            | 400, 401, 402, ..., 798, 799, 800, <223 dummy data>, 0, 1, 2, ..., 397, 398, 399 |



**Definition of Bin.** The bin is defined as the following structure.

```
AP format data
struct apBin_st{
    short a;
    short p;
};
```

```
IQ format data
struct iqBin_st{
    short q;
    short i;
};
```

**Definition of frame.** The frame is defined as the following structure.

```
AP format (1024 bins)
struct apFrame1024_st {
    struct apBin_st ap[1024];
};
```

```
IQ format (1024 bins)
struct iqFrame1024_st{
    struct iqBin_st iq[1024];
};
```

```
AP format (256 bins)
struct apFrame256_st{
    struct apBin_st ap[256];
};
```

```
IQ format (256 bins)
struct iqFrame256_st{
    struct iqBin_st iq[256];
};
```

**Calculation of Data.** All the data of amplitude, phase, I, and Q are transformed to 2-byte signed integers, then written on the file.

### Amplitude

For the APT or AP file, the amplitude is calculated using  $a$  with this formula.

$$\text{Amplitude} = a/128 + \text{GainOffset} + \text{MaxInputLevel} \text{ [dBm]}$$

For the IQT file, the amplitude is calculated using  $i$  and  $q$  with this formula.

$$\text{Amplitude} = 10 * \text{Ln}(i*i+q*q) / \text{Ln}(10) + \text{GainOffset} + \text{MaxInputLevel} \text{ [dBm]}$$

For the IQ file, the amplitude is calculated using  $i$  and  $q$  with this formula.

$$\text{Amplitude} = 10 * \text{Ln}((i*i+q*q)/(1 \ll (\text{DataShift} * 2))) / \text{Ln}(10) + \text{GainOffset} + \text{MaxInputLevel} \text{ [dBm]}$$

### Phase

For the APT or AP file, the phase is calculated using  $p$  with this formula.

$$\text{Phase} = p/128 \text{ [degree]}$$

For the IQT or IQ file, the phase is calculated using  $i$  and  $q$  with this formula.

$$\text{Phase} = \text{atan2}(q, i) * (180/\pi) \text{ [degree]}$$

### I, Q

For the IQT file, I and Q are calculated with this formula.

$$\text{IQScale} = \text{Sqrt}(\text{Power}(10, (\text{GainOffset} + \text{MaxInputLevel})/10)/20*2)$$

$$I = i * \text{IQScale} \text{ [V]}$$

$$Q = q * \text{IQScale} \text{ [V]}$$

For the IQ file, I and Q are calculated with this formula.

$$\text{IQScale} = \text{Sqrt}(\text{Power}(10, (\text{GainOffset} + \text{MaxInputLevel})/10)/20*2)$$

$$I = i/(1 \ll \text{DataShift}) * \text{IQScale} \text{ [V]}$$

$$Q = q/(1 \ll \text{DataShift}) * \text{IQScale} \text{ [V]}$$

## Correction Data Block

The correction data block contains gain and phase correction data as one frame in the frequency domain. When this block is added, the amplitude and phase are calculated with the following formula. Be careful about the sign for correction.

$$\text{Amplitude} = \text{Calculated value} - (\text{Correction data}/128) \text{ [dBm]}$$

$$\text{Phase} = \text{Calculated value} + (\text{Correction data}/128) \text{ [degree]}$$

where “Calculated value” is the one obtained by the formula described in previous section, *Calculation of Data* on page 3–134.



# Access to Windows 95

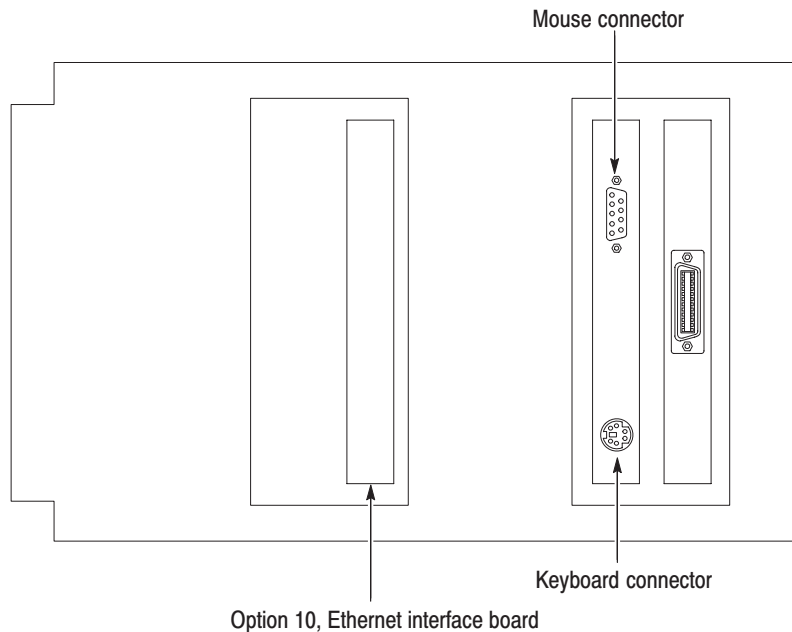
The user interface in this system operates under Windows 95. With the mouse and keyboard connected to this analyzer, you can use Windows 95 and its application software on the instrument. Printer driver installation is also enabled under Windows 95.

## Expansion Slots

The GPIB interface port on the rear panel can be used to incorporate this analyzer into a system. If the analyzer is used as a stand-alone instrument, you may not need to use the GPIB interface.

A hard disk or other equipment can also be connected to the SCSI interface port.

An interface board can be installed into the left-most expansion slots. For example, if you want to network the analyzer, the network interface board must be inserted in this slot. Interface board installation can be made only by a service personnel. Contact Tektronix for detail.



**Figure 3-71: Expansion slots**

## Connecting the Mouse and Keyboard



**CAUTION.** To avoid damaging the analyzer, make sure that the power is off before connecting the keyboard and mouse. If the power is on, turn off the Power Switch on the front panel and wait until the power shuts off completely.

Figure 3–71 shows the rear panel expansion slots. The mouse and keyboard interface boards (COM1 and COM2) are housed in the second rightmost slot. Connect the mouse and 101 or 106 type keyboard to the appropriate interface port.

### Operations with Mouse

The 3066 or 3086 analyzer software allows you to display a mouse driven, front panel interface (window). Through this interface, you can operate all the analyzer functions using a mouse. For details, refer to Appendix F, *Mouse Operations*.

### Operations with Keyboard

You can use an external keyboard for selecting menu items and entering numeric values, instead of using the keypad on the front panel.

Table 3–19 indicates the keyboard keys and how they can be used to control the analyzer.

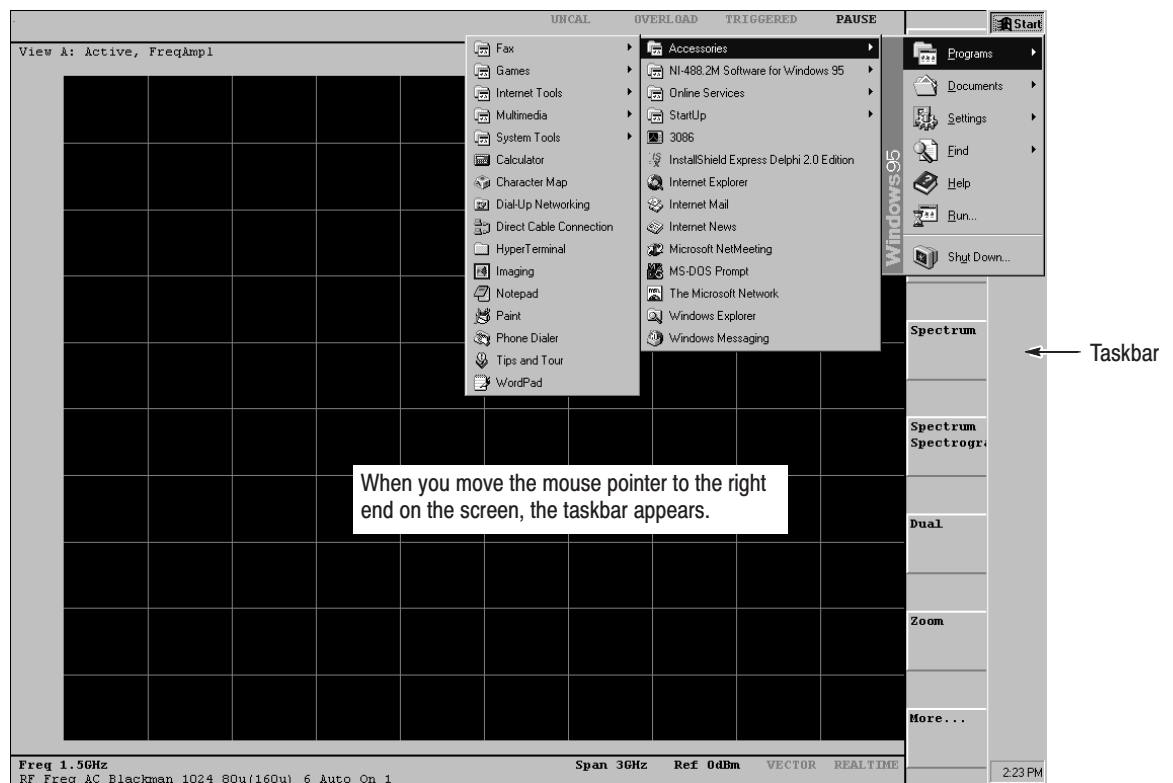
**Table 3–19: Functions available with a keyboard**

| Key          | Purpose          | Descriptions  |
|--------------|------------------|---|
| Numeric keys | Numeric input    | Inputs numbers in numeric fields  |
| Arrow keys   | Moving the caret | Moves the caret within the numeric field  |
|              | Selecting a item | Upper or left arrow allows you to select the menu item placed just above the currently selected item<br><br>Lower or right arrow allows you to select the menu item placed just below the currently selected item |
| Back Space   | Deleting an item | Deletes one character positioned just before the caret  |
| Delete       | Deleting an item | Deletes one character positioned just after the caret   |
| ESC          | Numeric input    | Clears text in the input field  |
| ENTER        | Numeric input    | Establishes the value in the input field to the instrument  |
| K and k keys | Numeric input    | Both keys represent k ( $10^{+3}$ ).<br>Be sure to press the ENTER key after the K or k.  |
| M and m keys | Numeric input    | Represent M ( $10^{+6}$ ) and m ( $10^{-3}$ ), respectively.<br>Be sure to press the ENTER key after the M or m.  |

## Access to Windows 95

When you power up after connecting the keyboard and mouse, the mouse pointer is displayed on the screen.

When you move the pointer to the right end on the screen, the taskbar appears. It contains the Start icon and the listing of the applications currently running in the analyzer. After clicking on Start icon, you can access any application included with Windows 95.



**Figure 3-72: Displaying the Windows 95 accessory menu**

**NOTE.** Each view displays the system-managed date and time. To set the date and time, refer to page 3-141.





# Setting the Date and Time

The analyzer displays the system-managed date and time in each view. You can change the date, time, and time zone using the Windows 95 date and time setting application from the front panel.

1. Press CONFIG:UTILITY key on the front panel.
2. Press **Action** side key and select **Assign**.
3. Press **UTIL D** side key and select **TimeDate**.

The Date/Time Properties dialog box appears.

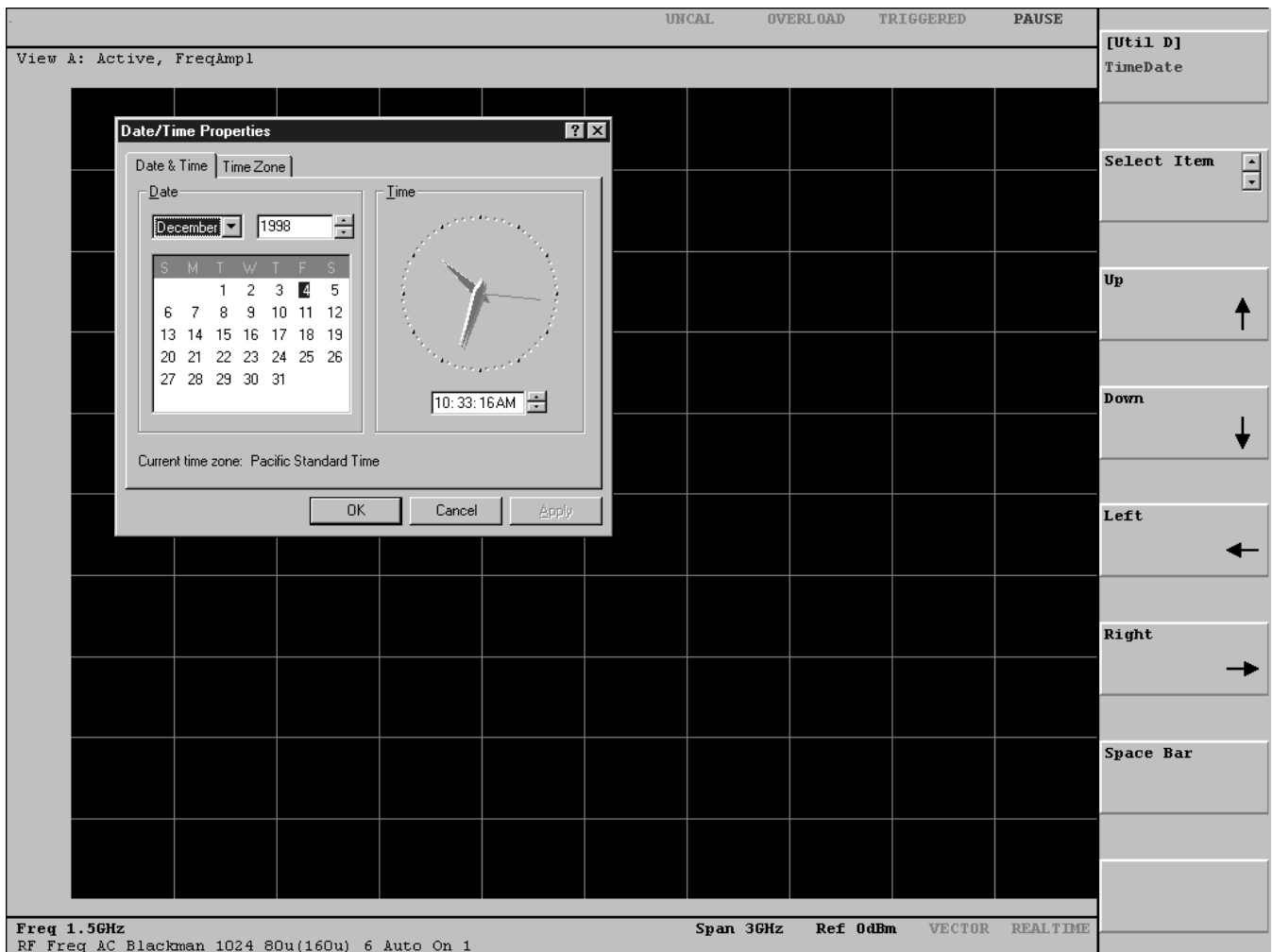


Figure 3-73: Date/Time Properties dialog box

4. Change the date and time with the following substeps. If you want to change the time zone, skip to the step 5.
  - a. Using the general purpose knob, move the cursor to select the field.
  - b. Change the value with the arrow (↑, ↓, ←, →) side keys.
  - c. Repeat substeps **a** and **b** until you set all the fields.
5. Change the time zone with the following substeps, or skip to the step 6.
  - a. Move the cursor to the Time & Date tab using the general purpose knob, and press the right arrow (→) key to select the Time Zone tab.
  - b. Using the general purpose knob, move the cursor to select the field.
  - c. Change the value with the arrow (↑, ↓, ←, →) side keys. To select the check box, use the **Space Bar** side key.
6. When you are finished, move the cursor to the **OK** button using the general purpose knob, and press the **Space Bar** side key to confirm your settings.

The Date/Time Properties dialog box appears again.
7. Press **UTIL D** side key and select **None** to close the Date/Time Properties dialog box.

# Hardcopy

You can make a hardcopy to a connected printer. By using the Windows 95 application you can also make a screen capture as a bit-map file to the hard disk or a floppy disk.

## Outputting Data to the Printer

Before you can print a hardcopy you need to connect a printer to the analyzer. In addition, you need to install the printer driver and set the default printer.

---

**NOTE.** *The instrument does not contain preinstalled printer drivers.*

---

### Connecting the Printer

Plug the printer cable into the rear panel parallel port. See Figure 2–3 or 3–71 for the parallel port locations.

If the network interface board is already installed in a user-available expansion slot, you can also use any printer connected to the network (see Figure 2–3 or 3–71 ). Contact Tektronix when you require installation of the network interface board.

### Installing the Printer Driver

Using the mouse, install the printer driver according to the Windows 95 printer wizard.

Refer to page 3–138 for connecting the mouse and keyboard to the rear-panel connectors.

1. Move the mouse pointer to the right end on the screen. The Windows 95 taskbar appears.
2. Open **Start**→**Settings**→**Printer**.
3. Start **Set up Printer** under **Printer**. The dialog box appears as shown in Figure 3–74.
4. Install the printer driver according to the messages appearing in the dialog box.

---

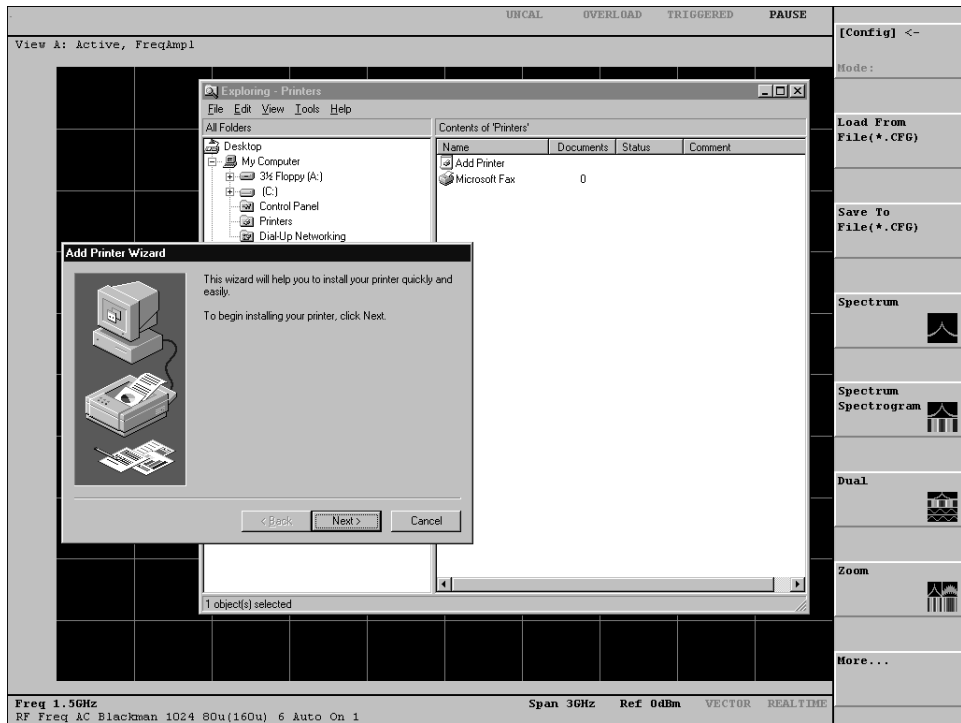
**NOTE.** *You can set the default printer when you install the printer.*

---

**Print** With signal acquisition at a stop, press the **PRINT** key on the front panel. The Print menu appears on the screen. Press the **Print Screen** side key to transfer the hardcopy of the whole display image to the printer.

If the default printer has not yet been set, the message *Default Printer Not Found* is displayed in red in the uppermost status display area on the screen. This message also appear when no printer drivers are installed.

If the printer is not connected or powered up, the printer driver prompts you to correct the problem.



**Figure 3-74: Installing the printer driver**

## Outputting the Hardcopy to a Disk

You can capture a display image as an image file for use with desktop publishing (DTP) software to create a report. There are two ways to save the image to a file:

- Use the front panel
- Use the mouse and keyboard

### Use the front panel.

1. Press the **PRINT** button on the front panel.
2. Press the **Save To File (\*.BMP)** side key.  
The directories and files are listed on the display.
3. Select a directory with the general purpose knob.
4. Enter a file name with the side key.
5. Press **OK** side key.

### Use the mouse and keyboard.

1. Press the **Print Screen** key on the keyboard to copy the bit map image to the Windows Clipboard.
2. Using the mouse, select **Start**→**Accessories**→**Paint** from the taskbar to launch the paint application.
3. Move the mouse pointer to the work area of the paint application.
4. Press the **Ctrl** and **V** keys together on the keyboard to paste the bit map data to the paint application.
5. Using the application, save the bit map data to the hard disk or a floppy disk.



# Outputting Spectrum Data in Text Form

You can extract the spectrum data as text data. With this function, you can use the acquisition data in a spreadsheet program and create a report; transfer the data to other equipment and analyze the spectrum in detail; or use the data as test data for the next-stage product.

## Restrictions on Use

The following restrictions are imposed on extracting the spectrum as text data.

- Data must be acquired in the vector mode  
Refer to *Physical and Logical Frames* on page 3–23 for the vector mode.
- Only one-frame data that is currently in display in the Waveform, Analog, or FSK view can be saved

You can extract the data from another frame by changing the frame.

## Output Format

The following is an example of data obtained by outputting the contents of the file or the clipboard to a file. The left column contains the data along the vertical axis. The right column contains the data along the horizontal axis. They are separated by a Tab character.

```
0          -10.1942459427812
7.8125E-8  -15.5797318785542
1.5625E-7  -15.9940859783336
2.34375E-7 -15.5557856085716
3.125E-7   -15.9780353894513
3.90625E-7 -15.7083613241091
4.6875E-7  -15.7874957521482
5.46875E-7 -15.7419274821247
6.25E-7    -16.2202259114158
7.03125E-7 -15.618887152088
. . .
```

For the units of the values, see the units of the vertical and horizontal axes that are currently in display in the current view.

The number of points output to the clipboard or to the file equals to the currently set number of FFT points in the time domain. It equals the number of bins in the frequency domain.

Figure 3–75 shows an example in which waveform data has been pasted in application software **Scratch Pad**.

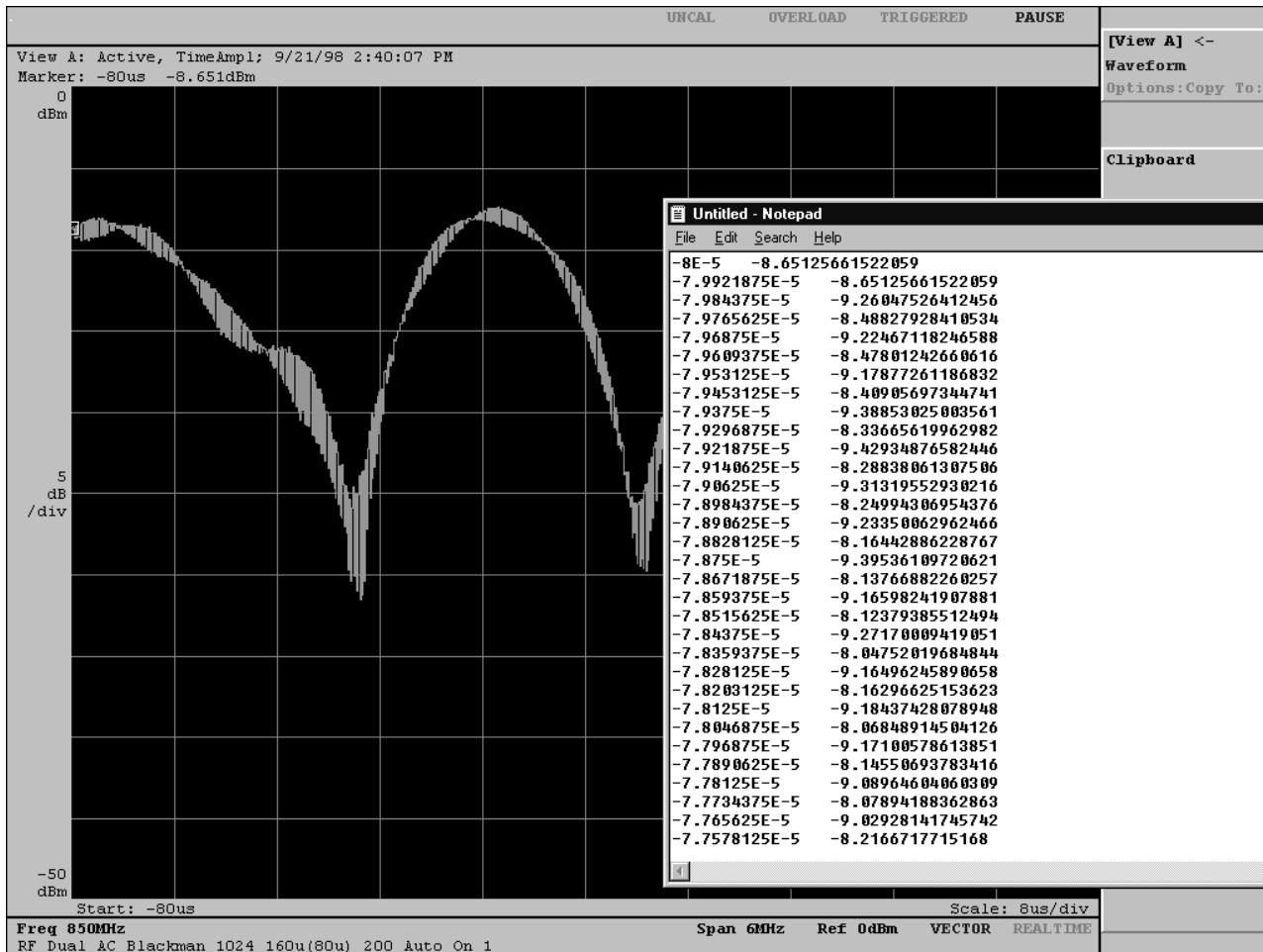


Figure 3–75: Copying data to the clipboard and pasting it to an application

## Text Output Procedure

With the data-in-display converted to text form, you can copy it to the Windows clipboard or save it to a text file.

Use the following procedure to output the data to the clipboard:

1. Acquire the signal in vector mode. Use the Waveform view to display the data.
2. If necessary, change the display frame.



3. Paste the displayed data to the clipboard using the following procedures:
  - a. Select **Options...→Copy To...→Clipboard** from the Waveform view menu.

The waveform data in display is pasted to the clipboard.

Paste the data from the clipboard to the application. As an example, the procedure to use Scratch Pad or Microsoft Excel is shown below. A similar procedure can be used for other applications.

4. Start the application.
5. Select **Paste** from the Edit menu, or press the **Ctrl** and **V** keys together on the keyboard.

The contents of the clipboard are pasted. This data is further output to a file.

6. Select **Save As...** from the File menu. A dialog used to save the file appears. Select the device and directory as required. Input the file name. Finally, click on **OK**.

Figure 3–76 shows an example of a graph obtained by pasting the data to Microsoft Excel.

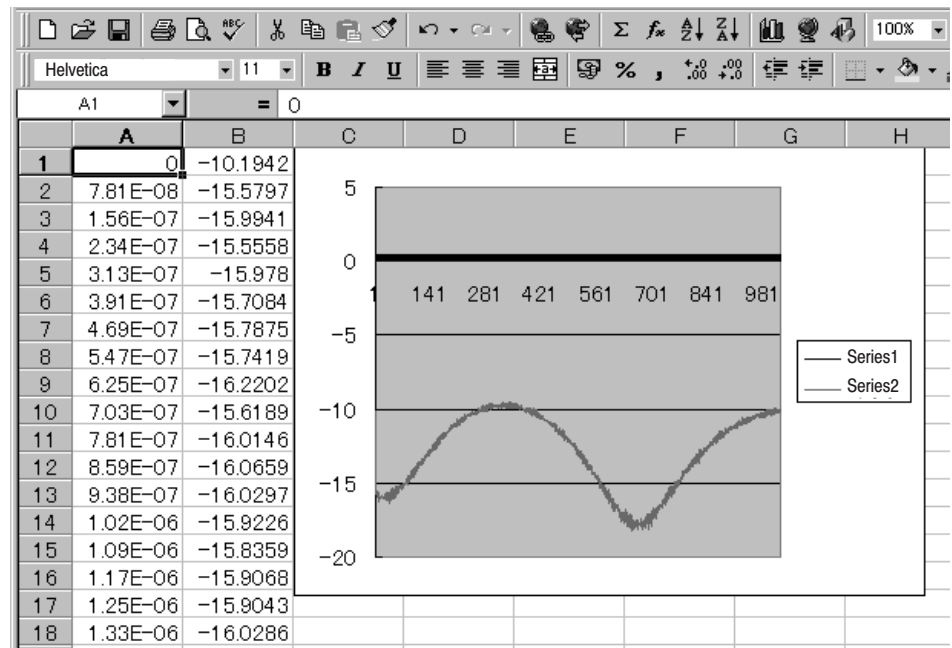


Figure 3–76: Example of pasting text data and creating a graph



## Displaying the Version and Self Test Results

You can view version information about the software and firmware used in this analyzer. This software can be replaced or modified. View the version information to determine your current configuration. At the same time, you can also view the result of the self test that immediately follows power-on.

To view the information, do the following procedure:

1. Press any key in the CONFIG area on the front panel.

For example, press the CONFIG:**MODE** key.

2. Press the uppermost side key.

The information is displayed on the screen as shown in Figure 3–77. The information is as follows:

- Version information

- Main System: Basic application software version
- Sub System: Firmware version

- Result of self test

Shows the result of test performed for the ROM, RAM, and the A20 board. “Pass” or “Fail” is indicated for the ROM and RAM. “Installed” or “Not installed” is indicated for the A20 board.

Note that the analyzer cannot be checked sufficiently with this self test. If you suspect that the analyzer operates abnormally, consult with Tektronix.

- Option information

If any optional software is installed, it is indicated with its version. For the options, refer to Appendix A.

```
3086 REALTIME SPECTRUM ANALYZER
Copyright (C) 1999 SONY/TEKTRONIX CORPORATION

Main System:
  Version:          2.22

Sub System:
  Version:          3.1
  Rom:              Pass
  Ram:              Pass
  A20:              Installed

Options:
  3066 cdmaOne Fwd Link:      1.0
  3086 W-CDMA Code Domain Power: 1.0
```

**Figure 3-77: Version information and self test results display  
(View of upper left corner)**

# Appendices



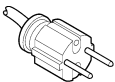
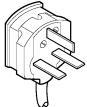

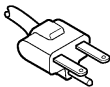
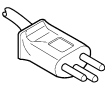
# Appendix A: Options and Accessories

This appendix describes the various options as well as the standard and optional accessories that are available for the analyzer.

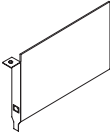
## Options

Table A-1 list the options available when ordering this product.

**Table A-1: Options**

|   | Option # | Label                            | Description  |
|---|----------|----------------------------------|--|
|    | A1       | Universal European power cord    | 220 V, 50 Hz power cord<br>Fuse 5A (T) (IEC 127)<br>Fuse Cap<br>Cable Retainer                     |
|   | A2       | UK power cord                    | 240 V, 50 Hz power cord<br>Fuse 5A (T) (IEC 127)<br>Fuse Cap<br>Cable Retainer                     |
|  | A3       | Australian power cord            | 240 V, 50 Hz power cord<br>Fuse 5A (T) (IEC 127)<br>Fuse Cap<br>Cable Retainer                     |
|  | A4       | North American power cord        | 240 V, 60 Hz power cord<br>Cable Retainer  |
|  | A5       | Switzerland power cord           | 220 V, 50 Hz power cord<br>Fuse 5A (T) (IEC 127)<br>Fuse Cap<br>Cable Retainer                     |
|   | 1S       | Data storage utility software    | Spectrum Analyzer comes with the data storage utility software (Auto Save Programs) pre-installed. |
|   | 15       | cdmaOne analysis software        | Spectrum Analyzer comes with the cdmaOne analysis software pre-installed.                          |
|   | 16       | W-CDMA/cdmaOne analysis software | Spectrum Analyzer comes with the W-CDMA/cdmaOne analysis software pre-installed.                   |
|   | 20       | CCDF analysis software           | Spectrum Analyzer comes with the CCDF analysis software pre-installed.                             |

**Table A-1: Options (cont.)**

|   | Option # | Label              | Description  |
|---|----------|--------------------|--|
|  | 10       | Ethernet interface | Add the Ethernet interface card with a 10BASE-T/100BASE-TX connector.  |
|   | 1R       | Rackmount          | Spectrum Analyzer comes configured for installation in a 19 inch wide instrument rack. For later field conversions, order kit # 016-1754-XX. |



## Standard Accessories

The analyzer comes standard with the accessories listed in Table A–2.

**Table A-2: Standard accessories**

| Accessory                         | Part number |
|-----------------------------------|-------------|
| User manual                       | 071-0501-XX |
| Programmer manual                 | 071-0502-XX |
| Serial mouse                      | 119-6037-XX |
| U.S. power cord                   | 161-0066-XX |
| BNC–N adapter                     | 103-0045-XX |
| Clip-on ferrite bead <sup>1</sup> | 119-5980-XX |

<sup>1</sup> In order to maintain compliance when operating with an optional keyboard, it is recommended that a clip-on ferrite bead be placed on the end of the keyboard connector.

## Optional Accessories

You can also order the optional accessories listed in Table A–3.

**Table A-3: Optional accessories**

| Accessory  | Part number |
|--|-------------|
| Ethernet interface (10BASE-T/100BASE-TX)         | 119-6036-XX |
| Keyboard   | 119-5662-XX |
| Rack mount kit (for field conversion)            | 016-1754-XX |
| Data display and analysis software for PC (3066) | SL7PC66     |
| Data display and analysis software for PC (3086) | SL7PC86     |



# Appendix B: Specifications

This appendix lists the electrical, physical, and environmental characteristics of the analyzer, specifies the performance requirements for those characteristics. The specifications are common to the 3066 and 3086, unless otherwise noted.

## Electrical Characteristics

Unless otherwise stated, the following tables of electrical characteristics and features apply to the spectrum analyzer after a 20 minute warm-up period (within the environmental limits) and after all normalization procedures have been carried out.

**Table B-1: Input/memory mode related**

| Characteristic                 | Description   |
|--------------------------------|---|
| Input mode                     | RF, Baseband; Wideband, IQ (3086 only)  |
| Input connector                | N type (RF, Baseband, Wideband); BNC type (IQ)  |
| Input impedance                | 50 $\Omega$   |
| VSWR (N type)                  | 1.5 ( Reference level $\geq$ -20 dBm)   |
| Acquisition mode               | Roll, Block   |
| Acquisition memory size        | 16 Mbytes   |
| Acquisition memory management  |   |
| RF, Baseband input             |   |
| Memory mode                    | Frequency, Dual, Zoom   |
| FFT points                     | 1024, 256 (Frequency mode)  |
| FFT window                     | Rectangular, Hamming, Blackman-Harris   |
| Block size                     | 1 to 16,000 frames (Frequency mode, 256 points)<br>1 to 4,000 frames (Frequency mode, 1024 points)<br>1 to 2,000 frames (Dual, Zoom mode) |
| Minimum frame update time      | 20 $\mu$ s (Frequency mode, 256 points)<br>80 $\mu$ s (Frequency mode, 1024 points)<br>160 $\mu$ s (Dual, Zoom mode)                      |
| Wideband, IQ Input (3086 only) |   |
| Memory mode                    | Zoom  |
| FFT points                     | 1024  |
| FFT window                     | Rectangular, Hamming, Blackman-Harris   |
| Block size                     | 1 to 2,000 frames   |
| Minimum frame update time      | 25 $\mu$ s  |

**Table B-2: Trigger related**

| Characteristic                   | Description   |
|----------------------------------|---|
| Trigger mode                     | Auto, Normal, Quick, Delayed, Interval, Quick-interval, Timeout<br>(RF (span $\leq$ 6 MHz) and Baseband Input)<br>Auto, Normal (Wideband and IQ Input; 3086 only) |
| Trigger source                   | Internal, External  |
| Trigger domain                   | Frequency, Time   |
| Trigger position                 | 0 to 100 %  |
| Frequency trigger mask           |   |
| Frequency resolution             | 1 bin   |
| Trigger level range              | 0 dBfs to -70 dBfs  |
| Time trigger mask                |   |
| Time resolution                  | 1 data point  |
| Trigger level range              | 0 dBfs to -40 dBfs  |
| External trigger threshold level | 1.6 V   |

**Table B-3: Marker/Zoom Related**

| Characteristic                | Description   |
|-------------------------------|---|
| Marker                        |   |
| Marker type                   | Normal, Delta, Band-power   |
| Search function               | Peak Right, Peak Left, Maximum  |
| Link between views            | On/Off  |
| Measurement Function          | Noise power, Power within band, C/N, Adjacent channel power, Occupied bandwidth |
| Digital zoom                  |   |
| Zoom ratio                    | 2 to 1000   |
| Maximum span in the Zoom mode | 5 MHz (RF, Baseband); 30 MHz (Wideband, IQ; 3086 only)                          |

**Table B-4: Display/View related**

| <b>Characteristic</b> | <b>Description</b>   |
|-----------------------|--|
| Data display          |  |
| Waveform              | Frequency vs. Amplitude/Phase<br>Frequency vs. I/Q voltage<br>Time vs. Amplitude/Phase<br>Time vs. I/Q voltage   |
| Spectrogram           | Time vs. Frequency vs. Amplitude/Phase   |
| Waterfall             | Time vs. Frequency vs. Amplitude/Phase<br>Time vs. Frequency vs. I/Q voltage<br>Time vs. Amplitude/Phase Multi-Frame<br>Time vs. I/Q voltage Multi-Frame |
| AM demodulation       | Time vs. Modulation depth  |
| FM demodulation       | Time vs. Frequency deviation   |
| PM demodulation       | Time vs. Phase deviation   |
| FSK demodulation      | Time vs Frequency deviation  |
| Polar                 | Vector diagram, Constellation diagram  |
| Eye pattern           | I, Q, Torellis   |
| Symbol table          | Binary, Octal, Hexadecimal   |
| Error vector          | EVM, Magnitude error, Phase error, Waveform quality ( $\rho$ )   |
| View                  |  |
| Number of views       | 1, 2, 4  |
| Settable views        | 8 maximum  |
| Display traces        | 2 on waveform display  |
| LCD Panel             |  |
| Size                  | 12.1 inch  |
| Display resolution    | 1024 x 768 pixels  |
| Color                 | 256 colors (maximum)   |

**Table B-5: Frequency standard related**

| Characteristic              | Description                  |
|-----------------------------|------------------------------|
| Reference frequency         | 10 MHz                       |
| Initial frequency tolerance | $\pm 0.1$ ppm                |
| Frequency stability         |                              |
| Aging                       | $\pm 0.0005$ ppm/day         |
| Temperature                 | $\pm 0.002$ ppm (5 to 40° C) |

**Table B-6: Controller/Data storage related**

| Characteristic | Description             |
|----------------|-------------------------|
| Controller     |                         |
| CPU            | Pentium MMX 200 MHz     |
| DRAM           | 64 Mbyte SIMM           |
| OS             | Windows 95              |
| System bus     | PCI, ISA                |
| Sub system CPU | TMP68301 16MHz          |
| Data Storage   |                         |
| Hard disk      | 2.1 Gbyte 3.5 inch EIDE |
| Floppy disk    | 1.44 Mbyte 3.5 inch     |
| Interface      |                         |
| Printer        | Centronics parallel     |
| SCSI           | SCSI-2                  |
| GPIB           | IEEE488.1               |
| Mouse          | Serial mouse            |
| Keyboard       | PC/AT                   |

**Table B-7: IQ input related (3086 only)**

| <b>Characteristic</b>  | <b>Description</b>                                      |
|--|---|
| Frequency  |   |
| Range  | ± 15 MHz  |
| Span   | 10 MHz, 20 MHz, 30 MHz                                  |
| Vector span  | 10 MHz, 20 MHz, 30 MHz                                  |
| Number of bins   | 501 (10 MHz and 20 MHz span)<br>751 (30 MHz span)       |
| Amplitude  |   |
| Reference level  | 100 mV (amplitude of IQ signal)                         |
| Maximum nondestructive input power   | ± 5 V   |
| Flatness within span   | ± 0.5 dB (25° C ± 5° C)                                 |
| Residual response  | -60 dBfs (30 MHz span)                                  |
| Alias suppression  | 55 dB   |
| Spurious free dynamic range, typical<br>(1 GHz CF, 0 dBm ref, sinusoidal signal<br>at the center, spur apart more than 500<br>kHz from the signal) | 65 dB at 10 MHz span<br>60 dB at 20 MHz and 30 MHz span |

**Table B-8: Wideband input related (3086 only)**

| Characteristic  | Description   |
|---|---|
| Frequency   |   |
| Range   | 50 MHz to 3 GHz   |
| Center frequency settability  | 0.1 Hz  |
| Span  | 10 MHz, 20 MHz, 30 MHz                                  |
| Vector span   | 10 MHz, 20 MHz, 30 MHz                                  |
| Number of bins  | 501 (10 MHz and 20 MHz span)<br>751 (30 MHz span)       |
| Amplitude   |   |
| Reference level   | -50 dBm to +30 dBm                                      |
| Maximum nondestructive input power  | +30 dBm   |
| Flatness within span  | $\pm 0.5$ dB ( $25^{\circ}$ C $\pm 5^{\circ}$ C)        |
| Input equivalent noise, typical   | -140 dBm/Hz   |
| 3rd order distortion  | -65 dBc (-10dBfs input, at 1GHz)                        |
| Residual response   | -60 dBfs (0dBm ref, 30 MHz span)                        |
| Image suppression   | 70 dB   |
| Spurious free dynamic range, typical<br>(1 GHz CF, 0 dBm ref, sinusoidal signal<br>at the center, spur apart more than 500<br>kHz from the signal.) | 65 dB at 10 MHz span<br>60 dB at 20 MHz and 30 MHz span |



**Table B-9: RF input related**

| Characteristic  | Description   |
|---|---|
| Frequency   |   |
| Range   | 10 MHz to 3 GHz   |
| Center frequency settability  | 0.1 Hz  |
| Span  | 100 Hz to 3 GHz   |
| Vector span   | 100 Hz to 6 MHz   |
| Real-time span  | 100 Hz to 5 MHz   |
| Number of bins  | 641 (100 Hz to 2 MHz span)<br>801 (5 MHz span)<br>481 (6 MHz span)<br>Span/6250 + 1 ( span $\geq$ 10 MHz)     |
| Spectrum purity   | -100 dBc/Hz (1 GHz CF, 200 kHz span, 0 dBm ref, 10 kHz offset)  |
| Residual FM   | 3 Hz p-p  |
| Amplitude   |   |
| Reference level   | -50 dBm to +30 dBm  |
| Maximum nondestructive input power  | +30 dBm   |
| Self gain-calibration accuracy  | $\pm$ 1.0 dB at 25 MHz within 5° C temperature variation  |
| Flatness  | $\pm$ 2.0 dB (10 MHz to 3 GHz)  |
| Input equivalent noise, typical   | -140 dBm/Hz   |
| 3rd order distortion  | -65 dBc (-10 dBfs input, at 1 GHz)  |
| Residual response   | -70 dBfs (0 dBm ref, 5 MHz span)  |
| Image suppression   | 70 dB   |
| Spurious free dynamic range, typical<br>(1 GHz CF, 0 dBm REF, sinusoidal signal<br>at the center, spur apart more than 10<br>kHz from the signal) | 80 dB at 50 kHz span<br>75 dB at 100 kHz span<br>70 dB at 200 kHz and 500 kHz span<br>65 dB at 1/2/5 MHz span |

**Table B-10: Baseband input related**

| Characteristic  | Description  |
|---|--|
| Frequency   |  |
| Range   | DC to 10 MHz   |
| Center frequency settability  | 0.1 Hz   |
| Span  | 100 Hz to 10 MHz   |
| Vector span   | 100 Hz to 6 MHz  |
| Real-time span  | 100 Hz to 5 MHz  |
| Number of bins  | 641 (100 Hz to 2 MHz span)<br>801 (5 MHz and 10 MHz span)<br>481 (6 MHz span)  |
| Spectrum purity   | -100 dBc/Hz (5 MHz CF, 200 kHz span, 0 dBm ref, 10 kHz offset)   |
| Residual FM   | 2 Hz p-p   |
| Amplitude   |  |
| Reference level   | -30 dBm to +30 dBm   |
| Maximum nondestructive input power  | +30 dBm  |
| Reference level accuracy  | ± 0.5 dB at 5 MHz  |
| Flatness  | ± 1.0 dB (1 MHz to 10 MHz)   |
| Input equivalent noise  | -150 dBm/Hz  |
| 2nd harmonic distortion   | -70 dBc at 4.5 MHz   |
| DC offset   | -40 dBfs   |
| Residual response   | -70 dBfs (5 MHz CF, 5 MHz span, 0 dBm ref)   |
| Alias suppression   | 65 dB  |
| Spurious free dynamic range, typical<br>(5 MHz CF, 0 dBm ref, sinusoidal signal<br>at the center, spur apart more than 10<br>kHz from the signal) | 85 dB at 50 kHz span<br>80 dB at 100 kHz span<br>75 dB at 200 kHz span<br>70 dB at 500 kHz span<br>70 dB at 1/2/5 MHz span |

**Table B-11: Digital demodulation related**

| Characteristic                    | Description  |
|-----------------------------------|--|
| Demodulator                       |  |
| Carrier type                      | Continuous, Burst  |
| Modulation format                 | BPSK, QPSK, $\pi/4$ Shift DQPSK, 8PSK, OQPSK, 16QAM, 64QAM, GMSK             |
| Measurement filter                | Root Cosine  |
| Reference filter                  | Cosine, Gauss  |
| Filter parameter                  | $\alpha$ /BT: 0.0001 to 1, 0.0001 step                                       |
| Maximum symbol rate               | 5.3 Msps (RF, Baseband); 20.48 Msps (Wideband, IQ; 3086 only)                |
| Standard setup                    | PDC, PHS, NADC, TETRA, GSM, CDPD, IS-95, T-53                                |
| Display format                    |  |
| Vector diagram                    | Symbol/locus display, Frequency error measurement, Origin offset measurement |
| Constellation diagram             | Symbol display, Frequency error measurement, Origin offset measurement       |
| Eye diagram                       | I/Q/Trellis display (1 to 16 symbols )                                       |
| Error vector diagram              | EVM, Magnitude error, Phase error, Waveform quality ( $\rho$ ) measurement   |
| Symbol table                      | Binary, Octal, Hexadecimal   |
| Error measurement accuracy        | 10 frames averaged   |
| PDC                               | EVM <1.2 %, Mag error <1.0 %, Phase error <0.8° (100 kHz span)               |
| PHS                               | EVM <1.4 %, Mag error <1.2 %, Phase error <0.8° (1 MHz span)                 |
| GSM                               | EVM <1.8 %, Mag error <1.2 %, Phase error <1.0° (1 MHz span)                 |
| IS-95 reverse link, typical       | EVM <2.0 % (5 MHz span)  |
| QPSK, 4.096 Msps, 2 GHz, typical  | EVM <2.5 % (20 MHz span)   |
| QPSK, 16.384 Msps, 2 GHz, typical | EVM <3.0 % (30 MHz span, 25° C $\pm$ 5° C)                                   |

**Table B-12: Frame time related**

| Characteristic | Description  |
|----------------|--|
| Frame time     | Baseband input                                       |
| 10 MHz span    | 20 $\mu$ s (256 points), 80 $\mu$ s (1024 points)    |
| Frame Time     | RF, Baseband input                                   |
| 6 MHz span     | 20 $\mu$ s (256 points), 80 $\mu$ s (1024 points)    |
| 5 MHz span     | 40 $\mu$ s (256 points), 160 $\mu$ s (1024 points)   |
| 2 MHz span     | 80 $\mu$ s (256 points), 320 $\mu$ s (1024 points)   |
| 1 MHz span     | 160 $\mu$ s (256 points), 640 $\mu$ s (1024 points)  |
| 500 kHz span   | 320 $\mu$ s (256 points), 1280 $\mu$ s (1024 points) |
| 200 kHz span   | 800 $\mu$ s (256 points), 3200 $\mu$ s (1024 points) |
| 100 kHz span   | 1.6 ms (256 points), 6.4 ms (1024 points)            |
| 50 kHz span    | 3.2 ms (256 points), 12.8 ms (1024 points)           |
| 20 kHz span    | 8 ms (256 points), 32 ms (1024 points)               |
| 10 kHz span    | 16 ms (256 points), 64 ms (1024 points)              |
| 5 kHz span     | 32 ms (256 points), 128 ms (1024 points)             |
| 2 kHz span     | 80 ms (256 points), 320 ms (1024 points)             |
| 1 kHz span     | 160 ms (256 points), 640 ms (1024 points)            |
| 500 Hz span    | 320 ms (256 points), 1280 ms (1024 points)           |
| 200 Hz span    | 800 ms (256 points), 3200 ms (1024 points)           |
| 100 Hz span    | 1600 ms (256 points), 6400 ms (1024 points)          |
| Frame Time     | Wideband, IQ input (3086 only)                       |
| 30 MHz span    | 25 $\mu$ s   |
| 20 MHz span    | 25 $\mu$ s   |
| 10 MHz span    | 50 $\mu$ s   |

**Table B-13: Frame update time related**

| <b>Characteristic</b>                            | <b>Description</b>  |
|--|---|
| Minimum frame update time<br>10 MHz span         | Baseband input, Frequency mode<br>20 $\mu$ s (256 points), 80 $\mu$ s (1024 points)     |
| Minimum frame update time<br>500 k to 6 MHz span | RF, Baseband input, Frequency mode<br>20 $\mu$ s (256 points), 80 $\mu$ s (1024 points) |
| 50 k to 200 kHz span                             | 200 $\mu$ s (256, 1024 points)  |
| 5 k to 20 kHz span                               | 2000 $\mu$ s (256, 1024 points)   |
| 500 to 2 kHz span                                | 20 ms (256, 1024 points)  |
| 200 Hz span                                      | 50 ms (256, 1024 points)  |
| 100 Hz span                                      | 100 ms (256, 1024 points)   |
| Minimum frame update time<br>500 k to 6 MHz span | RF, Baseband input, Dual mode<br>160 $\mu$ s  |
| 50 k to 500 kHz span                             | 400 $\mu$ s   |
| 5 k to 20 kHz span                               | 4 ms  |
| 500 to 2 kHz span                                | 40 ms   |
| 200 Hz span                                      | 100 ms  |
| 100 Hz span                                      | 200 ms  |
| Frame update time<br>5 MHz span                  | RF, Baseband input, Zoom mode<br>160 $\mu$ s  |
| 2 MHz span                                       | 320 $\mu$ s   |
| 1 MHz span                                       | 640 $\mu$ s   |
| 500 kHz span                                     | 1.28 ms   |
| 200 kHz span                                     | 3.2 ms  |
| 100 kHz span                                     | 6.4 ms  |
| 50 kHz span                                      | 12.8 ms   |
| 20 kHz span                                      | 32 ms   |
| 10 kHz span                                      | 64 ms   |
| 5 kHz span                                       | 128 ms  |
| 2 kHz span                                       | 320 ms  |
| 1 kHz span                                       | 640 ms  |
| 500 Hz span                                      | 1280 ms   |
| 200 Hz span                                      | 3200 ms   |
| 100 Hz span                                      | 6400 ms   |

**Table B-13: Frame update time related (Cont.)**

| Characteristic    | Description                    |
|-------------------|--------------------------------|
| Frame update time | Wideband, IQ input (3086 only) |
| 30 MHz span       | 25 $\mu$ s                     |
| 20 MHz span       | 25 $\mu$ s                     |
| 10 MHz span       | 50 $\mu$ s                     |

**Table B-14: Power requirements**

| Characteristic  | Description  |
|---|--|
| Line voltage  | 100 to 240 VAC   |
| Line frequency  | 47 to 66 Hz  |
| Line fuse   | 10 A, Fast   |
| Primary circuit dielectric voltage withstand<br>grounding impedance | 1,500 Vrms, 50 Hz for 15 s, without breakdown. Verify continuity of grounding connection, by any suitable means, between a representative part required to be grounding and attachment- plug cap grounding pin. (0.1 $\Omega$ at 30 A) |
| Maximum power   | 250 W (3066); 280 W (3086)   |
| Maximum line current  | 3.0 A rms at 50 Hz   |
| Surge current, typical  | 15 A at 100 VAC; 30 A at 200 VAC   |

## Physical Characteristics

**Table B-15: Physical**

| Characteristic | Description                    |
|----------------|--------------------------------|
| Width          | 430 mm                         |
| Height         | 270 mm                         |
| Length         | 600 mm                         |
| Net weight     | 24.0 kg (3066); 28.0 kg (3086) |

## Environmental Characteristics

**Table B-16: Environmental**

| Characteristic                      | Description  |
|-------------------------------------|--|
| Temperature                         |  |
| Operating                           | +5° C to +40° C (floppy not used); +10° C to +40° C (floppy in use)  |
| Non-operating                       | -20° C to +60° C   |
| Humidity                            |  |
| Operating and non-operating         | 80 % (no condensation); Maximum wet-bulb temperature 29° C   |
| Altitude                            |  |
| Operating                           | To 3,000 m (10,000 ft)   |
| Non-operating                       | To 12,000 m (40,000 feet)  |
| Random vibration                    |  |
| Operating                           | 0.27 g, 5 to 500 Hz, 10 minutes each axis  |
| Non-operating                       | 2.28 g, 5 to 500 Hz, 10 minutes each axis  |
| Shock                               |  |
| Non-operating                       | 20 g half-sine, 11ms duration, 3 shocks per axis in each direction (18 shocks total)   |
| Package product vibration and shock |  |
| Vibration and bounce                | Meets ASTM D999-75, Method A, Para. 3.1g, (NSTA proj. 1-A-B-1)   |
| Drop                                | Meets ASTM D775-61, Method 1, Para. 5, (NSTA proj. 1-A-B-2)  |
| Emissions                           |  |
| Enclosure                           | EN55011 Class A limits for radiated emissions  |
| AC main                             | EN61000-3-2 Power line harmonics<br>EN55011 Class A limits for conducted emissions   |
| Immunity                            |  |
| Enclosure                           | EN61000-4-2 ESD (Up to 8 kV, 150 pF through 330 Ω)<br>Internal terminals of connectors do not allow ESD test.<br>EN61000-4-3 Radiation |
| AC main                             | EN61000-4-4 Fast Transient Burst<br>EN61000-4-5 Surge<br>EN61000-4-6 Conductive Immunity   |

**Table B-17: Certifications and compliances**

| Characteristic  | Description   |
|---|---|
| EC Declaration of Conformity – EMC                    | <p>Meets intent of Directive 89/336/EEC for Electromagnetic Compatibility. Compliance was demonstrated to the following specifications as listed in the Official Journal of the European Union:</p> <p>EN 55011                      Class A Radiated and Conducted Emissions</p> <p>EN 50081-1 Emissions:<br/>EN 61000-3-2              AC Power Line Harmonic Emissions</p> <p>EN 50082-1 Immunity:<br/>EN61000-4-2              Electrostatic Discharge Immunity<br/>EN61000-4-3              RF Electromagnetic Field Immunity<br/>EN61000-4-4              Electrical Fast Transient/Burst Immunity<br/>EN61000-4-5              Power Line Surge Immunity<br/>EN61000-4-6              Conducted Disturbances Induced by RF Fields<br/>EN61000-4-8              Power Frequency Electromagnetic Field<br/>EN61000-4-11             Power Line Interruption Immunity</p> |
| Australia/New Zealand Declaration of Conformity – EMC | <p>Complies with EMC provision of Radiocommunications Act per the following standard(s):</p> <p>AS/NZS 2064.1/2              Industrial, Scientific, and Medical Equipment: 1992</p>  |
| EC Declaration of Conformity – Low Voltage            | <p>Compliance was demonstrated to the following specification as listed in the Official Journal of the European Union:</p> <p>Low Voltage Directive 73/23/EEC, amended by 93/69/EEC</p> <p>EN 61010-1:1993              Safety requirements for electrical equipment for measurement control and laboratory use.</p>  |
| U.S. Nationally Recognized Testing Laboratory Listing | <p>UL3111-1                      Standard for electrical measuring and test equipment.</p>  |
| Canadian Certification                                | <p>CAN/CSA C22.2 No. 231      CSA safety requirements for electrical and electronic measuring and test equipment.</p>   |
| Additional Compliance                                 | <p>ANSI/ISA S82.01:1994      Safety standard for electrical and electronic test, measuring, controlling, and related equipment.</p> <p>IEC61010-1                    Safety requirements for electrical equipment for measurement, control, and laboratory use.</p>   |
| Installation (Overvoltage) Category                   | <p>Terminals on this product may have different installation (overvoltage) category designations. The installation categories are:</p> <p>CAT III    Distribution-level mains (usually permanently connected). Equipment at this level is typically in a fixed industrial location.</p> <p>CAT II     Local-level mains (wall sockets). Equipment at this level includes appliances, portable tools, and similar products. Equipment is usually cord-connected.</p> <p>CAT I      Secondary (signal level) or battery operated circuits of electronic equipment.</p>  |



**Table B-17: Certifications and compliances (Cont.)**

| Characteristic                  | Description   |                    |   |                    |  |                    |  |                    |   |
|---------------------------------|---|--------------------|---|--------------------|--|--------------------|--|--------------------|---|
| Pollution Degree                | <p>A measure of the contaminates that could occur in the environment around and within a product. Typically the internal environment inside a product is considered to be the same as the external. Products should be used only in the environment for which they are rated.</p> <table border="0" data-bbox="646 510 1482 1041"> <tr> <td data-bbox="646 510 922 599">Pollution Degree 1</td> <td data-bbox="922 510 1482 599">No pollution or only dry, nonconductive pollution occurs. Products in this category are generally encapsulated, hermetically sealed, or located in clean rooms.</td> </tr> <tr> <td data-bbox="646 621 922 809">Pollution Degree 2</td> <td data-bbox="922 621 1482 809">Normally only dry, nonconductive pollution occurs. Occasionally a temporary conductivity that is caused by condensation must be expected. This location is a typical office/home environment. Temporary condensation occurs only when the product is out of service.</td> </tr> <tr> <td data-bbox="646 820 922 975">Pollution Degree 3</td> <td data-bbox="922 820 1482 975">Conductive pollution, or dry, nonconductive pollution that becomes conductive due to condensation. These are sheltered locations where neither temperature nor humidity is controlled. The area is protected from direct sunshine, rain, or direct wind.</td> </tr> <tr> <td data-bbox="646 986 922 1041">Pollution Degree 4</td> <td data-bbox="922 986 1482 1041">Pollution that generates persistent conductivity through conductive dust, rain, or snow. Typical outdoor locations.</td> </tr> </table> | Pollution Degree 1 | No pollution or only dry, nonconductive pollution occurs. Products in this category are generally encapsulated, hermetically sealed, or located in clean rooms. | Pollution Degree 2 | Normally only dry, nonconductive pollution occurs. Occasionally a temporary conductivity that is caused by condensation must be expected. This location is a typical office/home environment. Temporary condensation occurs only when the product is out of service. | Pollution Degree 3 | Conductive pollution, or dry, nonconductive pollution that becomes conductive due to condensation. These are sheltered locations where neither temperature nor humidity is controlled. The area is protected from direct sunshine, rain, or direct wind. | Pollution Degree 4 | Pollution that generates persistent conductivity through conductive dust, rain, or snow. Typical outdoor locations. |
| Pollution Degree 1              | No pollution or only dry, nonconductive pollution occurs. Products in this category are generally encapsulated, hermetically sealed, or located in clean rooms.   |                    |   |                    |  |                    |  |                    |   |
| Pollution Degree 2              | Normally only dry, nonconductive pollution occurs. Occasionally a temporary conductivity that is caused by condensation must be expected. This location is a typical office/home environment. Temporary condensation occurs only when the product is out of service.  |                    |   |                    |  |                    |  |                    |   |
| Pollution Degree 3              | Conductive pollution, or dry, nonconductive pollution that becomes conductive due to condensation. These are sheltered locations where neither temperature nor humidity is controlled. The area is protected from direct sunshine, rain, or direct wind.  |                    |   |                    |  |                    |  |                    |   |
| Pollution Degree 4              | Pollution that generates persistent conductivity through conductive dust, rain, or snow. Typical outdoor locations.   |                    |   |                    |  |                    |  |                    |   |
| Safety Certification Compliance |   |                    |   |                    |  |                    |  |                    |   |
| Equipment Type                  | Test and measuring  |                    |   |                    |  |                    |  |                    |   |
| Safety Class                    | Class 1 (as defined in IEC 1010-1, Annex H) – grounded product  |                    |   |                    |  |                    |  |                    |   |
| Overvoltage Category            | Overvoltage Category II (as defined in IEC 1010-1, Annex J)   |                    |   |                    |  |                    |  |                    |   |
| Pollution Degree                | Pollution Degree 2 (as defined in IEC 1010-1). Note: Rated for indoor use only.   |                    |   |                    |  |                    |  |                    |   |



# Appendix C: Default Settings

The basic configuration pattern settings performed by the CONFIG:MODE menu are listed up in Table C-1 and C-2.

## Basic Pattern Configuration Default Settings

Table C-1: Default settings for basic configuration pattern (Standard)

| Menu   | Item             | Spectrum  | Spectrum/<br>Spectrogram | Dual        | Zoom        | Digital<br>Demod | RST <sup>1</sup> |
|--------|------------------|-----------|--------------------------|-------------|-------------|------------------|------------------|
| CONFIG | Setup            | Standard  | Standard                 | Standard    | Standard    | Standard         |                  |
|        | View1            | Waveform  | Waveform                 | Waveform    | Waveform    | Waveform         |                  |
|        | View2            | None      | Spectrogram              | Spectrogram | Spectrogram | Spectrogram      |                  |
|        | View3            | None      | None                     | Waveform    | Waveform    | Polar            |                  |
|        | View4            | None      | None                     | Waveform    | Spectrogram | EyeDiagram       |                  |
| SETUP  | Input Mode       | RF        | RF                       | RF          | RF          | RF               | ○                |
|        | Memory Mode      | Frequency | Frequency                | Dual        | Zoom        | Dual             |                  |
|        | InputCoupling    | AC        | AC                       | AC          | AC          | AC               |                  |
|        | FFTWindow        | Blackman  | Blackman                 | Blackman    | Blackman    | Blackman         |                  |
|        | FFTPoints        | 1024      | 1024                     | 1024        | 1024        | 1024             |                  |
|        | Freq             | 1.5 GHz   | 1.5 GHz                  | 1.5 GHz     | 1.5 GHz     | 1.5 GHz          | ○                |
|        | Span             | 3 GHz     | 3 GHz                    | 3 GHz       | 3 GHz       | 3 GHz            | ○                |
|        | Ref              | 0 dBm     | 0 dBm                    | 0 dBm       | 0 dBm       | 0 dBm            | ○                |
|        | Reference Osc    | Internal  | Internal                 | Internal    | Internal    | Internal         |                  |
|        | Frequency Offset | 0         | 0                        | 0           | 0           | 0                |                  |
|        | Ref Offset       | 0         | 0                        | 0           | 0           | 0                |                  |
|        | FramePeriod      | 80 μ      | 160 μ                    | 160 μ       | 80 μ        | 160 μ            |                  |
|        | BlockSize        | 200       | 200                      | 200         | 200         | 200              |                  |
|        | Trigger Mode     | Auto      | Auto                     | Auto        | Auto        | Auto             |                  |
|        | Trigger Count    | On        | On                       | On          | On          | On               |                  |
|        | Trigger Times    | 1         | 1                        | 1           | 1           | 1                |                  |
|        | Trigger Domain   | Frequency | Frequency                | Frequency   | Frequency   | Frequency        |                  |
|        | Trigger Source   | Internal  | Internal                 | Internal    | Internal    | Internal         |                  |
|        | Trigger Slope    | Rise      | Rise                     | Rise        | Rise        | Rise             |                  |
|        | Trigger Position | 50 %      | 50 %                     | 50 %        | 50 %        | 50 %             |                  |

**Table C-1: Default settings for basic configuration pattern (Standard) (Cont.)**

| Menu   | Item                            | Spectrum | Spectrum/<br>Spectrogram | Dual     | Zoom                 | Digital<br>Demod  | RST <sup>1</sup> |
|--------|---------------------------------|----------|--------------------------|----------|----------------------|-------------------|------------------|
| SETUP  | Zoom Frequency                  |          |                          |          | 1.5 GHz <sup>2</sup> |                   |                  |
|        | Zoom Span                       |          |                          |          | 3 GHz <sup>2</sup>   |                   |                  |
|        | Zoom Mag                        |          |                          |          | 2 <sup>2</sup>       |                   |                  |
| View A | Source                          | Active   | Active                   | Active   | Active               | Active            |                  |
|        | Format                          | FreqAmpl | FreqAmpl                 | FreqAmpl | FreqAmpl             | FreqAmpl          |                  |
|        | Frame                           | 0        | 0                        | 0        | 0                    | 0                 |                  |
|        | Options...→Scale...→Hor. Scale  | 3 GHz    | 3 GHz                    | 3 GHz    | 3 GHz                | 3 GHz             |                  |
|        | Options...→Scale...→Hor. Start  | 0        | 0                        | 0        | 0                    | 0                 |                  |
|        | Options...→Scale...→Ver. Scale  | 100 dBm  | 100 dBm                  | 100 dBm  | 100 dBm              | 100 dBm           |                  |
|        | Options...→Scale...→Ver. Start  | -100 dBm | -100 dBm                 | -100 dBm | -100 dBm             | -100 dBm          |                  |
|        | Trace2...→Source                | None     | None                     | None     | None                 | None              |                  |
|        | Trace2...→Format                | FreqAmpl | FreqAmpl                 | FreqAmpl | FreqAmpl             | FreqAmpl          |                  |
|        | Trace2...→Frame                 | 0        | 0                        | 0        | 0                    | 0                 |                  |
| View B | Source                          |          | Active                   | Active   | Active               | Active            |                  |
|        | Format                          |          | FreqAmpl                 | FreqAmpl | FreqAmpl             | FreqAmpl          |                  |
|        | Options...→Scale...→Hor. Scale  |          | 3 GHz                    | 3 GHz    | 3 GHz                | 3 GHz             |                  |
|        | Options...→Scale...→Hor. Start  |          | 0                        | 0        | 0                    | 0                 |                  |
|        | Options...→Scale...→Ver. Scale  |          | 308                      | 132      | 308                  | 308               |                  |
|        | Options...→Scale...→Ver. Start  |          | 0                        | 0        | 0                    | 0                 |                  |
|        | Options...→Scale...→Color Scale |          | 100 dBm                  | 100 dBm  | 100 dBm              | 100 dBm           |                  |
|        | Options...→Scale...→Color Start |          | -100 dBm                 | -100 dBm | -100 dBm             | -100 dBm          |                  |
| View C | Source                          |          |                          | Active   | Zoom                 | Active            |                  |
|        | Format                          |          |                          | TimeI    | FreqAmpl             | Vector            |                  |
|        | Frame                           |          |                          | 0        | 0                    | 0                 |                  |
|        | Options...→Scale...→Hor. Scale  |          |                          | -        | -                    |                   |                  |
|        | Options...→Scale...→Hor. Start  |          |                          | -        | -                    |                   |                  |
|        | Options...→Scale...→Ver. Scale  |          |                          | 2 V      | 100 dBm              |                   |                  |
|        | Options...→Scale...→Ver. Start  |          |                          | -1 V     | -100 dBm             |                   |                  |
|        | Manual Setup...→Modulation      |          |                          |          |                      | 1/4 π QPSK        |                  |
|        | Manual Setup...→Symbol Rate     |          |                          |          |                      | 21 k              |                  |
|        | Manual Setup...→Filter          |          |                          |          |                      | RootRaised-Cosine |                  |
|        | Manual Setup...→Alpha/BT        |          |                          |          |                      | 0.5               |                  |

**Table C-1: Default settings for basic configuration pattern (Standard) (Cont.)**

| Menu   | Item                            | Spectrum | Spectrum/<br>Spectrogram | Dual   | Zoom     | Digital<br>Demod | RST <sup>1</sup> |
|--------|---------------------------------|----------|--------------------------|--------|----------|------------------|------------------|
| View C | Measurement Destination         |          |                          |        |          | D5D6             |                  |
|        | Reference Destination           |          |                          |        |          | D7D8             |                  |
| View D | Source                          |          |                          | Active | Zoom     | Measure-<br>ment |                  |
|        | Format                          |          |                          | TimeQ  | FreqAmpl | I                |                  |
|        | Frame                           |          |                          | 0      | 0        |                  |                  |
|        | Options...→Scale...→Hor. Scale  |          |                          | -      | -        |                  |                  |
|        | Options...→Scale...→Hor. Start  |          |                          | -      | -        |                  |                  |
|        | Options...→Scale...→Ver. Scale  |          |                          | 2 V    | 308      |                  |                  |
|        | Options...→Scale...→Ver. Start  |          |                          | -1 V   | 0        |                  |                  |
|        | Options...→Scale...→Color Scale |          |                          |        |          | 100 dBm          |                  |
|        | Options...→Scale...→Color Start |          |                          |        |          | -100 dBm         |                  |
|        | Eye Length                      |          |                          |        |          |                  | 2                |

<sup>1</sup> These items are not reset when you set the basic configuration pattern.

<sup>2</sup> In the beginning, these items are displayed in gray. When you set the span equal to 5 MHz or lower in Baseband mode, or equal to 10 MHz or lower in RF mode, these items are available.

**Table C-2: Default settings for basic configuration pattern (CDMA)**

| Menu   | Item          | EVM/Rho           | Spurious          | Time-<br>Domain | RST <sup>1</sup> |
|--------|---------------|-------------------|-------------------|-----------------|------------------|
| CONFIG | Setup         | CDMA              | CDMA              | CDMA            |                  |
|        | View1         | CDMA-<br>Waveform | CDMA-<br>Waveform | CDMA<br>Time    |                  |
|        | View2         | Spectrogram       | CDMA-<br>Waveform | CDMA<br>Time    |                  |
|        | View3         | CDMAPolar         | None              | None            |                  |
|        | View4         | EVM               | None              | None            |                  |
| SETUP  | Standard      | IS-95             | IS-95             | IS-95           | ○                |
|        | Channel       | 777               | 777               | 777             | ○                |
|        | Span          | 5 MHz             | 30 MHz            | 30 MHz          | ○                |
|        | Ref           | 0 dBm             | 0 dBm             | 0 dBm           | ○                |
|        | Reference Osc | Internal          | Internal          | Internal        |                  |
|        | Block Size    | 20                | 200               | 20              |                  |
|        | Trigger Mode  | Auto              | Auto              | Normal          |                  |

**Table C-2: Default settings for basic configuration pattern (CDMA) (Cont.)**

| Menu          | Item                                   | EVM/Rho   | Spurious  | Time-Domain | RST <sup>1</sup> |
|---------------|--|-----------|-----------|-------------|------------------|
| SETUP         | Trigger Count                          | Off       | Off       | Off         |                  |
|               | Trigger Times                          | 1         | 1         | 1           |                  |
|               | Trigger Domain                         | Frequency | Frequency | Time        |                  |
|               | Trigger Source                         | Internal  | Internal  | Internal    |                  |
|               | Trigger Slope                          | Rise      | Rise      | Rise        |                  |
|               | Trigger Position                       | 40 %      | 40 %      | 40 %        |                  |
|               | Trigger Level                          | -30 dB    | -30 dB    | -30 dB      |                  |
| CDMA Waveform | Source                                 | Active    | Active    |             |                  |
|               | Format                                 | FreqAmpl  | FreqAmpl  |             |                  |
|               | Frame                                  | 0         | 0         |             |                  |
|               | Options...→Scale...→Hor. Scale         | 1         | 1         |             |                  |
|               | Options...→Scale...→Hor. Start         | 0         | 0         |             |                  |
|               | Options...→Scale...→Ver. Scale         | 1         | 1         |             |                  |
|               | Options...→Scale...→Ver. Start         | 0         | 0         |             |                  |
|               | Options...→Marker...→Hor.              | 0         | 0         |             |                  |
|               | Options...→Marker...→Delta Marker      | Off       | Off       |             |                  |
|               | Options...→Mask...→RBW 30k, Frequency1 | 900 kHz   | 900 kHz   |             |                  |
|               | Options...→Mask...→RBW 30 k, Level1    | -42 dB    | -42 dB    |             |                  |
|               | Options...→Mask...→RBW 30k, Frequency2 | 1.98 MHz  | 1.98 MHz  |             |                  |
|               | Options...→Mask...→RBW 30 k, Level2    | -54 dB    | -54 dB    |             |                  |
|               | Options...→Mask...→RBW 1 M, Frequency  | 1.385 MHz | 1.385 MHz |             |                  |
|               | Options...→Mask...→RBW 1 M, Level      | -60 dBm   | -60 dBm   |             |                  |
|               | Options...→Position                    | 45 %      | 45 %      |             |                  |
|               | RBW                                    | 30 kHz    | 30 kHz    |             |                  |
|               | Measurement                            | Power     | Spurious  |             |                  |
|               | Measurement Oprions...→OBW             | 99 %      | 99 %      |             |                  |
|               | Measurement Oprions...→Separation      | 2 %       | 2 %       |             |                  |

Table C-2: Default settings for basic configuration pattern (CDMA) (Cont.)

| Menu                | Item                                    | EVM/Rho   | Spurious  | Time-Domain | RST <sup>1</sup> |
|---------------------|---|-----------|-----------|-------------|------------------|
| CDMA Waveform       | Measurement Oprions...→ Threshold       | -100 dB   | -100 dB   |             |                  |
|                     | Measurement Oprions...→ Sorted by       | Frequency | Frequency |             |                  |
|                     | Measurement Oprions...→ Spurious Search | On        | On        |             |                  |
|                     | Measurement Oprions...→ Standard        | IS-95     | IS-95     |             |                  |
|                     | Measurement Oprions...→ Channel         | 777       | 777       |             |                  |
| CDMA Time           | Source                                  |           |           | Active      |                  |
|                     | Block                                   |           |           | 0           |                  |
|                     | Trace1 (Raw)                            |           |           | On          |                  |
|                     | Trace2 (Average)                        |           |           | On          |                  |
|                     | Options...→Scale...→Hor. Scale          |           |           | 1           |                  |
|                     | Options...→Scale...→Hor. Start          |           |           | 0           |                  |
|                     | Options...→Scale...→Ver. Scale          |           |           | 1           |                  |
|                     | Options...→Scale...→Ver. Start          |           |           | 0           |                  |
|                     | Options...→Mask...→Off Left             |           |           | 169 μs      |                  |
|                     | Options...→Mask...→On Left              |           |           | 175 μs      |                  |
|                     | Options...→Mask...→On Right             |           |           | 1.425 ms    |                  |
|                     | Options...→Mask...→Off Right            |           |           | 1.431 ms    |                  |
|                     | Options...→Mask...→Off Level            |           |           | -20 dB      |                  |
|                     | Options...→Mask...→On Level             |           |           | -3 dB       |                  |
|                     | Options...→Num Average                  |           |           | 100         |                  |
| Options...→Position |   |           | 0         |             |                  |
| Spectrogram         | Source                                  | Active    |           |             |                  |
|                     | Format                                  | FreqAmpl  |           |             |                  |
|                     | Marker                                  | 0         |           |             |                  |
|                     | Ver. Start                              | 0         |           |             |                  |
|                     | Options...→Scale...→Hor. Scale          | 0         |           |             |                  |
|                     | Options...→Scale...→Hor. Start          | 0         |           |             |                  |
|                     | Options...→Scale...→Ver. Scale          | 1         |           |             |                  |
|                     | Options...→Scale...→Ver. Start          | 0         |           |             |                  |
|                     | Options...→Scale...→Color Scale         | 20        |           |             |                  |
|                     | Options...→Scale...→Color Start         | 0         |           |             |                  |

**Table C-2: Default settings for basic configuration pattern (CDMA) (Cont.)**

| Menu          | Item                                   | EVM/Rho               | Spurious | Time-Domain | RST <sup>1</sup> |
|---------------|--|-----------------------|----------|-------------|------------------|
| CDMA<br>Polar | Source                                 | Active                |          |             |                  |
|               | Frame                                  | 0                     |          |             |                  |
|               | Manual Setup...→Modulation             | CDMA<br>OQPSK         |          |             |                  |
|               | Manual Setup...→Symbol Rate            | 1.2288 M              |          |             |                  |
|               | Manual Setup...→<br>Measurement Filter | RootRaised-<br>Cosine |          |             |                  |
|               | Manual Setup...→<br>Reference Filter   | Raised-<br>Cosine     |          |             |                  |
|               | Manual Setup...→Alpha/BT               | 0.2                   |          |             |                  |
|               | Display                                | Measurement           |          |             |                  |
|               | Format                                 | Constellation         |          |             |                  |
|               | Marker                                 | 0                     |          |             |                  |
|               | Options...→<br>Measurement Destination | D5D6                  |          |             |                  |
|               | Options...→<br>Reference Destination   | D7D8                  |          |             |                  |
|               | Options...→Position                    | 45 %                  |          |             |                  |
| EVM           | Format                                 | EVM                   |          |             |                  |
|               | Options...→Scale...→Hor. Scale         | 1                     |          |             |                  |
|               | Options...→Scale...→Hor. Start         | 0                     |          |             |                  |
|               | Options...→Scale...→Ver. Scale         | 100 %                 |          |             |                  |
|               | Options...→Scale...→Ver. Start         | 0 %                   |          |             |                  |

<sup>1</sup> These items are not reset when you set the basic configuration pattern.



## Resetting to Default Settings

You can not reset the analyzer to a status at power up. When you select a basic configuration pattern after you have changed the parameters, the parameters indicated with ○ in the **RST** column of Table C-1 and C-2 can not be reset to the default basic configuration settings.

Do the following steps to reset the instrument to the default basic configuration pattern settings.

1. Press the **CONFIG:MAIN** key on the front panel.
2. Press a side key to target a basic configuration pattern.

Set the parameters that are not reset.

3. Change the input mode:
  - a. Press the **SETUP:MAIN** key.
  - b. Press the **Input Mode** side key and select **RF** with the general purpose knob.
4. Set the frequency, span and reference level:
  - a. Press the **SETUP:FREQ** key.
  - b. Press the **Span** side key and enter 1.5 GHz using the keypad keys.
  - c. Press the **Max Span** side key.
  - d. Press the **Ref** side key and enter 0 dBm using the keypad keys.



# Appendix D: Inspection and Cleaning

Inspect and clean the instrument as often as operating conditions require. The collection of dirt can cause instrument overheating and breakdown. Dirt acts as an insulating blanket, preventing efficient heat dissipation. Dirt also provides an electrical conduction path that can cause an instrument failure, especially under high-humidity conditions.



**CAUTION.** Avoid the use of chemical cleaning agents that might damage the plastics used in this instrument. Use only deionized water when cleaning the menu buttons or front-panel buttons. Use a 75% isopropyl alcohol solution as a cleaner and rinse with deionized water. Before using any other type of cleaner, consult your Tektronix Service Center or representative.

Avoid the use of high pressure compressed air when cleaning dust from the interior of this instrument. (High pressure air can cause ESD.) Instead, use low pressure compressed air (about 9 psi).

## Exterior Inspection

Using Table D-1 as a guide, inspect the outside of the instrument for damage, wear, and missing parts. You should thoroughly check instruments that appear to have been dropped or otherwise abused to verify correct operation and performance. Immediately repair defects that could cause personal injury or lead to further damage to the instrument.

**Table D-1: External inspection check list**

| Item                             | Inspect for   | Repair action  |
|----------------------------------|---|--|
| Cabinet, front panel, and cover  | Cracks, scratches, deformations, damaged hardware or gaskets                                | Replace defective module   |
| Front-panel knobs                | Missing, damaged, or loose knobs  | Repair or replace missing or defective knobs                           |
| Connectors                       | Broken shells, cracked insulation, and deformed contacts. Dirt in connectors                | Replace defective modules. Clear or wash out dirt                      |
| Carrying handle and cabinet feet | Correct operation   | Replace defective module   |
| Accessories                      | Missing items or parts of items, bent pins, broken or frayed cables, and damaged connectors | Replace damaged or missing items, frayed cables, and defective modules |

**Cleaning Procedure —  
Exterior**



Follow this procedure to clean the exterior.

---

**WARNING.** *To avoid injury or death, unplug the power cord from line voltage before cleaning the instrument. To avoid getting moisture inside the instrument during external cleaning, use only enough liquid to dampen the cloth or applicator.*

---

1. Remove loose dust on the outside of the instrument with a lint-free cloth.
2. Remove remaining dirt with a lint free cloth dampened in a general purpose detergent-and-water solution. Do not use abrasive cleaners.
3. Clean the monitor screen with a lint-free cloth dampened with either isopropyl alcohol or, preferably, a gentle, general purpose detergent-and-water solution.

## Appendix E: Repacking for Shipment

If you ship the analyzer, pack it in the original shipping carton and packing material. If the original packing material is not available, package the instrument as follows:

1. Obtain a corrugated cardboard shipping carton with inside dimensions at least 15 cm (6 inches) taller, wider, and deeper than the instrument. The shipping carton must be constructed of cardboard with 170 kg (375 pound) test strength.
2. If you are shipping the instrument to a Tektronix field office for repair, attach a tag to the instrument showing the instrument owner and address, the name of the person to contact about the instrument, the instrument type, and the serial number.
3. Wrap the instrument with polyethylene sheeting or equivalent material to protect the finish.
4. Cushion the instrument in the shipping carton by tightly packing dunnage or urethane foam on all sides between the carton and the oscilloscope. Allow 7.5 cm (3 in) on all sides, top, and bottom.
5. Seal the shipping carton with shipping tape or an industrial stapler.

---

**NOTE.** *Do not ship the instrument with a diskette inside the floppy disk drive. When the diskette is inside the drive, the disk release button sticks out. This makes the button more prone to damage.*

---



# Appendix F: Mouse Operations

With a mouse connected to the analyzer, you can perform all the menu operations for the analyzer. With a keyboard connected to the analyzer, you can more easily enter numeric values and file names.

## Overview

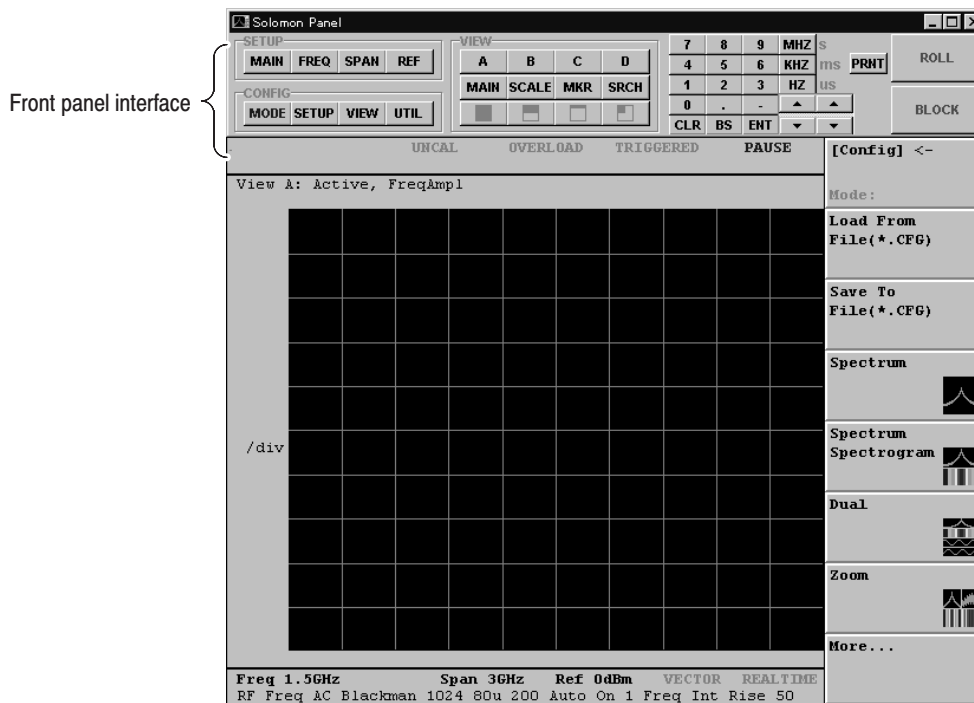
For the standard configuration, you can perform all operations for the analyzer using the front panel general purpose knob and keys. By connecting a mouse, you can operate the side menu by clicking the mouse button instead of pressing side keys.

The analyzer is equipped with an interface through which you can operate the front panel using a PC mouse. All operations for the analyzer can be controlled using the mouse.

Figure F-1 shows the interface used for mouse operations. The front panel interface is displayed at the top of the screen. This interface provides all the functions associated with the front panel keys.

Refer to *Connecting the Mouse and Keyboard* on page 3-138.

The mouse operation interface on the analyzer is also available on your PC. Refer to *External PC Application* on page F-10.



**Figure F-1: Interface for mouse operations**

This interface usually remains hidden, but it appears when you change the setting.

## Setting

You can start software from the taskbar or by clicking on a shortcut icon. You must make settings for both of these.

Take the following steps, with the mouse installed.

### Starting Software from the Taskbar

1. Move the mouse pointer to the left end or bottom of the screen. The Windows 95 taskbar appears.
2. Move the pointer to the **Start** icon and click the right mouse button there. A menu appears.
3. Select **Contents**→**Programs** from the menu and click the left mouse button. The program window appears.



4. Place the pointer on the 3066 or 3086 icon and click the right mouse button. A menu appears.
5. Select **Properties** from the menu to open the properties setting window.
6. Click on the shortcut tab in the properties setting window.
7. Select **Ordinary window** in the **Running size** field.
8. Click on the **OK** button to make the setting effective. The properties setting window disappears.

The front panel interface will appear at the next startup and after. If you have created a 3066 or 3086 shortcut, also make the above setting.

To return to the initial condition (no front panel interface display), select **Minimum window** in step 7 above.

### Starting Software from an Shortcut Icon

1. Move the mouse pointer to the shortcut icon and click on the right mouse button. A menu appears.
2. Select **Properties** from the menu to open the properties setting window.
3. Click on the shortcut tab in the properties setting window.
4. Select **Ordinary window** in the **Running size** field.
5. Click on the **OK** button to make the setting effective. The properties setting window disappears.

The front panel interface will appear at the next startup and after.

To return to the initial condition (no front panel interface display), select **Minimum window** in step 4 above.

## Mouse Operations

The mouse is available for the following operations:

- Operating the front panel interface
- Operating the side menu
- Selecting CONIG, SETUP, or VIEW
- Moving a marker or selecting a frame

### Operating the Front Panel Interface

The buttons in the front panel interface are associated with the front panel keys. It does not have the function associated with the general purpose knob; however, a similar function is implemented using the key pad arrow keys.

Figure F-2 shows the correspondence between the front panel interface and the front panel keys. Refer to *Menu Operations* on page 2–11 for operation details.

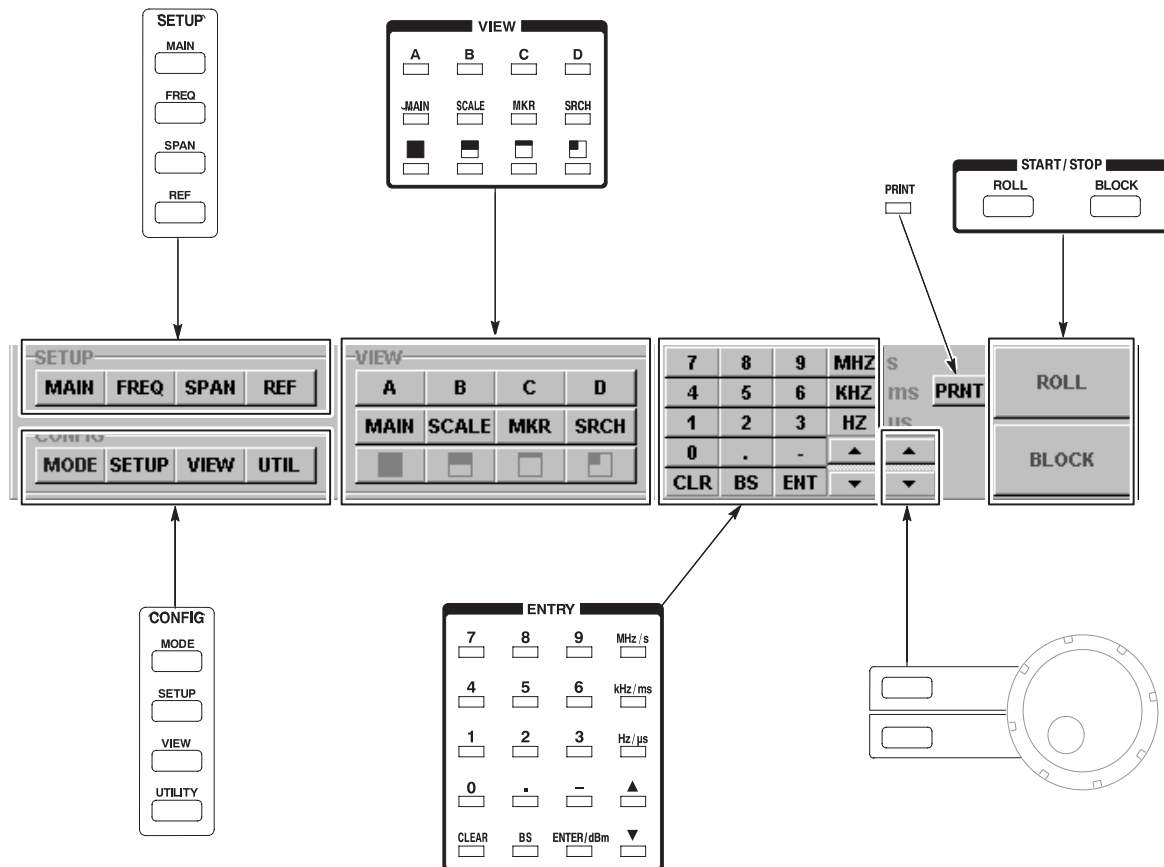
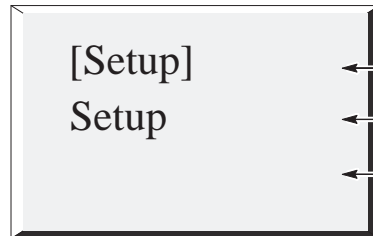
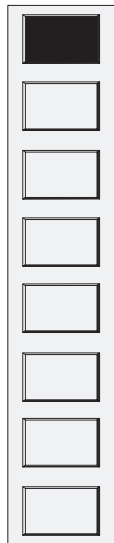


Figure F-2: Correspondence between front panel buttons and front panel interface keys

**Side Menu Operations**

Figures F-3 and F-4 summarize the side menu item operations. The front panel keys and knob and the side keys also work while you are operating the mouse. However, the side keys are no longer associated with the menu on the screen.

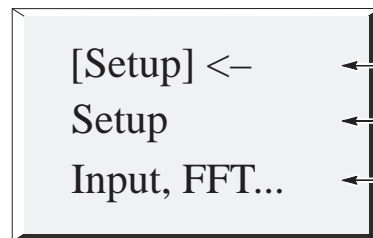
Refer to *Menu Operations* on page 2-11 for operations detail.



- ← Indicates that the top level menu is currently displayed.
- ← Currently displayed menu name.
- ← Displays nothing.

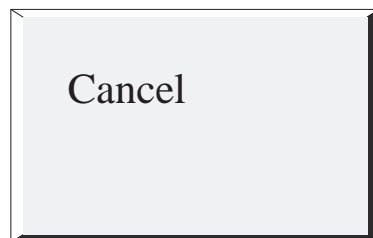
Even when you click this kind of menu item, no function executes. Operate with lower 7 menu items displayed.

To change the menu, use the CONFIG, SETUP, VIEW or PRINT keys on the front panel interface, or click a part of the displayed window, which is described in *Selecting the CONFIG, SETUP or VIEW Menu* on page F-7.




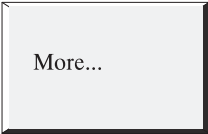


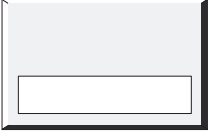
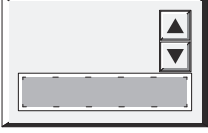
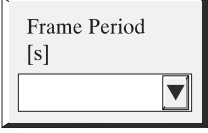
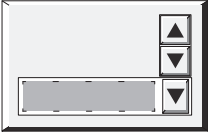
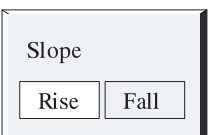
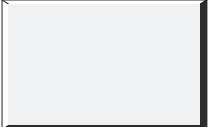
- ← Indicates that you can move to a higher menu level.
- ← Currently displayed menu name.
- ← Currently displayed submenu name.

Clicking this kind of menu item allows you to move to a higher menu level.



When you click this menu item, the menu currently displayed terminates and the menu previously displayed appears.

**Figure F-3: Operating the menu items (top level item)**

|   |   |   |
|---|---|---|
|    |    | Clicking the menu item labeled More... displays another side menu of the same menu level.   |
|   |    | Clicking the menu item labeled ... displays a subordinate side menu.  |
|   |    | When you click this kind of menu item, the function indicated by the label is executed.   |
|   |    | Used to input a numeric value. Clicking this kind of menu item causes the menu item display to change as shown below.   |
|   |   | The Up and Down arrows indicate that this menu item has been selected.<br><br>Input a value through the keypad or a keyboard connected to the instrument. You can use the general purpose knob or the Up and Down arrows to increase or decrease the current setting value. |
|   |  | The arrow button in the field indicates that the drop-down listing can be displayed. Clicking this kind of menu item causes the menu item display to change as shown below.   |
|   |  | The Up and Down arrows indicate that this menu item has been selected.<br><br>Select the desired item from the drop-down listing, or move and select the item using the Up or Down arrow.   |
|   |  | A toggle menu item, which switches between the two selections each time you click on the associated menu item.  |
|  | No function assigned.   |   |

**Figure F-4: Operating the menu items (7 items in lower level)**

**NOTE.** Opening the front panel interface causes the correspondence between the side keys and side menu items to disorder. When you use a side key while the front panel interface is open, pay attention to the correspondence.

**Selecting the CONFIG, SETUP, or VIEW Menu**

You can display the associated system by clicking in any of the locations shown in Figure F-5 or on the menu key.

When you click in this area, the CONFIG menu appears.

When you click in any view frame in display, its VIEW menu appears.

When you click in this area, the SETUP menu appears.

When you click in the specified area on the screen, the contents of the side menu change.

**Figure F-5: Selecting menus using the mouse**

### Moving the Markers and Selecting a Frame

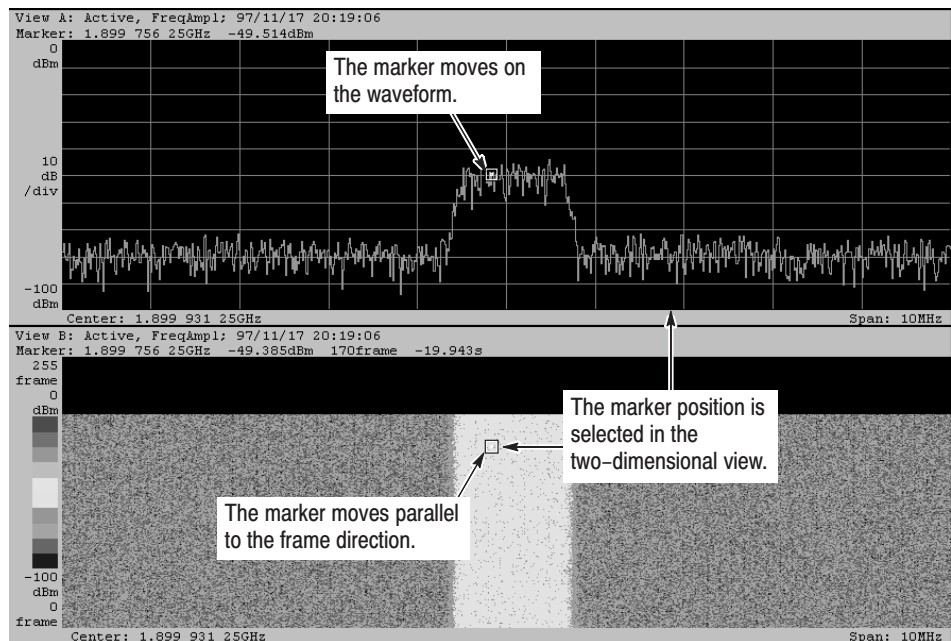
When you click on any point in the signal display area, the primary marker moves as follows:

- In two-dimensional displays, the marker moves to the measured data point for which the click point is on the horizontal position.
- In three-dimensional displays, the marker moves to the measured data point for which the click point is on the horizontal position. In the associated two-dimensional display, the display is replaced by the contents of the appropriate frame.

You can also move the primary marker continuously by dragging it as follows:

1. Move the mouse pointer to the marker and press the left mouse button.
2. Move the pointer to the desired position while holding down the mouse button, and release it.

For the delta marker, you can move only the □ marker using the mouse. Refer to *Marker Operations and Search* on page 3–35 and to *Display Frame Switching* on page 3–41 for details of marker operations.



**Figure F-6: Moving the markers and selecting a frame**

## Operations with Keyboard

Table F-1 shows the mapping between the keypad and a connected keyboard.

**Table F-1: Mapping between keypad keys and keyboard keys**

| Keypad keys | Keyboard keys                    |
|-------------|----------------------------------|
| 0 to 9      | 0 to 9                           |
| CLR         | ESC                              |
| BS          | Back Space                       |
| ENT         | ENTER                            |
| ▲ and ▼     | Up and Down arrows, respectively |
| Hz          | ENTER                            |
| kHz         | k and ENTER                      |
| MHz         | M and ENTER                      |
| s           | ENTER                            |
| ms          | m and ENTER                      |
| μs          | u and ENTER                      |

## Caution in Turning Off the Power

When you are using the mouse, turn off the power by placing the front panel Power switch in the STAND-BY position.

The analyzer normally controls the power not under the Windows 95 operating system but under the analyzer application software. Therefore the shutdown process commonly used on Windows 95 is not effective in normal operation.

## External PC Application

The mouse operation interface on the analyzer is also available on your PC with optional application software SL7PC66 (for the 3066) or SLPC86 (for the 3086). This application enables your PC to load the data acquired with the analyzer, and analyze and display it. Its functionality is the same as the version used on the analyzer, except that it cannot access the analyzer hardware components. With this software, the data can be displayed on the screen and/or analyzed. Just save the analyzer acquisition data in a file and copy it to the PC using a floppy disk or through a network.

For further details, refer to the manual supplied with the SL7PC66 and SLPC86 application software. For optional accessories, refer to *Options and Accessories* on page A-1.



# Appendix G: Data Storage Utility (Option 1S)

This chapter describes the data storage utility included in the Option 1S.

- Overview
- Restrictions
- Storing data
- Loading data

This chapter uses the following terms:

**Basic application software**

Refers to the 3066 or 3086 Basic Application software.

**Data storage utility**

Refers to the Auto Save Programs which is included in the Option 1S.

## Overview

The Data Storage Utility software stores the captured data into a specified file while acquiring data. This software functions as a 3066 or 3086 type view. Therefore, you can define it in the same manner as the other views.

This software supports two views: a view for block mode only and one for roll mode only.

With this software, you can save data to a file for a long time acquisition. Later, you can analyze the data in detail.

## Restrictions

- This utility operates with Version 1.83 or later of the basic application software.
- This utility does not initiate the next capture session until the whole of the one-block data captured in the BLOCK mode has been written.

The time required for the file write depends on the block size (i.e., number of frames) and the destination media (HD, FD, MO, JAZZ, or network disk, etc.). For the same media type, the access time additionally varies with the internal state of the media.

For example, suppose you store the data onto the 3,066 built-in hard disk drive (HDD). If the settings are 4,000 frames per block and 1,024 points per frame, the file capacity per block is a maximum of 16 MB. It takes about 15 seconds to write the file. If the block size is about a one- or two-digit number of frames, it still takes about a two- or three-digit number of milliseconds.

For logging a one-shot event, the program can be used effectively if you have specified a proper number of frames. If you want logging occurring at regular intervals or time reduction between blocks (guaranteeing the minimum time), this software may not work for you.

Refer to *Frame Period and Realtime* on page 3–17 for details.

## Storing Data

This section presents the data storage procedure.

1. Boot up the analyzer.
2. Set up the analyzer and press the **BLOCK** or **ROLL** key. Check that signals are actually observed.
3. Press the CONFIG:VIEW key.

The analyzer contains the following two selectable views that have been added:

- **BlockSave**: Save the data captured in the block mode.
  - **RollSave**: Save the data captured in the roll mode.
4. Define the views.

For example, define the Waveform view for View A, and define the BlockSave view for View B. To simplify set up, use the two- or four-view layout as shown in Figure G–1.

You may define both the BlockSave and RollSave views at the same time. Figure G–1 shows an example where these two views have been defined for both Views C and D. Only one of them is used depending on the acquisition mode when the span is less than or equal to 100 MHz.

5. Specify the name of the destination file where the data is saved.

Open the menu in the BlockSave or RollSave view. The File Name menu item appears. Press the **File Name** side key to specify the destination. If you skip this specification, by default the files are stored in the following folder which contains the basic pattern:

C:\Program Files\SONY Tektronix\3066 (for the 3066)  
C:\Program Files\SONY Tektronix\3086 (for the 3086)

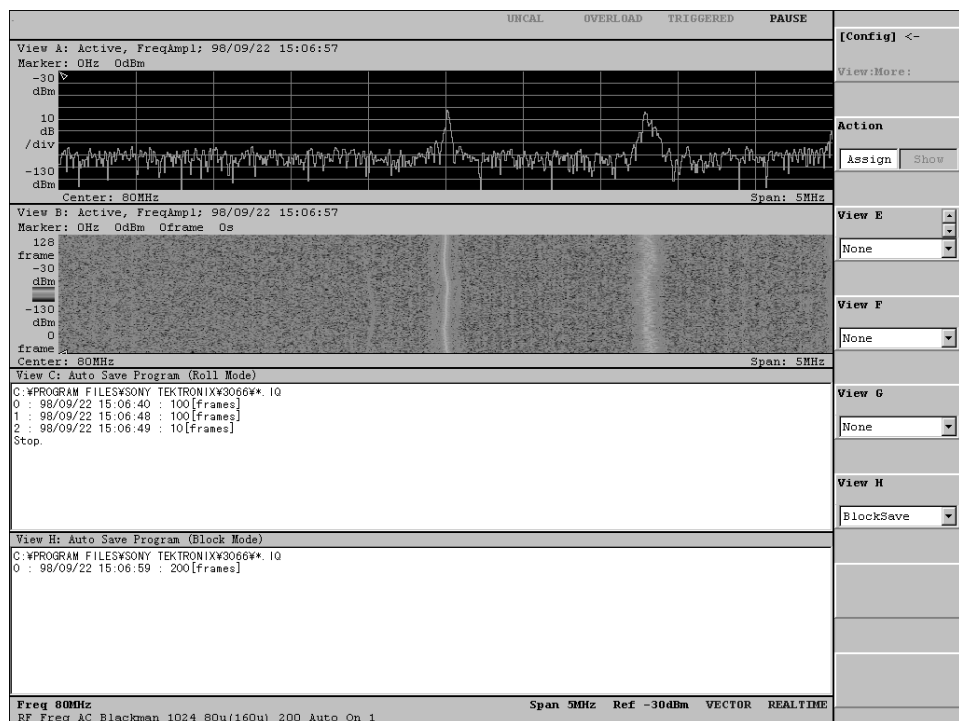
The example in Figure G–1 has specified that Block acquisition data is stored in *C:\Program Files\SONY Tektronix\3066\\*.IQ* in the BlockSave view. It also specifies that the Roll acquisition data is stored in *C:\Program Files\SONY Tektronix\3066\\*.IQ* in the RollSave view.

For any destination file that actually contains stored data, a serial number, beginning with 0, is added to extension .IQ. If the memory contains the time domain data that has been written, the .IQT file is created automatically.

If a file with the same name already exists, it is overwritten with the new one.

6. For the RollSave view, you must set the number of storage frames for the data saved.
7. Press the **BLOCK** or **ROLL** key to initiate the acquisition.

The mode depends on the key you pressed. In the block mode, the ob.Block-Save view functions. In the roll mode, the RollSave view functions.



**Figure G-1: Automatic data storage in the block mode**

The storage of data into files continues until the acquisition completes.

For the block mode, the data is output to the specified file each time one block is been captured. Suppose that you select **SETUP**→**Trigger**→**Count** and turn on the trigger count. Also, suppose that you select **SETUP**→**Trigger**→**Times** to set the count value to 4. The following four or eight files are generated in this case:

```
0.IQ (, 0.IQT)
1.IQ (, 1.IQT)
2.IQ (, 2.IQT)
3.IQ (, 3.IQT)
```

For the roll mode, the data is output to the specified file each time the specified number of frames have been captured. Suppose that you have specified 100 frames in the File Size menu item in the view. One file is generated each time 100 frames have been captured in this case. See Figure G–2. You can also change the number of frames during data acquisition.

```
View C: Auto Save Program (Roll Mode)
C:\PROGRAM FILES\SONY TEKTRONIX\3066\*.IQ
0 : 98/09/22 15:12:11 : 100[frames]
1 : 98/09/22 15:12:19 : 100[frames]
2 : 98/09/22 15:12:27 : 100[frames]
3 : 98/09/22 15:12:35 : 100[frames]
4 : 98/09/22 15:12:42 : 100[frames]
5 : 98/09/22 15:12:50 : 100[frames]
6 : 98/09/22 15:12:58 : 100[frames]
7 : 98/09/22 15:13:01 : 31[frames]
Setup is changed.
8 : 98/09/22 15:13:09 : 100[frames]
9 : 98/09/22 15:13:17 : 100[frames]
10 : 98/09/22 15:13:25 : 100[frames]
11 : 98/09/22 15:13:28 : 35[frames]
Stop.
```

**Figure G–2: Automatic data storage in the roll mode**

## Loading Data

Refer to *Load* on page 3–117. If an IQT-formatted file exists, it is also read automatically. To do so, merely specify the IQT-formatted file.



# Appendix H: cdmaOne Analysis (3066 Option 15)

This chapter describes the cdmaOne analysis functions included in the 3066 with option 15. The following topics are discussed.

- About cdmaOne analysis
- Operation examples
  - Standard code-domain power measurement
  - Code-domain power measurement for continuous symbols
- View menu functions

## About cdmaOne Analysis

The 3066 with option 15 processes the cdmaOne down-link signals specified in “TIA/EIA IS-95-A” (1995.5 TIA/EIA). Option 15 covers the cdmaOne parameters listed in Table H-1.

**Table H-1: cdmaOne parameters**

| Item               | Description                   |
|--------------------|-------------------------------|
| Chip rate          | 1.2288 Mcps                   |
| Symbol rate        | 19.2 ksps                     |
| Number of channels | 64                            |
| Spreading code     | Pilot PN code                 |
| Orthogonal code    | Walsh                         |
| Modulation method  | QPSK                          |
| Foward link filter | IS-95 or IS-95 plus equalizer |

### Measurement Functions

Option 15 has the following measurement functions.

- *Code-domain power*  
The analyzer measures the relative power to total power for each channel.
- *Code-domain power spectrogram*  
The analyzer measures the code-domain power continuously for 6144 symbols (0.32 s) maximum and displays spectrogram for each symbol.
- *Vector/constellation*  
The analyzer measures vector loci and chip points for all signals.
- *Modulation accuracy*  
The analyzer measures EVM (error vector magnitude), amplitude error, phase error, waveform quality, and origin offset for all signals.

### Measurement Process

The 3066 with option 15 processes the input signals internally with the following procedure.

1. Perform the flatness correction and filtering.
2. Establish the synchronization as QPSK and correct the frequency and phase.
3. Establish the long-code using pilot channels.
4. Perform Fast Hadamard Transformation.
5. Calculate the symbol power for all channels.
6. Create the reference waveform.



## Operation Examples

This section shows two typical operation examples: standard code-domain power measurement and code-domain power measurement for continuous symbols.

### Standard Code-Domain Power Measurement

The following is the basic procedure for standard code-domain power measurement.

1. Press the CONFIG:**MODE** key.
2. Press the **More...** side key.
3. Press the **cdmaOne Fwd Link** side key.

Default views are displayed as follows (see Figure H-1 to H-3):

View A . . . . . Spectrum  
 View B . . . . . Code-domain power spectrogram  
 View C . . . . . Vector diagram  
 View D . . . . . Code-domain power

4. Press the SETUP:**FREQ** key and set the center frequency and reference level.
5. Press the START/STOP:**ROLL** key to start data acquisition.

When the input level is too high, the OVERLOAD indicator displays in red. Then, increase the reference level.

The measurement for each symbol continues. To stop data acquisition, press START/STOP:**ROLL** key again

For details on each View menu, refer to *View Menu Functions* on page H-8.

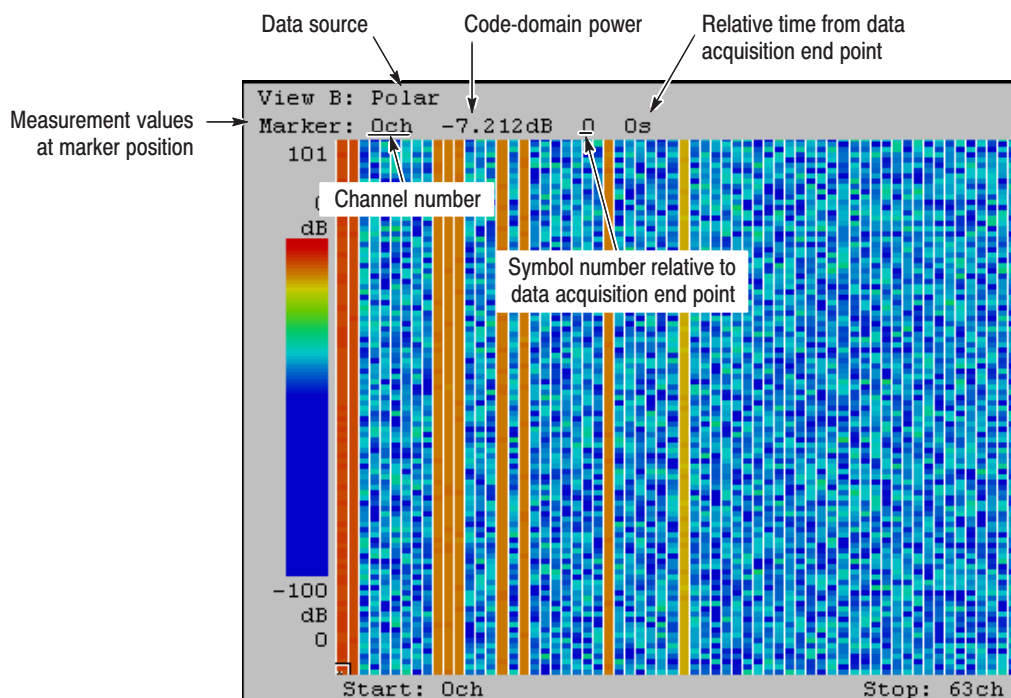


Figure H-1: Code-domain power spectrogram (View B)

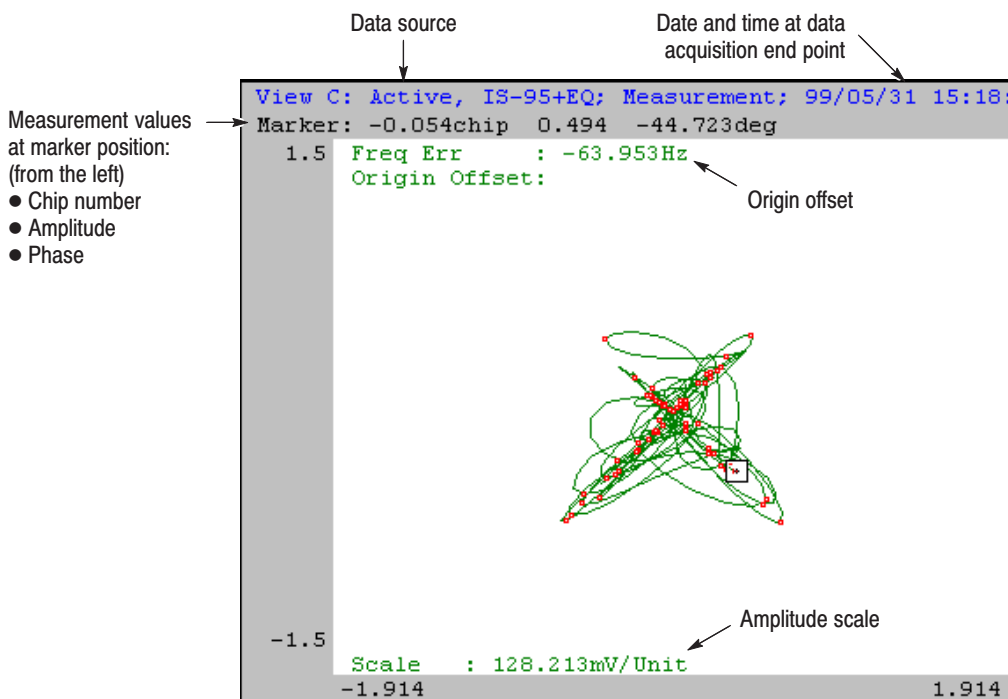


Figure H-2: Constellation (View C)

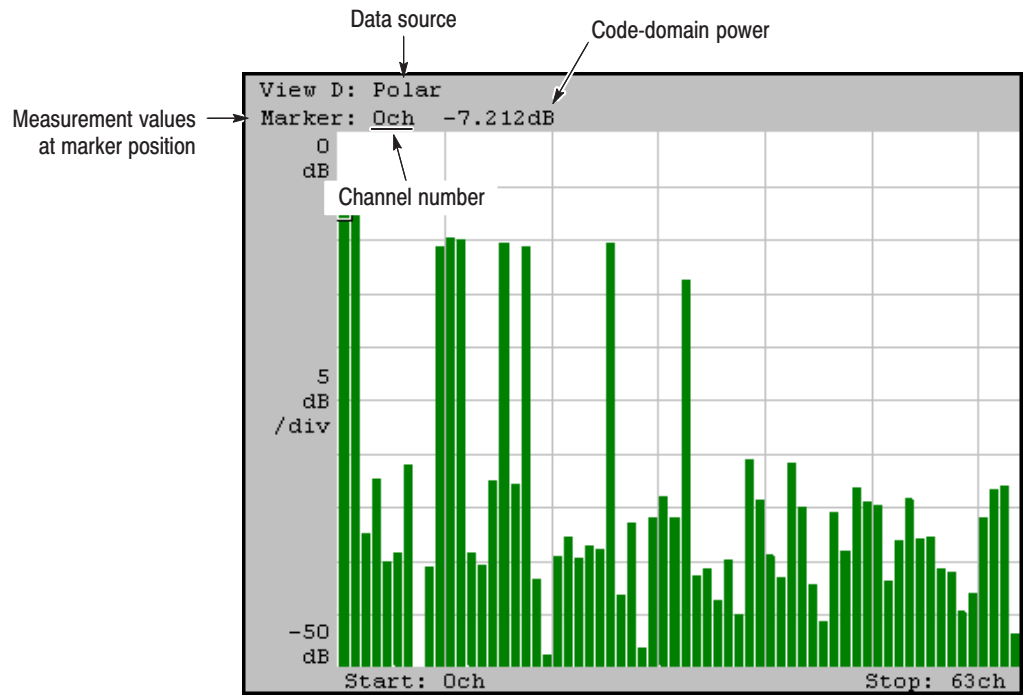


Figure H-3: Code-domain power (View D)

### **Code-Domain Power Measurement for Continuous Symbols**

The standard code-domain power measurement, as described above, acquires and processes frames one-by-one, so it can not capture symbols continuously because of the process time limit. The following shows the method to obtain continuous code-domain power by acquiring data for symbols in the lump and performing the measurement for continuous data.

1. Press the CONFIG:MODE key.
2. Press the **More...** side key.
3. Press the **cdmaOne Fwd Link** side key.
4. Press the SETUP:FREQ key and set the center frequency and reference level.
5. Press the SETUP:MAIN key.
6. Press the **Block Size** side key and enter the number of frames. The number of frames M must satisfy the following condition to analyze N symbols:

$$M > 0.33 \times N$$

7. Press the START/STOP:BLOCK key to start data acquisition.  
After the data acquisition, the first symbol is analyzed.
8. Press the VIEW:C key.
9. Press the **Analyze** side key to analyze for all frames.

**Example.** Figure H-4 shows an example of continuous symbol analysis. In this example, the analyzer has captured the phenomenon that the signal power is decreasing gradually, using the trigger functions (refer to *Trigger* on page 3-47 for using trigger functions). The movement of the marker along the time axis in View B links to the display of code-domain power in View A and D. So you can observe the time-varying signal with consistency between the frequency domain and code domain.

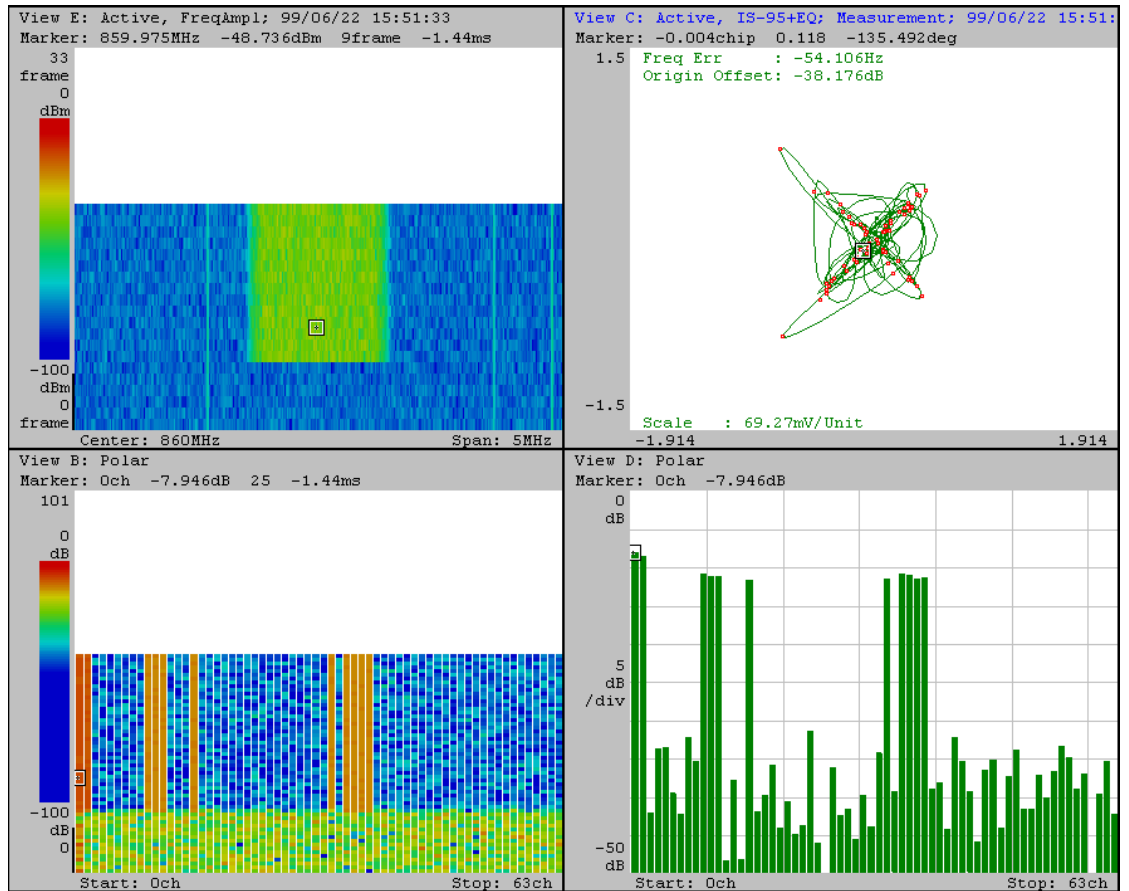


Figure H-4: Analyzing a transient signal

## View Menu Functions

**View A: Spectrum** View A displays the Waveform view. For details on the menu, refer to *Waveform View Menu* on page 2–70.

Press **VIEW:A** → **VIEW:MKR** to set the marker and delta marker. Press the **Measurement** side key to set the parameters. You can measure noise, power, occupied bandwidth, etc. Refer to *Power Measurement* on page 3–79.

**View B: Code-Domain Power Spectrogram** View B displays the code-domain power spectrogram by default, called “CodeSpectrogram”. It shows signal power in color for each channel in each symbol, with channel along the horizontal axis and symbol (time) along the vertical axis.

Table H–2 summarizes the structure of the CodeSpectrogram view menu.

**Table H-2: CodeSpectrogram view menu table**

| Top level         | Subordinate level, options and descriptions   |  |
|-------------------|---|--|
| <b>Symbol</b>     | Specifies the symbol number on which the marker is positioned.  |  |
| <b>Ver. Start</b> | Specifies the start symbol number on the vertical axis. The default is the symbol 0 which contains the latest data. |  |
| <b>Options...</b> | Scale...  | Sets the horizontal, vertical, and color axes.   |
|                   | Hor. Scale  | Sets the scale of the horizontal axis.   |
|                   | Hor. Start  | Sets the start value of the horizontal axis.   |
|                   | Ver. Scale  | Sets the scale of the vertical axis. The value is a multiple of the number of basic frames (1 to 16). For example, when it is set to 10, data is displayed every 10 frames.                        |
|                   | Ver. Start  | Sets the start value of the vertical axis.   |
|                   | Color Scale   | Inputs the width of the level represented in colors.   |
|                   | Color Start   | Inputs the start value of the level represented in colors.<br><br>The level is represented in 10 colors from blue (minimum) to red (maximum). The level below the minimum is represented in black. |
|                   | Auto Scale  | Automatically sets the start values and scales of the horizontal and vertical axes and level to view the whole waveform.   |

Table H-2: CodeSpectrogram view menu table (cont.)

| Top level     | Subordinate level, options and descriptions                                    |   |  |
|---------------|--|---|--|
| Marker...     | Operates the markers. Refer to page 3-35 for how to use the markers.           |   |  |
|               | Hor.   | Inputs the horizontal position to moves the □ marker. By default, it is positioned at the start point on the horizontal axis. |  |
|               | Ver.   | Inputs the frame number as the vertical position to moves the □ marker. By default, the marker is positioned on frame 0.      |  |
|               | Delta Marker   | Turns on or off the delta marker.   |  |
|               | Reset Delta  | Moves the ◇ marker to the □ position.   |  |
|               | Search...  | Searches for the peak spectrum in the current frame and positions the □ marker there.   |  |
|               |  | Peak  | Searches for the peak spectrum and moves the marker there. Rotate the general purpose knob clockwise to search for the peak rightward, and vice versa. |
|               |  | Max   | Searches for the maximum peak spectrum and moves the marker there.   |
|               |  | Min   | Searches for the minimum peak spectrum and moves the marker there.   |
|               |  | Separation  | Sets the minimum horizontal distance relative to full-scale (100 %) to separate two peaks.   |
|               |  | Ver.  | Inputs the frame number as the vertical position to moves the □ marker. By default, the marker is positioned in frame 0.                               |
|               |  | Delta Marker  | Turns On or Off the delta marker.  |
|               |  | Reset Delta   | Moves the ◇ to the □ position.   |
|               | Monochrome   | Determines whether to display in monochrome or color.   |  |
|               |  | Off   | Displays in color (default).   |
| On            |  | Displays in monochrome.   |  |
| Number Colors | Selects the number of display colors.  |   |  |
|               | 100  | Selects 100 color display (default).  |  |
|               | 10   | Selects 10 color display.   |  |
| Ver. Mag      | Sets the number of vertical pixels to display one frame. The range is 1 to 10. |   |  |

**View C: Vector Diagram** View C displays the IQ loci and chip positions for all input signals by default, called “CodePolar” view.

Pressing VIEW:C → VIEW:MAIN displays the side keys to set measurement conditions as listed in Table H-3.

**Table H-3: CodePolar view menu table**

| Top level              | Subordinate level, options and descriptions  |  |                                  |
|------------------------|--|--|----------------------------------|
| <b>Source</b>          | Specifies the input data used for the view.  |  |                                  |
|                        | None   | Specifies no input source. The display area in the view will be empty.   |                                  |
|                        | Active   | Specifies the data memory for the input source, that is, the acquired data is displayed as is.   |                                  |
|                        | Zoom   | Specifies the zoomed data for the input source.  |                                  |
|                        | File(*.IQ)   | Specifies the IQ-formatted, saved data file for the input source.  |                                  |
| <b>Analysis Symbol</b> | Specifies the symbol number to display the IQ locus. The default is the symbol 0 which contains the latest data. |  |                                  |
| <b>Standard...</b>     | Configures the analyzer according to the standard digital modulating system settings.                            |  |                                  |
|                        | IS-95  | Configures the modulating system according to IS-95 without equalizer.   |                                  |
|                        | IS-95+EQ   | Configures the modulating system according to IS-95 with equalizer.  |                                  |
| <b>Manual Setup...</b> | Sets the modulating system, symbol rate, filter, and $\alpha$ /BT manually.                                      |  |                                  |
|                        | Modulation   | Selects the modulating system required to demodulate the digital modulated signal.   |                                  |
|                        |  | IS-95  | Selects IS-95 without equalizer. |
|                        |  | IS-95+EQ   | Selects IS-95 with equalizer.    |
|                        | Chip Rate  | Inputs the chip rate to demodulate the digital modulated signal. The value must be 1.2288M.  |                                  |
|                        | Measurement Filter   | Selects the filter required to demodulate the digital modulated signal. You can select either None (no filter) or RootRaisedCosine. Refer to <i>Processing Flow</i> on page 3-69 for detail. |                                  |
|                        | Reference Filter   | Selects None (no filter), RaisedCosine, Gaussian, or IS95 for the filter required for creating reference data. Refer to <i>Processing Flow</i> on page 3-69 for detail.                      |                                  |
|                        | Alpha/BT   | Inputs the $\alpha$ /BT value.   |                                  |
|                        | Auto Carrier   | Determines whether to search the carrier automatically.  |                                  |
| Off                    |  | Sets the carrier frequency to the value with the Carrier (Hz) button which appears by pressing the Off button.   |                                  |
| On                     |  | Searches the carrier automatically, and displays the frequency error relative to center frequency on screen at Freq Err.   |                                  |



**Table H-3: CodePolar view menu table (cont.)**

| <b>Top level</b>  | <b>Subordinate level, options and descriptions</b>           |  |  |
|-------------------|--|--|--|
| <b>Options...</b> | Display  | Selects the display data. Refer to <i>Processing Flow</i> on page 3-69 for detail. |  |
|                   |  | Measure  | Displays measurement data.   |
|                   |  | Reference  | Displays reference data obtained by demodulating and modulating measurement data.        |
|                   | Format   | Selects the display format.  |  |
|                   |  | Vector   | Displays data in the vector format that represents chip-to-chip movements using vectors. |
|                   |  | Constellation  | Displays data in the constellation format that represents only chips.                    |
| Marker            | Inputs the time to move the <input type="checkbox"/> marker. |  |  |
| <b>Analyze</b>    | Performs measurement for all the symbols on data memory.     |  |  |

**View D: Code-Domain Power**

By default, View D displays signal power for each channel in the symbol specified with **Symbol** side key, called “CodePower” view.

Pressing **VIEW:D** → **VIEW:MAIN** displays the side keys to set the measurement conditions as listed in Table H-4.

**Table H-4: CodePower view menu table**

| Top level           | Subordinate level, options and descriptions  |   |   |
|---------------------|--|---|---|
| <b>Average</b>      | Determines whether to average data or not.   |   |   |
|                     | Off  | Specifies the data is not averaged.   |   |
|                     | On   | Displays the measurement result data averaged for a number of symbols.  |   |
| <b>Average Type</b> | Specifies the average mode.  |   |   |
|                     | RMSExpo  | Performs averaging with the exponential function RMS (root-mean-square). This mode decreases the influence of the older data exponentially. |   |
|                     | RMS  | Performs averaging with RMS (root-mean-square).   |   |
|                     | MaxHold  | Holds the maximum value.  |   |
|                     | MinHold  | Holds the minimum value.  |   |
| <b>Num Average</b>  | If you set the averaging mode to RMS, the average is obtained only for the frame specified with Num Average before switching to the fixed display. If you select RMSExpo in the averaging mode, Num Average will be used for weighted setting of the old data. The Num Average item is displayed only when Average is On.<br><br>Refer to page 3-109 for details on averaging. |   |   |
| <b>Symbol</b>       | Specifies the symbol number to display the data. The default is the symbol 0 which contains the latest data. The Symbol item is displayed only when Average is Off.  |   |   |
| <b>Options...</b>   | Scale...   | Sets up the horizontal and vertical axes.   |   |
|                     |  | Hor. Scale  | Sets the horizontal axis scale.   |
|                     |  | Hor. Start  | Sets the horizontal axis start value.   |
|                     |  | Ver. Scale  | Sets the vertical axis scale.   |
|                     |  | Ver. Start  | Sets the vertical axis start value.   |
|                     |  | Auto Scale  | Automatically sets the start values and scales of the horizontal and vertical axes to view the whole waveform.          |
|                     | Marker...  | Operates the markers. Refer to page 3-35 for how to use the markers.  |   |
|                     |  | Hor.  | Inputs the horizontal position and moves the □ marker. By default, it is positioned at the horizontal axis start point. |
|                     |  | Delta Marker  | Turns On or Off the delta marker.   |
|                     |  | Reset Delta   | Moves the ◇ to the □ marker position.   |

**Table H-4: CodePower view menu table (cont.)**

| Top level                 | Subordinate level, options and descriptions          |  |
|---------------------------|--|--|
|                           | Search...  | Searches for the peak spectrum and positions the □ marker there.   |
|                           | Peak   | Searches for the peak spectrum and moves the marker there. Rotate the general purpose knob clockwise to search for the peak rightward, and vice versa. |
|                           | Max  | Searches for the maximum peak spectrum and moves the marker there.   |
|                           | Min  | Searches for the minimum peak spectrum and moves the marker there.   |
|                           | Separation   | Sets the minimum horizontal distance relative to full-scale (100 %) to separate two peaks.   |
|                           | Delta Marker   | Turns on or off the delta marker.  |
|                           | Reset Delta  | Moves the ◇ to the □ marker position.  |
| <b>Average Options...</b> | Sets the averaging parameters or starts the process. |  |
|                           | Begin Symbol   | Specifies the first symbol to be averaged. The range is 0 to the number of symbols -1.   |
|                           | End Symbol   | Specifies the last symbol to be averaged. The range is 0 to the number of symbols -1.  |
|                           | All Symbols  | Specifies that the data is averaged for all symbols.   |
|                           | Mkr -> Symbol  | Sets Begin Symbol and End Symbol with the marker and delta marker.   |
|                           | Average Type   | Same as Average Type on page H-12.   |
|                           | Execute  | Executes averaging.  |



# Appendix I: W-CDMA/cdmaOne Analysis (3086 Option 16)

This chapter describes the W-CDMA (Wideband CDMA)/cdmaOne analysis functions included in the 3086 with option 16.

---

**NOTE.** Option 16 includes option 15 cdmaOne analysis functions. For the cdmaOne analysis, refer to Appendix H.

---

The following topics are discussed in this chapter.

- About W-CDMA analysis
- Operation examples
- View menu functions

## About W-CDMA Analysis

The 3086 with option 16 processes the W-CDMA down-link signals specified in “Specifications for W-CDMA Mobile Communication System Experiment Version 1.1” (1998.3 NTT Mobile Communications Network Inc.). Option 16 covers the W-CDMA parameters listed in Table I-1.

**Table I-1: W-CDMA parameters**

| Item                                      | Description   |
|---|---|
| Chip rate                                 | 4.096 Mcps, 8.192 Mcps, 16.384 Mcps   |
| Symbol rate                               | 16 ksps, 32 ksps, 64 ksps, 128 ksps, 256 ksps, 512 ksps, 1024 ksps                                    |
| Number of channels (maximum)              | 256 (4.096 Mcps), 512 (8.192 Mcps), 1024 (16.384 Mcps)  |
| Frame structure                           | Time slot: 625 $\mu$ s  |
| Long code                                 | 18-bit Gold code using M-sequence obtained from the generator polynomial                              |
| Short code                                | Hierarchical orthogonal code sequence specified with the combination of the chip rate and symbol rate |
| Short code in a long code mask (LMS) part | 8-bit Gold code using M-sequence obtained from the generator polynomial                               |
| Modulation method                         | QPSK  |
| Baseband filter                           | Root-cosine with $\alpha=0.22$ (default); $0.0001 \leq \alpha \leq 1$                                 |

## Measurement Functions

Option 16 has the following measurement functions.

- *Code-domain power*  
The analyzer measures the relative power to total power for each channel with multi-rate and 1024 channels maximum.
- *Time vs. code-domain power*  
The analyzer measures the relative power at symbol points for each channel as time series.
- *Code-domain power spectrogram*  
The analyzer measures the code-domain power continuously for maximum 160 slots (0.1 s) and displays spectrogram for each slot.
- *Vector/constellation*  
The analyzer measures the vector loci and chip points for entire signals, as well as constellation at symbol points for each channel.
- *Modulation accuracy*  
The analyzer measures EVM (error vector magnitude), amplitude error, phase error, waveform quality, and origin offset for each channel.

## Measurement Process

The 3086 with option 16 processes the input signals internally with the following procedure:

1. Perform the flatness correction and filtering.
2. Establish the synchronization with LMS of the 1<sup>st</sup> perch channel.
3. Determine the long-code number range at the 2<sup>nd</sup> perch channel.
4. Establish the long-code number and phase.
5. Correct the frequency and phase.
6. Perform Fast Hadamard Transformation.
7. Calculate the symbol power for all channels.
8. Extract effective channels from pilot symbols.

## Operation Examples

### Standard Code-Domain Power Measurement

The following is the basic procedure for standard code-domain power analysis.

1. Press the CONFIG:**MODE** key.
2. Press the **More...** side key.
3. Press the **W-CDMA Down Link** side key.

Default views are as follows:

View A . . . . . Spectrum  
 View B . . . . . Code-domain power spectrogram  
 View C . . . . . Vector diagram  
 View D . . . . . Code-domain power

4. Press the VIEW:C key.
5. Press the **Standard...** side key and select chip rate: 4.096, 8.192, or 16.384 Mcpc.
6. Press the SETUP:**SPAN** key and set the span as follows:
  - Span 10 MHz for the chip rate of 4.096 Mcpc
  - Span 30 MHz for the chip rate of 8.192 and 16.384 Mcpc
7. Press the SETUP:**FREQ** key and set the center frequency and reference level.
8. Press the START/STOP:**BLOCK** key to start data acquisition.

When the input level is too high, the OVERLOAD indicator displays in red. Then, increase the reference level.

The measurement for each slot continues. To stop data acquisition, press START/STOP:**BLOCK** key again.

For details on each View menu, refer to *View Menu Functions* on page I-8.

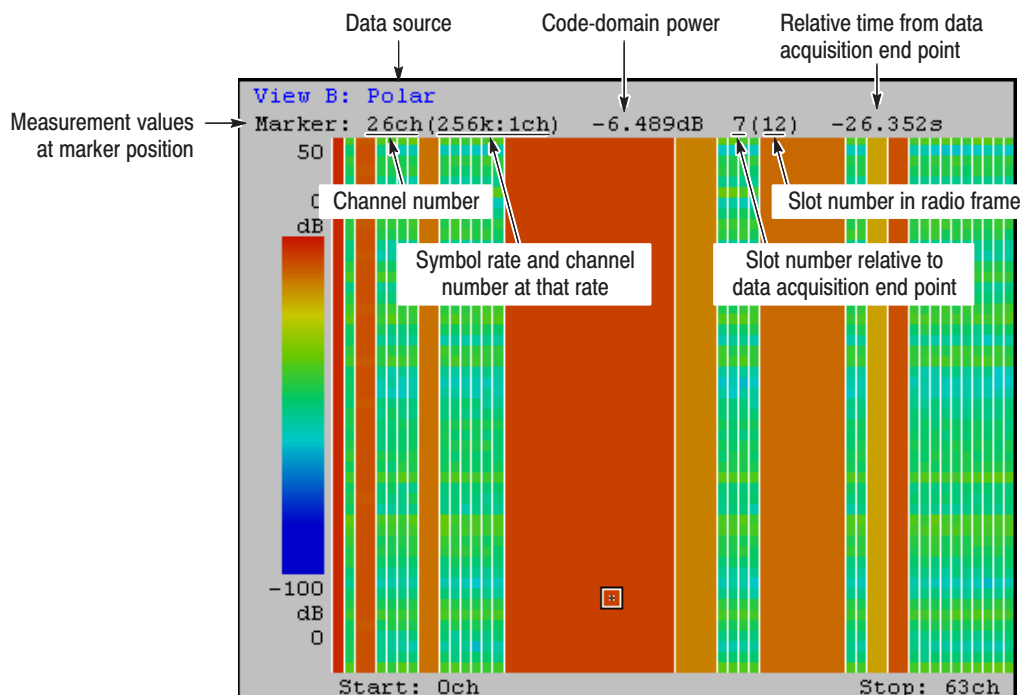


Figure I-1: Code-domain power spectrogram (View B)

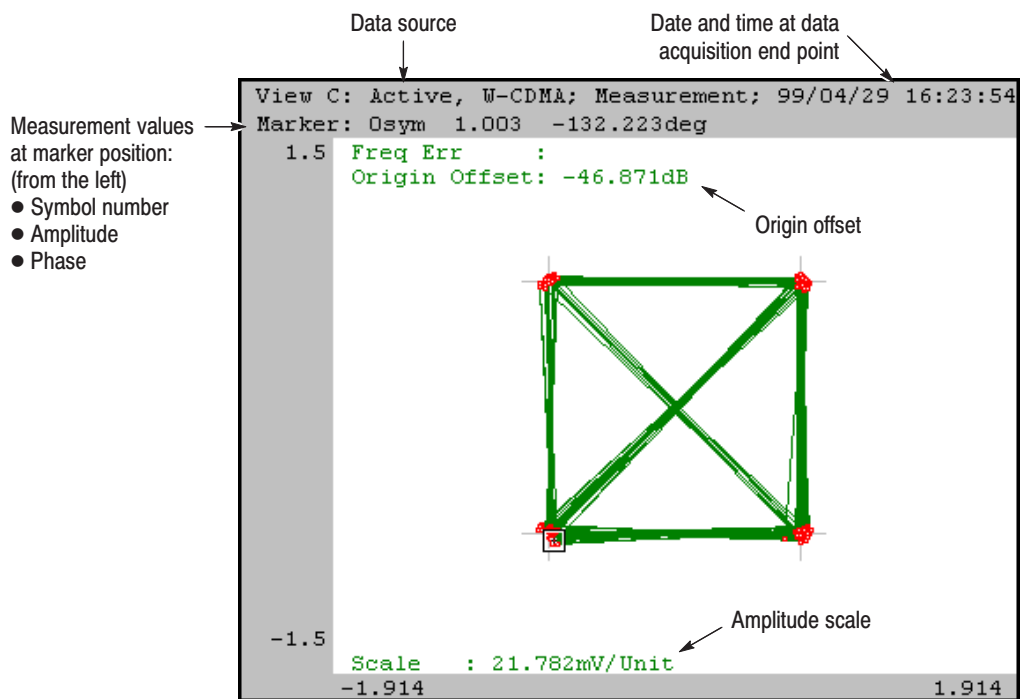


Figure I-2: Symbol constellation (View C)



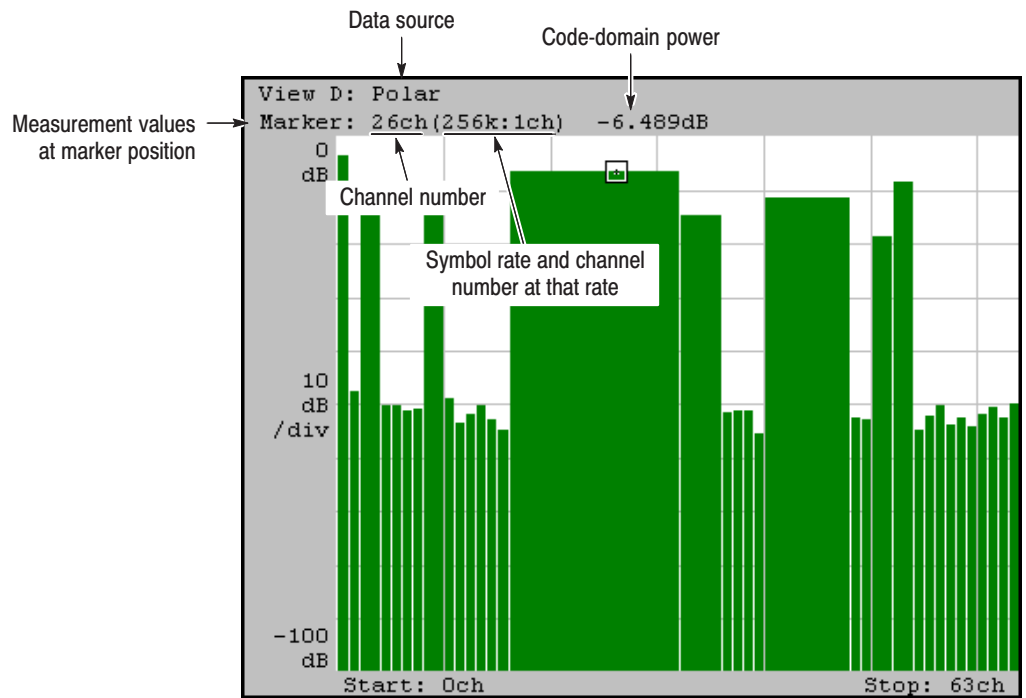


Figure I-3: Code-domain power (View D)

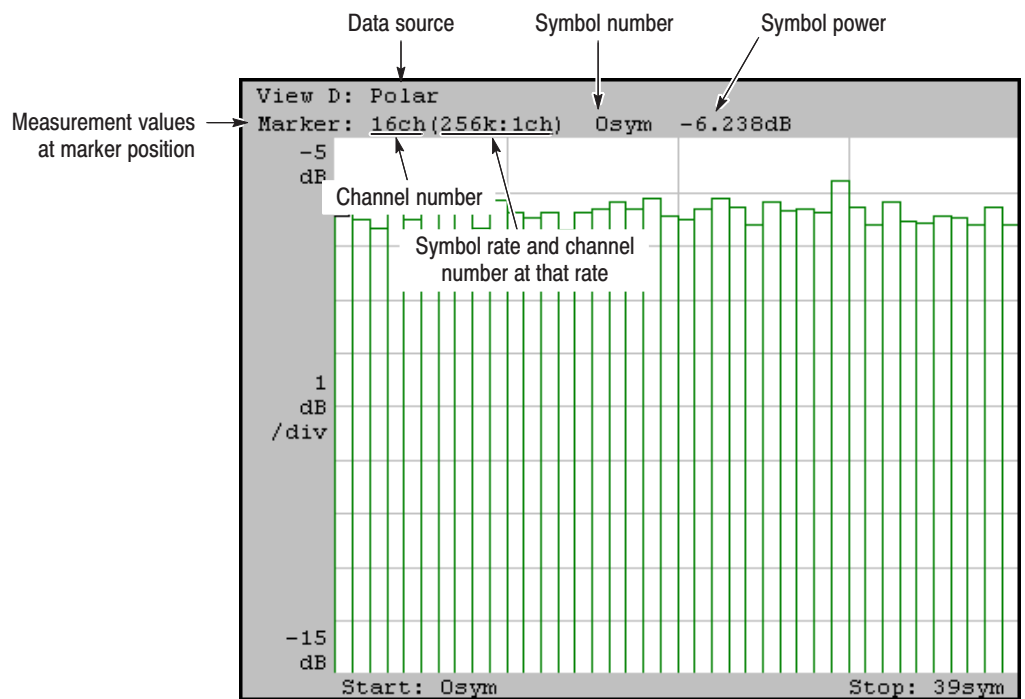


Figure I-4: Symbol power (View D)

**Code-Domain Power Measurement for Continuous Slots**

The standard code-domain power measurement, as described above, acquires and processes slots one-by-one, so it can not capture slots continuously because of the process time limit. The following shows the method to obtain continuous code-domain power by acquiring data for slots in the lump and performing the measurement for continuous data.

1. Press the CONFIG:MODE key.
2. Press the **More...** side key.
3. Press the **W-CDMA Down Link** side key.
4. Press the VIEW:C key.
5. Press the **Standard...** side key and select chip rate: 4.096, 8.192, or 16.384 Mcpc.
6. Press the SETUP:SPAN key and set the span as follows:
  - Span 10 MHz for the chip rate of 4.096 Mcpc
  - Span 30 MHz for the chip rate of 8.192 and 16.384 Mcpc
7. Press the SETUP:FREQ key and set the center frequency and reference level.
8. Press the SETUP:MAIN key.
9. Press the **Block Size** side key and set the number of frames. The number of frames M must satisfy the following condition to analyze N slots:
$$M > K(N + 1.5)$$
where K=12.5 for 10 MHz span, K=25 for 20 or 30 MHz span.
10. Press the **Trigger...** side key.
11. Set the **Count** side key to **On**.
12. Press the START/STOP:BLOCK key to start data acquisition.

After the data acquisition, the first slot is analyzed.
13. Press the VIEW:C key.
14. Press the **Analyze** side key to analyze for all frames.

**Example.** Figure I-5 shows an example of continuous slot analysis. In this example, the analyzer has captured the phenomenon that the signal power is decreasing gradually, using the trigger functions (refer to *Trigger* on page 3-47 for using trigger functions). The movement of the marker along the time axis in View B links to the display of code-domain power in View A and D. So you can observe the time-varying signals with consistency between the frequency domain and code domain.

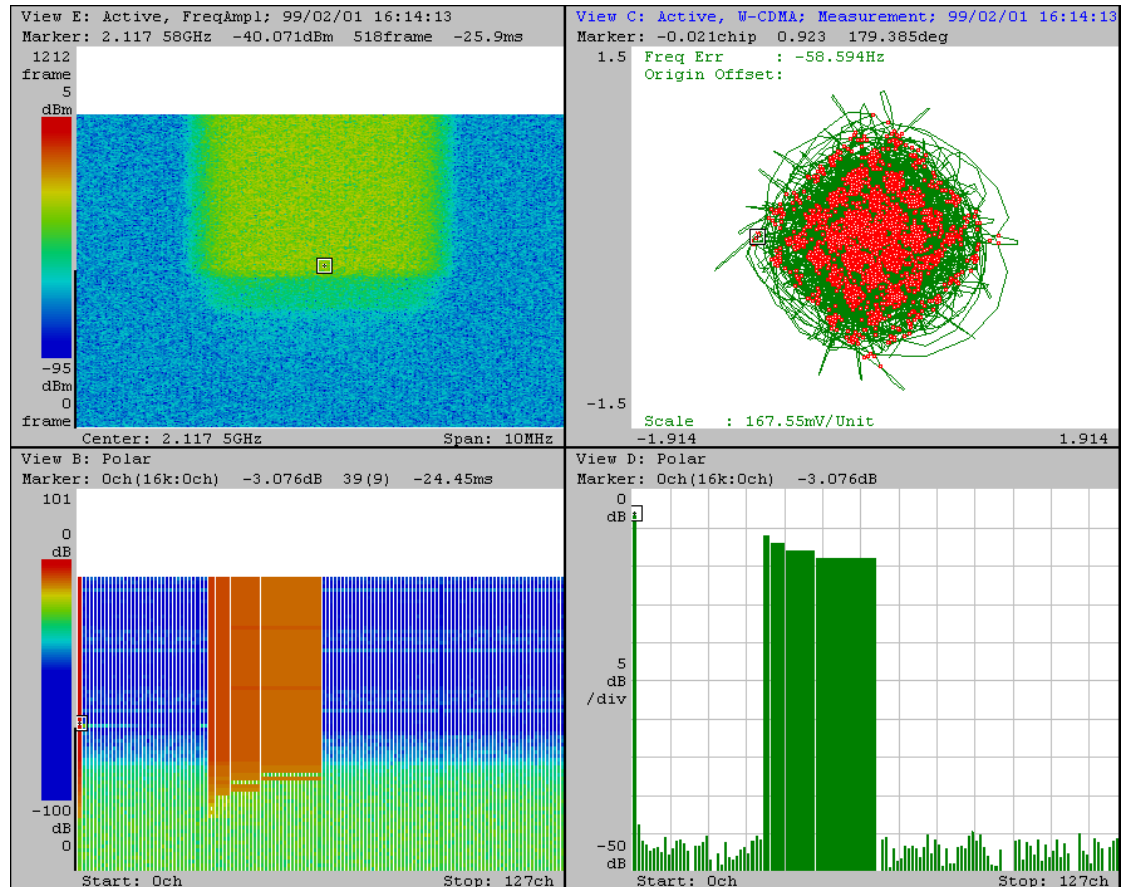


Figure I-5: Analyzing a transient signal

## View Menu Functions

**View A: Spectrum** View A displays the Waveform view. For details on the menu, refer to *Waveform View Menu* on page 2–70.

Press **VIEW:A** → **VIEW:MKR** to set the marker and delta marker. Press the **Measurement** side key to set the parameters. You can measure noise, power, occupied bandwidth, etc. Refer to *Power Measurement* on page 3–79.

**View B: Code-Domain Power Spectrogram** View B displays the code-domain power spectrogram by default, called “CodeWSpectrogram”. It shows the signal power in color for each channel in each slot, with channels along the horizontal axis and slots (time) along the vertical axis.

Table I–2 summarizes the structure of the CodeWSpectrogram view menu.

**Table I–2: CodeWSpectrogram view menu table**

| Top level          | Subordinate level, options and descriptions  |  |
|--------------------|--|--|
| <b>Time Slot</b>   | Specifies the time slot number on which the marker is positioned.  |  |
| <b>Ver. Start</b>  | Specifies the start time-slot number on the vertical axis. The default is the slot 0 which contains the latest data. |  |
| <b>Symbol Rate</b> | Composite/16/<br>32/64/128/256/<br>512/1024 ksps   | It is set to Composite by default that corresponds to multi-rate. When you select the other specific value, the measurement is done with the fixed rate.   |
| <b>Options...</b>  | Scale...   | Sets the horizontal, vertical and color axes.  |
|                    | Hor. Scale   | Sets the scale of the horizontal axis.   |
|                    | Hor. Start   | Sets the start value of the horizontal axis.   |
|                    | Ver. Scale   | Sets the scale of the vertical axis. The value is a multiple of the number of basic slots (1 to 16). For example, when it is set to 10, data is displayed every 10 slots.                          |
|                    | Ver. Start   | Sets the start value of the vertical axis.   |
|                    | Color Scale  | Inputs the width of the level represented in colors.   |
|                    | Color Start  | Inputs the start value of the level represented in colors.<br><br>The level is represented in 10 colors from blue (minimum) to red (maximum). The level below the minimum is represented in black. |
|                    | Auto Scale   | Automatically sets the start values and scales of the horizontal and vertical axes and level to view the whole waveform.   |

Table I-2: CodeWSpectrogram view menu table (cont.)

| Top level     | Subordinate level, options and descriptions                                   |   |  |
|---------------|---|---|--|
| Marker...     | Operates the markers. Refer to page 3–35 for how to use the markers.          |   |  |
|               | Hor.  | Inputs the horizontal position to moves the □ marker. By default, it is positioned at the start point on the horizontal axis. |  |
|               | Ver.  | Inputs the slot number as the vertical position to moves the □ marker. By default, the marker is positioned in slot 0.        |  |
|               | Delta Marker  | Turns on or off the delta marker.   |  |
|               | Reset Delta   | Moves the ◇ marker to the □ position.   |  |
|               | Search...   | Searches for the peak spectrum in the specified time slot and positions the □ marker there.                                   |  |
|               |   | Peak  | Searches for the peak spectrum and moves the marker there. Rotate the general purpose knob clockwise to search for the peak rightward, and vice versa. |
|               |   | Max   | Searches for the maximum peak spectrum and moves the marker there.   |
|               |   | Min   | Searches for the minimum peak spectrum and moves the marker there.   |
|               |   | Separation  | Sets the minimum horizontal distance relative to full-scale (100 %) to separate two peaks.   |
| Ver.          |   | Inputs the slot number as the vertical position to moves the □ marker. By default, the marker is positioned in slot 0.        |  |
| Delta Marker  |   | Turns on or off the delta marker.   |  |
| Reset Delta   |   | Moves the ◇ marker to the □ position.   |  |
| Monochrome    | Determines whether to display in color or monochrome.                         |   |  |
|               | Off   | Displays in color (default).  |  |
|               | On  | Displays in monochrome.   |  |
| Number Colors | Selects the number of display colors.   |   |  |
|               | 100   | Selects 100 color display (default).  |  |
|               | 10  | Selects 10 color display.   |  |
| Ver. Mag      | Sets the number of vertical pixels to display one slot. The range is 1 to 10. |   |  |

**View C: Vector Diagram** View C displays the IQ loci and chip positions for all input signals by default, called “CodeWPolar” view.

Pressing VIEW:C → VIEW:MAIN displays the side keys to set measurement conditions as listed in Table I-3.

**Table I-3: CodeWPolar view menu table**

| Top level                 | Subordinate level, options and descriptions   |  |                        |
|---------------------------|---|--|------------------------|
| <b>Source</b>             | Specifies the input data used for the view.   |  |                        |
|                           | None  | Specifies no input source. The display area in the view will be empty.   |                        |
|                           | Active  | Specifies the data memory for the input source, that is, the acquired data is displayed as is.   |                        |
|                           | Zoom  | Specifies the zoomed data for the input source.  |                        |
|                           | File(*.IQ)  | Specifies the IQ-formatted, saved data file for the input source.  |                        |
| <b>Analysis Time Slot</b> | Specifies the time slot number to display the IQ locus. The default is the slot 0 which contains the latest data. |  |                        |
| <b>Standard...</b>        | Configures the analyzer according to the standard digital modulating system settings.                             |  |                        |
|                           | W-CDMA 4.096M   | Selects W-CDMA with the chip rate of 4.096 Mcpc.   |                        |
|                           | W-CDMA 8.192M   | Selects W-CDMA with the chip rate of 8.192 Mcpc.   |                        |
|                           | W-CDMA 16.384M  | Selects W-CDMA with the chip rate of 16.384 Mcpc.  |                        |
| <b>Manual Setup...</b>    | Sets the modulating system, chip rate, filter, and $\alpha$ /BT manually.   |  |                        |
|                           | Modulation  | Selects the modulating system required to demodulate the digital modulated signal.   |                        |
|                           |   | W-CDMA   | Selects W-CDMA system. |
|                           | Chip Rate   | Inputs the chip rate: 4.096M, 8.192M, or 16.384M.  |                        |
|                           | Measurement Filter  | Selects the filter required to demodulate the digital modulated signal. You can select either None (no filter) or RootRaisedCosine. Refer to <i>Processing Flow</i> on page 3-69 for detail. |                        |
|                           | Reference Filter  | Selects None (no filter), RaisedCosine, or Gaussian for the filter required to create reference data. Refer to <i>Processing Flow</i> on page 3-69 for detail.                               |                        |
|                           | Alpha/BT  | Inputs the $\alpha$ /BT value.   |                        |
|                           | Auto Carrier  | Determines whether to search the carrier automatically.  |                        |
| Off                       |   | Sets the carrier frequency to the value with the Carrier (Hz) button which appears by pressing the Off button.   |                        |
| On                        |   | Searches the carrier automatically, and displays the frequency error relative to center frequency on screen at Freq Err.   |                        |

Table I-3: CodeWPolar view menu table (cont.)

| Top level                   | Subordinate level, options and descriptions                     |  |  |
|-----------------------------|---|--|--|
| <b>Symbol Constellation</b> | Specifies how to display the constellation.                     |  |  |
|                             | Off   | The constellation is displayed for all signals.  |  |
|                             | On  | The constellation is displayed for one short code.   |  |
| <b>Options...</b>           | Time Slot   | Sets the displayed time-slot number when Symbol Constellation is On. The range is 0 to the number of time slots - 1. |  |
|                             | Short Code  | Sets the displayed short-code number when Symbol Constellation is On. The range is 0 to 255.                         |  |
|                             | Display   | Selects the display data. Refer to <i>Processing Flow</i> on page 3-69 for detail.                                   |  |
|                             |   | Measure  | Displays measurement data.   |
|                             |   | Reference  | Displays reference data obtained by demodulating and modulating measurement data.            |
|                             | Format  | Selects the display format.  |  |
|                             |   | Vector   | Displays data in the vector format that represents symbol-to-symbol movements using vectors. |
|                             |   | Constellation  | Displays data in the constellation format that represents only symbols.                      |
| Marker                      | Inputs the time to move the <input type="checkbox"/> marker.    |  |  |
| <b>Analyze</b>              | Performs the measurement for all time slots on the data memory. |  |  |

**View D: Code-Domain Power**

By default, View D displays signal power for each channel in the slot specified with **Time Slot** side key, called “CodeWPower” view.

Pressing **VIEW:D** → **VIEW:MAIN** displays the side keys to set the measurement conditions as listed in Table I-4.

**Table I-4: CodeWPower view menu table**

| Top level           | Subordinate level, options and descriptions  |  |
|---------------------|--|--|
| <b>X Axis</b>       | Defines the parameter associated with the horizontal axis.   |  |
|                     | Short Code   | Specifies that the horizontal axis represents short-code numbers.  |
|                     | Symbol   | Specifies that the horizontal axis represents symbol numbers. The display is for the channel on which the marker is positioned when the horizontal axis is short-code numbers. |
| <b>Average</b>      | Determines whether to average data or not.   |  |
|                     | Off  | Specifies the data is not averaged.  |
|                     | On   | Displays the measurement result data averaged for a number of slots.   |
| <b>Average Type</b> | Specifies the average mode.  |  |
|                     | RMSExpo  | Performs averaging with the exponential function RMS (root-mean-square). This mode decreases the influence by the older data exponentially.                                    |
|                     | RMS  | Performs averaging with RMS (root-mean-square).  |
|                     | MaxHold  | Holds the maximum value.   |
|                     | MinHold  | Holds the minimum value.   |
| <b>Num Average</b>  | If you set the averaging mode to RMS, the average is obtained only for the frame specified with Num Average before switching to the fixed display. If you select RMSExpo in the averaging mode, Num Average will be used for weighted setting of the old data. The Num Average item is displayed only when Average is On.<br><br>Refer to page 3-109 for details on averaging. |  |
| <b>Time Slot</b>    | Specifies the time slot number to display the data. The default is the slot 0 which contains the latest data. The Time Slot item is displayed only when Average is Off.  |  |
| <b>Symbol Rate</b>  | Composite/16/32/64/128/256/512/1024 ksps   | It is set to Composite by default that corresponds to multi-rate. When you select the other specific value, the measurement is done with the fixed rate.                       |
| <b>Options...</b>   | Scale...   | Sets up the horizontal and vertical axes.  |
|                     | Hor. Scale   | Sets the horizontal axis scale.  |
|                     | Hor. Start   | Sets the horizontal axis start value.  |
|                     | Ver. Scale   | Sets the vertical axis scale.  |
|                     | Ver. Start   | Sets the vertical axis start value.  |
|                     | Auto Scale   | Automatically sets the start values and scales of the vertical axis to view the whole waveform.  |



Table I-4: CodeWPower view menu table (cont.)

| Top level    | Subordinate level, options and descriptions |  |  |
|--------------|---|--|--|
|              | Marker...                                   | Operates the markers. Refer to page 3–35 for how to use the markers. |  |
|              |   | Hor.   | Inputs the horizontal position and moves the □ marker. By default, it is positioned at the horizontal axis start point.                                |
|              |   | Delta Marker   | Turns on or off the delta marker.  |
|              |   | Reset Delta  | Moves the ◇ marker to the □ marker position.   |
|              | Search...                                   | Searches for the peak spectrum and positions the □ marker there.     |  |
|              |   | Peak   | Searches for the peak spectrum and moves the marker there. Rotate the general purpose knob clockwise to search for the peak rightward, and vice versa. |
|              |   | Max  | Searches for the maximum peak spectrum and moves the marker there.   |
|              |   | Min  | Searches for the minimum peak spectrum and moves the marker there.   |
|              |   | Separation   | Sets the minimum horizontal distance relative to full-scale (100 %) to separate two peaks.   |
|              |   | Delta Marker   | Turns on or off the delta marker.  |
|              |   | Reset Delta  | Moves the ◇ marker to the □ marker position.   |
|              | Average Options...                          | Sets the averaging parameters or starts the process.                 |  |
|              |   | Begin Slot   | Specifies the first slot to be averaged. The range is 0 to the number of time slots – 1.   |
|              |   | End Slot   | Specifies the last slot to be averaged. The range is 0 to the number of time slots – 1.  |
| All Slots    |   | Specifies that the averaging is done for all slots.                  |  |
| Mkr -> Slot  |   | Sets Begin Slot and End Slot with the marker and delta marker.       |  |
| Average Type |   | Same as Average Type on page I-12.                                   |  |
| Execute      |   | Executes averaging.  |  |



## Appendix J: CCDF Analysis (Option 20)

This chapter describes the CCDF (Complementary Cumulative Distribution Function) analysis functions included in Option 20. The following topics are discussed.

- About CCDF analysis
- Operation examples
- View menu functions

## About CCDF Analysis

CCDF (Complementary Cumulative Distribution Function) represents the probability that the peak power above average power of input signals exceeds a threshold. The analyzer displays the ratio of peak power to average power along the horizontal axis and the probability that the ratio is exceeded along the vertical axis.

The CCDF analysis functions along with realtime analysis function of the analyzer allow you to measure the time-varying crest factor quantitatively in time series for code-multiplexing signals such as CDMA/W-CDMA signals and multi-carrier signals such as OFDM signals.

**Calculation Process** CCDF is calculated with the following formula.

$$SP(X) = \int_X^{Max} P(Y) dY$$

$$CCDF(X) = SP(X + Average)$$

$$CCDF(crest\ factor) = 0$$

where

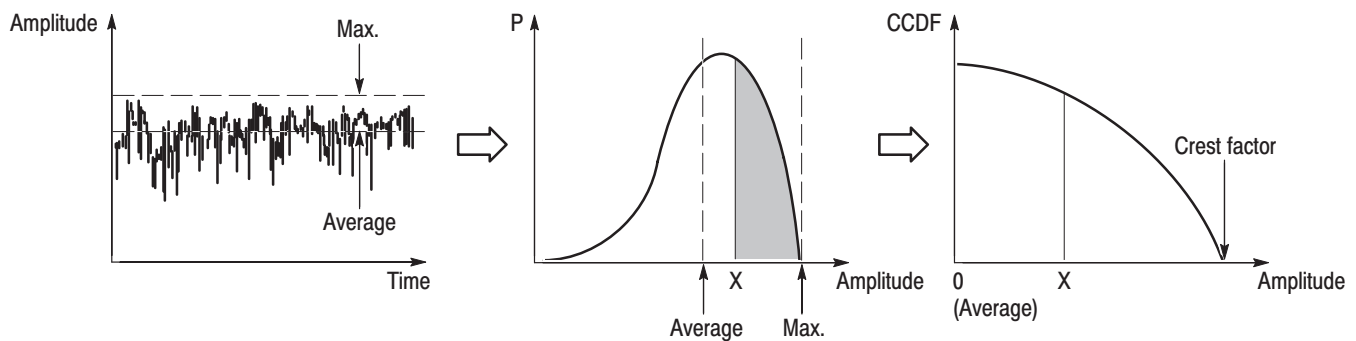
P: Probability density

Max: Maximum of amplitude

Average: Average of amplitude

The analyzer with option 20 processes input signals internally with the following procedure (see Figure J-1).

1. Measure the amplitude of the input signal over time.
2. Determine the amplitude distribution.
3. Obtain CCDF using the above formula.



**Figure J-1: CCDF calculation process**

## Operation Examples

The following procedure measures CCDF in View G and H. View A to F might be used for another measurement such as cdmaOne (3066 Option 15) or W-CDMA (3086 Option 16).

1. Press the CONFIG:MODE key.
2. Press the **More...** side key.
3. Press the **CCDF** side key (with the icon).

View G is set to the CCDF view and View H to the CCDFView display automatically.

4. Press the VIEW:C key two or three times (depending on the settings) to display the View G menu. (View G is the back screen of View C).
5. Press the **Calculate...** side key.
6. Set the CCDF calculation range using the **Begin Frame** and **End Frame** side keys. The unit frame period is as follows:
  - W-CDMA: 50  $\mu$ s for 10 MHz span
  - 25  $\mu$ s for 20 or 30 MHz span.
  - cdmaOne: 160  $\mu$ s for 5 MHz span
7. Press **Execute** side key to start the process. The results are shown in View G and H (see Figure J-2 and J-3).
8. Press the VIEW:D key two or three times (depending on the settings) to display the View H menu. (View H is the back screen of View D).
9. Press VIEW:SCALE key. The side keys are displayed to set the horizontal and vertical scales. The maximum value on the horizontal axis displayed by default is the crest factor.
10. When you replace View G or H with View A or B, press the VIEW:A or B key two or three times (depending on the settings).

For details on the View menu, refer to *View Menu Functions* on page J-5.

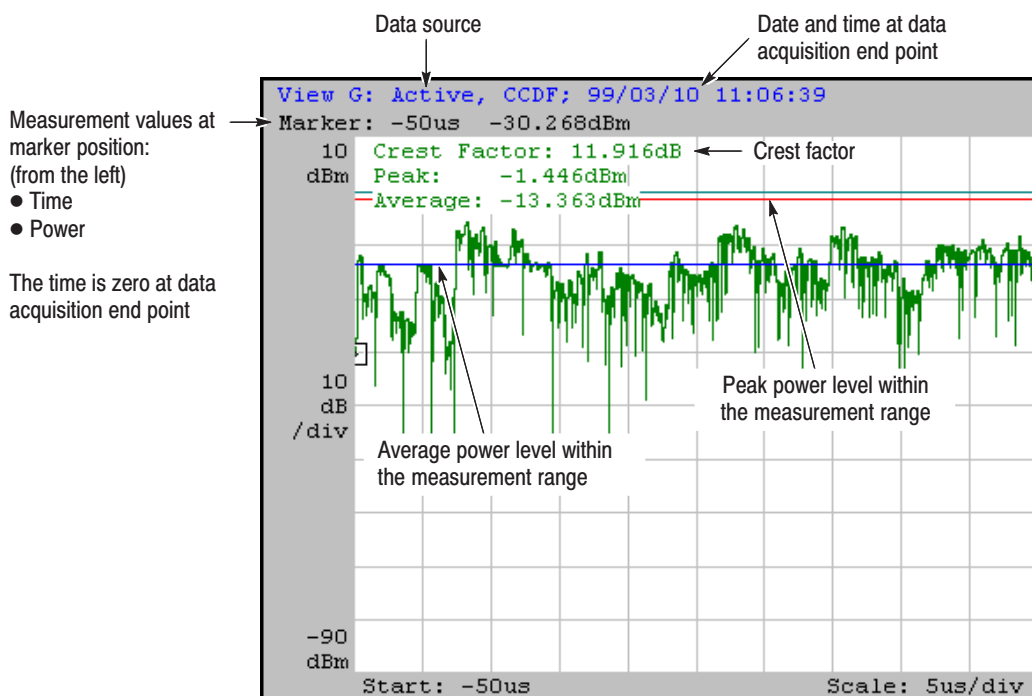


Figure J-2: CCDF measurement (View G)

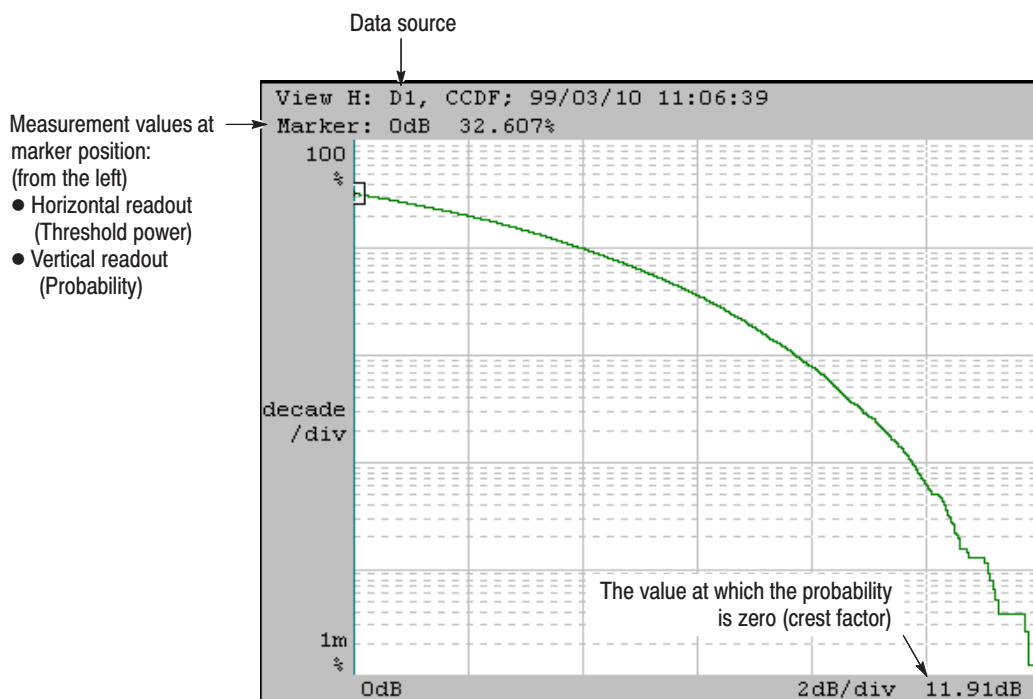


Figure J-3: CCDFView display (View H)

## View Menu Functions

**CCDF View** Table J-1 summarizes the structure of the CCDF view menu.

**Table J-1: CCDF view menu table**

| Top level         | Subordinate level, options and descriptions  |  |  |
|-------------------|--|--|--|
| <b>Source</b>     | Specifies the input data used for the view. You can select one of the following items:   |  |  |
|                   | None   | Specifies no input source. The display area in the view is empty.  |  |
|                   | Active   | Specifies the data memory for the input source, that is, the acquired data is displayed as is.   |  |
|                   | Zoom   | Specifies that the zoomed data is the input source. When you use the Zoom mode, select the Zoom. For Zoom, refer to pages 3-4 and 3-105. |  |
|                   | File (*.IQ)  | Specifies the IQ-formatted, saved data file for the input source.  |  |
| <b>Frame</b>      | Specifies the frame number to display the data. The default is the frame 0 which contains the latest data. Refer to page 3-17 for frame details. |  |  |
| <b>Options...</b> | Scale...   | Sets up the horizontal and vertical axes.  |  |
|                   |  | Hor. Scale   | Sets the horizontal axis scale.  |
|                   |  | Hor. Start   | Sets the horizontal axis start value.  |
|                   |  | Ver. Stop  | Sets the vertical axis stop value.   |
|                   |  | Ver. Start   | Sets the vertical axis start value.  |
|                   |  | Auto Scale   | Automatically sets the start values and scales of the horizontal and vertical axes to display the whole waveform.  |
|                   |  | Oigin Scale  | Reset the vertical scale to the default.   |
|                   |  | Frame Relative   | When Off is selected, the last data of frame 0 (the latest frame) is put on the time axis origin at the right edge. You can observe the old data going back along the time axis.<br><br>When On is selected, the first data of each displayed frame is put on the time axis origin at the left edge. |
|                   | Marker...  | Operates the markers. Refer to page 3-35 for how to use the markers.   |  |
|                   |  | Hor.   | Inputs the horizontal position and moves the <input type="checkbox"/> marker. By default, it is positioned at the horizontal axis start point.   |
|                   |  | Delta Marker   | Turns on or off the delta marker.  |
|                   |  | Reset Delta  | Moves the <input type="checkbox"/> marker to the <input type="checkbox"/> position.  |

**Table J-1: CCDF view menu table (cont.)**

| Top level            | Subordinate level, options and descriptions   |  |
|----------------------|---|--|
|                      | Search...   | Searches for the peak spectrum and positions the □ marker there.   |
|                      | Peak  | Searches for the peak spectrum and moves the marker there. Rotate the general purpose knob clockwise to search for the peak rightward, and vice versa.   |
|                      | Max   | Searches for the maximum peak spectrum and moves the marker there.   |
|                      | Min   | Searches for the minimum peak spectrum and moves the marker there.   |
|                      | Separation  | Sets the minimum horizontal distance relative to full-scale (100 %) to separate two peaks.   |
|                      | Delta Marker  | Turns on or off the delta marker.  |
|                      | Reset Delta   | Moves the ◇ marker to the □ position.  |
|                      | Position  | Specifies the frame position to display the data. The range is 0 to 100 % in 1 % steps relative to the block size. For example, if the block size is 1000 frames and the frame position 10 %, hundredth frame is displayed. The default is 100 %, i.e. the last frame.<br><br>If Position is set to the same value as Trigger Position (refer to page 2-67), the frame at the trigger position is displayed. |
|                      | Hold Ver. Scale   | Determines whether to hold or reset the vertical scale when you change the input source.   |
|                      | Off   | Resets the vertical scale to full-scale when you change the input source.  |
|                      | On  | Holds the vertical scale setting when you change the input source.   |
| <b>Output Format</b> | Selects the display format.   |  |
|                      | CCDF  | Displays CCDF for the amplitude above average.   |
|                      | Histogram   | Transforms the data into a histogram.  |
| <b>Destination</b>   | Specifies the destination data register from D1 to D8. The default is D1. But when another digital demodulating system such as cdmaOne or W-CDMA is active, use D1 to D4. |  |
| <b>Resolution</b>    | Sets the resolution for the histogram when Output Format is set to Histogram. The range is 0.01 dB to 10 dB in 1-2-5 steps.   |  |
| <b>Calculate...</b>  | Sets the CCDF calculation parameters or starts the process.   |  |
|                      | Begin Frame   | Specifies the first frame to be calculated. The range is 0 to the number of frames - 1.  |
|                      | End Frame   | Specifies the last frame to be calculated. The range is 0 to the number of frames - 1.   |
|                      | All Frames  | Specifies that the data is calculated for all frames.  |
|                      | Mkr -> Frame  | Sets Begin Frame and End Frame with the marker and delta marker.   |
|                      | Execute   | Executes the calculation.  |
| <b>Reset</b>         | This menu item is displayed during data acquisition. It restarts the CCDF calculation.  |  |



**CCDFView Display** Table J-1 summarizes the structure of the CCDFView display menu.

**Table J-2: CCDFView display menu table**

| Top level         | Subordinate level, options and descriptions  |   |   |
|-------------------|--|---|---|
| <b>Source</b>     | Specifies the input data used for the view. You can select one of the following items: |   |   |
|                   | D1/D2/D3/D4/<br>D5/D6/D7/D8  | Selects a data register.<br>Choose the same register as Destination in the CCDF view (refer to page J-6). |   |
| <b>Options...</b> | Scale...   | Sets up the horizontal and vertical axes.   |   |
|                   |  | Hor. Scale  | Sets the horizontal axis scale.   |
|                   |  | Hor. Start  | Sets the horizontal axis start value.   |
|                   |  | Ver. Stop   | Sets the vertical axis stop value.  |
|                   |  | Ver. Start  | Sets the vertical axis start value.   |
|                   |  | Auto Scale  | Automatically sets the start values and scales of the horizontal and vertical axes to view the whole waveform.  |
|                   |  | Origin Scale  | Resets the scale to the default.  |
|                   | Marker...  | Operates the markers. Refer to page 3-35 for how to use the markers.                                      |   |
|                   |  | Hor.  | Inputs the horizontal position and moves the <input type="checkbox"/> marker.<br>By default, it is positioned at the horizontal axis start point.         |
|                   |  | Delta Marker  | Turns on or off the delta marker.   |
|                   |  | Reset Delta   | Moves the <input type="checkbox"/> marker to the <input type="checkbox"/> position.   |
|                   | Search...  | Searches for the peak spectrum and positions the <input type="checkbox"/> marker there.                   |   |
|                   |  | Peak  | Searches for the peak spectrum and moves the marker there.<br>Rotate the general purpose knob clockwise to search for the peak rightward, and vice versa. |
|                   |  | Max   | Searches for the maximum peak spectrum and moves the marker there.  |
|                   |  | Min   | Searches for the minimum peak spectrum and moves the marker there.  |
|                   |  | Separation  | Sets the minimum horizontal distance relative to full-scale (100 %) to separate two peaks.  |
|                   |  | Delta Marker  | Turns on or off the delta marker.   |
|                   |  | Reset Delta   | Moves the <input type="checkbox"/> marker to the <input type="checkbox"/> position.   |



# Index



# Index

## Symbols

.AP, file extension, 3-115  
.CFG, file extension, 3-115  
.IQ, file extension, 3-115  
.IQT, file extension, G-5

## A

AC inlet, rear panel, 2-4  
Access to Windows 95, 3-137  
Accessories, A-1  
    optional, A-3  
    standard, A-3  
ACP, power measurement, 3-84  
Acquisition mode, 3-22  
Action, when abnormal situation, 1-14  
Analog modulation signal, 3-65  
Analog view menu table, 2-74  
Analysis  
    analog modulation, 3-65  
    CDMA, 3-91  
    digital modulation, 3-67  
    FSK signal, 3-77  
    power, 3-79  
Architecture, 1-5  
Auto, trigger mode, 3-51  
Auto-scale, 3-31  
Average menu table, 2-94  
Average using UTILITY averaging function, 3-114  
Average using view averaging function, 3-113  
Averaging, 3-109  
Averaging and compared display, tutorial, 2-36

## B

Backing up user files, 1-18  
Base line, trigger mask pattern, 3-64  
Baseband mode, 3-3  
Bin, 3-34  
Block size, 3-22  
Buffering the input value, 3-9

## C

C/N, power measurement, 3-83  
C/No, power measurement, 3-83  
Calibration, 1-16

CCDF analysis, J-1  
    Options, A-1  
CCDF view menu table, J-5  
CCDFView display menu table, J-7  
CDMA analysis, 3-91  
    modulation precision, 3-92  
    spurious, 3-95  
    time characteristics, 3-100  
    waveform quality, 3-92  
cdmaOne analysis, H-1  
    Options, A-1  
CDMAPolar view menu table, 2-83  
CDMATime view menu table, 2-86  
CDMAWaveform view menu table, 2-80  
CDPD, modulating system, 3-69  
Characteristics, B-1, B-12, B-13  
    Electrical, B-1  
    Environmental, B-13  
    Physical, B-12  
Cleaning, D-1  
Clock in/out connectors, rear panel, 2-4  
Code-domain power measurement  
    cdmaOne, H-3  
    W-CDMA, I-3  
CodePolar view menu table, H-10  
CodePower view menu table, H-12  
CodeSpectrogram view menu table, H-8  
CodeWPolar view menu table, I-10  
CodeWPower view menu table, I-12  
CodeWSpectrogram view menu table, I-8  
CONFIG menu table, 2-60  
Configuration, display, 2-5  
Configuration with basic configuration pattern, tutorial,  
    2-22  
Connecting the mouse, Installation, 1-10  
Constellation and vector displays, 3-71  
Conventions, *xx*  
Correction data block, 3-135  
Count, trigger, 3-55

## D

Data block, 3-130  
Data file format, 3-125  
Data in clipboard, 3-148  
Data in text file, 3-148  
Data storage utility, G-1  
    Options, A-1  
Date and time, setting, 3-141

- Default settings, C-1
- Delayed, trigger mode, 3-51
- Delta marker operation, 3-38
- Delta markers, tutorial, 2-41
- Demodulating and modulating process in Polar view, 3-69
- Difference between the 3066 and 3086, 1-3
- Digital modulation signal, 3-67
- Display, front panel, 2-2
- Display configuration, 2-5
- Display frame, 3-41
- Domain, 3-13
  - trigger, 3-50
- Draw line, trigger mask pattern, 3-60
- Dual mode, 3-4

## E

- Electrical Characteristics, B-1
- Environmental Characteristics, B-13
- Error vector analysis, 3-75
- Ethernet interface, Options, A-2
- EVM, 3-76
- EVM analysis, tutorial, 2-52
- EVM view menu table, 2-93
- Expansion slots, rear panel, 2-4
- External trigger input connector, front panel, 2-3
- Eye diagram display, 3-72
- Eye length, 3-72
- EyeDiagram view menu table, 2-91

## F

- Features of 3066/3086, 1-1
- FFT
  - points, 3-14
  - windows, 3-14
- File Access menu table, 2-96
- File extension
  - .AP, 3-115
  - .CFG, 3-115
  - .IQ, 3-115
  - .IQT, G-5
- File format, 3-125
- File format lists available for views, 3-117
- File handling, general, 3-119
- File header, 3-126
- Floppy disk drive, front panel, 2-2
- Format, data file, 3-125
- Four-view display, view layout, 3-30
- Frame data, 3-132
- Frame for display, 3-41

- Frame header, 3-130
- Frame period and realtime, 3-17
- Frame period table, 3-19
- Frame to be displayed, data display timing, 3-58
- Frequency and span, 3-7
- Frequency and time, domain, 3-13
- Frequency error, 3-71
- Frequency mode, 3-4
- Frequency setup using marker and search, 3-8
- Front panel
  - display, 2-2
  - external trigger input connector, 2-3
  - floppy disk drive, 2-2
  - reset button, 2-2
  - RF input connector, 2-3
  - side keys, 2-2
  - step keys, 2-3
  - switch, 2-2
- FSK signal, 3-77
- FSK view menu table, 2-76
- Full mouse operation, F-1

## G

- General file handling, 3-119
- GMS, modulating system, 3-69
- GPIO connector, rear panel, 2-4

## H

- Hardcopy
  - to a file, 3-145
  - to a printer, 3-143
- Heat radiation, Installation, 1-10

## I

- I/Q input connectors (3086 only), rear panel, 2-4
- Ideal signal, 3-71
- Input mode, 3-1
  - baseband, 3-3
  - IQ, 3-3
  - RF, 3-3
  - wideband, 3-3
- Inspection, 1-9, D-1
- Installation, 1-9
- Interface maps, 2-1
- Interval, trigger mode, 3-54
- IQ mode, 3-3
- IQ offset calibration, 1-18
- IS-95, modulating system, 3-69

**K**

Keyboard and mouse connections, 3-138  
 Keyboard interface connector, rear panel, 2-4

**L**

Logical and physical frame, 3-23

**M**

Mag error, 3-76  
 Making changes to hardware settings, tutorial, 2-27  
 Marker  
   band power markers, 3-87  
   movement in three-dimensional view, 3-46  
   operation, 3-35  
 Mask pattern, trigger, 3-59  
 Measurement signal, 3-71  
 Measuring a digital modulated signal, tutorial, 2-25  
 Mechanism for averaging process, 3-110  
 Memory mode, 3-1  
   Dual, 3-4  
   Frequency, 3-4  
   Scalar, 3-4  
   Zoom, 3-4  
 Menu display area, 2-5  
 Menu table  
   Analog view, 2-74  
   Average, 2-94  
   CCDF view, J-5  
   CCDFView display menu table, J-7  
   CDMAPolar view, 2-83  
   CDMATime view, 2-86  
   CDMAWaveform view, 2-80  
   CodePolar view, H-10  
   CodePower view, H-12  
   CodeSpectrogram view, H-8  
   CodeWPolar view, I-10  
   CodeWPower view, I-12  
   CodeWSpectrogram view, I-8  
   CONFIG, 2-60  
   EVM view, 2-93  
   EyeDiagram view, 2-91  
   File Access, 2-96  
   FSK view, 2-76  
   Polar view, 2-88  
   Print, 2-97  
   SaveLoad, 2-95  
   SETUP (CDMA), 2-68  
   SETUP (Standard), 2-64

Spectrogram view, 2-77  
 SymbolTable view, 2-92  
 Waterfall view, 2-79  
 Waveform view, 2-70

Minimum frame period, 3-19

**Mode**

input, 3-1  
 memory, 3-1  
 trigger, 3-51

Mode summary, 3-6

Modulating and demodulating process flow in Polar view, 3-69

**Modulating system**

CDPD, 3-69  
 GMS, 3-69  
 IS-95, 3-69  
 NADC, 3-69  
 PDC, 3-69  
 PHS, 3-69  
 T-53, 3-69  
 TETRA, 3-69

Modulation system, supported by 3066/3086, 3-69

**Mouse**

connection, 3-138  
 connector, rear panel, 2-4  
 installation, 1-10  
 operation, F-1

**N**

NADC, modulating system, 3-69  
 Never, trigger mode, 3-54  
 New clock settings dialog box, 1-12  
 Noise, power measurement, 3-81  
 Normal, trigger mode, 3-51

**O**

OBW, power measurement, 3-86  
 One-view display, view layout, 3-29  
 Option  
   15, H-1  
   16, I-1  
   1S, G-1  
   20, J-1  
 Options, A-1  
 Origin offset, 3-72  
 OVERLOAD  
   status, 3-11  
   status display, 2-7

**P**

Parallel interface connector, rear panel, 2–4  
PAUSE, status display, 2–7  
PDC, modulating system, 3–69  
Peak Hold, 3–109  
Phase error, 3–76  
PHS, modulating system, 3–69  
Physical and logical frames, 3–23  
Physical Characteristics, B–12  
Polar view menu table, 2–88  
Pos, trigger, 3–57  
Power, power measurement, 3–82  
Power cord  
    installation, 1–9  
    option, A–1  
Power measurement, 3–79  
    ACP, 3–84  
    C/N, 3–83  
    C/No, 3–83  
    noise, 3–81  
    OBW, 3–86  
    power, 3–82  
    tutorial, 2–55  
Power supply, Installation, 1–9  
Power switch, front panel, 2–2  
Power–off, Installation, 1–12  
Power–on, Installation, 1–11  
Print menu table, 2–97  
Procedures, inspection and cleaning, D–1  
Process for zoom, 3–108

**Q**

Quick, trigger mode, 3–51  
Quick Interval, trigger mode, 3–54

**R**

Rackmount, Options, A–2  
Radix, 3–74  
REALTIME, status display, 2–8  
Realtime and frame period, 3–17  
Rear panel  
    AC inlet, 2–4  
    clock in/out connectors, 2–4  
    expansion slots, 2–4  
    GPIB connector, 2–4  
    I/Q input connectors (3086 only), 2–4  
    keyboard interface connector, 2–4  
    mouse interface connector, 2–4  
    parallel interface connector, 2–4

    SCSI interface, 2–4  
    sync in/out connectors (3066 only), 2–4  
Recall and save, 3–115  
Reference level, 3–11  
Reference signal, 3–71  
Repacking, for shipment, E–1  
Reset button, front panel, 2–2  
RF input connector, front panel, 2–3  
RF mode, 3–3  
Rho meter, 3–76  
Rotate, 3–74

**S**

Save and recall, 3–115  
Saved files, backing up, 1–18  
SaveLoad menu table, 2–95  
Scalar mode, 3–4  
Scale, 3–31  
SCSI interface, rear panel, 2–4  
Search and zoom, tutorial, 2–38  
Search operation, 3–35  
Self gain–calibration, 1–16  
Self test  
    displaying the result, 3–151  
    Installation, 1–12  
Setting the date and time, 3–141  
SETUP (CDMA) menu table, 2–68  
SETUP (Standard) menu table, 2–64  
Setup display, 2–8  
Setup sequence, 2–59  
Setup/status display area, 2–5  
Shutdown, Installation, 1–12  
Side keys, 2–5  
    front panel, 2–2  
SL7PC66, A–3, F–10  
SL7PC86, A–3, F–10  
Slope, trigger, 3–57  
Software, displaying the version, 3–151  
Source, trigger, 3–50  
Span and frequency, 3–7  
Specifications, B–1  
Spectrogram view, 2–77  
Spectrum time series variation, tutorial, 2–50  
Spurious, CDMA analysis, 3–95  
Status display area, 2–5, 2–7  
Step keys, front panel, 2–3  
Summary of modes, 3–6  
Switching the display frame, 3–41  
Symbol, 3–75  
Symbol table display, 3–74  
SymbolTable view menu table, 2–92



Sync in/out connectors (3066 only), rear panel, 2–4

## T

T–53, modulating system, 3–69

Target of 3066/3086, 1–2

TETRA, modulating system, 3–69

Text file format, 3–147

Tilt display, 1–14

Time and date, setting, 3–141

Time and frequency, domain, 3–13

Time characteristics, CDMA analysis, 3–100

Timeout, trigger mode, 3–53

Trigger, 3–47

count, 3–55

data acquisition timing, 3–48

domain, 3–50

mask pattern, 3–59

mask pattern, tutorial, 2–44

mode, 3–51

pos, 3–57

slope, 3–57

source, 3–50

Trigger mode

Auto, 3–51

Delayed, 3–51

Interval, 3–54

Never, 3–54

Normal, 3–51

Quick, 3–51

Quick Interval, 3–54

Timeout, 3–53

TRIGGERED, status display, 2–7, 3–49

Tutorials, 2–19

Two–view display, view layout, 3–29

## U

UNCAL, status display, 2–7

Unpacking, 1–9

## V

VECTOR, status display, 2–8, 3–25

Vector and constellation displays, 3–71

View definition, 3–27

View definitions and layout, tutorial, 2–31

View display area, 2–5

View layout, 3–28

four–view display, 3–30

one–view display, 3–29

two–view display, 3–29

## W

W-CDMA analysis, I–1

Options, A–1

Waterfall view menu table, 2–79

Waveform view menu table, 2–70

Wideband mode, 3–3

Windows 95, 3–137

## Z

Zoom, 3–105

Zoom mode, 3–4





