

Reference

Tektronix

TAS 455 & TAS 465
Analog Oscilloscopes

070-8522-01



Using the TAS Two Channel Oscilloscopes

Cursor Control

TOGGLE switches the General Purpose Knob assignment between the displayed measurement cursors.

General Purpose Knob

Assigned to various operations, dependent on the last applicable menu operation:

- Position cursors.
- Adjust time for delay events.
- Variable volts/div and sec/div.
- Delayed trace separation.
- Calibration routines.

Using Time Saving Features

AUTOSET automatically adjusts instrument controls to obtain a usable display.

CURSOR turns measurement cursors on and displays the menu choices for the cursor modes.

UTILITY displays the configure and calibration menus.

SAVE/RECALL SETUP displays the menus for saving and recalling front-panel setups.

Selecting Sweeps

MAIN/DELAY SELECT assigns horizontal, trigger, and cursor functions to either the main or delayed sweep.

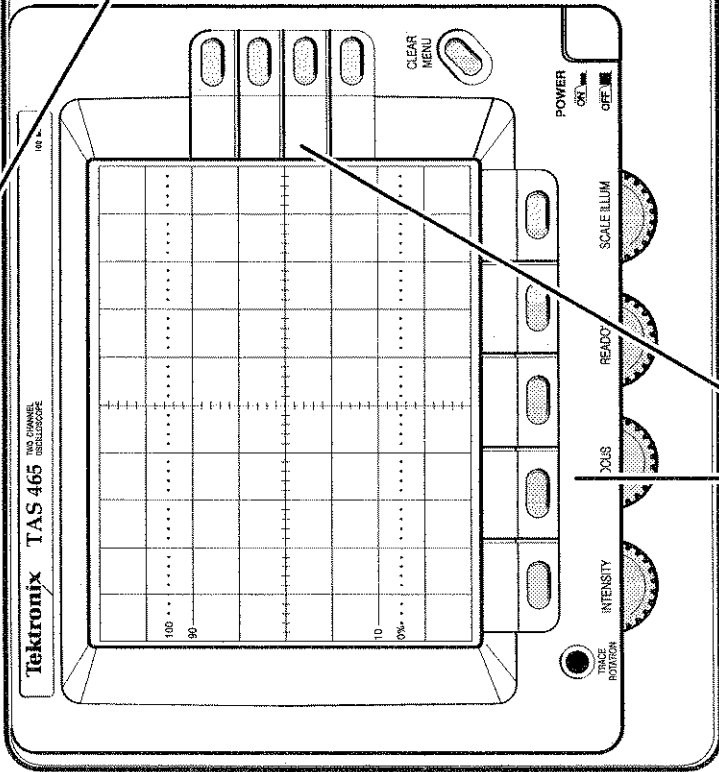

Using the Vertical System

Channel select buttons assign instrument control to the selected channel, indicated with a lighted LED.

ALT/CHOP, ADD displays the menu choices for the display mode and math operations.

WAVEFORM OFF clears the selected channel's waveform from the display until only one waveform remains.

Using the Horizontal System

POSITION moves the vertical position of the sweep.

VERTICAL MENU displays the menu choices or the vertical operating system.

VOLTS/DIV adjusts the vertical deflection factor.

WAVEFORM OFF clears the selected channel's waveform from the display until only one waveform remains.

Menu Map

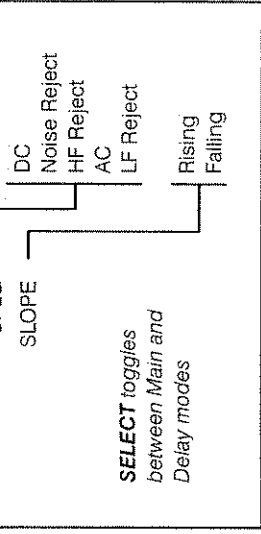
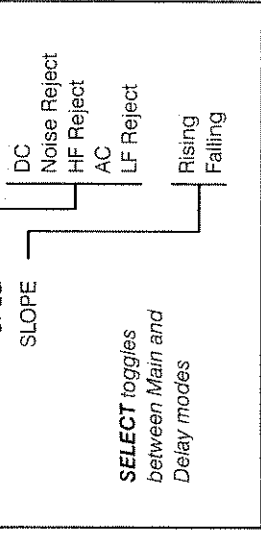
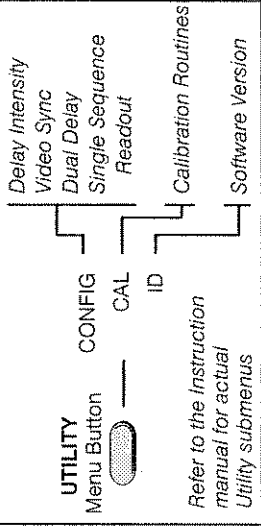
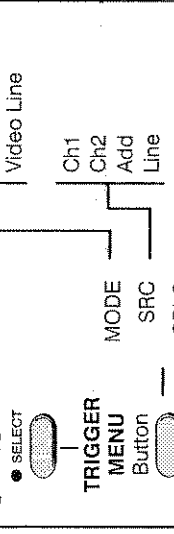
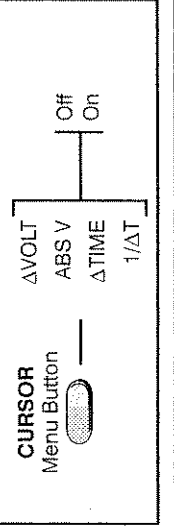
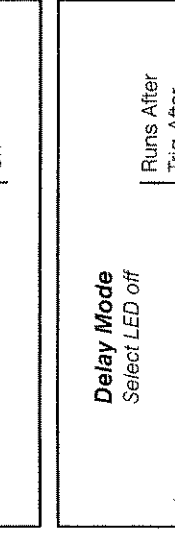
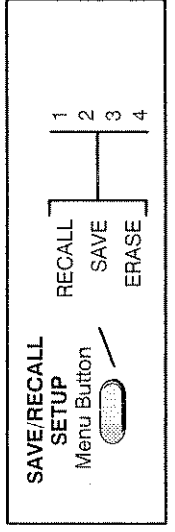
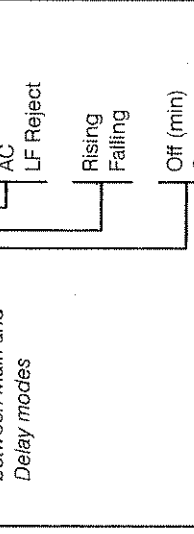
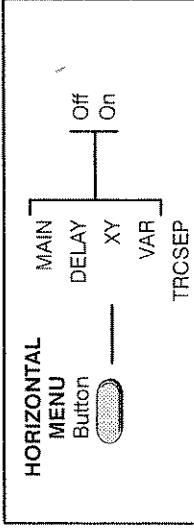
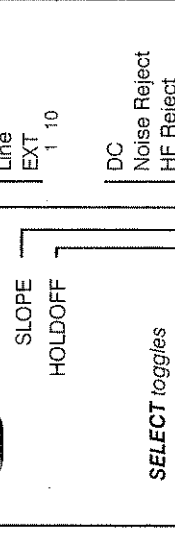
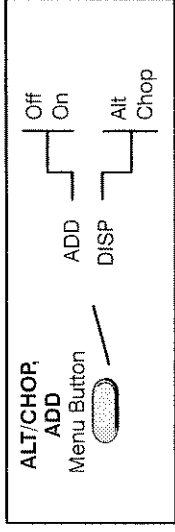
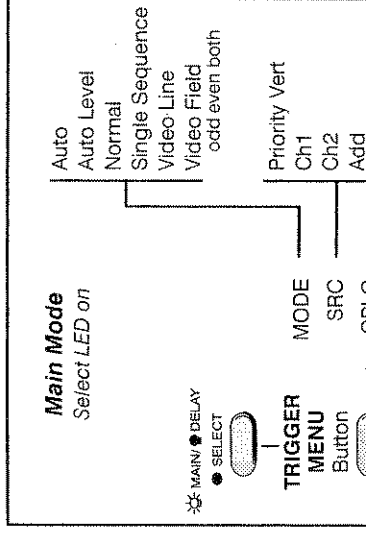
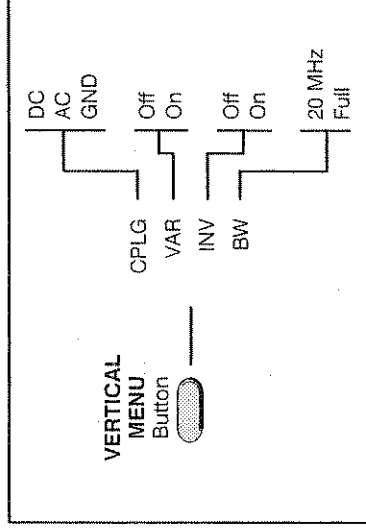

Using the Menus

Front-panel menu buttons display menu choices on the CRT.

Select instrument functions with the corresponding menu button below the CRT.

Select the operation for a selected function using the corresponding menu button to the right of the CRT.

Selections are underscored.