

071092300

Reference

**TDS3000B Series
Digital Phosphor
Oscilloscopes**

071-0923-00

www.tektronix.com

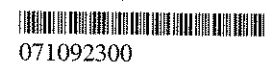
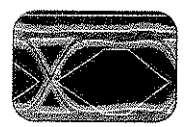

071092300

Tektronix

Copyright © Tektronix, Inc. All rights reserved.

Tektronix products are covered by U.S. and foreign patents, issued and pending. Information in this publication supercedes that in all previously published material. Specifications and price change privileges reserved.

Tektronix, Inc., P.O. Box 500, Beaverton, OR 97077

TEKTRONIX, TEK, TEKPROBE, and Tek Secure are registered trademarks of Tektronix, Inc.

DPX, WaveAlert, and e*Scope are trademarks of Tektronix, Inc.

WARRANTY SUMMARY

Tektronix warrants that the products that it manufactures and sells will be free from defects in materials and workmanship for a period of one (1) year from the date of shipment from an authorized Tektronix distributor. If a product proves defective within the respective period, Tektronix will provide repair or replacement as described in the complete warranty statement.

To arrange for service or obtain a copy of the complete warranty statement, please contact your nearest Tektronix sales and service office.

EXCEPT AS PROVIDED IN THIS SUMMARY OR THE APPLICABLE WARRANTY STATEMENT, TEKTRONIX MAKES NO WARRANTY OF ANY KIND, EXPRESS OR IMPLIED, INCLUDING WITHOUT LIMITATION THE IMPLIED WARRANTIES OF MERCHANTABILITY AND FITNESS FOR A PARTICULAR PURPOSE. IN NO EVENT SHALL TEKTRONIX BE LIABLE FOR INDIRECT, SPECIAL OR CONSEQUENTIAL DAMAGES.

Contacting Tektronix

Phone 1-800-833-9200*

Address Tektronix, Inc.
Department or name (if known)
14200 SW Karl Braun Drive
P.O. Box 500 Beaverton, OR 97077 USA

Web site www.tektronix.com

Sales support 1-800-833-9200, select option 1*

Service support 1-800-833-9200, select option 2*

Technical support Email: techsupport@tektronix.com
1-800-833-9200, select option 3*
1-503-627-2400
6:00 a.m. – 5:00 p.m. Pacific time

* This phone number is toll free in North America. After office hours, please leave a voice mail message. Outside North America, contact a Tektronix sales office or distributor; see the Tektronix web site for a list of offices.

Contents

Safety Summary	2
TDS3000B Initial Setup	5
QuickMenus	9
Menus	11
Acquire Menu	11
XY Cursor Menu	14
YT Cursor Menu	15
Display Menu	18
Measure Menu	21
Save/Recall Menu	24
Trigger Menus	26
Utility Menus	31
Vertical Menus	38
e*ScopeE Web-based Remote Control	41
Automatic Measurements	44

Safety Summary

To avoid potential hazards, use this product only as specified in the *TDS3000B Series Digital Phosphor Oscilloscope User Manual* which is located on the *TDS3000B Series Digital Phosphor Oscilloscope Manuals and Application Notes CD*. While using this product, you may need to access other parts of the system.

Read the *General Safety Summary* in the user manual and in other system manuals for warnings and cautions related to operating the system.

Preventing Electrostatic Damage



CAUTION. *Electrostatic discharge (ESD) can damage components in the oscilloscope and its accessories. To prevent ESD, observe these precautions when directed to do so.*

Use a Ground Strap. Wear a grounded antistatic wrist strap to discharge the static voltage from your body while installing or removing sensitive components.

Use a Safe Work Area. Do not use any devices capable of generating or holding a static charge in the work area where you install or remove sensitive components. Avoid handling sensitive components in areas that have a floor or benchtop surface capable of generating a static charge.

Handle Components Carefully. Do not slide sensitive components over any surface. Do not touch exposed connector pins. Handle sensitive components as little as possible.

Transport and Store Carefully. Transport and store sensitive components in a static-protected bag or container.

Manual Storage

The oscilloscope front cover has a convenient place to store this manual.

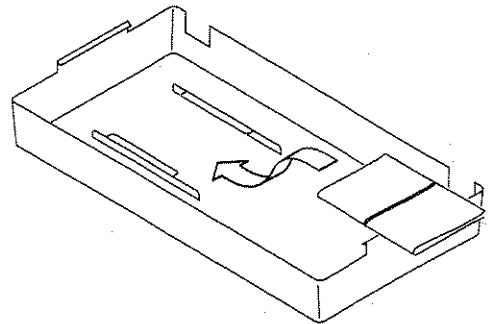

More Information

Refer to the *TDS3000B Series Digital Phosphor Oscilloscope User Manual*, which is located on the *TDS3000B Series Digital Phosphor Oscilloscope Manuals and Application Notes CD*, for more information about using this product.

TDS3000B Initial Setup

The following procedures describe how to quickly verify that the oscilloscope is powering up and functioning correctly, compensate passive probes using the built-in compensation signal, and run the signal path compensation (SPC) routine for maximum signal accuracy.

- You should perform all initial setup procedures the first time you use the oscilloscope.
- You should perform the probe compensation procedure whenever you attach a passive probe for the first time to any input channel.
- You should run the signal path compensation routine whenever the ambient temperature changes by 10° C or more.

Functional Check

1. Connect the oscilloscope power cable

2. Turn on the oscilloscope. Wait for the confirmation that the oscilloscope has passed all self-tests.

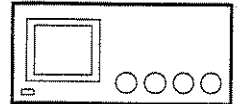

On/Standby
button

3. Connect the oscilloscope probe to channel 1. Attach the probe tip and reference lead to the **PROBE COMP** connectors.

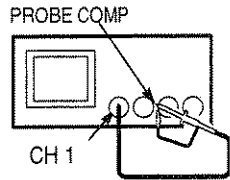

4. Push the **AUTOSET** button. You should see a square wave in the display (approximately 5 V at 1 kHz).

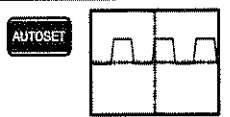

Probe Compensation

5. Check the shape of the displayed waveform.

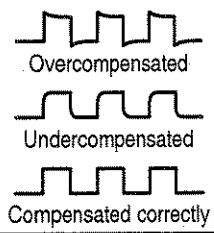

6. Adjust your probe if necessary to achieve correct compensation.

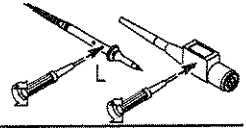

Signal Path Compensation (SPC)

The signal path compensation (SPC) routine optimizes the oscilloscope signal path for maximum measurement accuracy. You can run the routine anytime but you should always run the routine if the ambient temperature changes by 10° C or more.

To compensate the signal path, do the following steps:

- 1 Disconnect all probes or cables.
- 2 Push the **UTILITY** button.
- 3 Push the **System** screen button to select **Cal.**
- 4 Push the **Signal Path** screen button.
- 5 Push **OK Compensate Signal Path.**

Setting the User Interface Language

To set the user interface language, do the following steps:

- 1 Push the **UTILITY** button.
- 2 Push the **System** screen button to select **Config.**
- 3 Push a side menu button to select a language.

Adjusting Time and Date

To set your oscilloscope to the current date and time, do the following steps:

- 1 Push the **UTILITY** button.
- 2 Push the **System** menu button to select **Config**.
- 3 Push the **Set Date & Time** menu button.
- 4 Use the side menu buttons and general purpose knob to adjust the date and time values.
- 5 Push the **OK Enter Date/Time** menu button to set the instrument date and time.

User Manual

The *TDS3000B Series DPO Oscilloscope Manuals and Application Notes CD* contains the *TDS3000B Series Digital Phosphor Oscilloscope User Manual*, translated into all supported languages. The user manual contains complete information on how to operate your TDS3000B Series oscilloscope.

The CD also contains manuals for all TDS3000B Series accessories, application notes, oscilloscope and probe fundamentals, and software to install the Adobe Acrobat Reader, which is required to view the online documents.

QuickMenus

The QuickMenu feature simplifies the use of the oscilloscope. When you push the QUICKMENU button, a set of frequently used menu functions show on the display.

Scope is one type of QuickMenu that you can use to control the basic oscilloscope functions. You can perform many tasks without using the regular menu system.

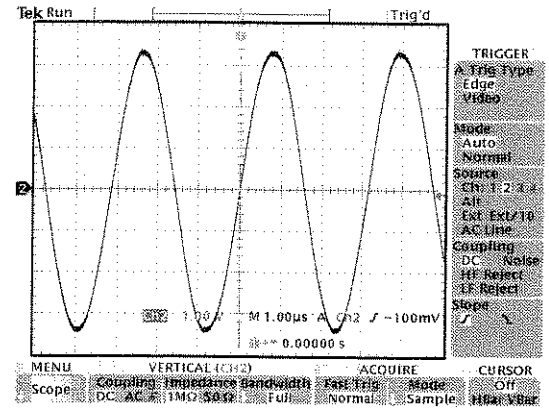

To use a QuickMenu, do these steps

- 1 Push the **QUICKMENU** button on the front panel.
- 2 Push the screen button that corresponds to the control you need to set. Push the screen button repeatedly to choose one of the settings. The small arrow icon indicates that there are additional settings available that are not shown.

You can use most of the front-panel controls at the same time you are using a QuickMenu. For example, if you push a channel button to select a different channel, the QuickMenu changes to show information about that channel.

You can still use the regular menus. For example, if you push the **MEASURE** button, you can set up and take automatic waveform measurements in the usual way. If you return to the QuickMenu, the measurement is still displayed on the screen.

You may have optional application modules installed that also have QuickMenu displays. To select the QuickMenu you want to use, push the **MENU** screen button. This menu item is shown only if application modules that contain a QuickMenu are installed.

Menus

The following sections briefly describe each oscilloscope menu item.

Acquire Menu

Bottom	Side	Description
Mode	Sample	Use for normal acquisition.
	Peak Detect	Detects glitches and reduces the possibility of aliasing.
	Envelope N	Captures variations of a signal over a period of time. (Adjust N with the general purpose knob.)
	Average N	Reduces random or uncorrelated noise in the signal display. (Adjust N with the general purpose knob.)
Horizontal Resolution	Fast Trigger (500 points)	Acquires 500 point waveforms at a fast repetition rate.
	Normal (10k points)	Acquires 10,000 point waveforms with more horizontal detail.
Reset Horizontal Delay	Set to 0 s	Resets the horizontal delay to zero.

Bottom	Side	Description
Autoset	Normal Autoset	Executes the autoset function. (Optional application modules may add choices to execute specialized autoset functions.)
	Undo Autoset	Reverts to the settings before the last autoset.
WaveAlert	Wfm Anomaly Detection On Off	Enables or disables the WaveAlert Waveform Anomaly Detection function. See page 13.
	Sensitivity nn.n%	Sets the comparison sensitivity. Use the general purpose knob to set sensitivity from 0% (least sensitive) to 100% (most sensitive).
	Beep On Anomaly On Off	When On, the oscilloscope beeps if it detects a waveform anomaly on any active channel.
	Stop On Anomaly On Off	When On, the oscilloscope stops waveform acquisition if there is a waveform anomaly on any channel. The input waveforms and anomalies remain displayed on the screen.

Bottom	Side	Description
WaveAlert (cont.)	Hardcopy On Anomaly On Off	When On, the oscilloscope sends an image of the screen to the hard copy device or floppy file if there is a waveform anomaly on any channel.
	Wfms To Disk On Anomaly On Off	When On, the oscilloscope saves the anomalous waveform(s) data to the floppy disk drive.
	Highlight Entire Wfm	Highlights the entire anomalous waveform.
	Highlight Anomaly	Highlights just the anomalous data in a waveform.

WaveAlert™ Waveform Anomaly Detection. WaveAlert provides a way to detect when a waveform deviates from a steady-state condition. WaveAlert monitors the current waveform acquisition and compares it to the previous waveform acquisition. If the current acquisition exceeds the comparison tolerance, the oscilloscope considers the current acquisition as an anomaly and responds by stopping acquisitions, emitting a beep, saving the anomalous waveform to a disk file, printing the screen image to a hard copy device, or any combination of the above. Refer to the *TDS3000B Series Digital Phosphor Oscilloscope User Manual* for more information.

XY Cursor Menu

The following cursor menu items are available in the XY display mode (**DISPLAY > XY Display > Triggered XY**). Push the **CURSOR** button to show the cursor menu.

Bottom	Side	Description
Function	Off	Turns cursors off.
	Waveform	Turns waveform cursors on and displays measurements in rectangular format (X and Y values). Use the front-panel SELECT button to select a cursor. Use the general purpose knob to move the active cursor.
Mode	Independent	Sets cursors to move independently.
	Tracking	Sets cursors to move together when the reference cursor is selected.

NOTE. *The Advanced Analysis application module (TDS3AAM) adds more XY cursor features, including graticule cursors and polar readouts.*

YT Cursor Menu

The following YT cursor menu items are available in the YT display mode (**DISPLAY > XY Display > Off (YT)**). Push the **CURSOR** button to show the cursor menu.

Bottom	Side	Description
Function	Off	Turns cursors off.
	H Bars	Use to take vertical measurements.
	V Bars	Use to take both vertical and horizontal measurements.
	Bring Selected Cursor to Center Screen	Moves the active cursor to center screen.
Mode	Bring Both Cursors On Screen	Moves any off-screen cursor onto the screen.
	Independent	Sets cursors to move independently.
	Tracking	Sets cursors to move together when cursor 1 is selected.

Bottom	Side	Description
V Bar Units	Sec (s) / 1/sec (Hz)	Sets horizontal units to seconds or frequency (Hz).
	Ratio (%)	Sets V Bar measurement units to percent.
	Phase (degrees)	Sets V Bar measurement units to degrees.
	Use cursor positions as %/°	Sets V Bar measurement scale so that 0% or 0° is the current position of left V Bar cursor and 100% or 360° is the current position of right V Bar cursor.
	Use 5 divs as %/°	Sets V Bar measurement scale so that 5 screen major divisions is 100% or 360°, where 0% or 0° is -2.5 divisions and 100% or 360° is +2.5 divisions from center graticule.

Bottom	Side	Description
H Bar Units	Base	Sets the H Bar units to be the same as the selected waveform's vertical measurement units (volts, IRE, dB, and so on).
	Ratio (%)	Sets H Bar measurement units to percent.
	Use cursor positions as 100%	Sets the H Bar measurement scale so that 0% is the current position of lowest H Bar cursor and 100% is the current position of highest H Bar cursor.
	Use 5 divs as 100%	Sets H Bar measurement scale so that 5 screen major divisions is 100%, where 0% is -2.5 divisions and 100% is +2.5 divisions from center graticule.

Cursor Movement. Use the general purpose knob to move the active cursor. Push the SELECT button to change which cursor is active.

Faster Cursor Movement. Push COARSE to set the general purpose knob to make faster cursor movements.

Display Menu

Bottom	Side	Description
Waveform Display	Dots Only	Set to on to see dots only. Set to off to see dots and vectors.
	Persist Time	Sets persist time.
	Set to Auto	Sets the WAVEFORM INTENSITY knob to control the persistence time.
	Clear Persistence	Clears any displayed persistence.
Backlight Intensity	High	Use for bright ambient conditions.
	Medium	Use for dim ambient conditions.
	Low	Use to extend battery-operation time.
Graticule	Full, Grid, Cross Hair, Frame	Selects the graticule type.

Bottom	Side	Description
XY Display	Off (YT)	Turns off an XY display.
	Triggered XY	Turns on triggered XY display.
	Gated XYZ	Displays XY signals when Z-channel signal is above a set level. Only available on 4-channel instruments.
	Ch1 (X) Versus	Sets Ch2, Ch3, or Ch4, as Y versus Ch1 as X.
	Ref1 (X) Versus	Sets Ref2, Ref3, or Ref4 as Y versus Ref1 as X.
	Gated By	Sets Ch2, Ch3, or Ch4 as Z channel (gate) source, and gating channel threshold level.
Color Palette	Normal	Selects the color display.
	Monochrome	Sets all waveforms to high-contrast black and white.

XY Waveforms. For XY waveforms, channel 1 or Ref 1 is displayed in the horizontal axis. Use the Vertical POSITION and SCALE controls to adjust the horizontal position and size of the XY waveform.

Another channel or reference waveform is displayed in the vertical axis. Use the Vertical POSITION and SCALE controls for that channel to adjust the vertical position and size of the XY waveform.

XY Waveform Triggering. The XY waveform is triggered so you can synchronize periodic input signals to the XY waveform. This feature is useful when only one part of the period contains valid information that you want to see in the XY format. Set the time base and trigger location to acquire just that part of the period.

When you want to see the complete period of the signals regardless of the time base setting, set the trigger source to an unused channel and the trigger mode to Auto.

Gated XYZ. Displays XY signals only when the Z (gating) channel is true. Gated XYZ is similar to analog oscilloscope modulated XYZ mode except that the displayed XY signal is either on or off; there is no intensity modulation. Gated XYZ is useful for displaying constellation diagrams.

The general purpose knob sets the Z-channel threshold level.

Measure Menu

Bottom	Side	Description
Select Measurement		Select an automatic measurement for the selected (active) channel. You can display up to four measurements at one time. See page 44.
Remove Measurement	Measurement 1-4	Removes a specific measurement.
	All Measurements	Removes all measurements.
Gating	Off	Use to take measurements on the full waveform record.
	Screen	Use to take measurements on the portion of the waveform on screen.
	Cursors	Use to take measurements on the portion of the waveform between the V Bar cursors.

Bottom	Side	Description
Gating	Bring Selected Cursor to Center Screen	Moves the active cursor to center screen.
	Bring Both Cursors On Screen	Moves any off-screen cursor onto the screen.
High-Low Setup	Auto Select	Automatically uses the best measurement method depending on the measurement type.
	Histogram	Use to measure pulses.
	Min-Max	Use to measure other wave shapes.

Bottom	Side	Description
Reference Levels	Set Levels in % or units	Use to choose custom reference levels in relative or absolute units.
	High Reference	Sets custom high reference level.
	Mid Reference	Sets custom mid reference level.
	Mid 2	Sets the custom mid reference level for the Delay and Phase measurement second waveform.
	Low Reference	Sets custom low reference level.
	Set to Defaults	Sets reference levels to default values.
Indicators	Measurement 1-4	Selects the measurement for which to display markers that show the portion of the waveform used to calculate the measurement value.
	Off	Turns measurement indicators off.

Save/Recall Menu

Bottom	Side	Description
Save Current Setup	To File	Saves a setup to disk.
	To Setup 1 ... To Setup 10	Saves a setup to nonvolatile memory.
	From File	Recalls a setup from disk.
Recall Saved Setup	Recall Setup 1 ... Recall Setup 10	Recalls a setup from nonvolatile memory.
	OK Confirm Factory Init	Initializes the setup to a known setup.
	To File	Shows file-format choices: Internal, Spreadsheet, or Mathcad. Saves active waveforms to disk.
Save Wfm	To Ref1 ... To Ref4	Saves the selected waveform to nonvolatile memory.
	From File Recall Ref1 ... Recall Ref4	Recalls a waveform from disk and displays it as a reference waveform.

File Utilities Menu

Bottom	Side	Description
File Utilities	Delete	Deletes a file.
	Rename	Names or renames a file.
	Copy	Copies a file to another directory.
	Print	Prints a file to a printer connected to one of the hard copy ports.
	Create Directory	Creates a new directory.
	Confirm Delete	Turns On or Off a confirmation message before files are deleted.
Labels	Overwrite Lock	Sets file overwrite protection to On or Off.
	Format	Formats a disk (erases all files).
		Create/edit labels for reference waveforms and instrument setups stored in nonvolatile memory.

Trigger Menus

Edge Trigger Menu

Bottom	Side	Description
Source	Ch1 ... Ch4	Sets the trigger source to a specific channel.
	AC Line	Selects the AC line trigger source (for AC line operation only)
	Ext	Sets the oscilloscope to trigger on the external trigger source. Ext/10 attenuates the external trigger signal by a factor of 10.
	Ext/10	
	Ext Probe nnX Voltage / Current (4-channel only)	Set this value to match the attenuation factor and the type of probe (voltage or current) that is attached to the external trigger connector. Push the menu button to select the probe type. Use the general purpose knob to set the attenuation factor. The default values are 1x and voltage.

Bottom	Side	Description
Source	Vert	Sets the trigger source to the lowest-numbered active channel in the display.
	Alternating (all active channels)	Sequentially uses each active channel as a trigger source, from the lowest-numbered active channel to the highest-numbered active channel.
Coupling	DC	Selects DC coupling.
	HF Reject	Rejects frequencies above 30 kHz in the trigger signal.
	LF Reject	Rejects frequencies below 80 kHz in the trigger signal.
	Noise Reject	DC coupling with low sensitivity to reject noise in the trigger signal.
Slope	/(rising edge)	Triggers on the rising edge of a signal.
	\(falling edge)	Triggers on the falling edge of a signal.

Bottom	Side	Description
Level	Level	Use to set the trigger level with the general purpose knob.
	Set to TTL	Sets the trigger level to +1.4 V for TTL logic.
	Set to ECL	Sets the trigger level to -1.3 V for ECL logic ($V_{ee} = -5.2$ V).
	Set to 50%	Sets the trigger level to the 50% amplitude level of the signal.
Mode & Holdoff	Auto (untriggered roll)	Enables free-running and roll-mode acquisitions.
	Normal	Triggers only on valid trigger events.
	Holdoff (time)	Sets holdoff to a specific time.
	Holdoff (% of record)	Sets holdoff to a percent of the record duration.
	Set to Min	Sets holdoff to the minimum value.

Video Trigger Menu

Bottom	Side	Description
Standard	525/NTSC	Triggers on a NTSC signal.
	625/PAL	Triggers on a PAL signal.
	SECAM	Triggers on a SECAM signal.
Source		Selects the trigger source. See <i>Edge Trigger Menu</i> for descriptions of these menu items.
Trigger On	Odd	Triggers on odd or even fields in an interlaced signal.
	Even	
	All Fields	Triggers on any field in an interlaced or noninterlaced signal.
	All Lines	Triggers on all lines.

NOTE. The *Extended Video* application module (TDS3VID) adds more video features including custom video triggering, video picture, vectorscope, and analog HDTV triggering.

B Trigger Menu

Bottom	Side	Description
B Trigger After A	B Trigger After A Time	Sets the oscilloscope to trigger on the next B-trigger event that occurs after a specified period of time from the A trigger. Use the general purpose knob to set the time value.
	Set to Delay Time (B→▼) then Set (B→▼) to 0s	Sets the B Trigger After A Time value to the horizontal B→▼ value, then sets B→▼ to zero seconds. B→▼ is the delay time from the B trigger point to the expansion point (center screen).
	Set to Min	Sets B Trigger After A time to 26.4 ns.
	B Events	Sets the oscilloscope to trigger on the <i>n</i> th B-trigger event after the A trigger. Use the general purpose knob to set the event value.
	Set to Min	Sets the B events count to 1.

Bottom	Side	Description
Source		Sets Source, coupling, slope, and level for the B trigger.
Coupling		These settings are independent of similar settings for the A trigger. See <i>Edge Trigger Menu</i> for descriptions of these menu items.
Slope		
Level		

Utility Menus

Configuration System Menu

Bottom	Side	Description
Language	English	Use to choose your native language. Most on-screen text appears in the language you choose.
	Français	
	Deutsch	
	Italiano	
	Español	
	Português	
	(Russian)	
	(Japanese)	
	(Korean)	
	(Simplified Chinese)	
(Traditional Chinese)		

Bottom	Side	Description
Set Date & Time	Display Date/Time	Use to turn the date/time display On or Off.
	Hour Min	Use to set the internal clock with the current hour and minute.
	Month Day	Use to set the internal clock with the current month and day.
	Year	Use to set the internal clock with the current year.
	OK Enter Date/Time	Sets the date and time of the internal clock.
Battery Time-Outs	Power Off Time-Out	Use to set the time before an automatic shut down.
	Backlight Time-Out	Use to set the time before the backlight automatically turns off.
Tek Secure Erase Memory		Erases all nonvolatile waveform and setup memory.
Version		Use to see the firmware version.

I/O System Menu

Bottom	Side	Description
GPIB (TDS3GV)	Talk/Listen Address	Sets the GPIB address.
	Hard Copy (Talk Only)	Sets the GPIB port to talk only for making hard copies.
	Off Bus	Disables the GPIB port.
	Debug	Enables and disables a message window to help you debug GPIB problems.
RS-232 (TDS3GV)	Baud Rate	Sets the baud rate in steps from 1200 to 38400.
	Flagging	Use to enable hard flagging (RTS/CTS) or turn flagging off.
	EOL	Selects end-of-line terminator.
	Debug	Enables and disables a message window to help you debug RS-232 problems.
	Set RS-232 Parameters to Default Values	Sets baud rate = 9600, hard flagging = on, and EOL = LF.

Bottom	Side	Description
Ethernet Network Settings	Change Instrument Settings	Sets oscilloscope Ethernet parameters such as the IP address, instrument name, and domain name.
	DHCP/BOOTP	Enables or disables DHCP/BOOTP support.
	Debug	Enables or disables a debug message window.
	Test Connection	Tests the connection to your network.
Ethernet Printer Settings	Add Printer	Adds, renames, or deletes an Ethernet network printer from the oscilloscope printer list.
	Rename Printer	
	Delete Printer	
	Confirm Delete	Enables or disables displaying a printer name delete confirmation message.

More Information. Refer to the *TDS3000 & TDS3000B Series Digital Phosphor Oscilloscope Programmer Manual* for more information.

Hard Copy System Menu (Utility > System: Hard Copy)

Bottom	Side	Description
Format		Choose the correct hard copy format for your printer.
Options	Portrait	Prints in a portrait orientation.
	Landscape	Prints in a landscape orientation.
	Compression	Turn on or off hard copy file .gz compression format.
Ink Saver	Off	Prints the display colors.
	On	Prints colors optimized for printing on white paper.
	Preview	Shows a preview of the hard copy colors on the display.
Port	Centronics	Uses the parallel printer port.
	GPIB	Uses the GPIB port.
	RS-232	Uses the RS-232 port.
	File	Saves the hard copy to the floppy disk.
	Ethernet	Uses the Ethernet LAN port.
Clear Spool		Stops a hard copy in progress. Clears the print spooler.

Calibration System Menu

Bottom	Side	Description
System Cal		
Signal Path		Compensates the signal paths to obtain best measurement accuracy.
Factory Cal		Used to calibrate the oscilloscope. This is a service function only.
Cal Due Control	Notify After Hours of Operation	Sets the number of hours of operation before notifying you that a calibration is due.
	Notify After Years of Elapsed Time	Sets the number of years before notifying you that a calibration is due.

Signal Path Compensation. You can run the Signal Path Compensation routine anytime but you should always run the routine if the ambient temperature changes by 10 °C or more.

Diagnostic System Menu

Bottom	Side	Description
System Diags		
Execute		Starts diagnostics.
Loop	Once	Executes the diagnostic loop once.
	Always	Executes the diagnostic loop continuously.
	Until Fail	Executes until a failure occurs.
Error Log	Page Up	Use to see the previous error log page.
	Page Down	Use to see the next error log page.

Vertical Menus

Channel Menu

Bottom	Side	Description
Coupling	DC	Sets input coupling to DC.
	AC	Sets input coupling to AC.
	GND	Provides a 0 V signal reference. The input BNC disconnects from internal circuits.
	Ω	Sets input resistance to 50 Ω or 1 M Ω .
Invert	Invert Off	Use for normal operation.
	Invert On	Inverts the polarity of the signal in the display.
Bandwidth	Full Bandwidth	Sets bandwidth to the full oscilloscope bandwidth.
	150 MHz	Sets the bandwidth to 150 MHz (not available on some models).
	20 MHz	Sets the bandwidth to 20 MHz.
Fine Scale		Enables fine scale adjustment with the general purpose knob.

Bottom	Side	Description
Position	Vertical Position	Enables numerical vertical position adjustment.
	Set to 0 divs	Sets vertical position to center screen.
Offset	Vertical Offset	Enables vertical offset adjustment with the general purpose knob.
	Set to 0 V	Sets vertical offset to 0 V.
Probe Setup	Voltage Probe	Use to set probe gain or attenuation for probes that do not have the TekProbe II interface.
	Current Probe	
	Deskew	Use to adjust the time skew correction for each probe.
	Set to 0	Use to set probe skew correction to zero.

Math Menu

Bottom	Side	Description
Dual Wfm Math	Set 1st Source to	Selects the first source waveform.
	Set Operator to	Selects the math operator: +, -, ×, or ÷
	Set 2nd Source to	Selects the second source waveform.

Ref Menu

Bottom	Side	Description
Ref 1	Save Ch1 to Ref1	Saves channel 1 to reference waveform Ref 1.
	Save Ch2 to Ref1	Saves channel 2 to reference waveform Ref 1.
	Save Ch3 to Ref1	Saves channel 3 to reference waveform Ref 1.
	Save Ch4 to Ref1	Saves channel 4 to reference waveform Ref 1.
	Save Math to Ref1	Saves the math waveform to reference waveform Ref 1.
Ref 2 Ref 3 Ref 4	Identical settings for reference waveforms Ref 2, Ref 3, and Ref 4.	

e*Scope™ Web-based Remote Control

e*Scope introduces the next generation of oscilloscope functionality. With e*Scope you can access any Internet-connected TDS3000B Series oscilloscope from a browser on your work station, PC, or laptop computer. No matter where you are, your TDS3000B is as close as the nearest browser!

There are two levels to e*Scope: basic and advanced. The basic level, which is hosted on the oscilloscope, lets you view a screen image of the current acquisition, save or load waveform and setup files, and remotely control the oscilloscope using the oscilloscope programming commands.

The advanced level, which is hosted on your system, provides a graphical user interface to remotely control the oscilloscope. To obtain the advanced level software, go to the Tektronix TDS3000B website and download the web-based remote control software.

NOTE. You can also use e*Scope on TDS3000 Series oscilloscopes that are equipped with a TDS3EM Ethernet communication module and are running firmware version 3 or above.

Configuring Your Oscilloscope Ethernet Settings

Before using the e*Scope feature, you must set your oscilloscope Ethernet network settings. The *TDS3000B Series Digital Phosphor Oscilloscope User Manual*, Appendix G, *Ethernet Setup*, describes how to enter the Ethernet network parameters for your oscilloscope.

Accessing e*Scope

After your instrument is set up with the correct ethernet settings, you are ready to access that instrument over the Internet. To access you instrument's e*Scope server, do the following steps:

- 1 On a PC or work station, open a network browser program.
- 2 In the Location or Address field (where you normally enter a URL), type in the IP address of the TDS3000B instrument to which you want to connect. For example, 188.121.212.107. Do not precede the IP address with any characters. Then press the Return key.
- 3 The browser program loads the instrument's e*Scope Web-based Remote Control home page, which is an image of the screen contents when your browser accessed the instrument.

Menu Functions

The menu at the top of the page provides the following functions:

- Home displays the oscilloscope screen.
- Applications takes you to the application URL specified in the Configure tab. The default URL is the application notes site at www.tektronix.com.
- Configure lets you specify URLs for the advanced Web-based Control HTML pages (Control), application notes (Applications), and help files (Help). The default values are for the Tektronix web site. However, you can host any of these on your local Intranet for faster access and better system security.
- Data lets you upload or download waveform data files and oscilloscope settings, as well as remotely control the oscilloscope using oscilloscope programming commands.
- Status displays the version screen, which shows the firmware version and lists installed application modules.
- Control displays the advanced Web-based Control page that lets you remotely control the oscilloscope.

Automatic Measurements

Measurement	Definition
Amplitude	Measured over the entire waveform. $Amplitude = High (100\%) - Low (0\%)$
Burst Width	The duration of a burst. Measured over the entire waveform.
Cycle Mean	The arithmetic mean over the first cycle in the waveform.
Cycle RMS	The true Root Mean Square voltage over the first cycle in the waveform.
Delay	The time between the Mid Reference crossings of two different waveforms.
Fall Time	Time that the falling edge of the first pulse in the waveform takes to fall from 90% to 10% of its amplitude.
Frequency	Reciprocal of the period of the first cycle in the waveform. Measured in Hertz (Hz).
High	The value used as 100%. Calculated using either the min/max or the histogram method. Measured over the entire waveform.
Low	The value used as 0%. Calculated using either the min/max or the histogram method. Measured over the entire waveform.

Measurement	Definition
Max	The maximum amplitude. The most positive peak voltage measured over the entire waveform.
Mean	The arithmetic mean over the entire waveform.
Min	The minimum amplitude. The most negative peak voltage measured over the entire waveform.
Negative Duty Cycle	Measurement of the first cycle in the waveform. $Negative Duty Cycle = \frac{Negative Width}{Period} \times 100\%$
Negative Overshoot	Measured over the entire waveform. $Negative Overshoot = \frac{Low - Min}{Amplitude} \times 100\%$
Negative Pulse Width	Measurement of the first negative pulse in the waveform. The time between the 50% amplitude points.
Phase	The amount one waveform leads or lags another in time. Expressed in degrees, where 360° comprise one waveform cycle.
Pk-Pk	Measured over the entire waveform. $Peak-to-peak = Max - Min$
Period	Time it takes for the first complete signal cycle to complete in the waveform. Measured in seconds.

Measurement	Definition
Positive Duty Cycle	Measurement of the first cycle in the waveform. $\text{Positive Duty Cycle} = \frac{\text{Positive Width}}{\text{Period}} \times 100\%$
Positive Overshoot	Measured over the entire waveform. $\text{Positive Overshoot} = \frac{\text{Max-High}}{\text{Amplitude}} \times 100\%$
Positive Width	Measurement of the first positive pulse in the waveform. The time between the 50% amplitude points.
Rise Time	Time that the leading edge of the first pulse in the waveform takes to rise from 10% to 90% of its amplitude.
RMS	The true Root Mean Square voltage over the entire waveform.
Snapshot All Measurements	Displays all measurement values (except two-channel measurements) at the time you pushed the Snapshot All Measurements button, for the selected waveform. Push the Snapshot All Measurements button again to update the list values. Push the MENU OFF button to clear the list from the screen.