

Instruction Manual



TSG 131A Multiformat Signal Generator S/N B040000 and Above

071-0499-01

Warning

The servicing instructions are for use by qualified personnel only. To avoid personal injury, do not perform any servicing unless you are qualified to do so. Refer to all safety summaries prior to performing service.

www.tektronix.com

Copyright © Tektronix, Inc. All rights reserved.

Tektronix products are covered by U.S. and foreign patents, issued and pending. Information in this publication supercedes that in all previously published material. Specifications and price change privileges reserved.

Printed in the U.S.A.

Tektronix, Inc., P.O. Box 500, Beaverton, OR 97077

TEKTRONIX and TEK are registered trademarks of Tektronix, Inc.

WARRANTY

Tektronix warrants that this product that it manufactures and sells will be free from defects in materials and workmanship for a period of one (1) year from the date of shipment. If any such product proves defective during this warranty period, Tektronix, at its option either will repair the defective product without charge for parts and labor, or will provide a replacement in exchange for the defective product.

In order to obtain service under this warranty, Customer must notify Tektronix of the defect before the expiration of the warranty period and make suitable arrangements for the performance of service. Customer shall be responsible for packing and shipping the defective product to the service center designated by Tektronix, with shipping charges prepaid. Tektronix shall pay for the return of the product to Customer if the shipment location is within the country in which the Tektronix service center is located. Customer shall be responsible for paying all shipping charges, duties, taxes, and any other charges for products returned to any other locations.

This warranty shall not apply to any defect, failure, or damage caused by improper use or improper or inadequate maintenance and care. Tektronix shall not be obligated to furnish service under this warranty a) to repair damage resulting from attempts by personnel other than Tektronix representatives to install, repair, or service the product; b) to repair damage resulting from improper use or connection to incompatible equipment; c) to service a product that has been modified or integrated with other products when the effect of such modification or integration increases the time or difficulty of servicing the product.

THIS WARRANTY IS GIVEN BY TEKTRONIX WITH RESPECT TO THIS PRODUCT IN LIEU OF ANY OTHER WARRANTIES, EXPRESS OR IMPLIED. TEKTRONIX AND ITS VENDORS DISPLAY ANY IMPLIED WARRANTIES OF MERCHANTABILITY OR FITNESS FOR A PARTICULAR PURPOSE. TEKTRONIX'S RESPONSIBILITY TO REPAIR OR REPLACE DEFECTIVE PRODUCTS IS THE SOLE AND EXCLUSIVE REMEDY PROVIDED TO THE CUSTOMER FOR BREACH OF THIS WARRANTY. TEKTRONIX AND ITS VENDORS WILL NOT BE LIABLE FOR AND INDIRECT, SPECIAL, INCIDENTAL, OR CONSEQUENTIAL DAMAGES IRRESPECTIVE OF WHETHER TEKTRONIX OR THE VENDOR HAS ADVANCE NOTICE OF THE POSSIBILITY OF SUCH DAMAGES.

Table of Contents

SECTION 1 INTRODUCTION

Physical Description	1-2
----------------------------	-----

SECTION 2 CONTROLS & CONNECTIONS

Operating Instructions	2-1
Front Panel Controls	2-1
Rear Panel Connections	2-3
Multi-purpose Outputs	2-3
Audio Tone ID	2-4
Power Supply	2-4
Using the Controls & Connectors (Standard Instrument ONLY)	2-5

SECTION 3 SIGNAL GENERATOR SPECIFICATIONS

Performance Conditions	3-1
Safety Standards	3-1
Electrical Specifications	3-2
Mechanical Specifications	3-17
Environmental Specifications	3-17
Waveform Illustrations	3-18
Composite Signals	3-19
Y-C Signal Format	3-33
Component Signals	3-53
CTDM Format	3-67
RGB Signals	3-71
Option 01 Signals MII CTDM (2-Wire)	3-85
Option 03 Signals — Y-C Unique Signals	3-89
Option 03 Signals — BetaCam 3-Wire Unique Signals	3-102
Option 03 Signals — CTDM (2-Wire) Unique Signals	3-117
Option 04 Unique Signals — Composite Signals Y-C Format	3-119
Option 04 Unique Signals — 3-Wire Signals Y, B-Y, R-Y Format	3-123
Option 04 Signals — CTDM (2-Wire) Format	3-133

TSG 131A — Table of Contents

SECTION 4 PERFORMANCE CHECK & ADJUSTMENT PROCEDURE

PERFORMANCE CHECK CHECKLIST	4-2
PERFORMANCE CHECK PROCEDURES	4-5
Oscillator Frequency	4-5
COMPOSITE Test Signal	4-6
Y Channel (Luminance) Output	4-9
C Channel (Chrominance)	4-12
B-Y Signals	4-13
R-Y Signals	4-14
Green Channel	4-15
Blue Channel	4-16
Red Channel	4-16
Inter-Channel Timing & Amplitude	4-18
Audio Output	4-18
BLACK BURST Output (Opt. 02 & 03 only)	4-19
Color Flag Reference Pulse Option 03 Only	4-19
Composite Sync Option 04 Only	4-20
Color Frame Square Wave Option 04 Only	4-20
Adjustment Procedure Checklist	4-21
Adjustment Procedures	4-22

SECTION 5 INSTALLATION & MAINTENANCE

Selecting the Power Supply Mains Voltage	5-1
Removing & Replacing the Audio Board	5-2
To Remove the Audio Board:	5-2
To Reassemble the Audio Board:	5-2
Special Diagnostic Signal Set	5-3
Setting the Internal Jumpers	5-4

SECTION 6 TSG 131A BLOCK DIAGRAM

TSG 131A BLOCK DIAGRAM	6-1
Front Panel	6-2
Digital Generation and Clock	6-3
Signal Memory	6-5
Digital Modulator and Lookup Table	6-6
Y and C Analog Outputs	6-7
CTDM/R-Y and Black/Sync Outputs	6-9
Audio Tone	6-11
Power Supply	6-13

**SECTION 7
OPTIONS**

Power Options	7-1
Power Cords	7-1
Configuration Options	7-2
TSG 131A Option 01	7-2
TSG 131A Option 02	7-2
TSG 131A Option 03	7-2
TSG 131A Option 04	7-2
TSG 131A Option 10	7-2

**SECTION 8
REPLACEABLE ELECTRICAL PARTS LIST**

**SECTION 9
DIAGRAMS / CIRCUIT BOARD ILLUSTRATIONS**

**SECTION 10
REPLACEABLE MECHANICAL PARTS LIST**

List of Figures

SECTION 1 INTRODUCTION

Fig. 1-1. Front panel of the TSG 131A.	1-1
Fig. 1-2. Rear panel of the TSG 131A.	1-1

SECTION 2 CONTROLS & CONNECTIONS

Fig. 2-1. Front panel of the TSG 131A.	2-1
Fig. 2-2. How to determine which signal is selected from the TSG 131A. Row 2 / Column 4 indicates that the 100% Field signal has been selected.	2-2
Fig. 2-3. Rear panel of the TSG 131A.	2-3
Fig. 2-4. Signals available in PAL/YC format.	2-5
Fig. 2-5. Valid outputs in the PAL/YC mode.	2-5
Fig. 2-6. Signals available in Y, B-Y, R-Y format.	2-6
Fig. 2-7. Outputs available in the Y, B-Y, R-Y format.	2-6
Fig. 2-8. Signals available in GBR format.	2-6
Fig. 2-8. Signals available in GBR format.	2-7
Fig. 2-9. Outputs available in the GBR format.	2-7
Fig. 2-10. Signals available in CTDM format.	2-8
Fig. 2-11. Outputs available in the Y, CTDM format.	2-8

SECTION 3 SIGNAL GENERATOR SPECIFICATIONS

Fig. 3-1. Black Burst.	3-18
Fig. 3-2. 75% Color Bars.	3-19
Fig. 3-3. 75% Red.	3-19
Fig. 3-4. 100% Color Bars.	3-20
Fig. 3-5. 100% Red.	3-20
Fig. 3-6. Red Field.	3-21
Fig. 3-7. Blue Field.	3-21
Fig. 3-8. Green Field.	3-21
Fig. 3-9. 0% Flat Field.	3-22
Fig. 3-10. 50% Flat Field.	3-22
Fig. 3-11. 100% Flat Field.	3-22
Fig. 3-12. Chroma Noise.	3-23
Fig. 3-13. 5-Step (Gray Scale).	3-23
Fig. 3-14. Convergence (horizontal).	3-24
Fig. 3-15. Convergence (vertical).	3-24
Fig. 3-16. Ramp.	3-25
Fig. 3-17. Modulated Ramp.	3-25
Fig. 3-18. Pulse & Bar with Window.	3-26
Fig. 3-19. Multiburst.	3-26
Fig. 3-20. Line Sweep.	3-27
Fig. 3-21. Reduced Sweep.	3-27
Fig. 3-22. Pluge.	3-28

Fig. 3-23. Matrix Signal — UK ITS 2.	3-28
Fig. 3-24. Matrix Signal — CCIR Line 17.	3-29
Fig. 3-25. Matrix Signal — CCIR Line 18.	3-29
Fig. 3-26. Matrix Signal — CCIR Line 330.	3-30
Fig. 3-27. Matrix Signal — CCIR Line 331.	3-30
Fig. 3-28. Matrix Signal — Sin(x)/x.	3-31
Fig. 3-29. Matrix Signal — 15 kHz Square Wave.	3-31
Fig. 3-30. Matrix Signal — Shallow Ramp.	3-32
Fig. 3-31. Matrix Signal — UK ITS 1.	3-32
Fig. 3-32. Y Channel — 75% Bars.	3-33
Fig. 3-33. C Channel — 75% Bars.	3-33
Fig. 3-34. Y Channel — 75% Red.(Same as Red Field)	3-34
Fig. 3-35. C Channel — 75% Red (Same as Red Field)	3-34
Fig. 3-36. Y Channel — 100% Bars.	3-35
Fig. 3-37. C Channel — 100% Bars.	3-35
Fig. 3-38. Y Channel — 100% Red.	3-36
Fig. 3-39. C Channel — 100% Red.	3-36
Fig. 3-40. Y Channel — Pluge.	3-37
Fig. 3-41. C Channel — Pluge.	3-37
Fig. 3-42. Y Channel — Blue Field.	3-38
Fig. 3-43. C Channel — Blue Field.	3-38
Fig. 3-44. Y Channel — Green Field.	3-39
Fig. 3-45. C Channel — Green Field.	3-39
Fig. 3-46. Y Channel — 0% Flat Field.	3-40
Fig. 3-47. C Channel — 0% Flat Field.	3-40
Fig. 3-48. Y Channel — 50% Flat Field.	3-41
Fig. 3-49. C Channel — 50% Flat Field.	3-41
Fig. 3-50. Y Channel — 100% Flat Field.	3-42
Fig. 3-51. C Channel — 100% Flat Field.	3-42
Fig. 3-52. Y Channel — Chroma Noise.	3-43
Fig. 3-53. C Channel — Chroma Noise.	3-43
Fig. 3-54. Y Channel — Pulse & Bar with Window.	3-44
Fig. 3-55. C Channel — Pulse & Bar with Window.	3-44
Fig. 3-56. Y Channel — 5-Step.	3-45
Fig. 3-57. C Channel — 5-Step.	3-45
Fig. 3-58. Y Channel — Ramp.	3-46
Fig. 3-59. C Channel — Ramp.	3-46
Fig. 3-60. Y Channel — Modulated Ramp.	3-47
Fig. 3-61. C Channel — Modulated Ramp.	3-47
Fig. 3-62. Y Channel — Multiburst.	3-48
Fig. 3-63. C Channel — Multiburst.	3-48
Fig. 3-64. Y Channel — Sweep.	3-49
Fig. 3-65. C Channel — Sweep.	3-49
Fig. 3-66. Y Channel — Reduced Sweep.	3-50
Fig. 3-67. C Channel — Reduced Sweep.	3-50
Fig. 3-68. Y Channel — Convergence (Vertical).	3-51
Fig. 3-69. Y Channel — Convergence (Horizontal).	3-52
Fig. 3-70. C Channel — Convergence.	3-52
Fig. 3-71. Y Channel — 75% Bars.	3-53
Fig. 3-72. B-Y Channel — 75% Bars.	3-53
Fig. 3-73. R-Y Channel — 75% Bars.	3-53
Fig. 3-74. Y Channel — 100% Bars.	3-54

TSG 131A — List of Figures

Fig. 3-75. B-Y Channel — 100% Bars.	3-54
Fig. 3-76. R-Y Channel — 100% Bars.	3-54
Fig. 3-77. Y Channel — 75% Red.	3-55
Fig. 3-78. B-Y Channel — 75% Red.	3-55
Fig. 3-79. R-Y Channel — 75% Red.	3-55
Fig. 3-80. Y Channel — 100% Red.	3-56
Fig. 3-81. B-Y Channel — 100% Red.	3-56
Fig. 3-82. R-Y Channel — 100% Red.	3-56
Fig. 3-83. Y Channel — 0% Flat Field.	3-57
Fig. 3-84. Y Channel — 50% Flat Field.	3-57
Fig. 3-85. Y Channel — 100% Flat Field.	3-57
Fig. 3-86. Y Channel — Valid 5-Step.	3-58
Fig. 3-87. B-Y Channel — Valid 5-Step	3-59
Fig. 3-88. R-Y Channel — Valid 5-Step.	3-60
Fig. 3-89. Y Channel — Pulse & Bar with Window.	3-61
Fig. 3-90. B-Y Channel — Pulse & Bar with Window.	3-61
Fig. 3-91. R-Y Channel — Pulse & Bar with Window.	3-61
Fig. 3-92. Y Channel — T Pulses.	3-62
Fig. 3-93. B-Y Channel — T Pulses.	3-62
Fig. 3-94. Y Channel — Line Sweep.	3-63
Fig. 3-95. B-Y & R-Y Channel — Line Sweep.	3-63
Fig. 3-96. Y Channel — Reduced Line Sweep.	3-64
Fig. 3-97. B-Y & R-Y Channel — Reduced Line Sweep.	3-64
Fig. 3-98. Y Channel — Bowtie.	3-65
Fig. 3-99. Y Channel — Bowtie Markers.	3-65
Fig. 3-100. B-Y & R-Y Channels — Bowtie.	3-65
Fig. 3-101. Y Channel — Multiburst.	3-66
Fig. 3-102. B-Y & R-Y Channels — Multiburst.	3-66
Fig. 3-103. Y Channel — 75% Bars.	3-67
Fig. 3-104. C Channel — 75% Bars.	3-67
Fig. 3-105. Y Channel — 100% Bars.	3-68
Fig. 3-106. C Channel — 100% Bars.	3-68
Fig. 3-107. C Channel — All Flat Field Signals.	3-69
Fig. 3-108. Y Channel — 0% Flat Field.	3-69
Fig. 3-109. Y Channel — 50% Flat Field.	3-70
Fig. 3-110. Y Channel — 100% Flat Field.	3-70
Fig. 3-111. Green Channel — 75% Color Bars.	3-71
Fig. 3-112. Blue Channel — 75% Color Bars.	3-71
Fig. 3-113. Red Channel — 75% Color Bars.	3-71
Fig. 3-114. Green Channel — 100% Color Bars.	3-72
Fig. 3-115. Blue Channel — 100% Color Bars.	3-72
Fig. 3-116. Red Channel — 100% Color Bars.	3-72
Fig. 3-117. Green Channel — Red Field.	3-73
Fig. 3-118. Blue Channel — Red Field.	3-73
Fig. 3-119. Red Channel — Red Field.	3-73
Fig. 3-120. Green Channel — Blue Field.	3-74
Fig. 3-121. Blue Channel — Blue Field.	3-74
Fig. 3-122. Red Channel — Blue Field.	3-74
Fig. 3-123. Green Channel — Green Field.	3-75
Fig. 3-124. Blue & Red Channels — Green Field.	3-75
Fig. 3-125. Green Channel — Convergence (hor).	3-76
Fig. 3-126. Blue & Red Channels — Convergence (hor).	3-76

Fig. 3-127. Green Channel — Convergence (vertical).	3-77
Fig. 3-128. Blue & Red Channels — Convergence (vrt).	3-77
Fig. 3-129. Green Channel — 10-Step.	3-78
Fig. 3-130. Blue & Red Channels — 10-Step.	3-78
Fig. 3-131. Green Channel — Pulse & Bar.	3-79
Fig. 3-132. Blue & Red Channels — Pulse & Bar.	3-79
Fig. 3-133. Green Channel — Multiburst.	3-80
Fig. 3-134. Blue & Red Channels — Multiburst.	3-80
Fig. 3-135. Green Channel — Sweep.	3-81
Fig. 3-136. Blue & Red Channels — Sweep.	3-81
Fig. 3-137. Green Channel — Bowtie.	3-82
Fig. 3-138. Blue & Red Channels — Bowtie.	3-82
Fig. 3-139. Green Channel — Bowtie Markers.	3-83
Fig. 3-140. Blue & Red Channels — Bowtie Markers.	3-83
Fig. 3-141. Y Channel — 75% Color Bars.	3-85
Fig. 3-142. C Channel — 75% Color Bars.	3-85
Fig. 3-143. Y Channel — 100% Color Bars.	3-86
Fig. 3-144. C Channel — 100% Color Bars.	3-86
Fig. 3-145. Y Channel — 0% Flat Field.	3-87
Fig. 3-146. C Channel — All Flat Field Signals.	3-87
Fig. 3-147. Y Channel — 50% Flat Field.	3-88
Fig. 3-148. Y Channel — 100% Flat Field.	3-88
Fig. 3-149. Y Channel — 75% Bars.	3-89
Fig. 3-150. C Channel — 75% Bars.	3-89
Fig. 3-151. Y Channel — 75% Red (same as Red Field).	3-90
Fig. 3-152. C Channel — 75% red (same as Red Field).	3-90
Fig. 3-153. Y Channel — 100% Bars.	3-91
Fig. 3-154. C Channel — 100% Bars.	3-91
Fig. 3-155. Y Channel — 100% Red.	3-92
Fig. 3-156. C Channel — 100% Red.	3-92
Fig. 3-157. Y Channel — Blue Field.	3-93
Fig. 3-158. C Channel — Blue Field.	3-93
Fig. 3-159. Y Channel — Green Field.	3-94
Fig. 3-160. C Channel — Green Field.	3-94
Fig. 3-161. Y Channel — 50% Flat Field.	3-95
Fig. 3-162. Y Channel — 100% Flat Field.	3-95
Fig. 3-163. Y Channel — Chroma Noise.	3-96
Fig. 3-164. C Channel — Chroma Noise.	3-96
Fig. 3-165. Y Channel — 5-Step.	3-97
Fig. 3-166. C Channel — 5-Step.	3-97
Fig. 3-167. Y Channel — Ramp.	3-98
Fig. 3-168. C Channel — Ramp.	3-98
Fig. 3-169. Y Channel — Sweep.	3-99
Fig. 3-170. C Channel — Sweep.	3-99
Fig. 3-171. Y Channel — Reduced Sweep.	3-100
Fig. 3-172. C Channel — Reduced Sweep.	3-100
Fig. 3-173. Y Channel — Convergence (Vertical).	3-101
Fig. 3-174. Y Channel — Convergence (Horizontal).	3-101
Fig. 3-175. Y Channel — 75% Color Bars.	3-102
Fig. 3-176. B-Y Channel — 75% Color Bars.	3-102
Fig. 3-177. R-Y Channel — 75% Color Bars.	3-102
Fig. 3-178. Y Channel — 100% Color Bars.	3-103

TSG 131A — List of Figures

Fig. 3-179. B-Y Channel — 100% Color Bars.	3-103
Fig. 3-180. R-Y Channel — 100% Color Bars.	3-103
Fig. 3-181. Y Channel — Pulse & Bar.	3-104
Fig. 3-182. B-Y Channel — Pulse & Bar.	3-104
Fig. 3-183. R-Y Channel — Pulse & Bar.	3-104
Fig. 3-184. Y Channel — 50% Flat Field.	3-105
Fig. 3-185. B-Y & R-Y Channels — 50% Flat Field.	3-105
Fig. 3-186. Y Channel — Flat Field in all Channels.	3-106
Fig. 3-187. B-Y & R-Y Channels — Flat Field.	3-106
Fig. 3-188. Y Channel — $\text{Sin}(x)/x$	3-107
Fig. 3-189. B-Y & R-Y Channels — $\text{Sin}(x)/x$	3-107
Fig. 3-190. Y Channel — 5-Step.	3-108
Fig. 3-191. B-Y & R-Y Channels — 5-Step.	3-108
Fig. 3-192. Y Channel — Quad Phase.	3-109
Fig. 3-193. B-Y Channel — Quad Phase.	3-109
Fig. 3-194. R-Y Channel — Quad Phase.	3-109
Fig. 3-195. Y Channel — T Pulses.	3-110
Fig. 3-196. B-Y Channel — T Pulses.	3-110
Fig. 3-197. Y Channel — Line 17.	3-111
Fig. 3-198. B-Y & R-Y Channels — Line 17.	3-111
Fig. 3-199. Y Channel — 60% Narrow Multiburst.	3-112
Fig. 3-200. B-Y & R-Y Channels — Narrow Multiburst.	3-112
Fig. 3-201. Y Channel — 60% Wide Multiburst.	3-113
Fig. 3-202. B-Y & R-Y Channels — Wide Multiburst.	3-113
Fig. 3-203. Y Channel — 60% Narrow Sweep.	3-114
Fig. 3-204. B-Y & R-Y Channels — 60% Narrow Sweep.	3-114
Fig. 3-205. Y Channel — Bowtie.	3-115
Fig. 3-206. B-Y & R-Y Channels — Bowtie.	3-115
Fig. 3-207. Y Channel — Bowtie Markers.	3-115
Fig. 3-208. Y Channel — 12T Pulses.	3-116
Fig. 3-209. B-Y Channel — 12T Pulses.	3-116
Fig. 3-210. R-Y Channel — 12T Pulses.	3-116
Fig. 3-211. Y Channel — 75% Bars.	3-117
Fig. 3-212. C Channel — 75% Bars.	3-117
Fig. 3-213. Y Channel — 75% Color Bars.	3-119
Fig. 3-214. C Channel — 75% Color Bars.	3-119
Fig. 3-215. Y Channel — Multiburst.	3-120
Fig. 3-216. C Channel — Multiburst.	3-120
Fig. 3-217. Y Channel — Ramp.	3-121
Fig. 3-218. C Channel — Ramp.	3-121
Fig. 3-219. Y Channel — Modulated Ramp.	3-122
Fig. 3-220. C Channel — Modulated Ramp.	3-122
Fig. 3-221. Y Channel — 75% Bars.	3-123
Fig. 3-222. B-Y Channel — 75% Bars.	3-123
Fig. 3-223. R-Y Channel — 75% Bars.	3-123
Fig. 3-224. Y Channel — Level Reference.	3-124
Fig. 3-225. B-Y & R-Y Channels — Level Reference.	3-124
Fig. 3-226. Y Channel — Pulse & Bar.	3-125
Fig. 3-227. B-Y Channel — Pulse & Bar.	3-125
Fig. 3-228. R-Y Channel — Pulse & Bar.	3-125
Fig. 3-229. Y Channel — T Pulses.	3-126
Fig. 3-230. B-Y & R-Y Channels — T Pulses.	3-126

Fig. 3-231. Y Channel — 5-Step.	3-127
Fig. 3-232. B-Y & R-Y Channels — 5-Step.	3-127
Fig. 3-233. Y Channel — 60% Sweep.	3-128
Fig. 3-234. B-Y & R-Y Channels — 60% Sweep.	3-128
Fig. 3-235. Y Channel — 100% Sweep.	3-129
Fig. 3-236. B-Y & R-Y Channels — 100% Sweep.	3-129
Fig. 3-237. Y Channel — Oversized ramp.	3-130
Fig. 3-238. B-Y & R-Y Channels — Oversized Ramp.	3-130
Fig. 3-239. Y Channel — 100% Bowtie.	3-131
Fig. 3-240. B-Y & R-Y Channels — 100% Bowtie.	3-131
Fig. 3-241. Y Channel — 100% Bowtie Markers.	3-132
Fig. 3-242. Y Channel — 100% Bars.	3-133
Fig. 3-243. C Channel — 100% Bars.	3-133

SECTION 4
PERFORMANCE CHECK & ADJUSTMENT PROCEDURE

Fig. 4-1. Setup to check the crystal frequency.	4-5
Fig. 4-2. Basic setup for the Performance Checks.	4-6
Fig. 4-3. Setup for the rest of the standard Performance Checks. Note that the EXT REF cable has been moved to the Y/G output.	4-13
Fig. 4-4. Bowtie crossover.	4-18
Fig. 4-5. Setup to measure the total harmonic distortion.	4-18
Fig. 4-6. Setup to Check the BLACK BURST output.	4-19
Fig. 4-7. Setup to check the pulse outputs for Options 02, 03, & 04.	4-19
Fig. 4-8. Setup to adjust the oscillator frequency.	4-22
Fig. 4-9. Audio amplitude calibration setup.	4-22
Fig. 4-10. Audio ID click frequency adjustment setup.	4-23
Fig. 4-11. Signals available in the diagnostic mode.	4-23
Fig. 4-12. Basic setup for the calibration procedures.	4-24
Fig. 4-13. Bowtie crossing.	4-27
Fig. 4-14. Setup to calibrate the BLACK BURST output.	4-27

SECTION 5
INSTALLATION & MAINTENANCE

Fig. 5-1. Remove these 5 screws with a Pozidrive® screwdriver in order to take out the Audio board for adjustment of the Black Burst/Comp Sync output.	5-2
---	-----

SECTION 6
TSG 131A BLOCK DIAGRAM

Fig. 1. Block diagram for <1>.	6-2
Fig. 2. Block diagram for <2>.	6-3
Fig. 3. Block diagram for <3>.	6-5
Fig. 4. Block diagram for <4>.	6-6
Fig. 5. Block diagram for <6>.	6-7
Fig. 6. Block diagram for <5> and <7>.	6-9
Fig. 7. Block diagram of the Audio circuitry.	6-11
Fig. 8. Block diagram of the Power Supply circuitry.	6-13

TSG 131A — List of Figures

SECTION 7 OPTIONS

Fig. 7-1. Option 52 Plug.	7-1
Fig. 7-2. Standard Plug.	7-1
Fig. 7-3. Option A2 Plug.	7-1
Fig. 7-4. Option A3 Plug.	7-1

List of Tables

SECTION 1 INTRODUCTION

Table 1-1. TSG 131A Test Signal Summary.	1-3
Standard and Option 02 (Black Burst) Signal Set (Front Panel Matrix — Represents where the signals are found on the Front Panel) .	1-3
Table 1-2. Available Outputs for the Standard TSG 131A in the Various Output Formats.	1-4
Table 1-3. List of the available outputs in the various formats for the TSG 131A Opt. 02.	1-4
Table 1-4. TSG 131A Test Signal Summary. Option 01 (MII Signal Set) (Front Panel Matrix — Represents where the signals are found on the Front Panel) .	1-5
Table 1-5. Available Outputs for the Option 01 TSG 131A in the Various Output Formats.	1-6
Table 1-6. TSG 131A Test Signal Summary for Option -03 Betacam signals with Black Burst Output (Front Panel Matrix — Represents where the signals are found on the Front Panel)	1-7
Table 1-7. Various rear panel outputs available in the various formats of the TSG 131A Opt. 03.	1-8
Table 1-8. TSG 131A Test Signal Summary for Option -04 MII signals with COMP SYNC on the Optional Output (Front Panel Matrix — Represents where the signals are found on the Front Panel)	1-9
Table 1-9. Rear Panel Outputs in the various formats for the TSG 131A Opt. 04.	1-10

SECTION 3 SIGNAL GENERATOR SPECIFICATIONS

Table 3-1. General Test Signal Characteristics.	3-2
Table 3-2. General PAL/YC Signal Characteristics. (The following specifications apply to the PAL/YC formats only.)	3-5
Table 3-3. NTSC/YC Test Signal Definitions.	3-6
Table 3-4. Component Test Signal Definitions (Y, B-Y and R-Y Format).	3-9
Table 3-5. Component Test Signal Definitions (CTDM Format).1	3-13
Table 3-6. Test Signal Generator — Test Signal Definitions, GBR Format.	3-14
Table 3-7. Black Burst Output (Opts. 02 & 03).	3-15
Table 3-8. Video Comp Sync (Opts. 2, 3, & 4).	3-15
Table 3-9. Audio Tone Characteristics.	3-15
Table 3-10. Power Supply Specifications.	3-16
Table 3-11. Physical Characteristics.	3-17
Table 3-12. Environmental Characteristics	3-17

SECTION 4 PERFORMANCE CHECK & ADJUSTMENT PROCEDURE

Table 4-1. Basic setup for the 1781R.	4-5
Table 4-2. Setup for the AA501A Distortion Analyzer.	4-22
Table 4-3. Initial setup of the 1781R.	4-24

TSG 131A — List of Tables

**SECTION 5
INSTALLATION & MAINTENANCE**

Table 5-1. List of the Diagnostic Signals available. 5-3
Table 5-2. List of Jumpers for the TSG 131A. 5-4

**SECTION 7
OPTIONS**

Table 7-1. Comparison between the various options 7-3

Contacting Tektronix

Product support	<p>For questions about using Tektronix measurement products, call toll free in North America: 1-800-833-9200 6:00 a.m. – 5:00 p.m. Pacific time</p> <p>Or contact us by e-mail: tm_app_supp@tek.com</p> <p>For product support outside of North America, contact your local Tektronix distributor or sales office.</p>
Service support	<p>Tektronix offers extended warranty and calibration programs as options on many products. Contact your local Tektronix distributor or sales office.</p> <p>For a listing of worldwide service centers, visit our web site.</p>
For other information	<p>In North America: 1-800-833-9200 An operator can direct your call.</p>
To write us	<p>Tektronix, Inc. P.O. Box 500 Beaverton, OR 97077-0001 USA</p>
Web site	<p>www.Tektronix.com</p>

General Safety Summary

Review the following safety precautions to avoid injury and prevent damage to this product or any products connected to it. To avoid potential hazards, use this product only as specified.

Only qualified personnel should perform service procedures.

To Avoid Fire or Personal Injury

Use Proper Power Cord. Use only the power cord specified for this product and certified for the country of use.

Use Proper Voltage Setting. Before applying power, ensure that the line selector is in the proper position for the power source being used.

Connect and Disconnect Properly. Do not connect or disconnect probes or test leads while they are connected to a voltage source.

Ground the Product. This product is grounded through the grounding conductor of the power cord. To avoid electric shock, the grounding conductor must be connected to earth ground. Before making connections to the input or output terminals of the product, ensure that the product is properly grounded.

Observe All Terminal Ratings. To avoid fire or shock hazard, observe all ratings and markings on the product. Consult the product manual for further ratings information before making connections to the product.

Do not apply a potential to any terminal, including the common terminal, that exceeds the maximum rating of that terminal.

Do Not Operate Without Covers. Do not operate this product with covers or panels removed.

Use Proper Fuse. Use only the fuse type and rating specified for this product.

Avoid Exposed Circuitry. Do not touch exposed connections and components when power is present.

Wear Eye Protection. Wear eye protection if exposure to high-intensity rays or laser radiation exists.

Do Not Operate With Suspected Failures. If you suspect there is damage to this product, have it inspected by qualified service personnel.

Do Not Operate in Wet/Damp Conditions.

Do Not Operate in an Explosive Atmosphere.

Keep Product Surfaces Clean and Dry.

Provide Proper Ventilation. Refer to the manual's installation instructions for details on installing the product so it has proper ventilation.

Symbols and Terms

Terms in this Manual. These terms may appear in this manual:



WARNING. Warning statements identify conditions or practices that could result in injury or loss of life.



CAUTION. Caution statements identify conditions or practices that could result in damage to this product or other property.

Terms on the Product. These terms may appear on the product:

DANGER indicates an injury hazard immediately accessible as you read the marking.

WARNING indicates an injury hazard not immediately accessible as you read the marking.

CAUTION indicates a hazard to property including the product.

Symbols on the Product. The following symbols may appear on the product:



CAUTION
Refer to Manual



WARNING
High Voltage



Double
Insulated



Protective Ground
(Earth) Terminal



Not suitable for
connection to
the public telecom-
munications network



Suitable for
connection to
the public telecom-
munications network

Service Safety Summary

Only qualified personnel should perform service procedures. Read this *Service Safety Summary* and the *General Safety Summary* before performing any service procedures.

Do Not Service Alone. Do not perform internal service or adjustments of this product unless another person capable of rendering first aid and resuscitation is present.

Disconnect Power. To avoid electric shock, switch off the instrument power, then disconnect the power cord from the mains power.

Use Care When Servicing With Power On. Dangerous voltages or currents may exist in this product. Disconnect power, remove battery (if applicable), and disconnect test leads before removing protective panels, soldering, or replacing components.

To avoid electric shock, do not touch exposed connections.

SECTION 1 INTRODUCTION

The TSG 131A Multiformat Signal Generator is a simple, cost-effective test signal generator designed for the service environment. The TSG 131A digitally generates a full complement of test signals in four different formats: PAL/YC; Y, B-Y, R-Y; Y, CTDM; and GBR.

Tables 1-1 lists the test signals available from the TSG 131A and Table 1-2 give what is available from each rear panel output in each of the four modes. The

rest of the tables, Tables 1-3 through 1-9, list the special signals and outputs available from each of the various options.

Besides a full complement of video signals in four formats, the TSG 131A supplies two channels of a balanced 1 kHz XLR-audio tone with a jumper-selectable ID click. The frequency of the ID click is also adjustable.

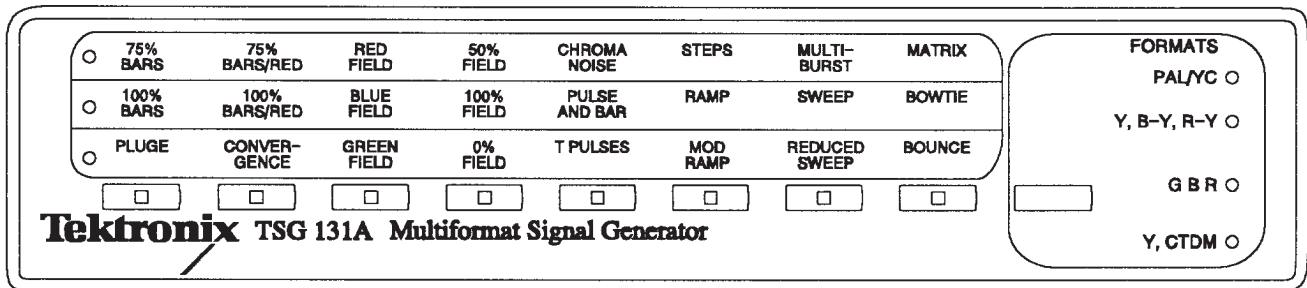

Fig. 1-1. Front panel of the TSG 131A.

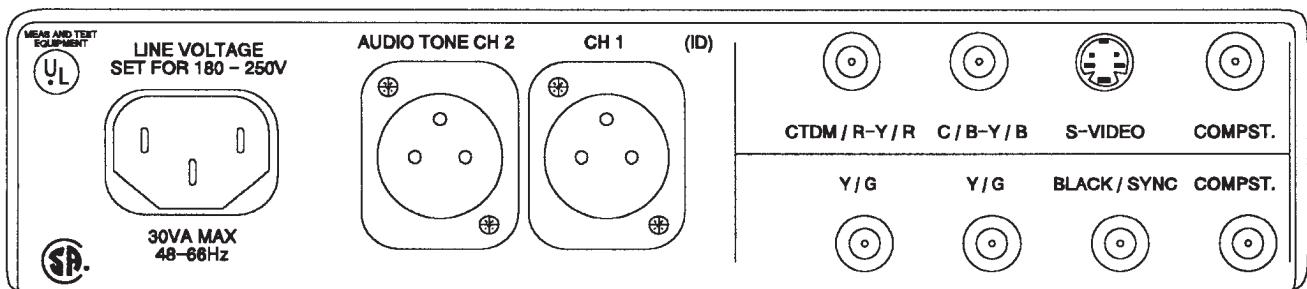

Fig. 1-2. Rear panel of the TSG 131A.

Physical Description

The TSG 130A consists of circuit boards and five cables in a rectangular sheet-aluminum chassis with a top cover. The major internal components are:

1. A main board that performs most of the TSG 131A's functions.
2. A front panel board that decodes front panel button selections.
3. A ribbon cable that feeds decoded front panel information to the main board.
4. A ribbon cable that supplies signals from the main board to the top BNC connector mounting board.
5. Two BNC connector mounting boards: the top board contains one SVHS and three BNC connectors; the bottom board contains four BNC connectors.
6. A ribbon cable that supplies signals from the main board to the bottom BNC connector mounting board.
7. An audio board which provides the audio signals and an optional id click.
8. A cable that supplies power to the audio board.

**Table 1-1. TSG 131A Test Signal Summary.
Standard and Option 02 (Black Burst) Signal Set
(Front Panel Matrix — Represents where the signals are found on the Front Panel)**

Format	1	2	3	4	5	6	7	8
PAL/YP	75% Color Bars	75% Color Bars over Red	Red Field	50% Flat Field	Chrominance Noise	5-Step	Multiburst	Matrix
	100% Color Bars	100% Color Bars over Red	Blue Field	100% Flat Field	Pulse & Bar	Ramp	Sweep	
	Pluge	Convergence	Green Field	0% Flat Field		Mod Ramp	Reduced Sweep	Bounce
Y, B-Y, R-Y (Betacam 3 Wire)	75% Color Bars	75% Color Bars over Red		50% Flat Field			Multiburst	Matrix
	100% Color Bars	100% Color Bars over Red		100% Flat Field	Pulse & Bar	Valid 5-Step	Sweep	Bowtie
				0% Flat Field	T Pulses		Reduced Sweep	
G B R	75% Color Bars		Red Field			10-Step	Multiburst	
	100% Color Bars		Blue Field		Pulse & Bar		Sweep	Bowtie
		Convergence	Green Field					
Y, CTDM (Betacam 2 Wire)	75% Color Bars			50% Flat Field				
	100% Color Bars			100% Flat Field				
				0% Flat Field				

Table 1-2. Available Outputs for the Standard TSG 131A in the Various Output Formats.

Format	Rear Panel Output					
	COMPOSITE	S-VIDEO	BLACK / SYNC	C / B-Y / B	Y / G	CTDM / R-Y / R
PAL / YC	PAL	Y / C	No Output	C	Y	Illegal Signal
Y, B-Y, R-Y (BetaCam)	Illegal Signal (Y + B-Y)	Y / B-Y	No Output	B-Y	Y	R-Y
G B R	Illegal Signal (G + B)	G / B	No Output	B	G (with/without sync)	R
Y, CTDM (BetaCam)	Y	Y / 0 Volts	No Output	0 Volts	Y	CTDM

Table 1-3. List of the available outputs in the various formats for the TSG 131A Opt. 02.

Format	Rear Panel Output					
	COMPOSITE	S-VIDEO	BLACK / SYNC	C / B-Y / B	Y / G	CTDM / R-Y / R
PAL / YC	PAL	Y / C	BLACK / SYNC	C	Y	Illegal Signal
Y, B-Y, R-Y (BetaCam)	Illegal Signal (Y + B-Y)	Y / B-Y	BLACK / SYNC	B-Y	Y	R-Y
G B R	Illegal Signal (G + B)	G / B	BLACK / SYNC	B	G (with sync / no sync)	R
Y, CTDM (BetaCam)	Y	Y / 0 Volts	BLACK / SYNC	0 Volts	Y	CTDM

**Table 1-4. TSG 131A Test Signal Summary.
Option 01 (MII Signal Set)**
(Front Panel Matrix — Represents where the signals are found on the Front Panel)

Format	1	2	3	4	5	6	7	8
PAL/YC	75% Color Bars	75% Color Bars over Red	Red Field	50% Flat Field	Chrominance Noise	5-Step	Multiburst	Matrix
	100% Color Bars	100% Color Bars over Red	Blue Field	100% Flat Field	Pulse & Bar	Ramp	Sweep	
	Pluge	Convergence	Green Field	0% Flat Field		Mod Ramp	Reduced Sweep	Bounce
Y, B-Y, R-Y (Betacam 3 Wire)	75% Color Bars	75% Color Bars over Red		50% Flat Field			Multiburst	Matrix
	100% Color Bars	100% Color Bars over Red		100% Flat Field	Pulse & Bar	Valid 5-Step	Sweep	Bowtie
				0% Flat Field	T Pulses		Reduced Sweep	
G B R	75% Color Bars		Red Field			10-Step	Multiburst	
	100% Color Bars		Blue Field		Pulse & Bar		Sweep	Bowtie
		Convergence	Green Field					
Y, CTDM (MII 2 Wire)	75% Color Bars ¹			50% Flat Field ¹				
	100% Color Bars ¹			100% Flat Field ¹				
				0% Flat Field ¹				

1. Unique MII signals.

Table 1-5. Available Outputs for the Option 01 TSG 131A in the Various Output Formats.

Format	Rear Panel Output						
	COMPOSITE	S-VIDEO	BLACK / SYNC	C / B-Y / B	Y / G	CTDM / R-Y / R	
PAL / YC	PAL	Y / C	No Output	C	Y	Illegal Signal	
Y, B-Y, R-Y (BetaCam)	Illegal Signal (Y + B-Y)	Y / B-Y	No Output	B-Y	Y	R-Y	
G B R	Illegal Signal (G + B)	G / B	No Output	B	G (with sync)	R	
Y, CTDM (BetaCam)	Y	Y / 0 Volts	No Output	0 Volts	Y	CTDM	

Table 1-6. TSG 131A Test Signal Summary.
 for Option -03 Betacam signals with Black Burst Output (Front Panel Matrix — Represents where the signals are found on the Front Panel)

Format	1	2	3	4	5	6	7	8
PAL/YC	75% Color Bars ¹	75% Color Bars over Red ¹	Red Field ¹	50% Flat Field ¹	Chrominance Noise ¹	5-Step ¹	Multiburst	Matrix
	100% Color Bars ¹	100% Color Bars over Red ¹	Blue Field ¹	100% Flat Field ¹	Pulse & Bar	Ramp ¹	Sweep ¹	
	Pluge	Convergence ¹	Green Field ¹	0% Flat Field		Mod 5-Step	Reduced Sweep ¹	Bounce
Y, B-Y, R-Y (Betacam 3 Wire)	75% Color Bars ¹			50% Flat Field ¹	Sin x/x *	5-Step*	60% Multiburst ¹	Matrix
	100% Color Bars ¹			100% Flat Field*	Pulse & Bar ¹	Quad Phase*	Multiburst*	Bowtie ¹
				0% Flat Field	T Pulses*	"Line 17"*	Sweep*	
G B R	75% Color Bars		Red Field			10-Step	Multiburst	
	100% Color Bars	Convergence	Blue Field		Pulse & Bar		Sweep	Bowtie
			Green Field					
Y, CTDM (Betacam 2 Wire)	75% Color Bars ¹							

1. Timing is different from the standard signal.
 * Unique signal.

Table 1-7.
Various rear panel outputs available in the various formats of the TSG 131A Opt. 03.

Format	Rear Panel Output							
	COMPOSITE	S-VIDEO	BLACK / SYNC or COMP SYNC	C / B-Y / B	Y / G (LEFT)	Y / G (RIGHT)	CTDM / R-Y / R	
PAL / YC	PAL	Y / C	BLACK BURST or COMP SYNC	C	Y	COLOR FLAG REFERENCE PULSE	Illegal Signal	
Y, B-Y, R-Y (BetaCam)	Illegal Signal (Y + B-Y)	Y / B-Y	BLACK BURST or COMP SYNC	B-Y	Y	COLOR FLAG REFERENCE PULSE	R-Y	
G B R	Illegal Signal (G + B)	G / B	BLACK BURST or COMP SYNC	B	G (with sync / no sync)	COLOR FLAG REFERENCE PULSE	R	
Y, CTDM (BetaCam)	Y	Y / 0 Volts	BLACK BURST or COMP SYNC	0 Volts	Y	COLOR FLAG REFERENCE PULSE	CTDM	

Table 1-8. TSG 131A Test Signal Summary.
 for Option -04 MII signals with COMP SYNC on the Optional Output
 (Front Panel Matrix — Represents where the signals are found on the Front Panel)

Format	1	2	3	4	5	6	7	8
PAL/YC	75% Color Bars*	75% Color Bars over Red*	Red Field	50% Flat Field	Chrominance Noise	5-Step	60% Multiburst *	Matrix
	100% Color Bars	100% Color Bars over Red	Blue Field	100% Flat Field	Pulse & Bar	Ramp*	100% Sweep*	
	Pluge	Convergence	Green Field	0% Flat Field		Mod Ramp*		Bounce
Y, B-Y, R-Y (Betacam 3 Wire)	75% Color Bars*			50% Flat Field		5-Step*		100% Bowtie*
	100% Color Bars			100% Flat Field	Pulse & Bar*	Over-sized Ramp*	100% Sweep*	50% Bowtie
	75% Color Bars with Level Reference*			0% Flat Field	T Pulses*		60% Sweep*	
G B R	75% Color Bars		Red Field			10-Step	Multiburst	
	100% Color Bars		Blue Field		Pulse & Bar		Sweep	Bowtie
		Convergence	Green Field					
Y, CTDM (MII 2 Wire)								
	100% Color Bars*							

* Unique signal.

Table 1-9.
Rear Panel Outputs in the various formats for the TSG 131A Opt. 04.

Format	Rear Panel Output							
	COMPOSITE	S-VIDEO	BLACK / SYNC	C / B-Y / B	Y / G (LEFT)	Y / G (RIGHT)	CTDM / R-Y / R	
PAL / YC	PAL	Y / C	COMP SYNC (TTL or Video)	C	Y	COLOR FRAME SQUARE WAVE	Illegal Signal	
Y, B-Y, R-Y (MII)	Illegal Signal (Y + B-Y)	Y / B-Y	COMP SYNC (TTL or Video)	B-Y	Y	COLOR FRAME SQUARE WAVE	R-Y	
G B R	Illegal Signal (G + B)	G / B	COMP SYNC (TTL or Video)	B	G (with/without sync)	COLOR FRAME SQUARE WAVE	R	
Y, CTDM (MII)	Y	Y / 0 Volts	COMP SYNC (TTL or Video)	0 Volts	Y	COLOR FRAME SQUARE WAVE	CTDM	

SECTION 2 CONTROLS & CONNECTIONS

Operating Instructions

This section describes the front panel controls, the rear panel connectors, and how to use them.

For information on configuring the internal jumpers see Section 5, Installation and Maintenance.

For information on configuring the power supply for 110 VAC or 220 VAC operation, see Section 5.

CAUTION

The TSG 131A is shipped from the factory configured for 220 VAC operation. Attempting to operate the TSG 131A at any other voltage without reconfiguring the power supply may cause damage. Refer to the Installation and Maintenance Section for further information.

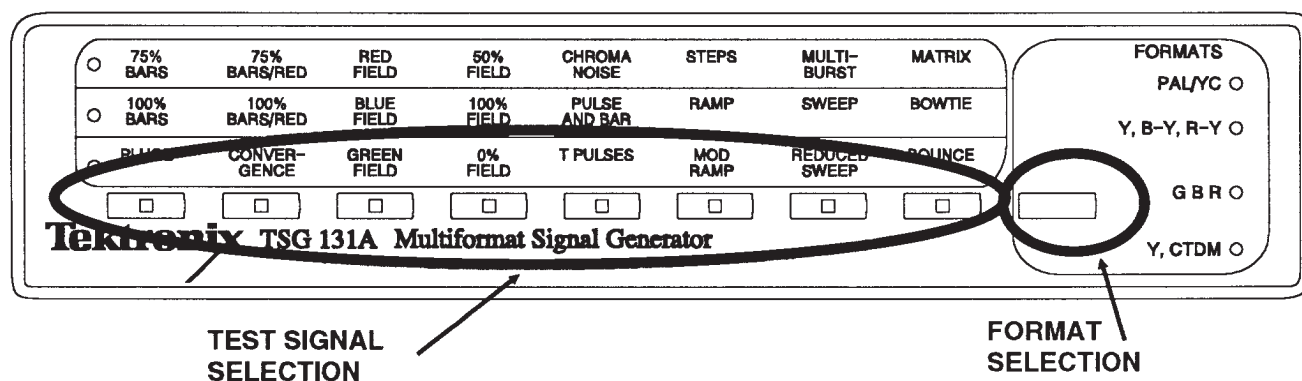

Fig. 2-1. Front panel of the TSG 131A.

Front Panel Controls (See Fig. 2-1)

The front panel is organized into two sections.

The right section is a format selection area. This area contains a single button, the Format Selection button. It selects one of the four video test signal formats. Pressing the button switches between the formats moving from top to bottom. The TSG 131A

powers up in the PAL/YC format. An LED indicates the signal format selected.

The left section contains eight Test Signal Selection buttons. Above the buttons are three rows of test signal selections, arranged in columns. On the left side are three LEDs, one for each row. These LEDs indicate the test signal row selected. There is an LED

TSG 131A — CONTROLS & CONNECTIONS

in the center of each Test Signal Selection button. The button lights to indicate which column is selected. To determine which test signal is selected, use the left LEDs to determine which row and the LED in the button to identify the column. See Fig. 2-2 for an example.

Pressing a Test Signal Selection button for the first time lights the top-row LED, if the signal format selected (for example, Y, B-Y, R-Y) offers that

particular test signal. Successive presses of the same button select other test signals in the column above the button. If a test signal is not available in a selected format, the selection indicator moves to the top of the column or first available signal. If the format is changed and no test signals are offered from that column in the selected format, the indicator moves to 75% Bars.

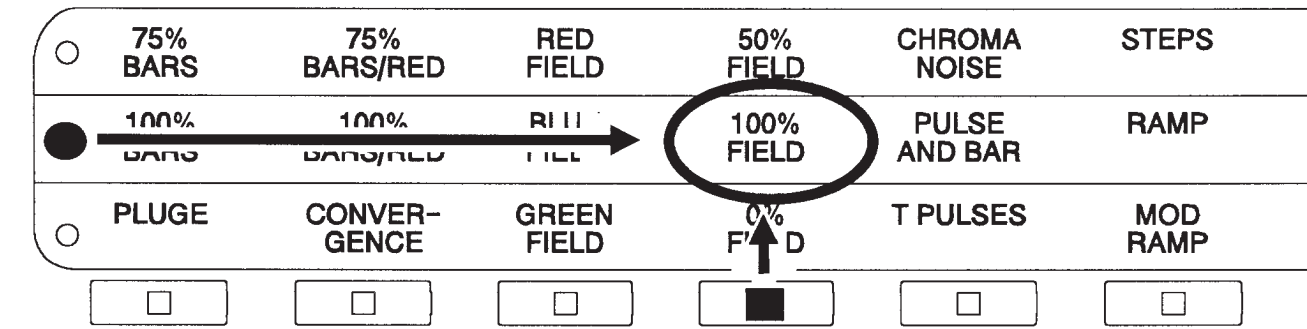

Fig. 2-2.
How to determine which signal is selected from the TSG 131A.
Row 2 / Column 4 indicates that the 100% Field signal has been selected.

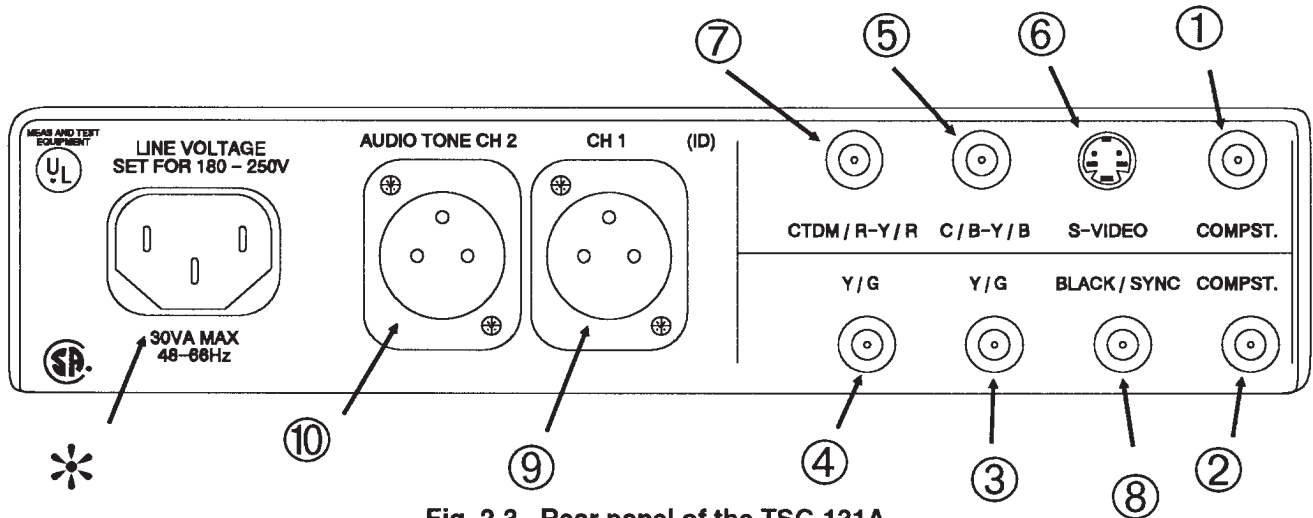

Fig. 2-3. Rear panel of the TSG 131A.

Rear Panel Connections (See Fig. 2-3)

This section describes the TSG 131A rear panel connections.

The rear panel provides the following outputs:

Multi-purpose Outputs

NOTE

Only the output associated with the "active signal set" selected from the front panel has a valid signal on it. For example, if PAL/YC is active there is not a valid signal on the CTDM / R-Y / R output.

- ① **COMPST.** PAL test signal output (PAL/YC format only).
- ② **COMPST.** PAL test signal output (PAL/YC format only).
- ③ **Y/G.** Luminance output for all formats except GBR, when it outputs Green.
- ④ **Y/G.** Luminance output for all formats, except GBR, when it outputs Green. Outputs only Color Frame Square Wave in Option 04. Outputs only Color Flag Reference Pulse in Option 03.

- ⑤ **C/B-Y/B.** Chrominance output (PAL/YC format); B-Y output in Y, B-Y, R-Y format; Blue in GBR format.
- ⑥ **S-VIDEO.** Y/C output (see S-Video connector pinout). The TSG 131A offers an S-Video output as an *alternative* to the Y and C outputs.

NOTE

It is recommended that the S-Video output not be used simultaneously with the Y and C BNC outputs. Using the S-Video output while also using the Y and C BNC outputs will degrade Y-channel output accuracy.

- ⑦ **CTDM/R-Y/R.** R-Y output in Y, B-Y, R-Y format; CTDM output in CTDM format; and Red in GBR format.
- ⑧ **Option.** Not used on the standard instrument and Opt. 01. Outputs either Black Burst or Comp Sync in Options 02 and 03. Outputs only Comp Sync for Option 04.

Audio Tone ID



*The Audio Outputs are designed to drive a 600Ω load **ONLY**. Attempting to drive any other load could damage the instrument.*

- ⑨ **CH 1 (ID)**. 1 kHz audio tone output with jumper-selectable ID click. The frequency of the ID click may be changed, or the click may be disabled. (See the Installation Section to disable the click and the adjustment procedures to change the frequency.)
- ⑩ **AUDIO TONE CH 2**. 1 kHz audio tone output in phase with CH 1. The TSG 131A's audio tone output is a balanced 1 kHz XLR audio tone. Audio output gain is adjustable via internal potentiometers (see the Adjustment Section).

Power Supply



There is not an ON/OFF switch for the power supply. If the instrument is plugged in to a power source it is "on".

- * **LINE VOLTAGE**. Electrical mains input, factory set for 220 V_{AC} (to change the power supply operating voltage, see *Section 5, Installation*).

Using the Controls & Connectors (Standard Instrument ONLY)

The following figures illustrate which test signals are available under a given format and what are valid outputs from the rear panel.

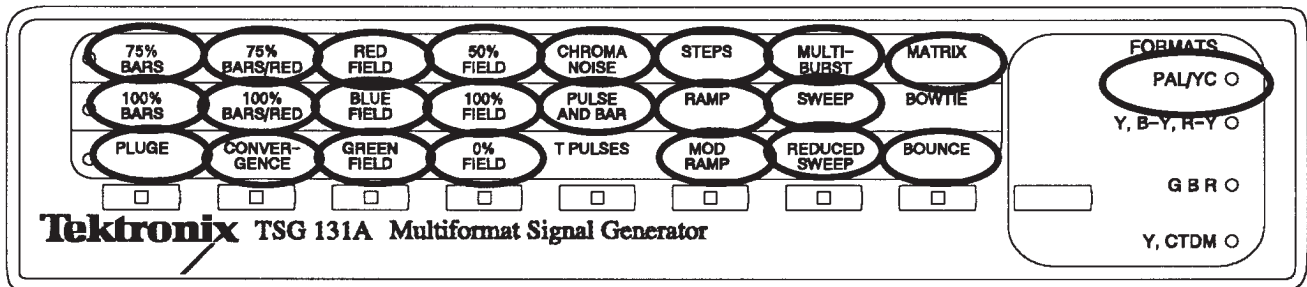

Fig. 2-4. Signals available in PAL/YC format.

1	2	3	4	5	6	7	8
75% Color Bars	75% Color Bars over Red	Red Field	50% Flat Field	Chrominance Noise	5-Step	Multiburst	Matrix
100% Color Bars	100% Color Bars over Red	Blue Field	100% Flat Field	Pulse & Bar	Ramp	Sweep	
Pluge	Convergence	Green Field	0% Flat Field		Mod Ramp	Reduced Sweep	Bounce

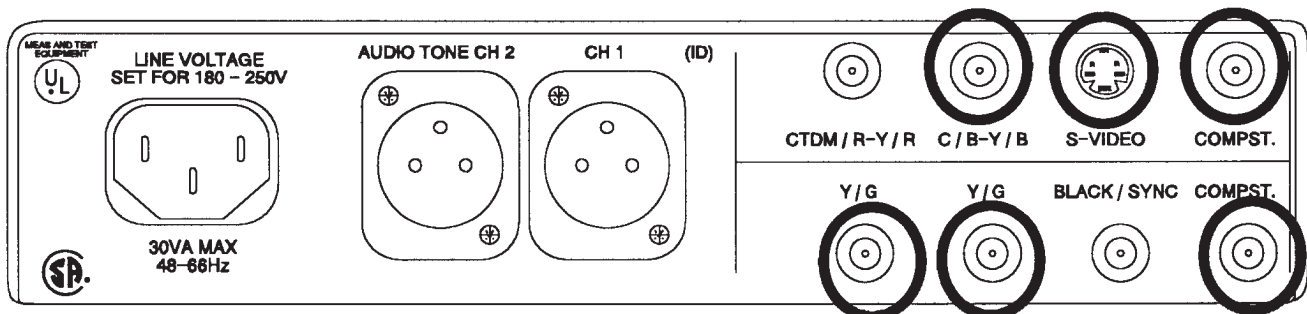

Fig. 2-5. Valid outputs in the PAL/YC mode.

COMPOSITE	S-VIDEO	C / B-Y / B	CTDM / R-Y / R	BLACK / SYNC	Y / G
PAL	Y / C	C	Illegal Signal	No Output	Y

TSG 131A — CONTROLS & CONNECTIONS

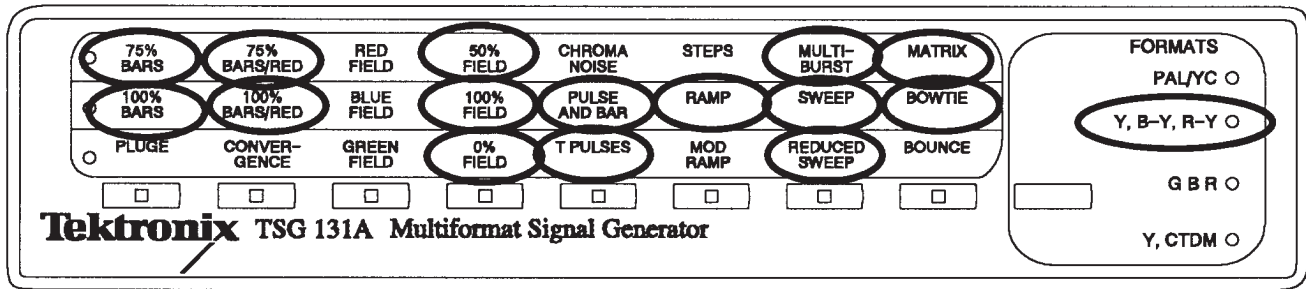

Fig. 2-6. Signals available in Y, B-Y, R-Y format.

1	2	3	4	5	6	7	8
75% Color Bars	75% Color Bars over Red		50% Flat Field			Multiburst	Matrix
100% Color Bars	100% Color Bars over Red		100% Flat Field	Pulse & Bar	Valid 5-Step	Sweep	Bowtie
			0% Flat Field	T Pulses		Reduced Sweep	

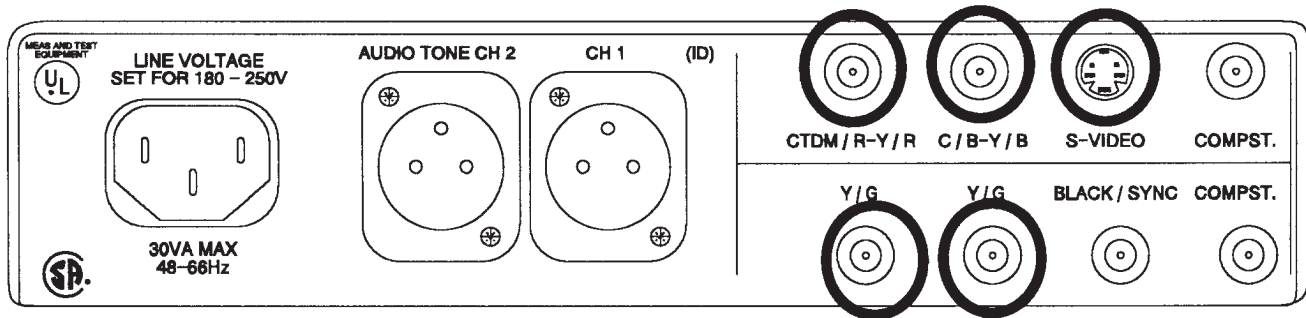

Fig. 2-7. Outputs available in the Y, B-Y, R-Y format.

COMPOSITE	S-VIDEO	C / B-Y / B	CTDM / R-Y / R	BLACK / SYNC	Y / G
Illegal Signal (Y + B-Y)	Y / B-Y	B-Y	R-Y	No Output	Y

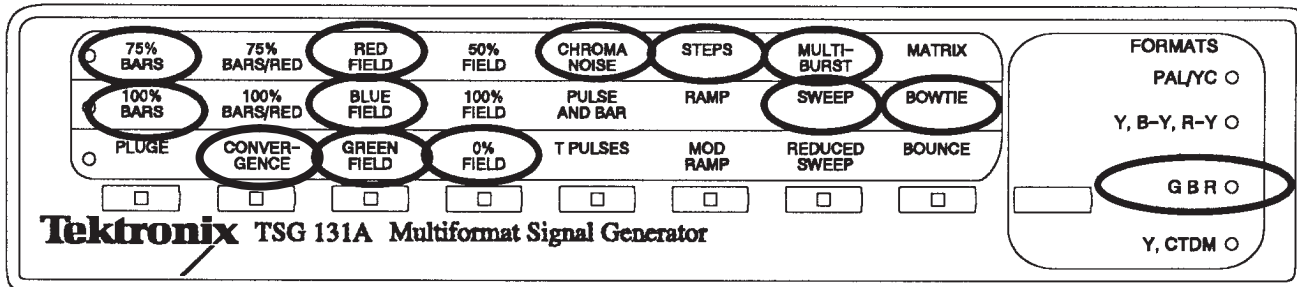

Fig. 2-8. Signals available in GBR format.

1	2	3	4	5	6	7	8
75% Color Bars		Red Field			10-Step	Multiburst	
100% Color Bars		Blue Field		Pulse & Bar		Sweep	Bowtie
	Convergence	Green Field					

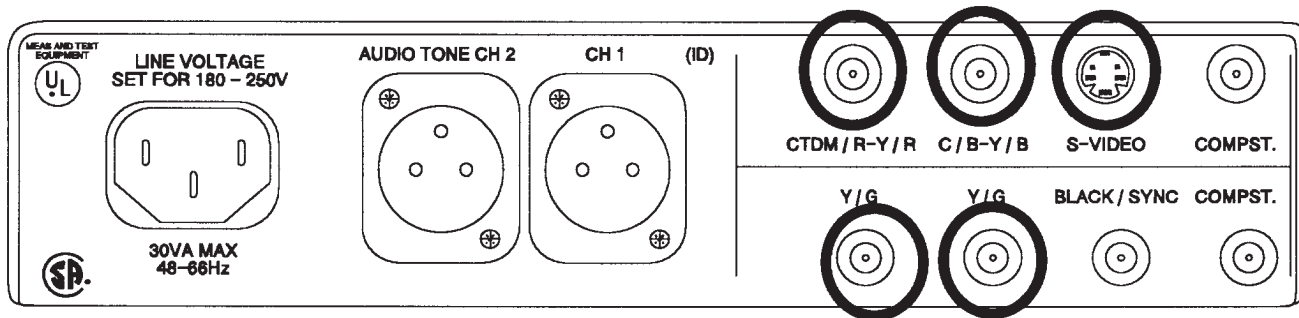

Fig. 2-9. Outputs available in the GBR format.

COMPOSITE	S-VIDEO	C/B-Y/B	CTDM/R-Y/R	BLACK/SYNC	Y/G
Illegal Signal (G + B)	G/B	B	R	No Output	G

TSG 131A — CONTROLS & CONNECTIONS

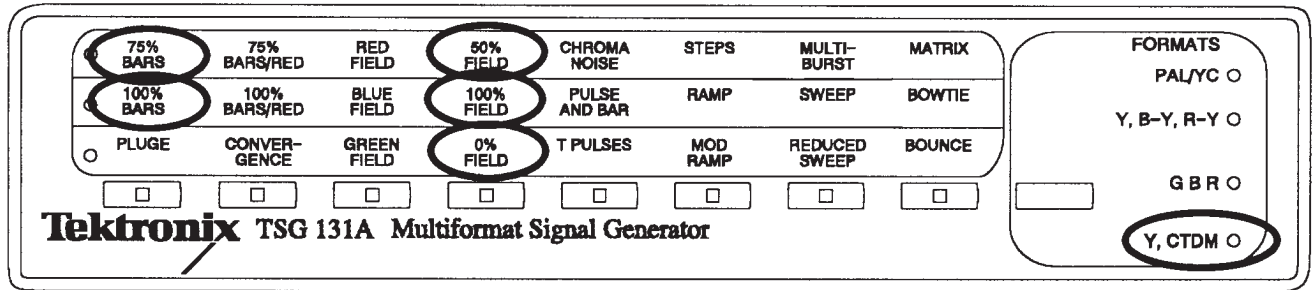

Fig. 2-10. Signals available in CTDM format.

1	2	3	4	5	6	7	8
75% Color Bars		50% Flat Field					
100% Color Bars		100% Flat Field					
		0% Flat Field					

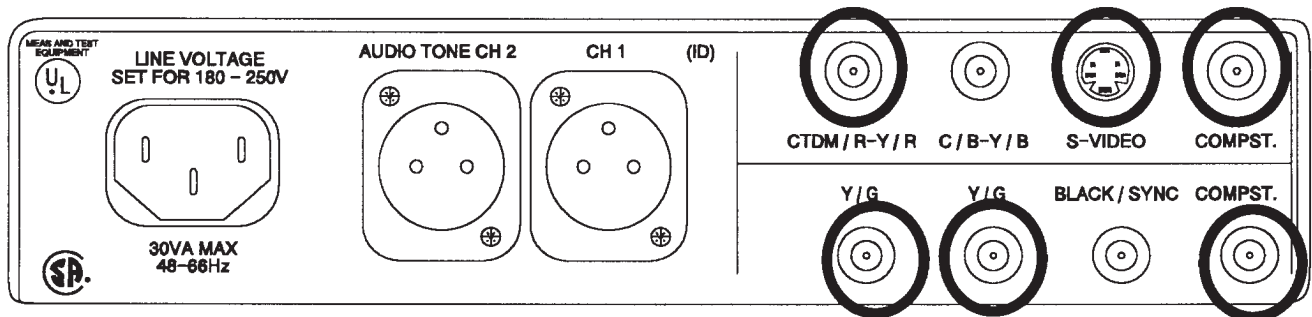

Fig. 2-11. Outputs available in the Y, CTDM format.

COMPOSITE	S-VIDEO	C/B-Y/B	CTDM/R-Y/R	BLACK/SYNC	Y/G
Y	Y / 0 Volts	0 Volts	CTDM	No Output	Y

SECTION 3

SIGNAL GENERATOR SPECIFICATIONS

The material in this section is organized into two main groupings: the specification tables and the supporting figures. The specification tables include:

1. General test signal specifications for all formats.
2. PAL/YC general and test signal specifications
3. Component test signal specifications
4. GBR test signal specifications.
5. CTDM test signal specifications.
6. Signal level specifications
7. Power supply, physical, and environmental specifications.

The supporting figures (waveform diagrams and related data) follow the specification tables.

Performance Conditions

The Performance Requirements are valid within the environmental limits if the instrument is adjusted at $25^{\circ}\text{C} \pm 5^{\circ}\text{C}$, and a minimum warm-up time of 20 minutes is allowed.

Electrical Specifications

NOTE

All figures referenced in this section are found after the Specification tables.

**Table 3-1.
General Test Signal Characteristics.**

CHARACTERISTICS	PERFORMANCE REQUIREMENTS	SUPPLEMENTAL INFORMATION	PER. CHECK STEP #
Amplitude Accuracy	$\pm 1\%$		PAL = 6. Y = 21. Blue = 47. Red = 54.
Channel Matching	$\pm 0.5\%$	B & R relative to G. Measured using GBR signals.	G to B = 59. G to R = 59.
Delay Channel Matching	within 5 ns	B-Y & R-Y relative to Y.	Y to B-Y = 57. Y to R-Y = 58.
Frequency Response Y, PAL, G, B, & R B-Y & R-Y Channels	Flat to 6.0 MHz $\pm 2\%$. Flat to 3.0 MHz $\pm 1\%$.		PAL = 18. B-Y = 39. R-Y = 44 Green = 45. Blue = 48. Red = 52.
Rise Time Luminance Chrominance Burst Sync Color Difference	250 ns ± 25 ns 350 ns ± 35 ns 350 ns ± 35 ns 250 ns ± 25 ns 350 ns ± 35 ns	Except as otherwise specified.	Sync = 16. Y = 17. C = 34. Burst = 33. B-Y = 37. R-Y = 42.
Sync Amplitude PAL/YC BetaCam MII 3 wire MII 2 wire GBR (sync on Green only)	300 mV ± 6 mV 300 mV ± 6 mV 300 mV ± 6 mV 300 mV ± 6 mV 300 mV ± 6 mV		PAL = 3. Y = 23. G = 46.
Line Sync Duration PAL/YC BetaCam 3 wire BetaCam 2 wire MII	4.7 μ s ± 50 ns 4.7 μ s ± 50 ns 5.0 μ s ± 50 ns 4.7 μ s ± 50 ns	50% amplitude point	PAL = 15. Y = 24.
Front Porch Duration (625/50)	1.55 μ s minimum		

Table 3-1. Cont.

CHARACTERISTICS	PERFORMANCE REQUIREMENTS	SUPPLEMENTAL INFORMATION	PER. CHECK STEP #
Line Blanking Interval	$12.0 \mu\text{s} \pm 0.15 \mu\text{s}$	Measured at the 50% point of active video.	PAL = 14.
Vertical Serration Duration	$4.7 \mu\text{s} \pm 50 \text{ ns}$	50% amplitude point	PAL = 13. Y = 30.
Equalizing Pulse Duration	$2.35 \mu\text{s} \pm 50 \text{ ns}$	50% amplitude point	PAL = 13. Y = 30.
DC Level	$0 V_{\text{dc}} \pm 50 \text{ mV}_{\text{dc}}$		PAL = 2. Y = 22. B-Y = 35. R-Y = 40.
Sine Squared Pulses Accuracy	HADs accurate within 25 ns.	Except as otherwise specified.	PAL = 12. Y = 29. B-Y = 38. R-Y = 43.
Step Staircase Linearity Error	$\leq 1\%$	Relative step matching.	PAL = 5. Y = 25. Blue = 49. Red = 53.
Field Tilt		$< 0.5\%$	
Line Tilt	$< 0.5\%$		PAL = 9. Y = 26. Blue = 50. Red = 55.
Pulse to Bar Ratio	$1:1 \pm 1\%$		PAL = 11. Y = 28. B = 51. R = 56.
2T K Factor (K_{2T} Factor) Pulse Ringing (2T Pulse)	$< 0.6\%$	$\leq 1\%$ peak	PAL = 10. Y = 27. B-Y = 36. R-Y = 41.
Output Impedance		75Ω	
Return Loss		$\geq 36 \text{ dB}$ to 5 MHz	
Crosstalk		$\geq 60 \text{ dB}$ down	
Residual Subcarrier		$\geq 60 \text{ dB}$ down	

TSG 131A — SPECIFICATIONS

Table 3-1. Cont.

CHARACTERISTICS	PERFORMANCE REQUIREMENTS	SUPPLEMENTAL INFORMATION	PER. CHECK STEP #
Oscillator Frequency Stability Normal Option 10	$F_{CLK} \pm 40 \text{ Hz over } 5^{\circ}\text{C to } 35^{\circ}\text{C}$ $F_{CLK} \pm 20 \text{ Hz over } 5^{\circ}\text{C to } 35^{\circ}\text{C}$	$F_{CLK} = 17.734375 \text{ MHz}$ temperature range after a 30 minute warm-up. Oscillator to be adjusted annually. (Divide by 4 to obtain subcarrier specification.)	1.
Subcarrier Frequency Stability Normal Option 10	$F_{sc} \pm 10 \text{ Hz over } 5^{\circ}\text{C to } 35^{\circ}\text{C}$ $F_{sc} \pm 5 \text{ Hz over } 5^{\circ}\text{C to } 35^{\circ}\text{C}$	$F_{sc} = \frac{1135H + 100}{4}$ $= 4.43361875 \text{ MHz}$ $H = \frac{1}{64 \mu\text{s}}$	

Table 3-2. General PAL/YC Signal Characteristics.
 (The following specifications apply to the PAL/YC formats only.)

CHARACTERISTICS	PERFORMANCE REQUIREMENTS	SUPPLEMENTAL INFORMATION	PER. CHECK STEP #
Diiferential Gain	0.7% maximum.	Typical 0.3%. Typical 0.3°. When averaged by a TEK 1781 or VM700 the quantization errors in the mod ramp are greatly reduced allowing a more accurate measurement of dg and dp.	19.
Differential Phase	0.5° maximum.		19.
Chrominance-to-Luminance Gain	± 1%		8.
Chrominance Accuracy on C Output	± 1%	Measured with the Chroma Noise signal.	7. & 31.
Burst Amplitude	300.0 mV _{p-p} ± 2%		4. & 32.
Burst Delay from Sync	5.6 μs ± 50 ns	from 50% point of sync	
Burst Duration	2.255 μs ± 0.1 μs	10 cycles of subcarrier.	
Breezeway Duration	900 ns ± 50 ns		
SC/H Phase	0° ± 5°		20.
Chrominance-to-Luminance Delay	≤ 5 ns		8.

Table 3-3.
NTSC/YC Test Signal Definitions.

CHARACTERISTICS	SIGNAL DEFINITIONS			SUPPLEMENTAL INFORMATION
75% Bars Luminance Rise Times White Yellow Cyan Green Magenta Red Blue	150 ns ± 25 ns Luminance Amplitude <i>mV</i> Subcarrier Amplitude <i>mV_{p-p}</i> Subcarrier Phase <i>degree</i> 700.0 0.0 0.0 465.1 470.5 167.1 368.0 663.8 283.5 308.2 620.1 240.7 216.8 620.1 60.7 157.0 663.8 103.5 59.9 470.5 347.1	See Figs. 3-2, 3-32, & 3-33. For Opt 03 see Figs. 3-149 & 3-150.		
100% Bars Luminance Rise Times White Yellow Cyan Green Magenta Red Blue	150 ns ± 25 ns Luminance Amplitude <i>mV</i> Subcarrier Amplitude <i>mV_{p-p}</i> Subcarrier Phase <i>degree</i> 700.0 0.0 0.0 620.2 627.3 167.1 490.7 885.1 283.5 410.9 826.8 240.7 289.1 826.8 60.7 209.3 885.1 103.5 79.8 627.3 347.1	See Figs. 3-4, 3-36, & 3-37. For Opt 03 see Figs. 3-153 & 3-154.		
75% Color Bars over Red Luminance Rise Times Field Timing Color Bars Red	150 ns ± 25 ns Lines 24 - 166 & 336 - 478 Lines 167 - 310 & 479 - 622 Luminance Amplitude <i>mV</i> Subcarrier Amplitude <i>mV_{p-p}</i> Subcarrier Phase <i>degree</i> 700.0 0.0 0.0 465.1 470.5 167.1 368.0 663.8 283.5 308.2 620.1 240.7 216.8 620.1 60.7 157.0 663.8 103.5 59.9 470.5 347.1	See Figs. 3-2, 3-3, 3-32, 3-33, 3-34, 3-35. For Opt 03 see Figs. 3-149, 3-150, 3-151, & 3-152.		

Table 3-3 Cont.

CHARACTERISTICS	SIGNAL DEFINITIONS	SUPPLEMENTAL INFORMATION																								
100% Color Bars over Red Luminance Rise Times Field Timing Color Bars Red White Yellow Cyan Green Magenta Red Blue	150 ns ± 25 ns Lines 24 - 166 & 336 - 478 Lines 167 - 310 & 479 - 622 <table border="1" data-bbox="649 556 1128 907"> <thead> <tr> <th>Luminance Amplitude <i>mV</i></th> <th>Subcarrier Amplitude <i>mV_{p-p}</i></th> <th>Subcarrier Phase <i>degree</i></th> </tr> </thead> <tbody> <tr> <td>700.0</td> <td>0.0</td> <td>0.0</td> </tr> <tr> <td>620.2</td> <td>627.3</td> <td>167.1</td> </tr> <tr> <td>490.7</td> <td>885.1</td> <td>283.5</td> </tr> <tr> <td>410.9</td> <td>826.8</td> <td>240.7</td> </tr> <tr> <td>289.1</td> <td>826.8</td> <td>60.7</td> </tr> <tr> <td>209.3</td> <td>885.1</td> <td>103.5</td> </tr> <tr> <td>79.8</td> <td>627.3</td> <td>347.1</td> </tr> </tbody> </table>	Luminance Amplitude <i>mV</i>	Subcarrier Amplitude <i>mV_{p-p}</i>	Subcarrier Phase <i>degree</i>	700.0	0.0	0.0	620.2	627.3	167.1	490.7	885.1	283.5	410.9	826.8	240.7	289.1	826.8	60.7	209.3	885.1	103.5	79.8	627.3	347.1	See Figs. 3-4, 3-5, 3-36, 3-37, 3-38, & 3-39. For Opt 03 see Figs. 3-153, 3-154, 3-155, & 3-156.
Luminance Amplitude <i>mV</i>	Subcarrier Amplitude <i>mV_{p-p}</i>	Subcarrier Phase <i>degree</i>																								
700.0	0.0	0.0																								
620.2	627.3	167.1																								
490.7	885.1	283.5																								
410.9	826.8	240.7																								
289.1	826.8	60.7																								
209.3	885.1	103.5																								
79.8	627.3	347.1																								
Red Field Luminance Pedestal Chrominance Amplitude Chrominance Phase	157.0 mV 663.8 mV _{p-p} 103.5°	See Figs. 3-6, 3-32, & 3-33. For Opt 03 see Figs. 3-151 & 3-152.																								
Green Field Luminance Pedestal Chrominance Amplitude Chrominance Phase	308.2 mV 620.1 mV _{p-p} 240.7°	See Figs. 3-8, 3-44, 3-45. For Opt 03 see Figs 3-159 & 3-160.																								
Blue Field Luminance Pedestal Chrominance Amplitude Chrominance Phase	59.9 mV 470.5 mV _{p-p} 347.1°	See Figs. 3-7, 3-42, & 3-43. For Opt 03 see Figs. 3-157 & 3-158.																								
Flat Field 50% 100% 0%	350 mV 700 mV 0 mV	See Figs. 3-9, 3-46, 3-47, 3-10, 3-48, 3-49, 3-11, 3-50, & 3-51. For Opt 03 see Figs. 3-161 & 3-162.																								
Chrominance Noise Luminance Pedestal Chrominance Amplitude Chrominance Phase	350 mV 700 mV _{p-p} 103.5° (Red)	See Figs. 3-12, 3-52, & 3-53. For Opt 03 see Fig. 3-163 & 3-164.																								

TSG 131A — SPECIFICATIONS

Table 3-3 Cont.

CHARACTERISTICS	SIGNAL DEFINITIONS	SUPPLEMENTAL INFORMATION
Convergence Amplitude Pattern Pulse HAD	525.0 mV 14 lines/field and 19 lines/horiz 225 ns	See Figs. 3-15, 3-14, 3-68, 3-69, & 3-70. For Opt 03 see Figs. 3-173 & 3-174.
5-Step (Gray Scale) Amplitude	700 mV	See Figs. 3-13, 3-56, & 3-57. For Opt 03 see Figs. 3-165 and 3-166.
Ramp/Modulated Ramp Luminance Amplitude Chrominance Amplitude	700 mV 280.0 mV _{p-p}	See Figs. 3-16, 3-17, 3-58, 3-59, 3-60, & 3-61. For Opt 03 see Figs. 3-167 and 3-168. Ramp only For Opt. 04 see Figs. 3-217, 3-218, 3-219, and 3-220.
Pulse & Bar with Window 20T Modulated Pulse HAD Chroma Phase Amplitude 2T Pulse HAD White Bar Amplitude Window Field Timing	2000 ns ± 20 ns 60.7° 700 mV 200 ns 700 mV Lines 96 - 238	See Figs. 3-18, 3-54, & 3-55.
Multiburst White Reference Bar Amplitude Packet Amplitudes Pedestal Burst Frequencies Packet Rise Time	420 mV _{p-p} 420 mV _{p-p} (Equal width packets) 350 mV 0.5, 1.0, 2.0, 4.0, 4.8, & 5.8 MHz 350 ns typical	See Figs. 3-19, 3-62, & 3-63.
Line Sweep Frequency Amplitude Markers	500 kHz to 6.5 MHz 700 mV _{p-p} 1, 2, 3, 4, 5, and 6 MHz.	See Figs. 3-20, 3-64, & 3-65. For Opt 03 see Fig. 3-169.
60% Reduced Line Sweep Frequency Amplitude Markers	500 Hz to 6.5 MHz 420 mV _{p-p} 1, 2, 3, 4, 5, and 6 MHz.	See Figs. 3-21, 3-66, & 3-67. For Opt 03 see Fig. 3-171. Not available on Opt 04.

Table 3-3 Cont.

CHARACTERISTICS	SIGNAL DEFINITIONS	SUPPLEMENTAL INFORMATION																												
Pluge Matrix Pluge Levels Lum Ref Levels	-14 mV and +14 mV 700 mV, 450 mV, 200 mV, and 110 mV	See Figs. 3-22, 3-40, & 3-41.																												
Bounce Amplitude Rate	0 or 700 mV flat field ≈ 1.3 second high, 1.3 second low																													
Matrix (Standard and Opts 01 & 02)	<table border="0"> <tr> <td><u>Signal</u></td> <td><u>Lines</u></td> </tr> <tr> <td>CCIR 17</td> <td>24-47 & 336-359</td> </tr> <tr> <td>CCIR 330</td> <td>48-71 & 360-383</td> </tr> <tr> <td>CCIR 331</td> <td>72-95 & 384-407</td> </tr> <tr> <td>CCIR 18</td> <td>96-119 & 408-431</td> </tr> <tr> <td>75% Color Bars . . .</td> <td>120-143 & 432-455</td> </tr> <tr> <td>Sin x/x</td> <td>144-166 & 456-478</td> </tr> <tr> <td>75% Red Field</td> <td>167-190 & 479-502</td> </tr> <tr> <td>15 kHz Square Wave</td> <td></td> </tr> <tr> <td>.</td> <td>191-214 & 503-526</td> </tr> <tr> <td>50% Flat Field</td> <td>215-238 & 527-550</td> </tr> <tr> <td>Shallow Ramp</td> <td>239-262 & 551-574</td> </tr> <tr> <td>UK ITS 1</td> <td>263-286 & 575-598</td> </tr> <tr> <td>UK ITS 2</td> <td>287-310 & 599-622</td> </tr> </table>	<u>Signal</u>	<u>Lines</u>	CCIR 17	24-47 & 336-359	CCIR 330	48-71 & 360-383	CCIR 331	72-95 & 384-407	CCIR 18	96-119 & 408-431	75% Color Bars . . .	120-143 & 432-455	Sin x/x	144-166 & 456-478	75% Red Field	167-190 & 479-502	15 kHz Square Wave		191-214 & 503-526	50% Flat Field	215-238 & 527-550	Shallow Ramp	239-262 & 551-574	UK ITS 1	263-286 & 575-598	UK ITS 2	287-310 & 599-622	See Fig. 3-24. See Fig. 3-26. See Fig. 3-27. See Fig. 3-25. See Fig. 3-28. See Fig. 3-29. See Fig. 3-30. See Fig. 3-31. See Fig. 3-23.
<u>Signal</u>	<u>Lines</u>																													
CCIR 17	24-47 & 336-359																													
CCIR 330	48-71 & 360-383																													
CCIR 331	72-95 & 384-407																													
CCIR 18	96-119 & 408-431																													
75% Color Bars . . .	120-143 & 432-455																													
Sin x/x	144-166 & 456-478																													
75% Red Field	167-190 & 479-502																													
15 kHz Square Wave																														
.	191-214 & 503-526																													
50% Flat Field	215-238 & 527-550																													
Shallow Ramp	239-262 & 551-574																													
UK ITS 1	263-286 & 575-598																													
UK ITS 2	287-310 & 599-622																													
Matrix (Opts 03 and 04)	75% Bars Red, Modulated Ramp, Line Sweep, Pulse & Bar, and 50% Flat Field.																													
Modulated 5-Step		See Figs. 3-XX and 3-YY. Option. 03 only.																												

Table 3-4.
Component Test Signal Definitions (Y, B-Y and R-Y Format).

CHARACTERISTICS	SIGNAL DEFINITIONS	SUPPLEMENTAL INFORMATION
75% Bars		See Figs. 3-71, 3-72, & 3-73. For Option 03 see Figs. 3-175, 3-176, & 3-177. For Opt 04 see Figs. 3-221, 3-222, & 3-223.
75% Bars over Red		See Figs. 3-71, 3-72, 3-73, 3-77, 3-78, & 3-79. Not available in Opts 03 & 04.

Table 3-4. Cont.

CHARACTERISTICS	SIGNAL DEFINITIONS	SUPPLEMENTAL INFORMATION
75% Bars and Level Reference (Opt 04 only)		See Figs. 3-221, 3-222, 3-223, 3-224, & 3-225.
100% Bars		See Figs. 3-74, 3-75, & 3-76. For Opt 03 see Figs. 3-178, 3-179, & 3-180.
100% Bars over Red		See Figs. 3-74, 3-75, 3-76, 3-80, 3-81, & 3-82. Not available in Opts 03 & 04.
Flat Field Nominal Amplitude Y Channel, 50% Y Channel, 100% Y Channel, 0% B-Y & R-Y (Opt 03 only)	350 mV 700 mV 0 mV 262 mV	See Figs. 3-83, 3-84, & 3-85. For Option 03 see Figs. 3-184, 3-185, 3-186, & 3-187.
Valid 5-Step Amplitude Linearity	700 mV in each channel with simultaneous offsetting signals in the other two channels. 1% relative step matching.	See Figs. 3-86, 3-87, & 3-88. Not available in Opts 03 & 04.
Pulse & Bar Bar Risetime Pulse HAD (T = 100 ns) Amplitude Y Channel B-Y Channel R-Y Channel	192.9 ns ± 20 ns 2T and 10T 700 mV ± 350 mV ± 350 mV	See Figs. 3-89, 3-90, & 3-91. For Opt 03 see Figs. 3-181, 3-182, & 3-183. For Opt 04 see Figs. 3-226, 3-227, & 3-228.
T Pulses Y Channel Pulses 2T Pulse HAD 3T Pulse HAD 5T Pulse HAD B-Y, R-Y Channel Pulses 4T Pulse HAD 8T Pulse HAD Bar Amplitude Y Channel B-Y, R-Y Channels	200 ns 300 ns 500 ns 400 ns 800 ns 0 - 700 mV ± 350 mV	See Figs. 3-92 & 3-93. For Opt 03 see Figs. 3-195 & 3-196. For Opt 04 see Figs. 3-229 & 3-230.

Table 3-4. Cont.

CHARACTERISTICS	SIGNAL DEFINITIONS	SUPPLEMENTAL INFORMATION
Line Sweep Sweep Amplitude Y Channel B-Y, R-Y Channel Reduced Sweep Amplitude Y Channel B-Y, R-Y Channel Frequency Response Y Channel B-Y, R-Y Channel Markers Y Channel B-Y, R-Y Channel	420 mV _{p-p} 420 mV _{p-p} 350 mV _{p-p} 350 mV _{p-p} 200 kHz to 6.5 MHz 100 kHz to 3.25 MHz 1, 2, 3, 4, 5, and 6 MHz 0.5, 1, 1.5, 2, 2.5, & 3 MHz	See Figs. 3-94, 3-95, 3-96, & 3-97. Reduced sweep not available on Opt 03. For Opt 03 see Figs. 3-203 & 3-204. For Opt 04 see Figs. 3-233, 3-234, 3-235, & 3-236.
Channel Timing (Bowtie) Amplitude Y Channel (50%) B-Y, R-Y Channel (50%) Y 100% (Opt 04 only) B-Y & R-Y 100% (Opt 04 only) Frequency Y Channel B-Y, R-Y Channel Timing Markers 12T Pulses (Opt 03 only)	350 mV ± 175 mV 700 mV ± 350 mV 500 kHz 502 kHz	See Figs. 3-98, 3-99, & 3-100. For Opt 03 see Figs. 3-205, 3-206, & 3-207. For Opt 04 (100%) see Figs. 3-239, 3-240, & 3-241. Eleven timing markers indicating 20 ns delay/advance between channels. Two timing markers centered about the center marker indicating 5 ns delay/advance between channels. See Figs. 3-208, 3-209, & 3-210 for the 12T pulses.
Multiburst Amplitude Y Channel R-Y, B-Y White Flag Frequencies Y Channel R-Y, B-Y	420 mV _{p-p} 420 mV _{p-p} 420 mV _{p-p} 0.5, 1.0, 2.0, 3.0, 4.0, & 5.0 MHz 0.5, 1.0, 1.5, 2.0, & 2.5 MHz	See Figs. 3-101 & 3-102. Centered on 350 mV Centered on 0 mV For Option 03 see Figs. 3-199 & 3-200. Not available on Opt 04.

Table 3-4. Cont.

CHARACTERISTICS	SIGNAL DEFINITIONS	SUPPLEMENTAL INFORMATION
Wide Multiburst (Opt 03 only) Amplitude Y Channel R-Y, B-Y White Flag Frequencies Y Channel R-Y, B-Y	420 mV _{p-p} 420 mV _{p-p} 420 mV _{p-p} 0.5, 1.0, 2.0, 3.0, 4.0, 5.0, & 6.0 MHz 0.5, 1.0, 1.5, 2.0, & 2.5 MHz	See Figs. 3-201 & 3-202. Centered on 350 mV Centered on 0 mV
5-Step Amplitude	700 mV	Only available on Opts 03 and 04. Opt. 03 see Figs. 3-190 & 3-191. Opt 04 see Figs. 3-231 & 3-232.
"Line 17" (Opt 03 only)		See Figs. 3-197 & 3-198.
Sin(x)/x (Opt 03 only)		See Figs. 3-188 & 3-189.
Quad Phase (Opt 03 only)		See Figs. 3-192, 3-193, & 3-194.
Oversized Ramp (Opt 04 only)		See Figs. 3-237 & 3-238.
Matrix	75% Bars, 50% Flat Field, Bowtie, Bowtie Markers, 5-Step, Multiburst, and T Pulses.	This is the matrix for the standard instrument and Opts. 01, 01/02, and 02.
Matrix (Opt. 03 only)	100% Color Bars 60% Wide Multiburst Bowtie Bowtie Markers "Line 17" T Pulses	

Table 3-5.
Component Test Signal Definitions (CTDM Format).¹

CHARACTERISTICS	SIGNAL DEFINITION		SUPPLEMENTAL INFORMATION	
	Standard	MII	Standard	MII
75% Bars			See Figs. 3-103 & 3-104. For Opt 03 see Figs. 3-211 & 3-212.	Opt 01 only. See Figs. 3-141 & 3-142.
100% Bars			See Figs. 3-105 & 3-106. Not available in Opt 03.	For Opt. 01 see Figs. 3-143 & 3-144. For Opt 04 see Figs. 3-242 & 3-243.
Flat Field Nominal Amplitude Y Channel, 50% Y Channel, 100% Y Channel, 0%	350 mV 700 mV 0 mV		See Figs. 3-108, 3-109, 3-110, & 3-107. Not available in Opt 03.	Opt 01 only. See Figs. 3-145, 3-146, 3-147, & 3-148.

- 1. Standard 2-wire component test signals are available on the TSG 131A standard instrument and Options 02 and 03. MII component test signals are available on the TSG 131A Options 01 and 04.

Table 3-6.
Test Signal Generator — Test Signal Definitions, GBR Format.

CHARACTERISTICS	SIGNAL DEFINITIONS	SUPPLEMENTAL INFORMATION
75% Bars		See Figs. 3-111 to 3-113.
100% Bars		See Figs. 3-114 to 3-116.
10-Step Staircase Amplitude (B & R)	700 mV	See Figs. 3-129 and 3-130.
2T Pulse & Bar with Window Window Timing 2T Pulse HAD Bar Amplitude	Lines 72 to 202 250 ns 700 mV	See Figs. 3-131 and 3-132.
Color Fields Red Field Green Field Blue Field	700 mV on R Channel 700 mV on G Channel 700 mV on B Channel	See Figs. 3-117 to 3-119. See Figs. 3-123 and 3-124. See Figs. 3-120 to 3-122.
Multiburst Amplitude White Flag Frequencies	420 mV _{p-p} centered on 350 mV 420 mV _{p-p} centered on 350 mV 1, 2, 3, 4, 5, and 6 MHz	See Figs. 3-133 and 3-134.
100% Line Sweep Amplitude Frequency Range Markers	700 mV 100 kHz to 6.6 MHz	See Figs. 3-135 and 3-136. 1, 2, 3, 4, 5, and 6 MHz
Bowtie G Channel B Channel R Channel Channel Amplitudes Timing Markers	500 kHz sine wave 502 kHz sine wave 502 kHz sine wave 350 mV (all Channels) 13 timing markers	See Figs. 3-137 to 3-140. Marker spacing indicates 20 ns delay or advance between channels.
Convergence Amplitude Pattern	525 mV (75%) Crosshatch 14 horizontal lines and 19 vertical lines per field.	See Figs. 3-125, 3-126, 3-127, and 3-128.

Table 3-7. Black Burst Output (Opts. 02 & 03).

CHARACTERISTICS	PERFORMANCE REQUIREMENTS	SUPPLEMENTAL INFORMATION	PER. CHECK STEP #
Black Amplitude	0 mV ± 50 mV		61.
Blanking Width	12.0 μs ± 0.15 μs		
Sync Timing	See Fig. 3-1.		

**Table 3-8
Video Comp Sync (Opts. 2, 3, & 4)**

CHARACTERISTICS	PERFORMANCE REQUIREMENT	SUPPLEMENTAL INFORMATION	PER. CHECK STEP #
Duration Horizontal Sync Vertical Serrations Equalizing Pulses	4.7 μs ± 100 ns 4.7 μs ± 100 ns 2.35 μs ± 100 ns		63.
Amplitude Opt 2 & 3 Opt 4 (TTL)	2.0 ± 0.4 V >2.8 V (Hi) to 0.2 ± 0.2 V (Lo)	Jumper Selectable to -4 V.	64.
Rise and Fall Times	250 ns ± 50 ns		65.
Impedance		75 Ω	
Return Loss		≥ 30 dB to 5 MHz	

**Table 3-9.
Audio Tone Characteristics.**

CHARACTERISTICS	PERFORMANCE REQUIREMENTS	SUPPLEMENTAL INFORMATION	PER. CHECK STEP #
Amplitude	0 to +8 dBu adjustable.	50 Ω output balanced XLR impedance to drive a 600 Ω load ONLY .	
Frequency	1 kHz		
Distortion (THD)	≤ 0.5% THD		60.
Audio ID “click” Frequency Range (one channel only)	Rate adjustable from 0.2 Hz to 4 Hz.		

TSG 131A – Specifications

**Table 3–10.
Power Supply Specifications**

CHARACTERISTICS	PERFORMANCE REQUIREMENT	SUPPLEMENTAL INFORMATION
Supply Accuracy +5 V –5.2 V –12 V +12 V		+5 V \pm 250 mV –5.2 V +300 mV to –500 mV –12 V \pm 600 mV +12 V \pm 600 mV
Power Limit		18 Watts
Hum +5 V –5.2 V –12 V +12 V		Typical 10 mV 20 mV 10 mV 10 mV
Noise +5 V –5.2 V –12 V +12 V		\leq 50 mV (5 MHz bandwidth) \leq 50 mV (5 MHz bandwidth) \leq 50 mV (5 MHz bandwidth) \leq 50 mV (5 MHz bandwidth)
Line Voltage Range 115 V _{ac} 240 V _{ac}		90 – 130 V _{ac} 180 – 250 V _{ac}
Fuse Data 110 V Setting 230 V Setting		250 V, 0.4 A Med. Blow 250 V, 0.4 A Med. Blow
Power Consumption, Typical		15 Watts
Line Frequency		48 – 62 Hz
Peak Inrush Current		0.3 A @ 180 V _{ac} /50 Hz 0.46 A @ 250 V _{ac} /50 Hz

Mechanical Specifications

Table 3-11.
Physical Characteristics.

CHARACTERISTICS	SUPPLEMENTAL INFORMATION
Dimensions	
Height	43.4 mm (1.71 in)
Width	205.7 mm (8.10 in)
Length	381.0 mm (15.0 in)
Net Weight	1.47 kg (4 lbs 6 oz)
Shipping Weight	3.2 kg (7 lbs 1 oz)

Environmental Specifications

Table 3-12.
Environmental Characteristics

CHARACTERISTICS	SUPPLEMENTAL INFORMATION
Temperature	
Non-Operating	-40 to +65 °C
Operating	0 to +35 °C
Altitude	
Non-Operating	To 50,000 feet
Operating	To 15,000 feet
Vibration (Operating)	5 minutes each axis at 0.060 inch, with frequency varied from 5-15-5 cycles per second with instrument secured to vibration platform. 5 minutes each axis at 0.020 inch, with frequency varied from 25-55-25 cycles per second with instrument secured to vibration platform. 5 minutes each axis at 0.040 inch, with frequency varied from 15-25-15 cycles per second with instrument secured to vibration platform. Ten minutes each axis at any resonant point or at 33 cycles per second.
Shock	50 g, 1/2 sine, 11 ms duration, 3 guillotine-type shocks per side.
Transportation	Qualified under PAL Test Procedure 1A, Category II (24 inch drop).

Table 3–13: Certifications and compliances

Category	Standards or description
EC Declaration of Conformity – EMC	<p>Meets intent of Directive 89/336/EEC for Electromagnetic Compatibility. Compliance was demonstrated to the following specifications as listed in the Official Journal of the European Union:</p> <p>EN 50081-1 Emissions: EN 55022 Class B Radiated and Conducted Emissions</p> <p>EN 50082-1 Immunity: IEC 801-2 Electrostatic Discharge Immunity IEC 801-3 RF Electromagnetic Field Immunity IEC 801-4 Electrical Fast Transient/Burst Immunity</p> <p>High quality shielded cables must be used to ensure compliance with the above listed specifications.</p>
Australia/New Zealand Declaration of Conformity – EMC	<p>Complies with EMC provision of Radiocommunications Act per the following standard(s):</p> <p>AN/NZS 2064.1/2 Industrial, Scientific, and Medical Equipment: 1992 AN/NZS 3548 Information Technology Equipment: 1995</p>
EMC Compliance	<p>Meets the intent of Directive 89/336/EEC for Electromagnetic Compatibility when it is used with the product(s) stated in the specifications table. Refer to the EMC specification published for the stated products. May not meet the intent of the directive if used with other products.</p>
FCC Compliance	<p>Emissions comply with FCC Code of Federal Regulations 47, Part 15, Subpart B, Class A Limits.</p>
EC Declaration of Conformity – Low Voltage	<p>Compliance was demonstrated to the following specification as listed in the Official Journal of the European Union:</p> <p>Low Voltage Directive 73/23/EEC, amended by 93/69/EEC</p> <p>EN 61010-1:1993 Safety requirements for electrical equipment for measurement control and laboratory use.</p>
U.S. Nationally Recognized Testing Laboratory Listing	<p>UL1244 Standard for electrical and electronic measuring and testing equipment.</p>
Canadian Certification	<p>CAN/CSA C22.2 No. 231 Safety requirements for electrical and electronic measuring and test equipment.</p>
Additional Compliance	<p>ANSI/ISA S82.01:1994 Safety standard for electrical and electronic test, measuring, controlling, and related equipment.</p> <p>IEC61010-1 Safety requirements for electrical equipment for measurement, control, and laboratory use.</p>
Installation (Overvoltage) Category	<p>Terminals on this product may have different installation (overvoltage) category designations. The installation categories are:</p> <p>CAT III Distribution-level mains (usually permanently connected). Equipment at this level is typically in a fixed industrial location.</p> <p>CAT II Local-level mains (wall sockets). Equipment at this level includes appliances, portable tools, and similar products. Equipment is usually cord-connected.</p> <p>CAT I Secondary (signal level) or battery operated circuits of electronic equipment.</p>

Table 3-13: Certifications and compliances (cont.)

Category	Standards or description
Pollution Degree	<p>A measure of the contaminates that could occur in the environment around and within a product. Typically the internal environment inside a product is considered to be the same as the external. Products should be used only in the environment for which they are rated.</p> <p>Pollution Degree 1 No pollution or only dry, nonconductive pollution occurs. Products in this category are generally encapsulated, hermetically sealed, or located in clean rooms.</p> <p>Pollution Degree 2 Normally only dry, nonconductive pollution occurs. Occasionally a temporary conductivity that is caused by condensation must be expected. This location is a typical office/home environment. Temporary condensation occurs only when the product is out of service.</p> <p>Pollution Degree 3 Conductive pollution, or dry, nonconductive pollution that becomes conductive due to condensation. These are sheltered locations where neither temperature nor humidity is controlled. The area is protected from direct sunshine, rain, or direct wind.</p> <p>Pollution Degree 4 Pollution that generates persistent conductivity through conductive dust, rain, or snow. Typical outdoor locations.</p>

Waveform Illustrations

NOTE

In the following waveform drawings, the time is referenced to the half-amplitude point (or the peak for a pulse) unless otherwise specified.

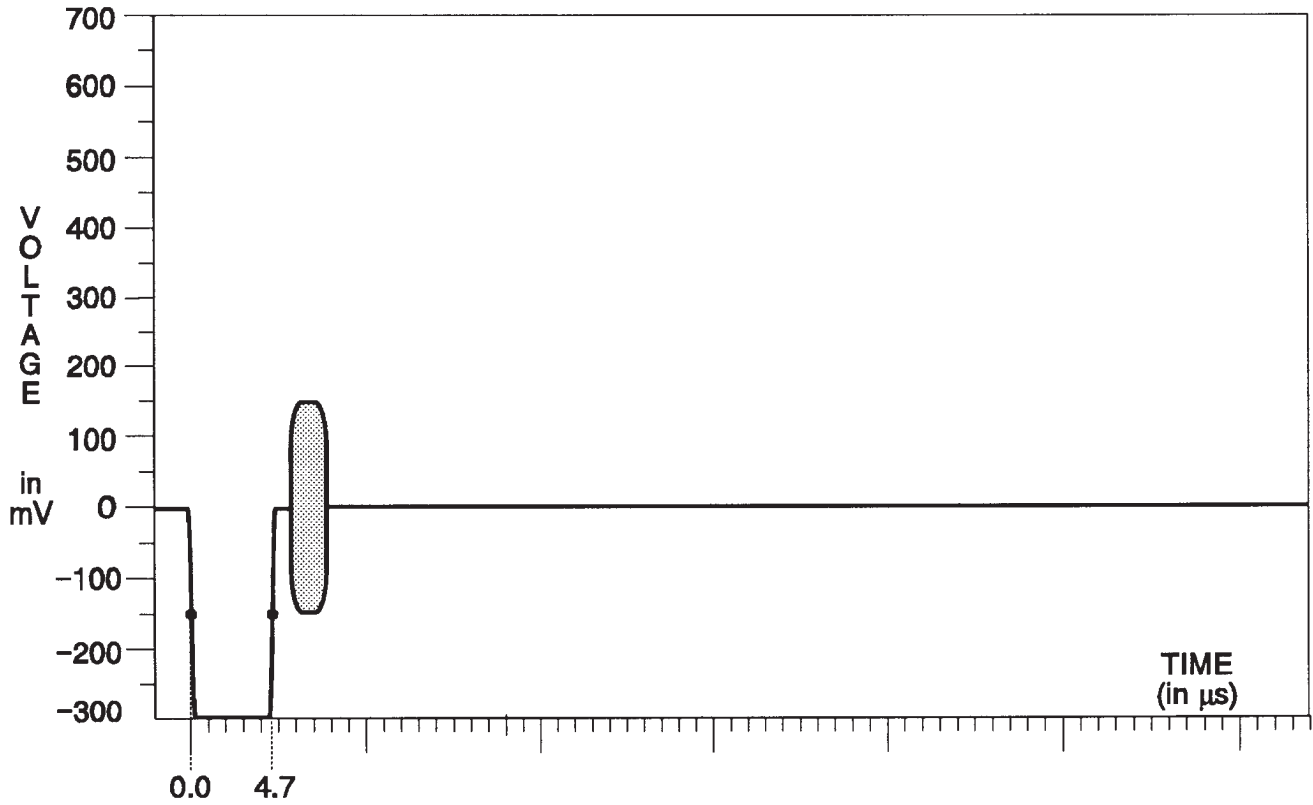

Fig. 3-1. Black Burst.

Composite Signals

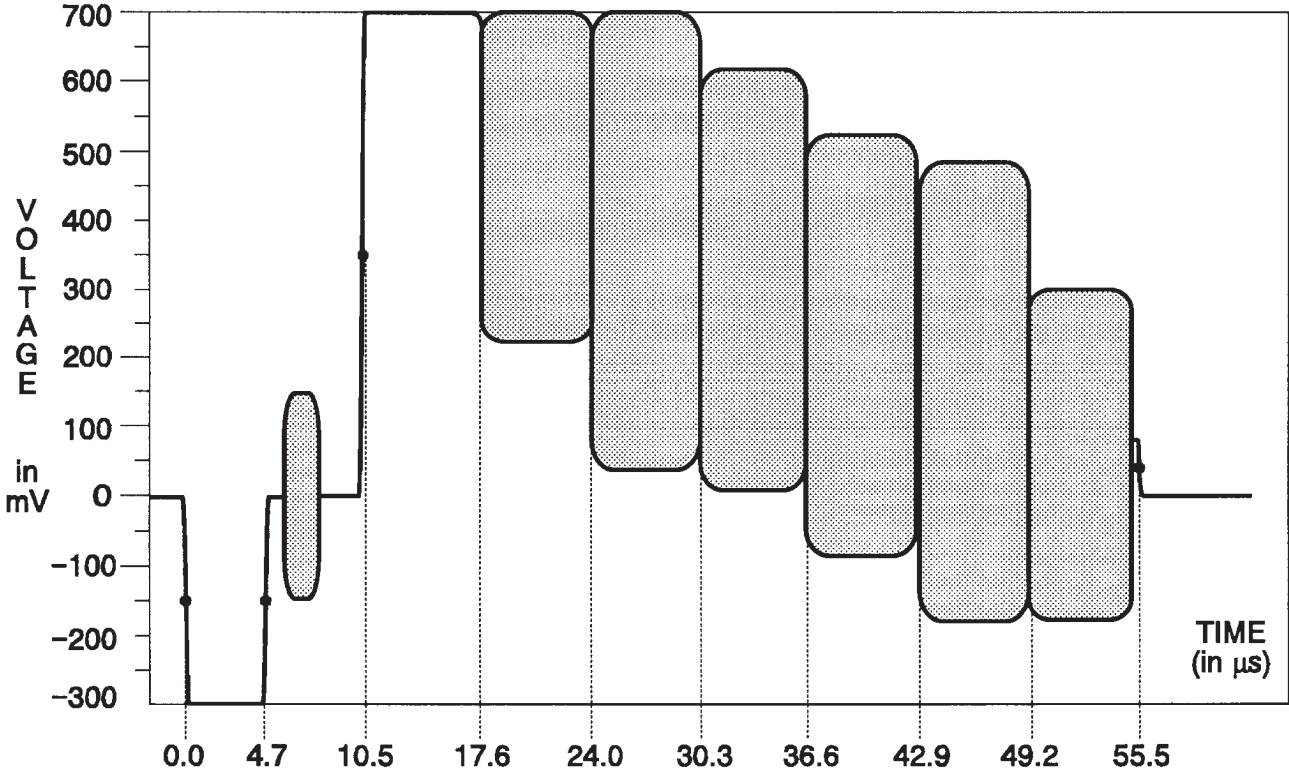

Fig. 3-2. 75% Color Bars.

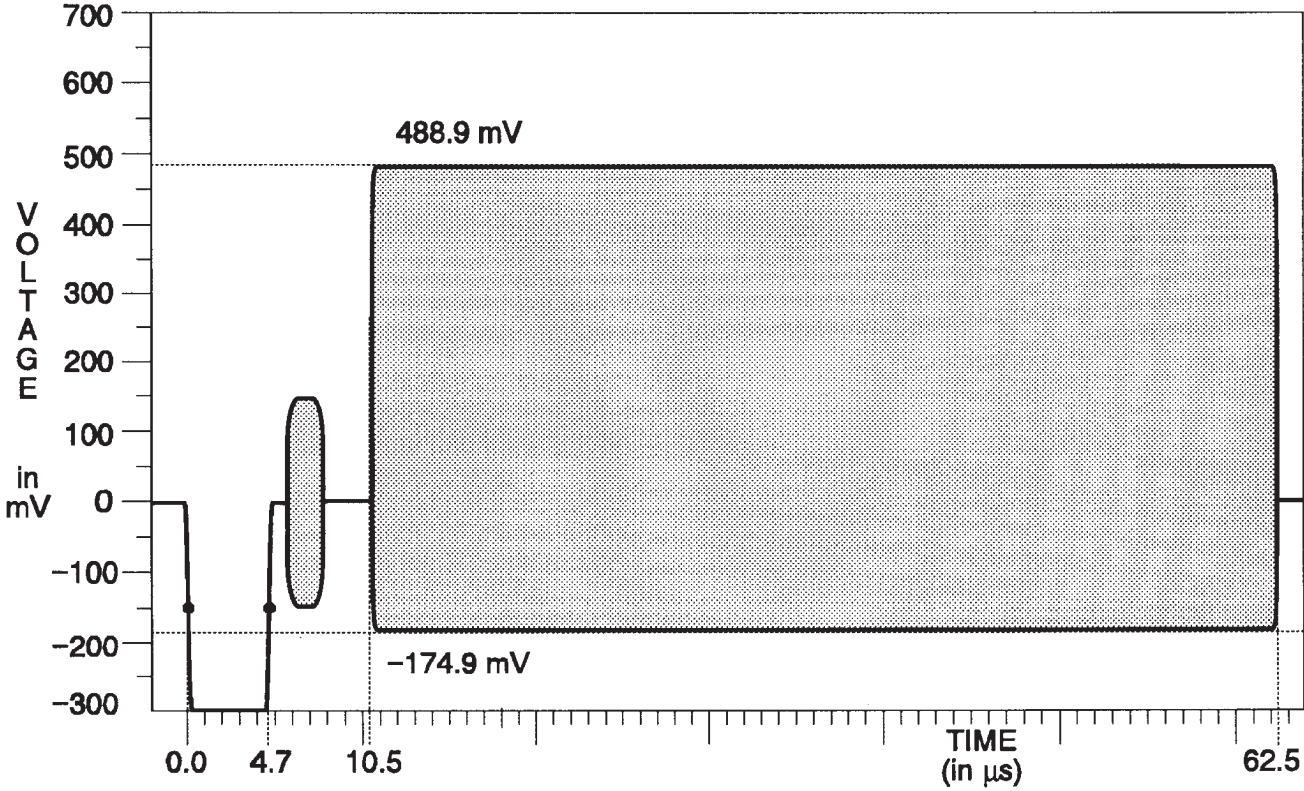
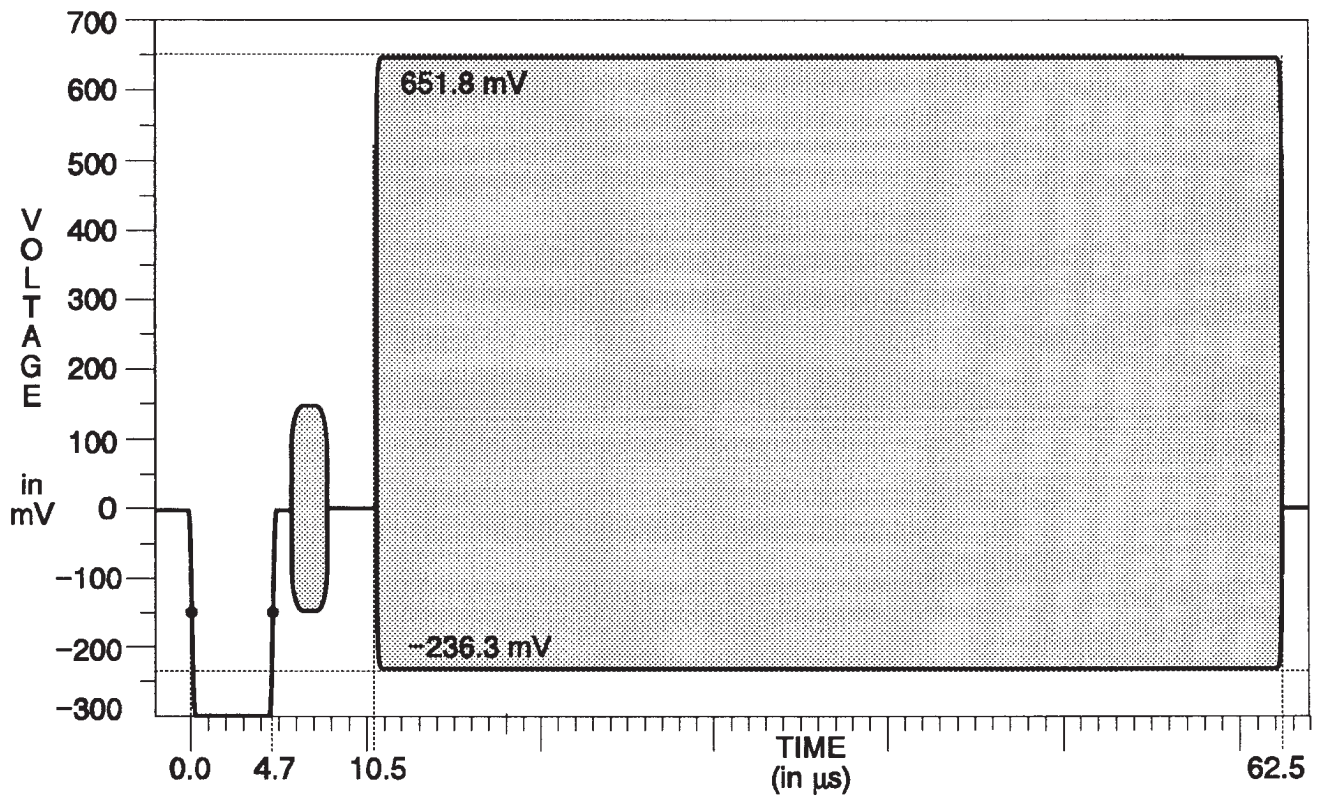
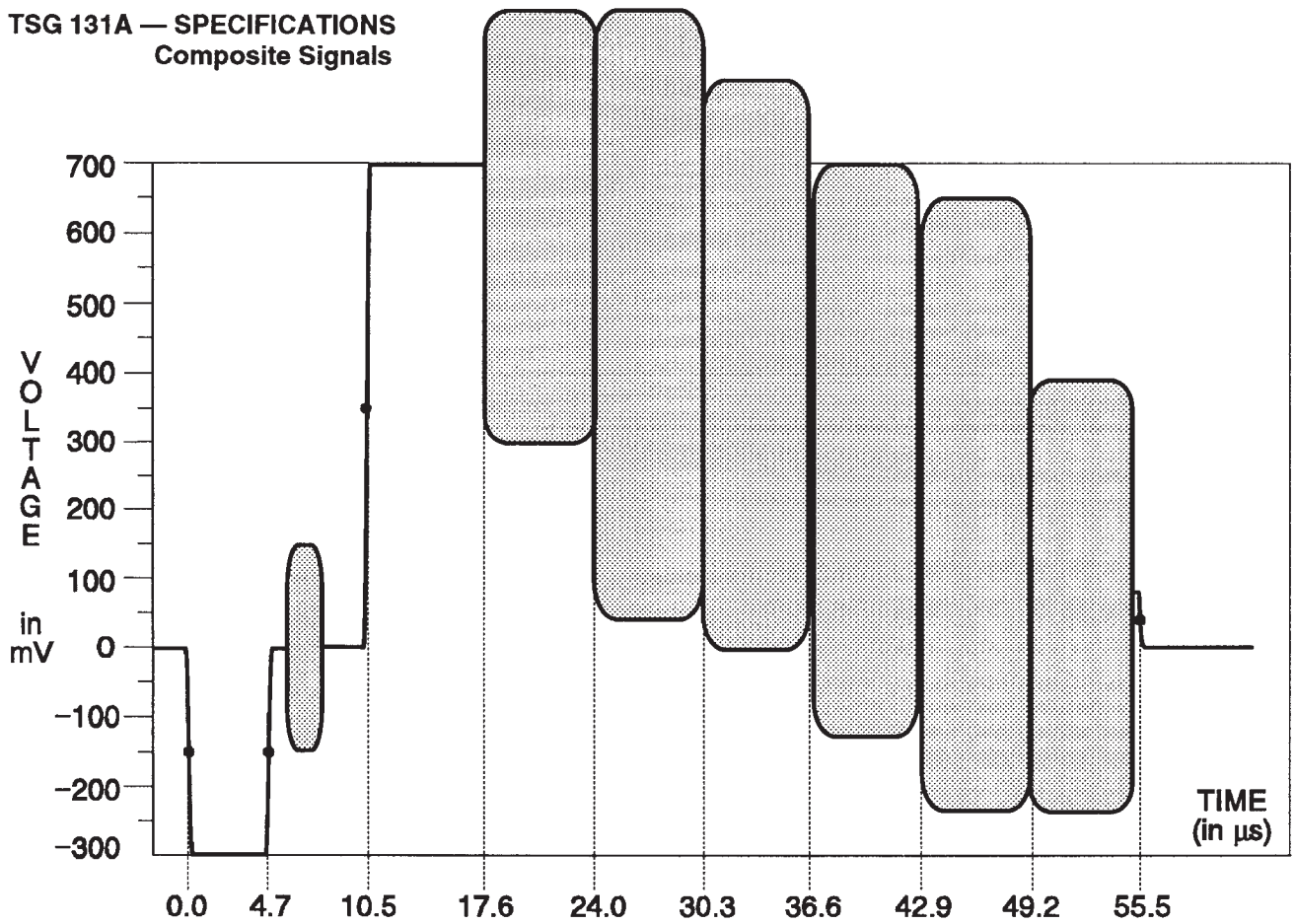

Fig. 3-3. 75% Red.

TSG 131A — SPECIFICATIONS
Composite Signals



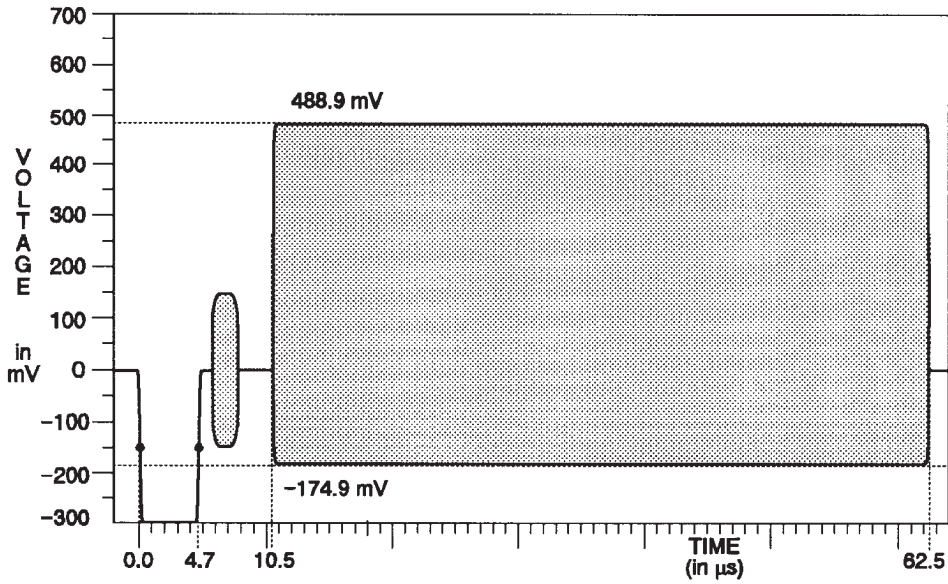

Fig. 3-6.
Red
Field.

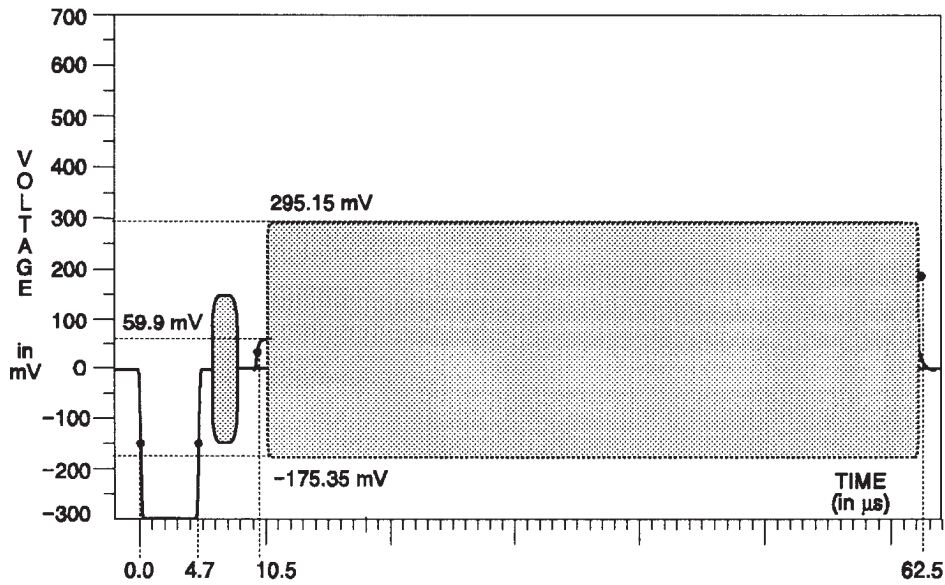

Fig. 3-7.
Blue
Field.

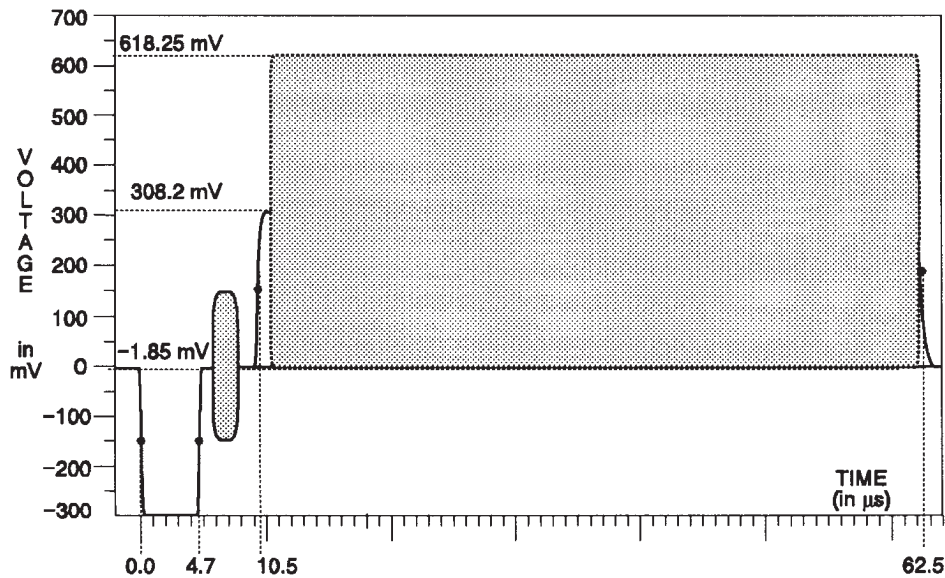

Fig. 3-8.
Green
Field.

TSG 131A — SPECIFICATIONS

Composite Signals

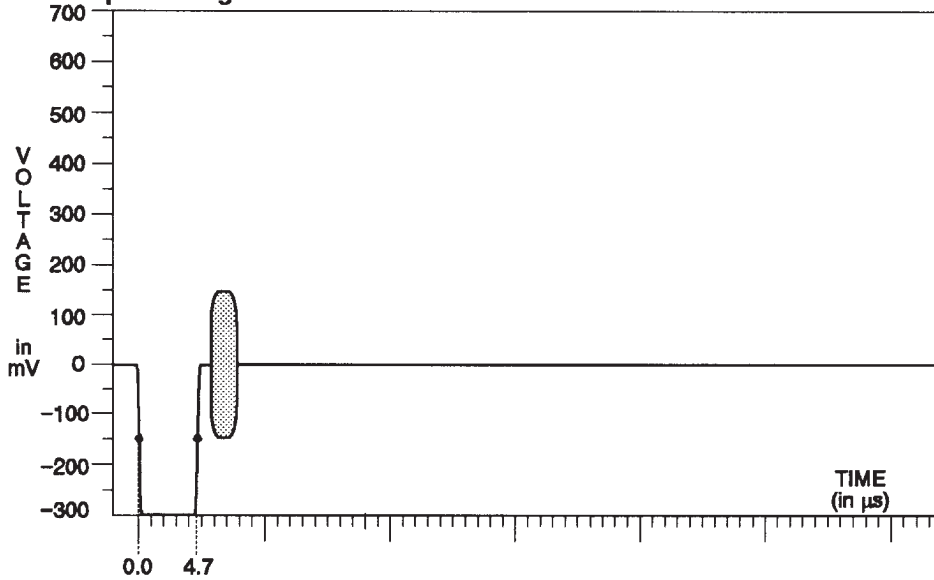

Fig. 3-9.
0% Flat
Field.

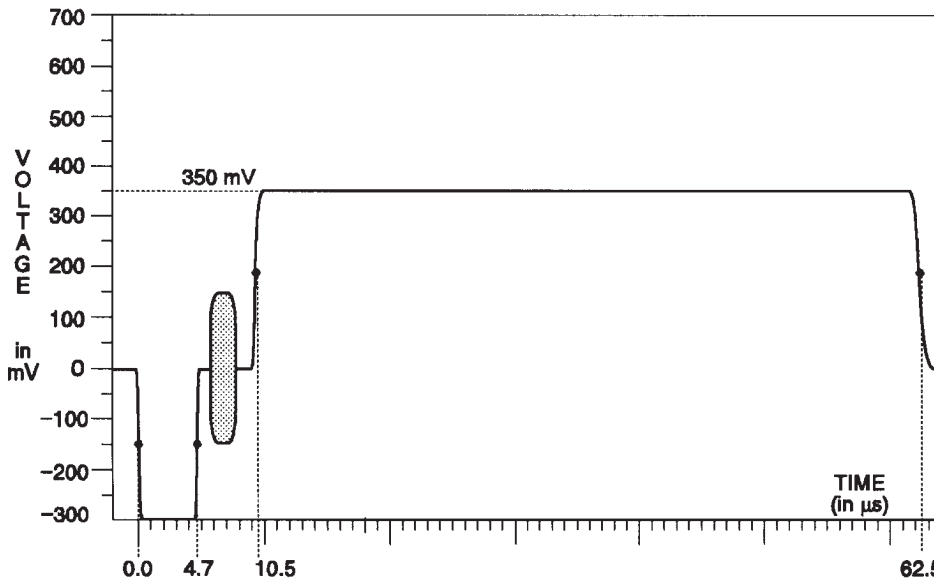

Fig. 3-10.
50% Flat
Field.

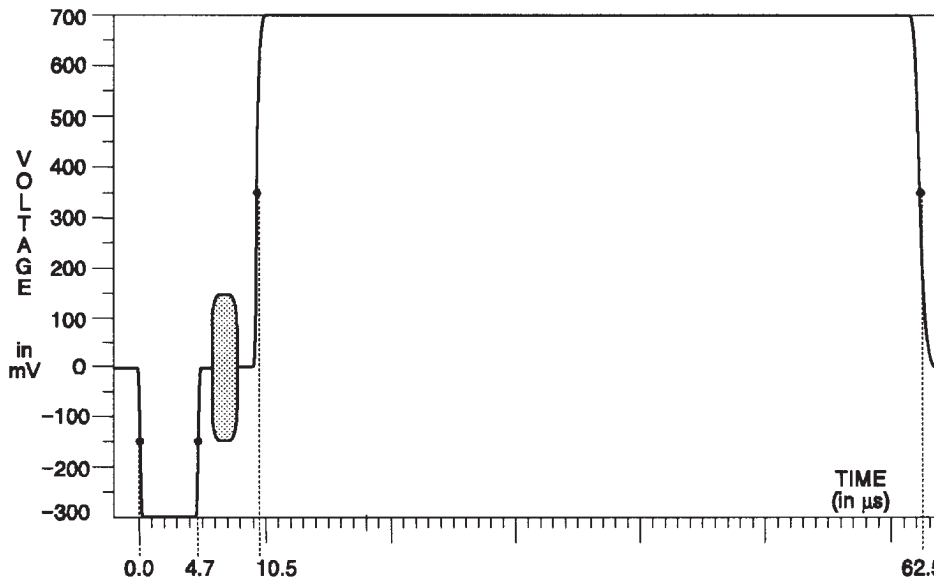

Fig. 3-11.
100% Flat
Field

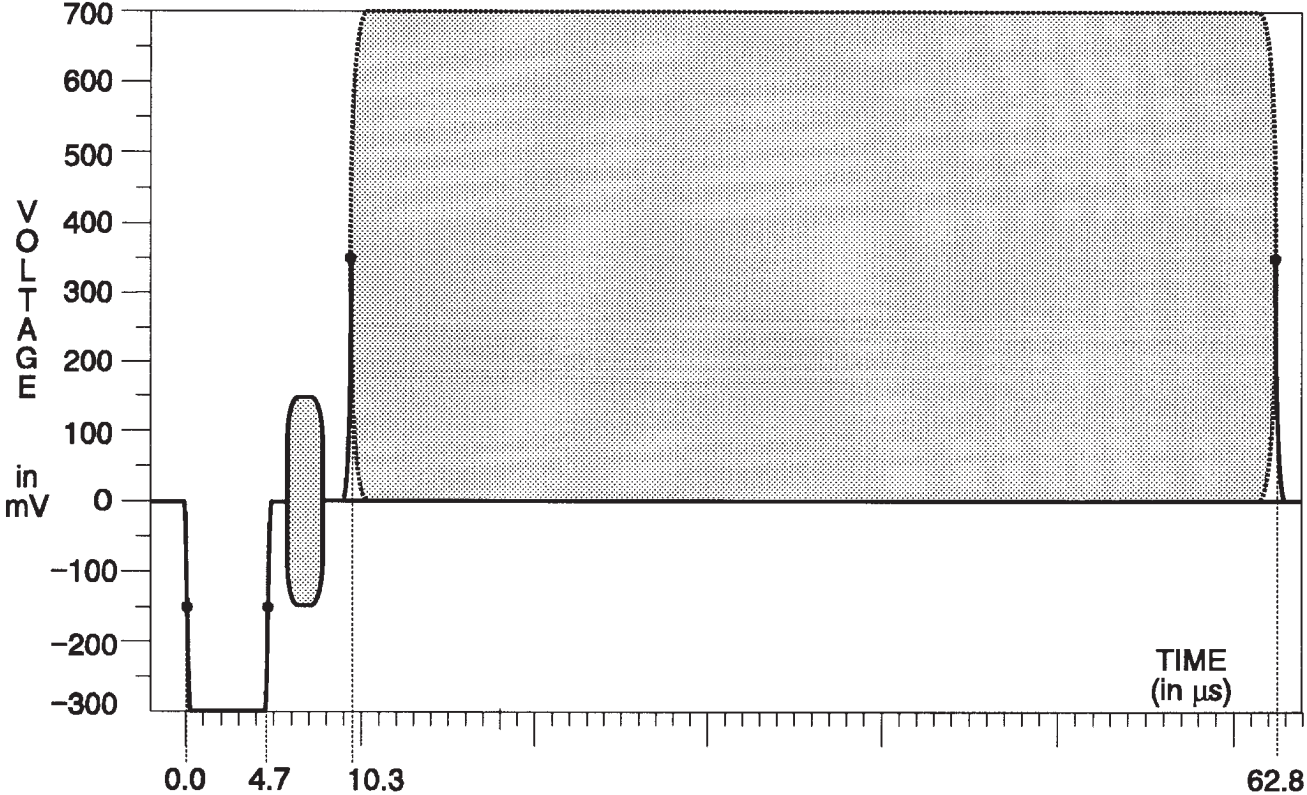

Fig. 3-12. Chroma Noise.

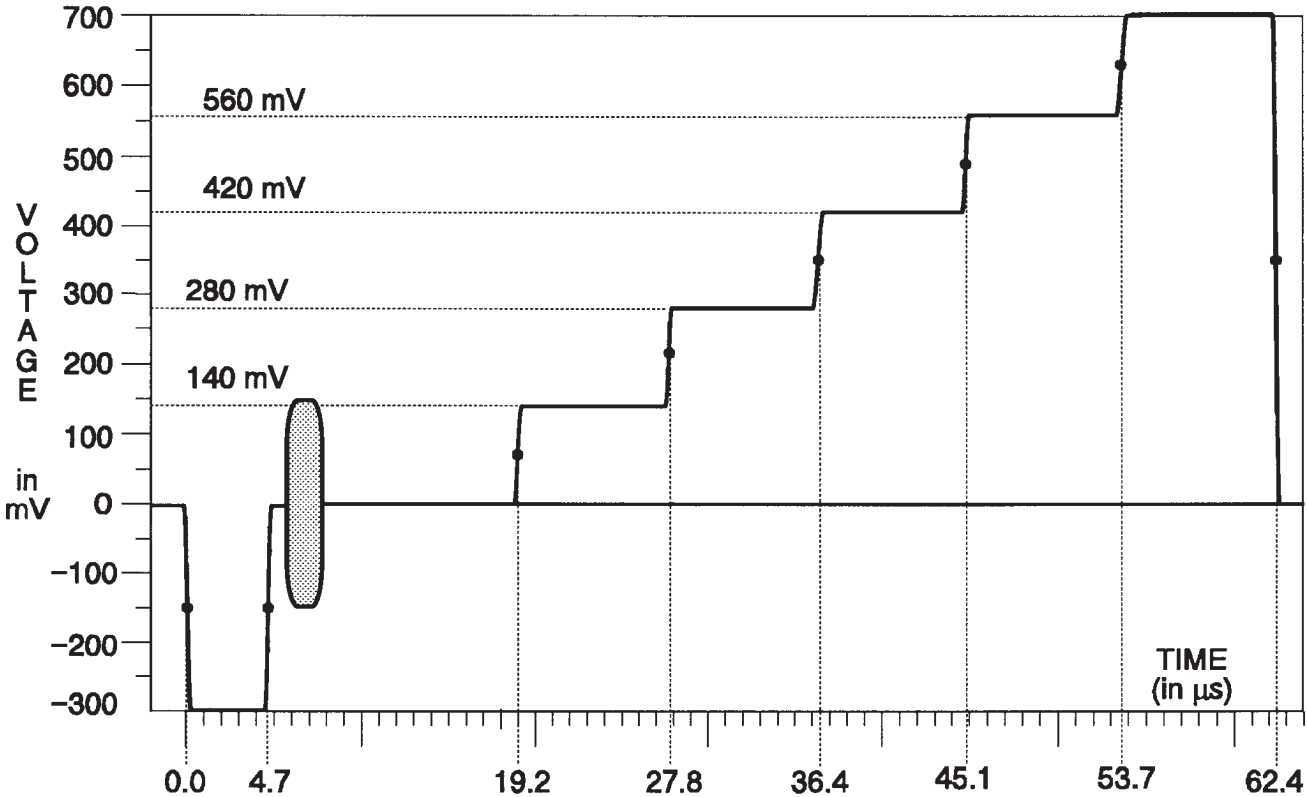

Fig. 3-13. 5-Step (Gray Scale).

TSG 131A — SPECIFICATIONS
Composite Signals

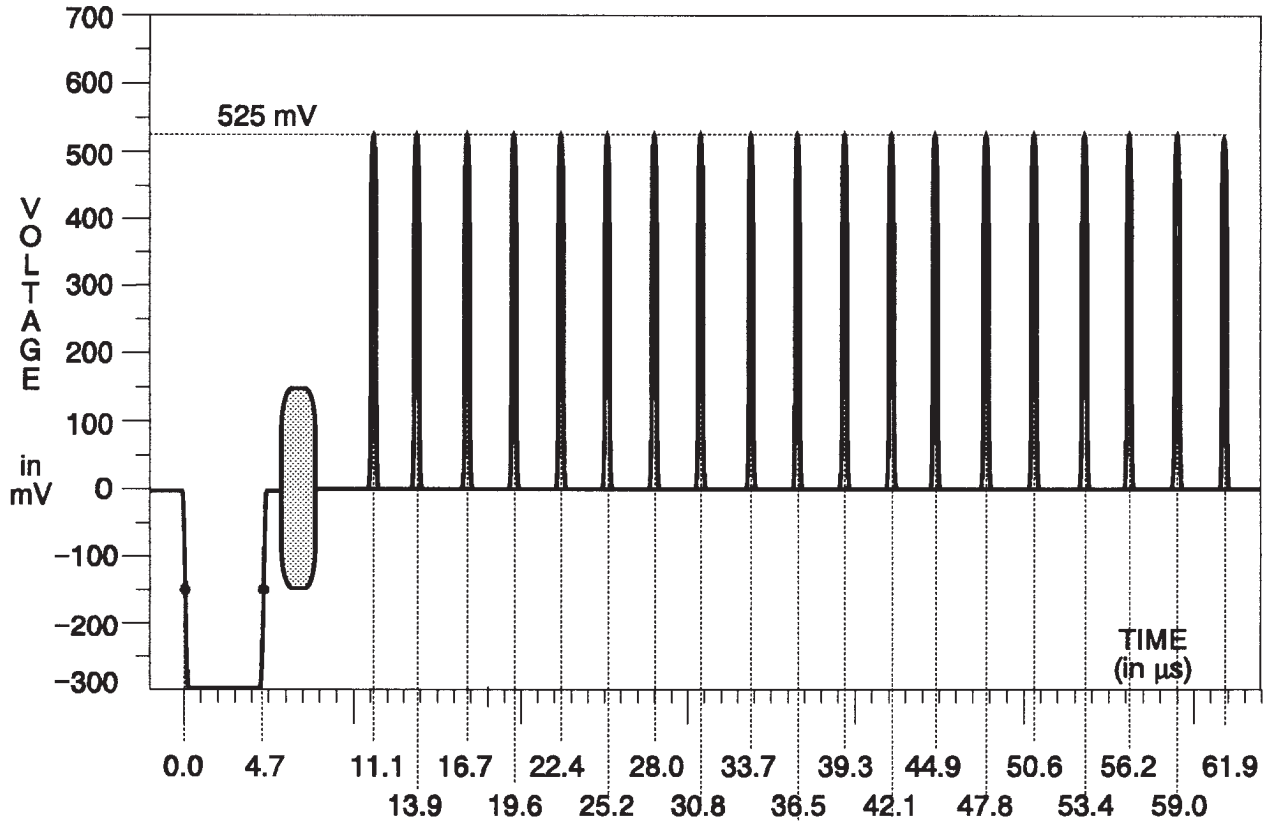

Fig. 3-15. Convergence (vertical).

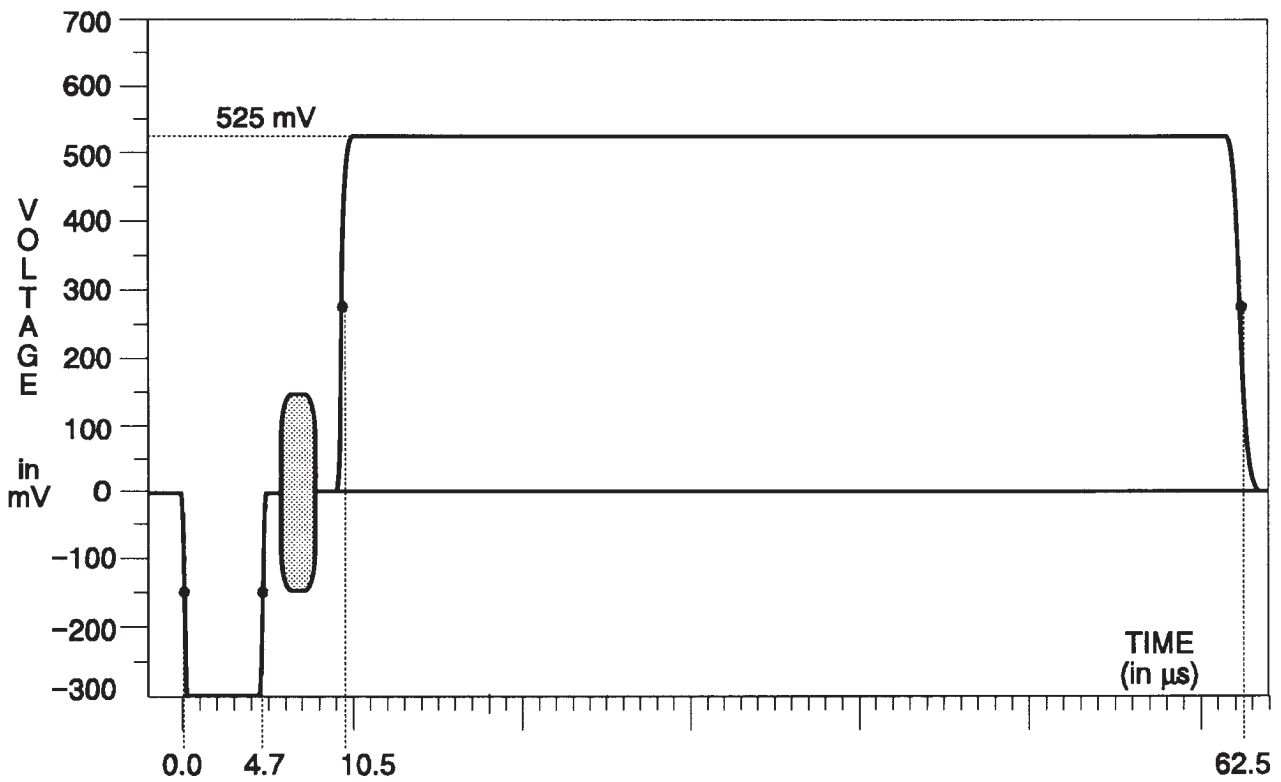

Fig. 3-14. Convergence (horizontal).

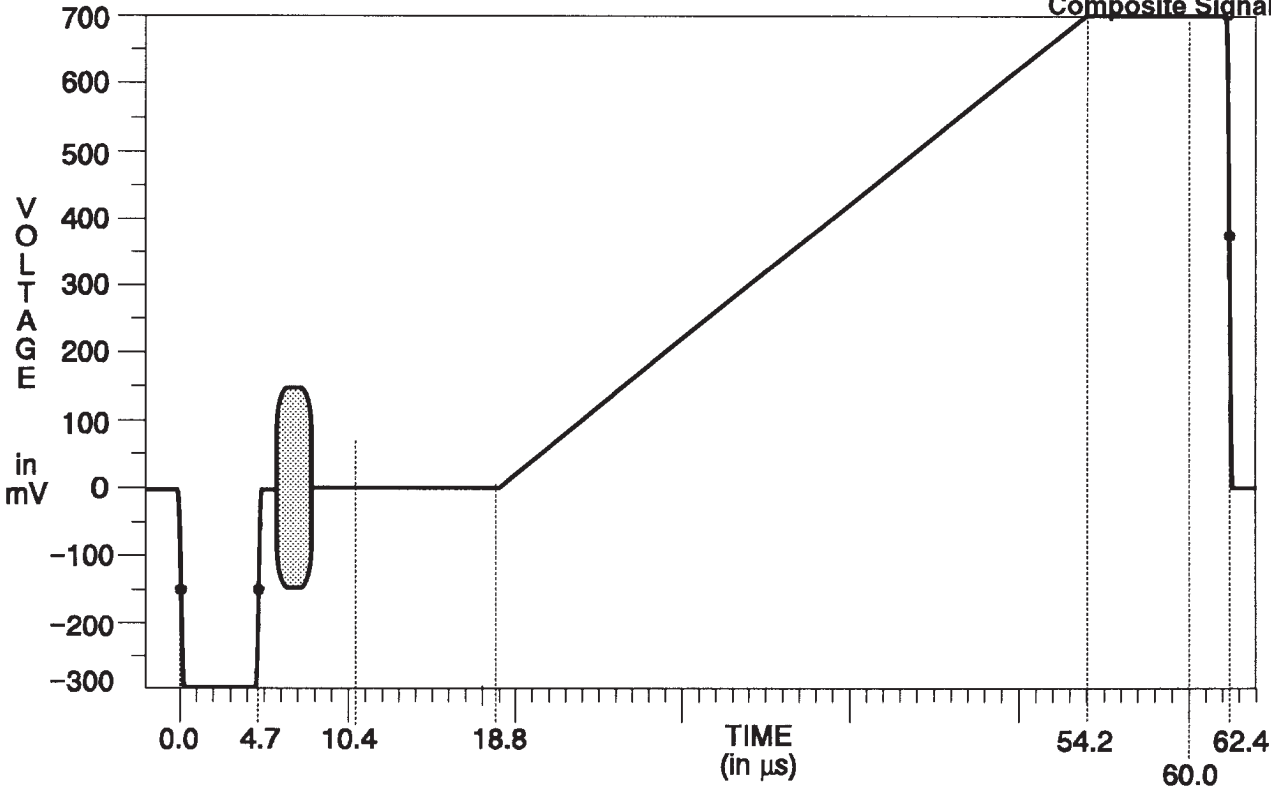

Fig. 3-16. Ramp.

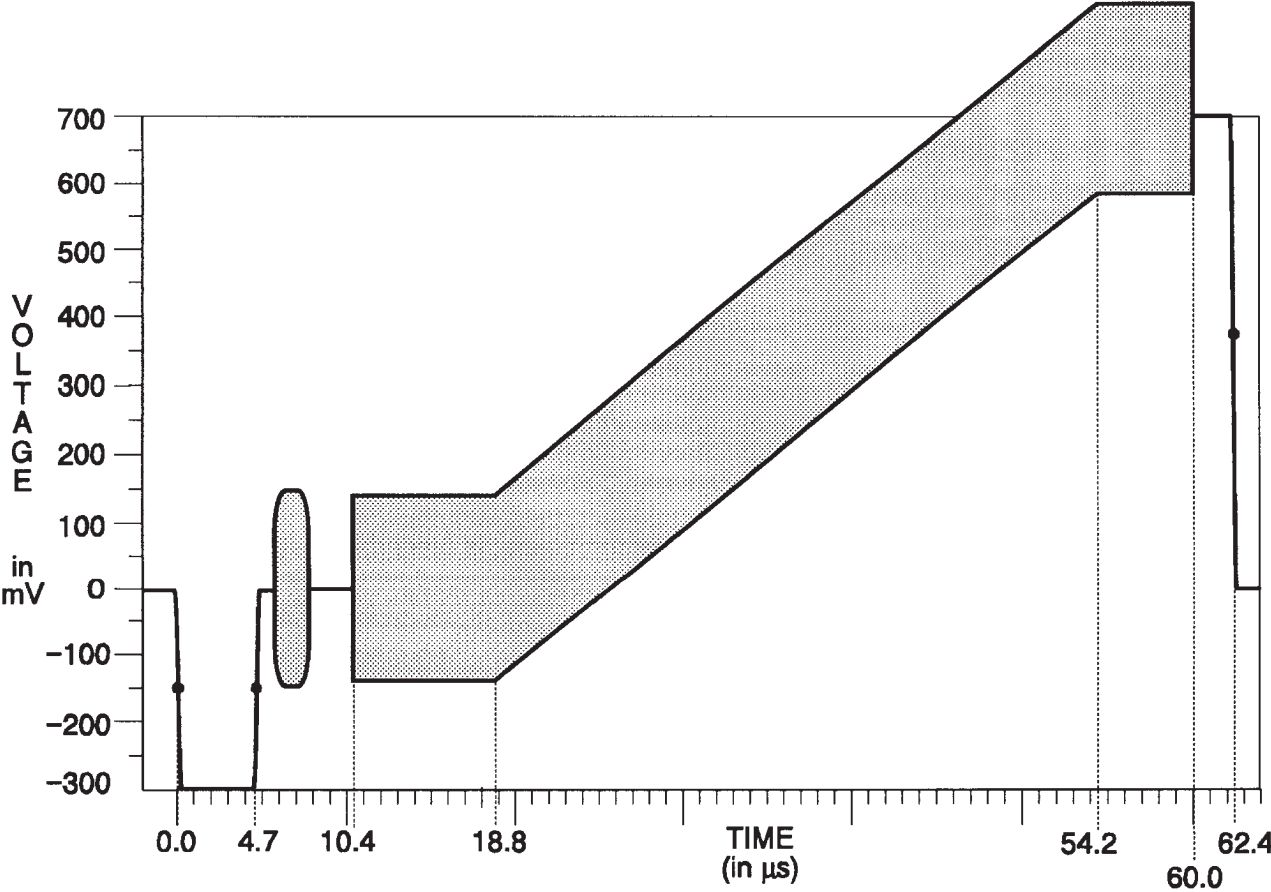

Fig. 3-17. Modulated Ramp.

TSG 131A — SPECIFICATIONS
Composite Signals

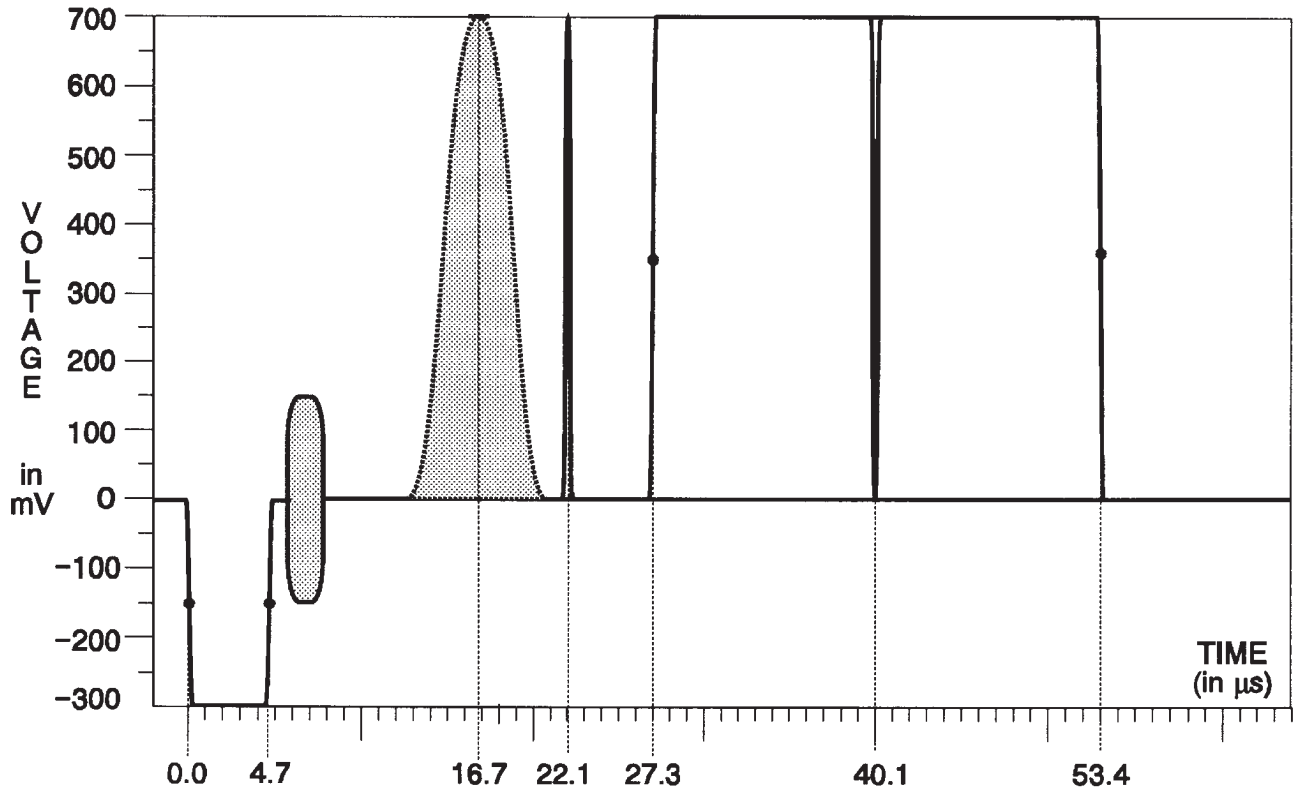

Fig. 3-18. Pulse & Bar with Window.

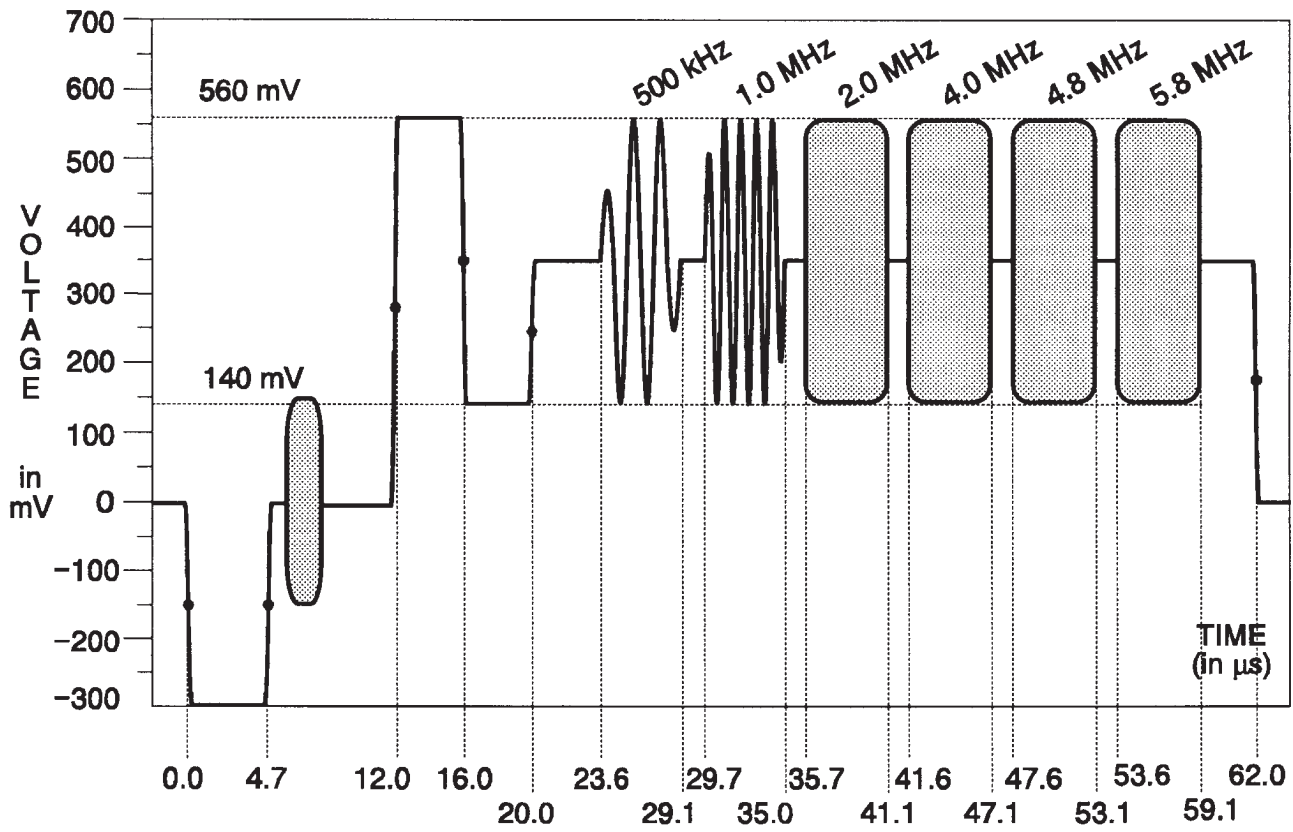

Fig. 3-19. Multiburst.

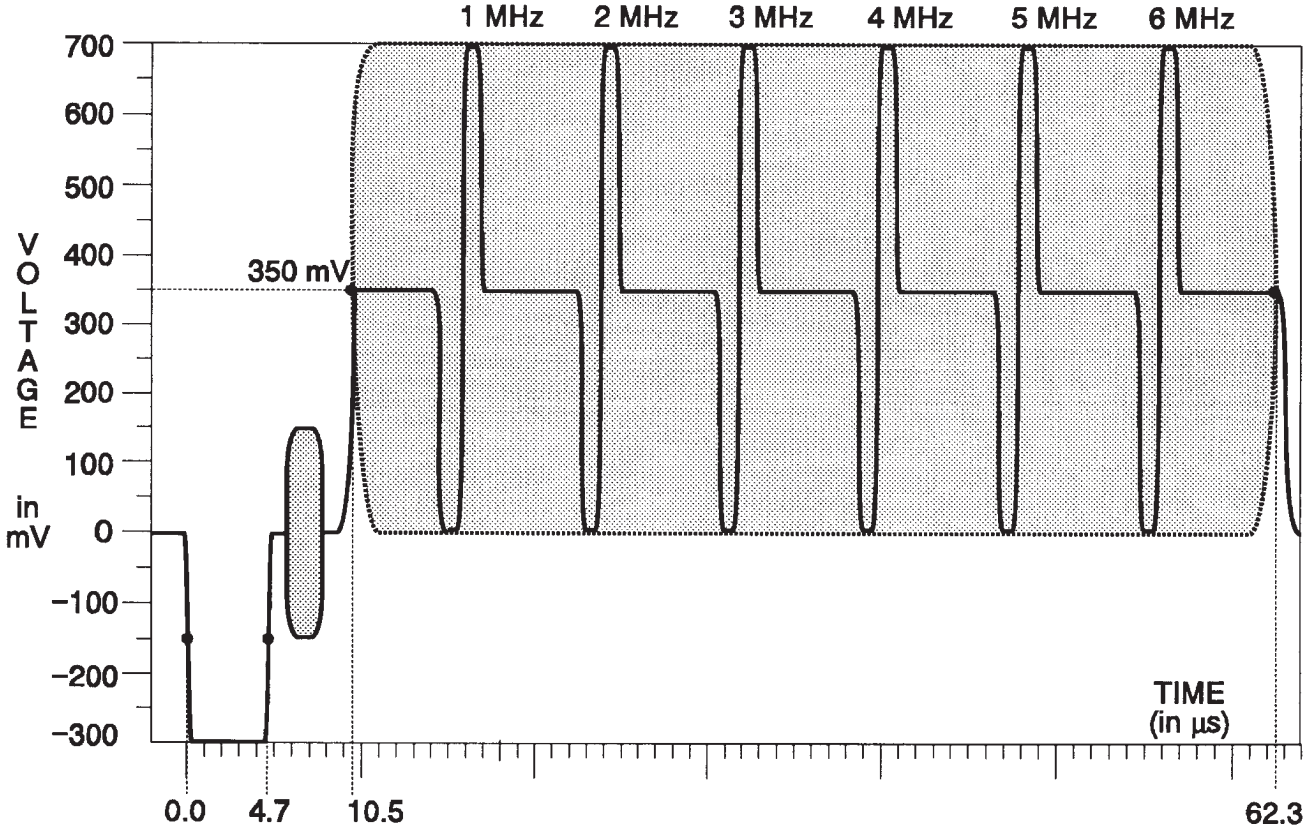

Fig. 3-20. Line Sweep.

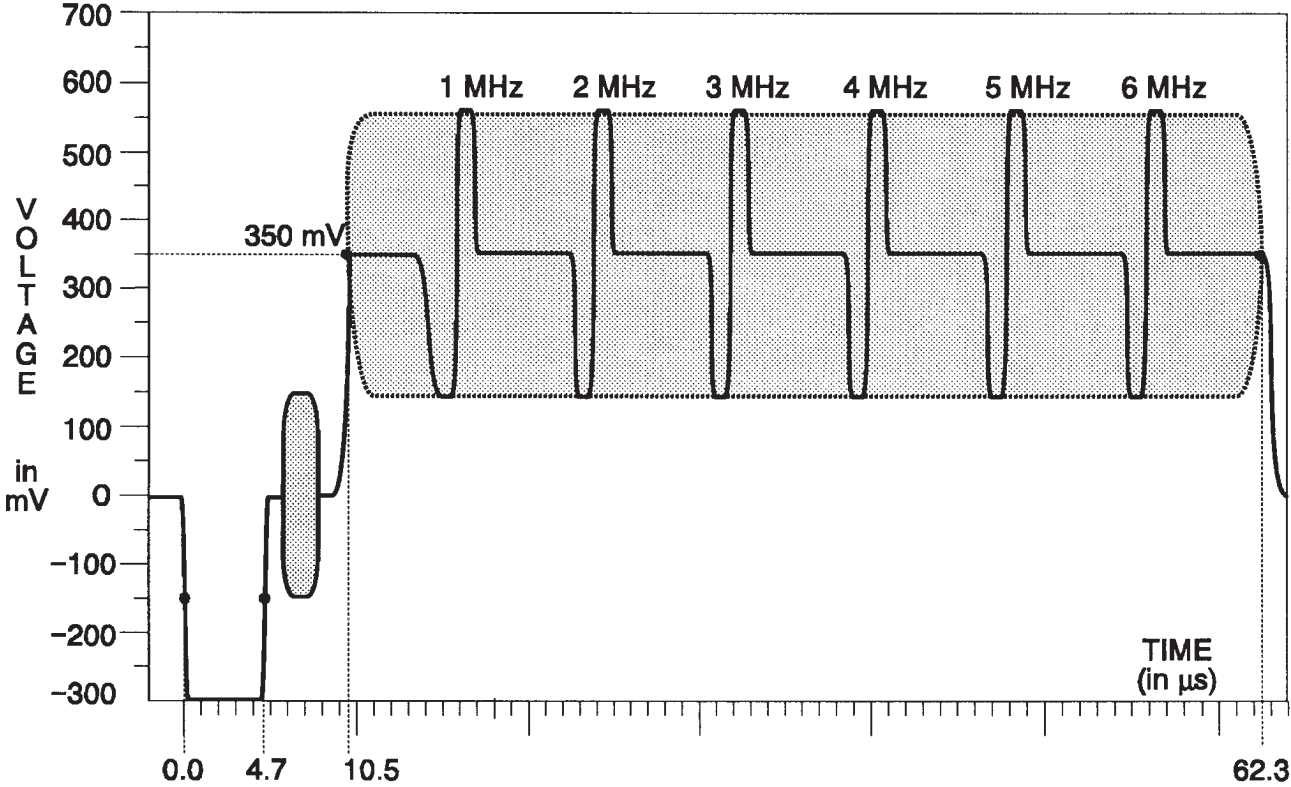

Fig. 3-21. Reduced Sweep.

TSG 131A — SPECIFICATIONS
Composite Signals

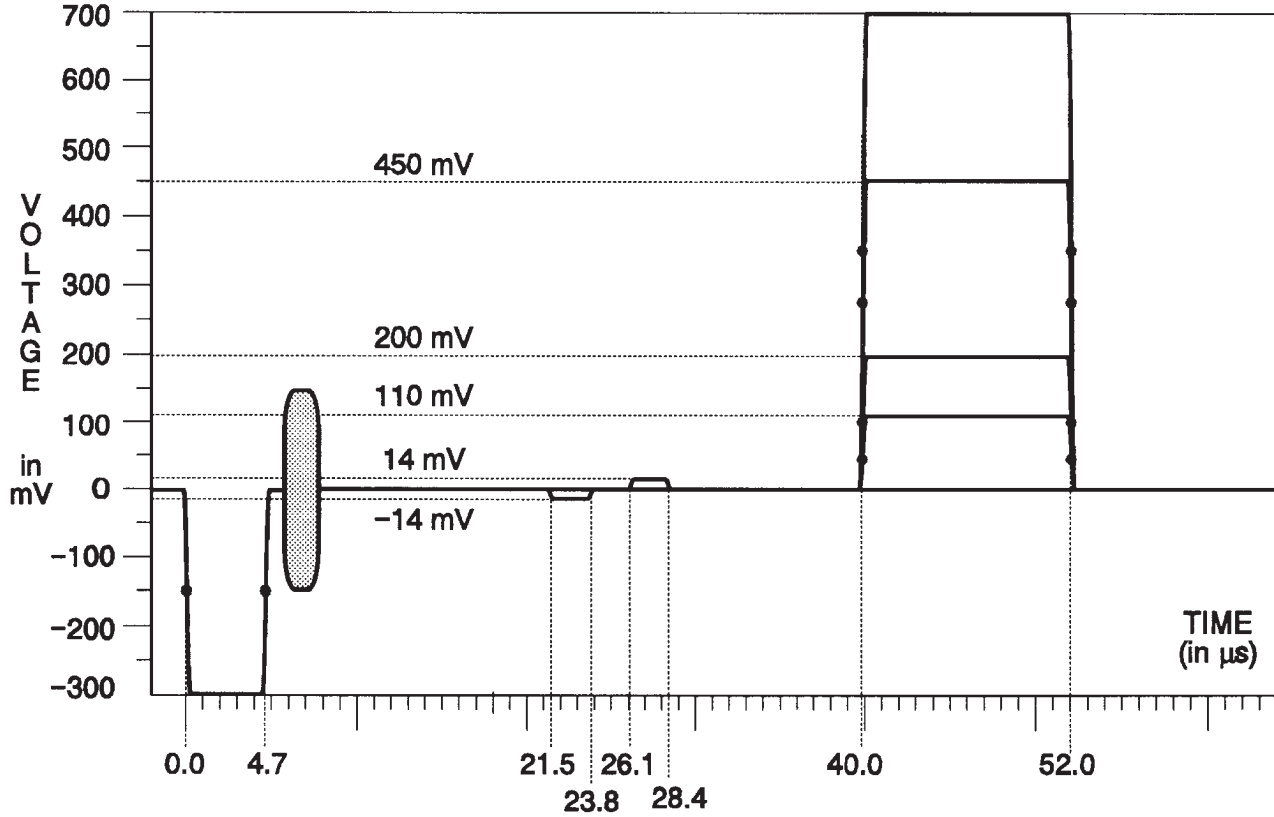

Fig. 3-22. Pluge.

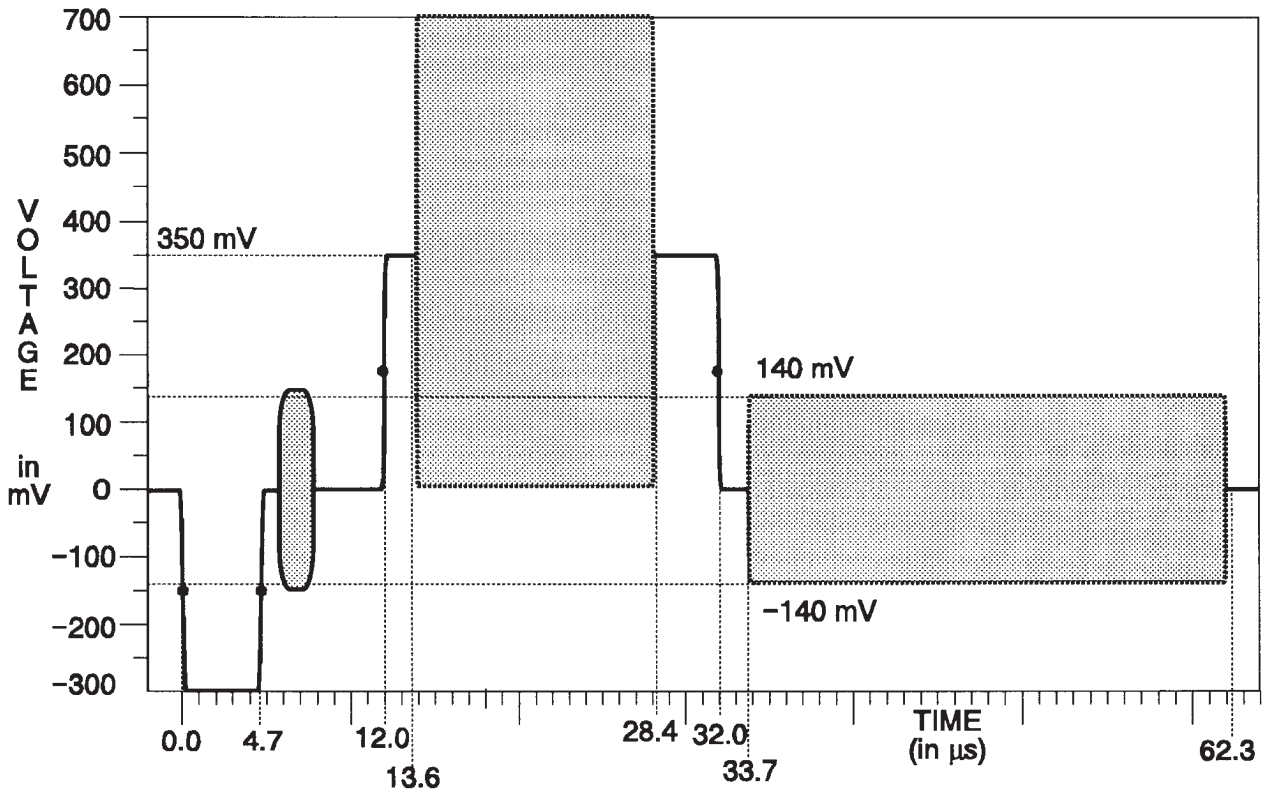

Fig. 3-23. Matrix Signal — UK ITS 2.

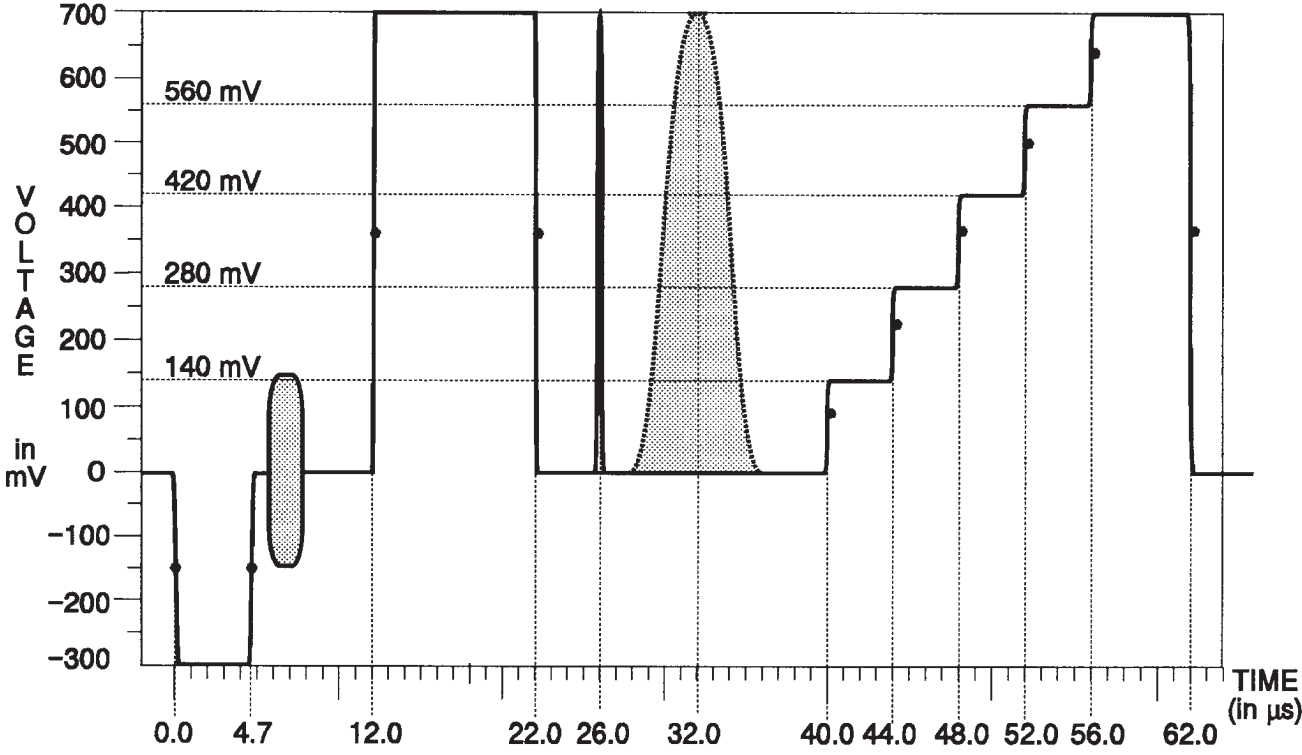

Fig. 3-24. Matrix Signal — CCIR Line 17.

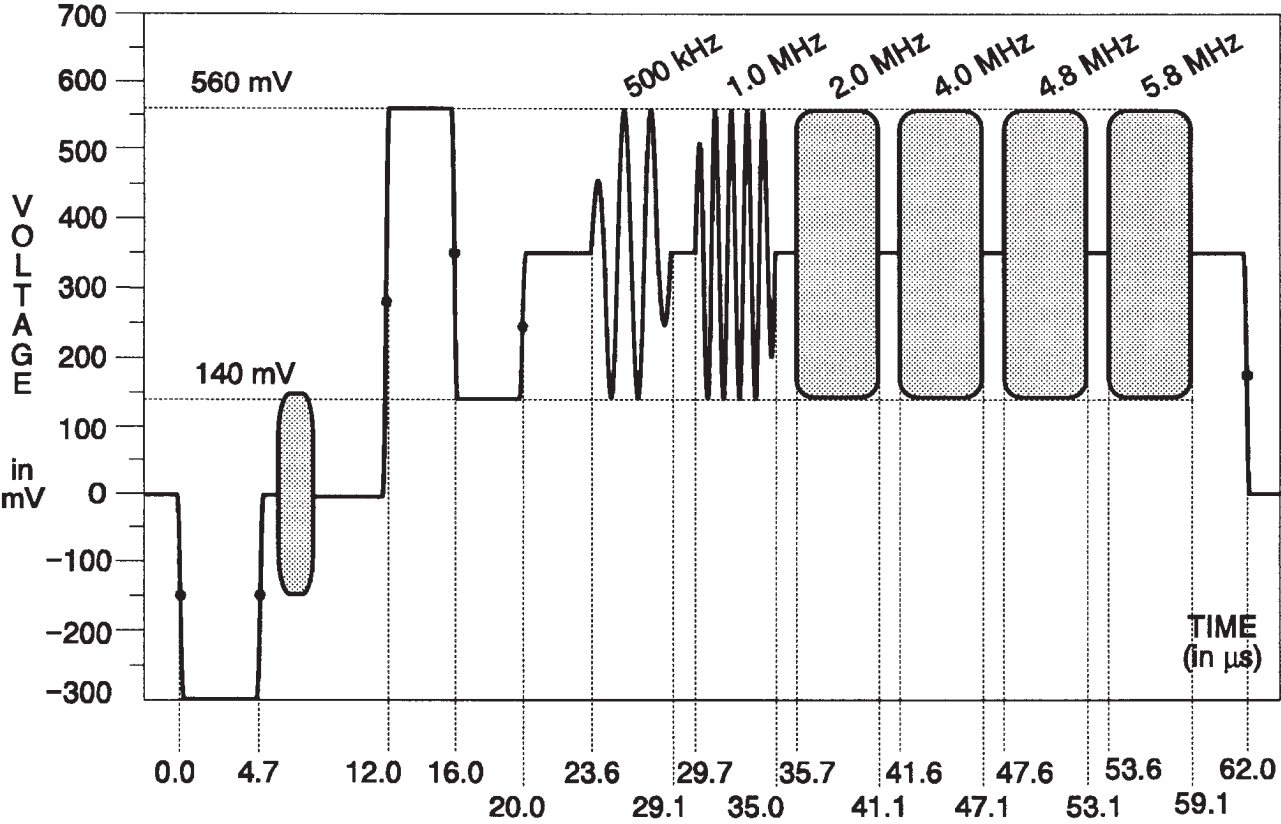

Fig. 3-25. Matrix Signal — CCIR Line 18.

TSG 131A — SPECIFICATIONS
Composite Signals

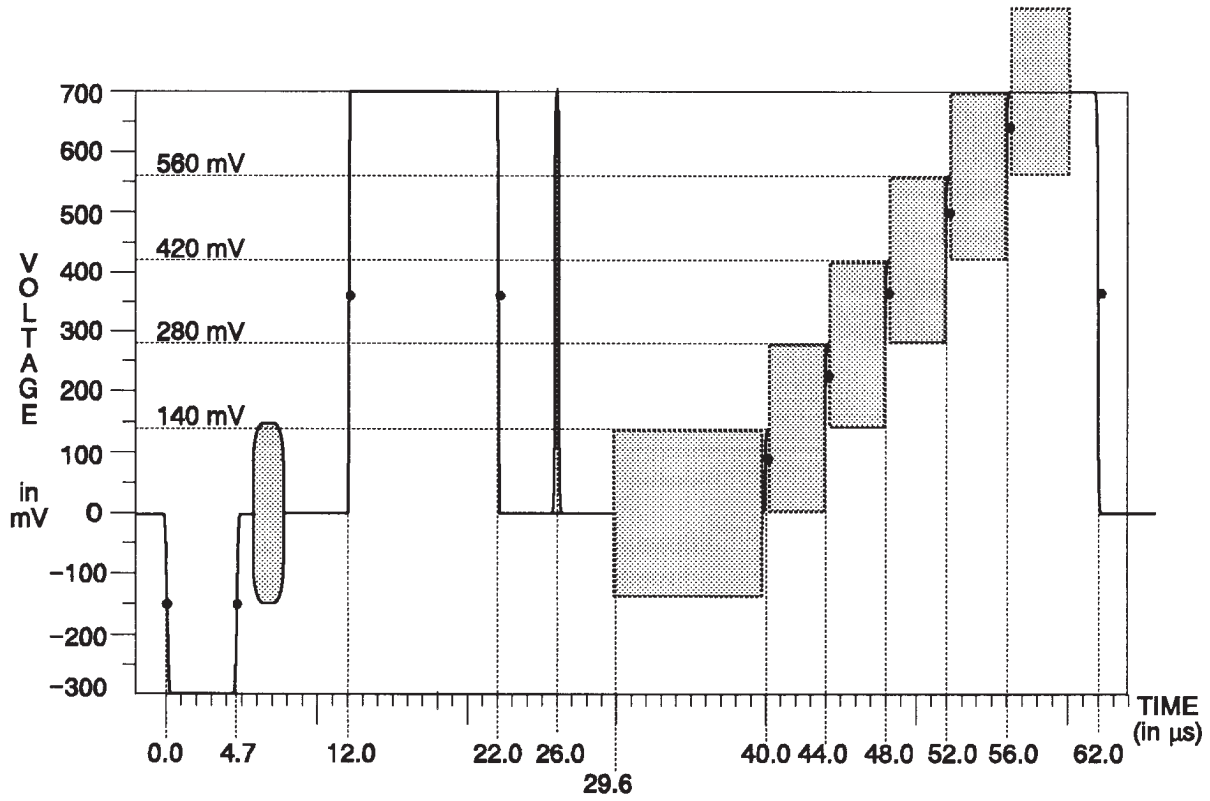

Fig. 3-26. Matrix Signal — CCIR Line 330.

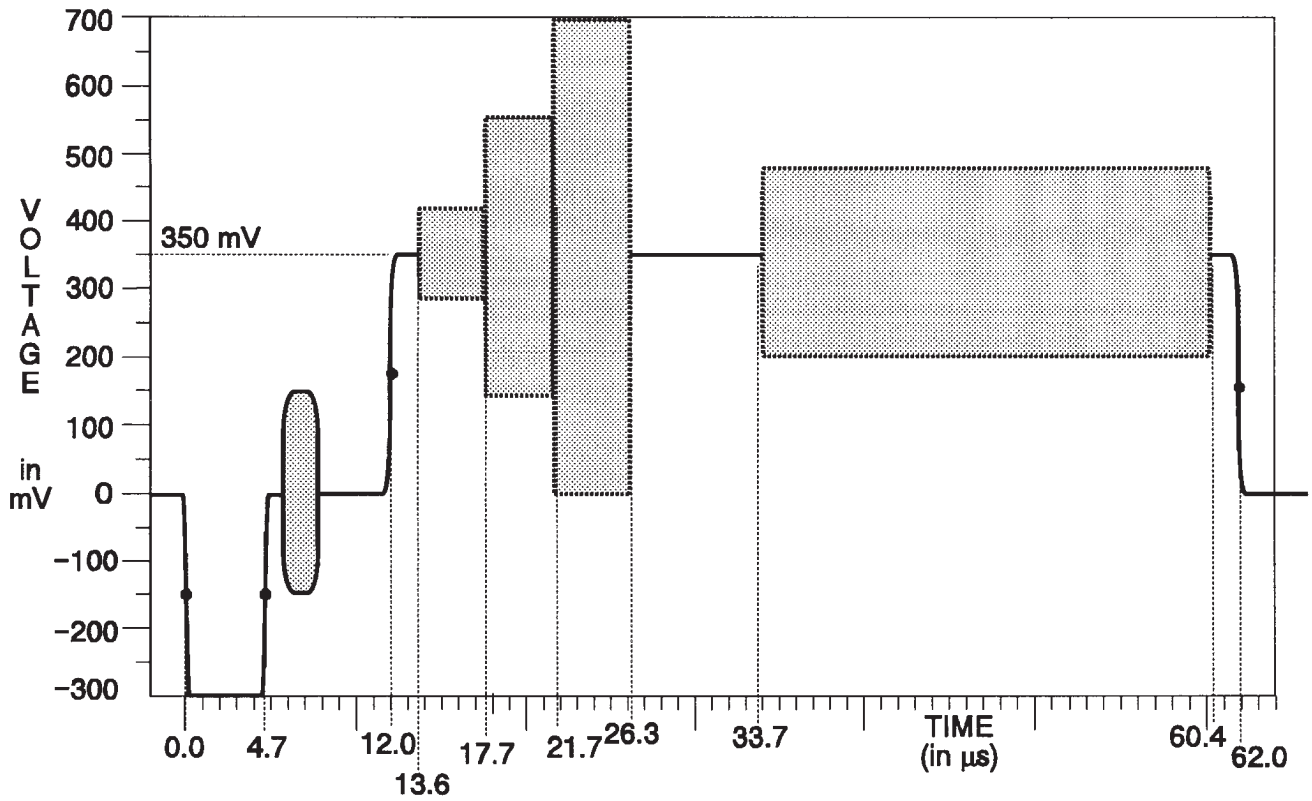

Fig. 3-27. Matrix Signal — CCIR Line 331.

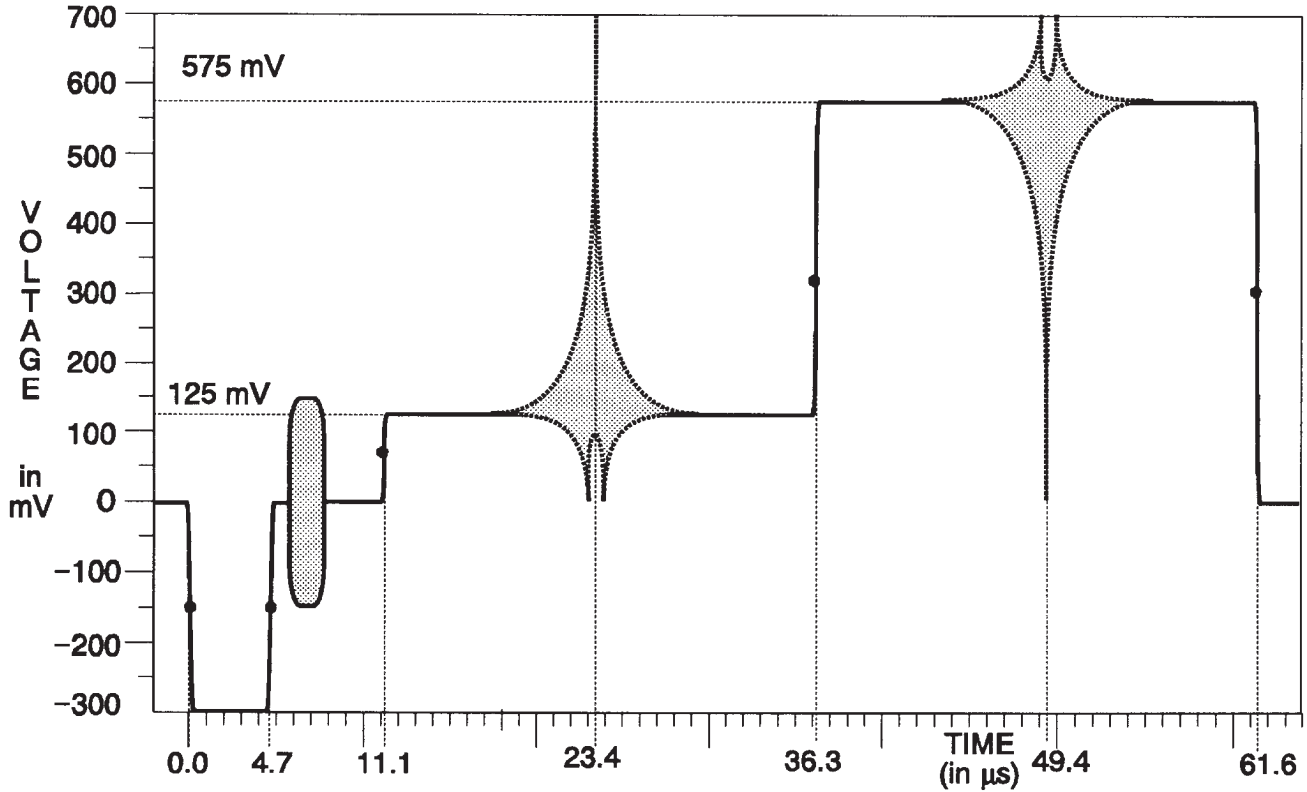

Fig. 3-28. Matrix Signal — $\text{Sin}(x)/x$.

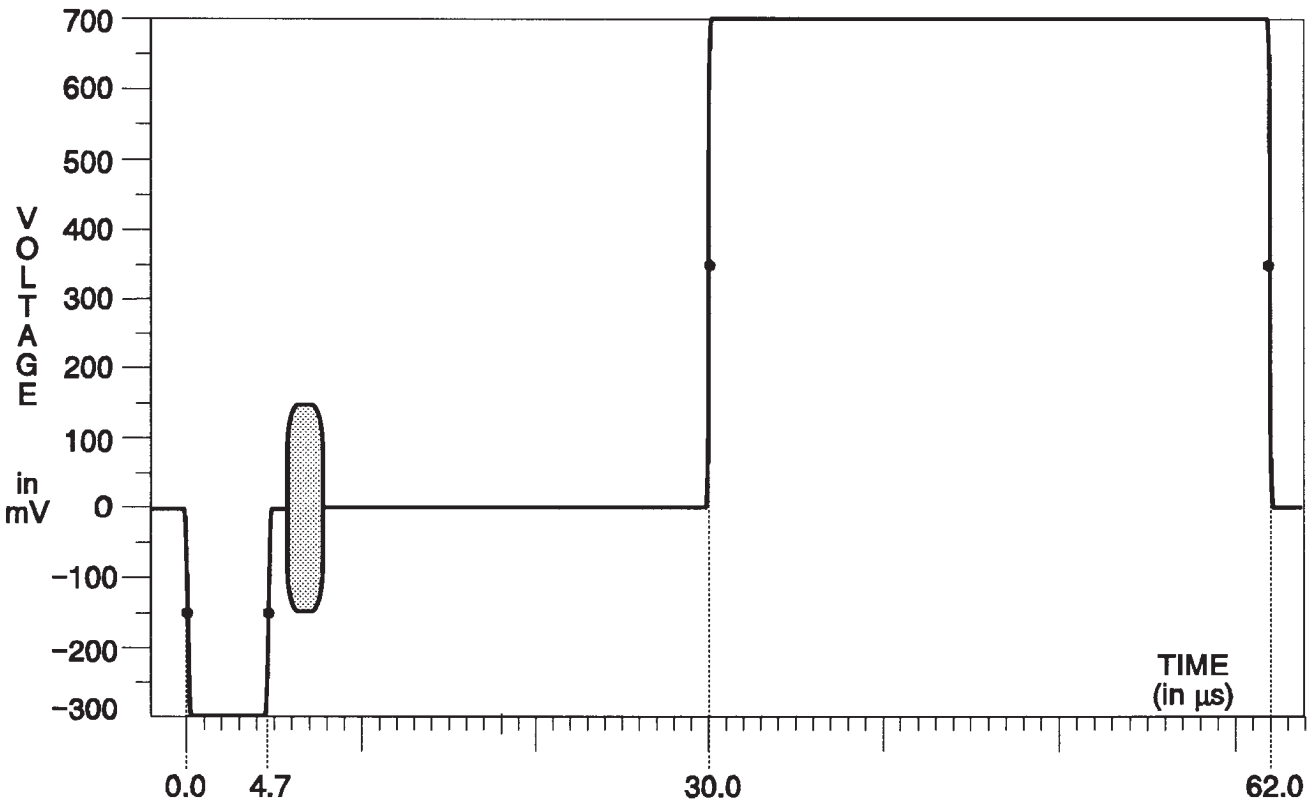

Fig. 3-29. Matrix Signal — 15 kHz Square Wave.

TSG 131A — SPECIFICATIONS
Composite Signals

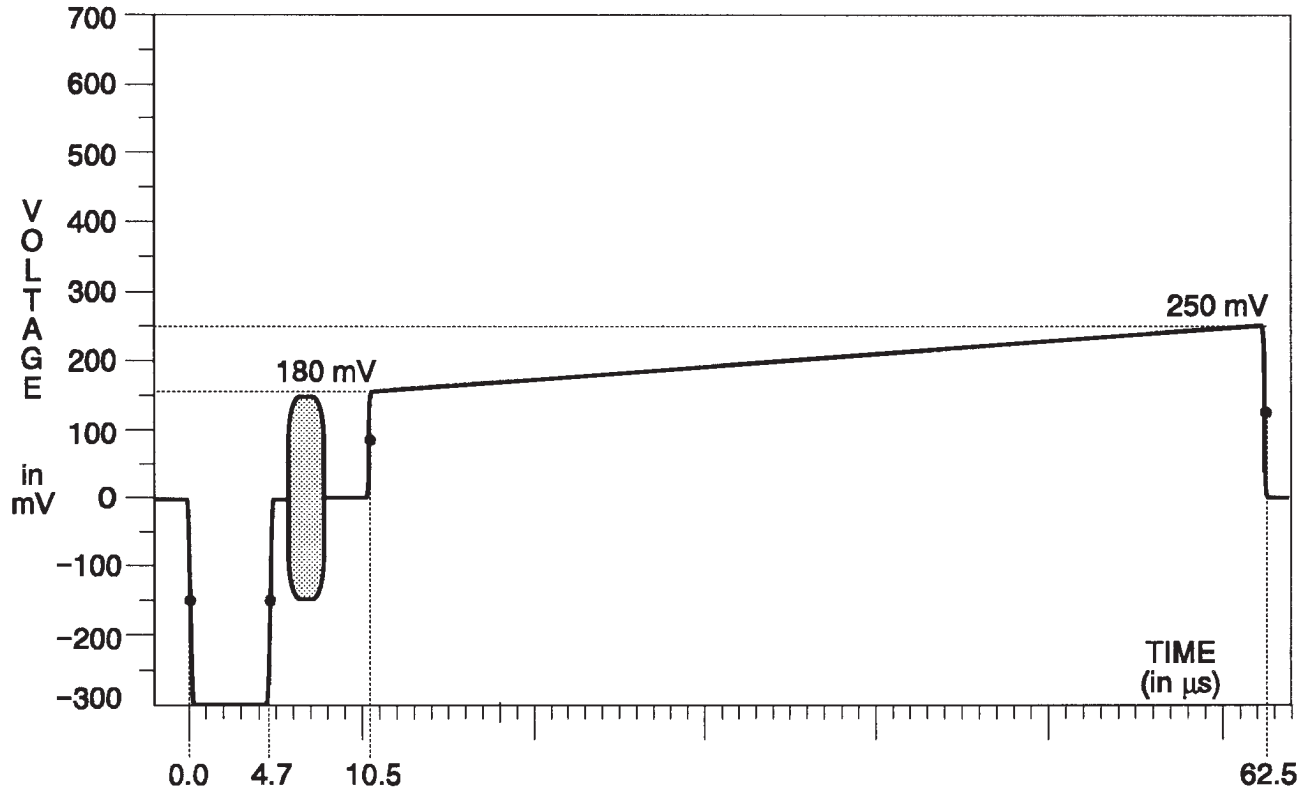

Fig. 3-30. Matrix Signal — Shallow Ramp.

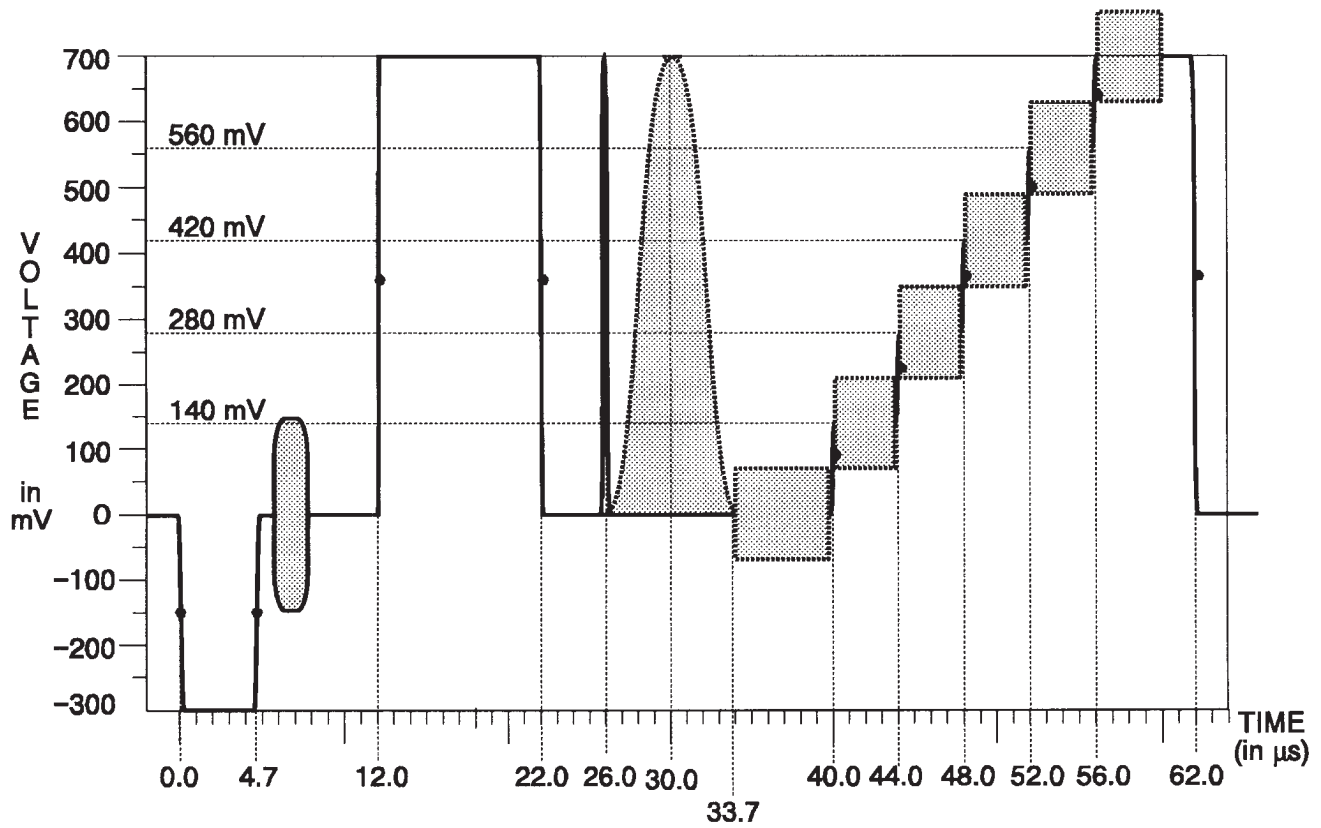

Fig. 3-31. Matrix Signal — UK ITS 1.

Y-C Signal Format

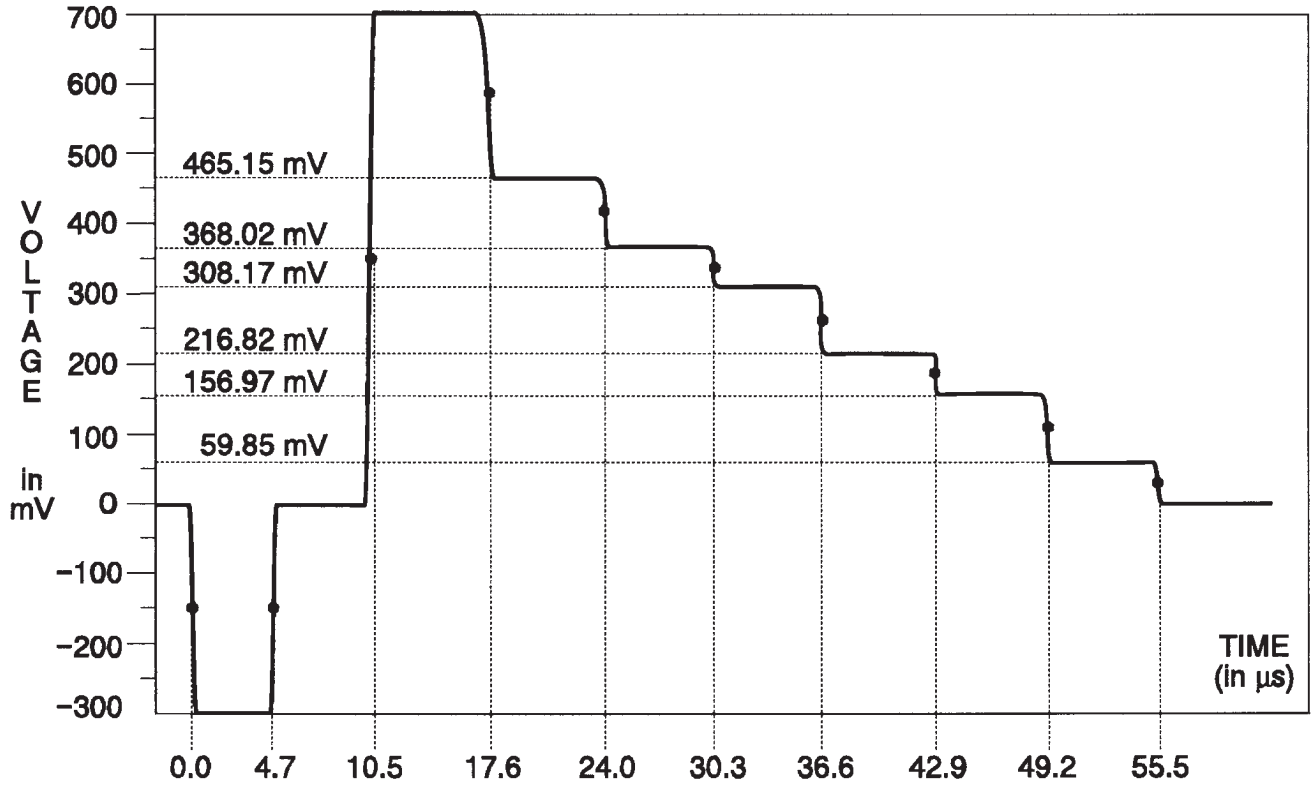

Fig. 3-32. Y Channel — 75% Bars.

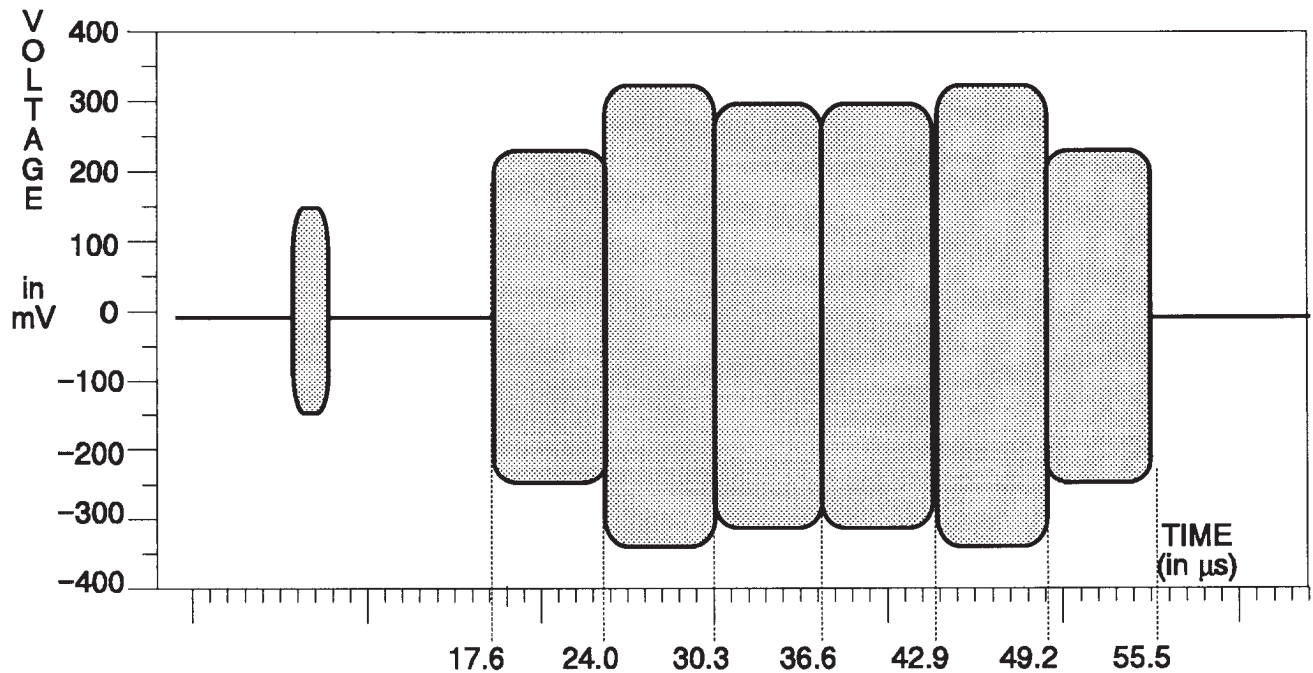

Fig. 3-33. C Channel — 75% Bars.

TSG 131A — SPECIFICATIONS
Composite Signals

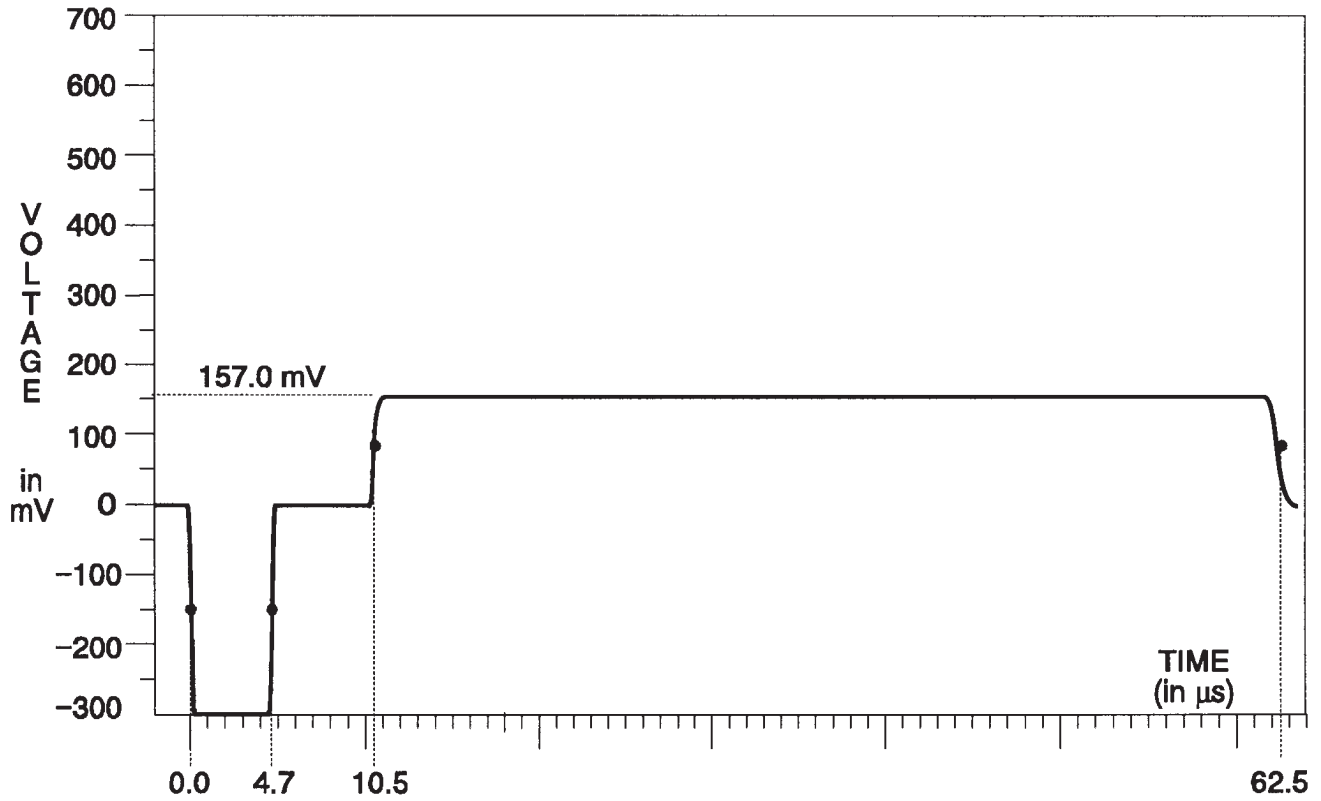

Fig. 3-34. Y Channel — 75% Red.(Same as Red Field)

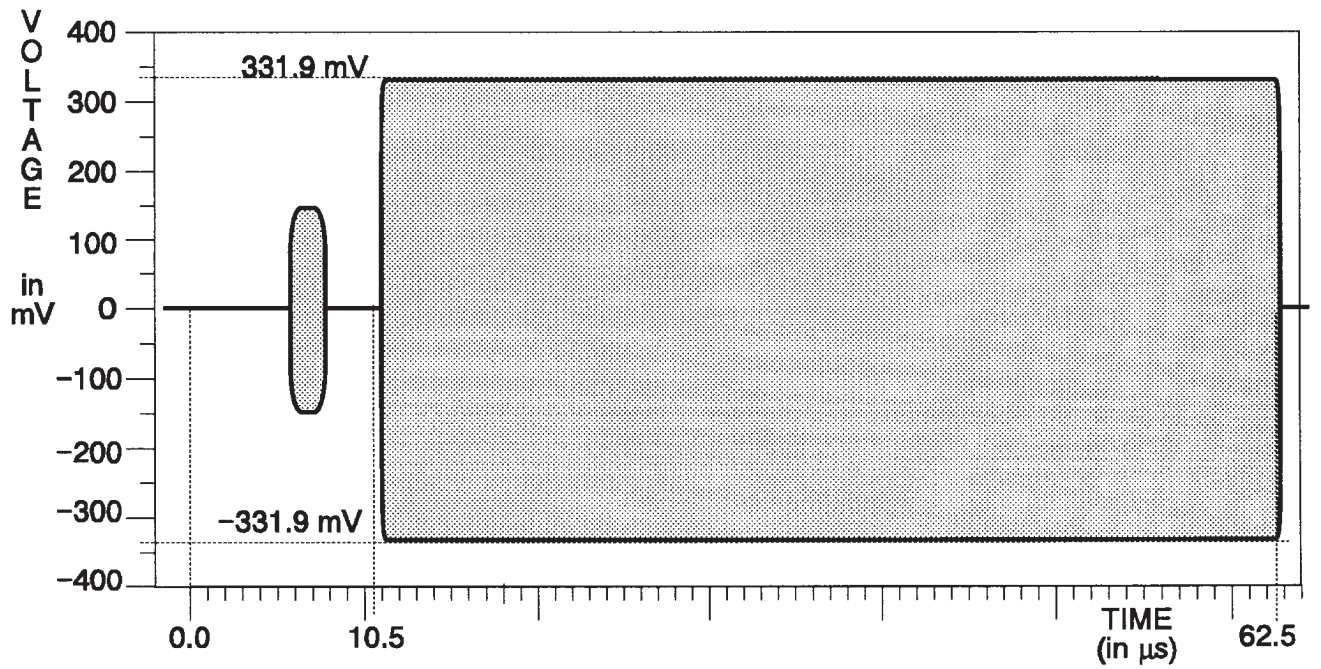

Fig. 3-35. C Channel — 75% Red (Same as Red Field)

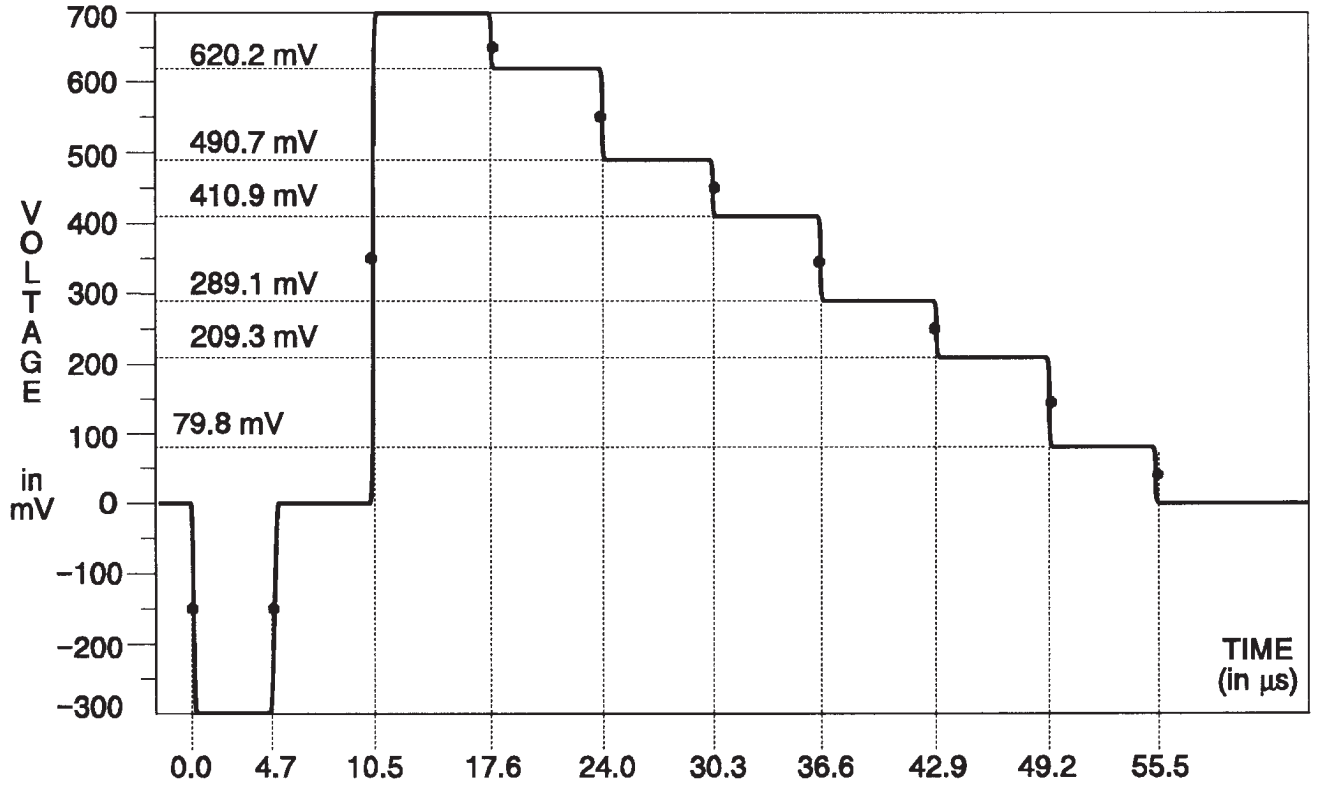

Fig. 3-36. Y Channel — 100% Bars.

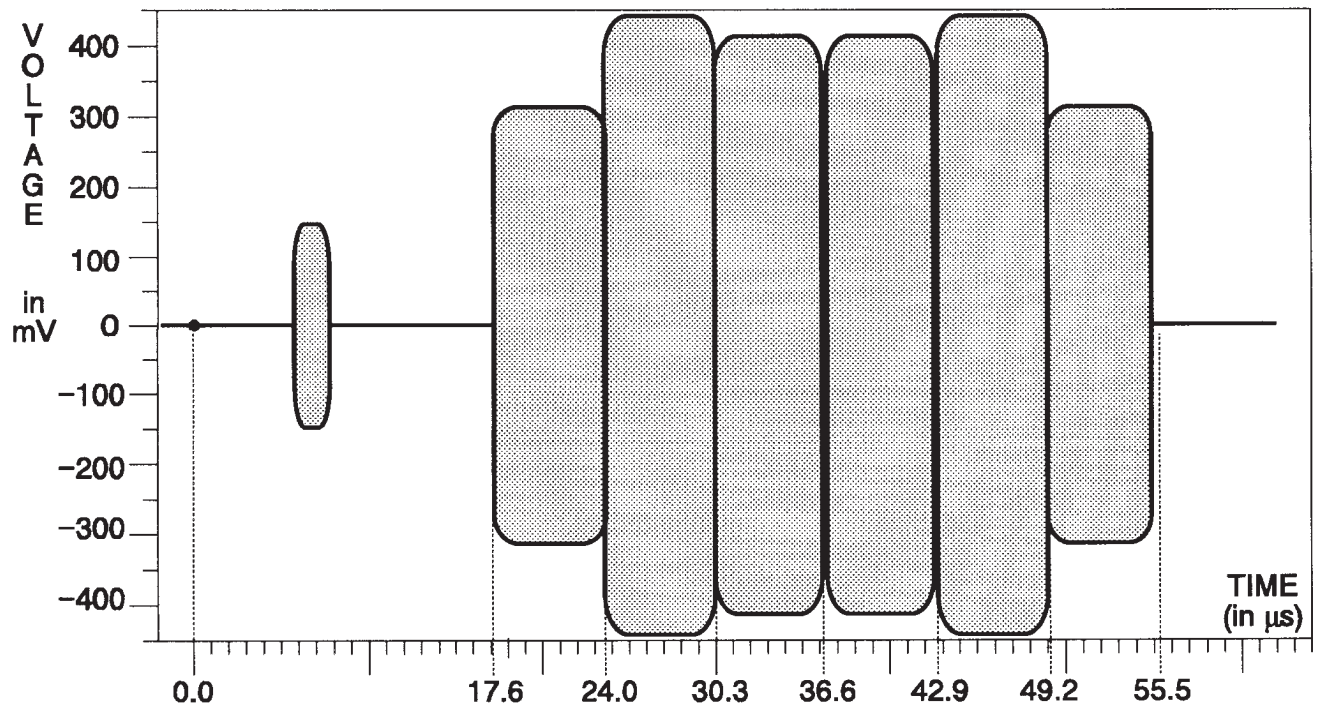

Fig. 3-37. C Channel — 100% Bars.

TSG 131A — SPECIFICATIONS
Composite Signals

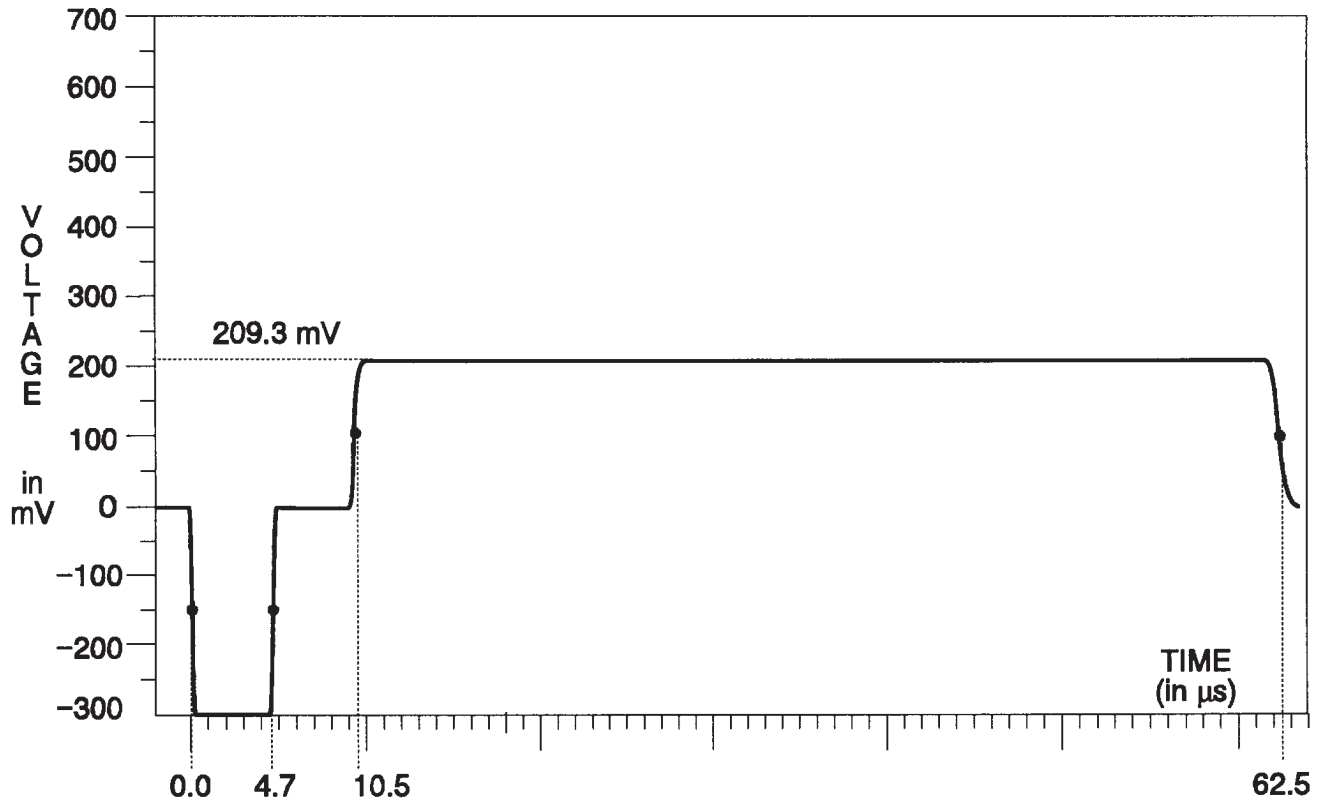

Fig. 3-38. Y Channel — 100% Red.

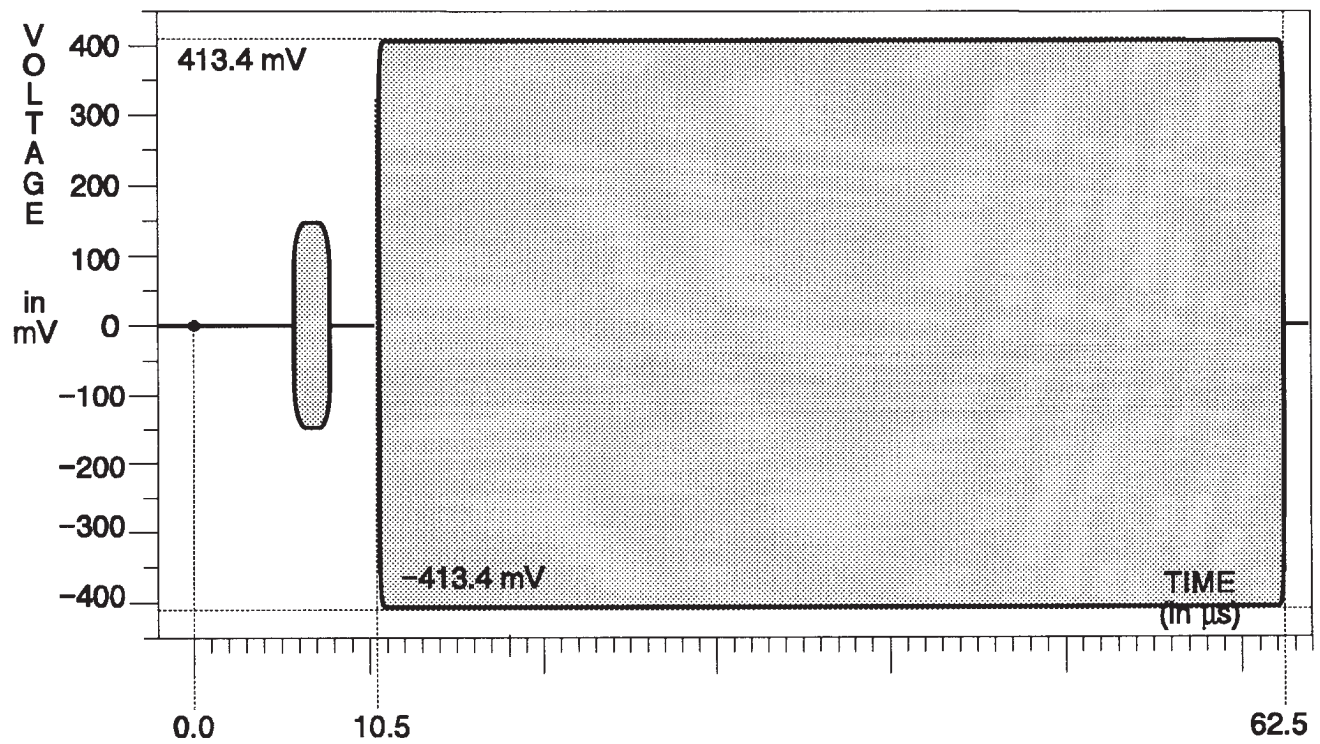

Fig. 3-39. C Channel — 100% Red.

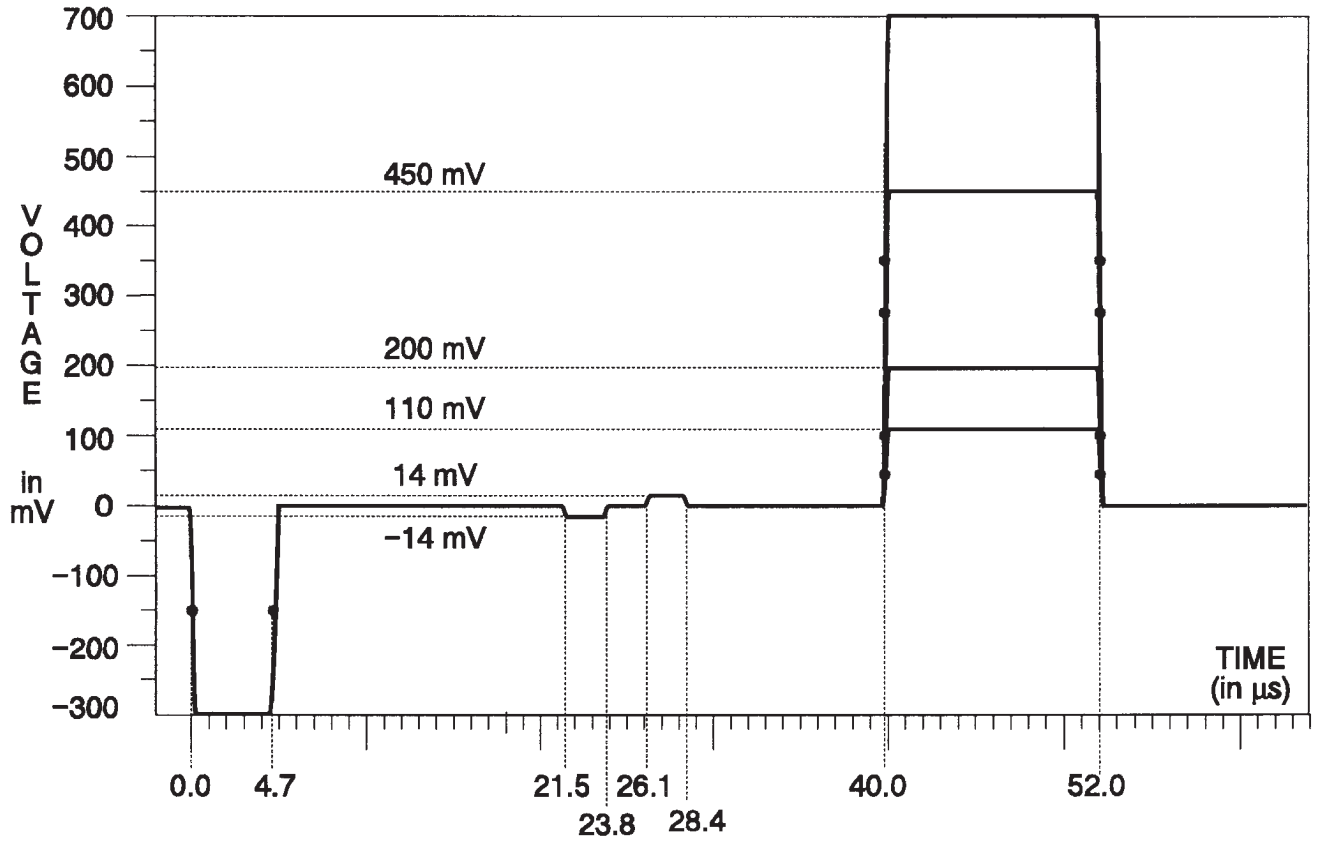

Fig. 3-40. Y Channel — Pluge.

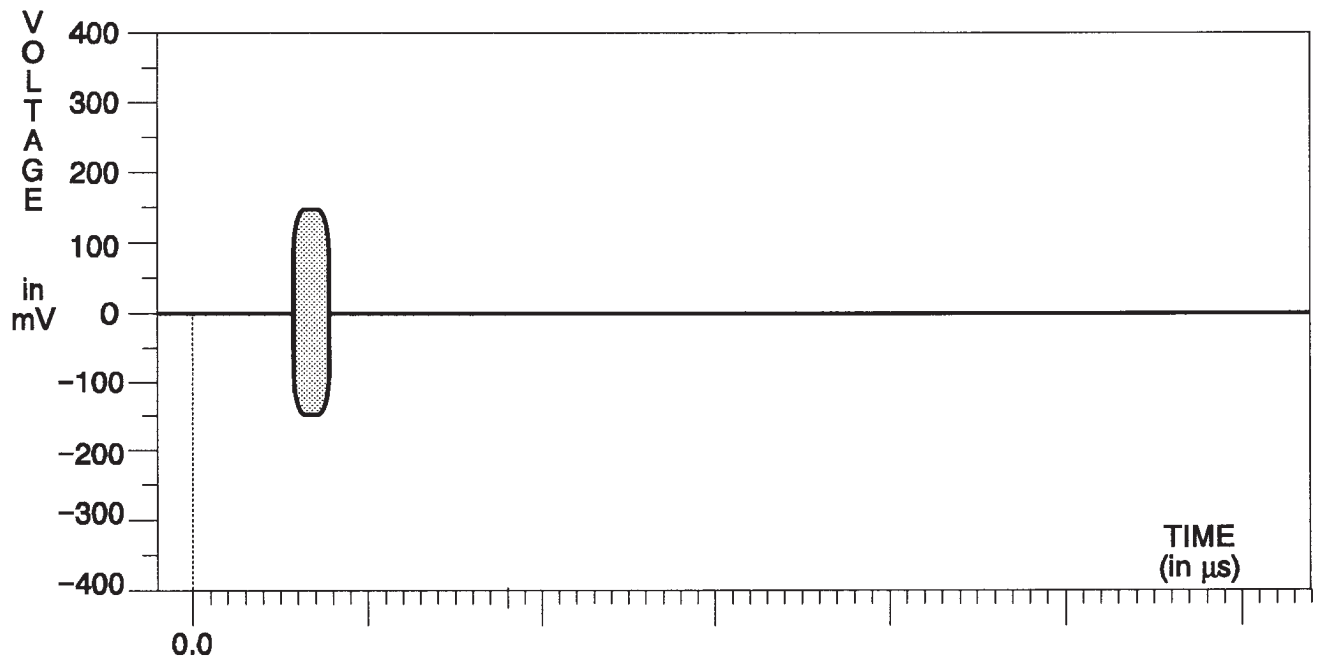

Fig. 3-41. C Channel — Pluge.

TSG 131A — SPECIFICATIONS
Composite Signals

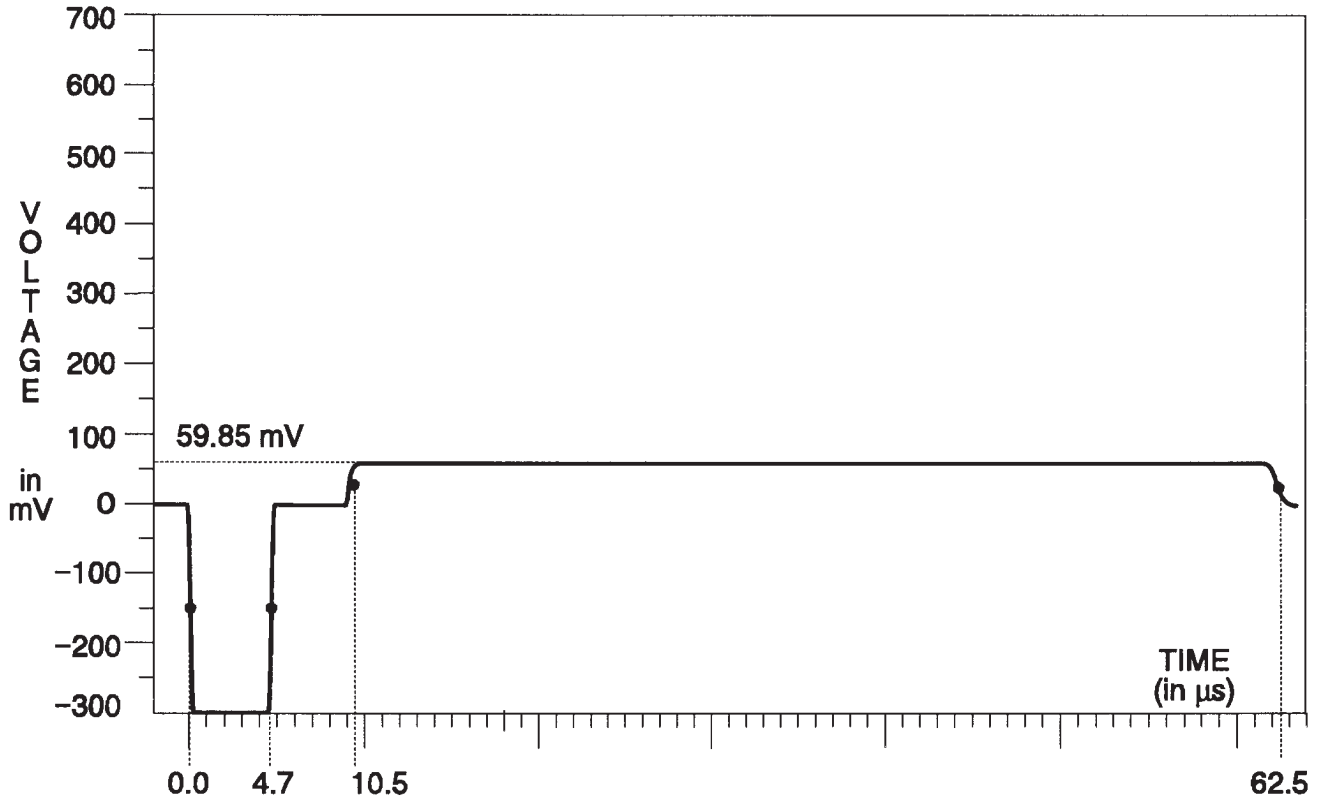

Fig. 3-42. Y Channel — Blue Field.

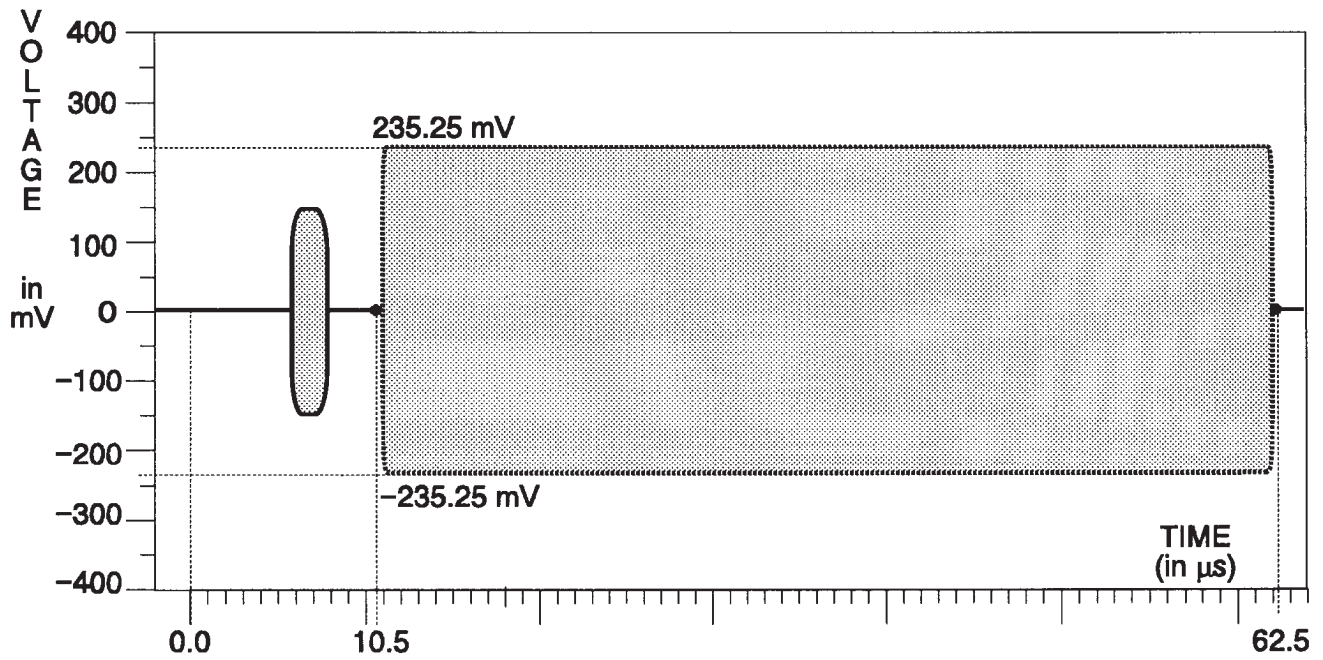

Fig. 3-43. C Channel — Blue Field.

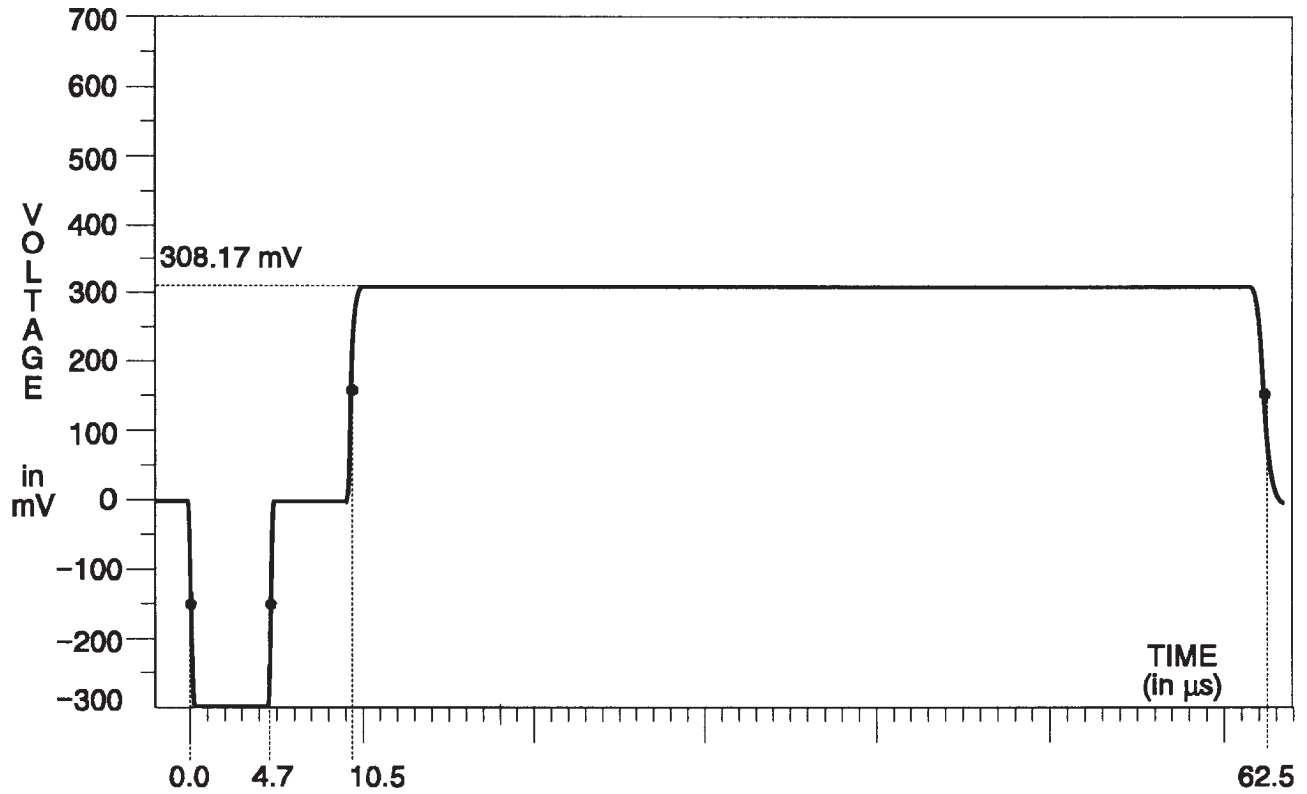

Fig. 3-44. Y Channel — Green Field.

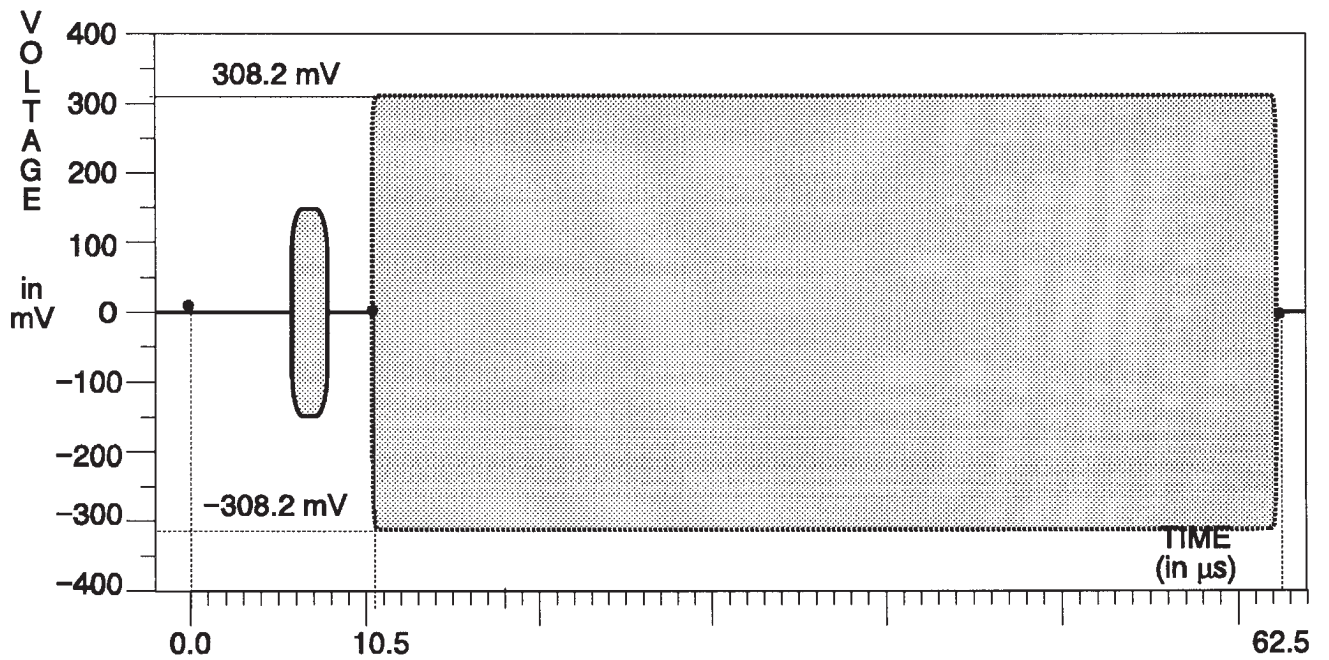

Fig. 3-45. C Channel — Green Field.

TSG 131A — SPECIFICATIONS
Composite Signals

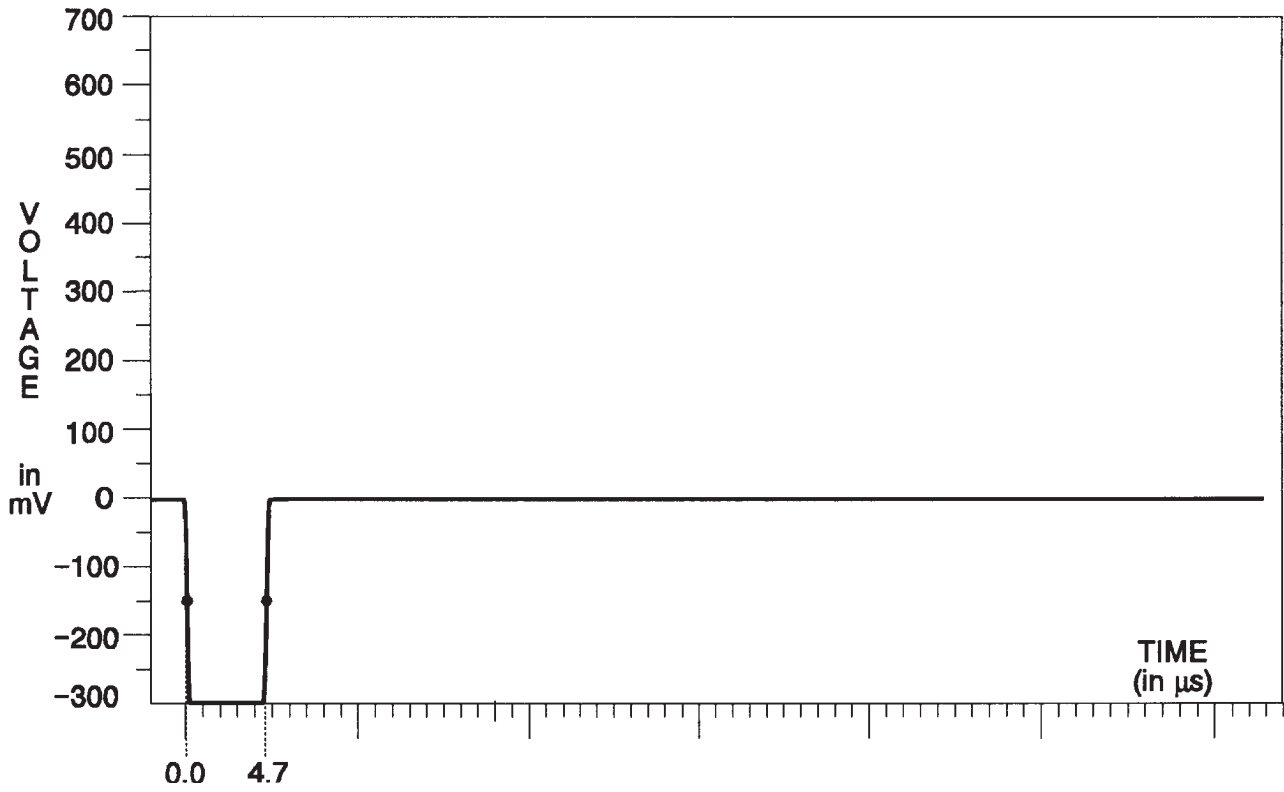

Fig. 3-46. Y Channel — 0% Flat Field.

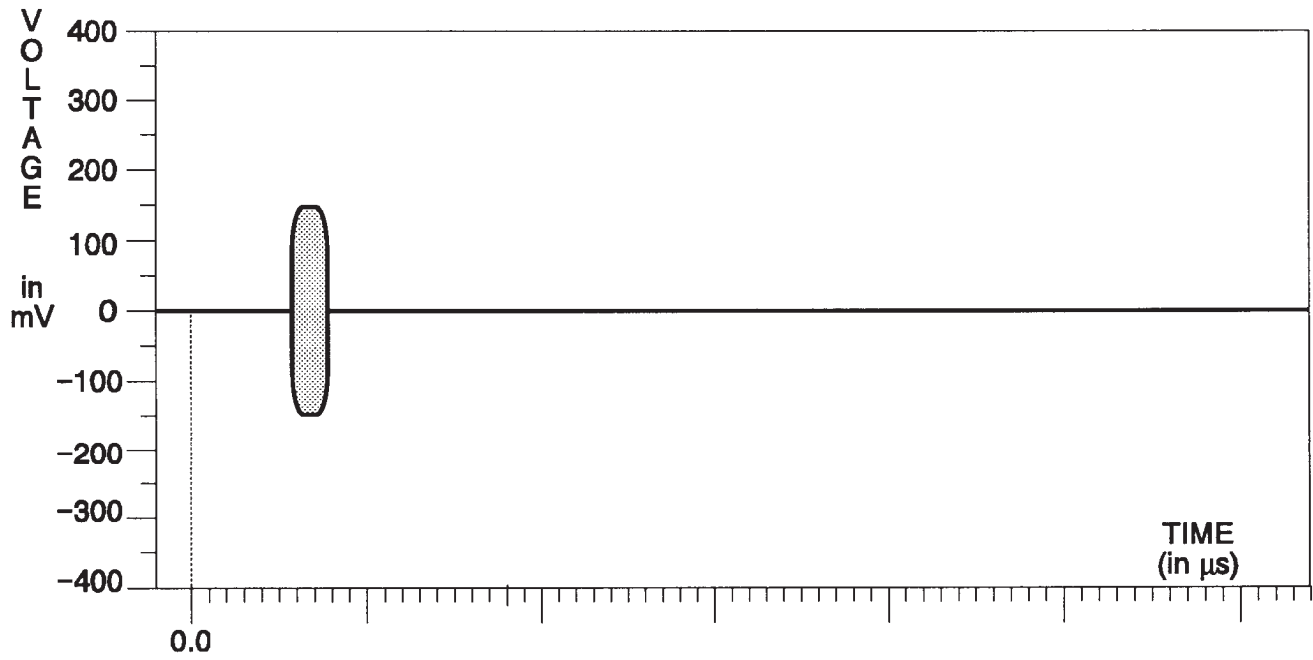

Fig. 3-47. C Channel — 0% Flat Field.

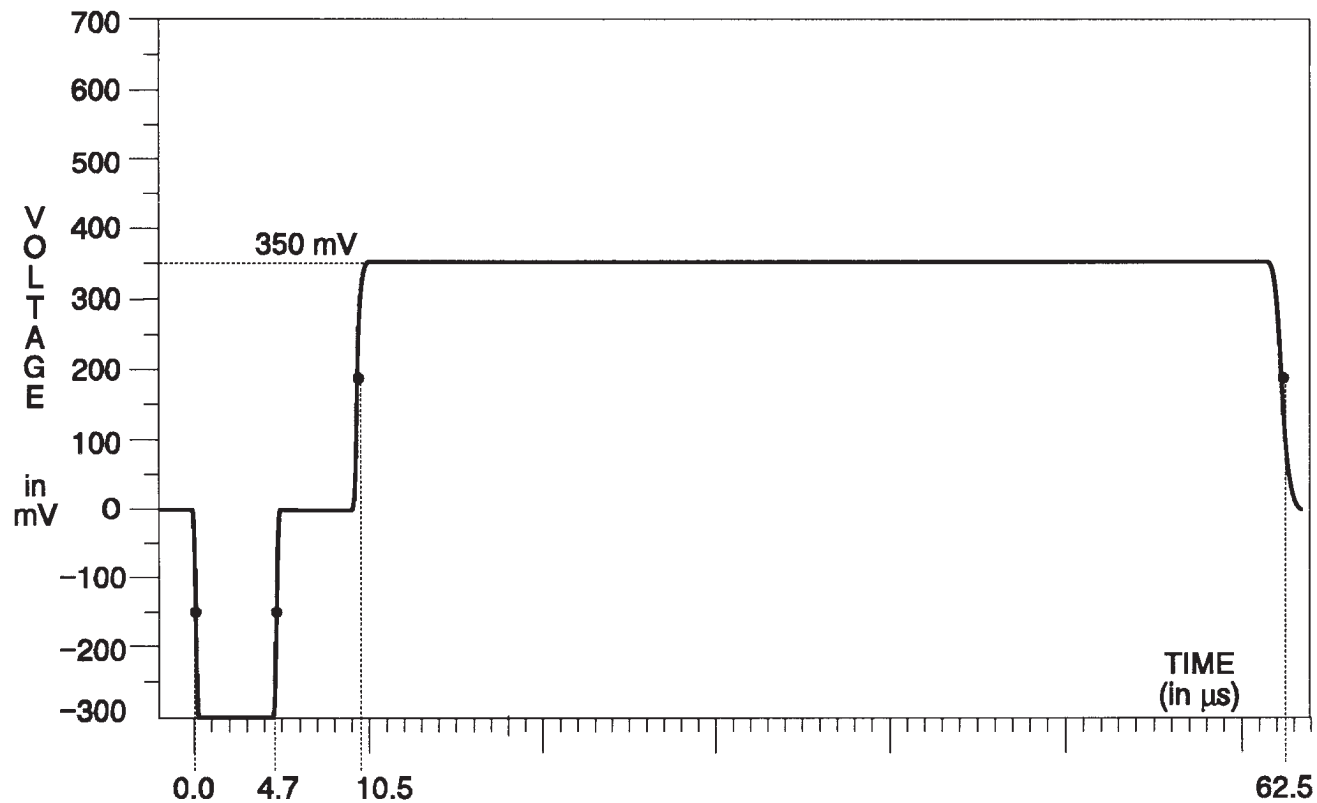

Fig. 3-48. Y Channel — 50% Flat Field.

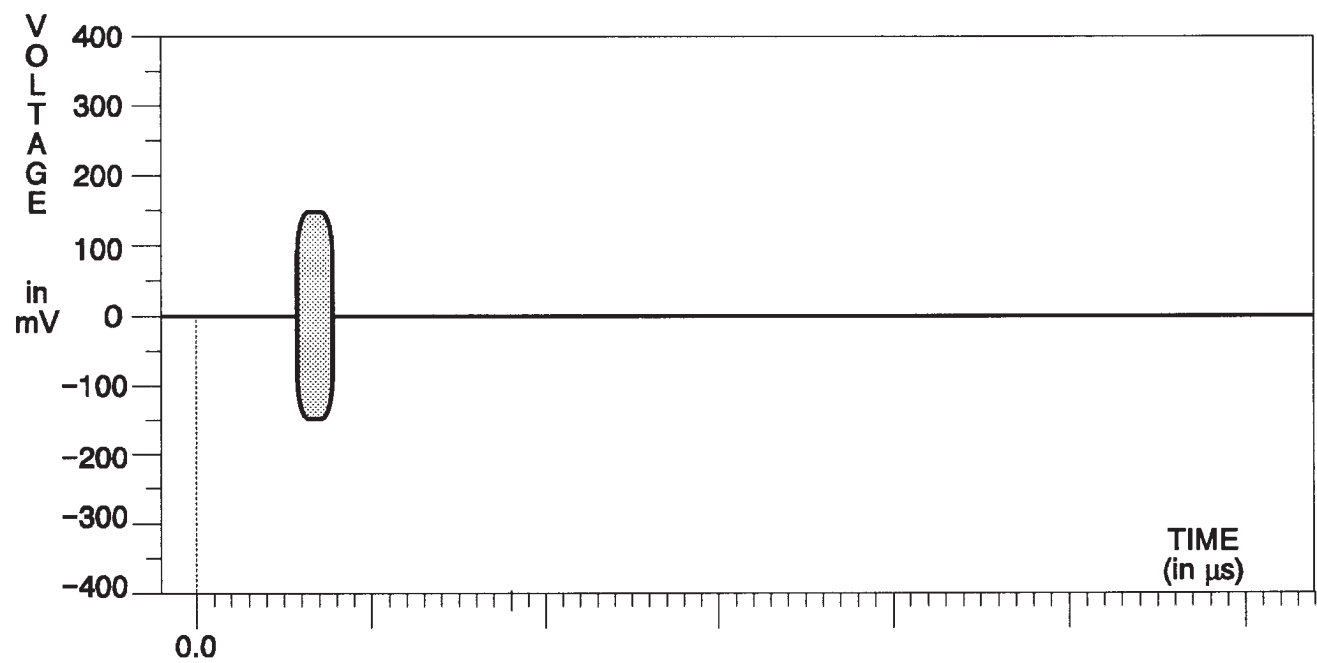

Fig. 3-49. C Channel — 50% Flat Field.

TSG 131A — SPECIFICATIONS
Composite Signals

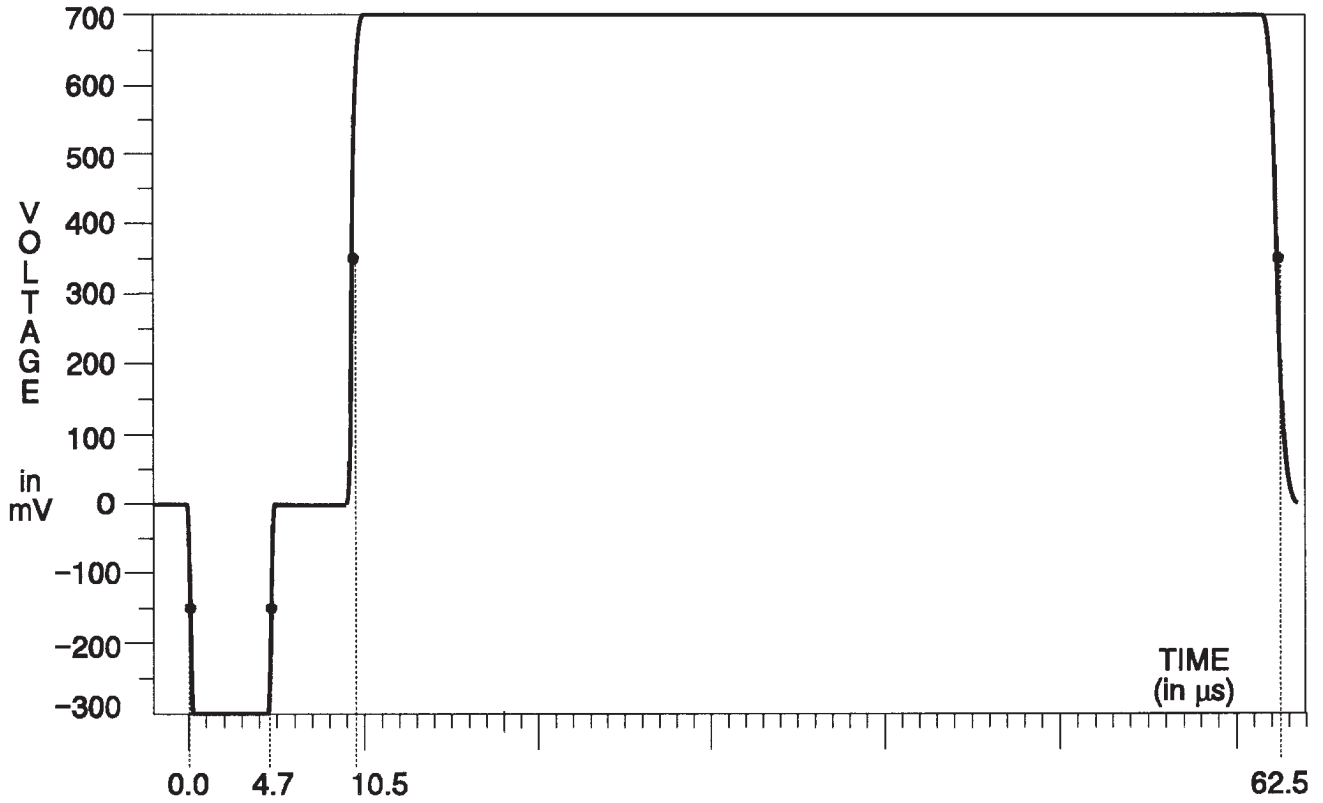

Fig. 3-50. Y Channel — 100% Flat Field.

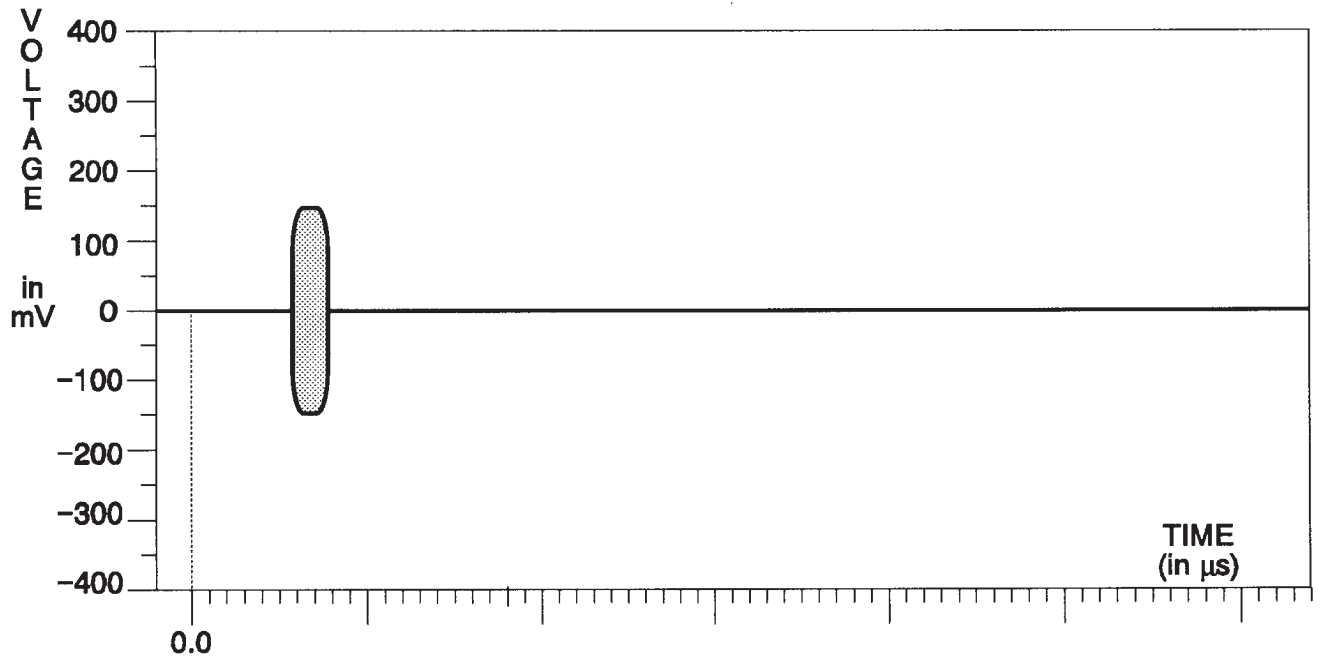

Fig. 3-51. C Channel — 100% Flat Field.

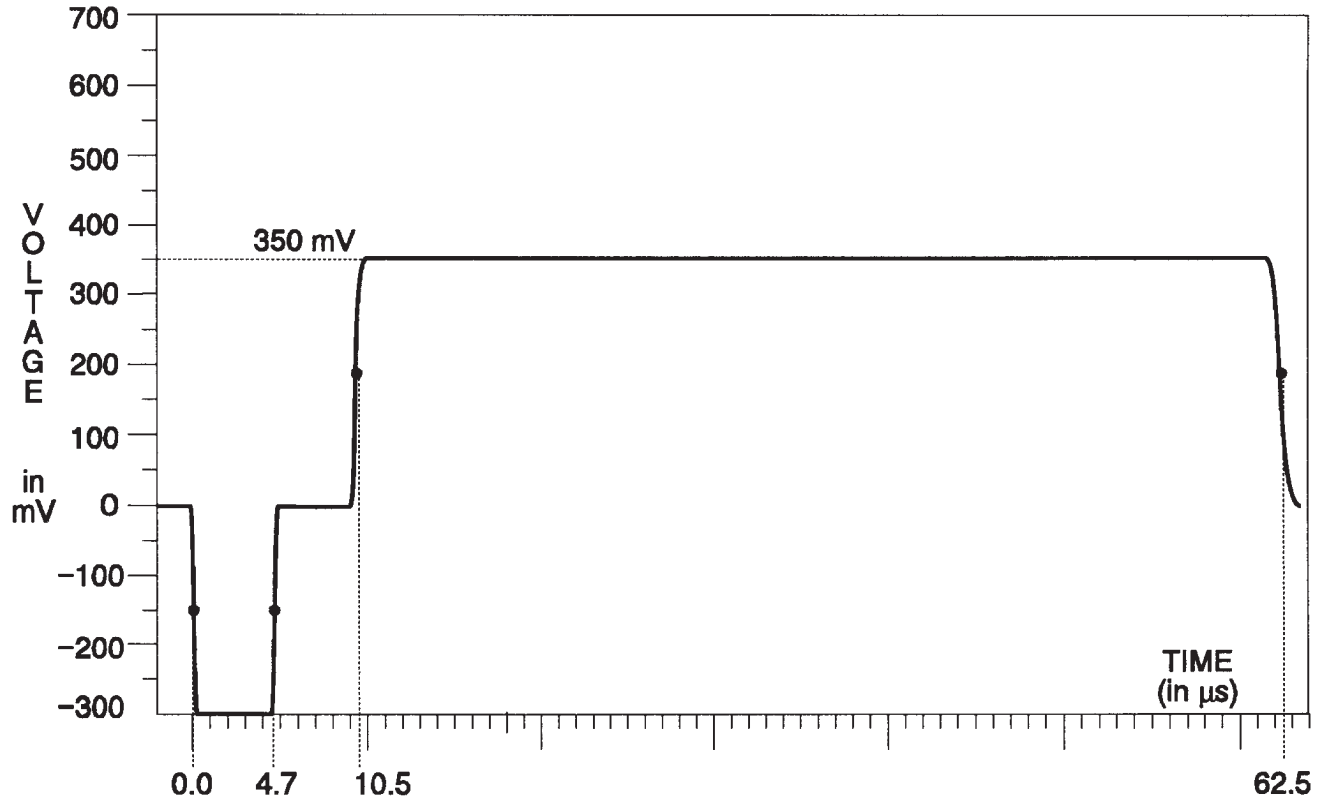

Fig. 3-52. Y Channel — Chroma Noise.

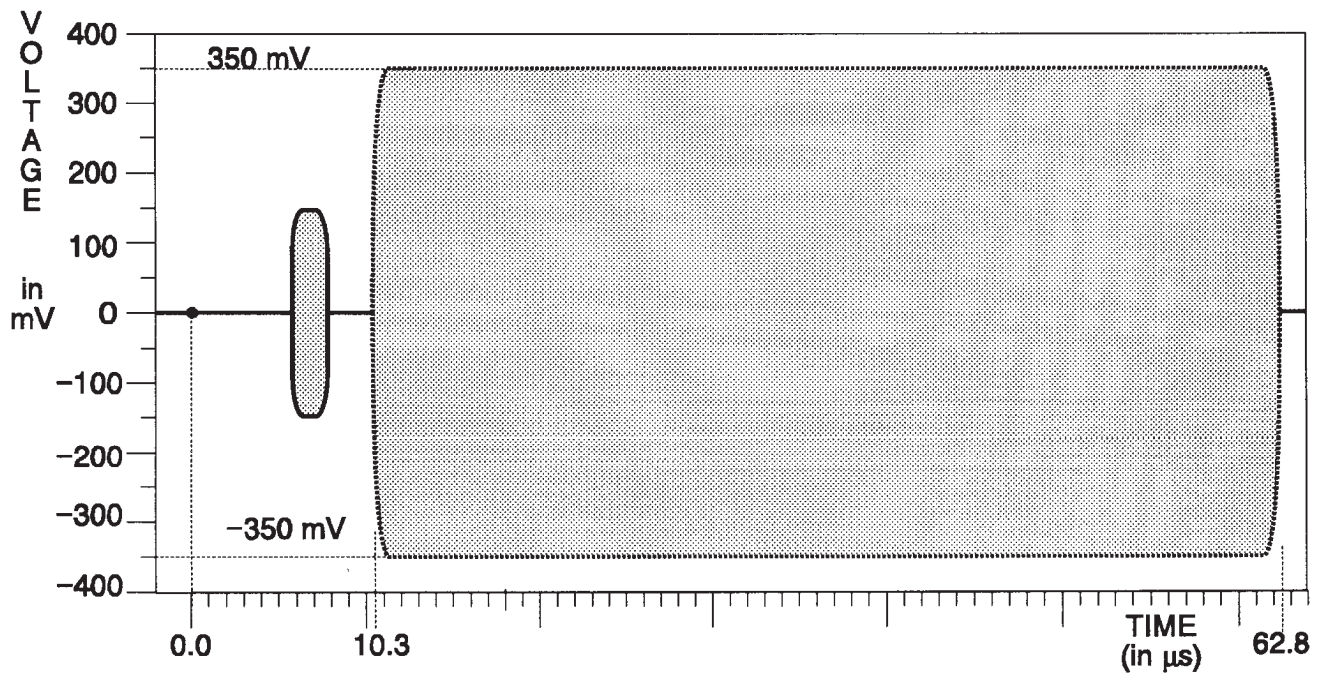

Fig. 3-53. C Channel — Chroma Noise.

TSG 131A — SPECIFICATIONS
Composite Signals

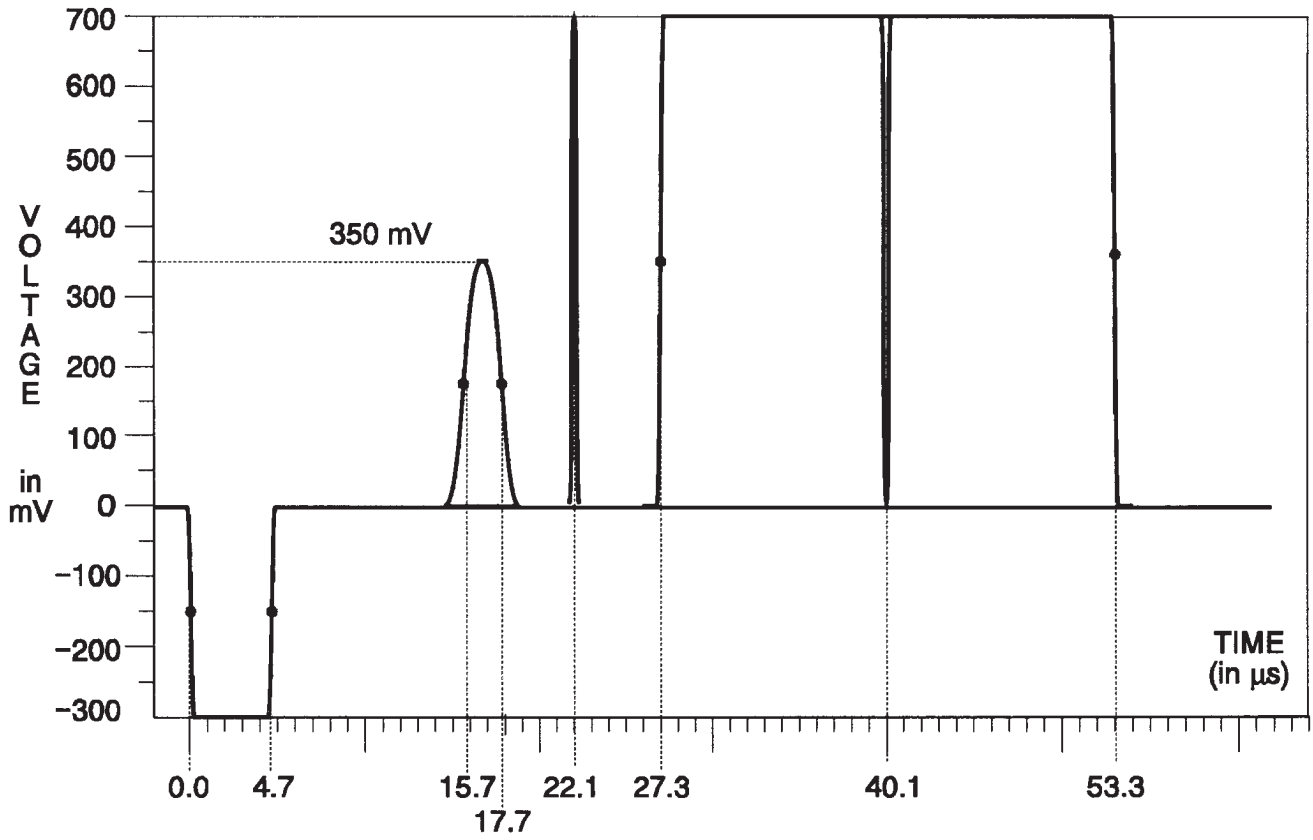

Fig. 3-54. Y Channel — Pulse & Bar with Window.

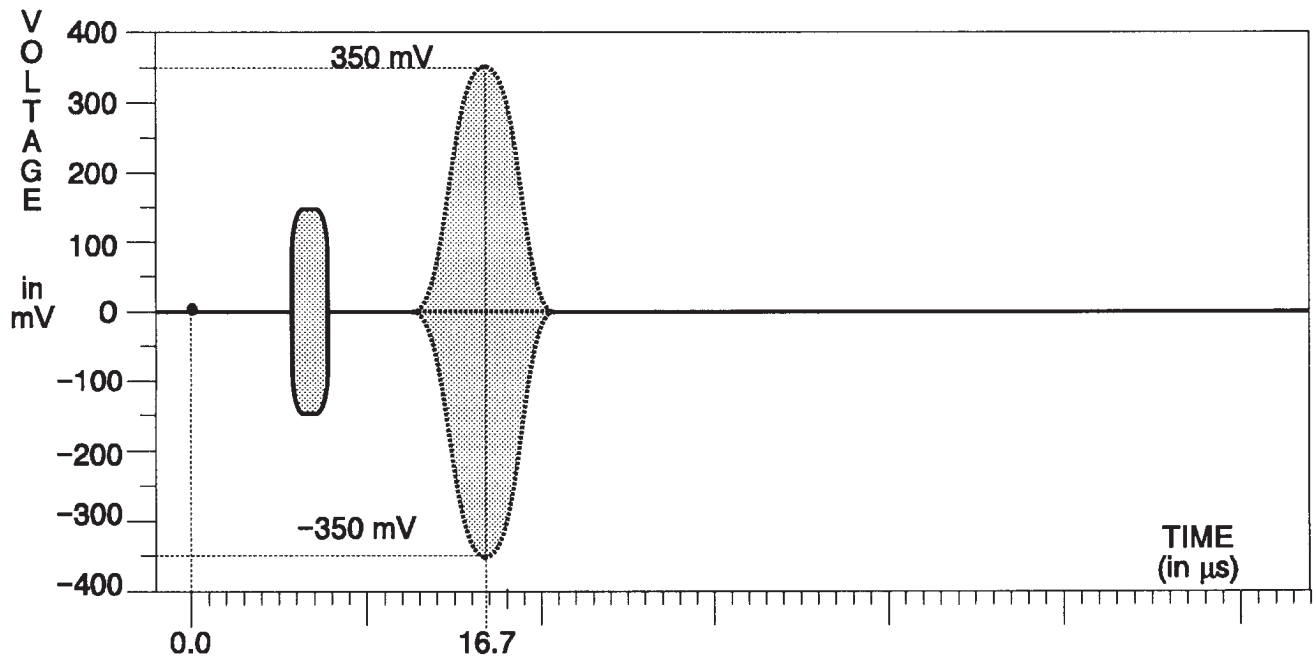

Fig. 3-55. C Channel — Pulse & Bar with Window.

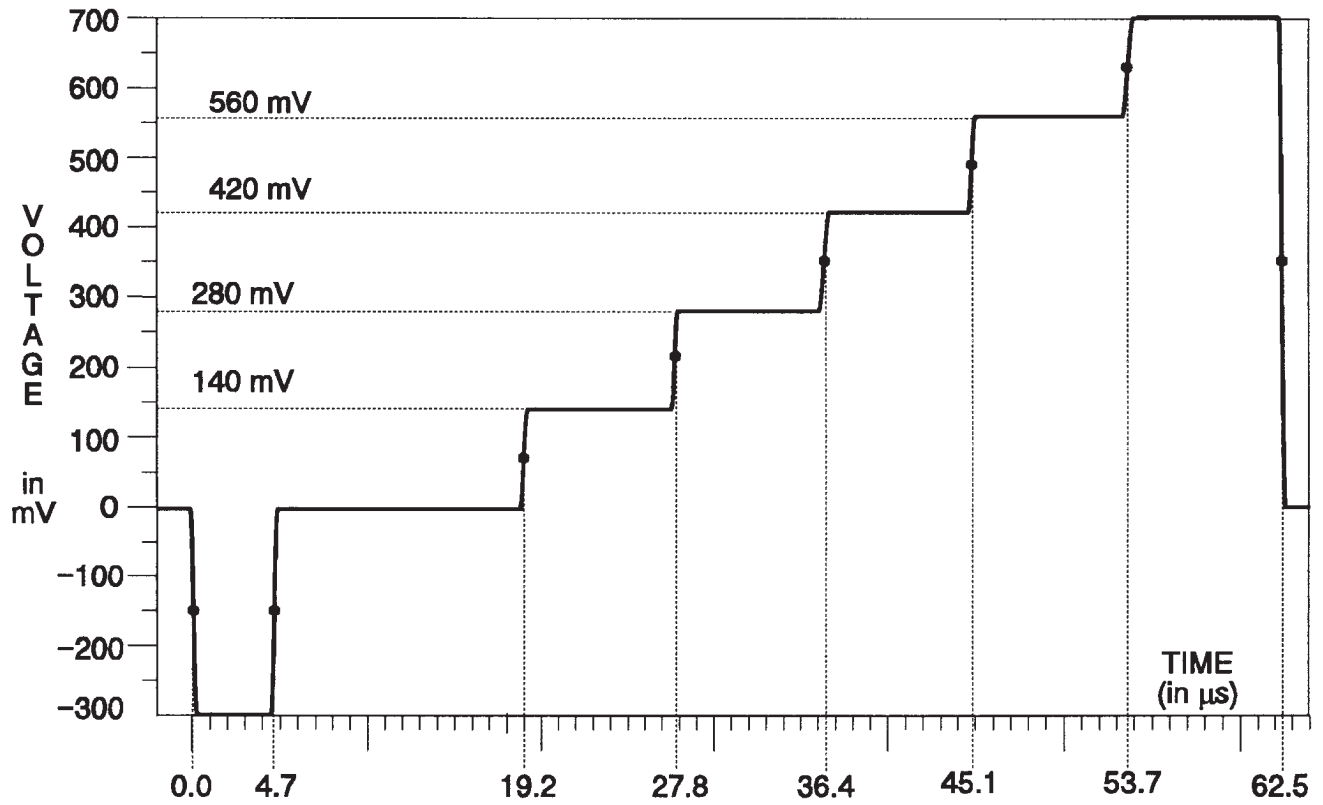

Fig. 3-56. Y Channel — 5-Step.

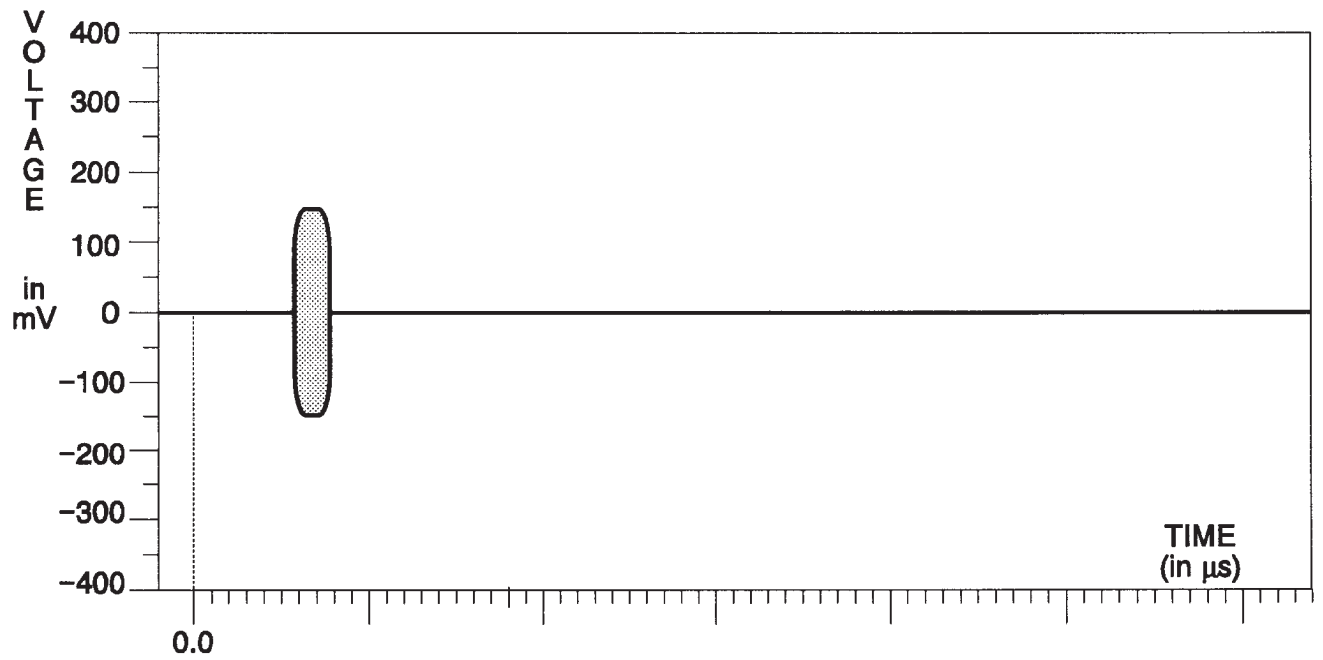

Fig. 3-57. C Channel — 5-Step.

TSG 131A — SPECIFICATIONS
Composite Signals

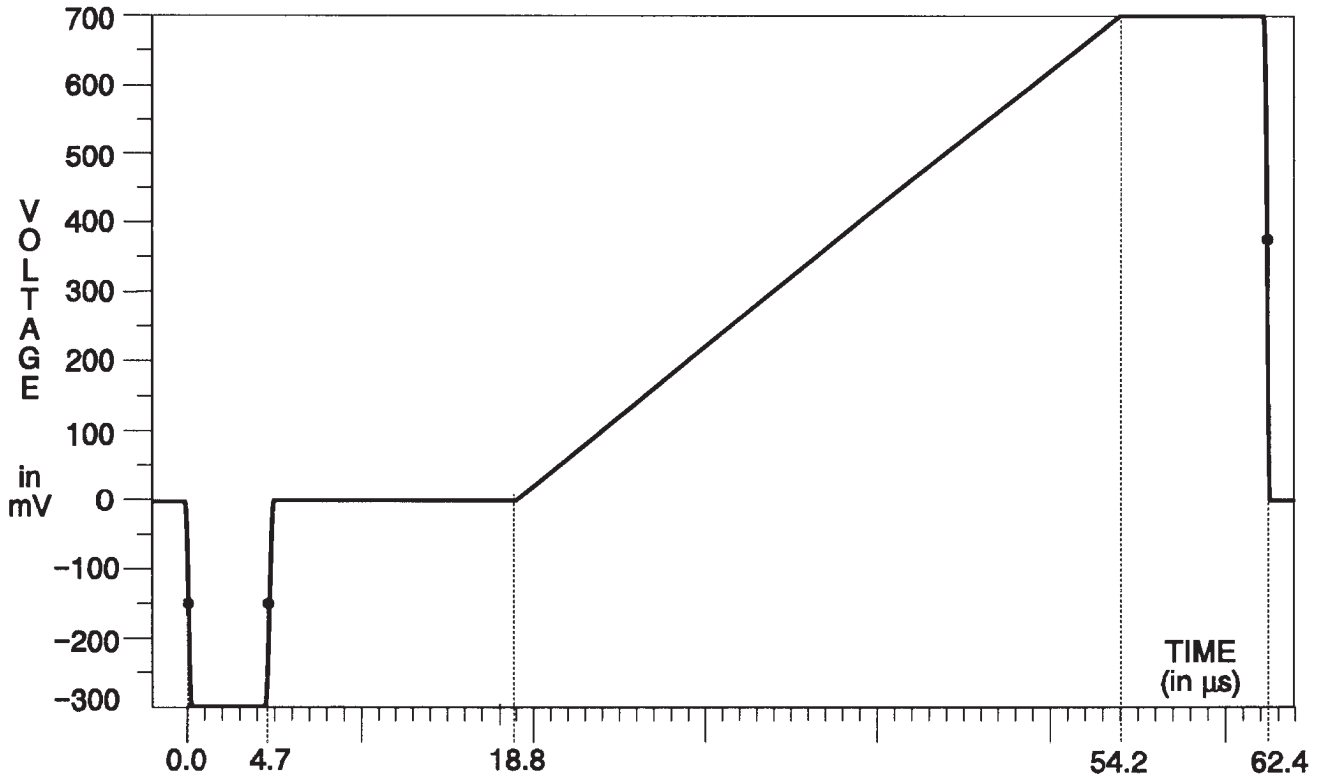

Fig. 3-58. Y Channel — Ramp.

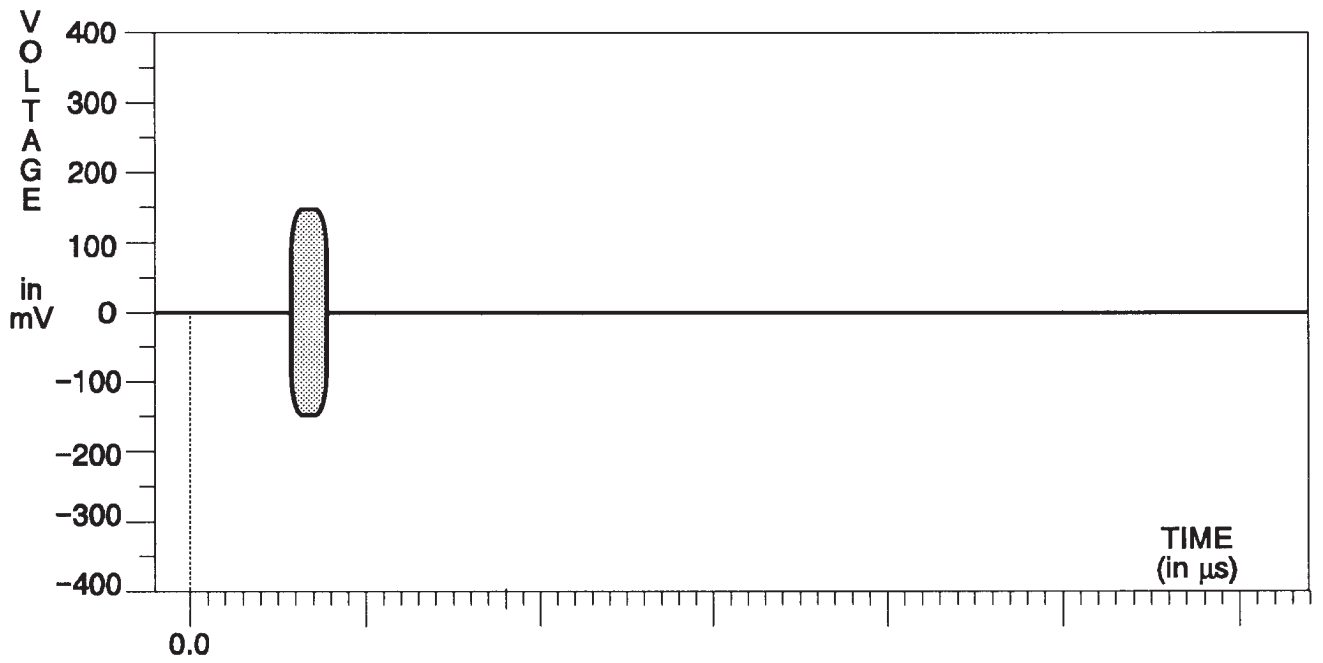

Fig. 3-59. C Channel — Ramp.

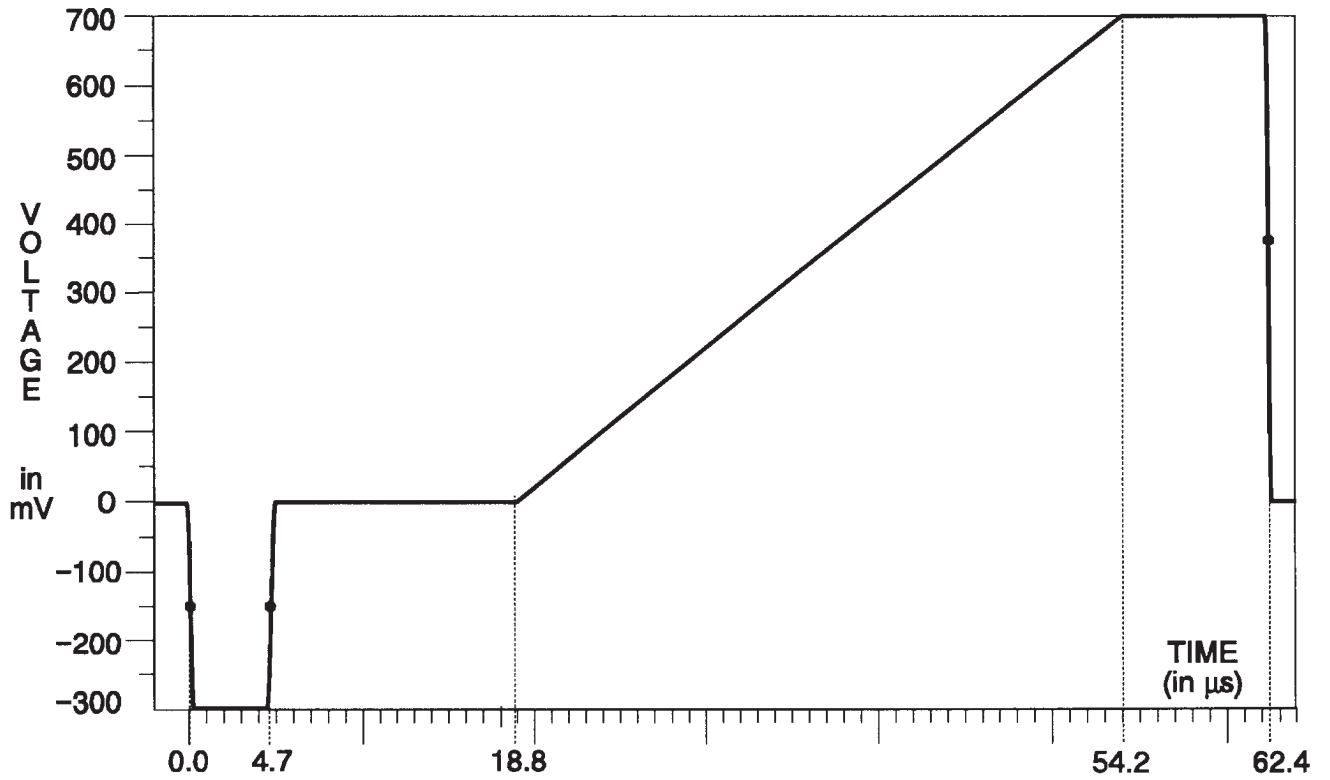

Fig. 3-60. Y Channel — Modulated Ramp.

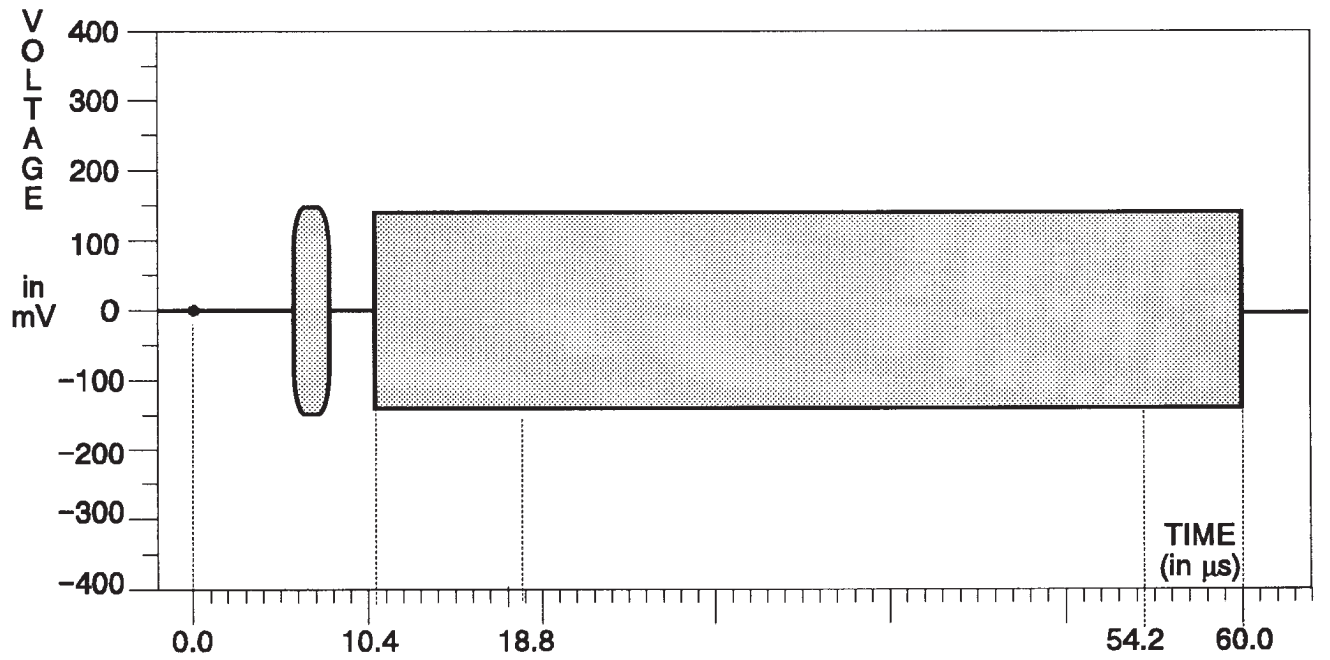

Fig. 3-61. C Channel — Modulated Ramp.

TSG 131A — SPECIFICATIONS
Composite Signals

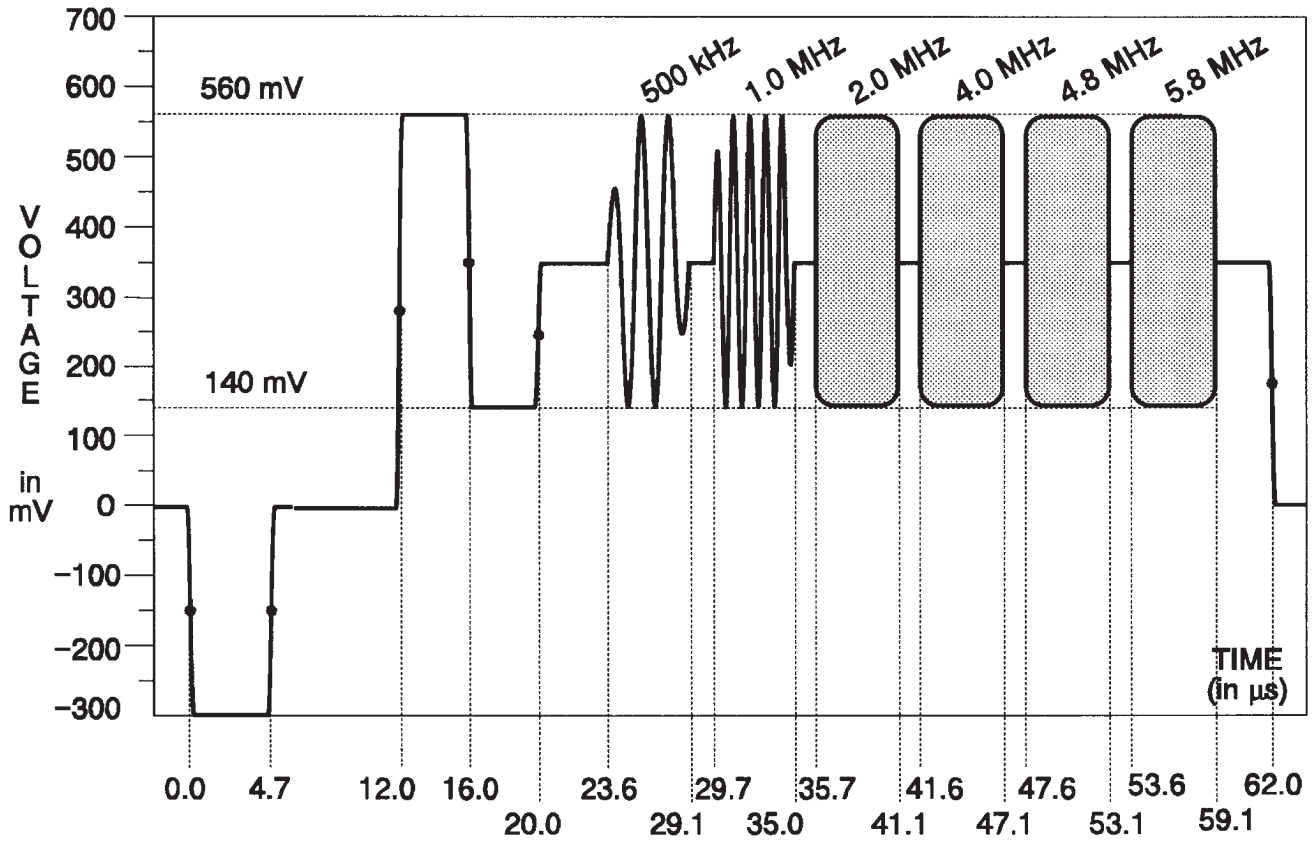

Fig. 3-62. Y Channel — Multiburst.

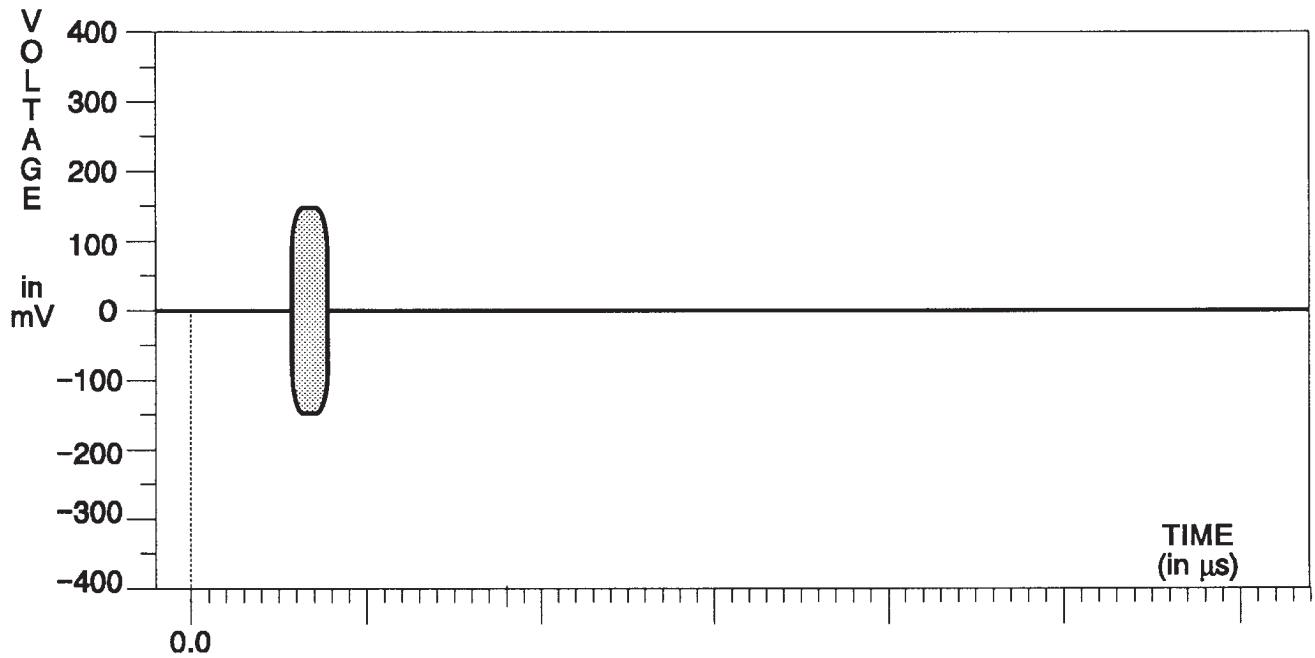

Fig. 3-63. C Channel — Multiburst.

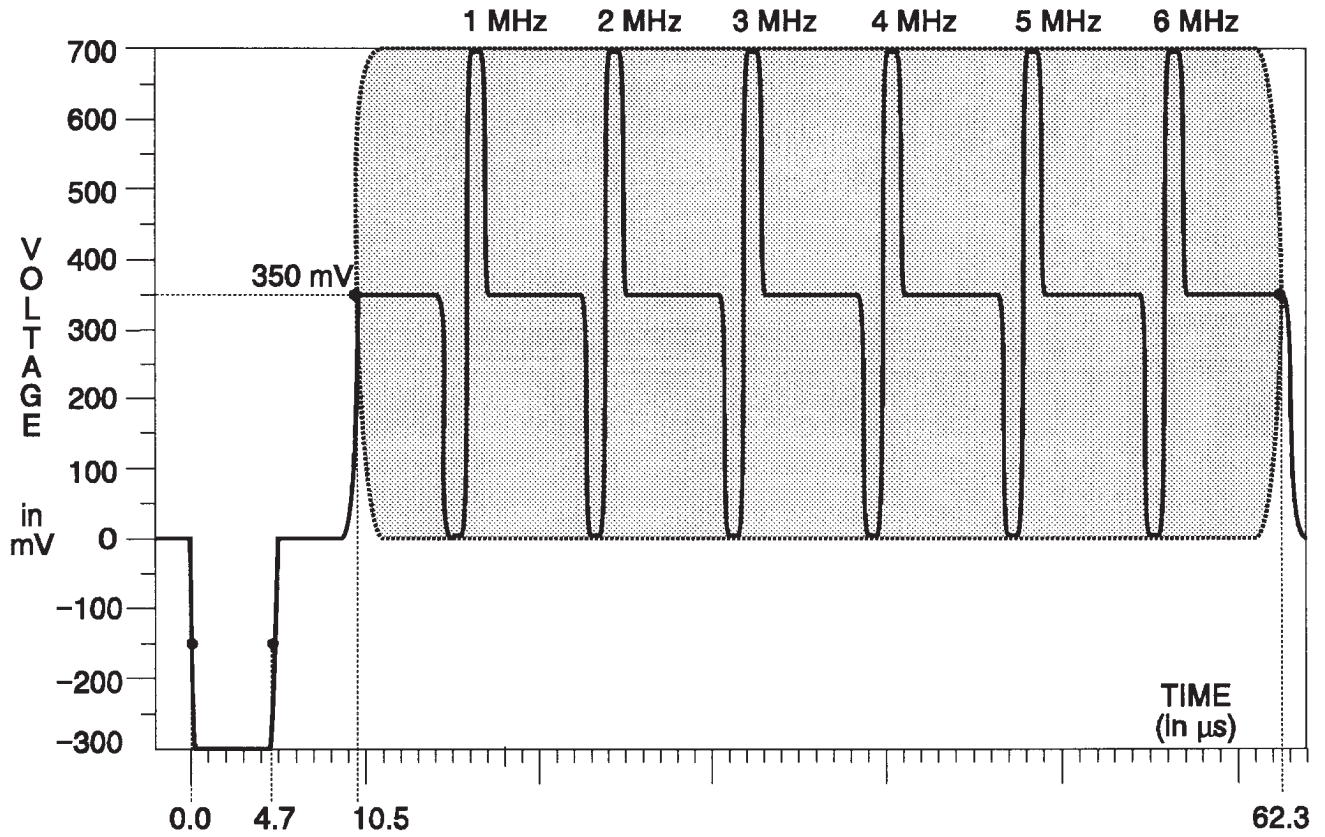

Fig. 3-64. Y Channel — Sweep.

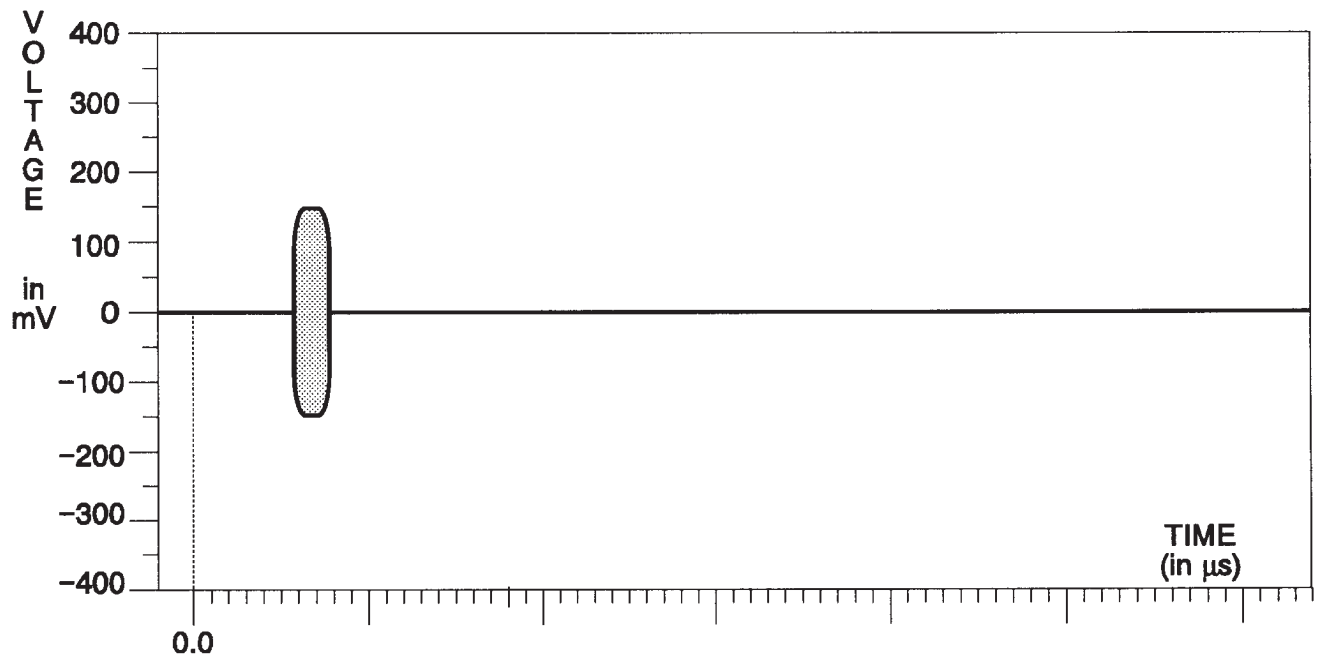

Fig. 3-65. C Channel — Sweep.

TSG 131A — SPECIFICATIONS
Composite Signals

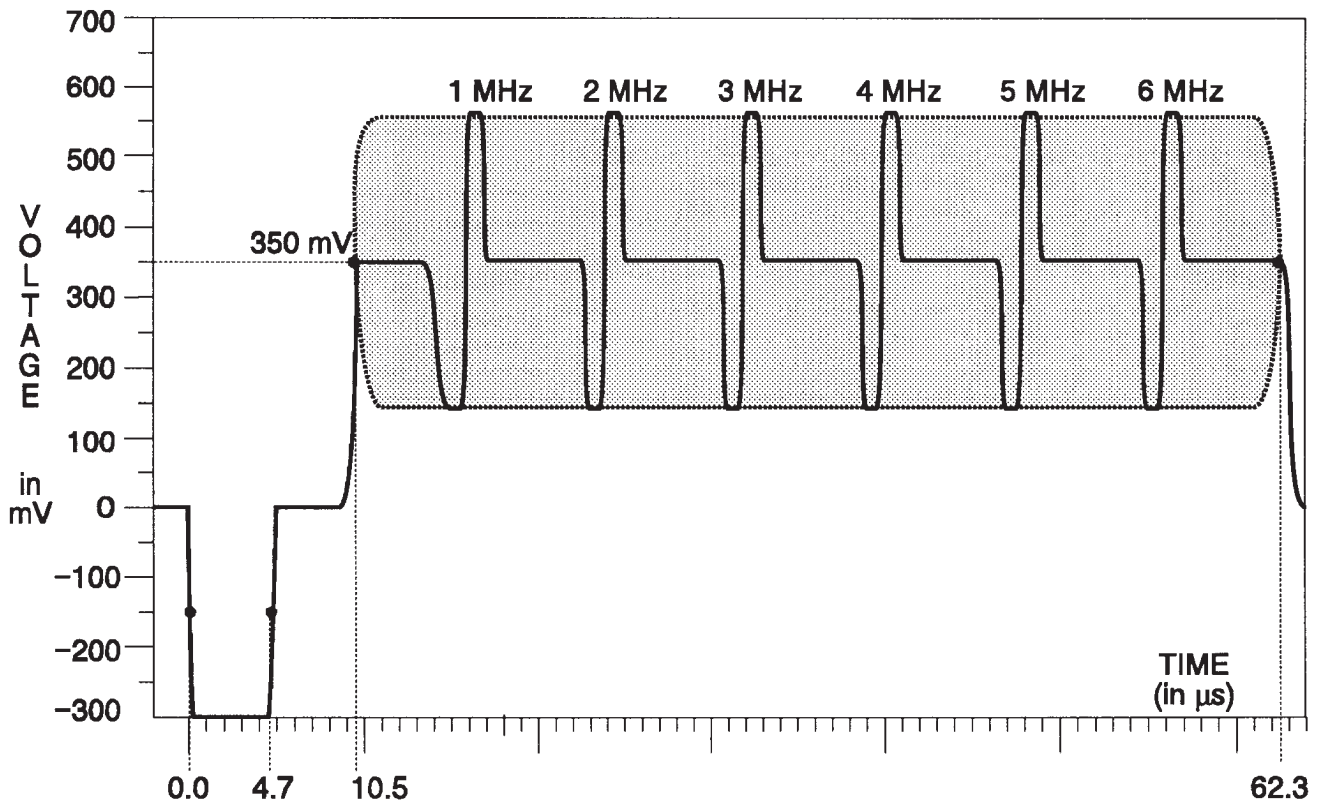

Fig. 3-66. Y Channel — Reduced Sweep.

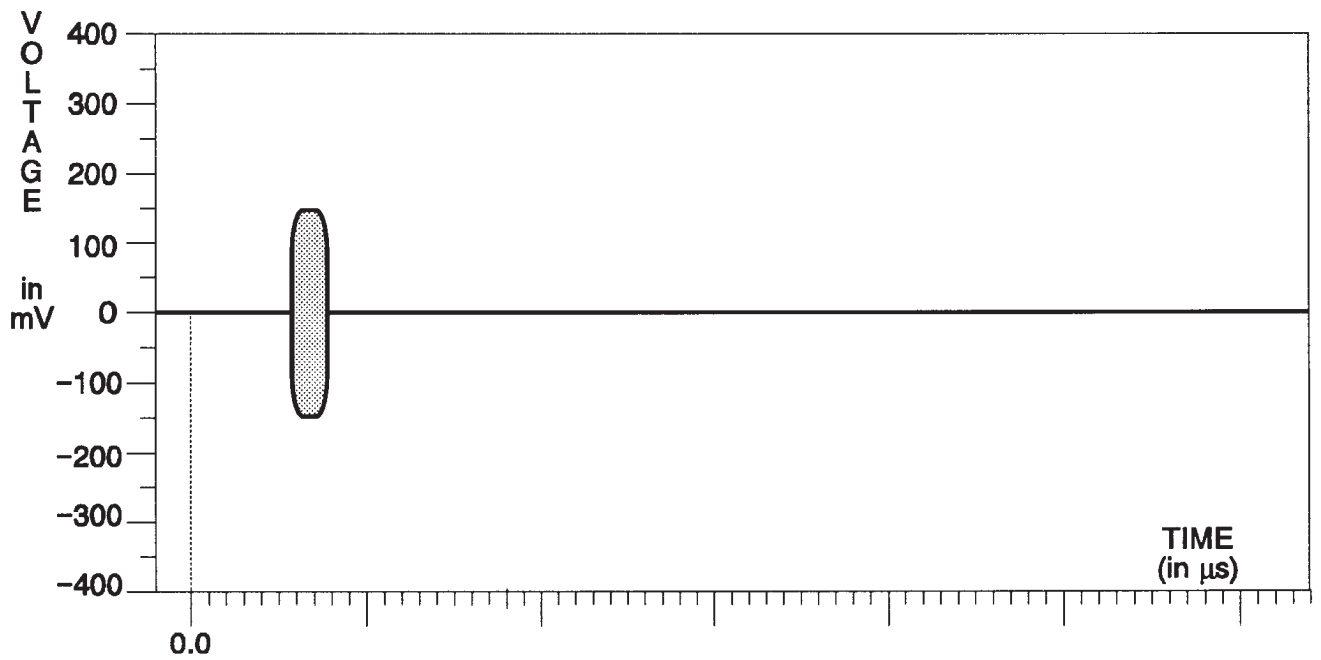

Fig. 3-67. C Channel — Reduced Sweep.

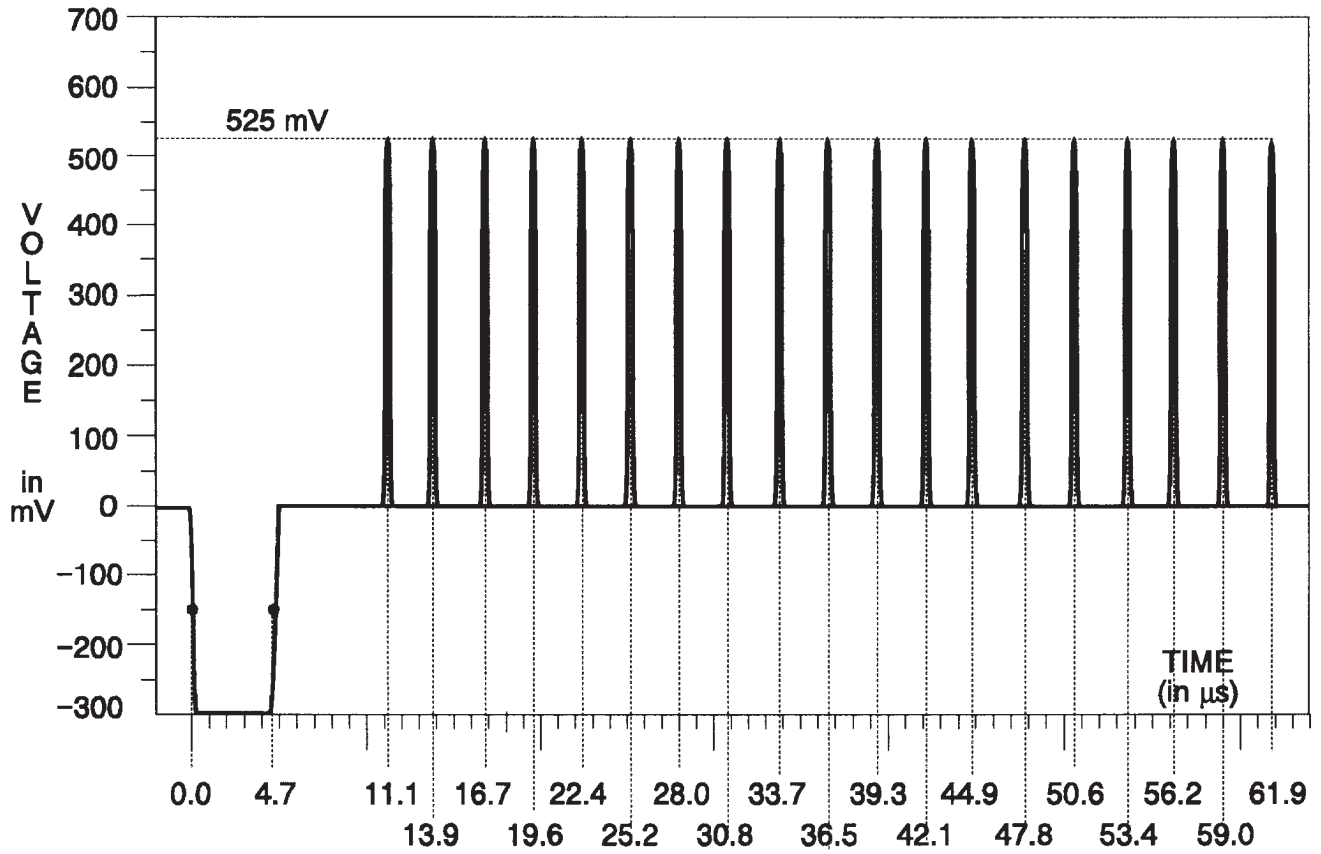

Fig. 3-68. Y Channel — Convergence (Vertical).

TSG 131A — SPECIFICATIONS
Composite Signals

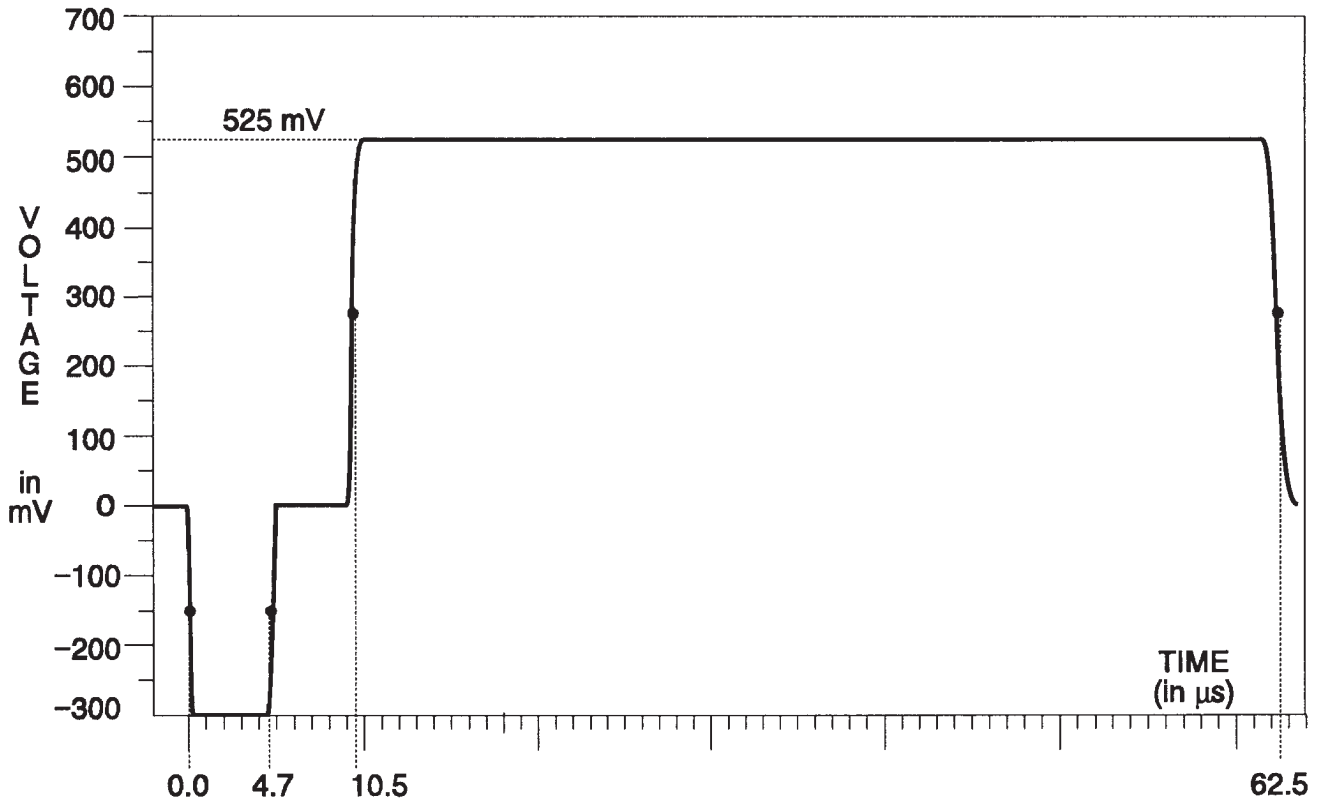

Fig. 3-69. Y Channel — Convergence (Horizontal).

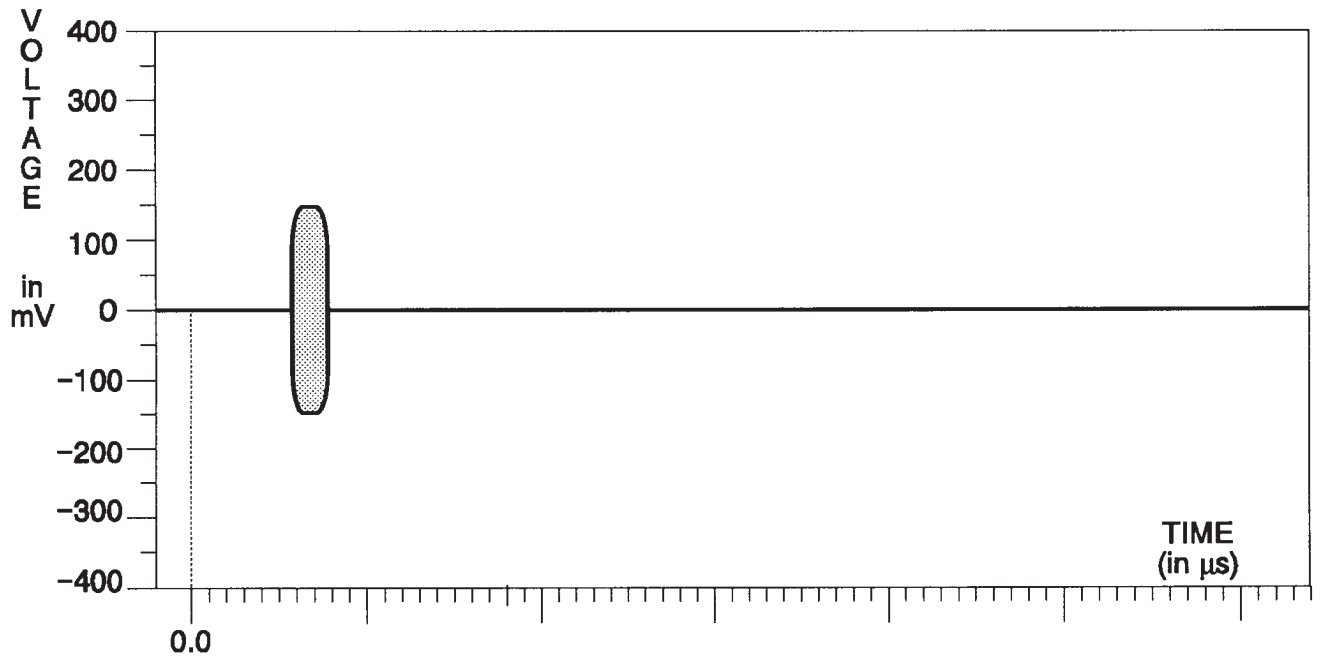

Fig. 3-70. C Channel — Convergence.

Component Signals

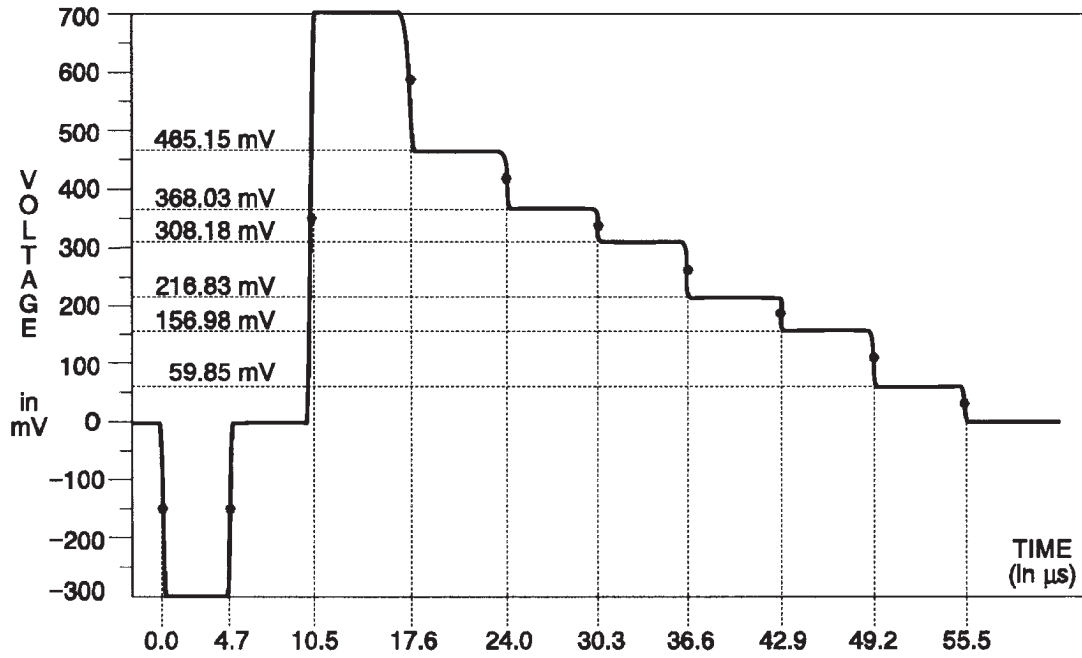

Fig. 3-71. Y Channel — 75% Bars.

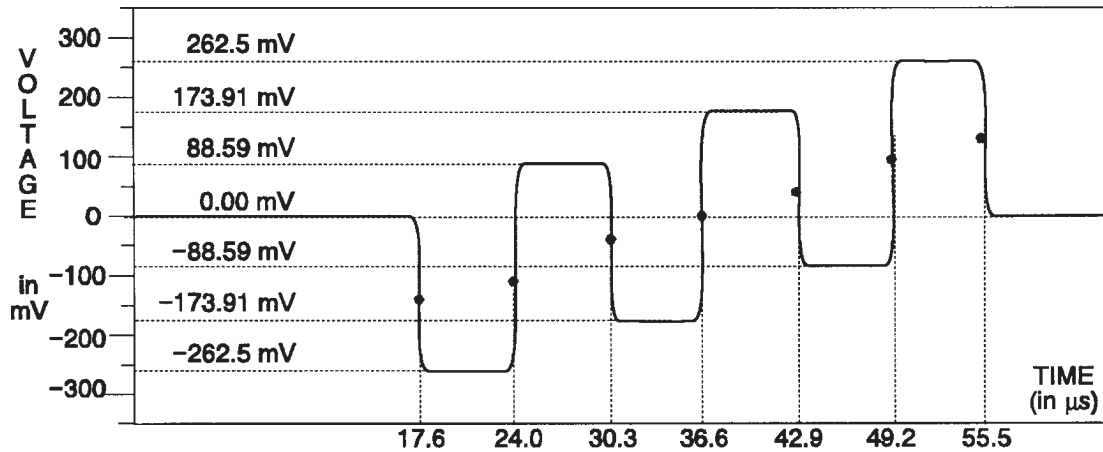

Fig. 3-72. B-Y Channel — 75% Bars.

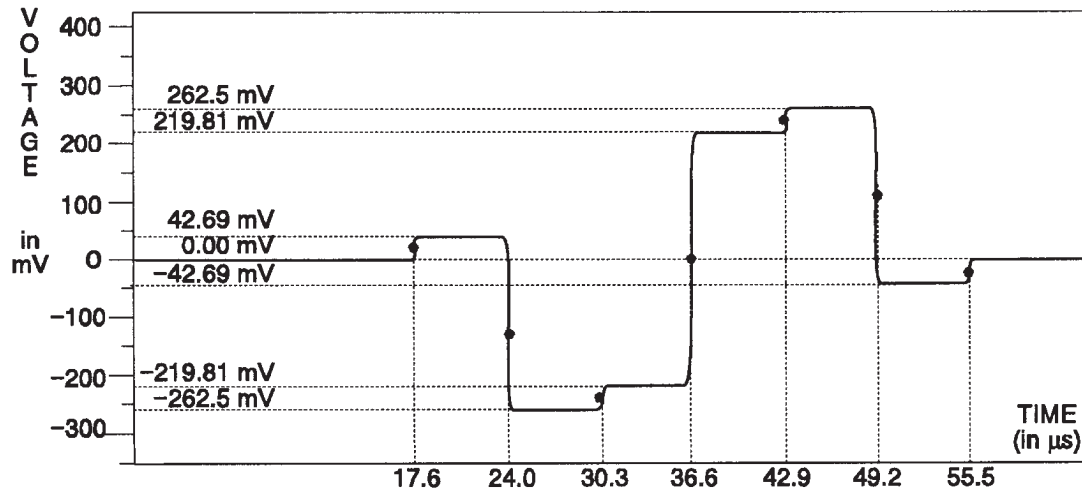

Fig. 3-73. R-Y Channel — 75% Bars.

TSG 131A — SPECIFICATIONS
Component Signals

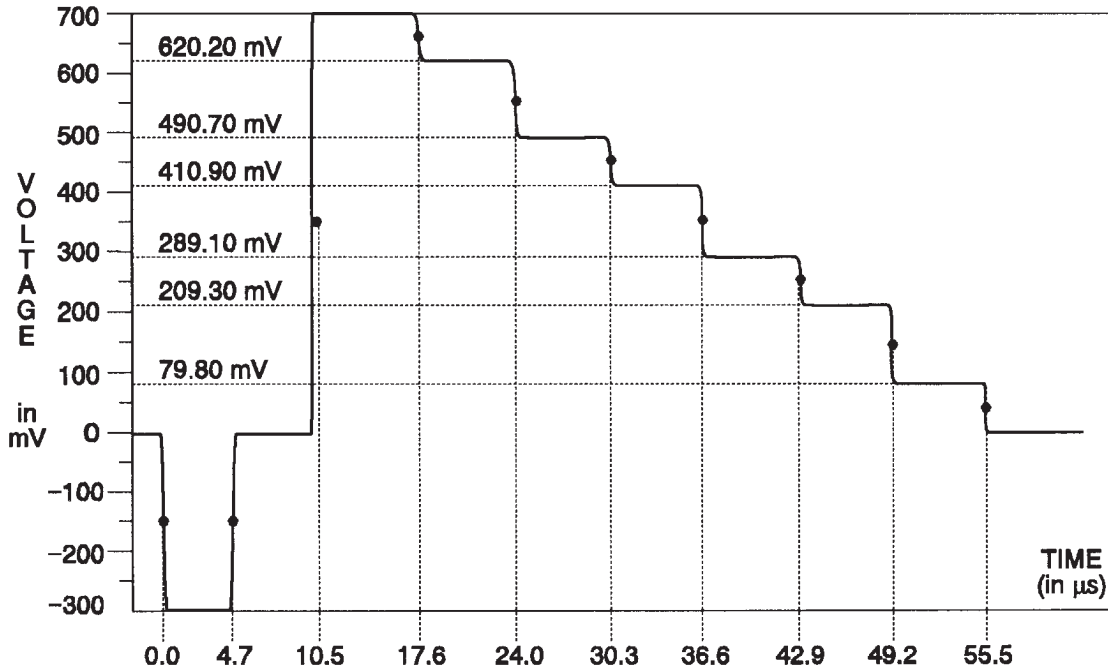

Fig. 3-74. Y Channel — 100% Bars.

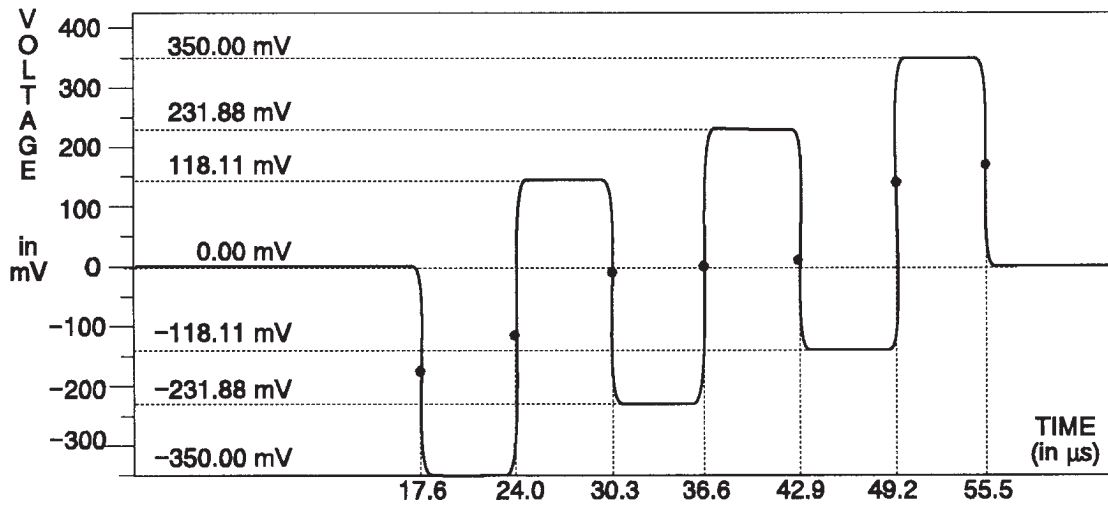

Fig. 3-75. B-Y Channel — 100% Bars.

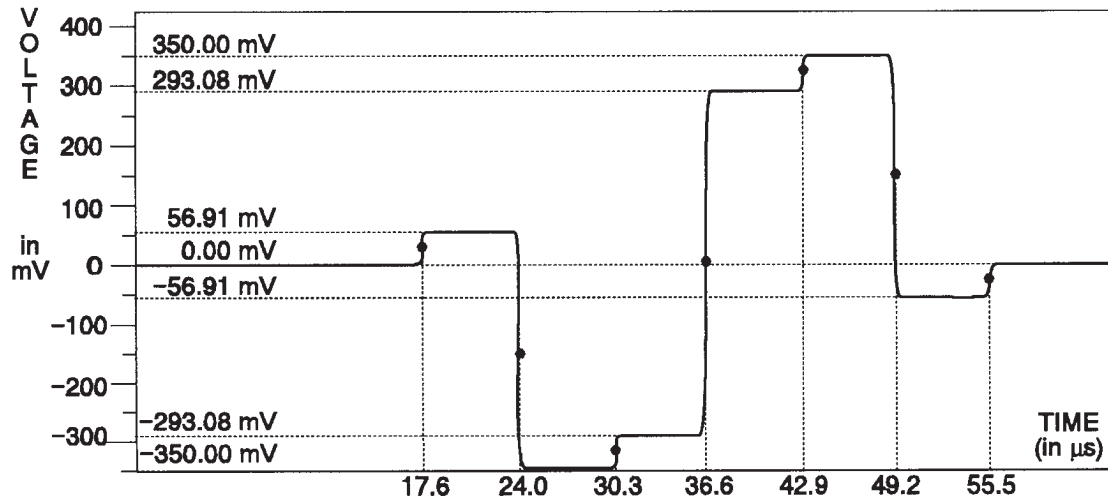

Fig. 3-76. R-Y Channel — 100% Bars.

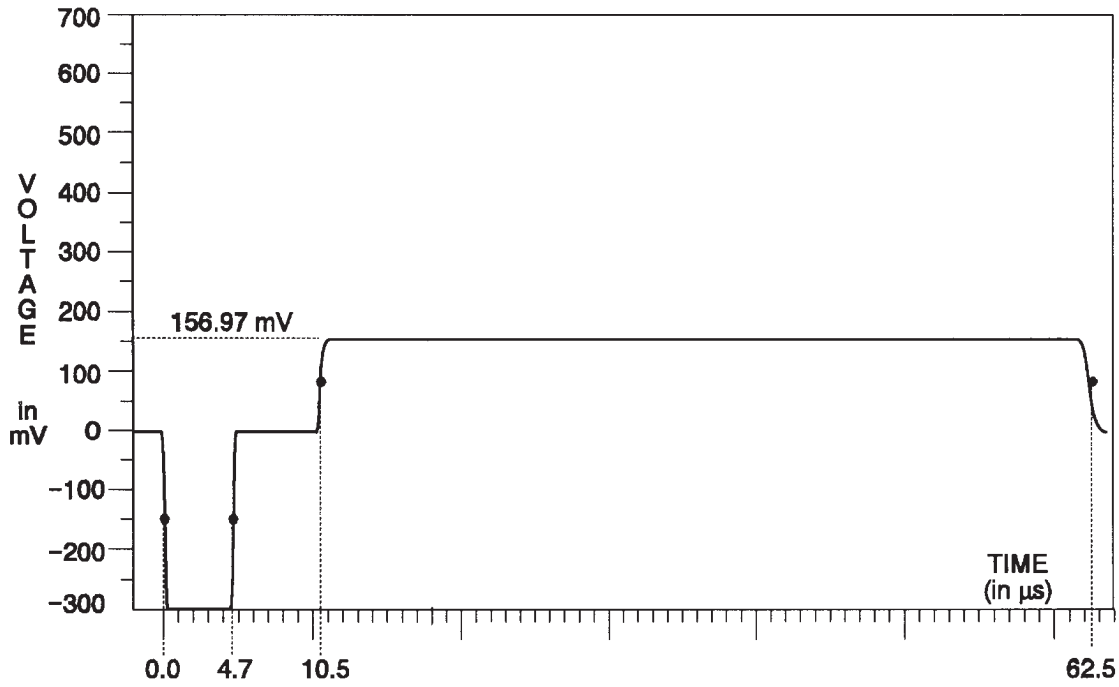

Fig. 3-77. Y Channel — 75% Red.

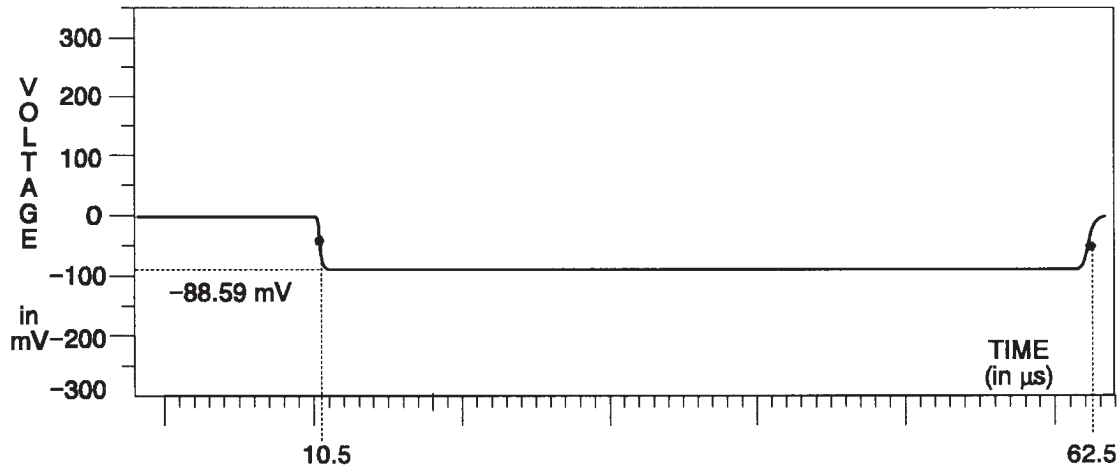

Fig. 3-78. B-Y Channel — 75% Red.

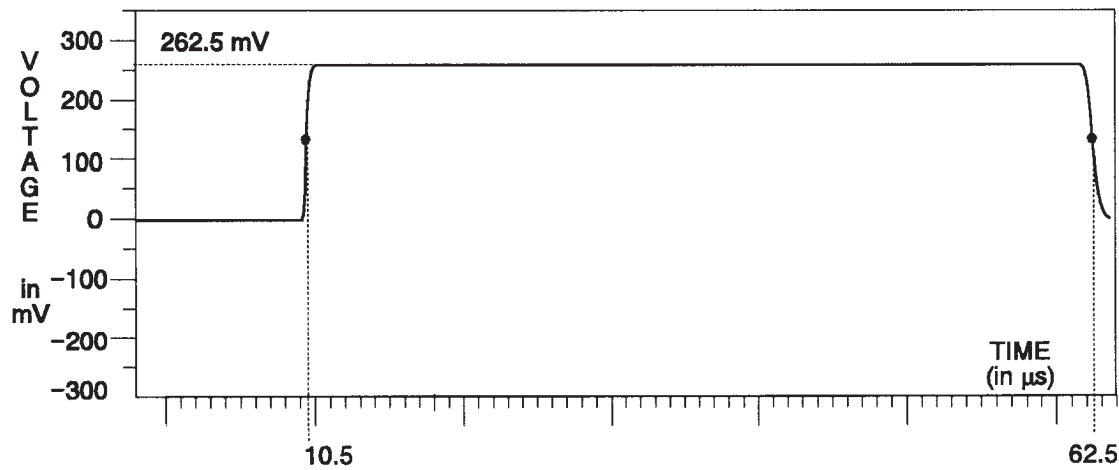

Fig. 3-79. R-Y Channel — 75% Red.

TSG 131A — SPECIFICATIONS
Component Signals

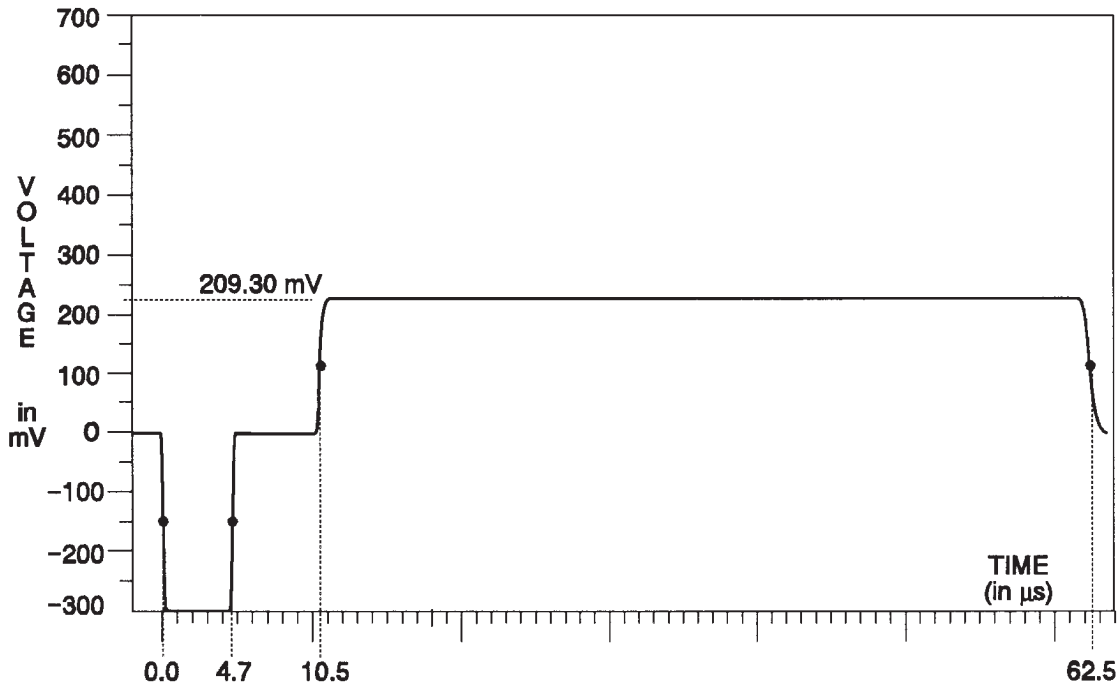

Fig. 3-80. Y Channel — 100% Red.

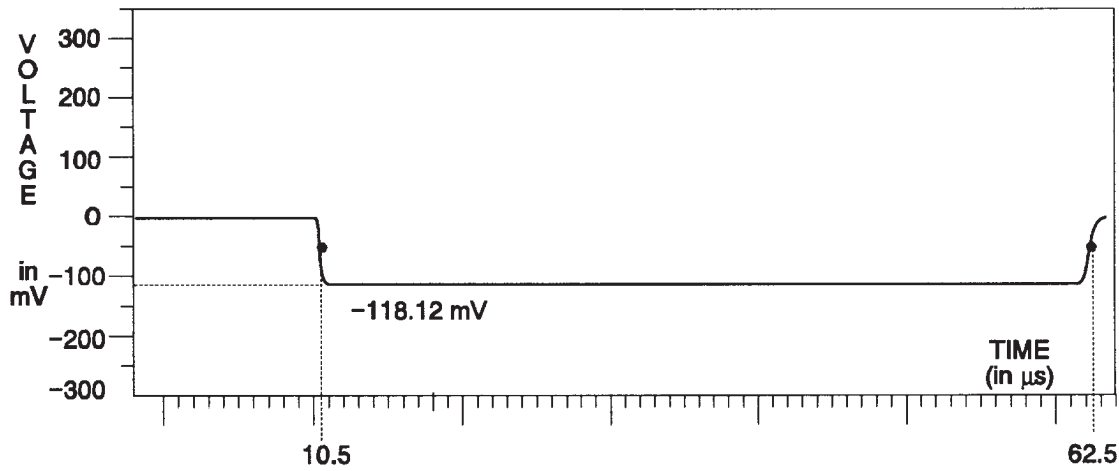

Fig. 3-81. B-Y Channel — 100% Red.

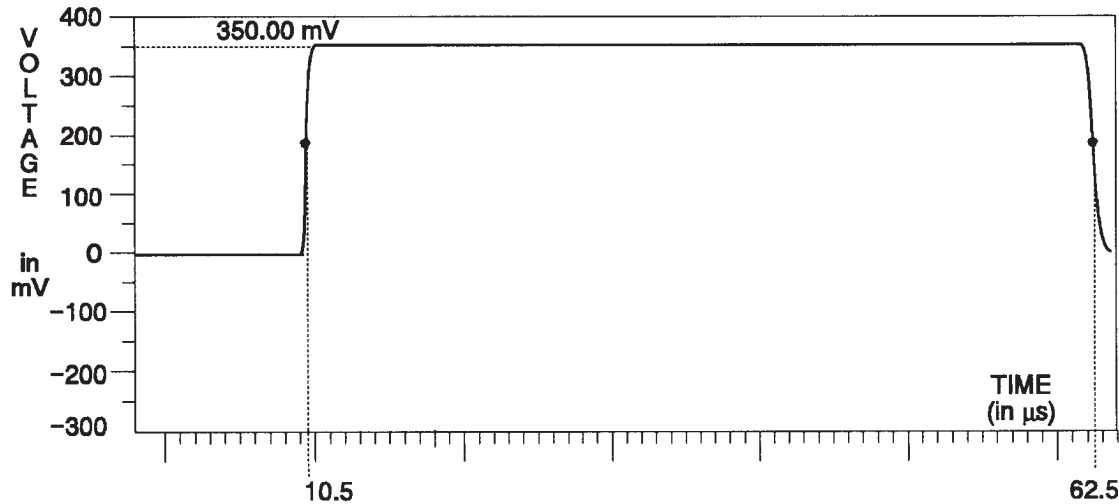

Fig. 3-82. R-Y Channel — 100% Red.

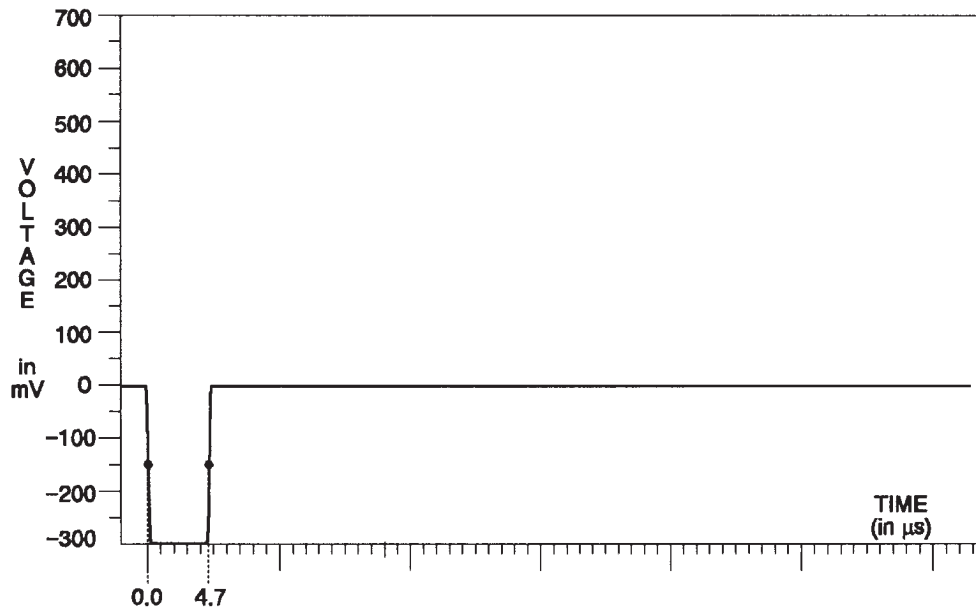

Fig. 3-83. Y Channel — 0% Flat Field.

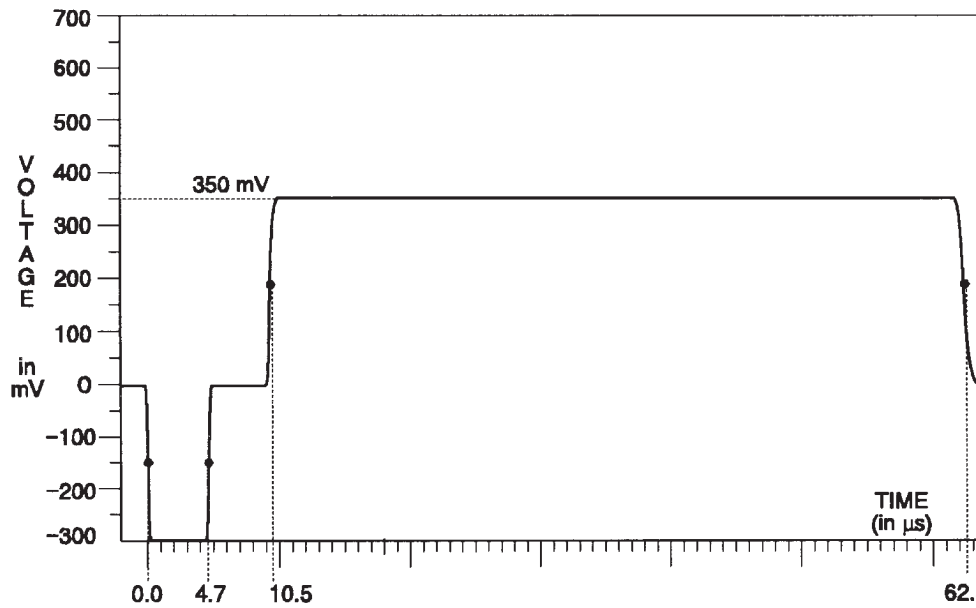

Fig. 3-84. Y Channel — 50% Flat Field.

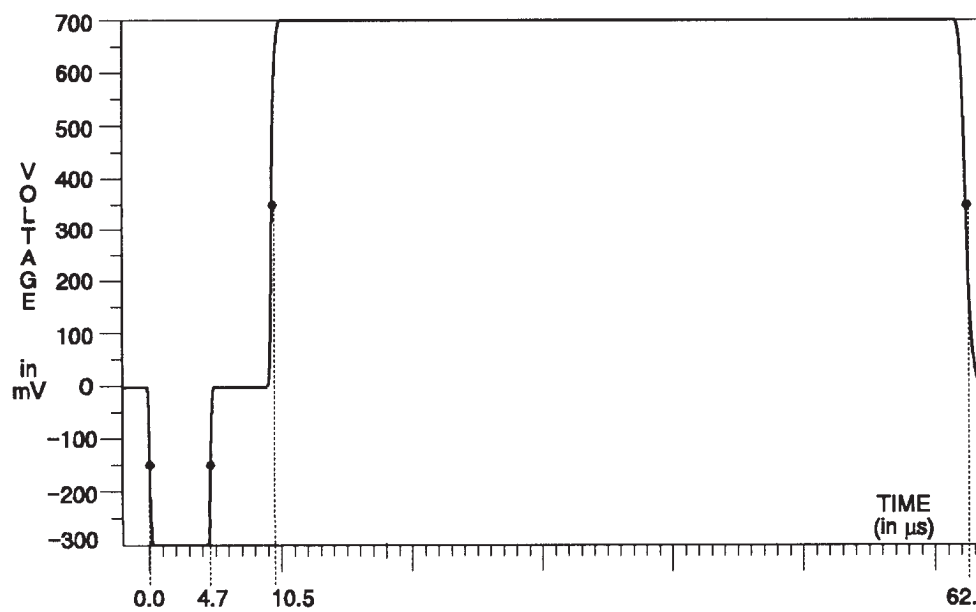

Fig. 3-85. Y Channel — 100% Flat Field.

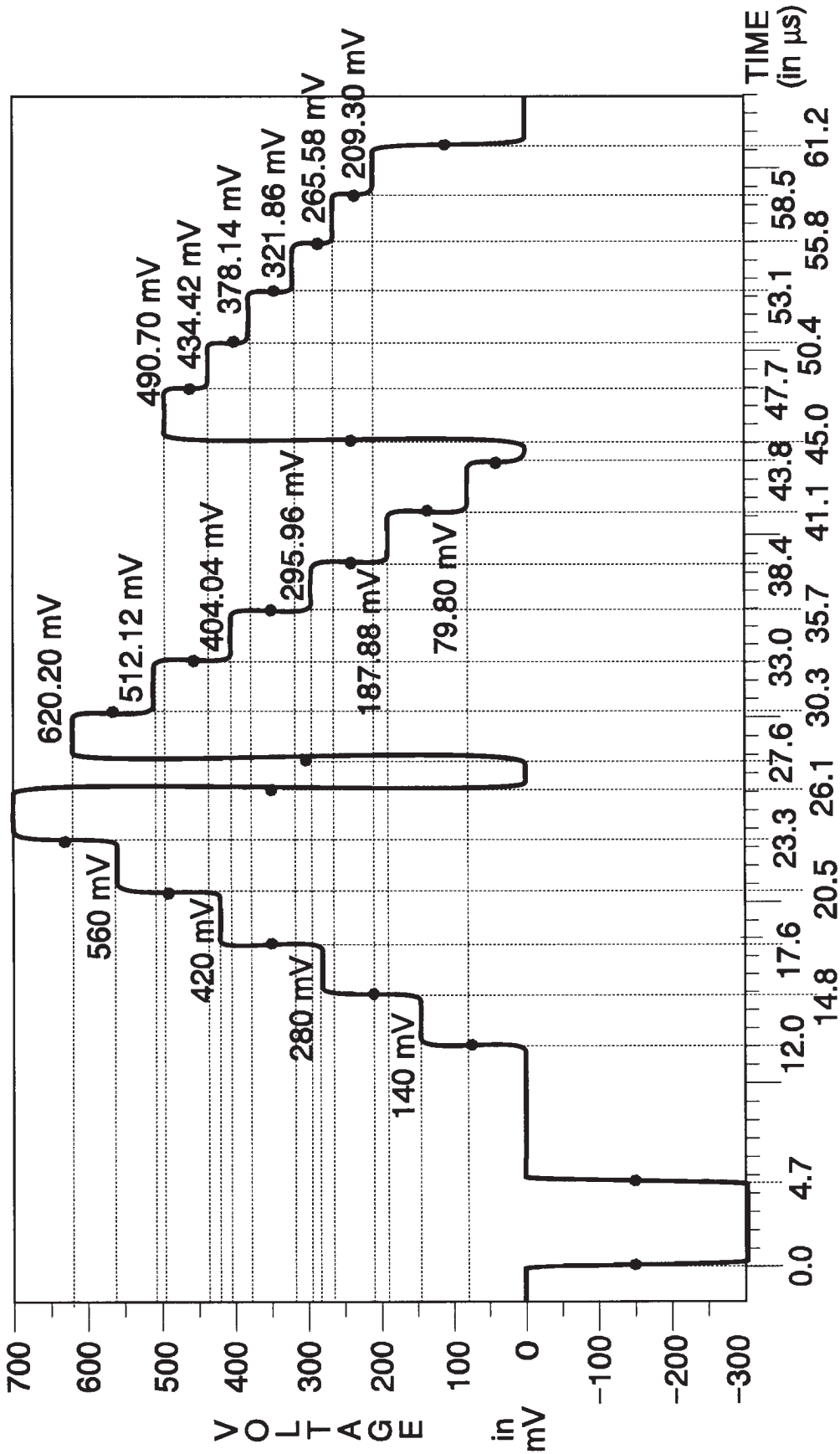

Fig. 3-86. Y Channel — Valid 5-Step.

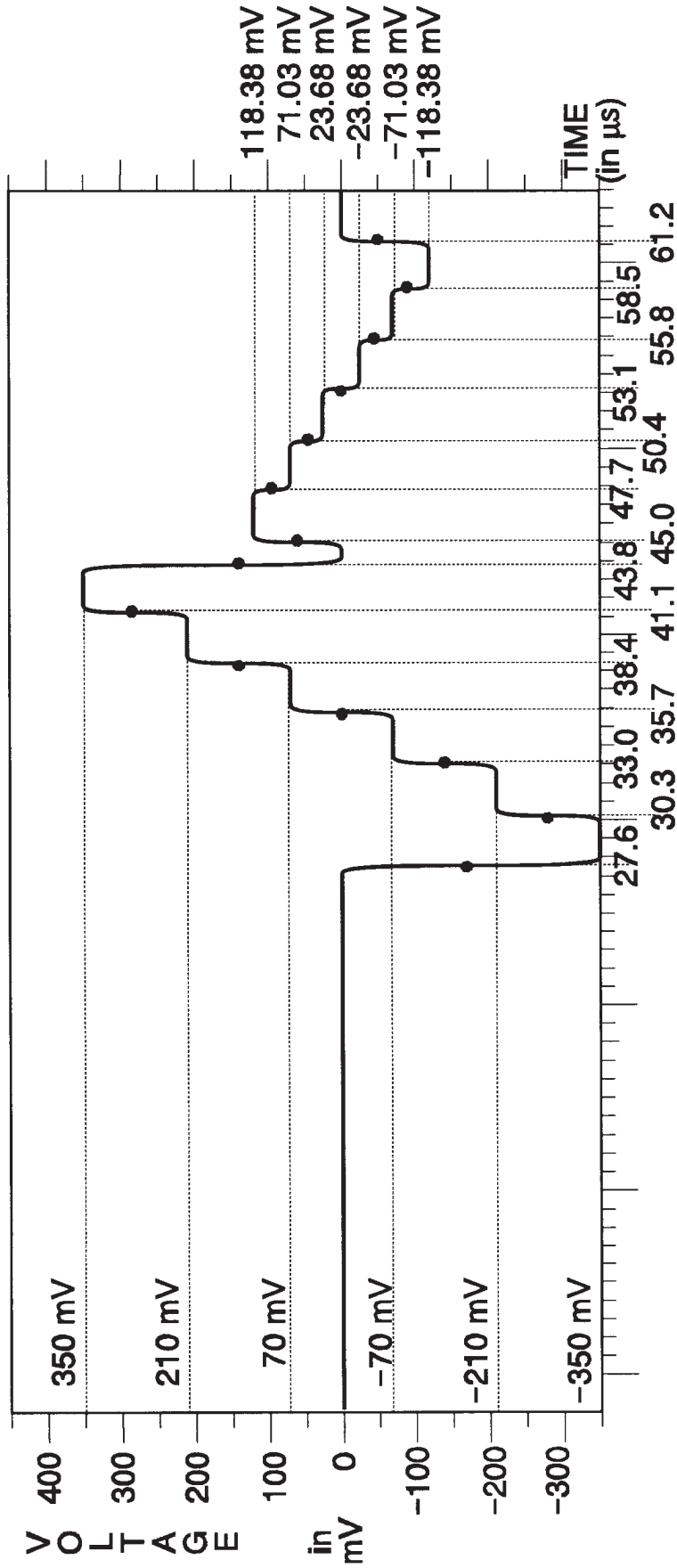

Fig. 3-87. B-Y Channel — Valid 5-Step

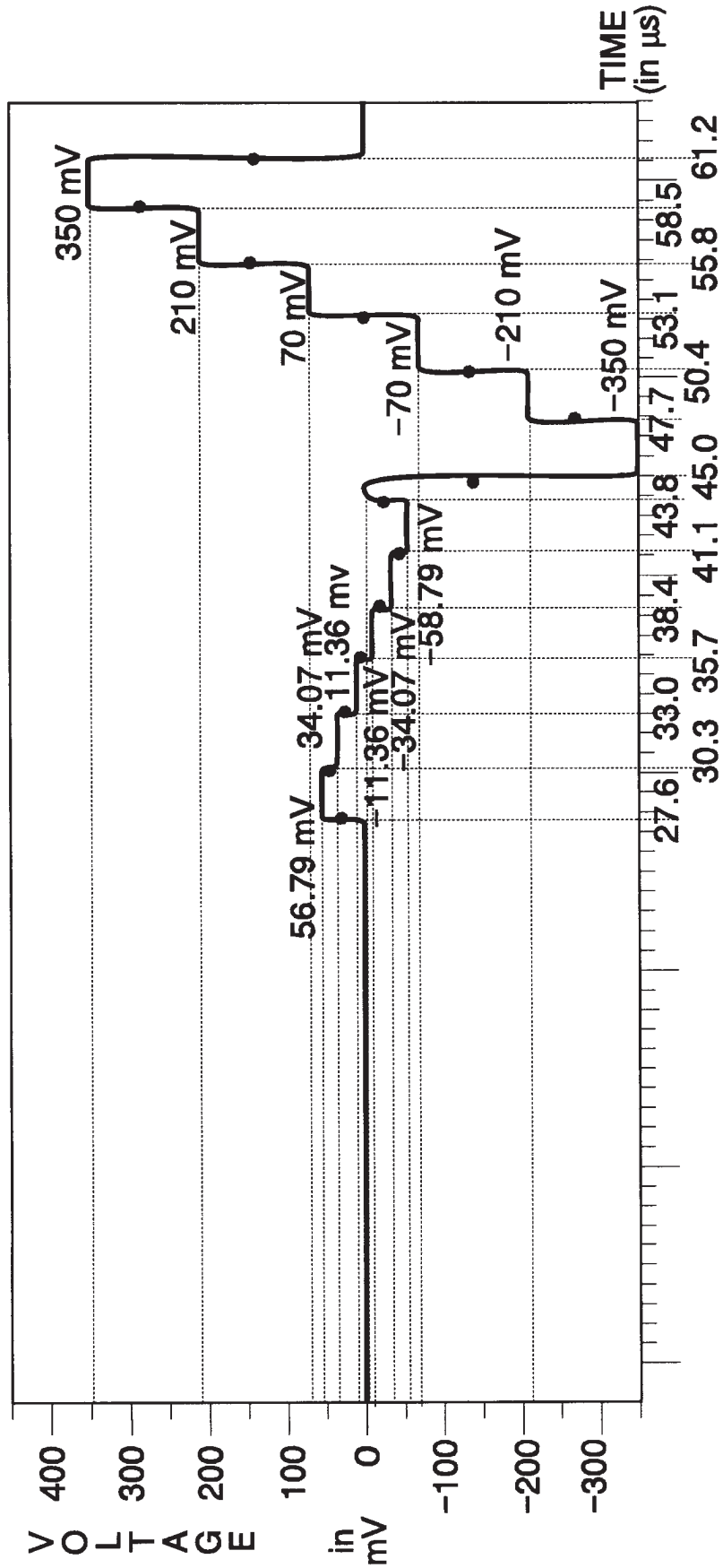

Fig. 3-88. R-Y Channel — Valid 5-Step.

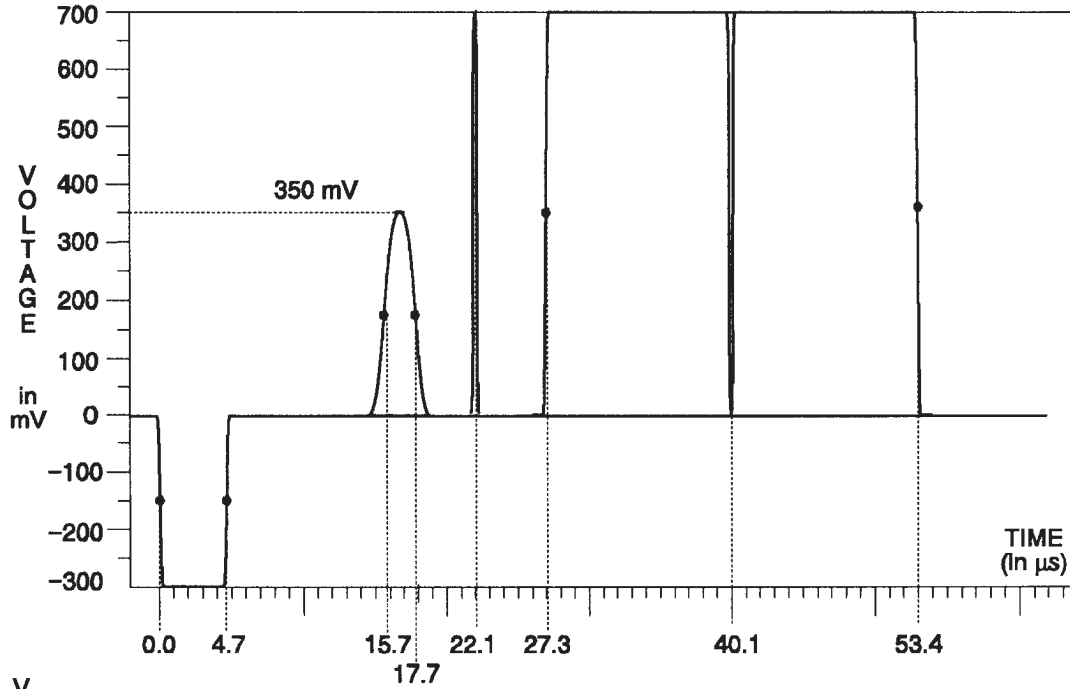

Fig. 3-89. Y Channel — Pulse & Bar with Window.

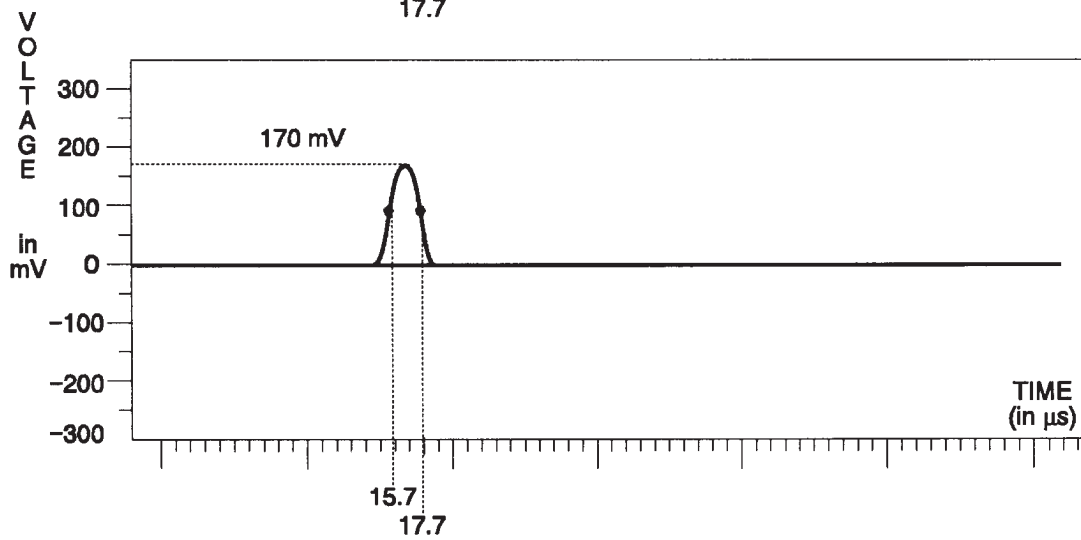

Fig. 3-90. B-Y Channel — Pulse & Bar with Window.

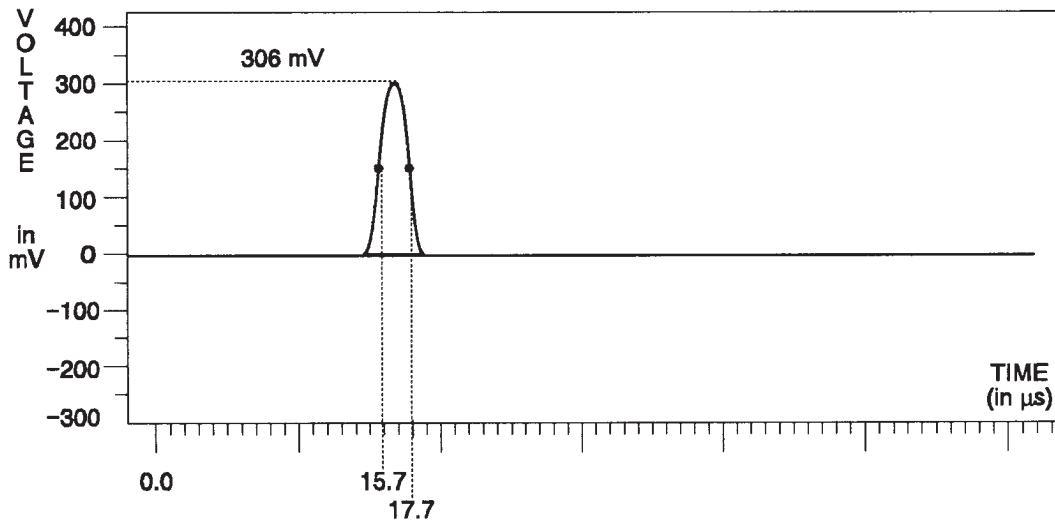

Fig. 3-91. R-Y Channel — Pulse & Bar with Window.

TSG 131A — SPECIFICATIONS
Component Signals

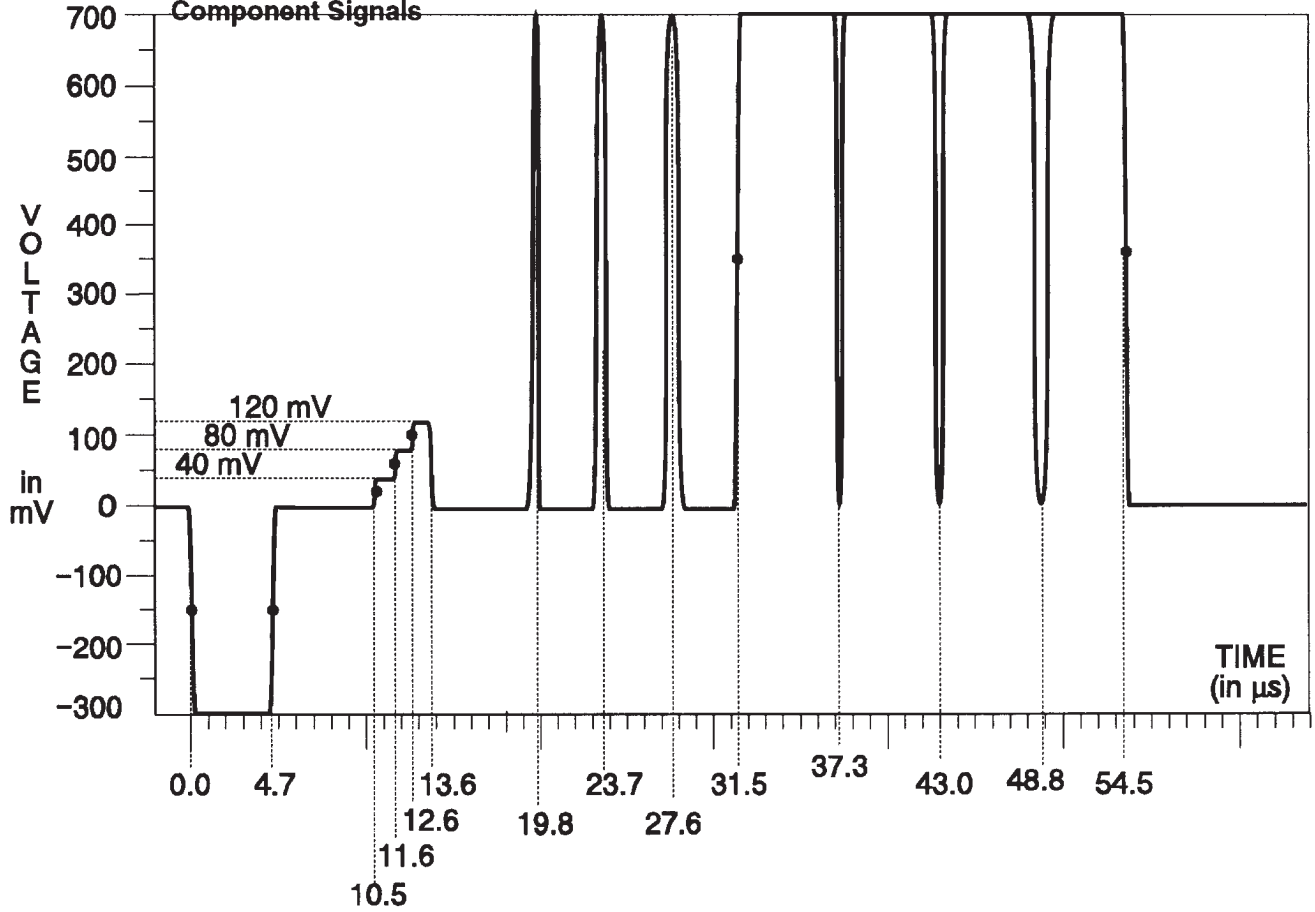

Fig. 3-92. Y Channel — T Pulses.

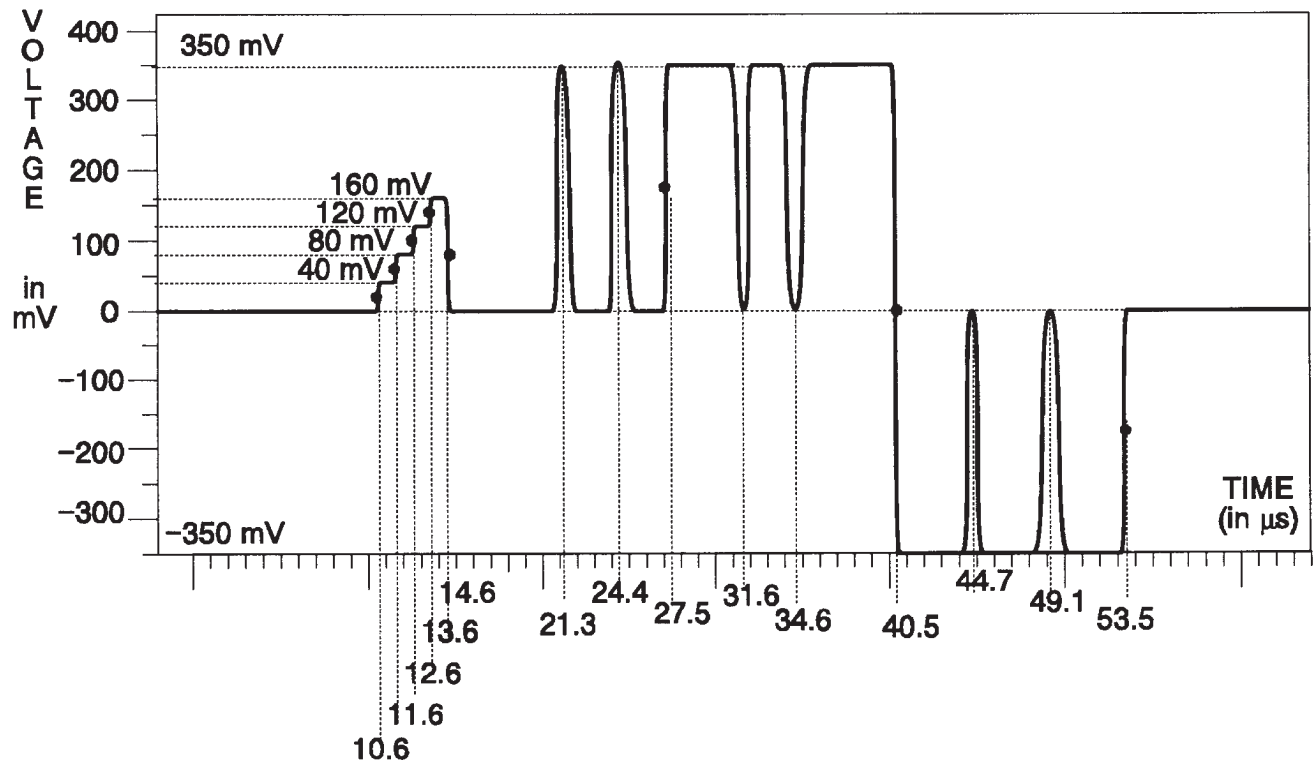

Fig. 3-93. B-Y Channel — T Pulses.

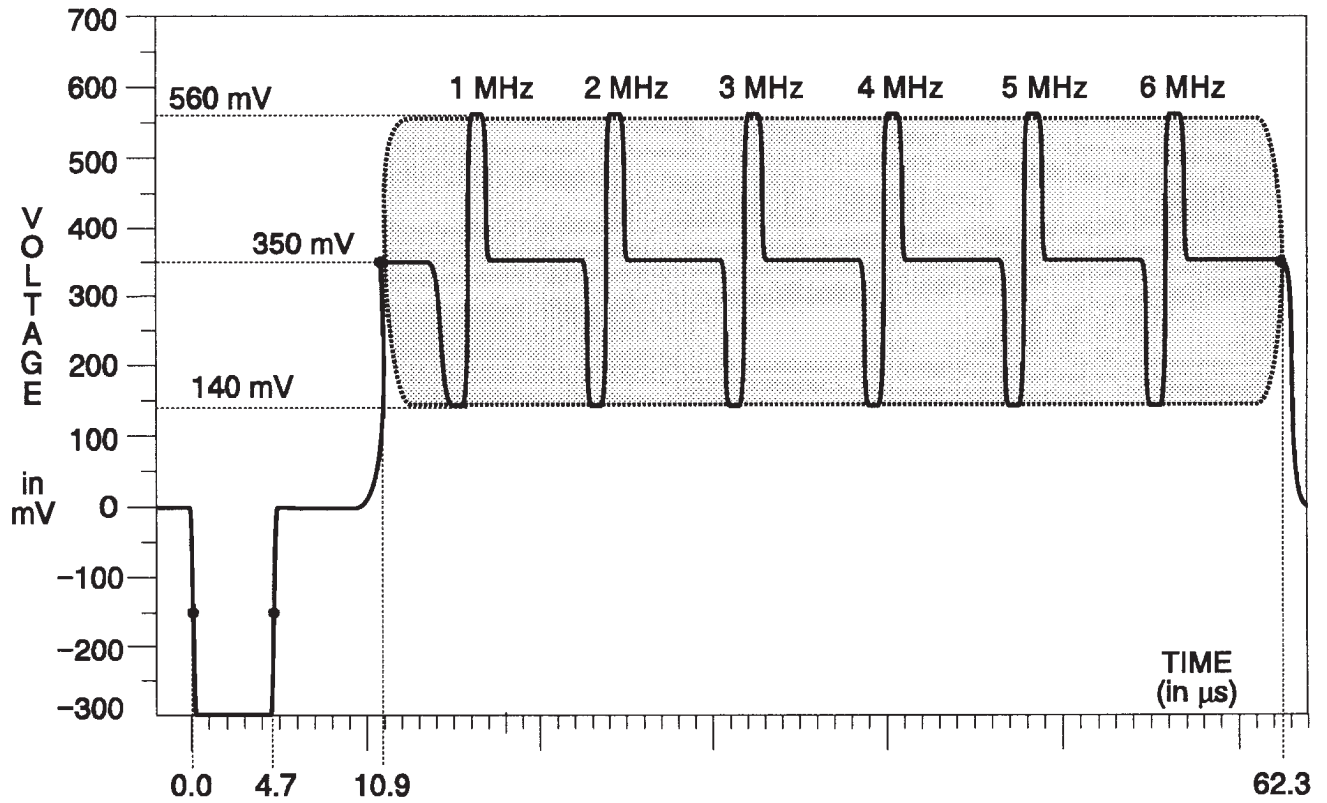

Fig. 3-94. Y Channel — Line Sweep.

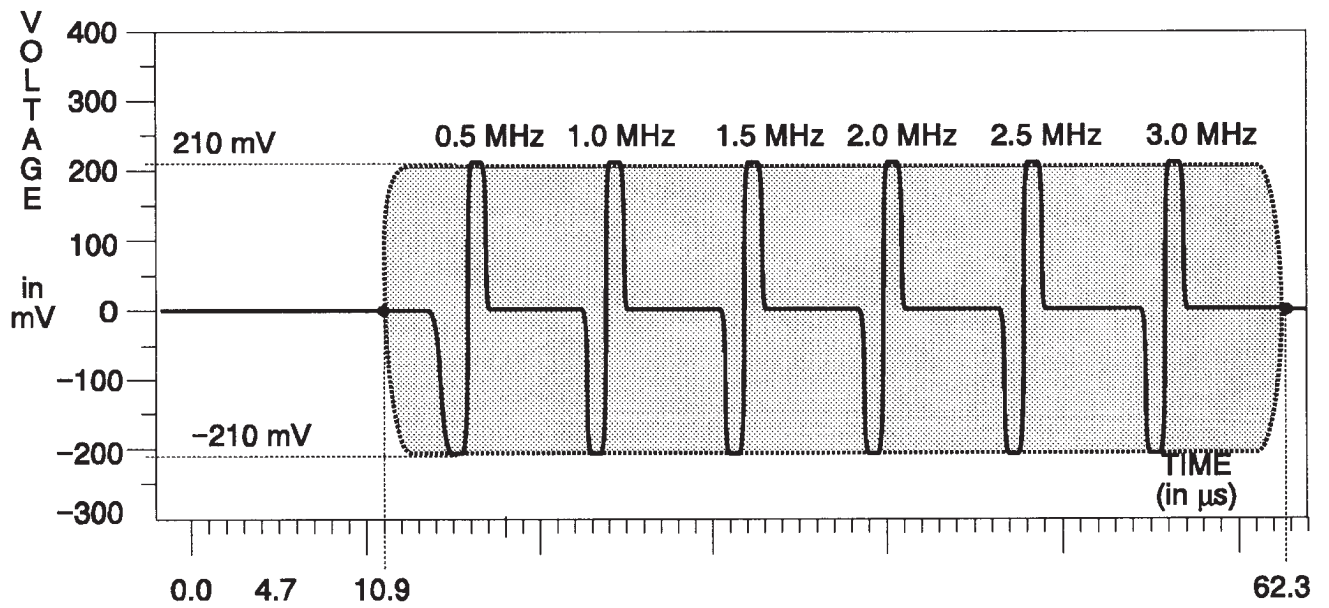

Fig. 3-95. B-Y & R-Y Channel — Line Sweep.

TSG 131A — SPECIFICATIONS
Component Signals

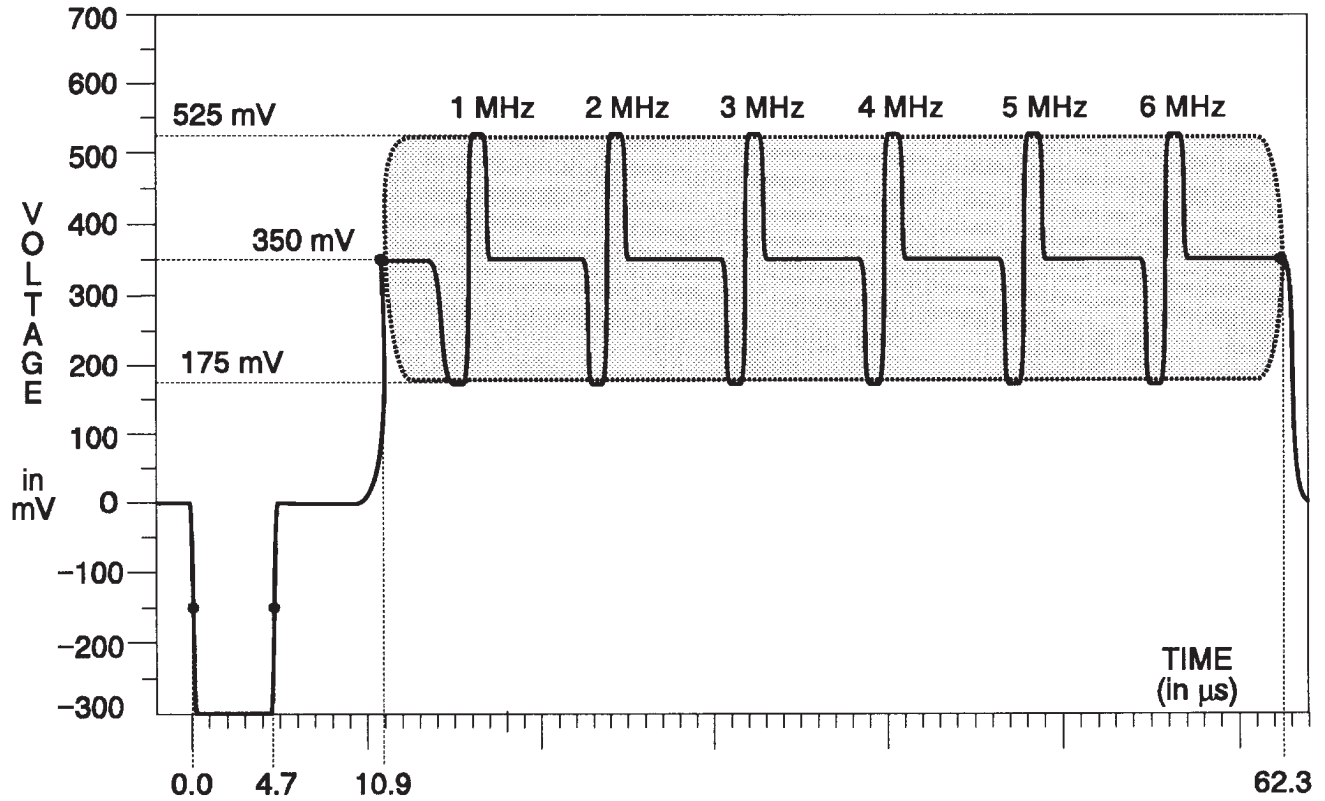

Fig. 3-96. Y Channel — Reduced Line Sweep.

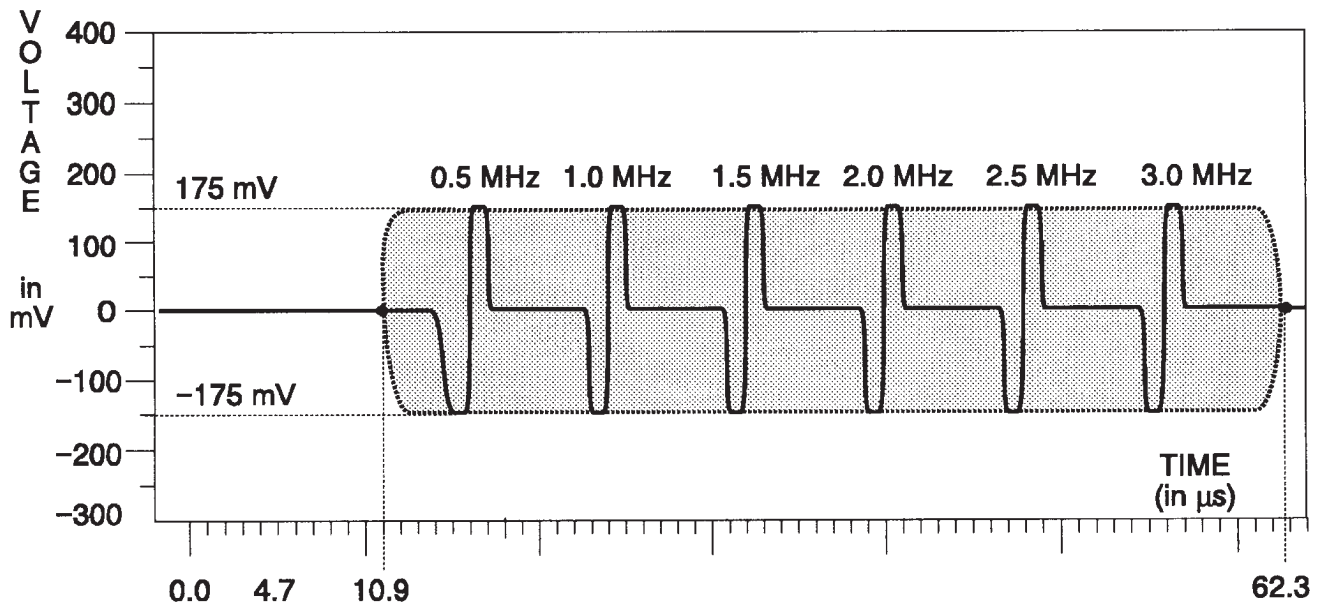

Fig. 3-97. B-Y & R-Y Channel — Reduced Line Sweep.

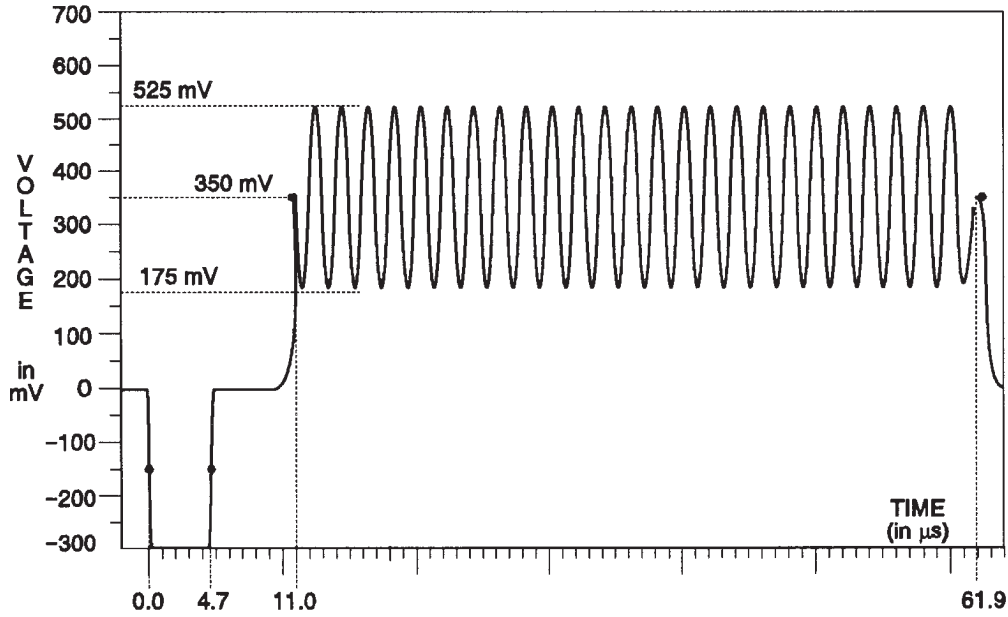

Fig. 3-98. Y Channel — Bowtie.

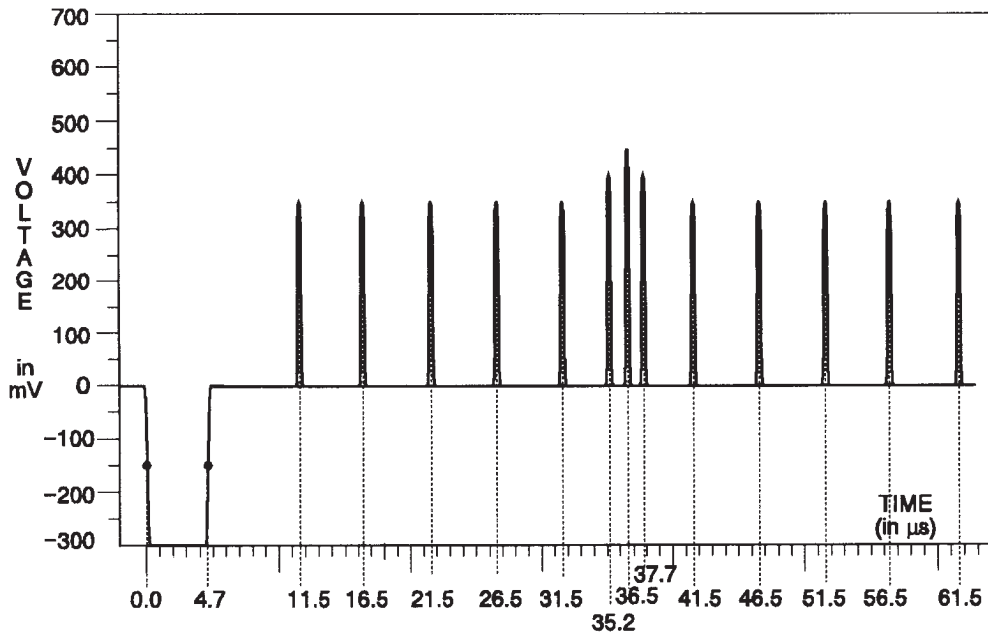

Fig. 3-99. Y Channel — Bowtie Markers.

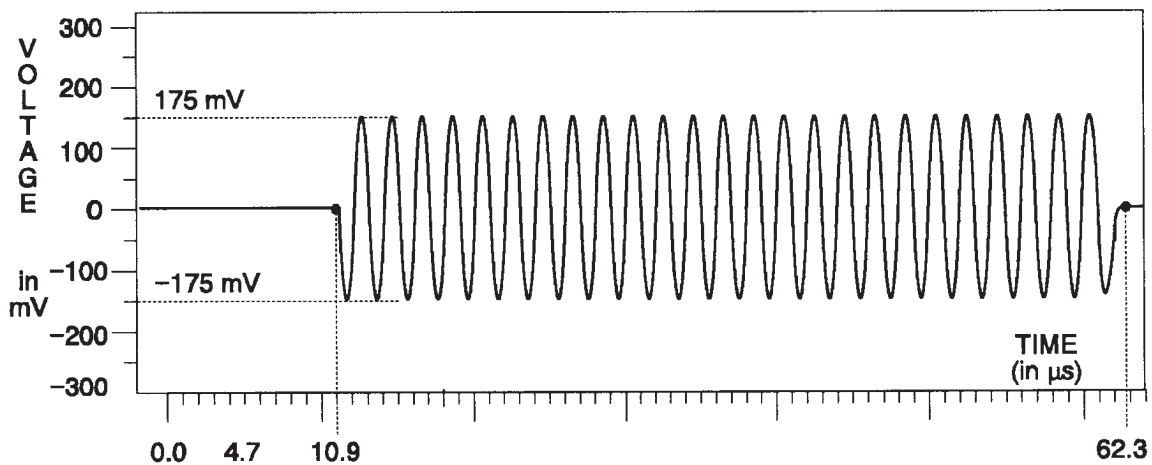

Fig. 3-100. B-Y & R-Y Channels — Bowtie.

TSG 131A — SPECIFICATIONS
Component Signals

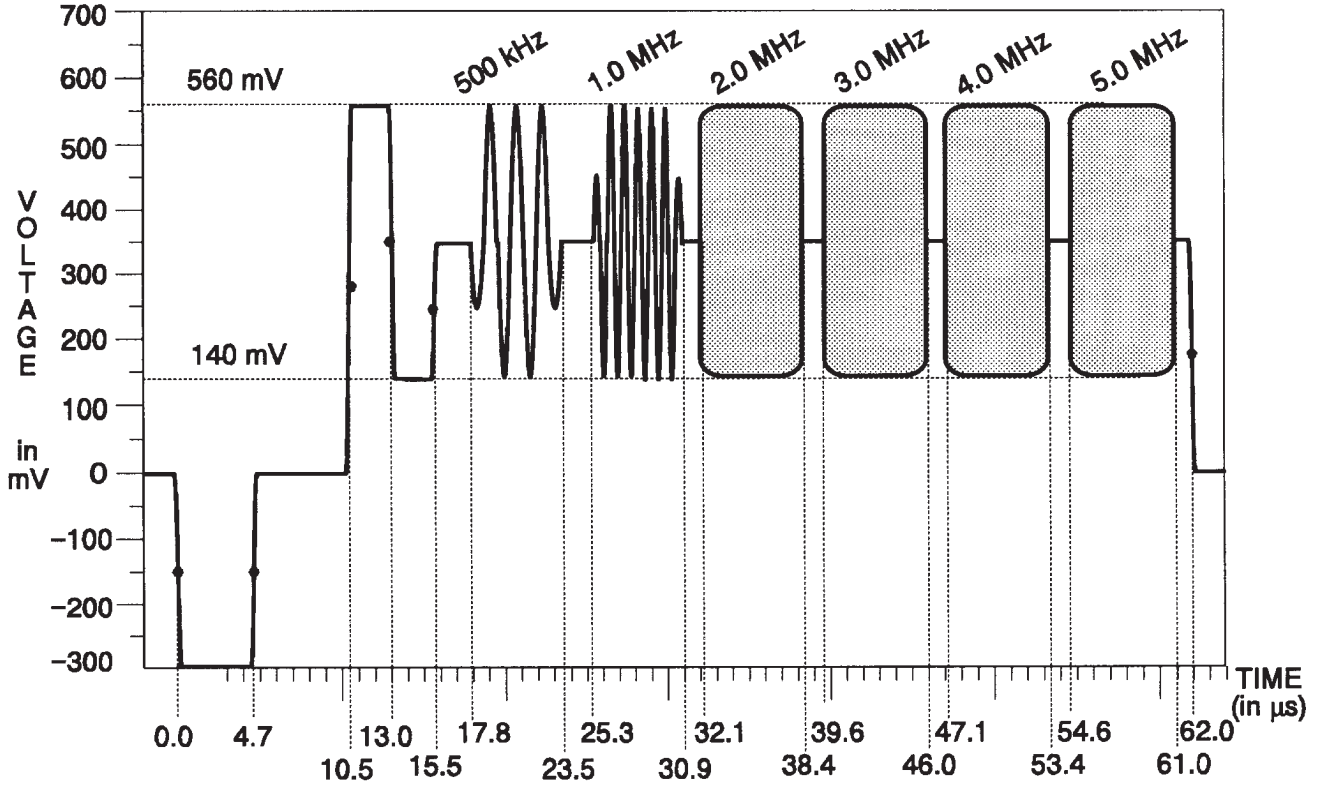

Fig. 3-101. Y Channel — Multiburst.

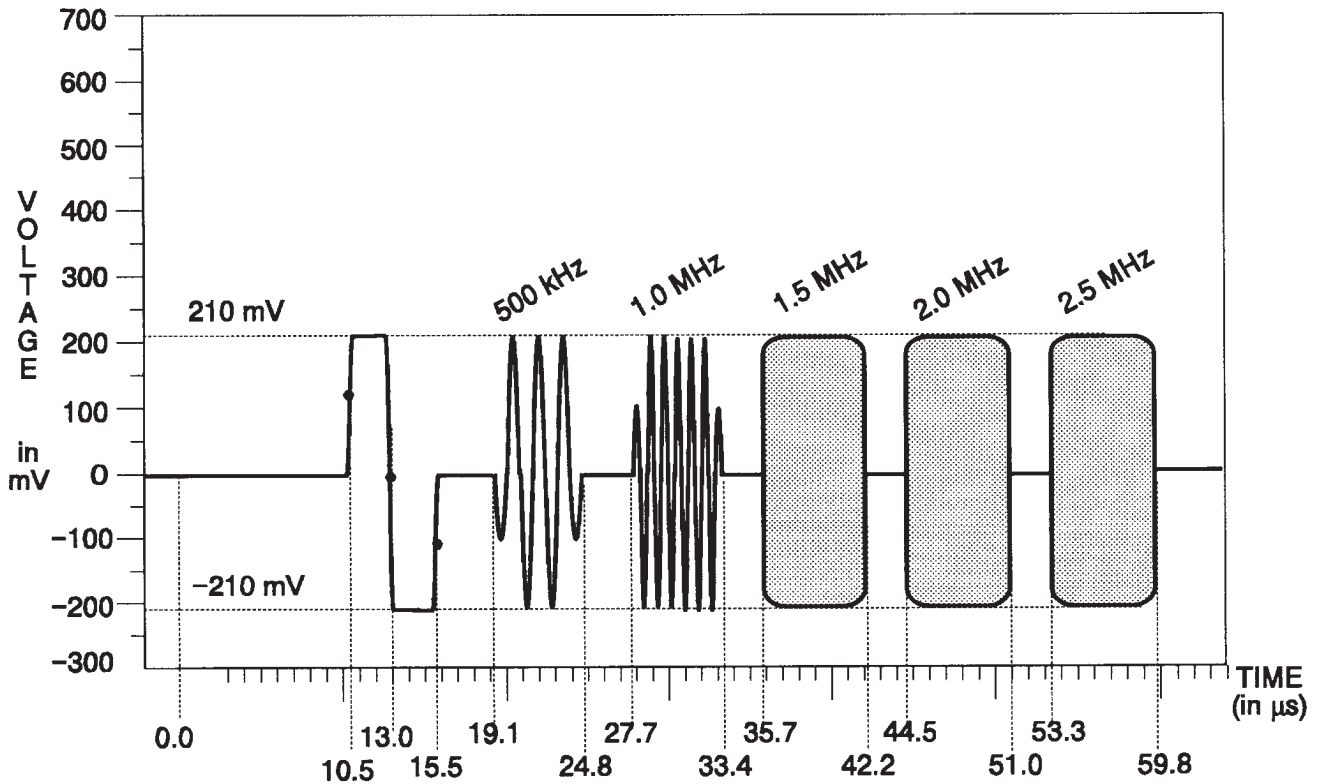

Fig. 3-102. B-Y & R-Y Channels — Multiburst.

CTDM Format

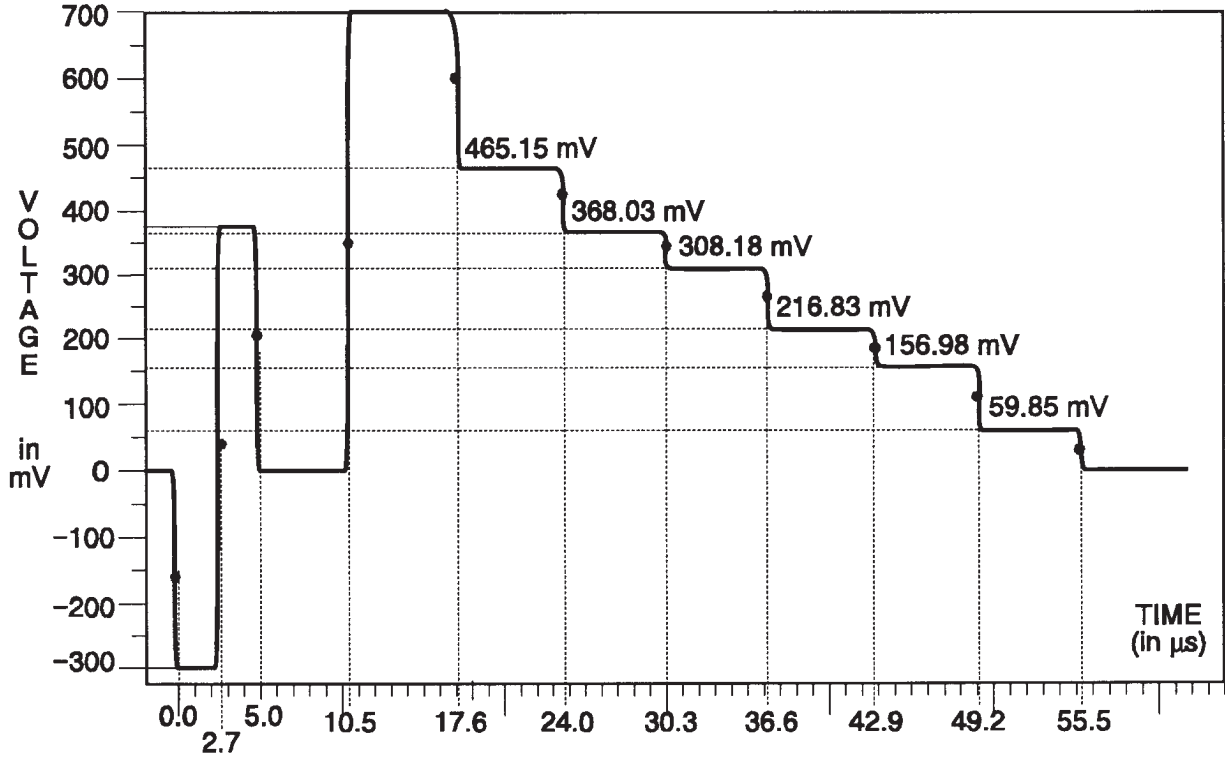

Fig. 3-103. Y Channel — 75% Bars.

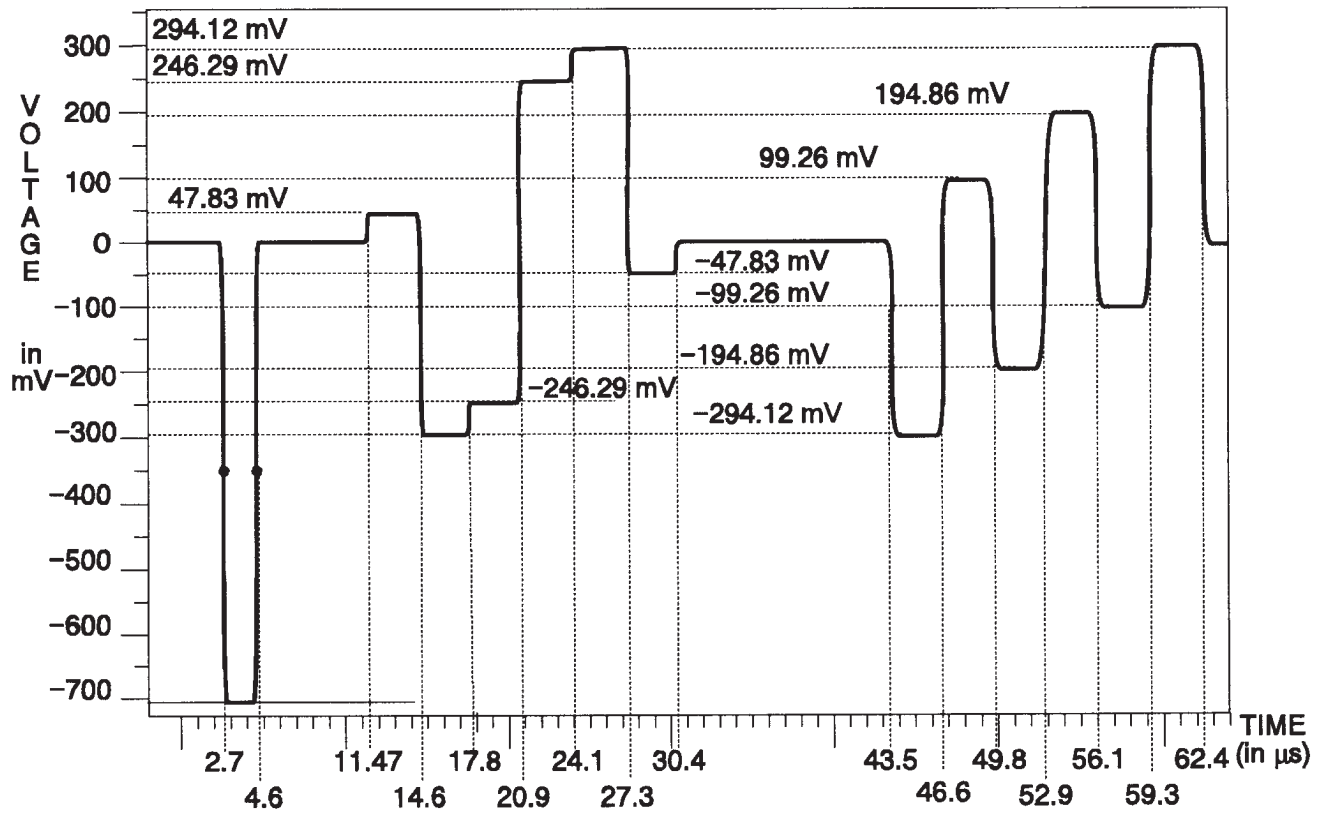

Fig. 3-104. C Channel — 75% Bars.

TSG 131A — SPECIFICATIONS
Component Signals

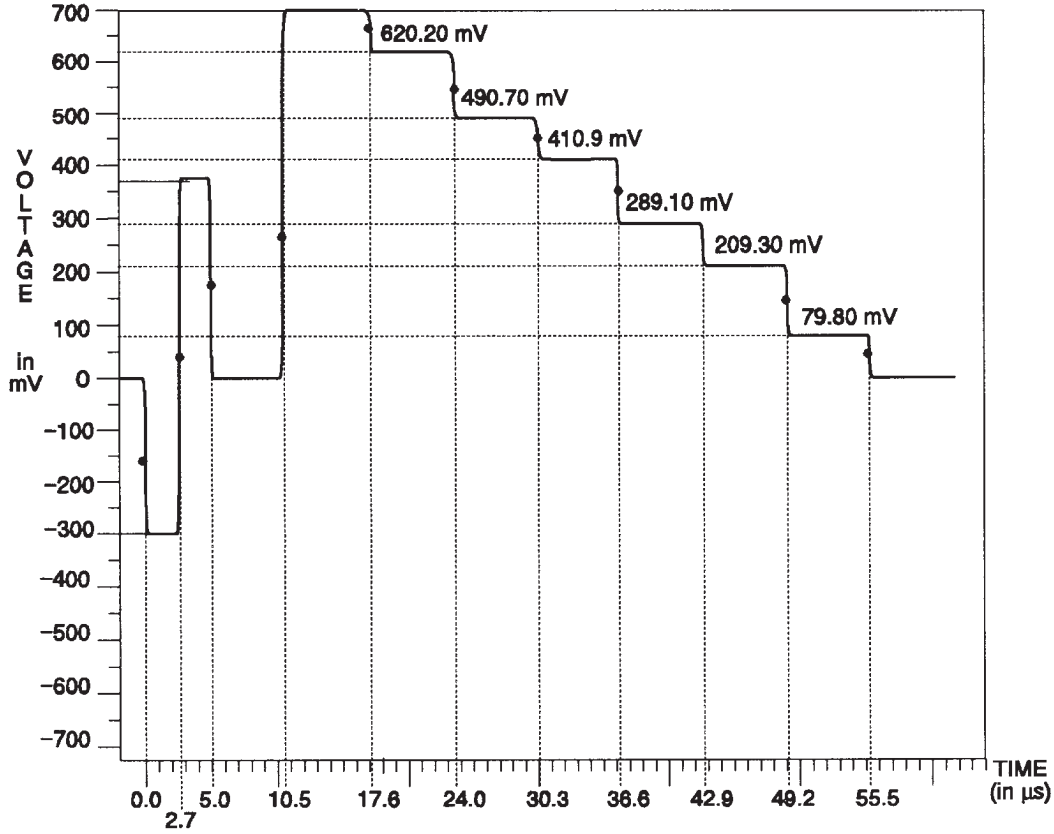

Fig. 3-105. Y Channel — 100% Bars.

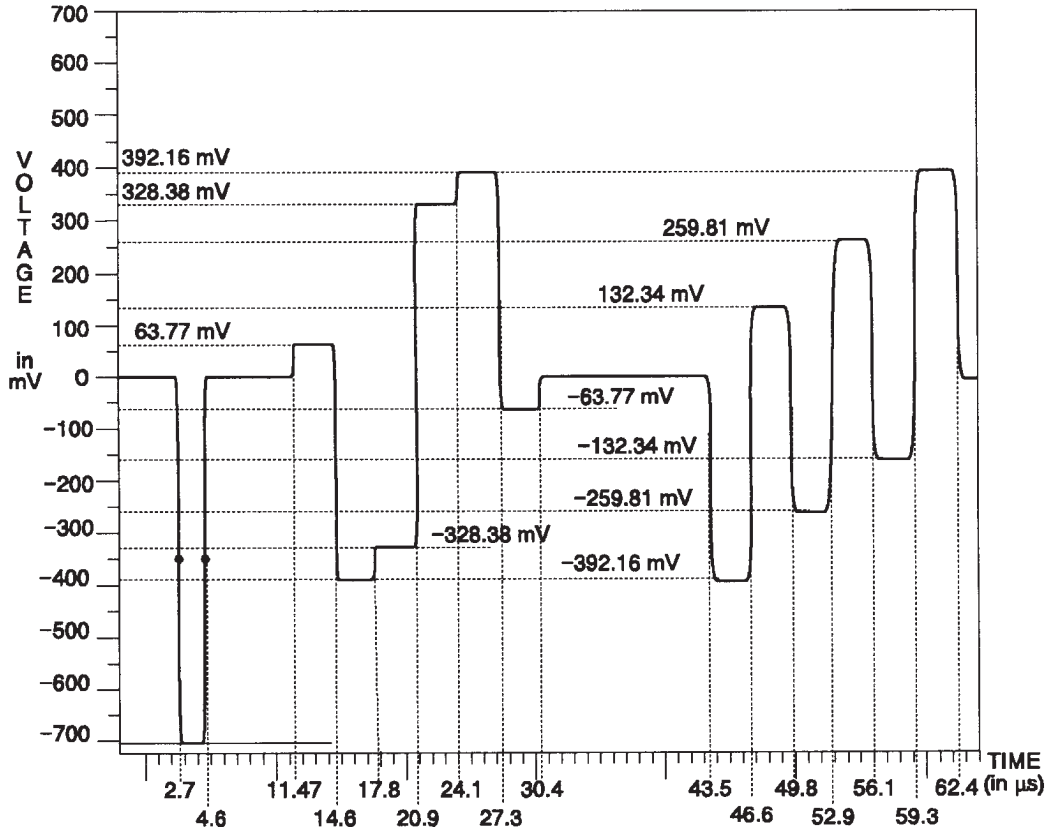

Fig. 3-106. C Channel — 100% Bars.

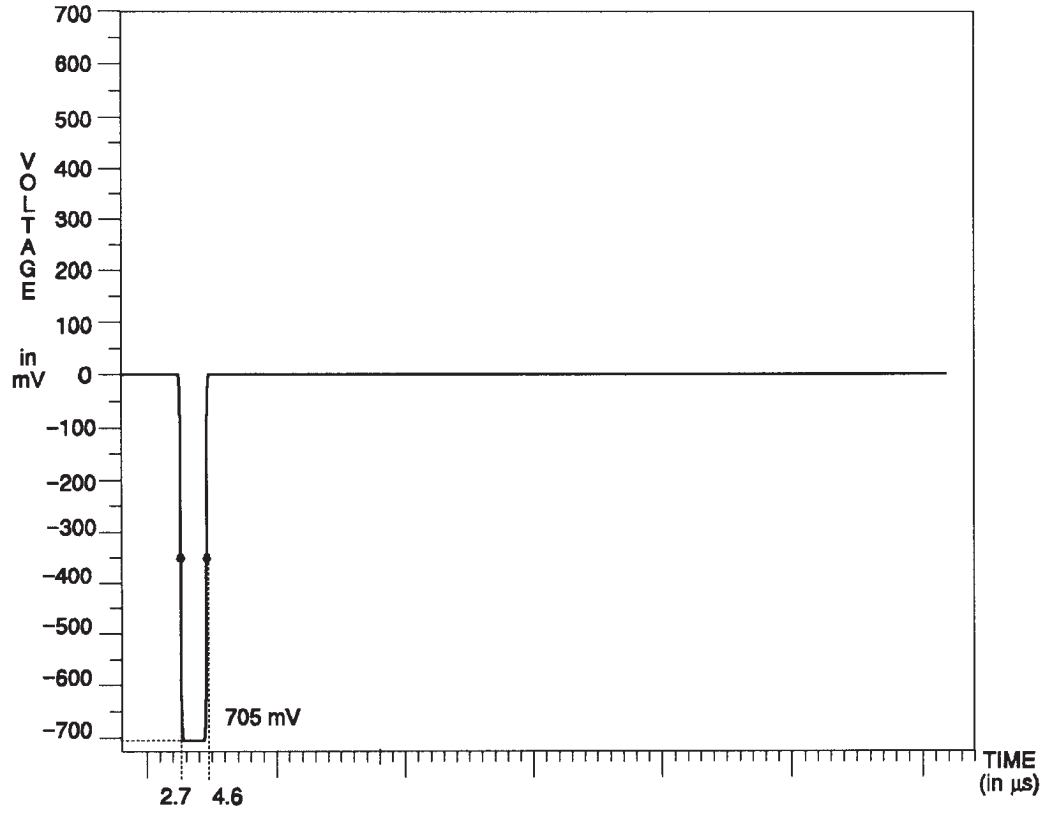

Fig. 3-107. C Channel — All Flat Field Signals.

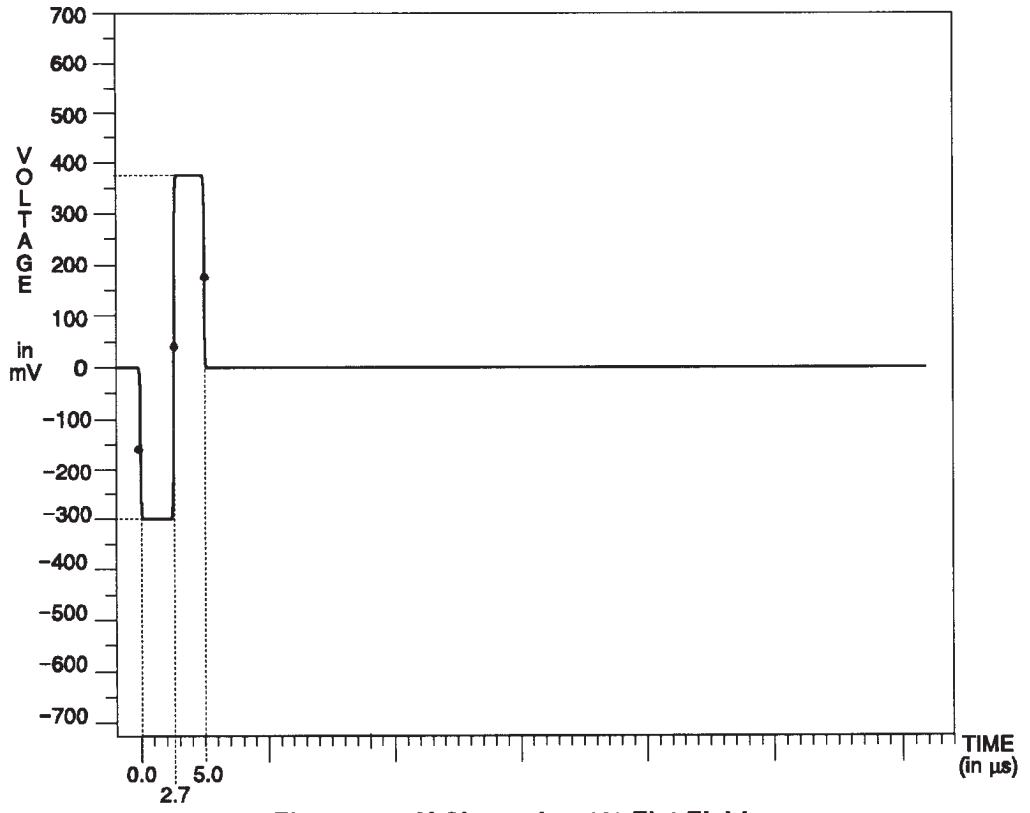

Fig. 3-108. Y Channel — 0% Flat Field.

TSG 131A — SPECIFICATIONS
Component Signals

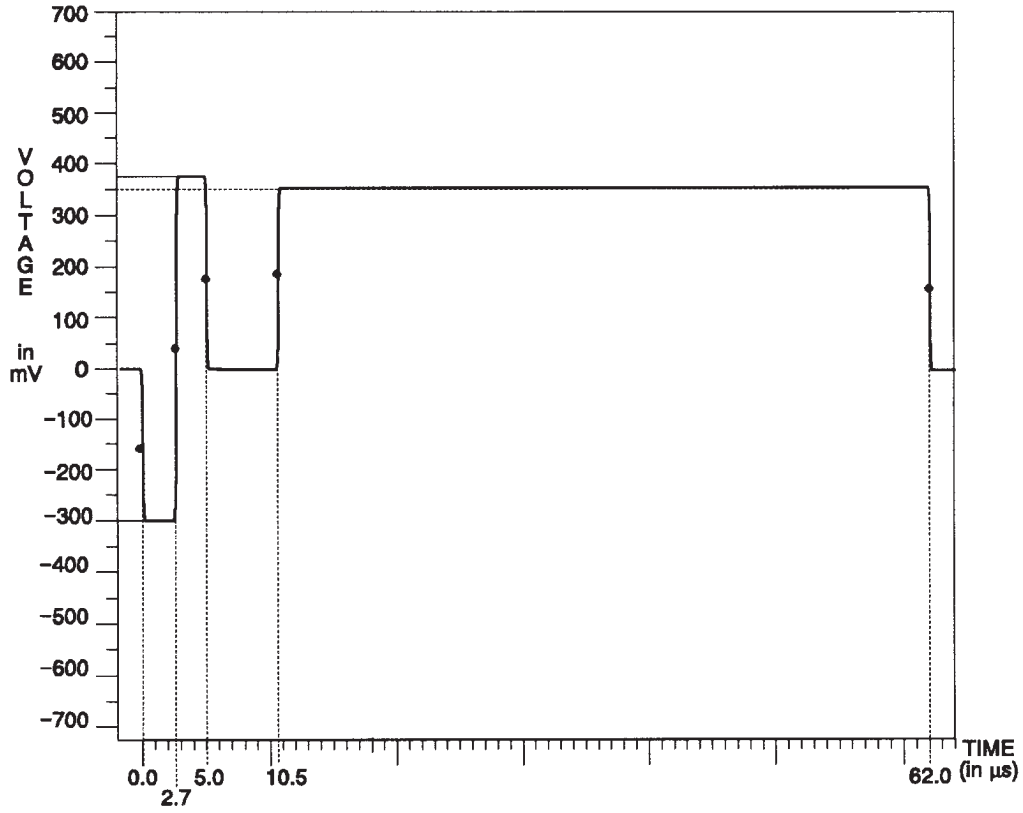

Fig. 3-109. Y Channel — 50% Flat Field.

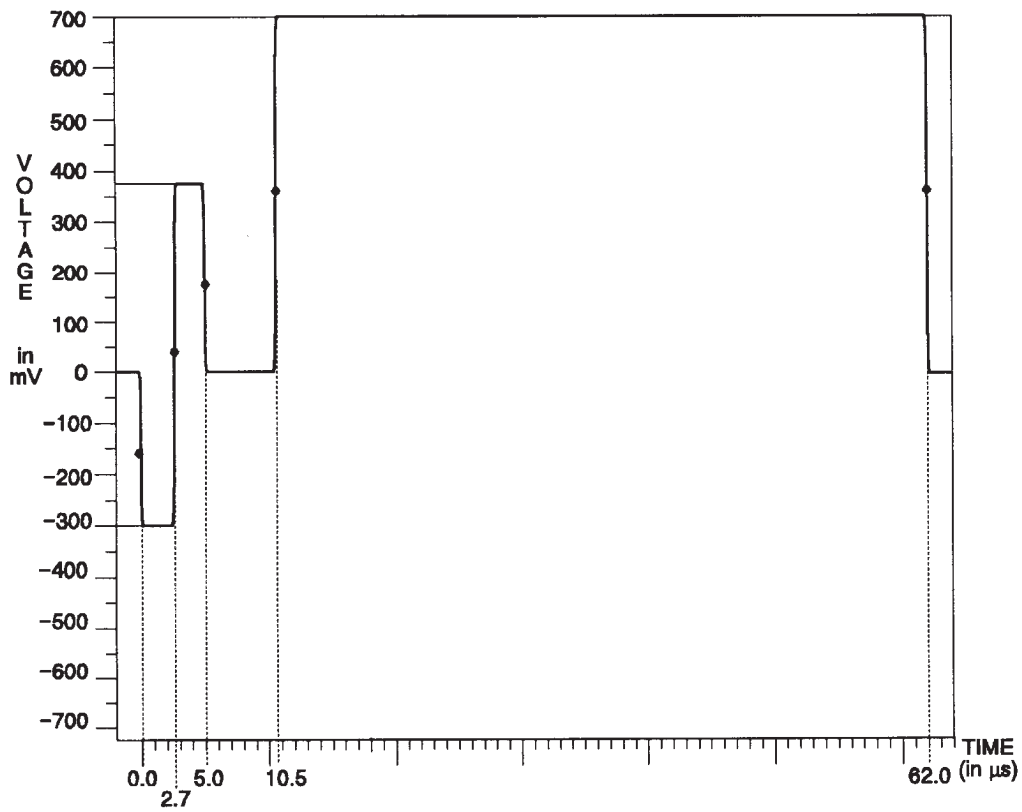

Fig. 3-110. Y Channel — 100% Flat Field.

GBR Signals

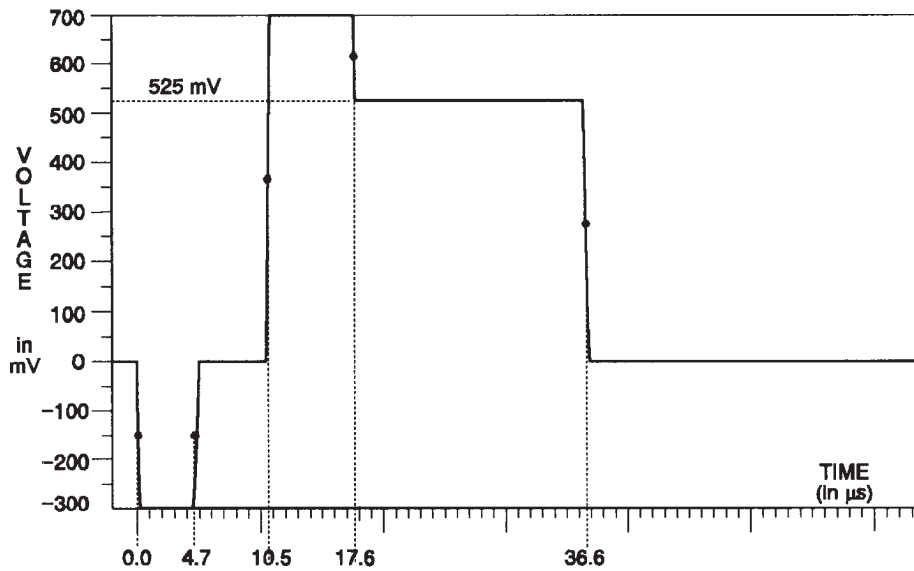

Fig. 3-111.
Green
Channel —
75% Color
Bars.

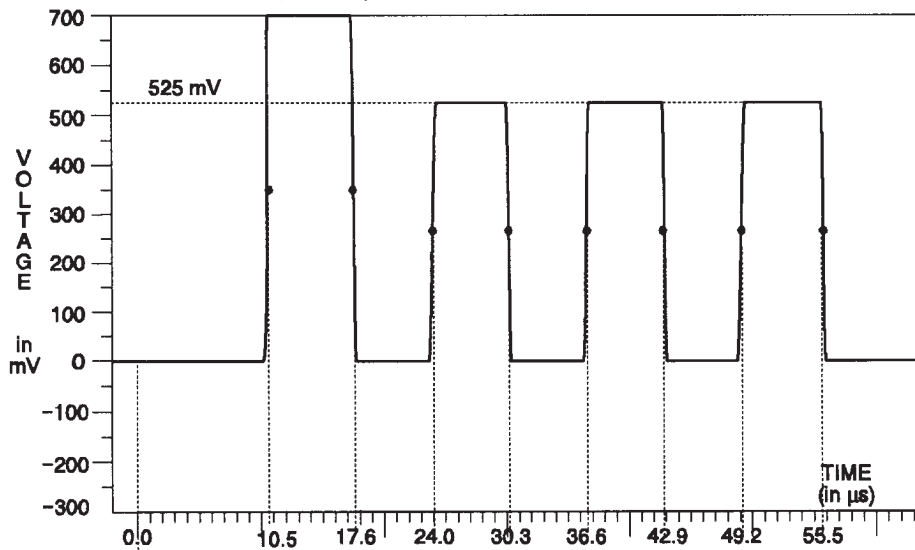

Fig. 3-112.
Blue Channel
— 75% Color
Bars.

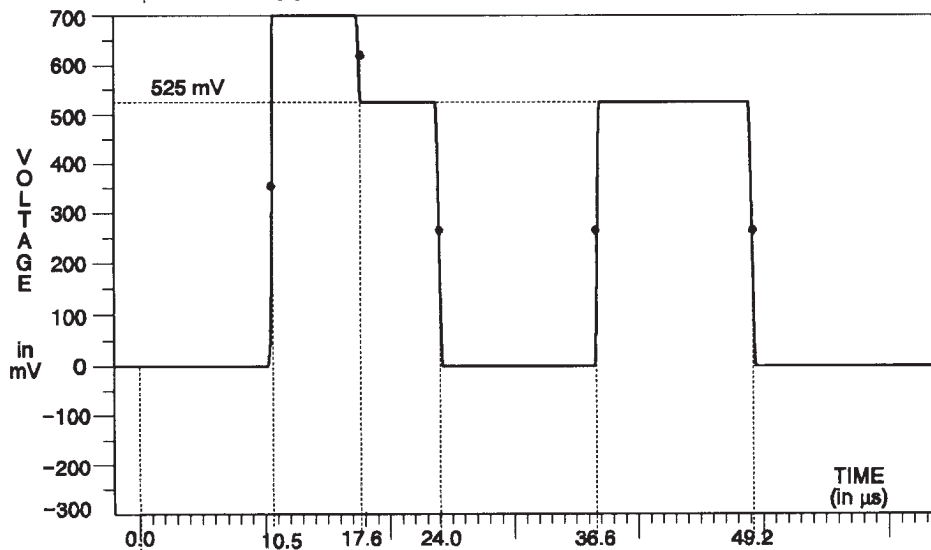

Fig. 3-113. Red
Channel —
75% Color
Bars.

TSG 131A — SPECIFICATIONS
GBR Signals

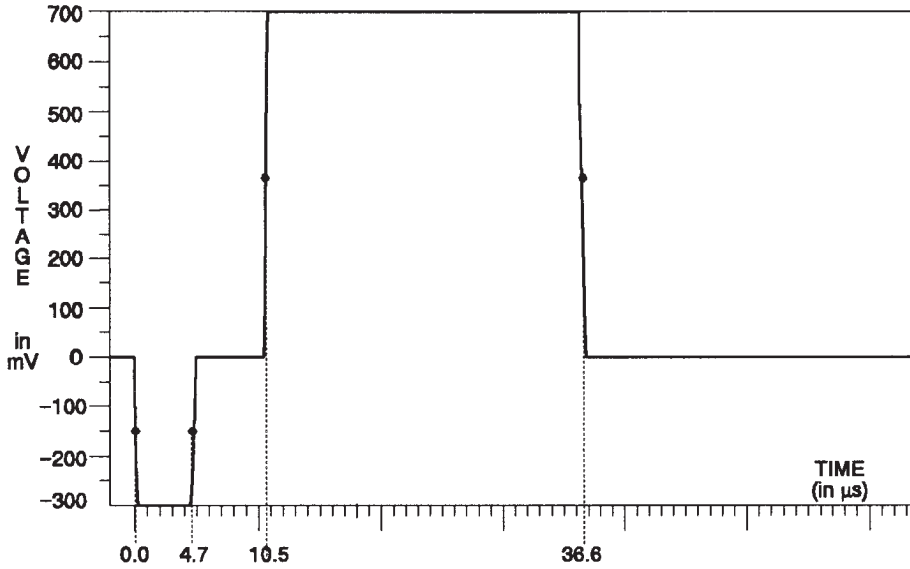

Fig. 3-114.
Green
Channel —
100% Color
Bars.

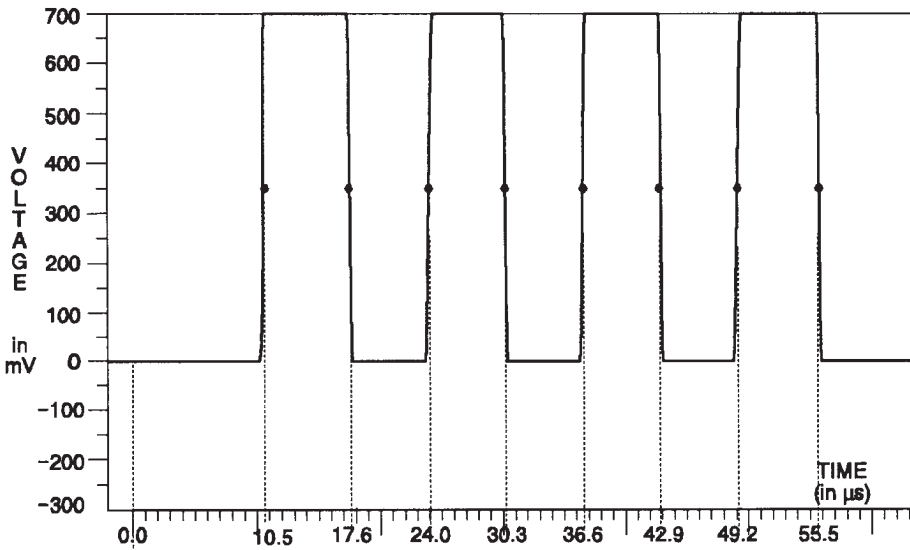

Fig. 3-115.
Blue Channel
— 100% Color
Bars.

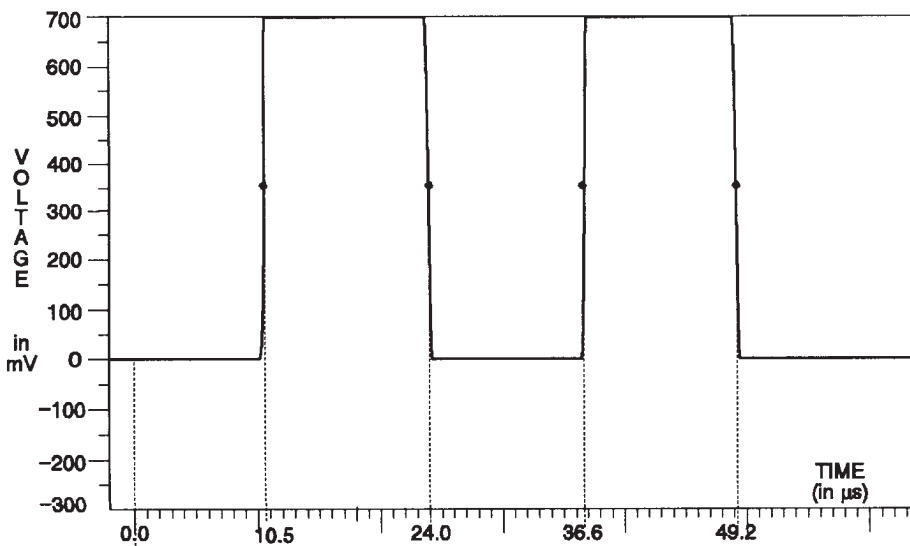

Fig. 3-116. **Red**
Channel —
100% Color
Bars.

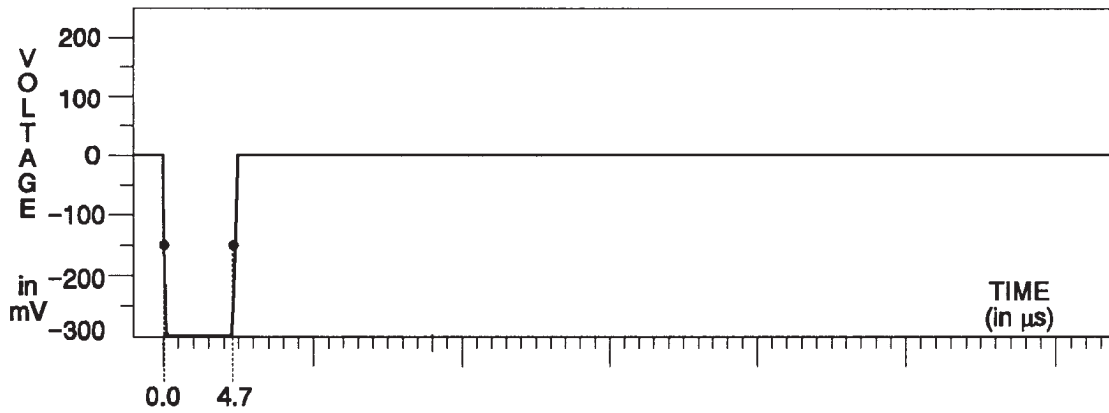

Fig. 3-117.
Green
Channel —
Red Field.

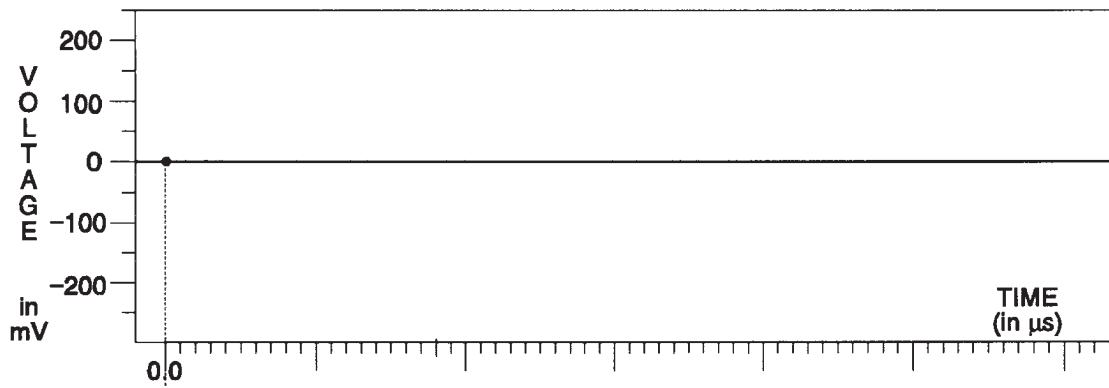

Fig. 3-118.
Blue Channel
— Red Field.

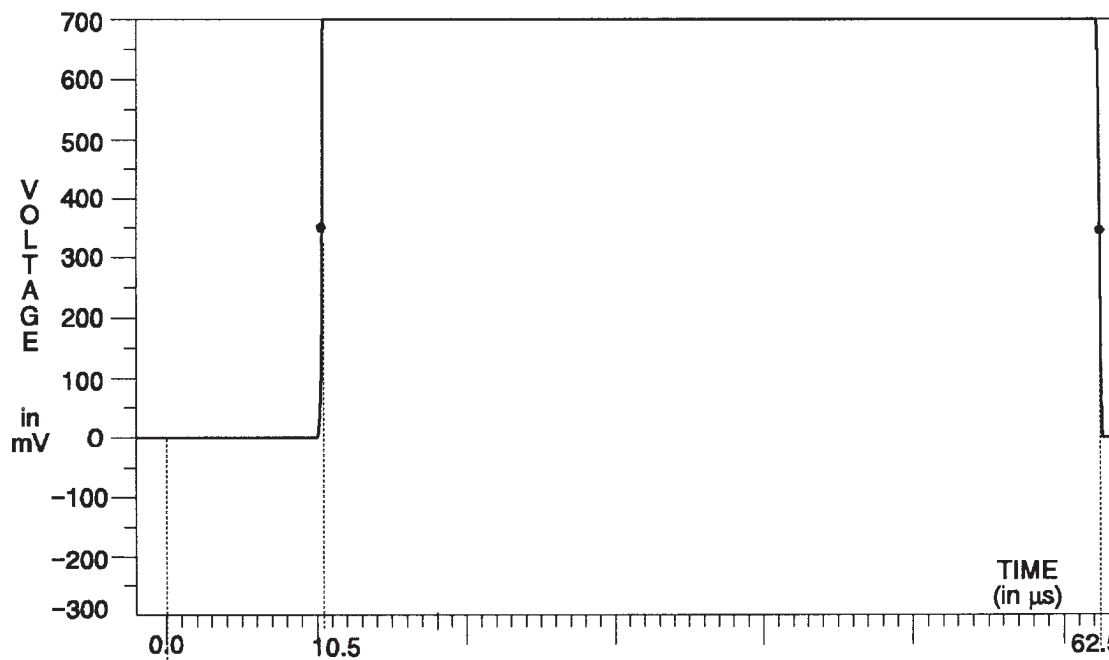

Fig. 3-119. Red
Channel — Red
Field.

TSG 131A — SPECIFICATIONS
GBR Signals

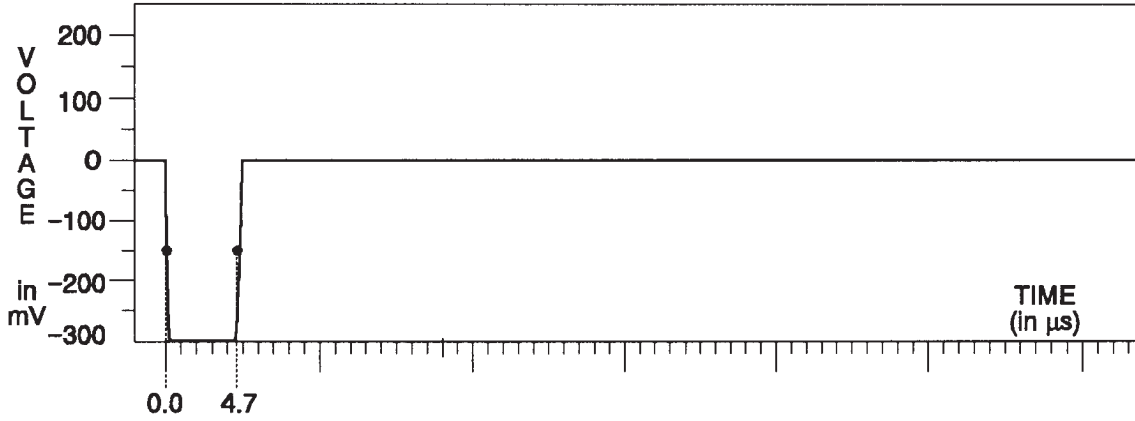

Fig. 3-120.
Green
Channel —
Blue Field.

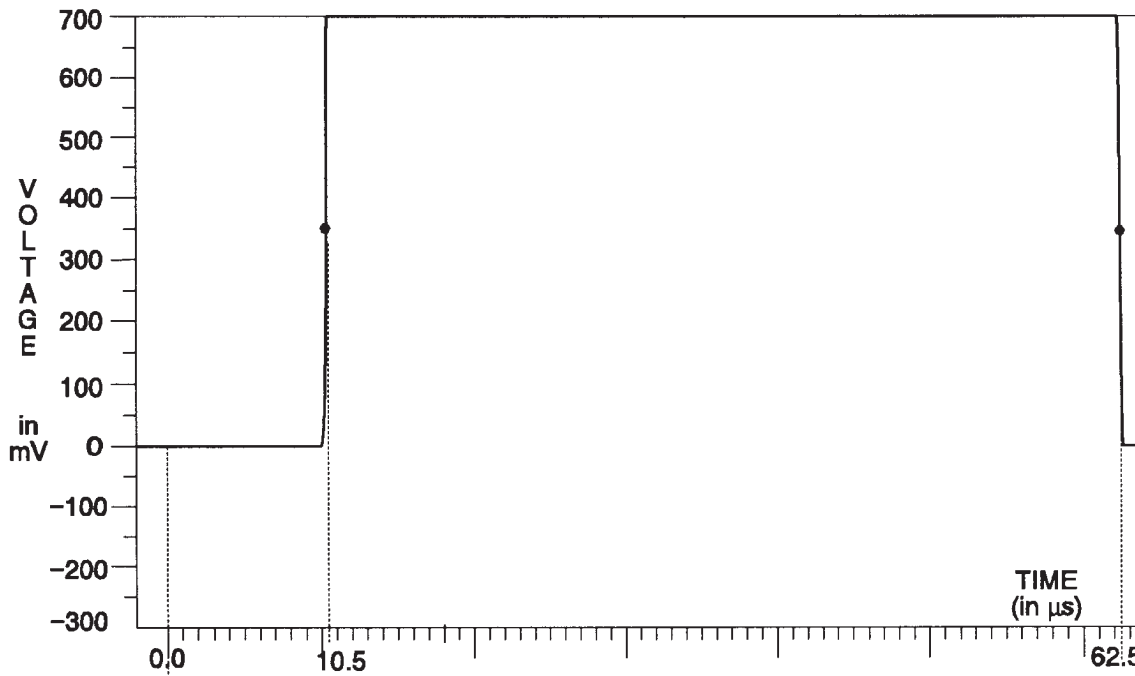

Fig. 3-121.
Blue
Channel —
Blue Field.

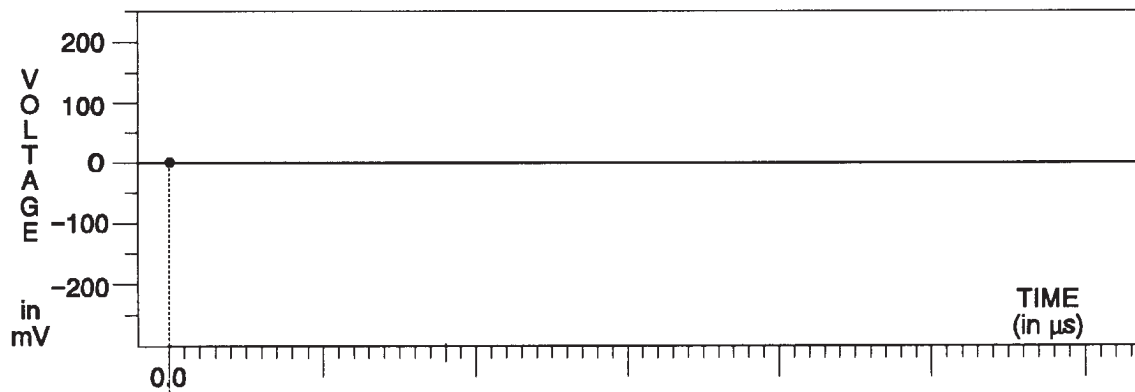

Fig. 3-122.
Red
Channel —
Blue Field.

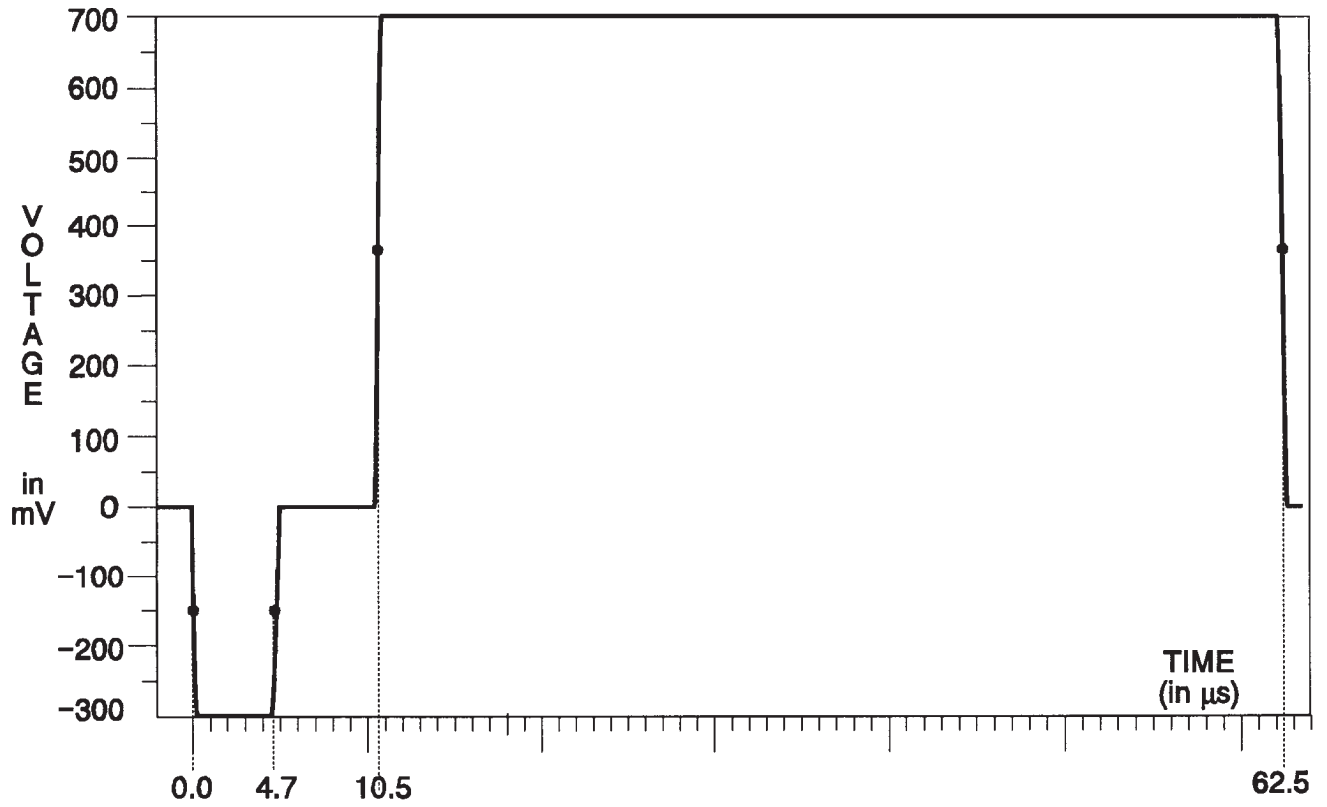

Fig. 3-123. Green Channel — Green Field.

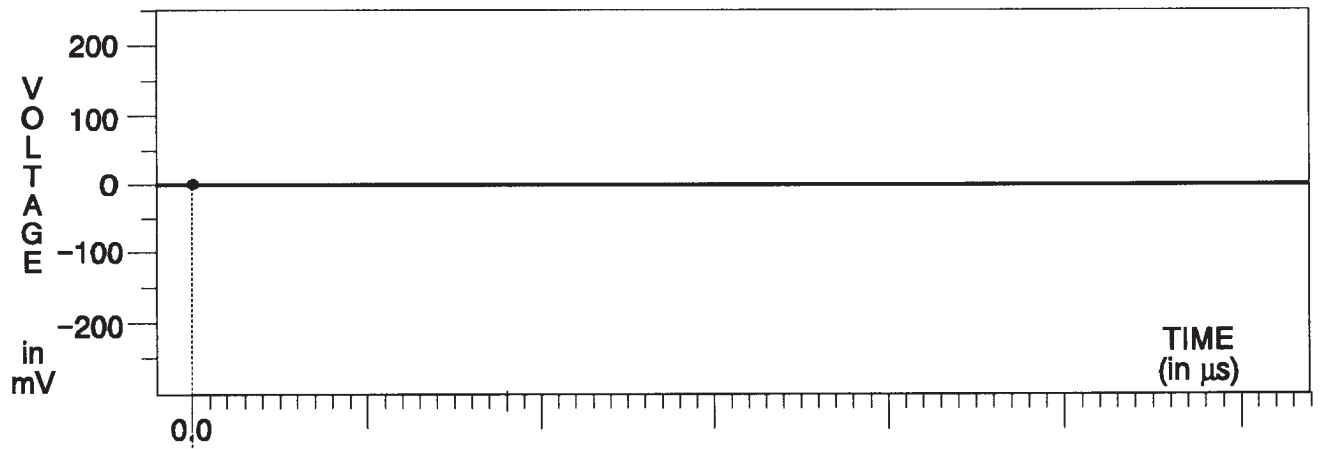

Fig. 3-124. Blue & Red Channels — Green Field.

TSG 131A — SPECIFICATIONS
GBR Signals

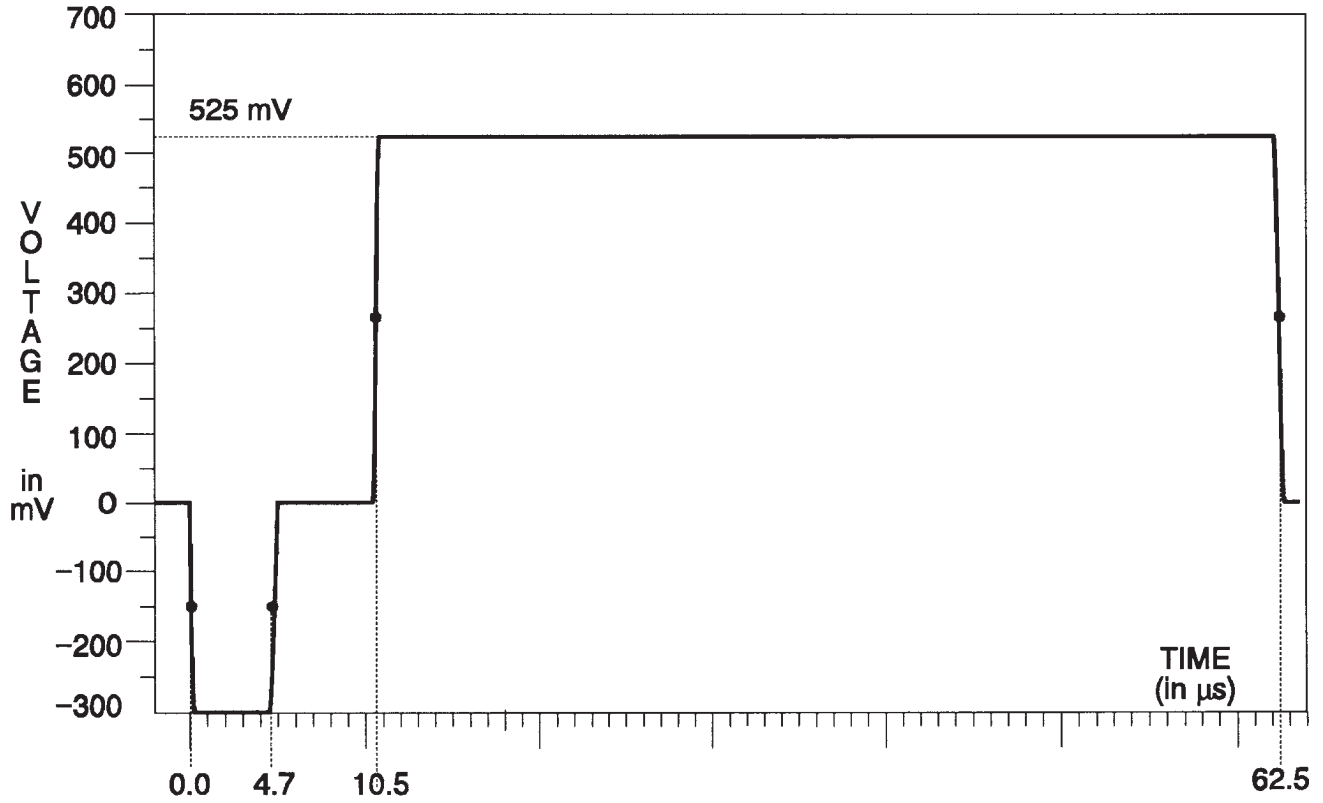

Fig. 3-125. Green Channel — Convergence (hor).

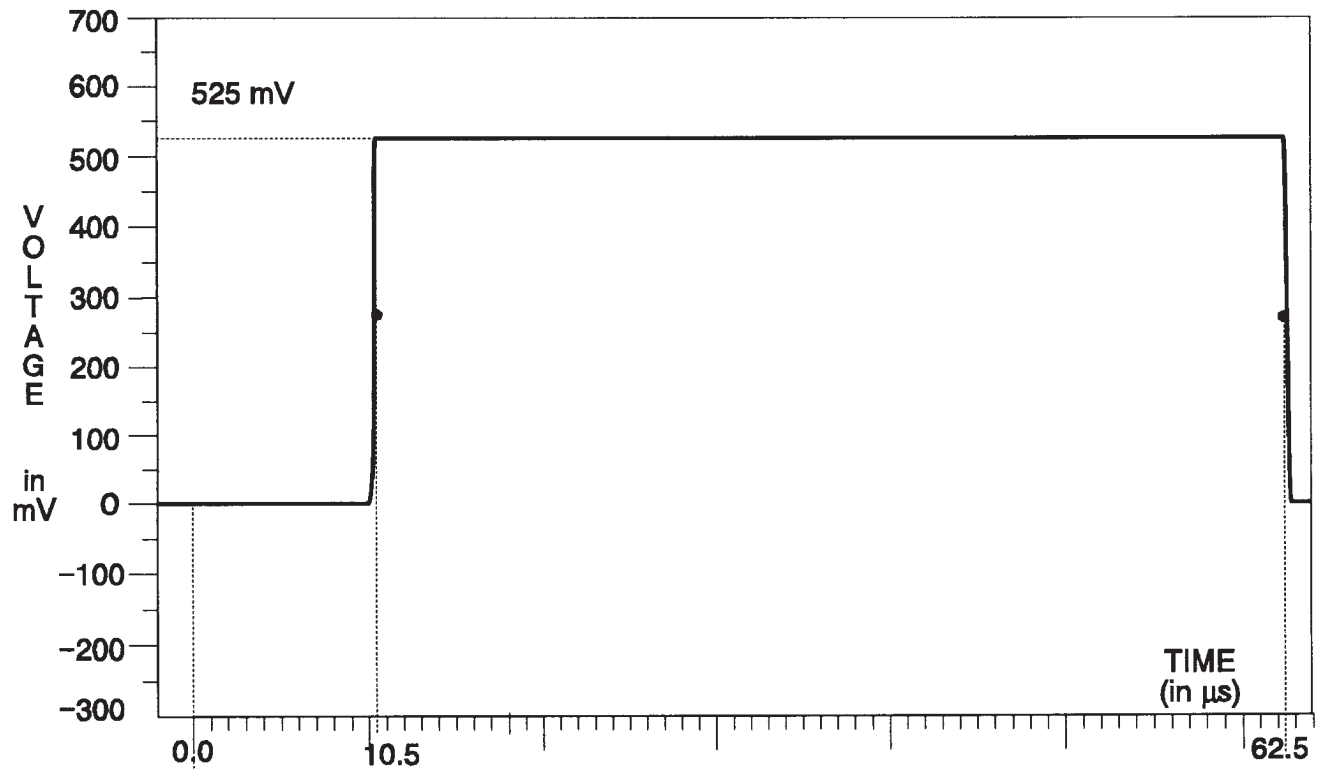

Fig. 3-126. Blue & Red Channels — Convergence (hor).

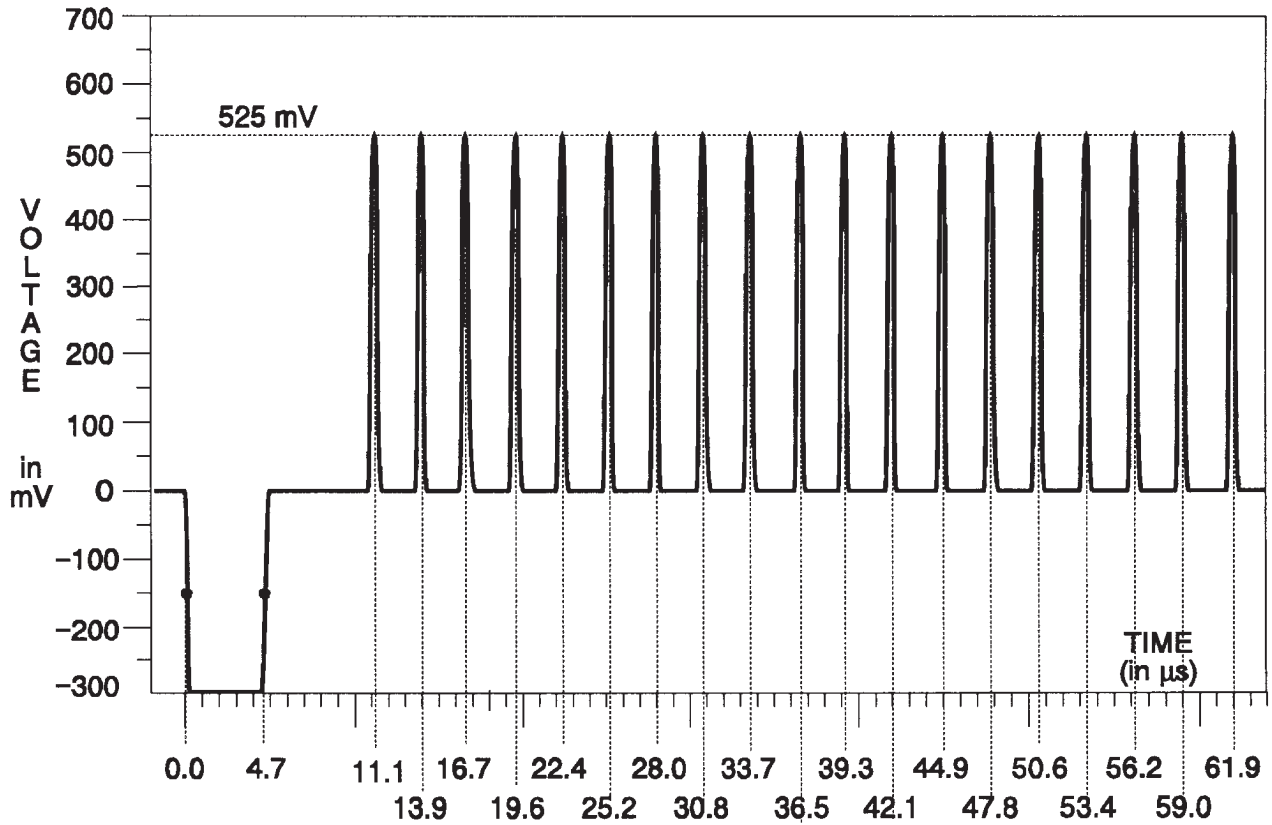

Fig. 3-127. Green Channel — Convergence (vertical).

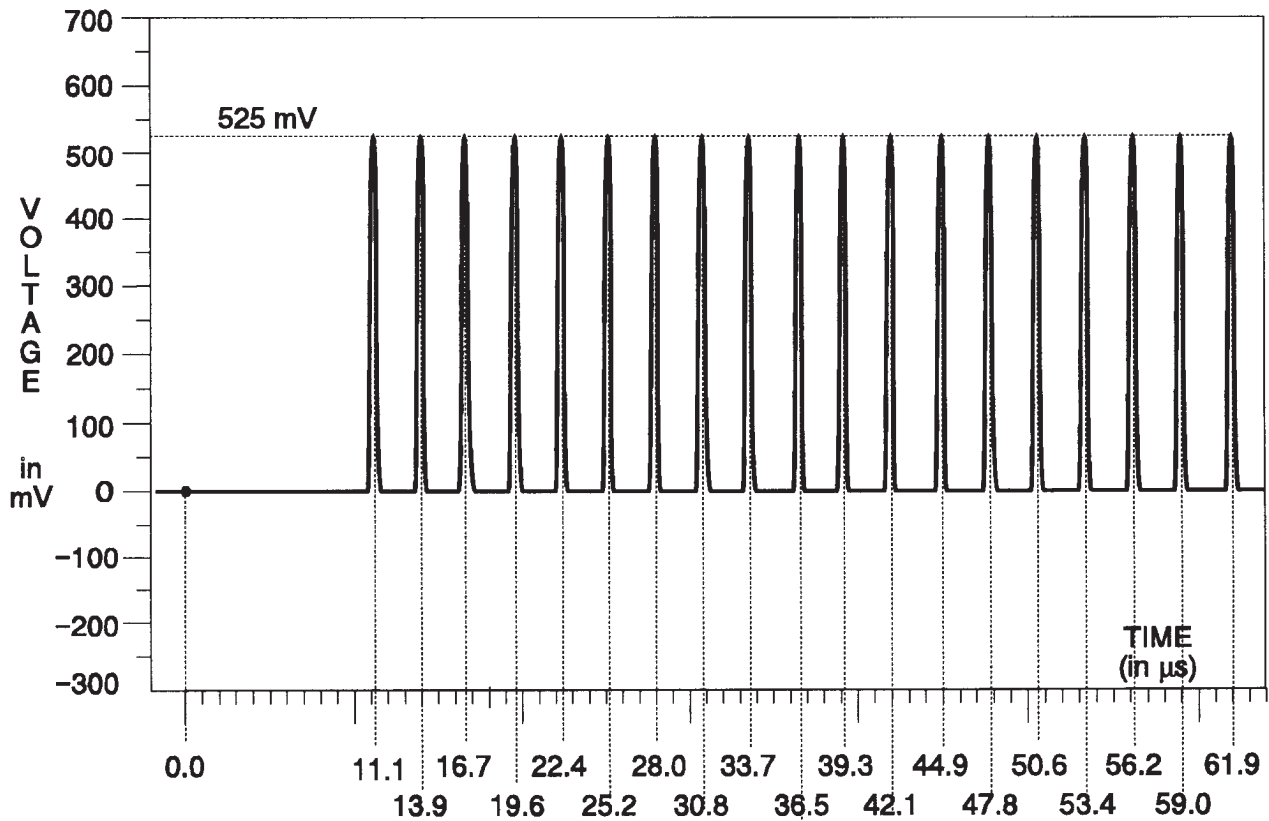

Fig. 3-128. Blue & Red Channels — Convergence (vrt).

TSG 131A — SPECIFICATIONS
GBR Signals

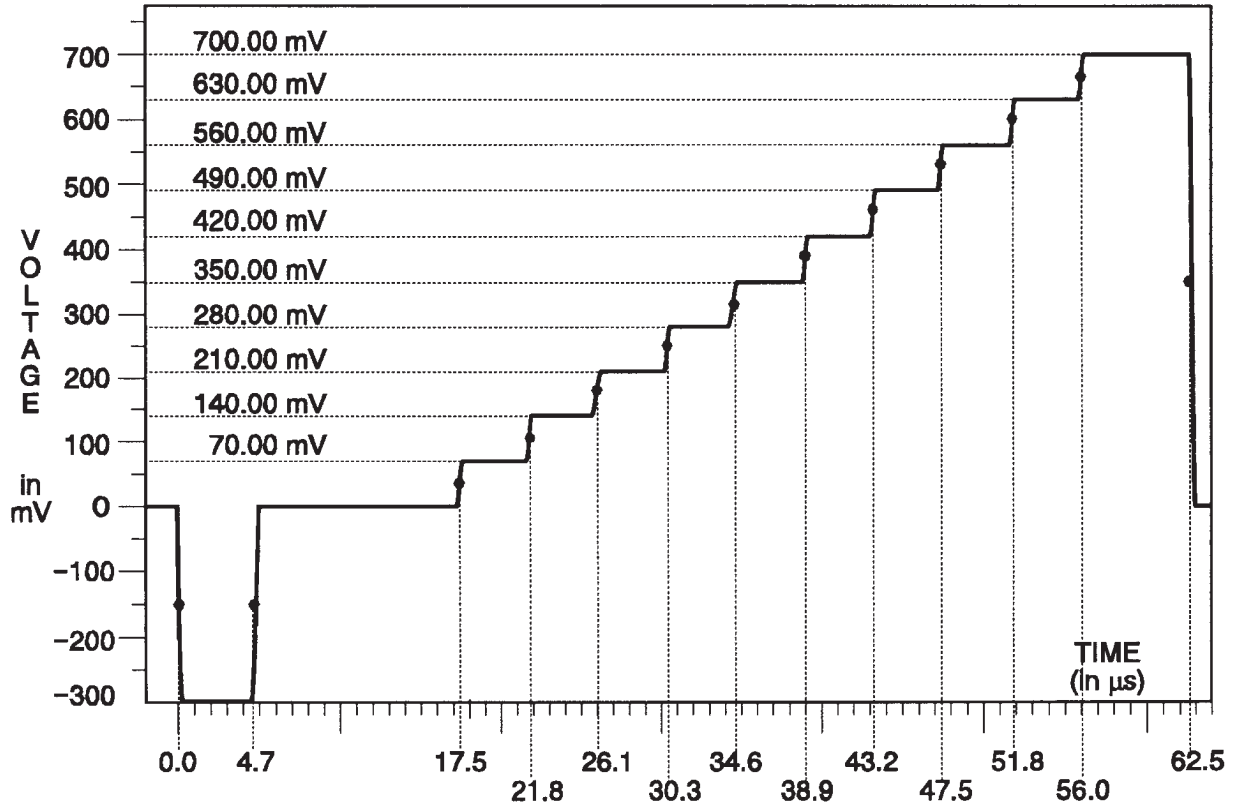

Fig. 3-129. Green Channel — 10-Step.

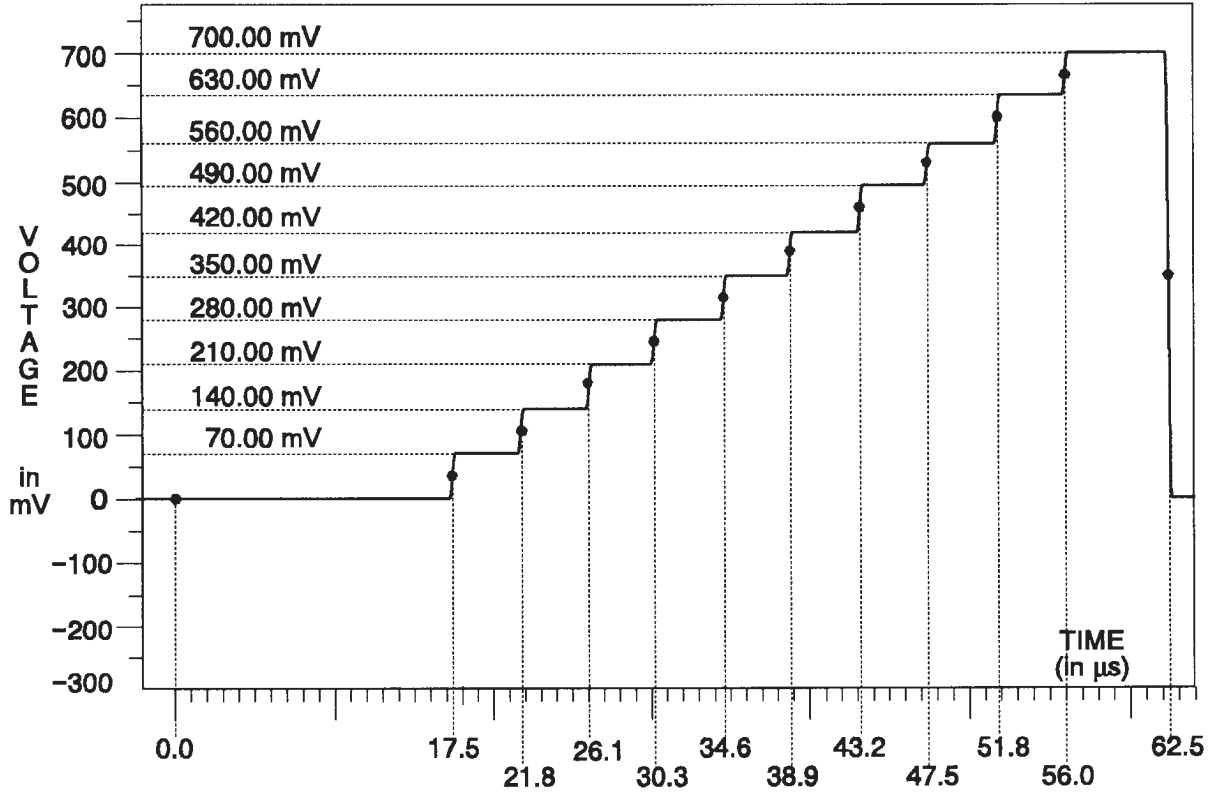

Fig. 3-130. Blue & Red Channels — 10-Step.

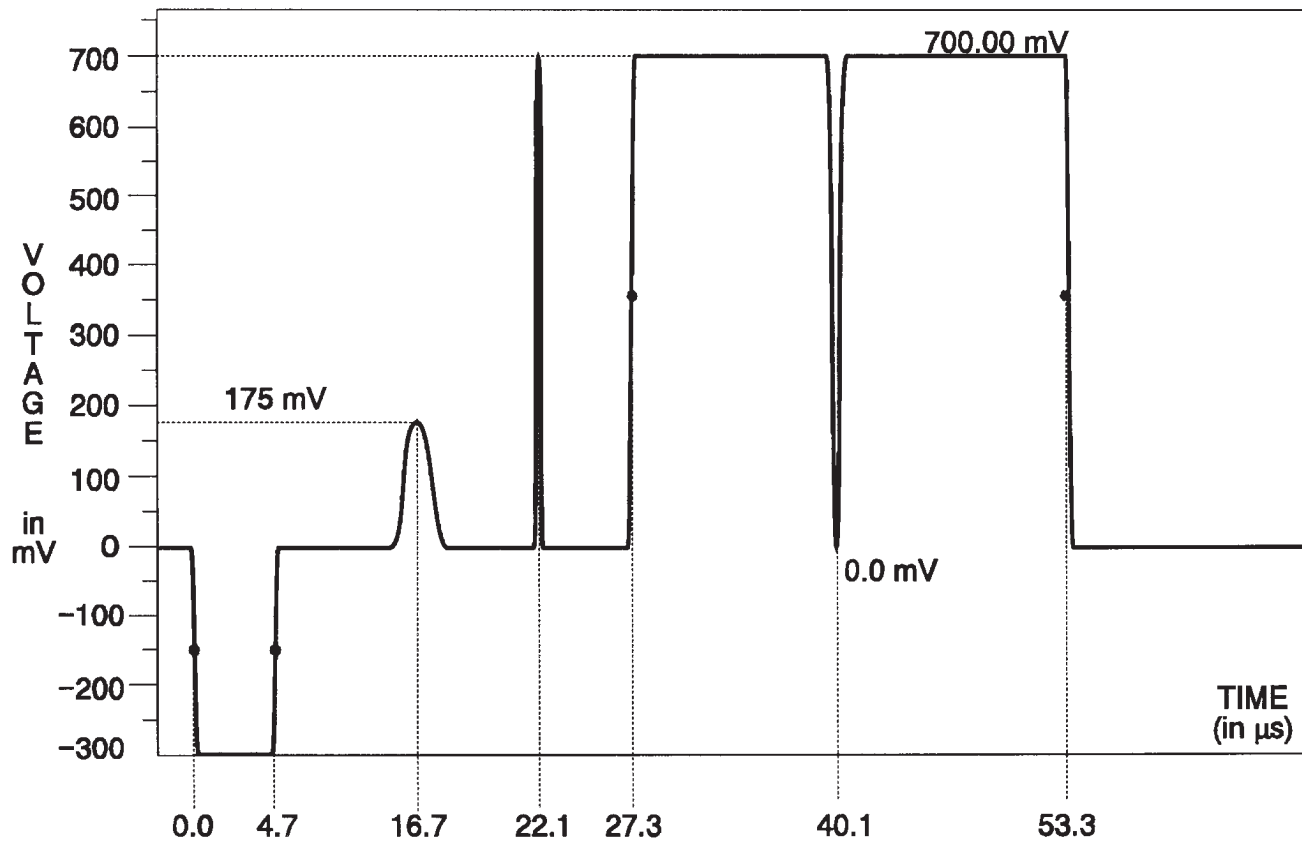

Fig. 3-131. Green Channel — Pulse & Bar.

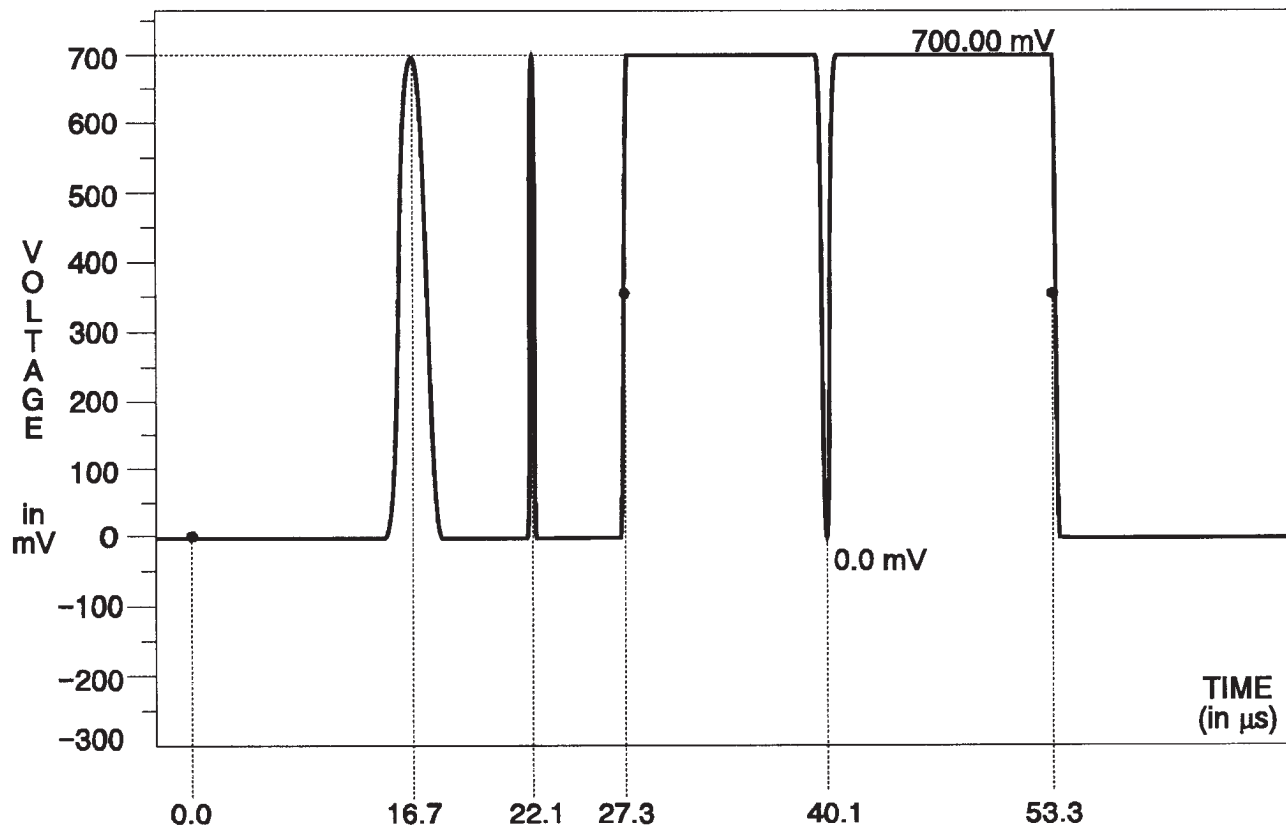

Fig. 3-132. Blue & Red Channels — Pulse & Bar.

TSG 131A — SPECIFICATIONS
GBR Signals

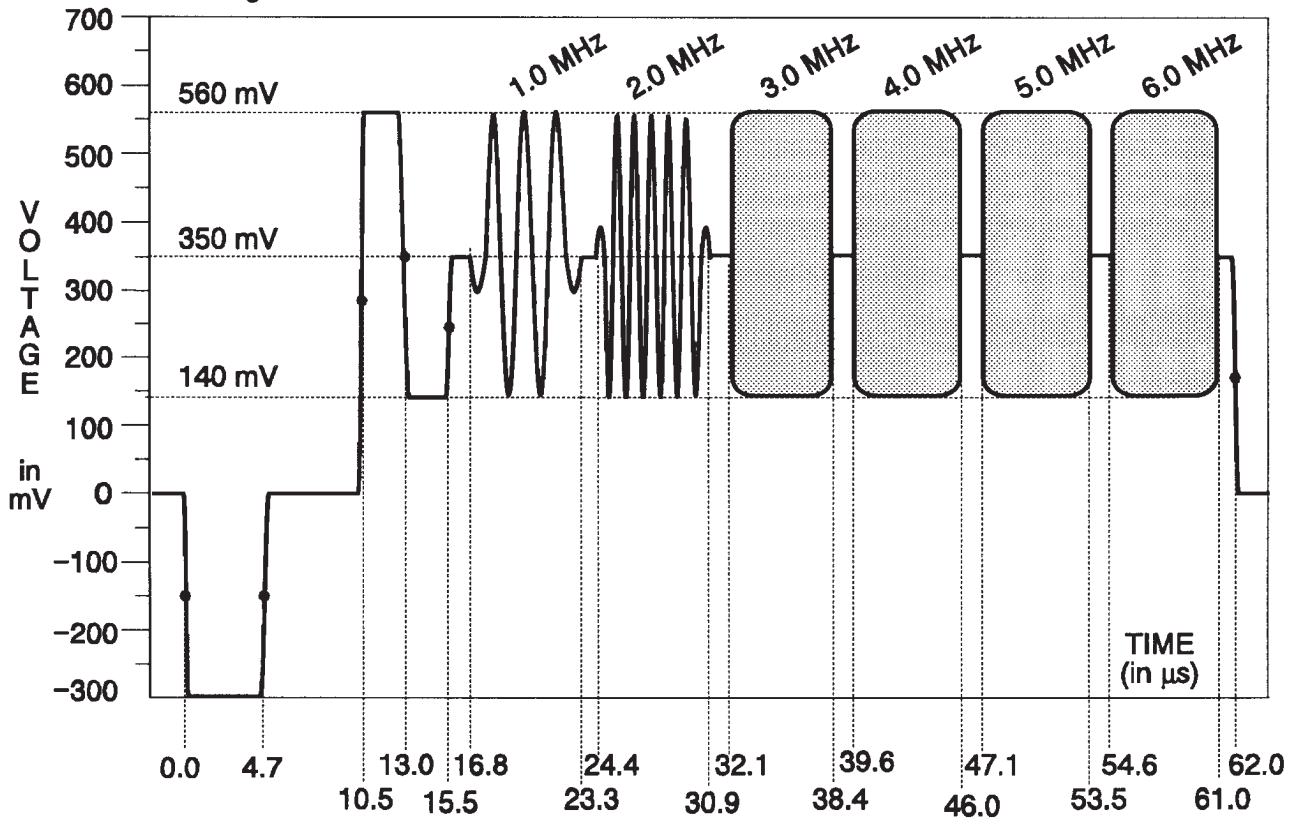

Fig. 3-133. Green Channel — Multiburst.

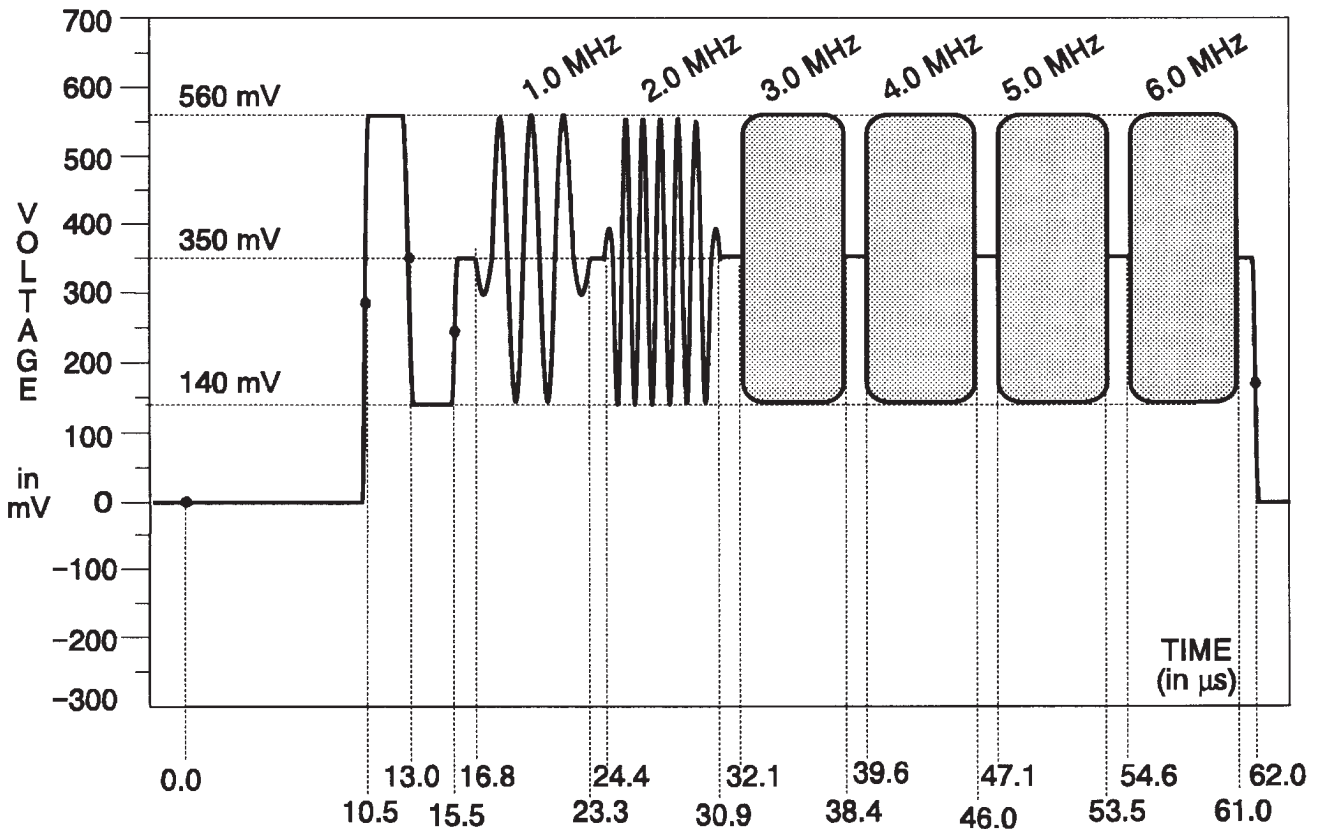

Fig. 3-134. Blue & Red Channels — Multiburst.

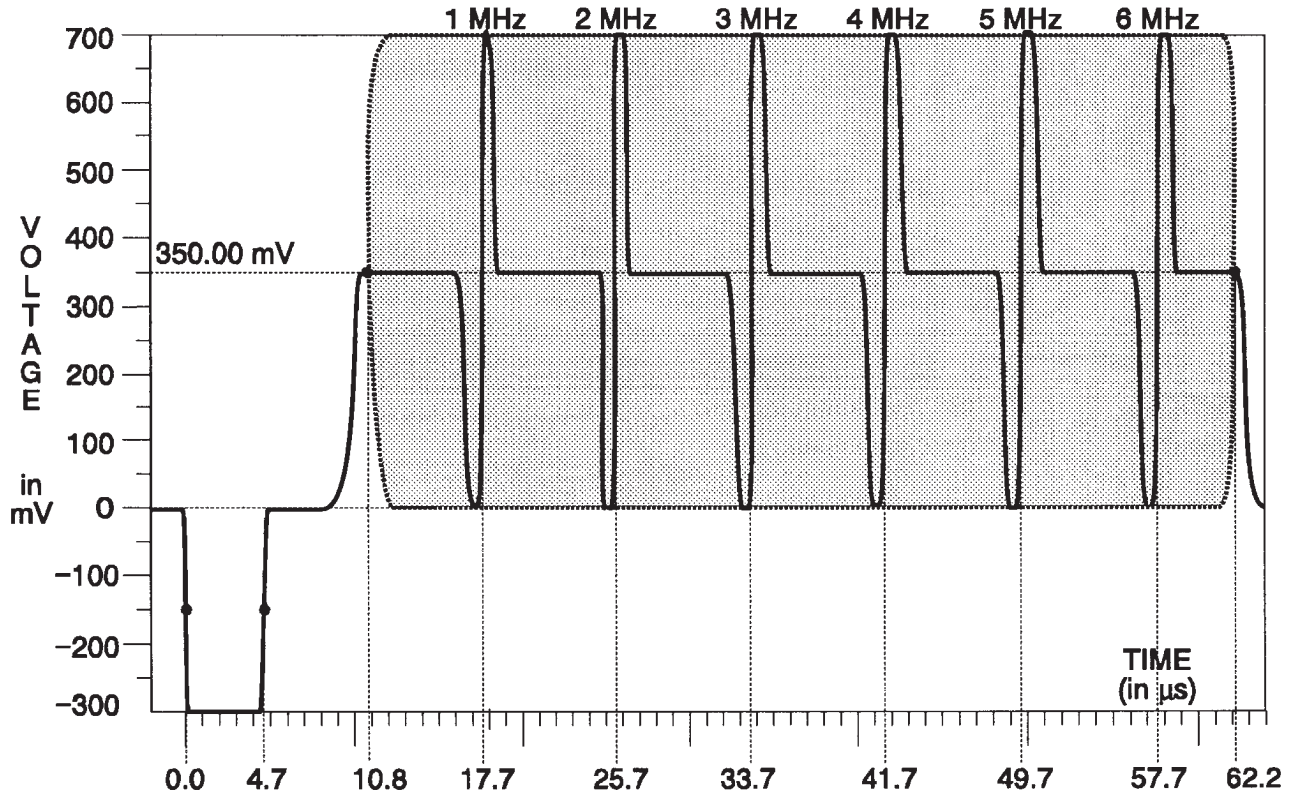

Fig. 3-135. Green Channel — Sweep.

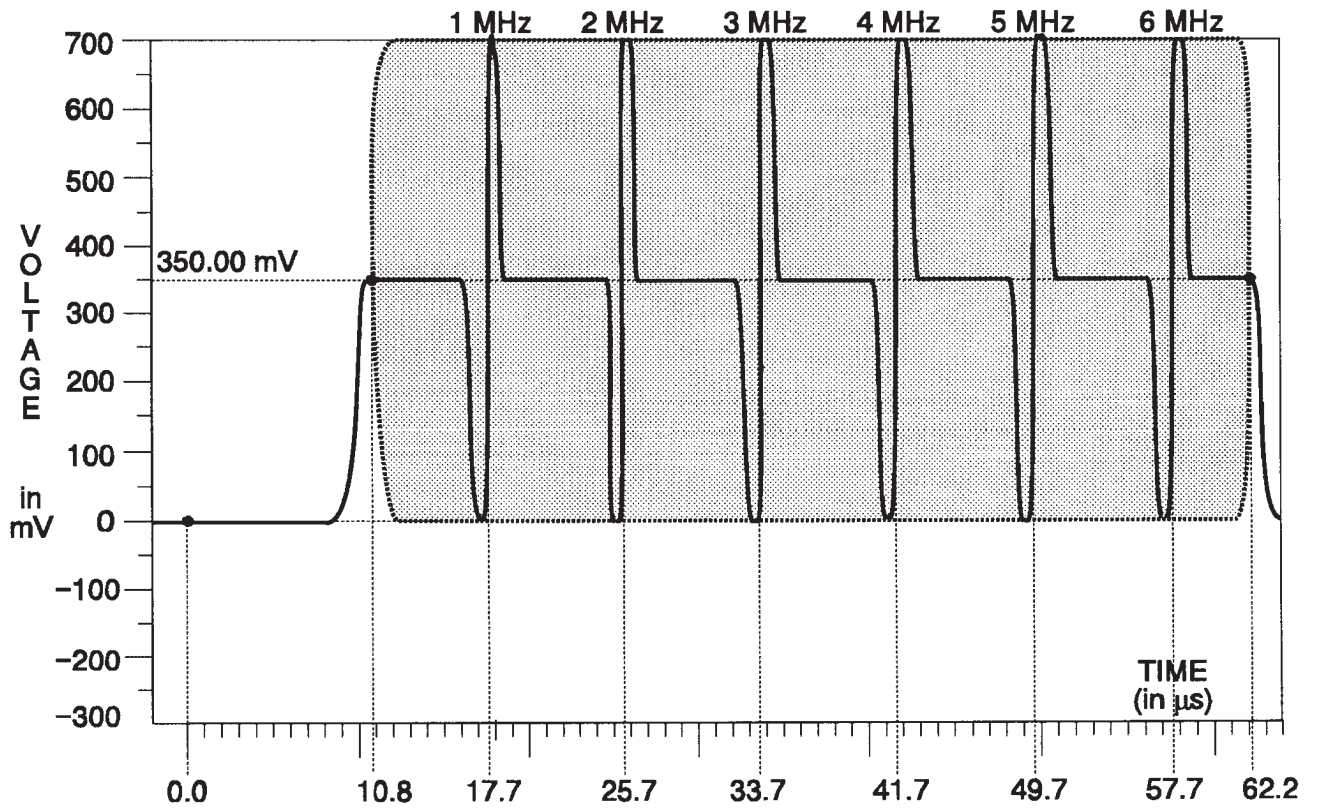

Fig. 3-136. Blue & Red Channels — Sweep.

TSG 131A — SPECIFICATIONS
GBR Signals

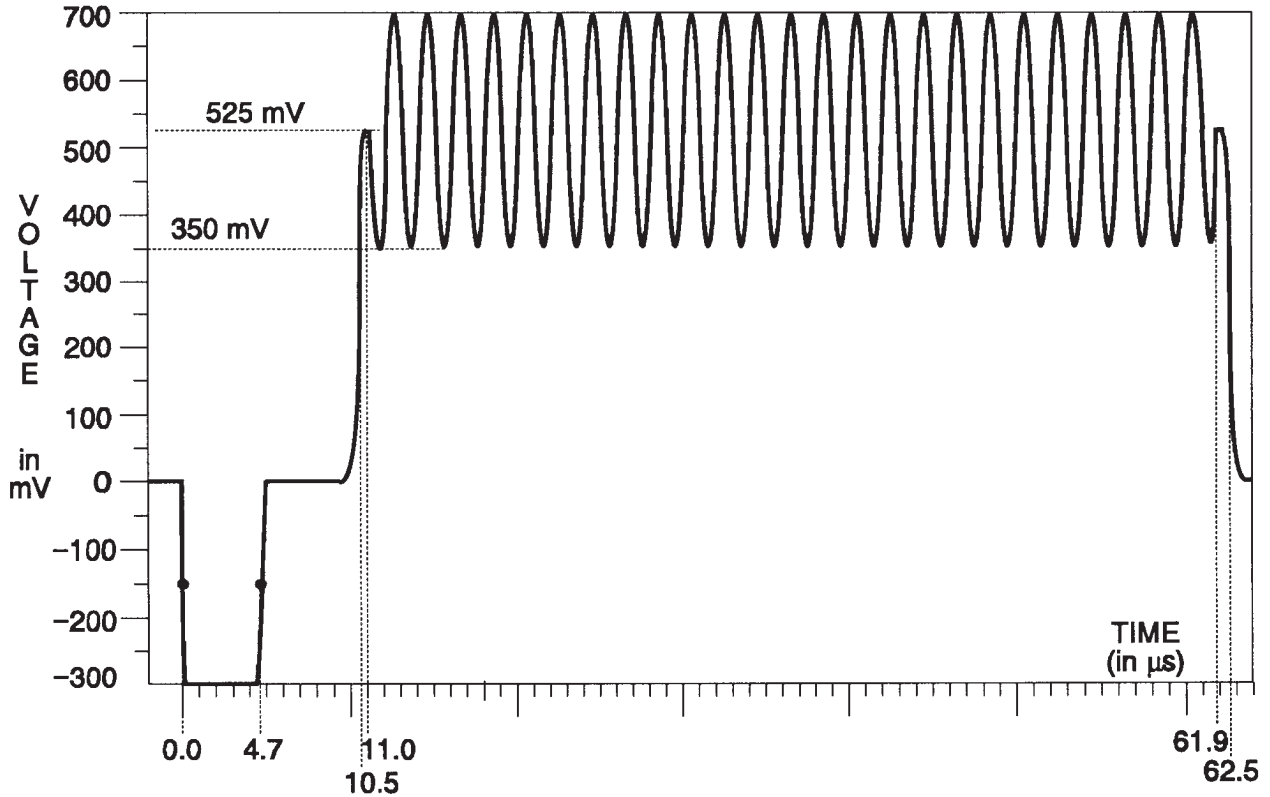

Fig. 3-137. Green Channel — Bowtie.

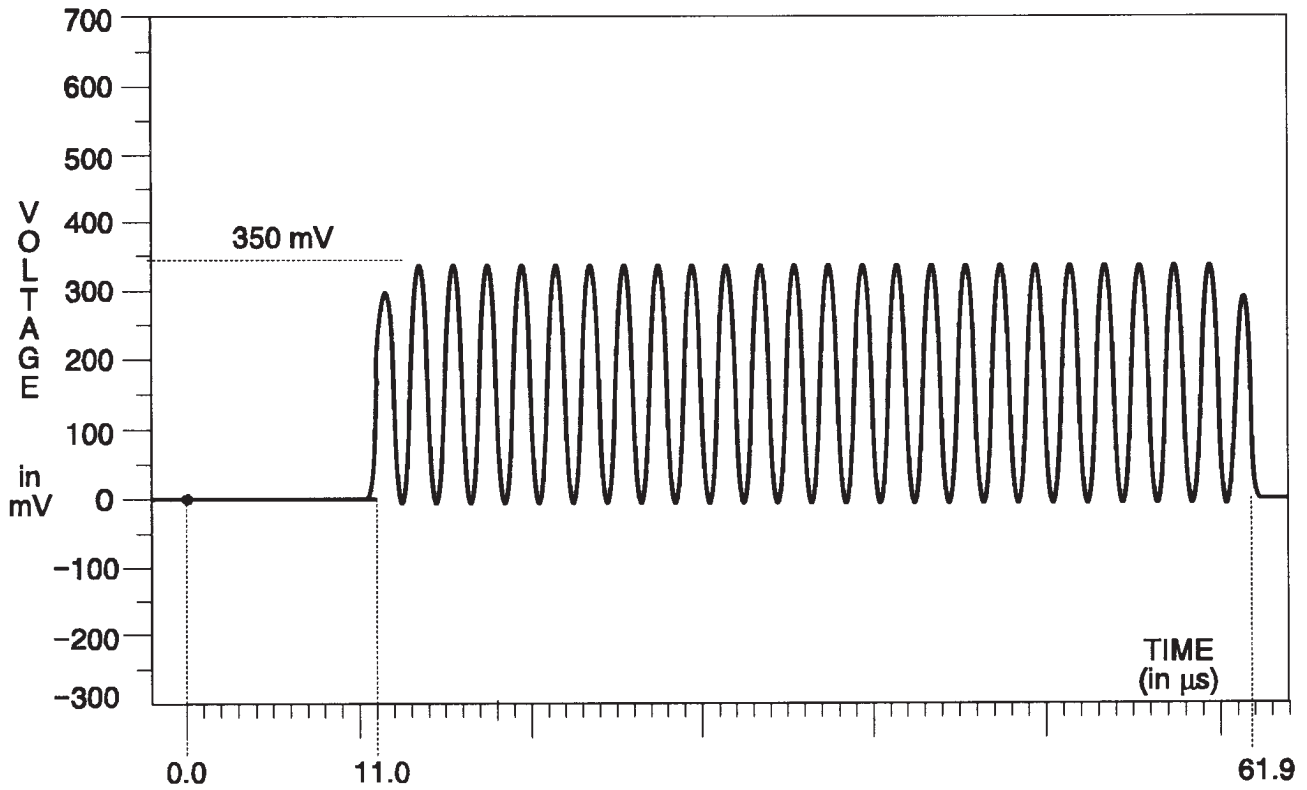

Fig. 3-138. Blue & Red Channels — Bowtie.

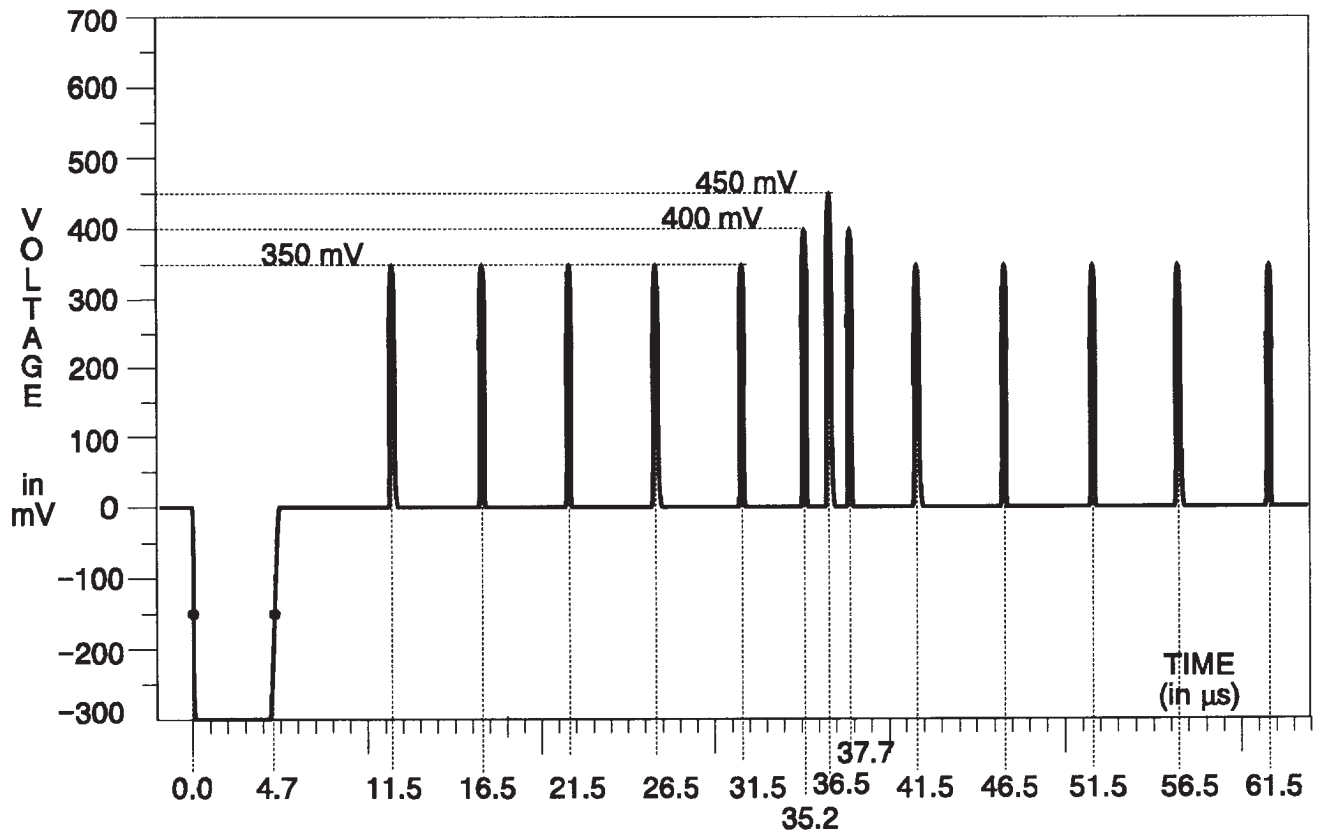

Fig. 3-139. Green Channel — Bowtie Markers.

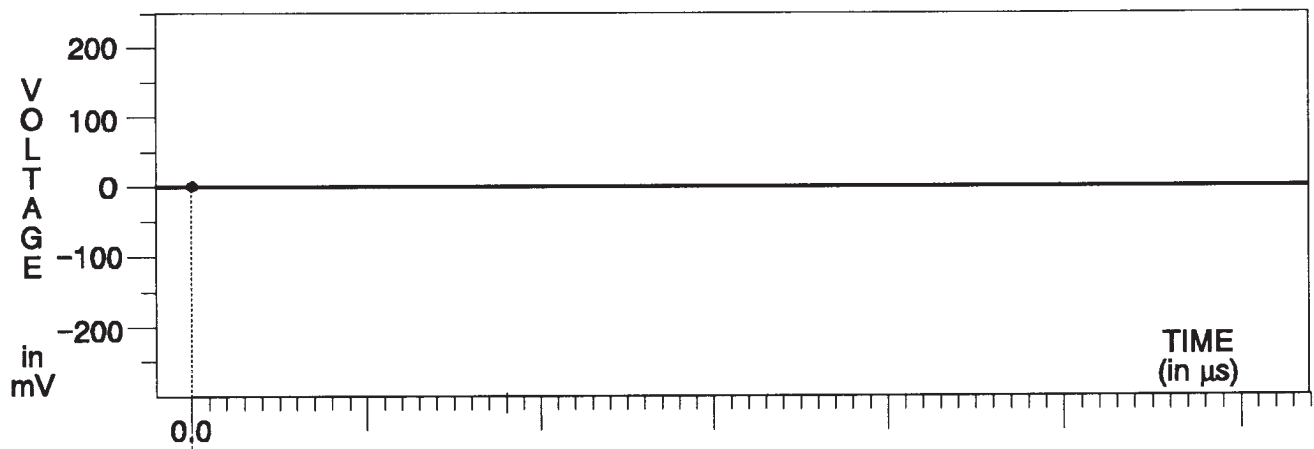

Fig. 3-140. Blue & Red Channels — Bowtie Markers.

**TSG 131A — SPECIFICATIONS
GBR Signals**

Option 01 Signals MII CTDM (2-Wire)

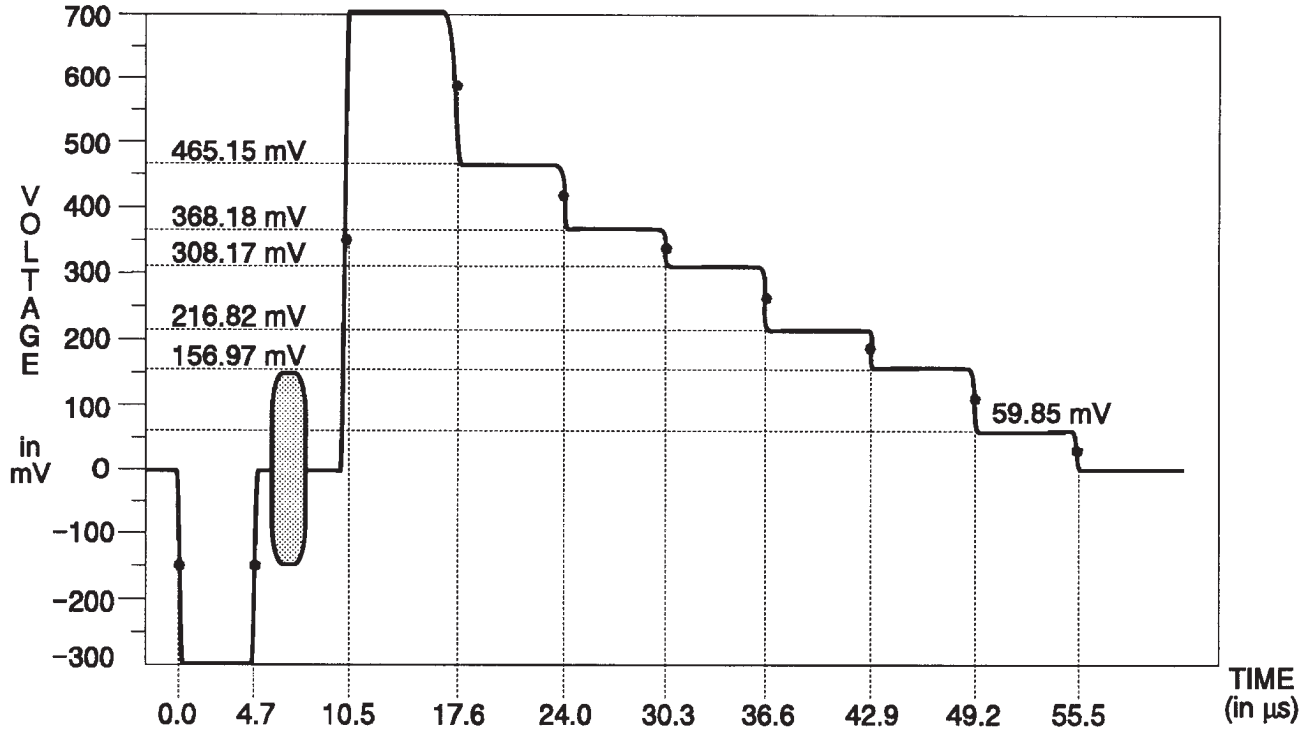

Fig. 3-141. Y Channel — 75% Color Bars.

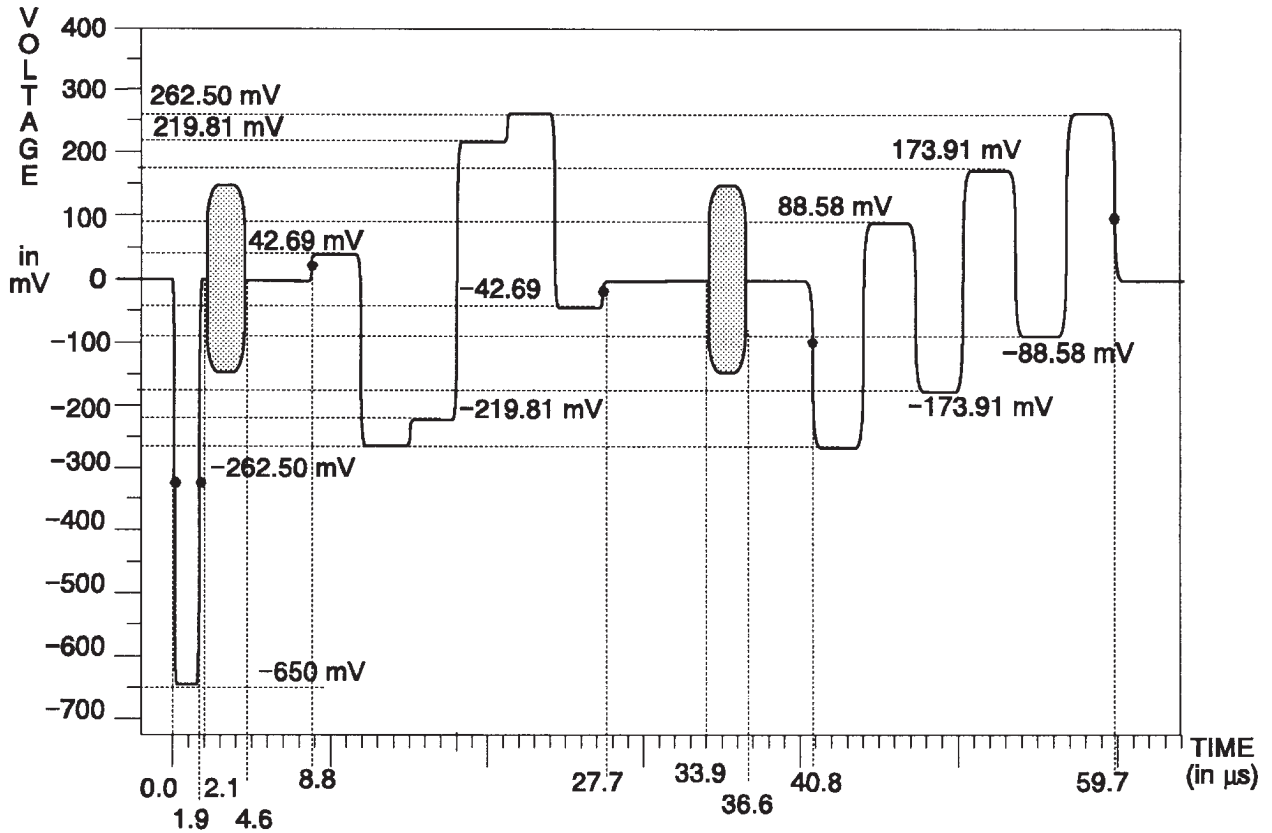

Fig. 3-142. C Channel — 75% Color Bars.

TSG 131A — Specifications
— Option -01 MLI Signals

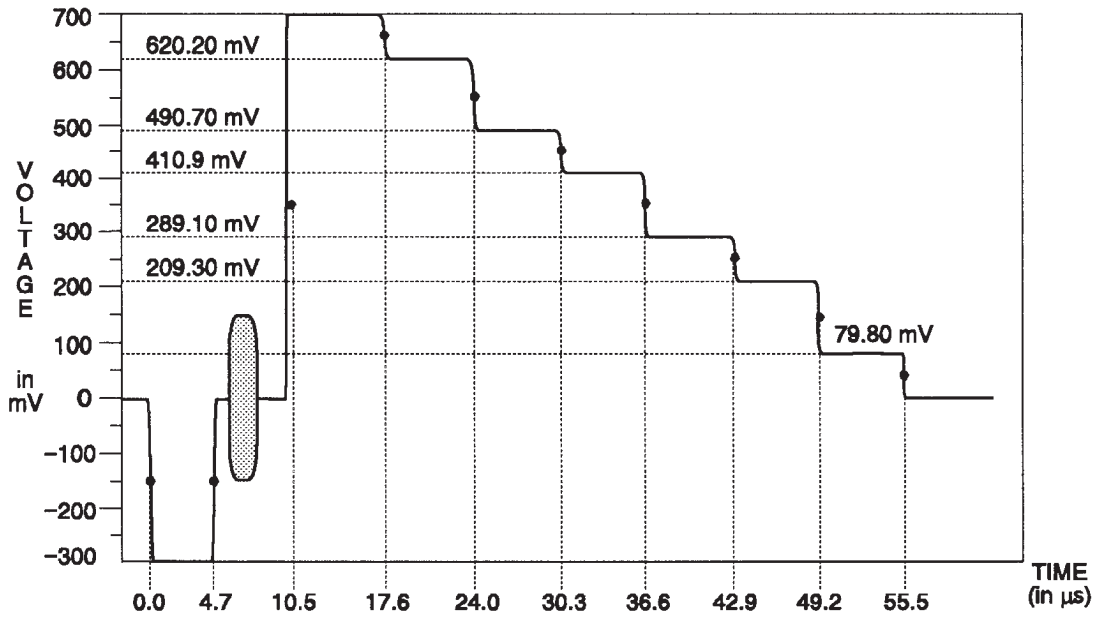

Fig. 3-143. Y Channel — 100% Color Bars.

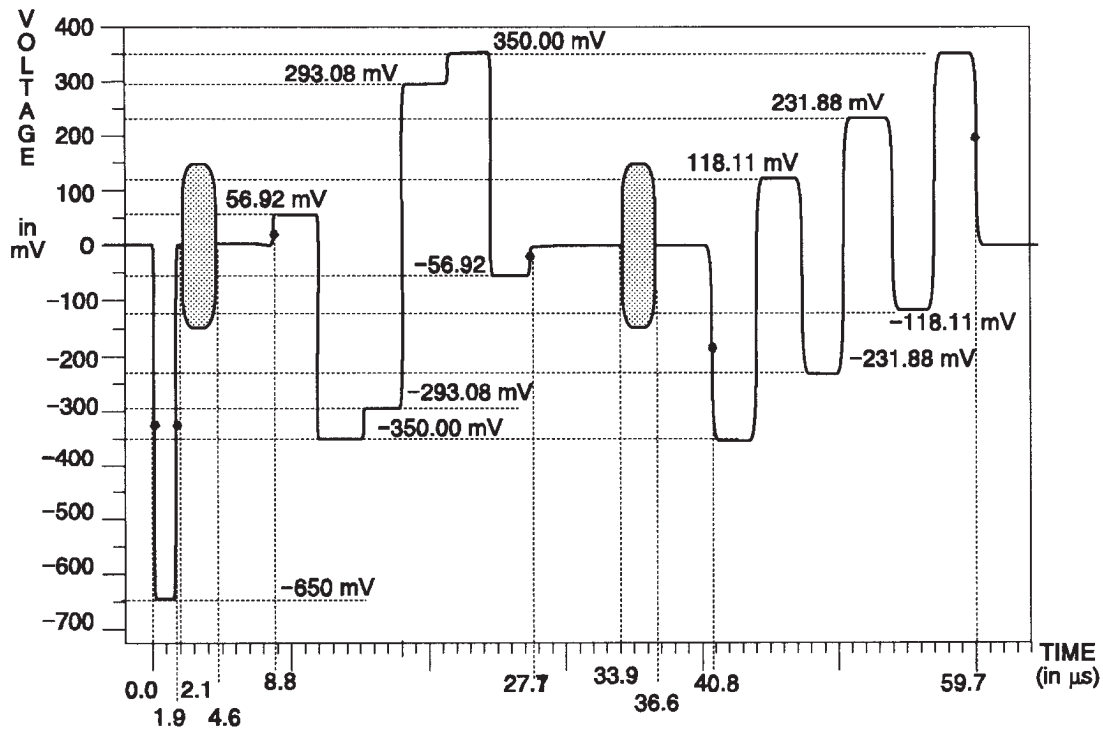

Fig. 3-144. C Channel — 100% Color Bars.

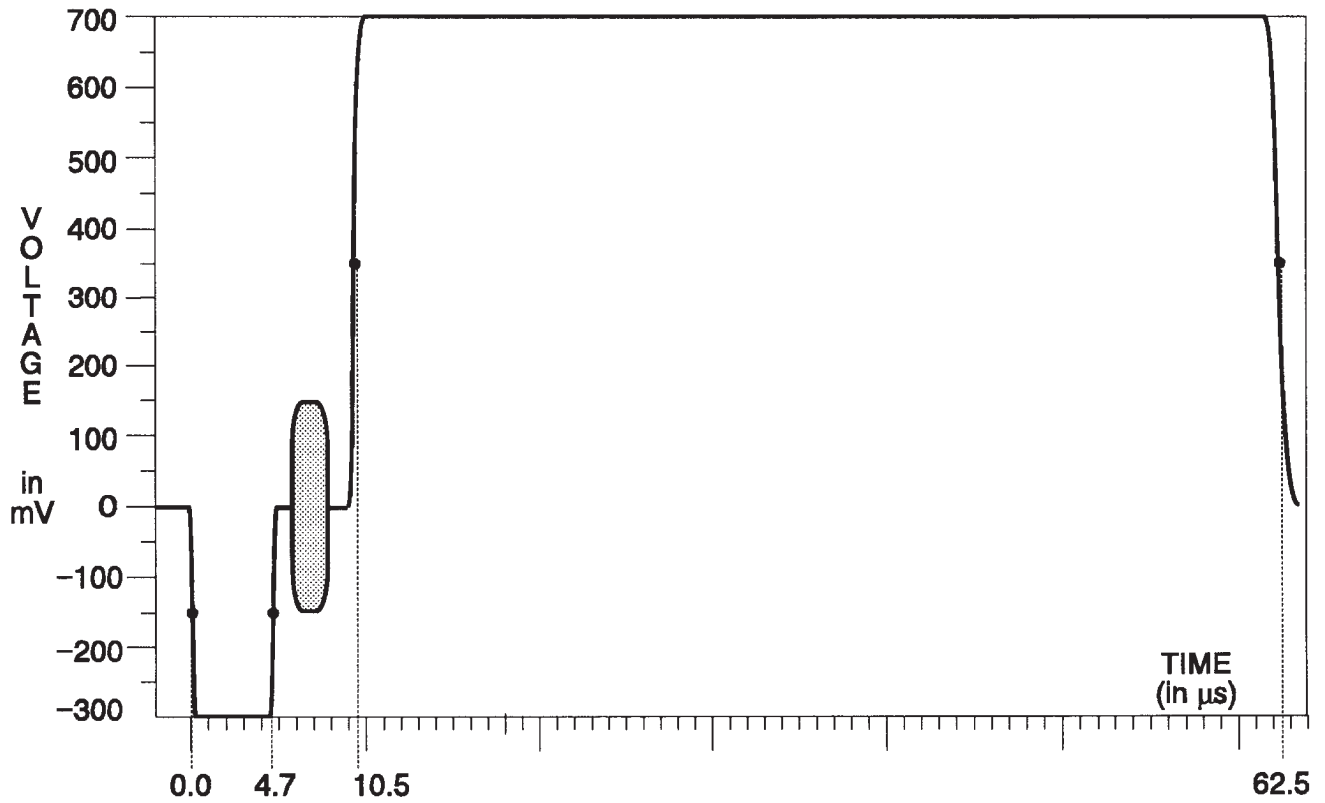

Fig. 3-145. Y Channel — 0% Flat Field.

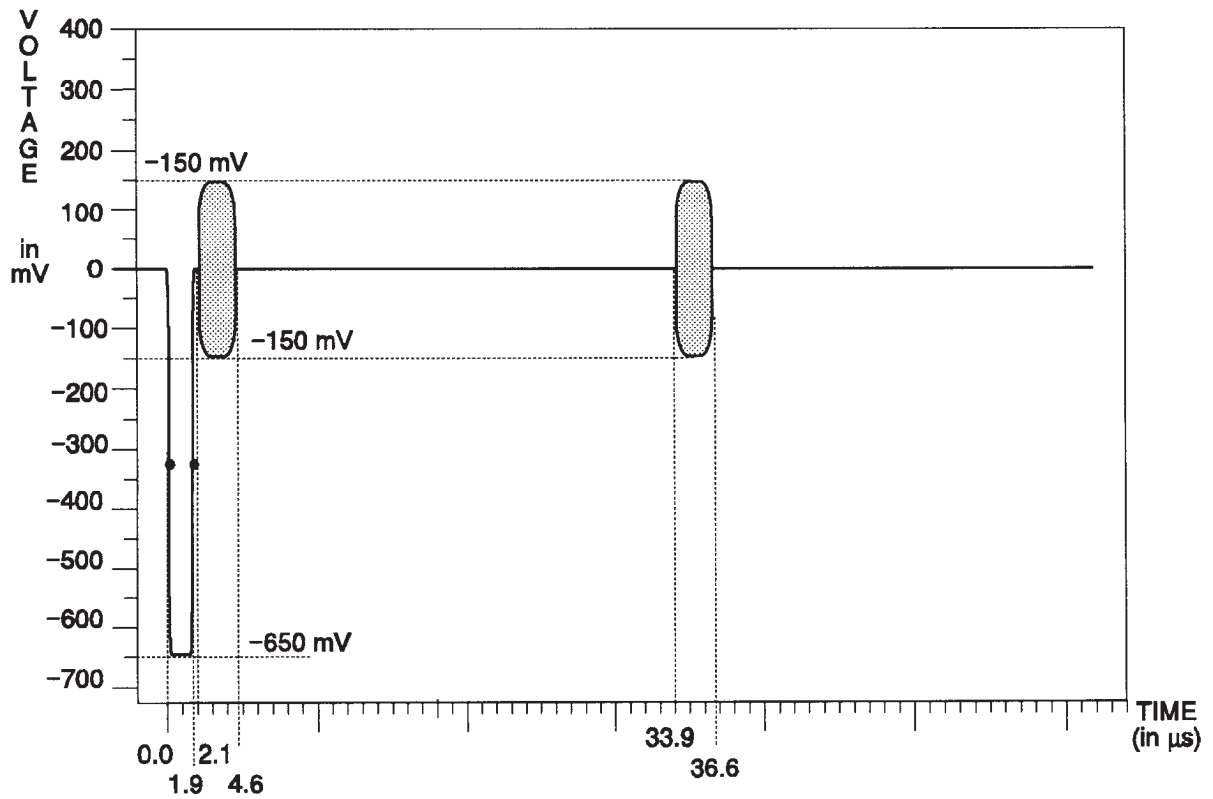

Fig. 3-146. C Channel — All Flat Field Signals.

TSG 131A — Specifications
— Option -01 MII Signals

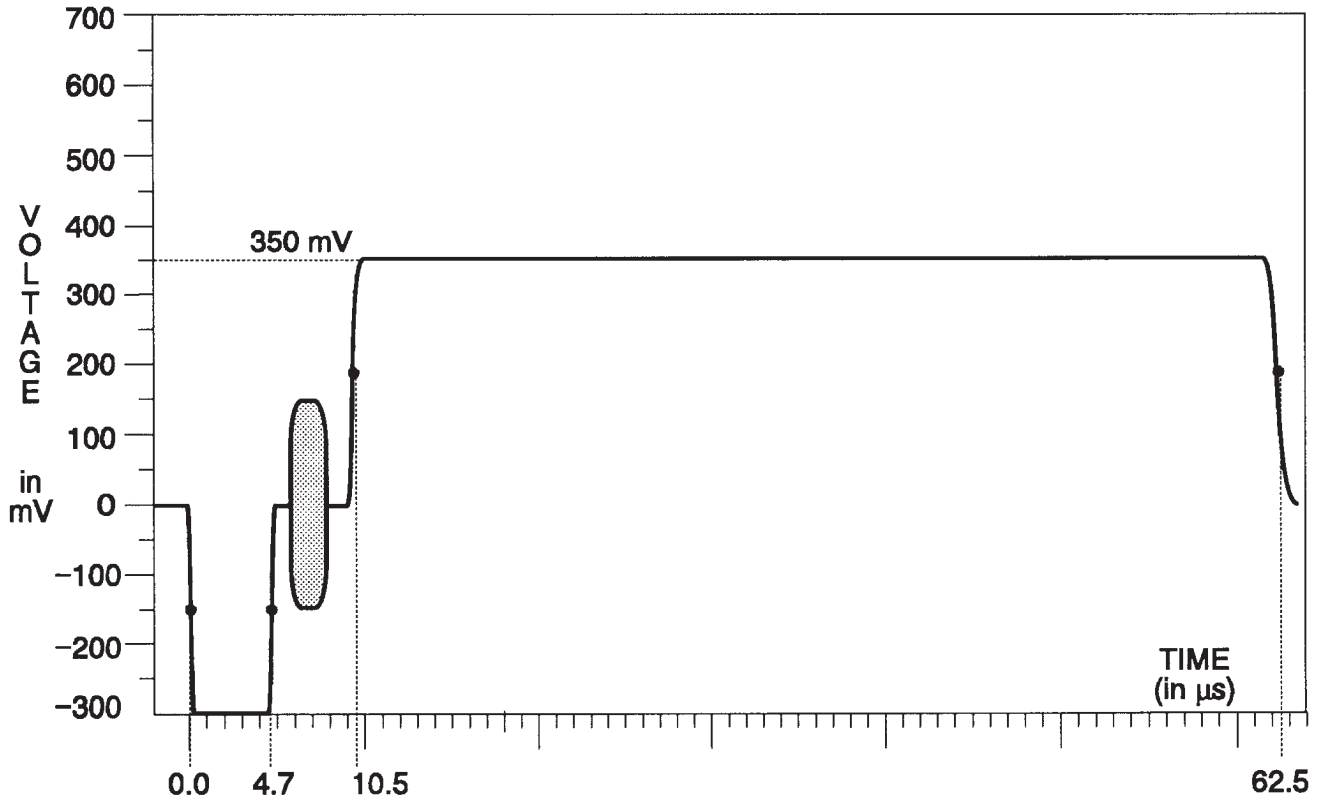

Fig. 3-147. Y Channel — 50% Flat Field.

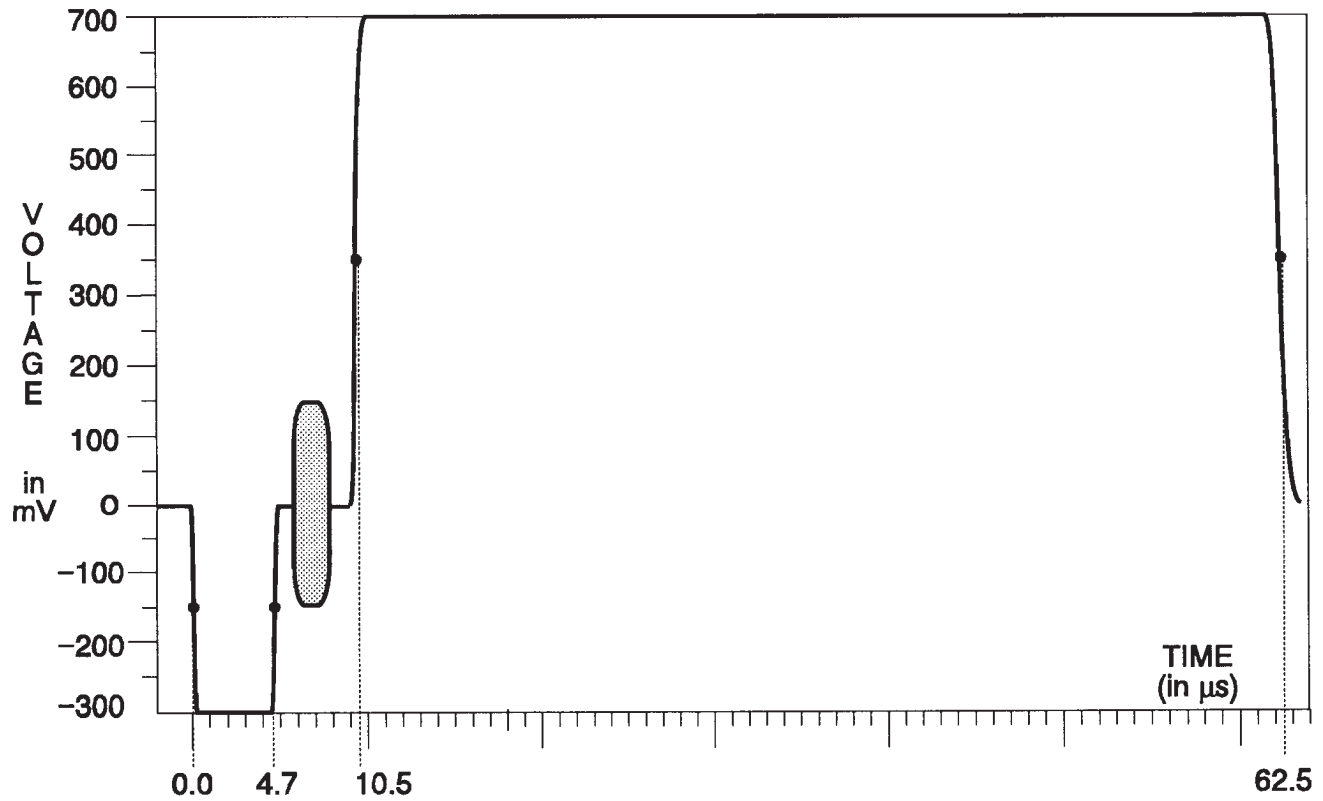

Fig. 3-148. Y Channel — 100% Flat Field.

Option 03 Signals — Y-C Unique Signals

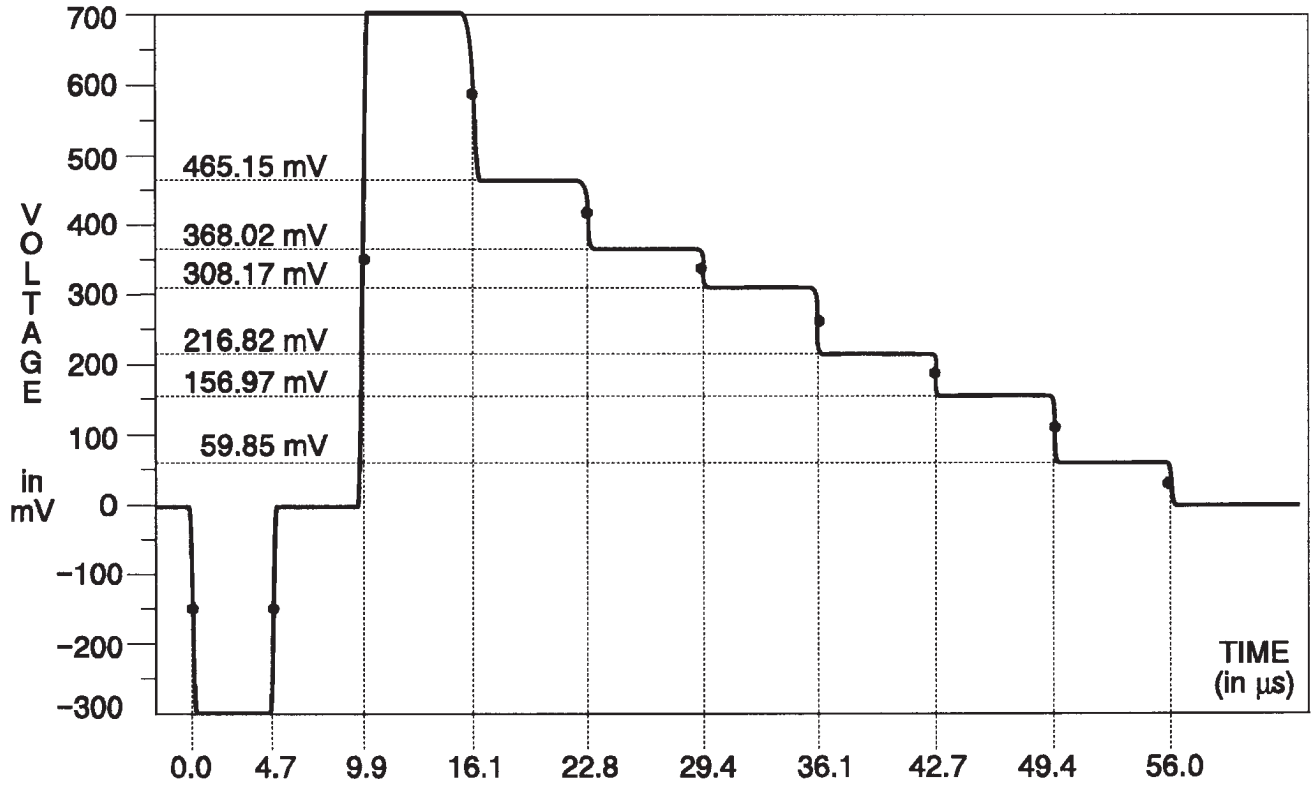

Fig. 3-149. Y Channel — 75% Bars.

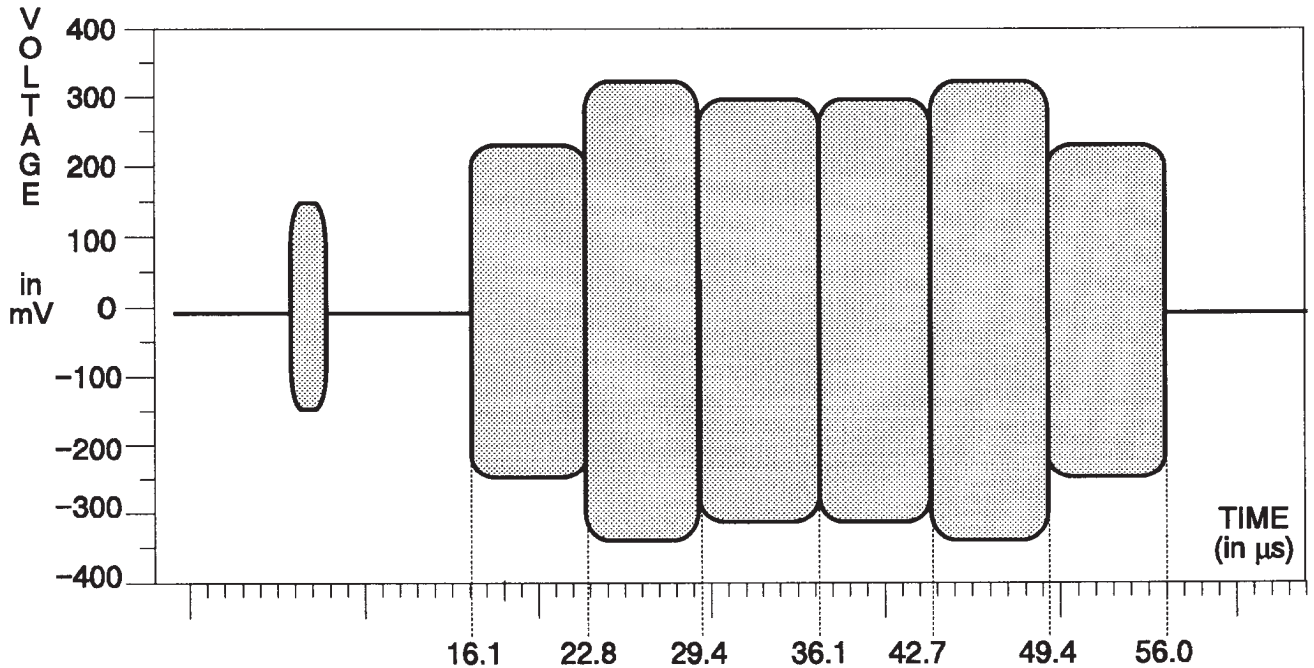

Fig. 3-150. C Channel — 75% Bars.

TSG 131A — SPECIFICATIONS
Option 03 Unique Signals

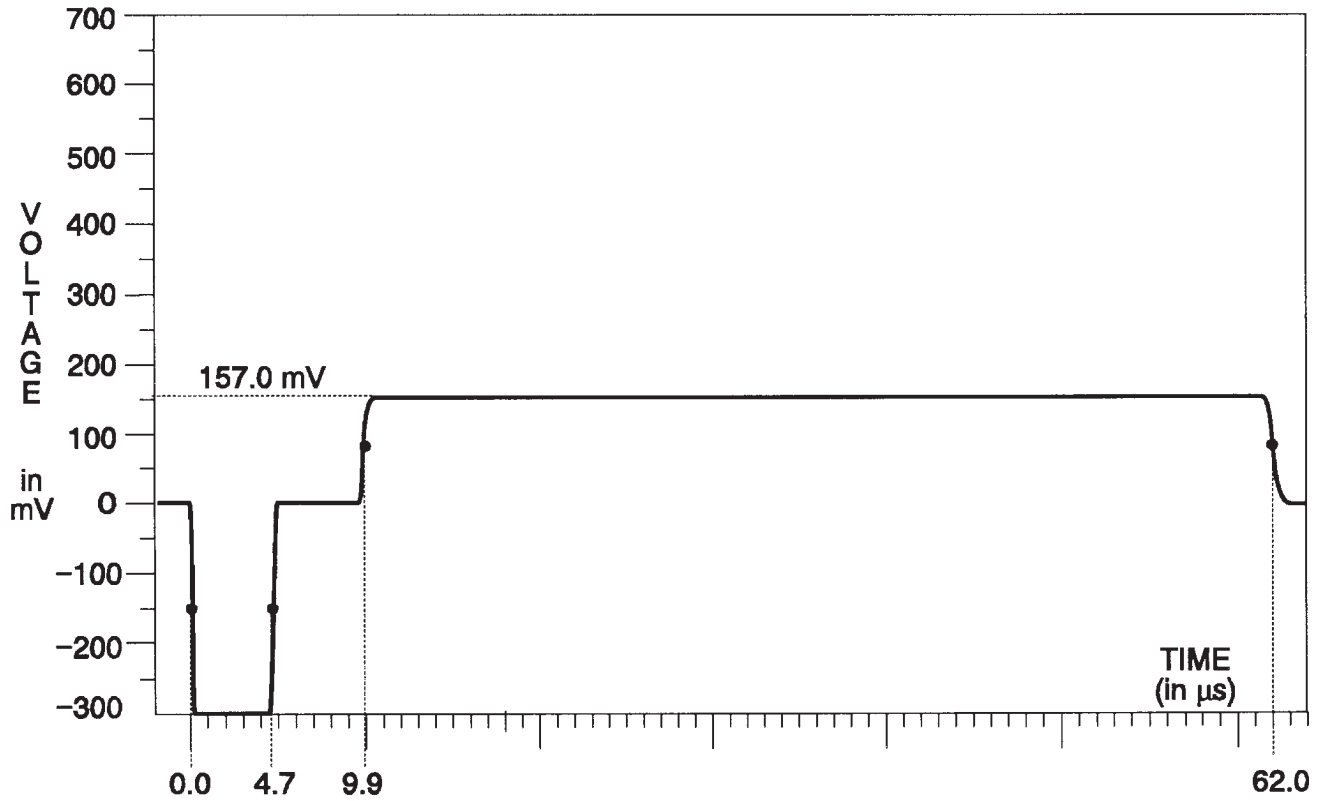

Fig. 3-151. Y Channel — 75% Red (same as Red Field).

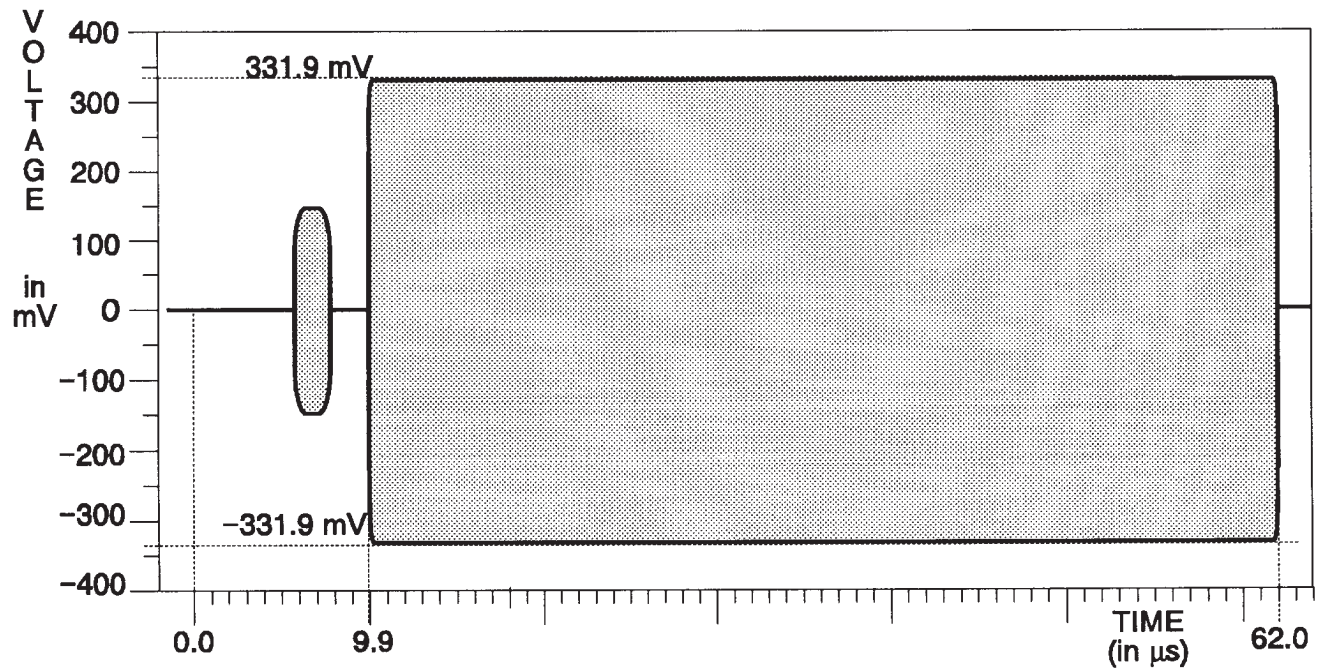

Fig. 3-152. C Channel — 75% red (same as Red Field).

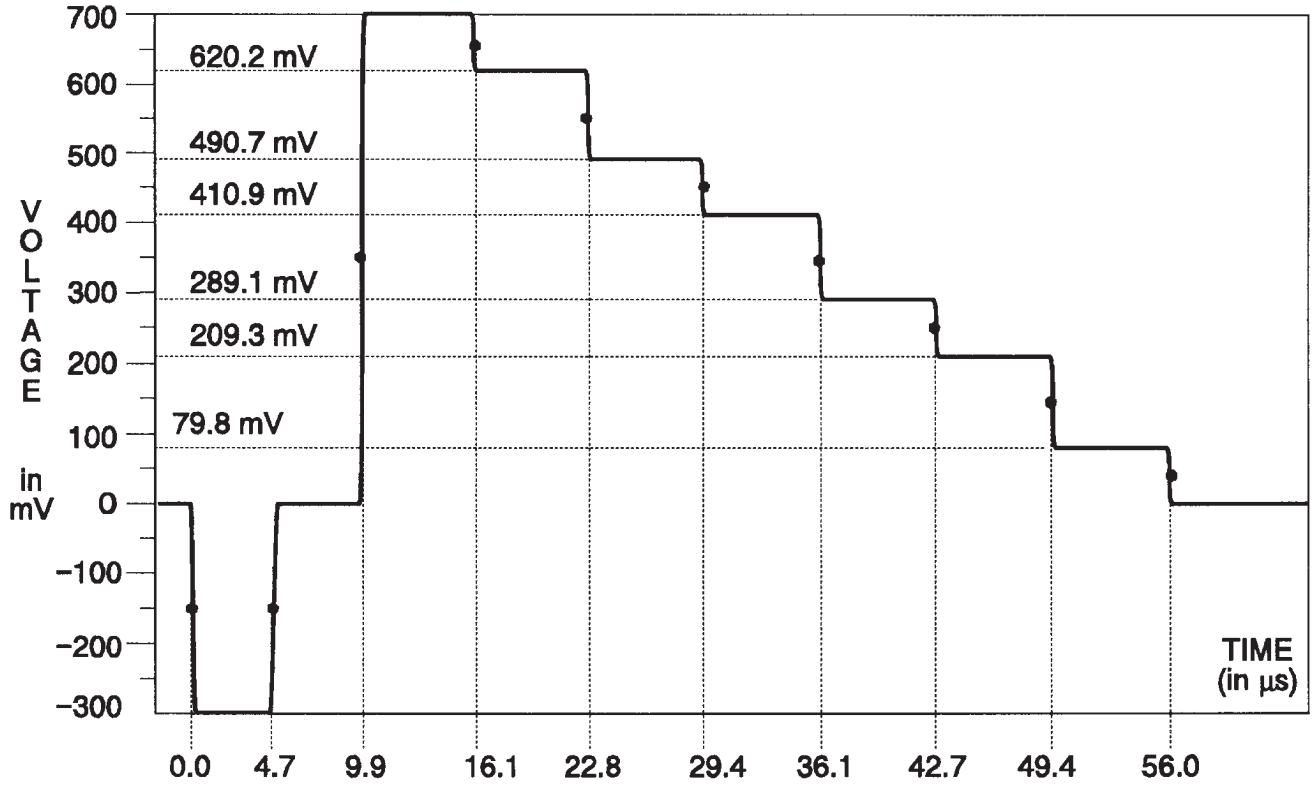

Fig. 3-153. Y Channel — 100% Bars.

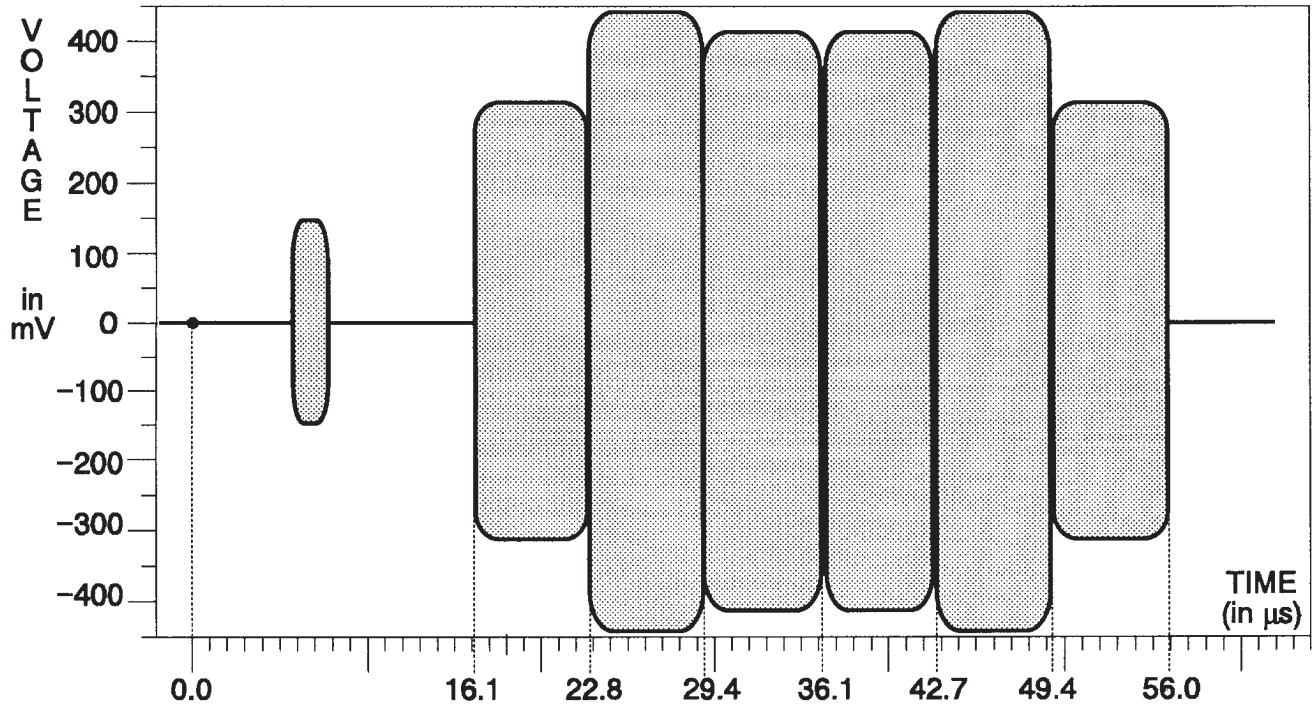

Fig. 3-154. C Channel — 100% Bars.

TSG 131A — SPECIFICATIONS
Option 03 Unique Signals

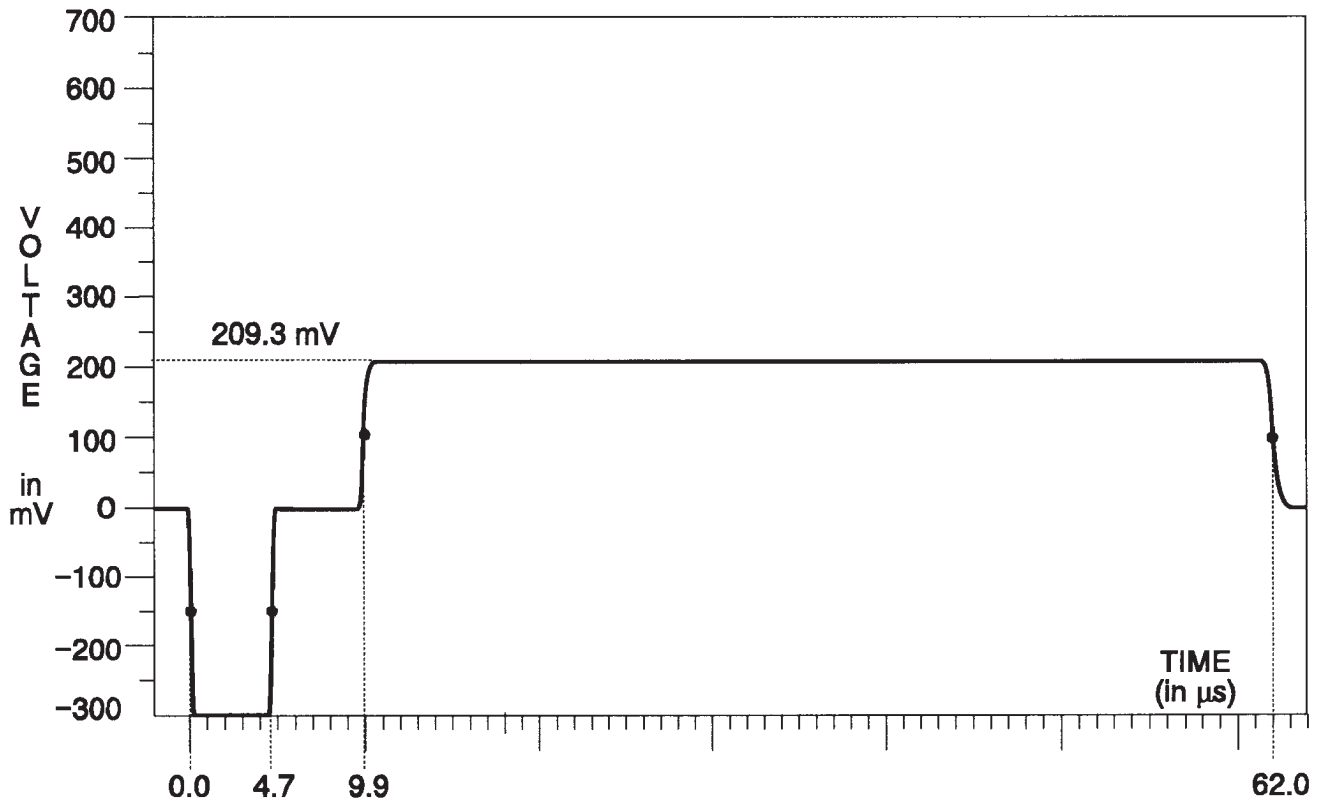

Fig. 3-155. Y Channel — 100% Red.

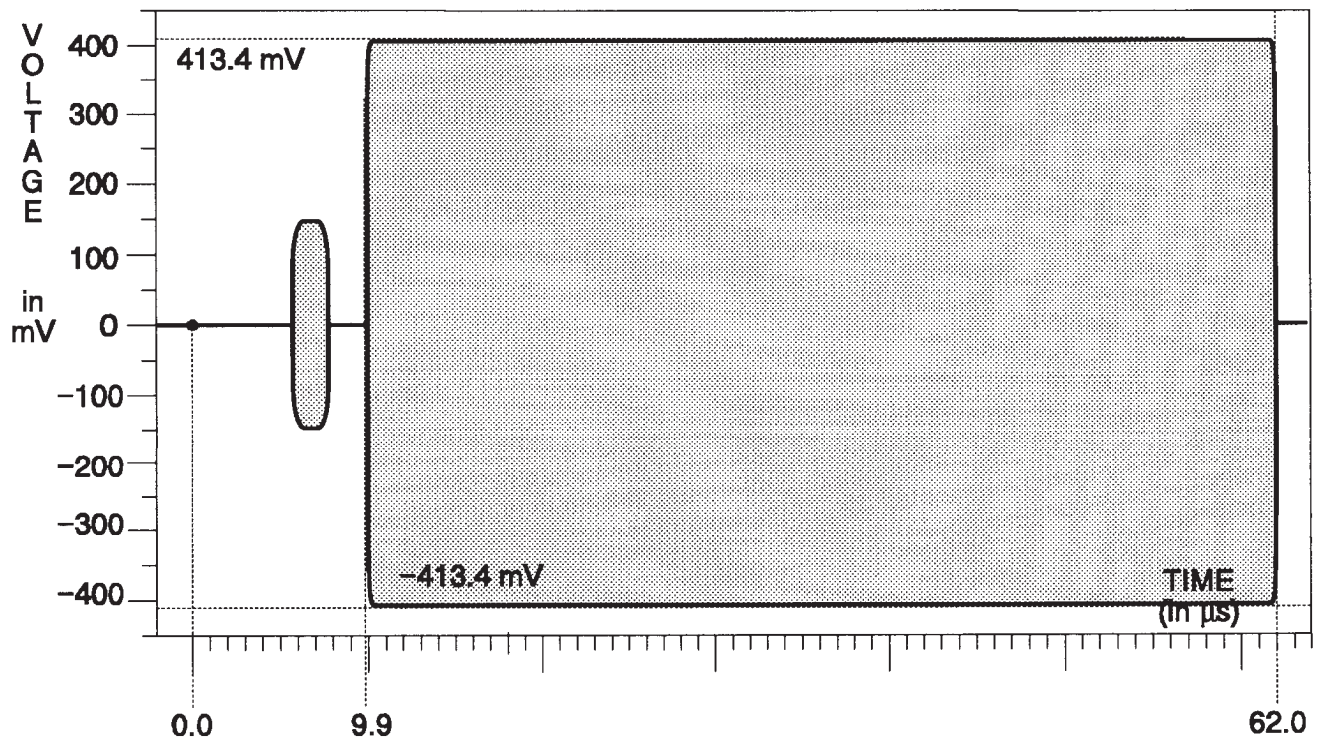

Fig. 3-156. C Channel — 100% Red.

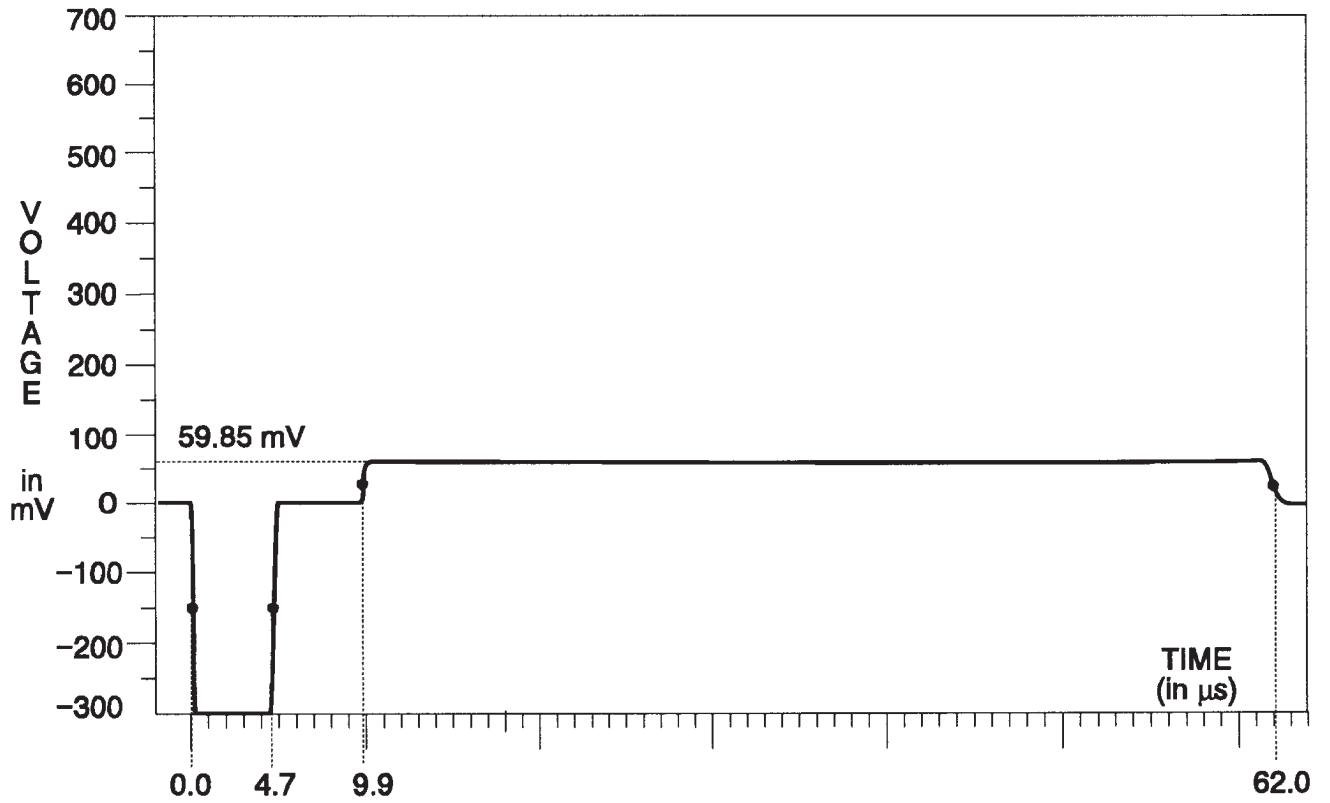

Fig. 3-157. Y Channel — Blue Field.

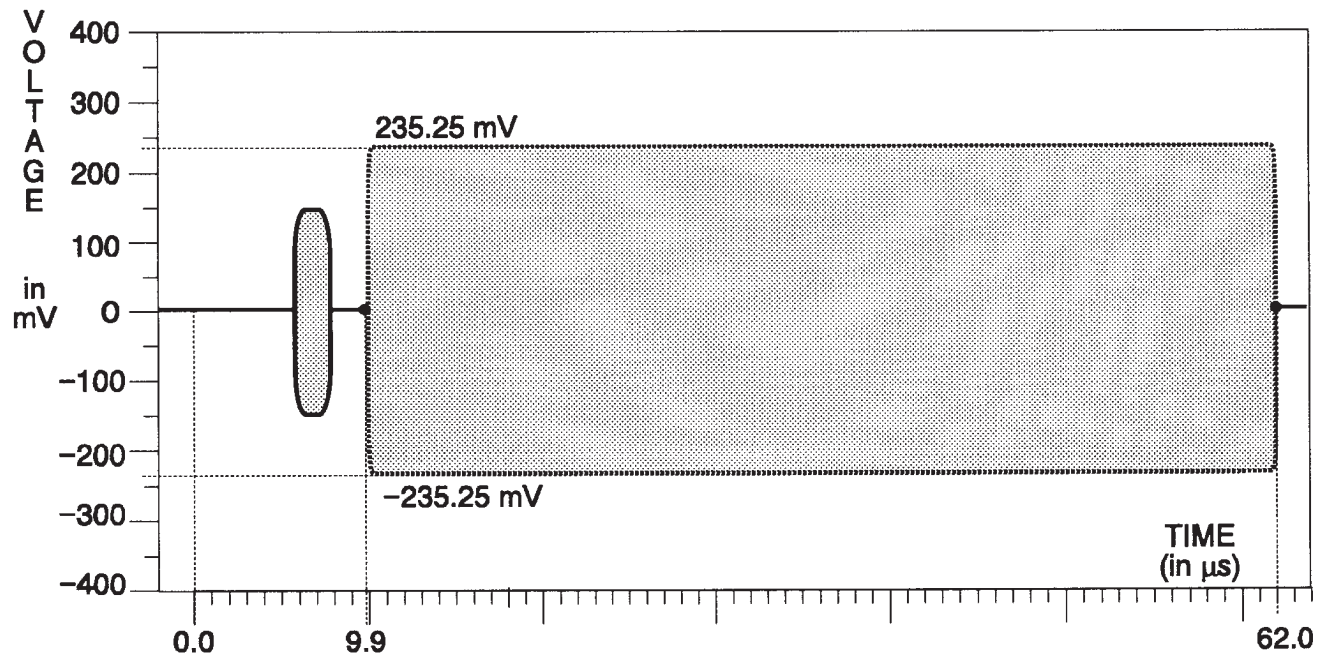

Fig. 3-158. C Channel — Blue Field.

TSG 131A — SPECIFICATIONS
 Option 03 Unique Signals

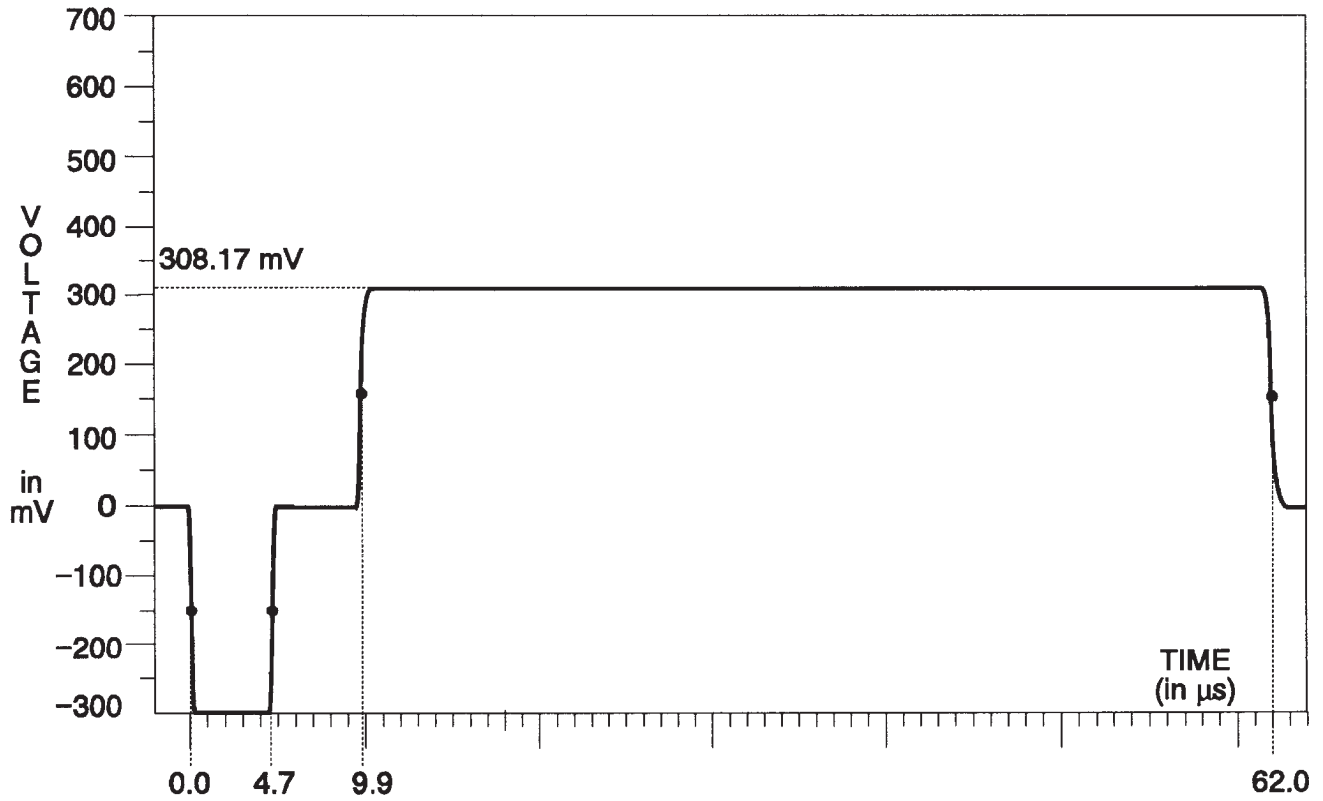

Fig. 3-159. Y Channel — Green Field.

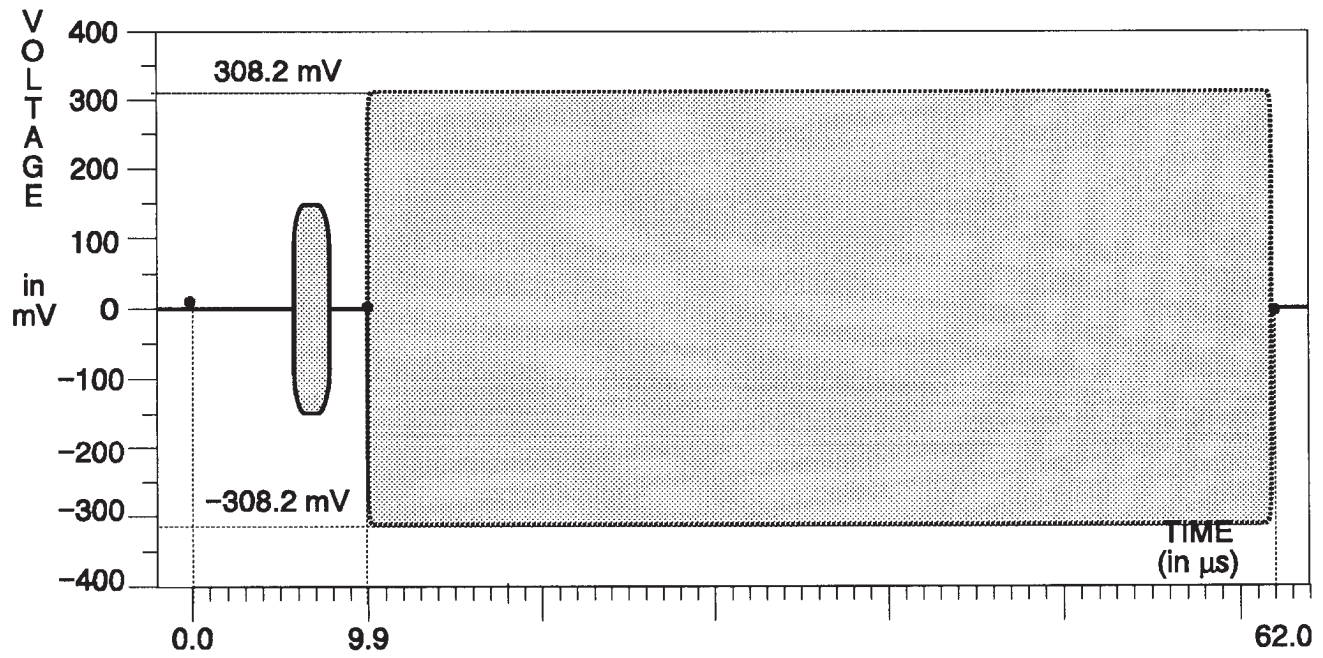

Fig. 3-160. C Channel — Green Field.

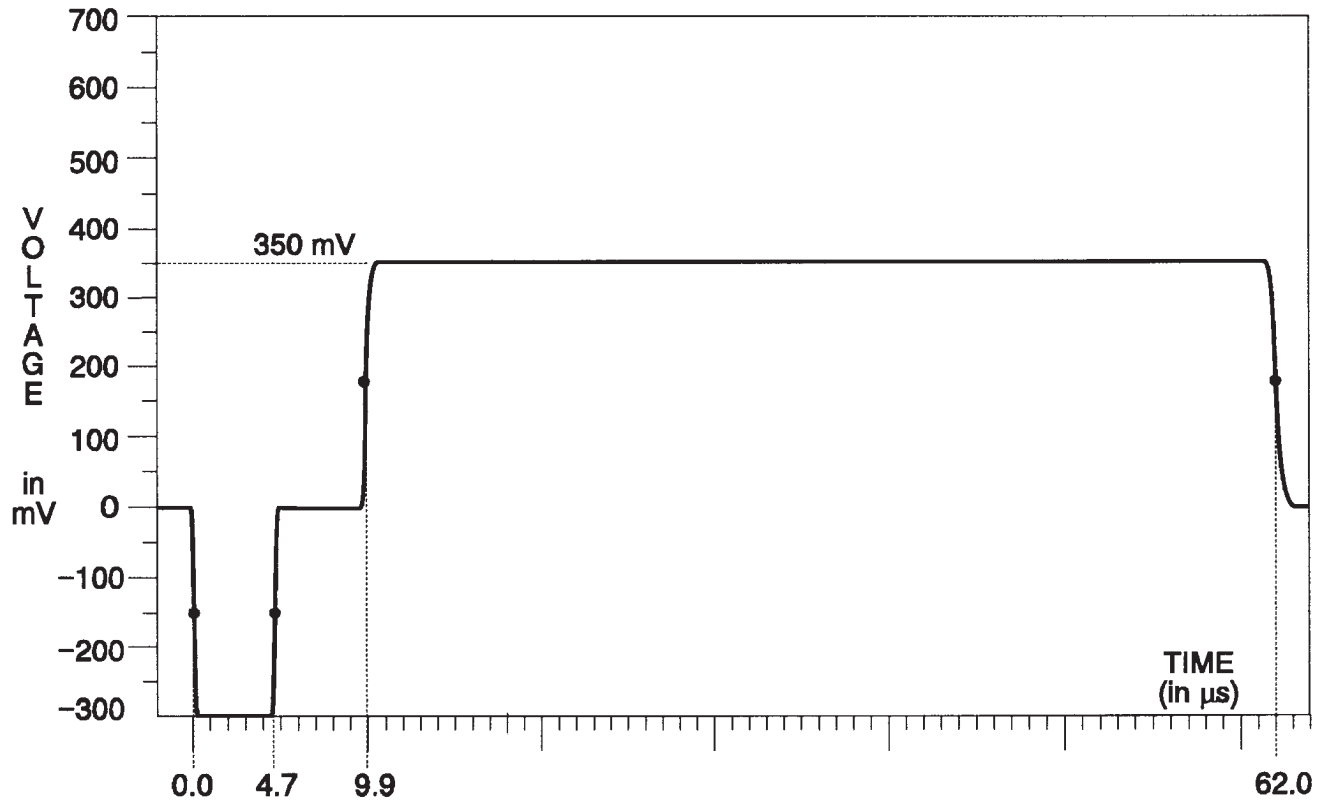

Fig. 3-161. Y Channel — 50% Flat Field.

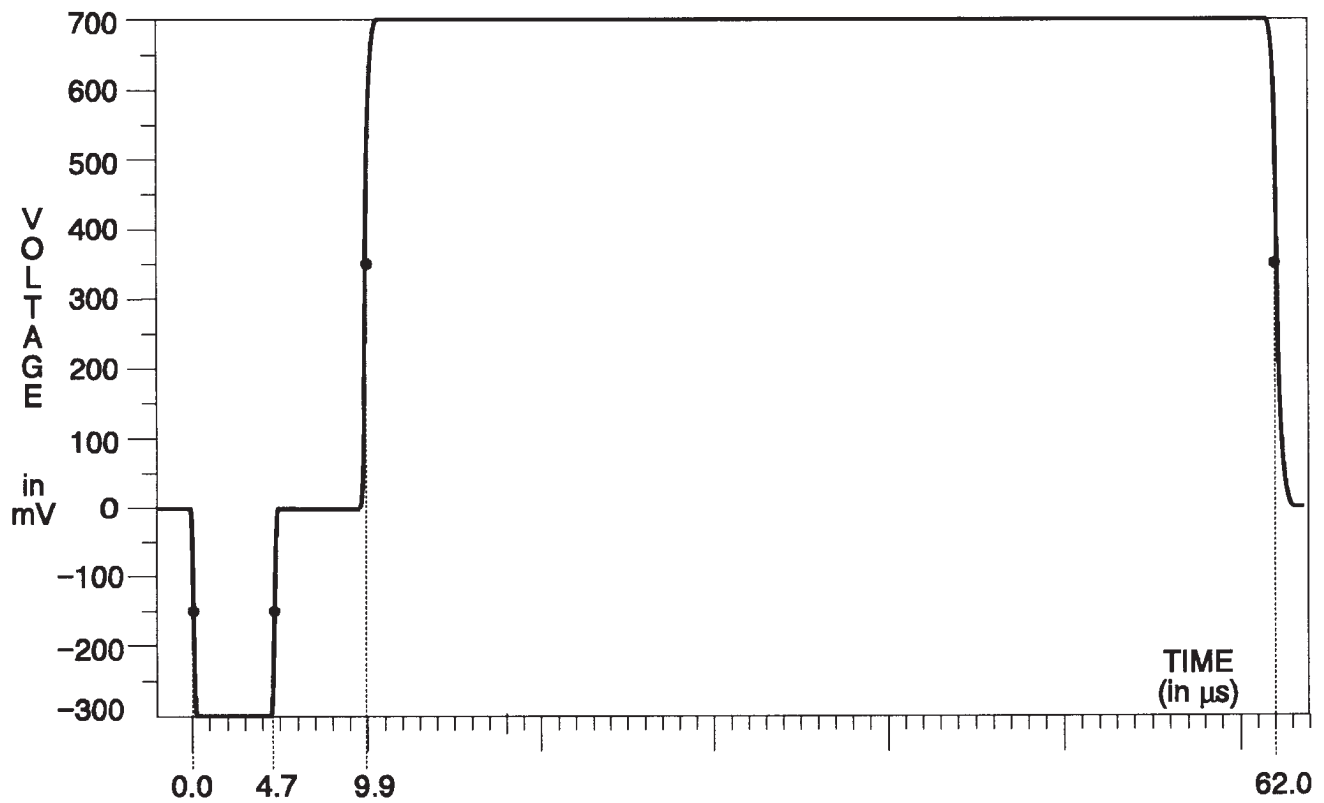

Fig. 3-162. Y Channel — 100% Flat Field.

TSG 131A — SPECIFICATIONS
 Option 03 Unique Signals

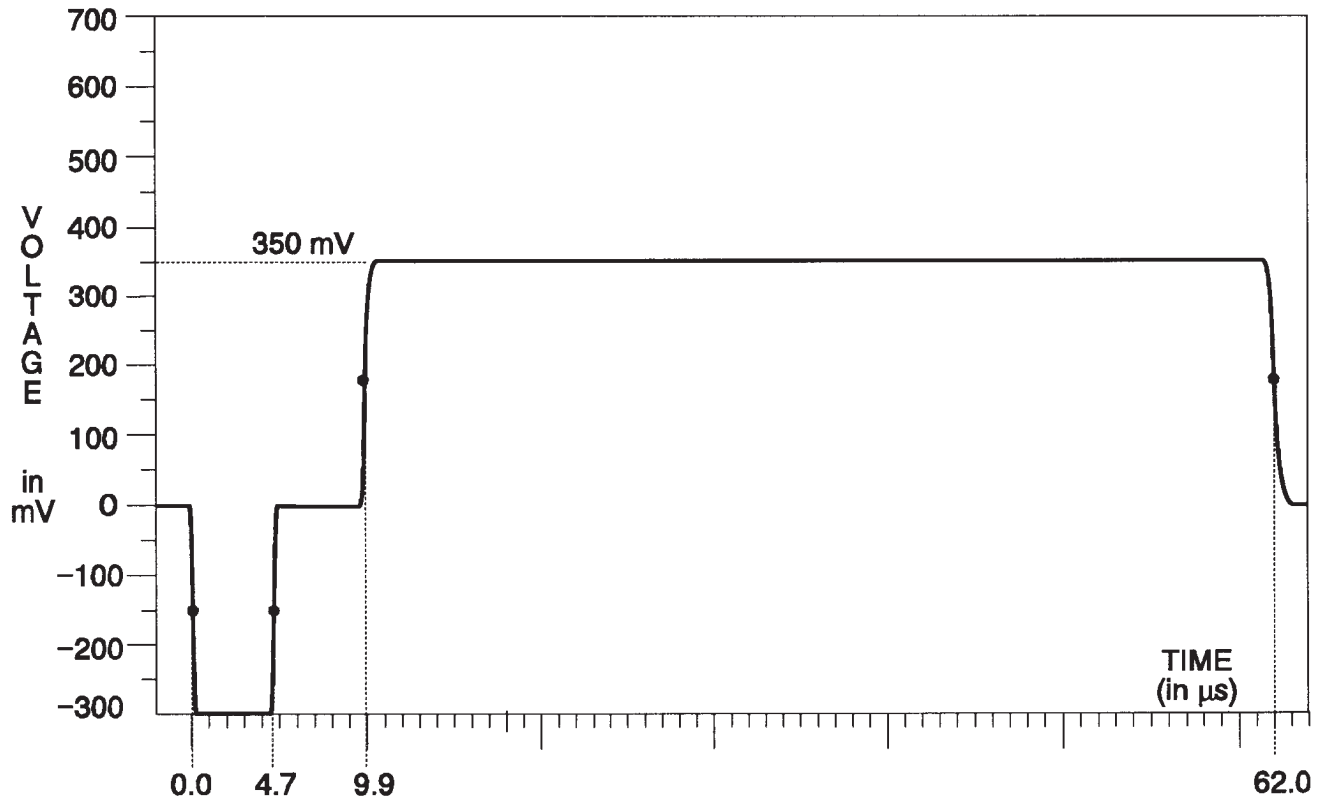

Fig. 3-163. Y Channel — Chroma Noise.

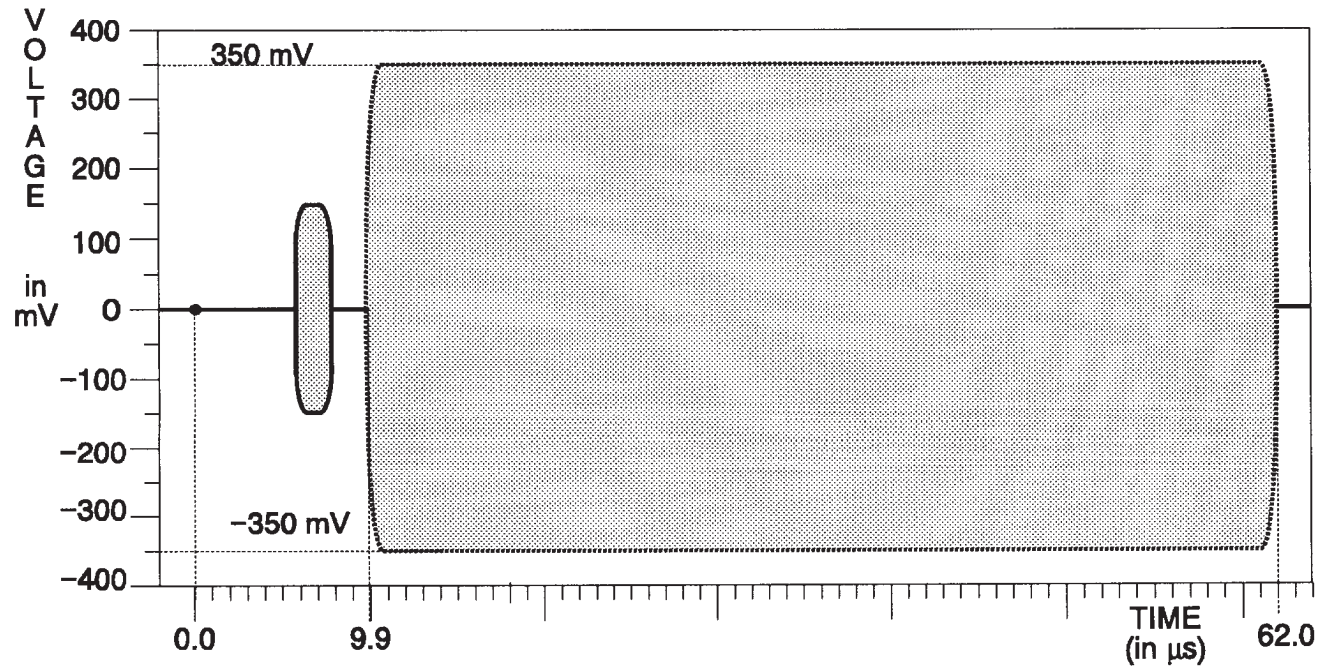

Fig. 3-164. C Channel — Chroma Noise.

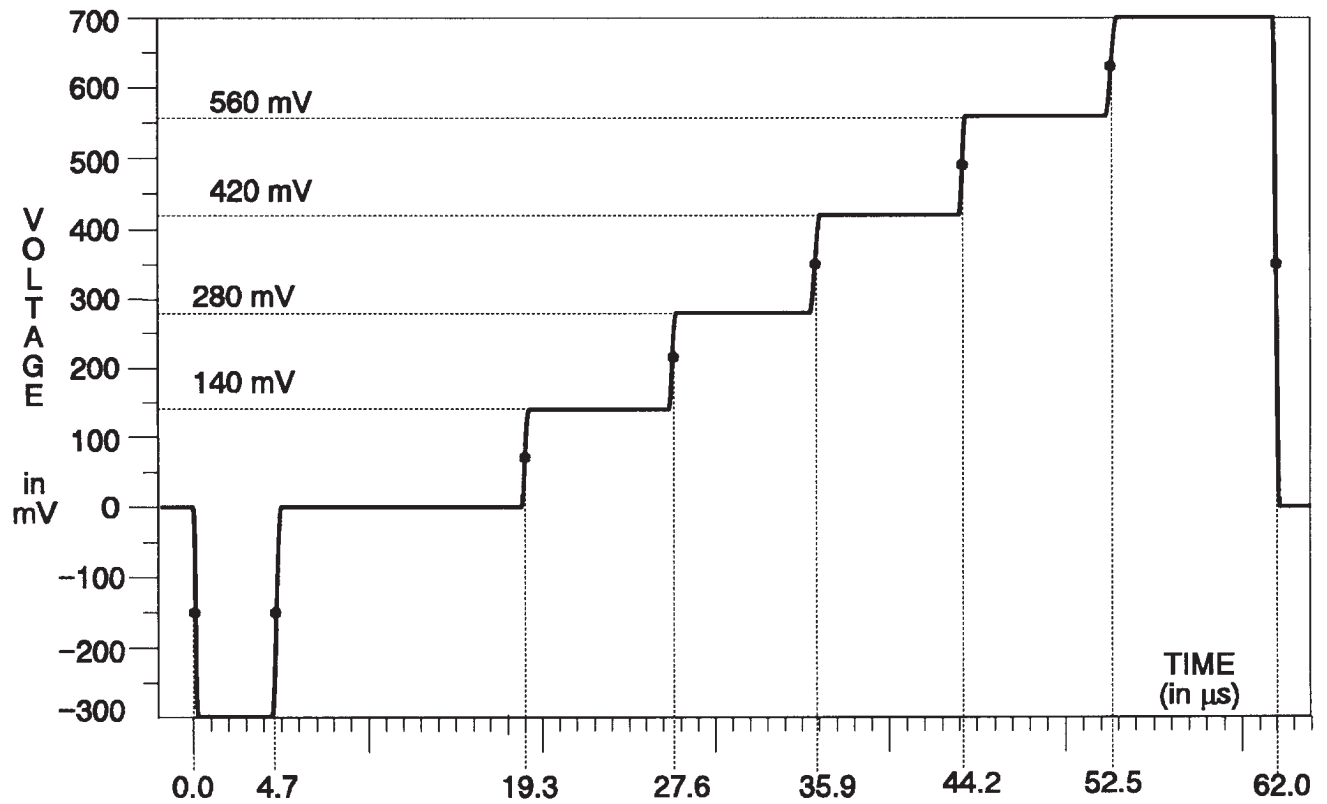

Fig. 3-165. Y Channel — 5-Step.

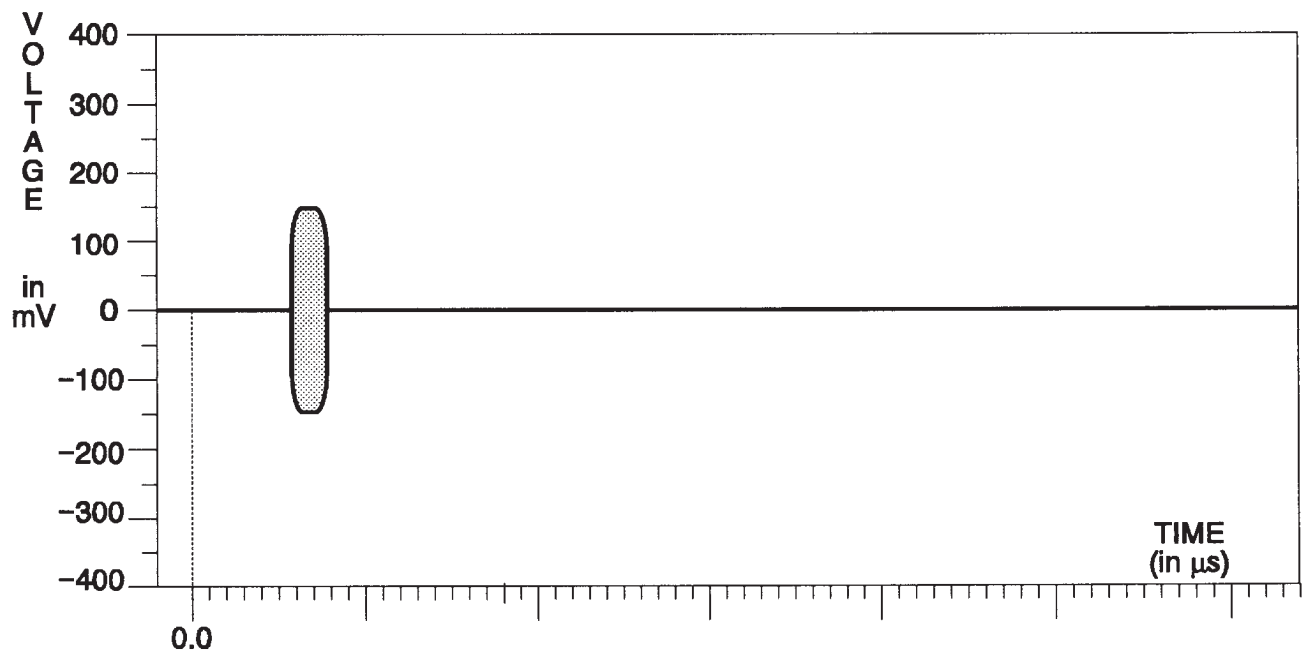

Fig. 3-166. C Channel — 5-Step.

TSG 131A — SPECIFICATIONS
Option 03 Unique Signals

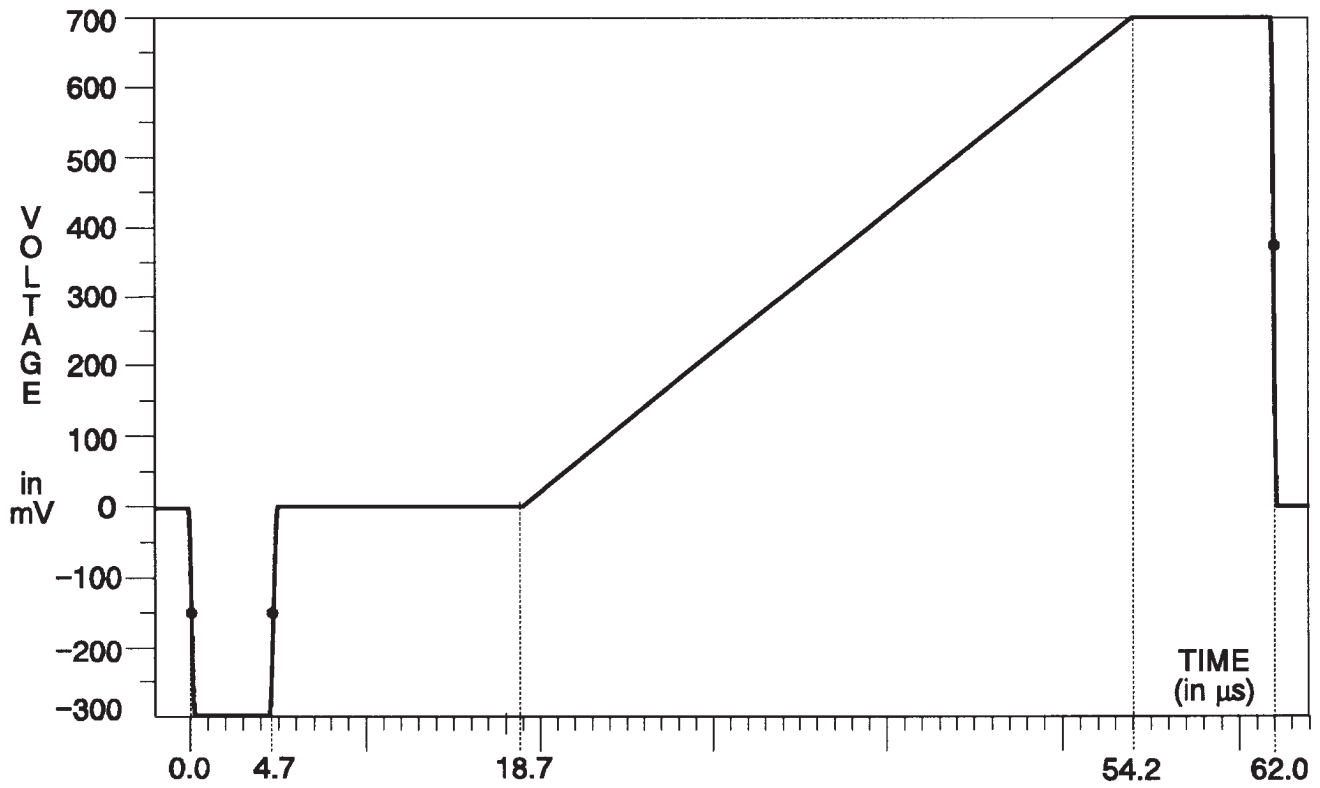

Fig. 3-167. Y Channel — Ramp.

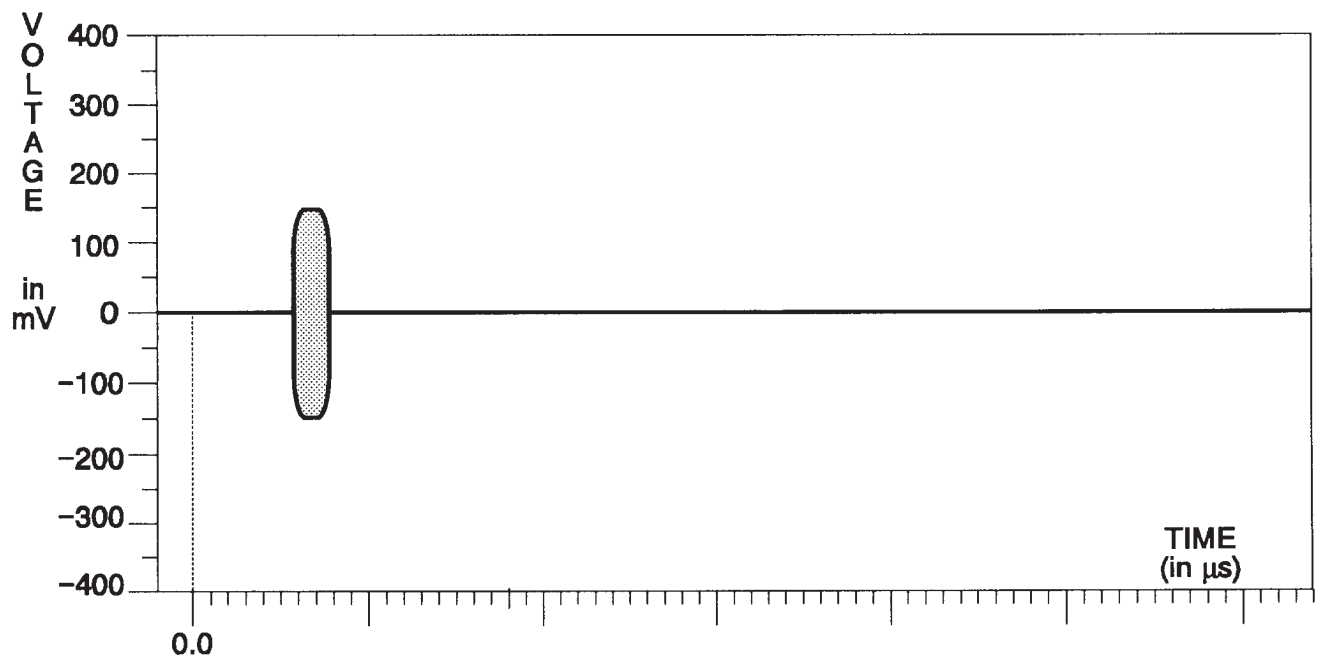

Fig. 3-168. C Channel — Ramp.

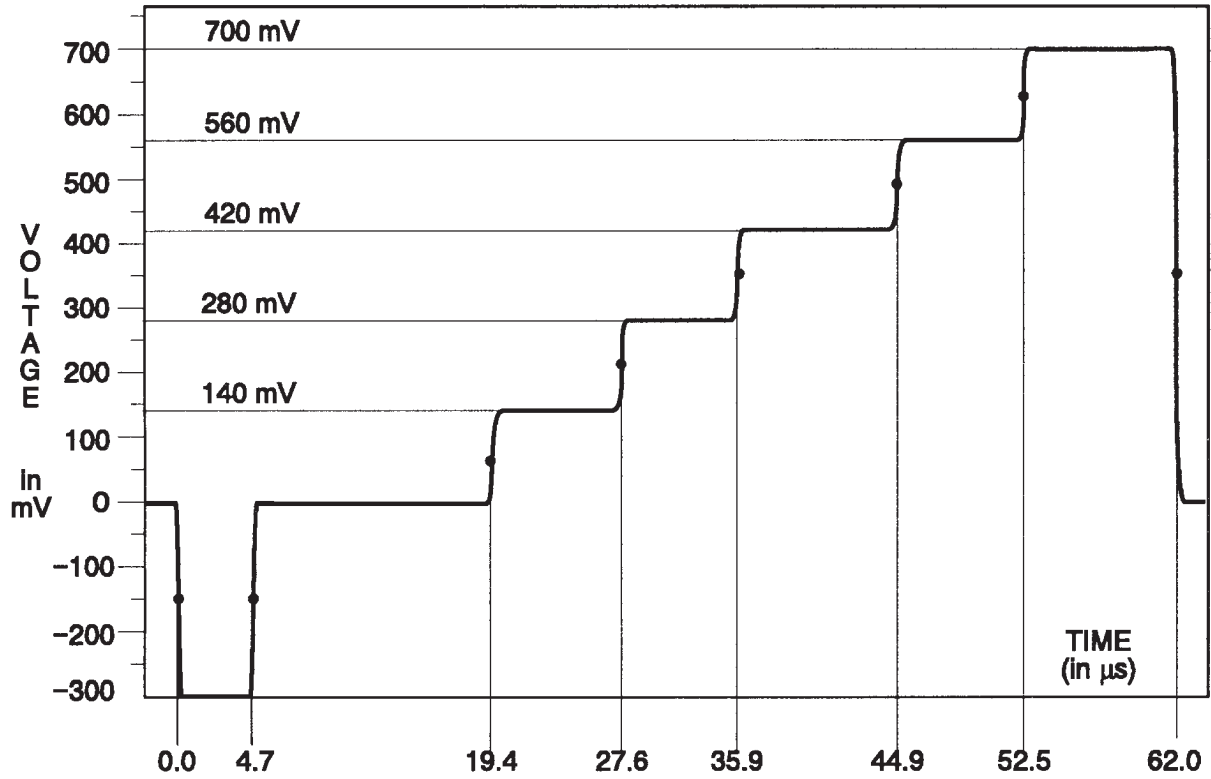

Fig. 3-168A Y Channel — Modulated 5-Step.

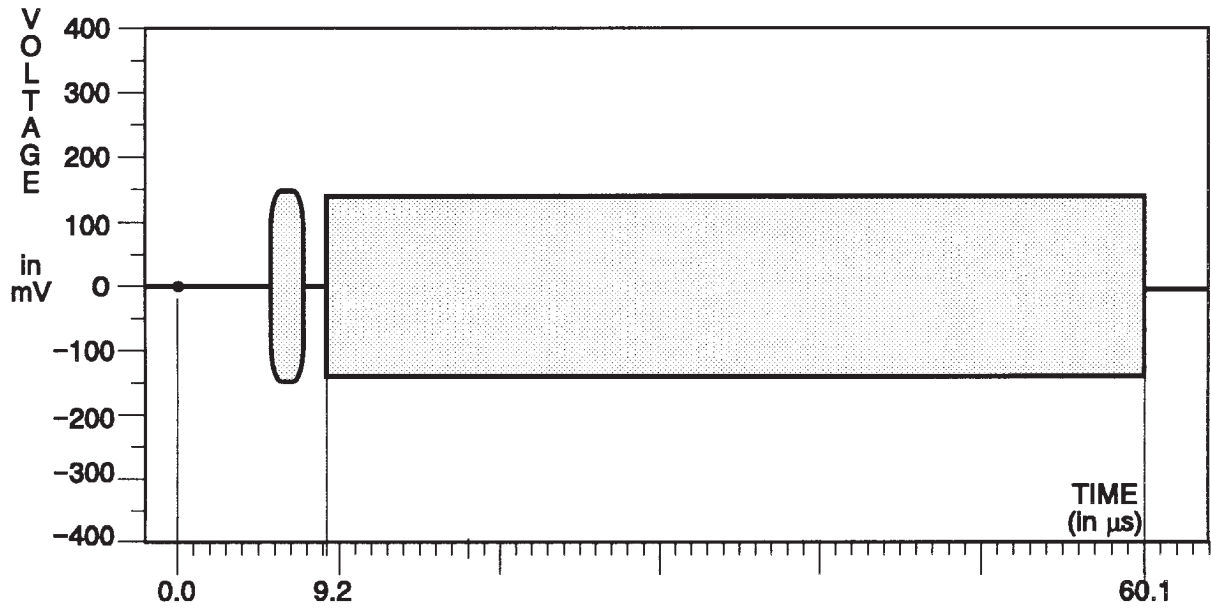

Fig. 3-168B C Channel — Modulated 5-Step.

This page intentionally left blank.

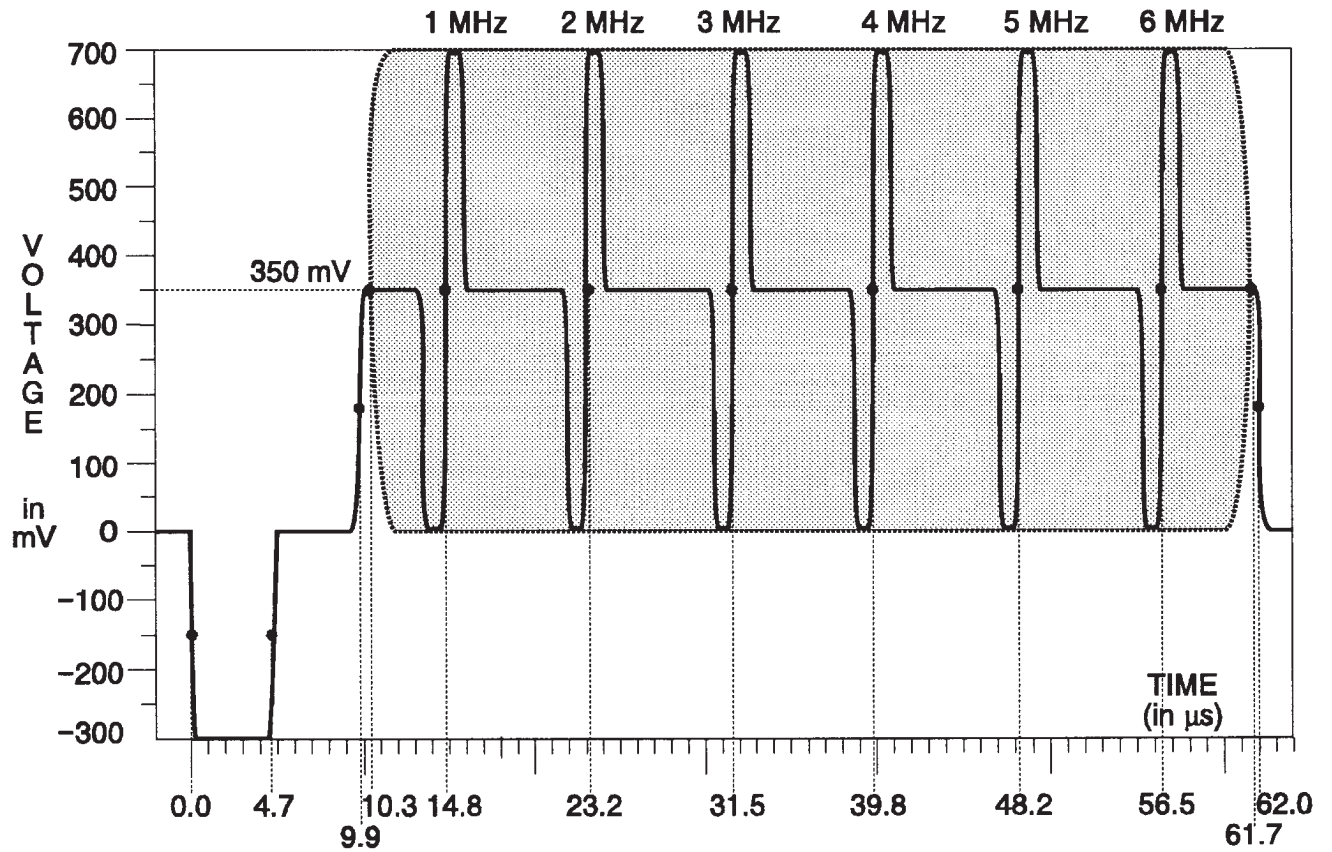

Fig. 3-169. Y Channel — Sweep.

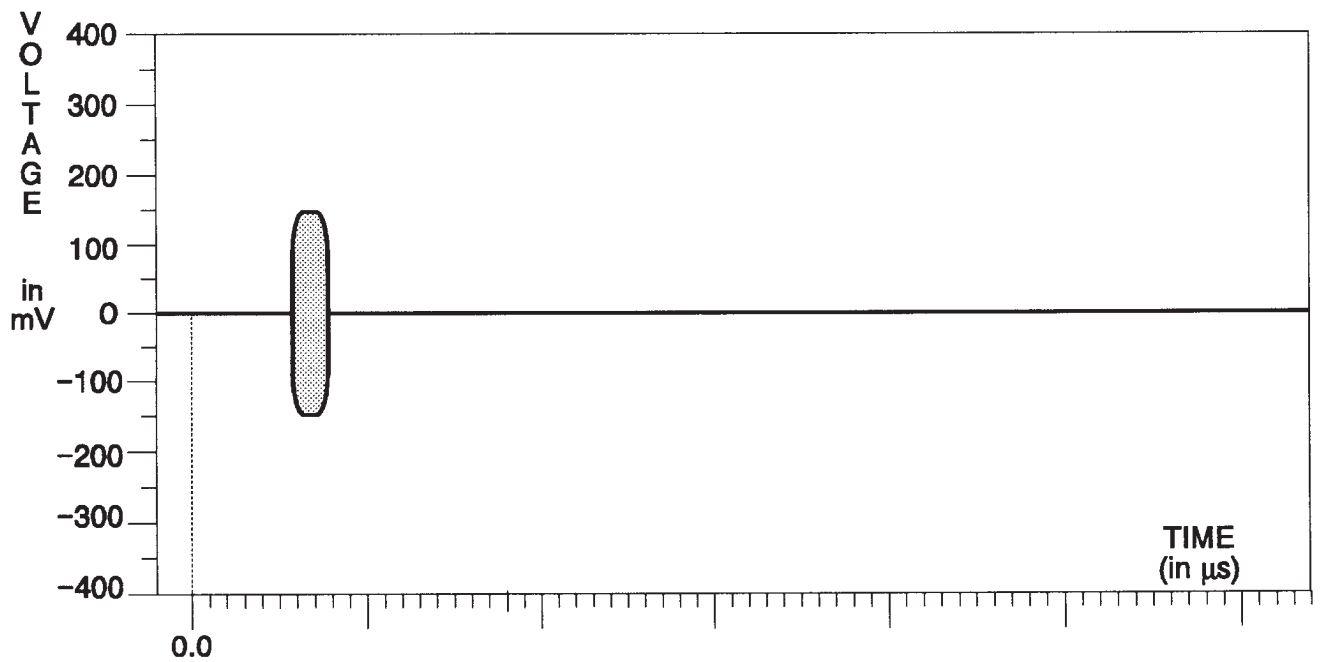

Fig. 3-170. C Channel — Sweep.

TSG 131A — SPECIFICATIONS
 Option 03 Unique Signals

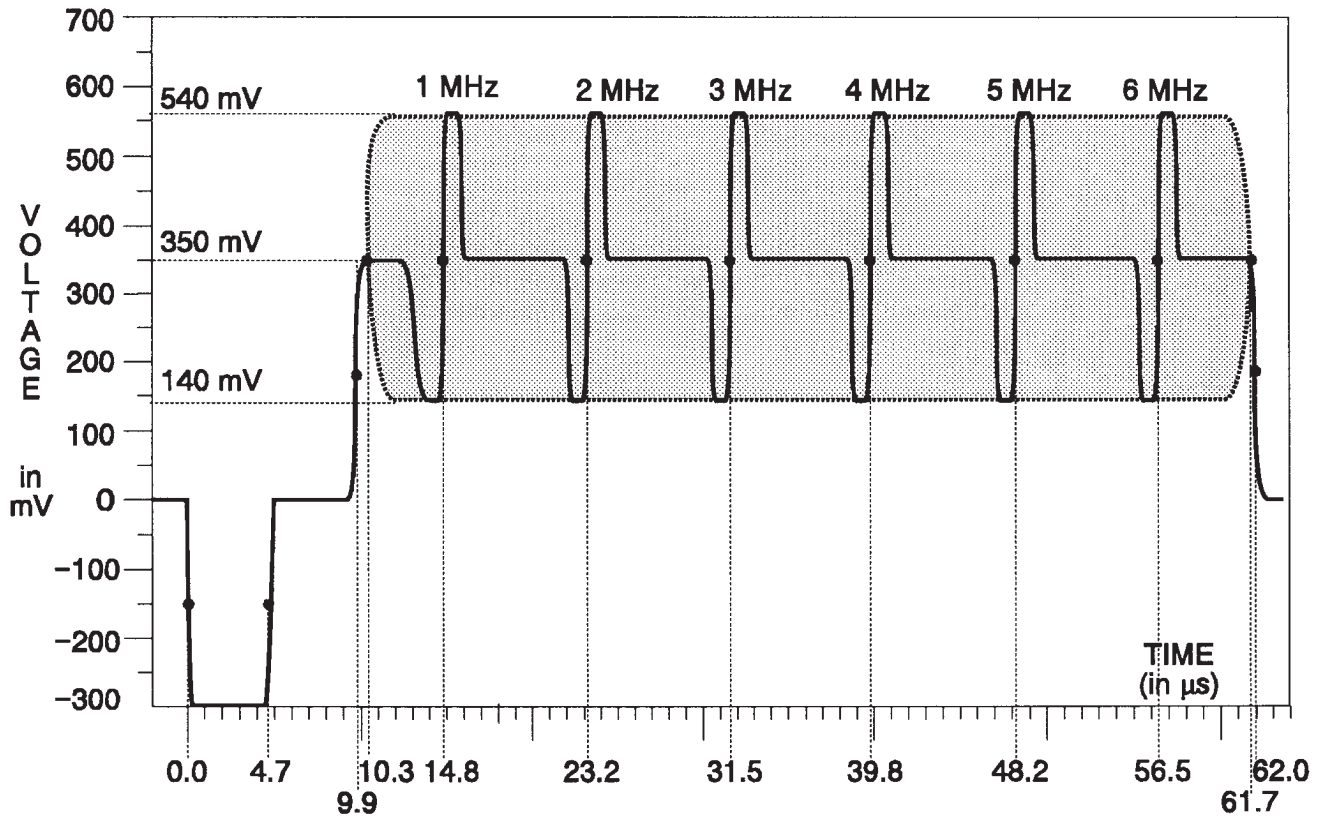

Fig. 3-171. Y Channel — Reduced Sweep.

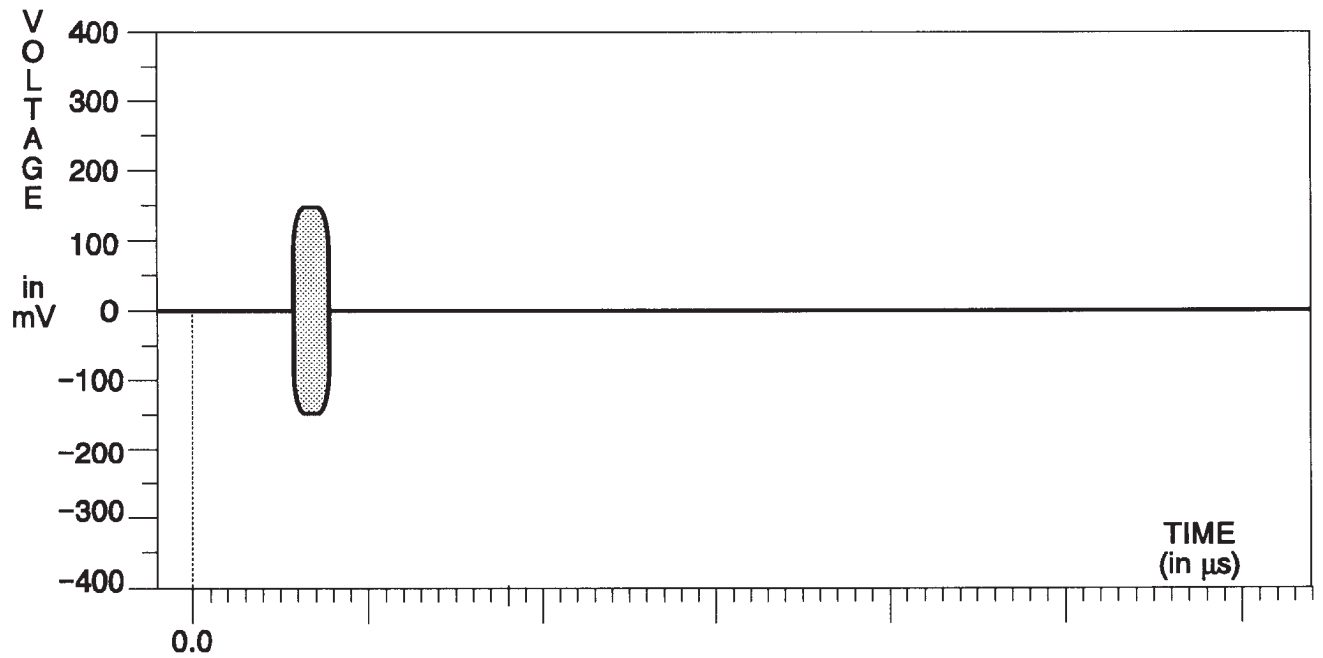

Fig. 3-172. C Channel — Reduced Sweep.

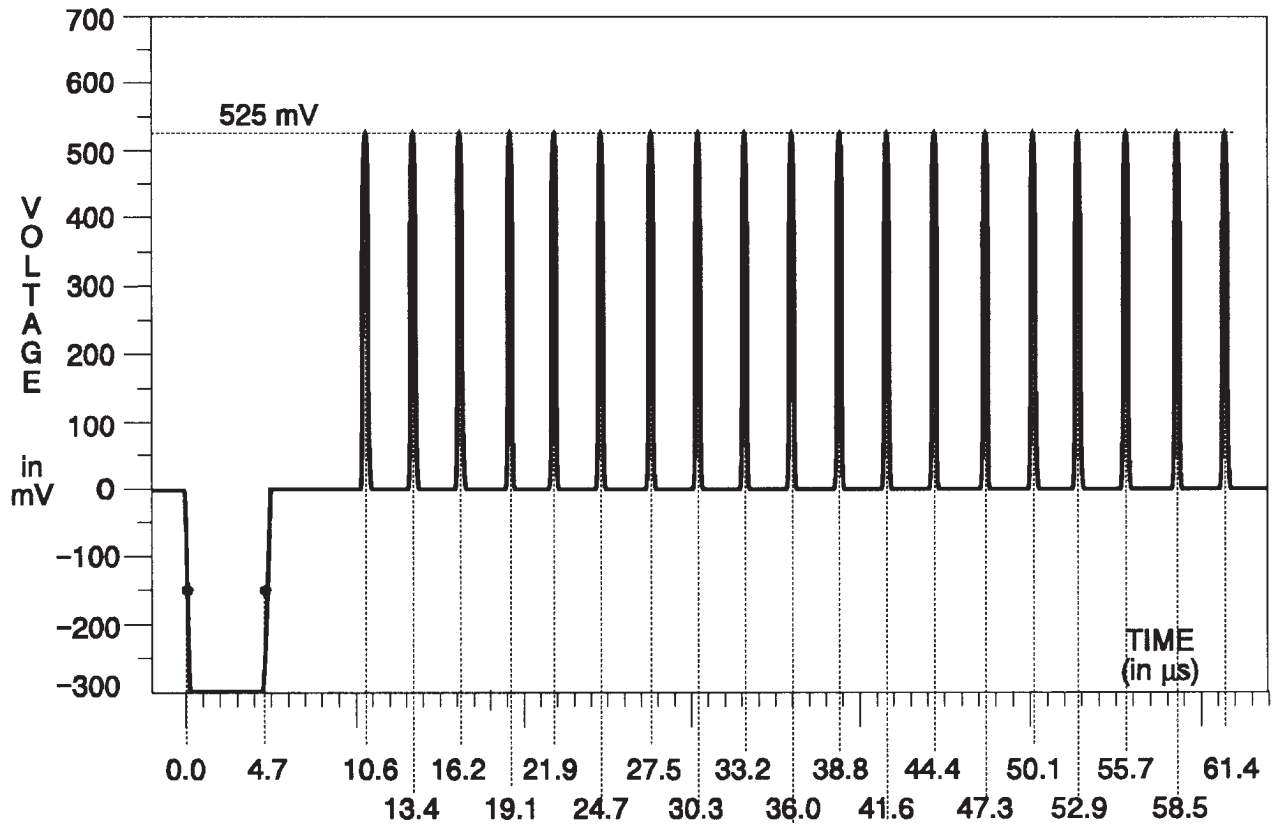

Fig. 3-173. Y Channel — Convergence (Vertical).

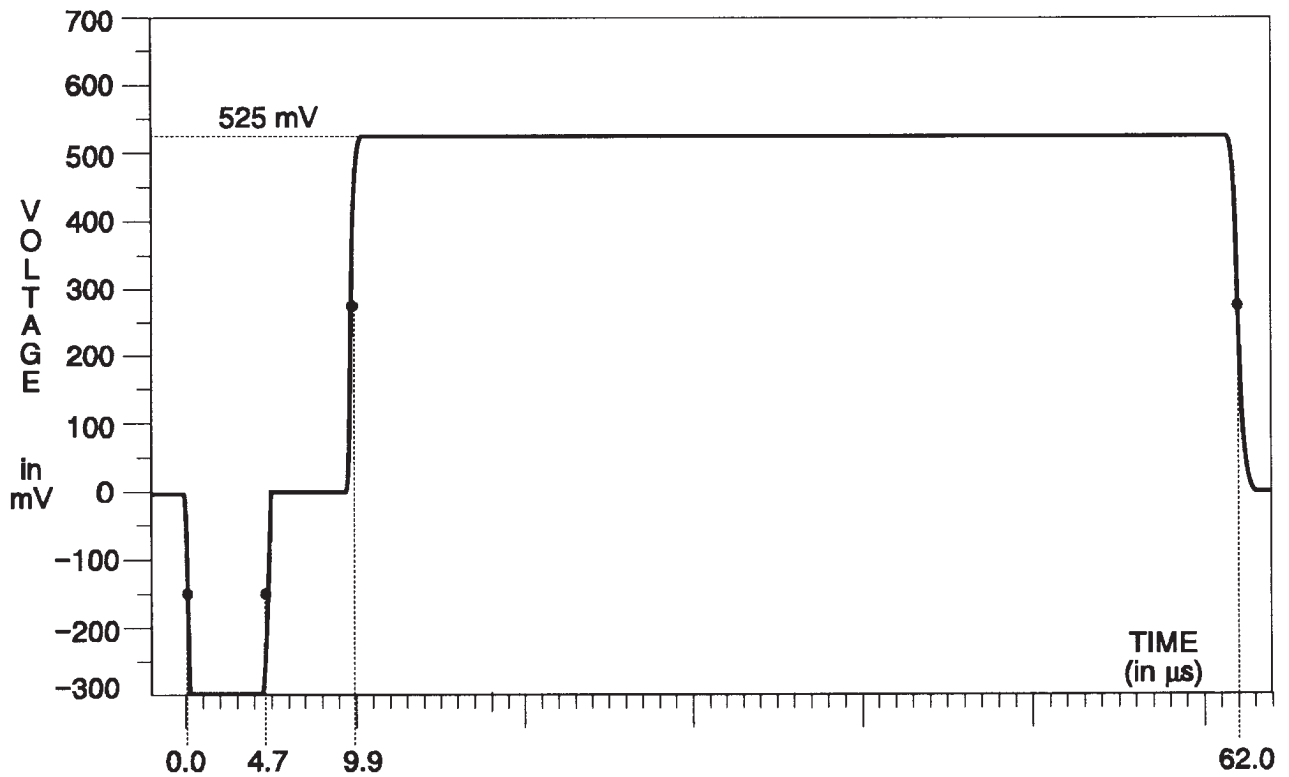

Fig. 3-174. Y Channel — Convergence (Horizontal).

Option 03 Signals — BetaCam 3-Wire Unique Signals

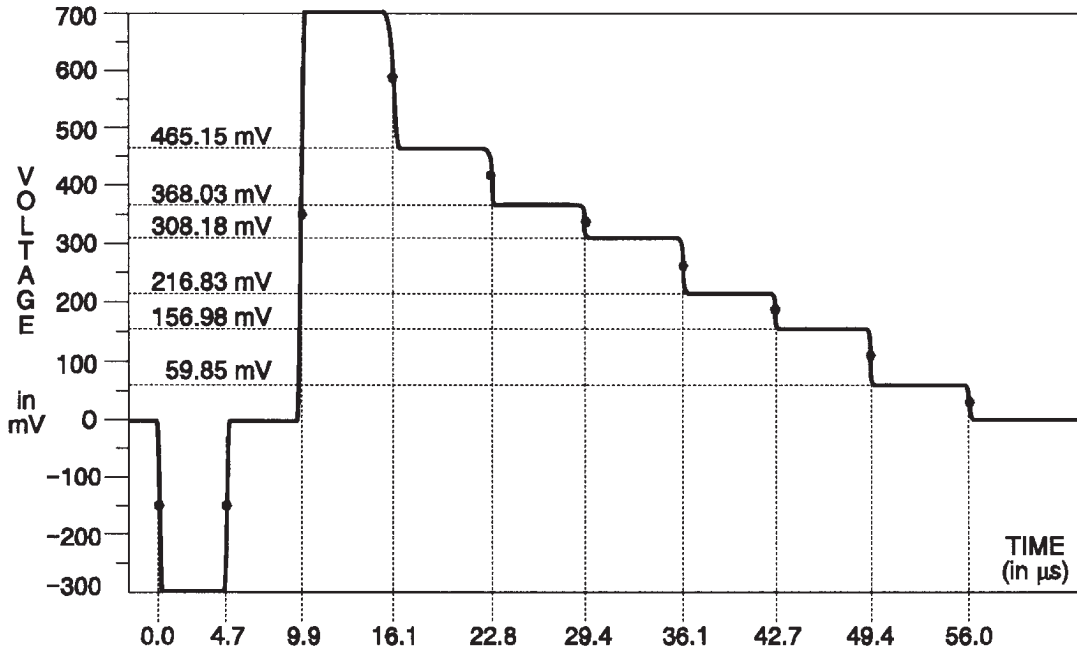

Fig. 3-175. Y Channel — 75% Color Bars.

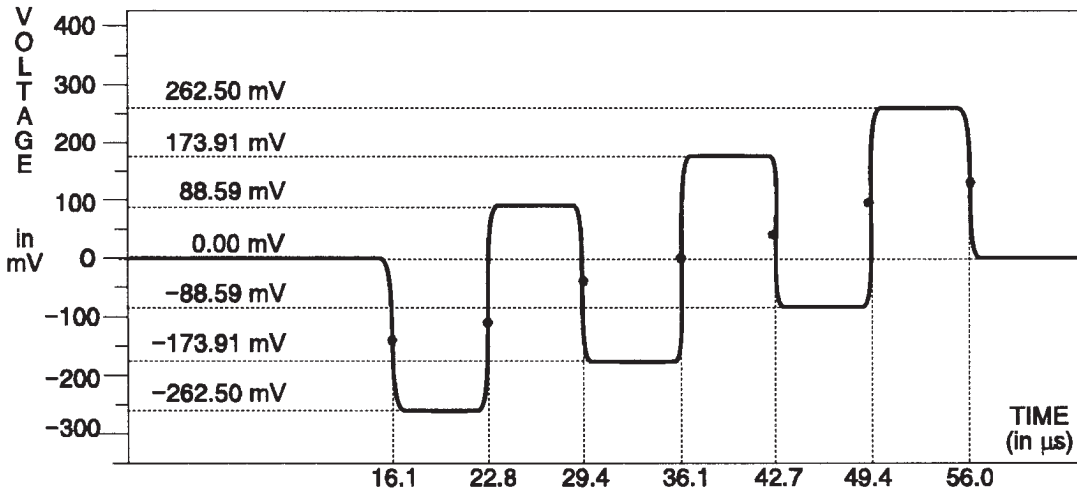

Fig. 3-176. B-Y Channel — 75% Color Bars.

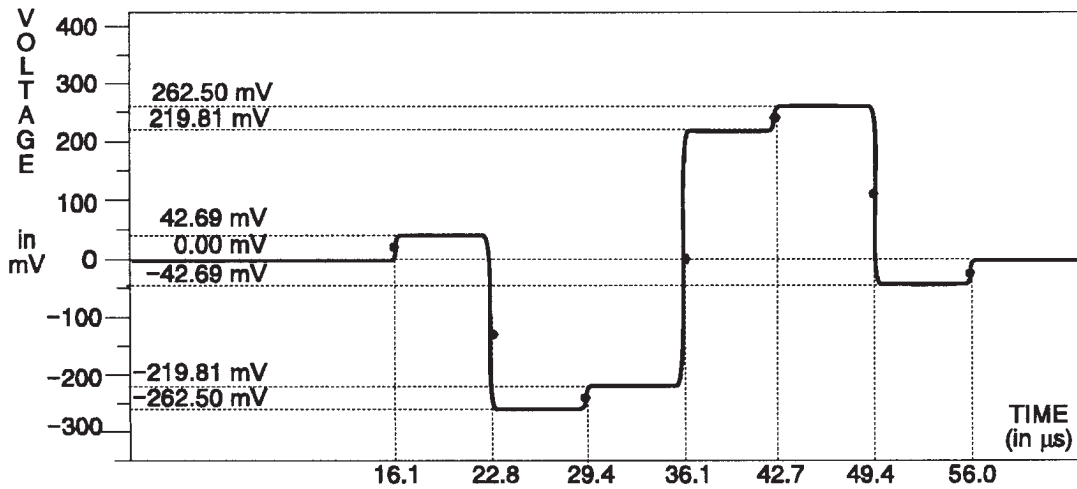

Fig. 3-177. R-Y Channel — 75% Color Bars.

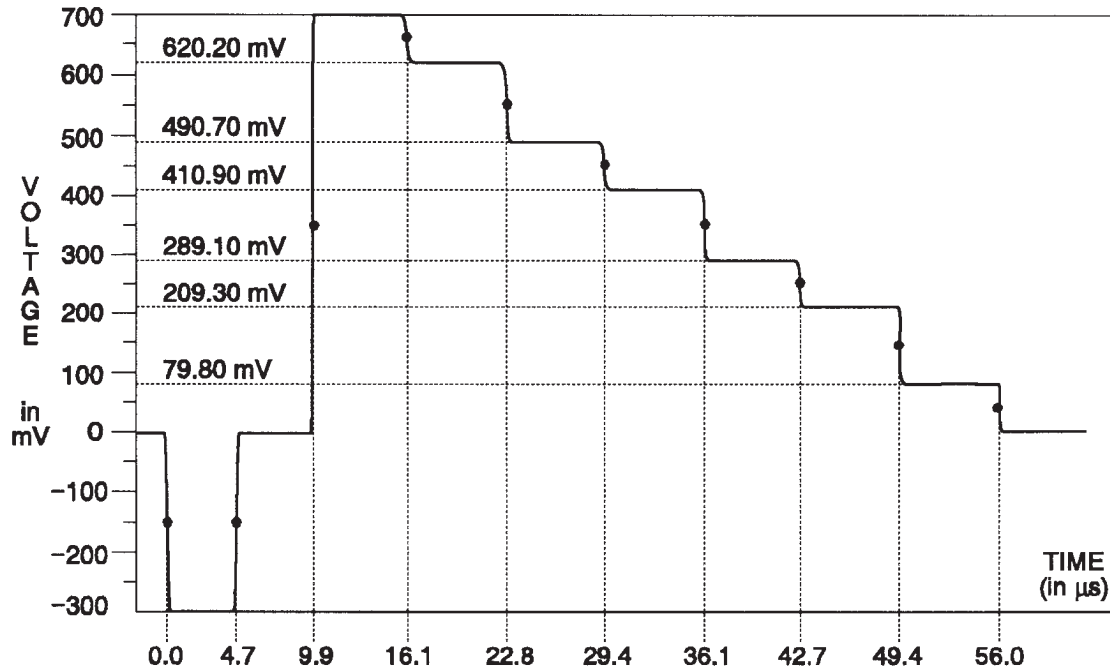

Fig. 3-178. Y Channel — 100% Color Bars.

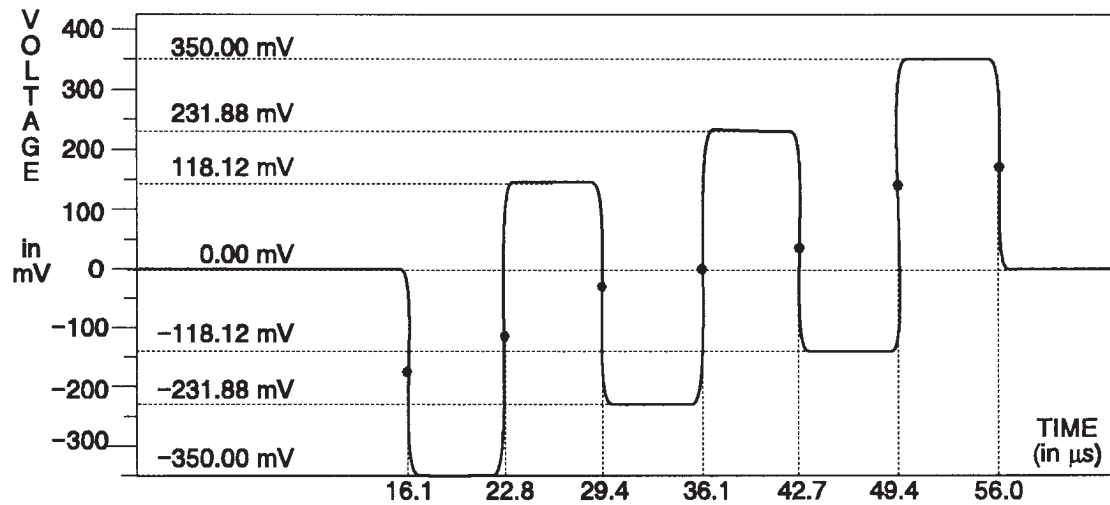

Fig. 3-179. B-Y Channel — 100% Color Bars.

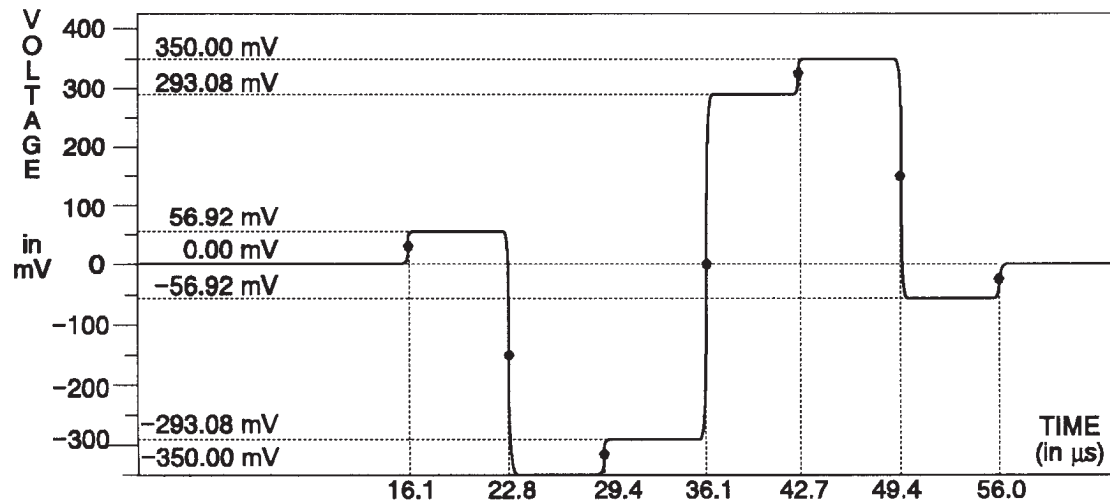

Fig. 3-180. R-Y Channel — 100% Color Bars.

TSG 131A — SPECIFICATIONS
Option 03 Unique Signals

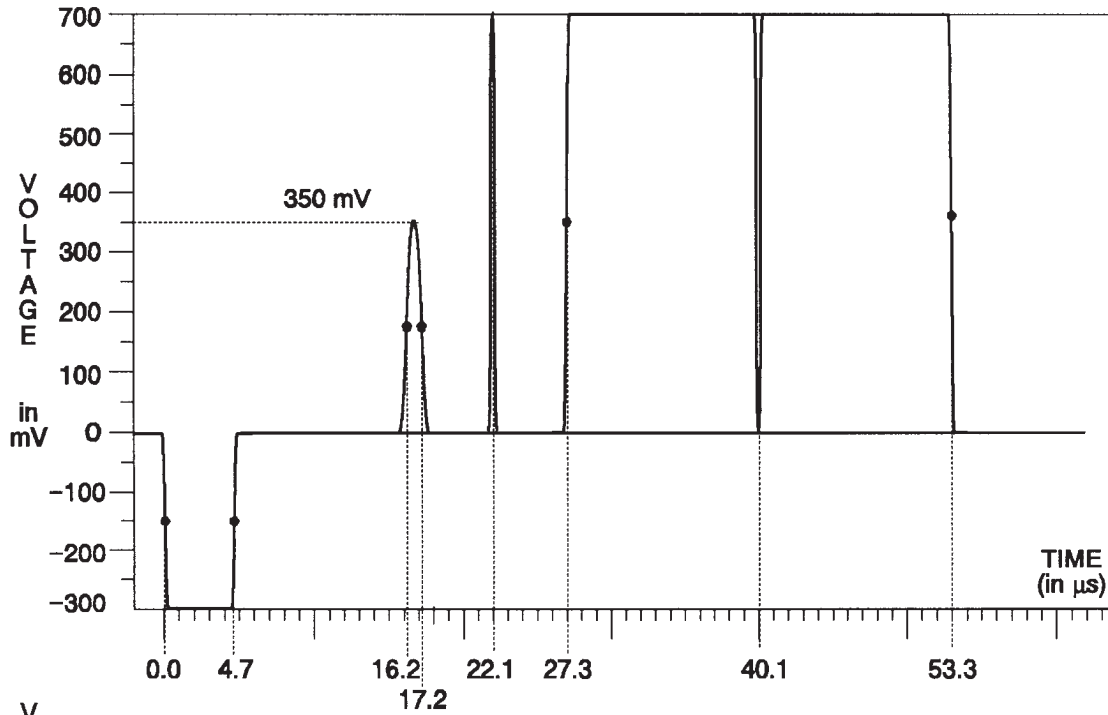

Fig. 3-181. Y Channel — Pulse & Bar.

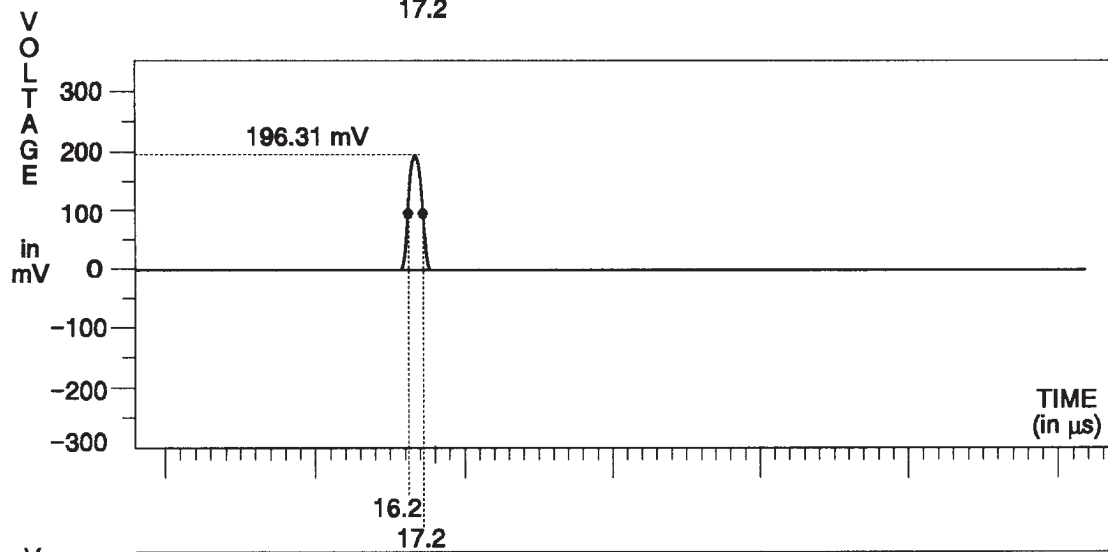

Fig. 3-182. B-Y Channel — Pulse & Bar.

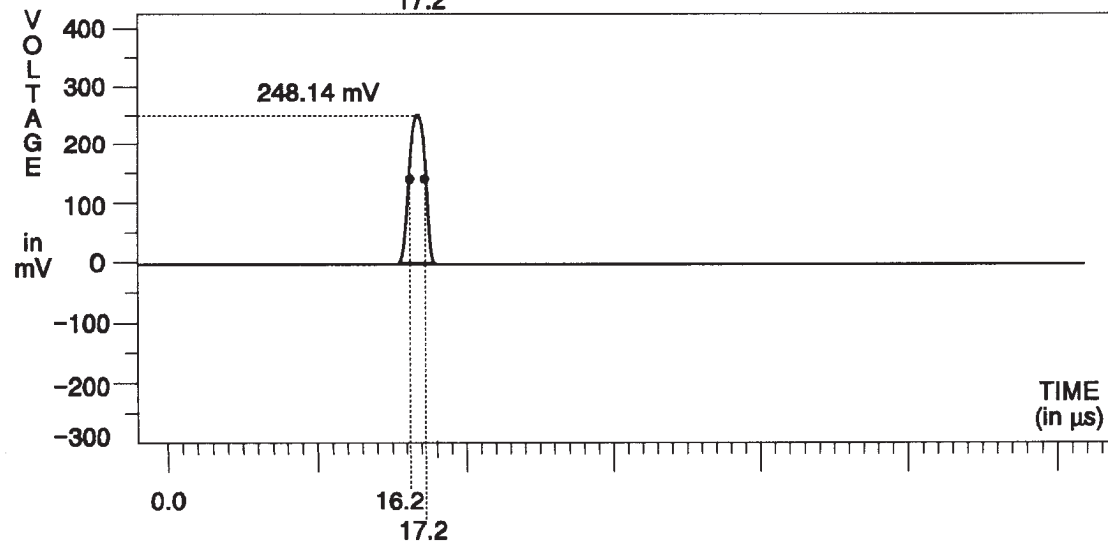

Fig. 3-183. R-Y Channel — Pulse & Bar.

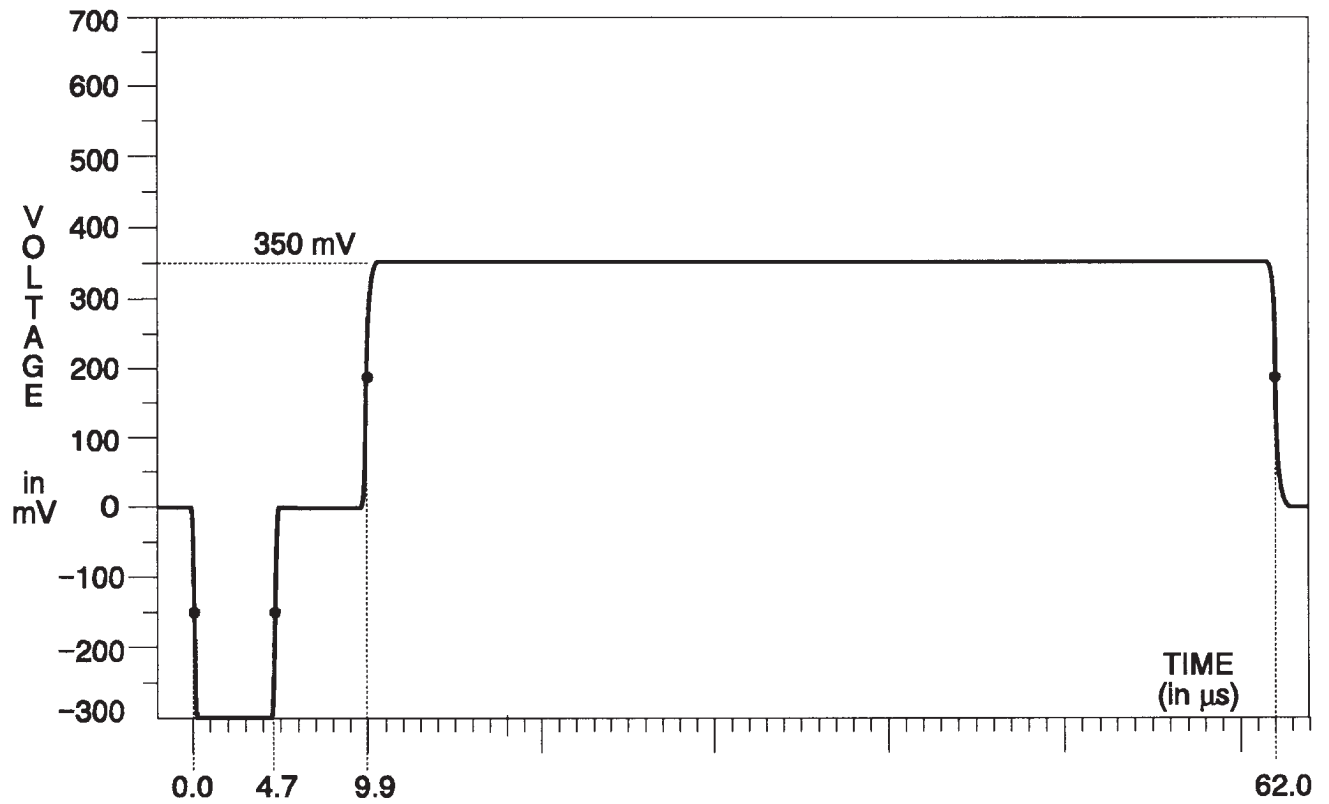

Fig. 3-184. Y Channel — 50% Flat Field.

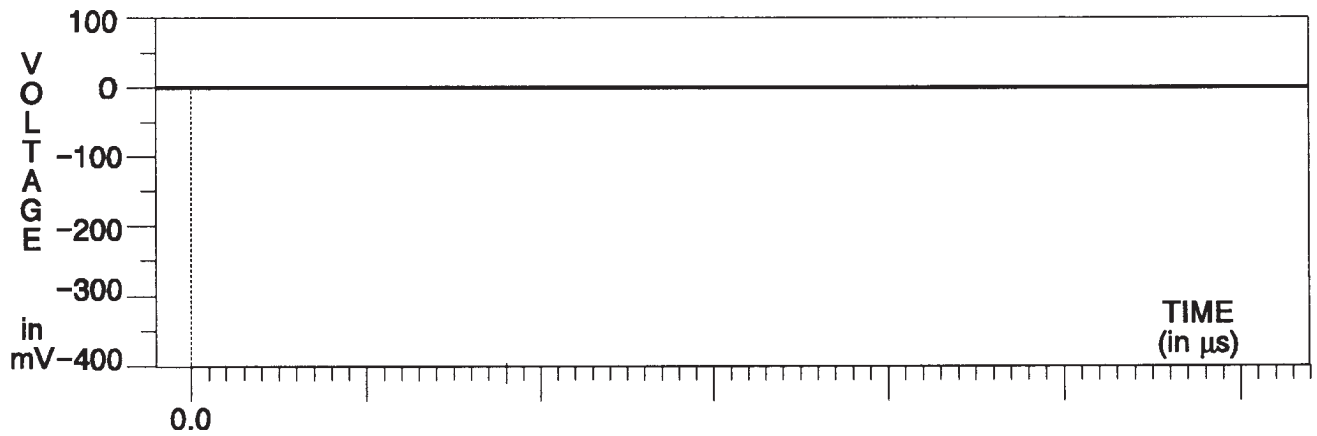

Fig. 3-185. B-Y & R-Y Channels — 50% Flat Field.

TSG 131A — SPECIFICATIONS
Option 03 Unique Signals

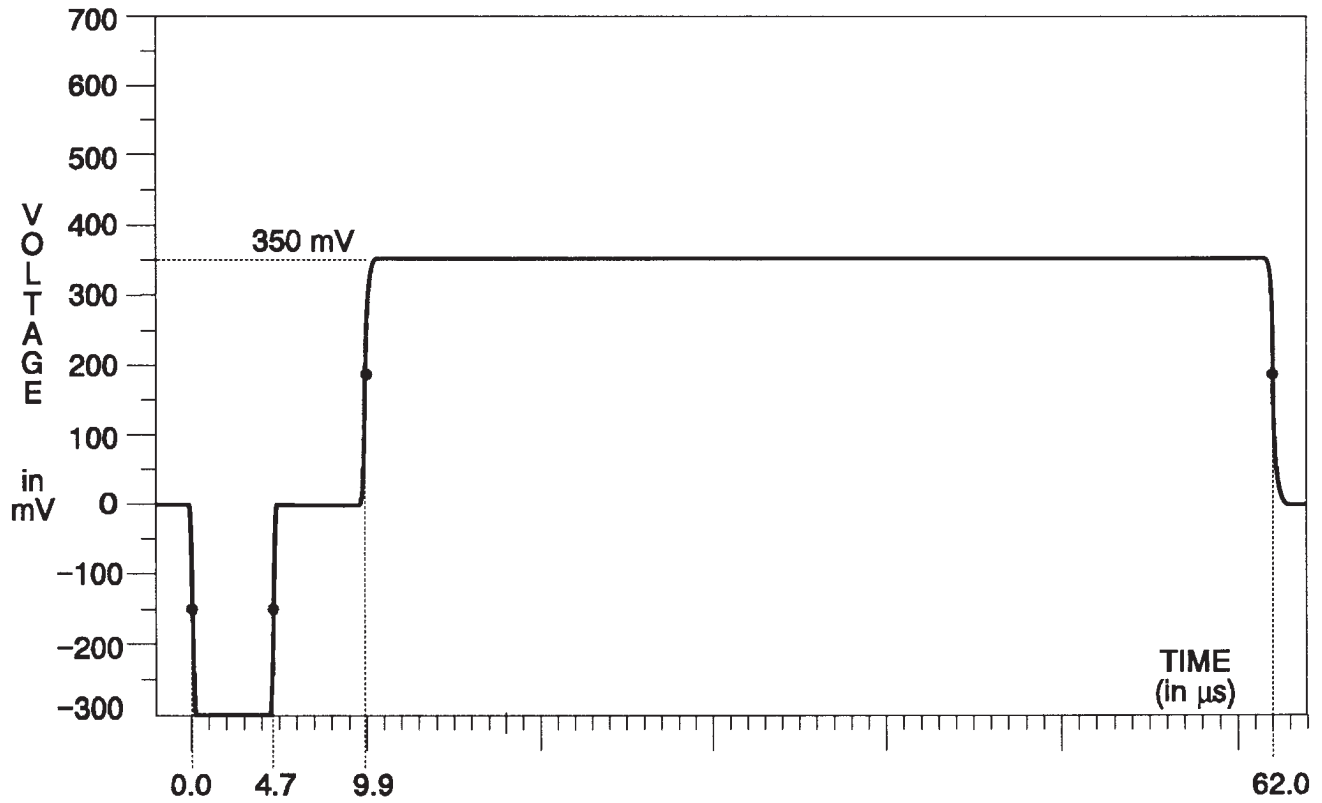

Fig. 3-186. Y Channel — Flat Field in all Channels.

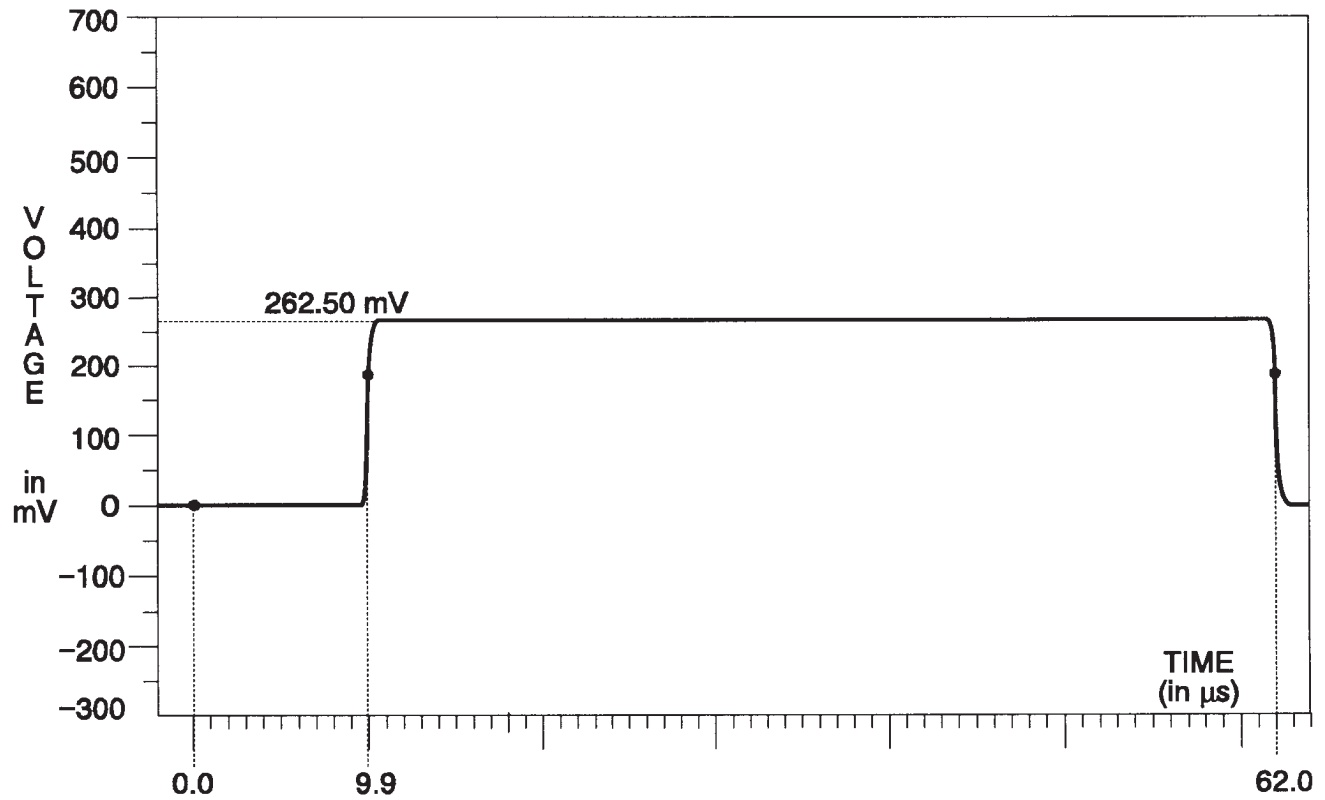

Fig. 3-187. B-Y & R-Y Channels — Flat Field.

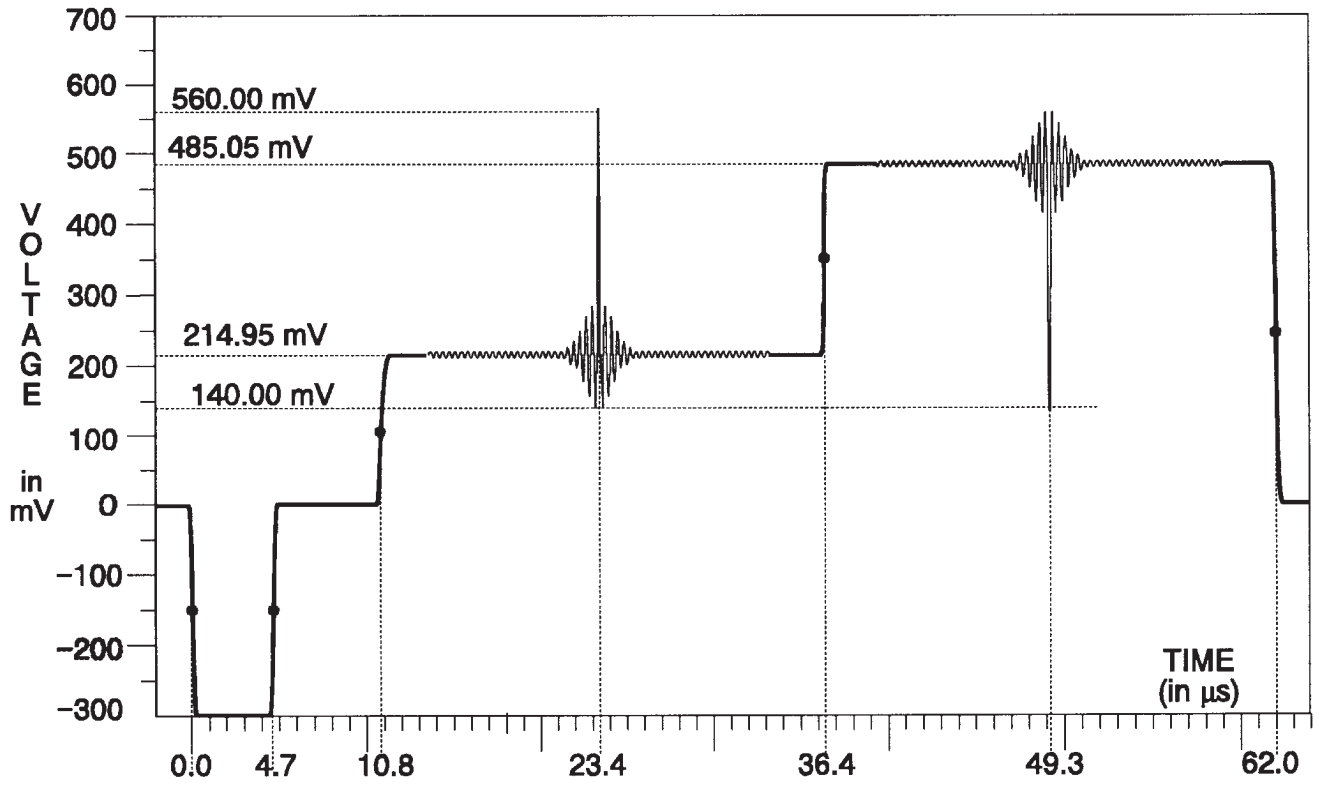

Fig. 3-188. Y Channel — Sin(x)/x.

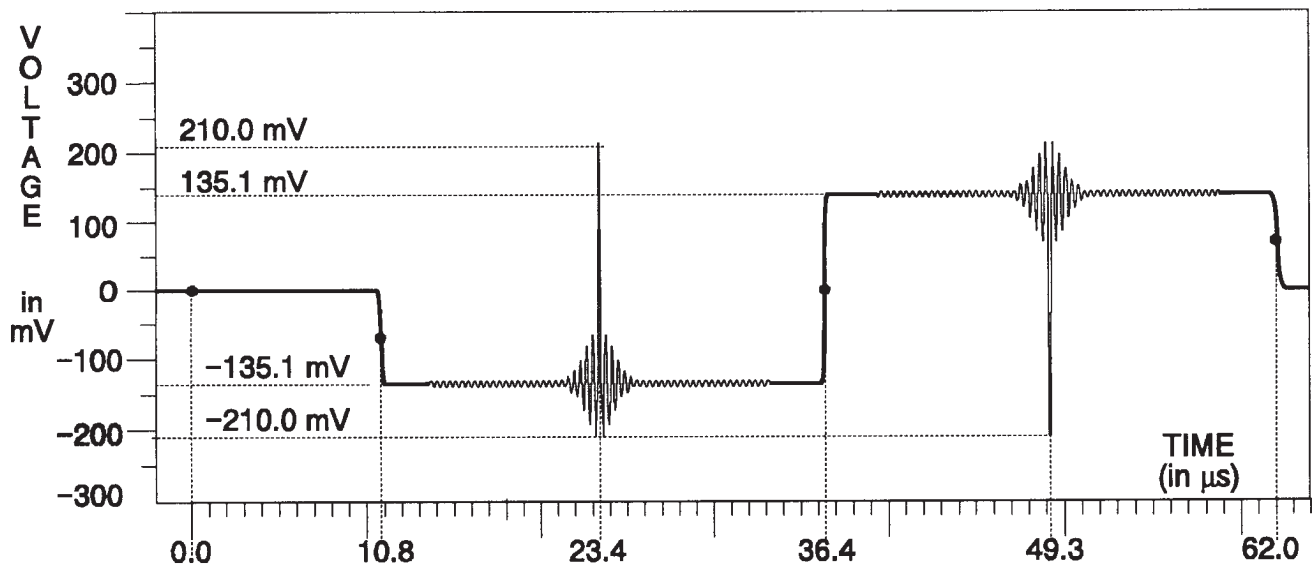

Fig. 3-189. B-Y & R-Y Channels — Sin(x)/x.

TSG 131A — SPECIFICATIONS
Option 03 Unique Signals

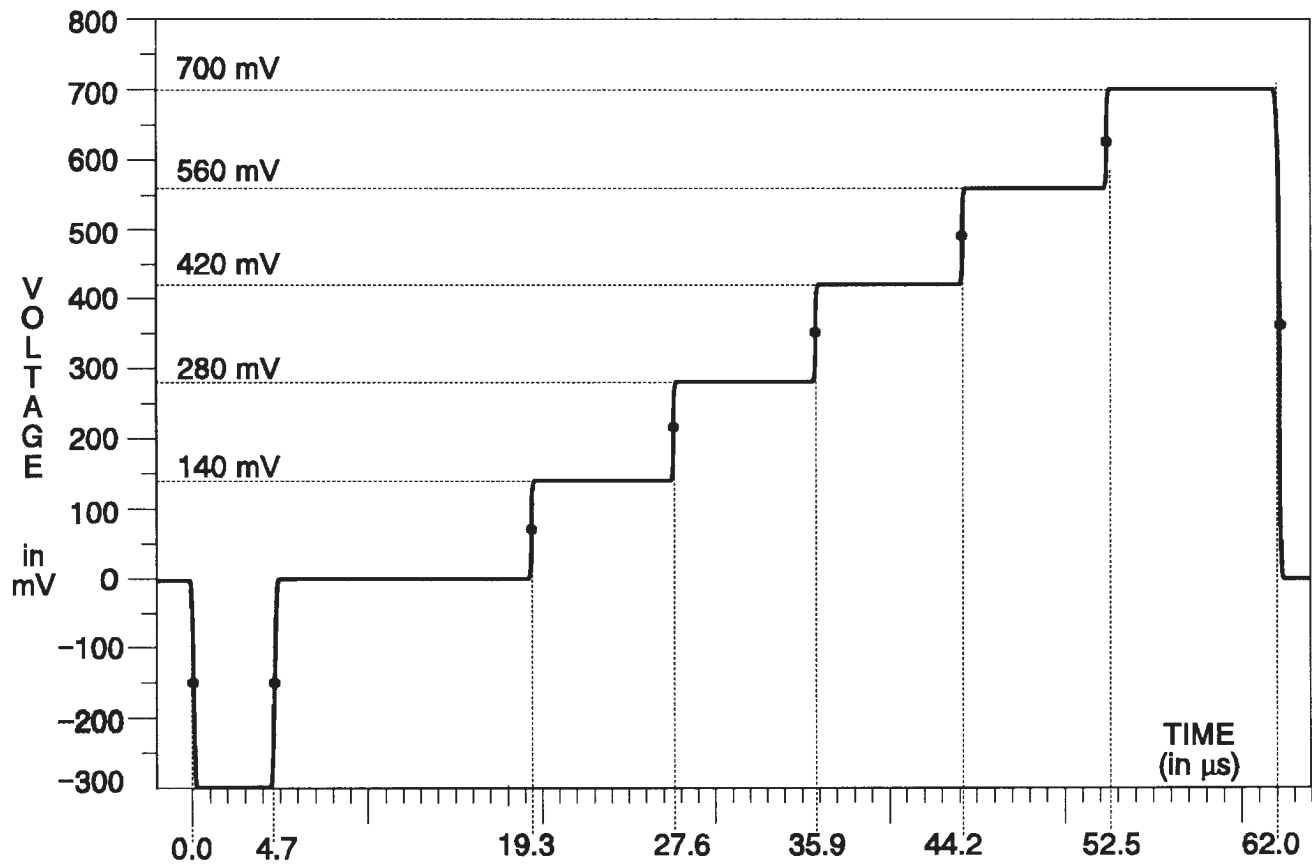

Fig. 3-190. Y Channel — 5-Step.

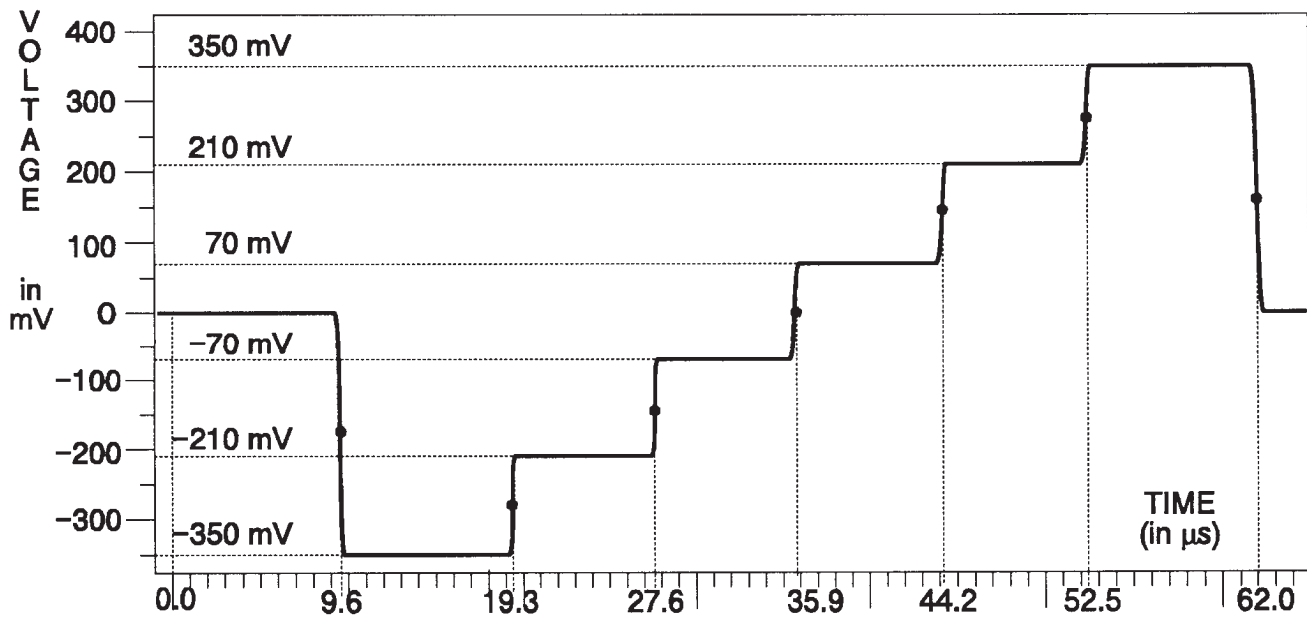

Fig. 3-191. B-Y & R-Y Channels — 5-Step.

TSG 131A — SPECIFICATIONS
Option 03 Unique Signals

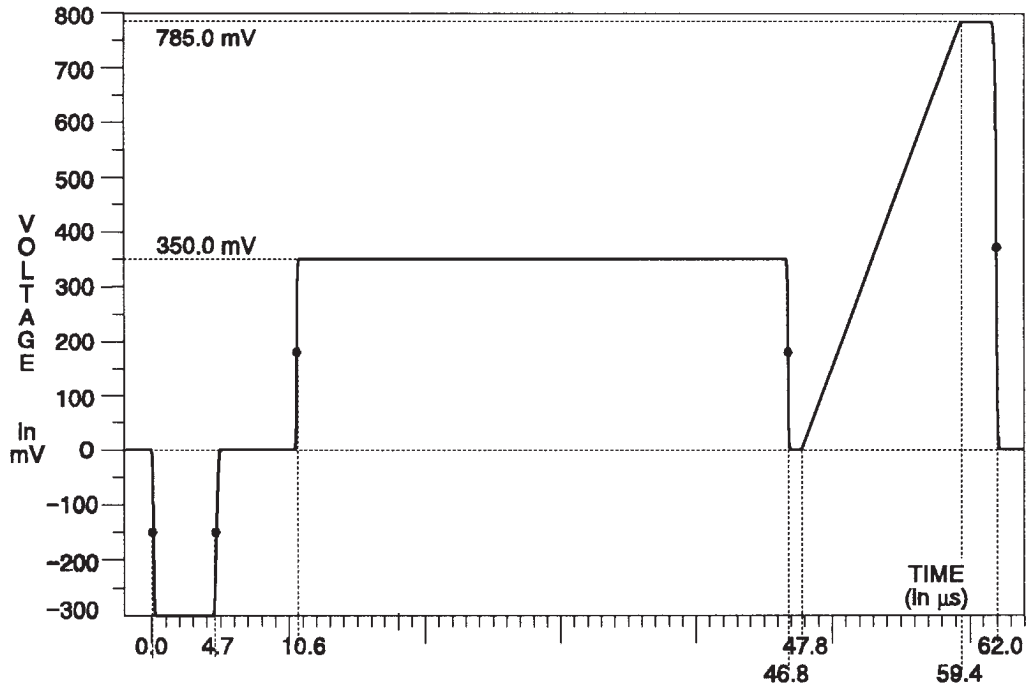

Fig. 3-192. Y Channel — Quad Phase.

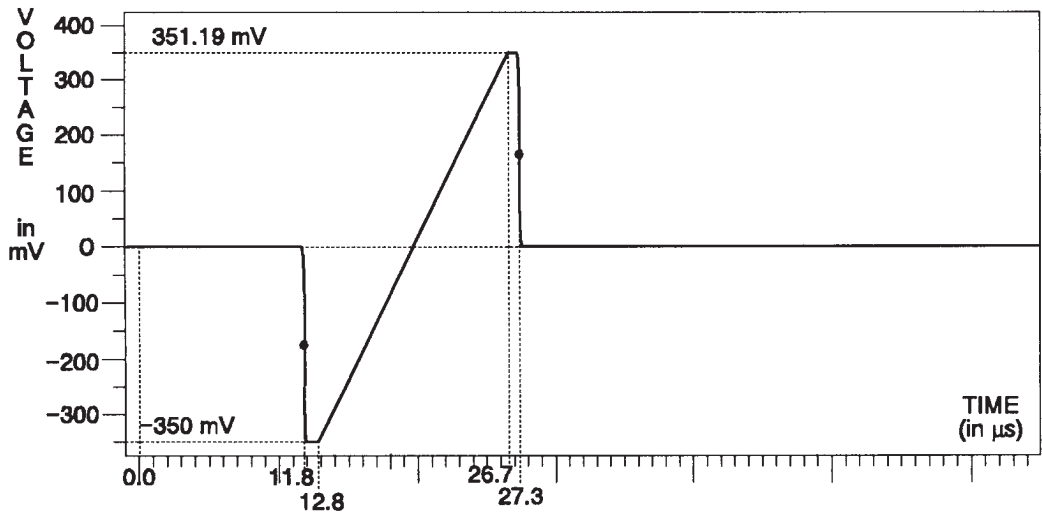

Fig. 3-193. B-Y Channel — Quad Phase.

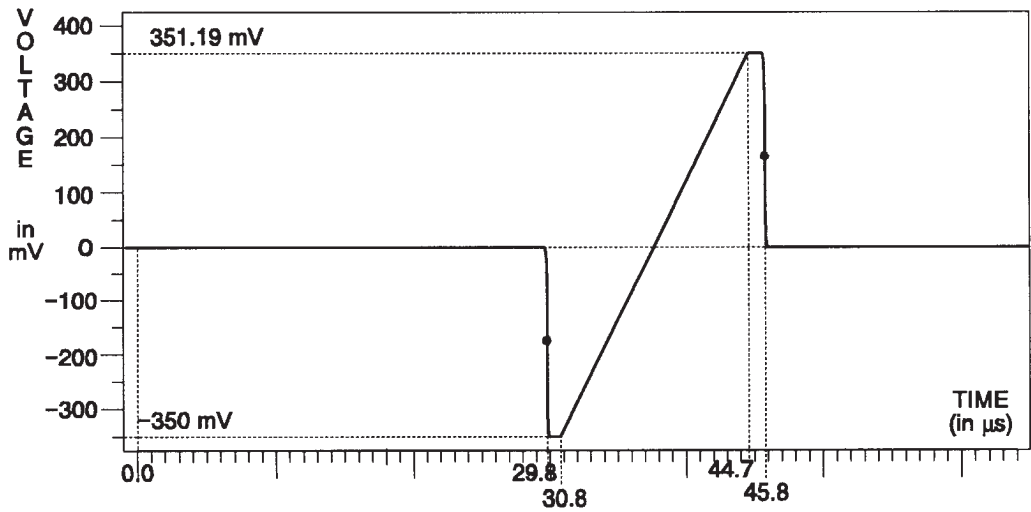

Fig. 3-194. R-Y Channel — Quad Phase.

TSG 131A — SPECIFICATIONS
 Option 03 Unique Signals

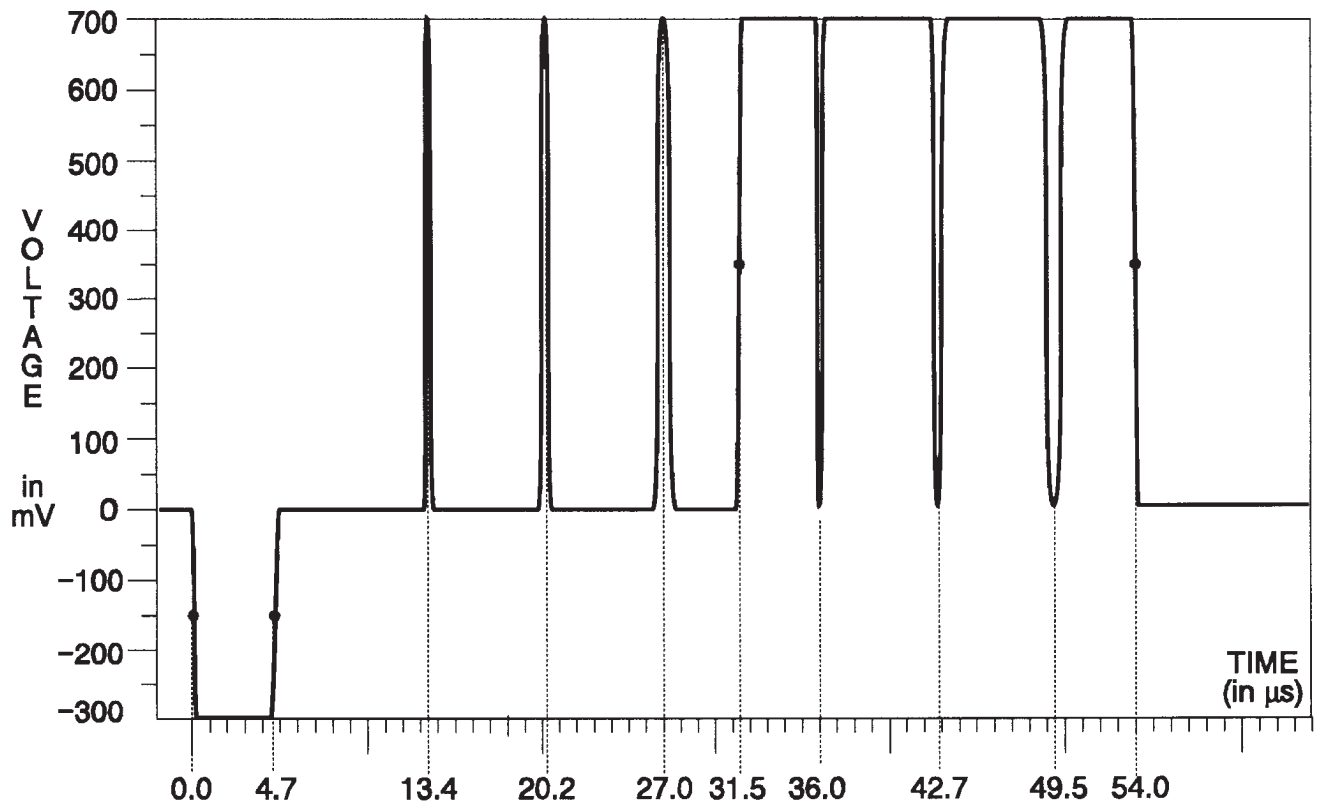

Fig. 3-195. Y Channel — T Pulses.

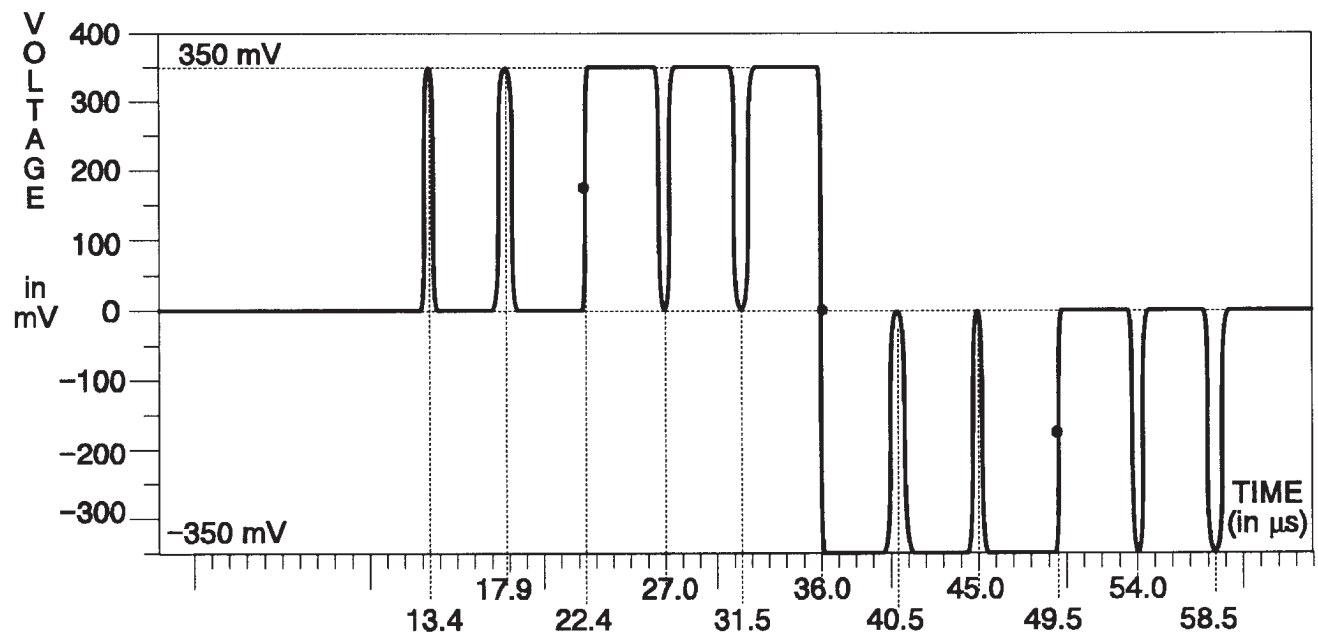

Fig. 3-196. B-Y Channel — T Pulses.

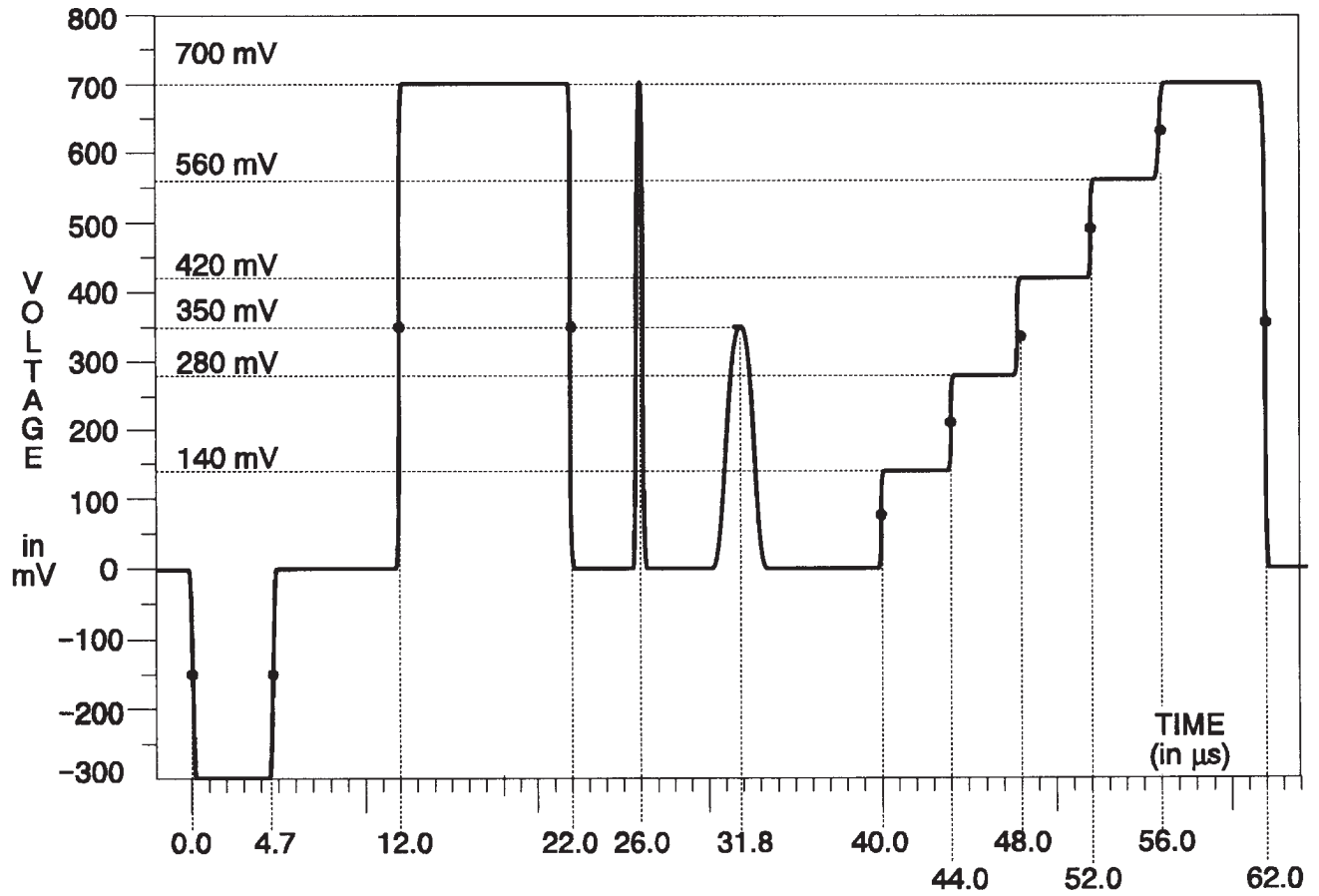

Fig. 3-197. Y Channel — Line 17.

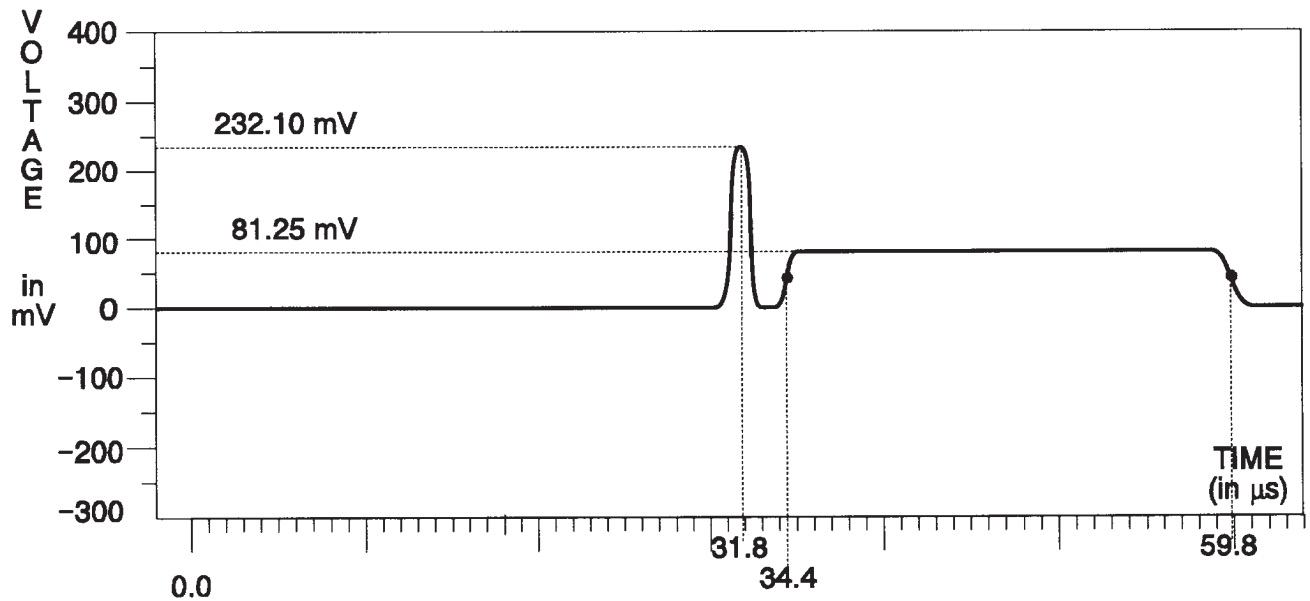

Fig. 3-198. B-Y & R-Y Channels — Line 17.

TSG 131A — SPECIFICATIONS
Option 03 Unique Signals

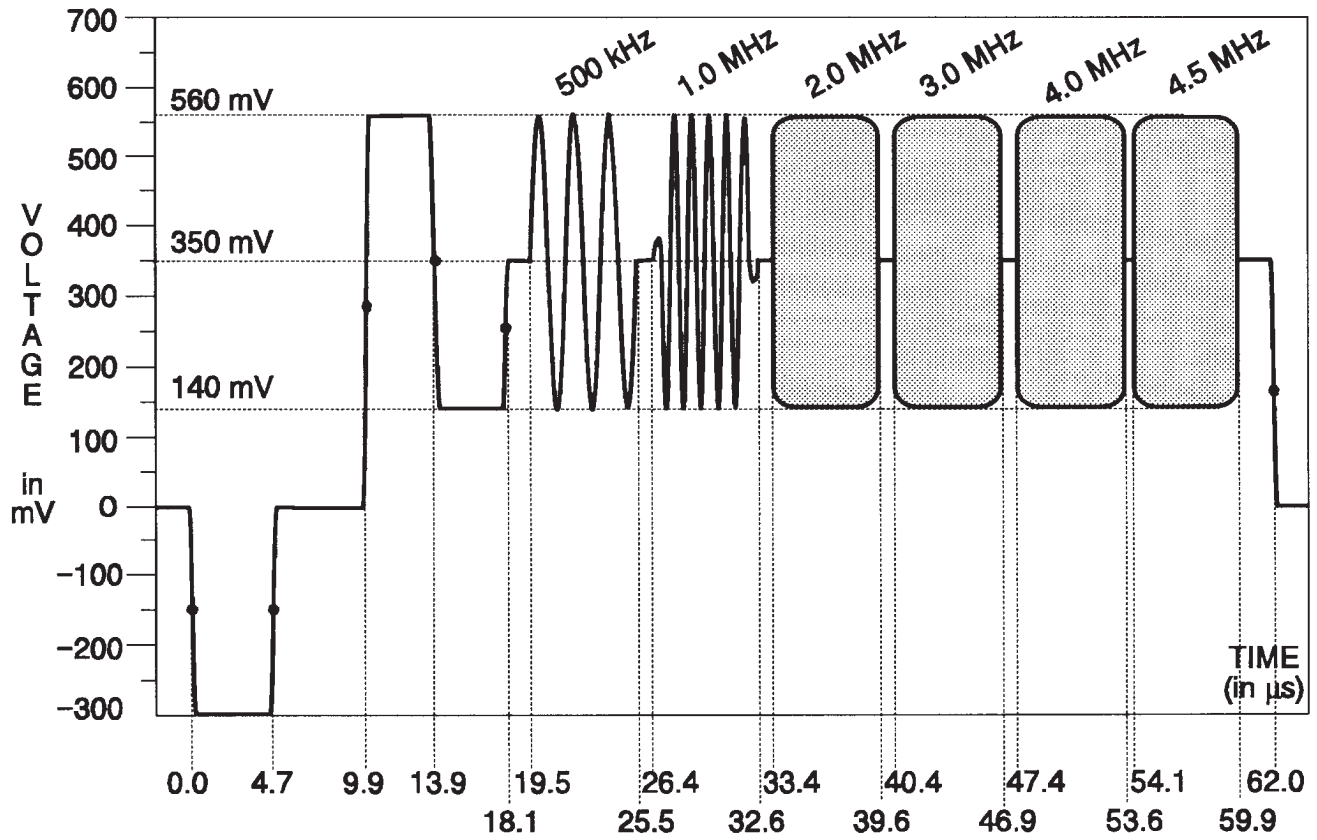

Fig. 3-199. Y Channel — 60% Narrow Multiburst.

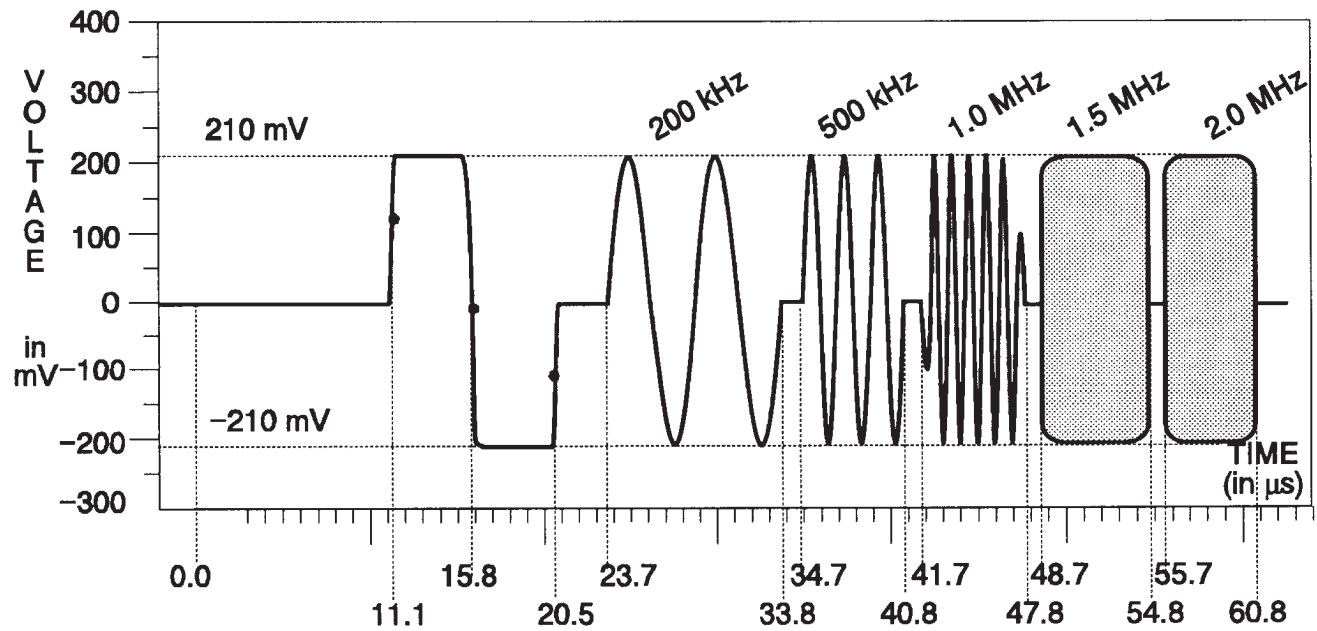

Fig. 3-200. B-Y & R-Y Channels — Narrow Multiburst.

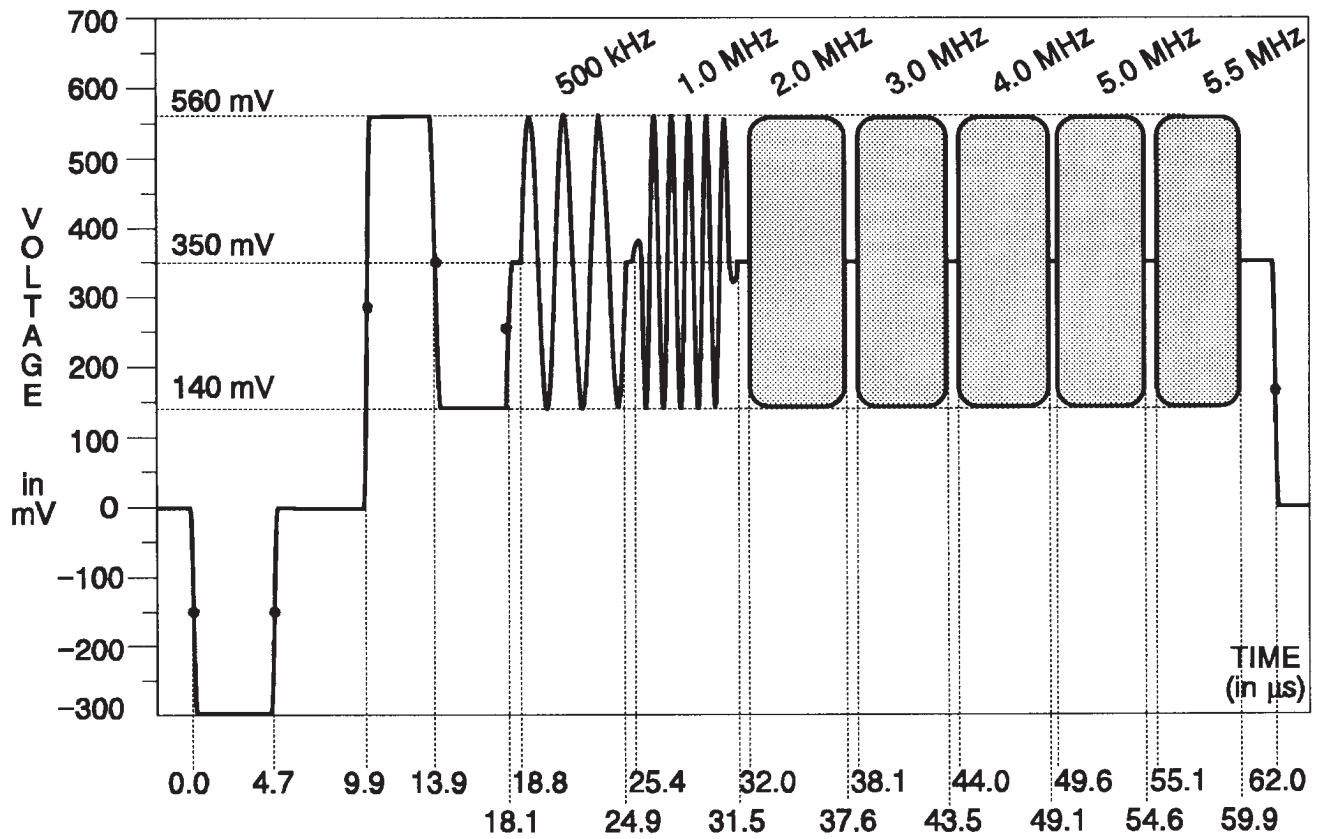

Fig. 3-201. Y Channel — 60% Wide Multiburst.

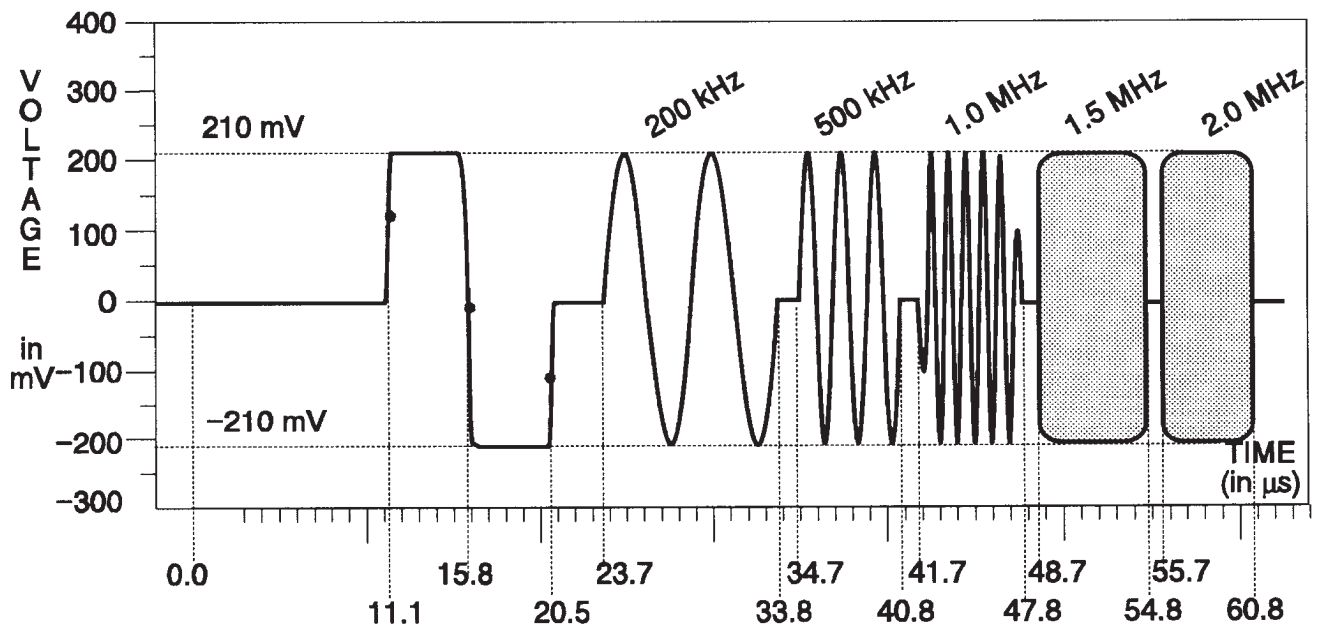

Fig. 3-202. B-Y & R-Y Channels — Wide Multiburst.

TSG 131A — SPECIFICATIONS
Option 03 Unique Signals

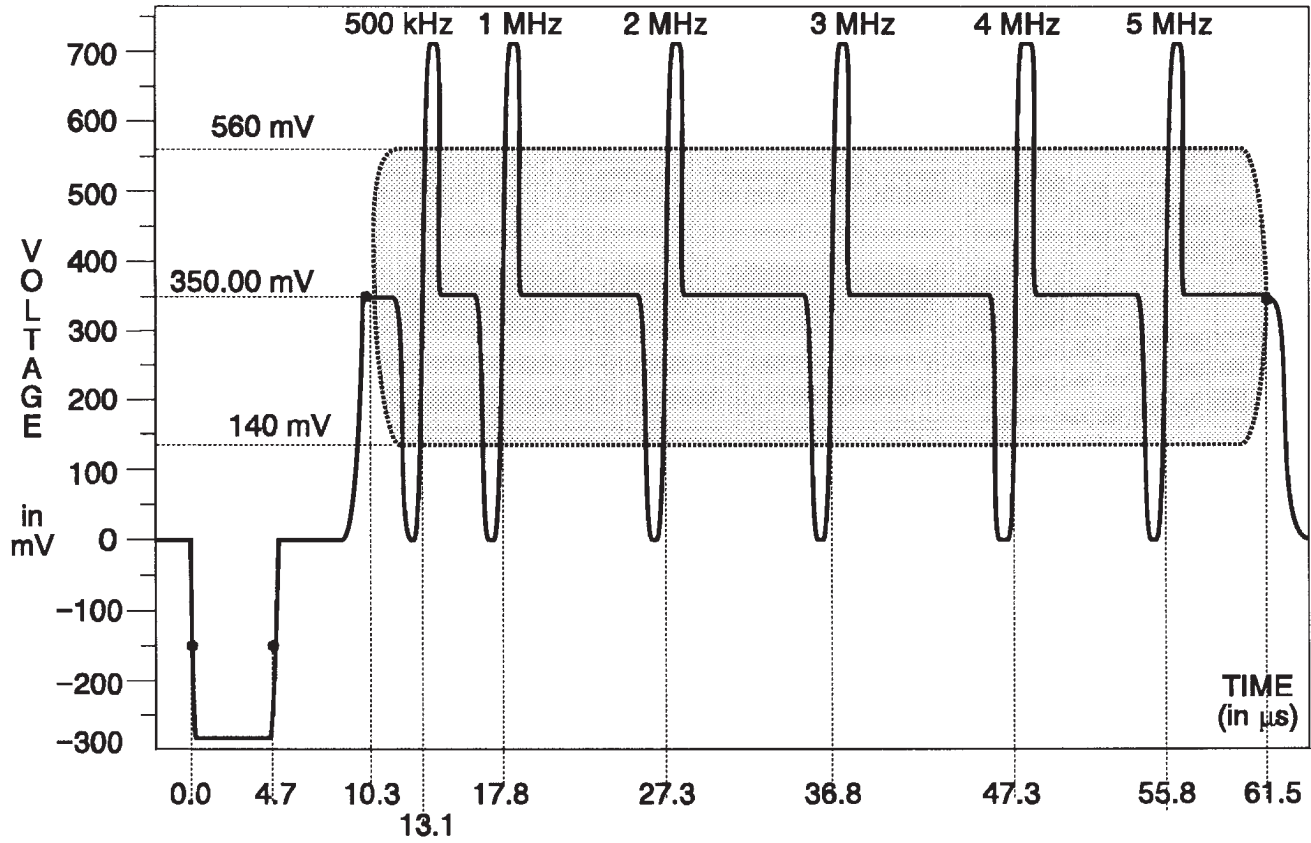

Fig. 3-203. Y Channel — 60% Narrow Sweep.

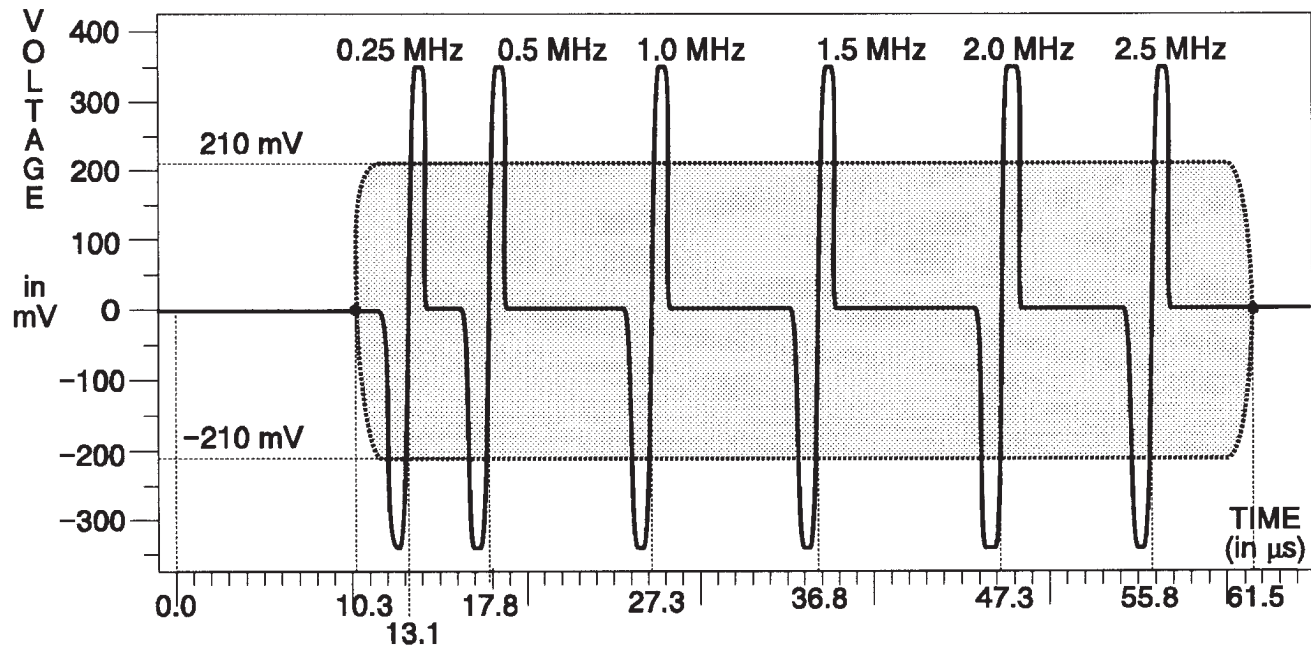
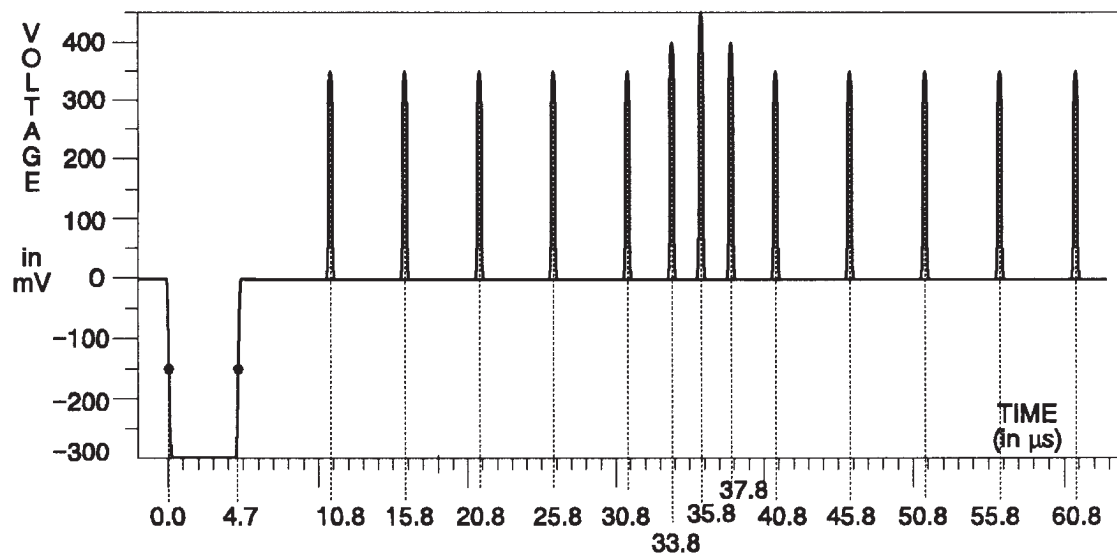
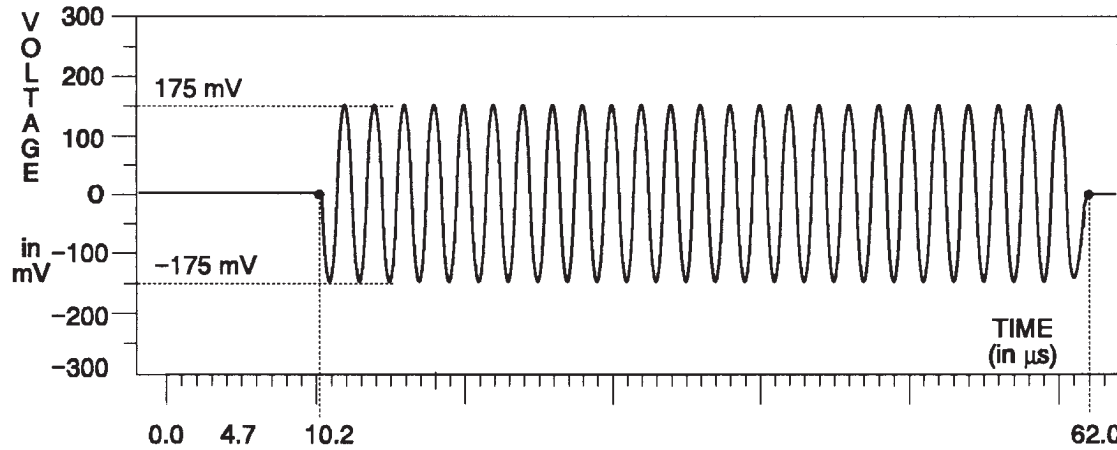
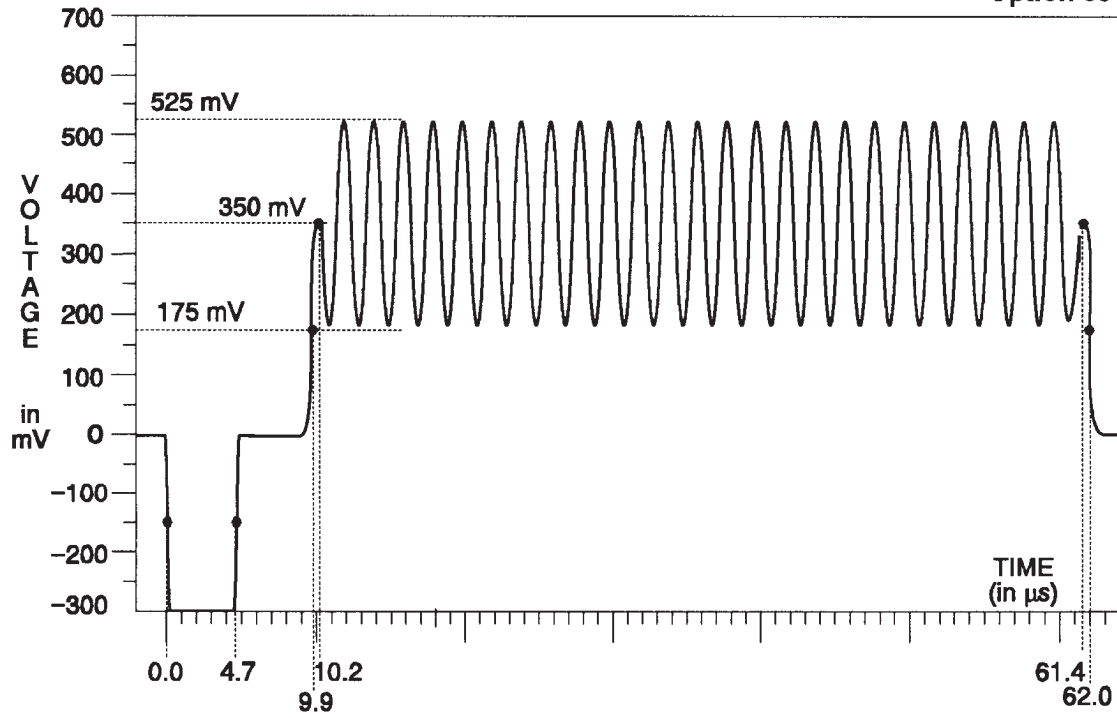

Fig. 3-204. B-Y & R-Y Channels — 60% Narrow Sweep.



TSG 131A — SPECIFICATIONS
Option 03 Unique Signals

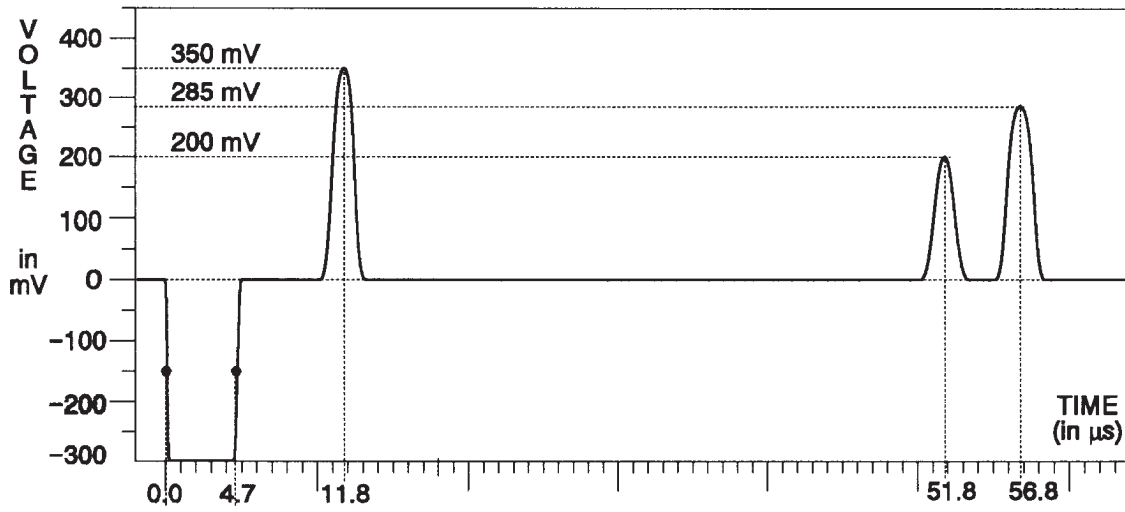

Fig. 3-208. Y Channel — 12T Pulses.

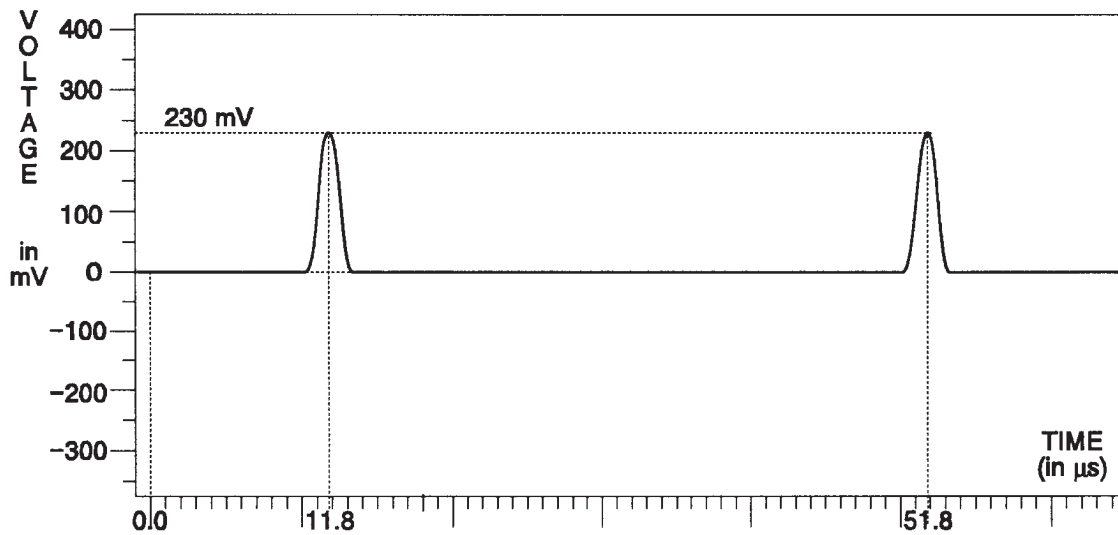

Fig. 3-209. B-Y Channel — 12T Pulses.

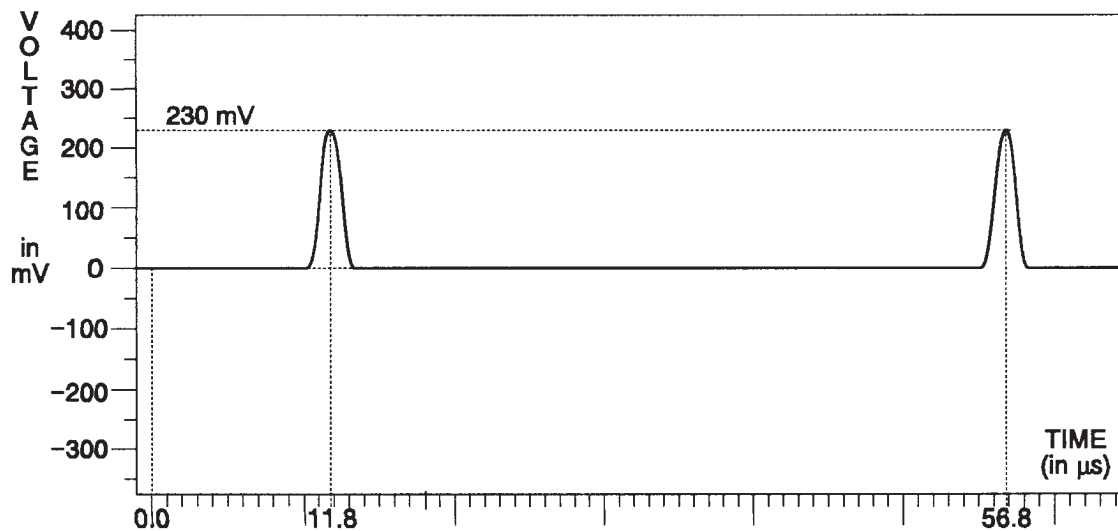

Fig. 3-210. R-Y Channel — 12T Pulses.

Option 03 Signals — CTD (2-Wire) Unique Signals

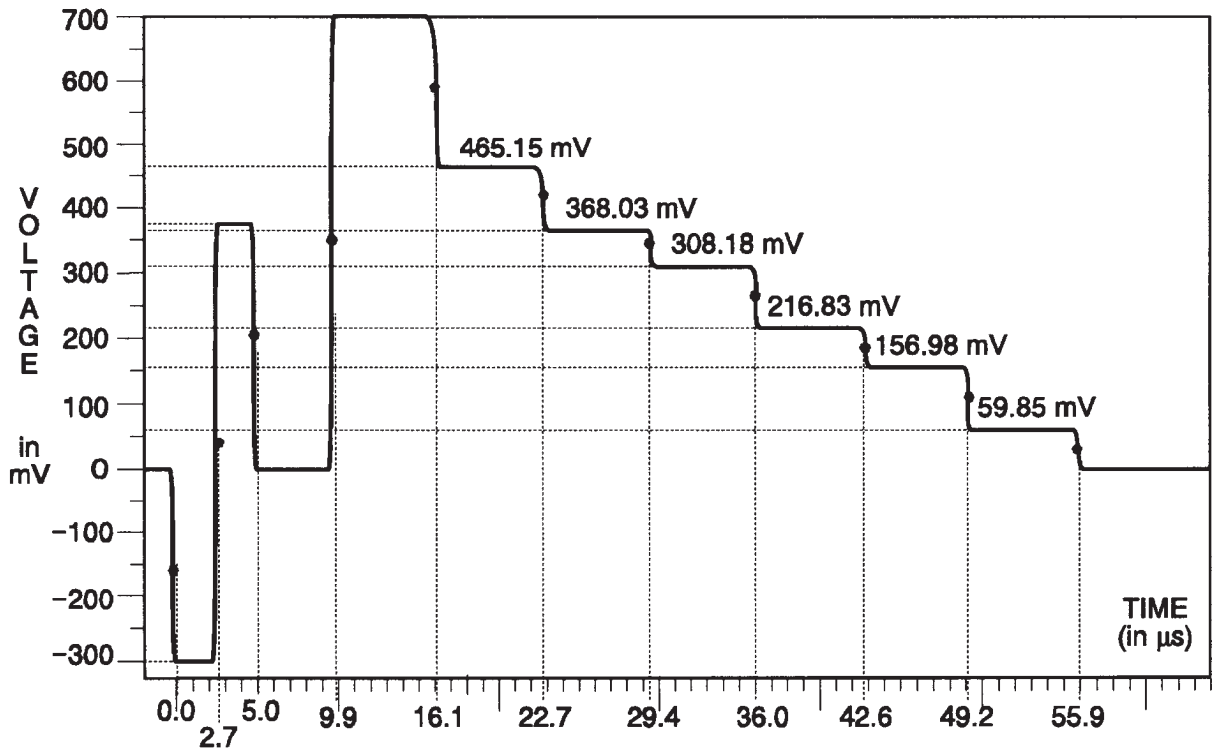

Fig. 3-211. Y Channel — 75% Bars.

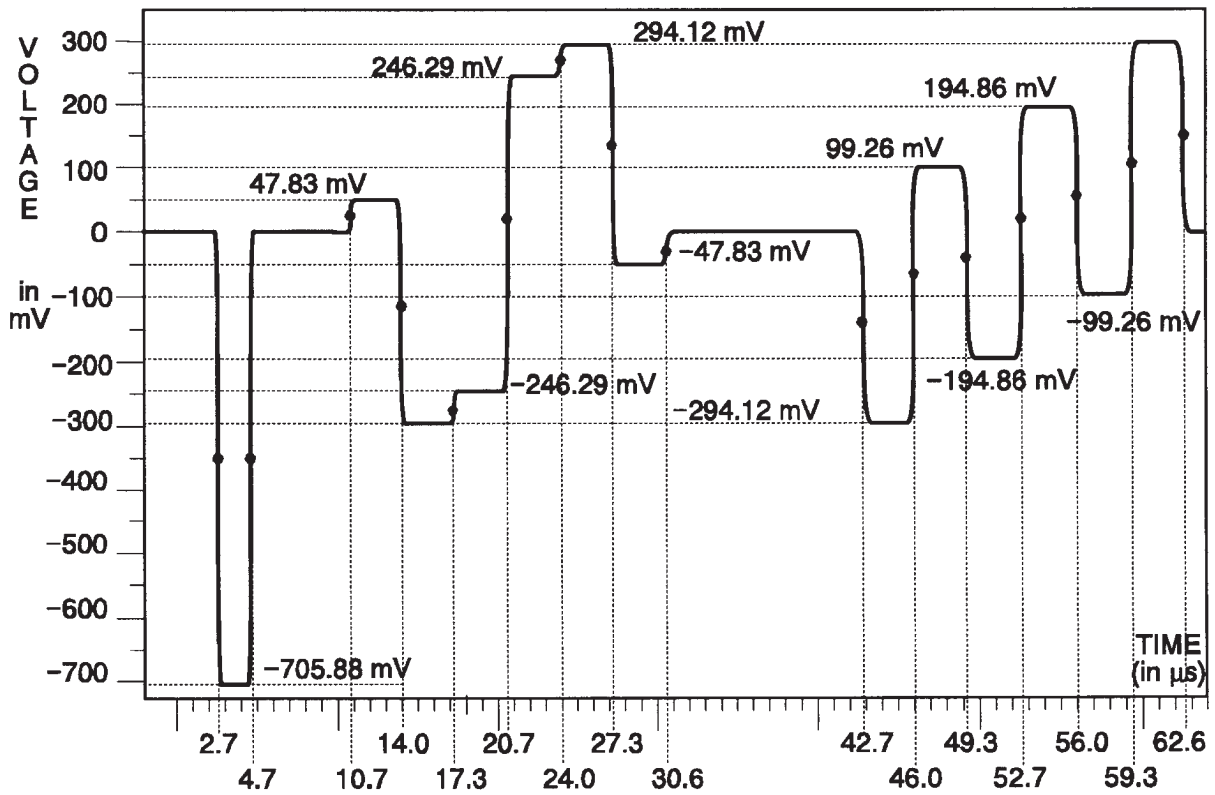

Fig. 3-212. C Channel — 75% Bars.

TSG 131A — SPECIFICATIONS
Option 03 Unique Signals

Option 04 Unique Signals — Composite Signals Y-C Format

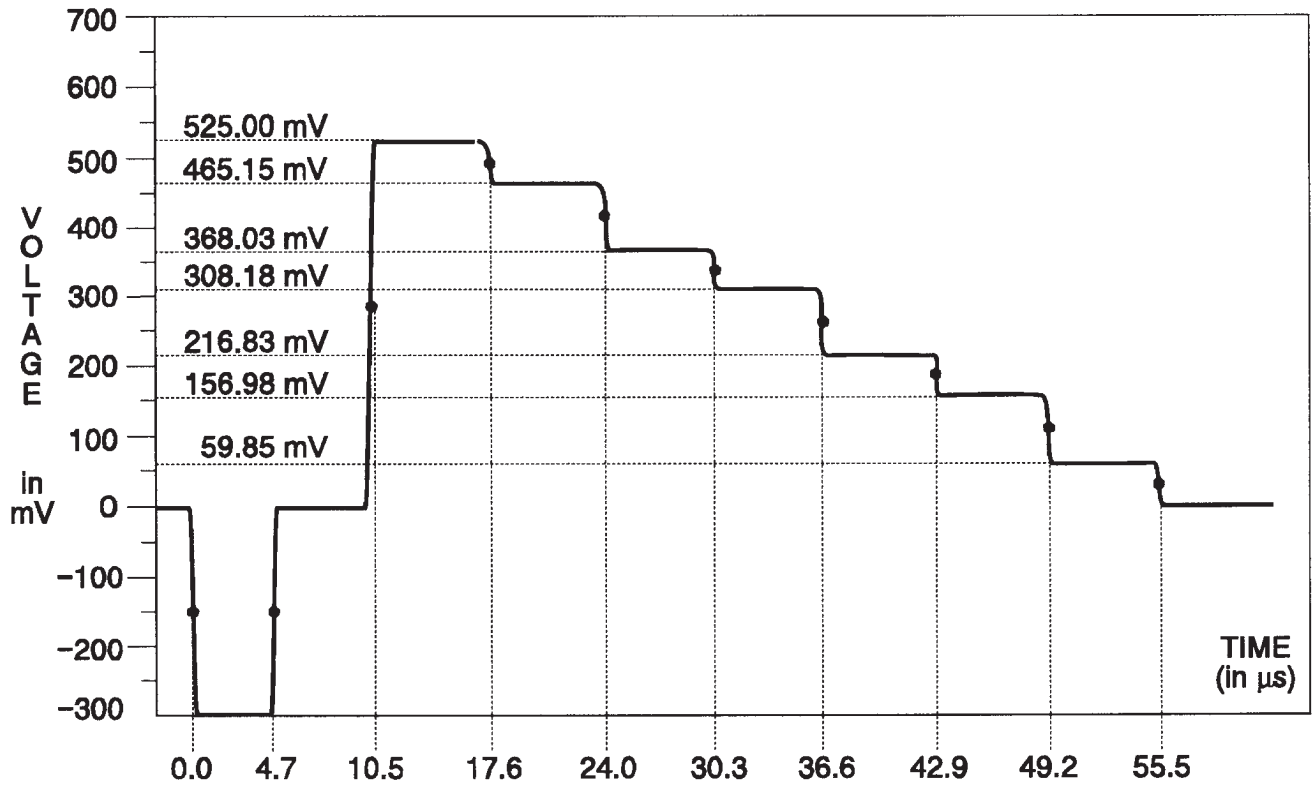

Fig. 3-213. Y Channel — 75% Color Bars.

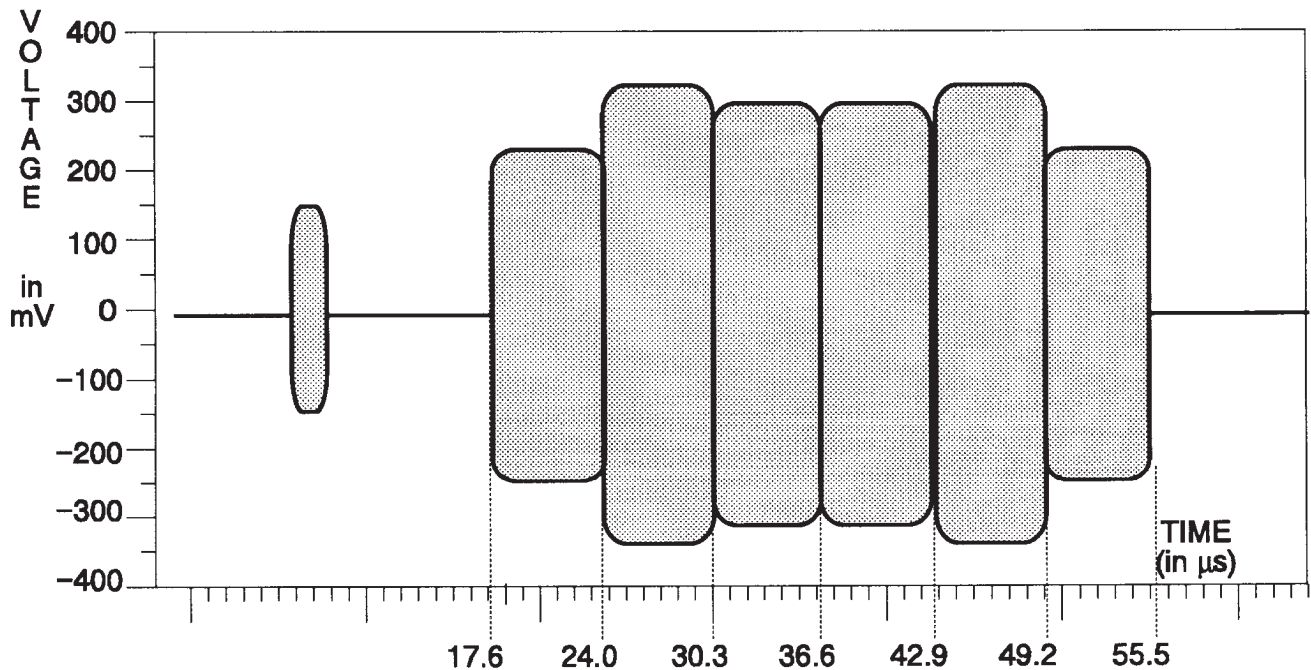

Fig. 3-214. C Channel — 75% Color Bars.

TSG 131A — Specifications
Option 04 Unique Signals

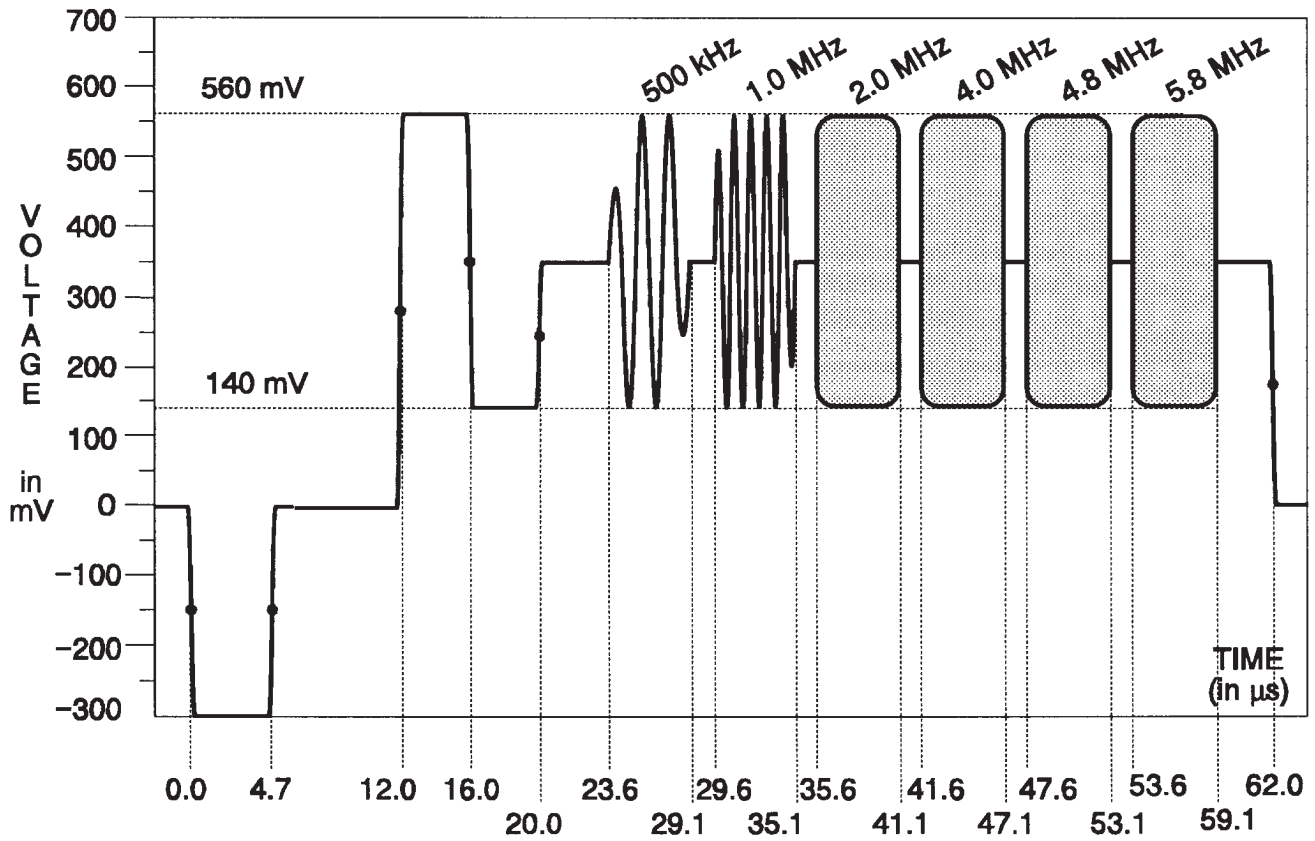

Fig. 3-215. Y Channel — Multiburst.

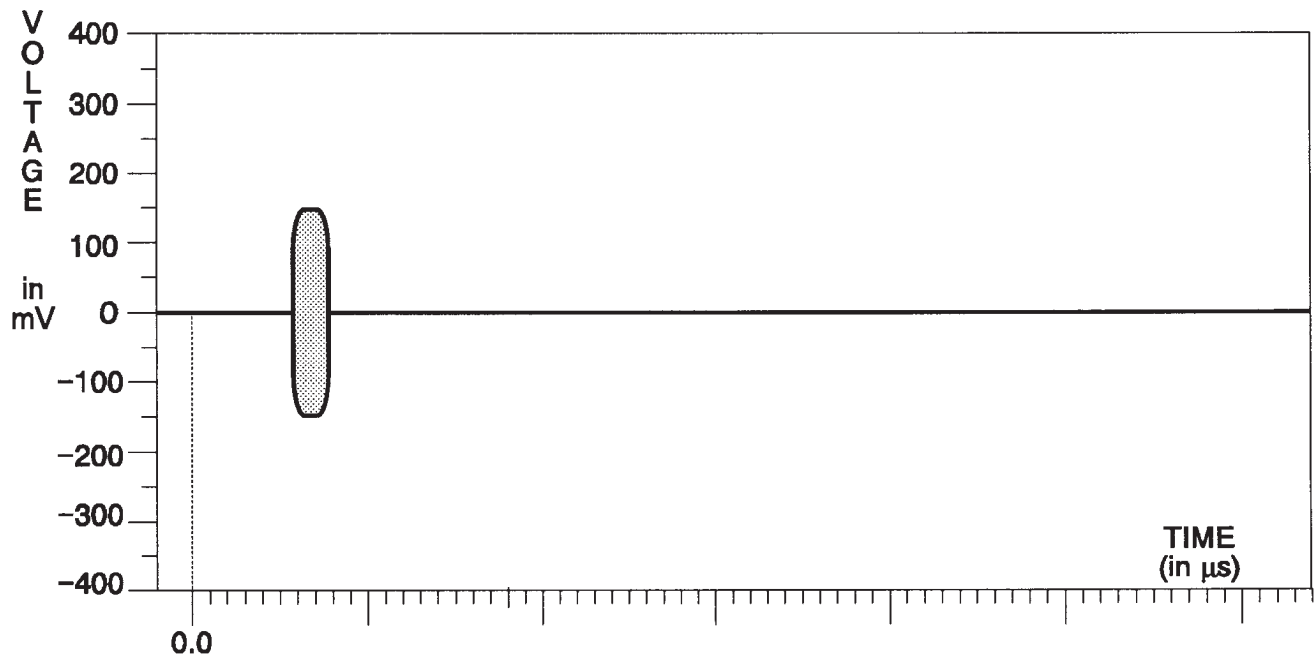

Fig. 3-216. C Channel — Multiburst.

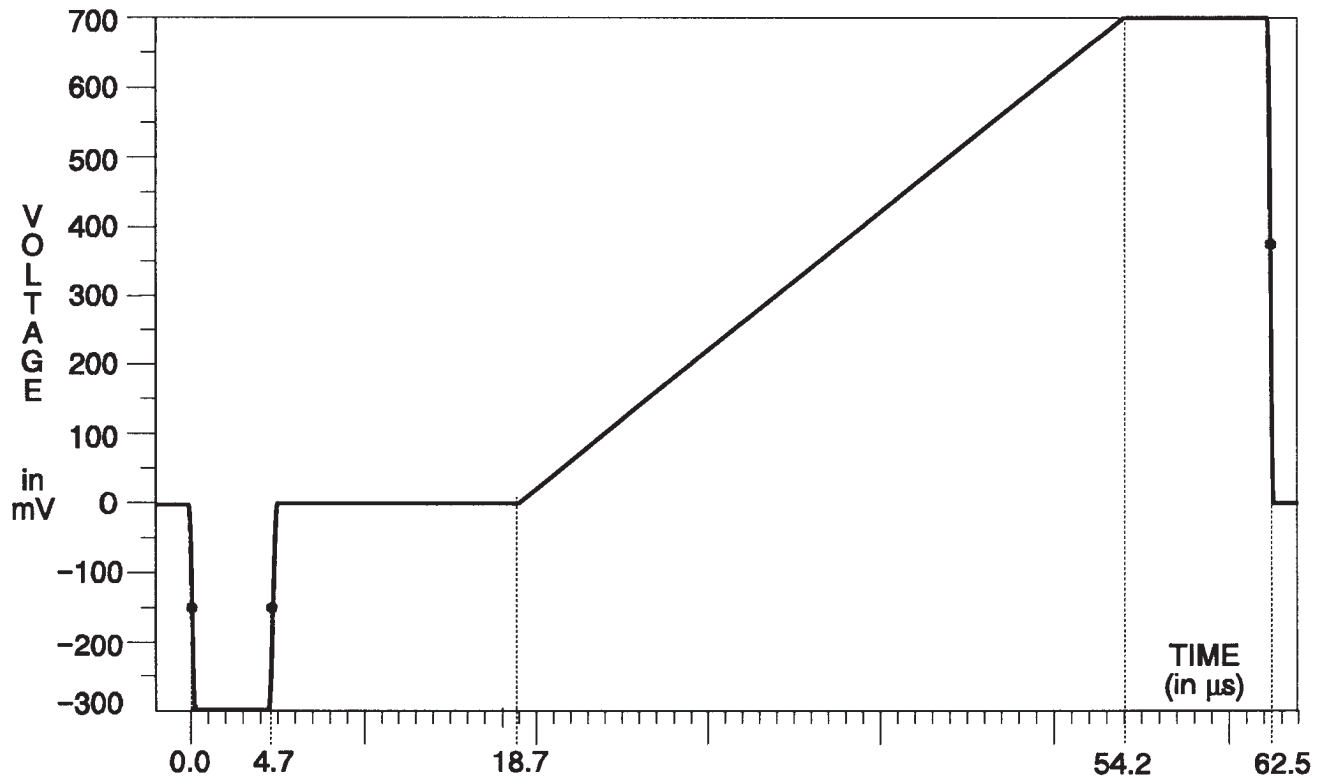

Fig. 3-217. Y Channel — Ramp.

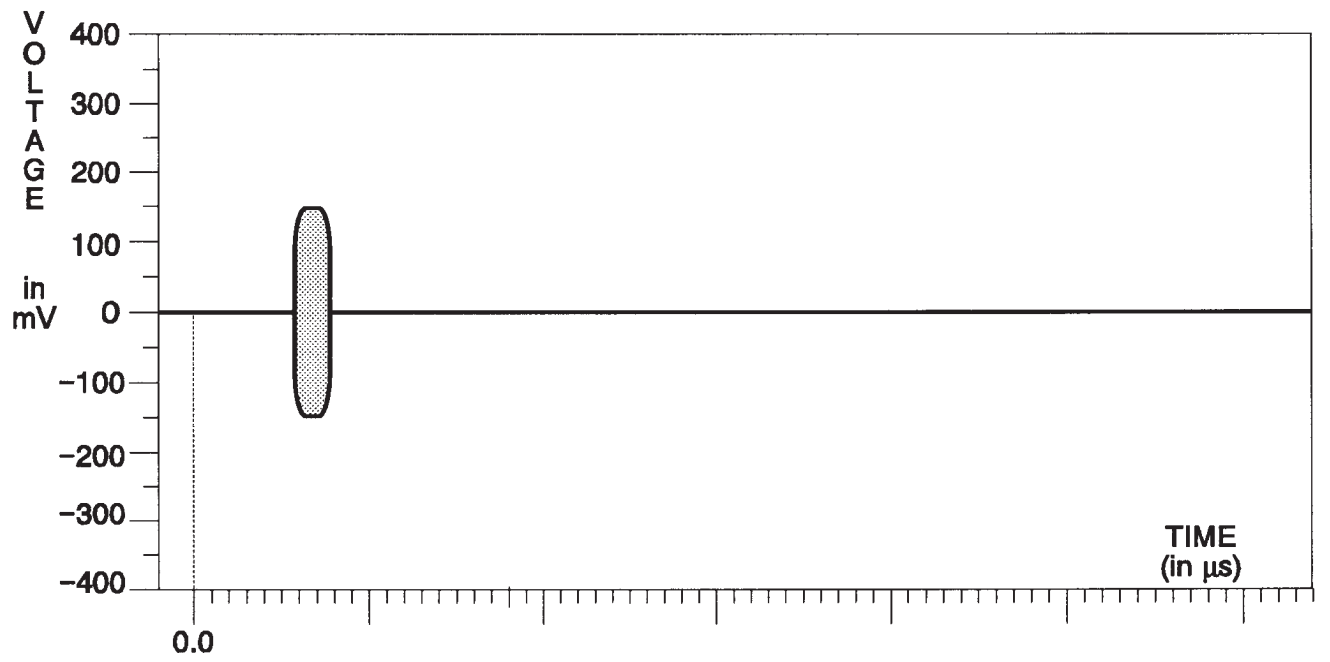

Fig. 3-218. C Channel — Ramp.

TSG 131A — Specifications
Option 04 Unique Signals

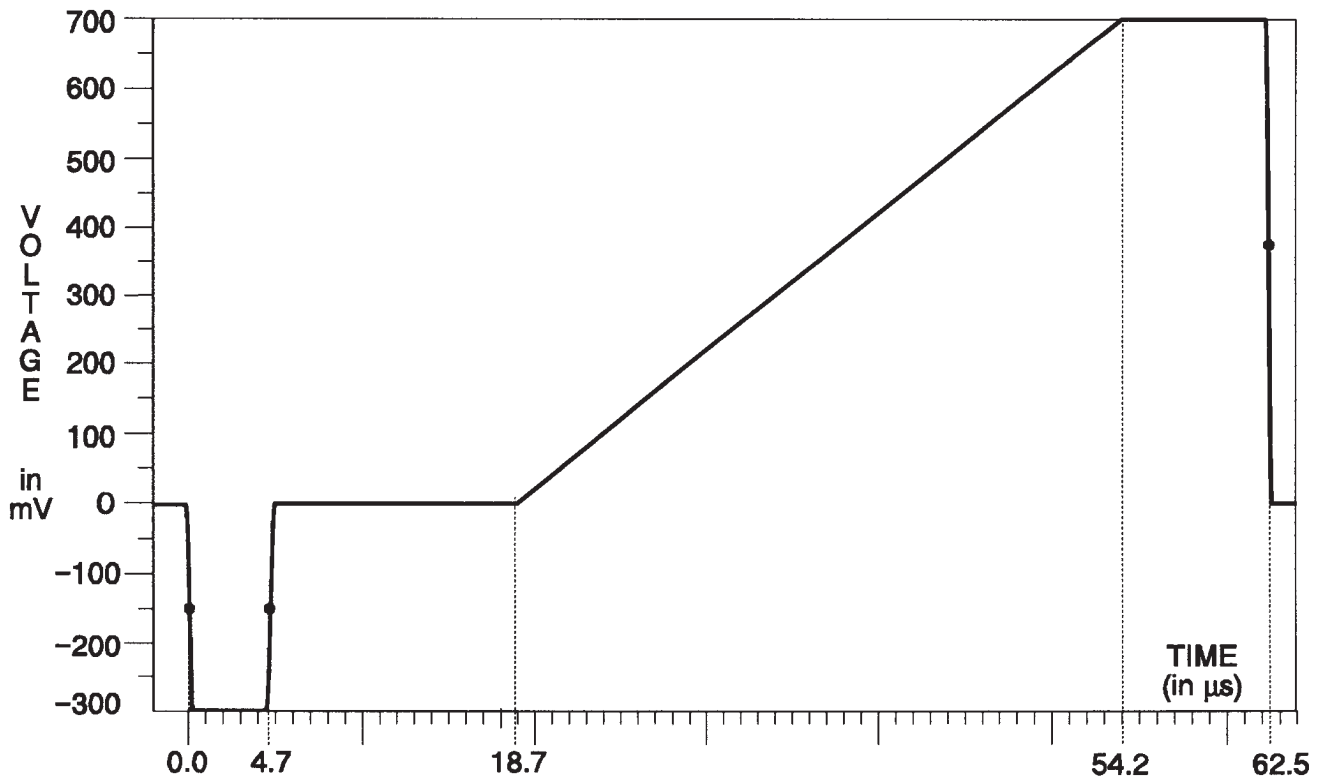

Fig. 3-219. Y Channel — Modulated Ramp.

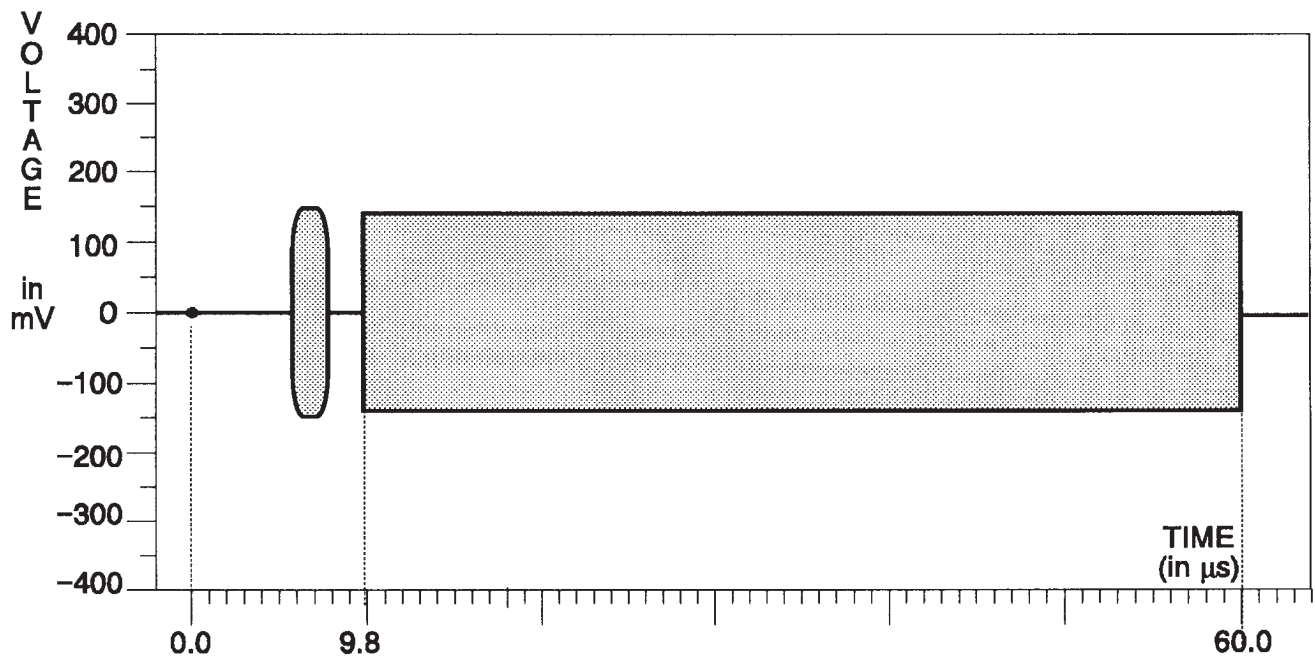

Fig. 3-220. C Channel — Modulated Ramp.

Option 04 Unique Signals — 3-Wire Signals Y, B-Y, R-Y Format

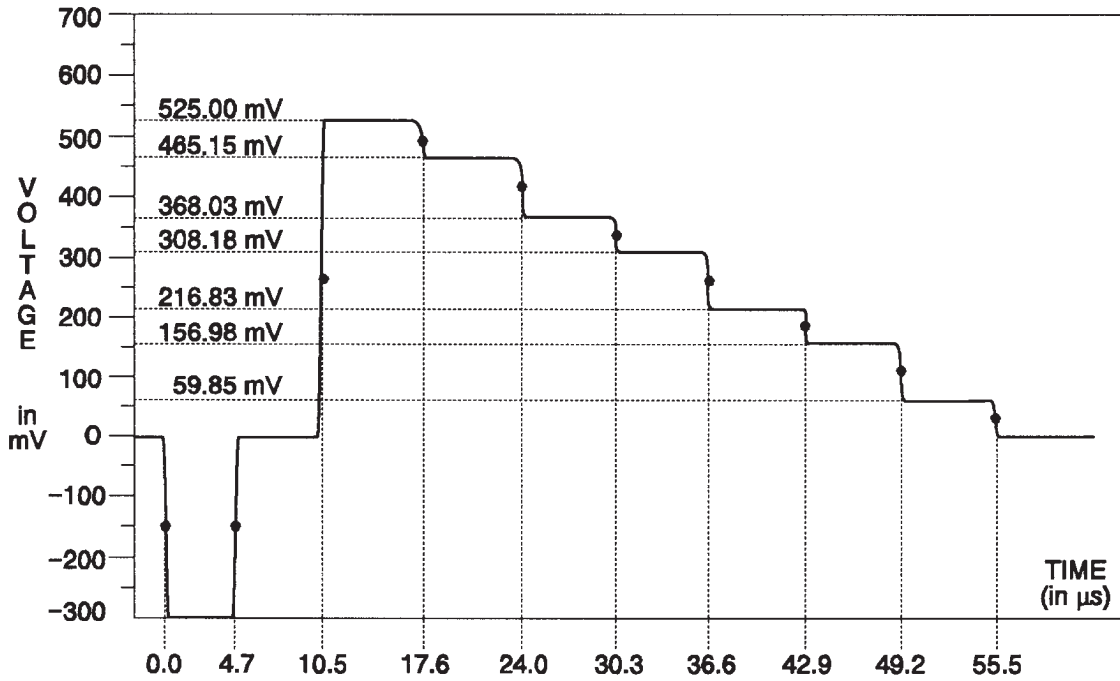

Fig. 3-221. Y Channel — 75% Bars.

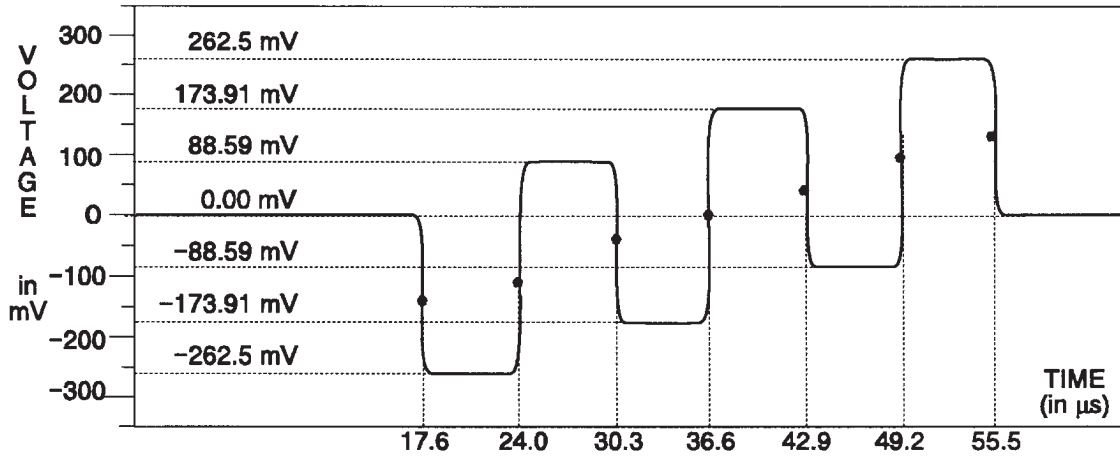

Fig. 3-222. B-Y Channel — 75% Bars.

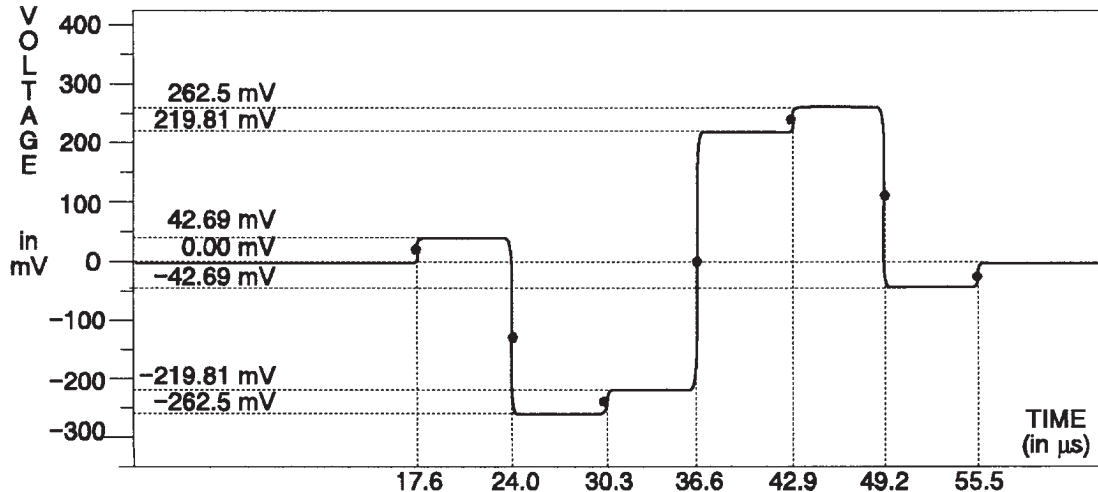

Fig. 3-223. R-Y Channel — 75% Bars.

TSG 131A — Specifications
 Option 04 Unique Signals

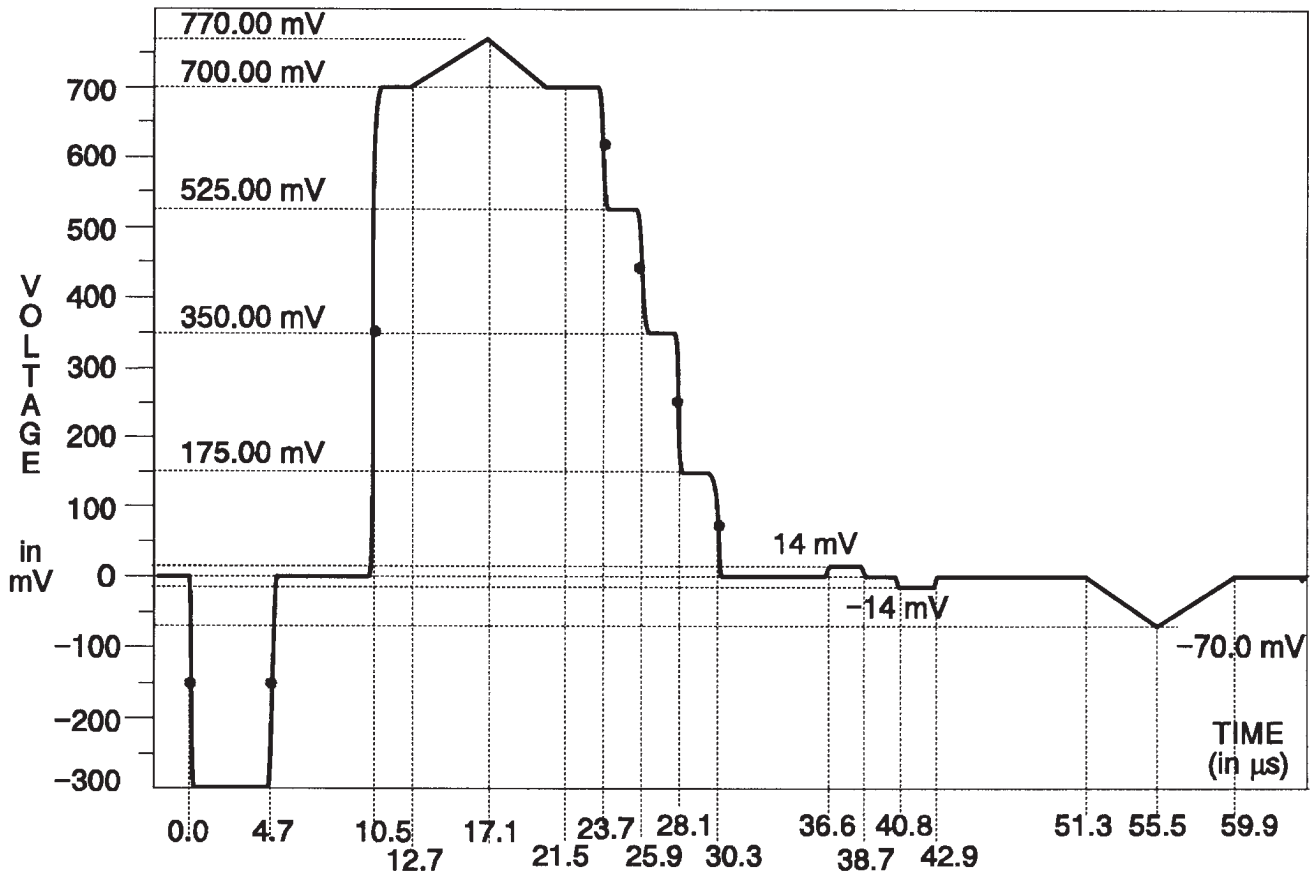

Fig. 3-224. Y Channel — Level Reference.

Fig. 3-225. B-Y & R-Y Channels — Level Reference.

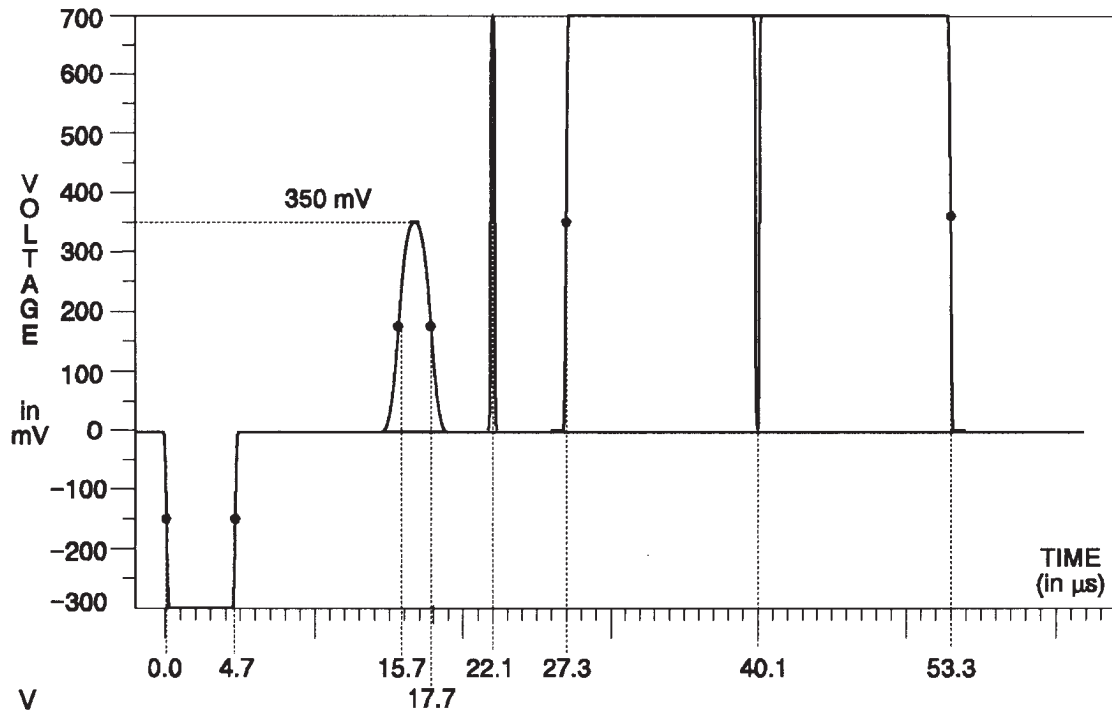

Fig. 3-226. Y Channel — Pulse & Bar.

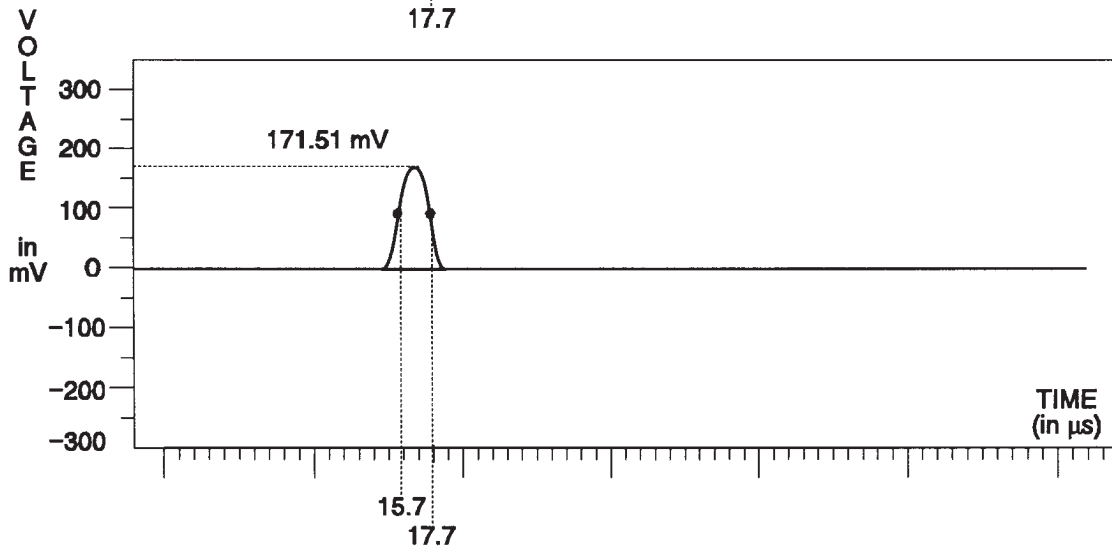

Fig. 3-227. B-Y Channel — Pulse & Bar.

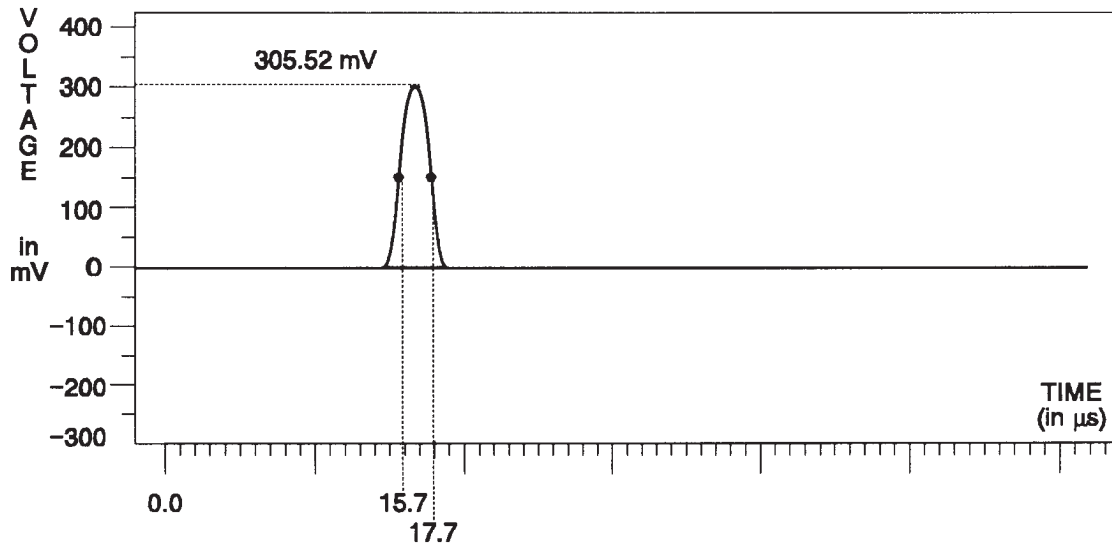

Fig. 3-228. R-Y Channel — Pulse & Bar.

TSG 131A — Specifications
Option 04 Unique Signals

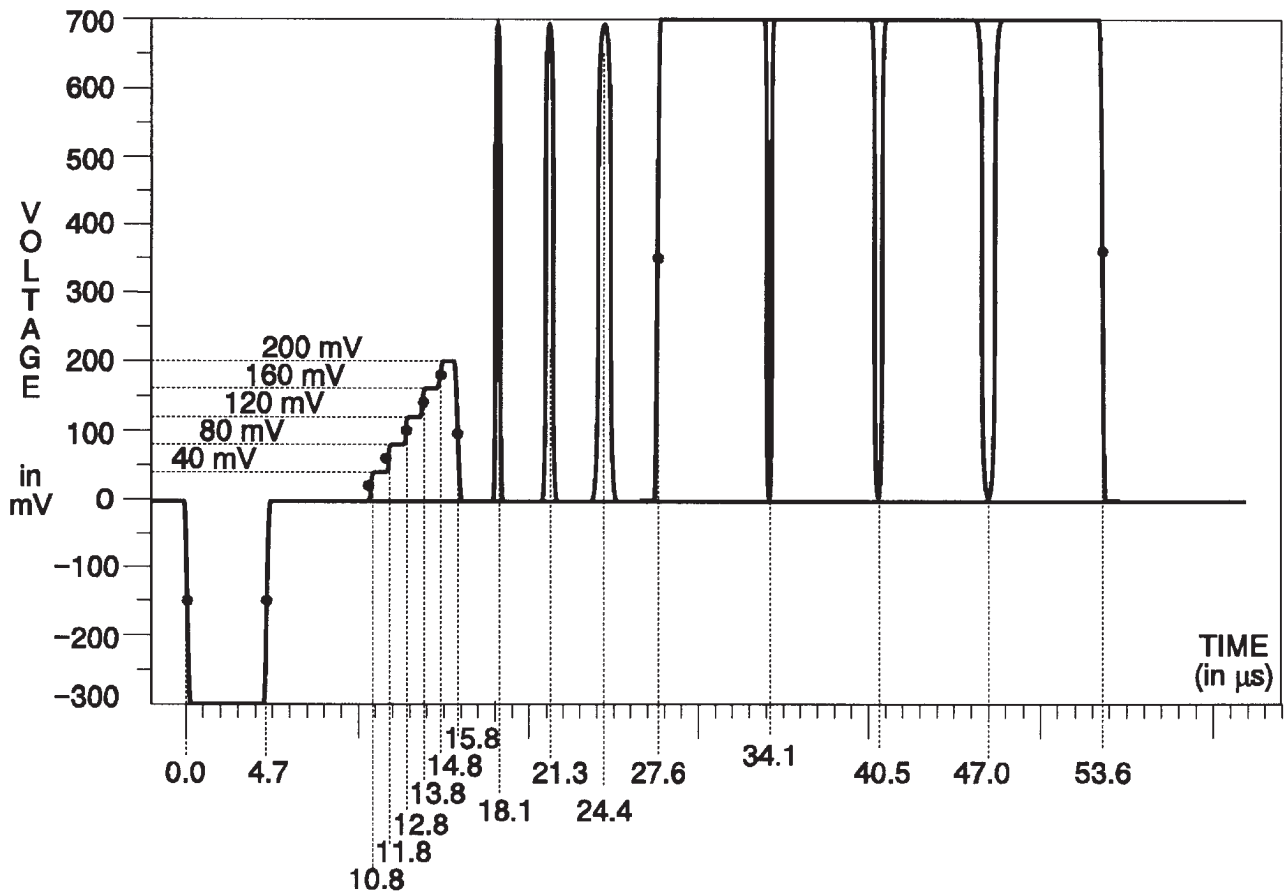

Fig. 3-229. Y Channel — T Pulses.

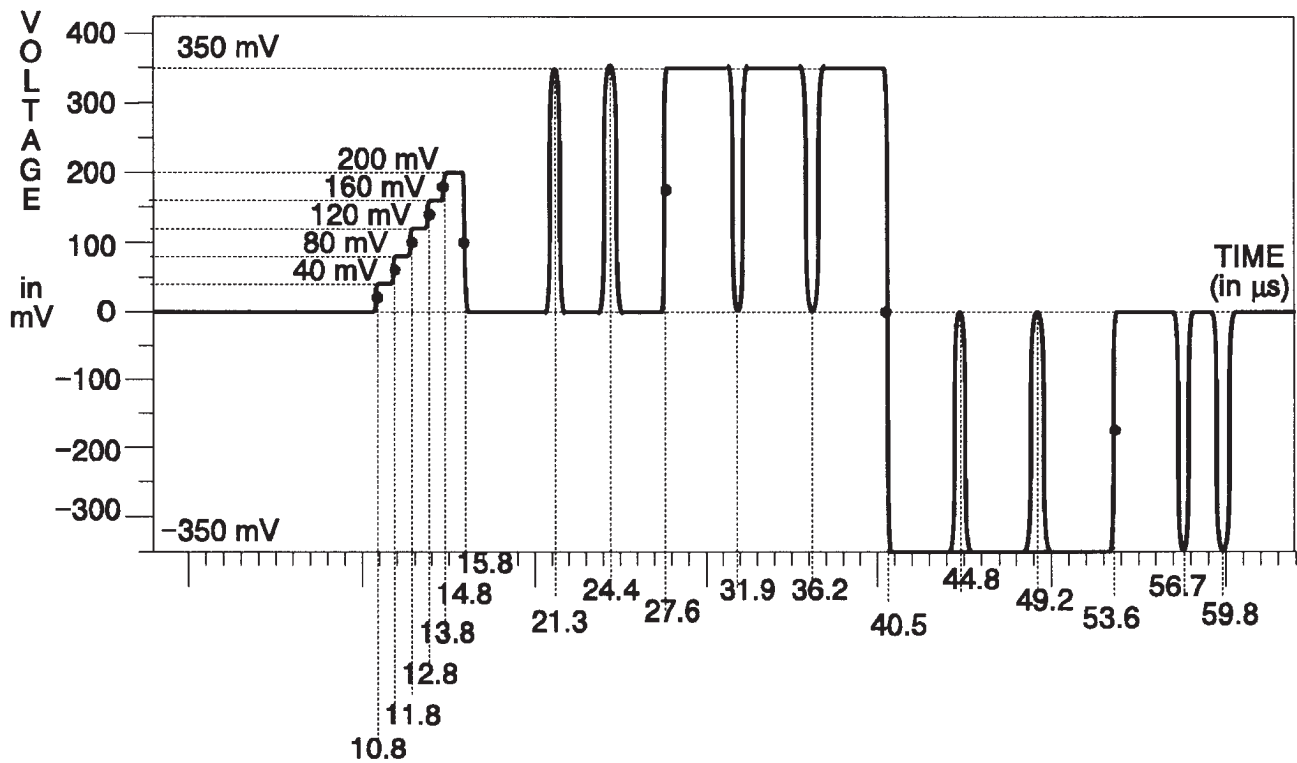

Fig. 3-230. B-Y & R-Y Channels — T Pulses.

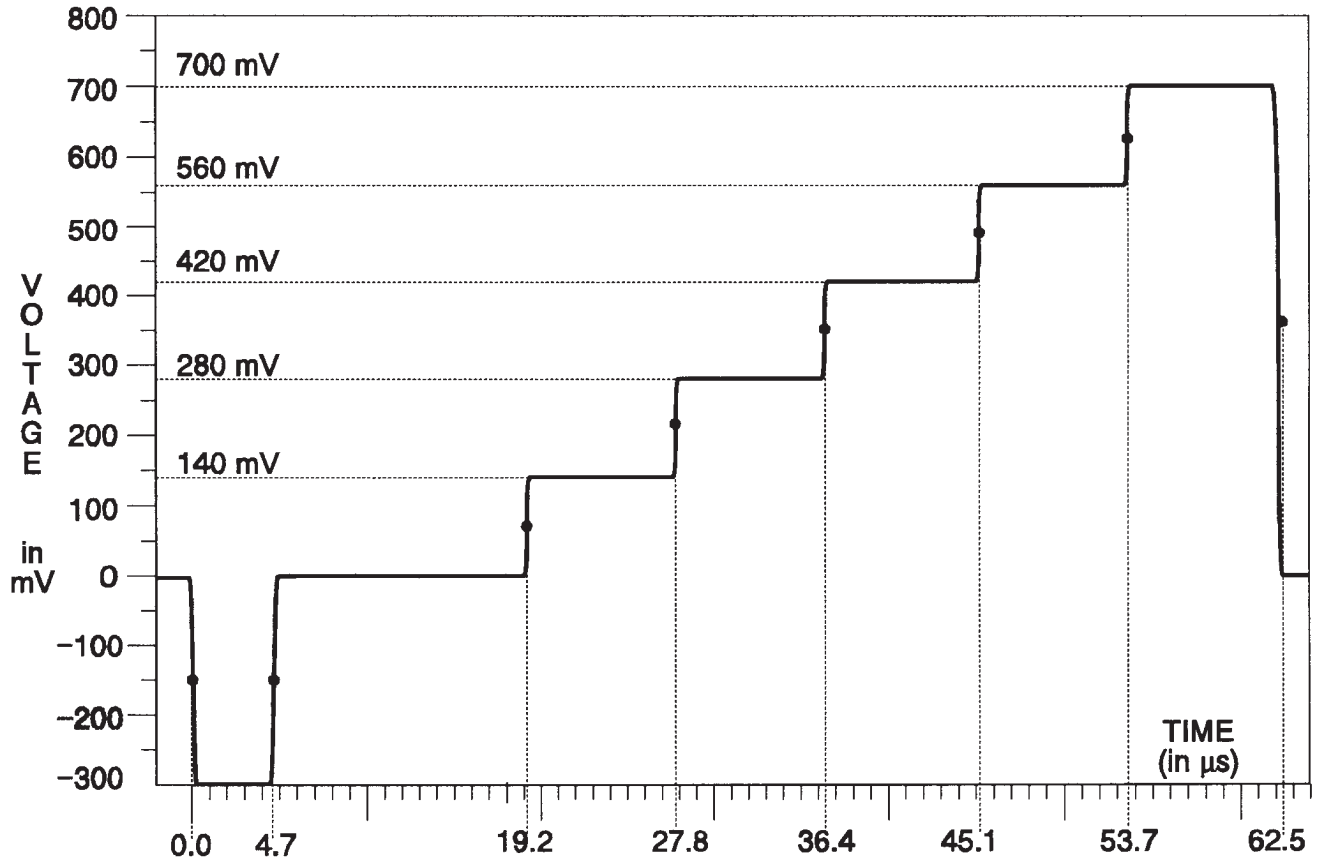

Fig. 3-231. Y Channel — 5-Step.

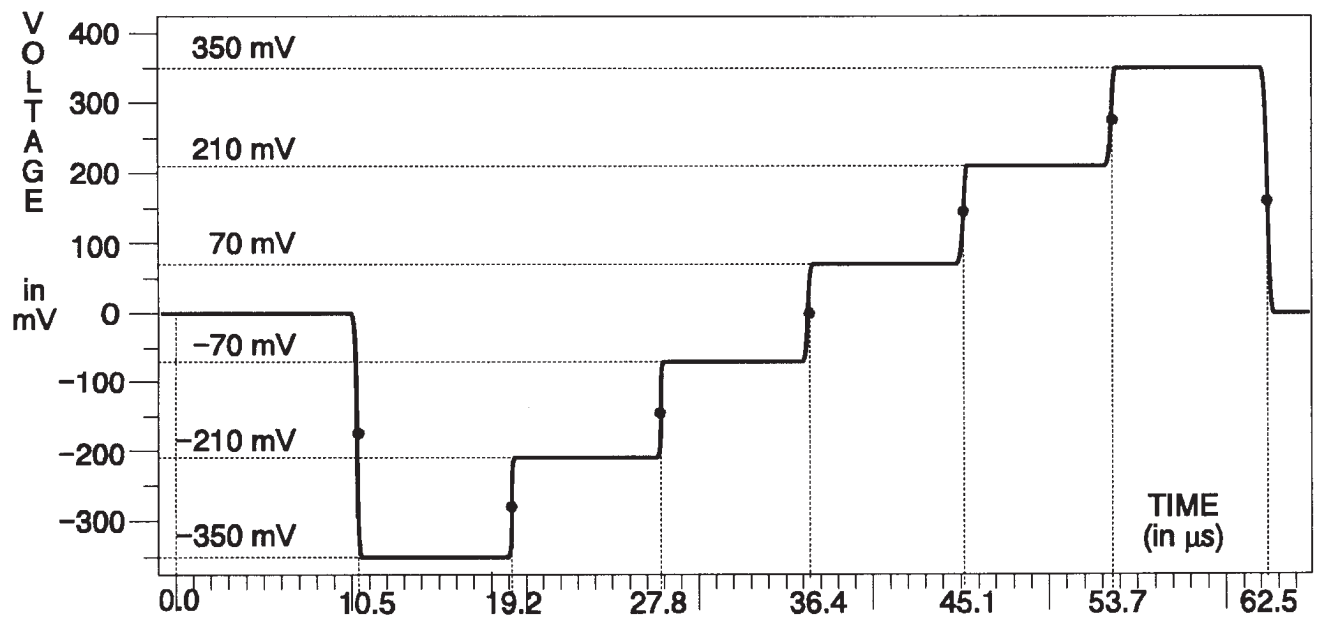

Fig. 3-232. B-Y & R-Y Channels — 5-Step.

TSG 131A — Specifications
Option 04 Unique Signals

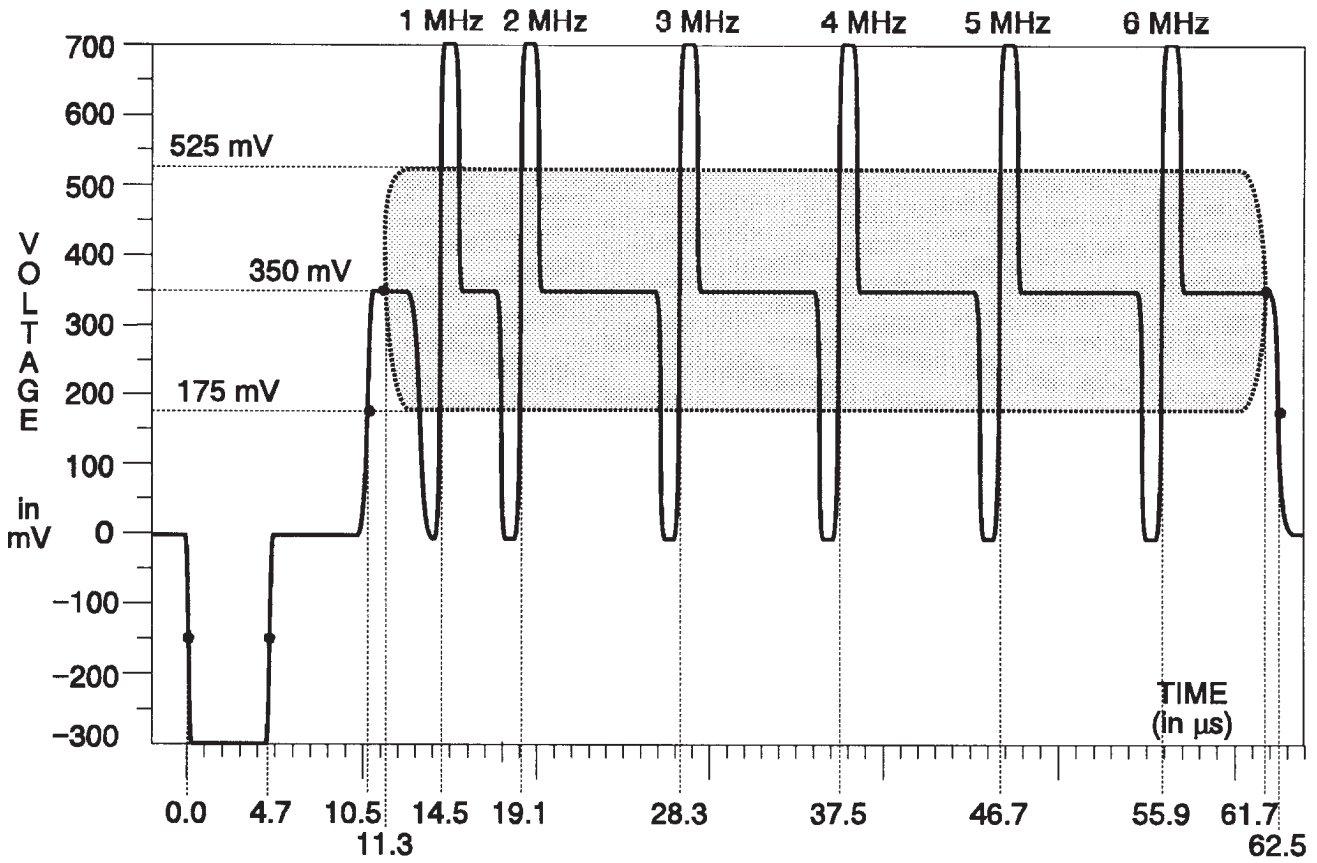

Fig. 3-233. Y Channel — 60% Sweep.

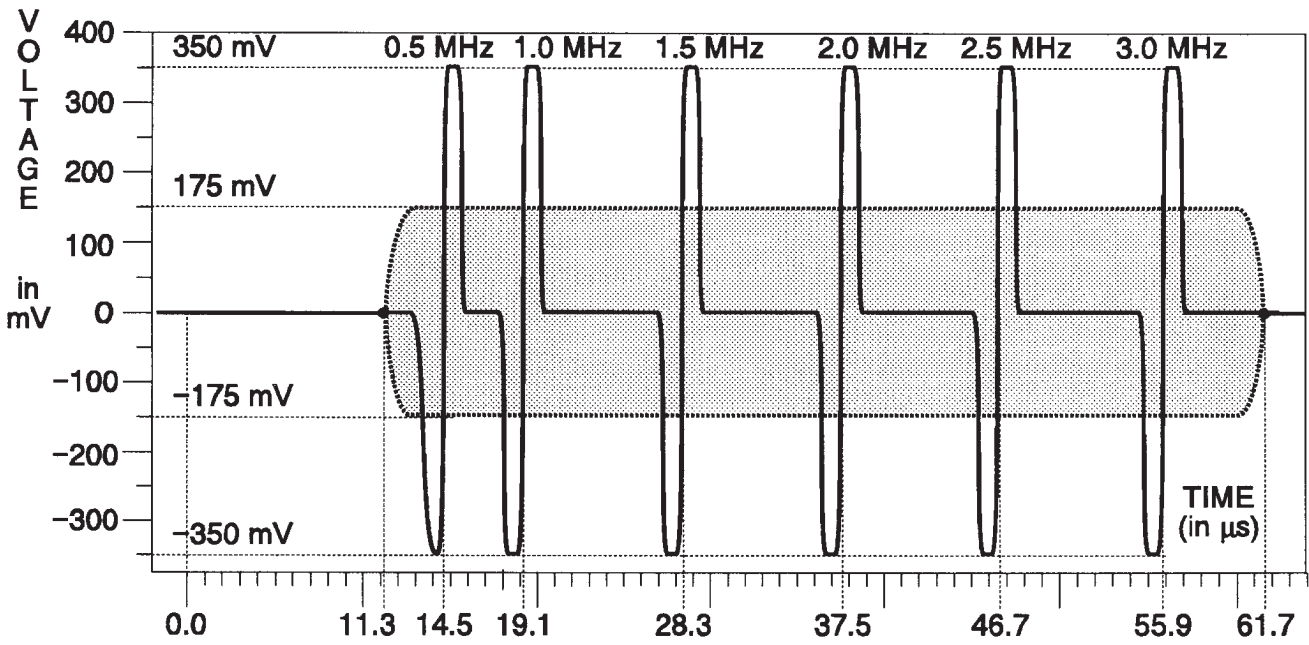

Fig. 3-234. B-Y & R-Y Channels — 60% Sweep.

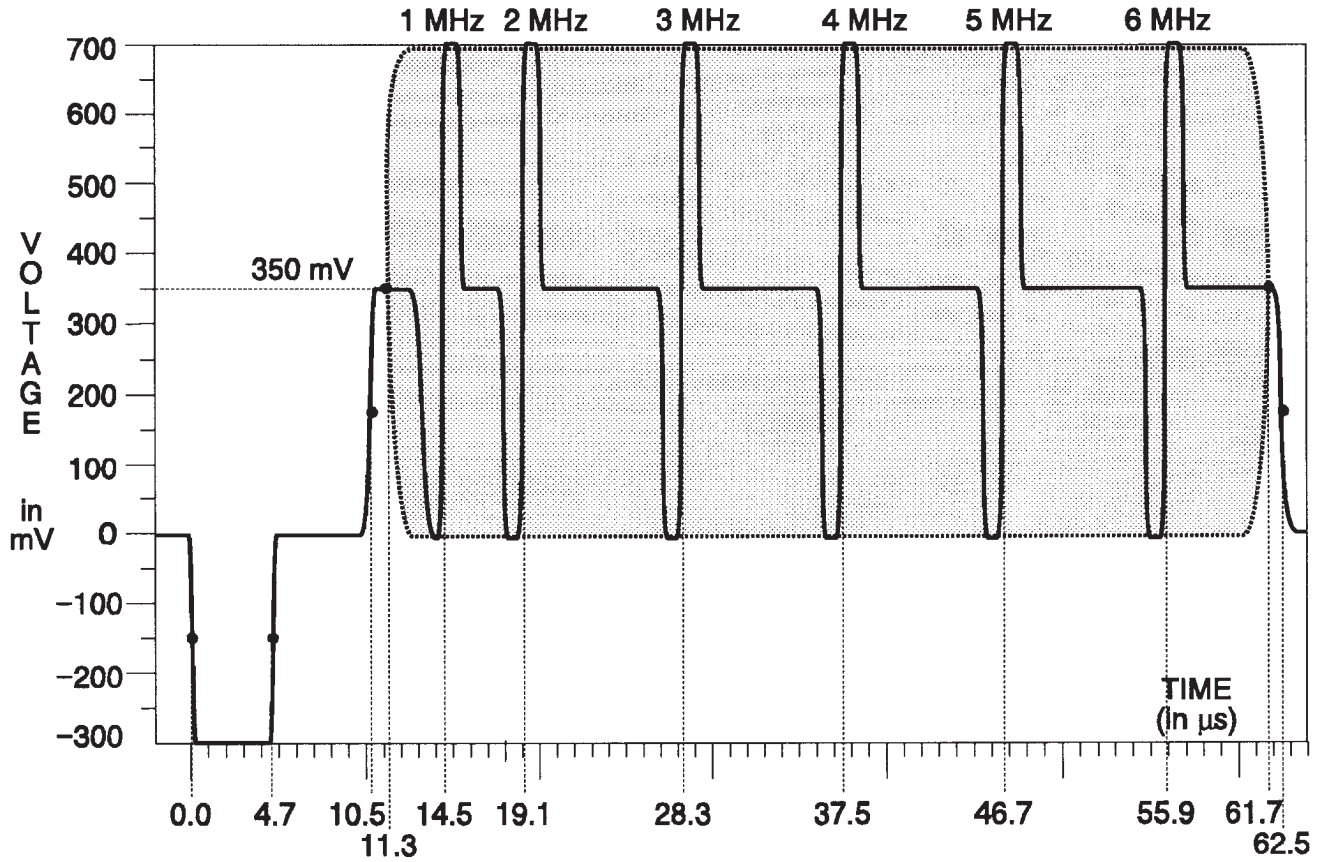

Fig. 3-235. Y Channel — 100% Sweep.

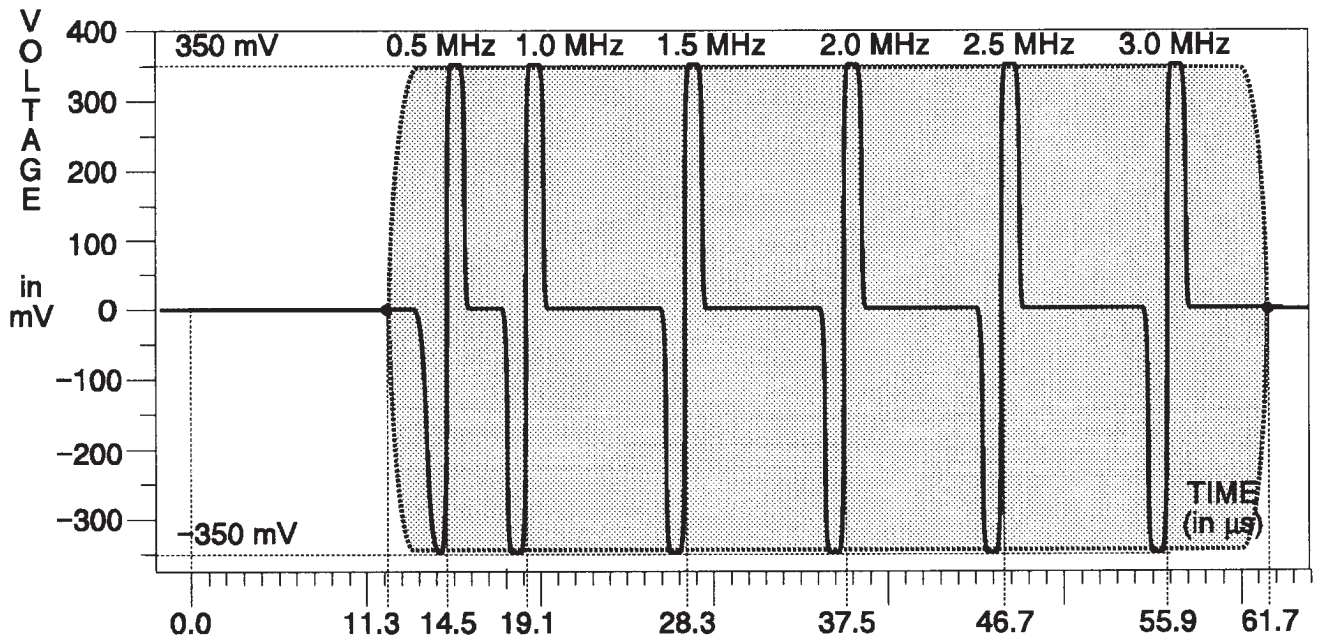

Fig. 3-236. B-Y & R-Y Channels — 100% Sweep.

TSG 131A — Specifications
Option 04 Unique Signals

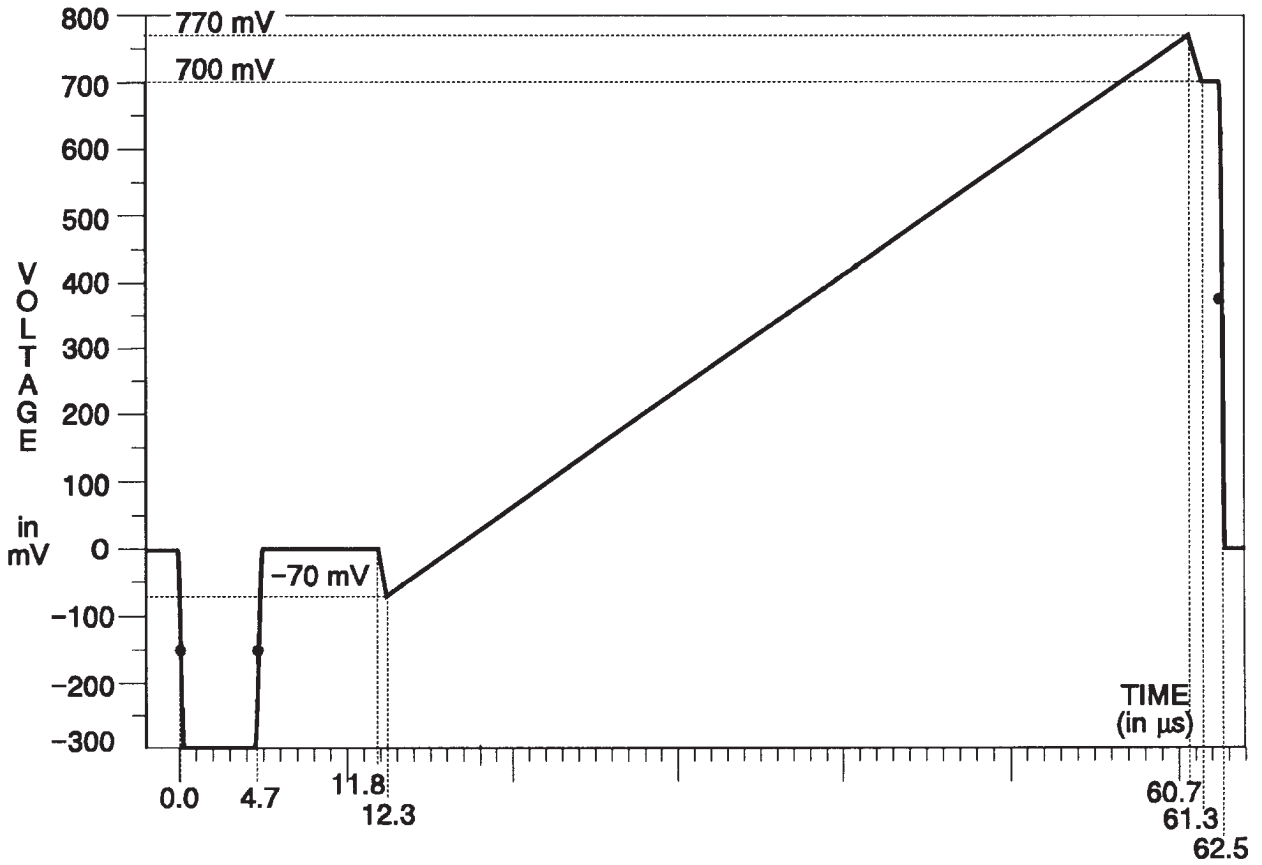

Fig. 3-237. Y Channel — Oversized ramp.

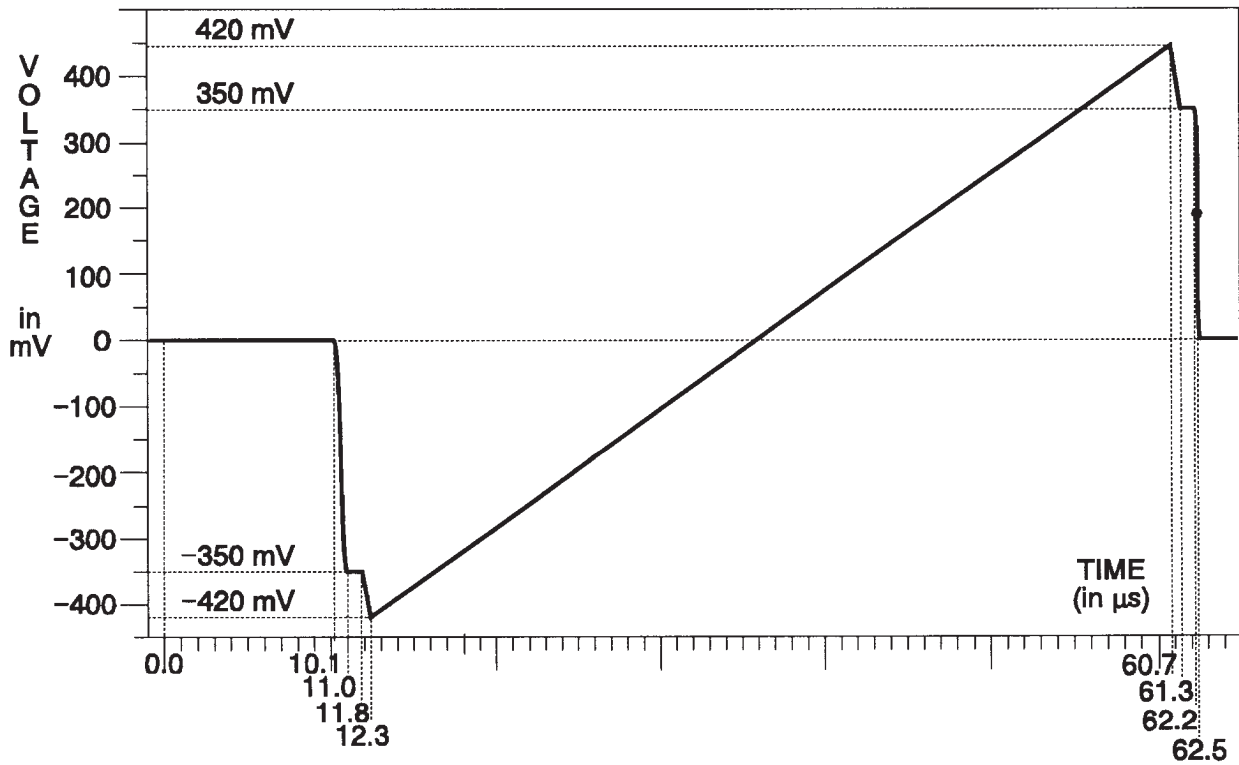

Fig. 3-238. B-Y & R-Y Channels — Oversized Ramp.

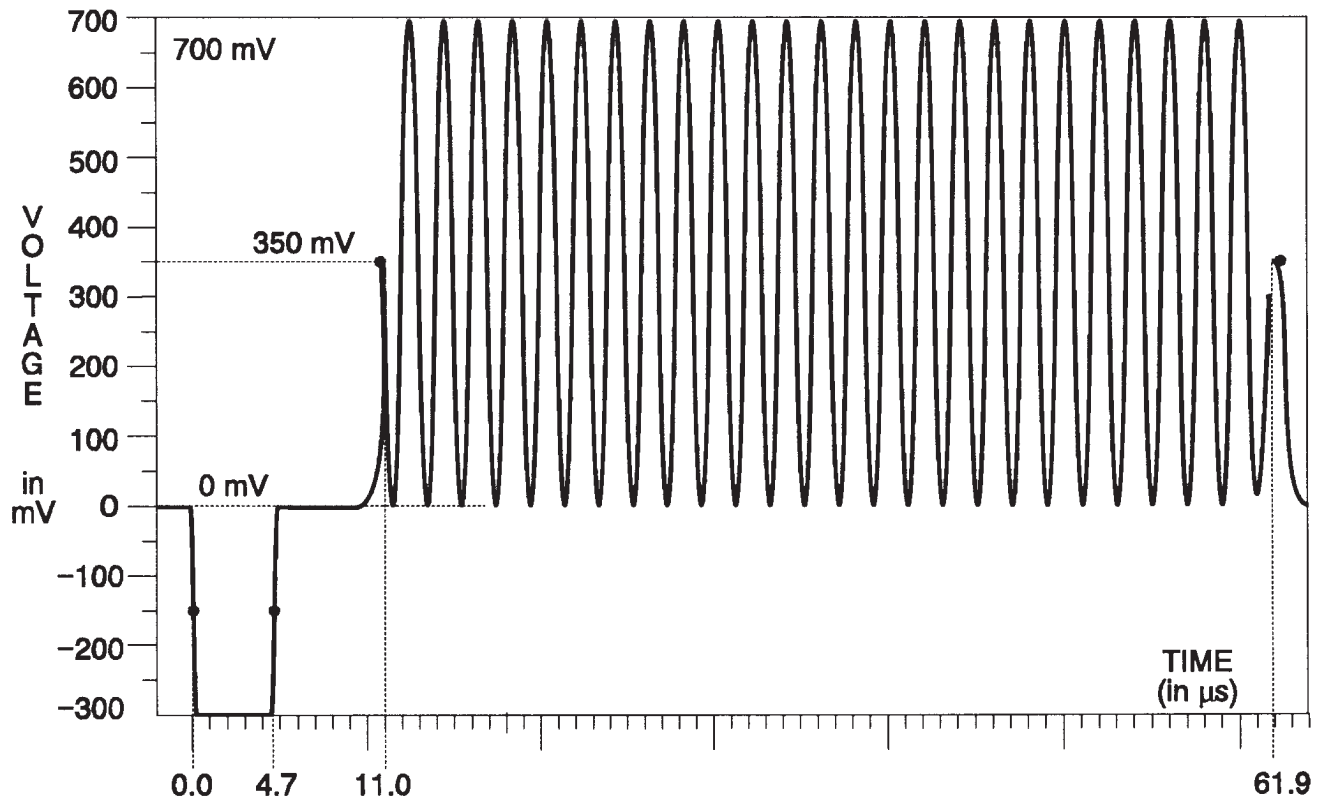

Fig. 3-239. Y Channel — 100% Bowtie.

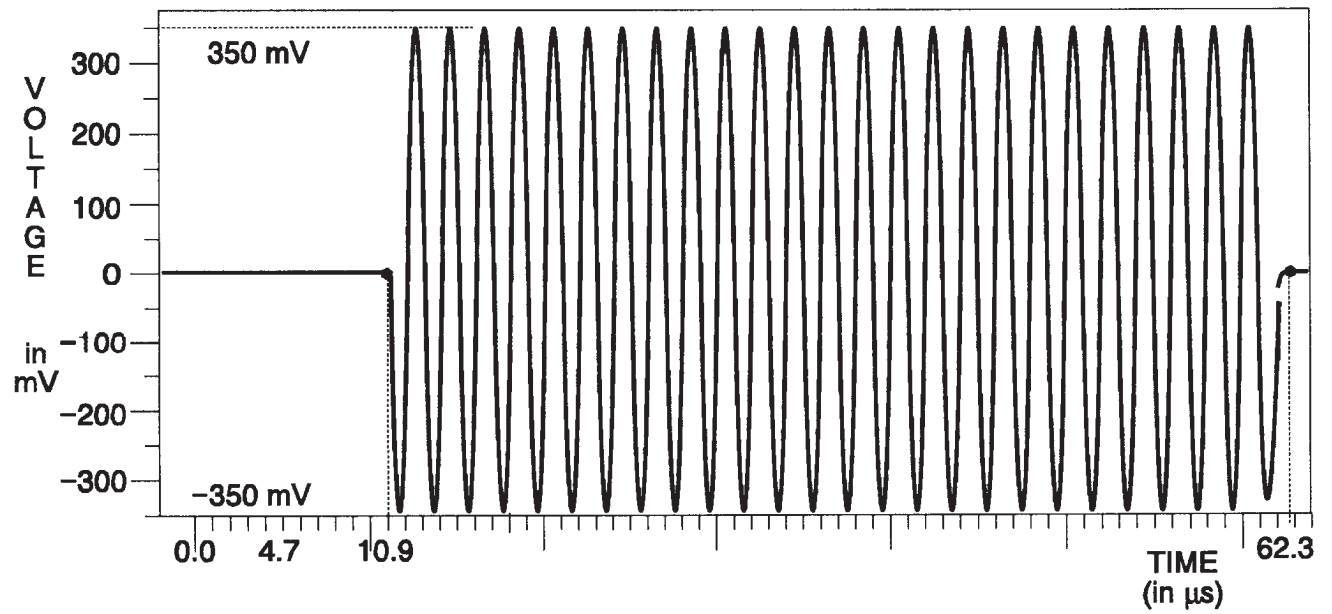

Fig. 3-240. B-Y & R-Y Channels — 100% Bowtie.

TSG 131A — Specifications
Option 04 Unique Signals

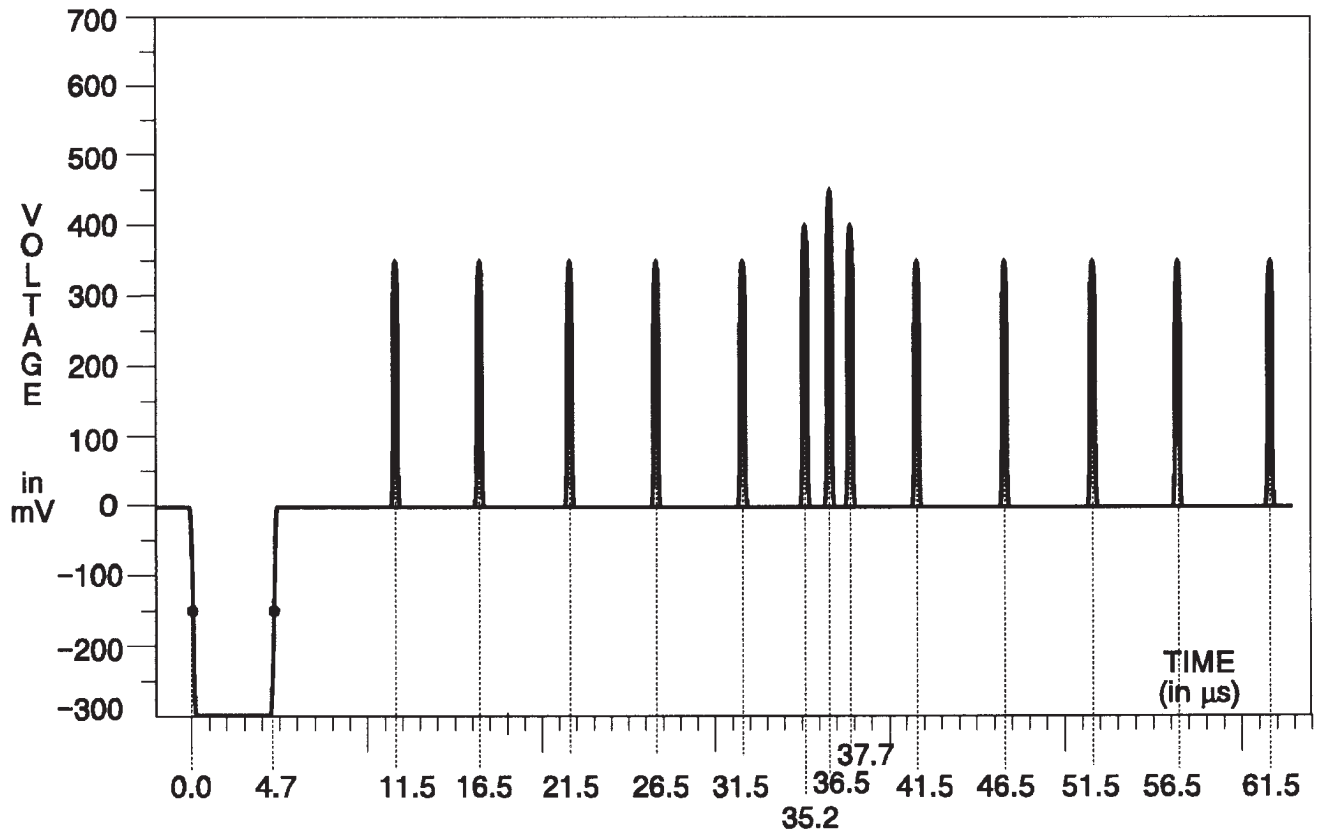

Fig. 3-241. Y Channel — 100% Bowtie Markers.

Option 04 Signals — CTDM (2-Wire) Format

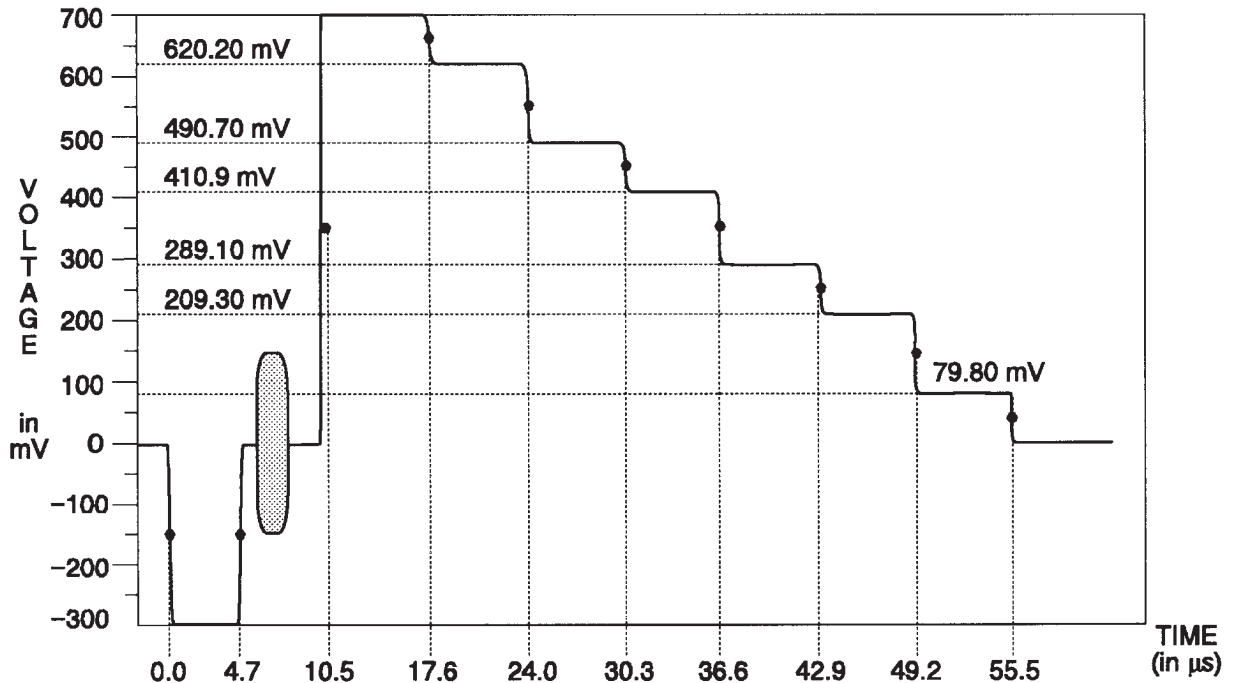

Fig. 3-242. Y Channel — 100% Bars.

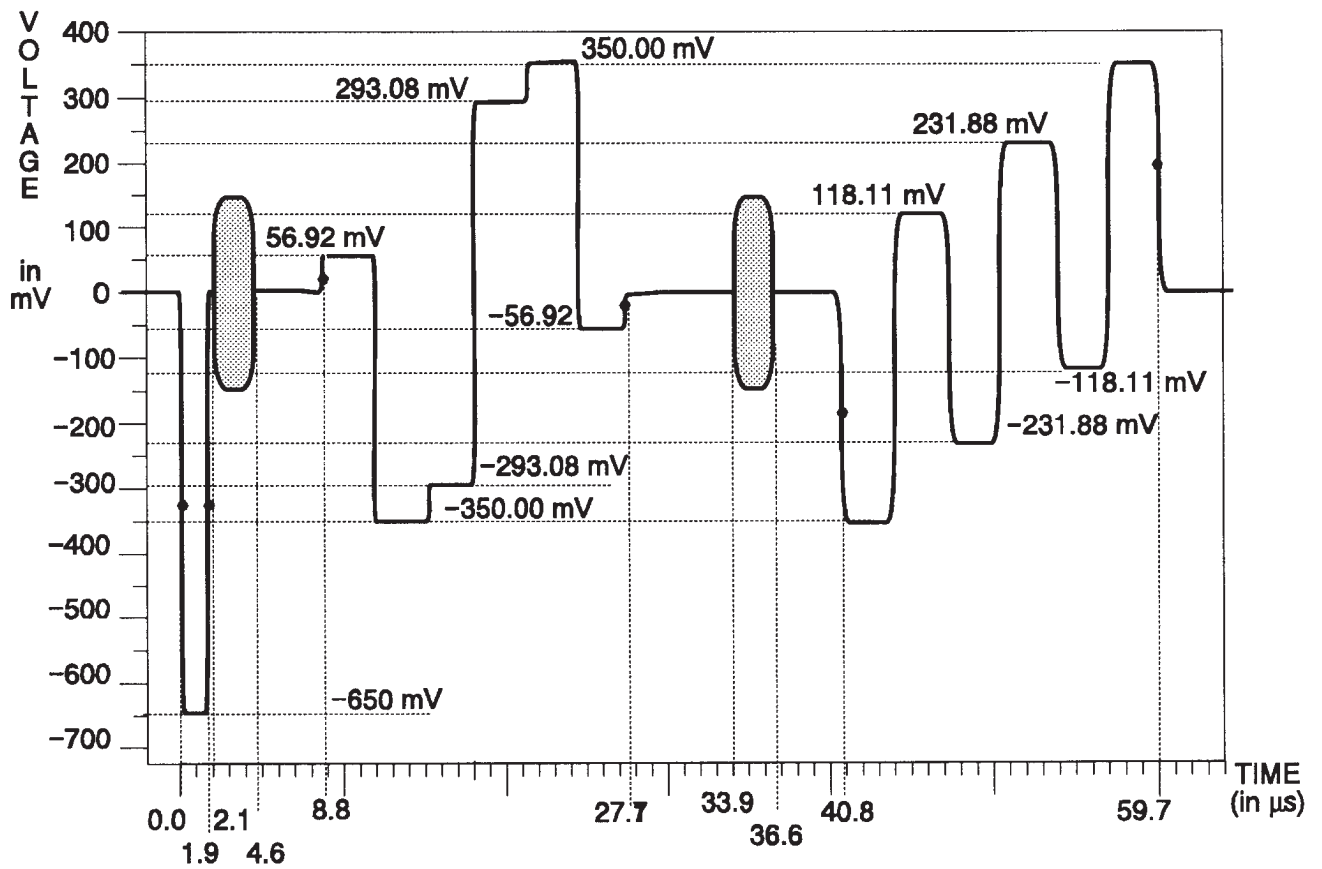

Fig. 3-243. C Channel — 100% Bars.

TSG 131A — Specifications
Option 04 Unique Signals

WARNING

THE FOLLOWING SERVICING INSTRUCTIONS ARE FOR USE BY QUALIFIED PERSONNEL ONLY. TO AVOID PERSONAL INJURY, DO NOT PERFORM ANY SERVICING OTHER THAN THAT CONTAINED IN OPERATING INSTRUCTIONS UNLESS YOU ARE QUALIFIED TO DO SO. REFER TO OPERATORS SAFETY SUMMARY AND SERVICE SAFETY SUMMARY PRIOR TO PERFORMING ANY SERVICE.



SECTION 4

PERFORMANCE CHECK & ADJUSTMENT PROCEDURE

This section consists of checklists and detailed procedures to use in verifying and adjusting TSG 131A performance parameters.

The order of these procedures has been chosen to minimize changes in equipment setup. Performance parameters may be checked in any order. However, because many adjustment steps are interactive, care must be taken when adjusting individual parameters to ensure that all others remain within specification.

The following is a list of equipment required for Performance Check and Adjustment. The equivalent of this may be used, but the use of inadequate equipment may result in faulty measurements or adjustment.

1. **PAL Video Measurement Set.** For measuring and displaying field-rate and line-rate waveforms, differential phase and gain, and SC/H phase.
Example: Tektronix 1781R Video Measurement Set.
2. **Frequency Counter.** Must be accurate to within 2.5 Hz out of 5 MHz.
Example: Tektronix DC 503A: plugs into a TM 503A Power Mainframe.
3. **Distortion Analyzer.** Must test power output over 0 - 8 dBm and be capable of detecting THD of 0.01% or less.
Example: Tektronix AA501A.
4. **Audio Amplifier.** 600 Ω impedance.

NOTE

It is very important for both the Performance Check and the Adjustment Procedure that the length and the propagation delay of the coax cables are identical.

5. **BNC Coax Cables (5).** 75 Ω impedance.
Example: Tektronix part number 012-0074-00.
Note that it is imperative that the cable lengths match.
6. **End-Line Terminations (5).** 75 Ω terminations equipped with a BNC connector.
Example: Tektronix part number 011-0102-00.
7. **Audio Connector-to-Triple Banana Cable.**
Example: ITT Pamona Electronics, Model 4953-J-36. Must be configured to match the TSG 131A audio output. Pin 1, shield; pin 2, +; pin 3, -.
8. **Test Oscilloscope & 1x Probe.** (only needed if Opt. 02, 03, or 04 is installed.) With the following minimum capabilities: 50 MHz bandwidth, 5 ns/div to 5 μ s/div sweep speeds, and triggering to 5 MHz.
Example: Tektronix 2430A Oscilloscope & 1x probe P6101A.
9. **Pozzi-driver tips and hex driver.** For removal of Audio Board. Small disconnects the Audio connectors from the rear panel and Medium is used to remove the cover and Audio board from its standpost.
Example General Tool 640-121 (small POZIDRIV® tip), 640-122 (medium POZIDRIV® tip), 624-440 (hex driver).

PERFORMANCE CHECK CHECKLIST

Oscillator Frequency

1. Oscillator Frequency
17.734375 MHz \pm 40 Hz (20 Hz Opt. 10)

NOTE

After initial delivery or long storage, allow a two-hour warm up to re-age the crystal. Thereafter, a 30 minute warm up is sufficient.

COMPOSITE Test Signal

2. DC Level
0 mV_{dc} \pm 50 mV_{dc}
3. Sync Amplitude
300 mV \pm 1%
4. Burst Amplitude
300 mV \pm 2%
5. Steps (5-Step) Staircase Linearity
< 1%
6. Luminance Amplitude Accuracy
 \pm 1%
7. Chrominance Accuracy
 \pm 1%
8. Chrominance-to-Luminance Delay and Gain
 \leq 5 ns and \pm 1%
9. Line Tilt
 \pm 0.5%
10. Ringing & K_{2T} Factor
 \leq 1% of peak & < 0.6%
11. Pulse-to-Bar Ratio
1:1 \pm 1%
12. Sine Squared Pulse Accuracy
HADs accurate within 25 ns
13. Horizontal Sync Duration, Vertical Serration Duration, & Equalizing Pulse Duration
Sync = 4.7 μ s \pm 50 ns
Vertical Serration = 4.7 μ s \pm 50 ns
Equalizing Pulse = 2.35 μ s \pm 50 ns
14. Line Blanking Interval
12.0 μ s \pm 0.15 μ s
15. Line Sync Duration
4.7 μ s \pm 50 ns
16. Sync Rise Times
250 ns \pm 25 ns
17. Luminance Rise Times
250 ns \pm 25 ns
18. Frequency Response
Flat to 6.0 MHz \pm 2%
19. Differential Phase and Gain
0.5° & 0.7% maximum
20. SC/H Phase
0° \pm 5°
21. Luminance Amplitude Accuracy
 \pm 1%
22. DC Level
0 mV_{dc} \pm 50 mV_{dc}
23. Sync Amplitude
300 mV \pm 2%
24. Line Sync Duration
4.7 μ s \pm 50 ns
5.0 μ s \pm 50 ns for 2 wire BetaCam
25. Steps (5-Step) Staircase Linearity
< 1%
26. Line Time Distortion (Line Tilt)
< 0.5%
27. Ringing & K_{2T} Factor
 \leq 1% of peak & < 0.6%
28. Pulse-to-Bar Ratio
1:1 \pm 1%
29. Sine Squared Pulse Accuracy
HADs accurate within 25 ns
30. Horizontal Sync Duration, Vertical Serration Duration, & Equalizing Pulse Duration
Sync = 4.7 μ s \pm 50 ns
Vertical Serration = 4.7 μ s \pm 50 ns
Equalizing Pulse = 2.35 μ s \pm 50 ns
31. Chrominance Amplitude
 \pm 1%
32. Burst Amplitude
300 mV_{p-p} \pm 2%
33. Burst Rise Times
350 ns \pm 35 ns
34. Chrominance Rise Times
350 ns \pm 35 ns

Y Channel (Luminance) Output

C Channel (Chrominance)

B-Y Signals

35. B-Y DC Level
0 mV_{dc} \pm 50 mV_{dc}

TSG 131A — PERFORMANCE CHECK AND ADJUSTMENT PROCEDURE

- 36. B-Y Ringing & K_{2T} Factor
 $\leq 1\%$ of peak & $< 0.6\%$
- 37. B-Y Rise Times
350 ns \pm 35 ns
- 38. B-Y Sine Squared Pulse Accuracy
HADs accurate within 25 ns
- 39. Frequency Response
Flat to 3.0 MHz \pm 1%

R-Y Signals

- 40. R-Y DC Level
0 mV_{dc} \pm 50 mV_{dc}
- 41. R-Y Ringing & K_{2T} Factor
 $\leq 1\%$ of peak & $< 0.6\%$
- 42. R-Y Rise Times
350 ns \pm 35 ns
- 43. R-Y Sine Squared Pulse Accuracy
HADs accurate within 25 ns
- 44. Frequency Response
Flat to 3.0 MHz \pm 1%

Green Channel

NOTE

Before using the GBR signal format, check that the Green Channel has sync enabled. (It can be disabled in some options.) If there is no sync on the Green signal, move jumper J123 to the 2-3 position.

- 45. Green Frequency Response
Flat to 6.0 MHz \pm 2%
- 46. Sync Amplitude
300.0 mV \pm 1%

Blue Channel

- 47. Blue Gain
 $\pm 1\%$
- 48. Blue Frequency Response
Flat to 6.0 MHz \pm 2%
- 49. Blue Staircase Linearity
 $< 1\%$

- 50. Line Tilt
 $\pm 0.5\%$
- 51. Pulse-to-Bar Ratio
1:1 \pm 1%

Red Channel

- 52. Red Frequency Response
Flat to 6.0 MHz \pm 2%
- 53. Staircase Linearity
 $\leq 1\%$
- 54. Red Gain
 $\pm 1\%$
- 55. Line Tilt
 $\pm 0.5\%$
- 56. Pulse-to-Bar Ratio
1:1 \pm 1%

Inter-Channel Timing & Amplitude

- 57. Y to B-Y Timing
within 5 ns
- 58. Y to R-Y Timing
within 5 ns
- 59. GBR Amplitude Matching
 $\pm 0.5\%$

Audio Outputs

- 60. Total Harmonic Distortion

BLACK BURST Output Opt. 02 & 03 only

- 61. BLACK BURST Amplitude
0 mV \pm 50 mV

Color Flag Reference Pulse Option 03 Only

- 62. Amplitude & Position

**TSG 131A — PERFORMANCE CHECK AND
ADJUSTMENT PROCEDURE**

**Composite Sync
Option 02, 03, & 04 Only**

63. Timing
Horizontal Sync $4.7 \mu\text{s} \pm 100 \text{ ns}$
Vertical Serrations $4.7 \mu\text{s} \pm 100 \text{ ns}$
Equalizing Pulses $2.35 \mu\text{s} \pm 100 \text{ ns}$
64. Amplitude
Opts 2 & 3 (If set for
Comp Sync) $-2.0 \text{ V} \pm 0.4 \text{ V}$.
Opt 4 $>2.8 \text{ V (Hi) to } 0.2 \pm 0.2 \text{ V (Lo)}$.

65. Rise & Fall Times
 $250 \text{ ns} \pm 50 \text{ ns}$

**Color Frame Square Wave
Option 04 Only**

66. Amplitude & Position

PERFORMANCE CHECK PROCEDURES

Oscillator Frequency

The following table lists the suggested Tektronix 1781R setup for the Performance Checks.

Table 4-1. Basic setup for the 1781R.

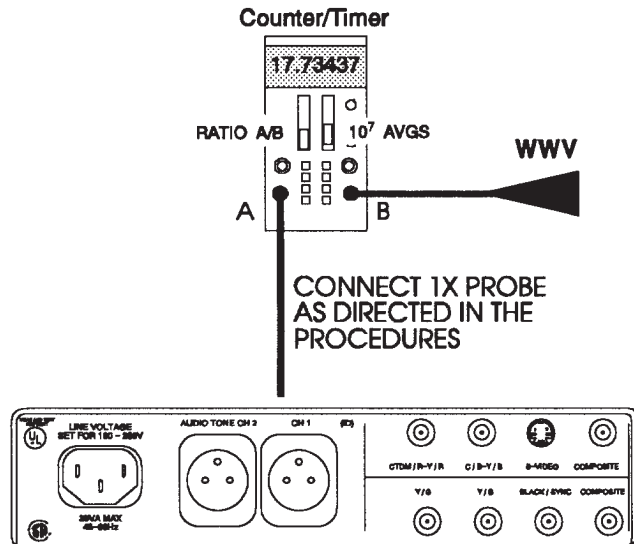

Fig. 4-1. Setup to check the crystal frequency.

1. **Oscillator Frequency**
17.734375 MHz \pm 40 Hz (\pm 20 Hz Opt. 10)

NOTE

After initial delivery or long storage, allow a two-hour warm up to re-age the crystal. Thereafter, 30 minutes warm up is sufficient.

- a. Connect the equipment as shown in Fig. 4-1, attaching the probe to W180.
- b. Set the frequency counter to count at a rate using ratio A/B.
- c. **CHECK** — that the measured oscillator frequency is 17.734375 MHz \pm 40 Hz (20 Hz if Opt. 10 is installed) at room temperature.

Configure	
Coupling	DC
Vector Grat	INT
WFM Grat	INT
ABS Units	mV
Vector Readout	ON
WFM Readout	ON
Front Panel	
Left Display	VECT
Right Display	WFM
WFM Horizontal	ONE/LINE
REF	INT
Filter	FLAT
Waveform Gain	OFF

TSG 131A — PERFORMANCE CHECK AND ADJUSTMENT PROCEDURE

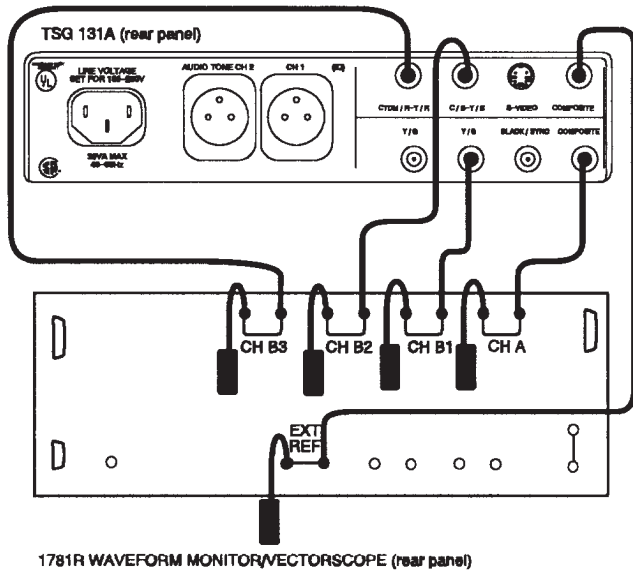

Fig. 4-2. Basic setup for the Performance Checks.

NOTE

If the TSG 131A under check has an optional Black Burst signal installed, use that signal as the waveform monitor EXT REF input.

COMPOSITE Test Signal

2. DC Level

$0 \text{ mV}_{\text{dc}} \pm 50 \text{ mV}_{\text{dc}}$

- Connect the equipment as shown in Fig. 4-2.
- Display CH A on the waveform monitor.
- Select the Steps (5-Step) signal in PAL/YC format from the TSG 131A.
- Confirm that any DC-restorer feature of the waveform monitor is off.
- Toggle the display between DC coupled and ground reference.
- Use the vertical position adjustment of the waveform monitor to set the ground line to a convenient reference graticule.
- Return to DC coupling.

h. **CHECK** — that the blanking level is on the reference graticule $\pm 50 \text{ mV}$.

3. Sync Amplitude $300 \text{ mV} \pm 30 \text{ mV}$

- Connect the test equipment as shown in Fig. 4-2.
- Display CH A on the waveform monitor.
- Select the Steps (5-Step) signal in PAL/YC format from the TSG 131A.
- With the WFM + CAL function of the measurement set match the dc level of the lower waveform to the sync tip of the upper waveform.
- CHECK** — that the sync amplitude is $300 \text{ mV} \pm 30 \text{ mV}$.

4. Burst Amplitude $300 \text{ mV} \pm 2\%$

- Connect the test equipment as shown in Fig. 4-2.
- Select any signal from the TSG 131A in the PAL/YC format.
- Display CH A on the waveform monitor in WFM + CAL mode.
- If necessary, adjust the measurement set to match the top of the lower burst to the bottom of the upper burst.
- CHECK** — for a burst amplitude of $300 \text{ mV} \pm 6 \text{ mV}$.

5. Steps (5-Step) Staircase Linearity < 1%

- Connect the test equipment as shown in Fig. 4-2.
- Display CH A on the waveform monitor.
- With the Steps (5-Step) signal selected in the PAL/YC format, set the test equipment to view the signal through the differentiated step filter.
- CHECK** — using the voltage cursors, that the difference between the highest and lowest spikes (differentiated steps) is < 1%.

TSG 131A — PERFORMANCE CHECK AND ADJUSTMENT PROCEDURE

6. Luminance Amplitude Accuracy $\pm 1\%$

- a. Connect the test equipment as shown in Fig. 4-2.
- b. Display CH A on the waveform monitor.
- c. Select the 100% Field signal in PAL/YC format from the TSG 131A.
- d. Put the waveform monitor in WFM + CAL mode.
- e. Set the test equipment to match the top of the lower waveform with the blanking level of the upper waveform.
- f. **CHECK** — that the signal amplitude is 700 mV ± 7 mV.
- g. Note the value for use in step 8.

7. Chrominance Accuracy $\pm 1\%$

- a. Connect the test equipment as shown in Fig. 4-2. Keep the waveform monitor in WFM + CAL.
- b. Display CH A on the waveform monitor.
- c. Select the Chroma Noise signal from the TSG 131A in PAL/YC format.
- d. Adjust the test equipment to match the top of the lower waveform with the DC Level of the upper.
- e. **CHECK** — that the signal amplitude is 700 mV ± 7 mV.
- f. Note the value for use in step 8.

8. Chrominance-to-Luminance Delay and Gain ≤ 5 ns and $\pm 1\%$

- a. Connect the test equipment as shown in Fig. 4-2.
- b. Display CH A on the waveform monitor.
- c. Select the Pulse & Bar signal in PAL/YC format from the TSG 131A.
- d. Set the waveform monitor to view the bottom of the 20T modulated pulse.
- e. Use the Chroma/Luma measurement mode of the Tektronix 1781R to measure both C/Y delay and gain.

- f. **CHECK** — that the delay is < 5 ns and the gain is $< 1\%$.
- g. Compare the measured values for luminance amplitude (from part 6.) and chrominance amplitude (from part 7.)
- h. **CHECK** — that these numbers are equal within 7 mV (1%).
- i. Use whichever value is greater (from part f or part h) for the C/Y gain.

9. Line Tilt $\pm 0.5\%$

- a. Connect the test equipment as shown in Fig. 4-2.
- b. Display CH A on the waveform monitor.
- c. Select the 100% Field signal in PAL/YC format from the TSG 131A.
- d. If necessary, normalize the signal gain so that the blanking level of the waveform is on the baseline and the top of the signal passes through 1000 mV at its midpoint.
- e. Center the signal over a horizontal graticule.
- f. **CHECK** — that the line tilts no more than 0.5% (3.5 mV_{p-p}) over its length. Ignore the first and last microsecond of the bar.

10. Ringing & K_{2T} Factor $\leq 1\%$ of peak & $< 0.6\%$

- a. Connect the test equipment as shown in Fig. 4-2.
- b. With the TSG 131A's Pulse & Bar in PAL/YC format still selected, set the waveform monitor to display the bottom of the 2T pulse.
- c. **CHECK** — using the voltage cursors or graticule, that the ringing is $< 1\%$ (7 mV).
- d. Use the 1781R's special measurement feature to measure the K_{2T} Factor.
- e. **CHECK** — that the K_{2T} Factor is $< 0.6\%$.

11. Pulse-to-Bar Ratio 1:1 $\pm 1\%$

- a. Connect the test equipment as shown in Fig. 4-2.
- b. Display CH A on the waveform monitor.

TSG 131A — PERFORMANCE CHECK AND ADJUSTMENT PROCEDURE

- c. Select the Pulse & Bar signal in PAL/YC format from the TSG 131A.
- d. Set the waveform monitor to display the tip of the inverted pulse of the Pulse and Bar signal.
- e. **CHECK** — that the inverted pulse tip is within 1% of blanking level, using the WFM + CAL signal.

12. Sine Squared Pulse Accuracy HADs accurate within 25 ns

- a. Connect the test equipment as shown in Fig. 4-2.
- b. Display CH A on the waveform monitor in the line display mode.
- c. Set the waveform monitor to display the 2T pulse on the Pulse and Bar signal in PAL/YC format.
- d. Use the variable gain control to normalize the pulse to 1000 mV and use the horizontal magnification to make the pulse fill the waveform monitor display.
- e. Using the timing cursors, measure the time between the 500 mV points.
- f. **CHECK** — that the HAD of the 2T pulse is $200 \text{ ns} \pm 25 \text{ ns}$.

13. Horizontal Sync Duration, Vertical Serration Duration, & Equalizing Pulse Duration Sync = $4.7 \mu\text{s} \pm 50 \text{ ns}$ Vertical Serration = $4.7 \mu\text{s} \pm 50 \text{ ns}$ Equalizing Pulse = $2.35 \mu\text{s} \pm 50 \text{ ns}$

- a. Connect the test equipment as shown in Fig. 4-2.
- b. Display CH A on the waveform monitor.
- c. Select any signal from the TSG 131A in the PAL/YC format.
- d. Use the variable vertical gain to normalize the sync to 0 - 1000 mV.
- e. **CHECK** — that horizontal sync duration between 50% points is $4.7 \mu\text{s} \pm 50 \text{ ns}$.
- f. Set the waveform monitor to display the serrations and equalizing pulses in the vertical interval.

- g. **CHECK** — that the half-amplitude duration of the vertical serrations is $4.7 \mu\text{s} \pm 50 \text{ ns}$.
- h. **CHECK** — that the half-amplitude duration of the equalizing pulses is $2.35 \mu\text{s} \pm 50 \text{ ns}$.

14. Line Blanking Interval $12.0 \mu\text{s} \pm 0.15 \mu\text{s}$

- a. Connect the test equipment as shown in Fig. 4-2.
- b. Display CH A on the waveform monitor in 2 line mode.
- c. Select the 100% Field signal in PAL/YC format from the TSG 131A.
- d. Set the waveform monitor to display horizontal blanking.
- e. **CHECK** — that the horizontal blanking interval is $12.0 \mu\text{s} \pm 0.15 \mu\text{s}$ between the 50% points of the signal.

15. Line Sync Duration $4.7 \mu\text{s} \pm 50 \text{ ns}$

- a. Connect the test equipment as shown in Fig. 4-2.
- b. Display CH A on the waveform monitor in the line display mode.
- c. Set the waveform monitor to display the sync on any TSG 131A test signal in PAL/YC format.
- d. Use the variable gain control to normalize the sync to 700 mV and set the top and bottom of the sync to 700 and 0 mV respectively.
- e. Using the timing cursor, measure the time from the 350 mV points of the sync.
- f. **CHECK** — that the sync duration is $4.7 \mu\text{s} \pm 50 \text{ ns}$.

16. Sync Rise Times $250 \text{ ns} \pm 25 \text{ ns}$

- a. Connect the test equipment as shown in Fig. 4-2.
- b. Display CH A on the waveform monitor.
- c. Set the waveform monitor to display the sync on any TSG 131A test signal in PAL/YC format.

TSG 131A — PERFORMANCE CHECK AND ADJUSTMENT PROCEDURE

- d. Identify the 10% and 90% points of the sync transitions. This can be done with voltage cursors or graticule, and may be aided by using variable gain to normalize the sync to 1000 mV.
- e. **CHECK** — that rise time between 10% and 90% is $250 \text{ ns} \pm 25 \text{ ns}$, using the timing cursors.

17. Luminance Rise Times $250 \text{ ns} \pm 25 \text{ ns}$

- a. Connect the test equipment as shown in Fig. 4-2.
- b. Set the TSG 131A to output the 100% Field signal in the PAL/YC format.
- c. Display CH A on the waveform monitor.
- d. Set the waveform monitor to display the rise from 0 - 1000 mV.
- e. Use the variable vertical gain to normalize the signal to 0 - 1000 mV and use the horizontal magnification to display the rise on the waveform monitor.
- f. Use the timing cursors to measure the rise time from the 100 mV graticule (10%) to the 900 mV graticule (90%).
- g. **CHECK** — that rise time is between $250 \text{ ns} \pm 25 \text{ ns}$.

18. Frequency Response Flat to 6.0 MHz $\pm 2\%$

- a. Connect the test equipment as shown in Fig. 4-2.
- b. Display CH A on the waveform monitor.
- c. Select the Sweep signal in PAL/YC format from the TSG 131A.
- d. **CHECK** — that the Sweep flat within 2% to 6.0 MHz.

19. Differential Phase and Gain 0.5° & 0.7% maximum

- a. Connect the test equipment as shown in Fig. 4-2.
- b. Display CH A on the waveform monitor using internal reference.

- c. Select the Mod Ramp signal in PAL/YC format from the TSG 131A.
- d. Set the 1781R to measure differential phase. (Use the double trace method, if possible.)
- e. **CHECK** — for differential phase of $\leq 0.5^\circ$.
- f. Set the test equipment to measure differential gain. (Again, use a double trace, if possible.)
- g. **CHECK** — that the differential gain of the modulated ramp is $\leq 0.7\%$.

20. SC/H Phase $0^\circ \pm 5^\circ$

NOTE

Accurate SC/H measurements may be difficult without test equipment having modes intended for that purpose. The SC/H phase error in TSG 131A test signals is typically less than 1° .

- a. Connect the test equipment as shown in Fig. 4-2.
- b. Display CH A on the waveform monitor using **internal reference**. (Internal reference is necessary for this measurement to measure the absolute SC/H phase of the signal instead of the SC/H relative to the external reference.)
- c. Select any test signal in PAL/YC format from the TSG 131A.
- d. Confirm that the measurement set is internally referenced and set it to display the SC/H phase of the signal.
- e. **CHECK** — that the SC/H phase error is $< 5^\circ$.
- f. Return the waveform monitor to external reference.

Y Channel (Luminance) Output

21. Luminance Amplitude Accuracy $\pm 1\%$

- a. Connect the test equipment as shown in Fig. 4-2.
- b. Display CH B1 on the waveform monitor.

TSG 131A — PERFORMANCE CHECK AND ADJUSTMENT PROCEDURE

- c. Select the 100% Field signal in PAL/YC format from the TSG 131A.
- d. With the WFM + CAL function of the measurement set match the top of the lower 100% Field waveform with the blanking level of the upper waveform.
- e. **CHECK** — that the 100% Field amplitude is $700\text{ mV} \pm 7\text{ mV}$ (1%).

22. DC Level

0 mV_{dc} ± 50 mV_{dc}

- a. Connect the equipment as shown in Fig. 4-2.
- b. Display CH B1 on the waveform monitor.
- c. Select the Steps (5-Step) signal in PAL/YC format from the TSG 131A.
- d. Confirm that any DC-restorer feature of the monitor or oscilloscope is off.
- e. Toggle the display between DC coupled and ground reference.
- f. Use the vertical position adjustment of the waveform monitor to set the ground line to a convenient reference graticule.
- g. Switch back to DC coupling.
- h. **CHECK** — that the blanking level is on the reference graticule $\pm 50\text{ mV}$.

23. Sync Amplitude

300 mV ± 1%

- a. Connect the test equipment as shown in Fig. 4-2.
- b. Display CH B1 on the waveform monitor.
- c. Select any signal from the TSG 131A in the PAL/YC format.
- d. Using the WFM + CAL, match the signal level of the lower waveform to the sync tip of the upper waveform.
- e. **CHECK** — that the sync amplitude is $300\text{ mV} \pm 1\%$.
- f. Select the 0% Field from the TSG 131A in the Y/CTDM format.
- g. Using the WFM + CAL, match the blanking level of the lower waveform to the sync tip of the upper waveform.

- h. **CHECK** — that the sync amplitude is $300\text{ mV} \pm 1\%$.
- i. Select the 0% Field from the TSG 131A in the Y, B-Y, R-Y format.
- j. Using the WFM + CAL, match the signal level of the lower waveform to the sync tip of the upper waveform.
- k. **CHECK** — that the sync amplitude is $300\text{ mV} \pm 1\%$.

24. Line Sync Duration

4.7 μs ± 50 ns

5.0 μs ± 50 ns for 2 wire BetaCam

- a. Connect the test equipment as shown in Fig. 4-2.
- b. Display CH B1 on the waveform monitor in the line display mode.
- c. Set the waveform monitor to display the sync on any TSG 131A test signal in the PAL/YC mode.
- d. Use the variable gain control to normalize the sync to 1000 mV and set the top and bottom of the sync to 1000 and 0 mV respectively.
- e. Using the timing cursor, measure the time from the 50% (500 mV graticule) points of the sync.
- f. **CHECK** — that the sync duration is $4.7\text{ μs} \pm 50\text{ ns}$.

NOTE

Only do the rest of these steps (g through j) if the instrument is standard or one of the BetaCam options is installed.

- g. Set the waveform monitor to display the sync on any TSG 131A test signal in the Y/CTDM mode using internal reference.
- h. Use the variable gain control to normalize the sync to 1000 mV and set the top and bottom of the sync to 1000 and 0 mV respectively.
- i. Using the timing cursor, measure the time from the 50% (500 mV graticule) points of the sync.
- j. **CHECK** — that the sync duration is $5.0\text{ μs} \pm 50\text{ ns}$.

TSG 131A — PERFORMANCE CHECK AND ADJUSTMENT PROCEDURE

25. Steps (5-Step) Staircase Linearity < 1%

- a. Connect the test equipment as shown in Fig. 4-2.
- b. Display CH B1 on the waveform monitor.
- c. Select the Steps (5-Step) signal in PAL/YC format. Set the test equipment to view the Y output through the Differentiated Step filter.
- d. **CHECK** — using the voltage cursors, that the difference between the highest and lowest spikes (differentiated steps) is no greater than 1%.

26. Line Time Distortion (Line Tilt) < 0.5%

- a. Connect the test equipment as shown in Fig. 4-2.
- b. Display CH B1 on the waveform monitor.
- c. Select the 100% Field signal from the TSG 131A in PAL/YC format.
- d. Normalize the signal gain so that the blanking level of the waveform is on the baseline and the top of the signal passes through 1000 mV at the midpoint of the line tilt.
- e. Center the bar horizontally over a graticule.
- f. **CHECK** — that the signal tilts no more than 0.5% (3.5 mV absolute or 5 mV graticule) over its length. Ignore the first and last microsecond of the signal.

27. Ringing & K_{2T} Factor $\leq 1\%$ of peak & < 0.6%

- a. Connect the test equipment as shown in Fig. 4-2.
- b. Display CH B1 on the waveform monitor.
- c. Select the Pulse & Bar signal in PAL/YC format from the TSG 131A.
- d. Normalize the signal gain so that the blanking level of the waveform is on the baseline and the top of the 2T pulse is at 1000 mV
- e. Set the equipment to display the bottom of the 2T pulse at line rate.
- f. **CHECK** — with voltage cursors or graticule that ringing is < 1% (7 mV peak).

- g. Use the special measurement mode of the 1781R to measure the K_{2T} Factor.
- h. **CHECK** — that the K_{2T} Factor is < 0.6%.

28. Pulse-to-Bar Ratio 1:1 $\pm 1\%$

- a. Connect the test equipment as shown in Fig. 4-2.
- b. Display CH B1 on the waveform monitor.
- c. Set the waveform monitor to display the tip of the inverted pulse of the Pulse & Bar with signal in PAL/YC format.
- d. **CHECK** — that the inverted pulse tip is within 1% (7 mV) of blanking level, using the WFM+CAL signal.

29. Sine Squared Pulse Accuracy HADs accurate within 25 ns

- a. Connect the test equipment as shown in Fig. 4-2.
- b. Display CH B1 on the waveform monitor in the line display mode using internal reference.
- c. Set the waveform monitor to display the 2T pulse on the T Pulses signal in Y, B-Y, R-Y format.
- d. Use the variable gain control to normalize the pulse to 1000 mV and use the horizontal magnification to make the pulse fill the waveform monitor display.
- e. Using the timing cursors, measure the time between the 50% points (500 mV graticule).
- f. **CHECK** — that the HAD of the 2T pulse is 200 ns \pm 25 ns.
- g. Set the waveform monitor to display the 3T pulse on the T Pulses signal in Y, B-Y, R-Y format.
- h. Use the variable gain control to normalize the pulse to 1000 mV and use the horizontal magnification to make the pulse fill the waveform monitor display.
- i. Using the timing cursors, measure the time between the 50% points (500 mV graticule).
- j. **CHECK** — that the HAD of the 3T pulse is 300 ns \pm 25 ns.

TSG 131A — PERFORMANCE CHECK AND ADJUSTMENT PROCEDURE

- k. Set the waveform monitor to display the 5T pulse on the T Pulses signal in Y, B-Y, R-Y format.
- l. Use the variable gain control to normalize the pulse to 1000 mV and use the horizontal magnification to make the pulse fill the waveform monitor display.
- m. Using the timing cursors, measure the time between the 50% points (500 mV graticule).
- n. **CHECK** — that the HAD of the 5T pulse is $500 \text{ ns} \pm 25 \text{ ns}$.

30. Horizontal Sync Duration, Vertical Serration Duration, & Equalizing Pulse Duration

Sync = $4.7 \mu\text{s} \pm 50 \text{ ns}$
Vertical Serration = $4.7 \mu\text{s} \pm 50 \text{ ns}$
Equalizing Pulse = $2.35 \mu\text{s} \pm 50 \text{ ns}$

- a. Connect the test equipment as shown in Fig. 4-2.
- b. Select any signal in the PAL/YC format.
- c. Display CH B1 on the waveform monitor.
- d. **CHECK** — that horizontal sync duration between 50% points is $4.7 \mu\text{s} \pm 50 \text{ ns}$.
- e. Set the waveform monitor to display the serrations and equalizing pulses in the vertical interval.
- f. **CHECK** — that the half-amplitude duration of the vertical serrations is $4.7 \mu\text{s} \pm 50 \text{ ns}$.
- g. **CHECK** — that the half-amplitude duration of the equalizing pulses is $2.35 \mu\text{s} \pm 50 \text{ ns}$.

C Channel (Chrominance)

31. Chrominance Amplitude $\pm 1\%$

- a. Connect the test equipment as shown in Fig. 4-2.
- b. Display CH B2 on the waveform monitor using external reference.
- c. Select Chroma Noise signal in PAL/YC format from the TSG 131A.
- d. Using the WFM + CAL, adjust the waveform to match the top of the lower waveform with the bottom of the upper.

- e. **CHECK** — that the chrominance amplitude is $700 \text{ mV}_{\text{p-p}} \pm 7 \text{ mV}$ (1%)

32. Burst Amplitude $300 \text{ mV}_{\text{p-p}} \pm 2\%$

- a. Connect the test equipment as shown in Fig. 4-2.
- b. Display CH B2 on the waveform monitor using external reference.
- c. Select any test signal in the PAL/YC format.
- d. Use the WFM + CAL feature to match the top of the lower burst with the bottom of the upper.
- e. **CHECK** — that burst amplitude is $300 \text{ mV}_{\text{p-p}} \pm 2\%$.

33. Burst Rise Times $350 \text{ ns} \pm 35 \text{ ns}$

- a. Connect the test equipment as shown in Fig. 4-2.
- b. Set the TSG 131A to output the any signal in the PAL/YC format.
- c. Display CH B2 on the waveform monitor using external reference.
- d. Set the waveform monitor to display the burst on the B2 channel.
- e. Use the variable vertical gain to normalize the burst to 1000 mV and use the horizontal magnification to display the rise on the waveform monitor.
- f. Use the timing cursors to measure the rise time of the burst envelope from the 450/550 mV graticule (10%) to the 50/950 mV graticule (90%).
- g. **CHECK** — that rise time is $350 \text{ ns} \pm 35 \text{ ns}$.

34. Chrominance Rise Times $350 \text{ ns} \pm 35 \text{ ns}$

- a. Connect the test equipment as shown in Fig. 4-2.
- b. Set the TSG 131A to output the Chroma Noise signal in the PAL/YC format.
- c. Display CH B2 on the waveform monitor using external reference.

TSG 131A — PERFORMANCE CHECK AND ADJUSTMENT PROCEDURE

- d. Set the waveform monitor to display the rise on the B2 channel.
- e. Use the variable vertical gain to normalize the rise to 1000 mV and use the horizontal magnification to display the rise on the waveform monitor.
- f. Use the timing cursors to measure the rise time of the chrominance envelope from the 450/550 mV graticule (10%) to the 50/950 mV graticule (90%).
- g. **CHECK** — that rise time is $350 \text{ ns} \pm 35 \text{ ns}$.

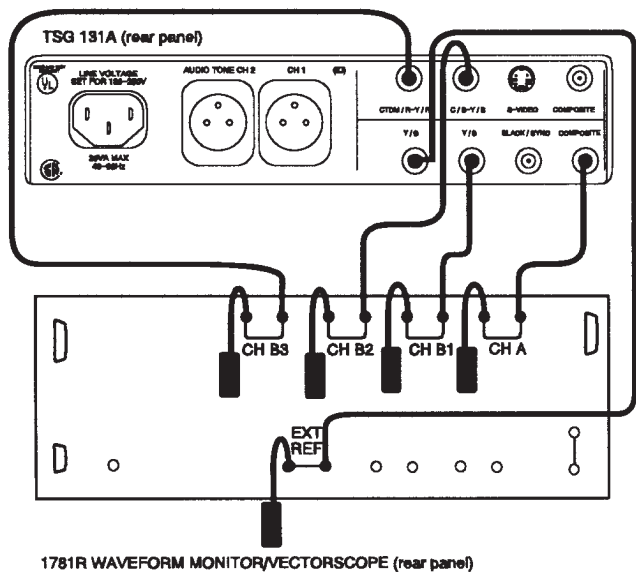

Fig. 4-3.

Setup for the rest of the standard Performance Checks. Note that the EXT REF cable has been moved to the Y/G output.

NOTE

If the TSG 131A under check has an optional Black Burst signal installed, use that signal as the waveform monitor EXT REF input (and no change in setup is required).

B-Y Signals

35. B-Y DC Level

$0 \text{ mV}_{\text{dc}} \pm 50 \text{ mV}_{\text{dc}}$

- a. Connect the equipment as shown in Fig. 4-3.
- b. Display CH B2 on the waveform monitor using external reference.
- c. Select any signal from the TSG 131A in Y, B-Y, R-Y format.
- d. Toggle the display between DC coupled and ground reference.
- e. Use the vertical position adjustment of the waveform monitor to set the ground line to a convenient reference graticule.
- f. Return to DC coupling.
- g. **CHECK** — that the blanking level is on the reference graticule $\pm 50 \text{ mV}$.

36. B-Y Ringing & K_{2T} Factor

$\leq 1\% \text{ of peak} \ \& \ < 0.6\%$

- a. Connect the test equipment as shown in Fig. 4-3.
- b. Display CH B2 on the waveform monitor using external reference.
- c. With the Y, B-Y, R-Y format and the T Pulses test signal selected, display the base of the smallest pulse with horizontal magnification to view the ringing.
- d. **CHECK** — that the ringing is $\leq 1\%$.
- e. Use the internal measurement mode of the 1781R to measure the K_{2T} Factor.
- f. **CHECK** — that the K_{2T} Factor is $< 0.6\%$.

37. B-Y Rise Times

$350 \text{ ns} \pm 35 \text{ ns}$

- a. Connect the test equipment as shown in Fig. 4-3.
- b. Set the TSG 131A to output the T Pulses signal in the Y, B-Y, R-Y format.
- c. Display CH B2 on the waveform monitor using external reference.
- d. Set the waveform monitor to display the rise on the bar on the B2 channel (B-Y).

TSG 131A — PERFORMANCE CHECK AND ADJUSTMENT PROCEDURE

- e. Use the variable vertical gain to normalize the signal to 1000 mV and use the horizontal magnification to display the rise of the bar on the waveform monitor.
- f. Use the timing cursors to measure the rise time of the bar from the 100 mV graticule (10%) to the 900 mV graticule (90%).
- g. **CHECK** — that the rise time is $350 \text{ ns} \pm 35 \text{ ns}$.

38. B-Y Sine Squared Pulse Accuracy HADs accurate within 25 ns

- a. Connect the test equipment as shown in Fig. 4-3.
- b. Display CH B2 on the waveform monitor in the line display mode using external reference.
- c. Set the waveform monitor to display the 4T pulse on the T Pulses signal in Y, B-Y, R-Y format.
- d. Use the variable gain control to normalize the pulse to 1000 mV and use the horizontal magnification to make the pulse fill the waveform monitor display.
- e. Using the timing cursors, measure the time between the 50% points (500 mV graticule).
- f. **CHECK** — that the HAD of the 4T pulse is $400 \text{ ns} \pm 25 \text{ ns}$.
- g. Set the waveform monitor to display the 8T pulse on the T Pulses signal in Y, B-Y, R-Y format.
- h. Use the variable gain control to normalize the pulse to 1000 mV and use the horizontal magnification to make the pulse fill the waveform monitor display.
- i. Using the timing cursors, measure the time between the 50% points.
- j. **CHECK** — that the HAD of the 8T pulse is $800 \text{ ns} \pm 25 \text{ ns}$.

39. Frequency Response Flat to 3.0 MHz $\pm 1\%$

- a. Connect the equipment as shown in Fig. 4-3.
- b. Display CH B2 on the waveform monitor, using external reference.

- c. Select the Multiburst signal in Y, B-Y, R-Y format.
- d. **CHECK** — that the packets are flat within 1% out to 3.0 MHz.

R-Y Signals

40. R-Y DC Level $0 \text{ mV}_{\text{dc}} \pm 50 \text{ mV}_{\text{dc}}$

- a. Connect the equipment as shown in Fig. 4-3.
- b. Display CH B3 on the waveform monitor using external reference.
- c. Select any signal from the TSG 131A in the Y, B-Y, R-Y format.
- d. Toggle the display between DC coupled and ground reference.
- e. Use the vertical position adjustment of the waveform monitor to set the ground line to a convenient reference graticule.
- f. Return to DC coupling.
- g. **CHECK** — that the blanking level is on the reference graticule $\pm 50 \text{ mV}$.

41. R-Y Ringing & K_{2T} Factor $\leq 1\% \text{ of peak} \ \& \ < 0.6\%$

- a. Connect the test equipment as shown in Fig. 4-3.
- b. Display CH B3 on the waveform monitor using external reference.
- c. Select Y, B-Y, R-Y format and the T Pulse test signal from the TSG 131A.
- d. Display the base of the first pulse with horizontal magnification to view the ringing.
- e. **CHECK** — that the ringing is $\leq 1\%$ of peak.
- f. Use the internal measurement mode of the 1781R to measure the K_{2T} Factor.
- g. **CHECK** — that the K_{2T} Factor is $< 0.6\%$.

42. R-Y Rise Times $350 \text{ ns} \pm 35 \text{ ns}$

- a. Connect the test equipment as shown in Fig. 4-3.

TSG 131A — PERFORMANCE CHECK AND ADJUSTMENT PROCEDURE

- b. Set the TSG 131A to output the T Pulses signal in the Y, B-Y, R-Y format.
- c. Display CH B3 on the waveform monitor using external reference.
- d. Set the waveform monitor to display the rise on the bar on the B3 channel (R-Y).
- e. Use the variable gain to normalize the signal to 1000 mV
- f. Use the timing and voltage cursors to measure the rise time from the 10% to 90% points.
- g. **CHECK** — that the rise time is $350 \text{ ns} \pm 35 \text{ ns}$.

43. R-Y Sine Squared Pulse Accuracy HADs accurate within 25 ns

- a. Connect the test equipment as shown in Fig. 4-3.
- b. Display CH B3 on the waveform monitor in the line display mode using external reference.
- c. Set the waveform monitor to display the 4T pulse on the T Pulses signal in Y, B-Y, R-Y format.
- d. Use the variable gain control to normalize the pulse to 1000 mV and use the horizontal magnification to make the pulse fill the waveform monitor display.
- e. Using the timing cursors, measure the time between the 50% points (500 mV graticule).
- f. **CHECK** — that the HAD of the 4T pulse is $400 \text{ ns} \pm 25 \text{ ns}$.
- g. Set the waveform monitor to display the 8T pulse on the T Pulses signal in Y, B-Y, R-Y format.
- h. Use the variable gain control to normalize the pulse to 1000 mV and use the horizontal magnification to make the pulse fill the waveform monitor display.
- i. Using the timing cursors, measure the time between the 50% points.
- j. **CHECK** — that the HAD of the 8T pulse is $800 \text{ ns} \pm 25 \text{ ns}$.

44. Frequency Response Flat to 3.0 MHz $\pm 1\%$

- a. Connect the equipment as shown in Fig. 4-3.

- b. Display CH B3 on the waveform monitor, using external reference.
- c. Select the Multiburst signal in Y, B-Y, R-Y format.
- d. **CHECK** — that the packets are flat within 1% out to 3.0 MHz.

Green Channel

NOTE

Before using the GBR signal format, check that the Green Channel has sync enabled. (It can be disabled in some options.) If there is no sync on the Green signal, move jumper J150 to the 1-2 position.

45. Green Frequency Response Flat to 6.0 MHz $\pm 2\%$

- a. Connect the test equipment as shown in Fig. 4-3.
- b. Display CH B1 on the waveform monitor.
- c. Select the Sweep signal from the TSG 131A in GBR format.
- d. **CHECK** — using the WFM + CAL function, that the signal amplitude is flat within 2% to 6.0 MHz.

46. Sync Amplitude 300.0 mV $\pm 1\%$

- a. Connect the test equipment as shown in Fig. 4-3.
- b. Display CH B1 on the waveform monitor.
- c. Select any signal from the TSG 131A in the GBR format.
- d. Using the WFM + CAL, match the signal level of the lower waveform to the sync tip of the upper waveform.
- e. **CHECK** — that the sync amplitude is $300.0 \text{ mV} \pm 1\%$.

TSG 131A — PERFORMANCE CHECK AND ADJUSTMENT PROCEDURE

Blue Channel

47. Blue Gain

$\pm 1\%$

- Connect the test equipment as shown in Fig. 4-3.
- Display CH B2 on the waveform monitor using external reference.
- Select GBR format and the Blue Field test signal from the TSG 131A.
- Use the WFM + CAL feature to match the top of the lower waveform with the bottom of the upper.
- CHECK** — that signal amplitude is 700 mV_{p-p} ± 7 mV (1%).

48. Blue Frequency Response

Flat to 6.0 MHz $\pm 2\%$

- Connect the test equipment as shown in Fig. 4-3.
- Display CH B2 on the waveform monitor using external reference.
- Select GBR format and the Sweep test signal from the TSG 131A.
- Use the WFM + CAL feature to match the top of the lower waveform with the bottom of the upper.
- CHECK** — that the sweep portion of the signal is flat within 2% out to 6.0 MHz.

49. Blue Staircase Linearity

$< 1\%$

- Connect the test equipment as shown in Fig. 4-3.
- Display CH B2 on the waveform monitor using external reference.
- Select GBR format and the Steps (10-Step) test signal from the TSG 131A.
- Set the test equipment to view the signal through a differentiated step filter.
- CHECK** — using the voltage cursors, that the upward spikes (differentiated steps) are equal within 1%.

50. Line Tilt

$\pm 0.5\%$

- Connect the test equipment as shown in Fig. 4-3.
- Display channel B2 on the waveform monitor using external reference.
- Select the Blue Field signal from the TSG 131A in the GBR format.
- Normalize the signal gain so that the blanking level of the waveform is on the baseline and the top of the signal passes through 1000 mV at its midpoint.
- Center the signal over a horizontal graticule, if the monitor has one.
- CHECK** — that the line tilts no more than 0.5% (3.5 mV absolute or 5 mV using the graticule) over its length. Ignore the first and last microsecond of the bar.

51. Pulse-to-Bar Ratio

1:1 $\pm 1\%$

- Connect the test equipment as shown in Fig. 4-3.
- Display CH B2 on the waveform monitor using external reference.
- Set the TSG 131A to output the Pulse & Bar signal in the GBR format.
- Set the waveform monitor to display the tip of the inverted pulse of the Pulse & Bar signal.
- CHECK** — that the inverted pulse tip is within 1% of the 0 mV reference graticule, using the WFM + CAL signal.

Red Channel

52. Red Frequency Response

Flat to 6.0 MHz $\pm 2\%$

- Connect the test equipment as shown in Fig. 4-3.
- Display CH B3 on the waveform monitor using external reference.
- Select GBR format and the Sweep test signal from the TSG 131A.

- d. Use the WFM + CAL feature to match the top of the lower waveform with the bottom of the upper.
- e. **CHECK** — that the sweep portion of the signal is flat within 2% out to 6.0 MHz.

53. Staircase Linearity

≤ 1%

- a. Connect the test equipment as shown in Fig. 4-3.
- b. Display CH B3 on the waveform monitor using external reference.
- c. Select GBR format and the Steps (10-Step) test signal from the TSG 131A.
- d. Set the test equipment to view the signal through a differentiated step filter.
- e. **CHECK** — that the upward spikes (differentiated steps) are equal within 1%.

54. Red Gain

± 1%

- a. Connect the test equipment as shown in Fig. 4-3.
- b. Display CH B3 on the waveform monitor using external reference.
- c. Select GBR format and Red Field test signal from the TSG 131A.
- d. Use the WFM + CAL to align to top of the lower waveform with the blanking level of the upper.
- e. **CHECK** — that signal amplitude is 700 mV ± 7 mV (1%).

55. Line Tilt

± 0.5%

- a. Connect the test equipment as shown in Fig. 4-3.
- b. Display channel B3 on the waveform monitor using external reference.
- c. Select the Red Field signal from the TSG 131A in GBR format.
- d. Normalize the signal gain so that blanking level of the waveform is on the baseline and the top of the signal passes through 1000 mV at its midpoint.
- e. Center the signal over a horizontal graticule, if the monitor has one.
- f. **CHECK** — that the line tilts no more than 0.5% over its length. Ignore the first and last microsecond of the bar.

56. Pulse-to-Bar Ratio

1:1 ± 1%

- a. Connect the test equipment as shown in Fig. 4-3.
- b. Display CH B3 on the waveform monitor in external reference.
- c. Set the TSG 131A to output the Pulse & Bar signal in the GBR format.
- d. Set the waveform monitor to display the tip of the inverted pulse of the Pulse & Bar signal.
- e. **CHECK** — that the inverted pulse tip is within 1% of blanking level, using the WFM + CAL signal.

TSG 131A — PERFORMANCE CHECK AND ADJUSTMENT PROCEDURE

Inter-Channel Timing & Amplitude

57. Y to B-Y Timing within 5 ns

- Connect the test equipment as shown in Fig. 4-3.
- Display CH B1-B2 on the waveform monitor using external reference.
- Select Y, B-Y, R-Y format and the Bowtie test signal from the TSG 131A.
- Use 5X waveform gain to accentuate the bowtie.
- CHECK** — that the crossover point of the bowtie falls within the 5 ns markers (see Fig. 4-4).

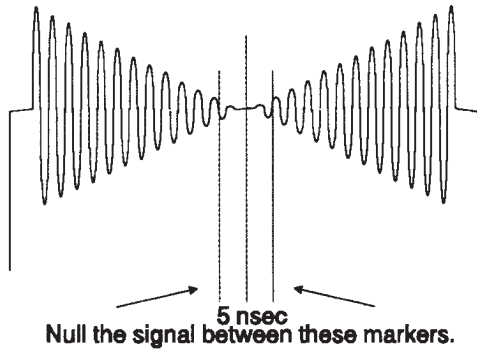

Fig. 4-4. Bowtie crossover.

58. Y to R-Y Timing within 5 ns

- Connect the test equipment as shown in Fig. 4-3.
- Display CH B1-B3 on the waveform monitor using external reference.
- Select Y, B-Y, R-Y format and the Bowtie test signal from the TSG 131A.
- Use 5X waveform gain to accentuate the bowtie.
- CHECK** — that the crossover point of the bowtie falls between the 5 ns markers (see Fig. 4-4).

59. GBR Amplitude Matching $\pm 0.5\%$

- Connect the test equipment as shown in Fig. 4-3.
- Display CH B1, B2, and B3 on the waveform monitor using external reference in overlay mode.
- Select GBR format and the 100% Bars test signal from the TSG 131A.
- Use the channel offset to set the bottom of the waveforms (active video) to the 0 mV graticule.
- Use the X5 gain to display any differences in the amplitude at the top of the signals.
- CHECK** — that the amplitude of the signals are equal within 0.5%.

AA501A DISTORTION ANALYZER

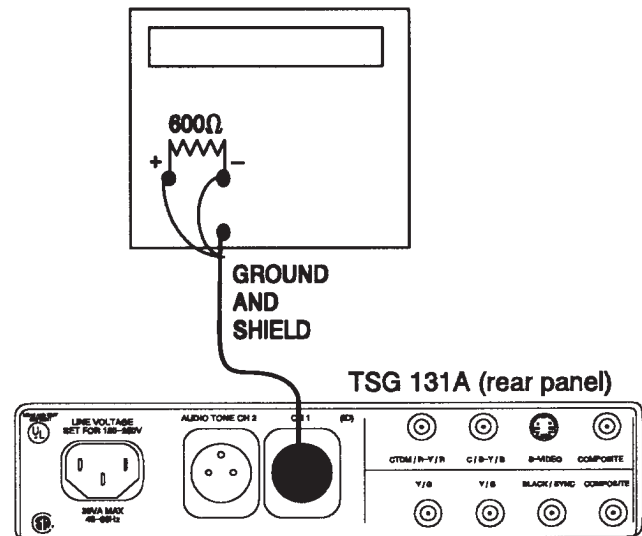

Fig. 4-5.

Setup to measure the total harmonic distortion.

Audio Output

60. Total Harmonic Distortion

- Disable the CH 1 ID click by moving jumper J12 to pins 2 and 3.

TSG 131A — PERFORMANCE CHECK AND ADJUSTMENT PROCEDURE

- b. Connect the equipment as shown in Fig. 4-5, placing a 600Ω resistor across the analyzer's + and - terminals (to represent the system load).
- c. Set the distortion analyzer to measure THD.
- d. **CHECK** — that the THD on CH 1 is $\leq 0.5\%$.
- e. Return jumper J12 to pins 1 and 2.
- f. Move the cable at the TSG 131A from audio Channel 1 to audio Channel 2.
- g. **CHECK** — that the THD on Channel 2 is $\leq 0.5\%$.

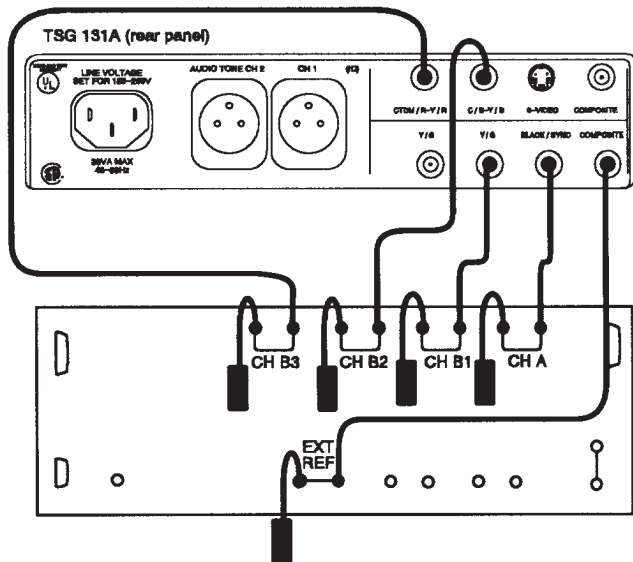

1781R WAVEFORM MONITOR/VECTORSCOPE (rear panel)

Fig. 4-6. Setup to Check the BLACK BURST output.

BLACK BURST Output Opts 2 and 3 (If set for Black Burst)

61. BLACK BURST Amplitude 0 mV \pm 50 mV

- a. Connect the equipment as shown in Fig. 4-6.
- b. Display CH A in the WFM + CAL mode.
- c. **CHECK** — that the amplitude of the signal is 0 mV \pm 50 mV.

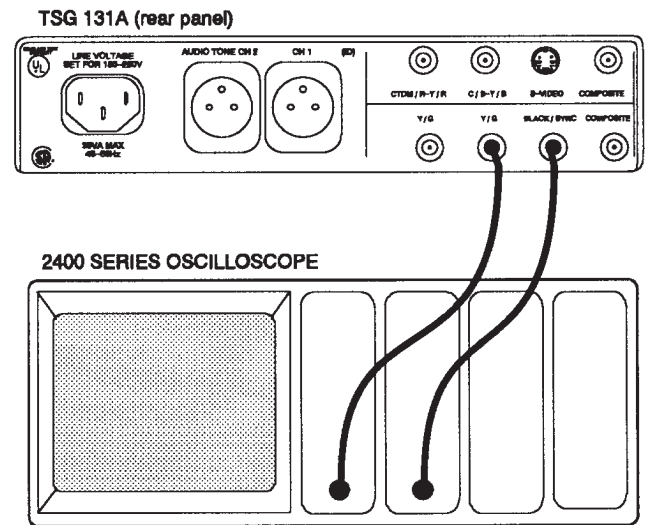

Fig. 4-7. Setup to check the pulse outputs for Options 02, 03, & 04.

Color Flag Reference Pulse Option 03 Only

62. Amplitude & Position

- a. Connect the TSG 131A BLACK/SYNC output to one of the oscilloscope inputs, using a 75Ω coax and a 75Ω feed-through terminator. Set this input to 1 or 2 V/div.
- b. Connect the left Y/G output to a second oscilloscope input. Set this input to 2 V/div.
- c. Set the oscilloscope to trigger from the BLACK/SYNC input, at a 10 ms sweep rate, displaying both inputs.
- d. **CHECK** — that there is a negative going pulse of approximately 5 V occurring on the Y/G output once every four fields, just before the F1L10 pulse on the Black Burst signal from the BLACK/SYNC output.
- e. Expand the oscilloscope horizontal to display this pulse at 100 μs/div.
- f. **CHECK** — that the color frame reference pulse is approximately 200 μs in duration, and aligns with the vertical sync pulse interval of the Black Burst signal.

TSG 131A — PERFORMANCE CHECK AND ADJUSTMENT PROCEDURE

Composite Sync Opts 2 and 3 (If set for Comp Sync) and Opt 4

63. Timing

Horizontal Sync $4.7 \mu\text{s} \pm 100 \text{ ns}$

Vertical Serrations $4.7 \mu\text{s} \pm 100 \text{ ns}$

Equalizing Pulses $2.35 \mu\text{s} \pm 100 \text{ ns}$

- Connect the equipment as shown in Fig. 4-6.
- Display CH A on the waveform monitor.
- CHECK** — that horizontal sync duration between 50% points is $4.7 \mu\text{s} \pm 100 \text{ ns}$.
- Set the waveform monitor to display the serrations and equalizing pulses in the vertical interval.
- CHECK** — that the half-amplitude duration of the vertical serrations is $4.7 \mu\text{s} \pm 100 \text{ ns}$.
- CHECK** — that the half-amplitude duration of the equalizing pulses is $2.35 \mu\text{s} \pm 100 \text{ ns}$.

64. Amplitude

-2.0 V \pm 0.4 V (Opt 2 & 3)

>2.8 V (Hi) to 0.2 \pm 0.2 V (Lo) (Opt 4)

- Connect the equipment as shown in Fig. 4-7.
- Display CH 2 on the oscilloscope.
- Set a ground reference at a convenient level.
- CHECK** — that the amplitude is as follows:
Opts 2 & 3 (If set for
Comp Sync) $-2.0 \text{ V} \pm 0.4 \text{ V}$.
Opt 4 $>2.8 \text{ V (Hi) to } 0.2 \pm 0.2 \text{ V (Lo)}$.

65. Rise & Fall Times

250 ns \pm 50 ns.

- Connect the equipment as shown in Fig. 4-7.
- Display CH 2 on the oscilloscope.
- Use the variable gain to normalize the signal to 1000 mV.
- CHECK** — that the rise and fall time, from 10% to 90%, is $250 \text{ ns} \pm 50 \text{ ns}$.

Color Frame Square Wave Option 04 Only

66. Amplitude & Position

- Connect the BLACK/SYNC output to one input of the oscilloscope and the first Y/G output to the other.
- Select the 0% Field from the TSG 131A in PAL/YC mode.
- CHECK** — that the amplitude of the Color Frame Square Wave is $>2.8 \text{ V (Hi) to } 0.2 \pm 0.2 \text{ V (Lo)}$.
- CHECK** — that the timing of the Color Frame Square Wave is low for fields 1 & 2 and high for fields 3 & 4. The transition should occur on line 11.

Adjustment Procedure Checklist

1. Oscillator Frequency — Y1
2. Audio Output Amplitude — R123 & R122
3. Audio ID Click Frequency — R126
4. Y/G Channel DC Level and Gain — R82 & R79
5. Y/G Channel Sin(x)/x Compensation — C69
6. C/B-Y/B Channel DC Level and Gain — R63 & R60
7. C/B-Y/B Channel Sin(x)/x Compensation — C47
8. CTDM/R-Y/R Channel DC Level and Gain — R101 & R98
9. CTDM/R-Y/R Channel Sin(x)/x Compensation — C99
10. Interchannel Gain Matching — R79, R60, & R98
11. COMPOSITE DC Level and Gain — R20 & R18
12. COMPOSITE Chrominance Gain — R23
13. COMPOSITE Sin(x)/x Compensation and Chroma Response — C19 & C21

NOTE

Steps 14 - 17 are interactive. Repeat them in sequence until the best possible results are obtained. If satisfactory results cannot be achieved, repeat steps 4 - 13 before returning to this sequence.

14. Inter-Channel Timing — C30 & C32
15. Chrominance-to-Luminance Delay
16. SC/H Phase
17. Channel 1 to Channel 2 Timing (Recheck)

NOTE

The following parts adjusted in steps 18 & 19 are only loaded in Options: 02 & 03.

18. Black Burst DC Level and Gain — R325 & R328
19. Black Burst Channel Sin(x)/x Compensation — C329

Adjustment Procedures

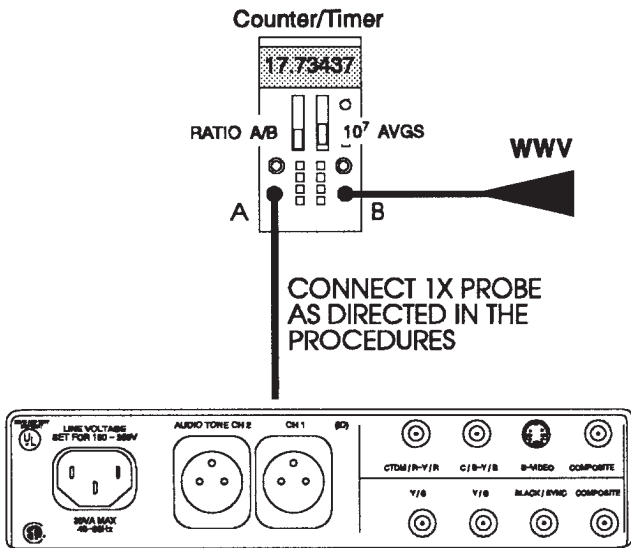

Fig. 4-8. Setup to adjust the oscillator frequency.

NOTE

After initial delivery or long storage, allow a two-hour warm up to re-age the crystal. Thereafter, a 30 minute warm up is sufficient.

1. Oscillator Frequency — Y1

- Connect the equipment as shown in Fig. 4-8. Connect the probe to W180.
- Set the DC503A to count a frequency referenced to channel B (ratio A/B).
- Remove the round plastic cap from the top of the oscillator (Y1).
- Fine-adjust the oscillator frequency to bring $4F_{sc}$ to $17.734375 \text{ MHz} \pm 40 \text{ Hz}$ (20 Hz for Opt. 10). (On Opt. 10, the oscillator adjustment may be located on the side of the oscillator can. In these cases, the front panel may need to be removed. To do this: unscrew 2 screws located on the bottom panel towards the front of the instrument and pull the front panel straight out.)
- Reinstall the plastic cap.

AA501A DISTORTION ANALYZER

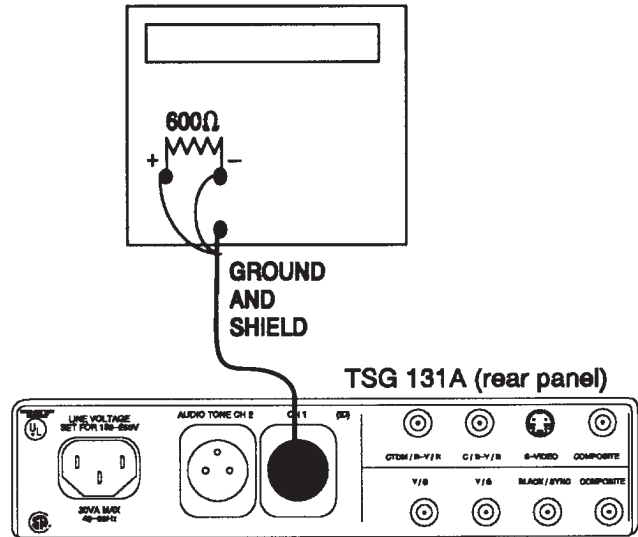

Fig. 4-9. Audio amplitude calibration setup.

2. Audio Output Amplitude — R123 & R122

- Connect the equipment as shown in Fig. 4-9 with the following AA501A (Distortion Analyzer) settings:

Table 4-2. Setup for the AA501A Distortion Analyzer.

Function	Setting
Input Level Range	Auto range
dBm Switch	In
Level Switch	In
All Filter Switches	Out

- Disable the CH 1 ID click by moving jumper J12 to pins 2 and 3.
- Adjust R123 to obtain the desired dB output for Audio 1 (factory setting is + 8 dBm).
- Return jumper J12 to the 1-2 position.

TSG 131A — PERFORMANCE CHECK AND ADJUSTMENT PROCEDURE

- e. Move the cable at the TSG 131A from audio CH 1 to audio CH 2.
- f. Adjust R122 to obtain the desired output level for Audio 2. (Factory setting is + 8 dBm.)

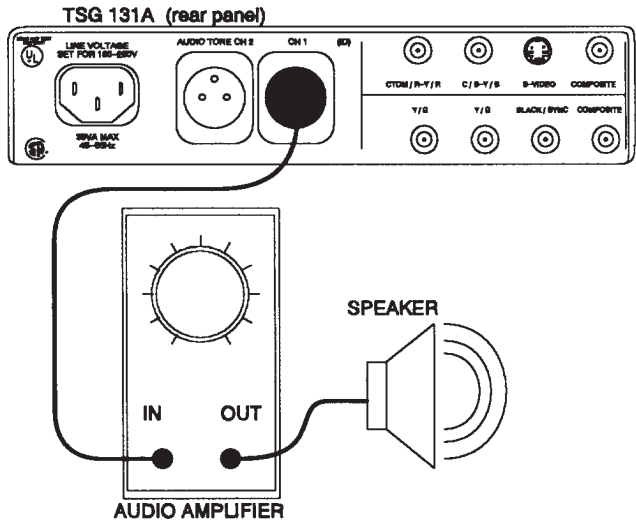

Fig. 4-10. Audio ID click frequency adjustment setup.

3. Audio ID Click Frequency — R126

- a. Connect the equipment as shown in Fig. 4-10.
- b. Adjust R126 for the desired interval between ID clicks. The range of adjustment is about 0.2- 4 seconds.

NOTE

For the remaining adjustment steps, move jumper J112 from pins 1 - 2 to pins 2 - 3. This changes the signals available through the second signal-select button when PAL/YC format is active. Instead of the 75% Bars/Red, 100% Bars/Red, and Convergence signals, the buttons select the (from top to bottom) Composite Matrix, Component Matrix, and GBR Field Square Wave diagnostic signals. See Fig. 4-11.

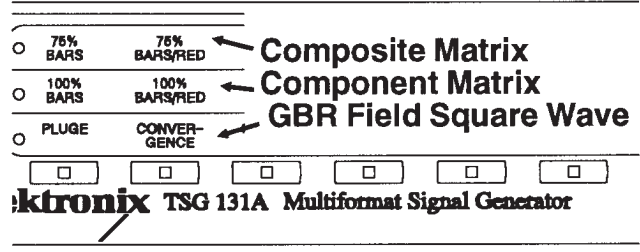

Fig. 4-11. Signals available in the diagnostic mode.

Button	Signal Name	Description
75% Bars over Red	Composite Matrix	Multiburst Pulse & Bar UK ITS 1
100% Bars over Red	Component Matrix	100% Color Bars Multiburst Pulse & Bar Bowtie 10 Step
Convergence	GBR Field Square Wave	Alterntes Black and White Between Fields.

TSG 131A — PERFORMANCE CHECK AND ADJUSTMENT PROCEDURE

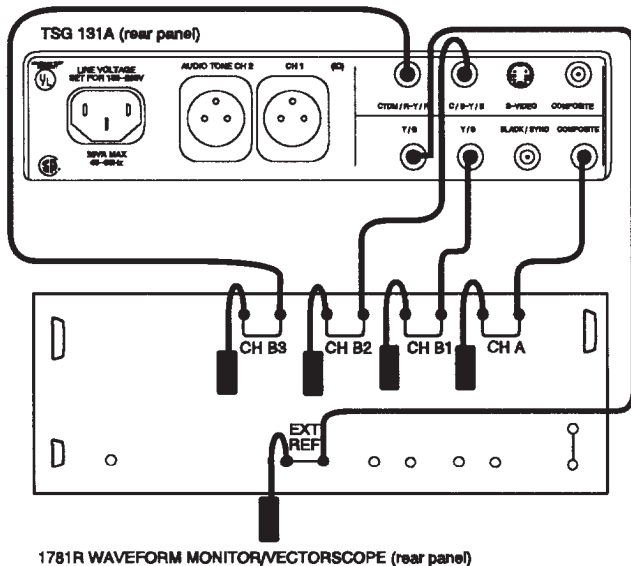

Fig. 4-12. Basic setup for the calibration procedures.

NOTE

If the TSG 131A under adjustment has an optional Black Burst signal installed, use that signal as the waveform monitor EXT REF input.

Table 4-3. Initial setup of the 1781R.

Configure	Front Panel
Coupling	DC
Left Display	VECT
Vector Grat	INT
Right Display	WFM
WFM Grat	INT
REF	EXT
ABS Units	IRE
Filter	FLAT
Vector Readout	ON
WFM Horizontal	ONE/LINE
WFM Readout	ON
Waveform Gain	X5

4. Y/G Channel DC Level and Gain — R82 & R79

- Begin with the 1781R reference setup shown in the table and select channel B1 as the input.
- Select the 0% Field signal in PAL/YC format from the TSG 131A.
- Set the 1781R to GND coupling and center the trace on a reference graticule.
- Switch to DC coupled.
- Adjust R82 for a dc level of 0 V (set the blanking level to the reference graticule).
- Select the 100% Field signal in PAL/YC format from the TSG 131A.
- Select WFM + CAL, set CAL for 700 mV.
- Adjust R79 to match the top of the lower waveform with the blanking level of the upper.
- Repeat these procedures as necessary to get satisfactory results.

5. Y/G Channel Sin(x)/x Compensation — C69

- Begin with the reference setup of the measurement set and select channel B1 as the input.
- Select the Sweep from the TSG 131A in PAL/YC format.
- Choose WFM + CAL at the 1781R and match the top of the lower sweep with the bottom of the upper.
- Adjust C69 for as flat a frequency response as possible from the beginning of the sweep out to 6.0 MHz within 2%.

6. C/B-Y/B Channel DC Level and Gain — R63 & R60

- Begin with the 1781R reference setup and display channel B2 using external reference.
- Select the 100% Bars signal in Y, B-Y, R-Y format from the TSG 131A.
- Set the 1781R to GND coupling and center the trace on a reference graticule.
- Switch to DC coupled.

TSG 131A — PERFORMANCE CHECK AND ADJUSTMENT PROCEDURE

- e. Adjust R63 for a DC Level of 0 V (set the blanking level to the reference graticule).
 - f. Select the Blue Field signal in GBR format from the TSG 131A.
 - g. Select WFM + CAL at the right display section of the 1781R, set CAL for 700 mV.
 - h. Adjust R60 to match the top of the lower waveform with the blanking level of the upper.
 - i. Repeat these steps as necessary to produce satisfactory results.
- 7. C/B-Y/B Channel Sin(x)/x Compensation — C47**
- a. Begin with the reference setup and select channel B2 as the input using external reference.
 - b. Select the Sweep in the GBR format from the TSG 131A.
 - c. Choose WFM + CAL at the 1781R and match the top of the lower sweep with the bottom of the upper; use the dual trace to aid adjustment.
 - d. Adjust C47 for as flat a frequency response as possible from the beginning of the sweep within 2% out to 6.0 MHz.
 - e. Check that the Sweep in the Y, B-Y, R-Y mode is flat within 1% out to 2.75 MHz. If not, readjust C47 to bring the signal within spec.
 - f. Recheck that the Sweep in the GBR format is still flat within 2% out to 6 MHz. If not, repeat steps d and e until both signals meet spec.
- 8. CTDM/R-Y/R Channel DC Level and Gain — R101 & R98**
- a. Begin with the 1781R reference setup and select channel B3 as the input using external reference.
 - b. Select the 100% Bars signal in GBR format from the TSG 131A.
 - c. Set the 1781R to GND coupling and center the trace on a reference graticule.
 - d. Switch to DC coupling.
 - e. Adjust R101 for a DC Level of 0 V by setting the blanking level to the reference graticule.
 - f. Select the Red Field signal in GBR format from the TSG 131A.
 - g. Select WFM + CAL at the right display section of the 1781R, set CAL for 700 mV.
 - h. Adjust R98 to match the top of the lower waveform with the blanking level of the upper.
 - i. Repeat these steps as necessary for best results.
- 9. CTDM/R-Y/R Channel Sin(x)/x Compensation — C99**
- a. Begin with the reference setup and select channel B3 as the input using external reference.
 - b. Select the Sweep in the GBR format from the TSG 131A.
 - c. Choose WFM + CAL at the 1781R and match the top of the lower sweep with the bottom of the upper; use the dual trace to aid adjustment.
 - d. Adjust C99 for as flat a frequency response as possible from the beginning of the sweep out to 6.0 MHz (within 2%).
 - e. Check that the Sweep in the Y, B-Y, R-Y mode is flat within 1% out to 2.75 MHz. If not, readjust C99 to bring the signal within spec.
 - f. Recheck that the Sweep in the GBR format is still flat within 2% out to 6 MHz. If not, repeat steps d and e until both signals meet spec.
- 10. Interchannel Matching —**
- | | |
|-----------------|-----------------------------|
| DC Level | R82, R63, & R101 |
| Gain | R79, R60, & R98 |
- a. Begin with the reference setup of the measurement set and select B1, B2, & B3 in overlay mode.
 - b. Select the 100% Bars signal in GBR format.
 - c. Set the offset to zero.
 - d. Set the vertical gain to X5 and display the blanking level of the waveform.
 - e. Set the coupling to GND and set the ground trace to a convenient graticule.
 - f. Return the coupling to dc.

TSG 131A — PERFORMANCE CHECK AND ADJUSTMENT PROCEDURE

- g. **CHECK** — that all of the blanking level are with 50 mV of each other and the reference graticule.
- h. Adjust, if necessary, the dc level to bring them into spec. (R82 for Green, R63 for Blue, and R101 for Red)
- i. Set the vertical gain to X5 and display the top of the waveform.
- j. **CHECK** — to see if all of the amplitudes are within 0.5% of each other.
- k. Adjust, if necessary, R79 for green, R60 for blue, and R98 for red to bring the amplitudes into spec.
- l. If any adjustments need to be made, repeat steps 4 -9 until these adjustment are no longer necessary.

11. COMPOSITE DC Level and Gain — R20 & R18

- a. Begin with the reference setup and select channel A as the INPUT.
- b. Select the Steps (5-Step) signal in PAL/YC format from the TSG 131A.
- c. Set the 1781R to GND coupling and center the trace on a reference graticule.
- d. Switch to DC coupling and adjust R20 for a DC Level of 0 V by setting the blanking level to the reference graticule.
- e. Select WFM + CAL at the right display section of the 1781R, set CAL for 700 mV.
- f. Adjust R18 to match the top of the lower waveform with the blanking level of the upper.
- g. Repeat these steps as necessary for best results.

12. COMPOSITE Chrominance Gain — R23

- a. Begin with the reference setup and select CH A as the INPUT.
- b. Select the Chroma Noise signal from the TSG 131A in PAL/YC format.
- c. Select WFM + CAL at the right display section of the 1781R, set CAL for 700 mV.
- d. Adjust R23 to match the bottom of the chrominance portion of the signal to blanking within 1%.

13. COMPOSITE Sin(x)/x Compensation and Chroma Response — C19 & C21

- a. Begin with the reference setup and select channel A as the input.
- b. Select the Sweep in PAL/YC format from the TSG 131A.
- c. Choose WFM + CAL at the 1781R and match the top of the lower sweep with the bottom of the upper; use the dual trace to aid adjustment.
- d. Adjust C19 for as flat a frequency response as possible from the beginning of the sweep out to 6.0 MHz (within 2%).
- e. Select any signal from the TSG 131A in PAL Y/C format.
- f. Again, use WFM + CAL to create a dual trace to aid adjustment.
- g. Set the WFM + CAL to 300 mV.
- h. Adjust C21 to match the top of the burst of the lower waveform to the bottom of the burst of the upper waveform.

NOTE

Steps 14 -17 are interactive. Repeat them in sequence until the best possible results are obtained. If satisfactory results cannot be achieved, repeat steps 4 - 13 before returning to this sequence.

14. Inter-Channel Timing — C30 & C32

- a. Begin with the reference setup of the measurement set and select B1-B2 as the input.
- b. Select the Bowtie signal in GBR format from the TSG 131A.
- c. Adjust C30 to place the crossover point of the bowtie on the center (highest amplitude) marker.
- d. Select B1-B3 as the input.
- e. Adjust C32 to center the crossover point (see Fig. 4-13).

TSG 131A — PERFORMANCE CHECK AND ADJUSTMENT PROCEDURE

- d. If the cross over point is outside the markers return to step 14. Otherwise go on to step 18.

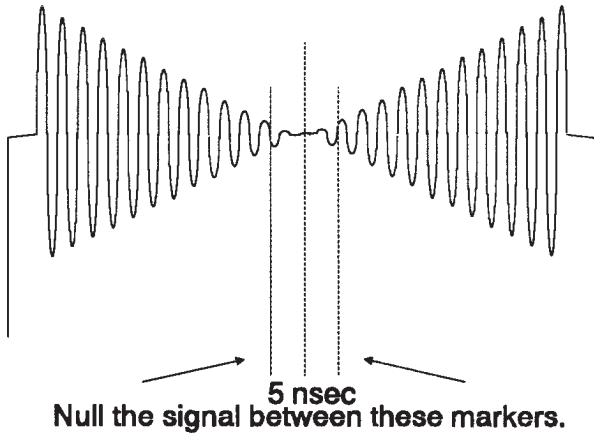

Fig. 4-13. Bowtie crossing.

15. Chrominance-to-Luminance Delay

- a. Begin with the reference setup and select channel A as the input.
- b. Select the Pulse & Bar signal in PAL/YC format from the TSG 131A.
- c. Display the bottom of the modulated pulse, using horizontal magnification to view the sine wave distortion.
- d. **CHECK** — using the 1781R's C-Y measurement feature, the chroma-to-luma delay.
- e. If the delay is > 5 ns, adjust C30 for a delay of < 5 ns.

16. SC/H Phase

- a. With channel A as the input, change the 1781R REF setting to **INT**ernal, and the LEFT DISPLAY to SC/H.
- b. **CHECK** — for and SC/H of $< 5^\circ$.
- c. If the SC/H is $> 5^\circ$, adjust C30 for an SC/H Phase difference of $< 5^\circ$.
- d. Return to EXT REF.

17. Channel 1 to Channel 2 Timing (Recheck)

- a. Change the 1781R input to B1-B2.
- b. Select the Bowtie signal from the TSG 131A.
- c. **CHECK** — that the cross over point remains in the ± 5 ns markers. (See Fig. 4-13.)

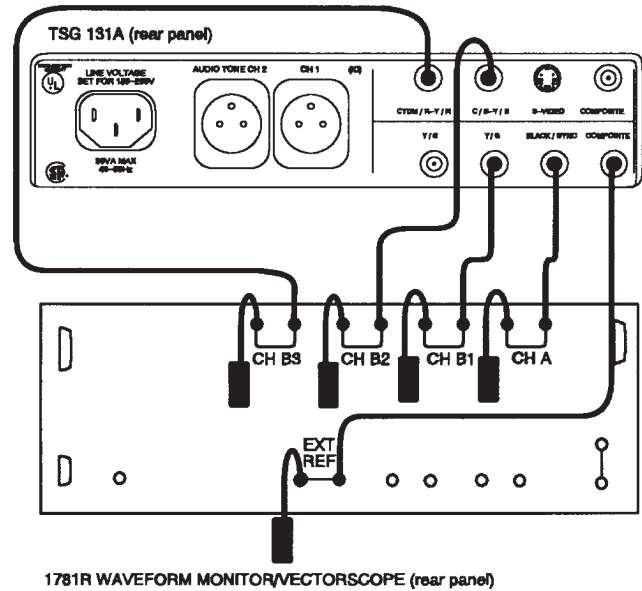

Fig. 4-14. Setup to calibrate the BLACK BURST output.

NOTE

The following parts adjusted in steps 18 & 19 are only loaded in Options: 02 and 03.

NOTE

The instrument needs to be disassembled to perform steps 18 & 19. Please check to make sure that the Black Burst signal is out of spec before disassembling the instrument to make these adjustments. See Section 5 for instructions to remove the Audio board.

18. Black Burst DC Level and Gain — R325 & R328

- a. Begin with the 1781R setup shown in Fig. 4-14 select channel A as the input.
- b. Set the 1781R to GND coupling and center the trace on a reference graticule.
- c. Switch to DC coupled.

TSG 131A — PERFORMANCE CHECK AND ADJUSTMENT PROCEDURE

- d. Adjust R325 so that the DC Level of the signal is on the reference graticule.
- e. Select WFM + CAL at the right display section of the 1781R, set CAL for 300 mV.
- f. Adjust R328 to match the top of the lower waveform's sync with the sync level of the upper waveform.
- g. Repeat these procedures as necessary to get satisfactory results.

19. Black Burst Channel Sin(x)/x Compensation — C329

- a. Begin with the reference setup and select channel A as the input.
- b. Select any signal in the PAL/YC format from the TSG 131A.
- c. Choose WFM + CAL at the 1781R and set it to 300 mV.
- d. Adjust C329 to match the burst amplitude to the WFM + CAL signal.

SECTION 5

INSTALLATION & MAINTENANCE

This section describes configuring the power supply for 110 V_{AC} operation, removing and replacing the audio board for maintenance of the circuits below it, accessing the Diagnostic signal set, and setting the internal jumpers for customized uses.

WARNING

Dangerous voltages are present in the power supply. To ensure safety, only qualified service personnel should perform the following procedures.

Selecting the Power Supply Mains Voltage

The TSG 131A is shipped from the factory configured for 220 V_{AC}, 60 Hz operation. To configure the TSG 131A for 110 V_{AC} operation, follow this procedure.

WARNING

Dangerous voltages are present in the power supply. Remove the power cord from the electrical mains supply before attempting this procedure. Failure to remove the power cord can result in life-threatening electrical shock.

1. Remove the TSG 131A power cord from the electrical mains supply.
2. Remove the instrument access cover.
3. Locate J122 near the AC line filter and power receptacle at the right rear of the main board.
4. For 220 V_{AC} instrument operation (the factory setting), the jumper should be in the 2-3-4-5 position.
5. For 110 V_{AC} instrument operation, the jumper should be in the 1-2-3-4 position.
6. Reinstall the instrument access cover.
7. **CHECK** — that the fuse is the proper value. For 220 V_{AC} operation, fuse F1 should be 0.2 Amp Med blow. For 110 V_{AC} operation the fuse should be 0.4 Amps Med blow.

Removing & Replacing the Audio Board

To Remove the Audio Board:

- a. Make sure that all connections, especially the power supply are removed from the instrument.
- b. Remove the top cover. (There are 8 Pozidrive® screws holding the top cover to the instrument.)
- c. Using Fig. 5-1 as a guide, remove one screw from the Audio board and four screws from the rear panel AUDIO TONE connectors. (Total of five screws.)
- d. Pull the two audio connectors straight out from the rear panel.
- e. Gently, slide the Audio board towards the front of the instrument until the part of the audio connectors that are soldered to the board clear the rear-panel holes.
- f. Lift the board up, flipping it over at the same time. (J128, attached to the board towards the front of the instrument, forces it to flip over revealing the component side of the board.)
- g. The adjustments for the Black Burst and Comp Sync can now be made.

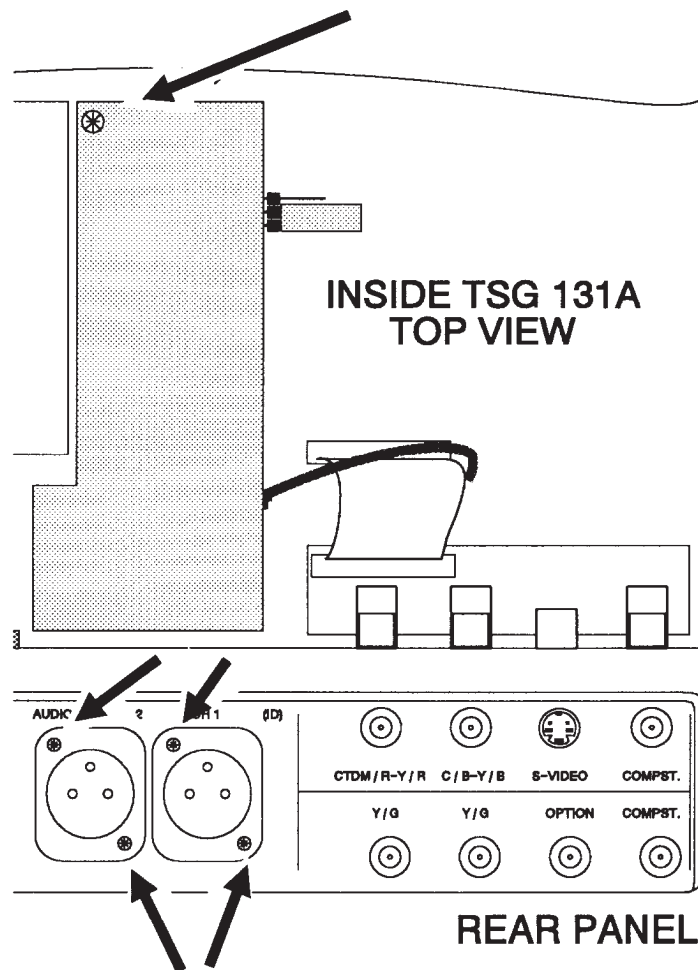

Fig. 5-1. Remove these 5 screws with a Pozidrive® screwdriver in order to take out the Audio board for adjustment of the Black Burst/Comp Sync output.

To Reassemble the Audio Board:

- h. Flip the Audio board back over so that the components are facing down.
- i. Slide the audio connectors that are soldered on the board back through the rear-panel holes.
- j. Slide the external audio connectors back through the rear-panel holes. The text on the audio connectors should be "UPSIDE DOWN".
- k. Screw the one screw on the board back in.
- l. Screw the four audio connector screws.
- m. Replace the top cover.

Special Diagnostic Signal Set

The TSG 131A has a special set of Diagnostic signals that can be accessed from the front panel. They are listed in Table 5-1.

Table 5-1. List of the Diagnostic Signals available.

Button	Signal Name	Description
75% Bars over Red	Composite Matrix	Multiburst Pulse & Bar UK ITS 1
100% Bars over Red	Component Matrix	100 Collor Bars Multiburst Pulse & Bar Bowtie 10 Step
Convergence	GBR Field Square Wave	Alterntes Black and White Between Fields.

These Diagnostic Signals replace the signals in the second row of the front panel (75% Bars over Red, 100% Bars over Red, and Convergence) when J112 is in the 2-3 position. No other signals are changed and the TSG 131A can be left in this mode if the Diagnostic signals are more useful to the operator than the standard signal set.

When the user wants the standard signal set, return J112 to the 1-2 position.

Setting the Internal Jumpers

See Table 5-2 for the available jumper functions and set the instrument according to individual needs.

Table 5-2. List of Jumpers for the TSG 131A.

JUMPER		POSITION	FUNCTION
Diagnostic Signals	J112 ②	1-2	Enables standard front panel operation.
		2-3	Allows selection of diagnostic test signals.
Black Burst F1L7 Reference	J110 ②	1-2	Enables whites flag on Field 1 Line 7.
		2-3	Disables white flag on Field 1 Line 7.
GBR SYNC on Green	J150 ②	1-2	Enables sync on G output.
		2-3	Disables sync on G output.
	J111 ②	1-2	Factory set.
		2-3	For future use.
25 Hz Offset	J124 ②	1-2	Enable.
		2-3	Disable.
Y Channel Test Signal Disable	J7 ⑥	1-2	Normal
		2-3	Y Channel Output Disable
C Channel Test Signal Disable	J6 ⑥	1-2	Normal
		2-3	C Channel Disable
	J113 ⑥	not installed	For future use.
R-Y Channel Test Signal Disable	J8 ⑦	1-2	Normal
		2-3	R-Y Channel Disable
Black Burst Disable	J130 ⑦	1-2	Black Burst output enabled.
		2-3	Black Burst output disabled.
BLACK/COMP SYNC Output only one at a time (located under the Audio board)	J145 ⑦	installed	BLACK/COMP SYNC outputs Black Burst.
	J152 ⑦	installed	BLACK/COMP SYNC outputs Comp Sync.

Table 5-2. List of Jumpers for the TSG 131A. (cont.)

JUMPER		POSITION	FUNCTION
Comp Sync Output Level	J151 7	1-2	-2 V level
		2-3	-4 V level
Audio Click	J12 9	1-2	Audio Click Enable
		2-3	Audio Click Disable
Power Supply Voltage Configuration	J122 10	2-3 4-5	Power supply configured for 110 V operation.
		3-4	Power supply configured for 220 V operation. (Standard)
+12 V Power Supply Test Jumper	J40 10	1-2 installed	Service use only.
-12 V Power Supply Test Jumper	J50 10	1-2 installed	Service use only.
-5 V Power Supply Test Jumper	J60 10	1-2 installed	Service use only.
+5 V Power Supply Test Jumper	J70 10	1-2 installed	Service use only.

SECTION 6 TSG 131A BLOCK DIAGRAM

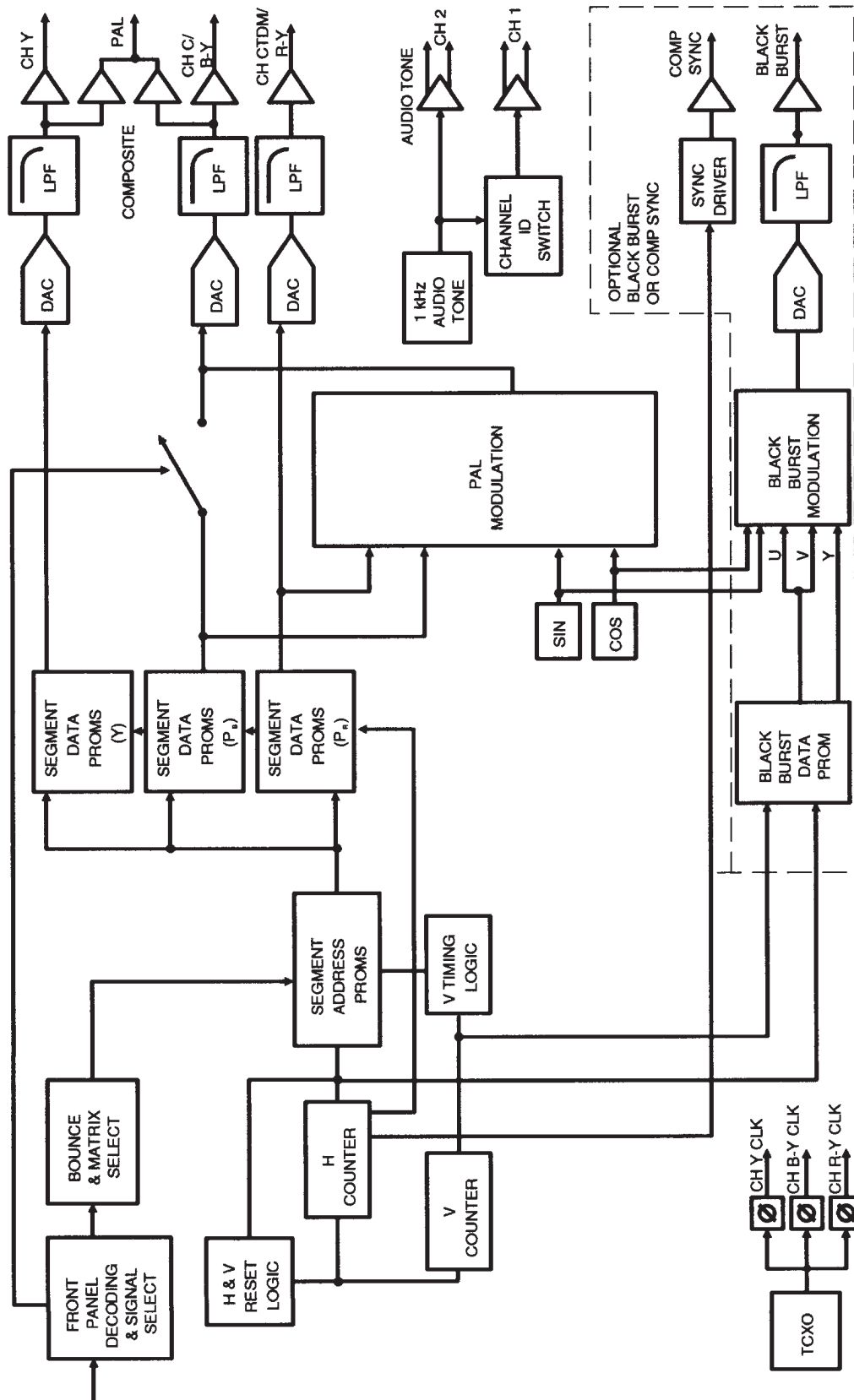

TSG 131A Theory of Operation

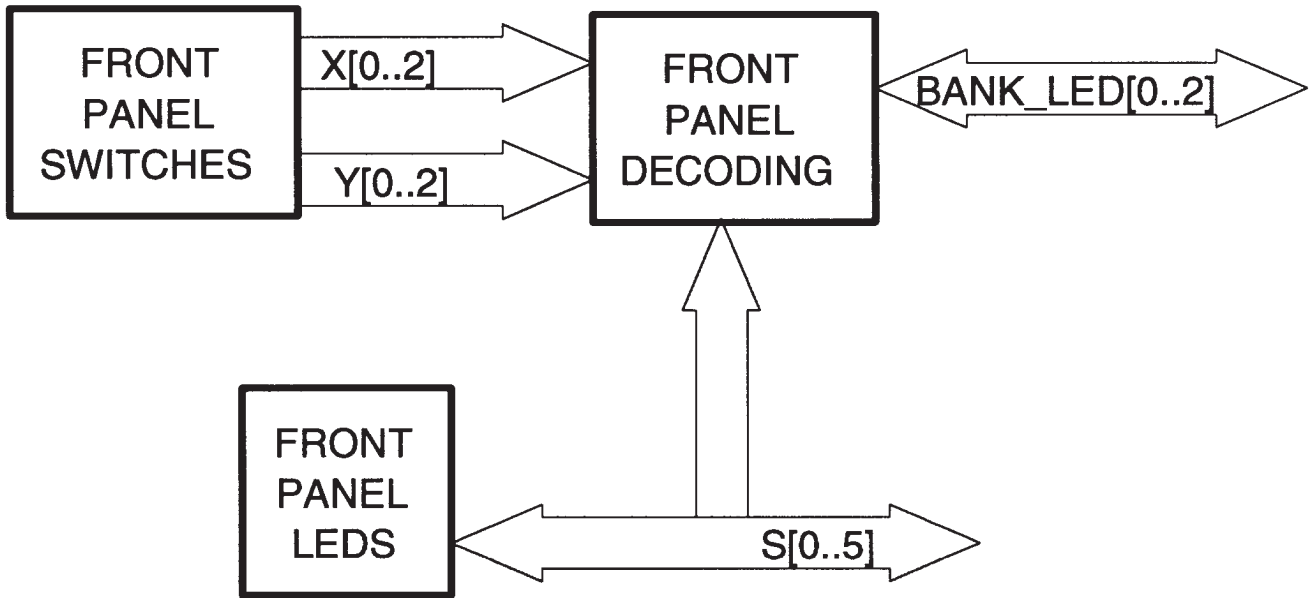

Fig. 1. Block diagram for <1>.

Front Panel <1>

The front panel switches (S201A through S209A) select which signals are available at the rear-panel BNCs and which LEDs are lit on the front panel. When one of the momentary contact switches closes, it sends a pulse to the encoder, U204, which translates it into signal KPAD[0..3]. EPROM U210 translates KPAD[0..3] into FMT[0..1] and K[0..2] for PROM U207. U210 also drives the Format LEDs (DS211, DS214, DS215, and DS218) with active low FMTLED[0..3].

U207 looks at the signal that is currently selected, S[0..5], along with the format and key selection information from U210, to determine the desired signal. The desired signal is output as S[0..5]. This signal is also translated in U209 to drive the LEDs in the push buttons, S202B through S209B. S[0..5] goes to U245 <2> on the Main board. U207 also generates BANK_LED[0..1] for U201 <2>. U201 then drives the row indicator LEDs (DS219, DS220, and DS221) with BANK_LED[0..2].

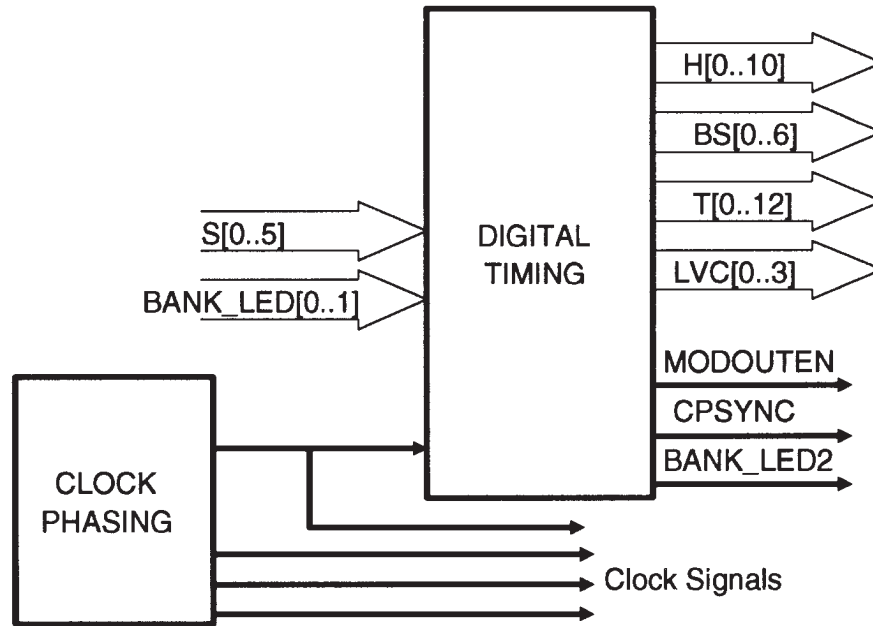

Fig. 2. Block diagram for <2>.

Digital Generation and Clock <2>

Clock Phasing

The clock for the instrument is a very stable 17.734375 MHz crystal, Y1. The TTL level of this signal is converted to ECL levels at pin 5 of U106. One copy of this signal is fed straight through to U108 and converted back to TTL level (CHY2_CLK). This signal is the general purpose clock used in the rest of the instrument. The other copy of the signal is timed by an RLC network (R231, L71, and C263) to assure that all clocks are in phase, then converted back to TTL level by U108 pins 2 and 3. The resulting signal is CHY1_CLK which is used by the Y Channel DAC. This signal is then fed back to U106 at pins 10 and 11. The resulting clocks then go through RLC networks where the capacitor (C30 or C32) is used to adjust the interchannel timing. These signals then go to the ECL to TTL converter, U108, and become CHBY_CLK and CHRY_CLK. These clocks are used by the other two channel's output DACs.

Digital Timing

The Digital Timing circuit has several purposes: to control the vertical and horizontal timing, to request the correct signal (according to the timing information), and to determine whether or not the signal should be modulated.

The selected signal, from the front panel, is coded in S[0..5]. That signal is latched in U245 where it is combined with other information (sync on green, F1L7 pulse on or off, and diagnostic signals) and converted to DS[0..6] (data segment). DS[0..6] drives EPROM U202.

U202 contains a horizontal, bounce, and vertical counter in addition to a timing decoder and signal selection decoders. H[0..11] is the output of the horizontal counter. It drives the Signal Segment Address Memory <3> and clocks its latches. BS[0..6] is a decoded version of the signal selection from the front panel. It is a modification of the signal selected to incorporate the bounce signal or a special signal required due to signal variations from line to line. For

TSG 131A — BLOCK DIAGRAM

example, a convergence signal has several lines of one signal and then a white line. The same is true of any matrix signal.

The levels of MODOUTEN and (MODOUTEN) are determined by the signal format selected. MODOUTEN is high for composite signals where the chrominance modulator, U222 <4>, output is enabled to drive to DAC (U31 <6>) inputs. MODOUTEN is low during component signals, which tri-states the modulator output and enables the line buffer, U230 and U231, to drive the DAC (U31 <6>) directly.

CPSYNC is the composite sync pulse output (available only on options 02, 03, and 04).

The other control signals tie together U202 with U201 which is predominantly a vertical counter followed by a decoder. 2FLDCLR makes sure that both vertical counters in the U201 and U202 are locked together. VCNTREN enables U201's vertical counter.

EPROM U201 has several purposes: to derive the control signal for the row indicator on the front panel <1>, to generate the 25 Hz offset timing T[0..12] for the Lookup Table <4>, and to provide the vertical matrix timing LVC[0..3] for the Signal Segment Address Memory <3>.

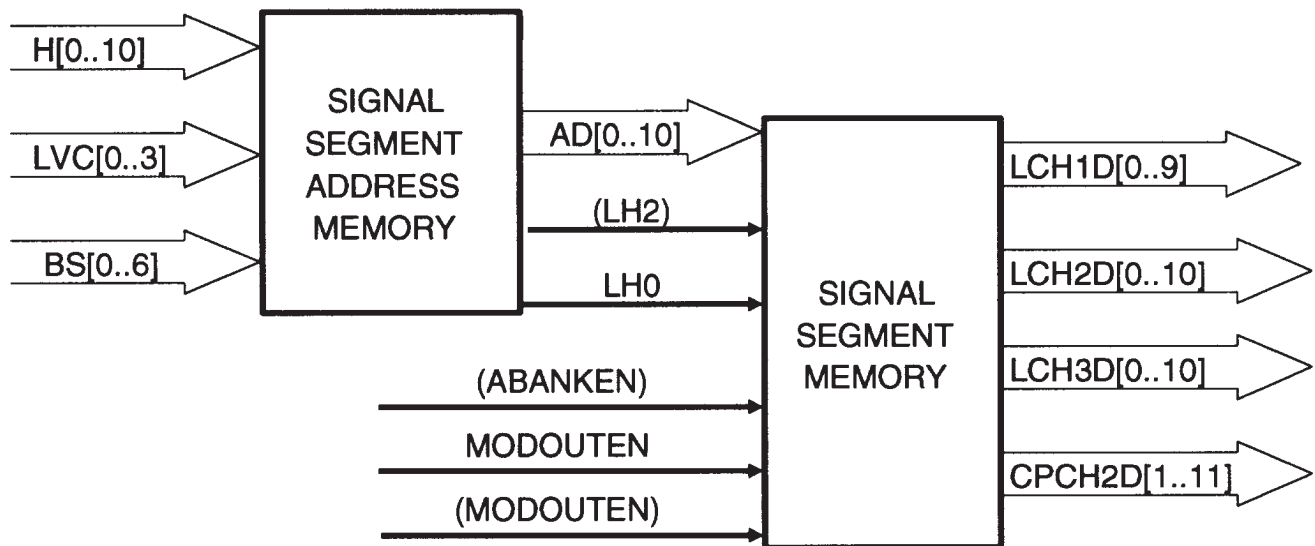

Fig. 3. Block diagram for <3>.

Signal Memory <3>

Signal Segment Address Memory

Signal information, LVC[0..3] and BS[0..6], along with the horizontal timing, H[3..10], are used by U104 and U102 to find the address for the signal segment required to create the selected signal. The output of these EPROMs are latched by U150 and U140. AD[0..10] is clocked out of these latches by a clock pulse derived from H3 (every eighth horizontal count). The address goes to the Signal Segment Memory.

Signal Segment Memory

On the opposite clock count from when it was loaded into the U150 and U240, the address is clocked into the Signal Segment Memory PROMs. U21 contains the data for the first channel (Y and Green). U23 contains the data for the second channel (half of C, B-Y, and Blue). U25 contains the data for the third channel (the other half of C, R-Y, and Red). U27

contains the LSBs for all of the channels. The first channel's signal, LCH1D[0..9], is always luminance (therefore never modulated), so it goes directly to the first channel's DAC (Channel Y/G/Y DAC), U34 <6>.

The other two channels need to be modulated only when the format is composite PAL. Therefore signals LCH2D[0..10] and LCH3D[0..10] don't need to be sent to the modulator for all the other output formats. Buffers U230 and U231 drive the second channel DAC (Channel C/B/B-Y DAC) U31 <6> with CPCH2D[1..11] when the second channel is not modulated. This is controlled by MODOUTEN and (MODOUTEN) from U202 on <2>. When the second and third channels need to be modulated - LCH2D[0..10] and LCH3D[0..10] go to the Modulator, U222 <4>.

Note that the output of the third channel is always invalid whenever the signal needs to be modulated (composite PAL).

TSG 131A — BLOCK DIAGRAM

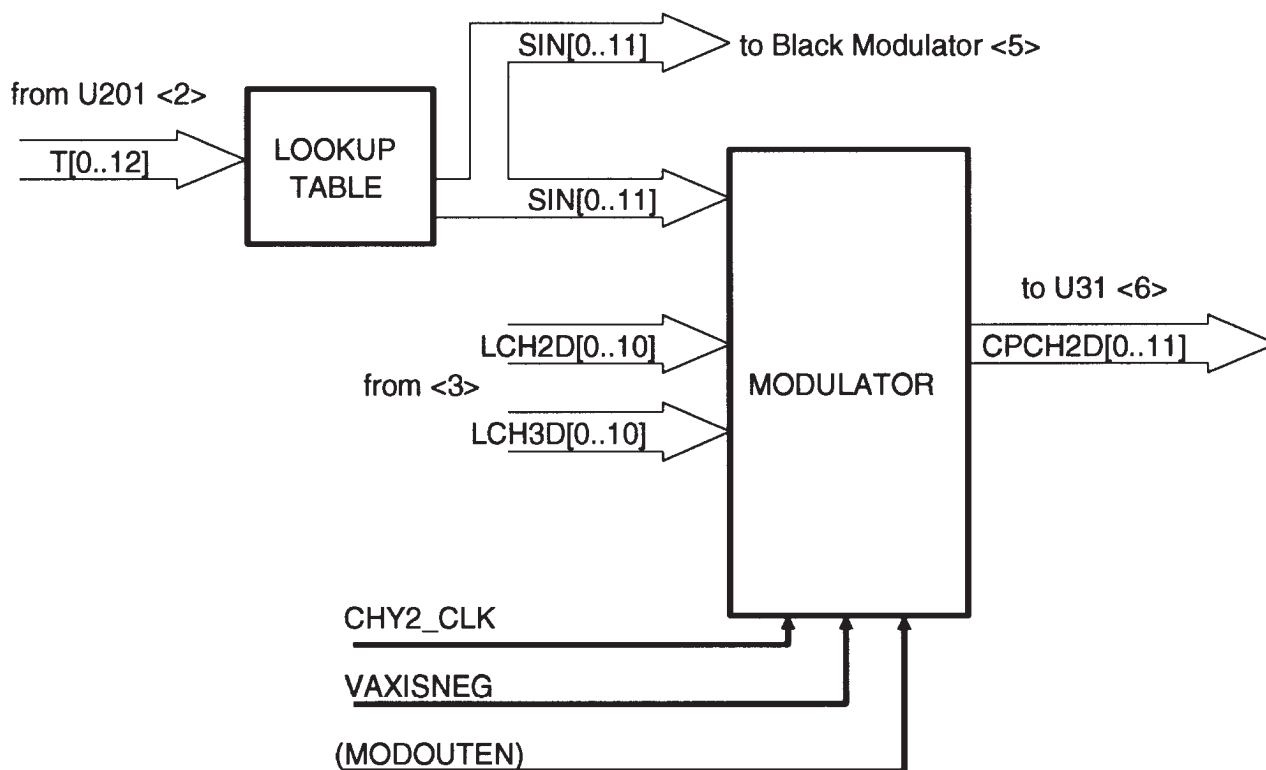

Fig. 4. Block diagram for <4>.

Digital Modulator and Lookup Table <4>

Lookup Table

U228 and U229 get their timing signal, T[0..12], from the Digital Timing circuit <2> and use that signal to derive the SIN[0..11] signal which is used by the modulator to determine how to modulate the signal. The SIN[0..11] signal is also used by the Black Burst Modulator (U235 <5>). This includes the 25 Hz offset to the modulation.

Modulator

U222 modulates the chrominance information for the PAL signal. If (MODOUTEN) is high, then the Modulator is turned off and the output is tri-stated, allowing the second channel information to come from U230 and U231 <3>. When (MODOUTEN) is low, it combines LCH2D[0..10] and LCH3D[0..10], using SIN[0..11] as the modulation offset, into the signal for the second channel. The output is CPCH2D[0..11] which drives the second output channel's DAC <6>.

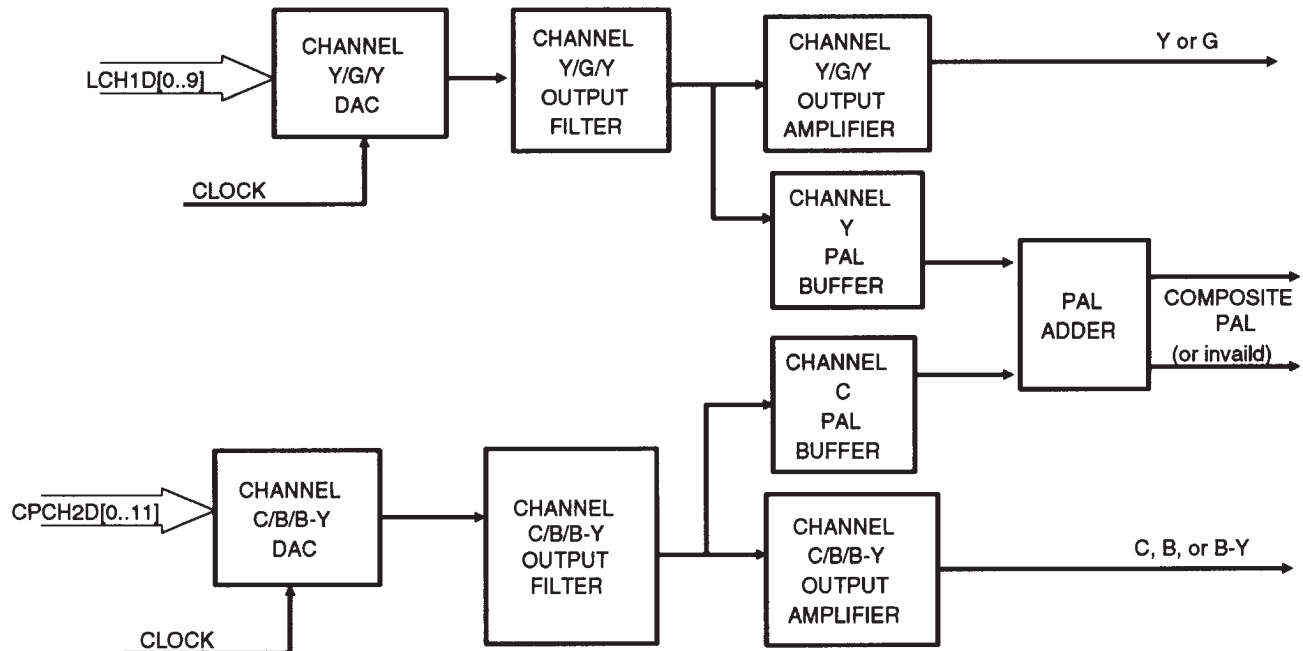

Fig. 5. Block diagram for <7>.

Y and C Analog Outputs <7>

Channel Y/G/Y DAC

U34 is a 10-bit DAC that converts the luminance or green information, LCH1D[0..9], from the Signal Segment Memory to a voltage. The voltage is sent to the Channel Y/G/Y Output Filter.

Channel Y/G/Y Output Filter

FL1 is a lowpass filter that removes any high frequency components caused by digitizing and makes the signal fit the defined PAL bandwidth. The lowpassed signal is then ready to be amplified by either the Output Amplifier or the Channel Y PAL Buffer.

Channel Y/G/Y Output Amplifier

Op amp U33 is the heart of the Output Amplifier. The amplifier raises the signal level a sufficient amount to drive 1 volt into 75 Ω. In the Output Amplifier, R79 is in the feedback path and is used to control the gain. The DC offset is adjusted by R82. C69 adjusts the

frequency response of the gain cell. The outputs of this amplifier are Y1, Y2, and Y3. Y1 and Y2 are the outputs available at the Y/G outputs at the rear of the instrument, while Y3 drives the Y component on the rear-panel S-Video output.

Channel Y PAL Buffer

This amplifier is identical to the Channel Y/G/Y Output Amplifier except instead of directly driving the outputs, it drives the PAL Adder. U1 is the op amp. R18 is in the feedback loop and controls the gain. The frequency response is corrected by C19. The DC offset is not adjustable in this amplifier. The output goes to the PAL Adder.

Channel C/B/B-Y DAC

U31 is the DAC for the second channel. CPCH2D[0..11] from either the Signal Segment Memory (for B and B-Y signals) <3> or the Modulator (for C signals) <4> drives the DAC. The 12-bit DAC converts the signal into a voltage.

Channel C/B/B-Y Output Filter

FL2 is a lowpass filter that removes any high frequency components caused by digitizing and makes the signal fit into the defined PAL bandwidth. The lowpassed signal is then ready to be amplified by either the Output Amplifier or the Channel C PAL Buffer.

Channel C/B/B-Y Output Amplifier

U30, is the same as U33, the Channel Y/G/Y Output Amplifier. Its purpose is to amplify the signal so that it can drive 1 volt into 75 Ω . R50 controls the gain. R63 adjusts the DC offset. C47 adjusts the frequency response. The output is C/B-Y1 and C/B-Y2. C/B-Y1 drives the C/B-Y/B output on the rear panel, while C/B-Y2 drives the C output on the S-Video connector.

Channel C PAL Buffer

This is the same as the Output Amplifier. The input signal is CH_C_BUFFER from the Channel C/B/B-Y Output Filter. U2 is an op amp at the heart of the buffer. R23 controls the gain. R20 controls the DC offset. C21 controls the frequency response. The output of this amplifier drives the PAL Adder.

PAL Adder

The PAL Adder is a balanced resistor network that takes the signal from channel 1 (either Y, G, or Y) and adds it to the output of Channel 2 (either C, B-Y, or B) and adds them together ($Y + C = \text{PAL signal}$). There is no intelligence in this adder, so if anything other than PAL/YC is requested from the front panel the output of this amplifier makes no sense or is otherwise confusing ($B + G$ and $B-Y + Y$). The outputs are PAL1 and PAL2 which drive the two COMPOSITE outputs at the rear panel.

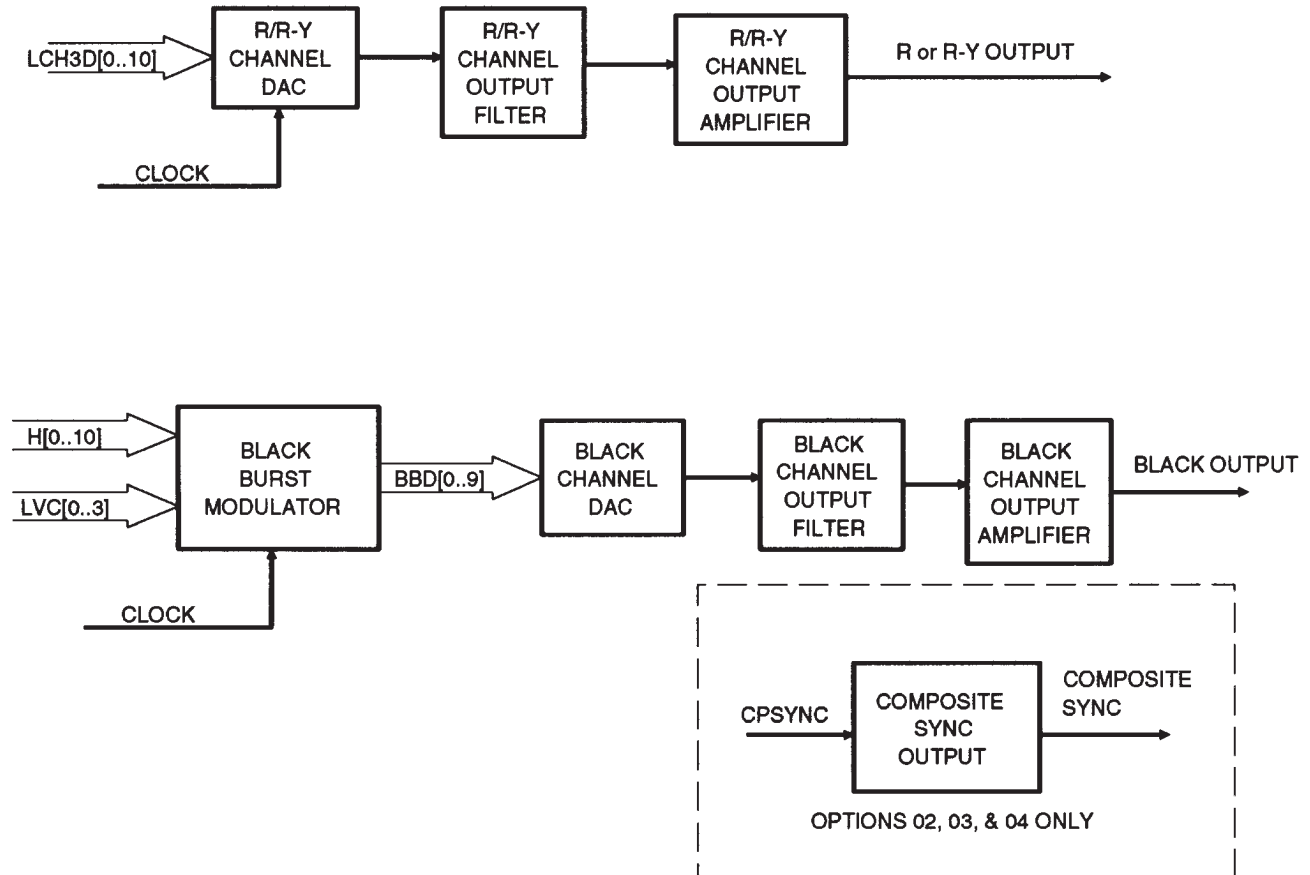

Fig. 6. Block diagram for < 6 >

CTDM/R-Y and Black/Sync Outputs < 6 >

The complete Black circuitry is only installed in options 02 and 03.

R/R-Y Channel DAC

U5 is a 12-bit DAC that takes the $LCH3D[0..10]$ signal from the Signal Segment Memory and converts it to an analog voltage. The resulting analog signal goes to the R/R-Y Channel Output Filter.

R/R-Y Channel Output Filter

FL3 is a lowpass filter that removes any high frequency components caused by digitizing and makes the signal fit the defined PAL bandwidth. The lowpassed signal is then ready to be amplified by the Output Amplifier.

R/R-Y Channel Output Amplifier

U4 is the op amp at the heart of this output amplifier. R98 adjusts the Gain. R101 adjusts the DC offset. C99 adjusts the frequency response. The output of this amplifier, CTDM/R-Y, drives 1 volt into 75Ω . This signal drives the CTDM/R-Y/R rear-panel output.

Black Burst Modulator on <5>

The Black Burst Modulator is made of two parts: the modulator (U235) and the black signal memory EPROM (U236).

U236 is given the horizontal and vertical timing information from the Signal Segment Memory <2>. It then uses this information to generate the luminance portion and the burst U and V components of the signal. U235, using the U and V components from U236 and the sine wave data from U228 and U229 <4> with 25 Hz offset, generate the chrominance portion of the signal. This is then added to the luminance portion BBCHY[0..8] of the signal. U235 outputs a digital composite Black Burst signal that drives U238, the Black Burst DAC.

Black Channel DAC

U238 is a 10-bit DAC that takes the BBD[0..9] signal from the Black Burst Modulator and converts it into an analog voltage. The analog signal is sent to the Output Filter.

Black Channel Output Filter

FL4, a lowpass filter, removes any high frequency components caused by digitizing and has the signal fit the defined PAL bandwidth. The lowpassed signal is then ready to be amplified by the Output Amplifier.

Black Channel Output Amplifier

U255 is the op amp for the Output Amplifier. R328 controls the gain, R325 adjusts the DC offset, and C329 adjusts the frequency response. The output has enough gain to drive 1 volt into 75 Ω . The output of this channel is available at the Black/Sync output on the rear panel.

Composite Sync Output (only available on options 02, 03, and 04)

The CPSYNC pulse comes from U202 <2>. The signal is amplified by the transistor network enough to drive -2 V or -4 V into a 75 Ω load.

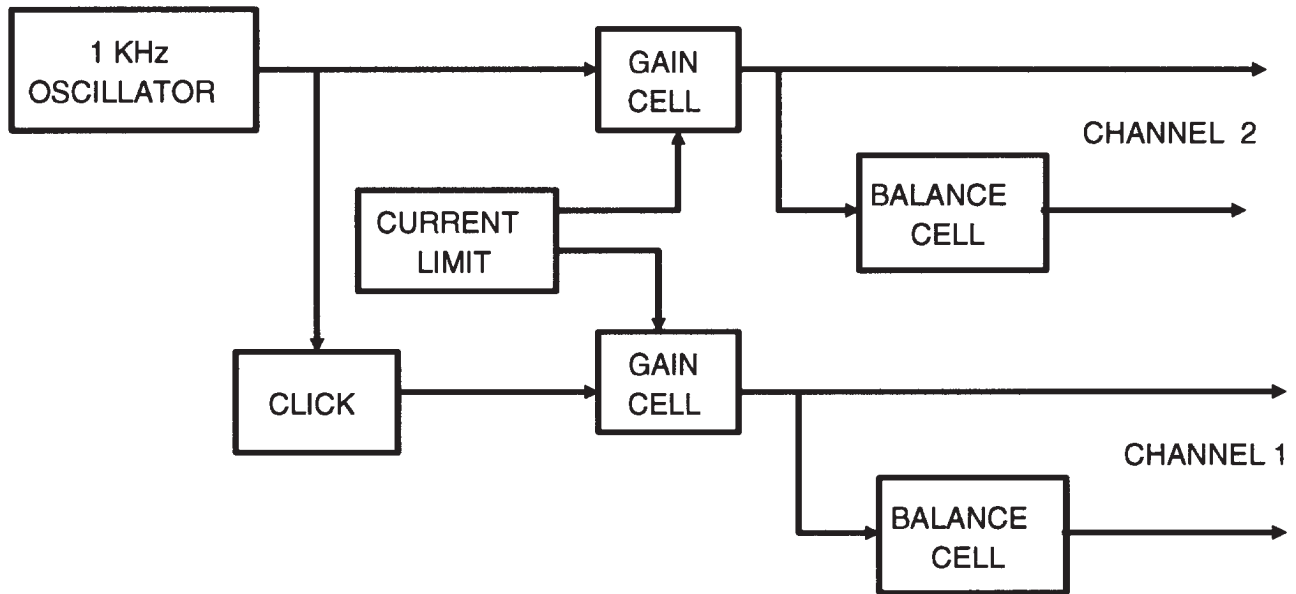

Fig. 7. Block diagram of the Audio circuitry.

Audio Tone <9>

1 KHz Oscillator

U40A is configured as a Wein oscillator, employing both positive and negative feedback. The positive feedback loop controls the frequency of oscillation, with C111, R107, R105, and C100 forming a bandpass filter tuned to 1 KHz. The negative feedback loop controls the gain to keep the circuit in oscillation.

The circuit is designed to operate with a gain of three. This occurs when the positive and the negative feedback is balanced, and produces an output signal of approximately 0.7 Vp-p. If the output amplitude starts to die off, the peak detector (U408 and associated components) reduces the drive to Q2, which increases the gain by increasing the current to the negative feedback loop.

On the other hand, if the output amplitude increases, then the peak detector increases the drive to Q2, decreasing the current to the negative feedback loop, decreasing the gain.

The output of the 1 KHz oscillator goes to the Gain Cells.

Click Circuit

The Click circuit consists of a 555 timer U43, its associated components, and an FET Q1. The rate at which the timer sends out pulses is adjustable by R125 or it can be disabled by removing R125 from the circuit with J12. When a pulse is output from pin 3, it slams the FET to ground, which in turn pulls the channel 1 to ground and creates the "click" sound.

Gain Cells

There are two gain cells, one for channel 1 and one for channel 2. The gain cells consist of an op amp (U42A or U41A) with a negative feedback loop used to adjust the gain. R122 or R123 adjust the gain in the feedback loop by increasing or decreasing the feedback resistance. The output of the gain cell goes to pin 3 of the audio connectors and to the Balance Cell.

TSG 131A — BLOCK DIAGRAM

Balance Cells

The balance cells are basically inverters that take a copy of the output of the gain cell and invert it to create the other channel for a balanced audio signal. The Outputs go to pin 2 of the audio connectors.

Current Limits

Q3 & Q4 and Q5 & Q6 are the Current Limit circuitry. If the outputs of the Audio circuits are shorted for any reason they will draw a tremendous amount of

current and overheat the transformer in the power supply. This circuit limits the amount of current that the audio output can draw.

The +10 V and -10 V to the gain cells are limited in the amount of current that they can draw by the amount of current that can flow through the base-emitted junction of the Q3/Q4 and Q5/Q6 transistors.

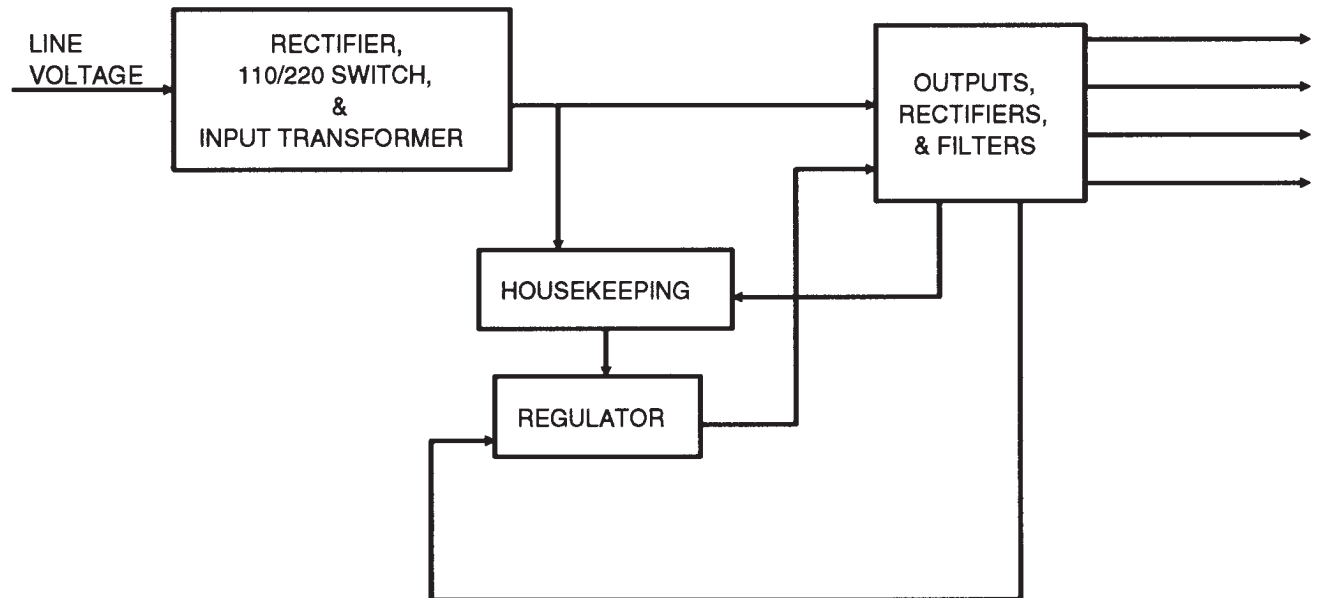

Fig. 8. Block diagram of the Power Supply circuitry.

Power Supply <10>

Rectifier & Input Transformer and 110/220 Switch

The input voltage can either be 110 V or 220 V. If it is 110 V, P10 and P122 are in, which puts all of transformer T1's windings in the circuit. If the Input voltage is 220 V then P11 is in, which removes half of T1's windings from the circuit. The available input voltage on the output side of T1 is then the same. The output of off the line transformer, T1, is a relative low voltage of approximately 20 volts.

This voltage is then rectified by CR10, CR11, CR12, and CR13. The rectifiers convert the sine wave into positive going sine-shaped pulses. C183 smooths the pulses to approximately 16 volts with ripple.

Housekeeping

VR30 and Q30 make up the Housekeeping circuitry. Its purpose is to supply 11 V to the Regulator (U200) during power-up conditions.

After power up, the Housekeeping circuit is shut down. The voltage from CR85 goes up to 15 V, which shuts down Q30.

Regulator

U200 is a Pulse Width Modulator that is a current mode controller. It uses inputs from the primary circuit and from the +5 V output to vary the width of the pulse controls, Q100. This regulates the secondary voltages through variations of input voltage, output load, etc.

Current mode control works by allowing the current flowing in the primary to reach peak level that is set by the output of the +5 V output. The current in the primary is sensed by the R267 and C308 and applied to U200 at pin 3 as a voltage. At the start of the cycle, the oscillator within the Pulse Width Modulator internal oscillator sets the internal flip-flop which turns on Q100. The primary current, and therefore the voltage to U200 pin 3, ramps up until the ISEN input level is high enough to trip the comparator. This rests the flip-flop, ending to drive pulse to Q100, and the energy stored in the transformer is transferred to the secondaries.

TSG 131A — BLOCK DIAGRAM

Line regulation, then, is a function of line voltage. As the line voltage varies, so will the primary current. An increase in line voltage causes an increase in primary current, so the slope of the ramp increases and the trip point is reached sooner. This results in a shorter pulse width. A decrease in line voltage causes a decrease in primary current, the slope of the ramp decreases and it takes longer to reach the trip point. However, the same peak current is reached in both cases, so the same amount of energy is transferred to the load. Line regulation is then achieved without having to wait for output voltage variations.

Power Inductor Operation (T2)

The heart of this power supply is T2, the power induction.

Inductor, T2, is initially uncharged (zero magnetic flux). Q100, acting as a switch, is turned on by the base drive from the regulator (U200). The polarity of this voltage is such that the voltage induced in the secondary will reverse bias their respective diodes (note the polarity dots). In this way, there is no current flowing in the secondaries while it is flowing in the primary. C303 and R262 are a snubber circuit used to reduce noise.

The primary current builds a linear ramp, storing the energy in T2 according to the relationship $E = \frac{1}{2}Li^2$, where L is the primary inductance and i is the current flowing through it.

The current path is broken when Q100 is switched off, so current stops flowing in the primary. The flyback action of T2 then causes the voltage in the secondaries to linearly ramp down to zero as the energy which was stored in T2's primary is delivered to the load, charging its own capacitors.

When all of the energy which was stored in T2 during the first half of the cycle is delivered to the load, the current in the secondaries is zero, and the diodes turn off. There is no current flowing in either the primaries or the secondaries until Q100 is turned back on to start the next cycle. As there is not a continuous flow of energy in T2, this is called a discontinuous flyback operation.

Load regulation is provided by sensing the +5 V supply with a resistor divider, R264 and R265. When +5 V goes too high, U200 narrows the pulse width. This reduces the amount of energy stored in T2, and therefore the amount of energy transferred to the load, so the +5 V goes down. Inversely, when the +5 V is too low, the pulse width is increased, increasing the amount of energy stored in T2 and then transferred to the load, so the voltage goes up.

Outputs, Rectifiers, & Filters

There are four separate circuits in the output: +5 V, -5 V, +12 V, and -12 V. They all work in a very similar manner.

During the first half of the cycle, when Q100 is shut off, the flyback action reverses the polarities of the secondary, and the diodes are forward-biased. This allows the energy within T2 to charge up the capacitors in the secondaries. The +5 V and the -5 V supplies use LC filters from this point, to further smooth the voltage and eliminate most of the ripple.

The +12 and -12 V supplies actually start as +15 and -15 V, at the transformer. Then they are filtered and applied to linear regulators, U212 and U50, which provide clean +12 V and -12 V outputs, respectively.

SECTION 7

OPTIONS

This is a summary of the catalog options available for the Tektronix TSG 131A Multifomat Signal Generator. Custom modifications are negotiated (and documented) on an individual basis.

Power Options

The standard power configuration is 220 V.

Power Cords

The standard power cord for the TSG 131A is a 220 V, 16 amp rated power cord with the Universal European three-prong power plug (Fig. 7-2). It is possible to order instruments with other power options.

The other power options are:

Option 52 a 120 V, 15 Amp cord equipped with standard North American three-prong power plug, as shown in Fig. 7-1.

Option A2 (Fig. 7-3) uses a 240 V, 15 amp rated power cord with the United Kingdom three-prong power plug.

Option A3 (Fig. 7-4) uses a 240 V, 10 amp rated power cord with the Australian three-prong power plug.

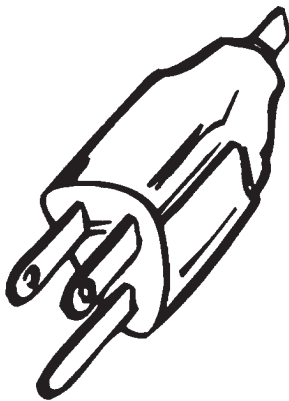

Fig. 7-1. Option 52 Plug.

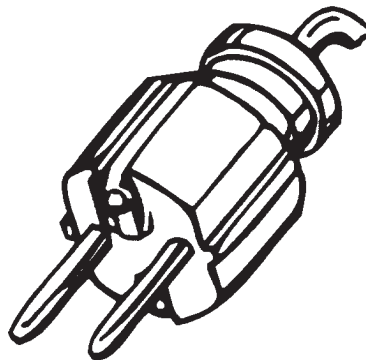

Fig. 7-2. Standard Plug.

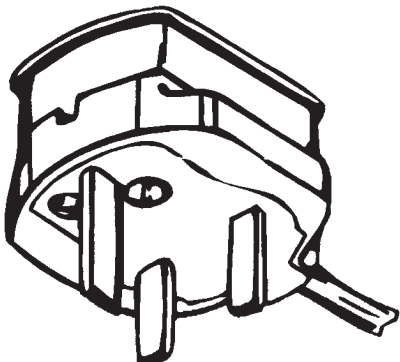

Fig. 7-3. Option A2 Plug.

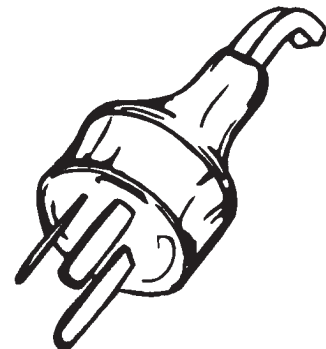

Fig. 7-4. Option A3 Plug.

Configuration Options

A summary of these options is given below and in Table 7-1 which gives a quick comparison between the various options.

For Options 01, 02, 03, 04, and 10 the information needed for the Performance Check and the Adjustment Procedure is given along with the standard procedures.

TSG 131A Option 01

This option changes the CTDM format to the MII standard. The rest of the instrument is identical to the standard.

TSG 131A Option 02

This option adds Black Burst or Composite Sync (selectable by internal jumper) from the BLACK/SYNC output, to the standard instrument. It also allows the Green signal to have the sync on or off (also selectable by an internal jumper).

TSG 131A Option 03

Option 03 has a longer blanking width (11.8 μ s) and a Color Flag Reference Pulse from one of the Y/G outputs. The sync on green is jumper selectable and is has a Black Burst or Composite Sync output. It also has a custom signal set for both the composite and BetaCam component signals.

TSG 131A Option 04

The 04 Option has VIR on line 19 and only Composite Sync from the BLACK/SYNC output. There is a Color Frame Square Wave from one of the Y/G outputs. It also has custom signal sets for both the composite and the MII component signals.

TSG 131A Option 10

The Option 10 is a tighter frequency specification crystal. Instead of the standard ± 10 Hz subcarrier range, the Option 10 has a ± 5 Hz range. This option can be ordered in conjunction with any other option or the standard instrument.

Table 7-1. Comparison between the various options of the TSG 131A.

	STANDARD	01	02	03	04	10
2 Wire Signal BetaCam or MII	BetaCam	MII	BetaCam	BetaCam	MII	any
Black Burst Output	—	—	Black Burst	Black Burst	Composite Sync	any
Blanking Width	10.9 μ s	10.9 μ s	10.9 μ s	11.8 μ s	10.9 μ s	any
Sync on Green	always	always	jumper selectable	jumper selectable	always	any
Color Flag Reference Pulse	—	—	—	from one of the Y/G outputs (low F1L1-3)	—	any
Color Frame Square Wave	—	—	—	—	from one of the Y/G outputs (low F1,2,3,&4 high F5,6,7,&8)	any
VISC on L22 & 335	—	—	—	—	yes	any
Special Composite Signal Set	Standard	Standard	Standard	Special	Special	any
Special Component Signal Set	Standard BetaCam Set	Standard MII Set	Standard BetaCam Set	Special	Special	any
Subcarrier Frequency Tolerance	± 10 Hz	± 10 Hz	± 10 Hz	± 10 Hz	± 10 Hz	± 5 Hz

TSG 131A — OPTIONS

Section 8

Replaceable Electrical Parts

This section contains a list of the components that are replaceable for the TSG 131A. Use this list to identify and order replacement parts. There is a separate Replaceable Electrical Parts list for each instrument.

Parts Ordering Information

Replacement parts are available from or through your local Tektronix, Inc., Field Office or representative.

Changes to Tektronix instruments are sometimes made to accommodate improved components as they become available and to give you the benefit of the latest circuit improvements. Therefore, when ordering parts, it is important to include the following information in your order.

- Part number
- Instrument type or model number
- Instrument serial number
- Instrument modification number, if applicable

If a part you have ordered has been replaced with a new or improved part, your local Tektronix, Inc., Field Office or representative will contact you concerning any change in part number.

Change information, if any, is located at the rear of this manual.

Using the Replaceable Electrical Parts List

The tabular information in the Replaceable Electrical Parts list is arranged for quick retrieval. Understanding the structure and features of the list will help you find all of the information you need for ordering replaceable parts.

Cross Index–Mfr. Code Number to Manufacturer

The Mfg. Code Number to Manufacturer Cross Index for the electrical parts list is located immediately after this page. The cross index provides codes, names, and addresses of manufacturers of components listed in the electrical parts list.

Abbreviations

Abbreviations conform to American National Standards Institute (ANSI) standard Y1.1.

List of Assemblies

A list of assemblies can be found at the beginning of the electrical parts list. The assemblies are listed in numerical order. When the complete component number of a part is known, this list will identify the assembly in which the part is located.

Column Descriptions

Component No. (Column 1)

The component circuit number appears on the diagrams and circuit board illustrations, located in the diagrams section. Assembly numbers are also marked on each diagram and circuit board illustration, in the Diagram section and on the mechanical exploded views, in the mechanical parts list. The component number is obtained by adding the assembly number prefix to the circuit number.

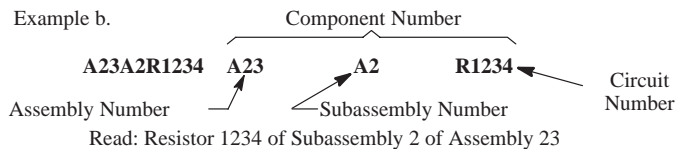
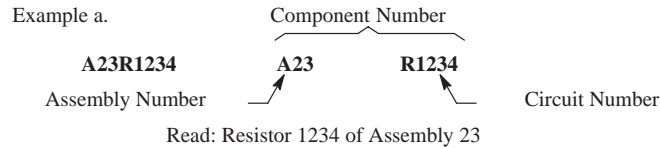

The electrical parts list is arranged by assemblies in numerical sequence (A1, with its subassemblies and parts, precedes A2, with its subassemblies and parts).

Mechanical subparts to the circuit boards are listed in the electrical parts list. These mechanical subparts are listed with their associated electrical part (for example, fuse holder follows fuse).

Chassis-mounted parts and cable assemblies have no assembly number prefix and are located at the end of the electrical parts list.

Tektronix Part No. (Column 2)

Indicates part number to be used when ordering replacement part from Tektronix.

Serial/Assembly No. (Column 3 and 4)

Column three (3) indicates the serial or assembly number at which the part was first used. Column four (4) indicates the serial or assembly number at which the part was removed. No serial or assembly number entered indicates part is good for all serial numbers.

Name and Description (Column 5)

An item name is separated from the description by a colon (:). Because of space limitations, an item name may sometimes appear as incomplete. Use the U.S. Federal Catalog handbook H6-1 for further item name identification.

The mechanical subparts are shown as *ATTACHED PARTS* / *END ATTACHED PARTS* or *MOUNTING PARTS* / *END MOUNTING PARTS* in column five (5).

Mfr. Code (Column 6)

Indicates the code number of the actual manufacturer of the part. (Code to name and address cross reference can be found immediately after this page.)

Mfr. Part No. (Column 7)

Indicates actual manufacturer's part number.

CROSS INDEX – MFR. CODE NUMBER TO MANUFACTURER

Mfr. Code.	Manufacturer	Address	City, State, Zip Code
00779	AMP INC	2800 FULLING MILL PO BOX 3608	HARRISBURG PA 17105
04222	AVX CERAMICS DIV OF AVX CORP	19TH AVE SOUTH P O BOX 867	MYRTLE BEACH SC 29577
04713	MOTOROLA INC SEMICONDUCTOR PRODUCTS SECTOR	5005 E MCDOWELL RD	PHOENIX AZ 85008-4229
07716	TRW INC TRW IRC FIXED RESISTORS/BURLINGTON	2850 MT PLEASANT AVE	BURLINGTON IA 52601
09023	CORNELL-DUBILIER ELECTRONICS DIV FEDERAL PACIFIC ELECTRIC CO	2652 DALRYMPLE ST	SANFORD NC 27330
09922	BURNDY CORP	RICHARDS AVE	NORWALK CT 06852
19701	PHILIPS COMPONENTS DISCRETE PRODUCTS DIV RESISTIVE PRODUCTS FACILITY AIRPORT ROAD	PO BOX 760	MINERAL WELLS TX 76067-0760
22229	SOLITRON DEVICES INC SEMICONDUCTOR GROUP SAN DIEGO OPERS	8808 BALBOA AVE	SAN DIEGO CA 92123
22526	DU PONT E I DE NEMOURS AND CO INC DU PONT ELECTRONICS DEPT	515 FISHING CREEK RD	NEW CUMBERLAND PA 17070-3007
24165	SPRAGUE ELECTRIC CO	267 LOWELL ROAD	HUDSON NH 03051
26364	COMPONENTS CORP	6 KINSEY PLACE	DENVILLE NJ 07834-2611
27014	NATIONAL SEMICONDUCTOR CORP	2900 SEMICONDUCTOR DR	SANTA CLARA CA 95051-0606
32997	BOURNS INC TRIMPOT DIV	1200 COLUMBIA AVE	RIVERSIDE CA 92507-2114
54473	MATSUSHITA ELECTRIC CORP OF AMERICA	ONE PANASONIC WAY PO BOX 1501	SECAUCUS NJ 07094-2917
55680	NICHICON /AMERICA/ CORP	927 E STATE PKY	SCHAUMBURG IL 60195-4526
57668	ROHM CORP	8 WHATNEY PO BOX 19515	IRVINE CA 92713
58361	QUALITY TECHNOLOGIES CORP		
59660	TUSONIX INC	7741 N BUSINESS PARK DR PO BOX 37144	TUCSON AZ 85740-7144
61964	OMRON ELECTRONICS INC	650 WOODFIELD ST	SCHAUMBURG IL 60195-5008
71400	BUSSMANN DIV OF COOPER INDUSTRIES INC	114 OLD STATE RD PO BOX 14460	ST LOUIS MO 63178
75042	IRC ELECTRONIC COMPONENTS PHILADELPHIA DIV TRW FIXED RESISTORS	401 N BROAD ST	PHILADELPHIA PA 19108-1001
75498	MULTICOMP INC	3005 SW 154TH TERRACE #3	BEAVERTON OR 97006
76493	BELL INDUSTRIES INC	19070 REYES AVE PO BOX 5825	COMPTON CA 90224-5825
80009	JW MILLER DIV TEKTRONIX INC	14150 SW KARL BRAUN DR PO BOX 500	BEAVERTON OR 97077-0001
82389	SWITCHCRAFT INC SUB OF RAYTHEON CO	5555 N ELSTRON AVE	CHICAGO IL 60630-1314
91506	AUGAT INC	33 PERRY AVE P O BOX 779	ATTLEBORO MA 02703-2417
91637	DALE ELECTRONICS INC	2064 12TH AVE PO BOX 609	COLUMBUS NE 68601-3632
93907	TEXTRON INC CAMCAR DIV	600 18TH AVE	ROCKFORD IL 61108-5181
S3629	SCHURTER AG H C/O PANEL COMPONENTS CORP	2015 SECOND STREET	BERKELEY CA 94170
S4307	SCHAFFNER ELECTRONIK AG		LUTERBACH SWITZERLAND
TK1345	ZMAN & ASSOCIATES		
TK1450	TOKYO COSMOS ELECTRIC CO LTD	2-268 SOBUDAI ZAWA	KANAGAWA 228 JAPAN

Replaceable Electrical Parts

Component Number	Tektronix Part Number	Effective	Discontinued	Name & Description	Mfr. Code	Mfr. Part Number
A1	671-2712-03			CIRCUIT BD ASSY:FRONT PANEL	80009	671-2712-03
A2	671-2539-04			CIRCUIT BD ASSY:MAIN (STANDARD ONLY)	80009	671-2539-04
A2	671-4982-00			CIRCUIT BD ASSY:MAIN (OPTION 01 ONLY)	80009	671-4982-00
A2	671-2760-04			CIRCUIT BD ASSY:MAIN (OPTION 02 ONLY)	80009	671-2760-04
A2	671-2759-04			CIRCUIT BD ASSY:MAIN (OPTION 03 ONLY)	80009	671-2759-04
A2	671-2762-04			CIRCUIT BD ASSY:MAIN (OPTION 04 ONLY)	80009	671-2762-04
A2	671-2808-04			CIRCUIT BD ASSY:MAIN (OPTION 10 ONLY)	80009	671-2808-04
A2	671-2817-04			CIRCUIT BD ASSY:MAIN (OPTION 01/10 ONLY)	80009	671-2817-04
A2	671-2819-04			CIRCUIT BD ASSY:MAIN (OPTION 02/10 ONLY)	80009	671-2819-04
A2	671-2816-04			CIRCUIT BD ASSY:MAIN (OPTION 03/10 ONLY)	80009	671-2816-04
A2	671-2820-04			CIRCUIT BD ASSY:MAIN (OPTION 04/10 ONLY)	80009	671-2820-04
A2	671-2827-04			CIRCUIT BD ASSY:MAIN (OPTION 01/02/10 ONLY)	80009	671-2827-04
A2	671-2572-03			CIRCUIT BD ASSY:MAIN (OPTION 01/02 ONLY)	80009	671-2572-03
A3	671-2183-01			CIRCUIT BD ASSY:TOP BNC	80009	671-2183-01
A4	671-2184-01			CIRCUIT BD ASSY:BOTTOM BNC	80009	671-2184-01
A5	671-2737-03			CIRCUIT BD ASSY:AUDIO	80009	671-2737-03
A1				CIRCUIT BD ASSY:FRONT PANEL		
A1C201	281-0775-01			CAP,FXD,CER DI:0.1UF,20%,50V	04222	SA105E104MAA
A1C202	281-0775-01			CAP,FXD,CER DI:0.1UF,20%,50V	04222	SA105E104MAA
A1C250	281-0775-01			CAP,FXD,CER DI:0.1UF,20%,50V	04222	SA105E104MAA
A1C251	281-0775-01			CAP,FXD,CER DI:0.1UF,20%,50V	04222	SA105E104MAA
A1C252	281-0775-01			CAP,FXD,CER DI:0.1UF,20%,50V	04222	SA105E104MAA
A1C253	281-0775-01			CAP,FXD,CER DI:0.1UF,20%,50V	04222	SA105E104MAA
A1DS211	150-1029-00			LT EMITTING DIO:GREEN,565NM,35MA	58361	Q6480/MV5274C
				MOUNTING PARTS		
	352-1012-00			HOLDER,LED:BLACK,ABS	80009	352-1012-00
				END MOUNTING PARTS		
A1DS214	150-1029-00			LT EMITTING DIO:GREEN,565NM,35MA	58361	Q6480/MV5274C
				MOUNTING PARTS		
	352-1012-00			HOLDER,LED:BLACK,ABS	80009	352-1012-00
				END MOUNTING PARTS		
A1DS215	150-1029-00			LT EMITTING DIO:GREEN,565NM,35MA	58361	Q6480/MV5274C
				MOUNTING PARTS		
	352-1012-00			HOLDER,LED:BLACK,ABS	80009	352-1012-00
				END MOUNTING PARTS		
A1DS218	150-1029-00			LT EMITTING DIO:GREEN,565NM,35MA	58361	Q6480/MV5274C
				MOUNTING PARTS		
	352-1012-00			HOLDER,LED:BLACK,ABS	80009	352-1012-00
				END MOUNTING PARTS		
A1DS219	150-1029-00			LT EMITTING DIO:GREEN,565NM,35MA	58361	Q6480/MV5274C
				MOUNTING PARTS		
	352-1012-00			HOLDER,LED:BLACK,ABS	80009	352-1012-00
				END MOUNTING PARTS		
A1DS220	150-1029-00			LT EMITTING DIO:GREEN,565NM,35MA	58361	Q6480/MV5274C
				MOUNTING PARTS		

Replaceable Electrical Parts

Component Number	Tektronix Part Number	Effective	Discontinued	Name & Description	Mfr. Code	Mfr. Part Number
	352-1012-00			HOLDER,LED:BLACK,ABS	80009	352-1012-00
				END MOUNTING PARTS		
A1DS221	150-1029-00			LT EMITTING DIO:GREEN,565NM,35MA	58361	Q6480/MV5274C
				MOUNTING PARTS		
	352-1012-00			HOLDER,LED:BLACK,ABS	80009	352-1012-00
				END MOUNTING PARTS		
A1J201	174-2405-00			TERMINAL,PIN:0.365 L X 0.025 BRZ GLD PL (QUANTITY 16)	80009	174-2405-00
A1R201	322-3114-00			RES,FXD,FILM:150 OHM,1%,0.2W,TC=T0	57668	CRB20 FXE 301E
A1R204	322-3143-00			RES,FXD,FILM:301 OHM,1%,0.2W,TC=T0	57668	CRB20 FXE 301E
A1R207	322-3143-00			RES,FXD,FILM:301 OHM,1%,0.2W,TC=T0	57668	CRB20 FXE 301E
A1S201	260-2673-00			SWITCH,KEY:NO LED,B3E-1000	61964	B3E-1000
				ATTACHED PARTS		
	366-0683-00			PUSH BUTTON:SWITCH CAP	80009	366-0683-00
				END ATTACHED PARTS		
A1S202	260-2675-00			SWITCH,PUSH:W/LED	80009	260-2675-00
				ATTACHED PARTS		
	366-0682-00			PUSH BUTTON:LIGHTED CAP,INSERT ASSY	80009	366-0682-00
				END ATTACHED PARTS		
A1S203	260-2675-00			SWITCH,PUSH:W/LED	80009	260-2675-00
				ATTACHED PARTS		
	366-0682-00			PUSH BUTTON:LIGHTED CAP,INSERT ASSY	80009	366-0682-00
				END ATTACHED PARTS		
A1S204	260-2675-00			SWITCH,PUSH:W/LED	80009	260-2675-00
				ATTACHED PARTS		
	366-0682-00			PUSH BUTTON:LIGHTED CAP,INSERT ASSY	80009	366-0682-00
				END ATTACHED PARTS		
A1S205	260-2675-00			SWITCH,PUSH:W/LED	80009	260-2675-00
				ATTACHED PARTS		
	366-0682-00			PUSH BUTTON:LIGHTED CAP,INSERT ASSY	80009	366-0682-00
				END ATTACHED PARTS		
A1S206	260-2675-00			SWITCH,PUSH:W/LED	80009	260-2675-00
				ATTACHED PARTS		
	366-0682-00			PUSH BUTTON:LIGHTED CAP,INSERT ASSY	80009	366-0682-00
				END ATTACHED PARTS		
A1S207	260-2675-00			SWITCH,PUSH:W/LED	80009	260-2675-00
				ATTACHED PARTS		
	366-0682-00			PUSH BUTTON:LIGHTED CAP,INSERT ASSY	80009	366-0682-00
				END ATTACHED PARTS		
A1S208	260-2675-00			SWITCH,PUSH:W/LED	80009	260-2675-00
				ATTACHED PARTS		
	366-0682-00			PUSH BUTTON:LIGHTED CAP,INSERT ASSY	80009	366-0682-00
				END ATTACHED PARTS		
A1S209	260-2675-00			SWITCH,PUSH:W/LED	80009	260-2675-00
				ATTACHED PARTS		
	366-0682-00			PUSH BUTTON:LIGHTED CAP,INSERT ASSY	80009	366-0682-00

Replaceable Electrical Parts

Component Number	Tektronix Part Number	Effective	Discontinued	Name & Description	Mfr. Code	Mfr. Part Number
				END ATTACHED PARTS		
A1U204	156-1215-01			IC,DIGITAL:CMOS,MUX/ENCODER;20-KEY ENCODER;74C923,DIP18.3,TUBE,SCRN	27014	MM74C923JA+
A1U207	160-4415-00			IC,DIGITAL:CMOS	80009	160-4415-00
				MOUNTING PARTS		
	136-0925-00			SOCKET,DIP::	91506	224-AG30D
				END MOUNTING PARTS		
A1U209	160-4416-00			IC,DIGITAL:CMOS,PLD;EEPLD,16V8,25NS	80009	160-4416-00
				MOUNTING PARTS		
	136-0752-00			SKT,PL-IN ELEC:MICROCIRCUIT,20 DIP	09922	DILB20P-108
				END MOUNTING PARTS		
A1U210	160-9066-00			IC,DIGITAL:CMOS,PLD;OPT,DUAL CLOCK	80009	160-9066-00
				MOUNTING PARTS		
	136-0925-00			SOCKET,DIP::	91506	224-AG30D
				END MOUNTING PARTS		
A1W201	174-2965-00			CA ASSY,SP,ELEC:RIBBON,;IDC,16,28 AWG,3.0 L,2X8,0.1 CTR,RECPT BOTH ENDS	80009	174-2965-00
A2				CIRCUIT BOARD:MAIN,TSG131A		
A2C1	281-0775-01			CAP,FXD,CERAMIC:MCL,0.1UF,20%,50V,Z5U	04222	SA105E104MAA
A2C2	281-0775-01			CAP,FXD,CERAMIC:MCL,0.1UF,20%,50V,Z5U	04222	SA105E104MAA
A2C3	281-0775-01			CAP,FXD,CERAMIC:MCL,0.1UF,20%,50V,Z5U	04222	SA105E104MAA
A2C5	281-0775-01			CAP,FXD,CERAMIC:MCL,0.1UF,20%,50V,Z5U	04222	SA105E104MAA
A2C6	281-0775-01			CAP,FXD,CERAMIC:MCL,0.1UF,20%,50V,Z5U	04222	SA105E104MAA
A2C7	281-0775-01			CAP,FXD,CERAMIC:MCL,0.1UF,20%,50V,Z5U	04222	SA105E104MAA
A2C8	281-0775-01			CAP,FXD,CERAMIC:MCL,0.1UF,20%,50V,Z5U	04222	SA105E104MAA
A2C9	290-0973-01			CAP,FXD,ALUM:100UF,20%,25VDC	62643	SME35VB101M8X11FT
A2C10	290-0973-01			CAP,FXD,ALUM:100UF,20%,25VDC	62643	SME35VB101M8X11FT
A2C13	283-0177-05			CAP,FXD,CER DI:1UF,+80-20%,25V	20932	5030ES25RD105Z
A2C15	283-0177-05			CAP,FXD,CER DI:1UF,+80-20%,25V	20932	5030ES25RD105Z
A2C18	281-0904-00			CAP,FXD,CERAMIC:MLC,12PF,10%,100V	04222	SA102A12OJAA
A2C19	281-0166-00			CAP,VAR,AIR DI:1.9-15.7 PF,250V,TOP ADJ	74970	187-0109-055
A2C20	281-0904-00			CAP,FXD,CERAMIC:MLC,12PF,10%,100V	04222	SA102A12OJAA
A2C21	281-0166-00			CAP,VAR,AIR DI:1.9-15.7 PF,250V,TOP ADJ	74970	187-0109-055
A2C23	281-0775-01			CAP,FXD,CERAMIC:MCL,0.1UF,20%,50V,Z5U	04222	SA105E104MAA
A2C30	281-0123-00			CAP,VAR,CER DI:5-25PF,100V,TOP ADJ	33095	53-709-001 A5-25
A2C31	283-0648-01			CAP,FXD,MICA DI:10PF,5%,500V	TK0891	RDM15CD100D03
A2C32	281-0123-00			CAP,VAR,CER DI:5-25PF,100V,TOP ADJ	33095	53-709-001 A5-25
A2C33	283-0648-01			CAP,FXD,MICA DI:10PF,5%,500V	TK0891	RDM15CD100D03
A2C37	281-0775-01			CAP,FXD,CERAMIC:MCL,0.1UF,20%,50V,Z5U	04222	SA105E104MAA
A2C38	281-0775-01			CAP,FXD,CERAMIC:MCL,0.1UF,20%,50V,Z5U	04222	SA105E104MAA
A2C39	283-0220-04			CAP,FXD,CER DI:0.01UFD,20%,50V	18796	RPE121978X7R103M050V
A2C40	283-0177-05			CAP,FXD,CER DI:1UF,+80-20%,25V	20932	5030ES25RD105Z
A2C41	281-0775-01			CAP,FXD,CERAMIC:MCL,0.1UF,20%,50V,Z5U	04222	SA105E104MAA
A2C42	283-0177-05			CAP,FXD,CER DI:1UF,+80-20%,25V	20932	5030ES25RD105Z
A2C43	283-0220-04			CAP,FXD,CER DI:0.01UFD,20%,50V	18796	RPE121978X7R103M050V
A2C46	281-0810-00			CAP,FXD,CERAMIC:MLC,5.6PF,+/-0.5PF,100V	04222	SA102A5R6DAA

Replaceable Electrical Parts

Component Number	Tektronix Part Number	Effective	Discontinued	Name & Description	Mfr. Code	Mfr. Part Number
A2C47	281-0153-00			CAP,VAR,AIR DI:1.7-10PF,150V,TOP ADJ	74970	187-0106-055
A2C59	281-0775-01			CAP,FXD,CERAMIC:MCL,0.1UF,20%,50V,Z5U	04222	SA105E104MAA
A2C60	281-0775-01			CAP,FXD,CERAMIC:MCL,0.1UF,20%,50V,Z5U	04222	SA105E104MAA
A2C61	283-0220-04			CAP,FXD,CER DI:0.01UFD,20%,50V	18796	RPE121978X7R103M050V
A2C62	283-0177-05			CAP,FXD,CER DI:1UF,+80-20%,25V	20932	5030ES25RD105Z
A2C63	281-0775-01			CAP,FXD,CERAMIC:MCL,0.1UF,20%,50V,Z5U	04222	SA105E104MAA
A2C64	283-0177-05			CAP,FXD,CER DI:1UF,+80-20%,25V	20932	5030ES25RD105Z
A2C65	283-0220-04			CAP,FXD,CER DI:0.01UFD,20%,50V	18796	RPE121978X7R103M050V
A2C68	281-0810-00			CAP,FXD,CERAMIC:MLC,5.6PF,+/-0.5PF,100V	04222	SA102A5R6DAA
A2C69	281-0153-00			CAP,VAR,AIR DI:1.7-10PF,150V,TOP ADJ	74970	187-0106-055
A2C88	281-0775-01			CAP,FXD,CERAMIC:MCL,0.1UF,20%,50V,Z5U	04222	SA105E104MAA
A2C89	283-0177-05			CAP,FXD,CER DI:1UF,+80-20%,25V	20932	5030ES25RD105Z
A2C91	283-0220-04			CAP,FXD,CER DI:0.01UFD,20%,50V	18796	RPE121978X7R103M050V
A2C92	283-0177-05			CAP,FXD,CER DI:1UF,+80-20%,25V	20932	5030ES25RD105Z
A2C93	283-0220-04			CAP,FXD,CER DI:0.01UFD,20%,50V	18796	RPE121978X7R103M050V
A2C94	281-0775-01			CAP,FXD,CERAMIC:MCL,0.1UF,20%,50V,Z5U	04222	SA105E104MAA
A2C95	281-0775-01			CAP,FXD,CERAMIC:MCL,0.1UF,20%,50V,Z5U	04222	SA105E104MAA
A2C98	281-0810-00			CAP,FXD,CERAMIC:MLC,5.6PF,+/-0.5PF,100V	04222	SA102A5R6DAA
A2C99	281-0153-00			CAP,VAR,AIR DI:1.7-10PF,150V,TOP ADJ	74970	187-0106-055
A2C142	281-0775-01			CAP,FXD,CERAMIC:MCL,0.1UF,20%,50V,Z5U	04222	SA105E104MAA
A2C153	281-0775-01			CAP,FXD,CERAMIC:MCL,0.1UF,20%,50V,Z5U	04222	SA105E104MAA
A2C160	281-0775-01			CAP,FXD,CERAMIC:MCL,0.1UF,20%,50V,Z5U	04222	SA105E104MAA
A2C161	281-0775-01			CAP,FXD,CERAMIC:MCL,0.1UF,20%,50V,Z5U	04222	SA105E104MAA
A2C183	290-1290-00			CAP,FXD,ALUM:2200UF,20%,25V	62643	CEAFM1E222M-E
A2C186	281-0775-01			CAP,FXD,CERAMIC:MCL,0.1UF,20%,50V,Z5U	04222	SA105E104MAA
A2C187	283-0177-05			CAP,FXD,CER DI:1UF,+80-20%,25V	20932	5030ES25RD105Z
A2C188	290-0943-02			CAP,FXD,ALUM:47UF,20%,25V ,AXIAL,T&R	62643	CEUSM1E470-T
A2C190	283-0177-05			CAP,FXD,CER DI:1UF,+80-20%,25V	20932	5030ES25RD105Z
A2C191	281-0775-01			CAP,FXD,CERAMIC:MCL,0.1UF,20%,50V,Z5U	04222	SA105E104MAA
A2C192	281-0775-01			CAP,FXD,CERAMIC:MCL,0.1UF,20%,50V,Z5U	04222	SA105E104MAA
A2C193	283-0177-05			CAP,FXD,CER DI:1UF,+80-20%,25V	20932	5030ES25RD105Z
A2C194	283-0177-05			CAP,FXD,CER DI:1UF,+80-20%,25V	20932	5030ES25RD105Z
A2C197	281-0775-01			CAP,FXD,CERAMIC:MCL,0.1UF,20%,50V,Z5U	04222	SA105E104MAA
A2C198	281-0775-01			CAP,FXD,CERAMIC:MCL,0.1UF,20%,50V,Z5U	04222	SA105E104MAA
A2C254	281-0775-01			CAP,FXD,CERAMIC:MCL,0.1UF,20%,50V,Z5U	04222	SA105E104MAA
A2C255	281-0775-01			CAP,FXD,CERAMIC:MCL,0.1UF,20%,50V,Z5U	04222	SA105E104MAA
A2C256	281-0775-01			CAP,FXD,CERAMIC:MCL,0.1UF,20%,50V,Z5U	04222	SA105E104MAA
A2C257	281-0775-01			CAP,FXD,CERAMIC:MCL,0.1UF,20%,50V,Z5U	04222	SA105E104MAA
A2C258	281-0775-01			CAP,FXD,CERAMIC:MCL,0.1UF,20%,50V,Z5U	04222	SA105E104MAA
A2C263	283-0168-00			CAP,FXD,CER DI:12PF,5%,100V SQUARE	04222	SR151A120JAA
A2C268	281-0775-01			CAP,FXD,CERAMIC:MCL,0.1UF,20%,50V,Z5U	04222	SA105E104MAA
A2C269	281-0775-01			CAP,FXD,CERAMIC:MCL,0.1UF,20%,50V,Z5U	04222	SA105E104MAA
A2C270	281-0775-01			CAP,FXD,CERAMIC:MCL,0.1UF,20%,50V,Z5U	04222	SA105E104MAA
A2C271	281-0775-01			CAP,FXD,CERAMIC:MCL,0.1UF,20%,50V,Z5U	04222	SA105E104MAA
A2C272	281-0775-01			CAP,FXD,CERAMIC:MCL,0.1UF,20%,50V,Z5U	04222	SA105E104MAA
A2C273	281-0775-01			CAP,FXD,CERAMIC:MCL,0.1UF,20%,50V,Z5U	04222	SA105E104MAA

Replaceable Electrical Parts

Component Number	Tektronix Part Number	Effective	Discontinued	Name & Description	Mfr. Code	Mfr. Part Number
A2C274	281-0775-01			CAP,FXD,CERAMIC:MCL,0.1UF,20%,50V,Z5U	04222	SA105E104MAA
A2C275	281-0775-01			CAP,FXD,CERAMIC:MCL,0.1UF,20%,50V,Z5U	04222	SA105E104MAA
A2C276	281-0775-01			CAP,FXD,CERAMIC:MCL,0.1UF,20%,50V,Z5U	04222	SA105E104MAA
A2C277	281-0775-01			CAP,FXD,CERAMIC:MCL,0.1UF,20%,50V,Z5U	04222	SA105E104MAA
A2C278	281-0775-01			CAP,FXD,CERAMIC:MCL,0.1UF,20%,50V,Z5U	04222	SA105E104MAA
A2C281	281-0775-01			CAP,FXD,CERAMIC:MCL,0.1UF,20%,50V,Z5U	04222	SA105E104MAA
A2C282	281-0775-01			CAP,FXD,CERAMIC:MCL,0.1UF,20%,50V,Z5U	04222	SA105E104MAA
A2C283	281-0775-01			CAP,FXD,CERAMIC:MCL,0.1UF,20%,50V,Z5U	04222	SA105E104MAA
A2C284	281-0775-01			CAP,FXD,CERAMIC:MCL,0.1UF,20%,50V,Z5U	04222	SA105E104MAA
A2C290	283-0203-02			CAP,FXD,CERAMIC:MLC,0.47UF,20%,50V,Z5U	18796	RPE112902Z5U474M50V
A2C291	290-0845-00			CAP,FXD,ALUM:330UF,20,25V ,RADIAL	55680	UVX1H331MPA
A2C292	283-0203-02			CAP,FXD,CERAMIC:MLC,0.47UF,20%,50V,Z5U	18796	RPE112902Z5U474M50V
A2C293	283-0203-02			CAP,FXD,CERAMIC:MLC,0.47UF,20%,50V,Z5U	18796	RPE112902Z5U474M50V
A2C294	290-0845-00			CAP,FXD,ALUM:330UF,20,25V ,RADIAL	55680	UVX1H331MPA
A2C295	290-0845-00			CAP,FXD,ALUM:330UF,20,25V ,RADIAL	55680	UVX1H331MPA
A2C296	290-0845-00			CAP,FXD,ALUM:330UF,20,25V ,RADIAL	55680	UVX1H331MPA
A2C297	290-1301-00			CAP,FXD,ALUM:2700UF,20%,10V	62643	CEEFM1A272M7
A2C298	283-0203-02			CAP,FXD,CERAMIC:MLC,0.47UF,20%,50V,Z5U	18796	RPE112902Z5U474M50V
A2C299	283-0203-02			CAP,FXD,CERAMIC:MLC,0.47UF,20%,50V,Z5U	18796	RPE112902Z5U474M50V
A2C300	290-0973-01			CAP,FXD,ALUM:100UF,20%,25VDC	62643	SME35VB101M8X11FT
A2C301	290-0973-01			CAP,FXD,ALUM:100UF,20%,25VDC	62643	SME35VB101M8X11FT
A2C302	283-0398-00			CAP,FXD,CER DI:680PF,2%,100V SQUARE	04222	SR201A681GAA
A2C303	283-0398-00			CAP,FXD,CER DI:680PF,2%,100V SQUARE	04222	SR201A681GAA
A2C304	283-0220-04			CAP,FXD,CER DI:0.01UFD,20%,50V	18796	RPE121978X7R103M050V
A2C305	281-0775-01			CAP,FXD,CERAMIC:MCL,0.1UF,20%,50V,Z5U	04222	SA105E104MAA
A2C306	283-0203-02			CAP,FXD,CERAMIC:MLC,0.47UF,20%,50V,Z5U	18796	RPE112902Z5U474M50V
A2C307	283-0005-03			CAP,FXD,CER DI:0.01 UF,+80-20%,250V	04222	SR30VE103ZAATR2
A2C308	283-0032-00			CAP,FXD,CER DI:470PF,5%,500V DISC	16546	2DD60L471J
A2C320	281-0775-01			CAP,FXD,CERAMIC:MCL,0.1UF,20%,50V,Z5U	04222	SA105E104MAA
A2C321	281-0775-01			CAP,FXD,CERAMIC:MCL,0.1UF,20%,50V,Z5U	04222	SA105E104MAA
A2C326	281-0775-01			CAP,FXD,CERAMIC:MCL,0.1UF,20%,50V,Z5U	04222	SA105E104MAA
A2C327	281-0775-01			CAP,FXD,CERAMIC:MCL,0.1UF,20%,50V,Z5U	04222	SA105E104MAA
A2C328	281-0904-00			CAP,FXD,CERAMIC:MLC,12PF,10%,100V	04222	SA102A120JAA
A2C336	281-0775-01			CAP,FXD,CERAMIC:MCL,0.1UF,20%,50V,Z5U	04222	SA105E104MAA
A2C351	281-0775-01			CAP,FXD,CERAMIC:MCL,0.1UF,20%,50V,Z5U	04222	SA105E104MAA
A2C352	281-0775-01			CAP,FXD,CERAMIC:MCL,0.1UF,20%,50V,Z5U	04222	SA105E104MAA
A2C353	281-0775-01			CAP,FXD,CERAMIC:MCL,0.1UF,20%,50V,Z5U	04222	SA105E104MAA
A2C355	281-0904-00			CAP,FXD,CERAMIC:MLC,12PF,10%,100V	04222	SA102A120JAA
A2C356	283-0796-01			CAP,FXD,MICA DI:100PF,5%,500V	09023	CDA10FD101J03
A2CR10	152-0601-01			DIODE,RECT:ULTRA FAST,150V,25NS,35A IFSM	12969	UES1103
A2CR11	152-0601-01			DIODE,RECT:ULTRA FAST,150V,25NS,35A IFSM	12969	UES1103
A2CR12	152-0601-01			DIODE,RECT:ULTRA FAST,150V,25NS,35A IFSM	12969	UES1103
A2CR13	152-0601-01			DIODE,RECT:ULTRA FAST,150V,25NS,35A IFSM	12969	UES1103
A2CR40	152-0601-01			DIODE,RECT:ULTRA FAST,150V,25NS,35A IFSM	12969	UES1103
A2CR50	152-0601-01			DIODE,RECT:ULTRA FAST,150V,25NS,35A IFSM	12969	UES1103
A2CR60	152-0670-00			DIODE,RECT:SCHTKY,40V,3A,1N5822	04713	1N5822

Replaceable Electrical Parts

Component Number	Tektronix Part Number	Effective	Discontinued	Name & Description	Mfr. Code	Mfr. Part Number
A2CR70	176-0120-00			WIRE,ELECTRICAL:18 AWG,BARE,12.0 L	TK1326	ORDER BY DESCRIPTION
A2CR71	152-0670-00			DIODE,RECT:SCHTKY,40V,3A,1N5822	04713	1N5822
A2CR85	152-0141-02			DIODE,SIG:ULTRA FAST,40V,1N4152	01295	1N4152R
A2CR86	152-0141-02			DIODE,SIG:ULTRA FAST,40V,1N4152	01295	1N4152R
A2F1	159-0044-00			FUSE,CARTRIDGE:3AG,0.2A,250V,20SEC	71400	MDL 2/10
A2F1A	344-0329-00			CLIP,ELECTRICAL:ACCOM 5 X 20MM FUSE	61857	H-0011-2
A2F1B	344-0329-00			CLIP,ELECTRICAL:ACCOM 5 X 20MM FUSE	61857	H-0011-2
A2FL1	119-4316-00			FILTER,LOWPASS:	19615	F4105
A2FL2	119-4316-00			FILTER,LOWPASS:	19615	F4105
A2FL3	119-4316-00			FILTER,LOWPASS:	19615	F4105
A2J4	131-0608-00			CONN,TERMINAL	22526	48283-018
A2J6	131-0608-00			CONN,TERMINAL	22526	48283-018
A2J7	131-0608-00			CONN,TERMINAL	22526	48283-018
A2J8	131-0608-00			CONN,TERMINAL	22526	48283-018
A2J40	131-0608-00			CONN,TERMINAL	22526	48283-018
A2J50	131-0608-00			CONN,TERMINAL	22526	48283-018
A2J60	131-0608-00			CONN,TERMINAL	22526	48283-018
A2J70	131-0608-00			CONN,TERMINAL	22526	48283-018
A2J106	131-0608-00			CONN,TERMINAL	22526	48283-018
A2J107	131-0608-00			CONN,TERMINAL	22526	48283-018
A2J110	131-0608-00			CONN,TERMINAL	22526	48283-018
A2J111	131-0608-00			CONN,TERMINAL	22526	48283-018
A2J112	131-0608-00			CONN,TERMINAL	22526	48283-018
A2J122	131-0608-00			CONN,TERMINAL	22526	48283-018
A2J124	131-0608-00			CONN,TERMINAL	22526	48283-018
A2J128	131-0608-00			CONN,TERMINAL	22526	48283-018
A2J150	131-0608-00			CONN,TERMINAL	22526	48283-018
A2L1	108-1491-00			INDUCTOR,FXD:SIGNAL,9.9UH,5.5%	OJR03	108-1491-00
A2L2	131-4566-00			BUS,CONDUCTOR:0 OHM	91637	FRJ-50
A2L4	108-0538-02			INDUCTOR,FXD:CUSTOM,POWER,2.7UH,10%	OJR03	108-0538-02
A2L5	108-0538-02			INDUCTOR,FXD:CUSTOM,POWER,2.7UH,10%	OJR03	108-0538-02
A2L7	108-1491-00			INDUCTOR,FXD:SIGNAL,9.9UH,5.5%	OJR03	108-1491-00
A2L13	108-1491-00			INDUCTOR,FXD:SIGNAL,9.9UH,5.5%	OJR03	108-1491-00
A2L19	108-1491-00			INDUCTOR,FXD:SIGNAL,9.9UH,5.5%	OJR03	108-1491-00
A2L28	108-0245-01			INDUCTOR,FXD:CUSTOM,POWER,3.9UH,10%	OJR03	108-0245-01
A2L29	108-0245-01			INDUCTOR,FXD:CUSTOM,POWER,3.9UH,10%	OJR03	108-0245-01
A2L60	108-1263-00			INDUCTOR,FXD:POWER,10UH,10%	TK2058	TSL0707-100K1R9
A2L70	108-1263-00			INDUCTOR,FXD:POWER,10UH,10%	TK2058	TSL0707-100K1R9
A2L81	131-4566-00			BUS,CONDUCTOR:0 OHM	91637	FRJ-50
A2LF1	119-1946-00			FILTER,RFI:1A,250V,400HZ W/PC TERMINAL	0GV52	FX326-1/02-K-D-T
A2P6	131-0993-02			CONN,BOX	00779	1-850100-0
A2P7	131-0993-02			CONN,BOX	00779	1-850100-0
A2P8	131-0993-02			CONN,BOX	00779	1-850100-0
A2P40	131-0993-02			CONN,BOX	00779	1-850100-0
A2P50	131-0993-02			CONN,BOX	00779	1-850100-0
A2P60	131-0993-02			CONN,BOX	00779	1-850100-0

Replaceable Electrical Parts

Component Number	Tektronix Part Number	Effective	Discontinued	Name & Description	Mfr. Code	Mfr. Part Number
A2P70	131-0993-02			CONN,BOX	00779	1-850100-0
A2P110	131-0993-05			BUS,CONDUCTOR:SHUNT ASSEMBLY,GREEN	00779	850100-5
A2P111	131-0993-02			CONN,BOX	00779	1-850100-0
A2P112	131-0993-02			CONN,BOX	00779	1-850100-0
A2P122	198-5783-00			WIRE,SET ELEC:TSG111/TSG121/TSG131	TK1547	198-5783-00
A2P124	131-0993-02			CONN,BOX	00779	1-850100-0
A2P130	131-0993-02			CONN,BOX	00779	1-850100-0
A2P150	131-0993-05			BUS,CONDUCTOR:SHUNT ASSEMBLY,GREEN	00779	850100-5
A2Q30	151-0190-09			TRANSISTOR,SIG:BIPOLAR,NPN,40V,2N3904	04713	2N3904RLRA
A2Q100	151-1171-00			TRANSISTOR,PWR:MOS,N-CH,50V,12A,BUZ71A/I RFZ22/MTP15N06V	04713	MTP15N05E
A2R14	307-0051-00			RES,FXD,FILM:2.7 OHM,5%,0.5W MI	50139	EB27G5
A2R15	307-0051-00			RES,FXD,FILM:2.7 OHM,5%,0.5W MI	50139	EB27G5
A2R16	322-3133-00			RES,FXD,FILM:237 OHM,1%,0.2W,TC=T0	91637	CCF50-2370F-R36
A2R17	322-3193-00			RES,FXD:METAL FILM,1K OHM,1%,0.2W	57668	CRB20T68EFX1001
A2R18	311-0634-00			RES,VAR,NONWW:TRMR,500 OHM,0.5W CERMET	32997	3329H-L58-501
A2R19	322-3313-00			RES,FXD,FILM:17.8K OHM,1%,0.2W,TC=T0	91637	CCF-50 1782F T-0
A2R20	311-0633-00			RES,VAR,NONWW:TRMR,5K OHM,0.5W CERMET	32997	3329H-L58-502
A2R21	322-3133-00			RES,FXD,FILM:237 OHM,1%,0.2W,TC=T0	91637	CCF50-2370F-R36
A2R22	322-3193-00			RES,FXD:METAL FILM,1K OHM,1%,0.2W	57668	CRB20T68EFX1001
A2R23	311-0609-00			RES,VAR,NONWW:TRMR,2K OHM,0.5W CERMET	32997	3329H-L58-202
A2R24	322-3329-00			RES,FXD,FILM:26.1K OHM.1%,0.2W,TC=T0	57668	CRB20 FXE 26K1
A2R29	322-3114-00			RES,FXD,FILM:150 OHM,1%,0.2W	57668	CRB20-FX-150E-AXIAL
A2R30	322-3114-00			RES,FXD,FILM:150 OHM,1%,0.2W	57668	CRB20-FX-150E-AXIAL
A2R31	322-3271-00			RES,FXD,FILM:6.49K OHM,1%,0.2W,TC=T0	91637	CCF50-6491F-R36
A2R32	322-3259-00			RES,FXD,FILM:4.87K OHM,1%,0.2W,TC=T0	09969	CCF50-4871F-R36
A2R40	322-3085-07			RES,FXD,FILM:METAL FILM,75 OHM,0.1%,0.2W	91637	CCF50-C75ROB-R36
A2R41	322-3085-07			RES,FXD,FILM:METAL FILM,75 OHM,0.1%,0.2W	91637	CCF50-C75ROB-R36
A2R42	322-3212-00			RES,FXD,FILM:1.58K OHM,1%,0.2W,TC=T0	57668	CRB20 FXE 1K58
A2R45	322-3056-01			RES,FXD,FILM:37.4 OHM,0.5%,0.2W,TC=T0	57668	CRB20 DXE 37E4
A2R46	322-3085-07			RES,FXD,FILM:METAL FILM,75 OHM,0.1%,0.2W	91637	CCF50-C75ROB-R36
A2R48	317-0036-00			RES,FXD,FILM:3.6 OHM,5%,0.125W	50139	BB36G5
A2R51	322-3226-00			RES,FXD:METAL FILM,2.21K OHM,1%,0.2W	57668	CRB20T68EFX2211
A2R54	317-0036-00			RES,FXD,FILM:3.6 OHM,5%,0.125W	50139	BB36G5
A2R57	322-3133-00			RES,FXD,FILM:237 OHM,1%,0.2W,TC=T0	91637	CCF50-2370F-R36
A2R58	322-3193-00			RES,FXD:METAL FILM,1K OHM,1%,0.2W	57668	CRB20T68EFX1001
A2R59	322-3233-00			RES,FXD,FILM:2.61K OHM,1%,0.2W,TC=T0	91637	CCF50-2611F-R36
A2R60	311-0634-00			RES,VAR,NONWW:TRMR,500 OHM,0.5W CERMET	32997	3329H-L58-501
A2R61	322-3085-07			RES,FXD,FILM:METAL FILM,75 OHM,0.1%,0.2W	91637	CCF50-C75ROB-R36
A2R62	322-3320-00			RES,FXD,FILM:21K OHM,1%,0.2W,TC=T0	57668	CRB20 FXE 21K0
A2R63	311-0633-00			RES,VAR,NONWW:TRMR,5K OHM,0.5W CERMET	32997	3329H-L58-502
A2R64	322-3056-01			RES,FXD,FILM:37.4 OHM,0.5%,0.2W,TC=T0	57668	CRB20 DXE 37E4
A2R65	322-3085-07			RES,FXD,FILM:METAL FILM,75 OHM,0.1%,0.2W	91637	CCF50-C75ROB-R36
A2R67	317-0036-00			RES,FXD,FILM:3.6 OHM,5%,0.125W	50139	BB36G5
A2R70	322-3226-00			RES,FXD:METAL FILM,2.21K OHM,1%,0.2W	57668	CRB20T68EFX2211
A2R73	317-0036-00			RES,FXD,FILM:3.6 OHM,5%,0.125W	50139	BB36G5
A2R76	322-3133-00			RES,FXD,FILM:237 OHM,1%,0.2W,TC=T0	91637	CCF50-2370F-R36

Replaceable Electrical Parts

Component Number	Tektronix Part Number	Effective	Discontinued	Name & Description	Mfr. Code	Mfr. Part Number
A2R77	322-3193-00			RES,FXD:METAL FILM,1K OHM,1%,0.2W	57668	CRB20T68EFX1001
A2R78	322-3218-00			RES,FXD:METAL FILM,1.82K OHM,1%,0.2W	57668	CRB20 FXE 1K82
A2R79	311-0634-00			RES,VAR,NONWW:TRMR,500 OHM,0.5W CERMET	32997	3329H-L58-501
A2R80	322-3085-07			RES,FXD,FILM:METAL FILM,75 OHM,0.1%,0.2W	91637	CCF50-C75ROB-R36
A2R81	322-3301-00			RES,FXD,FILM:13.3K OHM,1%,0.2W,TC=150PPM,	57668	CRB20 FXE 13K3
A2R82	311-0633-00			RES,VAR,NONWW:TRMR,5K OHM,0.5W CERMET	32997	3329H-L58-502
A2R83	322-3056-01			RES,FXD,FILM:37.4 OHM,0.5%,0.2W,TC=T0	57668	CRB20 DXE 37E4
A2R88	322-3226-00			RES,FXD:METAL FILM,2.21K OHM,1%,0.2W	57668	CRB20T68EFX2211
A2R89	317-0036-00			RES,FXD,FILM:3.6 OHM,5%,0.125W	50139	BB36G5
A2R90	317-0036-00			RES,FXD,FILM:3.6 OHM,5%,0.125W	50139	BB36G5
A2R92	322-3085-07			RES,FXD,FILM:METAL FILM,75 OHM,0.1%,0.2W	91637	CCF50-C75ROB-R36
A2R93	322-3085-07			RES,FXD,FILM:METAL FILM,75 OHM,0.1%,0.2W	91637	CCF50-C75ROB-R36
A2R94	131-4566-00			BUS,CONDUCTOR:0 OHM	91637	FRJ-50
A2R95	322-3133-00			RES,FXD,FILM:237 OHM,1%,0.2W,TC=T0	91637	CCF50-2370F-R36
A2R96	322-3193-00			RES,FXD:METAL FILM,1K OHM,1%,0.2W	57668	CRB20T68EFX1001
A2R97	322-3233-00			RES,FXD,FILM:2.61K OHM,1%,0.2W,TC=T0	91637	CCF50-2611F-R36
A2R98	311-0634-00			RES,VAR,NONWW:TRMR,500 OHM,0.5W CERMET	32997	3329H-L58-501
A2R99	322-3085-07			RES,FXD,FILM:METAL FILM,75 OHM,0.1%,0.2W	91637	CCF50-C75ROB-R36
A2R100	322-3320-00			RES,FXD,FILM:21K OHM,1%,0.2W,TC=T0	57668	CRB20 FXE 21K0
A2R101	311-0633-00			RES,VAR,NONWW:TRMR,5K OHM,0.5W CERMET	32997	3329H-L58-502
A2R140	315-0100-00			RES,FXD,FILM:10 OHM,5%,0.25W MI	50139	CB1005
A2R181	131-4566-00			BUS,CONDUCTOR:0 OHM	91637	FRJ-50
A2R182	322-3085-07			RES,FXD,FILM:METAL FILM,75 OHM,0.1%,0.2W	91637	CCF50-C75ROB-R36
A2R183	322-3114-00			RES,FXD,FILM:150 OHM,1%,0.2W,TC=100	57668	CRB20-FX-150E-AXIAL
A2R183	322-3114-00		671-2762-04	RES,FXD,FILM:150 OHM,1%,0.2W,TC=100 (OPTION 4 ONLY)	57668	CRB20-FX-150E-AXIAL
A2R183	322-3114-00		671-2820-04	RES,FXD,FILM:150 OHM,1%,0.2W,TC=100 (OPTION 4/10 ONLY)	57668	CRB20-FX-150E-AXIAL
A2R193	131-4566-00			BUS,CONDUCTOR:0 OHM	91637	FRJ-50
A2R194	131-4566-00			BUS,CONDUCTOR:0 OHM	91637	FRJ-50
A2R195	322-3085-07			RES,FXD,FILM:METAL FILM,75 OHM,0.1%,0.2W	91637	CCF50-C75ROB-R36
A2R196	322-3114-00			RES,FXD,FILM:150 OHM,1%,0.2W	57668	CRB20-FX-150E-AXIAL
A2R197	322-3114-00			RES,FXD,FILM:150 OHM,1%,0.2W	57668	CRB20-FX-150E-AXIAL
A2R198	307-0503-00			RES NTWK,FXD,FI:(9) 510 OHM,20%,0.125W,TC=50	11236	750-101-R510 OR 770-101-R510
A2R199	322-3212-00			RES,FXD,FILM:1.58K OHM,1%,0.2W,TC=T0	57668	CRB20 FXE 1K58
A2R211	322-3085-07			RES,FXD,FILM:METAL FILM,75 OHM,0.1%,0.2W	91637	CCF50-C75ROB-R36
A2R213	322-3193-00			RES,FXD:METAL FILM,1K OHM,1%,0.2W	57668	CRB20T68EFX1001
A2R232	322-3243-00			RES,FXD:METAL FILM,3.32K OHM,1%,0.2W	91637	CCF50-3321F-R36
A2R233	322-3243-00			RES,FXD:METAL FILM,3.32K OHM,1%,0.2W	91637	CCF50-3321F-R36
A2R235	322-3193-00			RES,FXD:METAL FILM,1K OHM,1%,0.2W	57668	CRB20T68EFX1001
A2R248	322-3243-00			RES,FXD:METAL FILM,3.32K OHM,1%,0.2W	91637	CCF50-3321F-R36
A2R260	322-3193-00			RES,FXD:METAL FILM,1K OHM,1%,0.2W	57668	CRB20T68EFX1001
A2R261	315-0101-00			RES,FXD,FILM:100 OHM,5%,0.25W	50139	CB1015
A2R262	315-0331-00			RES,FXD,FILM:330 OHM,5%,0.25W	50139	CB3315
A2R263	322-3235-00			RES,FXD:METAL FILM,2.74K OHM,1%,0.2W	57668	CRB20 FXE 2K74
A2R264	322-3235-00			RES,FXD:METAL FILM,2.74K OHM,1%,0.2W	57668	CRB20 FXE 2K74

Replaceable Electrical Parts

Component Number	Tektronix Part Number	Effective	Discontinued	Name & Description	Mfr. Code	Mfr. Part Number
A2R265	322-3235-00			RES,FXD:METAL FILM,2.74K OHM,1%,0.2W	57668	CRB20 FXE 2K74
A2R266	322-3414-00			RES,FXD:METAL FILM,200K OHM,1%,0.2W	57668	CRB 20 FXE 200 K OHM
A2R267	322-3258-00			RES,FXD:METAL FILM,4.75K OHM,1%,0.2W	56845	CCF50-4751F-R36
A2R268	322-3181-00			RES,FXD,FILM:750 OHM,1%,0.2W,TC=T0	91637	CCF50-7500F-R36
A2R269	308-0463-00			RES,FXD,WW:0.3 OHM,1%,3W	00213	1240SR3000F 0.31 PERCENT
A2R270	322-3222-00			RES,FXD:METAL FILM,2K OHM,1%,0.2W	57668	CRB20T68EFX2001
A2R271	315-0100-00			RES,FXD,FILM:10 OHM,5%,0.25W	50139	CB1005
A2R273	322-3097-00			RES,FXD,FILM:100 OHM,1%,0.2W	57668	CRB20T68EFX1000
A2R274	131-4566-00			BUS,CONDUCTOR:0 OHM	91637	FRJ-50
A2R300	322-3167-00			RES,FXD,FILM:536 OHM,1%,0.2W,TC=T0	57668	CRB20 FXE 536E
A2R301	322-3133-00			RES,FXD,FILM:237 OHM,1%,0.2W,TC=T0	91637	CCF50-2370F-R36
A2R302	322-3313-00			RES,FXD,FILM:20K OHM,1%,0.2W,TC=100	57668	CRB20T68EFX2002
A2R302	322-3255-00	671-2762-04		RES,FXD,FILM:4.42K OHM,1%,0.2W,TC=T0 (OPTION 4 ONLY)	57668	CRB20 FXE 4K42
	322-3255-00	671-2820-04		RES,FXD,FILM:4.42K OHM,1%,0.2W,TC=T0 (OPTION 4/10 ONLY)	57668	CRB20 FXE 4K42
A2R303	322-3259-00			RES,FXD,FILM:4.87K OHM,1%,0.2W,TC=T0	09969	CCF50-4871F-R36
A2R303	322-3131-00	671-2762-04		RES,FXD,FILM:226 OHM,1%,0.2W,TC=T0 (OPTION 4 ONLY)	91637	CCF50-2260F-R36
	322-3131-00	671-2820-04		RES,FXD,FILM:226 OHM,1%,0.2W,TC=T0 (OPTION 4/10 ONLY)	91637	CCF50-2260F-R36
A2R304	322-3056-01			RES,FXD,FILM:37.4 OHM,0.5%,0.2W,TC=T0	57668	CRB20 DXE 37E4
A2R305	322-3056-01			RES,FXD,FILM:37.4 OHM,0.5%,0.2W,TC=T0	57668	CRB20 DXE 37E4
A2R315	322-3056-01			RES,FXD,FILM:37.4 OHM,0.5%,0.2W,TC=T0	57668	CRB20 DXE 37E4
A2R316	317-0036-00			RES,FXD,FILM:3.6 OHM,5%,0.125W	50139	BB36G5
A2R317	317-0036-00			RES,FXD,FILM:3.6 OHM,5%,0.125W	50139	BB36G5
A2R318	322-3226-00			RES,FXD:METAL FILM,2.21K OHM,1%,0.2W	57668	CRB20T68EFX2211
A2R323	322-3085-07			RES,FXD,FILM:METAL FILM,75 OHM,0.1%,0.2W	91637	CCF50-C75ROB-R36
A2R327	322-3243-00			RES,FXD:METAL FILM,3.32K OHM,1%,0.2W	91637	CCF50-3321F-R36
A2R336	322-3114-00			RES,FXD,FILM:150 OHM,1%,0.2W	57668	CRB20-FX-150E-AXIAL
A2R340	322-3056-01			RES,FXD,FILM:37.4 OHM,0.5%,0.2W,TC=T0	57668	CRB20 DXE 37E4
A2R341	322-3085-07			RES,FXD,FILM:METAL FILM,75 OHM,0.1%,0.2W	91637	CCF50-C75ROB-R36
A2R342	322-3085-07			RES,FXD,FILM:METAL FILM,75 OHM,0.1%,0.2W	91637	CCF50-C75ROB-R36
A2R343	322-3085-07			RES,FXD,FILM:METAL FILM,75 OHM,0.1%,0.2W	91637	CCF50-C75ROB-R36
A2R344	322-3085-07			RES,FXD,FILM:METAL FILM,75 OHM,0.1%,0.2W	91637	CCF50-C75ROB-R36
A2R345	322-3085-07			RES,FXD,FILM:METAL FILM,75 OHM,0.1%,0.2W	91637	CCF50-C75ROB-R36
A2R346	322-3085-07			RES,FXD,FILM:METAL FILM,75 OHM,0.1%,0.2W	91637	CCF50-C75ROB-R36
A2R347	322-3085-07			RES,FXD,FILM:METAL FILM,75 OHM,0.1%,0.2W	91637	CCF50-C75ROB-R36
A2R348	322-3085-07			RES,FXD,FILM:METAL FILM,75 OHM,0.1%,0.2W	91637	CCF50-C75ROB-R36
A2R349	322-3085-07			RES,FXD,FILM:METAL FILM,75 OHM,0.1%,0.2W	91637	CCF50-C75ROB-R36
A2R350	322-3085-07			RES,FXD,FILM:METAL FILM,75 OHM,0.1%,0.2W	91637	CCF50-C75ROB-R36
A2R351	322-3085-07			RES,FXD,FILM:METAL FILM,75 OHM,0.1%,0.2W	91637	CCF50-C75ROB-R36
A2R352	322-3085-07			RES,FXD,FILM:METAL FILM,75 OHM,0.1%,0.2W	91637	CCF50-C75ROB-R36
A2R355	322-3243-00			RES,FXD:METAL FILM,3.32K OHM,1%,0.2W	91637	CCF50-3321F-R36
A2R357	322-3243-00			RES,FXD:METAL FILM,3.32K OHM,1%,0.2W	91637	CCF50-3321F-R36
A2R358	322-3243-00			RES,FXD:METAL FILM,3.32K OHM,1%,0.2W	91637	CCF50-3321F-R36
A2R359	322-3193-00			RES,FXD:METAL FILM,1K OHM,1%,0.2W	57668	CRB20T68EFX1001

Replaceable Electrical Parts

Component Number	Tektronix Part Number	Effective	Discontinued	Name & Description	Mfr. Code	Mfr. Part Number
A2R360	322-3222-00			RES,FXD:METAL FILM,2K OHM,1%,0.2W	57668	CRB20T68EFX2001
A2R361	322-3114-00			RES,FXD,FILM:150 OHM,1%,0.2W	57668	CRB20-FX-150E-AXIAL
A2R362	322-3171-00			RES,FXD,FILM:590 OHM,1%,0.2W,TC=T0	57668	CRB20 FXE 590E
A2R363	322-3113-00			RES,FXD,FILM:147 OHM,1%,0.2W,TC=T0	57668	CRB20 FXE 147E
A2R364	322-3025-00			RES,FXD,FILM:17.8 OHM,1%,0.2W	57668	CRB20FXE17E8
A2R365	322-3073-00			RES,FXD,FILM:56.2 OHM,1%,0.2W	57668	CRB20 FXE 56E2
A2R366	321-0103-00			ES,FXD,FILM:115 OHM,1%,0.125W,TC=T0 MI	07716	CEAD115R0F
A2R367	323-0085-00			RES,FXD,FILM:75.0 OHM,1%,0.5W,TC=T0	64537	PME70
A2R368	322-0073-00			RES,FXD,FILM:56.2 OHM,1%,0.25W,TC=T0,MI	91637	RN60D-56R2F-R36
A2R369	322-0073-00			RES,FXD,FILM:56.2 OHM,1%,0.25W,TC=T0,MI	91637	RN60D-56R2F-R36
A2R370	322-3193-00			RES,FXD:METAL FILM,1K OHM,1%,0.2W	57668	CRB20T68EFX1001
A2R371	322-0178-00			RES,FXD,FILM:698 OHM,1%,0.25W,TC=T0	19701	5043RD698R0F
A2R375	322-3034-00			RES,FXD,FILM:22.1 OHM,1%,0.2W	91637	CCF50-22R1F-R36
A2R376	322-3034-00			RES,FXD,FILM:22.1 OHM,1%,0.2W	91637	CCF50-22R1F-R36
A2R377	322-3034-00			RES,FXD,FILM:22.1 OHM,1%,0.2W	91637	CCF50-22R1F-R36
A2R378	322-3034-00			RES,FXD,FILM:22.1 OHM,1%,0.2W	91637	CCF50-22R1F-R36
A2R379	322-3277-00			RES,FXD,FILM:7.5K OHM,1%,0.2W,TC=T0	57668	CRB20 FXE 7K50
A2R380	322-3277-00			RES,FXD,FILM:7.5K OHM,1%,0.2W,TC=T0	57668	CRB20 FXE 7K50
A2R381	322-3277-00			RES,FXD,FILM:7.5K OHM,1%,0.2W,TC=T0	57668	CRB20 FXE 7K50
A2R382	322-3277-00			RES,FXD,FILM:7.5K OHM,1%,0.2W,TC=T0	57668	CRB20 FXE 7K50
A2R400	322-3283-00			RES,FXD,FILM:8.66K OHM,1%,0.2W,TC=T0	57668	CRR20 FXE 8K66
A2R410	322-3121-00			RES,FXD,FILM:178 OHM,1%,0.2W	57668	CRB20 FXE 178E
A2R412	322-3139-00			RES,FXD,FILM:274 OHM,1%,0.2W	57668	CRB20T68EFX2740
A2SKT5	136-1005-00			SOCKET,PLCC:PCB,28 POS,0.05 CTR	00779	3-821581-1
A2SKT21	136-1038-00			SOCKET,DIP:PCB,STR,28 POS	00779	2-643543-1
A2SKT23	136-1038-00			SOCKET,DIP:PCB,STR,28 POS	00779	2-643543-1
A2SKT25	136-1038-00			SOCKET,DIP:PCB,STR,28 POS	00779	2-643543-1
A2SKT27	136-1038-00			SOCKET,DIP:PCB,STR,28 POS	00779	2-643543-1
A2SKT31	136-1005-00			SOCKET,PLCC:PCB,28 POS,0.05 CTR	00779	3-821581-1
A2SKT34	136-1005-00			SOCKET,PLCC:PCB,28 POS,0.05 CTR	00779	3-821581-1
A2SKT102	136-0963-00			SOCKET,DIP:PCB,32,2 X 16,0.1 X 0.6 CTR	00779	2-644018-3
A2SKT104	136-0963-00			SOCKET,DIP:PCB,32,2 X 16,0.1 X 0.6 CTR	00779	2-644018-3
A2SKT201	136-1047-00			SOCKET,PLCC:PCB,44 POS,0.05 CTR	00779	821575-1
A2SKT202	136-1047-00			SOCKET,PLCC:PCB,44 POS,0.05 CTR	00779	821575-1
A2SKT222	136-0904-00			SOCKET,PGA:PCB,121 POS,13 X 13,0.1 X 0.1 CTR	00779	916223-2 (PKG B)
A2SKT228	136-0925-00			SOCKET,DIP:PCB,24 POS,2 X 12,0.1 X 0.3 CTR	00779	2-641932-3
A2SKT229	136-0925-00			SOCKET,DIP:PCB,24 POS,2 X 12,0.1 X 0.3 CTR	00779	2-641932-3
A2SKT245	136-0925-00			SOCKET,DIP:PCB,24 POS,2 X 12,0.1 X 0.3 CTR	00779	2-641932-3
A2T1	120-1902-00			TRANSFORMER,PWR:115/230 VAC,50/60HZ	08779	LP40-600
A2T2	120-1785-00			TRANSFORMER:FLYBACK,+/- 5V 2A, +/- 15V 0.2A	OJR03	128-7045-00
A2TP1	214-4085-00			TERM,TEST POINT:W/ RED NYLON COLLAR	26364	TP104-01-02
A2TP2	214-4085-00			TERM,TEST POINT:W/ RED NYLON COLLAR	26364	TP104-01-02
A2TP3	214-4085-00			TERM,TEST POINT:W/ RED NYLON COLLAR	26364	TP104-01-02
A2TP4	214-4085-00			TERM,TEST POINT:W/ RED NYLON COLLAR	26364	TP104-01-02
A2TP5	214-4085-00			TERM,TEST POINT:W/ RED NYLON COLLAR	26364	TP104-01-02
A2TP6	214-4085-00			TERM,TEST POINT:W/ RED NYLON COLLAR	26364	TP104-01-02

Replaceable Electrical Parts

Component Number	Tektronix Part Number	Effective	Discontinued	Name & Description	Mfr. Code	Mfr. Part Number
A2TP8	214-4085-00			TERM,TEST POINT:W/ RED NYLON COLLAR	26364	TP104-01-02
A2TP9	214-4085-00			TERM,TEST POINT:W/ RED NYLON COLLAR	26364	TP104-01-02
A2TP10	214-4085-00			TERM,TEST POINT:W/ RED NYLON COLLAR	26364	TP104-01-02
A2TP13	214-4085-00			TERM,TEST POINT:W/ RED NYLON COLLAR	26364	TP104-01-02
A2TP16	214-4085-00			TERM,TEST POINT:W/ RED NYLON COLLAR	26364	TP104-01-02
A2TP17	214-4085-00			TERM,TEST POINT:W/ RED NYLON COLLAR	26364	TP104-01-02
A2U1	156-4024-00			IC,LINEAR:BIPOLAR,OP-AMPAD9617JN,DIP08.3	24355	AD9617JN
A2U2	156-4024-00			IC,LINEAR:BIPOLAR,OP-AMPAD9617JN,DIP08.3	24355	AD9617JN
A2U4	156-4170-00			IC,LINEAR:BIPOLAR,OPA603AP,DIP08.3	13919	OPA603AP
A2U5	156-6345-00			IC,CONVERTER:BIPOLAR,D/A,AD9713BAP,PLC	24355	AD9713BAP
A2U21	160-4672-02	671-2539-04		IC,MEMORY:CMOS,PROM (STANDARD)	TK0198	160467202
	160-9453-02	671-4982-00		IC,MEMORY:CMOS,PROM (OPT 01)	TK0198	160945302
	160-4672-02	671-2808-04		IC,MEMORY:CMOS,PROM (OPT 10)	TK0198	160467202
	160-9453-02	671-2817-04		IC,MEMORY:CMOS,PROM (OPT 01 & 10)	TK0198	160945302
	160-4672-02	671-2760-04		IC,MEMORY:CMOS,PROM (OPT 02)	TK0198	160467202
	160-9453-02	671-2572-03		IC,MEMORY:CMOS,PROM (OPT 01 & 02)	TK0198	160945302
	160-9453-02	671-2827-04		IC,MEMORY:CMOS,PROM (OPT 01, 02, & 10)	TK0198	160945302
	160-4672-02	671-2819-04		IC,MEMORY:CMOS,PROM (OPT 02 & 10)	TK0198	160467202
	160-9309-02	671-2759-04		IC,MEMORY:CMOS,PROM (OPT 3)	TK0198	160930902
	160-9309-02	671-2816-04		IC,MEMORY:CMOS,PROM (OPT 3 & 10)	TK0198	160930902
	160-9319-02	671-2762-04		IC,MEMORY:CMOS,PROM (OPT 4)	TK0198	160931902
	160-9319-02	671-2820-04		IC,MEMORY:CMOS,PROM (OPT 4 & 10)	TK0198	160931902
A2U23	160-4975-02	671-2539-04		IC,MEMORY:CMOS,PROM (STANDARD)	TK0198	160497502
	160-9454-02	671-4982-00		IC,MEMORY:CMOS,PROM (OPT 01)	TK0198	160945402
	160-4975-02	671-2808-04		IC,MEMORY:CMOS,PROM (OPT 10)	TK0198	160497502
	160-9454-02	671-2817-04		IC,MEMORY:CMOS,PROM (OPT 01 & 10)	TK0198	160945402
	160-4975-02	671-2760-04		IC,MEMORY:CMOS,PROM (OPT 02)	TK0198	160497502
	160-9454-02	671-2572-03		IC,MEMORY:CMOS,PROM (OPT 01 & 02)	TK0198	160945402
	160-9454-02	671-2827-04		IC,MEMORY:CMOS,PROM (OPT 01, 02, & 10)	TK0198	160945402
	160-4975-02	671-2819-04		IC,MEMORY:CMOS,PROM (OPT 02 & 10)	TK0198	160497502
	160-9310-02	671-2759-04		IC,MEMORY:CMOS,PROM (OPT 3)	TK0198	160931002
	160-9310-02	671-2816-04		IC,MEMORY:CMOS,PROM (OPT 3 & 10)	TK0198	160931002
	160-9320-02	671-2762-04		IC,MEMORY:CMOS,PROM (OPT 4)	TK0198	160932002
	160-9320-02	671-2820-04		IC,MEMORY:CMOS,PROM (OPT 4 & 10)	TK0198	160932002
A2U25	160-4976-02	671-2539-04		IC,MEMORY:CMOS,PROM (STANDARD)	TK0198	160497602
	160-9455-02	671-4982-00		IC,MEMORY:CMOS,PROM (OPT 01)	TK0198	160945502
	160-4976-02	671-2808-04		IC,MEMORY:CMOS,PROM (OPT 10)	TK0198	160497602
	160-9455-02	671-2817-04		IC,MEMORY:CMOS,PROM (OPT 01 & 10)	TK0198	160945502
	160-4976-02	671-2760-04		IC,MEMORY:CMOS,PROM (OPT 02)	TK0198	160497602
	160-9455-02	671-2572-03		IC,MEMORY:CMOS,PROM (OPT 01 & 02)	TK0198	160945502
	160-9455-02	671-2827-04		IC,MEMORY:CMOS,PROM (OPT 01, 02, & 10)	TK0198	160945502
	160-4976-02	671-2819-04		IC,MEMORY:CMOS,PROM (OPT 02 & 10)	TK0198	160497602
	160-9311-02	671-2759-04		IC,MEMORY:CMOS,PROM (OPT 3)	TK0198	160931102
	160-9311-02	671-2816-04		IC,MEMORY:CMOS,PROM (OPT 3 & 10)	TK0198	160931102
	160-9321-02	671-2762-04		IC,MEMORY:CMOS,PROM (OPT 4)	TK0198	160932102
	160-9321-02	671-2820-04		IC,MEMORY:CMOS,PROM (OPT 4 & 10)	TK0198	160932102

Replaceable Electrical Parts

Component Number	Tektronix Part Number	Effective	Discontinued	Name & Description	Mfr. Code	Mfr. Part Number
A2U27	160-9303-02	671-2539-04		IC, MEMORY:CMOS,PROM (STANDARD)	TK0198	160930302
	160-9456-02	671-4982-00		IC, MEMORY:CMOS,PROM (OPT 01)	TK0198	160945602
	160-9303-02	671-2808-04		IC, MEMORY:CMOS,PROM (OPT 10)	TK0198	160930302
	160-9456-02	671-2817-04		IC, MEMORY:CMOS,PROM (OPT 01 & 10)	TK0198	160945602
	160-9303-02	671-2760-04		IC, MEMORY:CMOS,PROM (OPT 02)	TK0198	160930302
	160-9456-02	671-2572-03		IC, MEMORY:CMOS,PROM (OPT 01 & 02)	TK0198	160945602
	160-9456-02	671-2827-04		IC, MEMORY:CMOS,PROM (OPT 01, 02, & 10)	TK0198	160945602
	160-9303-02	671-2819-04		IC, MEMORY:CMOS,PROM (OPT 02 & 10)	TK0198	160930302
	160-9312-02	671-2759-04		IC, MEMORY:CMOS,PROM (OPT 3)	TK0198	160931202
	160-9312-02	671-2816-04		IC, MEMORY:CMOS,PROM (OPT 3 & 10)	TK0198	160931202
	160-9322-02	671-2762-04		IC, MEMORY:CMOS,PROM (OPT 4)	TK0198	160932202
	160-9322-02	671-2820-04		IC, MEMORY:CMOS,PROM (OPT 4 & 10)	TK0198	160932202
	A2U29	156-3019-00			IC, LINEAR:BIPOLAR,LM385BZ-1.2,TO-92	27014
A2U30	156-4170-00			IC, LINEAR:BIPOLAR,OPA603AP,DIP08.3	13919	OPA603AP
A2U31	156-6345-00			IC, CONVERTER:BIPOLAR,D/A,AD9713BAP,PLC	24355	AD9713BAP
A2U32	156-3019-00			IC, LINEAR:BIPOLAR,LM385BZ-1.2,TO-92	27014	LM385BZ-1.2
A2U33	156-4170-00			IC, LINEAR:BIPOLAR,OPA603AP,DIP08.3	13919	OPA603AP
A2U34	156-6345-00			IC, CONVERTER:BIPOLAR,D/A,AD9713BAP,PLC	24355	AD9713BAP
A2U37	156-3019-00			IC, LINEAR:BIPOLAR,LM385BZ-1.2,TO-92	27014	LM385BZ-1.2
A2U50	156-0872-00			IC, LINEAR:BIPOLAR,MC7912CT	01295	UA7912CKC
A2U102	160-9304-02	671-2539-04		IC, MEMORY:CMOS,EPROM (STANDARD)	TK0198	160930402
	160-9457-02	671-4982-00		IC, MEMORY:CMOS,EPROM (OPT 01)	TK0198	160945702
	160-9304-02	671-2808-04		IC, MEMORY:CMOS,EPROM (OPT 10)	TK0198	160930402
	160-9457-02	671-2817-04		IC, MEMORY:CMOS,EPROM (OPT 01 & 10)	TK0198	160945702
	160-9304-02	671-2760-04		IC, MEMORY:CMOS,EPROM (OPT 02)	TK0198	160930402
	160-9457-02	671-2572-03		IC, MEMORY:CMOS,EPROM (OPT 01 & 02)	TK0198	160945702
	160-9457-02	671-2827-04		IC, MEMORY:CMOS,EPROM (OPT 01, 02, & 10)	TK0198	160945702
	160-9304-02	671-2819-04		IC, MEMORY:CMOS,EPROM (OPT 02 & 10)	TK0198	160930402
	160-9313-02	671-2759-04		IC, MEMORY:CMOS,PROM (OPT 3)	TK0198	160931302
	160-9313-02	671-2816-04		IC, MEMORY:CMOS,PROM (OPT 3 & 10)	TK0198	160931302
	160-9323-02	671-2762-04		IC, MEMORY:CMOS,PROM (OPT 4)	TK0198	160932302
	160-9323-02	671-2820-04		IC, MEMORY:CMOS,PROM (OPT 4 & 10)	TK0198	160932302
	A2U104	160-9305-02	671-2539-04		IC, MEMORY:CMOS,EPROM (STANDARD)	TK0198
160-9458-02		671-4982-00		IC, MEMORY:CMOS,EPROM (OPT 01)	TK0198	160945802
160-9305-02		671-2808-04		IC, MEMORY:CMOS,EPROM (OPT 10)	TK0198	160930502
160-9458-02		671-2817-04		IC, MEMORY:CMOS,EPROM (OPT 01 & 10)	TK0198	160945802
160-9305-02		671-2760-04		IC, MEMORY:CMOS,EPROM (OPT 02)	TK0198	160930502
160-9458-02		671-2572-03		IC, MEMORY:CMOS,EPROM (OPT 01 & 02)	TK0198	160945802
160-9458-02		671-2827-04		IC, MEMORY:CMOS,EPROM (OPT 01, 02, & 10)	TK0198	160945802
160-9305-02		671-2819-04		IC, MEMORY:CMOS,EPROM (OPT 02 & 10)	TK0198	160930502
160-9314-02		671-2759-04		IC, MEMORY:CMOS,PROM (OPT 3)	TK0198	160931402
160-9314-02		671-2816-04		IC, MEMORY:CMOS,PROM (OPT 3 & 10)	TK0198	160931402
160-9324-02		671-2762-04		IC, MEMORY:CMOS,PROM (OPT 4)	TK0198	160932402
160-9324-02		671-2820-04		IC, MEMORY:CMOS,PROM (OPT 4 & 10)	TK0198	160932402
A2U106		156-2289-00			IC, DIGITAL:ECL, TRANSLATOR,10H124	04713
A2U108	156-2290-00			IC, DIGITAL:ECL, TRANSLATOR,10H125	04713	MC10H125P

Replaceable Electrical Parts

Component Number	Tektronix Part Number	Effective	Discontinued	Name & Description	Mfr. Code	Mfr. Part Number
A2U150	156-4677-00			IC,DIGITAL:ABTCMOS,FLIP FLOP,74ABT373	80009	156-4677-00
A2U200	156-4104-00			IC,LINEAR:BIPOLAR,UC3843	04713	UC3843N
A2U201	160-9306-01	671-2539-04		IC,DIGITAL:CMOS,PLD,(STANDARD)	TK0198	160930601
	160-9306-01	671-4982-00		IC,DIGITAL:CMOS,PLD,(OPT 01)	TK0198	160930601
	160-9306-01	671-2808-04		IC,DIGITAL:CMOS,PLD,(OPT 10)	TK0198	160930601
	160-9306-01	671-2817-04		IC,DIGITAL:CMOS,PLD,(OPT 01 & 10)	TK0198	160930601
	160-9306-01	671-2760-04		IC,DIGITAL:CMOS,PLD,(OPT 02)	TK0198	160930601
	160-9306-01	671-2572-03		IC,DIGITAL:CMOS,PLD,(OPT 01 & 02)	TK0198	160930601
	160-9306-01	671-2827-04		IC,DIGITAL:CMOS,PLD,(OPT 01, 02, & 10)	TK0198	160930601
	160-9306-01	671-2819-04		IC,DIGITAL:CMOS,PLD,(OPT 02 & 10)	TK0198	160930601
	160-9459-01	671-2759-04		IC,DIGITAL:CMOS,PLD,(OPT 03)	TK0198	160945901
	160-9459-01	671-2816-04		IC,DIGITAL:CMOS,PLD,(OPT 03 & 10)	TK0198	160945901
	160-9325-01	671-2762-04		IC,DIGITAL:CMOS,PLD, (OPT 04	TK0198	160932501
	160-9324-01	671-2820-04		IC,DIGITAL:CMOS,PLD, (OPT 04 & 10)	TK0198	160932501
A2U202	160-9307-02	671-2539-04		IC,DIGITAL:CMOS,PLD,(STANDARD)	TK0198	160930702
	160-9307-02	671-4982-00		IC,DIGITAL:CMOS,PLD,(OPT 01)	TK0198	160930702
	160-9307-02	671-2808-04		IC,DIGITAL:CMOS,PLD,(OPT 10)	TK0198	160930702
	160-9307-02	671-2817-04		IC,DIGITAL:CMOS,PLD,(OPT 01 & 10)	TK0198	160930702
	160-9307-02	671-2760-04		IC,DIGITAL:CMOS,PLD,(OPT 02)	TK0198	160930702
	160-9307-02	671-2572-03		IC,DIGITAL:CMOS,PLD,(OPT 01 & 02)	TK0198	160930702
	160-9307-02	671-2827-04		IC,DIGITAL:CMOS,PLD,(OPT 01, 02, & 10)	TK0198	160930702
	160-9307-02	671-2819-04		IC,DIGITAL:CMOS,PLD,(OPT 02 & 10)	TK0198	160930702
	160-9316-02	671-2759-04		IC,DIGITAL:CMOS,PLD,(OPT 03)	TK0198	160931602
	160-9316-02	671-2816-04		IC,DIGITAL:CMOS,PLD,(OPT 03 & 10)	TK0198	160931602
	160-9326-02	671-2762-04		IC,DIGITAL:CMOS,PLD, (OPT 04	TK0198	160932602
	160-9326-02	671-2820-04		IC,DIGITAL:CMOS,PLD, (OPT 04 & 10)	TK0198	160932602
A2U212	156-2735-00			IC,LINEAR:BIPOLAR,, 12V,100MA,5%,MC78L12ACP	01295	UA78L12ACLP
A2U220	156-1611-00			IC,DIGITAL:FTTL,FLIP FLOP,DUAL D-TYPE,74F74	04713	MC74F74N
A2U222	156-3156-00			IC,LINEAR:CMOS,TMC2249	07933	TMC2249H5C
A2U228	160-9409-01			IC,MEMORY:CMOS,EPROM	TK0198	160-9409-01
A2U229	160-9410-01			IC,MEMORY:CMOS,EPROM	TK0198	160-9410-01
A2U230	156-4152-00			IC,DIGITAL:FCTCMOS,BUFFER,OCTAL,3-STATE	61772	IDT74FCT241ATP
A2U231	156-4152-00			IC,DIGITAL:FCTCMOS,BUFFER,OCTAL,3-STATE	61772	IDT74FCT241ATP
A2U236	160-9318-00	671-2760-04		IC,DIGITAL:CMOS (OPT 02)	TK0198	160931800
	160-9318-00	671-2572-03		IC,DIGITAL:CMOS (OPT 01 & 02)	TK0198	160931800
	160-9318-00	671-2827-04		IC,DIGITAL:CMOS (OPT 01, 02, & 10)	TK0198	160931800
	160-9318-00	671-2819-04		IC,DIGITAL:CMOS (OPT 02 & 10)	TK0198	160931800
	160-9318-00	671-2759-04		IC,DIGITAL:CMOS (OPT 03)	TK0198	160931800
	160-9318-00	671-2816-04		IC,DIGITAL:CMOS (OPT 03 & 10)	TK0198	160931800
	160-9328-00	671-2762-04		IC,DIGITAL:CMOS (OPT 04)	TK0198	160932800
	160-9328-00	671-2820-04		IC,DIGITAL:CMOS (OPT 04 & 10)	TK0198	160932800
A2U240	156-4677-00			IC,DIGITAL:ABTCMOS,74ABT373	80009	156-4677-00
A2U245	160-9308-00	671-2539-04		IC,DIGITAL:CMOS,PROM (STANDARD)	TK0198	160930800
	160-9308-00	671-4982-00		IC,DIGITAL:CMOS,PROM (OPT 01)	TK0198	160930800
	160-9308-00	671-2808-04		IC,DIGITAL:CMOS,PROM (OPT 10)	TK0198	160930800
	160-9308-00	671-2817-04		IC,DIGITAL:CMOS,PROM (OPT 01 & 10)	TK0198	160930800

Replaceable Electrical Parts

Component Number	Tektronix Part Number	Effective	Discontinued	Name & Description	Mfr. Code	Mfr. Part Number
	160-9308-00	71-2760-04		IC,DIGITAL:CMOS,PROM (OPT 02)	TK0198	160930800
	160-9308-00	671-2572-03		IC,DIGITAL:CMOS,PROM (OPT 01 & 02)	TK0198	160930800
	160-9308-00	671-2827-04		IC,DIGITAL:CMOS,PROM (OPT 01, 02, & 10)	TK0198	160930800
	160-9308-00	671-2819-04		IC,DIGITAL:CMOS,PROM (OPT 2 & 10)	TK0198	160930800
	160-9317-00	671-2759-04		IC,DIGITAL:CMOS,PROM (OPT 03)	TK0198	160931700
	160-9317-00	671-2816-04		IC,DIGITAL:CMOS,PROM (OPT 03 & 10)	TK0198	160931700
	160-9327-00	671-2762-04		IC,DIGITAL:CMOS,PROM (OPT 04)	TK0198	160932700
	160-9327-00	671-2820-04		IC,DIGITAL:CMOS,PROM (OPT 04 & 10)	TK0198	160932700
A2VR30	152-0520-00			DIODE,ZENER:12V,5%,1W,1N4742A,DO-41,T&R	04713	1N4742ARL
A2W155	131-4566-00			BUS,CONDUCTOR:0 OHM	91637	FRJ-50
A2W156	131-4566-00			BUS,CONDUCTOR:0 OHM	91637	FRJ-50
A2W157	131-4566-00			BUS,CONDUCTOR:0 OHM	91637	FRJ-50
A2W158	131-4566-00			BUS,CONDUCTOR:0 OHM	91637	FRJ-50
A2W159	131-4566-00			BUS,CONDUCTOR:0 OHM	91637	FRJ-50
A2W166	131-4566-00			BUS,CONDUCTOR:0 OHM	91637	FRJ-50
A2W167	131-4566-00			BUS,CONDUCTOR:0 OHM	91637	FRJ-50
A2W168	131-4566-00			BUS,CONDUCTOR:0 OHM	91637	FRJ-50
A2W169	131-4566-00			BUS,CONDUCTOR:0 OHM	91637	FRJ-50
A2W179	131-4566-00			BUS,CONDUCTOR:0 OHM	91637	FRJ-50
A2W180	131-4566-00			BUS,CONDUCTOR:0 OHM	91637	FRJ-50
A2W182	131-4566-00			BUS,CONDUCTOR:0 OHM	91637	FRJ-50
A2Y1	119-4281-00	671-2539-04		XTAL UNIT,QTZ:17.734375MHZ,1PPM,TCXO,TUNE RANGE 5PPM (STANDARD)	80009	119-4281-00
A2Y1	119-4282-00	671-4982-00		XTAL UNIT,QTZ:17.734375MHZ,0.5PPM,TCXO, TUNE RANGE 5PPM (OPT 01)	80009	119-4281-00
A2Y1	119-4281-00	671-2760-04		XTAL UNIT,QTZ:17.734375MHZ,1PPM,TCXO,TUNE RANGE 5PPM (OPT 02)	80009	119-4281-00
A2Y1	119-4282-00	671-2572-03		XTAL UNIT,QTZ:17.734375MHZ,0.5PPM,TCXO,TUNE RANGE 5PPM (OPT 01 & 02)	80009	119-4281-00
A2Y1	119-4281-00	671-2808-04		XTAL UNIT,QTZ:17.734375MHZ,1PPM,TCXO, TUNE RANGE 5PPM (OPT 10)	80009	119-4282-00
A2Y1	119-4282-00	671-2817-04		XTAL UNIT,QTZ:17.734375MHZ,0.5PPM,TCXO, TUNE RANGE 5PPM (OPT 01 & 10)	80009	119-4282-00
A2Y1	119-4281-00	671-2819-04		XTAL UNIT,QTZ:17.734375MHZ,1PPM,TCXO, TUNE RANGE 5PPM (OPT 02 & 10)	80009	119-4282-00
A2Y1	119-4282-00	671-2827-04		XTAL UNIT,QTZ:17.734375MHZ,0.5PPM,TCXO, TUNE RANGE 5PPM (OPT 01, 02, & 10)	80009	119-4282-00

Replaceable Electrical Parts

Component Number	Tektronix Part Number	Effective	Discontinued	Name & Description	Mfr. Code	Mfr. Part Number
A3				CIRCUIT BD ASSY:TOP BNC		
A3J401	131-3378-00			CONN,RF JACK:	00779	227677-1
A3J402	131-5223-00			CONN,CIRC::PCB,MINI DIN;FEMALE,RTANG,4 POS,0.503 H X 0.137 TAIL,SILVER	80009	131-5223-00
A3J403	131-3378-00			CONN,RF JACK:	00779	227677-1
A3J404	131-3378-00			CONN,RF JACK:	00779	227677-1
A3J405	174-2512-00			TERMINAL,PIN:0.365 L X 0.025 BRZ GLD PL (QUANTITY 16)	80009	174-2512-00
A4				CIRCUIT BD ASSY:BOTTOM BNC		
A4J501	131-3378-00			CONN,RF JACK:	00779	227677-1
A4J502	131-3378-00			CONN,RF JACK:	00779	227677-1
A4J503	131-3378-00			CONN,RF JACK:	00779	227677-1
A3J505	174-2337-01			TERMINAL,PIN:0.365 L X 0.025 BRZ GLD PL (QUANTITY 10)	80009	174-2337-01
A4J504	131-3378-00			CONN,RF JACK:	00779	227677-1
A4J506	131-3766-00			CONN,HDR:PCB,;MALE,RTANG,1 X 2,0.1 CTR,0.235 MLG X 0.110 TAIL,30 GOLD,0.025 SQ	00779	A7232-2
A5				CIRCUIT BD ASSY:AUDIO		
	214-4528-01			SPRING, GROUND	80009	214-4528-01
A5C4	281-0775-01			CAP,FXD,CER DI:0.1UF,20%,50V	04222	SA105E104MAA
A5C81	281-0775-01			CAP,FXD,CER DI:0.1UF,20%,50V	04222	SA105E104MAA
A5C83	281-0775-01			CAP,FXD,CER DI:0.1UF,20%,50V	04222	SA105E104MAA
A5C84	281-0775-01			CAP,FXD,CER DI:0.1UF,20%,50V	04222	SA105E104MAA
A5C85	281-0775-01			CAP,FXD,CER DI:0.1UF,20%,50V	04222	SA105E104MAA
A5C86	281-0775-01			CAP,FXD,CER DI:0.1UF,20%,50V	04222	SA105E104MAA
A5C110	283-0594-02			CAP,FXD,MICA DI:1000PF,1%,100V,T&A	09023	CDA15FA102F03
A5C111	283-0594-02			CAP,FXD,MICA DI:1000PF,1%,100V,T&A	09023	CDA15FA102F03
A5C112	283-0177-05			CAP,FXD,CER DI:1UF,+80-20%,25V	04222	SR303E105ZAAAP1
A5C113	281-0775-01			CAP,FXD,CER DI:0.1UF,20%,50V	04222	SA105E104MAA
A5C114	290-1313-00			CAP,FXD,AL:10UF,20%,50V	80009	290-1313-00
A5C150	290-1313-00			CAP,FXD,AL:10UF,20%,50V	80009	290-1313-00
A5C259	281-0777-00			CAP,FXD,CER:MLC;51PF,5%,100V,0.100 X 0.170;AXIAL,MI	80009	281-0777-00
A5C260	281-0777-00			CAP,FXD,CER:MLC;51PF,5%,100V,0.100 X 0.170;AXIAL,MI	80009	281-0777-00
A5C261	281-0777-00			CAP,FXD,CER:MLC;51PF,5%,100V,0.100 X 0.170;AXIAL,MI	80009	281-0777-00
A5C262	281-0777-00			CAP,FXD,CER:MLC;51PF,5%,100V,0.100 X 0.170;AXIAL,MI	80009	281-0777-00
A5C350	281-0775-01			CAP,FXD,CER DI:0.1UF,20%,50V	04222	SA105E104MAA
A5C351	290-0943-02			CAP,FXD,ELCTLT:47UF,20%,25V	55680	UVX1E470MDA1TD
A5C352	290-0943-02			CAP,FXD,ELCTLT:47UF,20%,25V	55680	UVX1E470MDA1TD
A5CR1	152-0141-02			DIO,SIG:,ULTRA FAST;40V,150MA,4NS,2PF;1N4152,DO-35,T&R	80009	152-0141-02
A5CR2	152-0141-02			DIO,SIG:,ULTRA FAST;40V,150MA,4NS,2PF;1N4152,DO-35,T&R	80009	152-0141-02
A5FL1	119-4225-00			FILTER,EMI:T-CIRCUIT;25MHZ CUTOFF,1 NS LOSS 25DB@100-1000MHZ,C 0.5A,50V.180PF.70	80009	119-4225-00

Replaceable Electrical Parts

Component Number	Tektronix Part Number	Effective	Discontinued	Name & Description	Mfr. Code	Mfr. Part Number
A5FL2	119-4225-00			FILTER,EMI:T-CIRCUIT;25MHZ CUTOFF,1 NS LOSS 25DB@100-1000MHZ,C 0.5A,50V.180PF.70	80009	119-4225-00
A5FL3	119-4225-00			FILTER,EMI:T-CIRCUIT;25MHZ CUTOFF,1 NS LOSS 25DB@100-1000MHZ,C 0.5A,50V.180PF.70	80009	119-4225-00
A5FL4	119-4225-00			FILTER,EMI:T-CIRCUIT;25MHZ CUTOFF,1 NS LOSS 25DB@100-1000MHZ,C 0.5A,50V.180PF.70	80009	119-4225-00
A5J9	131-3987-00			CONN,CIRC::PCB,AUDIO,;MALE,RTANG,3 POS,1.22 H X 1.024 W,CTR PLZ,LATCHING	82389	E3MRA
	213-0055-00			*MOUNTING PARTS* SCREW,TPG,TF:2-32 X 0.188,TYPE B,PNH,STL	93907	ORDER BY DESCR
				END MOUNTING PARTS		
A5J10	131-3987-00			CONN,CIRC::PCB,AUDIO,;MALE,RTANG,3 POS,1.22 H X 1.024 W,CTR PLZ,LATCHING	82389	E3MRA
	213-0055-00			*MOUNTING PARTS* SCREW,TPG,TF:2-32 X 0.188,TYPE B,PNH,STL	93907	ORDER BY DESCR
				END MOUNTING PARTS		
A5J12	131-1426-00			CONN,HDR:PCB,;MALE,RTANG,1 X 36,0.1 CTR,0.23 MLG X 0.195 TAIL,GOLD,STACKABLE (QUANTITY 10)	22526	65524-136
A5P12	131-0993-05			BUS,CONDUCTOR:SHUNT ASSEMBLY,GREEN	00779	850100-5
A5Q1	151-1045-00			TRANSISTOR,SIG:JFET,P-CH;4.5V(SELECTED), 5MA,1MS,GENERAL;2N5460_SPECIAL,TO-92	80009	151-1045-00
A5Q2	151-1025-00			TRANSISTOR,SIG:JFET,N-CH;6V,15MA,4.5MS,AMPLIFIER;J304,TO-92,SDG	22229	F2263
A5Q3	151-0190-00			TRANSISTOR,SIG:BIPOLAR,2N3904,TO-92 EBC	80009	151-0190-00
A5Q4	151-0190-00			TRANSISTOR,SIG:BIPOLAR,2N3904,TO-92 EBC	80009	151-0190-00
A5Q5	151-0188-00			TRANSISTOR,SIG:BIPOLAR,2N3906,TO-92 EBC	80009	151-0188-00
A5Q6	151-0188-00			TRANSISTOR,SIG:BIPOLAR,2N3906,TO-92 EBC	80009	151-0188-00
A5R102	322-3039-00			RES,FXD,FILM:24.9 OHM,1%,0.2W,TC=T0	80009	322-3039-00
A5R103	322-3289-00			RES,FXD:METAL FILM;10K OHM,1%,0.2W	80009	322-3289-00
A5R104	322-3039-00			RES,FXD,FILM:24.9 OHM,1%,0.2W,TC=T0	80009	322-3039-00
A5R105	322-3222-00			RES,FXD:METAL FILM;2K OHM,1%,0.2W	57668	CRB20 FXE 2K00
A5R106	322-3404-00			RES,FXD,FILM:158K OHM,1%,0.2W,TC=T0	91637	CCF50-2F15802F
A5R107	322-3404-00			RES,FXD,FILM:158K OHM,1%,0.2W,TC=T0	91637	CCF50-2F15802F
A5R108	322-3260-00			RES,FXD,FILM:4.99K OHM,1%,0.2W,TC=T0	57668	CRB20 FXE 4K99
A5R109	322-3289-00			RES,FXD:METAL FILM;10K OHM,1%,0.2W	80009	322-3289-00
A5R110	322-3318-00			RES,FXD:METAL FILM;20K OHM,1%,0.2W	57668	CRB20 FXE 20K0
A5R111	322-3453-00			RES,FXD,FILM:511K OHM,1%,0.2W,TC=T0	91637	CCF50-2F51102F
A5R112	322-3275-00			RES,FXD,FILM:7.15K OHM,1%,0.2W,TC=T0	80009	322-3275-00
A5R113	322-3239-00			RES,FXD,FILM:3.01K OHM,1%,0.2W,TC=T0	57668	CRB20 FXE 3K01
A5R114	322-3409-00			RES,FXD,FILM:178K OHM,1%,0.2W,TC=T0	80009	322-3409-00
A5R115	322-3039-00			RES,FXD,FILM:24.9 OHM,1%,0.2W,TC=T0	80009	322-3039-00
A5R116	322-3289-00			RES,FXD:METAL FILM;10K OHM,1%,0.2W	80009	322-3289-00
A5R117	322-3039-00			RES,FXD,FILM:24.9 OHM,1%,0.2W,TC=T0	80009	322-3039-00
A5R118	322-3289-00			RES,FXD:METAL FILM;10K OHM,1%,0.2W	80009	322-3289-00
A5R119	322-3289-00			RES,FXD:METAL FILM;10K OHM,1%,0.2W	80009	322-3289-00
A5R120	322-3239-00			RES,FXD,FILM:3.01K OHM,1%,0.2W,TC=T0	57668	CRB20 FXE 3K01
A5R121	322-3280-00			RES,FXD,FILM:8.06K OHM,1%,0.2W,TC=T0	80009	322-3280-00
A5R122	311-2269-00			RES,VAR,NONWW:TRMR,20K OHM,20%,0.5W	80009	311-2269-00

Replaceable Electrical Parts

Component Number	Tektronix Part Number	Effective	Discontinued	Name & Description	Mfr. Code	Mfr. Part Number
A5R123	311-2269-00			RES,VAR,NONWW:TRMR,20K OHM,20%,0.5W	80009	311-2269-00
A5R124	322-3193-00			RES,FXD:METAL FILM;1K OHM,1%,0.2W	57668	CRB20 FXE 1K00
A5R125	322-3326-00			RES,FXD,FILM:24.3K OHM,1%,0.2W,TC=T0	91637	CCF50-2F24301F
A5R126	311-2262-00			RES,VAR,NONWW:TRMR,1M OHM,20%,0.5W	80009	311-2262-00
A5R127	322-3226-00			RES,FXD:METAL FILM;2.21K OHM,1%,0.2W	57668	CRB20 FXE 2K21
A5R150	322-3260-00			RES,FXD,FILM:4.99K OHM,1%,0.2W,TC=T0	57668	CRB20 FXE 4K99
A5R151	322-3260-00			RES,FXD,FILM:4.99K OHM,1%,0.2W,TC=T0	57668	CRB20 FXE 4K99
A5R152	322-3260-00			RES,FXD,FILM:4.99K OHM,1%,0.2W,TC=T0	57668	CRB20 FXE 4K99
A5R153	322-3260-00			RES,FXD,FILM:4.99K OHM,1%,0.2W,TC=T0	57668	CRB20 FXE 4K99
A5R209	321-0673-07			RES,FXD,FILM:17K OHM,0.1%,0.125W,TC=T9	07716	CEAE17001B
A5R210	321-0962-07			RES,FXD,FILM:8K OHM,0.1%,0.125W,TC=T9	80009	321-0962-07
A5R211	322-3056-00			RES,FXD,FILM:37.4 OHM,1%,0.2W,TC=T0	91637	CCF50-2F37R40F
A5R212	322-3056-00			RES,FXD,FILM:37.4 OHM,1%,0.2W,TC=T0	91637	CCF50-2F37R40F
A5R213	322-3487-00			RES,FXD,FILM:500 OHM,1%,0.2W,TC=T0	80009	322-3487-00
A5R214	322-3264-00			RES,FXD,FILM:5.49K OHM,1%,0.2W,TC=T0	57668	CRB20 FXE 5K49
A5R215	322-3264-00			RES,FXD,FILM:5.49K OHM,1%,0.2W,TC=T0	57668	CRB20 FXE 5K49
A5R216	322-3487-00			RES,FXD,FILM:500 OHM,1%,0.2W,TC=T0	80009	322-3487-00
A5TP12	214-4085-00			TERM,TEST POINT	26364	104-01-02
A5U40	156-1291-00			IC,LINEAR:BIFET,OP-AMP;DUAL,LOW POWER;TL062CP,DIP08.3	80009	156-1291-00
A5U41	156-1272-00			IC,LINEAR:BIPOLAR,OP-AMP;DUAL,HIGH OUTPUT DRIVE,LOW NOISE;NE5532N,DIP08.3	80009	156-1272-00
A5U42	156-1272-00			IC,LINEAR:BIPOLAR,OP-AMP;DUAL,HIGH OUTPUT DRIVE,LOW NOISE;NE5532N,DIP08.3	80009	156-1272-00
A5U43	156-0402-00			IC,MISC:BIPOLAR,TIMER;;LM555CN,DIP08.3	80009	156-0402-00
A5W128	174-2967-00			CA ASSY,SP,ELEC;RIBBON,;IDC,10,28 AWG,1.6 L,2X5,0.1 CTR,RECPT BOTH ENDS,ACCOM 0.025 SQ PIN	80009	174-2967-00

Diagrams and Circuit Board Illustrations

This section contains the troubleshooting procedures, block diagrams, circuit board illustrations, component locator tables, waveform illustrations, and schematic diagrams.

Symbols

Graphic symbols and class designation letters are based on ANSI Standard Y32.2-1975. Abbreviations are based on ANSI Y1.1-1972.

Logic symbology is based on ANSI/IEEE Standard 91-1984 in terms of positive logic. Logic symbols depict the logic function performed and can differ from the manufacturer's data.

The tilde (~) preceding a signal name indicates that the signal performs its intended function when in the low state.

Other standards used in the preparation of diagrams by Tektronix, Inc., include the following:

- Tektronix Standard 062-2476 Symbols and Practices for Schematic Drafting
- ANSI Y14.159-1971 Interconnection Diagrams
- ANSI Y32.16-1975 Reference Designations for Electronic Equipment
- MIL-HDBK-63038-1A Military Standard Technical Manual Writing Handbook

Component Values

Electrical components shown on the diagrams are in the following units unless noted otherwise:

Capacitors: Values one or greater are in picofarads (pF).
Values less than one are in microfarads (μF).

Resistors: Values are in Ohms (Ω).

Graphic Items and Special Symbols Used in This Manual

Each assembly in the instrument is assigned an assembly number (for example A5). The assembly number appears in the title on the diagram, in the lookup table for the schematic diagram, and corresponding component locator illustration. The Replaceable Electrical Parts list is arranged by assembly in numerical sequence; the components are listed by component number.

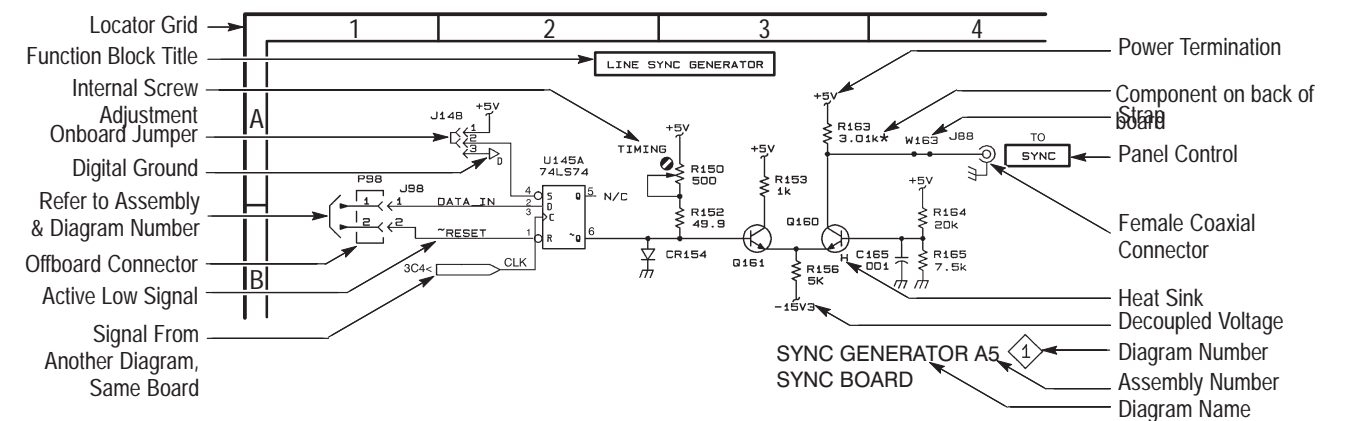

Component Locator Diagrams

The schematic diagram and circuit board component location illustrations have grids marked on them. The component lookup tables refer to these grids to help you locate a component. The circuit board illustration appears only once; its lookup table lists the diagram number of all diagrams on which the circuitry appears.

Some of the circuit board component location illustrations are expanded and divided into several parts to make it easier for you to locate small components. To determine which part of the whole locator diagram you are looking at, refer to the small locator key shown below. The gray block, within the larger circuit board outline, shows where that part fits in the whole locator diagram. Each part in the key is labeled with an identifying letter that appears in the figure titles under component locator diagrams.

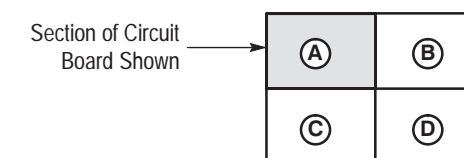

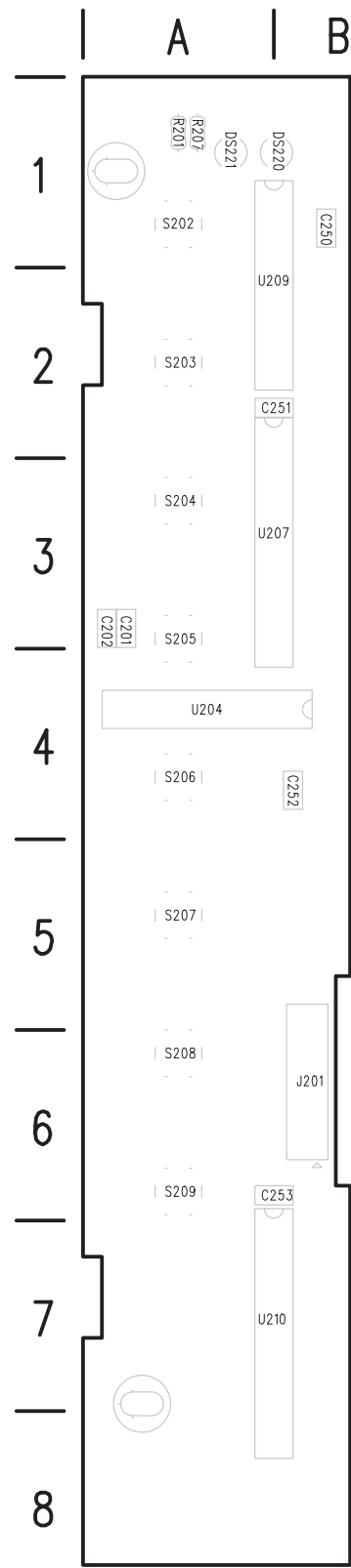

A1 Front Panel Board

**Front Panel Board and
Schematic Diagram <1>
Component Locator Chart**

*The schematic diagram has an
alpha-numeric grid to assist in
locating parts within that diagram.*

Assembly A1

Comp No	Diag Loc	Bd Loc
C201	C2	A3
C202	C2	A3
C250	A1	B1
C251	A1	A2
C252	B1	B4
C253	B1	A6
DS220	H3	B1
DS221	H3	A1
J201	A1	B6
R201	G5	A1
R207	H3	A1
S202A	C4	A1
S202B	C5	A1
S203A	C4	A2
S203B	C5	A2
S204A	D4	A3
S204B	D5	A3
S205A	E4	A3
S205B	E5	A3
S206A	E4	A4
S206B	E5	A4
S207A	F4	A5
S207B	F5	A5
S208A	F4	A6
S208B	G5	A6
S209A	G4	A6
S209B	G5	A6
U204	C2	A4
U207	F3	A3
U209	B5	A2
U210	D2	A7
W201	A1	

 **Static Sensitive Devices**
See Maintenance Section

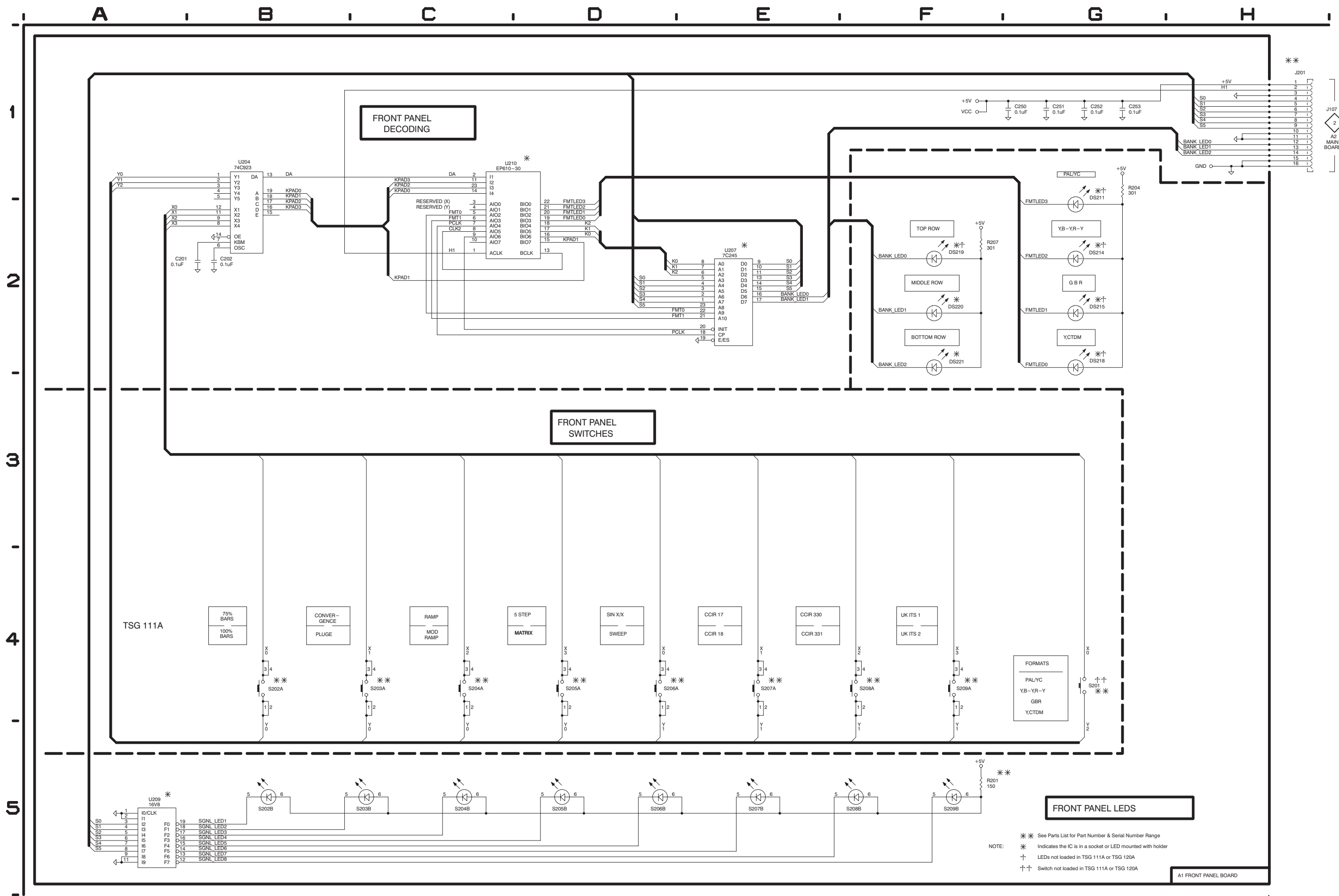

NOTE: * See Parts List for Part Number & Serial Number Range
 * Indicates the IC is in a socket or LED mounted with holder
 † LEDs not loaded in TSG 111A or TSG 120A
 †† Switch not loaded in TSG 111A or TSG 120A

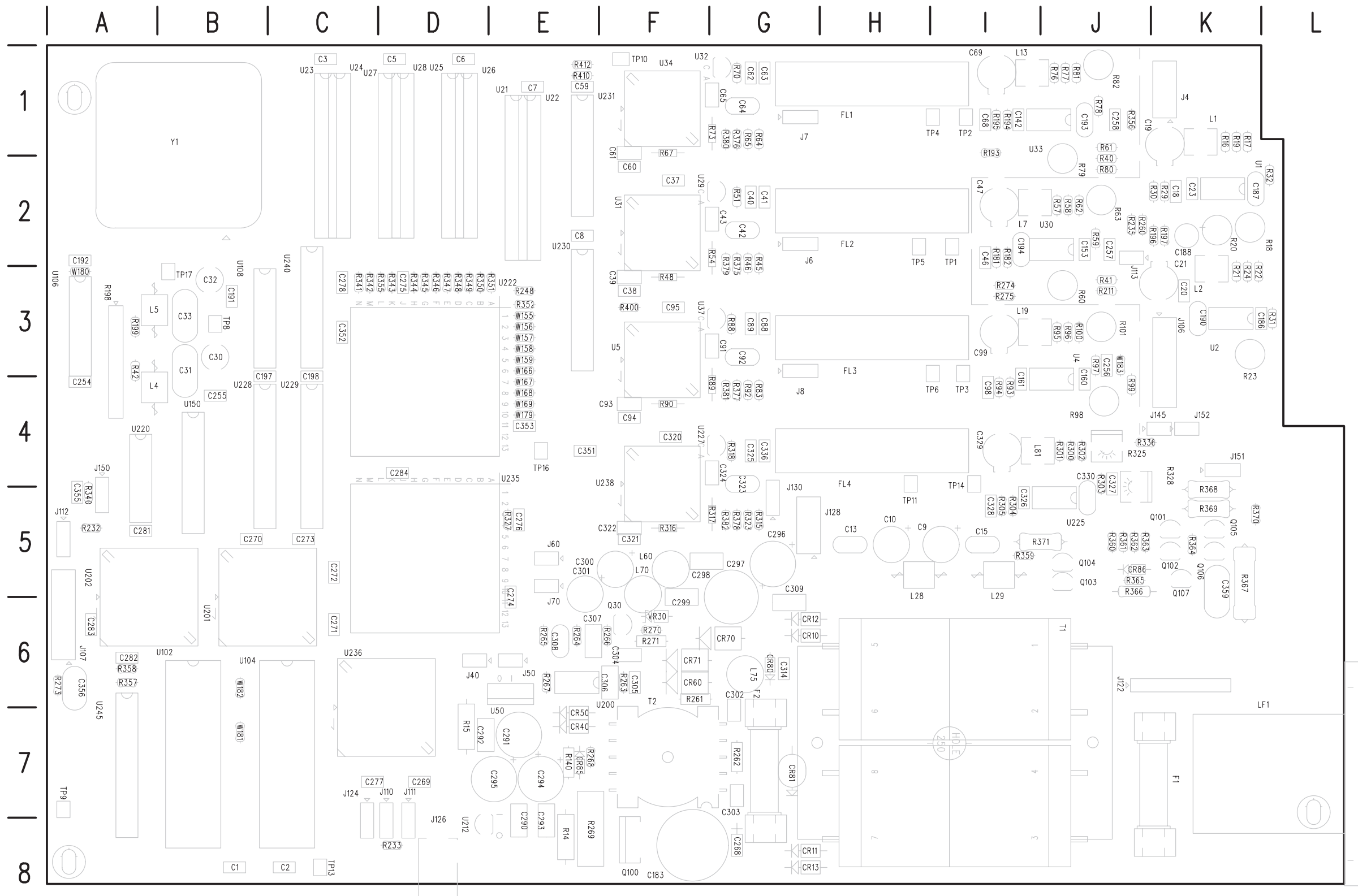

Figure 8-1: A2 Main Board component locations (TSG111 and TSG131A)

A2 Main Board Component Locator (with cross-references to schematic diagrams 2, 3, 4, 5, 8, 9, and 10)

Comp No	Diag No	Diag Loc	Bd Loc	Comp No	Diag No	Diag Loc	Bd Loc	Comp No	Diag No	Diag Loc	Bd Loc	Comp No	Diag No	Diag Loc	Bd Loc	Comp No	Diag No	Diag Loc	Bd Loc	Comp No	Diag No	Diag Loc	Bd Loc	Comp No	Diag No	Diag Loc	Bd Loc	Comp No	Diag No	Diag Loc	Bd Loc	Comp No	Diag No	Diag Loc	Bd Loc				
C1	10	F4	B8	C198	10	G4	C4	C296	10	E3	G5	C353	10	G5	E4	J112	2	A1	A5	P124	2	D3		R232	2	B1	A5	R320	7	B4	G4	TP9	3	A5	A7	U225	7	E3	J5
C2	10	G4	C8	C254	2	D5	A4	C297	10	E4	G6	C356	2	C3	A6	J122	10	B1	K6	P130	7	C3		R233	2	D1	D8	R321	7	A3	G5	TP10	3	A5	E1	U227	7	B4	G4
C3	10	G4	C1	C255	2	D5	B4	C298	10	E3	F5	CR10	10	C1	G6	J124	2	D3	C7	Q30	10	C2	F6	R248	4	E3	E3	R322	7	A4	G5	TP11	7	D1	H4	U228	4	B2	B4
C5	10	G4	D1	C256	6	E5	J3	C299	10	E4	F6	CR11	10	C1	G8	J126	10	A2	D8	Q100	10	D4	F8	R261	10	D4	F6	R323	7	C3	G5	TP13	4	H5	C8	U235	5	F1	D5
C6	10	G4	D1	C257	6	E5	J2	C300	10	E3	F5	CR12	10	C1	G6	J128	10	H2	G5	R14	10	E2	E8	R262	10	D3	G7	R325	7	D4	J4	TP14	7	D3	I4	U236	5	B1	D7
C7	10	G4	E1	C258	6	E5	J1	C301	10	E4	E6	CR13	10	C1	G8	J130	7	C3	G5	R15	10	E3	D7	R263	10	C4	F6	R327	5	E3	E5	TP16	5	H5	E4	U238	7	B3	F5
C8	10	H4	E2	C263	2	C4	A4	C302	10	D3	G6	CR40	10	D2	E7	J145	7	H3	K4	R20	6	F4	K2	R264	10	B4	E6	R328	7	E3	J4	TP17	2	A5	B3	U240	3	C3	C3
C9	10	G4	I5	C268	10	C1	G8	C303	10	D3	G7	CR50	10	D3	E7	L2	6	F4	K3	R21	6	F4	K3	R265	10	B4	E6	R341	4	G1	C3	U2	6	F3	K3	U245	2	C1	A7
C10	10	G3	H5	C269	10	F5	D7	C304	10	C4	F6	CR60	10	D3	F6	L4	2	C5	A4	R22	6	F4	K3	R266	10	B4	F6	R342	4	G1	C3	U22	3	G2	E2	VR30	10	C2	F6
C13	10	H3	H5	C270	10	G5	B5	C305	10	C4	F6	CR70	10	D4	G6	L28	10	G3	H5	R23	6	F4	K3	R267	10	B5	E6	R343	4	G1	D3	U24	3	G3	C1				
C15	10	H4	I5	C271	10	G5	C6	C306	10	C2	F6	CR71	10	E4	F6	L29	10	G4	I5	R24	6	F4	K3	R268	10	C5	E7	R344	4	G2	D3	U26	3	G4	D1	W155	4	E3	E3
C20	6	F4	K3	C272	10	G5	C5	C307	10	B5	E6	CR80	10	B2	G6	L60	10	E3	F5	R30	6	G2	K2	R269	10	D5	E8	R345	4	G2	D3	U28	3	G1	D1	W156	4	E3	E3
C21	6	F4	K3	C273	10	G5	C5	C308	10	C5	E6	CR81	10	B2	G7	L70	10	E4	F6	R31	6	F4	L3	R270	10	C2	F6	R346	4	G2	D3	U29	6	B4	G2	W157	4	E4	E3
C30	2	C5	B4	C274	10	G5	E5	C309	10	B1	G6	CR85	10	D2	E7	L71	2	C4	A4	R42	2	C5	A3	R271	10	C2	F6	R347	4	G2	D3	U31	6	B3	F2	W158	4	E4	E3
C37	6	C4	F2	C275	10	H5	D3	C314	10	B2	G6	F1	10	A1	K7	L75	10	B2	G6	R45	6	B3	G2	R273	2	C3	A6	R348	4	G2	D3	U50	10	E3	E6	W159	4	E4	E3
C38	6	C4	F3	C276	10	H5	E5	C320	7	C3	F4	F2	10	A2	G7	L81	7	E4	I4	R46	6	C3	G2	R274	6	E3	I3	R349	4	G2	D3	U102	3	B3	B7	W166	4	E4	E3
C39	6	C4	F3	C277	10	F5	C7	C321	7	C4	F5	FL2	6	C3	H2	LF1	10	A1	L7	R48	6	C4	F3	R275	6	E3	I3	R350	4	G2	D3	U104	3	B2	C7	W167	4	E4	E4
C40	6	B4	F2	C278	10	G5	C3	C322	7	C4	F5	FL4	7	C3	H4	P6	6	C3		R49	6	B4	G2	R300	7	E4	J4	R351	4	G2	E3	U106	2	B5	A3	W168	4	E5	E4
C41	6	A4	G2	C281	10	G5	A5	C323	7	B4	G4	J4	6	H2	K1	P10	10	A1		R50	6	B4	G2	R301	7	E4	J4	R352	4	G2	E3	U108	2	D4	B3	W169	4	E5	E4
C42	6	B4	G2	C282	10	G5	A6	C324	7	B4	G4	J6	6	C3	G2	P11	10	A1		R51	6	B5	G2	R302	7	D4	J4	R353	2	B1	A6	U150	3	C2	B4	W179	4	E5	E4
C43	6	B4	G2	C283	10	G5	A6	C325	7	B4	F5	J40	10	F2	D6	P40	10	F2		R52	6	A4	G2	R303	7	E3	J4	R357	2	C1	A6	U200	10	C4	E6	W180	2	A5	A3
C183	10	C1	F8	C284	10	G5	D4	C326	7	E3	I5	J50	10	F3	E6	P50	10	F3		R53	6	B4	G2	R304	7	D3	I5	R358	2	C1	A6	U201	2	F3	B6	W181	3	B4	B7
C186	6	F3	K3	C290	10	F2	E7	C327	7	D4	J4	J60	10	F3	E5	P60	10	F3		R54	6	B4	G2	R305	7	D3	I5	T1	10	B1	I7	U202	2	E1	A6	W182	3	B4	B6
C188	6	F3	K2	C291	10	F3	E7	C328	7	E4	I5	J70	10	F4	E5	P70	10	F4		R140	10	C4	E7	T2	10	D3	F7	U212	10	E2	D8	W183	7	G3	J3				
C190	6	F4	K3	C292	10	E3	D7	C329	7	E4	I4	J106	6	H3	K3	P110	2	B2		R197	6	G3	K2	U220A	3	B1	A4	U220B	3	B1	A4	Y1	2	A5	B1				
C191	2	D5	B3	C293	10	E2	E7	C330	7	E3	J5	J107	2	A3	A6	P111	2	D1		R198	2	B5	A3	R316	7	B4	F5	TP1	6	D3	I2	U222	4	F1	D4				
C192	2	B5	A2	C294	10	E2	E7	C336	7	A4	G4	J110	2	B2	D7	P112	2	A1		R199	2	C5	A3	R317	7	B4	G5	TP5	6	D4	H2								
C197	10	F4	B4	C295	10	E3	D7	C351	10	F5	E4	J111	2	D1	D7	C352	10	G5	C3	R231	2	C4	B3	R318	7	B4	G4	TP8	2	A5	B3								

**Schematic Diagram <2>
Component Locator Chart**

The schematic diagram has an alpha-numeric grid to assist in locating parts within that diagram.

Assembly A2.

Partial Assembly A2 also shown on Diagrams 3, 4, 5, 8, 9, and 10.

Comp No	Diag Loc	Bd Loc
C30	C5	B4
C191	D5	B3
C192	B5	A2
C254	D5	A4
C255	D5	B4
C263	C4	A4
C356	C3	A6
J107	A3	A6
J110	B2	D7
J111	D1	D7
J112	A1	A5
J124	D3	C7
L4	C5	A4
L71	C4	A4
P110	B2	
P111	D1	
P112	A1	
P124	D3	
R42	C5	A3
R198	B5	A3
R199	C5	A3
R231	C4	B3
R232	B1	A5
R233	D1	D8
R273	C3	A6
R357	B1	A6
R358	C1	A6
TP8	A5	B3
TP17	A5	B3
U106	B5	A3
U108	D4	B3
U201	F3	B6
U202	E1	A6
U245	C1	A7
W180	A5	A3
Y1	A5	B1

DIGITAL TIMING

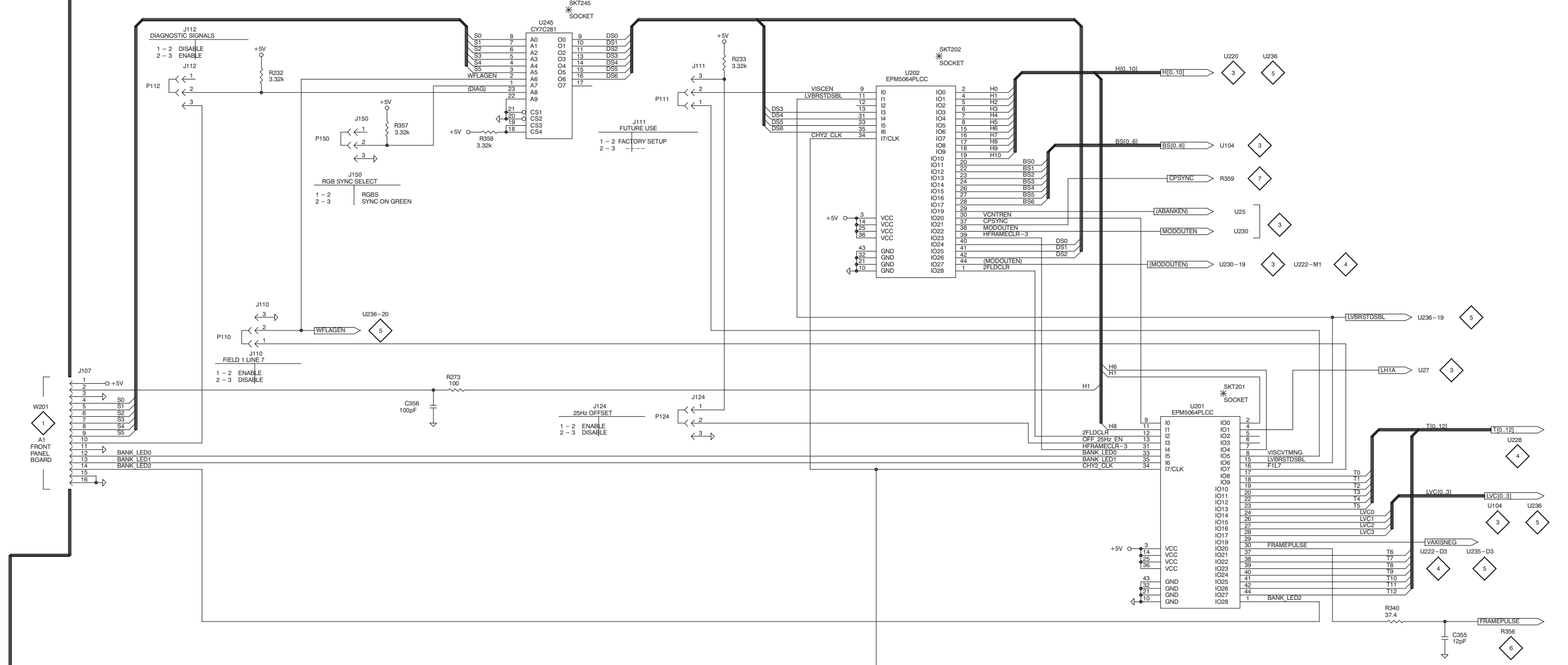

CLOCK PHASING

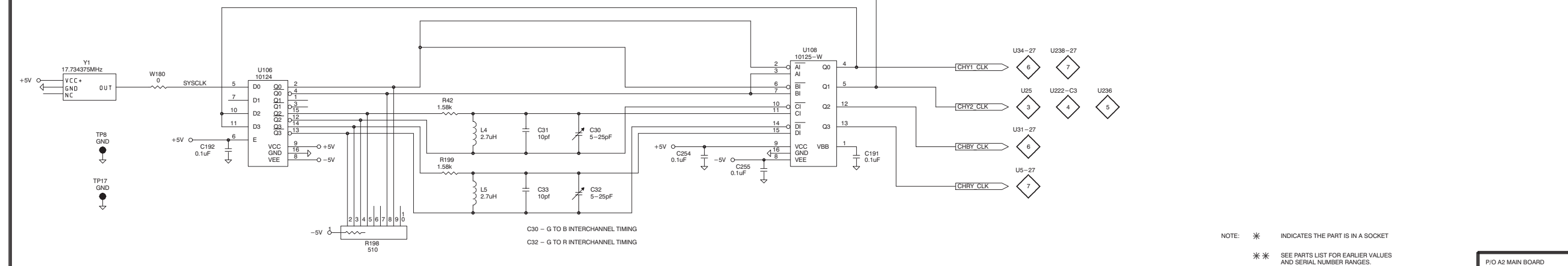

NOTE: * INDICATES THE PART IS IN A SOCKET
 ** SEE PARTS LIST FOR EARLIER VALUES AND SERIAL NUMBER RANGES.

P/O A2 MAIN BOARD

Schematic Diagram <3> Component Locator Chart

The schematic diagram has an alpha-numeric grid to assist in locating parts within that diagram.

Assembly A2.

Partial Assembly A2 also shown on Diagrams 2, 4, 5, 8, 9, and 10

Comp No	Diag Loc	Bd Loc	Comp No	Diag Loc	Bd Loc
TP9	A5	A7	U150	C2	B4
TP10	A5	E1	U220A	B1	A4
			U220B	B1	A4
U22	G2	E2	U240	C3	C3
U24	G3	C1			
U26	G4	D1	W181	B4	B7
U28	G1	D1	W182	B4	B6
U102	B3	B7			
U104	B2	C7			

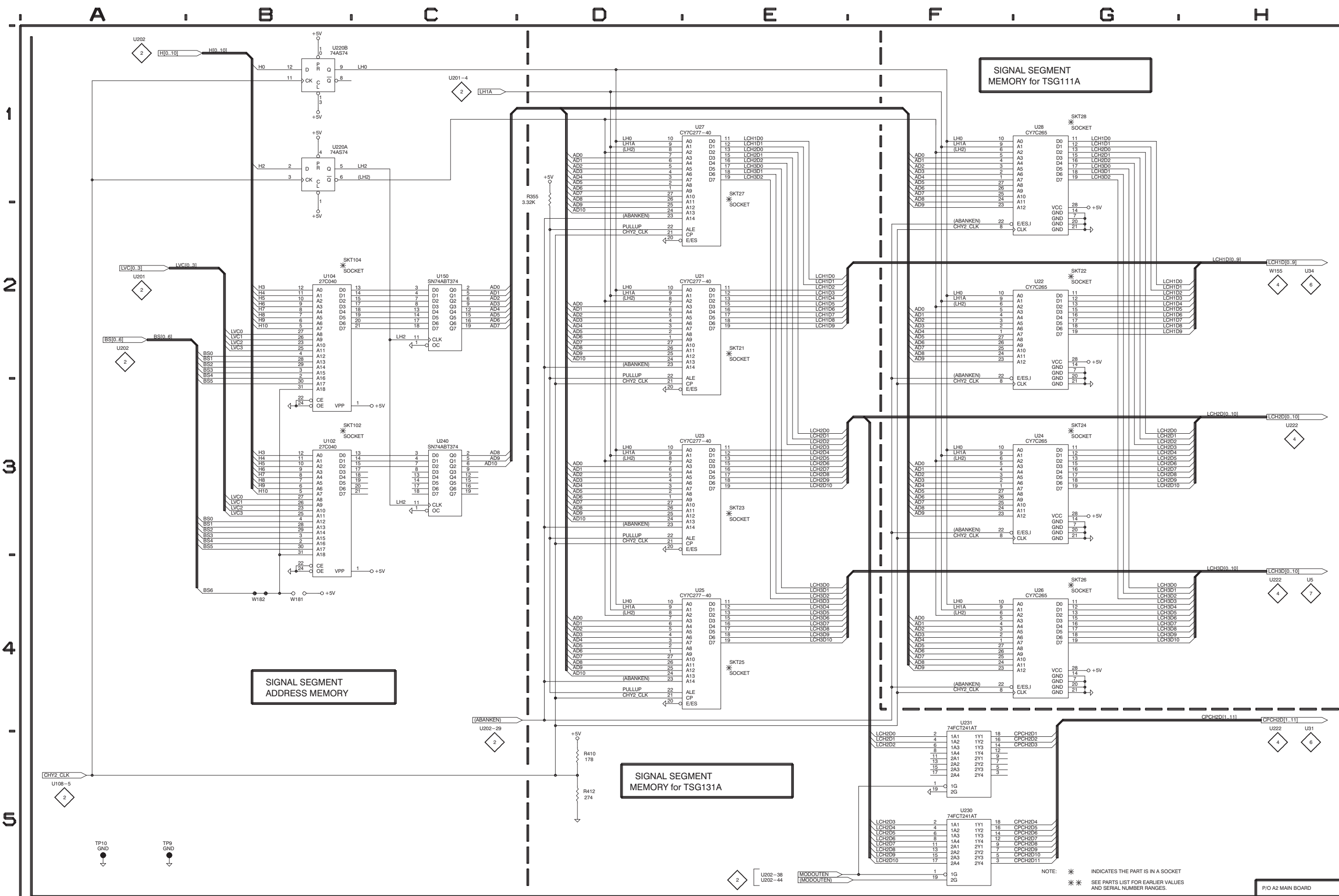

SIGNAL SEGMENT ADDRESS MEMORY

SIGNAL SEGMENT MEMORY for TSG131A

SIGNAL SEGMENT MEMORY for TSG111A

NOTE: * INDICATES THE PART IS IN A SOCKET
 ** SEE PARTS LIST FOR EARLIER VALUES AND SERIAL NUMBER RANGES.

P/O A2 MAIN BOARD

Schematic Diagram <4> Component Locator Chart

The schematic diagram has an alpha-numeric grid to assist in locating parts within that diagram.

Assembly A2.

Partial Assembly A2 also shown on Diagrams 2, 3, 5, 8, 9, and 10.

Comp No	Diag Loc	Bd Loc	Comp No	Diag Loc	Bd Loc
R248	E3	E3	U222	F1	D4
R341	G1	C3	U228	B2	B4
R342	G1	C3	U229	B2	C4
R343	G1	D3			
R344	G1	D3	W155	E3	E3
R345	G2	D3	W156	E3	E3
			W157	E4	E3
R346	G2	D3	W158	E4	E3
R347	G2	D3	W159	E4	E3
R348	G2	D3			
R349	G2	D3	W166	E4	E3
R350	G2	D3	W167	E4	E4
R351	G2	E3	W168	E5	E4
R352	G2	E3	W169	E5	E4
			W179	E5	E4
TP13	H5	C8			

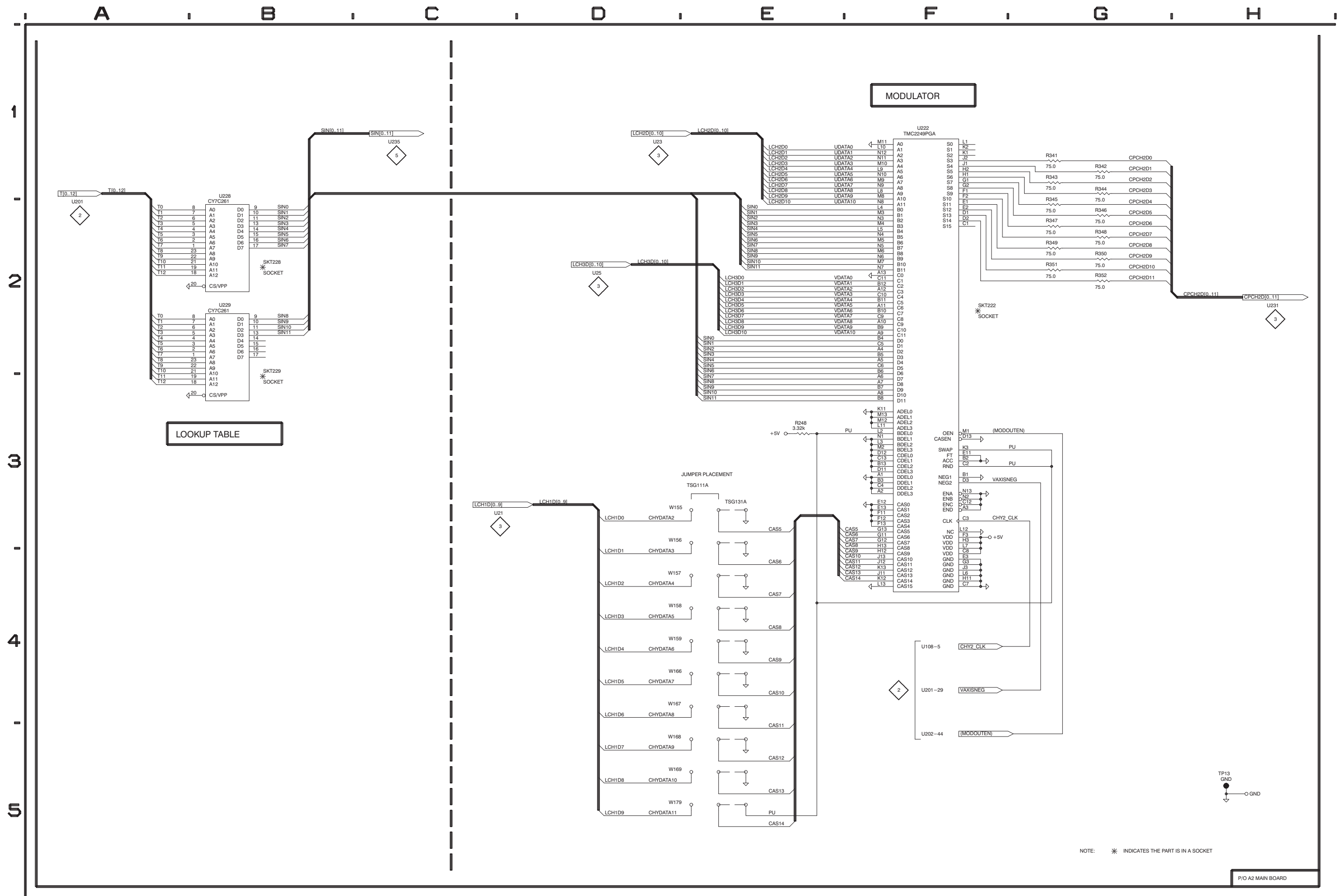

Schematic Diagram <5> Component Locator Chart

The schematic diagram has an alpha-numeric grid to assist in locating parts within that diagram.

Assembly A2.

Partial Assembly A2 also shown on Diagrams 2, 3, 4, 5, 8, and 10.

<i>Comp No</i>	<i>Diag Loc</i>	<i>Bd Loc</i>
R327	E3	E5
TP16	H5	E4
U235	F1	D5
U236	B1	D7

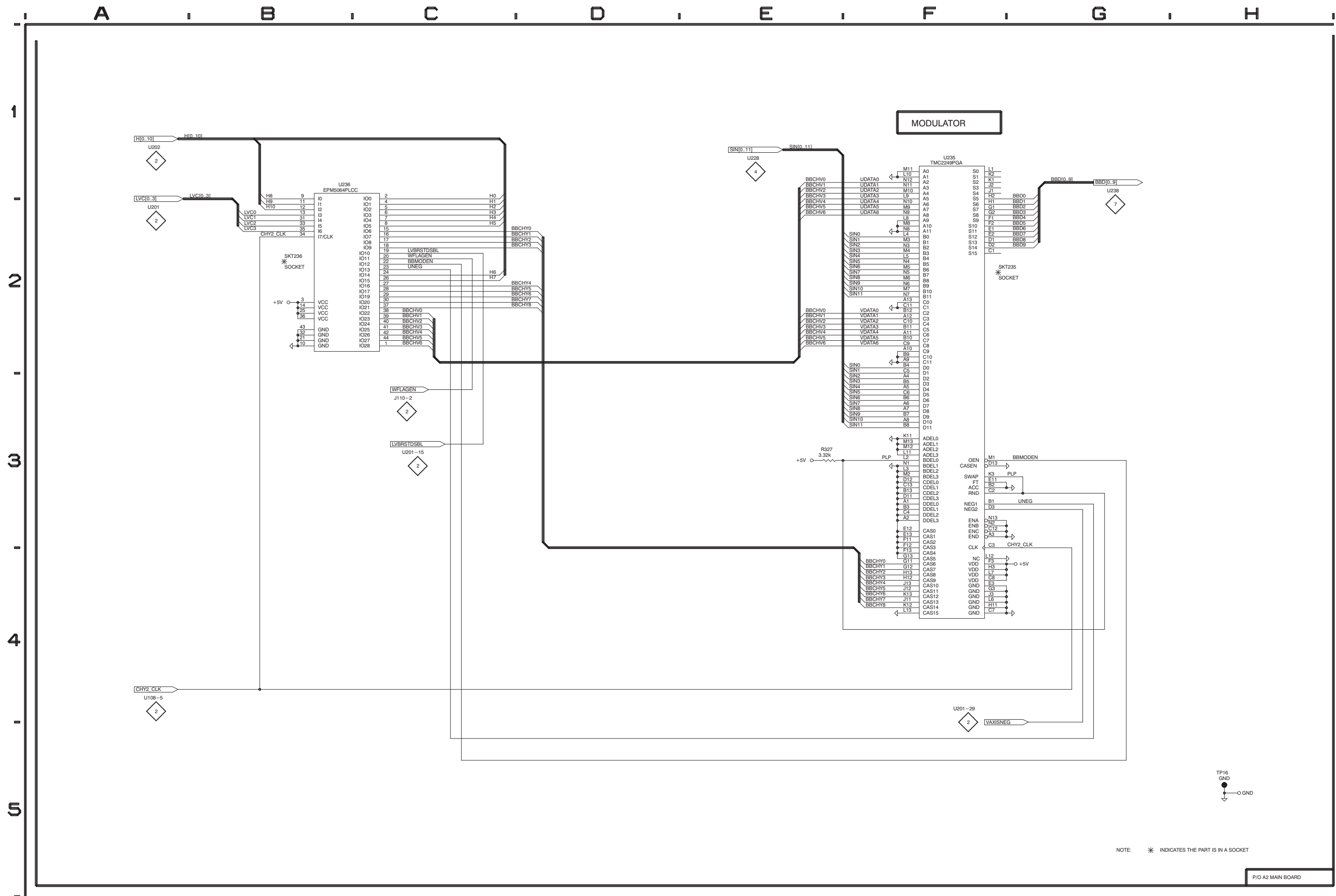

Schematic Diagram <6> Component Locator Chart

The schematic diagram has an alpha-numeric grid to assist in locating parts within that diagram.

Assembly A2.

Partial Assembly A2 also shown on Diagrams 2, 3, 4, 8, 9, and 10.

Comp No	Diag Loc	Bd Loc	Comp No	Diag Loc	Bd Loc
C20	F4	K3	R23	F4	K3
C21	F4	K3	R24	F4	K3
C37	C4	F2	R30	G2	K2
C38	C4	F3	R31	F4	L3
C39	C4	F3			
C40	B4	F2	R45	B3	G2
C41	A4	G2	R46	C3	G2
C42	B4	G2	R48	C4	F3
			R49	B4	G2
C43	B4	G2	R50	B4	G2
C186	F3	K3	R51	B5	G2
C188	F3	K2	R52	A4	G2
C190	F4	K3	R53	B4	G2
C256	E5	J3	R54	B4	G2
C257	E5	J2			
C258	E5	J1	R197	G3	K2
			R274	E3	I3
FL2	C3	H2			
			R275	E3	I3
J4	H2	K1			
J6	C3	G2	TP1	D3	I2
J106	H3	K3	TP5	D4	H2
L2	F4	K3	U2	F3	K3
			U29	B4	G2
P6	C3		U31	B3	F2
R20	F4	K2			
R21	F4	K3			
R22	F4	K3			

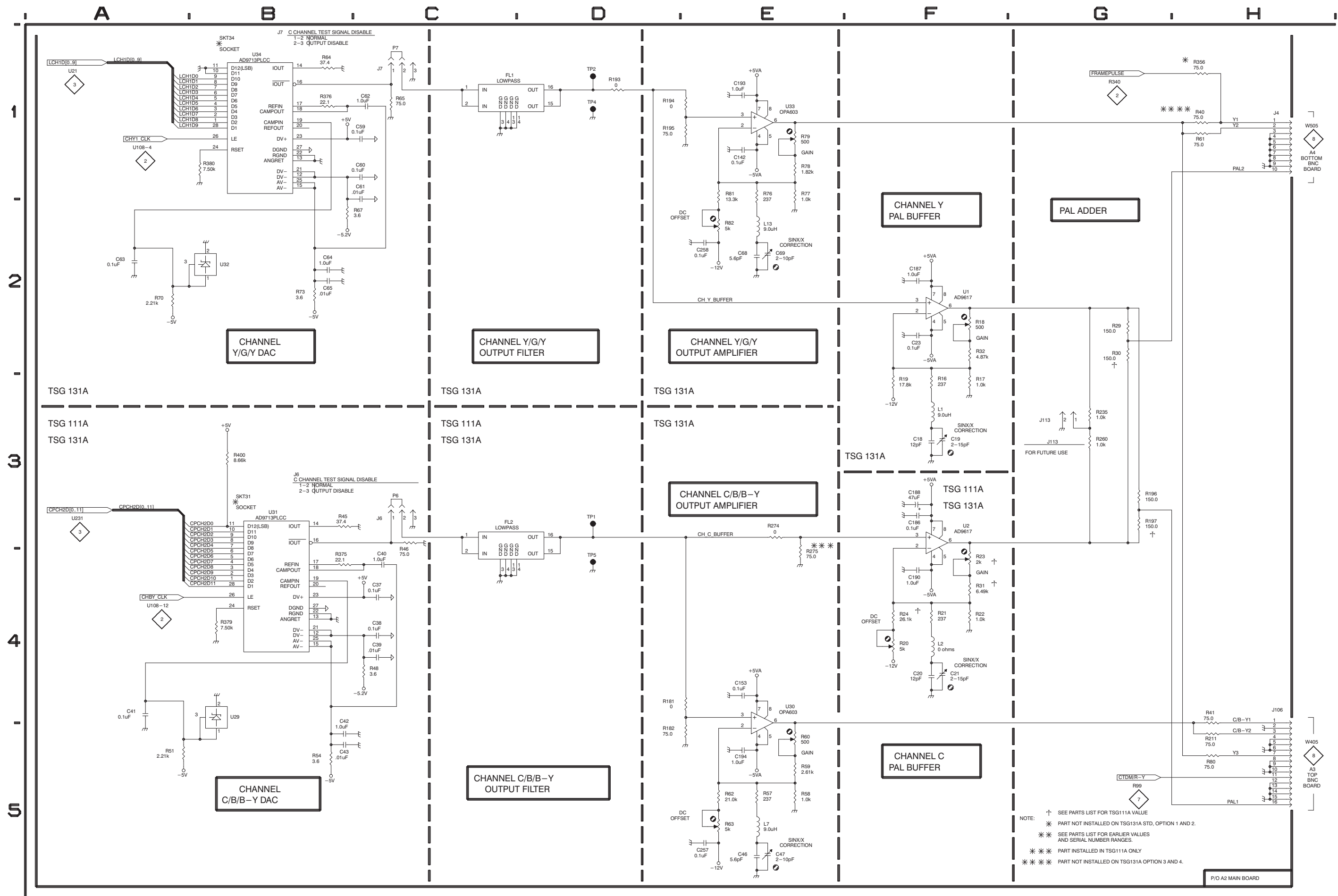

NOTE: † SEE PARTS LIST FOR TSG111A VALUE
 * PART NOT INSTALLED ON TSG131A STD. OPTION 1 AND 2.
 ** SEE PARTS LIST FOR EARLIER VALUES AND SERIAL NUMBER RANGES.
 *** PART INSTALLED IN TSG111A ONLY
 **** PART NOT INSTALLED ON TSG131A OPTION 3 AND 4.

Schematic Diagram <7> Component Locator Chart

The schematic diagram has an alpha-numeric grid to assist in locating parts within that diagram.

Assembly A2.

Partial Assembly A2 also shown on Diagrams 2, 3, 4, 5, 8, and 9.

<i>Comp No</i>	<i>Diag Loc</i>	<i>Bd Loc</i>
C320	C3	F4
C321	C4	F5
C322	C4	F5
C323	B4	G4
C324	B4	G4
C325	B4	F5
C326	E3	I5
C327	D4	J4
C328	E4	I5
C329	E4	I4
C330	E3	J5
C336	A4	G4
FL4	C3	H4
J130	C3	G5
J145	H3	K4
L81	E4	I4
P130	C3	
R300	E4	J4
R301	E4	J4
R302	D4	J4
R303	E3	J4
R304	D3	I5
R305	D3	I5
R315	B3	G5
R316	B4	F5
R317	B4	G5
R318	B4	G4
R319	B4	G4
R320	B4	G4
R321	A3	G5
R322	A4	G5
R323	C3	G5
R325	D4	J4
R328	E3	J4
R336	G3	J4
TP11	D1	H4
TP14	D3	I4
U225	E3	J5
U227	B4	G4
U238	B3	F5
W183	G3	J3

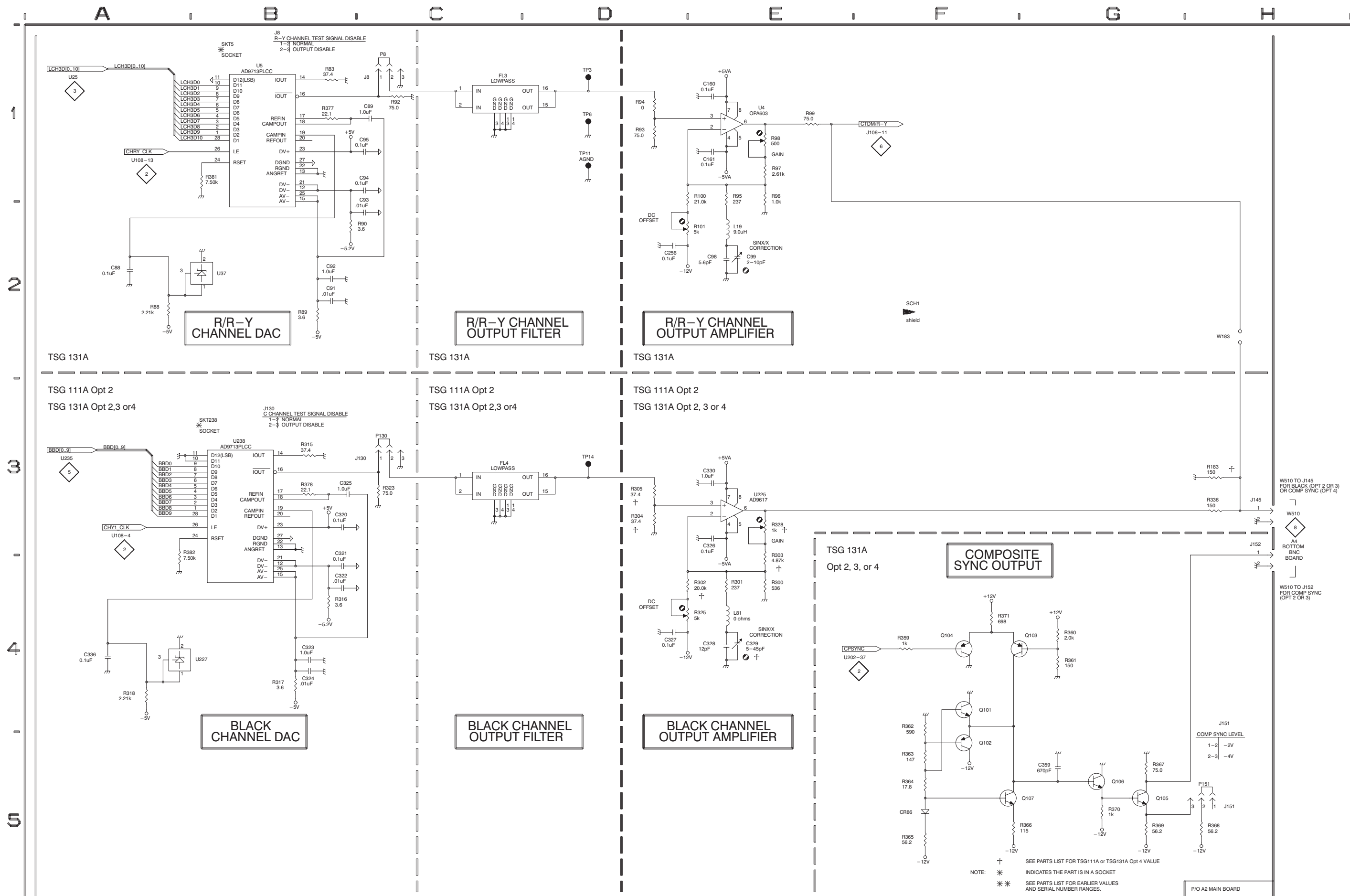

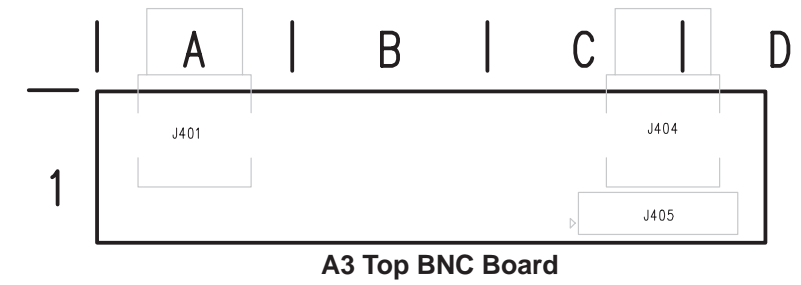

 **Static Sensitive Devices**
See Maintenance Section

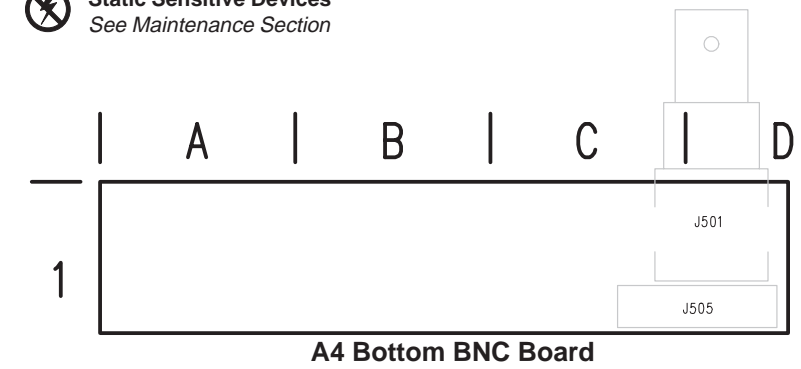

**A3 and A4 BNC Boards and Schematic Diagram <8>
Component Locator Chart**

The schematic diagram has an alpha-numeric grid to assist in locating parts within that diagram.

Assemblies A3 and A4.

Comp No	Diag Loc	Bd Loc
A3 Top BNC		
J401	H2	A1
J404	H2	C1
J405	A2	C1
W405	A2	
A4 Bottom BNC		
J501	H5	D1
J505	A4	D1
W505	A4	

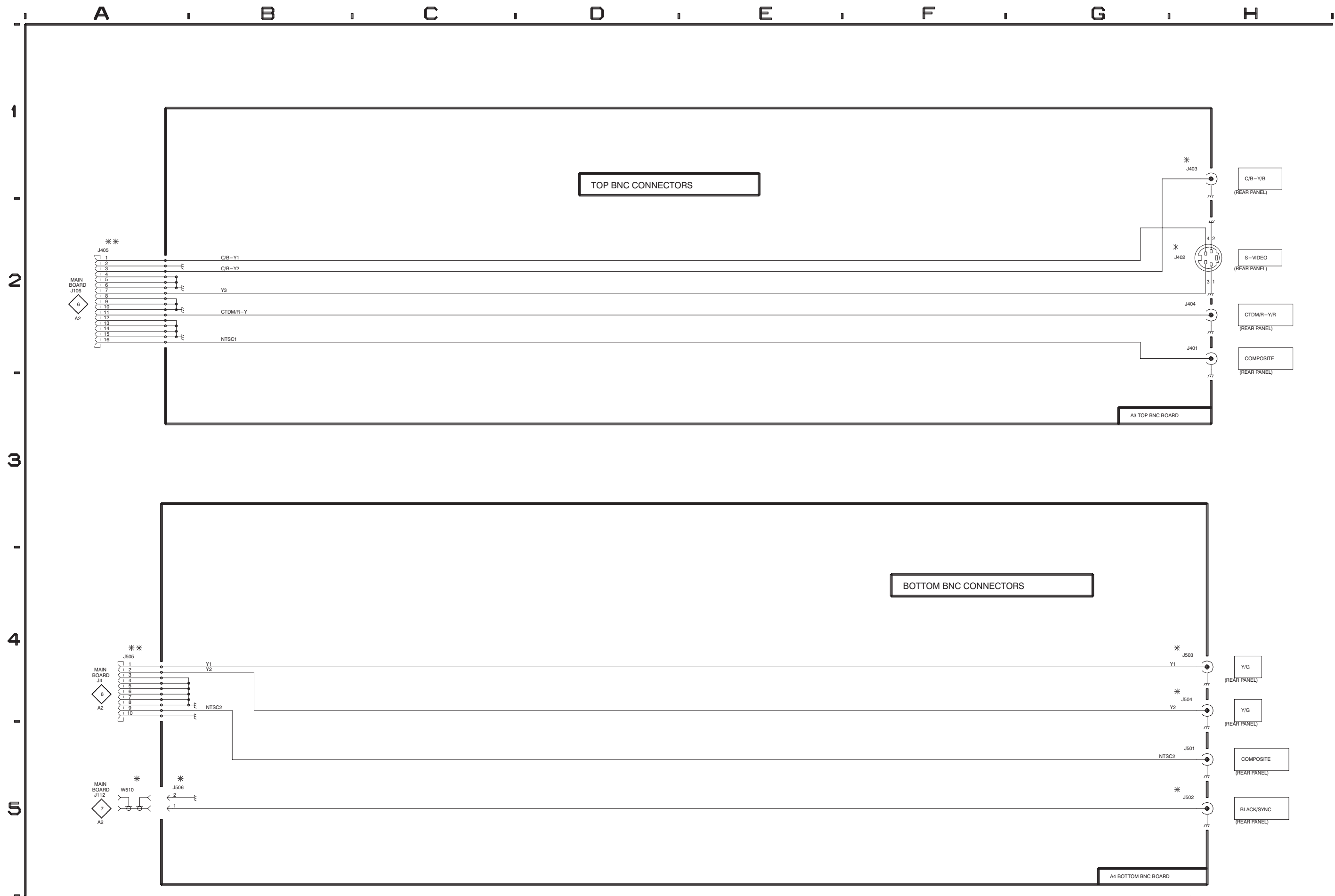

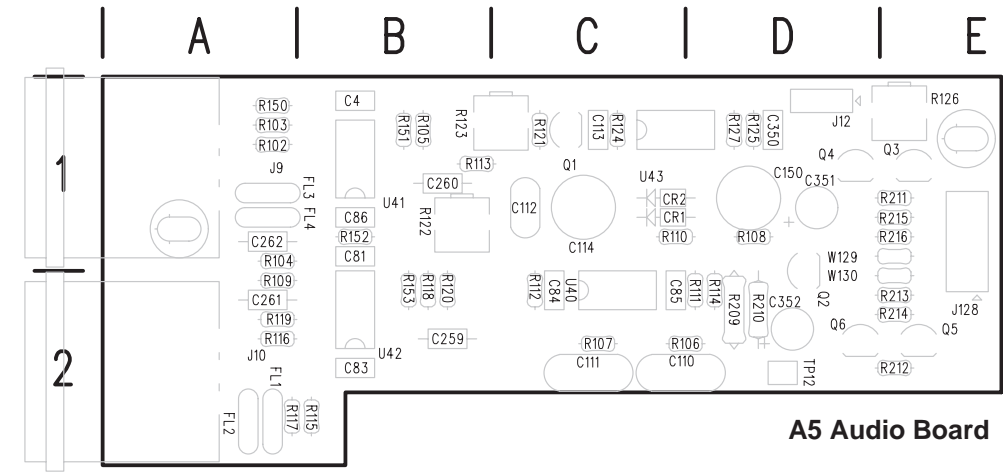

 **Static Sensitive Devices**
See Maintenance Section

Schematic Diagram <9> Component Locator Chart

The schematic diagram has an alpha-numeric grid to assist in locating parts within that diagram.

Assembly A5.

Comp No	Diag Loc	Bd Loc	Comp No	Diag Loc	Bd Loc	Comp No	Diag Loc	Bd Loc
C4	E3	B1	J128	A3	E1	R124	D3	C1
C81	E1	B1				R125	C3	D1
C83	E1	B2	P12	B3		R126	C3	E1
C84	B1	C2				R127	C3	D1
C85	B1	C2	Q1	D3	C1	R150	F4	A1
C86	E3	B1	Q2	Δ		R151	E3	B1
C110	B1	C2	Q3	Δ		R152	F2	B1
C111	B1	C2	Q4	Δ		R153	E1	B2
C112	D1	C1	Q5	Δ		R209	B2	D2
C113	D3	C1	Q6	Δ		R210	B2	D2
						R211	Δ	
C114	C3	C1	R102	G3	A1	R212	Δ	
C150	B2	D1	R103	F3	A1	R213	Δ	
C259	E1	B2	R104	G3	A1	R214	Δ	
C260	E3	B1	R105	D3	B1	R215	Δ	
C261	F1	A2	R106	B1	C2	R216	Δ	
C262	F3	A1	R107	B1	C2			
C350	B3	D1	R108	B2	D1	TP12	A3	D2
C351	C4	D1	R109	F3	A2			
C352	C5	D2	R110	C2	C1	U40A	B1	C2
			R111	B2	D2	U40B	C2	C2
CR1	C2	C1				U41A	E3	B1
CR2	C2	C1	R112	C2	C2	U41B	F3	B1
			R113	E2	B1	U42A	E1	B2
FL1*	G1	A2	R114	B2	D2	U42B	F2	B2
FL2*	G2	A2	R115	G1	B2	U43	C3	C1
FL3*	G3	A1	R116	F2	A2			
FL4*	G3	A1	R117	G2	A2	W128	A3	
			R118	D1	B2	W129	C4	E1
			R119	F1	A2	W130	C5	E2
			R120	E1	B2			
J9	H3	A1	R121	D2	C1			
J10	H1	A2	R122	E1	B1			
J12	B3	D1	R123	E2	B1			

* Check parts list for starting/ending S/N.
Δ Not used on TSG 111.

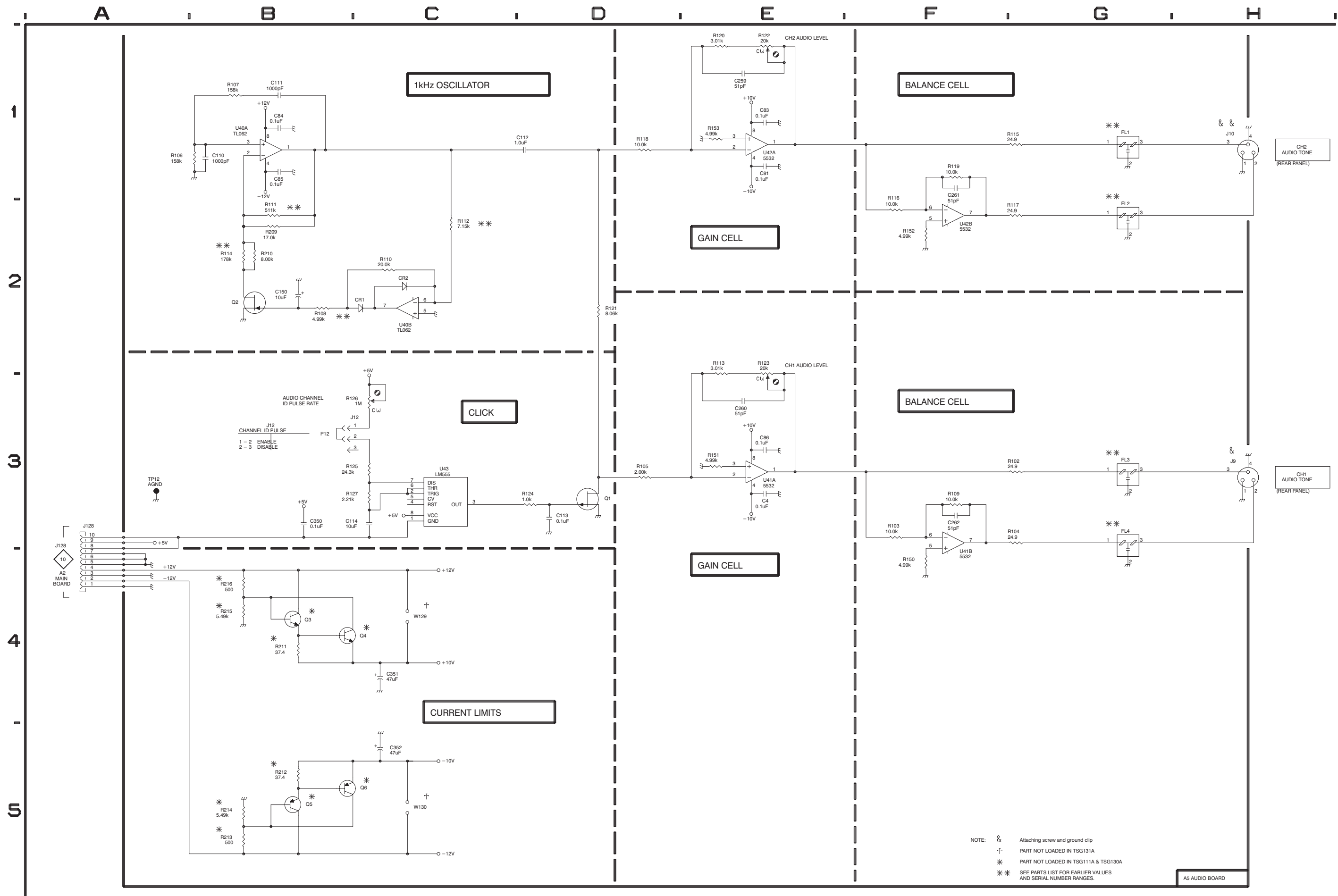

NOTE: & Attaching screw and ground clip
 † PART NOT LOADED IN TSG131A
 * PART NOT LOADED IN TSG111A & TSG130A
 ** SEE PARTS LIST FOR EARLIER VALUES AND SERIAL NUMBER RANGES.

AS AUDIO BOARD

Schematic Diagram <10> Component Locator Chart

The schematic diagram has an alpha-numeric grid to assist in locating parts within that diagram.

Assembly A2.

Partial Assembly A2 also shown on Diagrams 2, 3, 4, and 5.

Comp No	Diag Loc	Bd Loc	Comp No	Diag Loc	Bd Loc
C1	F4	B8	CR50	D3	E7
C2	G4	C8	CR60	D3	F6
C3	G4	C1	CR70	D4	G6
C5	G4	D1	CR71	E4	F6
C6	G4	D1	CR80	B2	G6
C7	G4	E1	CR81	B2	G7
C8	H4	E2	CR85	D2	E7
C9	G4	I5			
C10	G3	H5	F1	A1	K7
C13	H3	H5	F2	A2	G7
C15	H4	I5	J40	F2	D6
C183	C1	F8	J50	F3	E6
C197	F4	B4	J60	F3	E5
C198	G4	C4	J70	F4	E5
C268	C1	G8	J122	B1	K6
C269	F5	D7	J126	A2	D8
C270	G5	B5	J128	H2	G5
C271	G5	C6			
C272	G5	C5	L28	G3	H5
C273	G5	C5	L29	G4	I5
			L60	E3	F5
C274	G5	E5	L70	E4	F6
C275	H5	D3	L75	B2	G6
C276	H5	E5			
C277	F5	C7	LF1	A1	L7
C278	G5	C3			
C281	G5	A5	P10	A1	
C282	G5	A6	P11	A1	
C283	G5	A6	P40	F2	
C284	G5	D4	P50	F3	
C290	F2	E7	P60	F3	
			P70	F4	
C291	F3	E7	P122	A1	
C292	E3	D7			
C293	E2	E7	Q30	C2	F6
C294	E2	E7	Q100	D4	F8
C295	E3	D7			
C296	E3	G5	R14	E2	E8
C297	E4	G6	R15	E3	D7
C298	E3	F5	R140	C4	E7
C299	E4	F6	R261	D4	F6
C300	E3	F5	R262	D3	G7
			R263	C4	F6
C301	E4	E6	R264	B4	E6
C302	D3	G6	R265	B4	E6
C303	D3	G7	R266	B4	F6
C304	C4	F6	R267	B5	E6
C305	C4	F6	R268	C5	E7
C306	C2	F6	R269	D5	E8
C307	B5	E6	R270	C2	F6
C308	C5	E6	R271	C2	F6
C309	B1	G6			
C314	B2	G6	T1	B1	I7
			T2	D3	F7
C351	F5	E4	U50	E3	E6
C352	G5	C3	U200	C4	E6
C353	G5	E4	U212	E2	D8
CR10	C1	G6			
CR11	C1	G8			
CR12	C1	G6	VR30	C2	F6
CR13	C1	G8			
CR40	D2	E7			

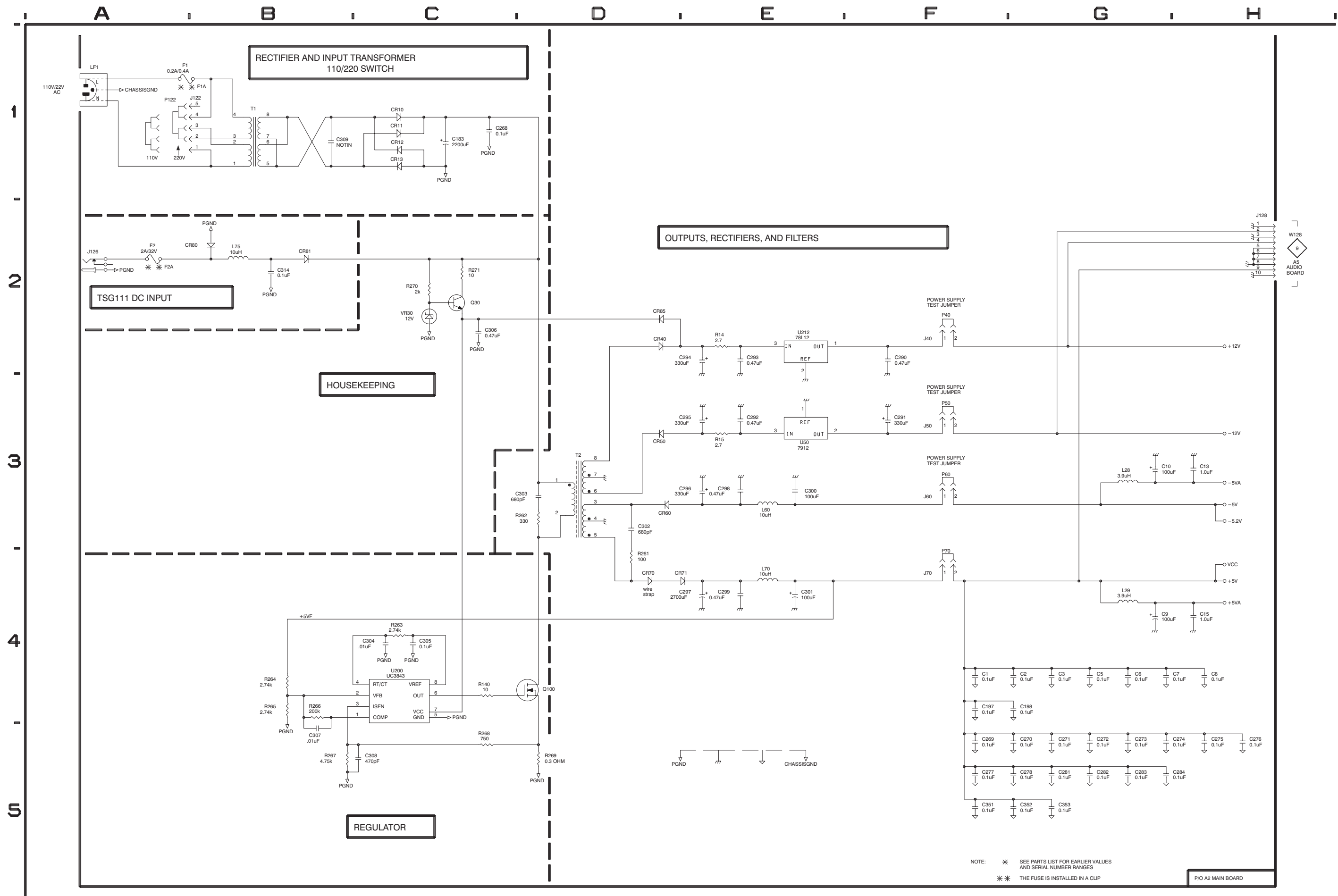

NOTE: * SEE PARTS LIST FOR EARLIER VALUES AND SERIAL NUMBER RANGES
 ** THE FUSE IS INSTALLED IN A CLIP

P/O A2 MAIN BOARD

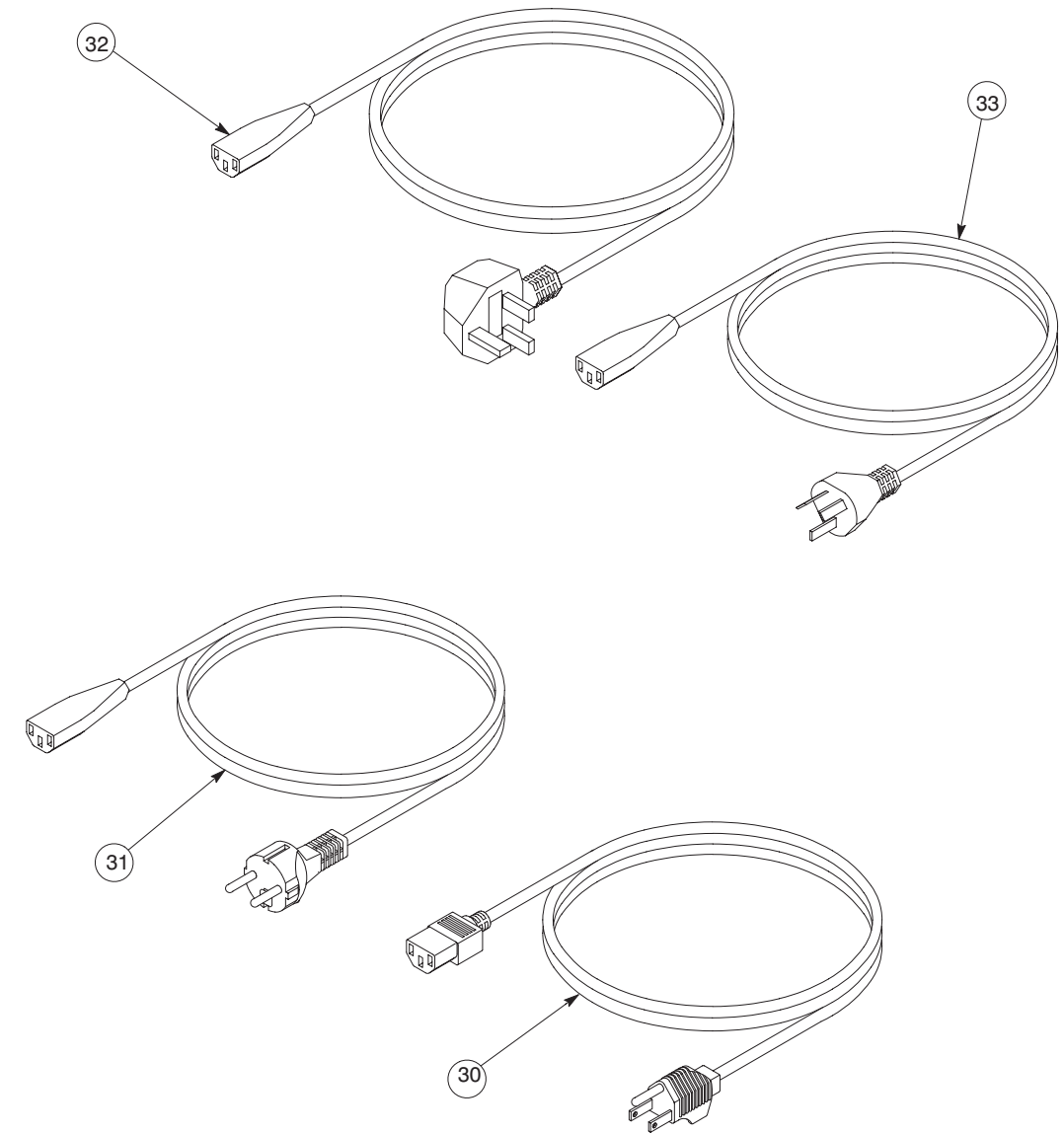
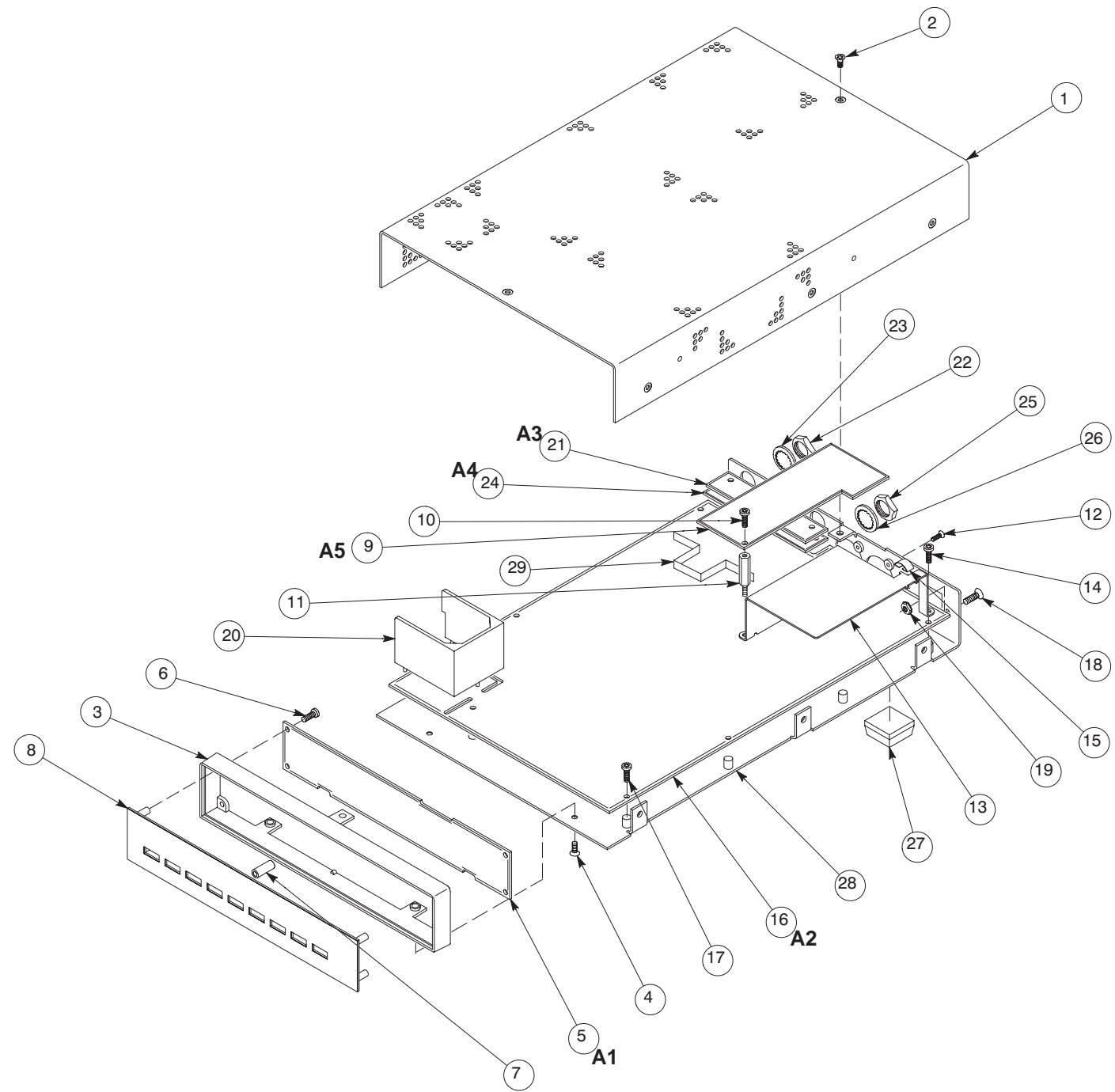

Section 10

Replaceable Mechanical Parts

This section contains a list of the components that are replaceable for the TSG 131A. Use this list to identify and order replacement parts. There is a separate Replaceable Mechanical Parts list for each instrument.

Parts Ordering Information

Replacement parts are available from or through your local Tektronix, Inc., Field Office or representative.

Changes to Tektronix instruments are sometimes made to accommodate improved components as they become available and to give you the benefit of the latest circuit improvements. Therefore, when ordering parts, it is important to include the following information in your order.

- Part number
- Instrument type or model number
- Instrument serial number
- Instrument modification number, if applicable

If a part you have ordered has been replaced with a new or improved part, your local Tektronix, Inc., Field Office or representative will contact you concerning any change in part number.

Change information, if any, is located at the rear of this manual.

Using the Replaceable Mechanical Parts List

The tabular information in the Replaceable Mechanical Parts list is arranged for quick retrieval. Understanding the structure and features of the list will help you find all of the information you need for ordering replaceable parts.

Cross Index–Mfr. Code Number to Manufacturer

The Mfg. Code Number to Manufacturer Cross Index for the mechanical parts list is located immediately after this page. The cross index provides codes, names, and addresses of manufacturers of components listed in the mechanical parts list.

Abbreviations

Abbreviations conform to American National Standards Institute (ANSI) standard Y1.1.

Chassis Parts

Chassis-mounted parts and cable assemblies are located at the end of the Replaceable Electrical Parts list.

Column Descriptions

Figure & Index No. (Column 1)	Items in this section are referenced by figure and index numbers to the illustrations.																																																												
Tektronix Part No. (Column 2)	Indicates part number to be used when ordering replacement part from Tektronix.																																																												
Serial No. (Column 3 and 4)	Column three (3) indicates the serial number at which the part was first used. Column four (4) indicates the serial number at which the part was removed. No serial number entered indicates part is good for all serial numbers.																																																												
Qty (Column 5)	This indicates the quantity of mechanical parts used.																																																												
Name and Description (Column 6)	<p>An item name is separated from the description by a colon (:). Because of space limitations, an item name may sometimes appear as incomplete. Use the U.S. Federal Catalog handbook H6-1 for further item name identification.</p> <p>Following is an example of the indentation system used to indicate relationship.</p> <table border="0" style="margin-left: 20px;"> <tr> <td style="padding-right: 5px;">1</td> <td style="padding-right: 5px;">2</td> <td style="padding-right: 5px;">3</td> <td style="padding-right: 5px;">4</td> <td style="padding-right: 5px;">5</td> <td>Name & Description</td> </tr> <tr> <td></td> <td></td> <td></td> <td></td> <td></td> <td>Assembly and/or Component</td> </tr> <tr> <td></td> <td></td> <td></td> <td></td> <td></td> <td>Mounting parts for Assembly and/or Component</td> </tr> <tr> <td></td> <td></td> <td></td> <td></td> <td></td> <td>*MOUNTING PARTS*/*END MOUNTING PARTS*</td> </tr> <tr> <td></td> <td></td> <td></td> <td></td> <td></td> <td>Detail Part of Assembly and/or Component</td> </tr> <tr> <td></td> <td></td> <td></td> <td></td> <td></td> <td>Mounting parts for Detail Part</td> </tr> <tr> <td></td> <td></td> <td></td> <td></td> <td></td> <td>*MOUNTING PARTS*/*END MOUNTING PARTS*</td> </tr> <tr> <td></td> <td></td> <td></td> <td></td> <td></td> <td>Parts of Detail Part</td> </tr> <tr> <td></td> <td></td> <td></td> <td></td> <td></td> <td>Mounting parts for Parts of Detail Part</td> </tr> <tr> <td></td> <td></td> <td></td> <td></td> <td></td> <td>*MOUNTING PARTS*/*END MOUNTING PARTS*</td> </tr> </table> <p>Mounting Parts always appear in the same indentation as the Item it mounts, while the detail parts are indented to the right. Indented items are part of and included with, the next higher indentation. Mounting parts must be purchased separately, unless otherwise specified.</p>	1	2	3	4	5	Name & Description						Assembly and/or Component						Mounting parts for Assembly and/or Component						*MOUNTING PARTS*/*END MOUNTING PARTS*						Detail Part of Assembly and/or Component						Mounting parts for Detail Part						*MOUNTING PARTS*/*END MOUNTING PARTS*						Parts of Detail Part						Mounting parts for Parts of Detail Part						*MOUNTING PARTS*/*END MOUNTING PARTS*
1	2	3	4	5	Name & Description																																																								
					Assembly and/or Component																																																								
					Mounting parts for Assembly and/or Component																																																								
					MOUNTING PARTS/*END MOUNTING PARTS*																																																								
					Detail Part of Assembly and/or Component																																																								
					Mounting parts for Detail Part																																																								
					MOUNTING PARTS/*END MOUNTING PARTS*																																																								
					Parts of Detail Part																																																								
					Mounting parts for Parts of Detail Part																																																								
					MOUNTING PARTS/*END MOUNTING PARTS*																																																								
Mfr. Code (Column 7)	Indicates the code number of the actual manufacturer of the part. (Code to name and address cross reference can be found immediately after this page.)																																																												
Mfr. Part Number (Column 8)	Indicates actual manufacturer's part number.																																																												

CROSS INDEX – MFR. CODE NUMBER TO MANUFACTURER

Mfr. Code.	Manufacturer	Address	City, State, Zip Code
24931	SPECIALTY CONNECTOR CO INC	2100 EARLYWOOD DR	FRANKLIN IN 46131
52152	MINNESOTA MINING AND MFG CO	PO BOX 547	ST PAUL MN 55144-0001
78189	INDUSTRIAL SPECIALTIES DIV	3M CENTER	
80009	ILLINOIS TOOL WORKS INC	ST CHARLES ROAD	ELGIN IL 60120
93907	SHAKEPROOF DIV		
TK0435	TEKTRONIX INC	14150 SW KARL BRAUN DR	BEAVERTON OR 97077-0001
TK0858	TEXTRON INC	PO BOX 500	ROCKFORD IL 61108-5181
TK1373	CAMCAR DIV	600 18TH AVE	
TK1947	LEWIS SCREW CO	4300 S RACINE AVE	CHICAGO IL 60609-3320
	STAUFFER SUPPLY CO (DIST)		
	PATELEC-CEM (ITALY)	10156 TORINO	VAICENTALLO 62/45S ITALY
	NORTHWEST ETCH TECHNOLOGY	2601 S HOOD ST	TACOMA, WA 98411-0610
		PO BOX 110610	

Replaceable Mechanical Parts

Fig. & Index No.	Tektronix Part No.	Serial Number		Qty	12345 Name & Description	Mfr. Code	Mfr. Part No.
		Effective	Dscont				
1-1	200-3898-01			1	COVER, TOP: SAFETY CONTROLLED *MOUNTING PARTS*	80009	200-3898-01
-2	211-0119-00			8	SCREW, MACHINE: 4-40 X 0.25, FLH, 100 DEG, STL *END MOUNTING PARTS*	93907	ORDER BY DESCR
-3	426-2420-01			1	FRAME, FRONT: ALUMINUM *MOUNTING PARTS*	80009	426-2420-01
-4	211-0119-00			2	SCREW, MACHINE: 4-40 X 0.25, FLH, 100 DEG, STL *END MOUNTING PARTS*	93907	ORDER BY DESCR
-5	-----			1	CIRCUIT BD ASSY: FRONT PANEL FAMILY FLAT (SEE A1 REPL) *MOUNTING PARTS*		
-6	211-0244-00			5	SCR, ASSEM WSHR: 4-40 X 0.312, PNH STL	TK0858	211-0244-00
-7	129-1411-00			1	SPACER, POST: 0.280 X 0.200, ABS *END MOUNTING PARTS*	80009	129-1411-00
-8	333-4059-00			1	PANEL, FRONT: TSG131A	80009	333-4059-00
-9	-----			1	CIRCUIT BD ASSY: AUDIO (SEE A5 REPL) *MOUNTING PARTS*		
-10	211-0244-00			1	SCR, ASSEM WSHR: 4-40 X 0.312, PNH STL *END MOUNTING PARTS*	TK0858	211-0244-00
-11	129-1394-00			1	SPACER, POST: 1.05 SPACING, 4-40 INT & 4-40 X 0.187 EXT THD, 0.250 HEX, STAINLESS STEEL	80009	129-1394-00
-12	211-0101-00			4	SCREW, MACHINE: 4-40 X 0.25, FLH, 100 DEG, STL	93907	ORDER BY DESCR
-13	337-3784-02			1	SHIELD, ELEC: TSG131A *MOUNTING PARTS*	80009	337-3784-02
-14	211-0244-00			1	SCR, ASSEM WSHR: 4-40 X 0.312, PNH STL *END MOUNTING PARTS*	TK0858	211-0244-00
-15	337-3892-00			1	SHIELD, ELEC: BE CU, CLIP ON, 1 X 60	80009	337-3892-00
-16	-----			1	CIRCUIT BD ASSY: FAMILY FLAT (SEE A2 REPL) *MOUNTING PARTS*		
-17	211-0244-00			8	SCR, ASSEM WSHR: 4-40 X 0.312, PNH STL	TK0858	211-0244-00
-18	211-0025-00			2	SCREW, MACHINE: 4-40 X 0.375, FLH, 100 DEG, STL	TK0435	ORDER BY DESCR
-19	210-0586-00			2	NUT, PL, ASSEM WA: 4-40 X 0.25, STL CD PL *END MOUNTING PARTS*	78189	211-041800-00
-20	337-3750-00			1	SHIELD, ELEC: PLASTIC	80009	337-3750-00
-21	-----			1	CIRCUIT BD ASSY: TOP BNC (SEE A3 REPL) *MOUNTING PARTS*		
-22	220-0497-00			3	NUT, PLAIN, HEX: 0.5-28 X 0.562 HEX, BRS CD PL	80009	220-0497-00
-23	210-1039-00			3	WASHER, LOCK: 0.521 ID, INT, 0.025 THK, SST *END MOUNTING PARTS*	24931	ORDER BY DESCR
-24	-----			1	CIRCUIT BD ASSY: BOTTOM BNC (SEE A4 REPL) *MOUNTING PARTS*		
-25	220-0497-00			4	NUT, PLAIN, HEX: 0.5-28 X 0.562 HEX, BRS CD PL	80009	220-0497-00
-26	210-1039-00			4	WASHER, LOCK: 0.521 ID, INT, 0.025 THK, SST *END MOUNTING PARTS*	24931	ORDER BY DESCR
-27	348-0844-00			4	PAD, CUSHIONING: 0.05 SQ X 0.23 H, POLYURETHAN E W/PRESSURE SENS ADHESIVE	52152	SJ-5018-GRAY
-28	200-3936-03	B030000		1	COVER, BOTTOM: SAFETY CONTROLLED	80009	200-3936-03
	200-3936-04			1	COVER, BOTTOM: SAFETY CONTROLLED	80009	200-3936-04
	334-3388-00			1	MARKER, IDENT: MARKED TEKTRONIX BEAVERTON	80009	334-3388-00
-29	337-3760-00			1	SHIELD, ELEC: TIN PLATED BRASS	TK1947	337-3760-00

Replaceable Mechanical Parts

Fig. & Index No.	Tektronix Part No.	Serial Number		Qty	12345 Name & Description	Mfr. Code	Mfr. Part No.
		Effective	Dscont				
-30	161-0066-00			1	CABLE ASSY,PWR,;3,18AWG,98 L,SVT,GREY/BLK,6 0 DEG C,IEC BME X STR,IEC RCPT,10A/125V (STANDARD ONLY)	80009	161-0066-00
	071-0499-XX			1	MANUAL,TECH: INSTRUCTION, TSG131A	80009	071-0499-XX
					OPTION ACCESSORIES		
-31	161-0066-09			1	CABLE ASSY,PWR,;3,0.75MM SQ,220V,99.0 L (EUROPEAN OPTION A1 ONLY)	80009	161-0066-09
-32	161-0066-10			1	CABLE ASSY,PWR,; (UNITED KINGDOM OPTION A2 ONLY)	TK1373	24230
-33	161-0066-11			1	CABLE ASSY,PWR,;3,0.75MM,240V,96.0 L (AUSTRALIAN OPTION A3 ONLY)	80009	161-0066-11
	-----			1	TVGF11A:RACK MOUNT KIT		

