

DISCLAIMER ALL PRODUCTS, PRODUCT SPECIFICATIONS AND DATA ARE SUBJECT TO CHANGE WITHOUT NOTICE. Vishay Precision Group, Inc., its affiliates, agents, and employees, and all persons acting on its or their behalf (collectively, "Vishay Precision Group"), disclaim any and all liability for any errors, inaccuracies or incompleteness contained herein or in any other disclosure relating to any product. The product specifications do not expand or otherwise modify Vishay Precision Group's terms and conditions of purchase, including but not limited to, the warranty expressed therein. Vishay Precision Group makes no warranty, representation or guarantee other than as set forth in the terms and conditions of purchase. **To the maximum extent permitted by applicable law, Vishay Precision Group disclaims (i) any and all liability arising out of the application or use of any product, (ii) any and all liability, including without limitation special, consequential or incidental damages, and (iii) any and all implied warranties, including warranties of fitness for particular purpose, non-infringement and merchantability.** Information provided in datasheets and/or specifications may vary from actual results in different applications and performance may vary over time. Statements regarding the suitability of products for certain types of applications are based on Vishay Precision Group's knowledge of typical requirements that are often placed on Vishay Precision Group products. It is the customer's responsibility to validate that a particular product with the properties described in the product specification is suitable for use in a particular application. No license, express, implied, or otherwise, to any intellectual property rights is granted by this document, or by any conduct of Vishay Precision Group. The products shown herein are not designed for use in life-saving or life-sustaining applications unless otherwise expressly indicated. Customers using or selling Vishay Precision Group products not expressly indicated for use in such applications do so entirely at their own risk and agree to fully indemnify Vishay Precision Group for any damages arising or resulting from such use or sale. Please contact authorized Vishay Precision Group personnel to obtain written terms and conditions regarding products designed for such applications. Product names and markings noted herein may be trademarks of their respective owners.



VISHAY
PRECISION
GROUP

Bulk Metal[®] Foil Resistors Design and Selector Guide

Vishay Foil Resistors

3 Great Valley Parkway • Malvern, PA 19355 • USA
Phone: +1-484-321-5300 • Email: foil.usa@vishaypg.com

Table of Contents

- Introduction 3
- Bulk Metal® Foil Technology Product Life Cycle 4
- Ten Technical Reasons to Choose Foil Resistors for Your Circuit 5
- Introduction to High-Precision Resistors 14
- Post Manufacturing Operations (PMO). 17
- Selector Guides 18
 - Surface-Mount Resistors 18
 - Through-Hole Resistors 28
 - Power Current-Sensing Resistors 35
 - Voltage Dividers and Resistor Networks 44
 - Hermetically-Sealed Resistors 52
 - Trimming Potentiometers 57
 - Hybrid Chips and Custom Designed Hermetically-Sealed Networks (PRND) 60
 - Avionics, Military, and Space (AMS) 64
- Foil In Action 70
- Prototype Service 83
- Contacts 85

Table of Contents

About Vishay Foil Resistors

Bulk Metal® Foil technology, first introduced by Vishay Foil Resistors (VFR) in 1962, still out-performs all other resistor technologies available for applications that require precision, stability, and reliability. VFR's unique, ultra precision Bulk Metal® Foil resistor products provide extremely low temperature coefficient of resistance (TCR) and exceptional long-term stability through temperature extremes. VFR continues to develop, manufacture, and market new types of foil resistor products, including military-established-reliability components (EEE-INST-002, DSCC, CECC, ESA, ER, QPL, etc).

The Vishay Foil Resistors portfolio comprises discrete resistors and resistor networks in surface mount and through-hole (leaded) configurations, precision trimming potentiometers, and discrete chips for use in hybrid circuits. Customized chip resistor networks and resistor arrays can also be manufactured. In this Design and Selector Guide, VFR has brought together all the technical data you need to choose the best Bulk Metal® Foil resistor for your application – including technical aspects of foil technology, selector guides, and applications section.

The selector guides are divided into sections providing the resistance range, tolerance, TCR, rated power, power coefficient of resistance (PCR), and load life stability of Bulk Metal® Foil products in eight categories:

- Surface-Mount
- Through-Hole
- Power Current-Sensing
- Voltage Dividers and Resistor Networks
- Hermetically-Sealed
- Trimming Potentiometers
- Hybrid Chips and Custom Designed Hermetically-Sealed Networks (PRND)
- Avionics, Military, and Space (AMS)

Introduction

Almost fifty years after its invention by physicist Dr. Felix Zandman in 1962, Bulk Metal® Foil technology still outperforms all other resistor technologies available today for applications that require precision, stability, and reliability. Vishay Precision Group (VPG) offers Bulk Metal® Foil products in a variety of resistor configurations and package types to meet the needs of a wide range of applications.

In 2000, Vishay Foil Resistors achieved a technological breakthrough with the introduction of Bulk Metal® Z-Foil. Products built on this revolutionary technology deliver an absolute temperature coefficient of resistance (TCR) of ± 0.2 ppm/°C (-55°C to +125°C, +25°C ref.) and ± 0.05 ppm/°C (0°C to +60°C, +25°C ref.), one order of magnitude better than previous Foil technologies. The lower the absolute TCR, the better a resistor can maintain its precise value despite ambient temperature variations and self-heating when power is applied.

By taking advantage of the overall stability and reliability of Vishay Foil resistors, designers can significantly reduce circuit errors and greatly improve overall circuit performance. Bulk Metal® technology allows Vishay Foil to produce customer-oriented products designed to satisfy challenging technical requirements. Customers are invited to contact our Application Engineering Department with non-standard technical requirements and special applications (email: foil@vishaypg.com).

Key Features

- Temperature coefficient of resistance (TCR) for Z-Foil technology
 - ± 0.05 ppm/°C typical (0°C to +60°C, +25°C ref.)
 - ± 0.2 ppm/°C typical (-55°C to +125°C, +25°C ref.)
- Power coefficient of resistance for Z-Foil technology (Power PCR)
 - “ R due to self heating”: ± 5 ppm at rated power
- Load life stability: to $\pm 0.005\%$ (50 ppm) at +70°C, 10,000 hours at rated power
- Resistance tolerance: to $\pm 0.001\%$ (10 ppm)
- Resistance range: 0.5 m to 1.8 M
- Electrostatic discharge (ESD) at least to 25 kV
- Non inductive, non capacitive design
- Rise time: 1 ns without ringing
- Thermal stabilization time <1 sec (nominal value achieved within 10 ppm of steady state value)
- Current noise: $0.010 \mu V_{RMS}/\text{volt}$ of applied voltage (<-40 dB)
- Thermal EMF: $0.05 \mu V/^\circ C$
- Voltage coefficient: <0.1 ppm/V
- Trimming operations increase resistance in precise steps but from remote locations so that the etched grid in the active area remains reliable and noise-free (see figures 4 and 5)
- Lead (Pb) free, tin/lead and gold terminations are available

Range of Foil Resistor Products

- Surface-mount chips, molded resistors and networks
- Power resistors and current sensors
- Military established reliability (QPL, DSCC, EEE-INST-002, ESA, CECC)
- Leaded (through-hole)
- Hermetically-sealed
- Trimming potentiometers
- Voltage dividers and networks

- Hybrid chips (wire-bondable chips)
- High temperature resistors (>220°C)
- Resistors for audio

Reason 1: Temperature Coefficient of Resistance (TCR)

“Why are extremely low absolute TCR resistors required?” is a proper question when evaluating the performance and cost of a system. The answers are as numerous as the systems in which they are installed. The following pages discuss ten different individual technical characteristics of the Bulk Metal® Foil technology that are important to precision analog circuits. While each characteristic is discussed independently for clarity, many circuits require some specific combination of these characteristics and, often, all characteristics are required in the same resistive devices. For example, one might examine the requirements of an operational amplifier.

In operational amplifiers the gain is set by the ratio of the feedback resistor to the input resistor. With differential amplifiers the Common Mode Rejection Ratio (CMRR) is based on the ratios of a four-resistor set. In both cases, any change in the ratios of these resistors directly affects the function of the circuit. The ratios might change due to different absolute temperature coefficients experiencing differential heating (either internal or external), differential tracking through changes in ambient temperature, differential time-response to step inputs or high frequency signals, differential Joule heating due to different power levels, different changes in resistance over design life, etc. So it can easily be seen that it is common for many circuits to depend on many application-related stability characteristics — all at the same time in the same devices. The Bulk Metal® Foil technology is the ONLY resistor technology that provides the tightest envelope of ALL of these characteristics in the same resistor devices, with low noise also coming along as inherent to the foil technology. Whether necessary for any specific application or not, all of these characteristics are inherent to the foil technology and all are automatically included in any of the foil resistors.

The solution to these problems is extremely low **absolute** TCR resistors to keep temperature-induced changes to a minimum.

Initial TCR

Two predictable and opposing physical phenomena within the composite structure of the resistive alloy and its substrate are the key to the low absolute TCR capability of a Bulk Metal® Foil resistor:

- Resistivity of the resistive alloy changes directly with temperature in free air (resistance of the foil increases when temperature increases.)
- The Coefficient of Thermal Expansion (CTE) of the alloy and the substrate to which the foil alloy is cemented are different resulting in a compressive stress on the resistive alloy when temperature increases (resistance of the foil decreases due to compression caused by the temperature increases).

The TCR of the Foil resistor is achieved by matching two opposing effects - the inherent increase in resistance due to temperature increase vs. the compression - related decrease in resistance due to that same temperature increase. The two effects occur simultaneously resulting in an unusually low predictable, repeatable, and controllable TCR. Due to VPG's Bulk Metal® Foil resistor design, this TCR characteristic is accomplished automatically, without selection, and regardless of the resistance value or the date of manufacture — even if years apart!

Ten Technical Reasons to Choose Foil Resistors for Your Circuit

Improved TCR in Bulk Metal® Z-Foil Resistors to ± 0.2 ppm/°C

Foil resistor technology has continued to progress over the years, with significant improvements in TCR. Figure 1 shows the typical TCR characteristics of the various foil alloys utilized by Vishay Foil to produce Bulk Metal® Foil resistors.

The original Alloy C Foil exhibits a negative parabolic response to temperature with a positive chord slope on the cold side and a negative chord slope on the hot side.

Figure 1. Typical Resistance versus Temperature Curve and its Chord Slopes (TCR) of Foil Alloys in Military Range

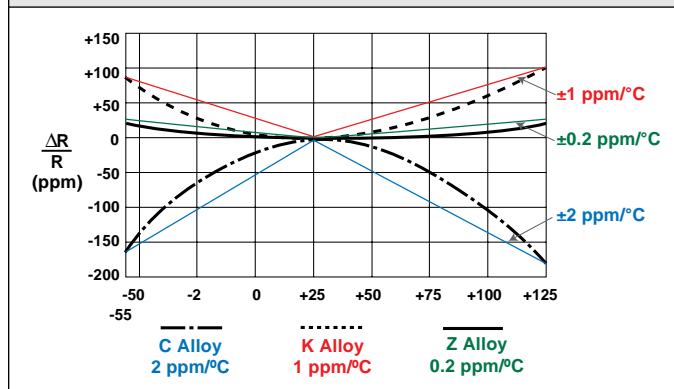

Following was the Alloy K Foil which produced an opposite parabolic response with temperature with a negative chord slope on the cold side and a positive chord slope on the hot side. In addition, it provides a TCR approximately one half that of Alloy C Foil.

The latest development are the Alloys Z and Z1-Foil Technologies Breakthrough which has a similar parabolic response as the Alloy K Foil but produces TCR characteristics an order of magnitude better than Alloy C and five times better than Alloy K.

Using this technology, extremely low TCR resistors have been developed that provide virtually zero response to temperature.

These technological developments have resulted in a major improvement in TCR characteristics compared to what was available before, and what is available in any other resistor technology.

Typical TCR

Foil typical TCR is defined as the chord slopes of the relative change of resistance vs temperature (RT) curve, and is expressed in ppm/°C (parts per million per degree centigrade). Slopes are defined from 0°C to +25°C and +25°C to +60°C (Instrument Range); and from -55°C to +25°C and +25°C to +125°C (Military Range). These specified temperatures and the defined typical TCR chord slopes apply to all resistance values including low value resistors. Note, however, that without four terminals and Kelvin connections in low values, allowance for lead resistance and associated TCR may have to be made. All resistance and TCR measurements of leaded styles are made by the factory at a gage point 1/2" from the standoffs. Contact the Application Engineering Department for the TCR increase to be expected for low value resistors.

TCR Tracking

"Tracking" is the stability of the ratio(s) of two or more resistors. When more than one resistor shares the same substrate (e.g. see Figure 2), the TCR tracking will be much better than the TCR provided by two discrete resistors. Resistors with different technologies increase or decrease in value when temperatures change also from the same batch. Resistance ratio tracking is influenced by heat that comes from outside the device (such as a rising ambient temperature or adjacent hotter objects) and from inside the device (as a result of self-heating due to power dissipation). Resistors may be selected for good TCR tracking when they are all at the same temperature. But, changes due to differential internal temperatures (e.g. differential power dissipation) or different local temperatures (e.g. differential heating from neighboring components) are superimposed upon the tracking and cause additional temperature - related errors. **Therefore, low absolute TCR is important for good TCR tracking of precision applications.**

The best analog design would be using a fundamentally low absolute TCR resistor since it would minimize the effect of ambient temperature and self-heating.

This is impossible to accomplish with high TCR resistors > 5 ppm/°C even with good initial TCR Tracking of less than 2 ppm/°C.

Figure 2. Typical Application

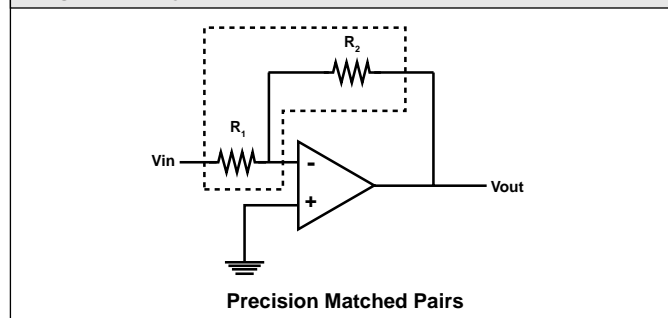

Reason 2: Power Coefficient of Resistance (PCR)

The TCR of a resistor for a given temperature range is established by measuring the resistance at two different ambient temperatures: at room temperature and in a cooling chamber or oven. The ratio of relative resistance change and temperature difference gives the slope of

$R/R = f(T)$ curve. This slope is usually expressed in parts per million per degree Centigrade (ppm/°C). In these conditions, a uniform temperature is achieved in the measured resistance. In practice, however, the temperature rise of the resistor is also partially due to self-heating as a result of the power it is dissipating (self-heating). As stipulated by the Joule effect, when current flows through a resistance, there will be an associated generation of heat. Therefore, the TCR alone does not provide the actual resistance change for precision resistor. Hence, another metric is introduced to incorporate this inherent characteristic - the Power Coefficient of Resistance (PCR). PCR is expressed in parts per million per Watt or in ppm at rated power. In the case of Z-based Bulk Metal® Foil, the PCR is 5 ppm typical at rated power or 4 ppm per Watt typical for power resistors. For example: for Foil power resistor with TCR of 0.2 ppm/°C and PCR of 4 ppm/W, a temperature change of 50°C (from +25°C to +75°C) at a power of 0.5 W will produce a R/R of $50 \times 0.2 + 0.5 \times 4 = 12$ ppm absolute change.

Reason 3: Thermal Stabilization

When power is applied to the resistor, self-heating occurs. Foil's low TCR and PCR capabilities help to minimize this effect. But to achieve high-precision results, a rapid response to any changes in the environment or other stimuli is necessary. When the level of power is changed, one would desire the resistance value to adjust accordingly as quickly as possible. A rapid thermal stabilization is important in applications where the steady state value of resistance according to all internal and external factors must be achieved quickly to within a few ppm.

While most resistor technologies may take minutes for such speed and precision of thermal stabilization to its steady state value, a Vishay Foil resistor is capable of almost immediate stabilization, down to within a few ppm in under a second. The exact response is dependent on the ambient temperature as well as the change in power applied; the heat flow when power is applied places mechanical stresses on the element and as a result causes temperature gradients. Regardless, Bulk Metal® Foil outperforms all other technologies by a large margin (see Figure 3).

Figure 3. Thermal stabilization demonstration (1 W applied to 50 m SMD 2512)

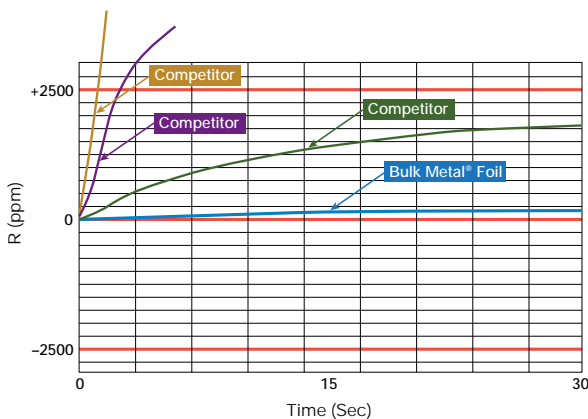

Reason 4: Resistance Tolerance

Why do users employ tight tolerance resistors? A system or a device or one particular circuit element must perform for a specified period of time and at the end of that service period, it must still perform within specification. During its service life, it may have been subjected to some hostile working conditions and therefore may no longer be within purchased tolerance. One reason for specifying a tighter purchased tolerance than the end of life error budget tolerance is to allow room for service shifts. Another reason is that the error budget is more economically applied to resistors than to most other components.

The Bulk Metal® Foil resistors are calibrated as accurately as 0.001% by selectively trimming various adjusting points that have been designed into the photoetched pattern of the resistive element (see Figure 4). They provide predictable step increases in resistance to the desired tolerance level. Trimming the pattern at one of these adjusting points will force the current to seek another longer path, thus raising the resistance value of the element by a specific percentage.

The trimming operations increase resistance in precise steps but from remote locations so that the etched grid in the active area remains reliable and noise-free (see Figure 5). In the fine adjusted areas, trimming affects the final resistance value by smaller and smaller amounts down to 0.001% and finally 0.0005% (5 ppm). This is the trimming resolution (see Figure 4).

Figure 4. Vishay Foil Resistors S102C Resistor Element

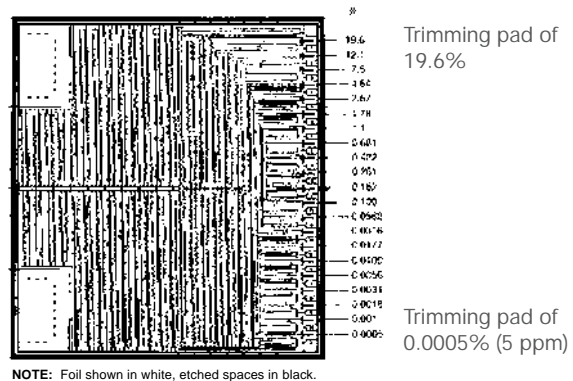
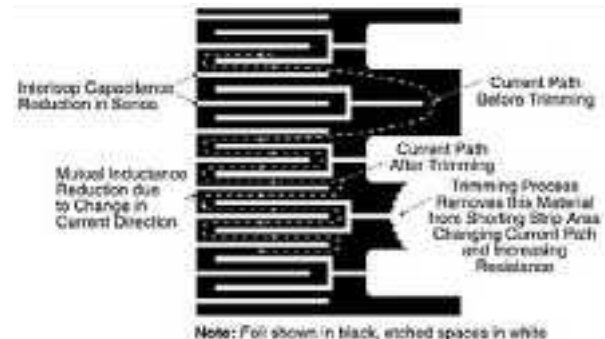

Figure 5. Trimming to Values (Conceptual Illustration)



Reason 5: Load Life Stability

Why are designers concerned about stability with applied load? Load life stability is the characteristic most relied upon to demonstrate a resistor's long-term reliability. Military testing requirements to 10,000 hours with limits on amount of shift and the number of failures results in a failure rate demonstration. Precision Bulk Metal® Foil resistors have the tightest allowable limits. Whether military or not, the load life stability of Vishay Foil resistors is unparalleled and long-term serviceability is assured.

The reason Vishay Foil resistors are so stable has to do with the materials of construction (Bulk Metal® Foil and high alumina substrate). For example, the S102C and Z201 resistors are rated at 0.3W at 125°C with an allowable ΔR of 150 ppm max after 2000 hours under load and 500 ppm max after 10,000 hours (see Figures 6 and 7 for the demonstrated behavior). Conversely, the ΔR is reduced by decreasing the applied power which lowers the element temperature rise in Vishay Foil resistors. Figure 6 shows the drift due to load life testing

Ten Technical Reasons to Choose Foil Resistors for Your Circuit

at rated power and Figure 7 shows the drift due to load life testing at varied power. Reducing the ambient temperature has a marked effect on load life results and Figure 8 shows the drift due to rated power at different ambient temperatures. The combination of lower power and ambient temperature is shown in Figure 9 for model S102C.

Our engineers have ensured the stability of our resistors through several tests and experiments. Figure 10 displays the results of our tests that has been in progress for 29 years. 50 sample S102C 10 k Ω resistors have been in a 70°C heating chamber while under 0.1W applied power for this entire duration. The average deviation in resistance is just 60 ppm.

Figure 11 shows documented shelf life performances made by a customer for hermetically sealed VHP101 Foil resistors for over 8 years. The average deviation did not exceed 1 ppm.

For evaluation of load life stability, the two parameters which must be mentioned together – power rating and ambient temperature – can be joined into one single parameter for a given style of resistor. If the steady state temperature rise can be established, it can be added to the ambient temperature, and the sum will represent the combined (load induced + ambient) temperature. For instance, the Vishay Foil resistor S102C has a temperature rise of 9°C per 0.1W of applied power. This leads to the following example calculations:

If $T = 75^{\circ}\text{C}$, $P = 0.2\text{W}$, and $t = 2000$ hrs. ;
 Then self-heating = $9^{\circ}\text{C} \times 2 = 18^{\circ}\text{C}$.
 18°C rise + 75°C ambient = 93°C total R .
 $R_{\text{max}} = 80$ ppm from the curve of Figure 12.

Figure 6. Relative Resistance Change ($\Delta R/R$) as a Function of Time, Load 0.3W, +125°C Ambient

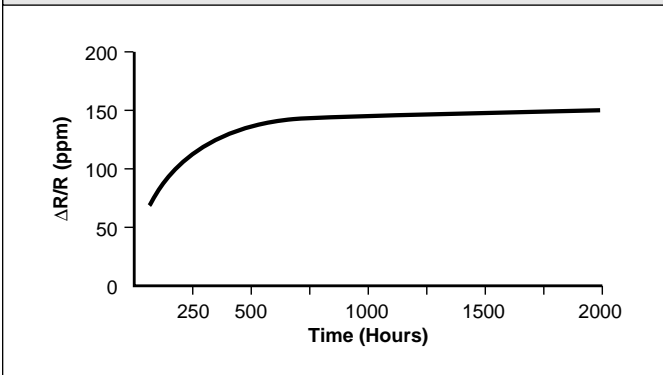

Figure 8. $R/R = F(\text{Time})$, Loads 0.03W, Different Ambient Temperatures

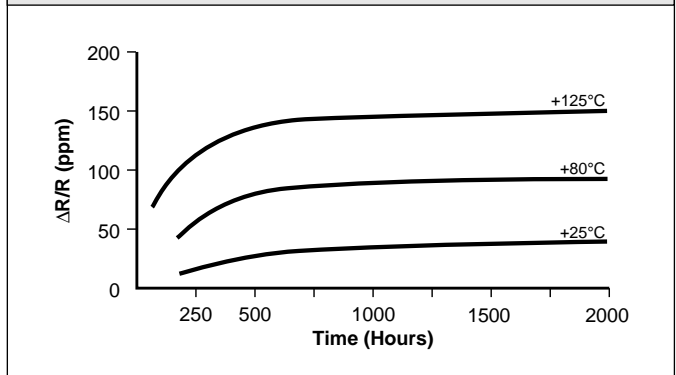

Figure 7. ($\Delta R/R$) = F (Time), Loads 0.05 to 0.5W, +125°C Ambient

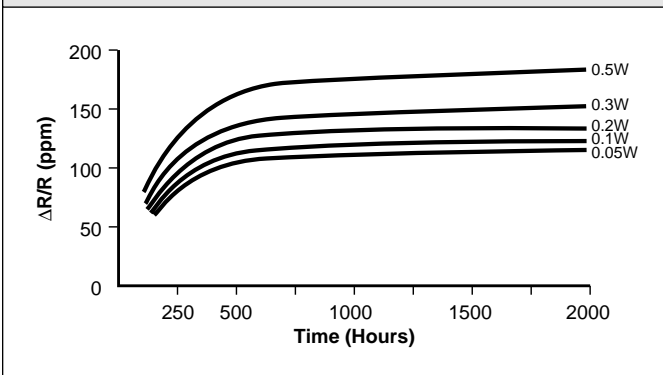

Figure 9. $R/R = F(\text{Time})$, Loads 0.05 to 0.5W, +25°C Ambient

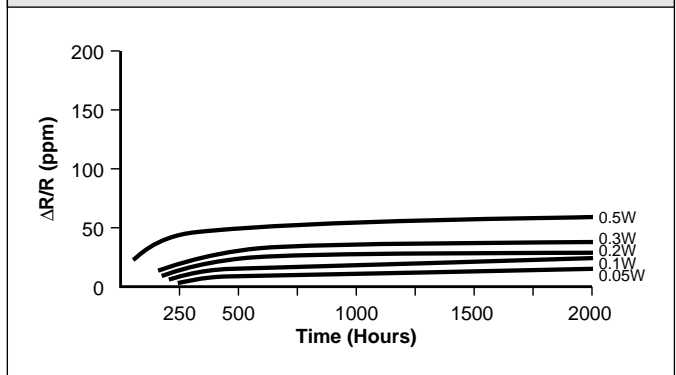

Figure 10. Long-Term Stability Over 29 Years, 0.1W at 70°C, 50 Samples (S102C, 10 K Ω)

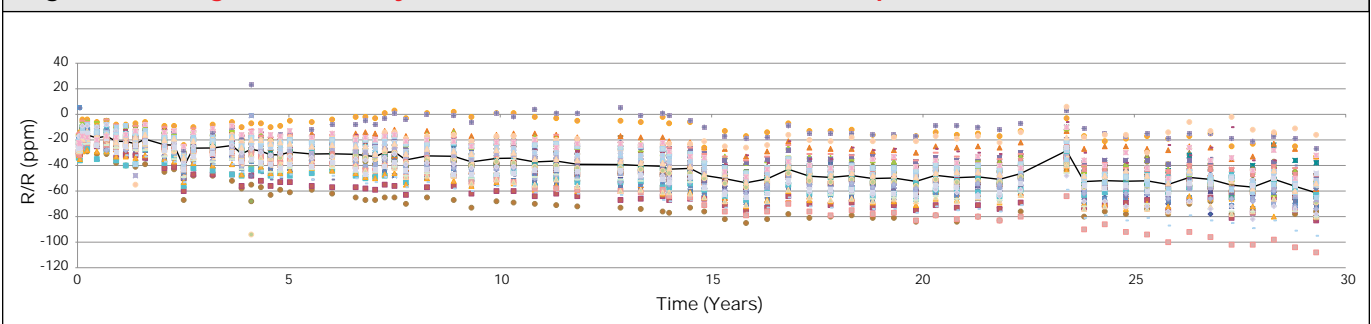

Figure 12 shows, for a given duration of load life test, how the drift increases with the level of the applied combined temperature. As explained above, the combined temperature comprises the effect of power induced temperature rise and the ambient temperature. The curve shows maximum drift.

Figure 11. Shelf Life Test Results of Hermetically Sealed VHP101 Foil Resistors Over 8 Years

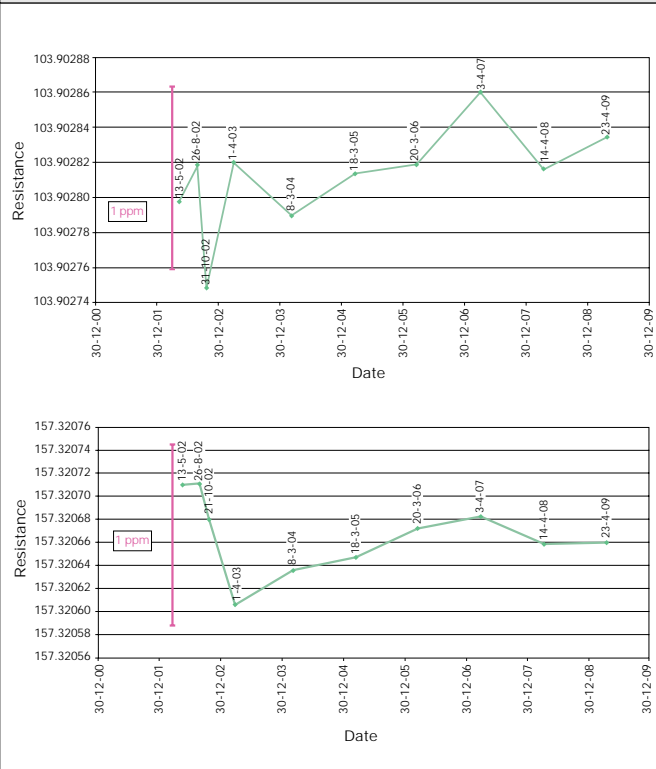
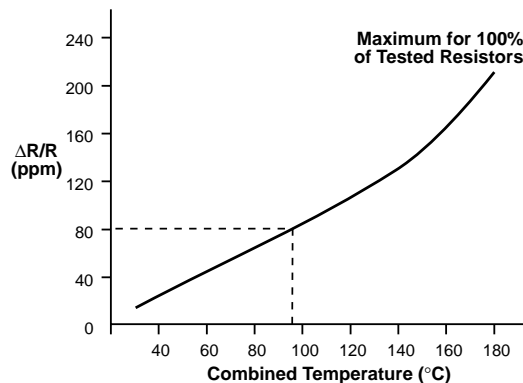

Figure 12. Maximum Resistance Shifts After 2000 Hours of Load Life Test Under Thermal Stresses*

* Combined temperature— ambient and temperature rise due to applied power.



This information is based on product taken off the line without any screen testing or power conditioning. Further drift reduction is available by factory power conditioning. Consult Application Engineering for this and other screening tests that are available.

Reason 6: High Speed and Response Time

The equivalent circuit of a resistor, as shown in Figure 13, combines a resistor in series with an inductance and in parallel with a capacitance (PLC). Resistors can perform like an R/C circuit, filter or inductor depending on their geometry. In spiraled and wirewound resistors, these reactances are created by the loops and spaces formed by the spirals or turns of wire. Figure 14 shows how the capacitance and inductance increase as the resistance value increases due to continually increasing the number of spirals or turns. Certain assembly techniques attempt to mitigate the inductance in wirewound resistors but all have only limited effect. On the other hand, in planar resistors such as the Bulk Metal® Foil resistors, the geometry of the lines of the resistor patterns is intentionally designed to counteract these reactances. Figure 15 shows a typical serpentine pattern of a planar resistor. Opposing current directions in adjacent lines reduces mutual

Figure 13. The Equivalent Circuit of a Resistor

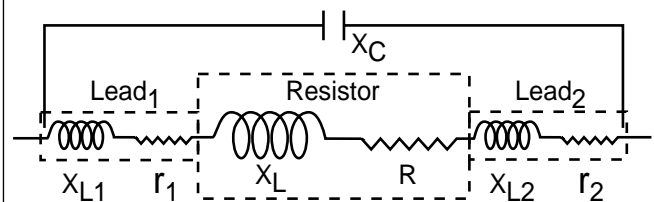

Figure 14. Capacitance and Inductance in a Wound or Spiraled Resistor

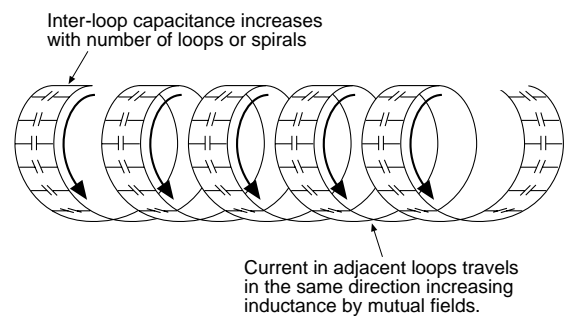
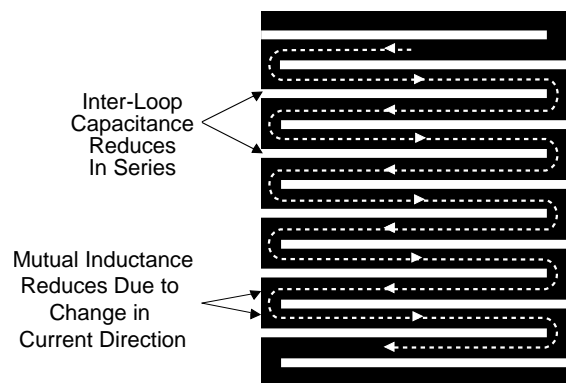

Figure 15. Bulk Metal® Foil Planar Design



Ten Technical Reasons to Choose Foil Resistors for Your Circuit

inductance while geometry-related inter-line capacitances in series reduces overall capacitance. Both inductance and capacitance produce reactance proportional to the operating frequency and it changes the effective resistance and the phase between the current and voltage in the circuit.

Both inductive and capacitive reactances distort input signals, particularly in pulse applications. Figure 16 shows the current response to a voltage pulse comparing a fast Bulk Metal® Foil resistor to a slower wirewound resistor. Here a pulse width of one nanosecond would have been completely missed by the wirewound resistor while the Vishay Foil resistor achieves full replication in the time allotted.

In frequency applications, these reactive distortions also cause changes in apparent resistance (impedance) with changes in frequency. Figure 17 shows a family of curves relating the AC resistance to the DC resistance in Bulk Metal® Foil resistors. Very good response is seen in the 100 range out to 100 MHz and all values have a good response out to 1 MHz. The performance curves for other resistor technologies can be expected to show considerably more distortion (particularly wirewounds).

Figure 16. Comparison of a Response to a Pulse

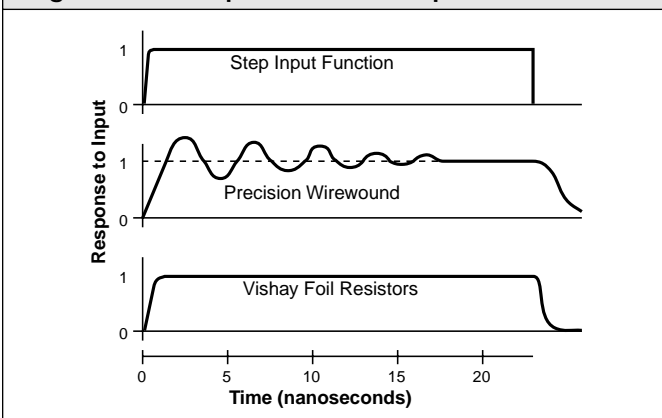
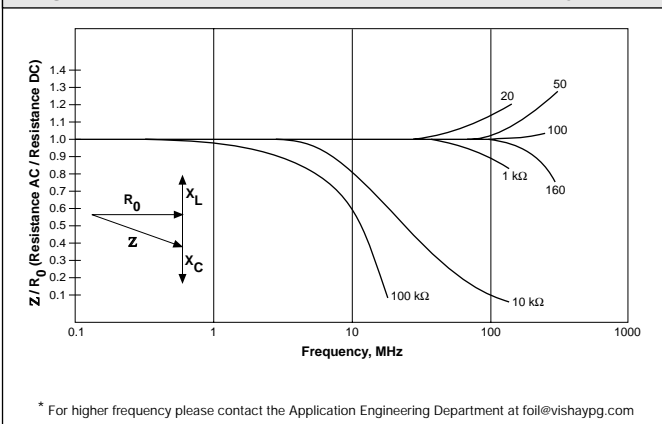

Figure 17. Effect of Operation at Frequency*



Reason 7: Noise: “Hear The Difference”

As sound reproduction requirements become more demanding, the selection of circuit components becomes more exacting and the resistors in the signal path are critical. Measurement instrumentation based on low level signal inputs and high gain amplification cannot tolerate microvolt level background noise when the signal being measured is itself in the microvolt range. Although audio circuitry, where signal purity is of utmost concern, is the most obvious use of noise-free components and other industries and technologies are equally concerned with this characteristic.

Resistors, depending on construction, can be a source of noise. This unintended signal addition is measurable and independent of the presence of a fundamental signal.

Figures 18-20 illustrate the effects of resistor noise on a fundamental signal. Resistors made of conductive particles in a non-conductive binder are the most likely to generate noise. In carbon composition and thick film resistors, conduction takes place at points of contact between the conductive particles within the binder matrix. Where these point-to-point contacts are made constitutes a high resistance conduction site which is the source for noise. These sites are sensitive to any distortion resulting from expansion mismatch, moisture swelling, mechanical strain, and voltage input levels. The response to these outside influences is an unwanted signal as the current finds its way through the matrix. Figure 21 illustrates this current path.

Figure 18. Segment of a Fundamental Curve

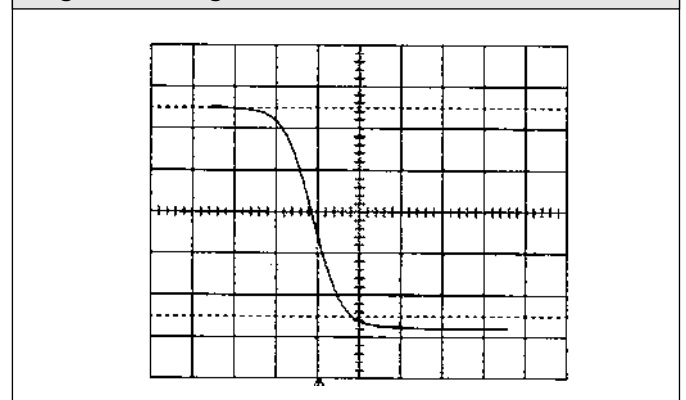
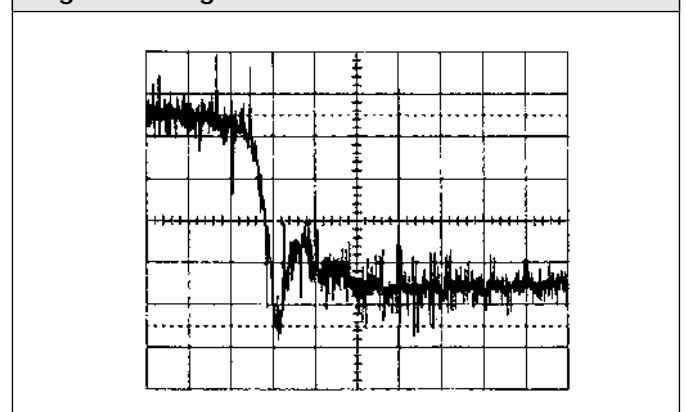

Figure 19. Signal with Added Resistor Noise



Resistors made of metal alloys, such as Bulk Metal® Foil resistors, are the least likely to be noise sources. Here, the conduction is across the inter-granular boundaries of the alloy. The intergranular current path from one or more metal crystals to another involves multiple and long current paths through the boundaries reducing the chance for noise generation. Figure 22 illustrates this current path.

In addition, the photolithography and fabrication techniques employed in the manufacture of Bulk Metal® Foil resistors results in more uniform current paths than is found in some other resistor constructions. Spiraled resistors, for example, have more geometric variations that contribute to insertion of noise signals. Bulk Metal® Foil resistors have the lowest noise of any resistor technology, with the noise level being essentially immeasurable. Signal purity can be a function of the selection of resistor technology for pre-amp and amplifier applications. Vishay Foil resistors offer the best performance for low noise audio applications.

Figure 20. Signal with a Vishay Foil Resistor

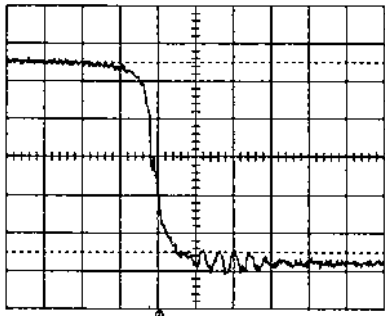
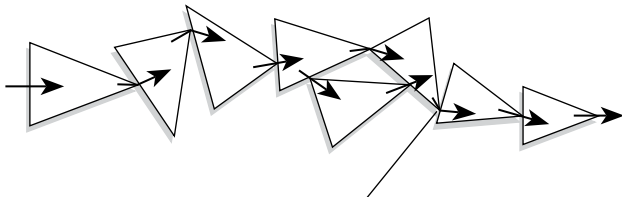
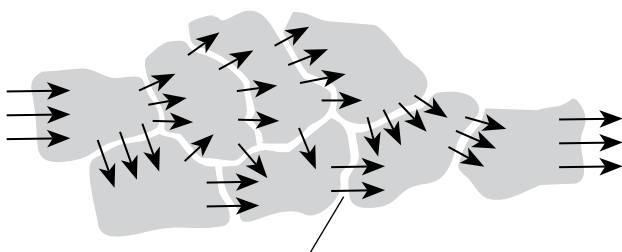

Figure 21. The Current Path in a Particle-to-Particle Matrix



Noise generation is maximum when current flow is through point to point contacts as shown in a particle to particle matrix.

Figure 22. The Current Path in a Resistive Alloy



Noise generation is minimal when current flow is through multiple paths as exists in Bulk Metal® Foil resistive alloy.

Reason 8: Thermal EMF

When a junction is formed by two dissimilar metals and is heated, a voltage is generated due to the different levels of molecular activity within these metals. This electromotive force, induced by temperature, is called Thermal EMF and is usually measured in microvolts. A useful purpose of this Thermal EMF is the measurement of temperature using a thermocouple and microvolt meter.

In resistors, this Thermal EMF is considered a parasitic effect interfering with pure resistance (especially at low values when DC is applied). It is often caused by the dissimilarity of the materials used in the resistor construction, especially at the junction of the resistor element and the lead materials. The Thermal EMF performance of a resistor can be degraded by external temperature differences between the two junctions, dissymmetry of power distribution within the element, and the dissimilarity of the molecular activity of the metals involved.

One of the key features feature of the Vishay Foil resistor is its low Thermal EMF design. The flattened paddle leads (in through hole design) make intimate contact with the chip thereby maximizing heat transfer and minimizing temperature variations. The resistor element is designed to uniformly dissipate power without creating hot spots and the lead material is compatible with the element material. These design factors result in a very low Thermal EMF resistor.

Figures 23 and 24 display the various design characteristics that give these resistors an extremely low thermal EMF.

Reason 9: Electrostatic Discharge (ESD)

Electrostatic discharge (ESD) can be defined as a rapid transfer of charge between bodies at different electrical potentials – either by direct contact, arcing, or induction – in an attempt to become electrically neutral. The human threshold for feeling an ESD is 3000V, so any discharge that can be felt is above this voltage level. Because the duration of this high voltage spike is less than a microsecond long, the net energy is small compared to the size of the human body over which it is spread. From the human body's point of view, ESD does no harm. But when the discharge is across a small electronic device, the relative energy density is so great that many components can be damaged by ESD at levels as low as 3000V or even 500V.

ESD damage is generally divided into three categories:

- Parametric Failure – the ESD event alters the resistance of the component causing it to shift from its required tolerance. This failure does not directly pertain to functionality; thus a parametric failure may be present even if the device is still functional.
- Catastrophic Damage – the ESD event causes the device to immediately stop functioning. This may occur after one or a number of ESD pulses, and may have many causes, such as human body discharge or the mere presence of an electrostatic field.
- Latent Damage – the ESD event causes moderate damage to the device, which is not noticeable, as the device appears to be functioning correctly. However, the load life of the device is dramatically reduced, as further degradation caused by operating stresses may cause the device to fail during service. This defect is of greatest concern as it is very difficult to detect by visual inspection or re-measurement.

Ten Technical Reasons to Choose Foil Resistors for Your Circuit

Figure 23. Ruggedized Construction

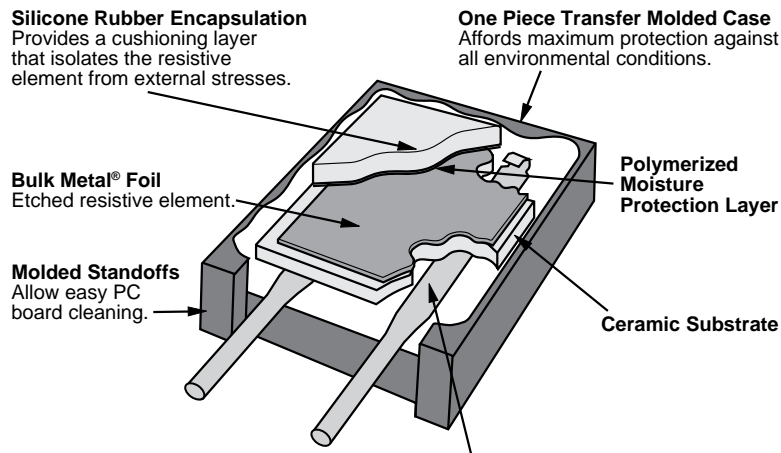

Paddle Leads with Welded Terminations— No Ribbons
Only two welds, both remote from the lead-to-case point-of-entry, the best arrangement for maximum reliability. Excellent moisture resistance, high temperature, and load life capabilities, low Thermal EMF.

The combination of ruggedized leads and molded case, plus the highly efficient heat transfer characteristics of the unique assembly and the ceramic substrate results in a high reliability resistor with excellent moisture resistance, high temperature, and load life capabilities. These also afford a very low Thermal EMF.

Flattened “paddles” are wrapped around the resistance element structure and welded directly to the resistance alloy – thus there is only one weld per lead. The closely related thermal characteristics of the selected materials, combined with the unique “paddle” lead design, produce a resistor with extremely low Thermal EMF.

Figure 24. Surface-Mount Wrap-Around Chip Foil Resistor Construction

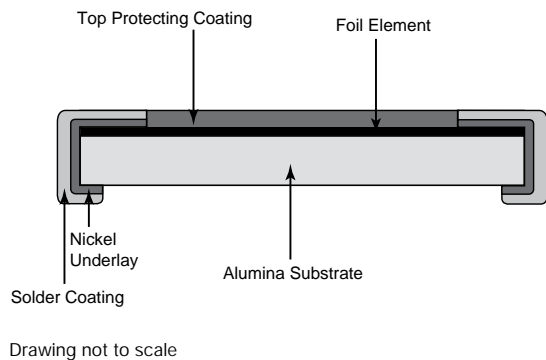

In resistors, ESD sensitivity is a function of their size. The smaller the resistor, the less space there is to spread the energy pulsed through it from the ESD. This energy concentration in a small area of a resistor's active element causes it to heat up, which could lead to irreversible damage. With the growing trend of miniaturization, electronic devices, including resistors, are becoming smaller and smaller, causing them to be more prone to ESD damage.

Thus, the superiority of Bulk Metal® Foil precision resistors over Thin Film resistors, when subjected to ESD, is attributed mainly to their greater thickness (foil is 100 times thicker than Thin Film), and therefore the heat capacity of the resistive foil layer is much higher

compared to the thin film layer. Thin film is created through particle deposition processes (evaporation or sputtering), while foil is a bulk alloy with a crystalline structure created through hot and cold rolling of the melt.

Tests performed have indicated that foil chip resistors can withstand ESD events at least to 25 kV (data available), while thin film and thick film chip resistors have been seen to undergo catastrophic failures at electric potentials as low as 3000 V (parametric failures at even much less). If the application is likely to confront the resistor with ESD pulses of significant magnitude, the best resistor choice is Bulk Metal® Foil.

Reason 10: Non-Measurable Voltage Coefficient

As mentioned earlier in our section on resistor noise, resistors can change value due to applied voltage. The term used to describe the rate of change of resistance with changing voltage is known as voltage coefficient. Resistors of different constructions have noticeably different voltage coefficients. In the extreme case, the effect in a carbon composition resistor is so noticeable that the resistance value varies greatly as a function of the applied voltage. Bulk Metal® Foil resistor elements are insensitive to voltage variation and the designer can count on Vishay Foil resistors having the same resistance under varying circuit voltage level conditions. The inherent bulk property of the metal alloy provides a non-measurable voltage coefficient.

Conclusion

All In One Resistor

The ten reasons to specify Foil resistors are inherent in the design and are not a function of manufacturing variables or a selection process. This combination of parameters is not available in any other resistor technology. Vishay Foil Resistors provides a unique, inherent combination of performance characteristics resulting in unmatched performance and high reliability, satisfying the needs of today's expanding requirements.

Special Order

Consider Vishay Foil Resistors for all of your low TCR needs. Special orders may be placed for low TCR, low value resistors, and tight TCR tracking of individual resistors and network combinations. Contact the Application Engineering Department to discuss your requirements for these and any other TCR applications (email: foil@vishaypg.com).

Introduction to High-Precision Resistor Industry

The electronics industry has evolved at a remarkable rate over the past three decades. New techniques and advances have helped shrink equipment size and have put pressure on manufacturers of discrete components to develop devices that approach the ideal in performance and reliability.

Among these devices are chip resistors, which remain in high demand today and are among the basic building blocks for many circuits. They are more space efficient than discrete encapsulated resistors and require less preparation prior to assembly. As they have grown more popular, their capabilities have also become more important. Key parameters include electrostatic discharge (ESD) protection, thermal electromotive force (thermal EMF), temperature coefficient of resistance (TCR) and self-heating properties, long-term stability, power coefficient, and noise.

In the technology comparisons to follow, wirewound resistors are discussed for their use in precision circuits. But it should be remembered that wirewound resistors are not available in true chip form (chip without a molding), and therefore are not usable in applications where weight and size limitations demand precision in the chip resistor format.

Although the overall system performance is improved by upgrading each component or subsystem, it is nevertheless true that overall performance is still determined by the weakest link in the chain. Each component comes to the system with built-in tradeoffs that limit overall performance, with particular concern over short- and long-term stability, frequency response, and noise. In the discrete-resistor industry, advances have been made in wirewound, thick film, thin film, and foil resistor technologies, with each offering various tradeoffs in performance per unit cost.

A brief review of the advantages and disadvantages of various resistor technologies shows the interlinked effects of thermal and mechanical forces on resistor electrical characteristics, as summarized in Table 1.

Stresses, whether mechanical or thermal, cause a resistor to change its electrical parameters. If such aspects as shape, length, geometry, configuration, or molecular structure are changed by mechanical or other means, the electrical parameters are also changed.

When current passes through a resistor element, heat is generated, and the temperature change causes mechanical changes by expansion or contraction in each of the materials involved in the component. The ideal resistor element would, therefore, incorporate those natural phenomena into a self-balancing, stability-enhancing system that maintains its physical integrity through the resistor manufacturing process, and eliminates the need to compensate for the effects of heat or stress during use.

Precision Wirewound Resistors

Wirewound resistors are generally classified as either “power wirewounds” or “precision wirewounds.” Power wirewound resistors are subject to greater changes in service and are not used where precision performance is required; therefore, they are not considered in this discussion.

The wirewound resistor is usually made by winding insulated resistance wire of a specific diameter around a bobbin. Different wire diameters, lengths, and alloys provide the desired resistance and initial characteristics. Precision wirewound resistors have better ESD stability and lower noise than thin or thick film resistors. Wirewounds also have a lower TCR and better stability.

The initial tolerance of wirewound resistors can be as low as $\pm 0.005\%$. The TCR, which is the amount of resistance change with each degree Centigrade change in temperature, can be as little as 3 ppm/ $^{\circ}\text{C}$ typical; but for low resistance values, wirewounds are generally in the region of 15 ppm/ $^{\circ}\text{C}$ to 25 ppm/ $^{\circ}\text{C}$. Thermal noise is low, and TCR tracking to ± 2 ppm/ $^{\circ}\text{C}$ over a limited temperature range is possible.

In the process of manufacturing wirewound resistors, the wire has its inner surface (the side closest to the bobbin) under compression, while its outer surface is under tension. Permanent deformations —

Technology	Temperature Coefficient of Resistance (TCR) -55°C to +125°C, +25°C ref.	Initial Tolerance	End of Life Tolerance	Load Life Stability at +70°C, Rated Power 2000 Hours and 10,000 Hours	ESD (V)	Thermal Stabilization	Noise (dB)
Bulk Metal® Foil	± 0.2 ppm/ $^{\circ}\text{C}$	From 0.005%	<0.05%	0.005% (50 ppm) 0.01% (100 ppm)	25,000	<1 second	-42
High-Precision Thin Film	± 5 ppm/ $^{\circ}\text{C}$	From 0.05%	<0.4%	0.05% (500 ppm) 0.15% (1500 ppm)	2500	>few minutes	-20
Precision Thick Film	± 50 ppm/ $^{\circ}\text{C}$	From 0.5%	<5%	0.5% (5000 ppm) 2% (20,000 ppm)	2000	>few minutes	+20
Wirewound	± 3 ppm/ $^{\circ}\text{C}$	From 0.005%	<0.5%	0.05% (500 ppm) 0.15% (1500 ppm)	25,000	>few minutes	-35

as compared to elastic or reversible deformations — caused by this process and subsequent in-service annealing of the wire are irreversible. Permanent mechanical changes, which happen unpredictably, cause equally random changes in the electrical parameters of the wire and the resistance. The result is that the resistance elements can have variable electrical performance characteristics.

Because of their coiled-wire construction, wirewound resistors are inductors, and the proximity of the turns creates intercoil capacitance. To increase the response time in service, special winding techniques may be used to reduce the inductance. Due to the inductance and capacitance inherent in the design, wirewound resistors have poor high-frequency characteristics, particularly above 50 kHz.

It is difficult to make two wirewound resistors that accurately track each other over a specified temperature range when they are of the same nominal resistance value, and especially so when their values are not the same or when they are of different sizes (e.g., to meet different power requirements). The difficulty increases as the divergence of the resistance values increases.

The reason for this disparity is that a 1 k Ω resistor is made with a different diameter, length, and possibly alloy of wire than, for example, a 100 k Ω resistor. Moreover, the core sizes and turns per inch are different — again, mechanical properties affect electrical properties. Since the different values have different thermo-mechanical characteristics, their in-service stabilities vary and designed resistor ratios diverge more through equipment life. The TCR tracking and ratio stability are extremely important in high-precision circuitry.

Traditional wirewound manufacturing methods do not isolate the resistive element from the various stresses arising out of the handling, packaging, insertion, and lead forming processes. Tension is often applied to axial leads during the mounting process and pressure can be exerted on the package by mechanically induced forces. Both can change the resistance, either with or without power applied. Over long periods of time, the wound element tends to change physically as the wire adjusts to its new shape.

Thin Film Resistors

Thin film resistors consist of a metallic deposition (made by vacuum deposition or sputtering process) with a 50 to 250 angstrom thickness on a ceramic substrate [recall that one angstrom (Å) = 0.1 nanometer = 1×10^{-10} meter]. Thin films can produce a higher resistance per given area than wirewound or Bulk Metal[®] Foil resistors, and are less expensive as well. This makes them quite economical and more space-efficient where high resistances are needed with intermediate levels of precision.

They have a temperature-sensitive optimum deposit thickness, but making all values at the optimum film thickness severely limits the range of possible values. Therefore, various deposit thicknesses are used to achieve various ranges of values.

The stability of the film is affected by elevated temperatures. The film aging-stabilization process varies depending upon the film thickness required to achieve various resistance values and is, therefore, variable throughout the resistance range. This chemical/mechanical aging also includes elevated temperature oxidation of the resistance alloy.

Also, the TCR is adversely affected by the shift from optimum film thickness. A high-resistance thin film resistor has a much greater deterioration rate because the thinner deposition is more responsive to oxidation. Since the mass of a thin film resistor is small, it is very susceptible to ESD.

Because of their small mass of metal, thin film resistors are also much more susceptible to self-etching in the presence of moisture. Water vapor picks up impurities as it penetrates through the encapsulant, and develops chemical etchants that can cause a thin film resistor to go open within a matter of hours in a low-voltage DC application.

Thick Film Resistors

In the preceding discussion, it was noted that wirewound resistors are not available in chip format because of their size, bulk, and weight. While offering far less precision than wirewounds, thick film resistors are much more universally used because of their much greater resistance density (high resistance/small size) and much lower cost.

They have faster frequency response, similar to thin films and foil, but are the noisiest of all currently used resistor technologies. While being of lesser precision than the other technologies, they are discussed here because of their extremely broad use in almost every type of circuit, including the less-demanding sections of high-precision circuits.

Thick film relies on particle-to-particle contact in a glass matrix to develop the resistance track. These points of contact develop the overall resistance, but are interrupted by thermal strain during service. Since there are many of them in parallel, the resistor does not go open, but continually increases in value with time and temperature. Thus, thick films are less stable (time, temperature, and power) than other resistor technologies.

The granular structure also accounts for the high noise of thick films due to the bunch-and-release electron charge movement through the structure. The higher the resistance value for a given size, the less the metal content, the greater the noise, and the less the stability. The glass content of the thick film structure forms a glassy phase protective coat during the curing of the resistor, and this gives the thick film resistor greater moisture resistance than the thin film resistor.

Foil Resistors

A specific foil alloy with known and controllable properties (Ni/Cr with additives) is cemented to a special ceramic substrate, resulting in a thermo-mechanic balance of forces. A resistive pattern is then photo-etched in the foil. This process uniquely combines the important characteristics of low TCR, long-term stability, non-inductance, ESD insensitivity, low capacitance, fast thermal stabilization, and low noise in one single resistor technology.

These capabilities bring high stability and reliability to system performance without any compromise between accuracy, stability, and speed. To acquire a precision resistance value, the Bulk Metal Foil chip is trimmed by selectively removing built-in “shorting bars.” To increase the resistance in known increments, selected areas are cut, producing progressively smaller increases in resistance.

Standard temperature coefficients of ± 1 ppm/ $^{\circ}$ C over the range of 0 $^{\circ}$ C to +60 $^{\circ}$ C (0.05 ppm/ $^{\circ}$ C for Z-Foil) are derived from the properties of the alloy and its interactive thermo-mechanical balance with the substrate (Figure 1).

In the planar foil, the parallel patterned element design reduces inductance; maximum total inductance of the resistor is 0.08 μ H. Capacitance is 0.5 pF maximum. A 1-k Ω resistor has a settling time of less than 1 ns up to 100 MHz. Rise time depends on resistance value, but higher and lower values are only slightly slower than mid-range values. Absence of ringing is especially important in high-speed switching as in, for example, signal conversion.

Figure 1. Resistance Change Versus Ambient Temperature Curve and TCR Chord Slopes for Different Temperature Ranges for Z-Foil Technology

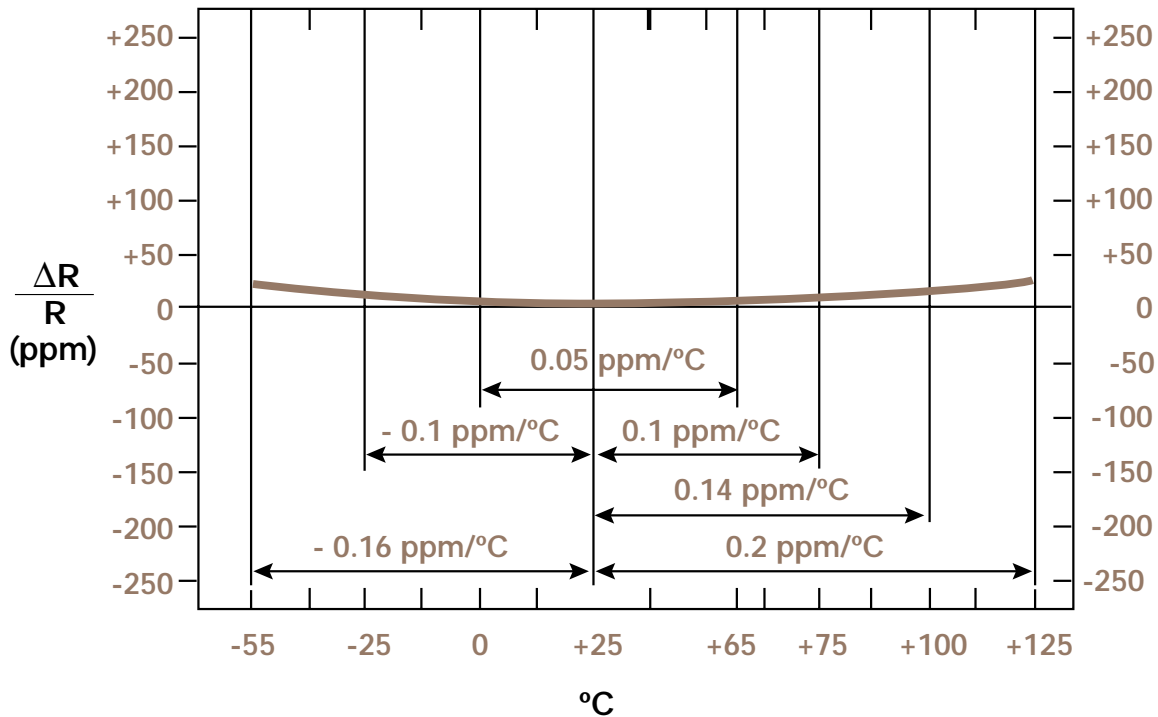

Note: the TCR slopes for <100 are influenced by the termination composition and result in deviation from this curve.

The DC resistance of 1-k Bulk Metal® Foil resistor compared with its AC resistance at 100 MHz can be expressed as follows:

$$\text{AC resistance/DC resistance} = 1.001$$

Foil techniques produce a combination of highly desirable and previously unattainable resistor specifications. These include low temperature coefficients of resistance (0.05 ppm/°C from 0°C to +60°C), tolerances as low as ± 0.005% (down to ±0.001% when hermetically sealed), load life stability of ±0.005% (50 ppm) at +70°C and rated power for 1000 hours, tracking between resistors of 0.1 ppm/°C from 0°C to +60°C, and ESD immunity at least to 25 kV.

How Much Performance?

Naturally, not every engineer needs an entire high-performance package for their circuitry. Resistors with much poorer specifications can be used satisfactorily in many applications, so the question of need is divided into four basic categories:

- Existing applications that can be upgraded by relying on the total performance package of Bulk Metal Foil resistors.
- Existing applications that require one or more, but not necessarily all, of the performance parameters to be "industry best."

- State-of-the-art circuitry that can only be developed now because of the availability of improved specifications for precision resistors.
- Purposeful pre-planning use of precision resistors to allow for future upgrading (e.g., cost savings can be realized by having the circuit accuracy maintained by the resistors rather than by the active devices, which would greatly increase cost for only slightly better levels of performance).

In category two (2), for example, the need for a single parameter must be weighed against the economics of the whole package. It could cost less to use a resistor with superior overall performance specifications, because the need for compensating circuitry (and the cost of the associated components plus their assembly) may be eliminated. Cost savings may also be achieved by concentrating precision in the resistors rather than in the active devices, because active devices have greater cost per marginal performance improvement than the resistors do.

Another question that might be posed is: "Would utilizing a higher-performance resistor in order to upgrade equipment performance enhance market acceptance of the equipment?"

Post Manufacturing Operations (PMO) Enhance the Already Superior Stability of Foil Resistors

These Post Manufacturing Operations (PMOs) are uniquely applicable to resistors made of resistive foil and they take the already superior stability of Vishay Foil devices one step further. They constitute an exercising of the resin that bonds the foil to the substrate, the foil, the alumina, the molding and the contacts. The operations employed are:

- Temperature Cycling/Thermal Shock
- Short Time Overload/Power Shot (Accelerated Load Life)
- Power Conditioning

Temperature Cycling

Temperature Cycling is done initially in the chip stage of all production and will eliminate any fallout. The cycling exercises the Foil and the contacts without reducing its initial bonding strength. A small reduction in resistance is tolerable during this PMO.

Short Time Overload (Accelerated Load Life)

Short Time Overload (STO) occurs when a circuit is subjected at one point in time to a temporary, unexpected high pulse (or overload) that can result in device failure. This STO is performed on all resistors during manufacturing, with a function to eliminate any hot spots if they exist.

Power Conditioning

The standard load life curve of a Foil resistor exhibits a significant portion of its change in the first 250-500 hours, after which the curve begins to stabilize (see Figure 1). The power conditioning exercise applies a load for a specified amount of time to eliminate this knee in the load life curve. Upon delivery, the resistor will be on the flat part of the curve for your convenience. The power conditioning is a function of the application and should be worked out between our Applications Engineering department and your design team.

Can We Use PMO on Other Resistor Technologies?

Applying these same operations to resistors of Thick Film, Thin Film, and Wirewound have vastly different consequences and can drive these devices out of tolerance or open circuit. These devices experience too many failures to discuss here. On the other hand, these operations are an enhancement to Foil resistor performance and should be considered when the level of stability required is beyond the published limits for standard products.

Figure 1. $(\Delta R/R) = F(\text{Time})$, Loads 0.05 to 0.5W, +125°C Ambient

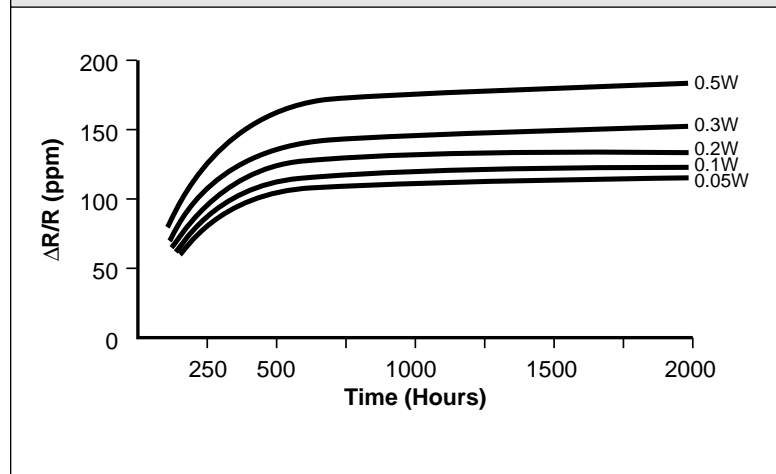

For further information and additional custom-designed PMO, please contact our Application Engineering department at: foil@vishaypg.com

Surface-Mount Resistors

Key Benefits

- Temperature coefficient of resistance (TCR):
 - ± 0.05 ppm/°C (0°C to 60°C) typical with Z-Foil
 - ± 0.2 ppm/°C (-55°C to +125°C, +25°C ref.) typical with Z-Foil
- Resistance tolerance to $\pm 0.01\%$
- Power Coefficient of Resistance (PCR) " R due to self heating": 5 ppm at rated power with Z-Foil
- Electrostatic discharge (ESD) at least to 25 kV
- Overload Capability (6.25 X rated power, 5 seconds) <math>< 0.005\%</math> (50 ppm)
- Rise Time: 1 ns without ringing
- Structure and process provides low sensitivity to moisture
- Non inductive, non capacitive image design
- Current noise: $0.010 \mu\text{V}_{\text{RMS}}/\text{V}$ of applied voltage (<math>< -40</math> dB)
- Thermal stabilization time <math>< 1\text{s}</math> (nominal value achieved within 10 ppm of steady state value)
- Matched sets are available upon request
- Vishay Foil resistors are not restricted to standard values; specific "as required" values can be supplied at no extra cost or delivery (e.g. 1K2345 vs. 1K)
- Lead (Pb) free, gold and tin/lead terminations available
- Now available with flexible terminations
- Prototype quantities available in just 5 working days or sooner

Applications

- Military and aerospace: DSCC Drawings, EPPL, ESA and EEE-INST-002 are available
- Commercial aviation
- Aircraft and missile guidance systems
- Medical
- Automatic test equipment (ATE)
- Electron beam applications
- Measurement systems
- Current sensing
- High-precision amplifiers
- Weighing systems

Vishay Foil Resistors' FRSH and VCS1625P Bulk Metal® Foil Chip Resistors Selected for EDN's Annual "Hot 100 Products"

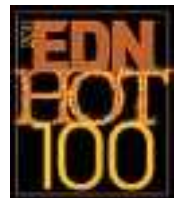

Our goal is to find solutions for challenging applications.

For any questions, please contact foil@vishaypg.com.

Model	Global Model	Product Description	Resistance Range*	Best Tolerance	TCR (- 55°C to +125°C, +25°C ref.) Typical	Rated Power at +70°C	PCR - Power Coefficient	Load Life Stability 2000 Hours, +70°C Under Power-Typical
Surface-Mount								
FRSM0402** (Z1-Foil) 	Y4020 New	New Z1-Foil technology, ultra high-precision wrap-around chip resistor for improved load life stability and high temperature applications up to +175°C	100 to 500	±0.1%	±0.2 ppm/°C	0.05W	5 ppm at rated power	±0.0025%
FRSM0603 (Z1-Foil) 	Y4021 New		100 to 4 k	±0.01%	±0.2 ppm/°C	0.1W	5 ppm at rated power	±0.0025%
FRSM0805 (Z1-Foil) 	Y4022 New		5 to 8 k	±0.01%	±0.2 ppm/°C	0.2W	5 ppm at rated power	±0.0025%
FRSM1206 (Z1-Foil) 	Y4023 New		5 to 25 k	±0.01%	±0.2 ppm/°C	0.3W	5 ppm at rated power	±0.0025%
FRSM1506 (Z1-Foil) 	Y4024 New		5 to 30 k	±0.01%	±0.2 ppm/°C	0.3W	5 ppm at rated power	±0.0025%
FRSM2010 (Z1-Foil) 	Y4025 New		5 to 70 k	±0.01%	±0.2 ppm/°C	0.5W	5 ppm at rated power	±0.0025%
FRSM2512 (Z1-Foil) 	Y4027 New		5 to 125 k	±0.01%	±0.2 ppm/°C	0.75W	5 ppm at rated power	±0.0025%

Uncalibrated chips are available for FRSM product family.





* Tighter performances and higher or lower value resistances are available for all models upon request.

** 0402 is planned to be released to production at 2012.

Surface-Mount Resistors

Vishay Foil Resistors

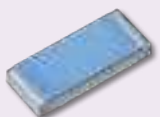
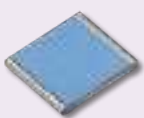
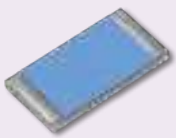

Model	Global Model	Product Description	Resistance Range *	Best Tolerance	TCR (- 55°C to +125°C, +25°C ref.) Typical	Rated Power at +70°C	PCR - Power Coefficient	Load Life Stability 2000 Hours, +70°C Under Power-Typical
Surface-Mount								
VSMP0603 (Z-Foil) 	Y1636	Ultra high-precision wrap-around chip resistor	100 to 5 k	±0.01%	±0.2 ppm/°C	0.1W	5 ppm at rated power	±0.005%
VSMP0805 (Z-Foil) 	Y1624	Ultra high-precision wrap-around chip resistor DSCC 07024	5 to 8 k	±0.01%	±0.2 ppm/°C	0.2W	5 ppm at rated power	±0.005%
VSMP1206 (Z-Foil) 	Y1625	Ultra high-precision wrap-around chip resistor DSCC 07025	5 to 25 k	±0.01%	±0.2 ppm/°C	0.3W	5 ppm at rated power	±0.005%
VSMP1506 (Z-Foil) 	Y1626	Ultra high-precision wrap-around chip resistor DSCC 03010	5 to 30 k	±0.01%	±0.2 ppm/°C	0.3W	5 ppm at rated power	±0.005%
VSMP2010 (Z-Foil) 	Y1627	Ultra high-precision wrap-around chip resistor DSCC 06001	5 to 70 k	±0.01%	±0.2 ppm/°C	0.5W	5 ppm at rated power	±0.005%
VSMP2018 (Z-Foil) 	Y1637	Ultra high-precision wrap-around chip resistor DSCC 9300	5 to 20 k **	±0.01%	±0.2 ppm/°C	0.75W	5 ppm at rated power	±0.005%
VSMP2512 (Z-Foil) 	Y1628	Ultra high-precision wrap-around chip resistor DSCC 06002	10 to 125 k	±0.01%	±0.2 ppm/°C	0.75W	5 ppm at rated power	±0.005%

Uncalibrated chips are available for VSMP product family.

* Tighter performances and higher or lower value resistances are available for all models upon request.

** Higher values from 20 k to 150 k can be supplied upon special request



Model	Global Model	Product Description	Resistance Range *	Best Tolerance	TCR (- 55°C to +125°C, +25°C ref.) Typical	Rated Power at +70°C	Load Life Stability 2000 Hours, +70°C Under Power-Typical
Surface-Mount							
VSM0805 	Y1172	High-precision wrap-around chip resistor DSCC 07024	5 to 8 k	±0.01%	±2 ppm/°C	0.1W	±0.005%
VSM1206 	Y1496	High-precision wrap-around chip resistor DSCC 07025	5 to 25 k	±0.01%	±2 ppm/°C	0.15W	±0.005%
VSM1506 	Y1455	High-precision wrap-around chip resistor DSCC 03010	5 to 30 k	±0.01%	±2 ppm/°C	0.2W	±0.005%
VSM2010 	Y1611	High-precision wrap-around chip resistor DSCC 06001	5 to 70 k	±0.01%	±2 ppm/°C	0.3W	±0.005%
VSM2512 	Y1612	High-precision wrap-around chip resistor DSCC 06002	10 to 125 k	±0.01%	±2 ppm/°C	0.4W	±0.005%
VSMF1206 	Y1615 New	Ultra high-precision wrap-around chip resistor with flexible terminations	10 to 25 k	±0.01%	±2 ppm/°C	0.15W	±0.01%
VSMF2010 	Y1616 New	Ultra high-precision wrap-around chip resistor with flexible terminations	10 to 70 k	±0.01%	±2 ppm/°C	0.3W	±0.01%
VSMF2512 	Y1617 New	Ultra high-precision chip resistor with flexible terminations	10 to 125 k	±0.01%	±2 ppm/°C	0.4W	±0.01%

Uncalibrated chips are available for VSM product family.

* Tighter performances and higher or lower value resistances are available for all models upon request.

Surface-Mount Resistors

Vishay Foil Resistors

Model	Global Model	Product Description	Resistance Range*	Best Tolerance	TCR (-55°C to +125°C, +25°C ref.) Typical	Rated Power at +70°C	PCR - Power Coefficient	Load Life Stability 2000 Hours, +70°C Under Power-Typical
Surface-Mount								
SMR1DZ (Z-Foil) 6.0 mm x 3.2 mm 	Y1745	Ultra high-precision molded resistor with flexible terminations DSCC 06020	5 to 33 k	±0.01%	±0.2 ppm/°C	0.25W	5 ppm at rated power	±0.005%
SMR1D 6.0 mm x 3.2 mm 	Y1121	High-precision molded resistor with flexible terminations DSCC 06020	5 to 33 k	±0.01%	±2 ppm/°C	0.25W		±0.005%
SMR3DZ (Z-Foil) 7.3 mm x 4.3 mm 	Y1746	Ultra high-precision molded resistor with flexible terminations DSCC 06021	5 to 80 k	±0.01%	±0.2 ppm/°C	0.6W	5 ppm at rated power	±0.005%
SMR3D 7.3 mm x 4.3 mm 	Y1168	High-precision molded resistor with flexible terminations DSCC 06021	5 to 80 k	±0.01%	±2 ppm/°C	0.6W		±0.005%
SMR3P (Z-Foil) 7.3 mm x 4.3 mm 	Y1169 New	Ultra high-precision industrial grade molded surface-mount resistor	100 to 15 k	±0.01%	±0.5 ppm/°C Maximum	0.6W	5 ppm at rated power	±0.005%

* Tighter performances and higher or lower value resistances are available for all models upon request.

SMRxDZ Flexible Termination - Thermal Expansion Effect

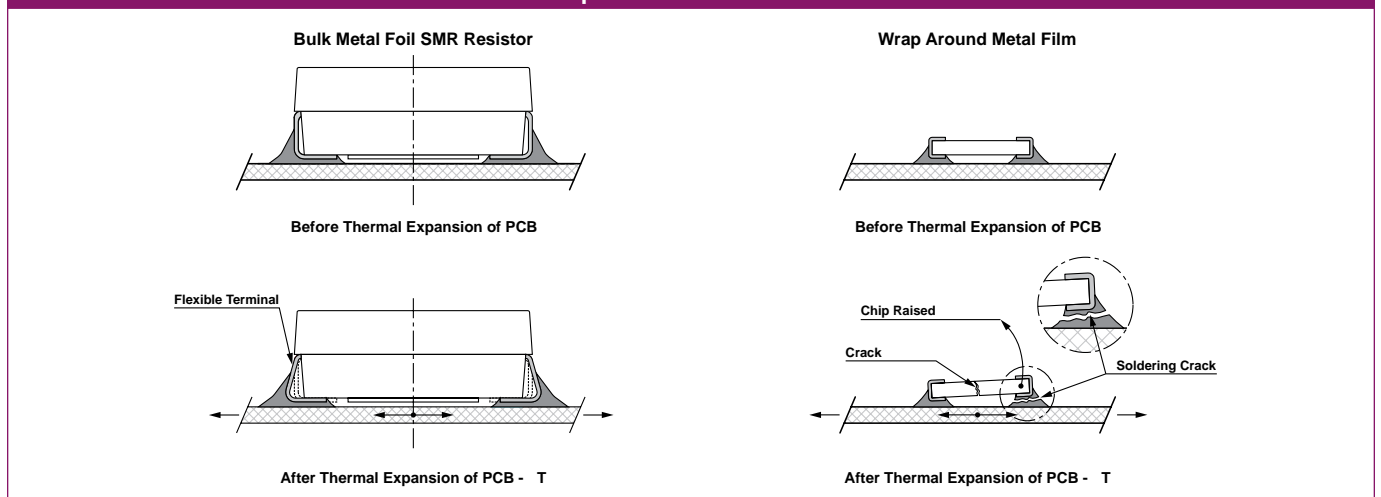

Model	Global Model	Product Description	Resistance Range*	Best Tolerance	TCR (-55°C to +200°C, +25°C ref.) Typical	Rated Power at +70°C**	Load Life 2000 Hours, +200°C at Working Power - Typical**	Long Term Stability at +225°C for 2000 hours, No Power - Typical
Surface-Mount, High Temperature Applications								
FRSH0603 (Z1-Foil) 	Y4061 New	Ultra high-precision surface-mount wrap-around resistor with extended pads for high power/high temperature applications up to +225°C	100 to 5 k	±0.02%	±2.5 ppm/°C	0.12W	±0.05%	±0.05%
FRSH0805 (Z1-Foil) 	Y4062 New		5 to 8 k	±0.02%	±2.5 ppm/°C	0.3W	±0.05%	±0.05%
FRSH 1206 (Z1-Foil) 	Y4063 New		5 to 25 k	±0.02%	±2.5 ppm/°C	0.5W	±0.05%	±0.05%
FRSH1506 (Z1-Foil) 	Y4064 New		5 to 30 k	±0.02%	±2.5 ppm/°C	0.6W	±0.05%	±0.05%
FRSH2010 (Z1-Foil) 	Y4065 New		5 to 70 k	±0.02%	±2.5 ppm/°C	0.8W	±0.05%	±0.05%
FRSH2512 (Z1-Foil) 	Y4066 New		5 to 125 k	±0.02%	±2.5 ppm/°C	1.2W	±0.05%	±0.05%

* Tighter performances and higher or lower value resistances are available for all models upon request.

** For further information, please refer to FRSH datasheet.

Surface-Mount Resistors

Vishay Foil Resistors



Model	Global Model	Product Description	Resistance Range	Best Tolerance	TCR (-55°C to +220°C, +25°C ref.) Typical	Rated Power at +220°C*	Long Term Stability at +240°C for 2000 Hours, No Power - Typical
Surface-Mount, High Temperature Applications							
HTHG5x5 (Z1-Foil) 	Y0780 New	High temperature hybrid chip up to +240°C, connection method: gold wire bonding	5 to 10 k	±0.02%	±2.5 ppm/°C	0.025W	±0.05%
HTHG15x5 (Z1-Foil) 	Y0781 New		5 to 30 k	±0.02%	±2.5 ppm/°C	0.05W	±0.05%
HTHG15x10 (Z1-Foil) 	Y0782 New		30 to 80 k	±0.02%	±2.5 ppm/°C	0.075W	±0.05%
HTHG0603 (Z1-Foil) 	Y0794 New	High temperature chip up to +240°C, connection method: gold wire bonding	100 to 5 k	±0.02%	±2.5 ppm/°C	0.0125W	±0.05%
HTHG0805 (Z1-Foil) 	Y0795 New		5 to 8 k	±0.02%	±2.5 ppm/°C	0.02W	±0.1%
HTHG1206 (Z1-Foil) 	Y0796 New		5 to 25 k	±0.02%	±2.5 ppm/°C	0.033W	±0.05%
HTHG1506 (Z1-Foil) 	Y0797 New		5 to 30 k	±0.02%	±2.5 ppm/°C	0.04W	±0.1%
HTHG2010 (Z1-Foil) 	Y0798 New		5 to 70 k	±0.02%	±2.5 ppm/°C	0.1W	±0.05%
HTHG2512 (Z1-Foil) 	Y0799 New		5 to 125 k	±0.02%	±2.5 ppm/°C	0.15W	±0.05%

* For further information, please refer to the HTHG datasheet (previously named HTH) at www.vishaypg.com/doc?63221

Model	Global Model	Product Description	Resistance Range	Best Tolerance	TCR (-55°C to +220°C, +25°C ref.) Typical	Rated Power at +220°C*	Long Term Stability at +240°C for 2000 Hours, No Power - Typical
Surface-Mount, High Temperature Applications							
HTHA0603 (Z1-Foil) 	Y0774 New	High temperature chip up to +240°C, connection method: aluminum wire bonding**	100 to 5 k	±0.02%	±2.5 ppm/°C	0.0125W	±0.05%
HTHA0805 (Z1-Foil) 	Y0775 New		5 to 8 k	±0.02%	±2.5 ppm/°C	0.02W	±0.05%
HTHA1206 (Z1-Foil) 	Y0776 New		5 to 25 k	±0.02%	±2.5 ppm/°C	0.033W	±0.05%
HTHA1506 (Z1-Foil) 	Y0777 New		5 to 30 k	±0.02%	±2.5 ppm/°C	0.04W	±0.05%
HTHA2010 (Z1-Foil) 	Y0778 New		5 to 70 k	±0.02%	±2.5 ppm/°C	0.1W	±0.05%
HTHA2512 (Z1-Foil) 	Y0779 New		5 to 125 k	±0.02%	±2.5 ppm/°C	0.15W	±0.05%

* For further information, please refer to HTHA datasheet.

** For other mounting options: flip chip (facing down) mounted by electrical conductive-epoxy or reflow soldering, please contact the application engineering department: foil@vishaypg.com

Surface-Mount Resistors

Vishay Foil Resistors



Model	Global Model	Product Description	Resistance Range*	Best Tolerance	TCR (- 55°C to +125°C, +25°C ref.) Typical	Rated Power at +70°C	PCR - Power Coefficient	Load Life Stability 2000 Hours, +70°C Under Power-Typical
Surface-Mount								
VFCP0805 (Z-Foil) 	Y1629	Ultra high-precision flip-chip resistor	10 to 8 k	±0.01%	±0.2 ppm/°C	0.1W	5 ppm at rated power	±0.005%
VFCP1206 (Z-Foil) 	Y1630		5 to 25 k	±0.01%	±0.2 ppm/°C	0.25W	5 ppm at rated power	±0.005%
VFCP1506 (Z-Foil) 	Y1631		5 to 30 k	±0.01%	±0.2 ppm/°C	0.3W	5 ppm at rated power	±0.005%
VFCP2010 (Z-Foil) 	Y1632		5 to 70 k	±0.01%	±0.2 ppm/°C	0.4W	5 ppm at rated power	±0.005%
VFCP2512 (Z-Foil) 	Y1633		5 to 125 k	±0.01%	±0.2 ppm/°C	0.6W	5 ppm at rated power	±0.005%
VPR220S 	Y1122	Precision foil power resistors, TO-220 configuration, 2-terminal connection	5 to 10 k	±0.01%	±2 ppm/°C	8W on heat sink 1.5W in free air	5 ppm/W typical	+0.005% at +25°C
VPR220SZ (Z-Foil) 	Y1623	Ultra high-precision surface-mount power current sense resistor	5 to 10 k	±0.01%	±0.2 ppm/°C	8W on heat sink 1.5W in free air	5 ppm/W typical	+0.005% at +25°C

* Tighter performances and higher or lower value resistances are available for all models upon request.

Model	Product Description	Resistance Range*	Best Tolerance	TCR (-55°C to +125°C, +25°C ref.) Typical	Rated Power at +70°C	PCR - Power Coefficient	Load Life Stability 2000 Hours, +70°C Under Power-Typical
Surface-Mount, Military and Space Applications							
303134  (0805)	Ultra high-precision surface-mount chip resistors, VSMP Z-Foil technology configuration, screen/test flow in compliance with EEE-INST-002 and MIL-PRF-55342	10 to 5 k	±0.02%	±0.2 ppm/°C	0.1W	5 ppm at rated power	±0.03% maximum
303135  (1206)		10 to 14 k	±0.02%	±0.2 ppm/°C	0.15W	5 ppm at rated power	±0.03% maximum
303136  (1506)		10 to 16 k	±0.02%	±0.2 ppm/°C	0.2W	5 ppm at rated power	±0.03% maximum
303137  (2010)		10 to 35 k	±0.02%	±0.2 ppm/°C	0.3W	5 ppm at rated power	±0.03% maximum
303138  (2512)		10 to 75 k	±0.02%	±0.2 ppm/°C	0.4W	5 ppm at rated power	±0.03% maximum
303139 	Molded surface-mount, space-and-military-grade resistors SMRxDZ, screen/test flow in compliance with EEE-INST-002, Level 1 and MIL-PRF-55182	5 to 14 k	±0.02%	±0.2 ppm/°C	0.25W	5 ppm at rated power	±0.005%
303140 		5 to 40 k	±0.02%	±0.2 ppm/°C	0.6W	5 ppm at rated power	±0.005%

Through-Hole Resistors

Key Benefits

- Absolute Temperature Coefficient of Resistance (TCR):
 - ± 0.05 ppm/°C (0°C to +60°C) typical with Z-Foil
 - ± 0.2 ppm/°C (-55°C to +125°C, +25°C ref.) typical with Z-Foil
- TCR Tracking: to 0.1 ppm/°C
- Power Coefficient of Resistance (PCR) "R due to self heating": 5 ppm at rated power with Z-Foil
- Resistance tolerance: absolute and match to $\pm 0.005\%$ (50 ppm)
- Electrostatic discharge (ESD) at least to 25 kV
- Load life stability: to $\pm 0.005\%$ +70°C, 10,000 hours, at rated power
- Current noise: $0.010 \mu V_{RMS}/V$ of applied voltage (<-40 dB)
- Vishay Foil resistors are not restricted to standard values; specific "as required" values can be supplied at no extra cost or delivery (e.g. 1K2345 vs. 1K). Prototype quantities available in just 5 working days or sooner
- Thermal stabilization time <1s (nominal value achieved within 10 ppm of steady state value)
- Rise time: 1 ns without ringing

Applications

- Military
- Medical
- Electron beam applications
- Industrial
- Down-hole
- Commercial and military avionics
- Audio
- Weigh scales
- Instrumentation amplifiers
- Laboratory
- Measurement systems
- Aerospace
- Automatic test equipment (ATE)

Our goal is to find solutions for challenging applications.
For any questions, please contact foil@vishaypg.com.

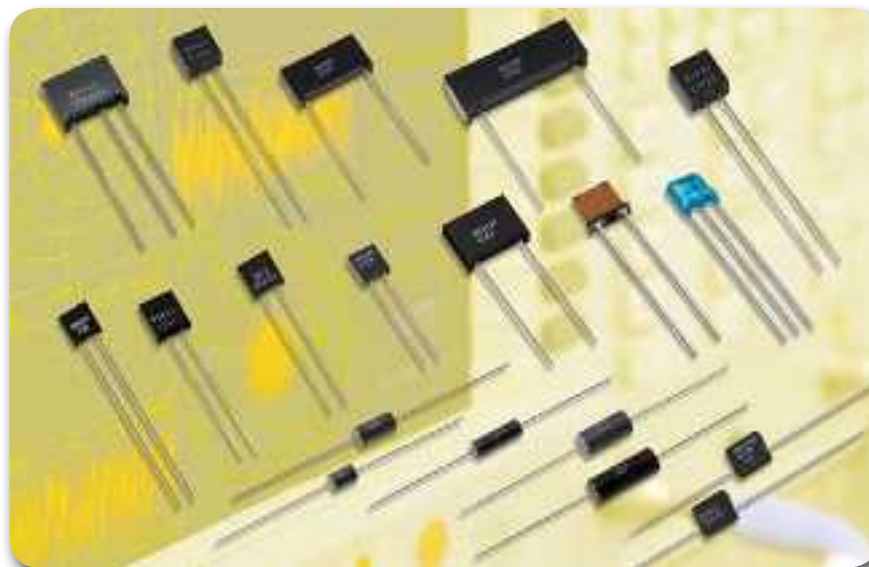





Type	Global Model	Product Description	Resistance Range*	Best Tolerance	TCR (-55°C to +125°C, +25°C ref.) Typical	Rated Power	PCR - Power Coefficient	Load Life Stability 2000 Hours, +70°C Under Power-Typical
Through-Hole, Z-Foil								
 Z201, Z201L	Y1453 Y1454	Ultra high-precision Z-Foil resistor	10 to 100 k	±0.005%	±0.2 ppm/°C	0.6W at +70°C 0.3W at +125°C	5 ppm at rated power	±0.005%
 Z202	Y1073	Ultra high-precision miniature resistor	5 to 30 k	±0.01%	±0.2 ppm/°C	0.25W at +70°C 0.125W at +125°C	5 ppm at rated power	±0.01%
 Z203, Z203L (Z1-Foil)	Y1445 Y1446 New	Ultra high-precision Z1-Foil resistor for metrology and laboratory applications	10 to 100 k	±0.005%	±0.5 ppm/°C maximum (+25°C to +125°C)	0.6W at +70°C 0.3W at +125°C	5 ppm at rated power	±0.005%
 Z204	Y1441	Ultra high-precision Z-Foil resistor	10 to 200 k	±0.005%	±0.2 ppm/°C	1W at +70°C 0.5W at +125°C	5 ppm at rated power	±0.005%
 Z205	Y1443	Ultra high-precision Z-Foil resistor	10 to 300 k	±0.005%	±0.2 ppm/°C	1.5W at +70°C 0.75W at +125°C	5 ppm at rated power	±0.005%
 Z206	Y1447	Ultra high-precision Z-Foil resistor	10 to 600 k	±0.005%	±0.2 ppm/°C	2W at +70°C up to 400 K 1W at +125°C over to 400 K	5 ppm at rated power	±0.005%
 VAR Noise-Free Style	Y0706 New	Ultra high-precision, high resolution Z-Foil audio resistor (no molded jacket)	10 to 100 k	±0.01%	±0.05 ppm/°C (0°C to +60°C, +25°C ref.)	0.4W at +70°C 0.2W at +125°C	5 ppm at rated power	±0.005%

* Tighter performances and higher or lower value resistances are available for all models upon request.

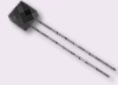
Through-Hole Resistors

Vishay Foil Resistors

Type	Global Model	Product Description	Resistance Range*	Best Tolerance	TCR (-55°C to +125°C, +25°C ref.) Typical	Rated Power	PCR -Power Coefficient	Load Life Stability 2000 Hours, +70°C Under Power-Typical
Through-Hole, Z-Foil								
 VSA101	Y0098 New	Ultra high-precision axial Z-Foil resistor	5 to 100 k	±0.005%	±0.2 ppm/°C	0.6W at +70°C 0.3W at +125°C	5 ppm at rated power	±0.005%
 E102Z E102JZ	Y1183 Y1182 New	Ultra high-performance high ohmic value, small size	100 k to 200 k	±0.005%	±0.2 ppm/°C	0.6W at +70°C 0.3W at +125°C	5 ppm at rated power	±0.005%
 VPR220Z (Z-Foil)	Y1622	Z-Foil precision foil power resistors, TO-220 configuration, 2-terminal connection	5 to 10 k	±0.01%	±0.2 ppm/°C	8W on heat sink 1.5W in free air at +25°C	4 ppm at rated power	±0.005%
 VSC1Z, VSH1Z (Z-Foil)	Y0904 Y0876	High-precision low profile conformally coated resistors, also used for audio application	5 to 60 k	±0.01%	±0.2 ppm/°C	0.3W at +70°C	5 ppm at rated power	±0.01%
 VSC2Z VSH2Z (Z-Foil)	Y0905 Y0937		60 to 120 k	±0.01%	±0.2 ppm/°C	0.3W at +70°C	5 ppm at rated power	±0.01%

* Tighter performances and higher or lower value resistances are available for all models upon request.









Type	Global Model	Product Description	Resistance Range*	Best Tolerance	TCR (-55°C to +125°C, +25°C ref.) Typical	Rated Power	Load Life Stability 2000 Hours, +70°C Under Power-Typical
Through-Hole							
 S102C	Y0007	S-Series high-precision resistor DSCC 89039 (S102C)	1 to 150 k	±0.005%	±2 ppm/°C	Up to 100 K: 0.6W at +70°C 0.3W at +125°C Over 100 K: 0.4W at +70°C 0.2W at +125°C	±0.005%
 S104D S104F	Y0011 Y5011	S-Series high-precision resistor	1 to 500 k	±0.005%	±2 ppm/°C	Up to 200 K: 1W at +70°C 0.5W at +125°C Over 200 K: 0.6W at +70°C 0.3W at +125°C	±0.005%
 S105D S105F	Y0012 Y4012	S-Series high-precision resistor	1 to 750 k	±0.005%	±2 ppm/°C	Up to 300 K: 1.5W at +70°C 0.75W at +125°C Over 300 K: 0.8W at +70°C 0.4W at +125°C	±0.005%
 S106D	Y0013	S-Series high-precision resistor	0.5 to 1 M	±0.005%	±2 ppm/°C	Up to 400 K: 2W at +70°C 1W at +125°C Over 400 K: 1W at +70°C 0.5W at +125°C	±0.005%
 S102K S102L	Y0062 Y0786	S-Series high-precision resistor, DSCC 97009 (S102K)	1 to 100 k	±0.005%	±1 ppm/°C	Up to 100 K: 0.6W at +70°C 0.3W at +125°C Over 100 K: 0.4W at +70°C 0.2W at +125°C	±0.005%
 S104K	Y0101	S-Series high-precision resistor	1 to 300 k	±0.005%	±1 ppm/°C	Up to 200 K: 1W at +70°C 0.5W at +125°C Over 200 K: 0.6W at +70°C 0.3W at +125°C	±0.005%
 S105K	Y0102	S-Series high-precision resistor	1 to 500 k	±0.005%	±1 ppm/°C	Up to 300 K: 1.5W at +70°C 0.75W at +125°C Over 300 K: 0.8W at +70°C 0.4W at +125°C	±0.005%

Uncalibrated S102 chip on strip resistors are available.



* Tighter performances and higher or lower value resistances are available for all models upon request.

Through-Hole Resistors

Vishay Foil Resistors

Type	Global Model	Product Description	Resistance Range*	Best Tolerance	TCR (-55°C to +125°C, +25°C ref.) Typical	Rated Power	Load Life Stability 2000 Hours, +70°C Under Power-Typical
Through-Hole							
 S106K	Y0103	S-Series high-precision resistor, DSCC 97009 (S102K)	0.5 to 600 k	±0.005%	±1 ppm/°C	Up to 400 K: 2W at +70°C 1W at +125°C Over 400 K: 1W at +70°C 0.5W at +125°C	±0.005%
 E102C, E102J	Y1186 Y1184	High-performance resistor High ohmic value, small size	150 k to 300 k	±0.005%	±2 ppm/°C	0.6W at +70°C 0.3W at +125°C	±0.005%
 VPR220	Y0925	Precision foil power resistors, TO-220 configuration, 2-terminal connection	5 to 10 k	±0.01%	±2 ppm/°C	8W at +25°C on heat sink 1.5W in free air	±0.005%
 VSR, VSRJ	Y0075 Y0789	VSR Series industrial precision resistors	1 to 150 k	±0.01%	±4 ppm/°C	Up to 100 K: 3W at +70°C 0.2W at +125°C Over 100 K: 0.25W at +70°C 0.15W at +125°C	±0.005%
 VSR4	Y0020		1 to 500 k	± 0.005%	±4 ppm/°C	Up to 200 K: 0.5W at +70°C 0.4W at +125°C Over 200 K: 0.25W at +70°C 0.2W at +125°C	±0.005%
 VSR5	Y0021		1 to 750 k	± 0.005%	±4 ppm/°C	Up to 300 K : 0.75W at +70°C 0.6W at +125°C Over 300 K : 0.4W at +70°C 0.3W at +125°C	±0.005%
 VSR6	Y0022		0.5 to 1 M	± 0.005%	±4 ppm/°C	Up to 400 K: 1.0W at +70°C 0.8W at +125°C Over 400 K : 0.5W at +70°C 0.4W at +125°C	±0.005%
 VRM 6.35mm x 25.4mm	Y0073		Industrial miniature precision resistor	5 to 50 k	±0.01%	±8 ppm/°C	0.25W at +70°C 0.125W at +125°C

* Tighter performances and higher or lower value resistances are available for all models upon request.

Type*	Global Model	Product Description	Resistance Range**	Best Tolerance	TCR (-55°C to +125°C, +25°C ref.) max	Rated Power	Load Life Stability, 2000 Hours +25°C at Rated Power
Through-Hole							
 VTA52	Y0028	Tubular axial lead resistors designed to meet or exceed MIL-PRF-39005 requirements	5 to 500 k	±0.01%	±8 ppm/°C	1W at +70°C 0.5W at +125°C	±0.05%
 VTA53	Y0029		5 to 300 k	±0.01%	±8 ppm/°C	0.66W at +70°C 0.33W at +125°C	±0.05%
 VTA54	Y0054		5 to 300 k	±0.01%	±8 ppm/°C	0.5W at +70°C 0.25W at +125°C	±0.05%
 VTA55	Y0058		5 to 150 k	±0.01%	±8 ppm/°C	0.3W at +70°C 0.15W at +125°C	±0.05%
 VTA56	Y0060		5 to 150 k	±0.01%	±8 ppm/°C	0.25W at +70°C 0.125W at +125°C	±0.05%
 VMTA55	Y0014		5 to 30 k	±0.01%	±8 ppm/°C	0.2W at +70°C 0.1W at +125°C	±0.05%
 VMTB60	Y0015		5 to 60 k	±0.01%	±8 ppm/°C	0.25W at +70°C 0.125W at +125°C	±0.05%
 VSC1, VSH1	Y0902 Y0875		Conformally coated precision resistor	5 to 60 k	±0.01%	±5 ppm/°C	0.3W at +70°C
 VSC2, VSH2, VSH4	Y0903 Y0934 Y1452	60 to 240 k		±0.01%	±5 ppm/°C	0.3W at +70°C	±0.05%





* VTA52 – VTA56, VMTA55, and VMTB60 are also available with Z-Foil technology [TCR of: ±0.2 ppm/°C typical (-55°C to +125°C, +25°C ref.) and ±0.05 ppm/°C typical (0°C to +60°C)].

** Tighter performances and higher or lower value resistances are available for all models upon request.

Through-Hole Resistors

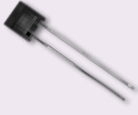
Vishay Foil Resistors

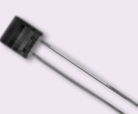

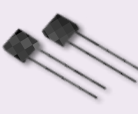
Type	Global Model	Product Description	Resistance Range*	Best Tolerance	TCR (-55°C to +125°C, +25°C ref.) Typical	Rated Power	PCR -Power Coefficient	Load Life Stability, 2000 Hours +125°C at Rated Power
Through-Hole, Military and Space Applications								
 RNC90Z (RNC90S)	Y1189 Y1506 Y0089 Y1508	Military established reliability QPL	30.1 to 121 k	±0.005%	±2 ppm/°C (-55°C to +175°C) maximum	0.6W at +70°C 0.3W at +125°C	5 ppm at rated power	0.05% maximum
			 RNC90Y (RNC90T)	4.99 to 121 k	±0.005%	±5 ppm/°C (-55°C to +125°C) maximum ±10 ppm/°C (125°C to +175°C) maximum	0.6W at +70°C 0.3W at +125°C	0.05% maximum
 Z555	Y1288	Z-Foil technology produced in QPL product line	4.99 to 121 k	±0.005%	5 ppm/°C	0.6W at +70°C 0.3W at +125°C	5 ppm at rated power	0.015% maximum
 S555	Y0088	Foil technology produced in QPL product line	1 to 150 k	±0.005%	5 ppm/°C	0.6W at +70°C 0.3W at +125°C		±0.015% maximum
 303143 303143L	303143 303143L	Ultra high-precision fixed resistor Z-Foil Z201, screen/test flow as modified from S-311-P813 proposed by NASA	10 to 100 k	±0.005%	5 ppm/°C	0.6W at +70°C 0.3W at +125°C	5 ppm at rated power	±0.005%
 RCK HR 02, 02A	Y7056 Y7057	ESA-qualified high-precision foil resistor for space applications	33 to 100 k	±0.01%	±2 ppm/°C	0.5W at +70°C		±0.005%
 RS92N, RS92NA, AN	Y1442 Y1687 Y1688	CECC-qualified high-precision foil resistor for space applications	80.6 to 120 k	±0.01%	±2 ppm/°C	0.5W at +70°C		±0.005%

Power Current-Sensing Resistors

Key Benefits

- Temperature Coefficient of Resistance (TCR):
 - ± 0.05 ppm/°C (0°C to +60°C) typical with Z-Foil
 - ± 0.2 ppm/°C (-55°C to +125°C, +25°C ref.) typical with Z-Foil
- Power Coefficient (PCR) “ R due to self heating”: 4 ppm/W or 5 ppm at rated power
- Resistance tolerance: absolute $\pm 0.01\%$
- Power rating: up to 10 W on heat sink
- Current noise: $0.010 \mu\text{V}_{\text{RMS}}/\text{V}$ of applied voltage (< -40 dB)
- 4 terminal (Kelvin) connections for high accuracy
- Vishay Foil resistors are not restricted to standard values; specific “as required” values can be supplied at no extra cost or delivery (e.g. 1K2345 vs. 1K)
- Load life stability: to $\pm 0.005\%$ at +25°C, 2000 hours, at rated power
- Rise time: 1 ns without ringing
- Thermal stabilization time <1s (nominal value achieved within 10 ppm of steady state value)
- Prototype quantities available in just 5 working days or sooner

Applications

- Military
- Medical
- Aerospace
- Force balance scales
- Electron beam applications
- Switching power supplies
- Electron microscopes
- Gyro navigation controls
- Pressure sensors
- Switching power supplies
- Motor speed controls
- Down-hole (high temperature)
- Weigh Scales

Our goal is to find solutions for challenging applications.
For any questions, please contact foil@vishaypg.com.



Power Current-Sensing Resistors

Vishay Foil Resistors



Power Current-Sensing Resistors

Vishay Foil power current-sensing resistors were developed with a low absolute TCR and Kelvin connection to meet demands for new and stable resistive product solutions in the industry today. These resistors are most-often used to monitor a current that is directly proportional to some physical characteristic (such as pressure, weight, etc.) being measured by an analog sensor. The resistor converts the current to a voltage that is representative of the physical characteristic and feeds that voltage into control circuits, instrumentation, or other indicators. Deviations induced in the resistor, not representative of the monitored characteristic, can be caused by high absolute TCR response to both ambient temperature and self-heating and can feed erroneous signals into the system. Resistance is usually kept low to reduce the self-heating (Joule effect) portion of the error while minimizing the stresses that cause long-term resistance changes. It is critical for this resistor to reach thermal equilibrium quickly in circuits that require fast response or where the current changes quickly. Thermal EMF is another important consideration in low ohmic current sensing resistors used mostly in DC circuits (there is no effect in AC circuitry). Vishay Foil resistors are able to minimize this effect through the use of appropriate materials between the resistive layer and the terminations.

Kelvin Connections

Four-terminal connections or Kelvin connections are required in these low ohmic value resistors to measure a precise voltage drop

across the resistive element. The 4-terminal configuration eliminates the IR-drop error voltage that would be present in the voltage sense leads if a standard two-terminal resistor were used. In current sense resistors the contact resistance and the terminations resistance may be greater than that of the resistive element itself so lead connection errors can be significant if only two terminal connections are used.

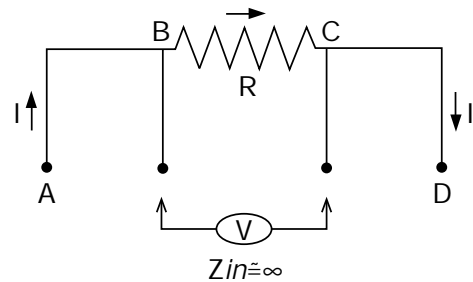

The four terminal device separates the current leads from the voltage sensing leads. This configuration eliminates the effect of the lead wire resistance from points A to B and C to D.

Overall, VFR's Bulk Metal® Foil technology provides performance capabilities far greater than any other resistor technology can supply in a product of comparable size.



Product	Global Model	Product Description	Resistance Range*	Best Tolerance	TCR (-55°C to +125°C, 25°C ref.) Typical	Rated Power at +70°C	PCR - Power Coefficient	Load Life Stability 2000 Hours, +70°C Under Power-Typical
Surface-Mount, Z- Foil								
 VCS1610Z (Z-Foil)	Y1119 New	High-precision, current sensing chip resistor (4-terminal)	0.3 to 1	±0.5%	±0.2 ppm/°C	0.25W	5 ppm at rated power	±0.015%
 VCS1610	Y1120	High-precision, current sensing chip resistor (4-terminal)	0.1 to 1	±0.5%	±2 ppm/°C	0.25W		±0.015%
 VCS1625ZP (Z-Foil)	Y1606	Ultra high-precision Z-Foil surface-mount current sensing for higher power	0.3 to 10	±0.2%	±0.2 ppm/°C	1W	5 ppm at rated power	±0.015%
 VCS1625Z** (Z-Foil)	Y1607	Ultra high-precision surface-mount current sense resistor DSCC 08003	0.3 to 10	±0.2%	±0.2 ppm/°C	0.5W maximum current 5 A	5 ppm at rated power	±0.015%
 VCS1625P	Y0856 New	High-precision Z-Foil surface mount current sensing for high power	0.01 to 10	±0.1%	±2 ppm/°C	1W		±0.015%
 VCS1625***	Y0850	High-precision current sensing chip resistor (4-terminal) DSCC 08003	0.01 to 10	±0.1%	±2 ppm/°C	0.5W maximum current 5 A		±0.015%

* Tighter performances and higher or lower value resistances are available for all models upon request.

** VCS1625Z was previously named VCS2516Z.

*** VCS1625 was previously named VCS2516.

Power Current-Sensing Resistors



Vishay Foil Resistors



Product	Global Model	Product Description	Resistance Range*	Best Tolerance	TCR (-55°C to +125°C, 25°C ref.) Typical	PCR - Power Coefficient	Rated Power at +70°C	Load Life Stability 2000 Hours, +70°C Under Power-Typical
Surface-Mount								
 <p>CSM2512 CSM3637</p>	Y1487 Y1488	High-precision metal strip resistor	1 m to 200 m	±0.1%	±15 ppm/°C maximum		Up to 3W Maximum current 38A	±0.2%
 <p>CSM2512S CSM3637S (Improved Stability)</p>	Y4487	Ultra high-precision current-sense resistor	10 m to 100 m	±0.1%	±15 ppm/°C maximum		1W	±0.05%
	Y1472		10 m to 100 m	±0.2%	±15 ppm/°C maximum		2W	±0.05%
 <p>CSM3637Z</p>	Y1473	Ultra high-precision, current sensing, power surface-mount, metal strip resistor	3 m to 50 m	±0.1%	±5 ppm/°C maximum		3W (3 m to 10 m) 2W (>10 m to 50 m)	±0.2%
 <p>CSM3637P</p>	Y1474	High-precision, current sensing, power surface-mount, metal strip resistor with improved power	3 m to 100 m	±0.1 %	±15 ppm/°C		5W (3 m <10 m) 4W (10 m to 100 m)	± 0.2 %
 <p>VPR221SZ (Z-Foil)</p>	Y2123	Ultra high-precision surface-mount power current sense resistor	0.5 to 500	±0.01%		4 ppm/W typical	8W on heat sink 1.5W in free air	±0.005% at +25°C
 <p>VPR221S</p>	Y1123	Precision foil power resistors, TO-220 configuration, 4-terminal connection	0.5 to 10 k	±0.01%	±2 ppm/°C		8W on heat sink 1.5W in free air	±0.005%

* Tighter performances and higher or lower value resistances are available for all models upon request.

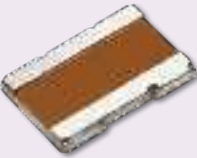
** Spec for space also available.

Product	Global Model	Product Description	Resistance Range*	Best Tolerance	TCR (-55°C to +125°C, 25°C ref.) Typical	Rated Power at +70°C	PCR - Power Coefficient	Load Life Stability 2000 Hours, +70°C Under Power
Surface-Mount, Military and Space Applications								
303119 		VCS1625 configuration, screen/test flow in compliance with EEE-INST-002 and MIL-PRF-55342	0.01 to 10	±0.5%	±2 ppm/°C	0.5W maximum current 5 A		±0.05%
303119Z 		VCS1625Z configuration, screen/test flow in compliance with EEE-INST-002 and MIL-PRF-55342	0.3 to 10	±0.5%	±0.2 ppm/°C	0.5W maximum current 5 A	5 ppm at rated power	±0.05%
303144 		CSM2512 and CSM3637 with screen/test flow in compliance with EEE-INST-002, MIL-PRF-55342, and MIL-PRF-49465	3 m to 200 m	±0.5%	±20 ppm/°C	1W maximum current 18 A		±1%
303145 		CSM2512 and CSM3637 with screen/test flow in compliance with EEE-INST-002, MIL-PRF-55342, and MIL-PRF-49465	2 m to 200 m	±0.5%	±20 ppm/°C	3W maximum current 38 A		±1%



Power Current-Sensing Resistors

Vishay Foil Resistors



Type	Global Model	Product Description	Resistance Range*	Best Tolerance	TCR (-55°C to +125°C, +25°C ref.) Typical	Rated Power at +25°C	PCR - Power Coefficient	Load Life Stability 2000 Hours, +25°C Under Power
Through-Hole, Z-Foil								
VCS331Z, VCS332Z (Z-Foil) 	Y1481 Y1467	Ultra high-precision power current sense resistor	0.25 to 500	±0.01%	±0.2	3W in free air 10W on heat sink	4 ppm/W typical	±0.01% in free air ±0.005% on heat sink
VHP4Z (Z-Foil) 	Y1479	Ultra high-precision hermetically-sealed power current sense resistor	0.25 to 500	±0.01%	±0.2	3W in free air 10W on heat sink	4 ppm/W typical	±0.01% in free air ±0.005% on heat sink
VFP4Z (Z-Foil) 	Y1468	Ultra high-precision power current sense resistor	0.25 to 500	±0.01%	±0.2	3W in free air 10W on heat sink	4 ppm/W typical	±0.01% in free air ±0.005% on heat sink
VPR247Z (Z-Foil) 	Y1480	Ultra high-precision hermetically-sealed power current sense resistor	0.25 to 500	±0.01%	±0.2	3W in free air 10W on heat sink	4 ppm/W typical	±0.01% in free air ±0.005% on heat sink
VPR5Z 	Y0118	Ultra high-precision current sensing resistor (direct replacement for certain wirewounds)	5 to 100 k	±0.01%	±0.2 ppm/°C	5W	4 ppm/W typical	±0.01% at +70°C
VPR7Z 	Y0119		5 to 100 k	±0.01%	±0.2 ppm/°C	7W	4 ppm/W typical	±0.01% at +70°C

* Tighter performances and higher or lower value resistances are available for all models upon request.

Type	Global Model	Product Description	Resistance Range*	Best Tolerance	TCR (-55°C to +125°C, +25°C ref.) Typical	Rated Power at +25°C	PCR - Power Coefficient	Load Life Stability 2000 Hours, +25°C Under Power
Through-Hole, Z-Foil								
<p>VCS232Z (Z-Foil)</p> 	Y1608	Ultra high-precision power current sense resistor	0.25 to 500	±0.02%	±0.2 ppm/°C	2W maximum current 3 A	4 ppm/W typical	±0.005%
<p>VPR221Z (Z-Foil)</p> 	Y1690	Ultra high-precision power resistors in TO-220 configuration, 4-lead Kelvin connected device	0.5 to 500	±0.01%	±0.2 ppm/°C	8W on heat sink 1.5W in free air	4 ppm/W typical	±0.005%

* Tighter performances and higher or lower value resistances are available for all models upon request.



Power Current-Sensing Resistors

Vishay Foil Resistors

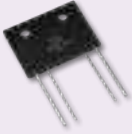

Product	Global Model	Product Description	Resistance Range*	Best Tolerance	TCR (-55°C to +125°C, 25°C ref.) Typical	Rated Power at +25°C	Load Life Stability 2000 Hours, +25°C Under Power
Through-Hole							
 <p>VFP3, VFP4</p>	Y0733 Y0734	Molded power high-precision current sensing resistors	0.05 to 80 k	±0.01%	±2 ppm/°C	3W in free air 10W on heat sink	±0.005%
 <p>VHP3, VHP4, VPR247</p>	Y0065 Y0066 Y0830	Hermetically-sealed and molded power high-precision current sensing resistors	0.05 to 80 k	±0.01%	±2 ppm/°C	3W in free air 10W on heat sink	±0.01%
 <p>VPR5</p>	Y0026	Current sensing resistor (direct replacement for certain wirewounds)	1 to 100 k	±0.01%	±5 ppm/°C above 10 ±10 ppm/°C below 10	5W	±0.01% at +70°C
 <p>VPR7</p>	Y0027		1 to 100 k	±0.01%	±5 ppm/°C above 10 ±10 ppm/°C below 10	7W	±0.01% at +70°C
 <p>VCS101, VCS103, VCS401</p>	Y0930 Y0940 Y0945	High-precision, low-value, current sense, shunt resistors, 4-lead Kelvin device	0.005 to 0.25	±0.1%	±15 ppm/°C max. (0°C to +60°C)	To 1.5W in free air maximum current 15A	±0.5%
 <p>VCS201 VCS202</p>	Y0955 Y0941	High-precision current sensing resistors, conformally coated	0.005 to 0.2	±0.1%	±15 ppm/°C	To 2W in free air maximum current to 15A	±0.02%
 <p>VCS232</p>	Y0942	High-precision power current sense resistor	0.2 to 500	±0.02%	±2 ppm/°C	To 2W in free air maximum current to 3A	±0.01%

* Tighter performances and higher or lower value resistances are available for all models upon request.

Product	Global Model	Product Description	Resistance Range*	Best Tolerance	TCR (-55°C to +125°C, 25°C ref.) Typical	Rated Power at +25°C	Load Life Stability 2000 Hours, +25°C Under Power
Through-Hole							
 VCS301 VCS302	Y0959 Y0943	High-precision current sensing resistors (4-terminal)	0.005 to 0.25	±0.5%	to ±3 ppm/°C max. (0°C to +60°C)	10W on heat sink 3W in free air maximum current 15A	±0.02%
 VCS331 VCS332	Y0960 Y0944	Precision power current sensor	0.25 to 500	±0.1%	to ±1 ppm/°C max. (0°C to +60°C)	10W on heat sink 3W in free air maximum current 5A	±0.01%
 VPR221	Y0926	High-precision power resistors in TO-220 configuration, 4-lead Kelvin connected device	0.5 to 500	±0.01%	±2 ppm/°C	8W on heat sink 1.5W in free air maximum current 3A	±0.005%

* Tighter performances and higher or lower value resistances are available for all models upon request.

New Generation of Power Current Sensing Resistors

Vishay Foil Resistors introduced New-Generation of Power Current Sensing Resistors which are **available as custom tailored products**.

For precise current measuring these new resistors combine very low noise with an absolute TCR of less than ±0.2 ppm/°C (0°C to +60°C, or +20°C to +70°C), power TCR of less than 1 ppm/W, with an absolute tolerance of ±0.01%, and a load life stability of ±0.005% for 2000 hours in free air.

The resistors feature a power rating of 20W in free air (60W on heat sink) over a resistance range from 0.5 m to 500 .

The maximum current for resistance values 10 m and up is 22A. Higher current values are available per customer requirements if needed. Thermal resistance (element to heat sink) for the resistors is 2°C/W typical.



Voltage Dividers and Resistor Networks

Key Benefits

- Absolute Temperature Coefficient of Resistance (TCR):
 - ± 0.05 ppm/ $^{\circ}\text{C}$ (0°C to $+60^{\circ}\text{C}$) typical with Z-Foil
 - ± 0.2 ppm/ $^{\circ}\text{C}$ (-55°C to $+125^{\circ}\text{C}$, $+25^{\circ}\text{C}$ ref.) typical with Z-Foil
- TCR tracking: 0.1 ppm/ $^{\circ}\text{C}$
- Power Coefficient of Resistance (PCR) tracking " R due to self heating": 5 ppm at rated power
- Resistance tolerance (absolute and match): $\pm 0.005\%$
- Load life ratio stability: $< 0.005\%$ (50 ppm) 1W at 70°C for 2000h
- Thermal EMF: 0.05 $\mu\text{V}/^{\circ}\text{C}$
- Electrostatic discharge (ESD) at least to 25 kV
- Thermal stabilization time $< 1\text{s}$ (nominal value achieved within 10 ppm of steady state value)
- Current noise: 0.010 $\mu\text{V}_{\text{RMS}}/\text{V}$ of applied voltage (< -40 dB)
- Shelf life stability: ± 2 ppm typical (for hermetically-sealed resistors) after at least 6 years
- Vishay Foil resistors are not restricted to standard values; specific "as required" values can be supplied at no extra cost or delivery (e.g. 1K2345 vs. 1K)
- Prototype quantities available in just 5 working days or sooner

Applications

- Military
- Aerospace and avionics
- Automotive
- Telecommunications
- Industrial
- Medical
- Test equipment
- Instrumentation
- High-precision amplifiers
- Laboratory
- Audio
- Electron beam applications
- Bridge networks
- Differential amplifiers
- Weigh scales
- Down-hole (high temperature)

Our goal is to find solutions for challenging applications.
For any questions, please contact foil@vishaypg.com.

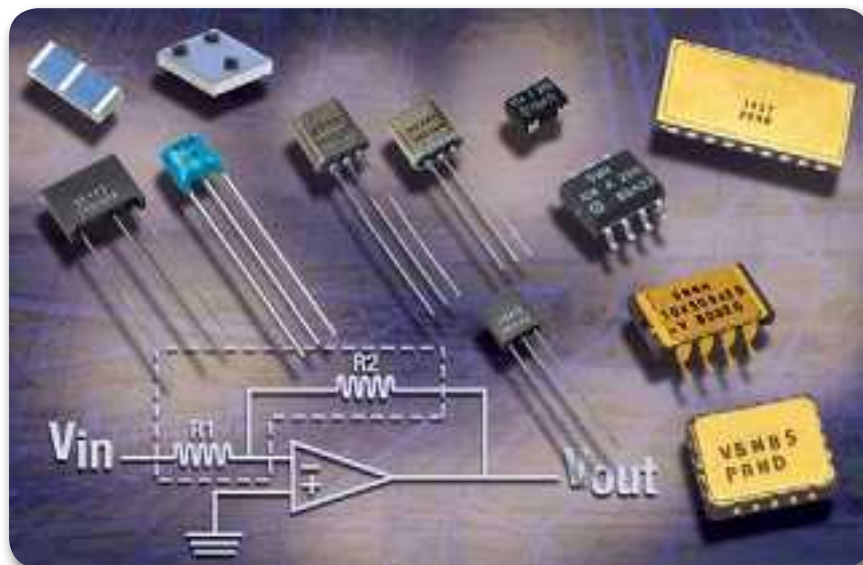

Voltage Dividers and Resistor Networks

Today, designers of circuits are demanding voltage dividers that approach the ideal in performance: stable, high speed, high accuracy components that will operate with assured, predictable reliability for years in a variety of environments. Vishay Foil voltage dividers and resistor networks are meeting those demands and add the dimensions of convenience and economy to resistor needs. Our long experience relieves the circuit designer of the complicated, costly and wasteful procedure of calculating the value of individual resistor components, ordering and then stabilizing, aging or matching these units, and literally assembling and testing his own resistor arrays. The Vishay Foil Resistors approach to dividers is simple and straight-forward, our solution consists of any combination of resistors, and the end result is what matters. As a consequence, the only data we require from the designer is the overall electrical performance specifications, the environment operational, and the desired physical requirements.

Four fundamental factors determine how "ideal" a precision voltage divider will be:

1. Initial absolute resistance value or how closely the absolute resistance value can be achieved.
2. How precisely the value of individual resistors can be controlled.
3. How precisely the end of life tolerance is maintained under a wide range of operating conditions and stress factors (temperature, humidity, load, ESD, etc.)
4. Fast response without ringing and fast thermal stabilization – and the ability of the resistor to react to rapid switching without adversely affecting the circuit function.

Most resistor technologies all compromised the theoretical ideal performance in one or more ways. For example, the winding of wire and the evaporation or the sputtering of extremely thin metal each produce metallurgical changes in the resistance materials and these noticeably deteriorate the electrical characteristics. Such changes are not predictable, and thus randomly alter performance parameters. The form factor of other units also introduces losses in high frequency performance, limits power dissipation, and prohibits size reduction.

However, Vishay Foil networks are the only technology to have perfected these four factors and have designed networks to eliminate the inter-parameter compromise inherent in all other types of networks. All important characteristics—tolerance, long term stability, temperature coefficient, power coefficient, ESD, noise, capacitance and inductance—are optimized, approaching the theoretical ideal in total performance.

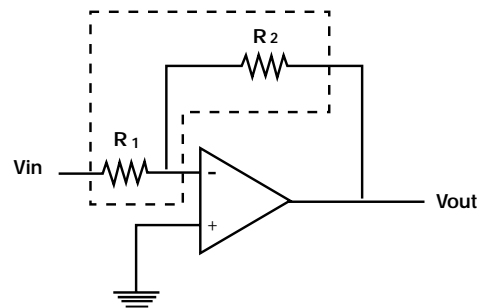

Typical Resistor Network Application*

Diagram 1: Inverting Amplifier

$$A = \frac{R1}{R2}$$

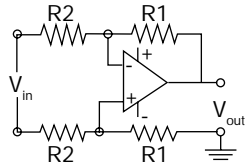

Diagram 2: Power Supply Voltage Filter

$$R1 = R2$$

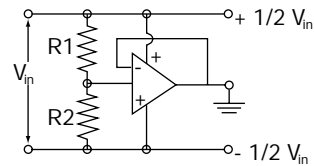

Diagram 3: Follower with Gain

$$A = \frac{R1 + R2}{R2}$$

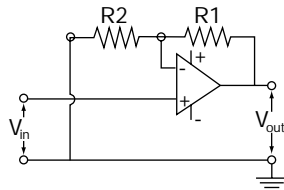

Diagram 4: Instrumentation AMP w/ Shield Driver

$$A = \frac{R4}{R3} \left(1 + \frac{R1}{R2}\right)$$

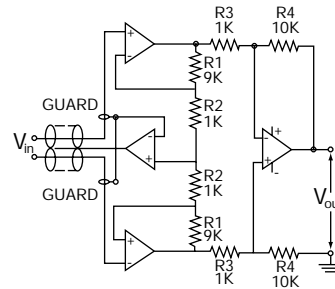

Diagram 5: Differential Input Amplifier

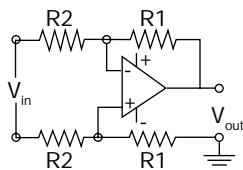

Diagram 6: Current Driver

$$I_{out} = V_{in} \frac{R3 + R4 + R5}{(R1 + R2) R5}$$

For $R3 + R4 + R5 \ll R1 + R2$

$$I_{out} \approx \frac{V_{in}}{R5}$$

$$MAX I_{out} = \frac{V_o MAX}{R_s + R_L}$$

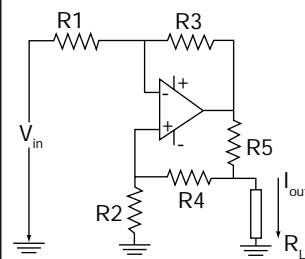

Diagram 7: Differential Input Instrumentation Amplifier

$$GAIN = 1 + \frac{R1}{R2}$$

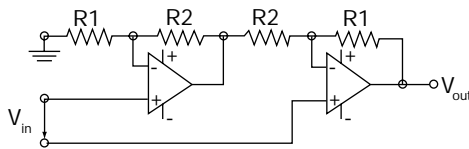
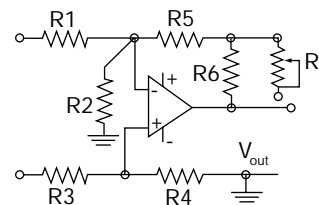

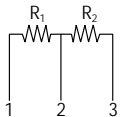

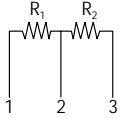

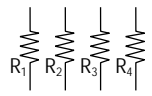

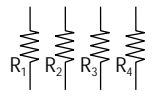

Diagram 8: High Common Mode Voltage Rejection Unity Gain Differential Amplifier



* These diagrams are supplied to illustrate typical resistor network applications. Vishay Foil Resistors assumes no responsibility for specific use or performance.

Model and Product Description	Global Model	Resistance Range	Best Resistance Tolerance		TCR (-55°C to +125°C +25°C ref.) Typical	Rated Power at +70°C	PCR Tracking	Load Life Stability 2000 Hours, +70°C Under Power-Typical
			Absolute	Ratio Match				
Voltage Dividers								
DSMZ (Z-Foil) Ultra high-precision, surface-mount, molded voltage divider 	Y4485	Any value 100 to 10 k per resistor 	±0.02%	0.01%	Absolute: ±0.2 ppm/°C Tracking: 0.1 ppm/°C	Entire package 0.1W Each resistor 0.05W at +70°C	5 ppm at rated power	0.005%
DSM High-precision, surface-mount, molded voltage divider 	Y1485	Any value 100 to 20 k per resistor 	±0.02%	0.01%	Absolute: ±2 ppm/°C Tracking: ±0.5 ppm/°C	Entire package 0.1W Each resistor 0.05W at +70°C		0.005%
SMNZ (Z-Foil) Ultra high-precision, surface-mount, 4-resistor network dual in-line, molded package, 50 mil pitch 	Y1747	Any value 100 to 10 k per resistor 	±0.02%	0.01%	Absolute: ±0.2 ppm/°C Tracking: 0.1 ppm/°C	Entire package 0.4W Each resistor 0.1W at +70°C	5 ppm at rated power	0.005%
SMN High-precision, surface-mount 4-resistor network dual in-line, molded package, 50 mil pitch 	Y1365	Any value 100 to 20 k per resistor 	±0.02%	0.01%	Absolute: ±2 ppm/°C Tracking: ±0.5 ppm/°C	Entire package 0.4W Each resistor 0.1W at +70°C		0.005%

* Tighter performances and higher or lower value resistances are available for all models.

Voltage Dividers and Resistor Networks

Vishay Foil Resistors

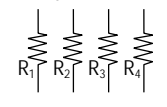
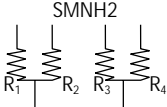
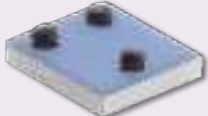
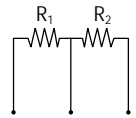
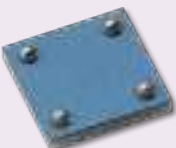
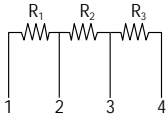
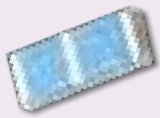
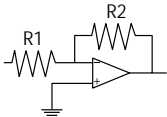

Model and Product Description	Global Model	Resistance Range	Best Resistance Tolerance		TCR (-55°C to +125°C +25°C ref.) Typical	Rated Power at +70°C	PCR Tracking	Load Life Stability 2000 Hours, +70°C Under Power-Typical
			Absolute	Ratio Match				
Voltage Dividers and Resistor Networks								
SMNH1, 2*, ** High-precision, hermetically-sealed, 4-resistors, surface-mount resistor network 	Y1521 Y1522	Any value 5 to 33 k per resistor  	±0.005%	0.005%	Absolute : ±2 ppm/°C Tracking: ±0.5 ppm/°C	Entire package 0.4W Each resistor 0.1W at +70°C		0.005%
VFB1012D (Z-Foil) Ultra high-precision ball grid array (BGA), surface-mount, voltage divider 	Y1683	1 k to 10 k 	±0.01%	0.01%	Absolute: ±0.2 ppm/°C Tracking: 0.1 ppm/°C	0.2W at +70°C, for the entire package divided proportionally between the two elements	5 ppm at rated power	0.01%
VFB1515N Ultra high-precision Z-Foil BGA surface-mount resistor network 	Y1684	Any value from 200 to 10 k per resistor 	0.01%	0.01%	Absolute: ±0.2 ppm/°C Tracking: 0.1 ppm/°C typical	0.1W per resistor	5 ppm at rated power	Ratio: 0.01%
VFCD1505 (Z-Foil) Ultra high-precision flip-chip, voltage divider 	Y1685	10 to 40 k 	±0.01%	±0.01% (±0.005% is available)	Tracking: 0.1 ppm/°C	0.1W at +70°C, for the entire package divided proportionally between the two elements		Absolute: 0.01% Ratio: 0.005%

* Shelf life stability: 2 ppm.

** Available with Z-Foil technology.

Tighter performances and higher or lower value resistances are available for all models.

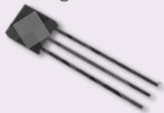
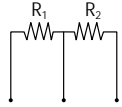
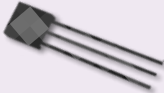
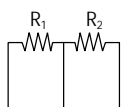
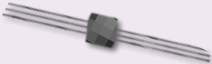
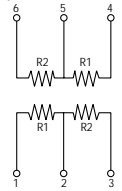
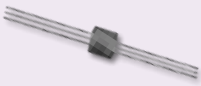
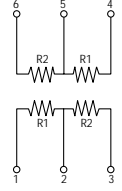
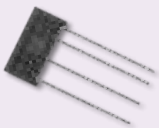
Model and Product Description	Global Model	Resistance Range	Best Resistance Tolerance		TCR (-55°C to +125°C +25°C ref.) Typical	Rated Power at +70°C	PCR Tracking	Load Life Stability 2000 Hours, +70°C Under Power-Typical
			Absolute	Ratio Match				
Voltage Dividers								
300144Z (Z-Foil) Ultra high-precision, small package molded voltage divider 	Y1691	Any value from 100 to 20 k per resistor 	±0.005%	0.005%	Absolute: ±0.2 ppm/°C Tracking: 0.1 ppm/°C	0.2W at +70°C, for the entire package divided proportionally between the two elements	5 ppm at rated power	±0.005%
300144* High-precision, small package molded voltage divider 	Y0006	Any value from 100 to 20 k per resistor DSCC 87026 	±0.005%	0.005%	Absolute: ±2 ppm/°C Tracking: 0.5 ppm/°C	0.2W at +85°C, for the entire package divided proportionally between the two elements		±0.005%
300145Z (Z-Foil) Ultra high-precision, small package molded pair of voltage dividers 	Y1735	Any value from 100 to 20 k per resistor 	±0.005%	0.005%	Absolute: ±0.2 ppm/°C Tracking: 0.1 ppm/°C	0.2W at +70°C, for the entire package divided proportionally between the two elements	5 ppm at rated power	±0.005%
300145 High-precision, small package molded pair of voltage dividers 	Y0035	Any value from 100 to 20 k per resistor 	±0.005%	0.005%	Absolute: ±2 ppm/°C Tracking: 0.5 ppm/°C	0.2W at +85°C (per voltage divider)		±0.005%
300190Z-9Z, 300210Z-12Z (Z-Foil) Ultra high-precision, molded resistor networks 2R, 3R, 4R, voltage dividers, bridge circuits, attenuators 	Refer to datasheet	Any value from 1 to 150 k per resistor	±0.005%	0.01%	Absolute: ±0.2 ppm/°C Tracking: 0.1 ppm/°C	0.6W at +70°C 0.3W at +125°C	5 ppm at rated power	

* 300144 uncalibrated resistors are available.

Tighter performances and higher or lower value resistances are available for all models.

Voltage Dividers and Resistor Networks

Vishay Foil Resistors



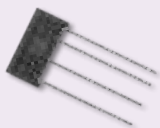
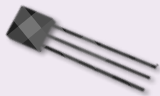
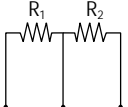
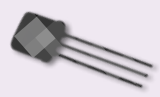
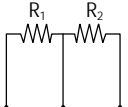
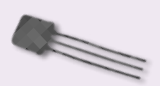
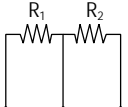

Model and Product Description	Global Model	Resistance Range	Best Resistance Tolerance		TCR (-55°C to +125°C +25°C ref.) Typical	Rated Power at +70°C	Load Life Stability 2000 Hours, +70°C Under Power-Typical
			Absolute	Ratio Match			
Voltage Dividers							
300190-9, 300210-12 Networks High-precision, molded resistor networks 2R, 3R, 4R, voltage dividers, bridge circuits, attenuators 	Refer to datasheet	Any value from 1 to 150 k per resistor	±0.005%	0.005%	Absolute: ±2 ppm/°C Tracking: 0.5 ppm/°C	0.5W per resistor at +70°C 0.25W per resistor at +125°C	±0.001%
VSR144 Industrial molded voltage divider 	Y0094	Any value 100 to 20 k 	±0.05%	0.02%	Absolute : ±4 ppm/°C Tracking: 1.5 ppm/°C	0.2W at +70°C, for the entire package divided proportionally between the two elements	±0.001%
VHD144*,** Hermetic version of the molded divider 300144 	Y0076	Any value from 100 to 20 k per side 	±0.005%	0.005%	Absolute: ±2 ppm/°C Tracking: 0.5 ppm/°C	0.2W	±0.001%
VHD200*,** Hermetically-sealed, oil-filled voltage divider, ultimate ratio match and TCR tracking 	Y5076	Any value from 100 to 20 k per side 	±0.005%	0.001%	Absolute: ±2 ppm/°C Tracking: 0.1 ppm/°C	0.1W	±0.001%

* Shelf life stability: 2 ppm

** Available with Z-Foil technology.

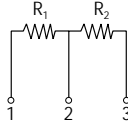
Tighter performances and higher or lower value resistances are available for all models.

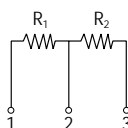
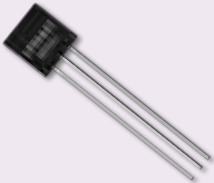
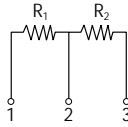
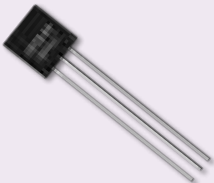
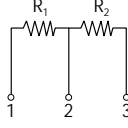
Model and Product Description	Global Model	Resistance Range	Best Resistance Tolerance		TCR (-55°C to +125°C +25°C ref.) Typical	Rated Power at +70°C	PCR Tracking	Load Life Stability 2000 Hours, +70°C Under Power-Typical
			Absolute	Ratio Match				
Voltage Dividers								
VSH144Z (Z-Foil) Ultra high-precision, low profile, conformally coated voltage divider resistor 	Y1680	Any value from 100 to 20 k per resistor 	0.01%	0.01%	Absolute: ±0.2 ppm/°C Tracking: 0.1 ppm/°C typical	0.2W at +70°C, for the entire package divided proportionally between the two elements	5 ppm at rated power	±0.01%
VSH144 Low profile, conformally coated, high-precision voltage divider resistor 	Y1767	Any value from 100 to 20 k per resistor 	0.01%	0.01%	Absolute: ±2 ppm/°C Tracking: 0.5 ppm/°C typical	0.2W at +70°C, for the entire package divided proportionally between the two elements		±0.01%
VFD244Z (Z-Foil) Ultra high-precision voltage divider resistor 	Y0115	Any value from 1 to 100 k per resistor 	0.005%	0.005%	Absolute: ±0.2 ppm/°C Tracking: 0.1 ppm/°C typical	1W at +70°C, for the entire package divided proportionally between the two elements	5 ppm at rated power	±0.005%
VFD244 High-precision voltage divider resistor 	Y0114	Any value from 1 to 150 k per resistor 	0.005%	0.005%	Absolute: ±2 ppm/°C Tracking: 0.5 ppm/°C typical	1W at +70°C, for the entire package divided proportionally between the two elements		±0.005%

Tighter performances and higher or lower value resistances are available for all models.

Hermetically-Sealed Resistors

Key Benefits

- Temperature Coefficient of Resistance (TCR):
 - ± 0.05 ppm/ $^{\circ}\text{C}$ (0°C to 60°C) typical with Z-Foil
 - ± 0.2 ppm/ $^{\circ}\text{C}$ (-55°C to $+125^{\circ}\text{C}$, $+25^{\circ}\text{C}$ ref.) typical with Z-Foil
- Resistance tolerance: $\pm 0.001\%$
- Power Coefficient of Resistance (PCR) tracking "R due to self heating": 5 ppm at rated power
- Load life stability: to $\pm 0.005\%$ $+70^{\circ}\text{C}$, 2000 hours at rated power
- Resistance range: 1 Ω to 3.3 M Ω
- Available with 4-terminal (Kelvin) connections
- Shelf-life stability: 2 ppm after at least 6 years
- Oil-filled for ultra hermetically (also available as oil-free)
- High degree of hermeticity: $<10^{-7}$ atmospheric cc/s
- Non inductive, non capacitive design
- Prototype quantities available in just 5 working days or sooner
- Certification to NIST standards available
- Available with laboratory and metrology level precision and long term stability with additional in-house oriented processes, such as:
 - Special TCR plotting
 - Mounted chip stabilization

- Thermal shock and bake prior to sealing
- Combined thermal shock and power conditioning on finished product
- Thermal and power conditioning
- Foil resistors are not restricted to standard values; specific "as required" values can be supplied at no extra cost or delivery (e.g. 1K2345 vs. 1K)
- Electrostatic discharge (ESD) at least to 25 kV
- Thermal stabilization time $<1\text{s}$ (nominal value achieved within 10 ppm of steady state value)
- Current noise: $0.010 \mu\text{V}_{\text{RMS}}/\text{V}$ of applied voltage (<-40 dB)

Applications

- Metrology
- Military
- Aerospace
- Medical
- Test equipment
- Instrumentation amplifiers
- Laboratory
- Industrial
- Measurements systems



Vishay Foil Resistors' H and HZ Series of Bulk Metal® Foil Resistors Selected for *Electronic Design's* Annual "Top 101 Components"

Vishay Foil Resistors' New-Generation, Ultra-Precision VHP100 Bulk Metal® Foil Resistor Wins **Product of the Year Award** from *Electronic Products Magazine*

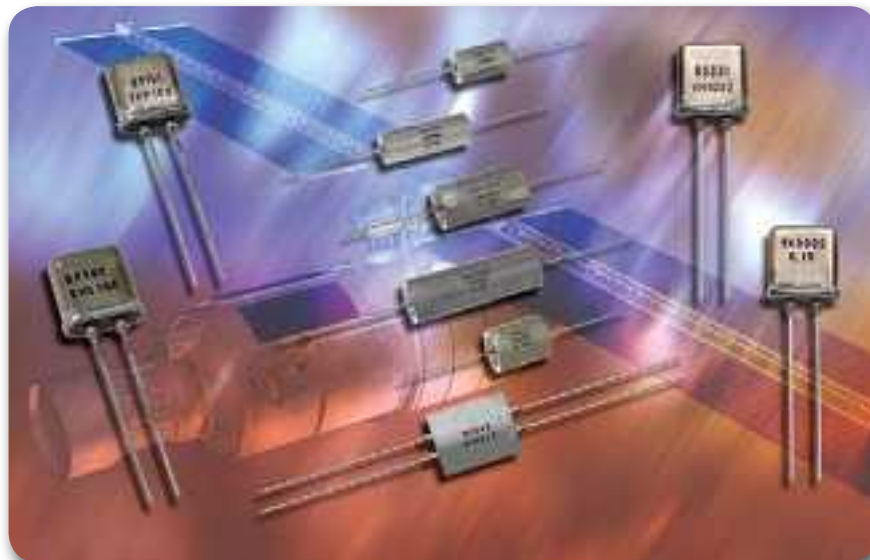
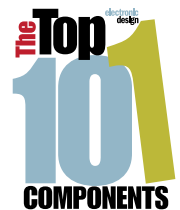

Our goal is to find solutions for challenging applications.

For any questions, please contact foil@vishaypg.com.

Hermetically-Sealed Resistors

Vishay Foil hermetically-sealed resistors eliminates the ingress of both oxygen, which degrades resistors over long periods, and moisture, which degrades resistors more quickly. A series of radial and axial configured resistors are placed in an enclosure impervious to gas transmission. Some of the models are simply standard through-hole products that are encapsulated; ie. VHZ555 is the hermetic version of Z555.

The degree of hermeticity is usually determined by exposure to pressurized helium and then measuring the rate at which the helium escapes. Vishay Foil hermetically-sealed resistors offers a remarkably low degree of hermeticity at less than 1×10^{-7} cc per second at normal atmospheric pressure.

Different forms of seal designs can be implemented:

- Oil-filled seals — the oil acts as a thermal conductor, thus eliminating long term degradation of elements of unsealed resistors, while at the same time allowing the device to accept short periods of overload without degradation.
- Rubber fill between the metal housing and resistance element acts both as a mechanical damper and thermal transfer path.
- Glass to metal seal enclosures employing Kovar eyelets allow the OFHC solder plated copper leads to pass through the enclosure to minimize the thermal EMF from the lead junctions.

Other resistor technologies tend to face several problems with the effects of oxygen and moisture. Thin-film technology, for example, can easily be damaged permanently by moisture. Condensation of microscopic quantities of water vapor on the surface of NiCr thin-film resistive element results in the dissolution of ionic contaminations available on the surface and formation of electrolyte solution. Since all plastics and all epoxies are hygroscopic, thermal cycling causes the resistor to “breathe in” water vapor that picks up encapsulation contaminants which are then condensed inside the package. Under low-power DC voltage, the ionic etching of thin NiCr films can cause rapid and significant resistance changes in a few minutes, completely destroying the resistor (open circuit) within a few hours. This is why any damage of humidity protection (coating, package) in thin-film resistor inevitably results in its failure.



Bulk Metal[®] resistive elements in Vishay Foil resistors are one hundred times thicker than thin-film resistive elements and therefore are much less vulnerable to the etching process. Hermetic versions of these resistors then completely eliminate any moisture influence whatsoever.



Hermetically-Sealed Resistors

Vishay Foil Resistors



Product	Global Model	Product Description	Resistance Range*	Best Tolerance	TCR (-55°C to +125°C, +25°C ref.) Typical	Rated Power at +70°C	PCR (at Rated Power)	Load Life Stability, 2000 Hours +70°C Under Power	
Hermetically Sealed - Z-Foil*									
VH102Z (Z-Foil)		Y5077	Hermetic version of the molded Z201 and Z555 devices	10 to 100 k	±0.005%	±0.2 ppm/°C Available with low window TCR over the required temp. range	0.6W	5 ppm typical	±0.005%
VHZ555 (Z-Foil)		Y1635		4.99 to 121 k	±0.005%	±0.2 ppm/°C	0.6W	5 ppm typical	±0.005%
VHP202Z (Z-Foil)		Y1748	Oil-filled hermetically sealed ultra high-precision resistors [4-lead terminal (Kelvin connection) available on special request]	5 to 100 k	±0.001% (1 K to max value)	±0.2 ppm/°C	0.3W	5 ppm typical	±0.002% at +25°C
VHA412Z (Z-Foil)		Y1749			±0.001% (1 K to max value)	±0.2 ppm/°C	0.3W	5 ppm typical	±0.002% at +25°C
VHA414Z (Z-Foil)		Y1751		5 to 200 k	±0.001% (1 K to max value)	±0.2 ppm/°C	0.5W	5 ppm typical	±0.002% at +25°C
VHA512Z** (Z-Foil)		Y1750		5 to 300 k	±0.001% (1 K to max value)	±0.2 ppm/°C	0.75W	5 ppm typical	±0.002% at +25°C
VHA516-4Z** (Z-Foil)		Y1752		5 to 400 k	±0.001% (1 K to max value)	±0.2 ppm/°C	1.0W	5 ppm typical	±0.002% at +25°C
VHA516-5Z** (Z-Foil)		Y1753		5 to 500 k	±0.001% (1 K to max value)	±0.2 ppm/°C	1.25W	5 ppm typical	±0.002% at +25°C
VHA516-6Z** (Z-Foil)		Y1754		5 to 600 k	±0.001% (1 K to max value)	±0.2 ppm/°C	1.5W	5 ppm typical	±0.002% at +25°C
VHA518-7Z** (Z-Foil)		Y1755		5 to 700 k	±0.001% (1 K to max value)	±0.2 ppm/°C	1.75W	5 ppm typical	±0.002% at +25°C
VHA518-8Z** (Z-Foil)		Y1756		5 to 800 k	±0.001% (1 K to max value)	±0.2 ppm/°C	2.0W	5 ppm typical	±0.002% at +25°C
VHA518-9Z** (Z-Foil)		Y1757		5 to 900 k	±0.001% (1 K to max value)	±0.2 ppm/°C	2.25W	5 ppm typical	±0.002% at +25°C
VHA518-10Z** (Z-Foil)		Y1758		5 to 1.0 M	±0.001% (1 K to max value)	±0.2 ppm/°C	2.5W	5 ppm typical	±0.002% at +25°C
VHA518-11Z** (Z-Foil)		Y1759		5 to 1.1 M	±0.001% (1 K to max value)	±0.2 ppm/°C		5 ppm typical	±0.002% at +25°C

* Tighter performances and higher or lower value resistances are available for all models.

** Available in 4-lead terminal: VHA512(Z) please use 302073(Z), VHA516(Z) please use 302074(Z), VHA518(Z) please use 302075(Z).

Product	Global Model	Product Description	Resistance Range*	Best Tolerance	TCR (-55°C to +125°C, +25°C ref.) Typical	Rated Power at +70°C	PCR (at Rated Power)	Load Life Stability, 2000 Hours +70°C Under Power
Hermetically Sealed								
VHS102	Y0077 Y0088	Hermetic version of the molded S102C, S102K, and S555 devices	1 to 150 k	±0.005%	±2 ppm/°C	0.6W at +70°C		±0.005%
VH102K	Y5787 Y0787		1 to 100 k	±0.005%	±1 ppm/°C			0.3W at +125°C
VHS555	Y0087		1 to 150 k	±0.005%	±5 ppm/°C maximum		±0.005%	
VHP100 VHP102 (0.2" L.S.)	Y0078 Y5078	Ultra high-precision resistor with very narrow TCR window	100 to 150 k	±0.005%	<60 ppm window (-55°C to +125°C)	0.3W at +70°C	5 ppm typical	±0.005%
VHP101 VHP103 (0.2" L.S.)	Y4078 Y6078		100 to 150 k	±0.005%	<10 ppm window (+15°C to +45 °C)	0.3W at +70°C	5 ppm typical	±0.005%
VHP202	Y0024	Oil-filled hermetically sealed high-precision resistors [4-lead terminal (Kelvin connection) available on special request]	5 to 150 k	±0.001% (1 K to max value)	±2 ppm/°C	0.3W		±0.002% at +25°C
VHA412	Y0019		5 to 335 k		±2 ppm/°C			0.5W
VHA414	Y0025		5 to 500 k		±2 ppm/°C	0.75W	±0.002% at +25°C	
VHA512**	Y0023		5 to 668 k		±2 ppm/°C	1.0W	±0.002% at +25°C	
VHA516-4**	Y0104		5 to 835 k		±2 ppm/°C	1.25W	±0.002% at +25°C	
VHA516-5**	Y0105		5 to 1 M		±2 ppm/°C	1.5W	±0.002% at +25°C	
VHA516-6**	Y0106		5 to 1.17 M		±2 ppm/°C	1.75W	±0.002% at +25°C	
VHA518-7**	Y0107		5 to 1.34 M		±2 ppm/°C	2.0W	±0.002% at +25°C	
VHA518-8**	Y0108		5 to 1.5 M		±2 ppm/°C	2.25W	±0.002% at +25°C	
VHA518-9**	Y0109		5 to 1.67 M		±2 ppm/°C	2.5W	±0.002% at +25°C	
VHA518-10**	Y0110		5 to 1.84 M		±2 ppm/°C	2.5W	±0.002% at +25°C	
VHA518-11**	Y0111							
VHP3, VHP4, VPR247	Y0065 Y0066 Y0830	Hermetically-sealed and molded power high-precision current sensing resistors	0.05 to 80 k	±0.01%		3W in free air 10W on heat sink		±0.01% at +25°C



* Tighter performances and higher or lower value resistances are available for all models.

** Available in 4-lead terminal: VHA512(Z) please use 302073(Z), VHA516(Z) please use 302074(Z), VHA518(Z) please use 302075(Z).

Hermetically-Sealed Resistors

Vishay Foil Resistors

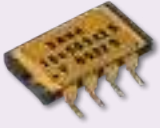
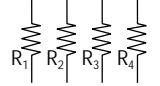
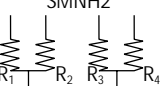
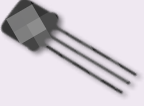
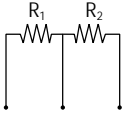
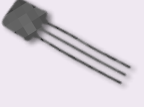
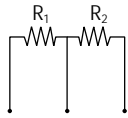

Model and Product Description	Global Model	Resistance Range	Resistance Ratio Available	Best Resistance Tolerance		TCR (-55°C to +125°C +25°C ref.) Typical	Rated Power at +70°C
				Absolute	Ratio Match		
Hermetic Voltage Divider							
SMNH1, 2*, ** High-precision, hermetically-sealed, 4-resistors, surface-mount resistor network 	Y1521 Y1522	Any value 5 to 33 k per resistor SMNH1  SMNH2 	Any ohmic value ratio within resistance range	±0.005%	0.005%	Absolute : ±2 ppm/°C Tracking: ±0.5 ppm/°C	Entire package 0.4W Each resistor 0.1W at +70°C
VHD144*, ** Hermetically-sealed (air-filled) version of the molded divider 300144 	Y0076	Any value from 100 to 20 k per side 	Any ohmic value ratio within resistance range	±0.005%	0.005%	Absolute: ±2 ppm/°C Tracking: 0.5 ppm/°C	0.2W at +85°C
VHD200*, ** Hermetically-sealed, oil-filled voltage divider, ultimate ratio match and TC tracking 	Y5076	Any value from 100 to 20 k per side 	Any ohmic value ratio within resistance range	±0.005%	0.001%	Absolute: ±2 ppm/°C Tracking: 0.1 ppm/°C	0.2W at +85°C
FSR Secondary Standard Foil Resistor serves as a reference and calibration device 	Y4028 New	1 to 150 k	Any ohmic value ratio within resistance range	Absolute: ±0.005%		±0.3 ppm/°C (+15°C to +45°C +25°C ref.)	±0.75W at 25°C

* Shelf life stability: 2 ppm.

** Available with Z-Foil technology.

Tighter performances and higher or lower value resistances are available for all models.

Trimming Potentiometers

Key Benefits

- Absolute Temperature Coefficient of Resistance (TCR): ± 5 ppm/ $^{\circ}\text{C}$ (-55 $^{\circ}\text{C}$ to +125 $^{\circ}\text{C}$, +25 $^{\circ}\text{C}$ ref.)
- TCR through the wiper: ± 25 ppm/ $^{\circ}\text{C}$
- Settability: down to $\pm 0.005\%$
- Setting stability: to 0.1%
- Load life stability: 0.1% typical R , 1.0% maximum R under full rated power at +85 $^{\circ}\text{C}$ for 10 000h
- Tap test: 0.05%
- All trimmers undergo noise and linearity tests during the standard production process
- "O" Ring prevents ingress of fluids during any board cleaning operation
- Prototype quantities available in just 5 working days or sooner
- A smooth and unidirectional resistance with leadscrew adjustment
- Power rating: 0.25W at +85 $^{\circ}\text{C}$
- Electrostatic discharge (ESD) at least to 25 kV

Applications

- High-precision instrumentation
- Test equipment and automatic test equipment
- Laboratory and industrial
- Audio equipment
- Military

Our goal is to find solutions for challenging applications.
For any questions, please contact foil@vishaypg.com.

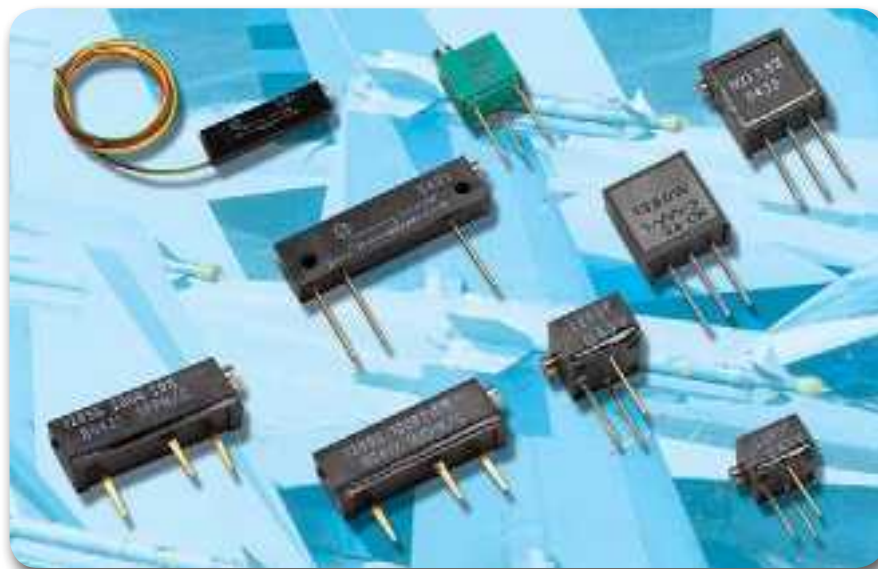

Trimming Potentiometers

Vishay Foil Resistors



Trimmers

Trimmers are mechanically driven, variable resistors. A wiper is moved across the resistance element, picking off an intermediate voltage in the potentiometer mode, or adding resistance in the rheostat mode. Its inherent mechanical aspects have caused some users to avoid designing with trimmers and are of special concern when selecting trimmers for precision applications.

However, with Vishay Foil trimmers, there is a smooth and unidirectional, infinite resolution adjustment for lower ohmic values, and somewhat lesser resolution for values 5 k Ω and above. Foil also achieves a very low TCR end-to-end, and the TCR though the wiper can be specified (and is also relatively low). Further, the unique element resistive pattern design minimizes the capacitive and inductive reactance levels.

The trimmer's advanced virtually back lash-free adjustment mechanism makes them easy to set quickly and accurately, while firmly maintaining its value. The contact resistance variation is now reduced through the use of a multi-fingered wiper on a planer surface — a comparison between the competing technologies shows these capabilities in the figure below.

Four key points:

1. Foil trimmers are preferred for precise adjustment.
2. Foil trimmers are preferred when the adjustment must be stable with mechanical vibration and temperature excursion.
3. Foil trimmers introduce the least noise.
4. The applied O-ring seal is the surest protection against contaminants.

All in all, Vishay Foil trimmers have become the choice for precise adjustment.

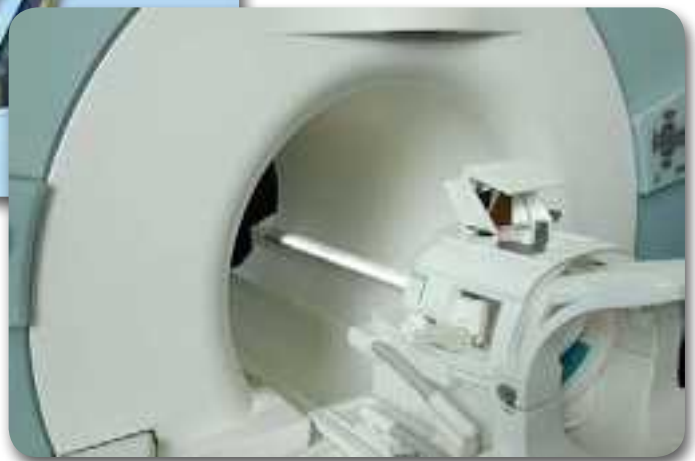
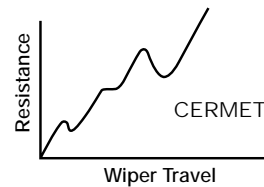
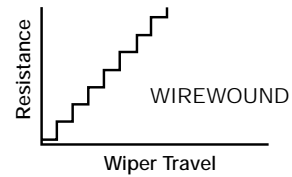
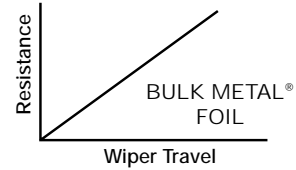

Model	Global Model	Product Description	Resistance Range*	Best Tolerance	TCR (-55°C to +150°C +25°C ref.)	Rated Power	Termination Style
Trimmers							
 <p>1240</p>	<p>Y4053 Y5053 Y0053</p>	<p>Precision trimming potentiometers, 1/4 inch square, RJ26 style DSCC 87126, multi turn</p>	5 to 10 k	±5%	±10 ppm/°C	0.25W at +85°C	<p>W-edge mount, top adjust X-edge mount, side adjust P-horizontal mount, side adjust</p>
 <p>1260</p>	<p>Y0069 Y4069</p>	<p>Precision trimming potentiometers, 3/8 inch square, RJ24 style, multi turn</p>	5 to 10 k	±5%	±10 ppm/°C	0.25W at +85°C	<p>W-edge mount, top adjust X-edge mount, side adjust</p>
 <p>1202</p>	<p>Y0051-P Y6050-PB Y5051-Y Y7050-YB Y5050-L Y0050-LB</p>	<p>Precision trimming potentiometers, 1 1/4 inch rectilinear, RJ12 style, multi turn</p>	2 to 20 k	±5%	±10 ppm/°C	0.5W at +85°C	<p>P-in line pins Y-staggered pins L-flexible leads B-panel mounted</p>
 <p>1242</p>	<p>Y0057 Y4057</p>	<p>Precision trimming potentiometers QPL, 1/4 inch square, qualified to MIL-PRF-22097, Char. F, RJ26, multi turn</p>	50 to 5 k	±10%	±10 ppm/°C	0.25W at +85°C	<p>W-edge mount, top adjust X-edge mount, side adjust</p>
 <p>1280G</p>	<p>Y0056</p>	<p>Precision trimming potentiometers, 3/4 inch rectilinear, multi turn</p>	10 to 20 k	±10%	±15 ppm/°C	0.75W at +25°C	<p>Edge mount, side adjust</p>
 <p>1285G</p>	<p>Y0059</p>	<p>Precision trimming potentiometers, 3/4 inch rectilinear, multi turn</p>	10 to 20 k	±5%	±5 ppm/°C	0.75W at +25°C	<p>Edge mount, side adjust</p>

* Tighter performances and higher or lower value resistances are available for all models.

Hybrid Chips and Custom Designed Hermetically-Sealed Networks (PRND)

Key Benefits

- Temperature Coefficient of Resistance (TCR):
 - 0.05 ppm/°C typical (0°C to +60°C)
 - 0.2 ppm/°C typical (-55°C to +125°C, +25°C ref.)
- TCR tracking: 0.5 ppm/°C
- Flexible schematic designs
- Resistance tolerance: absolute $\pm 0.005\%$; match 0.002%
- Resistance values: 5 to 80 k
- Load life stability: R = 0.01%, Ratio = 0.005% at +25°C, 2000 hrs at rated power
- Shelf life stability per resistor: 0.0002% (2 ppm)
- High degree of hermeticity: $< 5 \times 10^{-7}$ cc/sec
- Rated power per package up to 2.4W
- Resistance tolerance:
 - absolute: to $\pm 0.01\%$; match: to 0.01%
- Thermal stabilization time $< 1s$ (nominal value achieved within 10 ppm of steady state value)
- Current noise: $0.010 \mu V_{RMS}/V$ of applied voltage (< -40 dB)
- Vishay Foil resistors are not restricted to standard values; specific "as required" values can be supplied at no extra cost or delivery (e.g. 1K2345 vs. 1K)
- Electrostatic discharge (ESD) at least to 25 kV
- Available for high temperature applicat
- No engineering charges, no minimum quantities
- Quick prototype delivery
- Custom designed chip arrays are available

Our goal is to find solutions for challenging applications.
For any questions, please contact foil@vishaypg.com.

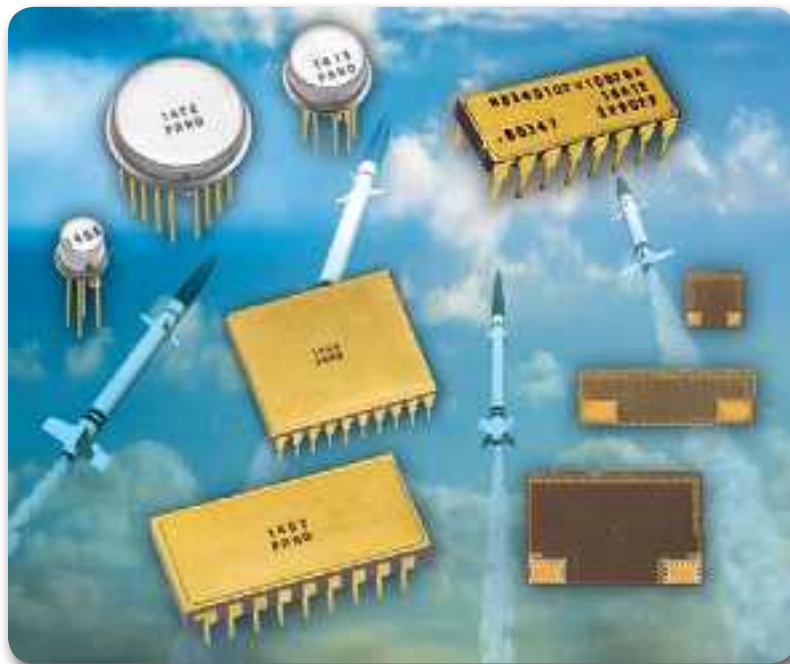

Hybrid Chips and Custom Designed Hermetic Precision Resistor Network Devices (PRND)

Customers have the opportunity to order Hybrid Chips and Custom Designed Hermetically-Sealed Networks for their own implementation into their design projects.

Hybrid Chips

Hybrid chips with gold-plated pads are available for the customer to use gold-wire bonding between the components in their circuit. The use of gold-wire bonding maintains the characteristics necessary for the chip to have a low thermal EMF, since using the same elements and materials reduces the potential difference which can cause an EMF. The customer has wide flexibility in determining the implementation and selection of chips. A number of chips are available varying in size, trimming specifications, and foil technology—this includes the latest release of Z-Foil hybrid chips.

The customer has the opportunity to order untrimmed chips, in which user trimming can be done either before or after bonding—using standard epoxies—onto the hybrid circuit substrate using standard laser, air abraid, or manual adjustment techniques. The Vishay Foil precision trimming system allows for adjustment to precise resistance values without concern over mechanical override and control problems encountered in laser or air abraid trimming of solid geometry resistance patterns. This ability to trim resistor chips to tolerance levels never before available to hybrid manufacturers, now gives a project manager the ability to increase the value-added level of their hybrid services. More of the profit thus available can be retained within the facility. Now, instead of buying precision resistors in separate packages or modules (which require additional PC board real estate) and integrating them into a system, the project manager can utilize Vishay Foil resistor chips or matched sets to manufacture the entire hybrid circuit in-house. This eliminates the need to “pin-out” for precision resistor requirements because the precision resistors are inside—part of the hybrid microcircuit design.

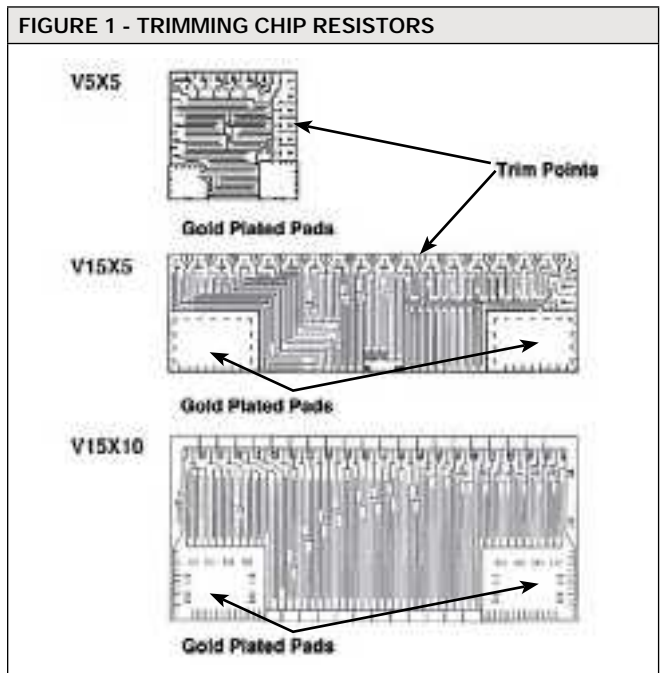

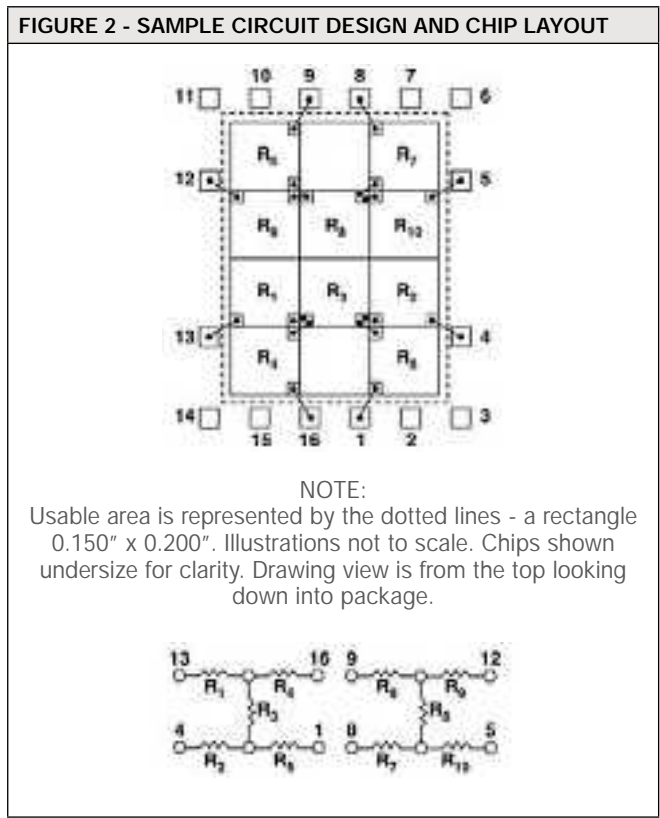

PRNDs

Precision Resistor Network Devices (PRNDs) are custom designed hermetically-sealed networks which can be configured to any circuit schematic and specifications the customer desires. Multiple resistors are deliberately arranged within the devices and connected by gold-wire bonding. Our Application Engineers are experienced to design a network which will operate properly and elude potential problems such a high heat concentrations or elongated gold-wires which can reduce the network's reliability. Please send your desired schematics and specifications to our Application Engineering Department to design your PRND.



Hybrid Chips and Custom Designed Hermetically-Sealed Networks (PRND)

Hybrid Chip Type	Global Model	Product Description	Resistance Range*	Best Tolerance	TCR (-55°C to +125°C, 25°C ref.) Typical	Rated Power at +70°C
V5x5PT (0.050" x 0.050") 	Y4045	Hybrid chips (gold-plated termination pads)	5 to 10 k	±0.005%	±2 ppm/°C	0.05W
V15x5PT (0.150" x 0.050") 	Y4047	Hybrid chips (gold-plated termination pads)	5 to 33 k	±0.005%	±2 ppm/°C	0.1W
V15x10PT (0.150" x 0.100") 	Y4475	Hybrid chips (gold-plated termination pads)	33 k to 80 k	±0.005%	±2 ppm/°C	0.15W
V5X5PU	Y4044	Untrimmed gold wire-bondable hybrid chips (gold-plated termination pads)	Good for 5 to 10 k	±0.005%	±2 ppm/°C	0.05W
V15X5PU	Y4046		Good for 5 to 33 k			0.1W
V15X10PU	Y4471		Good for 33 to 80 k			0.15W
Z-Foil						
V5X5ZT	Y4033	Ultra high-precision hybrid chips (gold-plated termination pads)	50 to 5 k	±0.01%	±0.2 ppm/°C	0.05W
V15X5ZT	Y4034		50 to 30 k	±0.01%	±0.2 ppm/°C	0.1W
V5X5ZU	Y4036	Ultra high-precision untrimmed hybrid chips (gold-plated termination pads)	Good for 50 to 5 k	±0.01%	±0.2 ppm/°C	0.05W
V15X5ZU	Y4037		Good for 50 to 30 k	±0.01%	±0.2 ppm/°C	0.1W

* Tighter performances and higher or lower value resistances are available for all models. Hybrid chips are also available for high temperature applications. For more information, please refer to HTH series on page 24.

Package Type	Product Description	Resistance Range*	Best Tolerance	TCR (-55 °C to +125 °C, +25 °C ref.) Typical
PRND				
TO: 1401, 1403, 1413, 1417, 1419, 1421, 1422 	Glass to metal seal headers	5 to 80 k per resistor	Absolute: ±0.005% Ratio match: 0.002%	Absolute: ±2 ppm/°C Tracking: 0.5 ppm/°C
DIP: 1442, 1445, 1446, 1457, 1460 	Ceramic dual-in-line package	5 to 80 k per resistor	Absolute: ±0.005% Ratio match: 0.002%	Absolute: ±2 ppm/°C Tracking: 0.5 ppm/°C
1445Q (7 resistors) 1446Q (8 resistors) 	QPL Networks qualified to MIL-PRF 83401 Characteristic "C" Schematic A	100 to 10 k	Absolute: ±0.1% Ratio match: 0.1%	Absolute: ±50 ppm/°C Tracking: 5 ppm/°C
VSM40, 42, 45, 46 (8, 14 and 16 pin) 	Hermetic resistor networks in gull wing configuration	5 to 80 k	Absolute: ±0.005% Match: ±0.002%	Absolute: ±2 ppm/°C Tracking: ±0.5 ppm/°C
VSM85, 86, 87, 88, 89 	Hermetic resistor networks in leadless chip carrier (LCC) configuration	5 to 80 k	Absolute: ±0.005% Match: ±0.002%	Absolute: ±2 ppm/°C Tracking: ±0.5 ppm/°C
VSM57 		5 to 80 k	Absolute: ±0.005% Match: ±0.002%	Absolute: ±2 ppm/°C Tracking: ±0.5 ppm/°C
1476 	Hermetic resistor networks in flatpacks configuration	5 to 80 k	Absolute: ±0.005% Match: ±0.002%	Absolute: ±2 ppm/°C Tracking: ±0.5 ppm/°C
1491 		5 to 80 k	Absolute: ±0.005% Match: ±0.002%	Absolute: ±2 ppm/°C Tracking: ±0.5 ppm/°C

Networks built to customer requirements. Send schematics and electrical specification to Application Engineering Dept. to: foil@vishaypg.com.

* Tighter performances and higher or lower value resistances are available for all models.

Avionics, Military, and Space (AMS) Applications

Avionics, Military, and Space (AMS) applications have reliability requirements that exceed the standard processes of electronic component manufacturing. Military (MIL) style testing consists of electrical and environmental stresses that may be applied to each resistor, or to a sample of parts from each production lot. By reviewing the behavior of the parts when they are subjected to the specified tests, the performance of a lot is guaranteed to a higher level of reliability, and lot-to-lot uniformity. Different qualification conformance inspection plans are applicable depending on the application, ranging from a DSCC specification, up to a MIL spec qualified component with an established reliability level. Additionally, custom screening plans, such as those modeled after NASA EEE-INST-002 guidelines, or plans intended to qualify products for use in higher temperatures may be considered. Contact VFR application engineers for the appropriate conformance inspection for your project.

Standards in Brief

- (1) **DSCC** (Defense Supply Center Columbus) — The Defense Supply Center Columbus is known to more than 24,000 military and civilian customers, plus 10,000 contractors as one of the largest suppliers of weapons systems spare parts.
- (2) **EEE-INST-002** (Instruction for EEE Parts Selection, Screening, Qualification, and Derating) — The purpose of this standard is to establish baseline criteria for selection, screening, qualification, and derating of EEE parts for use on NASA GSFC space flight projects. This standard shall provide a mechanism to assure that appropriate parts are used in the fabrication of space hardware that will meet mission reliability objectives within budget constraints.
- (3) **EPPL** (European Preferred Parts List — The EPPL is covered by ESCC 12300 (European Space Components Coordination), which provides the rules for establishing the list of preferred and suitable components to be used by European manufacturers of spacecraft hardware and associated equipment.
- (4) **ESA** (European Space Agency) — ESA has committed to developing a coherent, single set of user-friendly standards for all European space activities called the European Cooperation for Space Standardization. The ultimate goal of building such a standardization system at European level is to minimize life-cycle cost, while continually improving the quality, functional integrity, and compatibility of all elements in a space project. This goal is achieved by applying common standards for project management and for the development and testing of hardware and software.
- (5) **CECC** (CENELEC Electronic Components Committee-European Committee for Electrotechnical Standardization) — These manufacturer specifications are vital to designers who wish to use specific active and passive components that are approved to CECC QA Schemes. The CECC Detail Specifications Service provides detailed information needed in electronics design, specification, maintenance, purchasing, and other functions which must locate and select electronic components.



Our goal is to find solutions for challenging applications.
For any questions, please contact foil@vishaypg.com.

Established Reliability (ER)

The RNC90Y established reliability resistor has been the benchmark for high precision established reliability discrete resistors since 1982. In 2000, Vishay Precision Group achieved a technological breakthrough with the introduction of the Z201 resistor with a TCR of 0.2 ppm/°C. This breakthrough has allowed Vishay Precision Group to introduce the RNC90Z established reliability "R" level resistor, with a TCR limit of ±2 ppm/°C over the extended range of -55°C to +175°C, this being a significant improvement over the existing RNC90Y's ±5ppm/°C TCR specification.

Model	Failure Rate	MIL Spec No.	Resistance Range ()	TCR (MIL Range)	Absolute Tolerance	Termination Type
RNC90Y	Level R	MIL-PRF-55182/9	4.99 – 121 k	±5 ppm/°C	0.005%	Lead
RNC90T*			4.99 – 121 k	±5 ppm/°C	0.005%	Lead
RNC90Z			30.1 – 121 k	±2 ppm/°C	0.005%	Lead
RNC90S*			30.1 – 121 k	±2 ppm/°C	0.005%	Lead

* 0.200" lead spacing

QPL

Vishay Foil Resistors models 1445Q and 1446Q networks are qualified to MIL-PRF-83401, Characteristic C, Schematic A. Actual performance exceeds all the requirements of MIL-PRF-83401 characteristics "C".

Model	MIL Spec No.	Termination Type	Resistance Range ()	Absolute Tolerance	Number of Resistors	Absolute TCR (-55°C to +125°C, +25°C ref.)
1445Q	MIL-PRF-83401	14 pin DIP	100 – 10 k	0.1%	7	100R - 1K 10 ppm/°C 1K - 10K 5 ppm/°C
1446Q		16 pin DIP	100 – 10 k	0.1%	8	

Vishay Foil Resistors model RJ26 Precision Trimming ¼ inch Potentiometer is qualified to MIL-PRF-22097.

Model	MIL Spec No.	Termination Type	Resistance Range ()	Absolute Tolerance	Setability	TCR Through the Wiper (-55°C to +125°C, +25°C ref.)
RJ26 (Trimmer)	MIL-PRF-22097	Leaded	50 , 100 , 200 , 500 , 1 k , 2 k , 5 k	10%	0.05%	±25 ppm/°C

Type	Construction	DSCC (1) and MIL Spec Number	EEE-INST-002 (2) and MIL Spec Number	EPPL (3)	ESA (4)	CECC (5)	Typical TCR (-55°C to +125°C, +25°C ref.) (ppm/°C)	Load Life Stability 2000 Hours, +70°C Under Power-Typical
DSCC, EEE-INST-002, EPPL, ESA and CECC Foil Products								
VSMP0805	Wrap-around surface mount	07024 MIL-PRF-55342	303134 MIL-PRF-55342				0.2	0.005%
VSMP1206		07025 MIL-PRF-55342	303135 MIL-PRF-55342				0.2	0.005%
VSMP1506		03010 MIL-PRF-55342	303136 MIL-PRF-55342				0.2	0.005%
VSMP2010		06001 MIL-PRF-55342	303137 MIL-PRF-55342				0.2	0.005%
VSMP2512		06002 MIL-PRF-55342	303138 MIL-PRF-55342				0.2	0.005%
VSM0805		07024 MIL-PRF-55342					2	0.005%
VSM1206		07025 MIL-PRF-55342					2	0.005%
VSM1506		03010 MIL-PRF-55342					2	0.005%
VSM2010		06001 MIL-PRF-55342					2	0.005%
VSM2512		06002 MIL-PRF-55342					2	0.005%
VSM2018		93030 MIL-PRF-55342					0.2	0.005%
SMR1DZ		Molded, flexible terminations with robust construction	06020 MIL-PRF-55182	303139 MIL-PRF-55182				0.2
SMR1D	06020 MIL-PRF-55182						2	0.005%
SMR3DZ	06021 MIL-PRF-55182		303140 MIL-PRF-55182				0.2	0.005%
SMR3D	06021 MIL-PRF-55182						2	0.005%
VCS1625Z	Current-sense with Kelvin connections for high accuracy	08003 MIL-PRF-55342	303119Z MIL-PRF-55342				0.2	0.005%
VCS1625		00803 MIL-PRF-55342	303119 MIL-PRF-55342	✓			2	0.005%
CSM2512		07011 MIL-PRF-49465	303144 MIL-PRF-49465				15 Max	0.05%
CSM3637		07012 MIL-PRF-49465	303145 MIL-PRF-49465				15 Max	0.05%

Notes:

- (1) DSCC (Defense Supply Center Columbus)
 - (2) EEE-INST-002 (Instruction for EEE Parts Selection, Screening, Qualification, and Derating)
 - (3) EPPL (European Preferred Parts List)
 - (4) ESA -European Space Agency
 - (5) CENELEC Electronic Components Committee-European Committee for Electrotechnical Standardization
- All the above resistors are also available on the shelf as standard products.

Type	Construction	DSCC (1) and MIL Spec Number	EEE-INST-002 (2) and MIL Spec Number	EPPL (3)	ESA (4)	CECC (5)	Typical TCR (-55°C to +125°C, +25°C ref.) (ppm/°C)	Load Life Stability 2000 Hours, +70°C Under Power-Typical
DSCC, EEE-INST-002, EPPL, ESA and CECC Foil Products								
Z201	Through-hole		303143 S-311-P813				0.2	2
Z201L			303143L S-311-P813				0.2	2
RCK HR 02, 02A					✓		2	0.005%
RS92N, RS92NA, AN						✓	2	0.005%
S102			89039 MIL-PRF-89039				2	0.005%
300144	Through-hole voltage divider		87026 MIL-PRF-55182				2	0.005%
300144Z			87026 MIL-PRF-55182				0.2	0.005%
1240	Trimmer		87126 MIL-PRF-39035				10	0.1%
PRND	Hermetically- sealed network devices			✓			2	0.025% (1000 hrs)

Notes:

(1) DSCC (Defense Supply Center Columbus)

(2) EEE-INST-002 (Instruction for EEE Parts Selection, Screening, Qualification, and Derating)

(3) EPPL (European Preferred Parts List)

(4) ESA -European Space Agency

(5) CENELEC Electronic Components Committee-European Committee for Electrotechnical Standardization

All the above resistors are also available on the shelf as standard products.

Example of Test Flow

Models # 303144 and 303145 - fixed resistors CSM2512 and CSM3637 with screen/test flow in compliance with EEE-INST-002 (Tables 2A and 3A, Film/Foil, Level 1) MIL-PRF-55342 and MIL-PRF-49465.



RC Record	In tolerance
Thermal Shock	25 x (- 65 °C to + 150 °C)
RC Record	R = 0.1 %
High Temperature Exposure	+ 170 °C, 100 h, no power
RC Record	In tolerance R = 0.2 %
Final Inspection	5 % PDA on R, 10 % PDA on out of tolerance
Visual Inspection	Magnification 30 x to 60 x
Mechanical Inspection	Dimensions, workmanship, 3 units sample size

Note

(1) Vishay Foil Resistors will perform a pre-cap visual inspection 100% in the production flow prior to overcoating.

Group 2	Sample size: 3(0) Solderability MIL-STD-202, method 208
Group 3	Sample size: 10(0) - mounted on FR4 TCR measurement per MIL-STD-202, method 304 - 55 °C/+ 25 °C/+ 125 °C 303144: 3 m to < 100 m : ± 20 ppm/°C 100 m to 200 m : ± 25 ppm/°C 303145: 2 m to 3 m : ± 25 ppm/°C > 3 m to < 100 m : ± 20 ppm/°C 100 m to 200 m : ± 25 ppm/°C Low temperature storage per MIL-PRF-49465 R = 0.2 % - 55 °C ± 2 °C, 24 h ± 4 h ambient no load dwell for 2 h to 8 h at + 25 °C Low temperature operation per MIL-PRF-55342 R = 0.2 % - 65 °C ambient no load dwell for 1 h rated power for 45 min no load dwell at + 25 °C for 24 h ± 4 h Short time overload per MIL-STD-49465 R = 0.3 % 5 x rated power at + 25 °C for 5 s, not to exceed maximum current rating
Group 4	Sample size: 9(0) - mounted on FR4 Resistance to soldering heat R = 0.05 % 10 s to 12 s at + 260 °C reflow method Moisture resistance per MIL-STD-202, method 106 (7a and 7b not required) R = 0.05 % 240 h, no power
Group 5	Sample size: 9(0) Shock per MIL-STD-202, method 213, condition I R = 0.05 % 100G, 6 ms axes Z and Y, 10 shocks per axis Vibration per MIL-STD-202, method 204, condition D R = 0.05 % 10 Hz to 2000 Hz, 20G 2 axes, 6 h per axis
Group 6	Sample size: 12(0) - mounted on FR4 Life test per MIL-PRF-49465 R = 1 % 2000 h, + 70 °C, rated power

Notes

(2) Units selected randomly from lots which successfully passed the table 2A testing

Table 3. EEE-INST-002 (Table 3A Film/Foil, level 1) Destructive Tests — MIL-PRF-49465 ⁽²⁾

Group 7B	Sample Size: 10(0) - mounted on FR4	
	Solder mounting integrity per MIL-PRF-55342	303144: 3 kg force, 30 s 303145: 5 kg force, 30 s
Group 9	Sample size: 5(0) - mounted on FR4	
	High temperature exposure per MIL-PRF-49465	R = 0.3 % 1000 h, + 170 °C ± 7 °C, no power
Group 10⁽³⁾	Sample size: For 303144: 12 For 303145: 4	Per ASTM E595
	Outgassing	

Notes

⁽²⁾ Units selected randomly from lots which successfully passed the table 2A testing

⁽³⁾ Optional, per customer request.

Example of Load Life Results (10,000 hours)

RNC90Y is QPL product with established reliability (ER): meets requirements of MIL-PRF-55182/9.

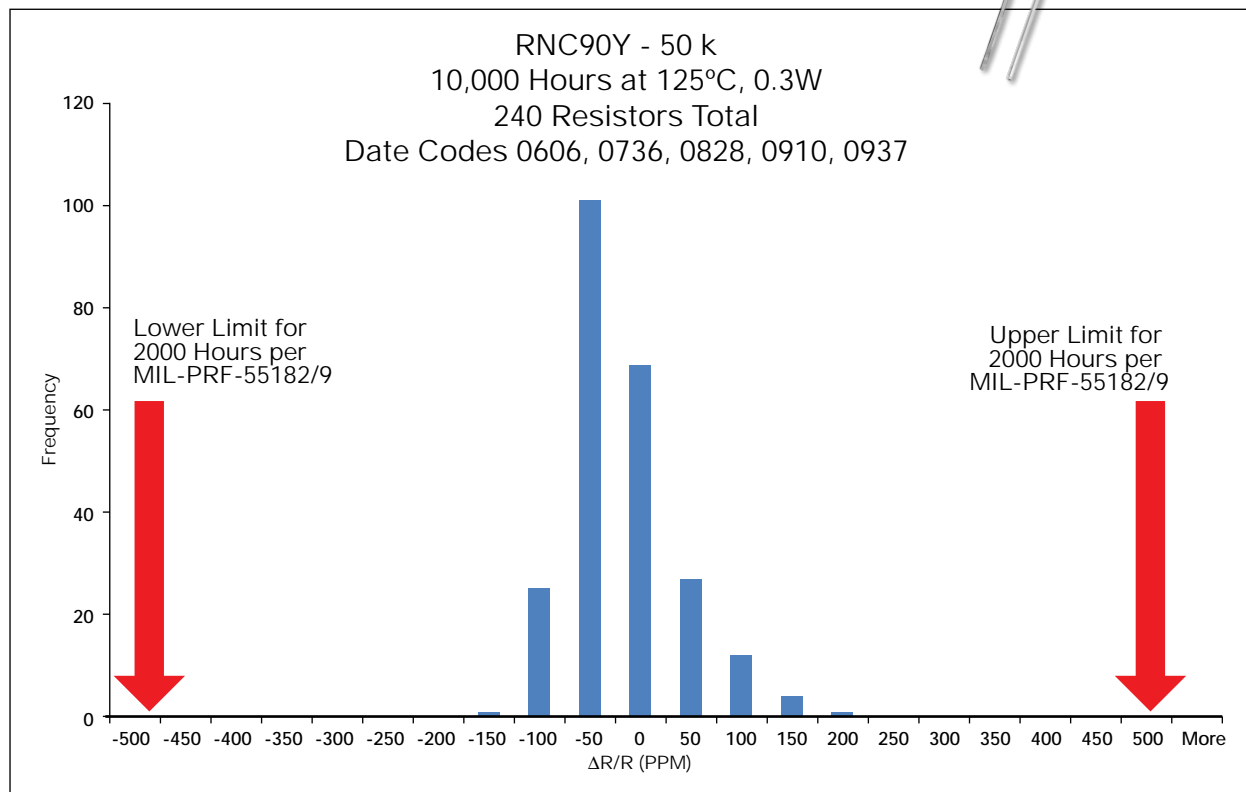

Aerospace

The demands of the aerospace segment differ from the commercial segments in one major area — ongoing reliability. In some cases, there is only one chance to complete the mission, and the system cannot be brought back into the shop for repairs. Some systems must transit deep-space for 10 years or more before being activated. Every component must activate when required and perform flawlessly to the end of the mission. This is why Vishay Foil resistors, with their long term consistency and reliability, are the only choice for aerospace applications.



End Product

Thruster Control System for Satellites

Function

Voltage Control

Customer Requirements

- Propulsion system must be precise due to high sensitivity of forces in anti-gravity environments
- High reliability since there will be no servicing during its lifetime
- Established reliability in previous aerospace applications

The Vishay Foil Resistors Solution

RNC90Y and RNC90Z

QPL resistors with established reliability (ER) and meets the requirements of MIL-PRF-55182/9

- The most precise and reliable resistor available used for decades in the aerospace industry:
 - Absolute TCR for RNC90Z: 2 ppm/°C maximum at -55°C to +175°C range
 - Absolute TCR for RNC90Y: 5 ppm/°C maximum at -55°C to +125°C range; 10 ppm/°C maximum at 125°C to +175°C range
 - Absolute tolerance: 0.005% (50 ppm)
 - Load life stability: ±0.005% for 2000 h, 0.3W at +125°C
 - Failure rate: Level R (per Mil PRF 55182-9 and MIL-STD-690)



303134, 303135, 303136, 303137, 303138

Screen/test flow in compliance with EEE-INST-002, (Tables 2A and 3A, Film/Foil, Level 1) and MIL-PRF-55342

- Ultra high-precision surface-mount chip resistors, VSMP Z-Foil technology configuration:
 - Temperature coefficient of resistance (TCR): 0.2 ppm/°C typical (-55°C to +125°C, +25°C ref.)
 - Resistance tolerance: to ±0.02%
 - Power coefficient " R due to self heating": 5 ppm at rated power
 - Power rating: to 400 mW at +70°C
 - Load life stability: ±0.03% at +70°C, 2000h at rated power
 - Electrostatic discharge (ESD) at least to 25 kV
 - Short time overload: 0.02%
 - Thermal stabilization time <1s (nominal value achieved within 10 ppm of steady state value)
 - Rise time: 1 ns effectively no ringing



Audio - “Hear the Difference”

In audio systems, “high end” means faithful reproduction of the original signal and the absence of noise insertion by the electronic components — particularly the resistors. The audio discrimination level is sometimes beyond the instrument measuring capability but nonetheless aurally detectable. Vishay Foil resistors are the lowest-noise such devices available and essential components of any high-end audio system.

End Product

High-End Audio Preamp

Function

Line Level Audio Signal Amplification



Customer Requirements

- Low noise preamplifier for implementation into differential amplifier circuit
- Tight settability required to maintain accurate amplifier gain
- Trimmer technology which provides consistent and reliable performance

The Vishay Foil Resistors Solution

1240 Trimmer

Ultra high-precision trimming potentiometer designed to meet or exceed the requirements of MIL-PRF-39035, Char. H with a smooth and unidirectional output

- Current noise: $0.010 \mu\text{V}_{\text{RMS}}/\text{V}$ of applied voltage (<-40 dB)
- Results in a high signal-to-noise ratio and a high common mode rejection ratio
- Settability: 0.05% typical; 0.1% maximum
- Setting stability: 0.1% typical; 0.5% maximum
- Trimmer design which ensures a smooth and unidirectional output:
 - Wirewound technology exhibits a step function in response to wiper travel, while cermet technology has wide deviations in response to wiper travel
 - Only VFR offers a linear and predictable response
- Immune to shock vibrations

*For further information, please see Application Note *Resistance Trimmers*.



VAR (VFR Audio Resistor)

Composed of VFR's Bulk Metal® Z-Foil technology, with improved sound quality, VAR provides a combination of low noise and low inductance/capacitance, making it unrivalled for applications requiring low noise and distortion-free properties.

- “Naked Z-Foil resistor” design without mold or encapsulation for reduced signal distortion:
 - Temperature coefficient of resistance (TCR): $\pm 0.2 \text{ ppm}/^\circ\text{C}$ typical at -55°C to $+125^\circ\text{C}$, 25°C ref.
 - Power rating: to 0.4 W at $+70^\circ\text{C}$
 - Resistance tolerance: to $\pm 0.005\%$
 - Load life stability: to $\pm 0.005\%$ at $+70^\circ\text{C}$, 2000h at rated power
 - Non inductive, non capacitive design
 - Rise time: 1 ns without ringing
 - Current noise: $0.010 \mu\text{V}_{\text{RMS}}/\text{V}$ of applied voltage (<-40 dB)
 - Thermal EMF: $0.05 \mu\text{V}/^\circ\text{C}$
 - Voltage coefficient: $<0.1 \text{ ppm}/\text{V}$
 - Inductance: $<0.08 \mu\text{H}$
- Thermal stabilization time $<1\text{s}$ (nominal value achieved within 10 ppm of steady state value)
- Electrostatic discharge (ESD) at least to 25 kV



For other recommendations for audio applications please refer to the following resistors: VSH, S102C, Z201, Z203.

Automatic Test Equipment (ATE)

Automatic Test Equipment (ATE) performs at high speeds, reading and recording of information from thousands of devices/boards that would otherwise need to be probed by hand. Any introduction of spurious signals from the ATE machine or its components could result in failure to reject a faulty device, or conversely, cause spurious rejection of perfectly good product. If ever there was a place not to be “penny wise and pound foolish” it is in the resistor complement of an ATE. The wisest resistor choice for ATEs is a Vishay Foil resistor.

End Product

DC Test Instrument

Function

Digitize an AC Signal

Customer Requirements

- Short term stability
- Low sensitivity to temperature (external and internal)
- Precision required due to resource constraints
- Requires resistor of minimal size due to real estate constraints



The Vishay Foil Resistors Solution

VFCP2010 (Flip Chip with Z-Foil)

Ultra high-precision Z-Foil flip chip resistor with 35% space saving vs. wraparound design

- The most stable and precise resistor available:
 - Load life stability: $\pm 0.005\%$ for 2000h, rated power at $+70^{\circ}\text{C}$
 - Absolute TCR: 0.2 ppm/ $^{\circ}\text{C}$ typical at -55°C to $+125^{\circ}\text{C}$ range $+25^{\circ}\text{C}$ ref.
 - Absolute tolerance: 0.01%
 - Flip chip design saves 35% more space than a wraparound design
- Electrostatic discharge (ESD) at least to 25 kV
- Thermal stabilization time $< 1\text{s}$ (nominal value achieved within 10 ppm of steady state value)
- Rise time: 1 ns effectively no ringing

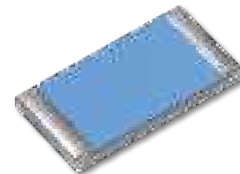

SMR1DZ/SMR3DZ (Z-Foil)

Unique flexible terminations to ensure minimal stress transference from the PCB due to a difference in Temperature Coefficient of Expansions (TCE)

- Ultra high-precision Z-Foil molded surface mount resistor:
 - Temperature Coefficient of Resistance (TCR):
 - ± 0.05 ppm/ $^{\circ}\text{C}$ typical (0°C to $+60^{\circ}\text{C}$)
 - ± 0.2 ppm/ $^{\circ}\text{C}$ typical (-55°C to $+125^{\circ}\text{C}$, $+25^{\circ}\text{C}$ ref.)
 - Resistance tolerance: to $\pm 0.01\%$
 - Power Coefficient of Resistance (PCR) “ R due to self heating”: 5 ppm at rated power
 - Load life stability: $\pm 0.005\%$ ($+70^{\circ}\text{C}$, 2000 hours at rated power)
 - Power rating: to 600 mW at 70°C
 - Matched sets with TCR tracking are available upon request
- Electrostatic discharge (ESD) at least to 25 kV
- Thermal stabilization time $< 1\text{s}$ (nominal value achieved within 10 ppm of steady state value)
- Rise time: 1 ns effectively no ringing



Flexible Terminations

Aviation

The electronics used in commercial avionics are exposed to dramatic temperature excursions, shock and vibration, moisture, and the test of time. In engine, cabin, and flight control applications, resistors need to maintain their values despite all of these factors. Vishay Foil resistors have a long history of applications in commercial aviation, supported by more than 30 years of load life testing.

End Product

Aircraft Engine

Function

High Temperature Measurement Control



Customer Requirements

- Precise voltage reference capable of measuring down to nano-volts
- Implementation into a microbridge configuration
- Must perform properly at a temperature of +80°C and power of 0.1W

The Vishay Foil Resistors Solution

300144Z

Ultra high-precision Z-Foil voltage divider resistors

- Precise voltage divider with flexibility of use and accurate performance at high temperatures:
 - Absolute tolerance: 0.005%
 - Ratio tolerance: 0.005%
 - Absolute TCR: 0.2 ppm/°C typical at -55°C to +125°C, +25°C ref.
 - Power rating: to 0.2W at +70°C
 - PCR: 5 ppm at rated power



Check also: VFD244Z, VSH144, DSMZ, SMNZ

303144, 303145

Screen/test flow in compliance with EEE-INST-002 (Tables 2A and 3A, Film/Foil, Level 1) MIL-PRF-55342 and MIL-PRF-49465

- Fixed resistors CSM2512 and CSM3637 for low value current-sense resistors, providing power and precision in a four terminal, surface-mount configuration:
 - Temperature coefficient: ±20 ppm/°C max. (-55°C to +125°C, +25°C ref.)
 - Resistance tolerance: ±0.5%
 - Four terminal (Kelvin) design: allows for precision accurate measurements
 - Power rating: 1W to 3W
 - Short time overload: ±0.1% typical
 - Thermal EMF: 3 μV/°C
 - Maximum current: up to 38 A

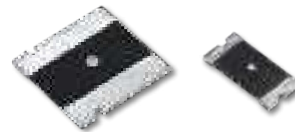

Cryogenics

Cryogenic applications require structural integrity capable of withstanding extreme thermal cycling without damage and without detriment to performance. Vishay Foil resistors have been used as heaters of small-mass samples and as circuit elements at cryogenic temperatures.

End Product

Liquefied Natural Gas Transport System

Function

Temperature Regulator

Customer Requirements

- Reliable performance in extremely low temperatures
- Flexibility in resistor configuration
- Use in high humidity and high pressure environments



The Vishay Foil Resistors Solution

Custom-Designed Hermetically-Sealed Networks

Also available as DIP version

- Custom networks designed to the customers requirements; normal values are:
 - Absolute tolerance: 0.005%
 - Tolerance match: 0.002%
 - Absolute TCR: 2 ppm/°C typical at -55°C to +125°C, +25°C ref.
 - TCR tracking: <0.5 ppm/°C
 - Hermeticity of 10^{-7} atmospheric cc/s: The hermetic package provides a seal around the resistive element which protects it from the natural damage caused by moisture over time



VSMP Series (0603, 0805, 1206, 1506, 2010, 2512) (Z-Foil)

VSMP Series is the industry's first device to provide high rated power, excellent load life stability along with extremely low TCR all in one resistor.

- Ultra high-precision foil wraparound surface-mount chip resistor:
 - Temperature coefficient of resistance (TCR):
 - 0.05 ppm/°C typical (0°C to +60°C)
 - 0.2 ppm/°C typical (-55°C to +125°C, +25°C ref.)
 - Resistance tolerance: to $\pm 0.01\%$
 - Power Coefficient of Resistance (PCR) " R due to self heating":
 - 5 ppm at rated power
 - Power rating: to 750 mW at +70°C
 - Thermal stabilization time <1s (nominal value achieved within 10 ppm of steady state value)
 - Load life stability: to $\pm 0.005\%$ at +70°C, 2000h at rated power
 - Electrostatic discharge (ESD) at least to 25 kV
 - Short time overload: 0.005%
 - Matched sets are available on request

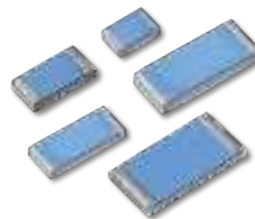

Down Hole

The high temperature of down hole applications is a huge challenge to electronic components and most resistor technologies. Temperatures upwards of 275°C are not uncommon and even above the melting point of some solders. Thin film resistors are oxidized into oblivion by these temperatures and wirewound devices see major value shifts. Even Vishay Foil resistors cannot be exposed indefinitely to these temperatures, but the encapsulation of the Vishay Foil element stands up to these environmental stresses long enough to enable down-hole measurements through dozens of deep travel cycles. The 100 times thicker resistive layer inherent in the foil resistor provides them with long term stability in cold and hot environment and helps establish it as the preferred resistor for seismic oil exploration as well as for down-hole applications.

End Product

Processor for Motor Control

Function

High-Precision Voltage Reference

Customer Requirements

- Low noise and high common mode rejection ratio
- Long term stability and minimal drift
- Will be used in high humidity and high pressure environments

The Vishay Foil Resistors Solution

VHD200

Oil-filled hermetically-sealed, small package, voltage dividers (oil filled as standard, air filled available upon request)

- Effective performance in any extreme environment:
 - Absolute TCR: 2 ppm/°C typical at -55°C to +125°C, +25°C ref.
 - Foil technology which exhibits low noise: <-40 dB
 - Ratio Stability: <0.001% for 2000h, rated power at +70°C
 - Absolute tolerance: 0.005%
 - Tolerance match: 0.001%
 - TCR tracking: 0.1 ppm/°C
 - Hermeticity of 10⁻⁷ atmospheric cc/s: The hermetic package provides a seal around the resistive element which protects it from the natural damage caused by moisture over time. In addition, VHD200 is oil-filled which further protects the device from degradation, and ensures long term performance in any extreme environment
- Shelf life stability: 2 ppm for at least 6 years
- Post Manufacture Operations (PMO) are available for enhanced performances

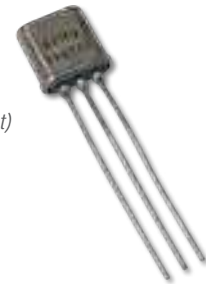

V5X5Z, V15X5Z (Z-Foil)

Offer an order of magnitude of improvement over other chip resistors in hybrid circuits, also available for high temperatures applications

- Ultra high-precision Bulk Metal® Z-Foil chip resistors:
 - Temperature coefficient of resistance (TCR):
 - 0.05 ppm/°C typical (0°C to +60°C)
 - 0.2 ppm/°C typical (-55°C to +125°C, +25°C ref.)
 - TCR tracking: to 0.5 ppm/°C
 - Resistance tolerance: absolute to ±0.01% (user trimmable to ±0.005%), match to 0.01%
 - Power rating: 50 mW to 100 mW at +70°C
 - Load life stability: ±0.01% at +70°C, 10 000h at rated power
 - Short time overload: 0.02%
 - Thermal stabilization time <1s (nominal value achieved within 10 ppm of steady state value)
 - Pattern design minimizing hot spots

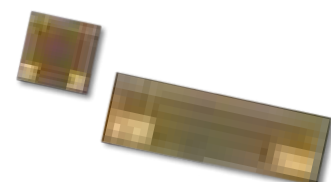

Electron Beam

Electron beam machining is enabling a whole new range of applications, but its successful use depends on accuracy, speed and repeatability. The resistors that drive the beam's X and Y coordinates and which control the beam's intensity must not add signals of their own due to temperature power fluctuations when operated as current sensor or other system fluctuations. They must also respond immediately to high power pulse signals that drive the X/Y deflections. Vishay Foil resistors are the preferred resistive device for these applications.



End Product

Electron Beam Microscope

Function

Focusing Mechanism

Customer Requirements

- High power rating and working voltage capacity
- Resistance of approximately 1 M required
- Extreme precision and reliability

The Vishay Foil Resistors Solution

VHA518-11Z

Oil-filled hermetically-sealed, ultra precision resistors; 11 resistor chips in series (Z-Foil)

- A robust design for the most accurate performance:
 - Power rating: 1.2–2.5W at +25°C
 - Maximum voltage capacity: 600V
 - Resistance range: 5 to 1.1 M
 - Absolute tolerance: 0.001%
 - Absolute TCR: 0.2 ppm/°C typical at -55°C to +125°C, +25°C ref.
 - Load life stability: ±0.002% for 2000h, rated power at +25 °C
 - Hermeticity of 10⁻⁷ atmospheric cc/s: The hermetic package provides a seal around the resistive element which protects it from the natural damage caused by moisture over time. In addition, VHA518 is oil-filled which further protects the device from degradation, and ensures long-term performance in any extreme environment

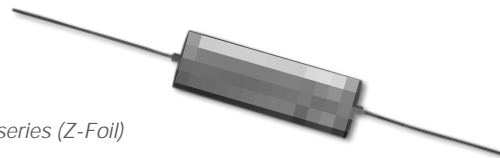

Vishay Foil Resistors' H and HZ Series of Bulk Metal® Foil Resistors Selected for Electronic Design's Annual "Top 101 Components"

VHP100

Ultra high-precision hermetically-sealed Bulk Metal® Foil resistor with Zero TCR, no humidity within a unique construction, minimizing the effects of stress factors, with total error budget of 2 ppm drift.

- Oil filled hermetically-sealed resistor:
 - Essentially zero TCR
 - Absolute resistance change (window):
 - VHP100 <60 ppm (-55°C to +125°C)
 - VHP101 <10 ppm (+15°C to +45°C)
 - Resistance tolerance: to ±0.005% (50 ppm) - (available to ±0.001% (10 ppm))
 - No humidity effect: hermetically sealed against moisture
 - Load life stability: ±50 ppm typical for 2000h, 70°C at rated power
 - Shelf life stability: ±2 ppm typical after at least 6 years
 - Current noise: 0.010 μV_{RMS}/V of applied voltage (<-40 dB)
 - Thermal EMF: 0.05 μV/°C typical
 - Oil filled as standard, air filled available upon request



Vishay Foil Resistors' New-Generation, Ultra-Precision VHP100 Bulk Metal® Foil Resistor Wins Product of the Year Award from Electronic Products Magazine

Industrial

Industrial systems sometimes favor price over quality when it comes to electronic components, but when all factors are taken into consideration, quality resistors turn out to be the least expensive solution. In the long run, a reliable and stable resistor costs less than one that must be replaced or which requires additional circuitry to compensate for lack of precision. Factor in warranty repair expense, downtime in the hands of the customer, and transportation costs for repairs, and the "savings" from using second-best resistors quickly disappear. Even when an assumed or measured returns rate is applied, the Vishay Foil resistor turns out to be the most economical solution.

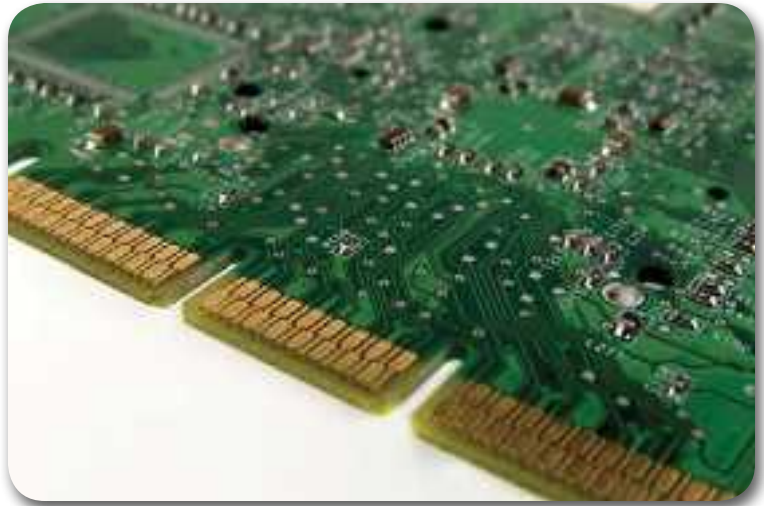

End Product

High Voltage Electrical Circuit Breaker

Function

Precision Measurement Control

Customer Requirements

- Network with specific configuration
- Precise measurements are necessary to ensure the safety of the circuit and the proper trigger for the circuit breaker
- Performance should be reliable within the temperature range of -40°C to 70°C
- Must endure both sporadic and continuous short-time overload

The Vishay Foil Resistors Solution

300193Z

Ultra high-precision Z-Foil voltage divider and network resistor; 3 resistor chips, 2 configured as voltage divider, and the other as an individual resistor

- Precise voltage divider with flexibility of use and accurate performance at high temperatures:
 - Ratio tolerance: 0.005%
 - Absolute tolerance: 0.005%
 - TCR tracking: 0.5 ppm/°C
 - Absolute TCR: 2 ppm/°C typical at -55°C to 125°C range, +25°C ref.
 - Short time overload: 0.002%
- Thermal stabilization time < 1 s (nominal value achieved within 10 ppm of steady state value)

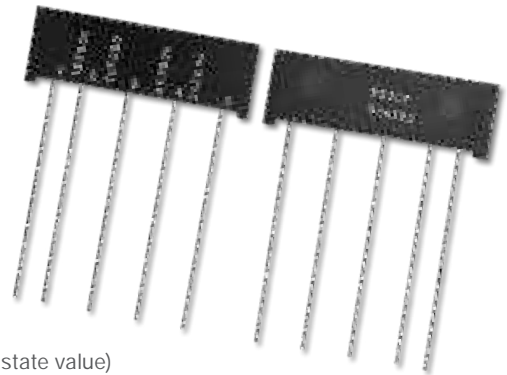

DSMZ (Z-Foil)

The DSMZ surface-mount voltage divider provides a matched pair of Bulk Metal® Z-Foil resistors in a small epoxy molded package. The electrical specification of this integrated construction offers improved performance and better real estate utilization over discrete resistors and matched pairs.

- Ultra high-precision Bulk Metal® Z-Foil surface-mount voltage divider:
 - Temperature coefficient of resistance (TCR):
 - ±0.05 ppm/°C typ. (0°C to +60°C)
 - ±0.2 ppm/°C typ. (-55°C to +125°C, +25°C ref.)
 - TCR tracking: 0.1 ppm/°C typical
 - Resistance tolerance: absolute: ±0.02%; match: 0.01%
 - Power rating at 70°C: entire package: 0.1W, each resistor: 0.05W
 - Ratio stability: 0.005% (0.05W at +70°C, 2000h)
 - Short time overload: 0.005%
 - Non inductive, non capacitive design
 - Rise time: 1 ns effectively no ringing



Laboratory and Metrology

In lab and metrology applications, the only appropriate resistors are those that will retain their initial value over time. Hermetic packaging is a must since every laboratory will have some humidity fluctuations. Additional essentials include stability under temperature fluctuations, no thermally active junctions, and a low temperature coefficient of resistance. Only one resistor combines all of these characteristics: Bulk Metal® Foil Resistors.

End Product

Real-Time Hydrogen-Specific Process Monitor

Function

Hydrogen Gas Measurement

Customer Requirements

- Reliable performance for real-time accuracy
- High speed response capabilities to detect instantaneous changes in environment
- Low TCR and low PCR specifications



The Vishay Foil Resistors Solution

VSMP0603 (Z-Foil)

Ultra high-precision foil wraparound surface-mount chip resistor (Z-Foil)

- Reliable, high-speed performance for real-time measurements:
 - Load life stability: $\pm 0.005\%$ for 2000 h, rated power at $+70^{\circ}\text{C}$
 - Absolute TCR: 0.2 ppm/ $^{\circ}\text{C}$ typical at -55°C to $+125^{\circ}\text{C}$ range
 - Power Coefficient of Resistance (PCR) " R due to self heating": 5 ppm at rated power
 - Absolute tolerance: 0.01%
 - Rise time: 1 ns effectively no ringing
- Electrostatic discharge (ESD) at least to 25 kV
- Thermal stabilization time $< 1\text{s}$ (nominal value achieved within 10 ppm of steady state value)
- Voltage coefficient: < 0.1 ppm/V
- Non inductive: < 0.08 μH

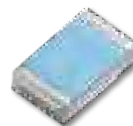

VHP203 (Z-Foil)

The hermetic sealing (oil-filled) eliminates the ingress of moisture and oxygen, while the oil acts as a thermal conductor, thus eliminating long term degradation of elements of unsealed resistors, while at the same time allowing the device to accept short periods of overload without degradation.

- Hermetically-sealed miniature ultra high-precision Z-Foil technology resistors:
 - Temperature coefficient of resistance (TCR): ± 0.05 ppm/ $^{\circ}\text{C}$ (0°C to $+60^{\circ}\text{C}$)
 - Resistance tolerance: to $\pm 0.001\%$ (10 ppm)
 - Load life stability: $\pm 0.002\%$ maximum R ($+60^{\circ}\text{C}$ for 2000h at 0.1W per chip)
 - Electrostatic discharge (ESD) up to 25 kV
 - Power rating: to 0.3W at $+25^{\circ}\text{C}$
 - Shelf life stability: 2 ppm for at least 6 years
 - Current noise: 0.010 $\mu\text{V}_{\text{RMS}}/\text{V}$ of applied voltage (< -40 dB)
 - Thermal EMF: 0.05 $\mu\text{V}/^{\circ}\text{C}$ typical
 - Voltage coefficient: < 0.1 ppm/V
 - Non inductive: < 0.08 μH



Medical

Accurate and stable instrumentation in the medical field requires the ability to detect very small signals without producing false readings. For the complement of resistors surrounding the operational amplifier and anywhere else resistors are needed in medical applications, the preferred choice of device is Vishay Foil.

End Product

Fluid Injector Device

Function

Current Sense for Motor Control

Customer Requirements

- Reliable measurements of motor control are necessary to perform injections at the precise location
- High speed response necessary to perform given task
- Low sensitivity to short-time overload
- Surface mount to preserve limited real estate
- 4 pad Kelvin connection desired as a way to improve accuracy



The Vishay Foil Resistors Solution

VCS1625ZP (Z-Foil)

Ultra high-precision Z-Foil surface-mount current sensing chip resistor

- High performance current sense:
 - Load life stability: 0.02% at 70°C, 2000h at rated power
 - Absolute tolerance: 0.2%
 - Absolute TCR: 0.05 ppm/°C typical at 0°C to +60°C range
 - Power Coefficient of Resistance (PCR) " R due to self heating": 5 ppm at rated power
 - Rise time: 1 ns effectively no ringing
 - Short time overload: <0.005%
 - Standard Kelvin connection configuration



VCS331Z, VCS332Z (Z-Foil)

High-precision 4 terminal power current sensing resistors when mounted on a heat sink can sustain 10 W continuously without an appreciable change in resistance.

- 4-Terminal power current sensing resistors:
 - Low temperature coefficient of resistance : 0.05 ppm/°C typical (0°C to +60°C)
 - Resistance tolerance : to ±0.01%
 - Rapid R stabilization under transient loads
 - Tenfold improvement of Power Coefficient of Resistance (PCR): 4 ppm/W
 - Thermal resistance: 6°C/W
 - Rise time: 1 ns, effectively no ringing
 - Power rating: to 10W on heatsink at +25°C, 3W in free air at +25°C
 - Thermal stabilization time <1s (nominal value achieved within 10 ppm of steady state value)
 - Load life stability: ±0.005% (50 ppm), 3W on heatsink at +25°C, 2000h, ±0.01% (100 ppm), 3W in free air at +25°C, 2000h



Military

Vishay Foil resistors have been used for more than 40 years in military equipment and even before a suitable MIL SPEC was established. In the late 60s, MIL PRF 55182 was established and the RNC90 style applied to the Vishay Foil resistors. Testing to "R" failure rate was conducted and the devices have been used continuously ever since. Today, Vishay Foil resistors are serving in every category of military equipment that relies on electronics for its functionality.



End Product

High Power Pulse Radio Frequency Transmitter

Function

Signal Generator and Feedback

Customer Requirements

- Real-time measurement capabilities
- Accurate digital to analog conversion capabilities
- High speed response necessary to perform given task
- Able to withstand electrostatic discharges (ESD)
- High stability
- End of life tolerance: <0.1%

The Vishay Foil Resistors Solution

Z201 (Z-Foil)

High-precision foil resistor

- The most reliable resistor for tasks that have no margin for error:
 - Temperature coefficient of resistance (TCR): ± 0.2 ppm/ $^{\circ}\text{C}$ typical (-55°C to $+125^{\circ}\text{C}$, $+25^{\circ}\text{C}$ ref.)
 - Resistance tolerance: to $\pm 0.005\%$
 - Load life stability: to $\pm 0.005\%$ at 70°C , 2000h at rated power
 - Electrostatic discharge (ESD) at least to 25 kV
 - Non inductive, non capacitive design
 - Rise time: 1 ns without ringing
 - Current noise: $0.010 \mu\text{V}_{\text{RMS}}$ /volt of applied voltage (<-40 dB)
 - Thermal EMF: $0.05 \mu\text{V}/^{\circ}\text{C}$



1445Q and 1446Q (QPL)

These networks are qualified to MIL-PRF-83401, characteristic C, schematic A, (Qualified Parts List - QPL). Actual performance exceeds all the requirements of MIL-PRF-83401 characteristics "C."

- QPL networks:
 - Hermetically sealed for maximum environmental protection - 100% leak protection
 - Gross leak: no bubbles
 - Fine leak: $<5 \times 10^{-7}$ cc/sec
 - Tested per MIL-PRF-83401
 - Ceramic package: 94% alumina (Al_2O_3)
 - Lid: gold-plated Kovar
 - Solder: tin/gold
 - Leads: alloy 42 (iron nickel) with 100μ inches gold plating (MIL-STD-1276, Type G-21-A)
 - Gold ball wire bonding
 - Foil chips V15X5

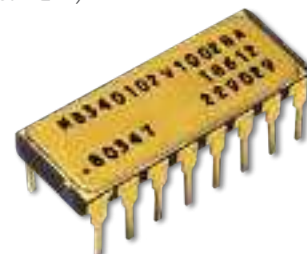

Precision Instrumentation

Whether they are used in the guidance system of a cruise missile, the autopilot of an airplane, or the remote responder of a weather station, Vishay Foil resistors are consistently the best choice for precision instrumentation because of their initial accuracy and long term stability.

End Product

Chromatography Data System Validation Instrument

Function

Unity Gain Inverting Amplifiers and Summing Amplifiers

Customer Requirements

- TCR tracking and a tight tolerance ratio is essential for gain control
- Long term stability and low drift is required for consistent performance
- Low noise capabilities which will not interfere with signal measurements



The Vishay Foil Resistors Solution

SMNZ (Z-Foil)

Ultra high-precision Z-Foil surface-mount 4 resistor network dual-in-line package

- The most precise network package for amplifier applications:
 - Absolute TCR: 0.2 ppm/°C typical at -55°C to 125°C range
 - TCR tracking: 0.1 ppm/°C typical at -55°C to +125°C range
 - Tolerance matching: 0.01%
 - Ratio stability: 0.005% for 2000h, rated power at +70°C
 - Power Coefficient of Resistance (PCR) "ΔR due to self heating": ±5 ppm at rated power
 - Current noise: 0.010 μV_{RMS}/V of applied voltage (<-40 dB)
 - Electrostatic discharge (ESD) at least to 25 kV



VFD244Z (Z-Foil)

Voltage divider with excellent Initial resistance and ratio matching, tracking in operation and fast response without ringing.

- Bulk Metal® Foil technology ultra high-precision Z-Foil voltage divider:
 - Temperature coefficient of resistance (TCR):
 - ±0.05 ppm/°C typical (0°C to +60°C)
 - ±0.2 ppm/°C typical (-55°C to +125°C, +25°C ref.)
 - TCR tracking: 0.1 ppm/°C typical
 - Resistance tolerance: absolute and matching to 0.005% (50 ppm)
 - Power rating: up to 1W at 70°C
 - Load life ratio stability: <0.005% (50 ppm) 1W at +70°C for 2000h
 - Maximum working voltage: 350V
 - Rise time: 1 ns effectively no ringing
 - Current noise: 0.010 μV_{RMS}/V of applied voltage (<-40 dB)
 - Thermal stabilization time <1s (nominal value achieved within 10 ppm of steady state value)

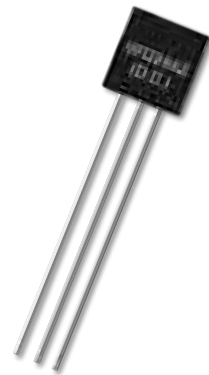

Weighing Scales

Whatever they're weighing, whether it's gems or pharmaceuticals, scales must be accurate day in and day out. Some are in harsh environments while others are in laboratories. But regardless of the application, accuracy and consistency are the prime targets. For nearly 50 years, Vishay Foil resistors have been a key enabling component for weighing systems, and they continue to serve this important sector today.

End Product

Weighing Scale

Function

Current Sense and Voltage Reference



Customer Requirements

- High-precision measurement capabilities
- Accurate digital to analog conversion capabilities
- Low noise for best performance

The Vishay Foil Resistors Solution

CSM3637S

Bulk Metal® Foil technology high-precision, current sensing, power surface mount, metal strip resistor that meets the requirements of MIL-PRF-49465B.

- The most precise and reliable resistor available:
 - Absolute tolerance: 0.2%
 - Absolute TCR: 20 ppm/°C maximum at -55°C to +125°C, +25°C ref.
 - Power rating: 2W
 - Load life stability: ±0.05% for 2000h, rated power at +70°C
 - Thermal EMF: <3 µV/°C



CSM2512S

Bulk Metal® Foil technology high-precision, surface-mount configuration with four terminal (Kelvin) design which allows precision and accurate measurements with improved stability.

- Current sensing, power surface-mount, metal strip resistor:
 - Temperature coefficient of resistance (TCR): ±15 ppm/°C maximum (-55°C to +125°C, +25°C ref.)
 - Load life stability to ±0.05% (70°C, 2000h at rated power)
 - Power rating: 1W
 - Resistance tolerance: ±0.1%
 - Short time overload: ±0.1% typical
 - Thermal EMF: <3 µV/°C
 - Maximum current: up to 10A



Check also: CSM3637Z, CSM3637P, CSM3637, CSM2512

Foil Door2Door Prototype Services

At Vishay Foil Resistors, we are dedicated to promoting successful relationships with all of our customers. One of the ways we help speed your time to market is by making prototype devices available quickly.

The parts delivered by Vishay Foil Resistors' Prototype Fastlane Services are the same parts as produced in our standard production, so they have all of the features and benefits of Foil technology:

Temperature coefficient of resistance (TCR): ± 0.2 ppm/ $^{\circ}\text{C}$ (-55°C to $+125^{\circ}\text{C}$, $+25^{\circ}\text{C}$ ref.)

Resistance tolerance absolute and match: to $\pm 0.005\%$

Power coefficient of resistance (PCR) " R due to self heating": 5 ppm at rated power

Electrostatic discharge (ESD): at least to 25 kV

Load Life Stability: $\pm 0.005\%$ (70°C , 2000h at rated power)

Vishay Foil resistors are not restricted to standard values; specific "as-required" values can be supplied at no extra cost or delivery (e.g. 1K00025 vs. 1K)

Non-capacitive design

Non-inductive: $< 0.08 \mu\text{H}$

Current noise: $0.010 \mu\text{V}_{\text{RMS}}/\text{V}$ of applied voltage (< -40 dB)

Voltage coefficient: < 0.1 ppm/V

Thermal stabilization time: $< 1\text{s}$ (nominal value achieved within 10 ppm of steady state value)

Pattern design minimizing hot spots

Terminal finishes available:
lead (Pb)-free or tin/lead alloy

Matched sets with TCR tracking
are available upon request

Resistors for high temperature
applications (to 220°C) are
also available



We launched novel rapid prototype sample services which will answer all market delivery demands for precision resistors.

Foil Door2Door – Service for Rapid Prototyping Samples

When you need to evaluate 1 to 5 standard precision resistors for your prototype, you want them in a hurry. Vishay Foil Resistors now guarantees a 5 working day delivery on any value from 0R002 to 1M and any tolerance to 0.005%, per individual product specifications (available through our Field Design Engineers only). There is no need to stock a wide array of R&D precision resistors at minimum order prices when you can buy only what you need and get them within days. And, because this resistor is the most precise resistor available, it will satisfy all your R&D requirements. With Foil Door2Door service — you can get Vishay Foil resistors in prototype quantities in just 5 working days or sooner!

We will send them directly from the main facility or via one of our precision centers or “Foil resistor quick delivery sources” which are spread around the world.

For prototype samples please contact us at foil@vishaypg.com or contact your regional Field Design Engineer or Precision Center as listed in the [Contacts](#) section.

24/7 Support Available – Contact foil@vishaypg.com

North America

Field Design Engineer (FDE) Territory Key:

Kip Reiner

(Also W. Canada, AK & HI)
email: kip.reiner@vishaypg.com
tel: +1 (949) 349-0604
mobile: +1 (610) 457-8095

Bill Demers

(Also E. Canada – Manitoba eastward)
email: bill.demers@vishaypg.com
tel: +1 (603) 329-0149
mobile: +1 (978) 502-8869

Jay Hampton

email: jay.hampton@vishaypg.com
tel: +1 (352) 293-4824
mobile: +1 (610) 504-9952

Precision Centers:

Contact: foil@vishaypg.com
Digikey – Thief River Falls, MN
Scott Stein
Wilbrecht Ledco – Saint Paul, MN
Greg Engst
ElcoPC, L.L.C – West Chester, PA
Hanna Kazimierzcyk
UHP Resistors – Ontario, CA
Haim Shmutz
Texas Components – Houston, TX
Nelson Bustos

Customer Service:

Angela Coley – Malvern, PA
email: angela.coley@vishaypg.com
tel: +1 (484) 321-5313
Lorraine Martinez – Malvern, PA
email: lorraine.martinez@vishaypg.com
tel: +1 (484) 321-5314
Scott Ryan – Malvern, PA
email: scott.ryan@vishaypg.com
tel: +1 (484) 321-5312

Application Engineering:

Aaron Ram – Malvern, PA
email: aaron.ram@vishaypg.com
tel: +1 (484)-321-5317
mobile: +1 (610) 969-5799
Steve Phillips – Malvern, PA
email: steve.phillips@vishaypg.com
tel: +1 (484) 321-5331
mobile: +1 (610) 324-7060

Strategic Account Manager:

John Frantz – Malvern, PA
email: john.frantz@vishaypg.com
tel: +1 (484) 321-5328
mobile: +1 (484) 844-3273

For Any Special Requests:

Please contact: Yuval Hernik
Director of Sales and Marketing
email: yuval.hernik@vishaypg.com
tel: +972 3 557 0852
mobile: +972 54 3000 191

★ FOIL DIVISION HEADQUARTERS
☆ PRECISION CENTER



24/7 Support Available – Contact foil@vishaypg.com

Europe

Field Design Engineer (FDE) Territory Key:

Rod Myall

email: rod.myall@vishaypg.com
tel: +44 1508488349
mobile: +44 7801336013

Kevin Smith

email: kevin.smith@vishaypg.com
tel: +44 1256 462131
mobile: +44 7881 336060

Frank Weise

email: frank.weise@vishaypg.com
tel: +49 33205 20408
mobile: +49 16094192188

Laurent Wallet

email: laurent.wallet@vishaypg.com
tel: +33 299742582
mobile: +33 680115951

Yosi Tzabari

email: yosi.tzabari@vishaypg.com
tel: +972 3 557 0401
mobile: +972 54 3000263

Hero Faierstein

email: hero.faienstein@vishaypg.com
tel: +972 3 557 0834
mobile: +972 54 3000063

Precision Centers:

Contact: foil@vishaypg.com
Powertron – Teltow, Germany
Klaus Baufeld
BedeK – Dinkelsbühl, Germany
Thomas Piltz
Charcroft – Llanwrtyd Wells, United Kingdom
Paul Newman

Customer Service:

Beryl Watts – Basingstoke, United Kingdom
email: beryl.watts@vishaypg.com
tel: +44 (1953) 860761
Daniela Wagner – Heilbronn, Germany
email: daniela.wagner@vishaypg.com
tel: +49 (0)7131-39099 192
Krisztina Bako – Heilbronn, Germany
email: krisztina.bako@vishaypg.com
tel: +49 (0)7131-39099 193

Strategic Account Manager:

Thomas Koch – Heilbronn, Germany
email: thomas.koch@vishaypg.com
tel: +49 (0)7131-39099 195
mobile: +49 (0)15112105798

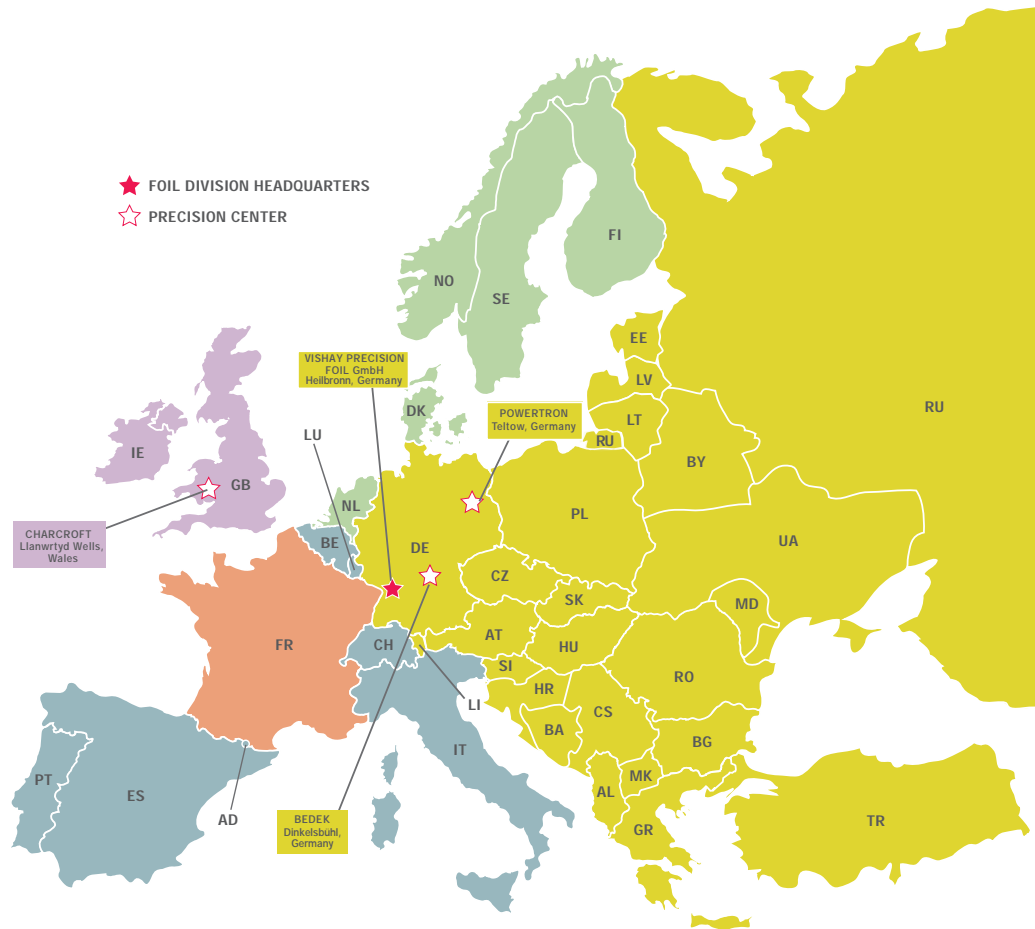

24/7 Support Available – Contact foil@vishaypg.com

Central and South America

Field Design Engineer (FDE) Territory Key:

Jay Hampton

email: jay.hampton@vishaypg.com
tel: +1 (352) 293-4824
mobile: +1 (610) 504-9952



24/7 Support Available – Contact foil@vishaypg.com

Asia and Israel

Field Design Engineer (FDE) Territory Key:

Takashi Sannomiya

email: takashi.sannomiya@vishaypg.com
tel: +81-3-5282-2673
mobile: +818054098970

Yosi Tzabari

email: yosi.tzabari@vishaypg.com
tel: +972 3 557 0401
mobile: +972 54 3000263

Precision Center:

Contact: sales-alpha@alpha-elec.co.jp
Alpha – Akita, Japan
Takashi Sannomiya

Customer Service:

Mieko Sugiyama – Tokyo, Japan
email: mieko.sugiyama@vishaypg.com
mieko.kato@vishaypg.com
tel: +81-3-5282-2761

Heian Cho – Tokyo, Japan

email: heian.cho@vishaypg.com
tel: +81-3-5282-2761

Sr. Sales Manager:

Takashi Sannomiya – Tokyo, Japan
email: takashi.sannomiya@vishaypg.com
tel: +81-3-5282-2673
mobile: +81-80-5409-8970

- ★ FOIL DIVISION HEADQUARTERS
- ☆ PRECISION CENTER





Product Listing

Bulk Metal®Foil Resistive Products

Strain Gage Transducers and Stress Analysis Systems

PhotoStress® Strain Gages Load Cells Instruments
Process Weighing Systems Onboard Weighing Systems
Web Tension Weighing Systems Data Acquisition Systems
Specialized Strain Gage Systems

Brands

Bulk Metal®Foil Resistive Products

Vishay Foil Resistors Alpha Electronics Powertron

Micro-Measurements

Micro-Measurements

Load Cells

Celtron Revere Sensortronics Tedea-Huntleigh

Weighing Systems

BLH Nobel Weighing Systems PM Onboard SI Onboard

Americas

United States

Vishay Precision Group
Vishay Foil Resistors

3 Great Valley Parkway, Suite 150 • Malvern, PA 19355
Ph: +1-484-321-5312/3/4 • Fax +1-610-884-7883
E-mail: foil.usa@vishaypg.com

Japan and Asia Pacific

Japan

Vishay Precision Group
Vishay Foil Resistors
Alpha Electronics Corporation
Vishay Precision Foil K.K.

2F Hagoromo Bldg., 1-2-10 • Uchikanda, Chiyoda-ku • Tokyo 101-0047
Ph: +81-3-5282-2761 • Fax: +81-3-5282-2748
E-mail: foil.jp@vishaypg.com

Israel

Vishay Precision Group
Vishay Foil Resistors

2 HaOfan Street • Holon 58814
Ph: +972-3-557-0907/0924 • Fax: +972-3-558-8385
E-mail: foil.il@vishaypg.com

Europe

Germany

Vishay Precision Group
Vishay Foil Resistors

Tatschenweg 1 • D-74078 Heilbronn D-74078
Ph: +49-7131-39099-190 • Fax: +49-7131-39099-199
E-mail: foil.de@vishaypg.com

France

Vishay Precision Group
Vishay Foil Resistors

16, Rue Francis Vovelle • Chartres 28000
Ph: +33-237-288-601 • Fax: +33-237-288-602
E-mail: foil.fr@vishaypg.com

United Kingdom

Vishay Precision Group
Vishay Foil Resistors

Stroudley Road • Hants • Basingstoke, Hampshire RG24 8FW
Ph: +44-1953-860761 • Fax: +44-1953-860761
E-mail: foil.uk@vishaypg.com



Technical Support Contact: foil@vishaypg.com