



BLH

**Model LCp-200
Weight/Rate Indicator
Operator's Manual**

NOTICE

BLH makes no representation or warranties of any kind whatsoever with respect to the contents hereof and specifically disclaims any implied warranties or merchantability or fitness for any particular purpose. BLH shall not be held liable for errors contained herein or for incidental or consequential damages in connection with the furnishing, performance, or use of this publication or its contents.

BLH reserves the right to revise this manual at any time and to make changes in the contents hereof without obligation to notify any person of such revision or changes.

Call (781) 298-2216 for BLH Field Service

Table of Contents

SECTION 1.	General Information	1-1
1.1	Instrument Description	1-1
1.1.1	Introducing the Plug-n-Weigh Concept	1-1
1.1.2	The Safe-Weigh Software System	1-1
1.1.3	The LCp-200 Front Panel.....	1-1
1.1.4	Main Configuration Flow Diagram.....	1-1
1.1.5	Serial Communication	1-4
1.2	OPTIONS	1-4
1.2.1	Mounting Options	1-4
1.2.2	Internal Summing Junction Board	1-4
1.2.3	Analog Output	1-4
1.2.4	Solid State Relay Set Point Outputs	1-4
1.2.5	Allen-Bradley Remote I/O Network Interface	1-4
1.2.6	MODBUS RTU Protocol.....	1-5
1.2.7	Fisher Provox Protocol.....	1-5
1.2.8	On-line Service Modem.....	1-5
1.2.9	MODBUS Plus Protocol	1-5
1.3	LCp-200 Specifications	1-5
1.4	Ordering Information	1-6
1.5	WARRANTY POLICY	1-6
1.6	FIELD ENGINEERING.....	1-7
SECTION 2.	Installation	2-1
2.1	INTRODUCTION.....	2-1
2.2	MOUNTING.....	2-1
2.2.1	Standard Unit Mounting	2-1
2.2.2	Optional NEMA 414X Enclosures	2-1
2.3	ELECTRICAL CONNECTIONS	2-3
2.3.1	The LCp-200 Rear Panel	2-3
2.3.2	Transducer Signal Inputs	2-3
2.3.3	Mains (AC) Power	2-3
2.3.4	Serial Communication	2-4
2.3.5	Analog Output (Option)	2-5
2.3.6	Digital (Remote) Inputs	2-5
2.3.7	Open Collector (Set Point) Outputs.....	2-5

2.3.8	Allen Bradley Remote I/O (Optional).....	2-6
2.3.9	Summing Junction Box Considerations	2-6
2.3.10	Modbus Plus.....	2-8
2.3.11	Solid State Relay Outputs (Optional)	2-8
SECTION 3.	Setup and Calibration.....	3-1
3.1	INTRODUCTION.....	3-1
3.2	SET-UP SYSTEM PARAMETERS	3-1
3.2.1	Display Units	3-1
3.2.2	Capacity	3-1
3.2.3	Decimal Point Location	3-1
3.2.4	Output.....	3-1
3.2.5	Front Panel Display Counts	3-1
3.3	SYSTEM CALIBRATION	3-1
3.3.1	Quick Type Calibration.....	3-1
3.3.2	Deadload Calibration.....	3-1
3.3.3	Keypad Calibration	3-1
SECTION 4.	Dynamic Digital Filter	4-1
4.1	GENERAL	4-1
4.1.1	Digital Averaging	4-1
4.1.2	Band Selection	4-1
4.1.3	Filter Set-Up Procedures.....	4-1
SECTION 5.	Front Panel Display Functions	5-1
5.1	FRONT PANEL FUNCTIONS	5-1
5.1.1	Horizontal Bar Graph	5-1
5.1.2	Vertical Bar Graph.....	5-1
5.1.3	Alarm Status Annunciators.....	5-1
5.1.4	Configuring the TARE Key	5-1
5.1.5	Configuring the ZERO Key.....	5-3
5.1.6	Configuring the Gross/Net (GIN) Key.....	5-3
5.2	VIEW mV/V SIGNAL	5-3
SECTION 6.	Analog Output, Serial Communication, and Set Points	6-1
6.1	ANALOG OUTPUT CONFIGURATION (Optional)	6-1
6.1.1	Output Definition.....	6-1
6.1.2	Set-Up Procedure.....	6-1
6.2	SERIAL COMMUNICATION	6-1

6.2.1	Transmit Only Output Formats (ASCII)	6-1
6.2.2	Full/Half Duplex Bi-Directional Interface	6-2
6.2.3	Modbus RTU Protocol (Optional)	6-2
6.2.4	Modbus Plus Protocol (Optional)	6-2
6.2.5	Fisher Rosemount - Provox Protocol (Optional)	6-2
6.2.6	Allen-Bradley Remote I/O (Optional).....	6-2
6.3	SETPOINT CONFIGURATION	6-11
6.3.1	Main Set point Function and Selections.....	6-11
6.3.2	Entering/Altering Main Set points.....	6-11
6.3.3	Dribble Set point Function and Selection	6-12
SECTION 7.	System Diagnostics.....	7-1
7.1	OVERVIEW	7-1
7.1.1	Diagnostic User	7-1
7.1.2	Diagnostic Version	7-1
7.1.3	Diagnostic Recall.....	7-1
7.1.4	Selecting Limits	7-1
7.1.5	Front Panel Key Test	7-1
7.1.6	Check Remote Inputs.....	7-1
7.1.7	Test/Verify the Analog Output.....	7-1
7.1.8	Test/Troubleshoot the Serial Output	7-1
7.2	SIMULATING A WEIGHMENT	7-1
7.3	TEST/TROUBLESHOOT THE INTERNAL MODEM	7-2
SECTION 8.	Rate-By-Weight.....	8-2
8.1	GENERAL	8-2
8.1.1	Determining Minimum Flow Rate Capability	8-2
8.1.2	Determining Display and Output Update Frequency	8-2
8.1.3	Determining Weight/Rate Resolution.....	8-2
8.2	PARAMETER SELECTIONS	8-2
8.2.1	Units	8-2
SECTION 9.	Security System	9-2
9.1	INTRODUCTION.....	9-2
9.1.1	Lock On/Off	9-2
9.1.2	Menu Locks.....	9-2
9.1.3	Key Locks.....	9-2
9.1.4	Set Point Locks	9-2

9.2	PASSWORD ACCESS	9-2
9.2.1	9.2.1 Selecting/Storing a Password	9-2
9.2.2	Entering the Password	9-2
SECTION 10.	Operation.....	10-2
10.1	GENERAL	10-2
10.2	GROSS WEIGHT WEIGHING	10-2
10.3	ZERO OPERATION	10-2
10.4	NET WEIGHT WEIGHING	10-2
10.5	TARE OPERATION	10-2
10.6	RATE-BY-WEIGHT	10-2
10.7	SETPOINT FUNCTION.....	10-2
10.8	ERROR DETECTION AND CORRECTION	10-2
SECTION 11.	Modem and Protocol Options.....	11-4
11.1	GENERAL	11-4
11.2	THE SERVICE LINK MODEM	11-4
11.3	MODBUS RTU PROTOCOL.....	11-4
11.3.1	Common Data Format.....	11-4
11.3.2	Modbus RTU Functions Supported.....	11-4
11.3.3	Setup	11-4
11.4	MODBUS PLUS INTERFACE.....	11-5
11.4.1	Routing Path Addressing	11-5
11.4.2	Global Data Transfers	11-5
11.4.3	Wiring and Node Addressing	11-5
11.4.4	Configuration	11-6
11.4.5	Data Formatting.....	11-6
11.4.6	Flashing LED Status	11-7
11.4.7	Manipulating the Front Panel Display	11-7
11.5	PROVOX PROTOCOL.....	11-7
11.5.1	Wiring	11-8
11.5.2	Configuration	11-8
11.5.3	Operation.....	11-8
SECTION 12.	Profibus	12-1
12.1	THE INTERFACE DEFINED.....	12-1
12.1.1	Profibus DP	12-1
12.1.2	GSD Files	12-1

12.2	INTERFACE WIRING	12-1
12.3	LCp-200 MENU CHANGES	12-1
12.3.1	I/O Menu Changes	12-1
12.3.2	Diagnostic Menu Changes	12-1
12.4	DATA EXCHANGE FORMATS.....	12-1
12.4.1	Input Data (LCp-200 Transmission)	12-1
12.4.2	Output Data (from the Master)	12-1
SECTION 13.	DeviceNet.....	13-1
13.1	THE INTERFACE DEFINED.....	13-1
13.1.1	General ODVA DeviceNet Description	13-1
13.1.2	LCP-200 DeviceNet Interface Description	13-1
13.2	INTERFACE WIRING	13-1
13.2.1	LCP-200 DeviceNet Interface Description	13-1
13.3	INTERFACE WIRING	13-1
13.4	LED STATUS INDICATION	13-2
13.4.1	LCp-200 Status	13-2
13.4.2	DeviceNet Network Status	13-2
13.4.3	LCp-200 MENU CHANGES	13-2
13.4.4	I/O Menu Changes	13-2
13.4.5	Diagnostic Menu Changes	13-3
13.4.6	Display Menu Changes	13-5
13.5	DATA EXCHANGE FORMATS.....	13-5
13.5.1	Produced Data (LCp-200 Transmission)	13-6
13.5.2	Consumed Data (LCp-200 Receive).....	13-6
13.5.3	Consumed Data (1.Cp-200 Receive).....	13-6
13.6	DeviceNet EDS FILE.....	13-11
Appendix A.	Outlines and Wiring Diagrams.....	1
Appendix B –	Flow Diagrams.....	4

Trademark Usage Acknowledgments

Allen-Bradley is a trademark of Allen-Bradley Company, Inc.
 PLC and PLC-5 are trademarks of Allen-Bradley Company, Inc.
 Modbus is a trademark of Schneider Automation.
 Provox is a trademark of Fisher Rosemount Inc.
 DeviceNet is a trademark of the Open DeviceNet Vendor Association, Inc.

SECTION 1. General Information

1.1 Instrument Description

The LCp-200 'Expert Series' indicator/controller (Figure 1-1) is a microprocessor based device designed to convert the mV/V signal from strain gage type force transducers (load cells) into a high resolution digital signal representing force, weight, or mass flow rate. Units operate at either 115 or 230 VAC and provide a regulated, fault protected 10 VDC excitation for up to eight 350 ohm transducers. Standard features include rate-by-weight operation, an RS-422/485 serial port with PC interface or simplex output ASCII protocol (Digi-System Network available in 1996), a sigma delta type ND converter, system simulation mode, 8 dc process control set points, and dynamic digital filtering. Options include a sixteen bit resolution analog output, Allen Bradley Remote I/O interface, various serial protocols, 8 ac set point outputs, and an internal modem for remote configuration, service, and monitoring.

Each unit is housed in an aluminum case with a powder coated aluminum panel mounting bezel. NEMA 4, 4X or explosion-proof wall mount enclosures are available as options. Simple entry of calibration data, diagnostic parameters, and filter selections is accomplished using the front panel keypad. All electrical connections are made at the rear panel with unpluggable screw terminal connectors.

1.1.1 Introducing the Plug-n-Weigh Concept

The BLH Plug-n-Weigh concept takes advantage of technology to minimize start-up time and the operator learning curve. Intuitive configuration menus, self configuration of many set-up parameters, and simple push-button type digital calibration combine together to make the LCp-200 one of the easiest process instruments to configure and operate.

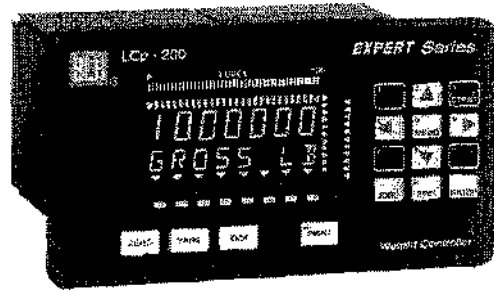

Figure 1-1. The LCp-200

1.1.2 The Safe-Weigh Software System

Safe-Weigh software system benefits include Expert System Diagnostics, Dynamic Digital Filtering, and a wide range of proven DCS/PLC connectivity options. Expert System Diagnostics provides on-line preventative maintenance information which quickly identifies electrical and/or mechanical problems. Dynamic Digital Filtering ensures precise, repeatable set point control in 'noisy' process environments. Proven connectivity with Allen-Bradley, Modicon (AEG Schneider) General Electric, Johnson Yokogawa, Honeywell, Fisher-ProVox, Bailey, and other PLC/DC devices eliminate the risks associated with digital integration of weight information into the process control environment.

1.1.3 The LCp-200 Front Panel

All configuration, calibration, and operation transactions are performed using the front panel numeric keypad, operating push buttons, and the high intensity vacuum fluorescent display (Figure 1-2). The user friendly design separates the operating push buttons (gross/net, zero, tare and print) from the configuration menu numeric keypad. The two line alphanumeric display indicates weight data and status while in the operate mode and provides instructions etc. during the configuration mode.

1.1.4 Main Configuration Flow Diagram

LCp-200 configuration is performed using the menu driven keypad on the right side of the front

panel and follows the flow diagram presented in Figure 1-3. This diagram shows the overall structure and general guidelines of the LCp-200 set-up, calibration, filter, display, I/O, diagnostic, and security configuration routines. Detailed explanations of sub menu parameter selections are defined in sequential chapters, starting with

Section 3. To browse through the menus, press MENU and use the arrow keys to move across menu subjects, or up and down within a menu. Parameters are not actually changed until the edit and enter keys are used. Another copy of this diagram is presented in Appendix A.

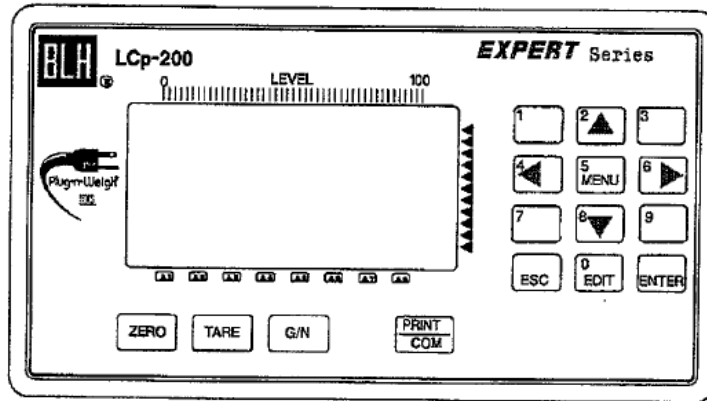

Figure 1-2. The LCp-200 Front Panel

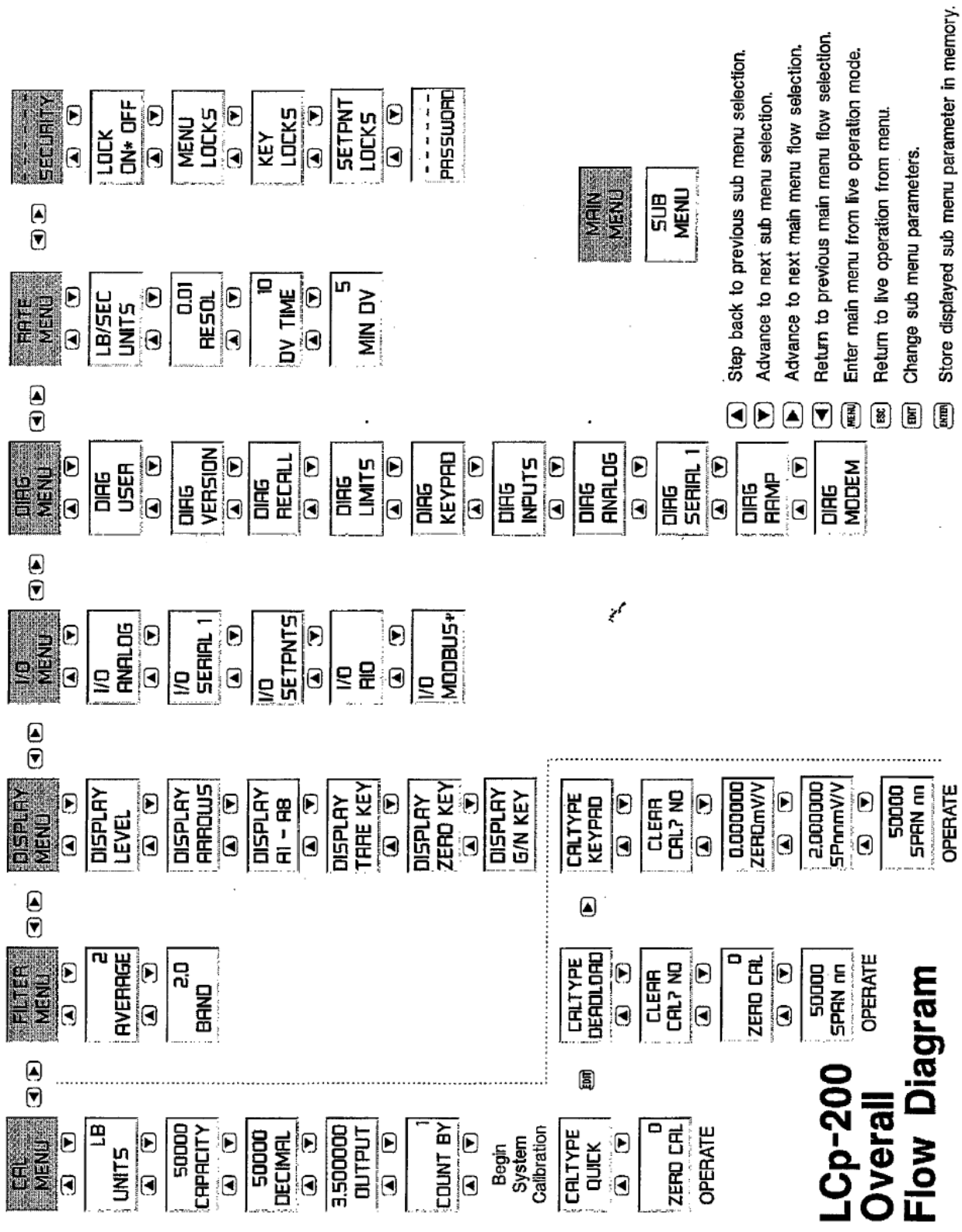

Figure 1-3. Main Flow Diagram.

LCp-200 Overall Flow Diagram

1.1.5 Serial Communication

The standard LCp-200 is equipped with a single serial communication port that can be selected to operate as an RS 422 full duplex, or RS 485 half duplex port. The type selection is made using a series of DIP switches on the back panel. Protocol selection is made within the keypad menu structure. The standard version is provided with BLH network or ASCII protocol selections. The BLH network protocol (avail. 1997) allows the LCp-200 to communicate in a local area network to a BLH network controller/gateway. The ASCII protocol option is designed to communicate with a printer, PC, remote display, or data logger and can be selected for continuous or demand operation. Extensive diagnostics verify transmit and receive, proper parity and framing, and a visualization function allows the user to view the actual serial transmit and receive characters. See Section II for wiring information and Section VI for protocol information.

1.2 OPTIONS

LCp-200 units are available with several different application enhancement options. Options include various mounting enclosures, solid state relay set point outputs, custom network interfaces and protocols, and a factory-link modem for on-line service/calibration assistance. All options will be fully defined later in this manual.

1.2.1 Mounting Options

For units located in a general factory/plant floor, or if corrosive, hose down, or sanitary requirements are a factor, a NEMA 4X stainless steel enclosure is available. For Div. 2 hazardous locations, units are available with FM approval as a non-incendive device. For Division 1 hazardous locations an explosion proof enclosure is available. (Note: BLH Intrinsic Safety Barrier Sets must be specified when load cells are located in a Division I area.) Refer to Appendix A for detailed enclosure outline drawings.

1.2.2 Internal Summing Junction Board

For systems where the LCp-200 is located within 10 meters of the load cells, an optional 306 summing board is available mounted inside the NEMA 4/4X enclosure.

1.2.3 Analog Output

The LCp-200 is available equipped with a high resolution 16 bit analog output. This output can be configured for 4-20 mA, 0-20 mA, or 0-24 mA operation via rear panel DIP switch selections. Set-up and calibration of the analog output is configured via the menu keypad and can be configured to track gross or net weight data. Loop diagnostics are also provided to verify that the analog connection is intact. See Section II for wiring information and Section VI for configuration details.

1.2.4 Solid State Relay Set Point Outputs

Solid state relay outputs provide ac set point control for up to 8 weight or rate values. As with standard (dc) outputs, values can be entered through the front panel numeric keypad or downloaded serially from a host device.

1.2.5 Allen-Bradley Remote I/O Network Interface

The Allen-Bradley Remote I/O interface is a communication link that supports remote, time critical I/O control communications between a master processor and a remote I/O slave. It is typically used to transfer I/O bit images between the master and slave. The LCp-200 represents a quarter (1/4) Rack of discrete I/O with 32 bits of input and output image files to the scanning PLC. All weight data and status information uses discrete reads and writes to communicate scale information to the PLC in the shortest time possible. Block data transfers are used to communicate non-time critical diagnostic and calibration data, remotely configure diagnostic limits, and digital filter parameters.

1.2.6 MODBUS RTU Protocol

MODBUS is recognized as an industry standard digital communication protocol between a master or host computer and a slave device. This protocol was originally developed by Modicon to communicate discrete and analog information between a PLC and a master host. As implemented in the LCp-200, this protocol efficiently communicates weight and diagnostics information to a MODBUS Master driver equipped host.

1.2.7 Fisher Provox Protocol

This option allows direct communication with a Fisher CL6921 type interface card when the CL6921 is configured for the 'Toledo' interface. Weight and/or rate data is transmitted every 50 milliseconds from the standard LCp-200 serial output port.

1.2.8 On-line Service Modem

A built-in modem is available to connect the LCp-200 via the telephone system, to the BLH factory field service office. Over the communication link, remote configuration, diagnostics of system problems and service procedures can be performed economically and virtually immediately. The on-line connection can also accommodate the download of upgraded operating software.

1.2.9 MODBUS Plus Protocol

MODBUS Plus protocol allows the LCp-200 to communicate on a peer-to-peer network link with Modicon 984 and Quantum PLC devices. See Section XI for a full description of this interface.

1.3 LCp-200 Specifications

Performance

Resolution	1048576 total counts
Displayed Resolution	700,000 counts
Conversion Speed	50 msec
Displayed Sensitivity	0.05 μ V per count
Noise	0.4 μ V per count (min. filt. setting)
Full Scale Range	3.5 mV/V
Dead Load Range	100% full scale
Input Impedance	10 m-ohms min
Excitation Voltage	10 Vdc @ 250 mA
Linearity	(\pm 0.0015% full scale
Software Filter	multi-variable up to 10,000 msec
Step Response	one conversion
Temp Coefficient Zero	(\pm 2ppm/ $^{\circ}$ C
Temp Coefficient Span	(\pm 7ppm/ $^{\circ}$ C

Environment

Operating Temperature	-10 to 55 $^{\circ}$ C (15 to 131 $^{\circ}$ F)
Storage Temperature	-20 to 85 $^{\circ}$ C (-5 to 185 $^{\circ}$ F)
Humidity	5 to 90% rh non-condensing
Voltage	117/230 Vac (\pm 15% @ 50/60 Hz)
Power	15 watts max

Enclosure

Dimensions (std)	4.63 x 8.40 x 6.5 in. HWD
NEMA 4/4X, 12 (opt)	8.5 x 13.5 x 10.45 in. HWD

Materials

Aluminum Case & Bezel	overlay meets 94V-0 rating
-----------------------	----------------------------

Display

Type	high intensity cobalt green vacuum fluorescent
Active Digits	7 digit alpha numeric .59" high for weight; 8 digit alpha numeric .39" high for status

Analog Output (Optional)

Conversion	16 bit D-A
Current Selectable max.	4-20 mA or 0-20 mA - 600 ohm

Remote Digital Inputs (Optically Isolated)

(Contact closure or dc logic compatible)	
Closed (Momentary)	logic low
Open	logic high
Cable Length	100 feet max.

DC Setpoint Outputs - 8 (Standard)

Type	open collector (current sinking)
Operating Voltage	5 - 35 Vdc
ON Voltage	1.2 Vdc @ 40 mA
	0.8 Vdc @ 1 mA
OFF State Leakage	0.04 μ A @ 40 Vdc
Power	external supply required

AC Setpoint Outputs - 8 (Optional)

Type	triac
Operating Voltage	12 - 240 Vac
AC Frequency	20 - 500 Hz
ON State Voltage Drop	1.2 Vrms
Min - Max Load Current	5mA - 1A
Leakage Current	1mA @ full rated load voltage
Power	external supply required

Communications (Standard)

Serial RS-422/485	full or half duplex ASCII, printer, Provox, MODBUS or BLH network protocols
Baud Rates	odd, even or no parity- selectable 300, 1200, 2400, 4800, 9600, or 19200
Addressing	0-99

Special Interfaces (Optional)

Alien-Bradley Modbus RTU	Remote I/O - 1/4 Logical Rack slave
Fisher Provox Card	CL6921 Weigh Scale Interface
Modbus Plus	release pending

Internal Service Modem (Optional)

Baud Rate	2400: Bell 212 and 103 compatible
Availability	U.S.A. and Canada only

1.4 Ordering Information

Basic Unit LCp-200 [M]-[AP]-[C]-[B]-[M]

[M] Mounting	(1) NEMA 4X Panel Mount (2) #1 & FM/CSA Division 2 Approval (5) NEMA 4x Stainless Steel Wall Mount (6) #5 & FM/CSA Division 2 Approval (7) #5 with 306 Internal Summing Board (8) #6 with 306 Internal Summing Board (13) #6 with Type Y Purge per NFPA 496 (suitable for Div. 1) (14) #8 with Type Y Purge per NFPA 496 (suitable for Div. 1)
[A] Expansion Slot A	(1) None (3) MODBUS Plus (4) Allen-Bradley Remote I/O (5) Profibus (6) DeviceNet
[P] Process Inputs and Outputs	(1) Remote Function Inputs (2) #1 & Analog Current Output
[C] Communication	(1) RS-485 or RS-422 with PC Interface ASCII Protocol (2) #1 & MODBUS RTU Protocol (3) #1 & Fisher Provox Protocol (includes 20 mA serial converter board)
[B] Expansion Slot B	(1) None (2) 8 Open Collector (DC) Setpoint Outputs (3) 8 Solid State Relay (AC) Setpoint Outputs
[M] Modem/On-Line Service	(1) None (2) Modem W/90 Days On-Line Service

NOTE: Always contact your local BLH representative for accurate ordering information

NOTE: This product will not interface with the LCp-40, 41, and 42 network controllers

1.5 WARRANTY POLICY

BLH warrants the products covered hereby to be free from defects in material and workmanship. BLH's liability under this guarantee shall be limited to repairing or furnishing parts to replace, f.o.b. point of manufacture, any parts which, within three (3) years from date of shipment of said product(s) from BLH's plant, fail because of defective workmanship or material performed or furnished by BLH. As a condition hereof, such defects must be brought to BLH's attention for verification when first discovered, and the material or parts alleged to be defective shall be returned to BLH if requested. BLH shall not be liable for transportation or installation charges, for expenses of Buyer for repairs or replacements or for any damages from delay or loss of use for other indirect or consequential damages of any kind. BLH may use improved designs of the parts to be replaced. This guarantee shall not apply to any material which shall have been repaired or altered outside of BLH's plant in any way, so as in BLH's judgment, to affect its strength, performance, or reliability, or to any defect due in any part to misuse, negligence, accident or any cause other than normal and reasonable use, nor shall it apply beyond their normal span of life to any materials whose normal span of life is shorter than the applicable period stated herein. In consideration of the forgoing guarantees, all implied warranties are waived by the Buyer, BLH does not guarantee quality of material or parts specified or furnished by Buyer, or by other parties designated by buyer, if not manufactured by BLH. If any modifications or repairs are made to this equipment without prior factory approval, the above warranty can become null and void.

1.6 FIELD ENGINEERING

Authorized BLH Field Service Engineers are available around the world to install LCp-200 transmitters and/or train factory personnel to do so. The field service department at BLH is the most important tool to assure the best performance from your application. Field service phone numbers are listed below.

Factory: (Main Number) (781) 298-2200

(800) 567-6098 in Canada

SECTION 2. Installation

2.1 INTRODUCTION

This chapter provides LCp-200 mounting and electrical installation information. Instruments will operate accurately (to specification) in locations with temperatures ranging from -10°C to +55°C (+14°F to + 130°F). The installation location should be free of vibration. Unless equipped with the proper enclosure option, instruments should not be located in areas containing explosive or corrosive vapors. In all installations, ac (mains) power should be supplied from a clean (transient free) instrument power source.

2.2 MOUNTING

2.2.1 Standard Unit Mounting

Standard LCp-200 controllers are shipped with the necessary hardware for panel mounting. Outline and panel cutout dimensions are depicted in Figure 2-1. Installation of panel

mount adapters is shown in Figure 2-2 (following page).

2.2.2 Optional NEMA 414X Enclosures

NEMA 4 and 4X enclosures are equipped with four pre-punched holes for mounting to a wall or bracket. A U-bolt can be used for mounting to a pipe support. The enclosure should be installed in a vibration free environment close to the load cell summing junction box. If conduit is used to shield interconnecting cables, drains should be provided to reduce the possibility of condensate entering the enclosure. Outline dimensions for NEMA 414X enclosures are presented in Figure 2-3 (following page).

NOTE: Units purchased with the NEMA enclosure option can be equipped with an internal transducer summing board (see paragraph 2.3.9).

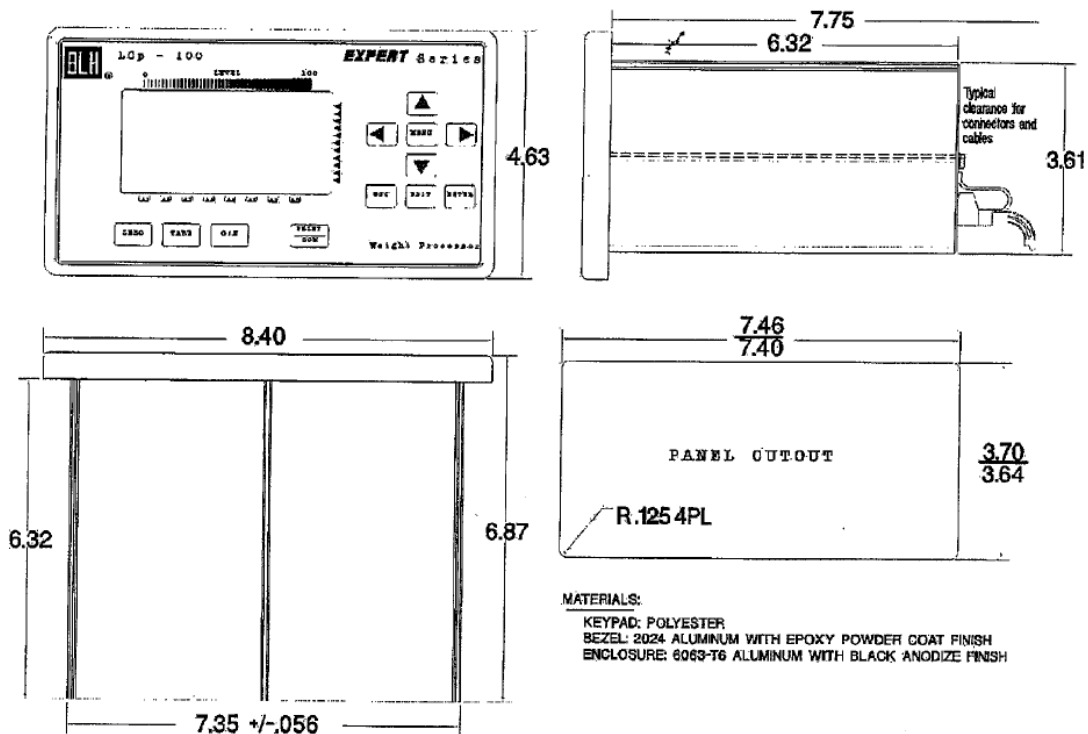

Figure 2-1. Standard Unit Outline Dimensions

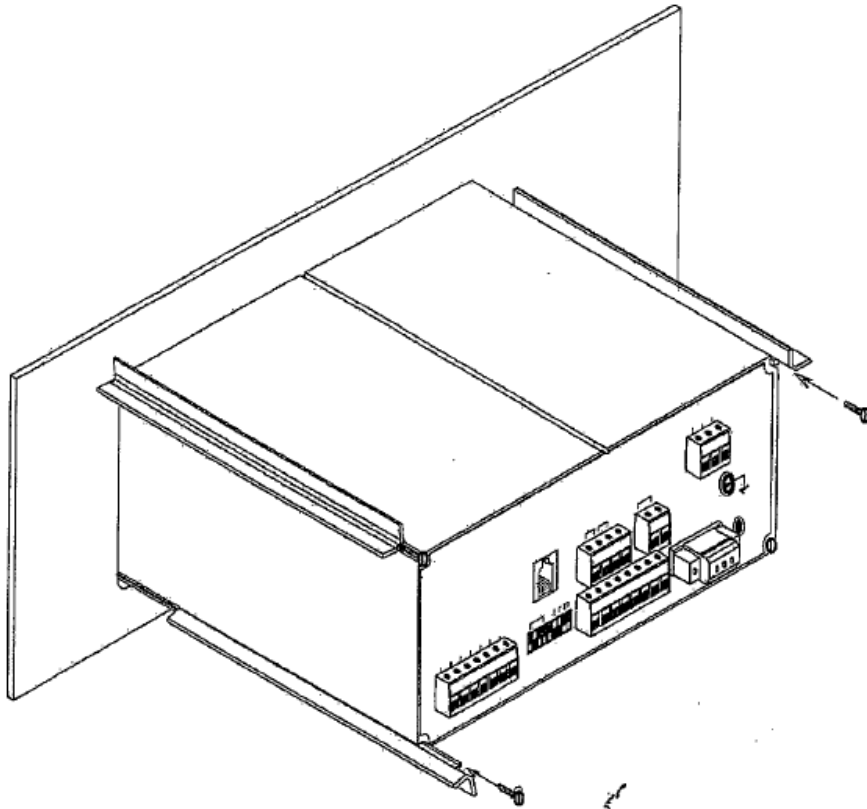

Figure 2-2. Panel Mounting Arrangement.

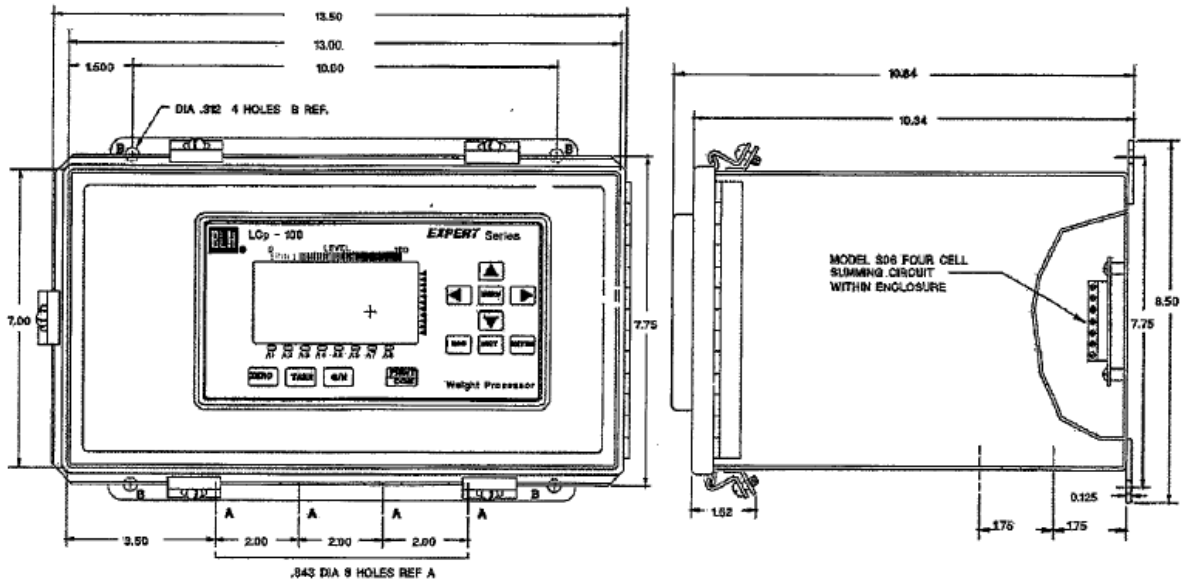

Figure 2-3. NEMA 4/4X Outline Dimensions.

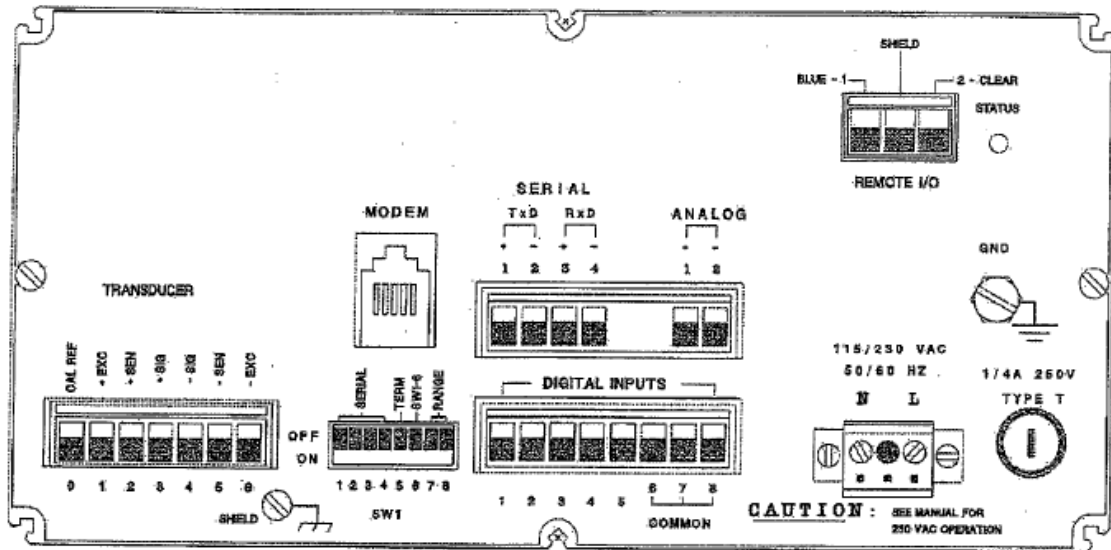

Figure 2-4. LCp-200 Rear Panel.

2.3 ELECTRICAL CONNECTIONS

2.3.1 The LCp-200 Rear Panel

Figure 2-4 shows the LCp-200 rear panel. Call outs depict wiring locations for all electrical connections. NOTE: See Appendix A for all electrical wiring diagrams on a single page.

2.3.2 Transducer Signal Inputs

Transducer input leads are wired to the LCp rear panel terminal block shown in Figure 2-5. BLH load cells and junction box cables are shipped with pre-stripped, tinned leads so that leads need only be inserted in the proper terminal location and the screw above tightened securely. Lead designations are clearly labeled for standard six conductor input cables (usually coming from a junction box). When using BLH supplied junction boxes, refer to document IS 308A-1 INSTALLATION AND OPERATING INSTRUCTIONS, for cable designations and lead color coding. For applications which use a four conductor cable (usually coming from a single load cell), jumpers must be installed from SEN + to EX + and SEN - to EX -. To insure good electrical and mechanical connection, BLH recommends that jumper leads be soldered to load cell leads.

NOTE: For many load cells, excitation (EX) leads are referred to as INPUT, and signal leads (SIG) are referred to as OUTPUT.

NOTE: If tension load cells are used, red (-signal) and white (+signal) leads may need to be reversed.

2.3.3 Mains (AC) Power

LCp-200 instruments are shipped ready to operate at 115 VAC (50 or 60 Hz). For 220 VAC operation, remove the rear panel and change the internal voltage selection switch as shown in Figure 2-6.

Each instrument is protected with a 1/4 amp, 250 volt 'T' type fuse located adjacent to the ac power socket. If the fuse opens, replace it with the same type, current, and voltage rating.

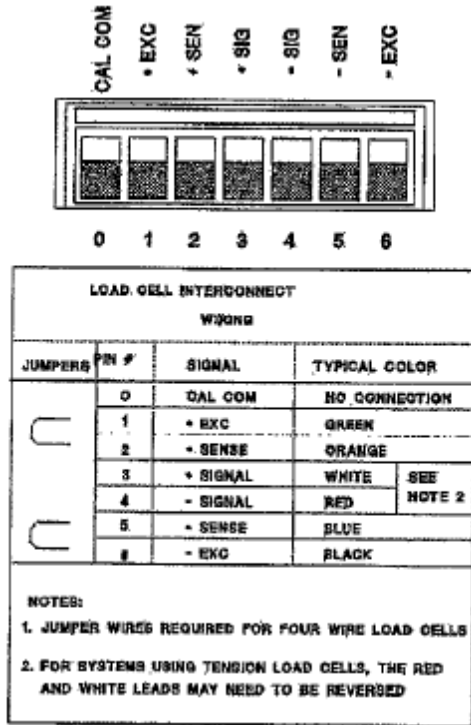

Figure 2-5. Load Cell Connections.

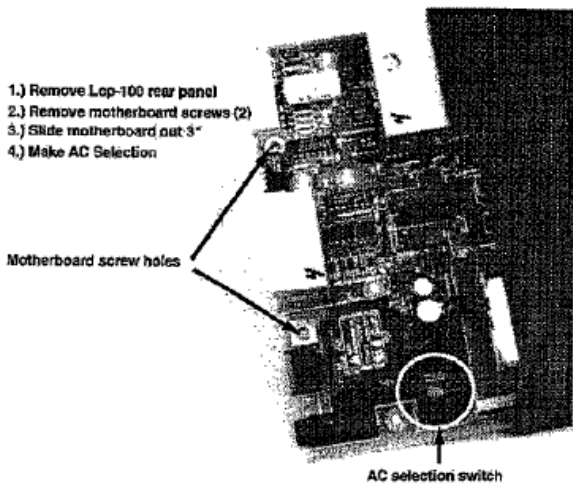

Figure 2-6. VAC Power Selection.

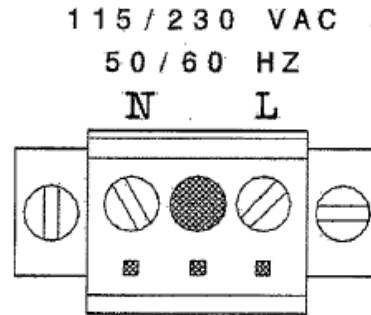

Figure 2-7. AC Voltage Connections.

2.3.4 Serial Communication

A 4-socket mating half connector is provided for serial communication wiring. Connect wires for either RS-485 or RS-422 operation as shown in Figure 2-8. Note that connector position 5 is a ground terminal and should be used for three-wire, RS-485 communication networks. Set DIP switch S1 positions 1-4 for desired interface function (Figure 2-8). See Section VI for details concerning serial interfacing.

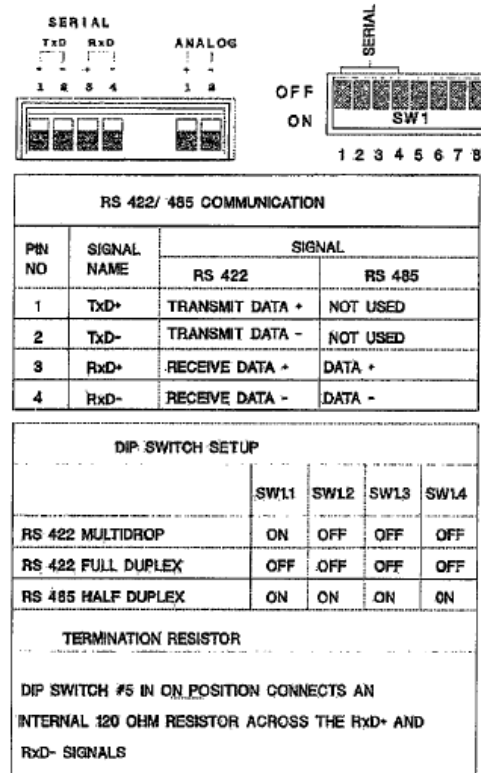

Figure 2-8. Serial Communication Configuration.

2.3.5 Analog Output (Option)

Analog current output is optional on LCp-200 instruments. To select current output type; 4-20 mA, 0-20 mA, or 0-24 mA, set rear panel DIP switch positions 7 and 8 as shown in Figure 2-9. Use the two-socket mating half terminal connector to attach plus and minus signal wires as shown in Figure 2-9. Route wires away from ac power lines and other EMI sources to prevent interference. Section VI provides analog output configuration procedures.

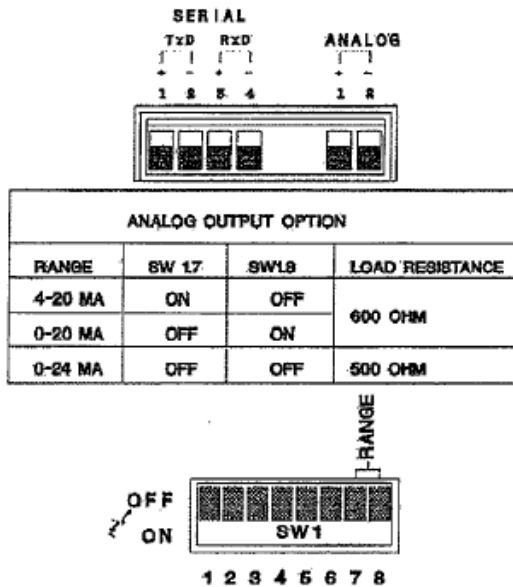

Figure 2-9. Analog Serial Selection/Connection.

2.3.6 Digital (Remote) Inputs

Certain front panel key functions can be initiated remotely using the rear panel digital inputs. Figure 2-10 gives wiring designations for remote operation of the ZERO, TARE, Gross/Net (GN), and PRINT keys. Interconnecting wire/cable length should not exceed 50 feet. Route wires/cable away from ac power lines and other EMI sources to prevent interference.

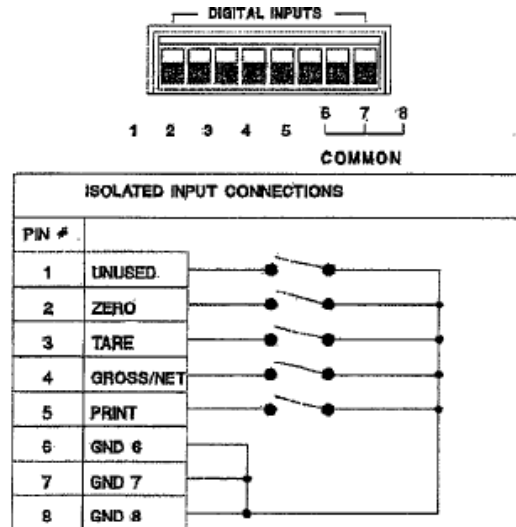

Figure 2.10. Remote Digital Inputs.

2.3.7 Open Collector (Set Point) Outputs

Standard units are equipped with eight open collector type set point outputs. Outputs can be configured for main or dribble operation with inflight compensation (see Section 6). Outputs are open collector type, capable of sinking 35 mA at 1.2 VDC. Wire set point outputs as shown in Figure 2-11.

OPEN COLLECTOR OUTPUTS

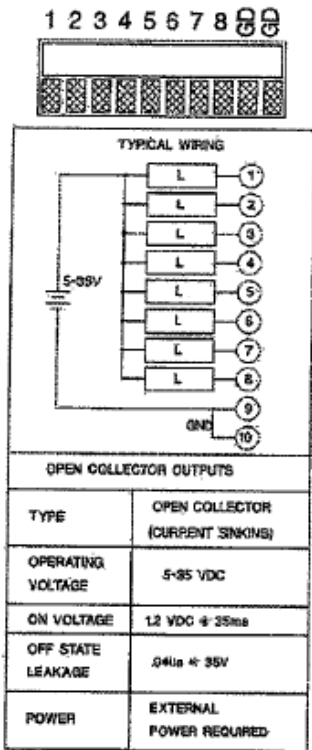

Figure 2.11. Open Collector Set Point Wiring.

2.3.8 Allen Bradley Remote I/O (Optional)

Units ordered with the Allen-Bradley remote I/O option have a 3-socket mating half connector for the REMOTE I/O port. Wiring designations are presented in Figure 2-12. Technical manual TM020 presents a complete description of the Allen-Bradley interface.

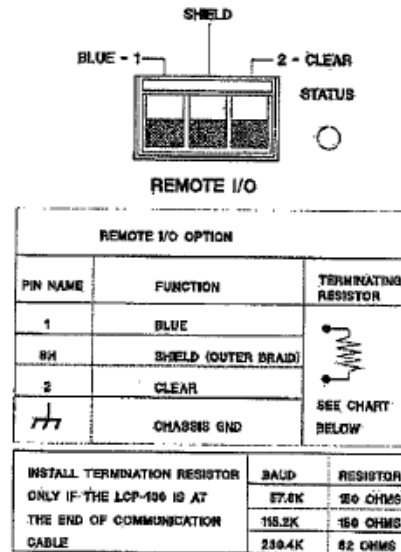

Figure 2-12. Allen-Bradley Remote I/O Option.

2.3.9 Summing Junction Box Considerations

BLH recommends using the Model 306 (not supplied) transducer summing junction box with the LCP-200. If the BLH Model 308A junction box is used, resistors R1 and R2 must be removed to ensure proper operation (see Figure 2-13). Internal 306 Junction Board (Optional)

Units shipped in the optional NEMA 414X enclosure may be ordered with an internal summing junction board as shown in Figure 2-3 (NEMA 414x outline dimensions). If the 306 option board is installed, transducers connect directly to the junction board, within the enclosure, eliminating the need for an external junction box. Connect transducers as shown in Figure 2-14. Wiring between the 306 board and the LCP-200 transducer input is performed and tested at the factory.

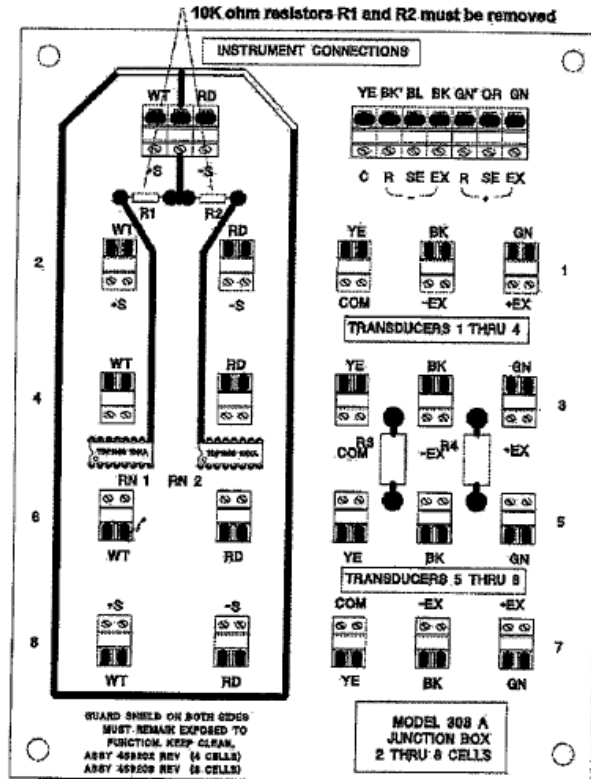

Figure 2-13. 308A Junction Box Modification.

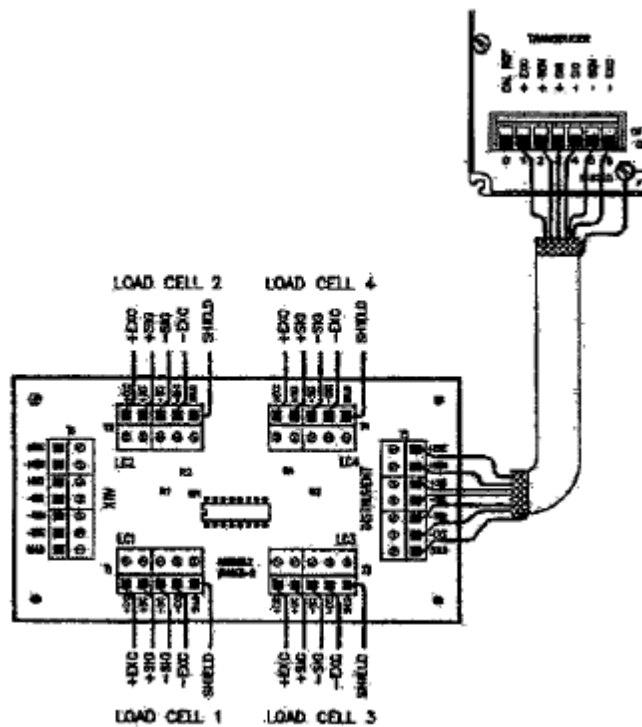

Figure 2-14. 306 Junction Board Transducer Connections.

2.3.10 Modbus Plus

Units shipped with the Modbus Plus option have a custom rear panel with a specific 9-socket D-type Modbus Plus Connector (see Figures 2-15, 11-2, and paragraph 11.4.1). This connector mates with an ASA Modicon AS-MBKT-085 9-pin, D-type connector*. BLH recommends using ASA Modicon number 490NAA27101* shielded cable for interconnect wiring.

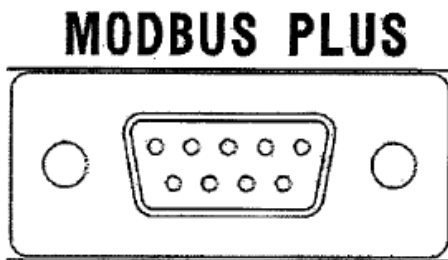

Figure 2-15. 9-Socket Modbus Plus Connector

2.3.11 Solid State Relay Outputs (Optional)

When installed, the solid state relay outputs parallel the standard open collector set point outputs. Solid state triac outputs operate at 12 to 240 VAC and handle loads of 50 mA to 1 amp. Operationally, they are identical to the open collector set point outputs defined in paragraph 2.3.7. Wire outputs in accordance with Figure 2-16.

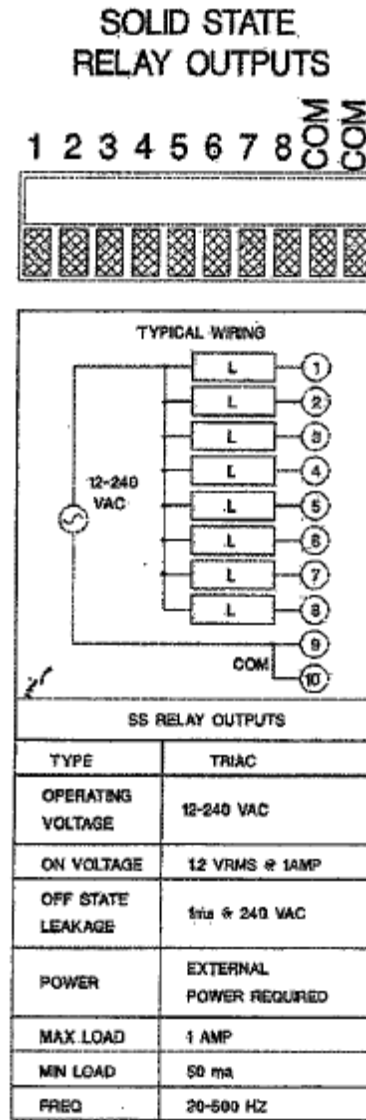

Figure 2-16. Solid State Set Point Output Wiring.

SECTION 3. Setup and Calibration

3.1 INTRODUCTION

After installation, set-up and calibration is the next step in preparing the LCp-200 for operation (see main menu diagram, Figure 1-3). Setup and calibration is accomplished easily using the front panel display and eight configuration keys. Figure 3-1 (page 3-2) presents details for set-up parameter entry and Figure 3-2 (page 3-3) shows procedures for each calibration type.

3.2 SET-UP SYSTEM PARAMETERS

Set-up establishes scale operating parameters such as system capacity, decimal point location, display units, count by, etc. Follow the flow diagram presented in Figure 3-1 to enter or alter set-up parameters.

3.2.1 Display Units

Designate the desired display units as pounds, kilo-grams, tons, ounces, grams, newtons, kilonewtons, liters, or a blank space. Selection also appears on print outs and other serial transactions.

3.2.2 Capacity

Enter the full scale system capacity value. (capacity is the rated load of the load cell(s) or platform - not simply live load or gross weight.) A capacity of 10000 can be displayed as 0.010000, 0.10000, 1.0000, 10.000, 100.00, 1000.0, or 10000 depending upon decimal point location.

3.2.3 Decimal Point Location

Position the decimal point as desired for weight display and serial communication.

3.2.4 Output

Enter the rated mV/V output of the system. (The electrical output at rated capacity independent of excitation) The rated output of multi-cell system is the average of the rated output of all the cells. For example: In a three cell system with load cell rated outputs of 2.01, 2.05, and 1.95 mV/V, the average rated output is 2003 mV/V.

3.2.5 Front Panel Display Counts

Define the count value of each display increment by selecting 1, 2, 5, 10, 20, 50, or 100 (note that decimal selection still applies). The LCp-200 will automatically default to the best possible resolution.

3.3 SYSTEM CALIBRATION

The LCp-200 *offers three types of calibration; quick, deadload, and keypad. Both quick and keypad calibration use an internal mV/V reference within the Wp-200 to perform an electrical only type calibration. The deadload type calibration is a method that is used when known amounts of weight are applied to the vessel or scale to achieve calibration. Figure 3-2 provides flow diagrams for each calibration type.

For a more detailed discussion of the most appropriate calibration method refer to BLH Pub. FSD 001, 'An Overview of Calibration Methods and Procedures for Process and Inventory Weigh Systems'.

3.3.1 Quick Type Calibration

Quick calibration is the fastest and least complex method of calibration. Based upon entries of scale capacity and mV/V output, the LCp-200 will automatically establish a calibration. This method is generally suitable on any linear system that has minimal piping or other load shunting structures.

3.3.2 Deadload Calibration

Deadload calibration is potentially the most complex method but results in the highest system accuracy. Deadload calibration requires that known quantities of weight be added incrementally to the scale/vessel, preferably to full capacity. This method is preferred on systems that have attached pipes or other load shunting structures.

3.3.3 Keypad Calibration

The LCp-200 is factory calibrated as a very precise mV/V measurement device. The keypad

calibration method establishes a relationship between force and mV/V, resulting in a very accurate electrical type of calibration. Keypad calibration requires a calibration sheet (Figure 3-3, page 3-4) for each weigh system load cell. The cal. sheet presents the load cell mV/V output reading for either 3 or 10 known weight/force values. Sheets also include a zero

balance (no load) mV/V reading. The keypad calibration method allows for the entry for the keypad entry of up to 10 points. On multi-cell systems, each point is an average of all the load cells at that specific capacity. This method is applicable on systems with minimal piping or other load shunting structures and can be used to correct for load cell non-linearities.

Enter/Alter Set-Up Parameters

CAL
MENU

Choose Display/Printout Unit Type

SELECTIONS:
LB (pounds)
KG (kilograms)
TN (tons)
OZ (ounces)
GM (grams)
N (newtons)
KN (kilonewtons)
L (liters)
(blank space)

LB
UNITS

Enter Full Scale Capacity

SELECTIONS:
0 to
9999999

50000
CAPACITY

Locate Display/Printout Decimal Point

SELECTIONS:
Use EDIT,
▼, and then
ENTER

500.00
DECIMAL

Enter Scale Output Rated mV/V
output of
system

SELECTIONS:
12,5,10,20,
50, or 100

3.500000
OUTPUT

SELECTIONS:
12,5,10,20,
50, or 100

COUNT BY

SELECTIONS:
12,5,10,20,
50, or 100

MAIN
MENU

SUB
MENU

General Key Functions:

- ▲ Step back to previous menu selection.
- ▼ Advance to next menu selection.
- EDIT Advance to next main menu selection.
- ESC Return to live operation from menu.
- ENT Change sub menu parameters.
- MEM Store displayed sub menu parameter in memory.

To Enter/Alter a Numeric Value:

- EDIT Press to initiate a change.
- 0-9 Key in desired numeric value.
- ESC Press to return to previously entered value.
- MEM Press to store selection in memory.

To Enter/Alter a Parameter Selection:

- EDIT Press to initiate a change.
- ▼ Press to view parameter options.
- MEM Press to store selection in memory.

Figure 3-1. Setup Parameter Entry.

Calibration Type - Flow Diagrams

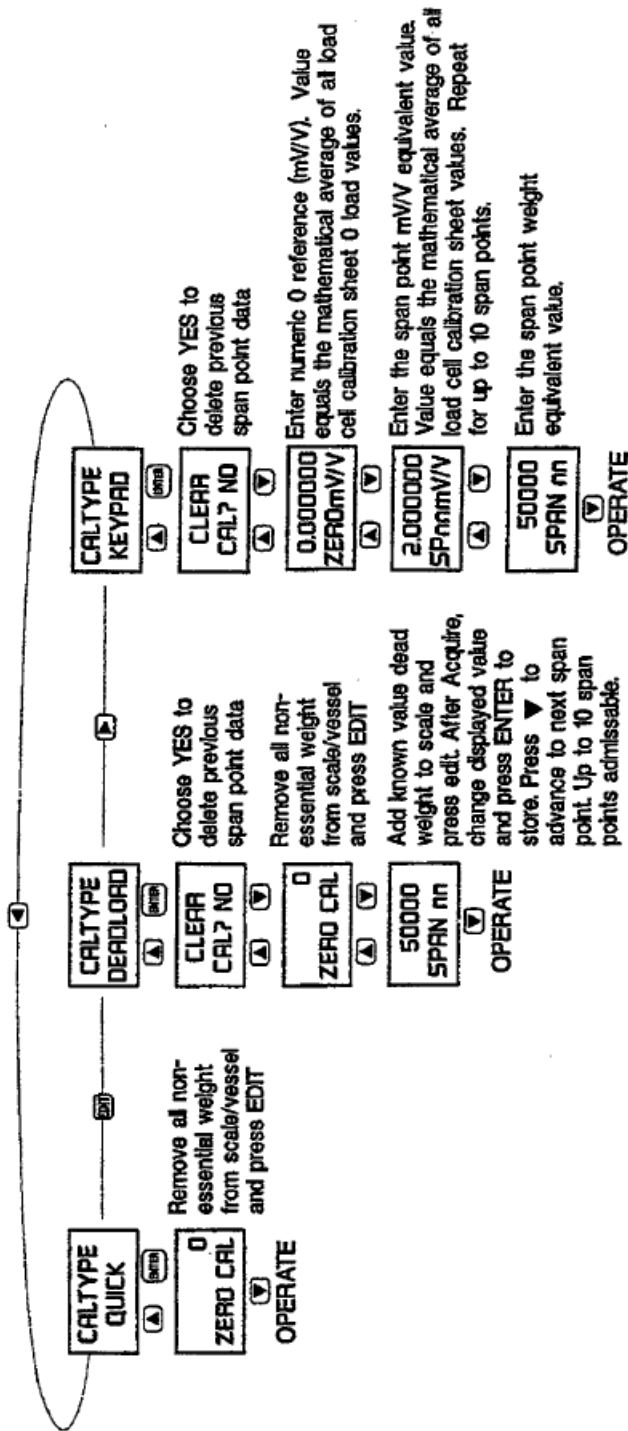

General Key Functions:

- Step back to previous menu selection.
- Advance to next menu selection.
- Advance to next main menu selection.
- Return to live operation from menu.
- Change sub menu parameters.
- Store displayed sub menu parameter in memory.



To Enter/Alter a Numeric Value:

- Press to initiate a change.
- Key in desired numeric value.
- Press to return to previously entered value.
- Press to store selection in memory.

To Enter/Alter a Parameter Selection:

- Press to initiate a change.
- Press to view parameter options.
- Press to store selection in memory.

Figure 3-2. Calibration Types and Parameters.

Calibration Chart

Customer: _____ **P.O:** F046999M0715
Capacity 10,000 lb **Type** C3P1 **Serial No.** 40243
Mode Compression **Bridge** A **Test Report No.** C94-6000
Indicator N.A. **Serial No.** N.A.
Date Of Calibration 3/4/94 **Temperature :** 71 F
Calibrated By: M. Houton **Humidity :** 49 %

Applied Load lbf	Response Run 1 mv/V	Response Run 2 mv/V	Response Run 3 mv/V
0	0.0000	0.0000	0.0000
1,000	0.2997	0.2999	0.2999
2,000	0.5997	0.5999	0.5998
3,000	0.8997	0.8998	0.8998
4,000	1.1998	1.1998	1.1998
5,000	1.5001	1.4998	1.4999
6,000	1.8002	1.8002	1.8002
7,000	2.1004	2.1004	2.1004
8,000	2.4007	2.4008	2.4008
9,000	2.7009	2.7009	2.7008
10,000	3.0012	3.0012	3.0012
5,000	1.5004	1.5003	1.5003
0	0.0000	0.0000	0.0000

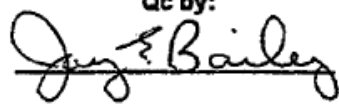
Qc by:

Applied Load [lb]	Output Average mv/V	Ideal Output mv/V	Output Error mv/V	Output Error % FS	Hysteresis Error % FS
0	0.0000	0.0000	0.0000	.000%	
1,000	0.2998	0.3001	-0.0003	-.010%	
2,000	0.5998	0.6002	-0.0004	-.015%	
3,000	0.8998	0.9004	-0.0006	-.020%	
4,000	1.1998	1.2005	-0.0007	-.023%	
5,000	1.4999	1.5006	-0.0007	-.022%	
6,000	1.8002	1.8007	-0.0005	-.017%	
7,000	2.1004	2.1008	-0.0004	-.015%	
8,000	2.4008	2.4010	-0.0002	-.006%	
9,000	2.7009	2.7011	-0.0002	-.007%	
10,000	3.0012	3.0012	0.0000		
5,000	1.5003	1.5006	-0.0003	-.009%	.013%
0	0.0000	0.0000	0.0000	.000%	.000%

Figure 3-3. Sample Load Cell Calibration Certificate.

SECTION 4. Dynamic Digital Filter

4.1 GENERAL

The LCp-200 uses a two stage digital filter. Each stage requires parameter entries as shown in Figure 41 (next page). Make parameter entries while viewing live weight value on the front panel display.

4.1.1 Digital Averaging

The filter first stage calculates a running average of weight input readings. Available selections are 1, 2, 4, 8, 16, 32, 64, and 128 conversions (see Figure 4-1). Using a 'first in - first out' algorithm, running averaging provides display updates every 50 msec regardless of the number of readings averaged. However, since each conversion averaged adds 60 msec to the filter length, the larger the averaging selection, the longer the filter length becomes. Table 4-1 shows the time relationship between conversions averaged and filter length.

4.1.2 Band Selection

The second stage of the filter, BAND, is applied after averaging is selected. A BAND value between 0 and 100 must be entered as shown in Figure 4-1. Dynamic Digital Altering constantly compares the amount of input signal change between consecutive conversions. If the difference falls within the BAND setting, a mathematical filter attenuates the conversion to conversion variation. Once the difference between conversions exceeds the BAND selection, the BAND filter is canceled and the display tracks live weight with maximum response. To achieve the best overall filter response, keep the BAND selection as low as possible without hindering system performance (see next paragraph for set-up instructions). If the BAND setting is higher than necessary, sensitivity to small weight changes will be reduced.

4.1.3 Filter Set-Up Procedures

Setting filter parameters requires a balance between achieving maximum noise reduction

and maintaining quick response and good sensitivity to real weight changes. The goal of filter set-up is to use the lowest averaging and BAND selections needed for smooth system display/operation. If selections are higher than necessary, accurate detection of small weight changes may be hindered. Using the six steps presented in Table 4-2, tune the system to its maximum performance level.

Table 4-1. Averaging Selections and Filter Length

Average	Response
1	0.05 sec
2	0.10 sec
4	0.20 sec
8	0.40 sec
16	0.80 sec
32	1.60 sec
64	3.20 sec
128	6.40 sec

Table 4-2. Dynamic Digital Filter Set-Up Procedures

1. Begin with the BAND set at a low value (approx. r4-10).
2. Increase averaging until the noise (watch display) is reduced to the least significant digit (approx. + 1- 10 divisions).
3. Increase BAND, if necessary, to reduce the remaining noise to the desired level.
4. If increasing the BAND value does not reduce the noise, return to averaging and select the next higher setting, then repeat step three.
5. If the BAND value required to quiet the display becomes large (65-100), it may be better to use more averaging. Try to achieve the best balance between BAND (small weight change sensitivity reduction) and averaging (longer response time).
6. If a stable weight display cannot be achieved with reasonable selections, it may be necessary to change the instrument set-up to reduce sensitivity.

Enter/Alter Filter Parameters

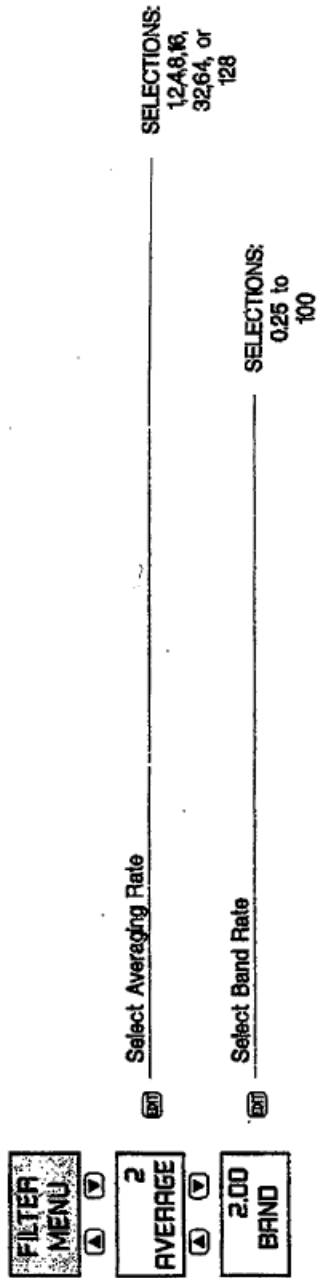

General Key Functions:

- ▲ Step back to previous menu selection.
- ▼ Advance to next menu selection.
- ▶ Advance to next main menu selection.
- ▶ Return to live operation from menu.
- ▶ Change sub menu parameters.
- ▶ Store displayed sub menu parameter in memory.



To Enter/Alter a Parameter Selection:

- ▶ Press to initiate a change.
- ▶ Press to view parameter options.
- ▶ Press to store selection in memory.

Figure 4-1. Dynamic Digital Filter Parameter Entry.

SECTION 5. Front Panel Display Functions

5.1 FRONT PANEL FUNCTIONS

The front panel display of the LCp-200 (Figure 5-1) includes a two line alpha numeric digital display for weight and status information as well as horizontal and vertical bar graphs and diagnostic alarm annunciators. The bar graphs and alarm annunciators can be configured to display various information. Use the display menu flow diagram (Figure 5-2) to configure the front panel functions for desired system operation.

5.1.1 Horizontal Bar Graph

The horizontal bar graph is the primary level indicator and is typically used to monitor the overall gross weight contents of the scale vessel. Vacuum fluorescent segments located under the 0 to 100% bar graph give instant visual reference to system capacity. Select ON to use; OFF for no function. Choose net or gross weight tracking and then enter the starting and ending weight values. Note that this indicator also can be configured for reverse polarity depending upon the starting and ending values.

5.1.2 Vertical Bar Graph

The vertical bar graph is considered the secondary level indicator and is typically used to monitor net weight. Located to the right of the weight display area, this indicator provides a graphical representation of 0 to 100% in 10% increments (each arrow = 10% capacity). Select ON to use; OFF for no function. Choose net or gross weight tracking and then enter the starting

and ending weight values. Note that this indicator also can be configured for reverse polarity depending upon the starting and ending values.

5.1.3 Alarm Status Annunciators

Eight front panel alarm/status annunciators provide ongoing system diagnostic information. Each annunciator can be configured to represent 1 of 16 conditions; OFF (no function), system in motion, zero limit exceeded, overload limit exceeded, serial communication receive, serial communication transmit, serial communication parity error, serial framing error, analog output fault, analog output over high selection, analog output under low selection, Allen-Bradley Remote I/O (option) status, modem receive active, modem transmit active, set point active, or Modbus Plus status. Once configured as AI-A13, vacuum fluorescent segments will be illuminated when configured condition is true. Configure each annunciator consecutively as shown in Figure 6-2.

5.1.4 Configuring the TARE Key

The front panel TARE key can be configured for manual or automatic operation. If 'automatic' is selected and the unit is operating in net mode, the displayed weight value will be zeroed resulting in a display of zero (units) net. If manual is selected and the unit is operating in net mode, the operator will be prompted to enter the desired tare weight value. TARE has no function in the gross weight weighing mode.

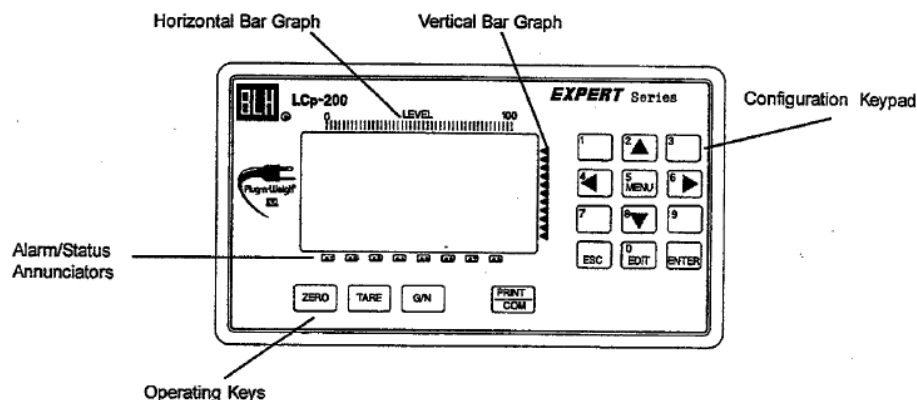

Figure 5-1. The LCp-200 Functional Front Panel

Display Menu Flow Diagram

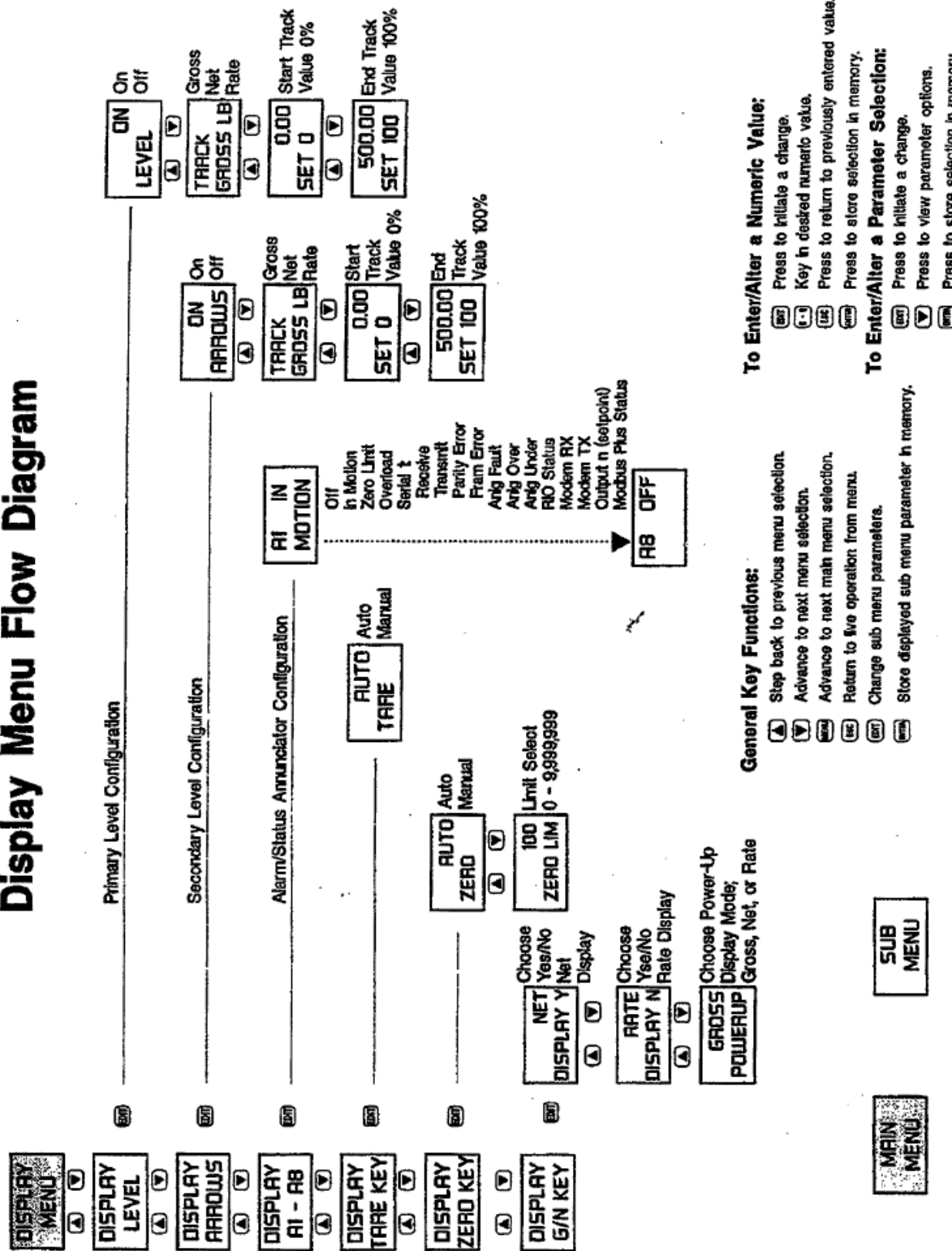

Figure 5-2. Front Panel Functions, Configuration Menu.

5.1.5 Configuring the ZERO Key

The front panel ZERO key can be configured for manual or automatic operation. If 'automatic' is selected, the displayed gross weight value will be zeroed out when the key is pressed. If manual is selected, the operator will be prompted to enter the desired gross zero weight value. ZERO has no function in the net weight weighing mode.

A full scale limit selection also must be entered for the zero key. Enter a zero limit value between scale zero and full scale capacity (recommended 2-20%). The zero key will not function automatically or manually after the displayed weight value has exceeded the zero limit entry.

5.1.6 Configuring the Gross/Net (GIN) Key

With the addition of rate-by-weight processing to LCp-200 units, the G/N key actually toggles between Gross, Net, and Rate. Rate and/or Net can be removed from this toggle sequence by selecting 'NO' in the DISPLAY GIN KEY menu.

Power-up selection determines which mode (gross, net, or rate) the unit displays upon power-up. This selection applies to all communication outputs as well as the front panel display.

NOTE: Units always power-up in the selected mode, regardless of what mode they were powered-down in.

5.2 VIEW mV/V SIGNAL

Pressing the right arrow configuration key during live operation results in a display of the current mV/V input signal. This function is useful for diagnosing electrical drift/malfunction errors. Recording mV/V signals during calibration procedures provides check-cal or re-calibration test points.

Pressing the left arrow configuration key during live operation results in a display of the current live mV/V input signal (dead weight signal subtracted).

SECTION 6. Analog Output, Serial Communication, and Set Points

6.1 ANALOG OUTPUT CONFIGURATION (Optional)

6.1.1 Output Definition

LCp-200 indicators provide a high resolution analog current output representing either gross or net weight for driving external process equipment/recorders. Use rear panel switch 1 positions 7 and 8 (Figure 2-8) to select either 4-20, 0-20, or 0-24 mA operation (note load resistance reduction with 0-24 mA). This output is based upon a 16 bit digital to analog (D-A) conversion which represents up to one part in 65536 of analog precision. The scaling of the output is accomplished after the LCp-200 is calibrated and can be ranged for any portion of the gross or net weight output curve.

Systems using the analog output for level control usually configure the output to track gross weight (live product weight). Batch control systems that use weight as a variable to determine set point cutoffs can be configured to operate in the net weighing mode while using a discrete remote input to activate the tare function.

6.1.2 Set-Up Procedure

Connect a current meter to the rear panel analog output points (see Figure 2-8 for +, - designations) and proceed with ANALOG I/O configuration as shown in Figure 6-1 (page 6-3).

6.2 SERIAL COMMUNICATION

LCp-200 units come with a versatile, bi-directional, serial communication port. Electronically, this port can be configured for RS-422 multi-drop (loop), RS-422 full duplex (point-to-point, transmit/receive), or RS-485 half duplex (point-to-point, transmit then receive) operation. Selection is made via rear panel DIP switch positions 1-4 (see Figure 2-9).

After selecting the electrical interface, the port operating parameters must be entered using the flow diagram presented in Figure 6-1. Figure 6-2 (page 6-4) provides a full description of each (serial communication) parameter block depicted

in Figure 6-1. Note that certain parameter entries are dependent upon the print format selection (accessed by pressing edit when SERIAL 1/0 is displayed). Standard LCp-200 indicators offer 3 formats; PRINT for output to a printer, CONT (continuous) for constant output to a data logger, PLC, etc., and PC for full duplex interfacing with a more sophisticated host device. Modbus, Fisher ProVox, and Allen-Bradley Remote I/O options will be discussed in Section 11.

6.2.1 Transmit Only Output Formats (ASCII)

Both the PRINT and CONT ASCII output formats are transmit only. The print format is designed for use in conjunction with the front panel PRINT/COM key. Pressing the PRINT/COM key transmits all data strings that are selected 'YES' in Figure 6-1 (DIS-PLOY, GROSS, NET, ZERO, and TARE) to the printer. Table 6-1 shows the printer output format used for each transmitted data string.

The CONT output string is defined in Table 6-2 (page 6-2). Continuous output transmissions occur at the time rate configure in Figure 6-1. Continuous outputs 'feed' weight data, status, and address information to a remote data logger or PLC type device without operator intervention.

Table 6-1. Printer Output Transmission String

Printout string:

stx/adr/data/units/statusictif

Defined:

stx	start of text character, hex 02
adr....	address, 3 ASCII chars: first two are '01'299' followed by an ASCII space
data...	weigh data 8 characters: 7 digits with decimal point or leading space; if msd is an ASCII minus '-' the data is negative
abbreviated.	two characters; first character is 'N','K','L','S', or 'spaces' for pounds, kilograms, tons, ounces, grams, newtons, kilonewtons, liters,
special	or null (space). second character is 'G','N','Z',or 'T' for gross, net, zero, or tare
expanded units	ten characters; first three characters are a space plus a two character units abbreviation KG',' TN',' OZ','

	GM', 'N', 'KN', 'L', or 4 spaces, for pounds, kilograms, tons, ounces, grams, newtons, kilonewtons, liters, or 4 user defined characters, the last seven characters are a space plus the data type spelled out with added spaces 'GROSS ', 'NET ', 'ZERO ', or ' TARE '
stat...	one status character: ' ' = everything ok, 'M' = motion, 'U' = aid underload (signal below instrument capability), 'V' = above overload limit, 'O' = aid overload (signal beyond instrument capability), 'E' = load cell connect fault
space...	ASCII space, hex 20
CRLF...	carriage return linefeed two characters

Table 6-2. Continuous Output String Format

Tx string:

stx/adr/data/units/status/crlf

Defined:

stx...	start of text character, hex 02
adr...	address, 3 ASCII chars: first two are '01'299' followed by an ASCII space
data...	weigh data 8 characters: 7 digits with decimal point or leading space; if msd is an ASCII minus the data is negative
units..	two characters; first character is 'N', 'K', 'L', 'S', or 'null' for pounds, kilograms, tons, ounces, grams, newtons, kilonewtons, liters, special, or null (space). second character is 'G', 'N', 'Z', or for gross, net, zero, or tare
stat,..	one status character: ' ' everything ok, 'M' = motion, 'U' = a/d underload (signal below instrument capability), 'V' = above overload limit, 'O' = a/d overload (signal beyond instrument capability), 'E' = load cell connect fault
space...	ASCII space, hex 20
CRLF...	carriage return linefeed two characters 0DH 0AH

Output string formats can be modified to accommodate custom interface requirements (Figure 6-1). Leading zeros can be replaced with ASCII spaces. STX (start of text), address, and instrument status can be omitted by selecting 'NO'. Units can be expanded or abbreviated in the print format and dropped altogether from the continuous format. Line feed can be deleted from the CRLF output or both characters can be replaced by an ASCII space. Figure 6-2 provides definitions for each parameter to assist in formatting custom output strings.

6.2.2 Full/Half Duplex Bi-Directional Interface

If PC output format is selected, units are capable of transmitting and receiving ASCII data strings. Table 6-3 (page 6-5) presents digit for digit data and syntax information for the interface.

Basically, the Model LCp-200 has 92 internal (EEPROM) registers which store all calibration, con-figuration, operation, and live weight data parameters. The PC format allows data in these registers to be read or re-written. By re-writing calibration span points (keypad type calibration) and operating parameters, the Model LCp-200 can be quickly and completely re-configured by a remote host device.

Several additional tables are provided to explain PC interfacing. Table 6-4 (page 6-7) provides examples of EEPROM reading/writing, and error code exchanges. Table 6-5 (page 6-8) demonstrates live weight transactions. Table 6-6 (page 6-10) gives set point communication formats and examples.

6.2.3 Modbus RTU Protocol (Optional)

Refer to Section XI for details concerning optional Modbus RTU protocol formatting.

6.2.4 Modbus Plus Protocol (Optional)

Refer to Section XI for details concerning optional Modbus Plus protocol formatting.

6.2.5 Fisher Rosemount - Provox Protocol (Optional)

Refer to Section XI for details concerning optional Provox protocol formatting.

6.2.6 Allen-Bradley Remote I/O (Optional)

The Allen-Bradley Remote I/O interface is fully defined in BLH technical manual # TM020. Model LCp-200/R10 wiring is defined in Section 2, paragraph 2.3.8 of this manual.

Analogue, Serial, and Setpoint Output Flow Diagram

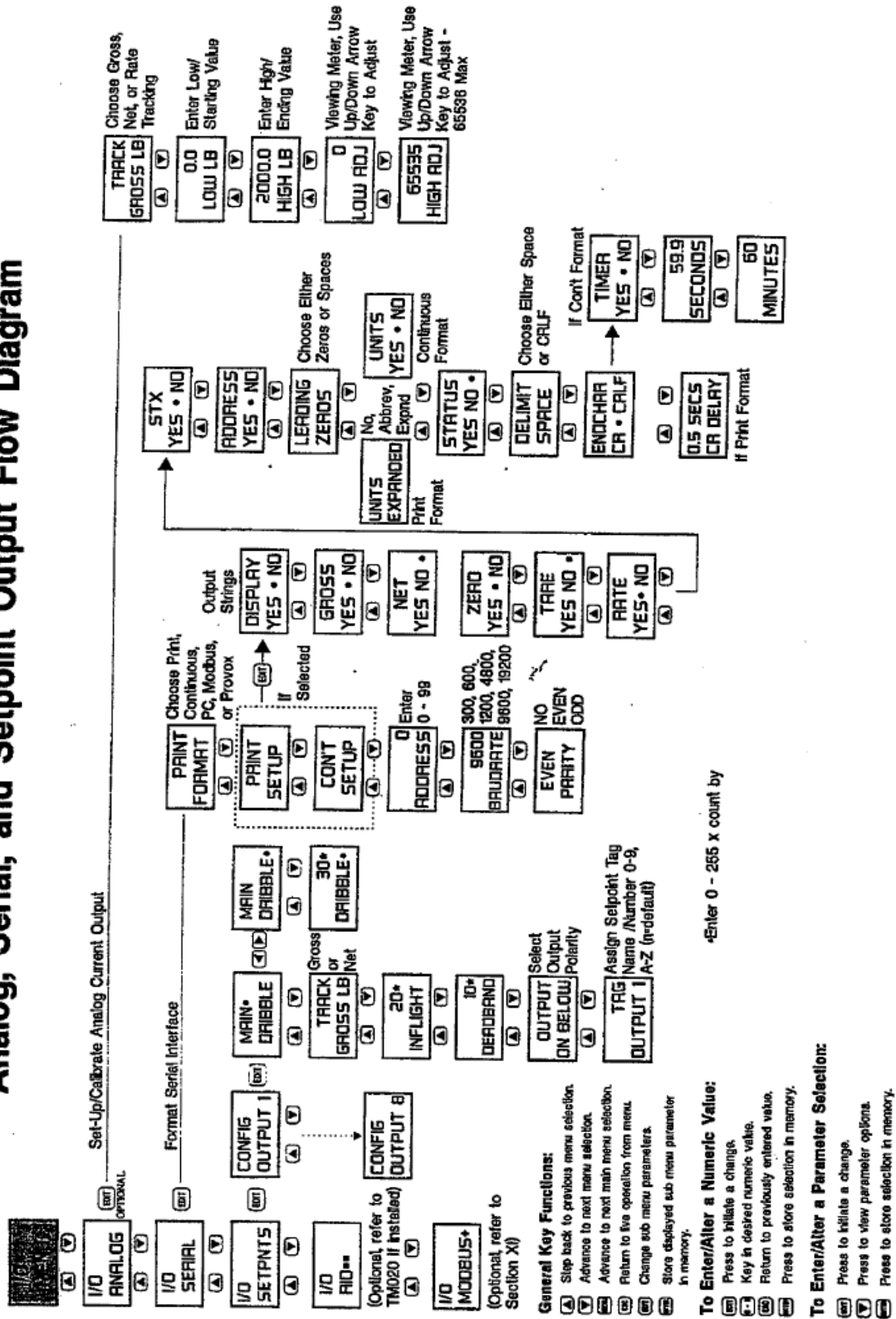

Figure 6-1. Analogue and Serial Communication Menu.

Serial Output Flow Diagram Block Explanations

DISPLAY YES • NO	Transmit current weight display (gross or net)	STX YES • NO	Typical leading character of any ASCII output data string
GROSS YES • NO	Transmit current gross weight value	ADDRESS YES • NO	Include designated address in output data string
NET YES • NO	Transmit current net weight value	LEADING SPACES	Choose either leading spaces or leading zeros in output string
ZERO YES • NO	Transmit current manual zero value	UNITS EXPANDED	Choose either no units, abbreviated units (2 characters), or expanded (10 character) units in printout
TARE YES • NO	Transmit current manual tare value	UNITS YES • NO	Include units in transmit string; units are abbreviated (2 characters)
		STATUS YES • NO	Include status character in output string
		DELIMIT SPACE	If more than one data selection (i.e. gross, net, tare) is requested, choose either a space or a carriage return/line feed (CRLF) to separate them
		ENDCHAR CR CRLF	Choose either a carriage return (CR) or a carriage return/line feed (CRLF) to end the output string
		0.5 SECS CR DELAY	If the printer does not have a character buffer, prevent data loss by selecting a delay time between carriage returns
		TIMER YES • NO	Choose whether or not to use a timed interval between continuous transmissions
		SECS SECONDS	If YES chosen, select seconds portion of time interval
		MIN MINUTES	If YES chosen, select minutes portion of time interval
BOTH FORMATS		PRINTER OUTPUT FORMAT	

Figure 6-2. Parameter Definitions.

Table 6-3. Bi-Directional PC Interface Register Assignments

Note - This is an ASCII interface. Requesting data from the LCp-II is done mainly by sending a 3 character command followed by a carriage return (ODH). These 3 character commands are listed under CODE in the following chart. The LCp-I I's response to these commands is listed under RESPONSE. The response data is followed by a carriage return line feed (ODH, OAH).

There are also ways of stringing the commands together as shown in examples immediately following this chart.

Note - <00000000> represents weight data: # of zeros = number of digits. If there is a decimal point there will be one less digit. If the number is negative the most significant digit will be an ASCII minus i.e. -500 will be '<00000000>0500', -0.5 will be '<00000000>00.5' is numeric data, <x.:coococ> is mV/V data; if negative leading x =

Note - If unit address is selected, PC must transmit address code as 01A, 02A, etc. to establish communication

CODE	DEFINITION	RESPONSE	EXPLANATION
00;	AID REV	00<IA>	1-9 = ND TYPE, A-Z = REV
01;	SERIAL #	01<1234567>	1 = YEAR, 2-3 = WEEK, 4-7 = instrument number
02;	REF DATE	02<MMDDYY>	Month Day Year of mV/V cal
03;	mV/V ZERO CAL	03<x.xxx=>	instrument mV/V zero cal point
04;	mV/V SPAN CAL	04<xxooax>	instrument mV/V span cal point
05;	ZERO mV/V	05<xa00000c>	zero in mV/V
06;	SPAN1 mV/V	06<xx000oz>	span1 in mV/V
07;	SPAN1 units	07<00000000>	span1 in units
08;	SPAN2 mV/V	08<xm0000c>	span2 in mV/V
09;	SPAN2 units	09<00000000>	span2 in units
10;	SPAN3 mV/V	10<XJ00000:>	span3 in mV/V
11;	SPAN3 units	11<00000000>	span3 in units
12;	SPAN4 mV/V	12<x.)0000tx>	span4 in mV/V
13;	SPAN4 units	13<00000000>	span4 in units
14;	SPAN5 mV/V	14<xmc000c>	span5 in mV/V
15;	SPAN5 units	15<00000000>	span5 in units
16;	SPAN6 mV/V	16<xxoccx>	span6 in mV/V
17;	SPAN6 units	17<00000000>	span6 in units
18;	SPAN7 mV/V	18<xaoc000c>	span7 in mV/V
19;	SPAN7 units	19<00000000>	span7 in units
20;	SPAN8 mV/V	20<xxococ>	span8 in mV/V
21;	SPAN8 units	21<00000000>	span8 in units
22;	SPAN9 mV/V	22<xmoccoc>	span9 in mV/V
23;	SPAN9 units	23<00000000>	span9 in units
24;	SPAN10 mV/V	24<xaococa>	span 0 in mV/V
25;	SPAN10 units	25<00000000>	span 0 in units
26;	# of SPAN POINTS	26<xx>	00 - 10
27;	CAL TYPE	27<x>	0= QUICK, 1 = DEADLOAD, 2 = KEYPAD
28;	ENG UNITS	28<x>	0 = LB, 1 = KG, 2 = TN, 3 = OZ, 4 = GM, 5 = N, 6 = KN, 7 = L or 4 user defined characters
29;	CAPACITY	29<00000000>	sum of rated capacity of load cells
30;	DECIMAL POINT	30<x>	0 - 6 decimal point position 0 = none, 3 = 0.000
31;	RATED OUTPUT	31<xxocxxx>	average of load cells rated output in mV/V
32;	UNIT COUNT BY	32<x>	0- 6 = 1,2,5,10,20,50,100
33;	ZERO LIMIT	33<00000000>	keypad push to zero limit from cal zero, 0 = no limit
34;	OVERLOAD	34<00000000>	overload limit, 0 = no limit
35;	LEVEL CONFIG	35 <x>	level bar graph configuration, 0 = off/gross, 1 = on/gross, 2 = off/net 3 = on/net
36;	LEVEL 0%	36<00000000>	level 0% setting level 100% setting
37;	LEVEL 100%	37<00000000>	side arrows configuration
38;	ARROWS CON FIG	38<x>	0 = off/gross, 1 = on/gross
39;	ARROWS 0%	39<00000000>	2 = off/net 3 = on/net
40;	ARROWS 100%	40<00000000>	arrows 0% setting arrows 100% setting
41;	A1 ANNUNCIATOR	41<xx>	0-13: 7= serl fram err
42;	A2 ANNUNCIATOR	42<xx>	0 = off 8 = analog fault
43;	A3 ANNUNCIATOR	43<xx>	1 = in motion 9 = analog over
44;	A4 ANNUNCIATOR	44<)x>	2 = zero lim 10 = analog under

45;	A5 ANNUNCIATOR	45<xx>	3 = overload	11 = rio status
46;	A6 ANNUNCIATOR	46<xx>	4 = seri nc	12 = modem rx
47;	A7 ANNUNCIATOR	47<xx>	5 = seri ix	13 = modem bc
48;	AS ANNUNCIATOR	48<xx>	6 = seri par err	
49;	ZERO KEY CONFIG	49<x>	0 = auto	
50;	TARE KEY CONFIG	50<x>	0 = auto	
51;	ANALOG CONFIG	51<x>	0 = gross	
52;	ANALOG LOW	52<00000000>	low output weight setting	
53;	ANALOG HIGH	53<00000000>	high output weight setting	
54;	ANALOG LOW	54<)ocxxx>	low analog output adjustment	
55;	ANALOG HIGH	55<x)cotx>	high analog output adjustment	
56;	MANUAL ZERO	56<00000000> 57<00000000>	manual zero manual tare	
57;	FILTER	58<x>	0 - 7 = 1,2,4,8,16,32,64,128	
58;	FILTER BAND	5 9 < x x x x x >	0, 0.25 - 2.50, 3 - 100	
59;	MOTION	60<>otoc>	0, 0.25 - 2.50, 3-50	
60;	MOTION TIMER	6 1 < x >	0 - 3 = 0.5, 1.0, 1.5, 2.0	
61;	SECURITY	62,X.	0 = off, 1 = on	
62;	PASSWORD	63<AAAAAAA >	security password 1-0,'-',",A-Z	
63;	MENU LOCKS	64<xioccc>	0 = off, 1 = on; msd - lsd =diag,i/o,display,filter,cal	
64;	KEY LOCKS	65 <v000c>	0 = off, 1 = on; msd - lsd =edit,print,q/n,tare, zero	
65;	SERIAL 1	66z.>	0 = print, 1 = continuous, 2 = pc, 3= MODBUS, 4 = ProVox	
67;	SERIAL 1		0- 99	
68;	SERIAL 1 BAUD RATE	68<x>	0 = 9600, 1 = 19200,2 = 300,3 = 600,4 = 1200, 5 = 2400, 6 = 4800	
69;	SERIAL 1	69<x>	0 = none, 1 = even, 2 = odd	
70;	PRINT DATA	70<l000c<>	0 = no, 1 = yes; msd - lsd = tare,zero,net,gross,display	
71;	PRINT DATA	71<>c00000r>	lsd = six: 0/1 = no/yes 2sd = address: 0/1 = no/yes 3sd = leading 0s: 0 = spaces, 1 = zeros 4sd = units: 0= no, 1 = abbreviated, 2 = expanded 5sd = status: 0/1 = no/yes 6sd = delimiter: 0 = space, 1 = off 7sd = terminating character, 0 = crif, 1 = cr	
72;	PRINT CRLF	72<x.x>	0 0 - 9.9 seconds	
73;	CONT DATA	73<i000cc>	0 = no, 1 = yes; lsd - msd =display,gross,net,zero,tare	
74;	CONT DATA	74<ioccorx>oc>	lsd = stc 0/1 = no/yes 2sd = address: 0/1 = no/yes 3sd = leading 0s: 0 = spaces, 1 = zeros 4sd = units: 0/1 = no/yes 5sd = status: 0/1 = no/yes 6sd = delimiter: 0 = space, 1 = crif 7sd = terminating character° = off, 1 = cr 8sd = timer: 011 = no/yes	
75;	CONT TX	75<xx.x>	00.0 - 59.9 seconds	
76;	CONT TX	76<xxx>	0 - 240 minutes	
77;	TAG NO.	77<AAAAAAA>	cust tag no. 1-0,'-',",A-Z	
78;	CAL DATE	78<MMDDYY>	Month Day Year of calibration	
79;	NEXT CAL	79<MMDDYY>	Month Day Year of next cal	
80;	INSTRUMENT	84<:ococ>	instrument type: (0100) for LCc-11	
81;	FIRMWARE	85<:000c>	firmware version (1.00, 9020 etc)	
82;	OPTIONS	86<:00000c)	[MI - fAI - f9 - fCI - fEI] - LK	
VER	SOFTWARE	VER<xmc>	1.00- 9.99	
OPT	OPTIONS	OPT<x)occc>	M EAYIPI P M M	
CLR	CLEAR	CALCLR	clear calibration	
CAL	CALIBRATE		used to precede other commands	

Table 6.4. Read/Write and Error Code Examples.

EEPROM data request examples:

note - CRLF = carriage return = two ASCII characters OD, OA Hex

note - CR = carriage return = one ASCII character OD Hex

note - using a dash between command numbers facilitates retrieving multiple parameters (see example #3).

1. to get span 1 mV/V value (code 06;)

sent	received
06;CR	06<x.x>0000c>CRLF

2. to get span 1 mV/V and units values (code 06; and 07;)

sent	received
06;07;CR	06<xx000c<>07<00000000>CRLF

3. to get complete analog output setup (codes 51; through 55;)

sent	received
51-55;CR	5152<00000000>53<00000000>54<)&ococx>55<roococ>CRLF

EEPROM data write examples:

Note - Downloading data to the LCG-II is done by sending a 3 character command, the data enclosed in brackets <>, and a carriage return as shown in the examples below. The response will be staggered depending upon the time it takes to store the data. First the command will be returned and then after the data is stored the CRLF or next command will be returned.

1. to download capacity setting (code 29;), send (if capacity is 60000): 29<00050000>CR or 29<50000>CR response will be: 29<0050000>CRLF
2. to download display LEVEL bar graph settings (codes 35; 36; 37;), send (if tracking gross and 0% is 0 and 100% is 15000): 35<0>36<00000000>37<00015000>CR or 35<0>36<>37<15000>CR response will be: 35<0>36<00000000>37<00015000>CRLF
3. to download zero and span 1 settings (codes 05; 06; 07;), send (if zero mV/V = 0.500000, span1 mV/V = 1.500000, span1 units = 20000): 05<0.500000>06<1.500000>07<20000>CR response will be: 05<0.500000>06<1.500000>07<00020000>CRLF
4. to acquire a new system zero (not download) (code 05;), send CALOS<O>CR:
The LCc-II will store the current mV/V value as a new system zero response will be: immediately CAL then after zero is acquired: 05<x.rcooca>CRLF
5. to acquire a live deadload span 1 (code 07;), send (if span 1 = 2000.0) CAL07<2000.0>CR: the LCc-II will store the current live (above system zero) mV/V level as span 1 mV/V value (code 06;) and store 2000.0 as the units value response will be: immediately CAL, then after span is acquired: 07<0002000.0>CRLF
6. to clear existing calibration send CALCLR CR:
If the LCc-II is in deadload or keypad cal all spans will be cleared, # of span points will be set to 0 and digital output will be based on system capacity and load cell mV/v output settings. response will be: immediately CALCLR then after cal is cleared, CRLF.

Note: cal zero is not cleared by this command. If the LCc-II is in quick cal, response will be: CALCLR<NA>,CRLF.

INTERFACE ERROR CODES

- NA = not allowed
- NT = no terminator
- LM = limit
- BF = input buffer overflow (too many characters sent, max is 255) AD = a/d error
- ? = unknown command

ERROR CODE EXAMPLES

sent	received	description
99,CR	99,CRLF	unknown command
CR	?CRLF	unknown command
00<A1>CR00<NA>CRLF		not allowed value for a/d rev
00<000>CR	00<NA>CRLF	not allowed value for a/d rev
28<5>CR	28<LM>CRLF	value limit for eng units
07<000050000>CR	07<NT>CRLF	no terminator (too many digits)

Table 6.5. Live Data Transactions and Default Settings

LNE DATA

Note: live weight data uses 0 and not as a frame, this is because the numerical part of the live weight data and stored EEPROM data codes are the same number sequence 00 01 etc.

CODE	DEFINITION	RESPONSE	EXPLANATION
00, 1, 2, 03, 04,	GROSS NET mV/V LIVE mV/V WEIGHT STATUS	00(00000000) 01(00000000) 02(x.xx.cooc) 03(xi0000m>) 04(A)	current gross weight current net weight current mV/V data current live mV/V data A = aid status Q= = normal (M) = motion (U) = signal underload (V) = above overload limit (O) = signal overload (E) -- load cell connect fault A = analog output status () = normal (U) = analog under range (O) = analog overrange (E) = analog open circuit 0 - 65537 analog output upper display - alpha numeric with dp or leading space lower display - alpha numeric with dp or leading space level - from left to right - = off @ = left arrow on A-Z = segments on + = right arrow on arrows- from bottom to top - = off @ = bottom arrow on A-I = arrows on + = top arrow on annunciators - A1,A2,A3,A4 = low 4 bits of T T = 1 0 0 0 0 0 AI A2 A3 A4 for AI-A4 off T = @(40 hex) If A3 is on T = B (42 hex) A5,A6,A7,A8 = low 4 bits of U U = 1 0 0 0 0 0 A5 A6 A7 A8 for A5-A8 off U = @ (40 Hex) if A6,A7 are on U = F (46 hex)
05,	ANALOG STATUS	05(A)	
06, 07,	ANALOG DISPLAY	06(scccc0) 07(ABCDEFGH IJKLMNOPQ TU)	
08 09 10	REMOTE INPUT PEAK DATA VALLEY DATA	08(moo0C) 09(00000000) 10(00000000)	Isb = freeze, all others = unused current peak data value current valley data

LIVE DATA REQUEST EXAMPLES

1. to get gross weight (code 00.) if current gross weight is -10.1 lb
 sent received
 00,CR 00(-000010.1)CRLF

2. to get gross & net weights and status (codes 00, 01, 04.) if current gross weight is 440.05, tare value is 200.1 and scale is in motion:
 sent received
 00,01,04,CR 00(000440.05)01(000240.04)04(M)CRLF

3. to get live data codes 00 - 05 (data values used as example only):
 sent received
 00-05,CR 00(000440.05)01(000240.04)02(1.200505)03(0.800400)04(M)05()CRLF

Table 6.5. Continued

LIVE DATA CONVENIENCE COMMAND CODES

code	definition	response	explanation
G	SWITCH TO GROSS	(per print format)	switch to gross and return current gross weight
N	SWITCH TO NET	(per print format)	switch to net and return current net weight
T	SWITCH TO NET & TARE	(per print format)	switch to net, tare, return current net weight
Z	SWITCH TO GROSS & ZERO	(per print format)	switch to gross, zero, return current gross weigh
P	PCLEAR PEAK/VALLEY DATA	(previous data)	clear peak and valley registers

LIVE DATA CONVENIENCE COMMANDS (examples)

1. to switch LCp-100 to gross mode and get gross weight (code G), if current gross weight is -10.1 lb, unit # is 01, and scale is in motion:
 sent received (according to print format setup)
 GCR 01 -000010.1LGM CRLF

2. to switch LCp-100 to net mode, tare and get net weight (code T), if current gross weight is -10.1 lb, unit # is 01:
 sent received (according to print format setup)
 TCR 01 000000.0LN CRLF

Table 6-6. Set point Data Communication Format SETPOINT DATA for Discrete outputs 1-8.

Note - set point data uses and not <> or () as a frame, this is because the numerical part of the live weight data and stored EEPROM data codes are the same number sequence 00 01 etc.

CODE	DEFINITION	RESPONSE	EXPLANATION
00/	OUTPT 1 MAIN	00[00000000]	output 1 main value
011	OUTPT 1 INFLIGHT	01[000000]	output 1 inflight
02/	OUTPT 1 DEADBAND	02[000000]	output 1 deadband
03/	OUTPT 1 CONFIG	03[000]	output 1 config; rtsd on below(0)/above
			2sd gross(0)lnet, lsd main(0)/dribble
04/	OUTPT 1 TAG	04[AAAAAAAA]	output 1 tag; space, 1-0, '-', A-Z
05/	OUTPT 2 MAIN/DRIB	05[000000001]	output 2 main or drib value
06/	OUTPT 2 INFLIGHT	06[000000]	output 2 inflight if config is main
07/	OUTPT 2 DEADBAND	07[000000]	output 2 deadband if config is main
08/	OUTPT 2 CONFIG	08[000]	output 2 config; msd on below(0)/above
			2sci gross(0)/net, lad main(0)/dribble
09/	OUTPT 2 TAG	09[AAAAAAAA]	output 2 tag; space, 1-0, '-', A-2
10/	OUTPT 3 MAIN/DRIB	10[00000000]	output 3 main or drib value
11/	OUTPT 3 INFLIGHT	11[000000]	output 3 inflight if config is main
12/	OUTFT 3 DEADBAND	12[000000j]	output 3 deadband if config is main
14/	OUTPT 3 CON FIG	13[000]	output 3 config; msd on below(0)above
			2sd gross(0)lnet, lad main(0)/dribble
14/	OUTPT 3 TAG	14[AAAAAAAA]	output 3 tag; space, 1-0, '-', A-2
15/	OUTPT 4 MAIN/DRIB	15[00000000]	output 4 main or drib value
16/	OUTPT 4 INFLIGHT	16[000000]	output 4 inflight if config is main
171	OUTPT 4 DEADBAND	17[000000]	output 4 deadband if config is main
18/	OUTPT 4 CONFIG	18[000]	output 4 config; mad on below(0)above
			2sd gross(0)/net, lsd main(0)/dribble
19/	OUTPT 4 TAG	19[AAAAAAAA]	output 4 tag; space, 1-0, '-', A-Z *
201	OUTPT 5 MAIN/DRIB	20[00000000]	output 5 main or drib value
21/	OUTPT 5 INFLIGHT	21[000000]	output 5 inflight if config is main
22/	OUTFT 5 DEADBAND	22[000000]	output 5 deadband if config is main
23/	OUTPT 5 CONFIG	23[000]	output 5 config; msdgn below(0)/above
			2sci gross(0)net, lscfmain(0)/dribble
24/	OUTPT 5 TAG	24[AAAAAAAA]	output 5 tag; space, 1-0, '-', A-2
25/	OUTPT 6 MAIN/DRIB	25[00000000]	output 6 main or drib value
26/	OUTPT 6 INFLIGHT	26[000000]	output 6 inflight if config is main
271	OUTPT 6 DEADBAND	27[000000]	output 6 deadband if config is main
281	OUTPT 6 CONFIG	28[000]	output 6 config; mod on below(0)/above
			2sd gross(0)lnet lsd main(0)/dribble
29/	OUTPT 6 TAG	29[AAAAAAAA]	output 6 tag; space, 1-0, '-', A-Z
30/	OUTPT 7 MAIN/DRIB	30[00000000]	output 7 main or drib value
31/	OUTPT 7 INFLIGHT	31[000000] -	output 7 inflight if config is main
32/	OUTPT 7 DEADBAND	32[000000]	output 7 deadband if config is main
33/	OUTPT 7 CONFIG	33[000]	output 7 config; msd on below(0)above
			2sd gross(0)/net, lsd main(0)/dribble
34/	OUTFT 7 TAG	34[AA ^s .AAAAA1]	output 7 tag; space, 1-0, v, A-Z
35/	OUTPT 8 MAIN/DRIB	35[00000000]	output 8 main or drib value
361	OUTPT 8 INFLIGHT	36[000000]	output 8 config; msd on below(0)/above
			2sd gross(0)lnet, lad main(0)/dribble
39/	OUTPT 8 TAG	39[AAAAAAAAAN]	output 8 tag; space, 1-0, 'A-Z
40/	SETPOINT LOCKS	40Dxxxxc3	set point locks 0 = off, 1 = on;

SETPOINT DATA request examples

1. to get output 1 main (code 00/) if main = 2000
sent received
00/CR 00(0002000)CRLF
2. to get output 1 main, inflight, deadband, status, tag, and output 2 is configured as dribble to output 1; if main = 2000.
inflight = 10, deadband = 5, status = on below tracking net weight, tag = SLURRY. dribble = 35:
sent received
00-09/CR 00[00002000]011000010]02[000005]03[010]04[SLURRY 3
05[00000035]06[000000107[000000108[001109[OUTPUT 2] CRLF
3. to get outputs 1 -4 main values: if 2000, 4000, 6000, and 8000
sent received
00/05/10/15/CR 00[00002000]05100004000110[00006000]15[00008000]CRLF

OUTPUT data write examples:

Note - Downloading data to the LCp-200 is done by sending a 3 character command, the data enclosed in [] brackets, and a carriage return as shown in the examples below. The response will be staggered depending upon the time it takes to store the data. First the command will be returned and then after the data is stored the CRLF of next command will be returned.

1. to download output 1 (code 001)
send (if main = 50000)
00[00050000]CR or 00[50000]CR
response will be: 00[00050000]CRLF
2. to download output 1 inflight deadload status and tag
send (if inflight and deadband are 15 and 5, configured as on below tracking gross, and tag is WATER)
01[000015302[0000051031000104[WATER]CR or
01[15]02[5103(000]04[VVATER]CR
response will be: 01[000015102[0000051031000104[WATER]CRLF

6.3 SETPOINT CONFIGURATION

Model LCp-200 controllers provide eight outputs for set point operation. Standard units offer open collector/TTL signals at the rear panel connector. Optionally, triac based analog outputs may be ordered. In either case, the output signals are identical, based upon configuration selections presented in Figure 6-1. Following the flow diagram to select main or dribble function for each output used. Also, select the polarity (valve EON' above or below set point) and a tag description (name) for each set point.

6.3.1 Main Set point Function and Selections

Main corresponds to a fast (coarse) or high speed in-put. To avoid over-filling in fast mode, enter an INFUGHT value which corresponds to ingredient weight that will fall into the process vessel after valve closure. To make sure the valve does not reopen, enter a DEADBAND (hysteresis) value. After vessel motion ceases,

the Model LCp-200 checks vessel weight against the main set point value (entered via the front panel STPNT key). If vessel weight is less than the set point value minus the total inflight and dead band values, the Model LCp-200 will signal the valve to reopen, otherwise the main set point is complete. Set point polarity (i.e. valve on below or above selected value) can be configured for each main set-point. The TAG selection allows each main set point to be designated by an alphanumeric name or number. Tag designations are communicated through the PC and PLC interfaces to a host device.

NOTE: Set point relays always "OPEN" when an error condition is detected, regardless of polarity selection.

6.3.2 Entering/Altering Main Set points

Main set point values may be entered/ altered at any time by pressing the front panel STPNT key. Use the procedure shown in Figure 6-3 to enter/alter main set-points.

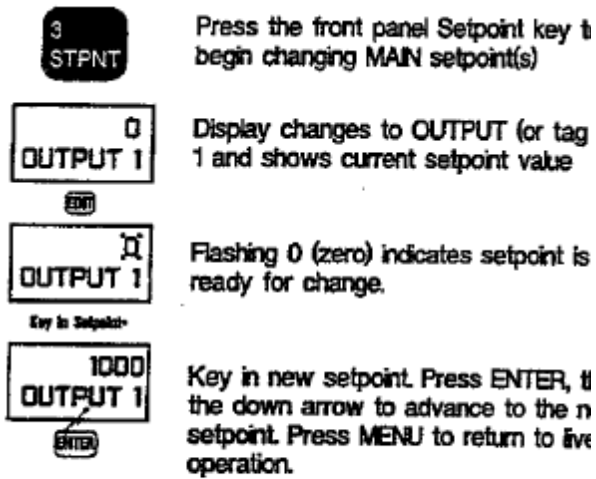

*** To Enter/Alter a Numeric Value:**

- Key in desired numeric value.
- Press to return to previously entered value.
- Press to store selection in memory.

Figure 6-3. Entering/Altering Main Set Points.

6.3.3 Dribble Set point Function and Selection

Many high resolution process systems have two speeds (or two valves) for ingredient filling. Dribble represents the slow, (fine) precision, fill mode. Select a value that allows ample time for the system to switch from main to dribble (dribble value is subtracted from the main value) and achieve a highly accurate final fill.

Dribble values can only be entered/alterd during con-figuration. After designating a set point for dribble function, the value must be entered, immediately. Enter a whole number dribble set point value (i.e. 1000 lb).

NOTE: Dribble set point values cannot be entered/alterd using the front panel S1PNT key. Dribble set points will be skipped over by the STPNT key.

SECTION 7. System Diagnostics

7.1 OVERVIEW

LCp-200 diagnostics provide easy access to critical operating system data, and test/verification procedures for many indicator functions. Unique to LCp-200 diagnostics is the simulated weighment or ramp feature.

Figure 7-1 (next page) presents the diagnostic flow diagram. Follow the procedures in this diagram to view values, set function limitations, test the front panel keypad, verify I/O functions, and run a simulated weighment.

7.1.1 Diagnostic User

Diagnostic user provides three registers for storage of customer tag and calibration records. Users may enter a tag number, current calibration date, and projected date of next calibration, if desired.

7.1.2 Diagnostic Version

Diagnostic version provides the software version, the installed option code derived from the ordering specification, the serial number, the A/D converter revision level, and the date of the factory calibration.

7.1.3 Diagnostic Recall

Recall allows the operator to view current tare and zero values.

7.1.4 Selecting Limits

DIAG LIMITS is accessed to enter/alter zero, overload, and motion limits and motion timer. The value entered for zero will limit the range of the front panel zero key (recommended 2-20%). Overload sets the alarm annunciator activate point Motion determines how many counts must be exceeded before the 'in motion' alarm annunciator is activated. The motion timer determines how long the motion alarm remains activated after the motion condition is cleared.

7.1.5 Front Panel Key Test

DIAG KEYPAD allows an operator to functionally test any/all front panel keys. Press any two keys simultaneously to exit.

7.1.6 Check Remote Inputs

DIAG INPUTS is a check of all remote inputs. If inputs are inactive, their respective numbers will appear (54321). Once activated, the input number will change to a dash.

7.1.7 Test/Verify the Analog Output

D1AG ANALOG tests the analog output. Test should be performed with a current meter attached. Testing firstly shows the actual analog count value being transmitted. Since the analog output is based on a 16 bit D-A conversion, the percent of span can be calculated by dividing the displayed counts by 65535. Secondly, any value may be entered to test the analog output. Enter a known value such as 65535 (max setting) and check current meter for appropriate output Exiting this menu will automatically discontinue the test mode.

7.1.8 Test/Troubleshoot the Serial Output

DIAG SERIAL provides the means to view both the transmit and receive buffers. After pressing EDIT, use the left/right arrow keys to increment forward or decrement backward through the selected buffer and view the hexadecimal value of each character. Using this procedure, incoming data requests can be checked for protocol/syntax accuracy and compared to LCp-200 output responses.

7.2 SIMULATING A WEIGHMENT

'Ramping' allows entry of starting and ending gross weight values, and then simulates a live weight addition without adding actual product/ingredients to the vessel. During the ramping exercise all outputs function as if an actual weight change were in progress.

DIAG RAMP allows entry of simulated starting (typically 0) and ending (typically full scale system capacity) weight points. Time for a complete ramp 'up' cycle (starting point up to ending point) can be selected from 1 to 240 seconds. Once ramp 'up' is complete, a ramp 'down' (ending point down to starting point) sequence automatically begins. At

the BEGIN display, press EDIT to start ramping. Ramping will continue until ESC is pressed.

7.3 TEST/TROUBLESHOOT THE INTERNAL MODEM

DIAG MODEM allows evaluation of the modem transmit and receive buffers. See paragraph 7.1.8 for operational details.

Diagnostic Menu Flow Diagram

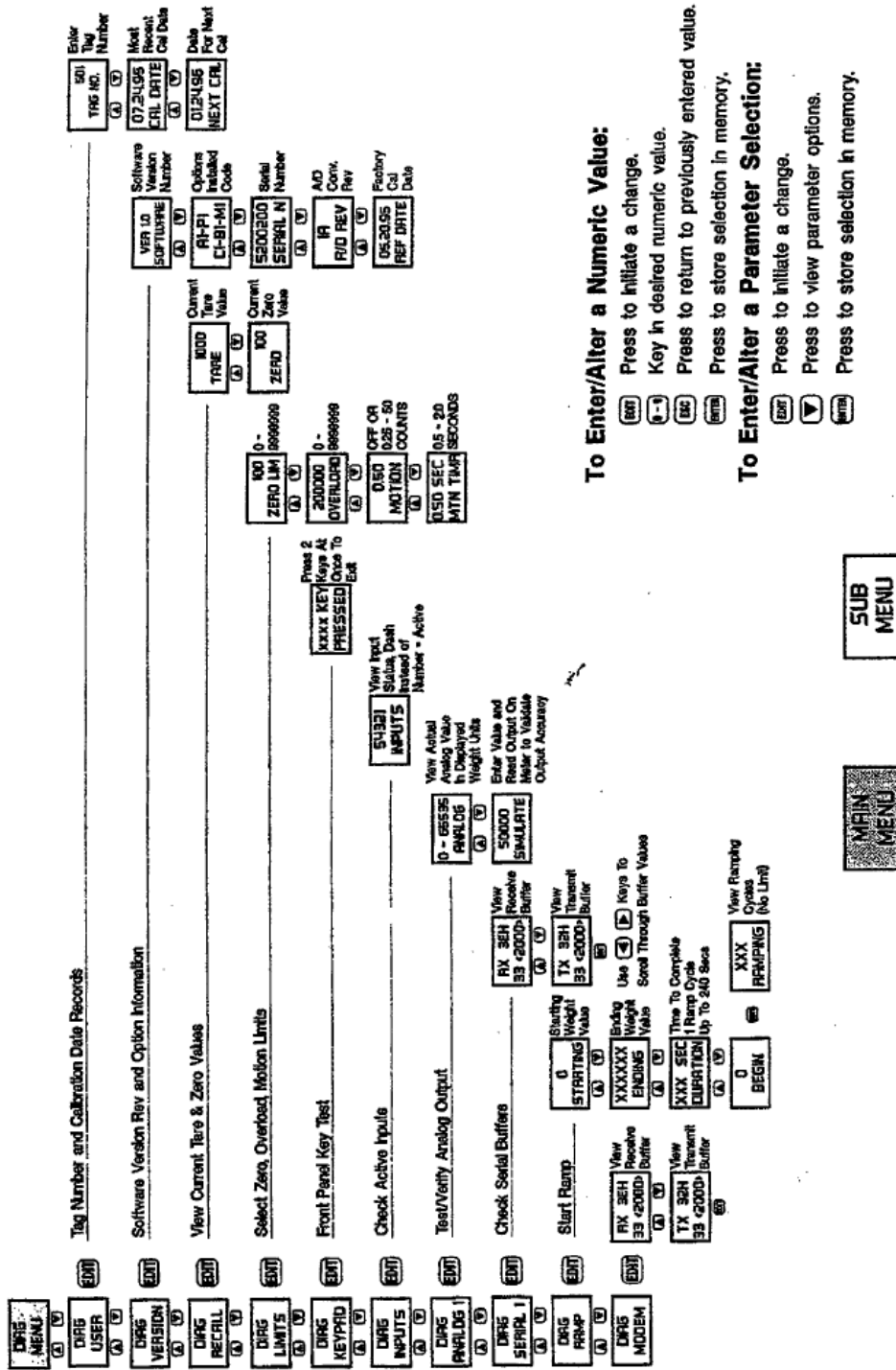

Figure 7-1. Diagnostic Menu Flow Diagram.

SECTION 8. Rate-By-Weight

8.1 GENERAL

LCp-200 controllers calculate the mass flow rate by dividing change in weight by elapsed time. Flowrate is computed each update based upon filtered weight data. Rate values are accumulated based upon the derivation time selected by the operator (Figure 8-1, page 8-3). Display and output values are the average of accumulated rate updates during the derivation time period. For example, if a derivation time of ten seconds is selected, display updates will be based upon the running average of 200 rate updates which occur every 50 ms. The minimum derivation time selection is calculated automatically by the LCp-200 based upon unit

and resolution entries (Figure 8-1). Longer derivation time selections result in greater sensitivity (resolution) while selecting a time less than the calculated minimum derivation could result in erroneous readings.

8.1.1 Determining Minimum Flow Rate Capability

Application parameters such as transducer type, dead/live loads, and the use of intrinsic safety barriers (Div 1 hazardous locations only) affect the instrument's ability to measure very low flow rates. Use the equation presented in Table 8-1 to determine the limitations induced by the application.

Table 8-1. Minimum Derivation Time Calculation

Equation for determining minimum derivation time to achieve desired flow rate resolution:

$$\frac{(\text{System Capacity})}{(\text{Load Cell Output})(\text{Desired Flow Rate Resolution})} \times (5 \times 10^{-6}) = \text{Minimum Derivation Time}$$

EXAMPLE

Given:

Minimum flow rate = 18 lb/min.

System capacity = 20,000 lb.

Load cell output (full scale) = 2 mV/V.

Desired flow rate resolution = 0.01 lb/sec.

5×10^{-6} is the constant sensitivity of the LCp-200 instrument.

$$\frac{20,000 \text{ lb}}{(2 \text{ mV/V})(0.01 \text{ lb/sec})} \times (5 \times 10^{-6}) = 5 \text{ seconds}$$

Conclusion: 0.01 lb/sec can be achieved with a minimum derivation time of 5 seconds.

8.1.2 Determining Display and Output Update Frequency

The LCp-200 allocates finite memory buffers to accumulate weight data over time in order to calculate rate. When long derivation times are used, pre-set buffer limits are imposed. As a result, effective display and output frequencies are affected. Table 8-2 summarizes this relationship.

8.1.3 Determining Weight/Rate Resolution

Rate resolution varies according to unit selection (seconds or minutes) and display count (count by's) configuration. Also, static weight and rate-by-weight resolutions can be set independently. For example, a system with a static weight resolution of 1.0 lb can potentially have a rate resolution of 0.002 lb/sec. Table 8-3 shows the effect of units and count by selections on rate resolution.

8.2 PARAMETER SELECTIONS

Figure 8-1 shows the flow diagram for selecting and entering rate parameters. Follow the sequence to make all entries and then check to be sure the derivation time entered is not LESS than the automatically calculated minimum derivation time.

8.2.1 Units

Faster flow rates should be entered as units (lb, kg, etc., see paragraph 32.1) per second while slower flow rates should be entered as units per minute.

Table 8-2. Derivation Time and Update Frequency

DV TIME Seconds	Update Frequency, Milliseconds
1.25	50
26 - 50	100
51 - 100	200
101 - 126	250
126 - 260	600
251 - 500	1000
502 - 1000	2000
1005- 1250	2500

8.2.2 Resolution

Select the resolution that corresponds to the units previously specified. This selection tells the LCp-200 approximately how many units will flow in the time frame selected; i.e. 0.01 pounds per second.

8.2.3 Derivation Time

Derivation time is the estimated time frame in which a specified amount (resolution/units) of material will flow into or out of the weigh vessel. Minimum derivation time is automatically calculated by the Cep-200 (next parameter). Do not enter a value less than the calculated minimum value or erroneous readings may result.

8.2.4 Minimum Derivation Time

This value is automatically calculated by the LCp-200 based upon units and resolution entries. This value cannot be changed and serves only as a minimal guideline for the previous entry. If a derivation time value has been entered which is less than this value step back to derivation time (DV TIME) and change it before attempting system operation.

Table 8-3. Instrument Weight and Rate Resolution Settings (without decimal point)

Rate Resolution Examples - Possible Settings		
	Units/Second	
0.001	0.002	0.005
0.002	0.005	0.01
0.005	0.01	0.02
0.01	0.02	0.05
0.02	0.05	0.1
0.05	0.1	0.2
0.1	0.2	0.5
0.2	0.5	1
0.5	1	2
1	2	5
2	5	10
5	10	20
10	20	50
	Units Per Minute	
0.01	0.2	0.5
0.2	0.5	1
0.5	1	2
1	2	5
2	5	10
5	10	20
10	20	50
20	50	100
50	100	200
100	200	500
200	500	1000
500	1000	2000
1000	2000	5000

Rate-By-Weight Flow Diagram

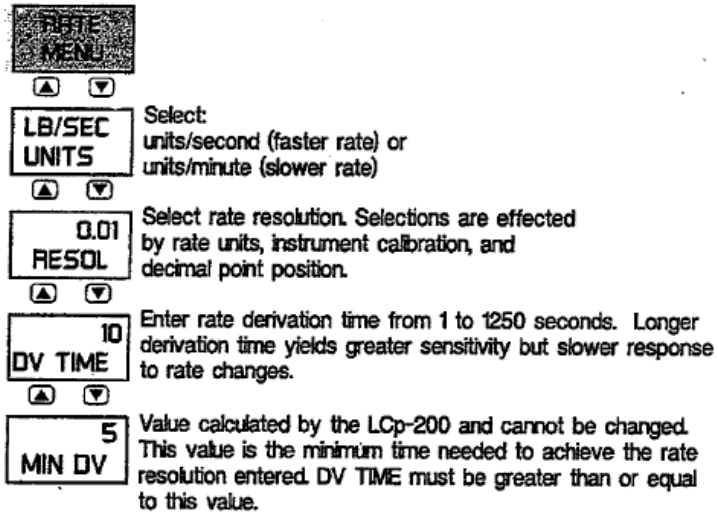

To Enter/Alter a Numeric Value:

- EDIT** Press to initiate a change.
- 0 - 9** Key in desired numeric value.
- ESC** Press to return to previously entered value.
- ENTER** Press to store selection in memory.

To Enter/Alter a Parameter Selection:

- EDIT** Press to initiate a change.
- ▼** Press to view parameter options.
- ENTER** Press to store selection in memory.

General Key Functions:

- ▲** Step back to previous menu selection.
- ▼** Advance to next menu selection.
- MENU** Advance to next main menu selection.
- ESC** Return to live operation from menu.
- EDIT** Change sub menu parameters.
- ENTER** Store displayed sub menu parameter in memory.

SUB
MENU

Figure 8-1. Rate-By-Weight Flow Diagram

SECTION 9. Security System

9.1 INTRODUCTION

From password access to individually selectable menu and key 'locks', Safe-Weigh Software protects the entire weigh system from overt tampering or accidental data/configuration/calibration alterations. Figure 8-1 (next page) presents the security menu flow diagram. Follow the procedures designated to secure as many parameters as desired.

9.1.1 Lock On/Off

Lock 'On' restricts access to the security menu and all other menus/keys designated as 'locked'. If locked, the designated password (see paragraph 9.2) must be entered to gain access to the security menu. Units are shipped with the lock 'Off to allow initial configuration without a password.

9.1.2 Menu Locks

Any or all of the LCp-200 main menus can be 'locked' to prevent parameter changes. To lock a menu, choose ON by pressing the EDIT and RIGHT arrow keys in sequence. Then press ENTER to store. Once a menu is designated as locked access to that menu is barred. To 'unlock' a locked menu, return to the security menu, enter the correct password, and change the status to OFF.

9.1.3 Key Locks

Five of the LCp-200 front panel keys can be 'locked' to prohibit key function. Keys that can be locked are; ZERO, TARE, G/N (gross/net), PRINT, and EDIT. To lock a key, choose ON by pressing the EDIT and RIGHT arrow keys in sequence. Then press ENTER to store. If a key is designated as locked, it will not function when pressed. To 'unlock' a locked key, return to the security menu, enter the correct password, and change the status to OFF.

9.1.4 Set Point Locks

Set Point entries may be locked to prevent accidental value changes and maintain recipe integrity.

NOTE: Lock conditions apply only to operator key en-tries. Lock conditions do not affect serial interface transactions.

9.2 PASSWORD ACCESS

If lock ON is selected (paragraph 9.1.1), a password must be entered to regain access to the security menu. The following paragraphs explain how to select and enter a password. Once a password is chosen, it should be written down and stored in a confidential area.

9.2.1 9.2.1 Selecting/Storing a Password

A password can be any combination of alphanumeric characters up to seven digits long. It is not necessary to use all seven digits.

At the PASSWORD display, key in the designated characters using the arrow keys (LEFT/RIGHT to change digits, UP/DOWN to select character). When the password is correctly displayed, press ENTER to store.

9.2.2 Entering the Password

If the lock is 'ON', the password must be entered to access the security menu. W4th the display reading SECUTY (a row of dashes above), press EDIT. Use the arrow keys to enter the complete password, as it was stored, on the row above SECURITY. When the correct password is displayed, press ENTER. Note that entering the password does not turn the lock off; it simply allows access to the security menu. If the lock is left ON, the password must be entered each time the security menu is accessed.

Master Password:

In addition to the user selected password there is also factory installed master password. If the user selected password is lost, contact any BLH service location for the master password.

Security Menu Flow Diagram

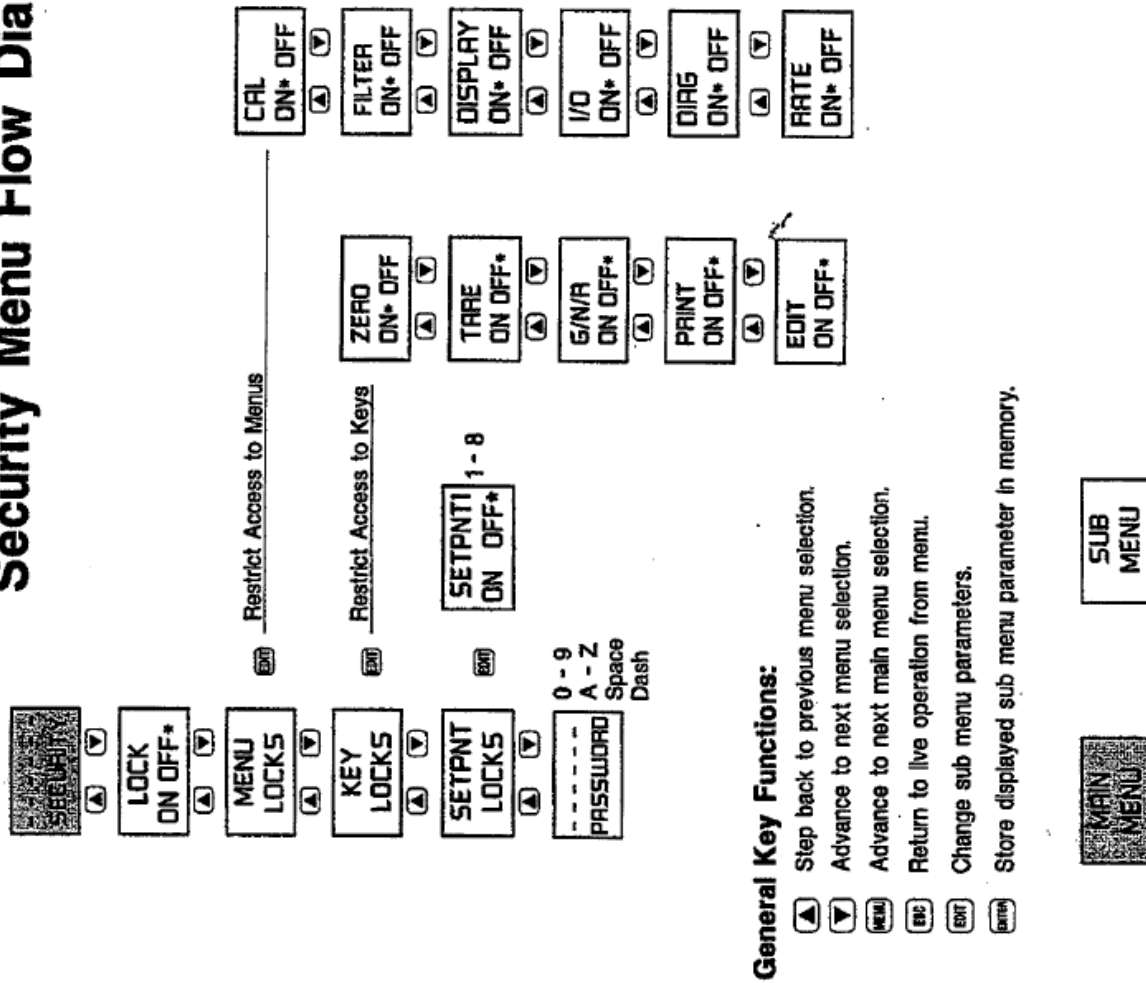

Figure 9-1. Security Menu Functions.

SECTION 10. Operation

10.1 GENERAL

LCp-200 indicator/transmitters power up in the gross weight weighing mode. If no system errors are detected, the front panel display will show the system live gross weight value. Note: For initial system power up, units are factory pre-calibrated with default values. Calibration (SECTION III), however, should be performed before attempting system operation.

Figure 10-1 presents the front panel switch functions for the operating mode. GM toggles the operating mode from gross to net to rate (see Section V paragraph 5.1.6). ZERO performs push to zero (gross mode) and TARE initiates the tare function in the net mode. PR1NT/COM transmits the current weight status data to a printer if print format is selected. If the LCp-200 is connected to a host computer or PLC, gross, net, zero, tare, and print functions can be initiated remotely using the rear panel digital inputs.

10.2 GROSS WEIGHT WEIGHING

In the gross mode, all of the live weight of the system is displayed on the front panel. Live weight does not include the dead weight of a vessel or other mechanical equipment that is factored out during calibration.

10.3 ZERO OPERATION

A new zero can be acquired to compensate for changes in the dead load of the system due to heel build-up etc. Acquiring a new zero reference value does not affect the slope of the calibration. The push to zero range in the LCp-200 can be configured from OFF to 100% of system capacity (or 9999999). To prevent system overload, the zero selection limit usually does not exceed 20% of system capacity. Zero may be acquired only if the system is not in motion and the zero limit has not been exceeded.

10.4 NET WEIGHT WEIGHING

Net weight weighing is used when the operator wants to reset zero to compensate for the

addition of live weight, or a container, before adding a specific amount of material. Tare is used to establish a zero reference in net mode.



Figure 10-1. Front Panel Operating Keys.

10.5 TARE OPERATION

With the LCp-200 in net weighing mode, the tare function resets the output to zero. Push button taring (TARE key) allows the operator to achieve a new zero reference before addition of each ingredient so that errors do not become cumulative. If manual tare is selected, a tare value must be entered using the 0 - 9 numeric keys (press ENTER to store). Manual tare values typically represent the known weight of empty containers placed upon the scale/platform.

10.6 RATE-BY-WEIGHT

Mass flow rate (rate-by-weight) may be displayed at any time by pressing the G/N operating key. LCp-200 algorithms constantly convert change in weight to a rate equivalent based upon parameters entered in Section VIII. Continuous serial communication outputs reflect rate data in this operating mode.

10.7 SETPOINT FUNCTION

Set point values are entered using the configuration keypad (reference Figure 5-1) numeric keys, 0-9. To enter or alter set point values, start by pressing the S7PNT key. The front panel display will display the current value of set point 1. To enter or alter set point 1, key in the desired numeric value i.e. 1000' and press enter. Press the down arrow key to advance to the next set point(s) and enter/alter in the same way. After values are established, press the MENU key to return to live operation. Set points function in accordance with parameters entered in Section VI. If rate-by-weight mode is selected, set points will function based upon vessel weight

NOTE: Set point actuation can be tested in ramp mode (paragraph 7.2) without live system processing.

10.8 ERROR DETECTION AND CORRECTION

Should an error condition occur, a scrolling message will appear on the bottom line of the front panel display. As much as possible, messages define the exact error and suggest a remedy. Once the error is cleared, the scrolling

message will stop and normal operation will resume. Table 10-1 presents all error messages with recommended solutions.

Should an error condition occur, a scrolling message will appear on the bottom line of the front panel display. As much as possible, messages define the exact error and suggest a remedy. Once the error is cleared, the scrolling message will stop and normal operation will resume. Table 10-1 presents all error messages with recommended solutions.

Table 10-1. Error Messages and Explanations.

POWER-UP FAULT MESSAGES

<u>FAULT CONDITION</u>	<u>DISPLAY</u>	<u>REMEDY</u>
The a/d module does not have a revision number	NO A/D REV	Factory procedure
The a/d module does not have a mv/V calibration date	NO CAL DATE	Factory procedure
The a/d module does not have a temperature compensation reference	NO TMP COMP	Factory procedure
The a/d module does not have a mv/V calibration	NO mv/V CAL	Factory procedure
The instrument serial number has not been downloaded	NO SER NUMBER	Factory procedure
The instrument has not been calibrated for weight	NO CAL	Set to quick cal or Acquire deadload cal or Enter keypad cal
The instrument does not have a manual zero value	NO MAN ZERO	Acquire zero using zero key or enter manual zero
The instrument does not have a manual tare value	NO MAN TARE	Acquire tare using tare key of enter manual tare

OPERATE MODE FAULT DISPLAYS

Load cell excitation short, or no excitation	FAULT LOAD CELL scrolling message = "EXCITATION FAULT CHECK CONNECTIONS"	Check connections
Load cell excitation fault cleared	FAULT CLEARED	
A/D reference values out of limit	A/D FAULT followed by RESTART, followed by reset of instrument	Check connections, possible sense line open
Eeprom read/write failure when storing parameters	EEPROM ERROR	Contact BLH field service
A/d output has reached maximum value	OVER RANGE	Check connections, excitation to signal short
A/d output has reached minimum value	UNDER RANGE	Check connections, excitation to signal short

OPERATE MODE SPECIAL DISPLAYS

Gross weight is equal to or greater than overload setting	5000 OVER LB (over is blinking)	
Rate of change too large for internal math registers	OVERFLW LB/SEC	Lower rate resolution
Attempt to enter locked menu or perform locked function	LOCKED	Go to security menu to unlock
Attempt to zero gross weight when in net mode	SWITCH TO GROSS	Switch to gross mode
Attempt to tare net weight when in gross mode	SWITCH TO NET	Switch to net mode
Attempt to zero gross weight at or above zero limit	ZERO LIMIT	
Attempt to zero gross weight or tare net weight in motion	IN MOTION	Wait for stable weight signal

SECTION 11. Modem and Protocol Options

11.1 GENERAL

Section XI provides information for LCp-200 interface and protocol options. Options such as the Service Link Modem, Modbus RTU, Modbus Plus, and Provox protocol are currently available. Fieldbus will be offered in the future.

11.2 THE SERVICE LINK MODEM

The LCp-200 modem is a V.22 bis data modem compatible with Carr V.22 bis (2400 bps), Bell 212A (1200 bps), and Bell 103 (300 bps). It is programmed to answer a call after 1 ring. The originating modem should be set for 2400 baud using 8 data bits with no parity. Once connection is established, all data transfers follow the PC format presented in Section VI, Table 6-3.

When BIM Field Service is desired, contact the field service manager at (617) 821-2000 extension 215. The Field Service Manager will arrange a diagnostic session, via modem, between the factory computer system and the installed LCp-200. .

The Service Link Modem is currently operable only in the United States and Canada. Outside these territories, please contact the factory for assistance.

11.3 MODBUS RTU PROTOCOL

This interface method is applicable to virtually any PC or other process control computer with Modbus RTU Master communication capability. The interface provides weight and diagnostic information and allows for remote control of tare, zero, and gross/net functions. New calibration data also may be downloaded via this interface. Information is transmitted in blocks of data, thereby minimizing polling and response time delays. The interface operates with the I-Cp-200 configured as the slave device and the host computer as the master. To initiate Modbus RTU protocol, simply select the Modbus print format as shown in Figure 6-1 (page 6-2). Modbus RTU uses the standard LCp-200 RS-485/422 communication port and requires no hardware alterations.

11.3.1 Common Data Format

Table 11-2 presents a complete overview of Modbus register and bit allocations. Table 11-2 information which appears in conventional text applies to both Modbus RTU and Modbus Plus formats. Allocations which pertain only to Modbus Plus appear in italic text. In addition to Table 11-2 information, the following data formats and definitions are identical for both Modbus protocol options:

- Weight Data (BLH format for Modbus Plus) - Two 16 bit signed integers, the first (high) integer must be multiplied by 32768 and then added to the second (low) integer.
- Status and setup parameters - One 16 bit unsigned integer.
- Alpha data - For each register: high byte is first character, low byte is second character.

NOTE: If a decimal point is required the resulting value must be multiplied by the appropriate fraction, i.e. 0.01 for hundreds of a unit. In the case of mV/V values the multiplier is 0.000001. The LCp-200 range is (-9999991+ 9999999).

NOTE: counts refers to displayed counts. If displayed weight is counting by 2 lb increments then presetting a register to 9 would mean 18 lbs.

11.3.2 Modbus RTU Functions Supported

02 Read Input Status

03 Read Holding Registers

06 Preset Single Register

16 (10 Hex) Preset Multiple Registers

11.3.3 Setup

Modbus RTU format, Device address, baud rate, and parity are all selectable under the SERIAL 1 section of the I/O MENU.

11.4 MODBUS PLUS INTERFACE

BLH is an official ModConnect) Partner. As such, BLH has been authorized by Schneider Automation to incorporate Modbus Plus Communication Technology in its LCp-200 series product line. Modbus Plus protocol allows the LCp-200 to communicate on a peer-to-peer network link with Modicon 984 and Quantum PLC devices.

LCp-200 units equipped with the Modbus Plus option have a custom rear panel with a specific MODBUS PLUS connector (see Figure 11-2 and paragraph 11.4.3). The Modbus Plus interface does not use the standard LCp-200 RS-485/422 communication port.

11.4.1 Routing Path Addressing

The LCp-200 Modbus Plus node is a Host Computer node with 8 data-slave input paths. When using Read/Write MSTR operations, or multiple Modbus Plus networks, take note of the message routing format. A routing address is five bytes in length. This allows communication between multiple Modbus Plus Networks over Bridge Mux hardware devices. Since the LCp is a host computer node, two of the five routing address bytes are required to identify it.

The next-to-last non-zero byte specifies the network node station address (1-64). The last non-zero byte specifies the input path or task number (1-8) to which the message is assigned. The other three routing address bytes allow communication through up to 3 Bridge Mux Devices. Table 11-1 depicts the address routing path for an LCp device at address 12, using path/task number 1.

Table 11-1. Routing Path Address Designations

Routing Path Example	Five Byte Address
No Bridge Mux Devices	12 - 1 - 0 - 0 - 0
Bridge Mux @Address 26	26 - 12 - 1 - 0 - 0
1 st Bridge Mux @ Ad. 26, 2 nd Bridge Mux @ Ad. 28, 3 rd Bridge Mux @ Ad. 30	26 - 28 - 30 - 12 - 1

NOTE: If multiple devices access the same LCp, BLH recommends using a different task/path number for each requesting device. This will prevent address contention problems.

NOTE: Host device routing path format is different from PLC designated device addressing. When using PLC designated devices, the input path/task number is not required since it is automatically selected.

NOTE: BLH assumes reader/operator familiarity with Modbus Plus token passing network operation. Readers/operators unfamiliar with Modbus Plus should obtain the 'Modicon Modbus Plus Network Planning and Installation Guide' (GM-MBPL-001) and 'Modicon Ladder Logic Block Library User Guide' (840 USE 101 00) from the Schneider Corporation.

11.4.2 Global Data Transfers

For high speed process control, BLH recommends that global data transfers be used. LCp-200 Global data allocations are defined in the Figure 11-1 parameter selection menu.

11.4.3 Wiring and Node Addressing

Wiring is simply a matter of connecting the Modicon supplied, 9 pin D-type connector cable to the LCp-200 rear panel Modbus PLUS D-type socket mating half. (see Figure 11-2).

LCp-200 nodes may occupy any station address location from 1 to 64. Selection is made at the rear panel (see table in Figure 11-2) DIP Switch designated AD-DRESS. Add '1' to the switch selection to obtain the actual address (i.e.,

selection-0 + 1 = 1). DIP switch positions 7 and 8 are unused.

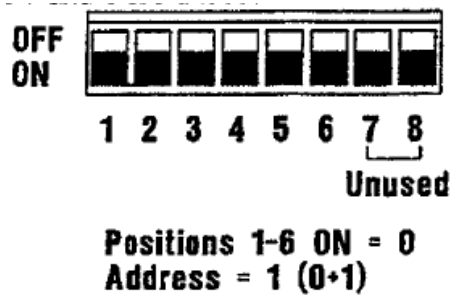

NOTE: Switch selections are read only during power-up. If the address selection is changed, the instrument must be powered down and then powered up again.

11.4.4 Configuration

Figure 11-1 presents the Modbus Plus configuration menu. Parameters are as follows:

ADDRESS is non-configurable. It simply indicates that the network has recognized the LCp-200 device at the designated address.

GLOBAL DATA allows up to 14 words of live weight and status data to be selected for broadcast with each token pass. Each item selected represents two words of global data. The first item selected 'YES' becomes the first two words, the second 'YES' becomes words three and four, and so forth. The seven available selections, status, gross weight, net weight, mV/V, live mV/V, rate, and set points are defined in Figure 11-1.

ROTATION is non-configurable. Rotation shows the time used for one complete token pass of all network nodes.

11.4.5 Data Formatting

Table 11-2 presents a complete overview of Modbus register and bit allocations. Table 11-2 information which appears in conventional text applies to both Modbus MU and Modbus Plus formats. Allocations which pertain only to Modbus Plus appear in italic text.

BLH offers two formats for actual data communication; double precision and BLH. Both formats are defined in the following subparagraphs. With both formats, two 16 bit status words (read only) supply system operating parameter information (see Table 11-3). To select the desired format, choose DOUBLE or BU-I as depicted in Figure 11-1 Modbus Plus Parameter Selections. Note that double precision is the default format.

Double Precision Format

Modicon Double Precision EMTH Functions allow PLC users to perform math functions in a 32 bit format. This is accomplished by combining data from two 16 bit registers. Each register holds a value in the range of 0 to 9999, for a combined Double Precision value in the range of 0 to 99,999,999. The combined value is referred to as operand 1.

The low-order half of operand 1 (register 1) is stored in the displayed register and the high-order half is stored in the implied register (register 2). Double precision formatting, however, makes no provision for transmitting a data polarity indicator (plus or minus). BLH therefore, makes a slight format modification to transmit this vital statistic.

Double Precision data formatting uses two, 16 bit registers of information to transmit weight data (see below). Each register contains four significant digits. Since the most significant bit of register one is unused (always '0'), BLH uses this bit to transmit data polarity. If data is negative, this bit is set to a '1'. If data is positive (as assumed with conventional Double Precision format), this bit remains a zero. Upon receiving a data transmission, the polarity bit must be immediately evaluated. If data is negative (MSB = 41'), store the negative polarity bit in another PLC register (establish a negative data flag) and reset the MSB of register 1 to ZERO. Do not process the data in register 1 until the MSB is set to zero. Attempting to process data with the negative polarity bit set will result in erroneous information. Once the MSB of register 1 is confirmed to be zero, process data using

conventional Double Precision EMTH instructions.

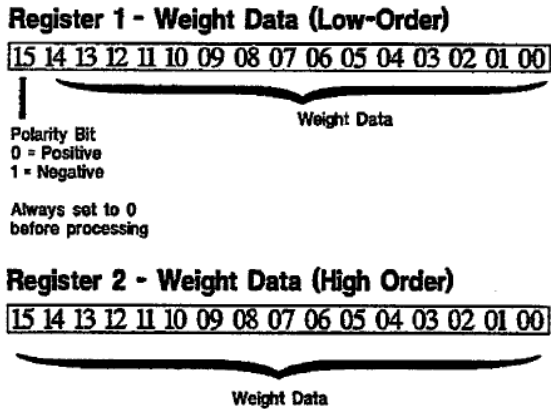

BLH Data Format

BLH formatted weight data consists of two 16 bit signed integers, the first (high) integer must be multiplied by 32768 and then added to the second (low) integer (see below).

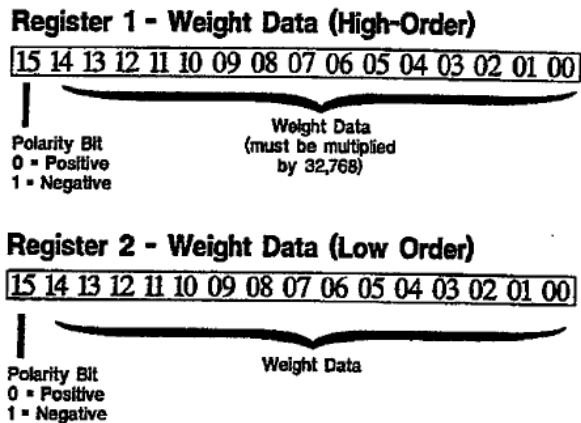

NOTE: If a decimal point is required the resulting value must be multiplied by the appropriate fraction, i.e. 0.01 for hundreds of a unit In the case of mV/V values the multiplier is 0.000001. The LCp-200 range is (-9999991+9999999).

NOTE: counts refers to displayed counts. If displayed weight is counting by 2 lb increments then presetting a register to 9 would mean 18 lbs.

11.4.6 Flashing LED Status

A flashing green 'ACTIVE' LED located on the LCp-200 rear panel (Figure 11-2) indicates the status of Modbus Plus network operation. To interpret flash patterns, refer to the Modbus Plus Planning Guide (GM-MBPL-004).

NOTE: To display flashing status on the LCp-200 front panel, configuring an Alarm/Status Annunciators for 'Modbus Plus Status' indication (see Section V).

11.4.7 Manipulating the Front Panel Display

Provision has been made for the host PLC to display messages on the LCp-200 front panel display. Messages may occupy both the upper (7 character) and lower (8 character) display lines (Figure 11-3). To send a message, the host PLC transmits the message coded in conventional ASCII characters* to registers 40258 thru 40265 along with a display control word; register 40257. Information written to these LCp-200 registers determines not only the message content but also the display time period. When the host message display time period expires, the LCp-200 will revert to its normal weight/status display. See Table 11-2 and Figure 11-3 for a detailed breakout of register allocations and functions.

Host messages displayed on the LCp front panel can be used to alert operators to error conditions, prompt required inputs, etc.

NOTE: Host messages are not displayed if the LCp-200 is in any calibration or parameter configuration menu mode.

To transmit a decimal point, set the 7sd of the ASCII character byte to a '1'.

11.5 PROVOX PROTOCOL

This interface allows direct communication with a Fisher Rosemount CL6921 type external interface card (card must be configured for 'Toledo' communication format). For further details, request BLH document 1D-073.

11.5.1 Wiring

The Provox interface is transmit only and requires only a twisted pair of wires. Connect wires to the TxD+ and TxD- screw terminals on the 470294-1 interface converter board as shown in Figure 11-4. Plug the interface converter board into the LCp-200 rear panel serial port as shown in Figure 11-4. Set the SW1 DIP switches as shown in Figure 11-4 (BLH drawing #470315-2). Note that the 470294-1 converter board supplied by BLH converts the LCp-200 output signal from RS-422 to 20 mA current loop for Provox operation.

The CL6921 external interface card input wiring pins are 17 (Rx-) and 18 (Rc+) as shown in Figure 11-4.

11.5.2 Configuration

To configure the LCp-200 for Provox communication use the flow diagram presented

in Figure 6-1. At the WO serial display, simply press edit and select the Provox PRINT FORMAT. Once Provox format is selected, all parameters -such as 4800 baud rate, string format, even parity, and transmission timing are automatically specified; no further parameter entries are needed.

11.5.3 Operation

With Provox format selected, the LCp-200 continuously transmits 18 bytes of information containing displayed and tare weight data to the external inter-face card at 4800 baud. This rate is pre-defined by Fisher Rosemount and cannot be changed. Each byte is 10 bit ASCII formatted .as follows: bit 1= start, bits 2-8 contain actual data, bit 9 = even parity, and bit 10 = stop. Table 11-4 presents the protocol for each of the 18 bytes.

Table 11-2. Modbus Register Allocations.

REGISTER ADDRESSES

Registers 1 - 18 are read only, 20 - 136 are read/write, 256 is write only

REG#	DATA	REGS	DESCRIPTION
40001	SERIAL #	4	7 ASCII digits 0-9 starting with high byte of reg 40001 to high byte of reg 40004; reg 40004 low byte = 0
40005	SOFTWARE VER	1	number with 2 decimal places
40006	A/D REV	1	2 ASCII chars starting with high byte
40007	REF DATE	3	MMDDYY Month Day Year of internal cal; 6 ASCII digits 0-9 starting with high byte of reg 40007 to low byte of reg 40009
40010	STAT1	1	status register 1 (see page 11-8, Table 11-3 for def)
40011	STAT2	1	status register 2 (see page 11-8, Table 11-3 for def)
40012	GROSS WEIGHT	2	
40014	NET WEIGHT	2	
40016	mv/V ACTUAL	2	
40018	mv/V LIVE	2	
40020	ZERO	2	
40022	TARE	2	
40024	ZERO mv/V	2	zero cal point in mv/V
40026	SPAN1 mv/V	2	span1 cal point in mv/V
40028	SPAN1 units	2	span1 cal point in units
40030	SPAN2 mv/V	2	span2 cal point in mv/V
40032	SPAN2 units	2	span2 cal point in units
40034	SPAN3 mv/V	2	span3 cal point in mv/V
40036	SPAN3 units	2	span3 cal point in units
40038	SPAN4 mv/V	2	span4 cal point in mv/V
40040	SPAN4 units	2	span4 cal point in units
40042	SPAN5 mv/V	2	span5 cal point in mv/V
40044	SPAN5 units	2	span5 cal point in units
40046	SPAN6 mv/V	2	span6 cal point in mv/V
40048	SPAN6 units	2	span6 cal point in units
40050	SPAN7 mv/V	2	span7 cal point in mv/V
40052	SPAN7 units	2	span7 cal point in units
40054	SPAN8 mv/V	2	span8 cal point in mv/V
40056	SPAN8 units	2	span8 cal point in units
40058	SPAN9 mv/V	2	span9 cal point in mv/V
40060	SPAN9 units	2	span9 cal point in units
40062	SPAN10 mv/V	2	span10 cal point in mv/V
40064	SPAN10 units	2	span10 cal point in units
40066	# SPAN POINTS	1	0 - 10 (0 if no deadload or keypad cal)
40067	CAL TYPE	1	0 = QUICK, 1 = DEADLOAD, 2 = KEYPAD
40068	ENG UNITS	1	0 = LB, 1 = KG, 2 = TN, 3 = OZ, 4 = GM, 5 = N, 6 = KN, 7 = L
40069	CAPACITY	2	sum of rated capacity of load
40071	DECIMAL POINT	1	0-6 decimal point position: 0= none, 3= 0.000
40072	RATED OUTPUT	2	average of load cells rated output in mv/V
40074	UNIT COUNT BY	1	0-6 = 1,2,5,10,20,50,100
40075	ZERO LIMIT	2	keypad push to zero limit
40077	OVERLOAD	2	overload limit, 0 = no limit
40079	LEVEL CONFIG	1	level bar graph configuration: 0 = off/gross, 1 = on/gross, 2 = off/net, 3 = on/net, 4 = off/rate, 5 = on/rate
40080	LEVEL 0%	2	level 0% setting
40082	LEVEL 100%	2	level 100% setting
40084	ARROWS CONFIG	1	side arrows configuration: 0 = off/gross, 1 = on/gross, 2 = off/net, 3 = on/net, 4 = off/rate, 5 = on/rate
40085	ARROWS 0%	2	arrows 0% setting
40087	ARROWS 100%	2	arrows 100% setting
40089	A1 ANNUNCIATOR	1	0-15: 0 = off
40090	A2 ANNUNCIATOR	1	1 = in motion
40091	A3 ANNUNCIATOR	1	2 = zero lim
40092	A4 ANNUNCIATOR	1	3 = overload
40093	A5 ANNUNCIATOR	1	4 = ser1 rx
40094	A6 ANNUNCIATOR	1	5 = ser1 tx
40095	A7 ANNUNCIATOR	1	6 = s1 par err
40096	A8 ANNUNCIATOR	1	7 = s1 fram err
40097	ZERO KEY CONFIG	1	0 = auto, 1 = manual
40098	TARE KEY CONFIG	1	0 = auto, 1 = manual
40099	ANALOG CONFIG	1	0 = gross, 1 = net, 2 = rate
40100	ANALOG LOW	2	low analog output weight setting
40102	ANALOG HIGH	2	high analog output weight setting
40104	ANALOG LOW ADJ	2	low analog output adjustment

Table 11-2. con't.

40106	ANALOG HIGH ADJ	2	high analog output adjustment
40108	FILTER AVERAGING	1	0-7 = 1,2,4,8,16,32,64,128 conversions
40109	FILTER BAND	1	0-10 = 0-2.5 counts, 11-108 = 3-100 counts
40110	MOTION	1	0 = off, 1-10 = 0-2.5 counts, 11-58 = 3-50 counts
40111	MOTION TIMER	1	0-3 = 0.5, 1.0, 1.5, 2.0 seconds
40112	PASSWORD	4	allowable ASCII chars are 0-9,A-Z, minus, space. Reg 40112 high byte is first char, reg 40115 high byte is last char; reg 40115, low byte set to 0
40116	KEY/SECY LOCKS	1	bits 0-4 = zero,tare,g/n,print,edit keys bit 5 = security lock; 0 = off, 1 = on
40117	MENU LOCKS	1	bits 0-5 = cal,filter,display,i/o,diag, rate; 0 = unlock, 1 = lock
40118	SERIAL 1 FORMAT	1	0 = print, 1 = continuous, 2 = pc, 3 = Modbus, 4 = Provox
40119	SERIAL 1 ADDRESS	1	0-99
40120	SERIAL 1 BAUD RATE	1	0 = 9600, 1 = 19200, 2 = 300, 3 = 600, 4 = 1200, 5 = 2400, 6 = 4800
40121	SERIAL 1 PARITY	1	0 = none, 1 = even, 2 = odd
40122	PRINT DATA SELECT	1	bits 0-5 = display,gross,net,zero,tare, rate; 0 = no, 1 = yes
40123	PRINT DATA FRMAT	1	bits 0-1 = stx,address; 0 = no, 1 = yes bit 2 = leading 0s; 0 = spaces, 1 = zeros bit 4 = status; 0 = no, 1 = yes bit 5 = delimiter; 0 = space, 1 = crlf bit 6 = terminating char; 0 = crlf, 1 = cr bits 7,3 = units; 00 = no, 01 = abbreviated 0-99 = 0.0 - 9.9 seconds
40124	PRINT CRLF DELAY	1	bits 0-5 = display,gross,net,zero,tare, rate; 0 = no, 1 = yes
40125	CON'T DATA SELECT	1	bits 0-1 = stx,address; 0 = no, 1 = yes
40126	CON'T DATA FRMAT	1	bit 2 = leading 0s; 0 = spaces, 1 = zeros bit 3-4 = units,status; 0/1 = no/yes bit 5 = delimiter 0 = space, 1 = crlf bit 6 = terminating char; 0 = crlf, 1 = cr bit 7 = timer; 0 = no, 1 = yes 0-599 = 00.0 - 59.9 seconds
40127	CON'T TX TIMER	1	0-240 = 0 - 240 minutes
40128	CON'T TX TIMER	1	allowable ASCII chars are 0-9,A-Z, minus, space. Reg 40129 high byte is first char, reg 40132 high byte is last char, reg 40132 low byte set to 0.
40129	TAG NO.	4	MMDDYY Month Day Year of customer cal 6 ASCII digits 0-9 starting with high byte of reg 40133 to low byte of reg 40135.
40133	CAL DATE	3	MMDDYY Month Day Year of customer next cal. 6 ASCII digits 0-9 starting with high byte of reg 40136 to low byte of reg 40138
40136	NEXT CAL	3	0 = 57.6K, 1 = 115.2K, 2 = 230.4K
40139	RIO BAUD RATE	1	0-63 = 1-77 octal
40140	RIO RACK #	1	0-3 = 1-4 starting quarter
40141	RIO QUARTER	1	0 = not last rack, 1 = last rack
40142	RIO LAST RACK	1	Instrument type: 200 for LCP-200
40143	INSTRUMENT	1	[M]-[A]-[P]-[C]-[B]-[M] 6 ASCII digits 0-9 starting with high byte of reg 40144 to low byte of reg 40146
40144	OPTIONS	3	rate units; 0 = unit/sec, 1 = unit/min
40147	RATE UNITS	1	rate resolution; (0-12) 0 = highest, 12 = lowest
40148	RATE RESOLUTION	1	rate derivation time (1-1250) seconds
40149	RATE DV TIME	1	rate minimum derivation time (1-1250) seconds
40150	RATE MIN DV TIME	1	current rate data
40151	CURRENT RATE DATA	2	low nibble = display power up; 0 = gross, 1 = net, 2 = rate
40153	G/N KEY CONFIG	1	high nibble: 4 = net display (0/1 = no/yes) 5 = rate display (0/1 = no/yes); 6&7 = spare
40154	MB+ GLOBAL DATA	1 (bits 0-7)	0 = no, 1 = yes bit 0 = status bit 1 = gross bit 2 = net bit 3 = mV/V bit 4 = live mV/V bit 5 = rate bit 6 = setpnts bit 7 = spare
40155 - 40169			spare
40170	OUTPT 1 MAIN	2	output 1 main value
40172	OUTPT 1 INFLIGHT	1	output 1 inflight
40173	OUTPT 1 DEADBAND	1	output 1 deadband
40174	OUTPT 1 CONFIG	1	output 1 configuration; bit 0 = main(0)/drib(1), bit 1 = track gross(0)/net(1), bit 2 = 0, bit 3 = on below (0)/above (1)
40175	OUTPT 1 TAG	4	output 1 tag; 8 ASCII characters (space,1-0, '-',A-Z) starting with high byte of reg 40175 to low byte of reg 40178

Table 11-2. con't.

40179	OUTPT 2 MAIN/DRIB	2	output 2 main (or output 1 dribble) value
40181	OUTPT 2 INFLIGHT	1	output 2 inflight
40182	OUTPT 2 DEADBAND	1	output 2 deadband
40183	OUTPT 2 CONFIG	1	output 2 config; see definition for output 1 config
40184	OUTPT 2 TAG	4	output 2 tag; see definition for output 1 tag
40188	OUTPT 3 MAIN/DRIB	2	output 3 main (or output 2 dribble) value
40190	OUTPT 3 INFLIGHT	1	output 3 inflight
40191	OUTPT 3 DEADBAND	1	output 3 deadband
40192	OUTPT 3 CONFIG	1	output 3 config; see definition for output 1 config
40193	OUTPT 3 TAG	4	output 3 tag; see definition for output 1 tag
40197	OUTPT 4 MAIN/DRIB	2	output 4 main (or output 3 dribble) value
40199	OUTPT 4 INFLIGHT	1	output 4 inflight
40200	OUTPT 4 DEADBAND	1	output 4 deadband
40201	OUTPT 4 CONFIG	1	output 4 config; see definition for output 1 config
40202	OUTPT 4 TAG	4	output 4 tag; see definition for output 1 tag
40206	OUTPT 5 MAIN/DRIB	2	output 5 main (or output 4 dribble) value
40208	OUTPT 5 INFLIGHT	1	output 5 inflight
40209	OUTPT 5 DEADBAND	1	output 5 deadband
40210	OUTPT 5 CONFIG	1	output 5 config; see definition for output 1 config
40211	OUTPT 5 TAG	4	output 5 tag; see definition for output 1 tag
40215	OUTPT 6 MAIN/DRIB	2	output 6 main (or output 5 dribble) value
40217	OUTPT 6 INFLIGHT	1	output 6 inflight
40218	OUTPT 6 DEADBAND	1	output 6 deadband
40219	OUTPT 6 CONFIG	1	output 6 config; see definition for output 1 config
40220	OUTPT 6 TAG	4	output 6 tag; see definition for output 1 tag
40224	OUTPT 7 MAIN/DRIB	2	output 7 main (or output 6 dribble) value
40226	OUTPT 7 INFLIGHT	1	output 7 inflight
40227	OUTPT 7 DEADBAND	1	output 7 deadband
40228	OUTPT 7 CONFIG	1	output 7 config; see definition for output 1 config
40229	OUTPT 7 TAG	4	output 7 tag; see definition for output 1 tag
40233	OUTPT 8 MAIN/DRIB	2	output 8 main (or output 7 dribble) value
40235	OUTPT 8 INFLIGHT	1	output 8 inflight
40236	OUTPT 8 DEADBAND	1	output 8 deadband
40237	OUTPT 8 CONFIG	1	output 8 config; see definition for output 1 config
40238	OUTPT 8 TAG	4	output 8 tag; see definition for output 1 tag
40242	SETPOINT LOCKS	1	bits 0-7 = setpoints 1-8; 0= off, 1 = on
40243-40255			spare
40256	COMMAND	1	Write only register. 1 = tare net weight 2 = push to zero gross weight 3 = clear status register 1
40257	CONTROL DATA	1	if bit 0 = 1, apply data in registers 40258-40261 to upper display if bit 1 = 1, apply data in registers 40262-40265 to lower display if bit 2 = 1 and bit 0 = 1, flash the upper display if bit 3 = 1 and bit 1 = 1, flash the lower display bits 4-7 are spares, set to zero bits 8-15 are the display timer, each increment adds 50 msec i.e. 00000001 = 50 msec timer; 00000010 = 100 msec timer NOTE: 00000000 = 12800 msec timer (12.8 seconds) see Figure 11-3 for byte allocations
40258-40261	UPPER DISPLAY DATA	4 registers	
40262-40265	LOWER DISPLAY DATA	4 registers	

Table 11-3. Status Byte Bit Allocations.

STATUS REGISTERS

Note: Status registers 1 & 2 are read only (function 03) registers. The bits in these registers can also be read as inputs 1 - 32 using function 02.

Note: In status register 1 the bits latch on if the condition is true. To clear status register 1 a 3 must be sent to command register 40256. In status register 2 the bits do not latch but follow the current status of the condition.

(INPUT) STAT1 STATUS REGISTER 1

(1)	BIT	0 - POWERUP
(2)	BIT	1 - UNABLE TO TARE/ZERO BECAUSE OF MOTION
(3)	BIT	2 - UNABLE TO ZERO BECAUSE OF LIMIT
(4)	BIT	3 - LOAD CELL SIGNAL UNDERRANGE
(5)	BIT	4 - LOAD CELL SIGNAL OVERRANGE
(6)	BIT	5 - LOAD CELL CONNECT FAULT
(7)	BIT	6 - ANALOG OUTPUT UNDERRANGE
(8)	BIT	7 - ANALOG OUTPUT OVERRANGE
(9)	BIT	8 - ANALOG OUTPUT OPEN CIRCUIT
(10)	BIT	9 - NO mV/V CAL
(11)	BIT	10 - NO ENGINEERING CAL
(12)	BIT	11 - NO TEMPERATURE COMPENSATION
(13)	BIT	12 - NO MANUAL ZERO
(14)	BIT	13 - NO MANUAL TARE
(15)	BIT	14 - EEPROM ERROR
(16)	BIT	15 - SPARE

(INPUT) STAT2 STATUS REGISTER 2

(17)	BIT	0 - POWERUP (on for 5 seconds after power up)
(18)	BIT	1 - UNABLE TO TARE/ZERO BECAUSE OF MOTION (on for 2 sec if true)
(19)	BIT	2 - UNABLE TO ZERO BECAUSE OF LIMIT (on for 2 sec if true)
(20)	BIT	3 - LOAD CELL SIGNAL UNDERRANGE
(21)	BIT	4 - LOAD CELL SIGNAL OVERRANGE
(22)	BIT	5 - LOAD CELL CONNECT FAULT
(23)	BIT	6 - ANALOG OUTPUT UNDERRANGE
(24)	BIT	7 - ANALOG OUTPUT OVERRANGE
(25)	BIT	8 - ANALOG OUTPUT OPEN CIRCUIT
(26)	BIT	9 -
(27)	BIT	10 -
(28)	BIT	11 -
(29)	BIT	12 - MOTION
(30)	BIT	13 - FAULT (on if any bits on in status register 1)
(31)	BIT	14 - ZERO LIMIT
(32)	BIT	15 - OVERLOAD

Modbus Plus Parameter Selections

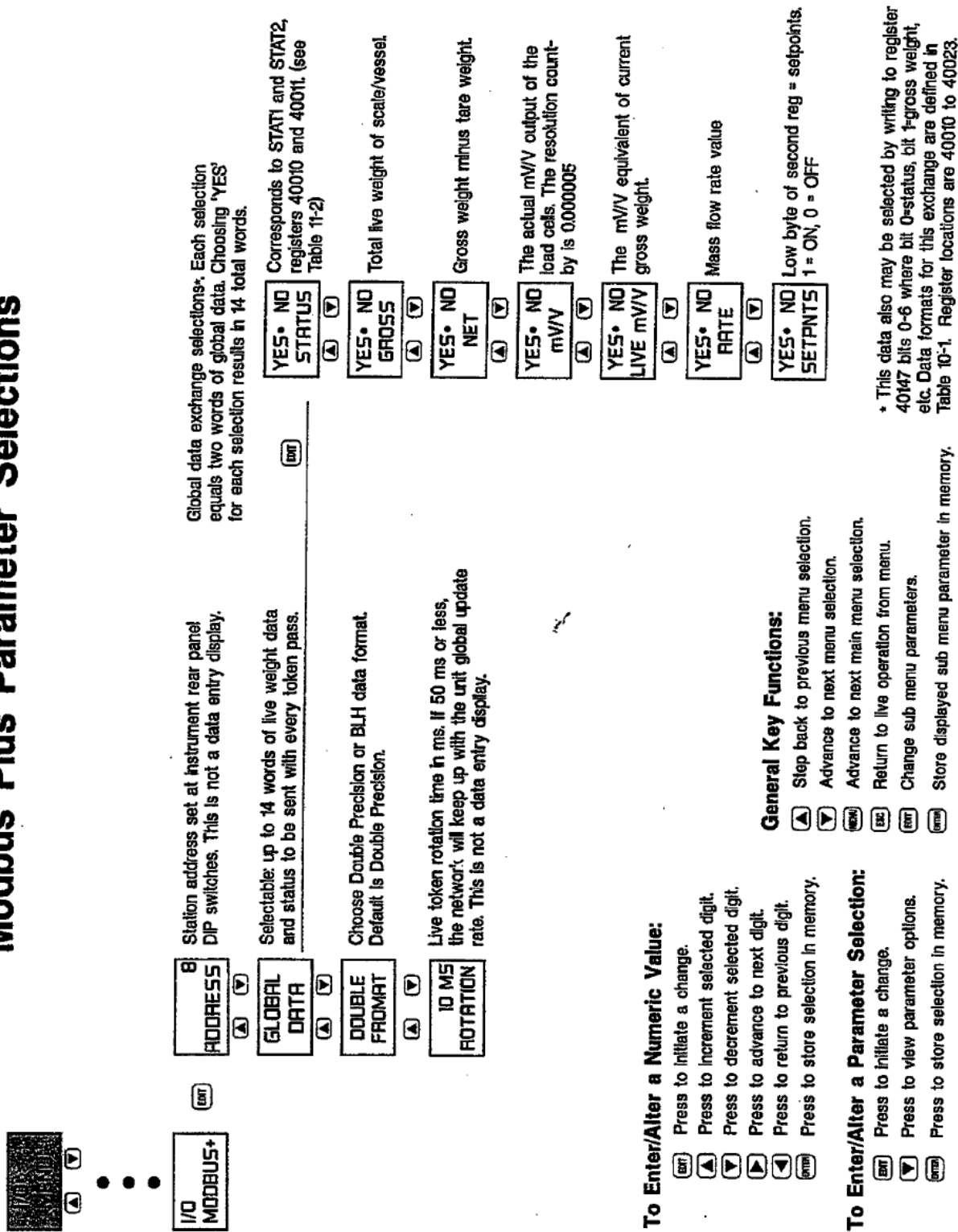

Figure 11-1. Modbus Plus Parameter Selections.

To Enter/Alter a Numeric Value:

- (ENT) Press to initiate a change.
- (▲) Press to increment selected digit.
- (▼) Press to decrement selected digit.
- (▶) Press to advance to next digit.
- (◀) Press to return to previous digit.
- (ENT) Press to store selection in memory.

To Enter/Alter a Parameter Selection:

- (ENT) Press to initiate a change.
- (▼) Press to view parameter options.
- (ENT) Press to store selection in memory.

General Key Functions:

- (▲) Step back to previous menu selection.
- (▼) Advance to next menu selection.
- (ENT) Advance to next main menu selection.
- (ESC) Return to live operation from menu.
- (ENT) Change sub menu parameters.
- (ENT) Store displayed sub menu parameter in memory.

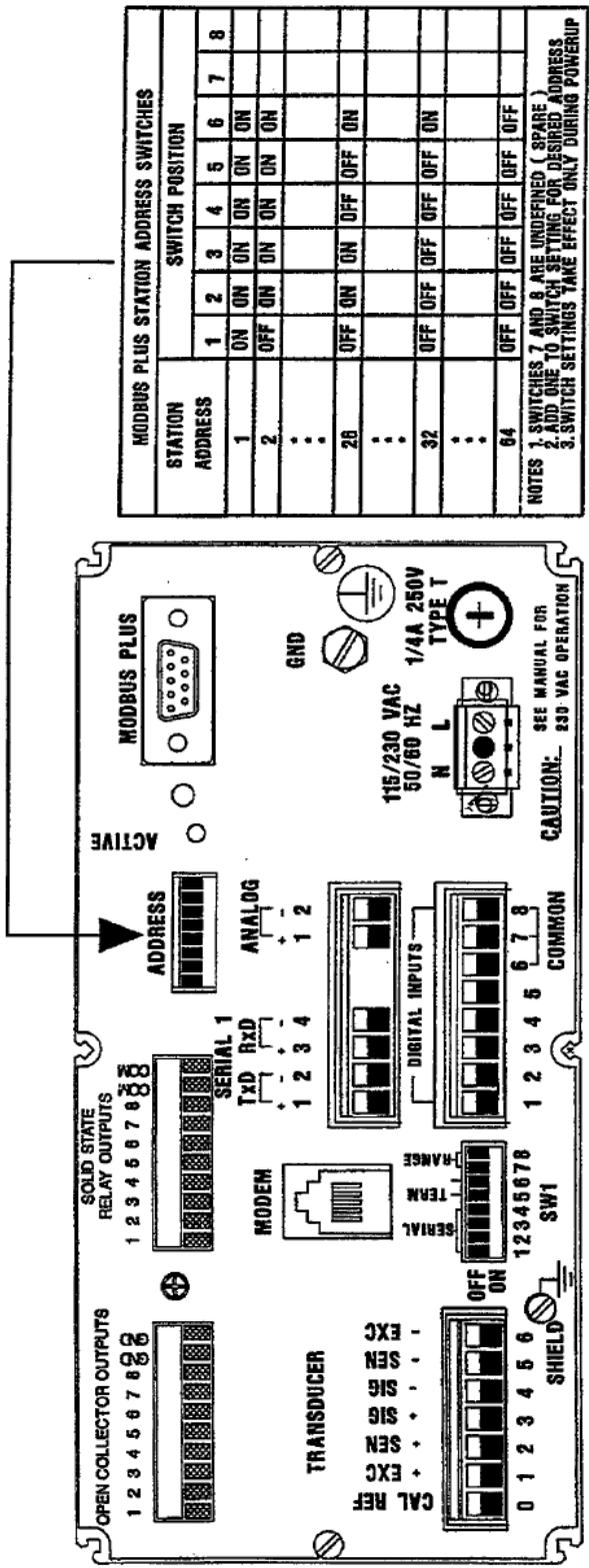
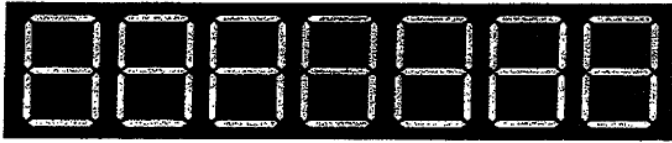

Figure 11-2. Modbus Plus Rear Panel Configuration.

LcP Upper Display Line



40258 High Byte
 40258 Low Byte
 40259 High Byte
 40259 Low Byte
 40260 High Byte
 40260 Low Byte
 40261 High Byte

LcP Lower Display Line



40262 High Byte
 40262 Low Byte
 40263 High Byte
 40263 Low Byte
 40264 High Byte
 40264 Low Byte
 40265 High Byte
 40265 Low Byte

Figure 11-3. Display Write, Register and Byte Allocations

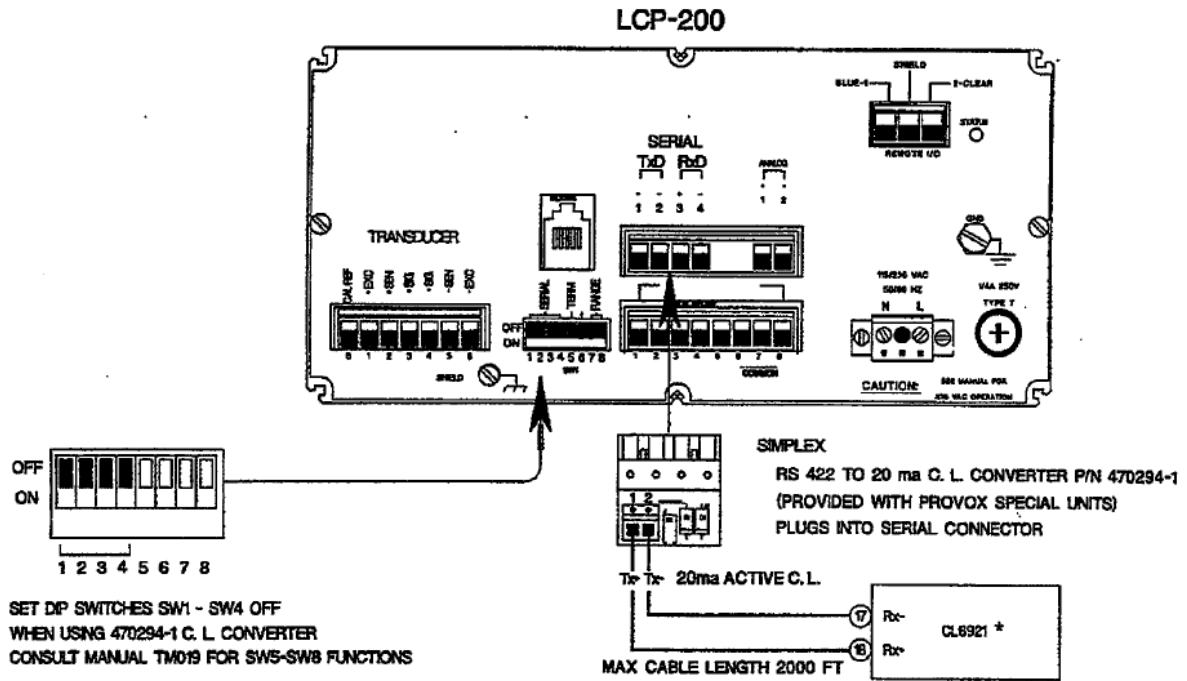

Figure 11-4. Fisher Provox Wiring Arrangements.

Table 11-4. 18 Byte Fisher Provox Protocol

Byte 1: STX (02H)

Byte 2: Status Word A - Decimal Point Position or Dummy Zero Status

Bit	X00	X0	X	0.X	0.XX	0.XXX	0.XXXX	0.XXXXX
0	0	1	0	1	0	1	0	1
1	0	0	1	1	0	0	1	1
2	0	0	0	0	1	1	1	1

Byte 2: Status Word A - Count By Factor

Bit	Count By 1	Count By 2	Count By 5
3	1	0	1
4	0	1	1

5 - Always a 1

6 - Always a 0

Byte 3: Status Word B

Bit	Status - 0	Status - 1
1	Gross	Net
2	Positive	Negative
3	Not Overrange	Overrange
4	No Motion	Motion
5	Always a 1	
6	Normal Operation	Power Up

Byte 4: Status Word C - Bit 5 = 1, all other Bits = 0

Bytes 5:-10: Indicated Weight Value

Bytes 11-15: Tare Weight Value

Byte 17: Carriage Return (0DH)

Byte 18: Checksum Character

*Wiring designations based upon BLH's current understanding of the CL6921 board. Always consult with Fisher Rosemount to verify correctness of information.

SECTION 12. Profibus

This chapter defines the optional Profibus interface as it pertains to BLH LCp-200 instruments. Profibus, standardized in the European standard EN 50 170, is the operational network interface for Siemens PLC based control systems.

12.1 THE INTERFACE DEFINED

Consisting of three communication levels, the inter-face structure was designed for high-speed (up to 12 mbaud) communication between master (typically PLC) and slave devices.

12.1.1 Profibus DP

Although three communication levels exist, LCp-200 units communicate only at the Profibus DP (decentralized periphery) level. At this level LCps are dedicated slaves with no master status or functionality. They cannot manipulate the bus or control token passes. They will respond quickly, however, to any master device on the network.

12.1.2 GSD Files

GSD files are required to establish communication on the Profibus network. GSD files contain all device specific parameters such as supported baud rates, message lengths, I/O numbers, and diagnostic messaging. BLH supplies two GSD files on the accompanying diskette included with each order. Read the HINTSGSD.txt file contained on this diskette and load the appropriate GSD file into the master(s) network device.

12.2 INTERFACE WIRING

Figure 12-1 depicts the LCp-200 rear panel wiring arrangements. Simply connect a shielded, two-wire twisted pair cable to the PROFIBUS terminal. Cable shielding **MUST BE** connected at both ends to ensure proper operation. BLH recommends using a Siemens nine-pin, sub D connector with integrated termination (PN 6ES7972-0BA10-0XA0). If another connector is used, mandatory A and B signals must be accommodated as well as provision for termination, when required.

For reliable network operation, BLH recommends that the first and last network node be powered up at all times.

12.3 LCp-200 MENU CHANGES

With the Profibus option installed, parameter selections change in several menus. These changes override definitions and selections presented in earlier chapters of this manual.

12.3.1 I/O Menu Changes

With Profibus installed, other expansion slot A interfaces are disabled. Figure 12-2 shows the modified I/O menu with Profibus available rather than Modbus Plus or Allen-Bradley Remote I/O. Additional Profibus selections allow individual units to be reset or taken offline.

12.3.2 Diagnostic Menu Changes

Figure 12-3 presents changes to the diagnostic menu. Two added features define Profibus errors if they occur and current online/offline status.

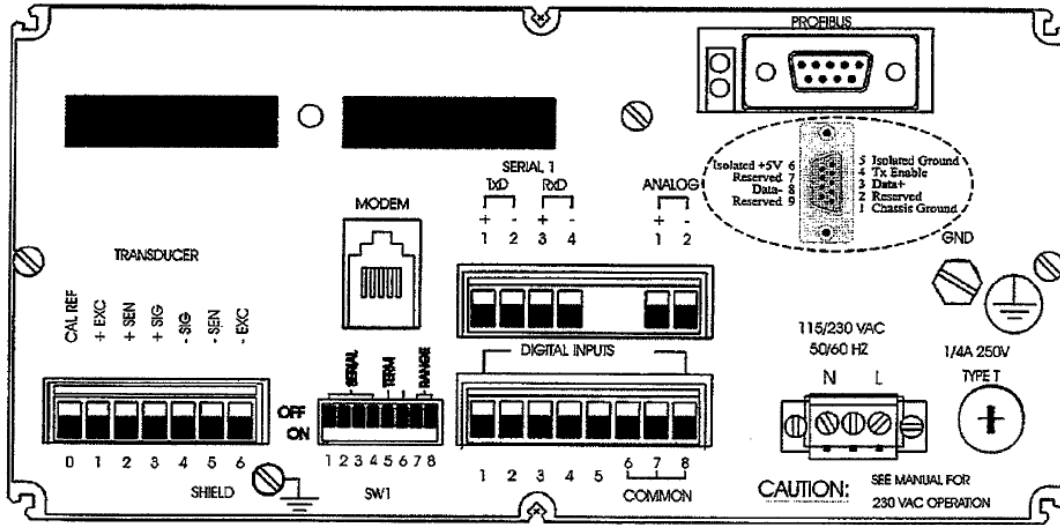

Figure 12-1. Profibus Rear Panel Connections.

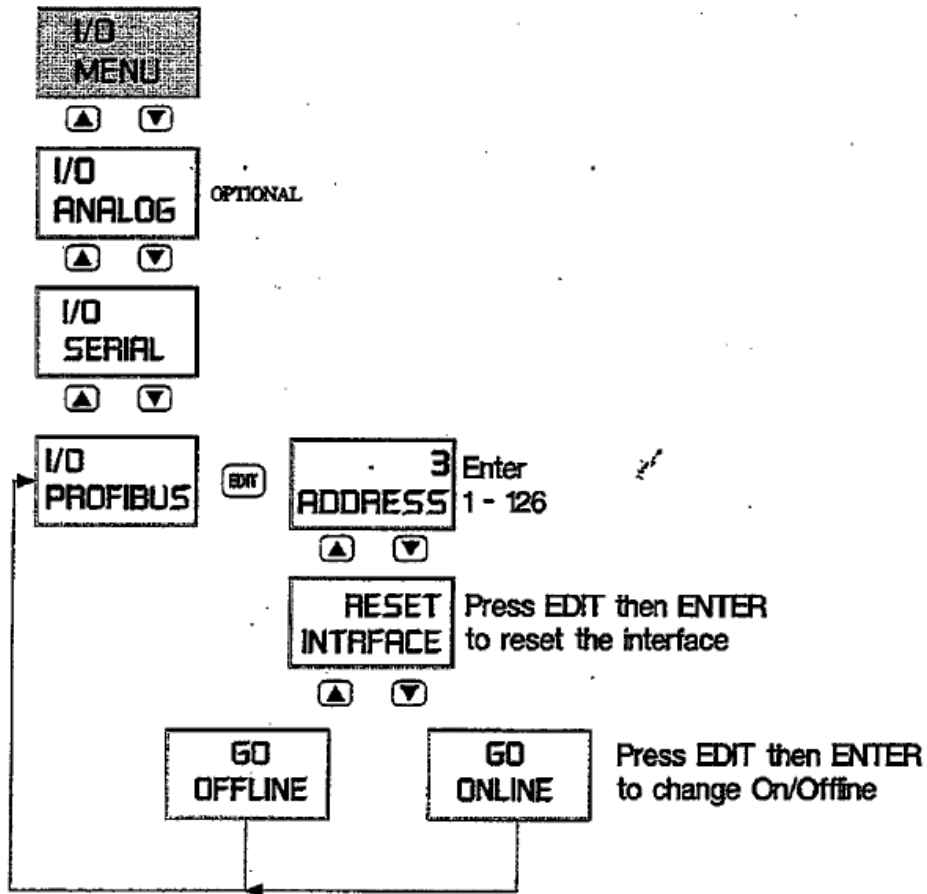

Figure 12-2. I/O Menu Changes

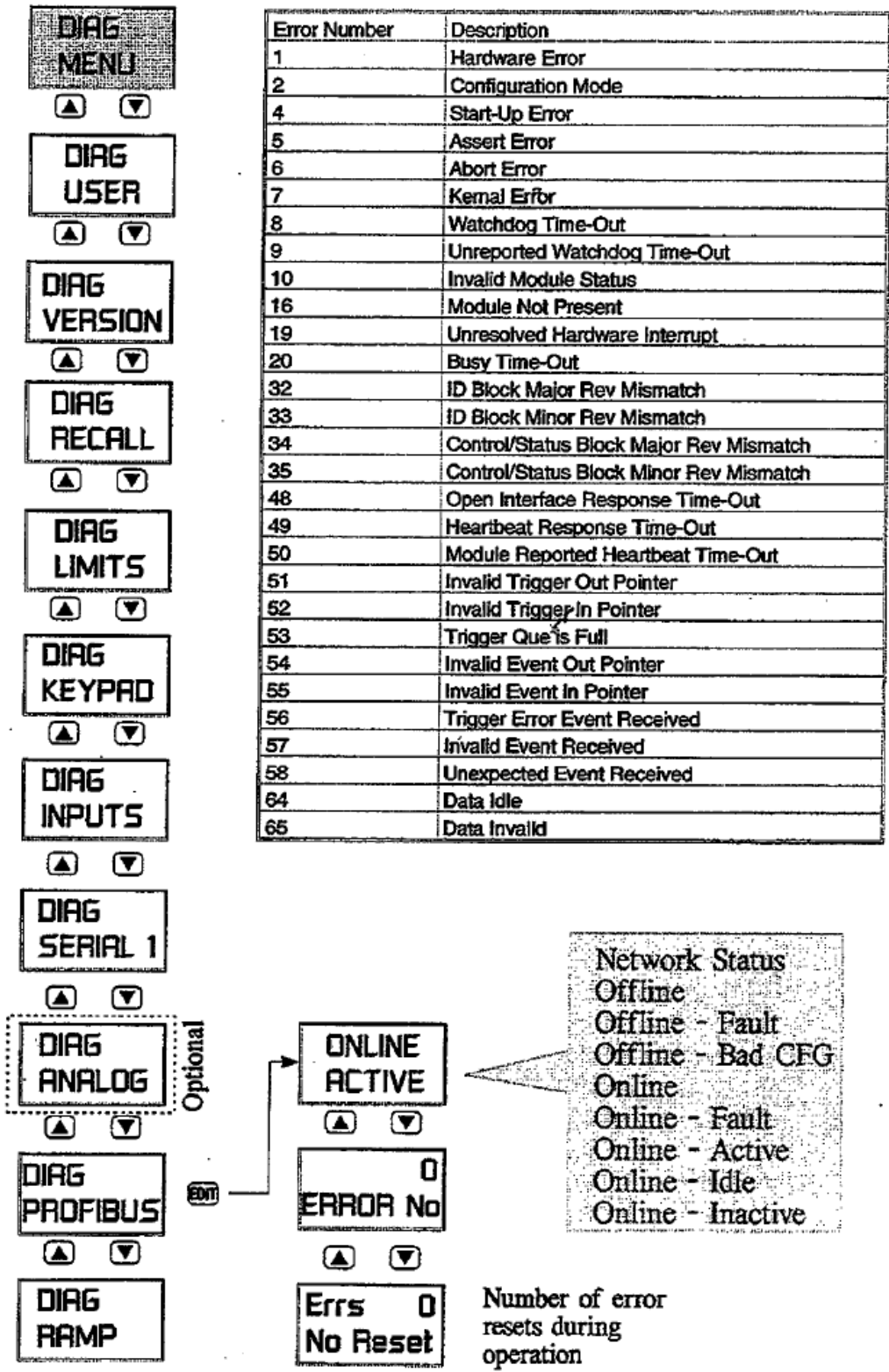

Figure 12-3. Diagnostic Menu Changes

12.4 DATA EXCHANGE FORMATS

LCp-200 Profibus input and output data formats consist of up to 8 bytes each as shown in Table 12-1. Each grouping of two bytes constitutes one 16-bit word.

Table 12-1. Data Exchange Formats.

Input Data Format							
msg#	DataID	Status	Data Low		Data High		
Word 1		Word 2		Word 3		Word 4	
byte1	byte2	byte3	byte4	byte5	byte6	byte7	byte8
Output Data Format							
msg#	DataID	Command	Data Low		Data High		
Word 1		Word 2		Word 3		Word 4	
byte1	byte2	byte3	byte4	byte5	byte6	byte7	byte8

12.4.1 Input Data (LCp-200 Transmission)

The input data string is transmitted by the LCp-200 to the requesting master device. Each string consists of eight bytes and breaks down as follows:

Byte 1. Message #: Message # is an echo of the first byte of the output data string (transmitted by the master). This is used by the master for data transfer verification.

Byte 2 Input data ID: Data ID code as shown in Table 12-4.

Bytes 3 & 4. Status: The LCp-200 operating status, each bit of the word made up of bytes 3 & 4 represents specific operating status. The descriptions of the bits are in Table 12-2. Bits 0 - 7 are in Byte 3, bits 8- 15 are in Byte 4.

Table 12-2, Status Word Definitions

Status Word					
Bit Description	Decimal Point Position				
0	Decimal Point Posn. A	C	B	A	Posn.
1	Decimal Point Posn. B	0	0	0	0
2	Decimal Point Posn. C	0	0	1	0.0
3	Display Data A	0	1	0	0.00
4	Display Data B	0	1	1	0.000
5	Motion	1	0	0	.0000
6	Overload	1	0	1	.00000
7	Storing Data in EEPROM	1	1	0	.000000
8	Unable to Zero/Tare				0
9	Download Address Error				
10	Download Data Error		Display Data		
11	4/20 Output Error		B	A	Display
12	A/D Underrange		0	0	Gross
13	A/D Overrange		0	1	Net
14	Excitation Fault		1	0	Rate
15	EEPROM Error		1	1	Spare

Bytes 5 - 8 (Words 3 & 4). Input data: These two words contain the actual weight value (low word and then high word). Word 3, low word, is a 16 bit signed integer -32768 to 32767 with byte 5 being the low byte. Word 4, high word, is a 16 bit signed integer times 32768 with byte 7 being the low byte. If word 3 = 2 and word 4 = 1 the total data value would be 32770 (2 4- 32768).

12.4.2 Output Data (from the Master)

Output data is transmitted to the LCp-200 by the re-requesting master. It consists primarily of command and ID data. ID data is defined in Table 12-4. Each string consists of eight bytes and breaks down as follows:

Byte 1. Message #: Any number between 0 and 255 generated by the master and copied by the LCp-200 into the first byte of the input string. This is for host data transfer verification.'

Byte 2 Output data ID: When the Profibus master issues a download command, it must include the output data ID and the output data as well. Byte 2 of the Profibus output provides output data ID code as shown in Table 12-4.

Bytes 3 & 4 (Word 2). Command: This command word is used by Profibus master to control LCp-200 (as a slave). The meanings of commands are shown in Table 12-3.

Table 12-3. Profibus Master Command List.

Profibus Interface Commands	
Command ID	Description
0	Null Command
1	Switch to Gross
2	Switch to Net
3	Switch to Rate
4	Zero Gross Weight
5	Tare Net Weight
6	Download Data

Bytes 5 - 8 (Words 3 & 4). Output Data: The third and fourth words of the Profibus output are low word and high word of the actual download data. Word 3, low word, is a 16 bit signed

integer -32768 to 32767. Word 4, high word, is a 16 bit signed integer times 32768. See example in Inputs Words 3 & 4 definition. See Table 5 for ID codes and definitions of writable data.

Table 12-4. Profibus Data ID Codes

Type	ID Code	Data	Words	Description
Operate	0*	Gross Weight	2	System Gross Weight Value
Operate	1*	Net Weight	2	System Net Weight Value
Operate	2*	Rate	2	Current Rate Data
Operate	3*	mV/V Actual	2	Input mV/V Signal
Operate	4*	mV/V Live	2	Live mV/V Signal (less dead weight)
Operate*	5	Zero	2	Keypad Push to Zero Value
Operate	6	Tare	2	Tare Value
Operate	7	Zero Limit	2	Keypad Push to Zero Limit
Operate	8	Overload	2	Overload Limit 0 = No Limit
Operate	9	Filter	2	Low Reg, Averaging 0-7 = 1, 2, 4, 8, 16, 32, 64, 128 Conversions High Reg, Band 0-10 = 0-2.5 counts, 11-108 = 3-100 counts
Operate	10	Motion	2	Low Reg, Motion Band 0=Off, 1-10=0-2.5counts, 11-58=3-50 counts High Reg, Motion Timer 0-3 = 0.5, 1.0, 1.5, 2.0 seconds
Operate	11	Zero Key Configuration	1	Low Reg, 0 = auto zero, 1 = manual zero
Operate	12	Tare Key Configuration	1	Low Reg, 0 = auto tare, 1 = manual tare
Cal	13	Zero mV/V	2	cal zero in mV/V
Cal	14	Span 1 mV/V	2	cal span 1 in mV/V
Cal	15	Span 1 Units	2	cal span 1 in units
Cal	16	Span 2 mV/V	2	cal span 2 in mV/V
Cal	17	Span 2 Units	2	cal span 2 in units
Cal	18	Span 3 mV/V	2	cal span 3 in mV/V
Cal	19	Span 3 Units	2	cal span 3 in units
Cal	20	Span 4 mV/V	2	cal span 4 in mV/V
Cal	21	Span 4 Units	2	cal span 4 in units
Cal	22	Span 5 mV/V	2	cal span 5 in mV/V
Cal	23	Span 5 Units	2	cal span 5 in units
Cal	24	Span 6 mV/V	2	cal span 6 in mV/V
Cal	25	Span 6 Units	2	cal span 6 in units
Cal	26	Span 7 mV/V	2	cal span 7 in mV/V
Cal	27	Span 7 Units	2	cal span 7 in units
Cal	28	Span 8 mV/V	2	cal span 8 in mV/V
Cal	29	Span 8 Units	2	cal span 8 in units
Cal	30	Span 9 mV/V	2	cal span 9 in mV/V
Cal	31	Span 9 Units	2	cal span 9 in units
Cal	32	Span 10 mV/V	2	cal span 10 in mV/V
Cal	33	Span 10 Units	2	cal span 10 in units
Cal	34	Number of Span Points	2	0-10, 0 = no eng cal
Cal	35	Cal Type	1	0 = quick, 1 = deadload, 2 = keypad
Cal	36	Eng Units	1	0 = lb, 1 = kg, 2 = tn, 3 = oz, 4 = gm
Cal	37	Capacity	2	sum of rated capacity of load
Cal	38	Decimal Point	1	0-6 = decimal point position, 0 = none, 6 = 0.000000
Cal	39	Rated Output mV/V	2	average of load cells rated output in mV/V
Cal	40	Unit Count By	1	0-6 = 1, 2, 5, 10, 20, 50, 100
Display	41	Display Powerup	1	0 = gross, 1 = net
Display	42	Level Config	1	Level bar graph: bit 0 = off, 1 = gross, 3 = net
Display	43	Level %	2	level % setting
Display	44	Level 100%	2	level 100% setting
Display	45	Arrows Config	1	side arrows: bit 0 = off, 1 = gross, 3 = net
Display	46	Arrows %	2	arrows % setting
Display	47	Arrows 100%	2	arrows 100% setting
Display	48	Annunciators A1	1	0 = off 8 = d/a fault
Display	49	Annunciators A1	1	1 = in motion 9 = d/a overrange
Display	50	Annunciators A1	1	2 = zero lim 10 = d/a underrange
Display	51	Annunciators A1	1	3 = overload 11 = Profibus status
Display	52	Annunciators A1	1	4 = serial RX 14 = spare
Display	53	Annunciators A1	1	5 = serial TX
Display	54	Annunciators A1	1	6 = parity
Display	55	Annunciators A1	1	7 = framing error

* Read Only Registers

see next page for more ID numbers

Table 12-4. Profibus Data ID Codes (cont.)				
Type	ID Code	Data	Words	Description
Reserved	98-122	Not Used At This Time		
Security	123	Password Upper 4	2	password upper 4 chars: ASCII 0-9, A-Z, minus or space
Security	124	Password Lower 3	2	password lower 3 chars: ASCII 0-9, A-Z, minus or space
Security	125	Key/Security Locks	1	bits 0-4 = zero, tare, g/n, print, edit keys - bit 5 = security lock
Security	126	Menu Locks	1	bits 0-4 = cal, filter, display, i/o, and diag menus
Security	127	Spare		
Instrument	128*	Serial # Upper 4	2	upper 4 digits of 7 digit ASCII numeric code (0-9)
Instrument	129*	Serial # Lower 3	2	lower 3 digits of 7 digit ASCII numeric code (0-9)
Instrument	130*	Software Version #	1	number with 2 decimal places (i.e. 100 = ver. 1.00)
Instrument	131*	A/D Rev.	1	2 ASCII characters
Instrument	132*	Ref Date Month/Day	2	upper 4 digits of 6 digit ASCII date code (MMDD) date format = MMDDYY month-day-year of internal cal
Instrument	133*	Ref Date Year	1	lower 2 digits of 6 digit ASCII date code (YY)
Instrument	134*	Instrument Model	1	100 = LCp-200
Instrument	135*	Options Upper 4	2	upper 4 digits of 6 digit ASCII option code [M]-[A]-[P]-[C]
Instrument	136*	Options Lower 2	1	lower 2 digits of 6 digit ASCII option code [B]-[M]
User	137	Tag Number Upper 4	2	upper 4 digits of 4 digit ASCII tag # - 0-9, A-Z, minus or space
User	138	Tag Number Lower 3	2	lower 3 digits of 4 digit ASCII tag # - 0-9, A-Z, minus or space
User	139	Cal Date Month/Day		
User	140	Cal Date Year	1	lower 2 digits of 6 digit ASCII date code (YY)
User	141	Next Cal Date Month/Day	2	upper 4 digits of 6 digit ASCII date code (MMDD) date format = MMDDYY month-day-year of internal cal
User	142	Next Cal Date Year	1	lower 2 digits of 6 digit ASCII date code (YY)

* Read Only Register

SECTION 13. DeviceNet

This chapter defines the optional DeviceNet interface as it pertains to BLH LCp-200 instruments. DeviceNet is a low cost industrial network designed to easily connect up to 64 "cell" type devices to a PLC/PC. Information in this section defines the LCp-200 DeviceNet register allocations and interface instructions.

13.1 THE INTERFACE DEFINED

13.1.1 General ODVA DeviceNet Description

DeviceNet is one of the world's leading device-level networks for industrial automation. In fact, more than 40% of end users surveyed by independent industry analysts report choosing DeviceNet over other net-works. DeviceNet offers robust, efficient data handling because it is based on Producer/Consumer technology. This modern communications model offers key capabilities that allow the user to effectively determine what information is needed and when. Users also benefit from ODVA's strong conformance testing policies, which ensure that products are interoperable. As a result, users can mix-and-match products from a variety of suppliers and integrate them seamlessly.

NOTE: ODVA stands for Open DeviceNet Vendor Association. For all specifications, wiring, power, cable lengths, etc., please access the ODVA web site. Reference: Specifications DeviceNet Volume II, release 2.0 (latest release), web address: <http://www.odva.org>

13.1.2 LCP-200 DeviceNet Interface Description

The LCp-200 DeviceNet interface uses vendor supplied product technology. This product has passed the compliance specifications set forth by ODVA and is registered with them (ODVA) by the vendor. BLH embeds this product in the

LCp-200 to communicate weight and parameter data to a connected device. Thermo BLH is registered with ODVA as Vendor #661.

13.2 INTERFACE WIRING

Figure 13-1 depicts the LCp-200 rear panel DeviceNet connector options. Depending upon ordering specifications, the LCp will have either a DeviceNet compatible 5-pin pluggable connector or a DeviceNet compatible sealed micro connector. Make connections in accordance with device type pinouts as shown.

NOTE: ODVA stands for Open DeviceNet Vendor Association. For all specifications, wiring, power, cable lengths, etc., please access the ODVA web site. Reference: Specifications DeviceNet Volume II, release 2.0 (latest release), web address: <http://www.odva.org>

NOTE: For additional connection information and cable length specifications visit the ODVA website - <http://www.odva.org>

13.2.1 LCP-200 DeviceNet Interface Description

The LCp-200 DeviceNet interface uses vendor supplied product technology. This product has passed the compliance specifications set forth by ODVA and is registered with them (ODVA) by the vendor. BLH embeds this product in the LCp-200 to communicate weight and parameter data to a connected device. Thermo BLH is registered with ODVA as Vendor #661.

13.3 INTERFACE WIRING

Figure 13-1 depicts the LCp-200 rear panel DeviceNet connector options. Depending upon ordering specifications, the LCp will have either a DeviceNet compatible 5-pin pluggable connector or a DeviceNet compatible sealed micro connector. Make connections in accordance with device type pin-outs as shown.

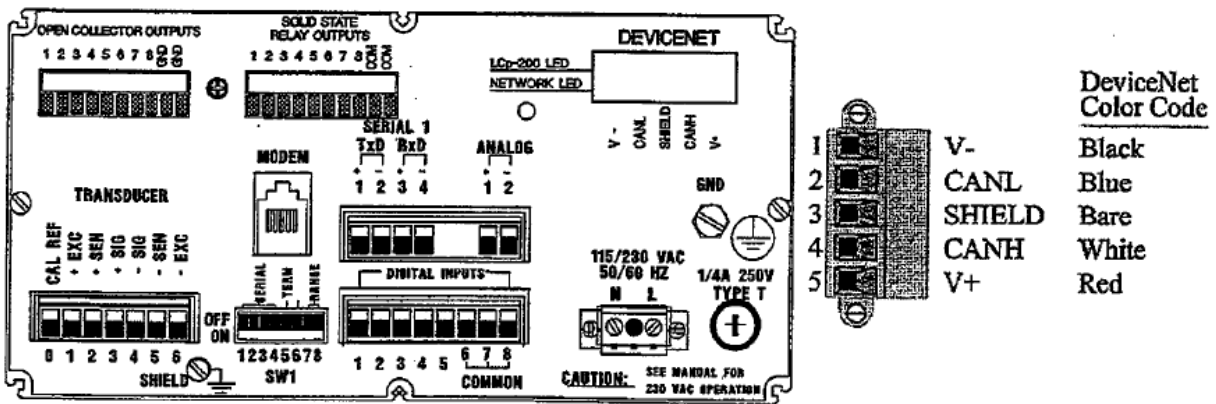

Figure 13-1. DeviceNet Rear Panel Connections.

13.4 LED STATUS INDICATION

Two bicolor (red/green) LED indicators are mounted beside the network connector (Figure 13-1). The upper LED indicates LCP-200 status while the lower LED displays the DeviceNet Network Status. If an LED is flashing, the nominal flash rate is 500ms ON, and 500ms OFF.

LED Status	DeviceNet Network Status
Off	
No Power	
Flashing Red	I/O connection in timed-out state or other recoverable fault
Solid Red	Unrecoverable fault
Flashing Green	Device is online but has no connections
Solid Green	Device online with established connections
Red/Green	Device is in communication faulted state and responding to an identify communication faulted request

13.4.1 LCP-200 Status

The upper (LCP-200 status) LED indicator flash sequences are defined in the following Table:

LED Status	LCP-200 Network Status
Off	
No Power	
Flashing Red	Recoverable configuration fault (invalid firmware, OEM data, or personality data)
Solid Red	Hardware error
Flashing Green	No errors, client interface is not open
Solid Green	No errors, client interface is active
Red/Green	Configuration mode

13.4.2 DeviceNet Network Status

The lower (network status) LED indicator flash sequences are defined in the following Table:

13.4.3 LCP-200 MENU CHANGES

With the DeviceNet option installed, parameter selections change in several menus. These changes override definitions and selections presented in earlier chapters of this manual. The following pages discuss specific changes to several menus.

13.4.4 I/O Menu Changes

With DeviceNet installed, other expansion slot A interfaces are disabled. Figure 13-2 shows the modified I/O menu with DeviceNet available rather than Modbus Plus, Allen-Bradley Remote I/O, or Profibus. Baud rates, address selections, and commands can be selected through the front panel display under the I/O DeviceNet menu. Baud rate selection must be identical to the master control setting. The Mac ID address must be uniquely different from all other nodes. Additional DeviceNet selections allow individual units to be reset or taken off-line.

NOTE: Go commands can be used if an operator wants to change settings on the Lcp-200 and does not want invalid data to be sent to

the master controller. Also if a customer wants to change baud rate or Mac id, the LCp-200 must be off line.

NOTE: Upon power up the LCp-200 will attempt to link to a master host.

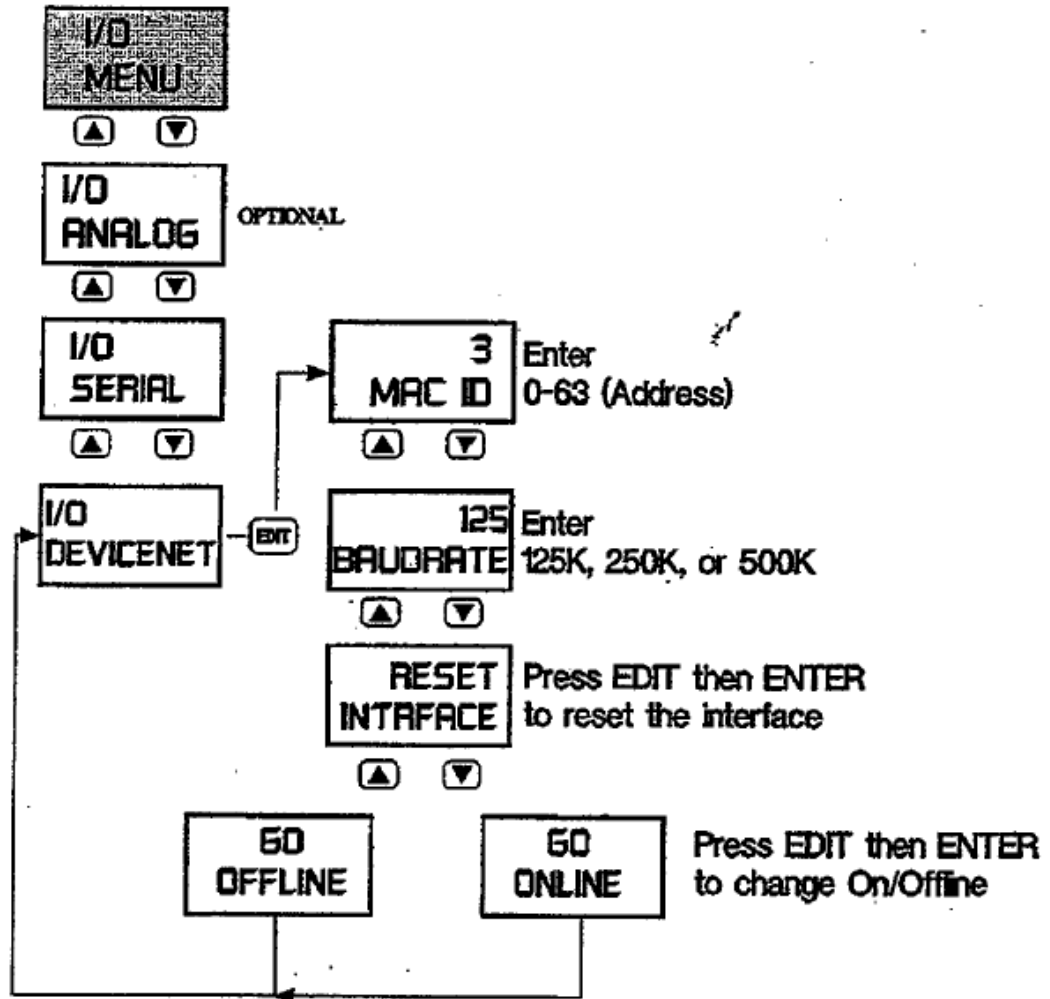

Reset: This command is a hard reset of the Devicenet interface. Reset also transpires during power up.

Go online: This command can be issued from the LCp-200 to instruct the DeviceNet interface to initiate communication with a master.

Go offline: This command can be issued from the LCp-200 to instruct the Devicenet interface to stop communication with a master.

Figure 13-2. I/O Menu Changes.

13.4.5 Diagnostic Menu Changes

Figure 13-3 presents changes to the diagnostic menu. Two added features define DeviceNet

errors if they occur and current online/offline status.

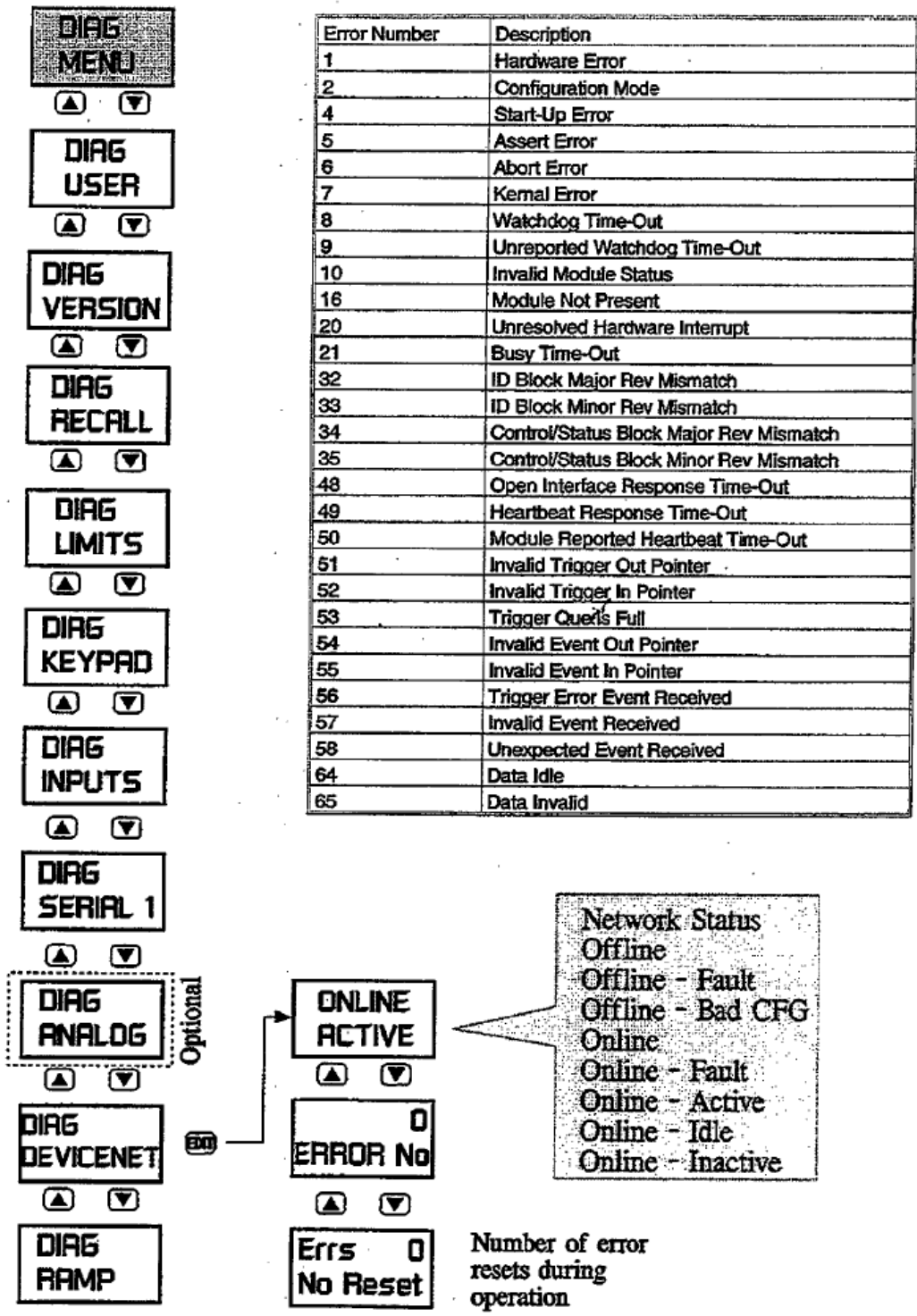

Figure 13-3. Diagnostic Menu Changes.

13.4.6 Display Menu Changes

See Figure 13-4 for alarm annunciator changes. The DeviceNet selection allows the lower rear

panel net-Work status LED activity to be mirrored on one of the eight front panel annunciators. Behavior of this LED is network specific and defined in Figure 13-4.

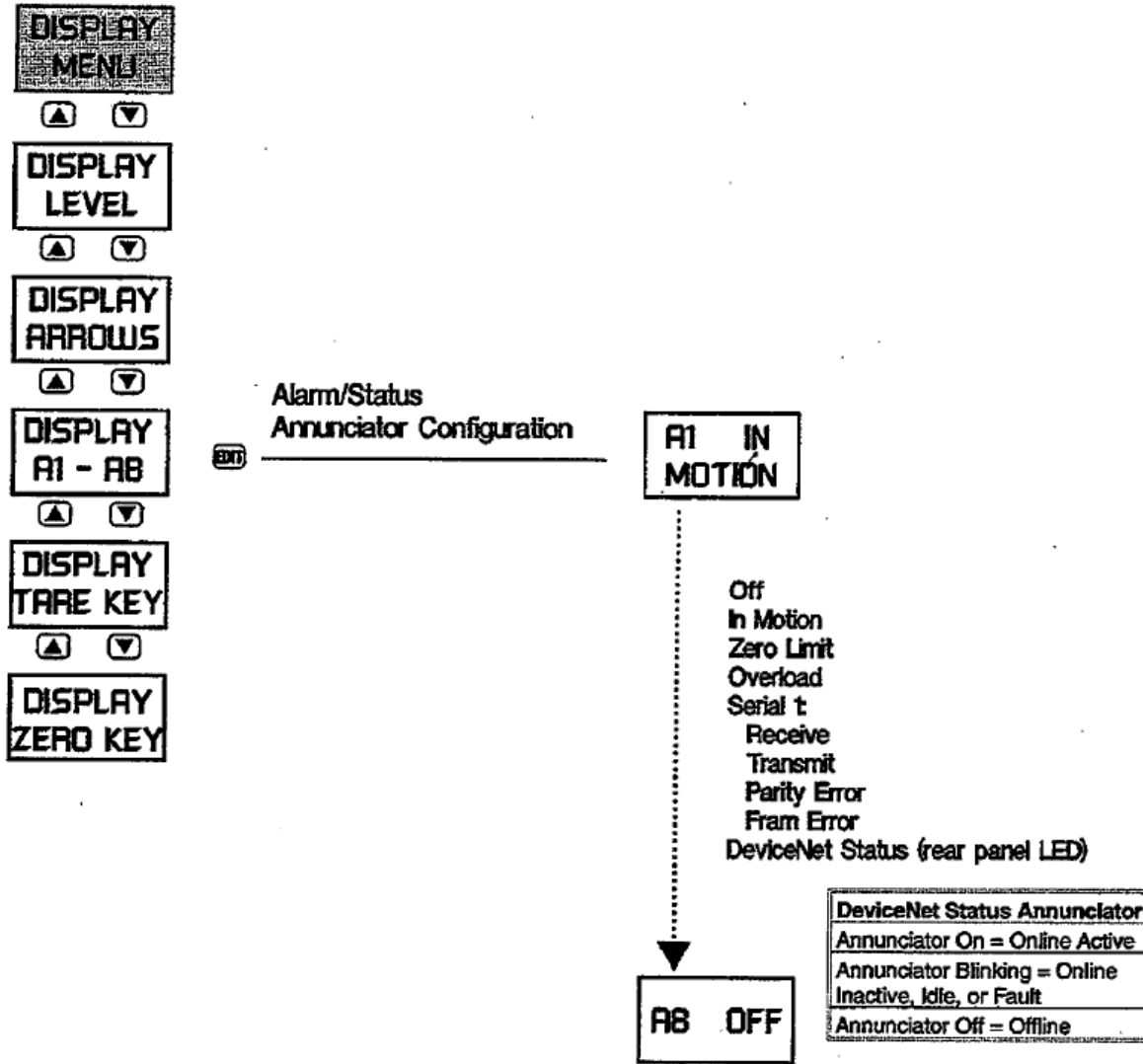

Figure 13-4. Display Menu Changes.

13.5 DATA EXCHANGE FORMATS

LCp-200 DeviceNet input and output data formats consist of up to 8 bytes each as shown in Table 13-1. Each grouping of two bytes constitutes one 16-bit word.

Table 13-1. Data Exchange Formats.

Input Data Format							
msg#	DataID	Status	Data Low		Data High		
Word 1		Word 2	Word 3		Word 4		
byte1	byte2	byte3	byte4	byte5	byte6	byte7	byte8
Output Data Format							
msg#	DataID	Command	Data Low		Data High		
Word 1		Word 2	Word 3		Word 4		
byte1	byte2	byte3	byte4	byte5	byte6	byte7	byte8

13.5.1 Produced Data (LCp-200 Transmission)

The input data string is transmitted by the LCp-200 to the requesting master device. Each string consists of eight bytes and breaks down as follows:

Byte 1. Message #: Message # is an echo of the first byte of the output data string (transmitted by the master). This is used by the master for data transfer verification.

Bytes 5 - 8 (Words 3 & 4). Input data: These two words contain the actual weight value (low word and then high word). Word 3, low word, is a 16 bit signed integer -32768 to 32767 with byte 5 being the low byte. Word 4, high word, is a 16 bit signed integer times 32768 with byte 7 being the low byte. If word 3 = 2 and word 4 = 1 the total data value would be 32770 (2 + 32768).

13.5.2 Consumed Data (LCp-200 Receive)

Output data is transmitted to the LCp-200 by the re-requesting master. It consists primarily of command and ID data. ID data is defined in Table 13-4. Each string consists of eight bytes and breaks down as follows:

Byte 1. Message #: Any number between 0 and 255 generated by the master and copied by the LCp-200 into the first byte of the input string. This is for host data transfer verification.

Byte 2 Output data ID: When the DeviceNet master issues a download command, it must include the output data ID and the output data as well. Byte 2 of the DeviceNet output provides output data ID code as shown in Table 13-4.

Byte 2 Input data ID: Data ID code as shown in Table 13-4.

Bytes 3 & 4. Status: The LCp-200 operating status, each bit of the word made up of bytes 3 & 4 represents specific operating status. The descriptions of the bits are in Table 13-2. Bits 0 - 7 are in Byte 3, bits 8- 15 are in Byte 4.

Table 13-2. Status Word Definitions.

Status Word					
Bit Description	Decimal Point Position				
0	Decimal Point Posn. A	C	B	A	Posn.
1	Decimal Point Posn. B	0	0	0	0
2	Decimal Point Posn. C	0	0	1	0.0
3	Display Data A	0	1	0	0.00
4	Display Data B	0	1	1	0.000
5	Motion	1	0	0	.0000
6	Overload	1	0	1	.00000
7	Storing Data in EEPROM	1	1	0	.00000 0
8	Unable to Zero/Tare				
9	Download Address Error				
10	Download Data Error		Display Data		
11	4/20 Output Error		B	A	Display
12	A/D Underrange		0	0	Gross
13	A/D Overrange		0	1	Net
14	Excitation Fault		1	0	Rate
15	EEPROM Error		1	1	Spare

Bytes 5 - 8 (Words 3 & 4). Input data: These two words contain the actual weight value (low word and then high word). Word 3, low word, is a 16 bit signed integer -32768 to 32767 with byte 5 being the low byte. Word 4, high word, is a 16 bit signed integer times 32768 with byte 7 being the low byte. If word 3 = 2 and word 4 = 1 the total data value would be 32770 (2 + 32768).

13.5.3 Consumed Data (LCp-200 Receive)

Output data is transmitted to the LCp-200 by the re-requesting master. It consists primarily of command and ID data. ID data is defined in Table 13-4. Each string consists of eight bytes and breaks down as follows:

Byte 1. Message #: Any number between 0 and 255 generated by the master and copied by the LCp-200 into the first byte of the input string. This is for host data transfer verification.

Byte 2 Output data ID: When the DeviceNet master issues a download command, it must include the output data ID and the output data as well. Byte 2 of the DeviceNet output provides output data ID code as shown in Table 13-4.

Bytes 3 & 4 (Word 2). Command: This command word is used by DeviceNet master to control LCp-200 (as a slave). The meanings of commands are shown in Table 13-3.

Table 13-3. DeviceNet Master Command List.

DeviceNet Interface Commands	
Command ID	Description
0	Null Command
1	Switch to Gross
2	Switch to Net
3	Switch to Rate
4	Zero Gross Weight
5	Tare Net Weight
6	Download Data

Bytes 5 - 8 (Words 3 & 4). Output Data: The third and fourth words of the DeviceNet output are low word and high word of the actual download data. Word 3, low word, is a 16 bit signed

integer -32768 to 32767. Word 4, high word, is a 16 bit signed integer times 32768. See example in Inputs Words 3 & 4 definition. See Table 5 for ID codes and definitions of writable data.

Table 13-4. DeviceNet Data ID Codes

Type	ID Code	Data	Words	Description
Operate	0*	Gross Weight	2	System Gross Weight Value
Operate	1*	Net Weight	2	System Net Weight Value
Operate	2*	Rate	2	Current Rate Data
Operate	3*	mV/V Actual	2	Input mV/V Signal
Operate	4*	mV/V Live	2	Live mV/V Signal (less dead weight)
Operate*	5	Zero	2	Keypad Push to Zero Value
Operate	6	Tare	2	Tare Value
Operate	7	Zero Limit	2	Keypad Push to Zero Limit
Operate	8	Overload	2	Overload Limit 0 = No Limit
Operate	9	Filter	2	Low Reg, Averaging 0-7 = 1, 2, 4, 8, 16, 32, 64, 128 Conversions High Reg, Band 0-10 = 0-2.5 counts, 11-108 = 3-100 counts
Operate	10	Motion	2	Low Reg, Motion Band 0=Off, 1-10=0-2.5counts, 11-58=3-50 counts High Reg, Motion Timer 0-3 = 0.5, 1.0, 1.5, 2.0 seconds
Operate	11	Zero Key Configuration	1	Low Reg, 0 = auto zero, 1 = manual zero
Operate	12	Tare Key Configuration	1	Low Reg, 0 = auto tare, 1 = manual tare
Cal	13	Zero mV/V	2	cal zero in mV/V
Cal	14	Span 1 mV/V	2	cal span 1 in mV/V
Cal	15	Span 1 Units	2	cal span 1 in units
Cal	16	Span 2 mV/V	2	cal span 2 in mV/V
Cal	17	Span 2 Units	2	cal span 2 in units
Cal	18	Span 3 mV/V	2	cal span 3 in mV/V
Cal	19	Span 3 Units	2	cal span 3 in units
Cal	20	Span 4 mV/V	2	cal span 4 in mV/V
Cal	21	Span 4 Units	2	cal span 4 in units
Cal	22	Span 5 mV/V	2	cal span 5 in mV/V
Cal	23	Span 5 Units	2	cal span 5 in units
Cal	24	Span 6 mV/V	2	cal span 6 in mV/V
Cal	25	Span 6 Units	2	cal span 6 in units
Cal	26	Span 7 mV/V	2	cal span 7 in mV/V
Cal	27	Span 7 Units	2	cal span 7 in units
Cal	28	Span 8 mV/V	2	cal span 8 in mV/V
Cal	29	Span 8 Units	2	cal span 8 in units
Cal	30	Span 9 mV/V	2	cal span 9 in mV/V
Cal	31	Span 9 Units	2	cal span 9 in units
Cal	32	Span 10 mV/V	2	cal span 10 in mV/V
Cal	33	Span 10 Units	2	cal span 10 in units
Cal	34	Number of Span Points	2	0-10, 0 = no eng cal
Cal	35	Cal Type	1	0 = quick, 1 = deadload, 2 = keypad
Cal	36	Eng Units	1	0 = lb, 1 = kg, 2 = tn, 3 = oz, 4 = gm
Cal	37	Capacity	2	sum of rated capacity of load
Cal	38	Decimal Point	1	0-6 = decimal point position, 0 = none, 6 = 0.000000
Cal	39	Rated Output mV/V	2	average of load cells rated output in mV/V
Cal	40	Unit Count By	1	0-6 = 1, 2, 5, 10, 20, 50, 100
Display	41	Display Powerup	1	0 = gross, 1 = net
Display	42	Level Config	1	Level bar graph: bit 0 = off, 1 = gross, 3 = net
Display	43	Level %	2	level % setting
Display	44	Level 100%	2	level 100% setting
Display	45	Arrows Config	1	side arrows: bit 0 = off, 1 = gross, 3 = net
Display	46	Arrows %	2	arrows % setting
Display	47	Arrows 100%	2	arrows 100% setting
Display	48	Annunciators A1	1	0 = off 8 = d/a fault
Display	49	Annunciators A1	1	1 = in motion 9 = d/a overrange
Display	50	Annunciators A1	1	2 = zero lim 10 = d/a underrange
Display	51	Annunciators A1	1	3 = overload 11 = DeviceNet status
Display	52	Annunciators A1	1	4 = serial RX 14 = spare
Display	53	Annunciators A1	1	5 = serial TX
Display	54	Annunciators A1	1	6 = parity
Display	55	Annunciators A1	1	7 = framing error

* Read Only Registers

see next page for more ID numbers

Table 13-4. DeviceNet Data ID Codes (cont.)

Type	ID Code	Data	Words	Description
Analog	56	Analog Config	1	0 = gross, 1 = net
Analog	57	Analog Low	2	low analog output weight setting
Analog	58	Analog High	2	high analog output weight setting
Analog	59	Analog Low Adjust	2	low analog output adjustment
Analog	60	Analog High Adjust	2	high analog output adjustment
Serial	61	Serial Format	1	0 = print, 1 = continuous, 2 = pc, 3 = modbus, 4 = provox
Serial	62	Serial Address	1	0 - 99
Serial	63	Serial Baudrate	1	0=9600, 1=19200, 2=300, 3=600, 4=1200, 5=2400, 6=4800
Serial	64	Serial Parity	1	0 = none, 1 = even, 2 = odd
Serial	65	Print Data Select	1	bits 0-5 = display, gross, net, zero, tare, spare
Serial	66	Print Data Format	1	bits 0-2: sbx, address, leading 0s bit 4 = status bit 5 = delimiter: 0 = space, 1 = crlf bit 6 = terminating character: 0 = crlf, 1 = cr bits 7,3 = units: 00 = none, 01 = abbreviated, 10 = expanded
Serial	67	Print CRLF Delay	1	0 - 99 = 0.0 to 99 seconds
Serial	68	Con't Data Select	1	bits 0-5 = display, gross, net, zero, tare, spare
Serial	69	Con't Data Format	1	same as print format selection (65)
Serial	70	Con't TX Timer	2	low reg 0-599 = 0.00 to 59 secs, high reg 0-240 = 0 to 240 min
Rate	71	units/sec/min	1	0 = units/sec, 1 = units/min
Rate	72	Resolution	1	(0-12)
Rate	73	Derivation Time	1	1 to 1250 seconds
Setpoint 1	74	Main	2	Setpoint 1 main value
Setpoint 1	75	Inflight	1	(0-255)
Setpoint 1	76	Deadband	1	(0-255)
Setpoint 1	77	Config	1	lsd on main(0)/dribble(1), bit 1 = track gross (0)/net (1), bit 2 = 0 and bit 3 = on below (0)/above (1)
Setpoint 1	78	Tag	2	upper 4 digits ASCII 0-9, A-Z, minus, space
Setpoint 1	79	Tag	2	lower 4 digits ASCII 0-9, A-Z, minus, space
Setpoint 2	80	Main	2	Setpoint 2 main/dribble value
Setpoint 2	81	Inflight	1	(0-255)
Setpoint 2	82	Deadband	1	(0-255)
Setpoint 2	83	Config	1	lsd on main(0)/dribble(1), bit 1 = track gross (0)/net (1), bit 2 = 0 and bit 3 = on below (0)/above (1)
Setpoint 2	84	Tag	2	upper 4 digits ASCII 0-9, A-Z, minus, space
Setpoint 2	85	Tag	2	lower 4 digits ASCII 0-9, A-Z, minus, space
Setpoint 3	86	Main	2	Setpoint 3 main/dribble value
Setpoint 3	87	Inflight	1	(0-255)
Setpoint 3	88	Deadband	1	(0-255)
Setpoint 3	89	Config	1	lsd on main(0)/dribble(1), bit 1 = track gross (0)/net (1), bit 2 = 0 and bit 3 = on below (0)/above (1)
Setpoint 3	90	Tag	2	upper 4 digits ASCII 0-9, A-Z, minus, space
Setpoint 3	91	Tag	2	lower 4 digits ASCII 0-9, A-Z, minus, space
Setpoint 4	92	Main	2	Setpoint 4 main/dribble value
Setpoint 4	93	Inflight	1	(0-255)
Setpoint 4	94	Deadband	1	(0-255)
Setpoint 4	95	Config	1	lsd on main(0)/dribble(1), bit 1 = track gross (0)/net (1), bit 2 = 0 and bit 3 = on below (0)/above (1)
Setpoint 4	96	Tag	2	upper 4 digits ASCII 0-9, A-Z, minus, space
Setpoint 4	97	Tag	2	lower 4 digits ASCII 0-9, A-Z, minus, space

see next page for Setpoint 5 - 8 allocations

* Read Only Register

Table 13-4. DeviceNet Data ID Codes (cont.)				
Type	ID Code	Data	Words	Description
Setpoint 5	98	Main	2	Setpoint 5 main/dribble value
Setpoint 5	99	Inflight	1	(0-255)
Setpoint 5	100	Deadband	1	(0-255)
Setpoint 5	101	Config	1	lsd on main(0)/dribble(1), bit 1 = track gross (0)/net (1), bit 2 = 0 and bit 3 = on below (0)/above (1)
Setpoint 5	102	Tag	2	upper 4 digits ASCII 0-9, A-Z, minus, space
Setpoint 5	103	Tag	2	lower 4 digits ASCII 0-9, A-Z, minus, space
Setpoint 6	104	Main	2	Setpoint 6 main/dribble value
Setpoint 6	105	Inflight	1	(0-255)
Setpoint 6	106	Deadband	1	(0-255)
Setpoint 6	107	Config	1	lsd on main(0)/dribble(1), bit 1 = track gross (0)/net (1), bit 2 = 0 and bit 3 = on below (0)/above (1)
Setpoint 6	108	Tag	2	upper 4 digits ASCII 0-9, A-Z, minus, space
Setpoint 6	109	Tag	2	lower 4 digits ASCII 0-9, A-Z, minus, space
Setpoint 7	110	Main	2	Setpoint 7 main/dribble value
Setpoint 7	111	Inflight	1	(0-255)
Setpoint 7	112	Deadband	1	(0-255)
Setpoint 7	113	Config	1	lsd on main(0)/dribble(1), bit 1 = track gross (0)/net (1), bit 2 = 0 and bit 3 = on below (0)/above (1)
Setpoint 7	114	Tag	2	upper 4 digits ASCII 0-9, A-Z, minus, space
Setpoint 7	115	Tag	2	lower 4 digits ASCII 0-9, A-Z, minus, space
Setpoint 8	116	Main	2	Setpoint 8 main/dribble value
Setpoint 8	117	Inflight	1	(0-255)
Setpoint 1	118	Deadband	1	(0-255)
Setpoint 8	119	Config	1	lsd on main(0)/dribble(1), bit 1 = track gross (0)/net (1), bit 2 = 0 and bit 3 = on below (0)/above (1)
Setpoint 8	120	Tag	2	upper 4 digits ASCII 0-9, A-Z, minus, space
Setpoint 8	121	Tag	2	lower 4 digits ASCII 0-9, A-Z, minus, space
Setpoint	122*	Status	1	Status bits = 0 to 8: status of setpoint, 0=off/1=on, LSB = Setpoint 1, MSB = Setpoint 8

* Read Only Register

Table 13-4. DeviceNet Data ID Codes (cont.)				
Type	ID Code	Data	Words	Description
Reserved	98-122	Not Used At This Time		
Security	123	Password Upper 4	2	password upper 4 chars: ASCII 0-9, A-Z, minus or space
Security	124	Password Lower 3	2	password lower 3 chars: ASCII 0-9, A-Z, minus or space
Security	125	Key/Security Locks	1	bits 0-4 = zero, tare, g/n, print, edit keys - bit 5 = security lock
Security	126	Menu Locks	1	bits 0-4 = cal, filter, display, i/o, and diag menus
Security	127	Spare		
Instrument	128*	Serial # Upper 4	2	upper 4 digits of 7 digit ASCII numeric code (0-9)
Instrument	129*	Serial # Lower 3	2	lower 3 digits of 7 digit ASCII numeric code (0-9)
Instrument	130*	Software Version #	1	number with 2 decimal places (i.e. 100 = ver. 1.00)
Instrument	131*	A/D Rev.	1	2 ASCII characters
Instrument	132*	Ref Date Month/Day	2	upper 4 digits of 6 digit ASCII date code (MMDD) date format = MMDDYY month-day-year of internal cal
Instrument	133*	Ref Date Year	1	lower 2 digits of 6 digit ASCII date code (YY)
Instrument	134*	Instrument Model	1	100 = LCP-200
Instrument	135*	Options Upper 4	2	upper 4 digits of 6 digit ASCII option code [M]-[A]-[P]-[C]
Instrument	136*	Options Lower 2	1	lower 2 digits of 6 digit ASCII option code [B]-[M]

13.6 DeviceNet EDS FILE

An Electronic Data Sheet (EDS) is a simple file format that includes the device's configurable parameters and public interfaces to those parameters. It provides user friendly configuration tools that can be easily updated without having to constantly revise the configuration software tool. EDS files are used by network tools to read or set device parameters. Table 13-5 presents the simple EDS file code used for the LCp-200.

Table 13-5. LCp-200 EDS Code Defined

```
$ DeviceNet Electronic Data Sheet
$ Electronic Data Sheet generated using SST EDS Editor
$ Copyright (C) 1998 S-S Technologies Inc.
[File]
  DescText = "Weight/Rate Transmitter eds file";
  CreateDate = 11 - 16-00;
  CreateTime = 11:19:02;
  ModDate = 01 -18-01;
  ModTime = 09:48:45; Revision = 1.0;

[Device]
  VendCode = 661;
  VendName = "Thermo BLH";
  ProdType = 12;
  ProdTypeStr = "Communication Adapter";
  ProdCode = 1;
  MajRev = 1;
  MinRev = 1;
  ProdName = "Lcp-series";
  Catalog = "";

[IO_Info]
  Default = 0x0001;
  PollInfo = 0x000D, 1, 1;
  COSInfo = 0x000D, 1, 1;
  CyclicInfo = 0x000D, 1, 1;
  Input1 =
    8, 0, 0x000D,
    "Input1 ",
    2,"61 49",
    "",
  Output1 =
    8, 0, 0x000D,
    "output1 ",
    2, "61 4F",
    "",

[Param Class]
[Params]
[EnumPar]
[Groups]
```

Appendix A. Outlines and Wiring Diagrams

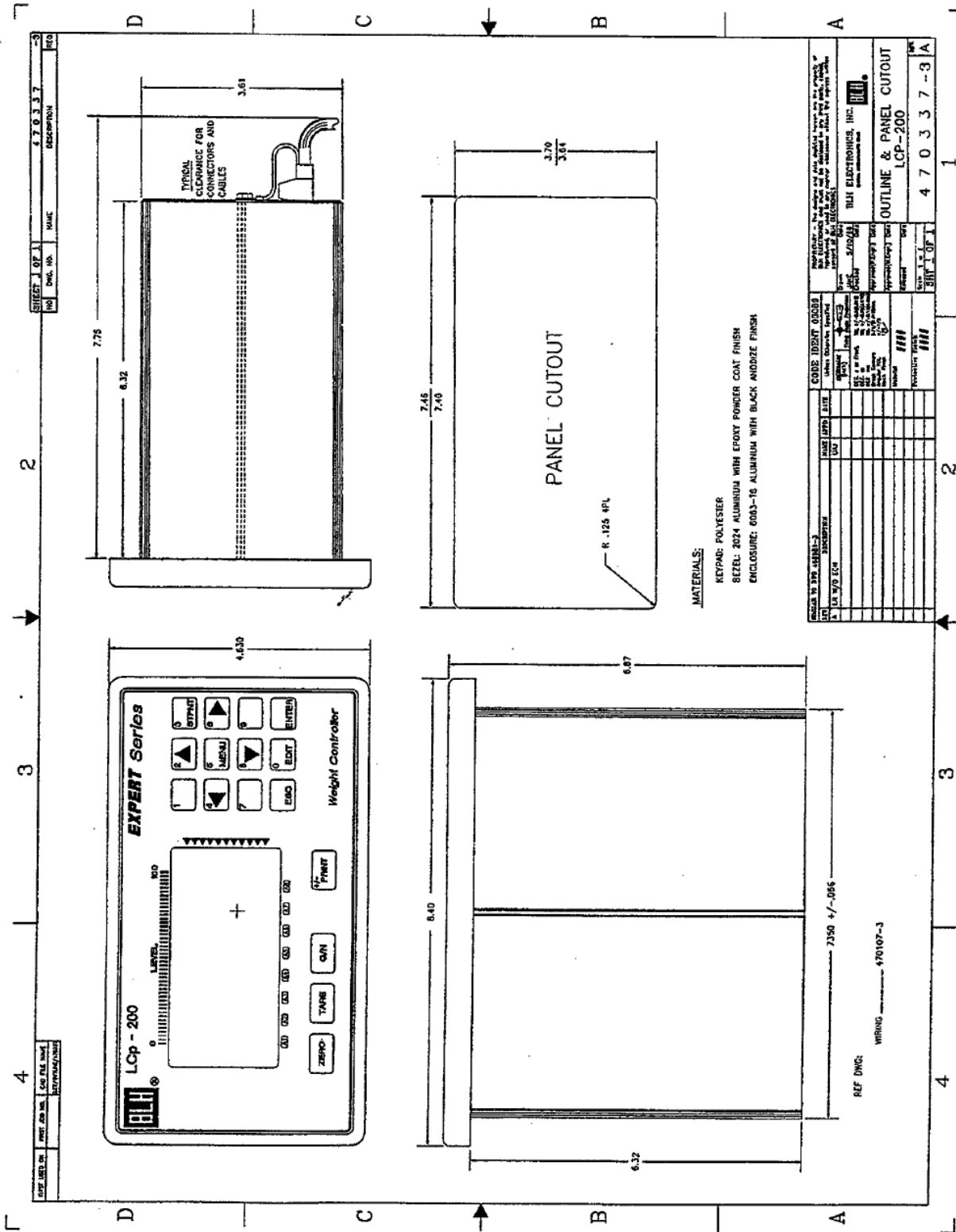

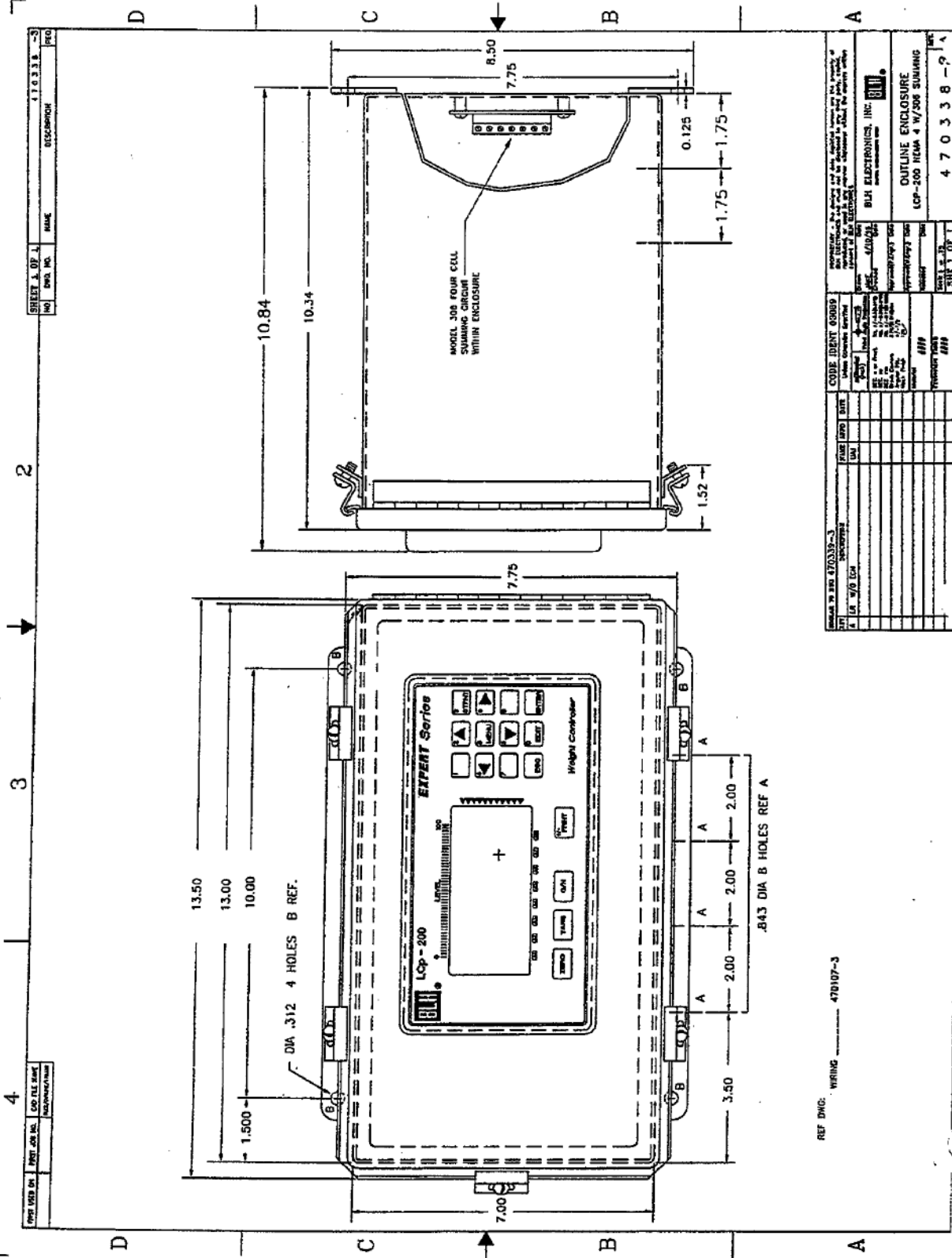

NO	DWG NO.	NAME	DATE
	470338-3	BISCHOFF	

DATE USED ON	PROJECT JOB NO.	CAD FILE NAME
		ENCLOSURE.DWG

GENERAL		PROJECT NO.	470338-3
DRAWN BY		DATE	
CHECKED BY		DATE	
APPROVED BY		DATE	
TITLE		OUTLINE ENCLOSURE	
PROJECT		LCP-200 REMA 4 W/306 SUMMING	
DRAWN		BILH ELECTRONICS, INC.	
CHECKED		BILH ELECTRONICS, INC.	
APPROVED		BILH ELECTRONICS, INC.	
DATE		1970-12-15	

REF DWG: WIRING 470107-3

ANALOG OUTPUT OPTION

RANGE	SW 1.7	SW 1.8	LOAD RESISTANCE
6-20 MA	ON	OFF	600 OHM
0-20 MA	OFF	ON	500 OHM
0-24 MA	OFF	OFF	500 OHM

REMOTE I/O OPTION

PIN NAME	FUNCTION	TERMINATING RESISTOR
1	BLUE	RESISTOR
5H	SHIELD (OUTER BRAID)	57.6K
2	CLEAR	115.2K
7	CHASSIS GND	230.4K

INITIAL TERMINATION RESISTOR ONLY IF THE LCP-100 IS AT THE END OF COMMUNICATION CABLE

RS 422/485 COMMUNICATION

PIN NO	SIGNAL NAME	RS 422		RS 485	
		TRNSMIT DATA +	NOT USED	TRNSMIT DATA -	NOT USED
1	TxD+	ON	OFF	ON	ON
2	TxD-	OFF	OFF	ON	ON
3	RxD+	ON	ON	ON	ON
4	RxD-	DATA -	DATA -		

DIP SWITCH SETUP

SW 1.1	SW 1.2	SW 1.3	SW 1.4
RS 422 MULTIDROP	ON	OFF	OFF
RS 422 FULL DUPLEX	OFF	OFF	OFF
RS 485 HALF DUPLEX	ON	ON	ON

TERMINATION RESISTOR
 DIP SWITCH #5 IN ON POSITION CONNECTS AN INTERNAL 120 OHM RESISTOR ACROSS THE RxD+ AND RxD- SIGNALS

SS RELAY OUTPUTS

13-240 VAC

TYPE	TRM/C
OPERATING	12-240 VAC
ON VOLTAGE	1.2 VRMS @ 1AMP
OFF STATE LEAVAGE	1mo @ 240 VAC
POWER	EXTERNAL POWER REQUIRED
MAX LOAD	1 AMP
MIN LOAD	50 mA
FREQ	20-550 HZ

OPEN COLLECTOR OUTPUTS

3-35V

TYPE	TRM/C
OPERATING	1.2 VDC @ .35mA
ON VOLTAGE	1.2 VDC @ .35mA
OFF STATE LEAVAGE	1.0ma @ 35V
POWER	EXTERNAL POWER REQUIRED

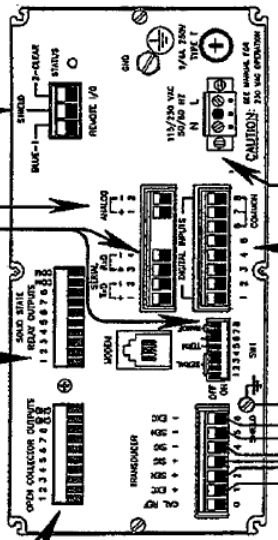

LOAD CELL INTERCONNECT WIRING

SIGNAL	TYPICAL COLOR
1 - EDC	GREEN
2 - EDC	WHITE
3 - EDC	RED
4 - EDC	BLACK

NOTE: 1. FOR SYSTEMS OTHER THAN LOAD CELLS, THE RED AND WHITE LEADS MAY NEED TO BE REVERSED

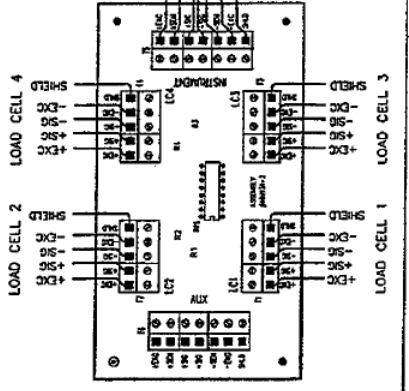

ISOLATED INPUT CONNECTIONS

PIN #	FUNCTION
1	UNUSED
2	ZERO
3	YARE
4	CROSS/NET
5	PRINT
6	GND 6
7	GND 7
8	GND 8

CLOSED (ARBITRARY)
 SHORT CIRCUIT OR 0 TO 4VDC
 OPEN
 OPEN CIRCUIT OR 4 TO 24VDC

BIH ELECTRONICS, INC.
 470108-3
 WIRING LCP-200
 W/306 SUMMING CIRCUIT

DATE: 1/1/81
 DRAWN BY: J. W. BROWN
 CHECKED BY: J. W. BROWN
 APPROVED BY: J. W. BROWN

REVISIONS:

NO.	DESCRIPTION	DATE
1	INITIAL RELEASE	1/1/81

Appendix B – Flow Diagrams

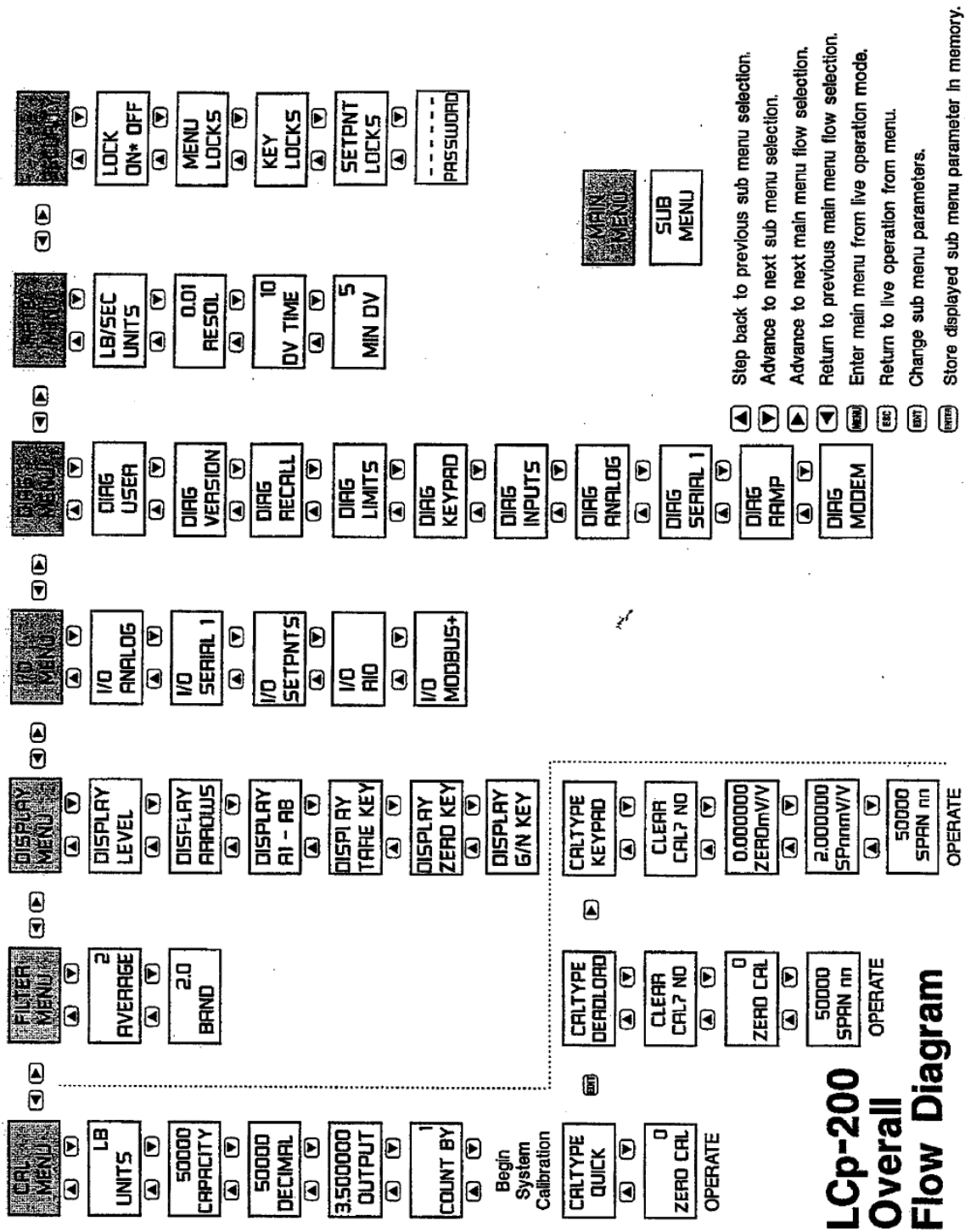

LcP-200 Overall Flow Diagram

Enter/Alter Set-Up Parameters

MAIN MENU [ENTER] [UP] [DOWN]

LB UNITS [ENTER] [UP] [DOWN]

Choose Display/Printout Unit Type

50000 CAPACITY [ENTER] [UP] [DOWN]

Enter Full Scale Capacity

500.00 DECIMAL [ENTER] [UP] [DOWN]

Locate Display/Printout Decimal Point

3.500000 OUTPUT [ENTER] [UP] [DOWN]

Enter Scale Output Rated mV/V output of system

COUNT BY 1 [ENTER] [UP] [DOWN]

SELECTIONS:
12,5,10,20,
50, or 100

SELECTIONS:
0 to
99999999

SELECTIONS:
LB (pounds)
KG (kilograms)
TN (tons)
OZ (ounces)
GM (grams)
N (newtons)
KN (kilonewtons)
L (liters)
(blank space)

SELECTIONS:
Use EDIT,
[DOWN], and then
ENTER

General Key Functions:

- [UP] Step back to previous menu selection.
- [DOWN] Advance to next menu selection.
- [MENU] Advance to next main menu selection.
- [ESC] Return to live operation from menu.
- [ENTER] Change sub menu parameters.
- [ENTER] Store displayed sub menu parameter in memory.



To Enter/Alter a Numeric Value:

- [ENTER] Press to initiate a change.
- [UP] Press to increment selected digit.
- [DOWN] Press to decrement selected digit.
- [RIGHT] Press to advance to next digit.
- [LEFT] Press to return to previous digit.
- [ENTER] Press to store selection in memory.

To Enter/Alter a Parameter Selection:

- [ENTER] Press to initiate a change.
- [DOWN] Press to view parameter options.
- [ENTER] Press to store selection in memory.

Calibration Type - Flow Diagrams

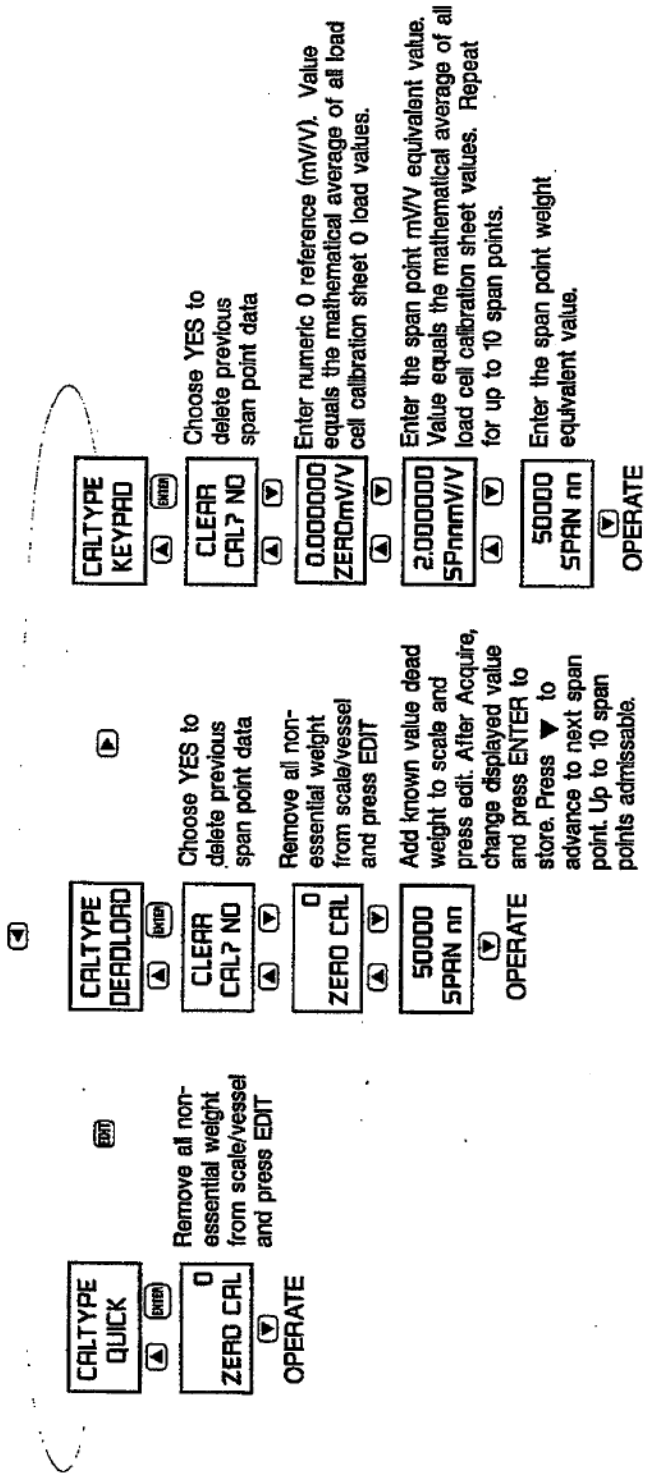

General Key Functions:

- Step back to previous menu selection.
- Advance to next menu selection.
- Advance to next main menu selection.
- Return to live operation from menu.
- Change sub menu parameters.
- Store displayed sub menu parameter in memory.



To Enter/Alter a Numeric Value:

- Press to initiate a change.
- Key in desired numeric value.
- Press to return to previously entered value.
- Press to store selection in memory.

To Enter/Alter a Parameter Selection:

- Press to initiate a change.
- Press to view parameter options.
- Press to store selection in memory.

Enter/Alter Filter Parameters

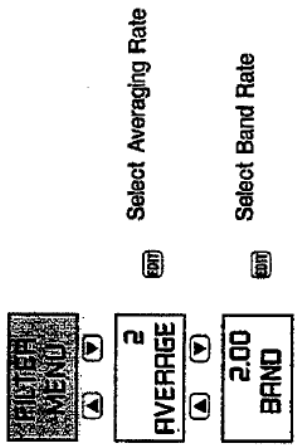

SELECTIONS:
1,2,4,8,16,
32,64, or
128

SELECTIONS:
0.25 to
100

General Key Functions:

- ▲ Step back to previous menu selection.
- ▼ Advance to next menu selection.
- MENU Advance to next main menu selection.
- ESC Return to live operation from menu.
- EXIT Change sub menu parameters.
- ENTER Store displayed sub menu parameter in memory.



To Enter/Alter a Parameter Selection:

- EXIT Press to initiate a change.
- ▼ Press to view parameter options.
- ENTER Press to store selection in memory.

Display Menu Flow Diagram

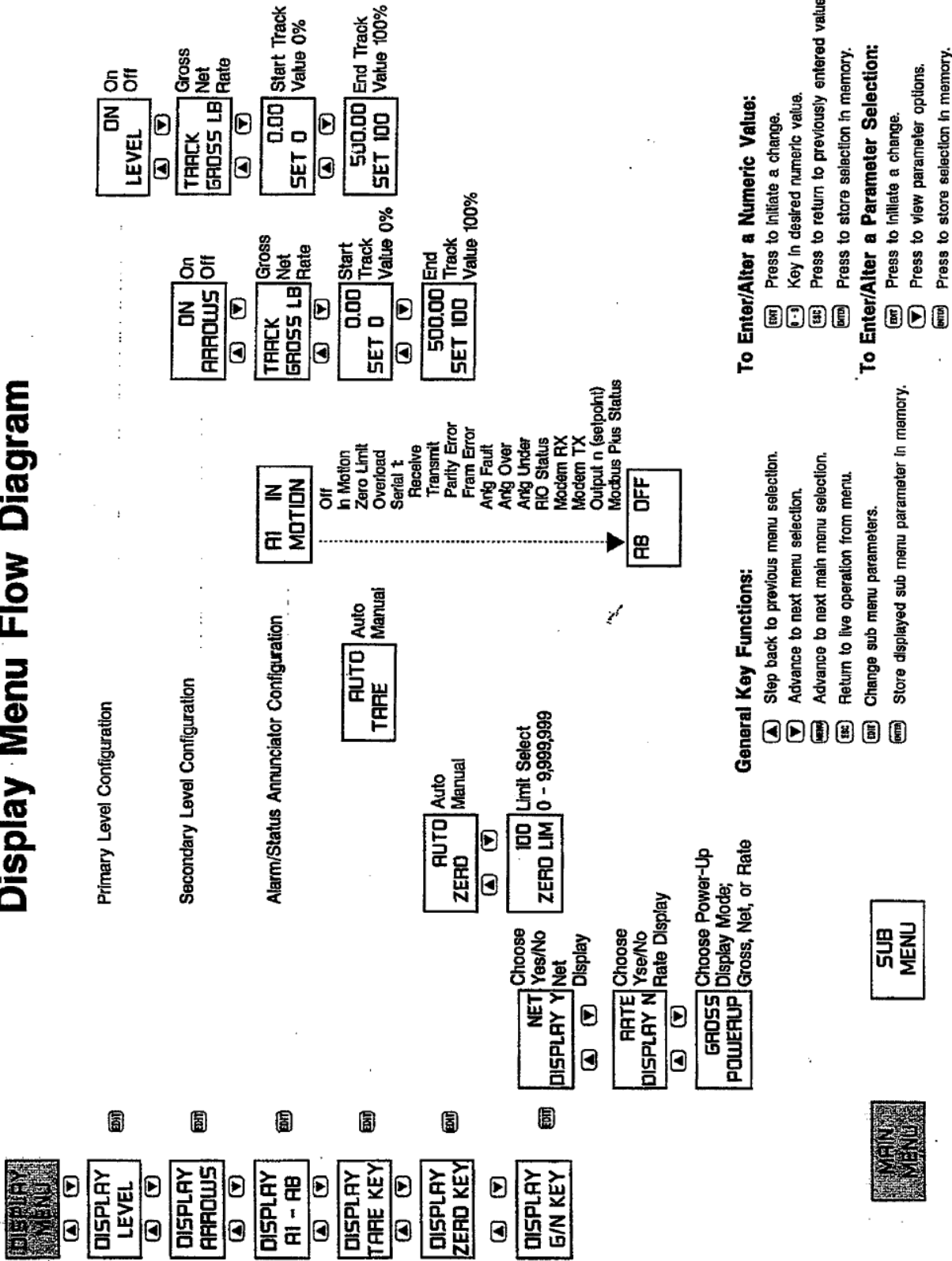

Diagnostic Menu Flow Diagram

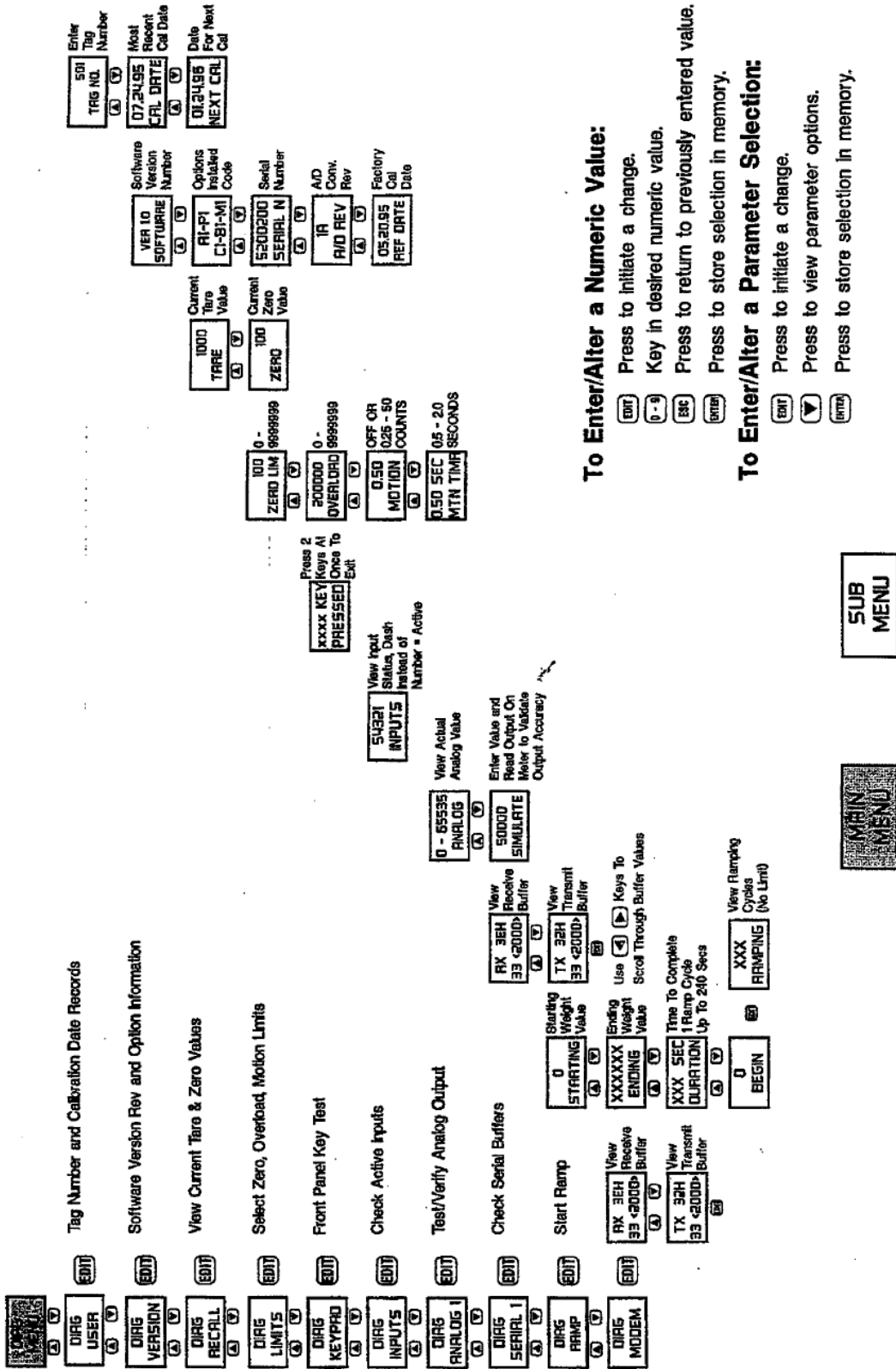

Security Menu Flow Diagram

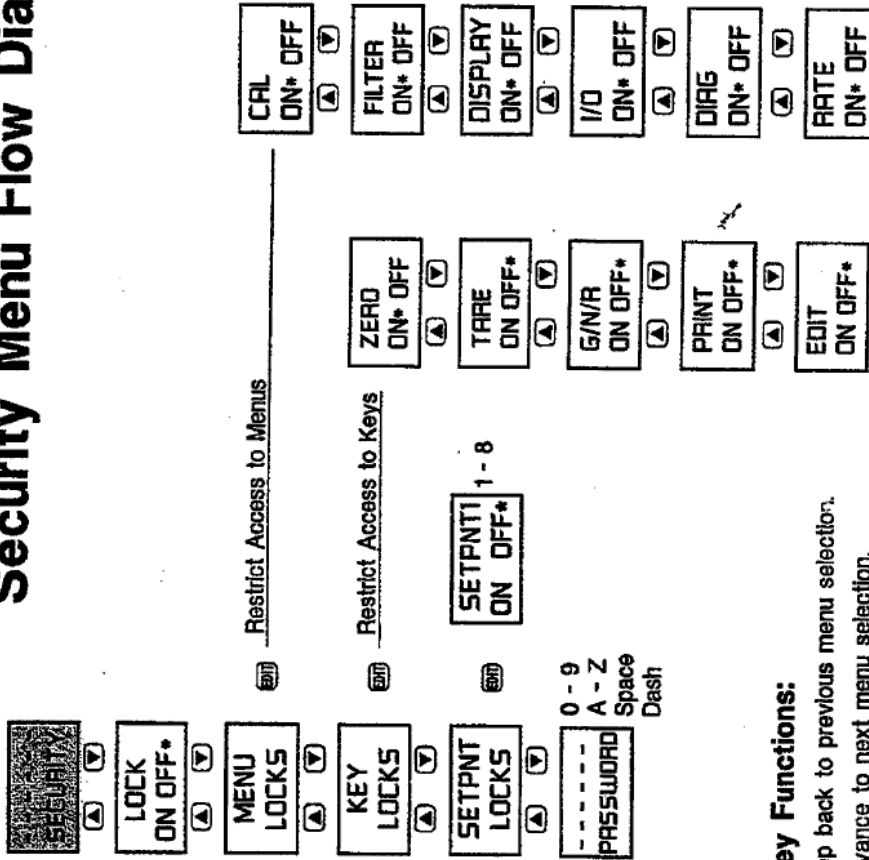

General Key Functions:

- ▲ Step back to previous menu selection.
- ▼ Advance to next menu selection.
- MEMU Advance to next main menu selection.
- END Return to live operation from menu.
- ENT Change sub menu parameters.
- ENT Store displayed sub menu parameter in memory.



To Enter/Alter a Numeric Value:

- ENT Press to initiate a change.
- 0-9 Key in desired numeric value.
- ESC Press to return to previously entered value.
- ENT Press to store selection in memory.

To Enter/Alter a Parameter Selection:

- ENT Press to initiate a change.
- ▼ Press to view parameter options.
- ENT Press to store selection in memory.

Rate-By-Weight Flow Diagram

RATE MENU



LB/SEC UNITS



Select:
units/second (faster rate) or
units/minute (slower rate)

0.01 RESOL



Select rate resolution. Selections are effected by rate units, instrument calibration, and decimal point position.

10 DV TIME







Enter rate derivation time from 1 to 1250 seconds. Longer derivation time yields greater sensitivity but slower response to rate changes.



5 MIN DV

Value calculated by the LCp-200 and cannot be changed. This value is the minimum time needed to achieve the rate resolution entered. DV TIME must be greater than or equal to this value.







To Enter/Alter a Numeric Value:

-  Press to initiate a change.
-  Key in desired numeric value.
-  Press to return to previously entered value.
-  Press to store selection in memory.

To Enter/Alter a Parameter Selection:

-  Press to initiate a change.
-  Press to view parameter options.
-  Press to store selection in memory.

General Key Functions:

-  Step back to previous menu selection.
-  Advance to next menu selection.
-  Advance to next main menu selection.
-  Return to live operation from menu.
-  Change sub menu parameters.
-  Store displayed sub menu parameter in memory.

MAIN MENU

SUB MENU



BLH

3 Edgewater Drive,
Norwood, MA 02062 U.S.A.

Phone (781)298-2200

Fax (781)762-3988

www.vishaypg.com