

# Strain Gage Selection: Criteria, Procedures, Recommendations

## 1.0 Introduction

The initial step in preparing for any strain gage installation is the selection of the appropriate gage for the task. It might at first appear that gage selection is a simple exercise, of no great consequence to the stress analyst; but quite the opposite is true. Careful, rational selection of gage characteristics and parameters can be very important in: optimizing the gage performance for specified environmental and operating conditions, obtaining accurate and reliable strain measurements, contributing to the ease of installation, and minimizing the *total* cost of the gage installation.

The installation and operating characteristics of a strain gage are affected by the following parameters, which are selectable in varying degrees:

- strain-sensitive alloy
- backing material (carrier)
- grid resistance
- gage pattern
- self-temperature compensation number
- gage length
- options

Basically, the gage selection process consists of determining the particular available combination of parameters which is most compatible with the environmental and other operating *conditions*, and at the same time best satisfies the installation and operating *constraints*. These constraints are generally expressed in the form of requirements such as:

- |               |                        |
|---------------|------------------------|
| • accuracy    | • test duration        |
| • stability   | • cyclic endurance     |
| • temperature | • ease of installation |
| • elongation  | • environment          |

The cost of the strain gage itself is not ordinarily a prime consideration in gage selection, since the significant economic measure is the total cost of the complete installation, of which the gage cost is usually but a small fraction. In many cases, the selection of a gage series or optional feature which increases the gage cost serves to decrease the total installation cost.

It must be appreciated that the process of gage selection generally involves compromises. This is because parameter choices which tend to satisfy one of the constraints or requirements may work against satisfying others. For example, in the case of a small-radius fillet, where the space available for gage installation is very limited, and the strain gradient extremely high, one of the shortest available gages might be the obvious choice. At the same time, however, gages shorter than about 0.125 in (3 mm) are generally characterized by lower maximum elongation, reduced fatigue life, less stable behavior, and greater installation difficulty. Another situation which often influences gage selection, and leads to compromise, is the stock of gages at hand for day-to-day strain measurements. While compromises are almost always necessary, the stress analyst should be fully aware of the effects of such compromises on meeting the requirements of the gage installation. This understanding is necessary to make the best overall compromise for any particular set of circumstances, and to judge the effects of that compromise on the accuracy and validity of the test data.

The strain gage selection criteria considered here relate primarily to stress analysis applications. The selection criteria for strain gages used on transducer spring elements, while similar in many respects to the considerations presented here, may vary significantly from application to application and should be treated accordingly. The Micro-Measurements Applications Engineering Department can assist in this selection.

## 2.0 Gage Selection Parameters

### 2.1 Strain-Sensing Alloys

The principal component which determines the operating characteristics of a strain gage is the strain-sensitive alloy used in the foil grid. However, the alloy is not in every case an independently selectable parameter. This is because each Micro-Measurements strain gage series (identified by the first two, or three, letters in the alphanumeric gage designation) is designed as a complete system. That system is comprised of a particular foil and backing combination, and usually incorporates additional gage construction features (such as encapsulation, integral leadwires, or solder dots) specific to the series in question.

Micro-Measurements supplies a variety of strain gage alloys as follows (with their respective letter designations):

## Strain Gage Selection: Criteria, Procedures, Recommendations

- A: Constantan in self-temperature-compensated form.
- P: Annealed constantan.
- D: Isoelastic.
- K: Nickel-chromium alloy, a modified Karma in self-temperature-compensated form.

### 2.1.1 Constantan Alloy

Of all modern strain gage alloys, constantan is the oldest, and still the most widely used. This situation reflects the fact that constantan has the best overall combination of properties needed for many strain gage applications. This alloy has, for example, an adequately high strain sensitivity, or *gage factor*, which is relatively insensitive to strain level and temperature. Its resistivity is high enough to achieve suitable resistance values in even very small grids, and its temperature coefficient of resistance is not excessive. In addition, constantan is characterized by good fatigue life and relatively high elongation capability. It must be noted, however, that constantan tends to exhibit a continuous drift at temperatures above +150°F (+65°C); and this characteristic should be taken into account when zero stability of the strain gage is critical over a period of hours or days.

Very importantly, constantan can be processed for self-temperature-compensation (see box at right) to match a wide range of test material expansion coefficients. A alloy is supplied in self-temperature-compensation (S-T-C) numbers 00, 03, 05, 06, 09, 13, 15, 18, 30, 40 and 50, for use on test materials with corresponding thermal expansion coefficients (expressed in ppm/°F).

For the measurement of very large strains, 5% (50 000  $\mu\epsilon$ ) or above, annealed constantan (P alloy) is the grid material normally selected. Constantan in this form is very ductile; and, in gage lengths of 0.125 in (3 mm) and longer, can be strained to >20%. It should be borne in mind, however, that under high *cyclic* strains the P alloy will exhibit some permanent resistance change with each cycle, and cause a corresponding zero shift in the strain gage. Because of this characteristic, and the tendency for premature grid failure with repeated straining, P alloy is not ordinarily recommended for cyclic strain applications. P alloy is available with S-T-C numbers of 08 and 40 for use on metals and plastics, respectively.

### 2.1.2 Isoelastic Alloy

When purely dynamic strain measurements are to be made — that is, when it is not necessary to maintain a stable reference zero — isoelastic (D alloy) offers certain advantages. Principal among these are superior fatigue life, compared to A alloy, and a high gage factor (approximately 3.2) which improves the signal-to-noise ratio in dynamic testing.

D alloy is not subject to self-temperature-compensation. Moreover, as shown in the graph (see box), its thermal output is so high (about 80  $\mu\epsilon/^\circ\text{F}$  (145  $\mu\epsilon/^\circ\text{C}$ ) that this alloy is not normally usable for static strain measurements. There are times, however, when D alloy finds application in special-purpose transducers where a high output is needed, and where a full-bridge arrangement can be used to achieve reasonable temperature compensation within the circuit.

#### Self-Temperature-Compensation

An important property shared by constantan and modified Karma strain gage alloys is their responsiveness to special processing for self-temperature-compensation. Self-temperature-compensated strain gages are designed to produce minimum thermal output (temperature-induced apparent strain) over the temperature range from about -50° to +400°F (-45° to +200°C). When selecting either constantan (A-alloy) or modified Karma (K-alloy) strain gages, the self-temperature-compensation (S-T-C) number must be specified. The S-T-C number is the approximate thermal expansion coefficient in ppm/°F of the structural material on which the strain gage will display minimum thermal output.

The accompanying graph illustrates typical thermal output characteristics for A and K alloys. The thermal output of uncompensated isoelastic alloy is included in the same graph for comparison purposes. In normal practice, the S-T-C number for an A- or K-alloy gage is selected to most closely match the thermal expansion coefficient of the test material. However, the thermal output curves for these alloys can be rotated about the room-temperature reference point to favor a particular temperature range. This is done by intentionally mismatching the S-T-C number and the expansion coefficient in the appropriate direction. When the selected S-T-C number is lower than the expansion coefficient, the curve is rotated counterclockwise. An opposite mismatch produces clockwise rotation of the thermal output curve. Under conditions of S-T-C mismatch, the thermal output curves for A and K alloys do not apply, of course, and it will generally be necessary to calibrate the installation for thermal output as a function of temperature.

For additional information on strain gage temperature effects, see Tech Note TN-504.

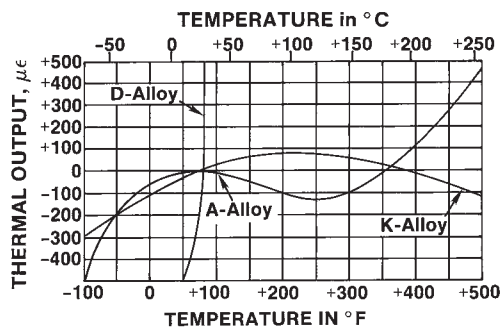

## Strain Gage Selection: Criteria, Procedures, Recommendations

Other properties of D alloy should also be noted when considering the selection of this grid material. It is, for instance, magnetoresistive; and its response to strain is somewhat nonlinear, becoming significantly so at strains beyond  $\pm 5000 \mu\epsilon$ .

### 2.1.3 Karma Alloy

Modified Karma, or K alloy, with its wide areas of application, represents an important member in the family of strain gage alloys. This alloy is characterized by good fatigue life and excellent stability; and is the preferred choice for accurate static strain measurements over long periods of time (months or years) at room temperature, or lesser periods at elevated temperature. It is recommended for extended static strain measurements over the temperature range from  $-452^\circ$  to  $+500^\circ\text{F}$  ( $-269^\circ$  to  $+260^\circ\text{C}$ ). For short periods, encapsulated K-alloy strain gages can be exposed to temperatures as high as  $+750^\circ\text{F}$  ( $+400^\circ\text{C}$ ). An inert atmosphere will improve stability and extend the useful gage life at high temperatures.

Among its other advantages, K alloy offers a much flatter thermal output curve than A alloy, and thus permits more accurate correction for thermal output errors at temperature extremes. Like constantan, K alloy can be self-temperature-compensated for use on materials with different thermal expansion coefficients. The available S-T-C numbers in K alloy are limited, however, to the following: 00, 03, 05, 06, 09, 13, and 15. K alloy is the normal selection when a temperature-compensated gage is required that has environmental capabilities and performance characteristics not attainable in A-alloy gages.

Due to the difficulty of soldering directly to K alloy, the duplex copper feature, which was formerly offered as an option, is now standard on all Micro-Measurements open-faced strain gages produced with K alloy. The duplex copper feature is a precisely formed copper soldering pad (DP) or dot (DD), depending on the available tab area. All K-alloy gages which do not have leads or solder dots are specified with DP or DD as part of the designation (in place of, or in addition to, the option specifier). The specific style of copper treatment will be advised when the Customer Service Department is contacted. Open-faced K-alloy gages may also be ordered with solder dots.

### 2.2 Backing Materials

Conventional foil strain gage construction involves a photo-etched metal foil pattern mounted on a plastic backing or carrier. The backing serves several important functions:

- provides a means for handling the foil pattern during installation

- presents a readily bondable surface for adhering the gage to the test specimen
- provides electrical insulation between the metal foil and the test object

Backing materials supplied on Micro-Measurements strain gages are of two basic types: polyimide and glass-fiber-reinforced epoxy-phenolic. As in the case of the strain-sensitive alloy, the backing is not completely an independently specifiable parameter. Certain backing and alloy combinations, along with special construction features, are designed as systems, and given gage series designations. As a result, when arriving at the optimum gage type for a particular application, the process does not permit the arbitrary combination of an alloy and a backing material, but requires the specification of an available gage series. Micro-Measurements gage series and their properties are described in the following *Section 2.3*. Each series has its own characteristics and preferred areas of application; and selection recommendations are given in the tables that follow. The individual backing materials are discussed here, as the alloys were in the previous section, to aid in understanding the properties of the series in which the alloys and backing materials occur.

The Micro-Measurements polyimide E backing is a tough and extremely flexible carrier, and can be contoured readily to fit small radii. In addition, the high peel strength of the foil on the polyimide backing makes polyimide-backed gages less sensitive to mechanical damage during installation. With its ease of handling and its suitability for use over the temperature range from  $-320^\circ$  to  $+350^\circ\text{F}$  ( $-195^\circ$  to  $+175^\circ\text{C}$ ), polyimide is an ideal backing material for general-purpose static and dynamic stress analysis. This backing is capable of large elongations, and can be used to measure plastic strains in excess of 20%. Polyimide backing is a feature of Micro-Measurements EA-, CEA-, EP-, EK-, S2K-, N2A-, and ED-Series strain gages.

Micro-Measurements also offers the C2- and L2 laminated polyimide backing—a tough, flexible carrier, provided with an encapsulation layer to protect the grid. These backings can conform to a small radius or fillet and are typically found with Micro-Measurements pre-leaded and pre-cabled strain gages.

For outstanding performance over the widest range of temperatures, the glass-fiber-reinforced epoxy-phenolic backing material is the most suitable choice. This backing can be used for static and dynamic strain measurement from  $-452^\circ$  to  $+550^\circ\text{F}$  ( $-269^\circ$  to  $+290^\circ\text{C}$ ). In short-term applications, the upper temperature limit can be extended to as high as  $+750^\circ\text{F}$  ( $+400^\circ\text{C}$ ). The maximum elongation of this carrier material is limited, however, to about 1 to 2%. Reinforced epoxy-phenolic backing is employed on the following gage series: WA, WK, SA, SK, WD, and SD.

## Strain Gage Selection: Criteria, Procedures, Recommendations

### 2.3 Gage Series

As noted in *Sections 2.1 and 2.2*, the strain-sensing alloy and backing material are not subject to completely independent selection and arbitrary combination. Instead, a selection must be made from among the available gage systems, or series, where each series generally incorporates special design or construction features, as well as a specific combination of alloy and backing material. For convenience in identifying the appropriate gage series to meet specified test requirements, the information on gage series performance and selection is presented in the two tables below, in condensed form.

The first table gives brief descriptions of all general-purpose Micro-Measurements gage series — including in each case the alloy and backing combination and the principal construction features. This table defines the performance of each series in terms of operating temperature range, strain range, and cyclic endurance as a function of strain level. It must be noted, however, that the performance data are *nominal*, and apply primarily to gages of 0.125 in (3 mm) or longer gage length.

**STANDARD STRAIN GAGE SERIES SELECTION CHART**

Gage Series	Description and Primary Application	Temperature Range	Strain Range	Fatigue Life	
				Strain Level in $\mu\epsilon$	Number of Cycles
EA	Constantan foil in combination with a tough, flexible, polyimide backing. Wide range of options available. Primarily intended for general-purpose static and dynamic stress analysis. Not recommended for highest accuracy transducers.	Normal: -100° to +350°F (-75° to +175°C) Special or Short-Term: -320° to +400°F (-195° to +205°C)	±3% for gage lengths under 1/8 in (3.2 mm); ±5% for 1/8 in and over	±1800 ±1500 ±1200	10 <sup>5</sup> 10 <sup>6</sup> 10 <sup>8</sup>
CEA	Universal general-purpose strain gages. Constantan grid completely encapsulated in polyimide, with large, rugged copper-coated tabs. Primarily used for general-purpose static and dynamic stress analysis. 'C'-Feature gages are specially highlighted throughout the gage listings of our Precision Strain Gages Data Book.	Normal: -100° to +350°F (-75° to +175°C) Stacked rosettes limited to +150°F (+65°C)	±3% for gage lengths under 1/8 in (3.2 mm); ±5% for 1/8 in and over	±1500 ±1500	10 <sup>5</sup> 10 <sup>6*</sup>
C2A	General purpose stress analysis strain gages. Supplied with pre-attached cables for direct connection to instrumentation.	-60° to +180°F (-50° to +80°C)	±3%	±1700 ±1500	10 <sup>5</sup> 10 <sup>6</sup>
L2A	General-purpose stress analysis strain gages. Supplied with pre-attached leadwire ribbons.	-100° to +250°F (-75° to +120°C)	±3%	±1700 ±1500	10 <sup>5</sup> 10 <sup>6</sup>
W2A IPX8S Rated	For water-exposure applications. Based on the CEA Series with Option P2 pre-attached cables, W2A strain gages are fully enclosed with a silicone rubber coating and tested to 10 GΩ insulation resistance, 1 meter water depth, 30 minutes duration. Other requirements can be addressed on demand.	-60° to +180°F (-50° to +80°C)	±3%	±1500	10 <sup>5</sup>
N2A	Open-faced constantan foil gages with a thin, laminated, polyimide-film backing. Primarily recommended for use in precision transducers, the N2A Series is characterized by low and repeatable creep performance. Also recommended for stress analysis applications employing large gage patterns, where the especially flat matrix eases gage installation.	Normal Static Transducer Service: -100° to +200°F (-75° to +95°C)	±3%	±1700 ±1500	10 <sup>6</sup> 10 <sup>7</sup>
WA	Fully encapsulated constantan gages with high-endurance leadwires. Useful over wider temperature ranges and in more extreme environments than EA Series. Option W available on some patterns, but restricts fatigue life to some extent.	Normal: -100° to +400°F (-75° to +205°C) Special or Short-Term: -320° to +500°F (-195° to +260°C)	±2%	±2000 ±1800 ±1500	10 <sup>5</sup> 10 <sup>6</sup> 10 <sup>7</sup>
SA	Fully encapsulated constantan gages with solder dots. Same matrix as WA Series. Same uses as WA Series but derated somewhat in maximum temperature and operating environment because of solder dots.	Normal: -100° to +400°F (-75° to +205°C) Special or Short-Term: -320° to +450°F (-195° to +230°C)	±2%	±1800 ±1500	10 <sup>6</sup> 10 <sup>7</sup>
EP	Specially annealed constantan foil with tough, high-elongation polyimide backing. Used primarily for measurements of large post-yield strains. Available with Options E, L, and LE (may restrict elongation capability).	-100° to +400°F (-75° to +205°C)	±10% for gage lengths under 1/8 in (3.2 mm); ±20% for 1/8 in and over	±1000	10 <sup>4</sup>

\*Fatigue life improved using low-modulus solder.

EP gages show zero shift under high-cyclic strains.

The performance data given here are *nominal*, and apply primarily to gages of 0.125-in (3-mm) gage length or larger.

## Strain Gage Selection: Criteria, Procedures, Recommendations

STANDARD STRAIN GAGE SERIES SELECTION CHART (cont.)

Gage Series	Description and Primary Application	Temperature Range	Strain Range	Fatigue Life	
				Strain Level in $\mu\epsilon$	Number of Cycles
ED	Isoelastic foil in combination with tough, flexible polyimide backing. High gage factor and extended fatigue life excellent for dynamic measurements. Not normally used in static measurements due to very high thermal-output characteristics.	Dynamic: -320° to +400°F (-195° to +205°C)	±2% Nonlinear at strain levels over ±0.5%	±2500 ±2200	10 <sup>6</sup> 10 <sup>7</sup>
WD	Fully encapsulated isoelastic gages with high-endurance leadwires. Used in wide-range dynamic strain measurement applications in severe environments.	Dynamic: -320° to +500°F (-195° to +260°C)	±1.5% Nonlinear at strain levels over ±0.5%	±3000 ±2500 ±2200	10 <sup>5</sup> 10 <sup>7</sup> 10 <sup>8</sup>
SD	Equivalent to WD Series, but with solder dots instead of leadwires.	Dynamic: -320° to +400°F (-195° to +205°C)	±1.5% See above note	±2500 ±2200	10 <sup>6</sup> 10 <sup>7</sup>
EK	K-alloy foil in combination with a tough, flexible polyimide backing. Primarily used where a combination of higher grid resistances, stability at elevated temperature, and greatest backing flexibility are required.	Normal: -320° to +350°F (-195° to +175°C) Special or Short-Term: -452° to +400°F (-269° to +205°C)	±1.5%	±1800	10 <sup>7</sup>
WK	Fully encapsulated K-alloy gages with high-endurance leadwires. Widest temperature range and most extreme environmental capability of any general-purpose gage when self-temperature-compensation is required. Option W available on some patterns, but restricts both fatigue life and maximum operating temperature.	-452° to +550°F (-269° to +290°C) Special or Short-Term: -452° to +750°F (-269° to +400°C)	±1.5%	±2200 ±2000	10 <sup>6</sup> 10 <sup>7</sup>
SK	Fully encapsulated K-alloy gages with solder dots. Same uses as WK Series, but derated in maximum temperature and operating environment because of solder dots.	Normal: -452° to +450°F (-269° to +230°C) Special or Short-Term: -452° to +500°F (-269° to +260°C)	±1.5%	±2200 ±2000	10 <sup>6</sup> 10 <sup>7</sup>
S2K	K-alloy foil laminated to 0.001 in (0.025 mm) thick, high-performance polyimide backing, with a laminated polyimide overlay fully encapsulating the grid and solder tabs. Provided with large solder pads for ease of leadwire attachment.	Normal: -100° to +250°F (-75° to +120°C) Special or Short-Term: -300° to +300°F (-185° to +150°C)	±1.5%	±1800 ±1500	10 <sup>6</sup> 10 <sup>7</sup>

The performance data given here are *nominal*, and apply primarily to gages of 0.125-in (3-mm) gage length or larger.

The second table below gives the recommended gage series for specific test “profiles,” or sets of test requirements, categorized by the following criteria:

- type of strain measurement (static, dynamic, etc.)
- operating temperature of gage installation
- test duration
- accuracy required
- cyclic endurance required

This table provides the basic means for preliminary selection of the gage series for most conventional applications. It also includes recommendations for adhesives, since the adhesive in a strain gage installation becomes part of the gage system, and correspondingly affects the performance

of the gage. This selection table, supplemented by the information in the first table, is used in conjunction with our Precision Strain Gages Data Book, to arrive at the complete gage selection. The procedure for accomplishing this is described in *Section 3.0* of this Tech Note.

When a test profile is encountered that is beyond the ranges specified in the above table, it can usually be assumed that the test requirements approach or exceed the performance limitations of available gages. Under these conditions, the interactions between gage performance characteristics become too complex for presentation in a simple table. In such cases, the user should consult our Applications Engineering Department for assistance in arriving at the best compromise.

## Strain Gage Selection: Criteria, Procedures, Recommendations

Type of Test or Application	Operating Temperature Range	Test Duration in Hours	Accuracy Required **	Cyclic Endurance Req'd		Typical Selection	
				Maximum Strain, $\mu\epsilon$	Number Of Cycles	Gage Series	M-Bond Adhesive
General Static or Static-Dynamic Stress Analysis*	-50° to +150°F (-45° to +65°C)	<10 <sup>4</sup>	Moderate	±1300	<10 <sup>6</sup>	C2A, L2A, W2A, CEA, EA	200 or AE-10
		<10 <sup>4</sup>	Moderate	±1300	<10 <sup>6</sup>	C2A, L2A, W2A, CEA, EA	AE-10 or AE-15
		<10 <sup>4</sup>	Very High	±1600	<10 <sup>6</sup>	WA, SA	AE-15 or 610
		<10 <sup>4</sup>	High	±2000	<10 <sup>6</sup>	WK, SK	AE-15 or 610
	-50° to +400°F (-45° to +205°C)	<10 <sup>3</sup>	Moderate	±1600	<10 <sup>6</sup>	WA, SA	600 or 610
		<10 <sup>3</sup>	High	±2000	<10 <sup>6</sup>	WK, SK	600 or 610
	-452° to +450°F (-269° to +230°C)	<10 <sup>3</sup>	Moderate	±2000	>10 <sup>6</sup>	WK, SK	610
	<600°F (<315°C)	<10 <sup>2</sup>	Moderate	±1800	<10 <sup>6</sup>	WK	610
	<700°F (<370°C)	<10	Moderate	±1500	<10 <sup>6</sup>	WK	610
High-Elongation (Post-Yield)	-50° to +150°F (-45° to +65°C)	<10	Moderate	±50 000	1	CEA, EA	AE-10
		>10 <sup>3</sup>	Moderate	±100 000	1	EP	AE-15
		>10 <sup>3</sup>	Moderate	±200 000	1	EP	A-12
	0° to +500°F (-20° to +260°C)	<10 <sup>2</sup>	Moderate	±15 000	1	SA, SK, WA, WK	610
	-452° to +500°F (-269° to +260°C)	<10 <sup>3</sup>	Moderate	±10 000	1	SK, WK	600 or 610
Dynamic (Cyclic) Stress Analysis	-100° to +150°F (-75° to +65°C)	<10 <sup>4</sup>	Moderate	±2000	10 <sup>7</sup>	ED	200 or AE-10
		<10 <sup>4</sup>	Moderate	±2400	10 <sup>7</sup>	WD	AE-10 or AE-15
	-320° to +500°F (-195° to +260°C)	<10 <sup>4</sup>	Moderate	±2000	10 <sup>7</sup>	WD	600 or 610
		<10 <sup>4</sup>	Moderate	±2300	10 <sup>6</sup>	WD	600 or 610
Transducer Gaging	-50° to +150°F (-45° to +65°C)	<10 <sup>4</sup>	1 to 5%	±1300	<10 <sup>6</sup>	CEA, EA	AE-10 or AE-15
		<10 <sup>6</sup>	1 to 5%	±1300	<10 <sup>6</sup>	CEA	AE-15
	-50° to +200°F (-45° to +95°C)	<10 <sup>4</sup>	Better than 0.2%	±1500	10 <sup>6</sup>	N2A	600, 610, or 43B
	-50° to +300°F (-45° to +150°C)	<10 <sup>4</sup>	0.2 to 0.5%	±1600	10 <sup>6</sup>	WA, SA	610
	-320° to +350°F (-195° to +175°C)	<10 <sup>4</sup>	Better than 0.5%	±1800	10 <sup>6</sup>	WK, SK	610

\* This category includes most testing situations where some degree of stability under static test conditions is required. For absolute stability with constantan gages over long periods of usage and temperatures above +150°F (+65°C), it may be necessary to employ half- or full-bridge configurations. Protective coatings may also influence stability in cases other than transducer applications where the element is hermetically sealed.

\*\* It is inappropriate to quantify "accuracy" as used in this table without consideration of various aspects of the actual test program and the instrumentation used. In general, "moderate" for stress analysis purposes is in the 2 to 5% range, "high" in the 1 to 3% range, and "very high" 1% or better.

## Strain Gage Selection: Criteria, Procedures, Recommendations

As indicated in the previous table, the CEA Series is usually the preferred choice for routine strain-measurement situations, not requiring extremes in performance or environmental capabilities (and not requiring the very smallest in gage lengths, or specialized grid configurations). CEA-Series strain gages are polyimide-encapsulated A-alloy gages, featuring large, rugged, copper-coated tabs for ease in soldering leadwires directly to the gage (below). These thin, flexible gages can be contoured to almost any radius. In overall handling characteristics, for example, convenience, resistance to damage in handling, etc., CEA-Series gages are outstanding.

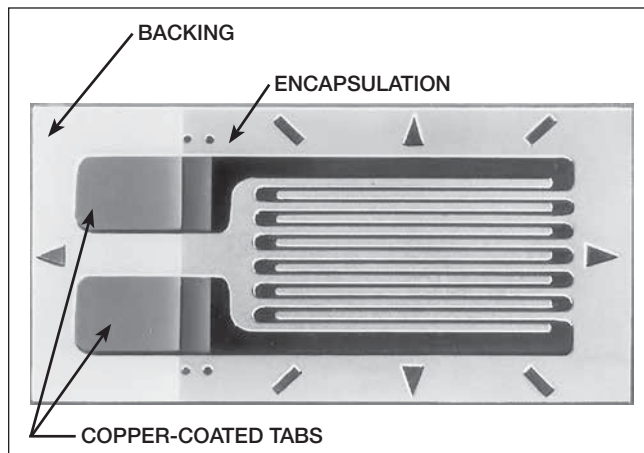

The C2A Series strain gages have been a popular choice in particular for field applications where time is of the essence. The C2A Series gages are a laminated polyimide-encapsulated A-alloy gage with 10 feet of pre-attached vinyl cable which helps to save time during the gage installation, whether in the lab or in the field.

The W2A is one of Micro-Measurements' newest products that offers water resistance by adding a layer of RTV silicone rubber applied over the top of a traditional CEA Series gage pattern.

### 2.4 Gage Length

The gage length of a strain gage is the active or strain-sensitive length of the grid, as shown below. The end loops and solder tabs are considered insensitive to strain because of their relatively large cross-sectional area and low electrical resistance. To satisfy the widely varying needs of

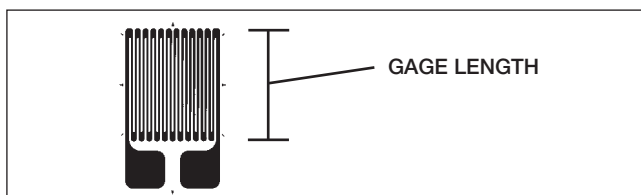

experimental stress analysis and transducer applications, Micro-Measurements offers gage lengths ranging from 0.008 in (0.2 mm) to 4 in (100 mm).

Gage length is often a very important factor in determining the gage performance under a given set of circumstances. For example, strain measurements are usually made at the most critical points on a machine part or structure — that is, at the most highly stressed points. And, very commonly, the highly stressed points are associated with stress concentrations, where the strain gradient is quite steep and the area of maximum strain is restricted to a very small region. The strain gage tends to integrate, or average, the

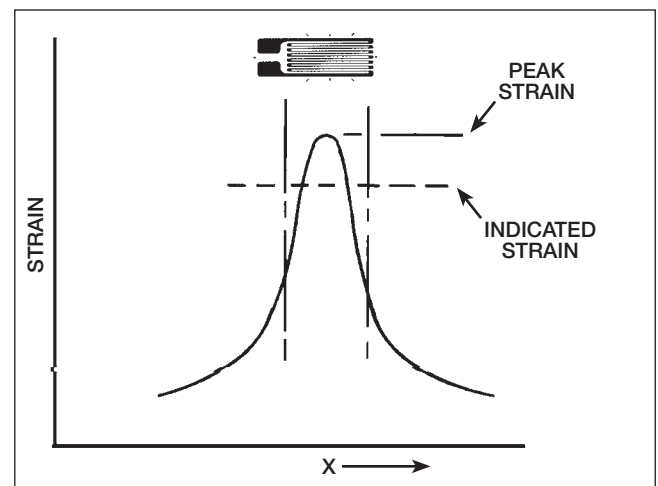

strain over the area covered by the grid. Since the average of any nonuniform strain distribution is always less than the maximum, a strain gage which is noticeably larger than the maximum strain region will indicate a strain magnitude that is too low. The sketch above illustrates a representative strain distribution in the vicinity of a stress concentration, and demonstrates the error in strain indicated by a gage which is too long with respect to the zone of peak strain.

As a rule of thumb, *when practicable*, the gage length should be no greater than 0.1 times the radius of a hole, fillet, or notch, or the corresponding dimension of any other stress raiser at which the strain measurement is to be made. With stress-raiser configurations having the significant dimension less than, say, 0.5 in (13 mm), this rule of thumb can lead to very small gage lengths. Because the use of a small strain gage may introduce a number of other problems, it is often necessary to compromise.

Strain gages of less than about 0.125 in (3 mm) gage length tend to exhibit degraded performance — particularly in terms of the maximum allowable elongation, the stability under static strain, and endurance when subjected to alternating cyclic strain. When any of these considerations outweigh the inaccuracy due to strain averaging, a larger gage may be required.

## Strain Gage Selection: Criteria, Procedures, Recommendations

When they can be employed, larger gages offer several advantages worth noting. They are usually easier to handle (in gage lengths up to, say, 0.5 in or 13 mm) in nearly every aspect of the installation and wiring procedure than miniature gages. Furthermore, large gages provide improved heat dissipation because they introduce, for the same nominal gage resistance, lower wattage per unit of grid area. This consideration can be very important when the gage is installed on a plastic or other substrate with poor heat transfer properties. Inadequate heat dissipation causes high temperatures in the grid, backing, adhesive, and test specimen surface, and may noticeably affect gage performance and accuracy (see Tech Note TN-502, *Optimizing Strain Gage Excitation Levels*).

Still another application of large strain gages — in this case, often very large gages — is in strain measurement on nonhomogeneous materials. Consider concrete, for example, which is a mixture of aggregate (usually stone) and cement. When measuring strains in a concrete structure it is ordinarily desirable to use a strain gage of sufficient gage length to span several pieces of aggregate in order to measure the representative strain in the structure. In other words, it is usually the *average* strain that is sought in such instances, not the severe local fluctuations in strain occurring at the interfaces between the aggregate particles and the cement. In general, when measuring strains on structures made of composite materials of any kind, the gage length should normally be large with respect to the dimensions of the inhomogeneities in the material.

As a generally applicable guide, when the foregoing considerations do not dictate otherwise, gage lengths in the range from 0.125 to 0.25 in (3 to 6 mm) are preferable. The largest selection of gage patterns and stock gages is available in this range of lengths. Furthermore, larger or smaller sizes generally cost more, and larger gages do not noticeably improve fatigue life, stability, or elongation, while shorter gages are usually inferior in these characteristics.

### 2.5 Gage Pattern

The gage pattern refers cumulatively to the shape of the grid, the number and orientation of the grids in a multiple-grid gage, the solder tab configuration, and various construction features which are standard for a particular pattern. All details of the grid and solder tab configurations are illustrated in the “Gage Pattern” columns of our strain gage data book. The wide variety of patterns in the list is designed to satisfy the full range of normal gage installation and strain measurement requirements.

With single-grid gages, pattern suitability for a particular application depends primarily on the following:

*Solder tabs* — These should, of course, be compatible in size and orientation with the space available at the

gage installation site. It is also important that the tab arrangement be such as to not excessively tax the proficiency of the installer in making proper leadwire connections.

*Grid width* — When severe strain gradients perpendicular to the gage axis exist in the test specimen surface, a narrow grid will minimize the averaging error. Wider grids, when available and suitable to the installation site, will improve the heat dissipation and enhance gage stability — particularly when the gage is to be installed on a material or specimen with poor heat transfer properties.

*Gage resistance* — In certain instances, the only difference between two gage patterns available in the same series is the grid resistance — typically 120 ohms vs. 350 ohms. When the choice exists, the higher-resistance gage is preferable in that it reduces the heat generation rate by a factor of three (for the same applied voltage across the gage). Higher gage resistance also has the advantage of decreasing leadwire effects such as circuit desensitization due to leadwire resistance, and unwanted signal variations caused by leadwire resistance changes with temperature fluctuations. Similarly, when the gage circuit includes switches, slip rings, or other sources of random resistance change, the signal-to-noise ratio is improved with higher resistance gages operating at the same power level.

In experimental stress analysis, a single-grid gage would normally be used only when the stress state at the point of measurement is known to be uniaxial and the directions of the principal axes are known with reasonable accuracy ( $\pm 5^\circ$ ).

These requirements severely limit the meaningful applicability of single-grid strain gages in stress analysis; and failure to consider biaxiality of the stress state can lead to large errors in the stress magnitude inferred from measurements made with a single-grid gage.

For a biaxial stress state — a common case necessitating strain measurement — a two- or three-element rosette is required in order to determine the principal stresses. When the directions of the principal axes are known in advance, a two-element 90-degree (or “tee”) rosette can be employed with the gage axes aligned to coincide with the principal axes. The directions of the principal axes can sometimes be determined with sufficient accuracy from one of several considerations. For example, the shape of the test object and the mode of loading may be such that the directions of the principal axes are obvious from the symmetry of the situation, as in a cylindrical pressure vessel. The principal axes can also be defined by PhotoStress<sup>®</sup> testing.

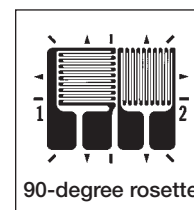



## Strain Gage Selection: Criteria, Procedures, Recommendations

In the most general case of surface stresses, when the directions of the principal axes are not known from other considerations, a three-element rosette must be used to obtain the principal stress magnitudes. The rosette can be installed with any orientation, but is usually mounted so that one of the grids is aligned with some significant axis of the test object. Three-element rosettes are available in both 45-degree rectangular and 60-degree delta configurations. The usual choice is the rectangular rosette since the data-reduction task is somewhat simpler for this configuration.

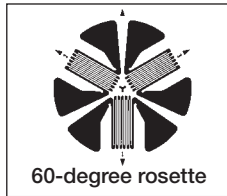
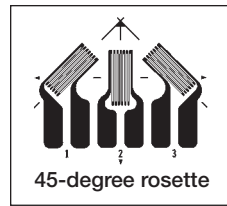

When a rosette is to be employed, careful consideration should always be given to the difference in characteristics between single-plane and stacked rosettes. For any given gage length, the single-plane rosette is superior to the stacked rosette in terms of heat transfer to the test specimen, generally providing better stability and accuracy for static strain measurements. Furthermore, when there is a significant strain gradient perpendicular to the test surface (as in bending), the single-plane rosette will produce more accurate strain data because all grids are as close as possible to the test surface. Still another consideration is that stacked rosettes are generally less conformable to contoured surfaces than single-plane rosettes.

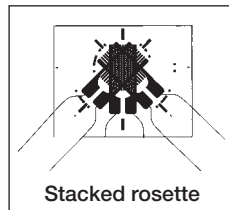

On the other hand, when there are large strain gradients in the plane of the test surface, as is often the case, the single-plane rosette can produce errors in strain indication because

the grids sample the strain at different points. For these applications the stacked rosette is ordinarily preferable. The stacked rosette is also advantageous when the space for mounting the rosette is limited.

### 2.6 Optional Features

Micro-Measurements offers a wide selection of optional features for its general-purpose strain gages and special-purpose sensors. The addition of options to the basic gage construction usually increases the cost, but this is generally offset by the benefits. Examples are:

- Significant reduction of installation time and costs
- Reduction of the skill level necessary to make dependable installations
- Simplified installation of sensors in difficult locations on components or in the field.
- Increased protection, both in handling during installation and shielding from the test environment.
- Achievement of special performance characteristics.

Availability of each option varies with gage series and pattern. Standard options are noted for each sensor in the product listing.

#### 2.6.1 Standard Options

The optional features shown below are considered standard when they are listed with the gage series and pattern in the strain gage product datasheets. If the option desired is not listed, it may be available as a special order. Please contact our Applications Engineering Department for specific information.

Standard Option	Brief Description	Available on Gage Series
<b>W</b>	Integral Terminals and Encapsulation	As shown in the individual strain gage datasheet
<b>E</b>	Encapsulation with Exposed Tabs	
<b>SE</b>	Solder Dots and Encapsulation	
<b>L</b>	Preattached Leads	
<b>LE</b>	Preattached Leads and Encapsulation	
<b>P</b>	Preattached Leadwire Cables and Encapsulation	
<b>P2</b>	Preattached Leadwire Cables for CEA-Series Gages	
<b>SP20</b>	Increases solid-copper jumper wire length to 20 in.	C2A
<b>SP35</b>	10 feet of preattached 30 AWG, twisted, etched Teflon® leadwires	CEA, WK
<b>R</b>	Individually Furnished Resistance Value	Special order required
<b>S</b>	Solder Dots	
<b>W3</b>	Special Terminals	

Note 1: Products with designations and options shown in **bold** are not RoHS compliant.

## Strain Gage Selection: Criteria, Procedures, Recommendations

### 2.6.2 Special Options

The following applies:

1. Availability will depend on the specific gage series and pattern.
2. A quotation is required and can be requested from our Customer Service Department.
3. A minimum order quantity may be required.
4. Whenever more than one Special Option is required, a custom part number will be assigned to the gage/option combination.



Special Option	Brief Description	Available on Gage Series
SP-11-14	Single Batch of Foil per Order	All
SP21-24	'Modulus-Compensating' Foil	EK, WK, SK, S2K
SP30	Round Ni-Clad Copper Leads	EA, WA, ED, WD, EK, WK, EP
SP60	Special Encapsulation	Only on Manganin Gages
SP61	Preattached Leads and Encapsulation	N2A, N2P

### 2.6.3 Standard Options Descriptions

OPTION W	SERIES AVAILABILITY: EA, EP, WA, ED, WD, EK, WK	
<p><b>General Description:</b> This option provides encapsulation, and thin, printed circuit terminals at the tab end of the gage. Beryllium copper jumpers connect the terminals to the gage tabs. The terminals are 0.0014 in (0.036 mm) thick copper on polyimide backing nominally 0.0015 in (0.038 mm) thick. Option W gages are rugged and well protected, and permit the direct attachment of larger leadwires than would be possible with open-faced gages. This option is primarily used on EA-Series gages for general-purpose applications. <b>Solder:</b> +430°F (+220°C) tin-silver alloy solder joints on E-backed gages, +570°F (+300°C) lead-tin-silver alloy solder joints on W-backed gages. <b>Temperature Limit:</b> +350°F (+175°C) for E-backed gages, +450°F (+230°C) for W-backed gages. <b>Grid Protection:</b> Entire grid and part of terminals are encapsulated with polyimide. <b>Fatigue Life:</b> Some loss in fatigue life unless strain levels at the terminal location are below <math>\pm 1000\mu\epsilon</math>. <b>Size:</b> Option W extends from the soldering tab end of the gages and thereby increases gage size. With some patterns, width is slightly greater. <b>Strain Range:</b> With some gage series, notably E-backed gages, strain range will be reduced. This effect is greatest with EP gages, and Option W should be avoided with them if possible. <b>Flexibility:</b> Option W adds encapsulation, making gages slightly thicker and stiffer. Conformance to curved surfaces will be somewhat reduced. In the terminal area itself, stiffness is markedly increased. <b>Resistance Tolerance:</b> On E-backed gages, resistance tolerance is normally doubled.</p>		

OPTION E	SERIES AVAILABILITY: EA, ED, EK, EP	
<p><b>General Description:</b> Option E consists of a protective encapsulation of polyimide film approximately 0.001 in (0.025 mm) thick. This provides ruggedness and excellent grid protection, with little sacrifice in flexibility. Soldering is greatly simplified since the solder is prevented from tinning any more of the gage tab than is deliberately exposed for lead attachment. Option E protects the grid from fingerprints and other contaminating agents during installation and, therefore, contributes significantly to long-term gage stability. Heavier leads may be attached directly to the gage tabs for simple static load tests. Supplementary protective coatings should still be applied after lead attachment in most cases. <b>Temperature Limit:</b> No degradation. <b>Grid Protection:</b> Entire grid and part of tabs are encapsulated. <b>Fatigue Life:</b> When gages are properly wired with small jumpers, maximum endurance is easily obtained. <b>Size:</b> Gage size is not affected. <b>Strain Range:</b> Strain range of gages will be reduced because the additional reinforcement of the polyimide encapsulation can cause bond failure before the gage reaches its full strain capability. <b>Flexibility:</b> Option E gages are almost as conformable on curved surfaces as open-faced gages, since no internal leads or solder are present at the time of installation. <b>Resistance Tolerance:</b> Resistance tolerance is normally doubled when Option E is selected.</p>		

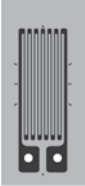
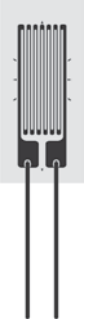
## Strain Gage Selection: Criteria, Procedures, Recommendations

OPTION SE	SERIES AVAILABILITY: EA, ED, EK, EP	
<p><b>General Description:</b> Option SE is the combination of solder dots on the gage tabs with a 0.001 in (0.025 mm) polyimide encapsulation layer that covers the entire gage. The encapsulation is removed over the solder dots providing access for lead attachment. These gages are very flexible, and well protected from handling damage during installation. Option SE is primarily intended for small gages that must be installed in restricted areas, since leadwires can be routed to the exposed solder dots from any direction. The option does not increase overall gage dimensions, so the matrix may be field-trimmed very close to the actual pattern size. Option SE is sometimes useful on miniature transducers of medium- or low-accuracy class, or in stress analysis work on miniature parts. <b>Solder:</b> +570°F (+300°C) lead-tin-silver alloy. To prevent loss of long-term stability, gages with Option SE must be soldered with noncorrosive (rosin) flux, and all flux residue should be carefully removed with <i>M-LINE</i> Rosin Solvent after wiring. Protective coatings should then be used. <b>Temperature Limit:</b> No degradation. <b>Grid Protection:</b> Entire gage is encapsulated. <b>Fatigue Life:</b> When gages are properly wired with small jumpers, maximum endurance is easily obtained. <b>Size:</b> Gage size is not affected. <b>Strain Range:</b> Strain range of gages will be reduced because the additional reinforcement of the polyimide encapsulation can cause bond failure before the gage reaches its full strain capability. <b>Flexibility:</b> Option SE gages are almost as conformable on curved surfaces as open-faced gages. <b>Resistance Tolerance:</b> Resistance tolerance is normally doubled when Option SE is selected.</p>		
<p><b>OPTION L</b></p> <p><b>General Description:</b> Option L is the addition of soft copper lead ribbons to open-faced polyimide-backed gages. The use of this type of ribbon results in a thinner and more conformable gage than would be the case with round wires of equivalent cross section. At the same time, the ribbon is so designed that it forms almost as readily in any desired direction. <b>Leads:</b> Nominal ribbon size for most gages is 0.012 wide x 0.004 in thick (0.30 x 0.10 mm). Leads are approximately 0.8 in (20 mm) long. <b>Solder:</b> +430°F (+220°C) tin-silver alloy. <b>Temperature Limit:</b> +400°F (+200°C). <b>Fatigue Life:</b> Fatigue life will normally be degraded by Option L. This occurs primarily because the copper ribbon has limited cyclic endurance. When it is possible to carefully dress the leads so that they are not bonded in a high strain field, the performance limitation will not apply. Option L is not often recommended for very high endurance gages such as the ED Series. <b>Size:</b> Matrix size is unchanged. <b>Strain Range:</b> Strain range will usually be reduced by the addition of Option L. <b>Flexibility:</b> Gages with Option L are not as conformable as standard gages. <b>Resistance Tolerance:</b> Not affected.</p>	<p><b>SERIES AVAILABILITY: EA, ED, EK, EP</b></p>	
<p><b>OPTION LE</b></p> <p><b>General Description:</b> This option provides the same conformable soft copper lead ribbons as used in Option L, but with the addition of a 0.001 in (0.025 mm) thick encapsulation layer of polyimide film. The encapsulation layer provides excellent protection for the gage during handling and installation. It also contributes greatly to environmental protection, though supplementary coatings are still recommended for field use. Gages with Option LE will normally show better long-term stability than open-faced gages which are “waterproofed” only after installation. A good part of the reason for this is that the encapsulation layer prevents contamination of the grid surface from fingerprints or other agents during handling and installation. The presence of such contaminants will cause some loss in gage stability, even though the gage is subsequently coated with protective compounds. <b>Leads:</b> Nominal ribbon size for most gages is 0.012 wide x 0.004 in thick (0.30 x 0.10 mm) copper ribbons. Leads are approximately 0.8 in (20 mm) long. <b>Solder:</b> +430°F (+220°C) tin-silver alloy. <b>Temperature Limit:</b> +400°F (+200°C). <b>Grid Protection:</b> Entire gage is encapsulated. A short extension of the backing is left uncovered at the leadwire end to prevent contact between the leadwires and the specimen surface. <b>Fatigue Life:</b> Fatigue life will normally be degraded by Option LE. This occurs primarily because the copper ribbon has limited cyclic endurance. Option LE is not often recommended for very high endurance gages such as the ED Series. <b>Size:</b> Matrix size is unchanged. <b>Strain Range:</b> Strain range will usually be reduced by the addition of Option LE. <b>Flexibility:</b> Gages with Option LE are not as conformable as standard gages. <b>Resistance Tolerance:</b> Resistance tolerance is normally doubled by the addition of Option LE.</p>	<p><b>SERIES AVAILABILITY: EA, ED, EK, EP</b></p>	

## Strain Gage Selection: Criteria, Procedures, Recommendations

### LEADWIRE ORIENTATION FOR OPTIONS L AND LE

These illustrations show the standard orientation of leadwires relative to the gage pattern geometry for Options L and LE. The general rule is that the leads are parallel to the longest dimension of the pattern. The illustrations also apply to leadwire orientation for WA-, WK- and WD-Series gages, when the pattern shown is available in one of these series.

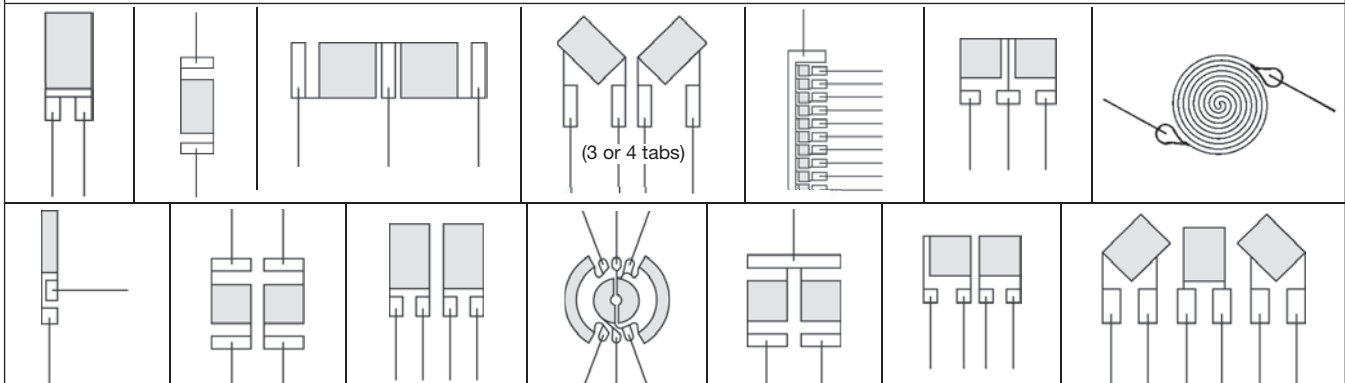

### OPTION P

### SERIES AVAILABILITY: EA, N2A

**General Description:** Option P is the addition of preattached leadwire cables to many patterns of EA Series strain gages. Encapsulation seals small “jumper” leadwires at gage end, and cable insulation protects solder joints at cable end. Option P virtually eliminates need for soldering during gage installation. **Leads:** A pair of 1 in (25 mm) *M-LINE* 134-AWP (solid copper, polyurethane enamel) single conductor “jumper” leadwires. **Cable:** 10 ft (3.1 m) of color-coded, flat, three-conductor 26-gauge (0.404 mm dia.), stranded, tinned copper with vinyl insulation (similar to *M-LINE* 326-DFV). Solder: +430°F (+220°C) tin-silver alloy solder joints, “jumper” to gage. Cable conductors and “jumpers” joined with +361°F solder beneath cable insulation. Exposed leadwires on unattached end of cable are pretinned for ease of hookup. **Temperature Limit:** -60° to +180°F (-50° to +80°C); limited by vinyl insulation on cable. **Grid Encapsulation:** Entire grid and tabs are encapsulated. **Fatigue Life:** Fatigue life will normally be degraded by Option P, primarily because the copper “jumper” wires have limited cyclic endurance. **Pattern Availability:** Most EA-Series single-grid patterns that are 0.062 in (1.5 mm) or greater gage length, with parallel solder tabs on one end of the grid, and suitable for encapsulation. (Consult our Applications Engineering Department for availability of Option P on other gage series/patterns, and for nonstandard cable lengths.) **Size:** Matrix size is unchanged. **Strain Range:** Strain range will usually be reduced by the addition of Option P. **Flexibility:** E-backed gages with Option P are not as conformable as standard gages. **Resistance Considerations:** Each conductor of the cable has a nominal resistance of 0.04 ohm/ft (0.13 ohm/m). Gage resistance is measured at gage tabs. **Gage Factor:** Gage factor is determined for gages without preattached cable. **Resistance Tolerance:** Resistance tolerance is normally ±0.5% for single-element gages, and ±0.6% for multiple-grid gages.

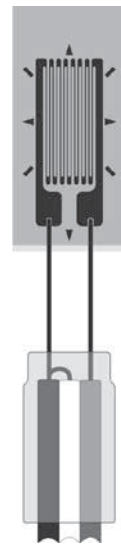

### OPTION P2

### SERIES AVAILABILITY: CEA

**General Description:** Option P2 is the addition of preattached leadwire cables to CEA-Series strain gages. Option P2 virtually eliminates need for soldering during gage installation. **Cable:** 10 ft (3.1 m) of color-coded, flat, three-conductor 30-gauge (0.255 mm), stranded, tinned copper with vinyl insulation (similar to *M-LINE* 330-DFV). Solder: +361°F (+180°C) tin-lead alloy solder joints. Exposed leadwires on unattached end of cable are pretinned for ease of hookup. **Temperature Limit:** -60° to +180°F (-50° to +80°C); limited by vinyl insulation on cable. **Grid Encapsulation:** Entire grid is encapsulated. (Solder tabs are not encapsulated.) **Fatigue Life:** Fatigue life will normally be unchanged by Option P2. **Pattern Availability:** Most CEA-Series single- and multiple-grid patterns. **Size:** Matrix size is unchanged. **Strain Range:** Standard for CEA-Series gages. **Flexibility:** No appreciable increase in stiffness. **Resistance Considerations:** Each conductor of the cable has a nominal resistance of 0.1 ohm/ft (0.35 ohm/m). Gage resistance is measured at gage tabs. **Gage Factor:** Gage factor is determined for gages without preattached cable. **Resistance Tolerance:** Not affected.

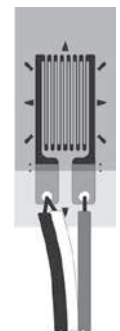

## Strain Gage Selection: Criteria, Procedures, Recommendations

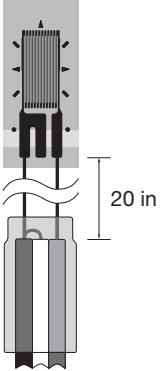
OPTION SP20	SERIES AVAILABILITY: C2A	
<p><b>General Description:</b> This option provides pre-attached instrument cables which have been optimized for Printed Circuit Board (PCB) testing. The jumper wire between gage and instrument cable is the same 34 AWG single conductor, polyurethane insulated copper wire as the standard C2A-Series gages, but the length has been increased with this option to 20 in (0.5 m). This length of wire permits ease of routing the wires on the PCB and through the seal on vacuum test fixtures. The jumper wire transitions to the C2A-Series standard 10-ft (3-m) 26-AWG stranded instrument cable. On multi-grid strain gages, the instrument cable is numbered to match the grid numbering to which the cable is attached. This option does not change any other specifications of the standard C2A-Series. <b>Temperature range:</b> -60°F to +180°F (-50°C to +80°C).</p>		 <p>The diagram shows a cross-section of a strain gage with a grid pattern. A long, thin jumper wire (20 inches) is attached to the gage and extends downwards. This jumper wire then connects to a thicker, standard instrument cable. A dimension line indicates the length of the jumper wire is 20 inches.</p>

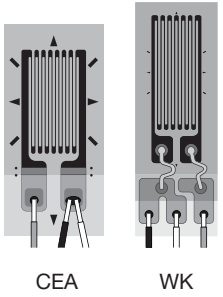
OPTION SP35	SERIES AVAILABILITY: CEA, WK	
<p><b>General Description:</b> Option SP35 provides 10 feet of 30 AWG, twisted, etched Teflon® leadwires (330-FTE) preattached to applicable CEA and WK series gages. This allows for a higher temperature rating compared to similar vinyl insulated preattached leaded gages (Option P, Option P2 and C2A series). CEA series gages will use our +430°F (+220°C) tin-silver alloy solder joints. WK series gages will have the standard Option W or W3 added as appropriate for the gage geometry (see Option W or W3 specifications), and will use our +450°F (+232°C) tin-alloy solder. <b>Temperature Limit:</b> +350°F (+177°C) for CEA gages, +400°F (+204°C) for WK gages. <b>Grid Protection:</b> Both the CEA and WK versions have an encapsulating layer over the grids. This helps to protect the sensing grids during the installation. <b>Fatigue Life:</b> The fatigue life will be the same as standard CEA series fatigue tables. While the WK series is slightly reduced (same as adding option W to the WK series gages). <b>Size:</b> The CEA versions will have the same dimensions as the parent gage. The WK versions with the option W will add to the matrix length dimension of the parent gage (varies slightly by pattern). <b>Strain Range:</b> CEA and WK with Option W strain range should be unaffected. <b>Flexibility:</b> The flexibility will be slightly affected by the Teflon as it is stiffer than a typical vinyl insulated wire of the same AWG. <b>Resistance Tolerance:</b> The resistance tolerance is increased to ±0.5% for planar gages and ±0.6% for stacked gages.</p>		 <p>The diagram shows two side-by-side cross-sections of strain gages. The left one is labeled 'CEA' and shows a grid with leadwires attached to the bottom tabs. The right one is labeled 'WK' and shows a similar grid but with a different leadwire configuration, including a small component on the bottom tabs.</p>

OPTION R	SERIES AVAILABILITY: ALL
<p>The resistance of each gage is separately measured with an accurate digital ohmmeter and the exact value is recorded on the transparent folder that contains the gage. Resistance is given to the nearest 0.01 ohm, and the overall absolute accuracy is ±0.05% or better for gages of 60-ohm or greater resistance; thus allowing the user to select gages very closely matched in resistance from the total group of gages purchased. The necessary order quantity can be estimated for any matching requirements by assuming an even distribution of resistance values through the tolerance band, which is unchanged. Note: This feature is less effective for open-faced gages without leadwires or solder dots because of the uncertainty in leadwire position on the tabs with user-installed leadwires.</p>	

OPTION S	SERIES AVAILABILITY: EA, ED, EP
<p>Precisely formed hemispherical solder dots are installed in the center of each solder tab. This feature facilitates soldering by providing a pretinned area for lead attachment. A film of adhesive or appropriate protective coating is normally applied over the gage before soldering, and this prevents the solder from spreading on the tab when leads are reinstalled. After the top coating has been cured, the solder dot is easily exposed for soldering by scraping with a scalpel or by simply post-tinning. Solder used for the dots is +570°F (+300°C) lead-tin-silver alloy. Dot diameter varies somewhat with tab size but is usually about 0.02 in (0.5 mm). Temperature limit for this feature is +500°F (+260°C). Because the solder dots result in much greater soldering uniformity, the variable fatigue life factor, which results from excessive solder on the gage tabs, is eliminated. Solder dots are small and interfere very little with flexibility and conformability of strain gages.</p>	

## Strain Gage Selection: Criteria, Procedures, Recommendations

<b>OPTION W3</b>	<b>SERIES AVAILABILITY: EA, EP, WA, ED, EK, WK</b>
<p>This feature is identical to Standard Catalog Option W, except that the printed circuit wiring terminals have three solder pads, two of which are electrically common. These terminals facilitate the connection of three-conductor cable for single active gage circuits using the three-wire lead system. Many of the gage patterns which are marked as available with Option W in the General-Purpose Strain Gage Listings are available with three-pad terminals.</p>	

### 2.6.4 Special Options Descriptions

<b>OPTIONS SP11, 12, 13, 14</b>	<b>SERIES AVAILABILITY: ALL</b>
<p>These options specify that all sensors are supplied from a single process batch and lot of foil. They are primarily used to obtain the closest possible matching of performance characteristics from a large group of gages.</p> <p>SP11: One sensor type from a single batch of processed foil                  SP12: Two sensor types from a single batch of processed foil                  SP13: Three sensor types from a single batch of processed foil                  SP14: Four sensor types from a single batch of processed foil</p>	

<b>OPTIONS SP21, 22, 23, 24</b>	<b>SERIES AVAILABILITY: EK, WK, SK, S2K</b>																						
<p>This option series provides strain gages with 'Modulus Compensation' features through use of specially modified lots of K alloy. The 'Mod-Comp' match will be quite close for the materials specified, although thermal output characteristics may not be ideal.</p> <p>When force-responsive type transducers are manufactured from the metals listed, and the appropriate Special Option gages are used, the result is a transducer which demonstrates very little span change with temperature.</p> <table border="1"> <thead> <tr> <th rowspan="2">Option</th> <th colspan="2">NOMINAL GAGE FACTOR SLOPE</th> <th rowspan="2">For Use On</th> </tr> <tr> <th>%/100°F</th> <th>%/100°C</th> </tr> </thead> <tbody> <tr> <td>SP21</td> <td>-1.50</td> <td>-2.70</td> <td>Stainless Steels</td> </tr> <tr> <td>SP22</td> <td>-2.35</td> <td>-4.25</td> <td>Aluminum</td> </tr> <tr> <td>SP23</td> <td>-1.25</td> <td>-2.25</td> <td>Tool Steels</td> </tr> <tr> <td>SP24</td> <td>-1.35</td> <td>-2.45</td> <td>Tool Steels</td> </tr> </tbody> </table>		Option	NOMINAL GAGE FACTOR SLOPE		For Use On	%/100°F	%/100°C	SP21	-1.50	-2.70	Stainless Steels	SP22	-2.35	-4.25	Aluminum	SP23	-1.25	-2.25	Tool Steels	SP24	-1.35	-2.45	Tool Steels
Option	NOMINAL GAGE FACTOR SLOPE		For Use On																				
	%/100°F	%/100°C																					
SP21	-1.50	-2.70	Stainless Steels																				
SP22	-2.35	-4.25	Aluminum																				
SP23	-1.25	-2.25	Tool Steels																				
SP24	-1.35	-2.45	Tool Steels																				

<b>OPTION SP30</b>	<b>SERIES AVAILABILITY: EA, WA, ED, WD, EK, WK, EP</b>
<p><b>General Description:</b> This option consists of special leadwires, either added to open-faced gages, or substituted for lead ribbons on WA-, WK-, or WD-Series gages. The wire is very formable, and may be spot-welded or soldered to main leadwires. The primary advantages are easy handling and excellent resistance to oxidation at the highest temperatures the gages can withstand. <b>Leads:</b> 0.8 in (20 mm) long nickel-clad copper wires 0.005 in (0.13 mm) diameter. For some gage types, usually small patterns, wire size must be reduced to 0.0035 in (0.09 mm) diameter. <b>Solder:</b> EA-, ED-, EK-, EP-Series gages: +430°F (+220°C) tin-silver alloy; WA-Series gages: +570°F (+300°C) lead-tin-silver alloy; WK- and WD-Series gages: +770°F (+410°C) solder. <b>Temperature Limit:</b> E-backed gages: +400°F (+200°C); WA-Series gages: +500°F (+260°C); WKand WD-Series gages: +750°F (+400°C). <b>Fatigue Life:</b> Fatigue life will normally be degraded by Option SP30. This occurs primarily because the copper wire has limited cyclic endurance. Option SP30 should therefore not be used when best fatigue life is required, unless the tab area of the gage is in a low strain area (<math>\pm 1000\mu\epsilon</math> or less). Loss of cyclic endurance is experienced particularly with WA-, WK-, and WD-Series gages. <b>Size:</b> Matrix size is unchanged. On W-backed gages, SP30 leads are substituted for the normal beryllium copper ribbon leads. One wire lead per tab is supplied. <b>Strain Range:</b> Option SP30 normally reduces the strain range of E-backed gages but does not similarly affect W-backed gages. <b>Flexibility:</b> E-backed gages with SP30 leads are not as conformable as standard gages. W-backed gages are not affected. <b>Resistance Tolerance:</b> Not affected.</p>	

<b>OPTION SP60</b>	<b>SERIES AVAILABILITY: ONLY ON MANGANIN GAGES</b>
<p>SP60 is an encapsulation option available for L-backed manganin gages. The end of each tab includes a thin copper coating that is left exposed for lead attachment.</p>	

## Strain Gage Selection: Criteria, Procedures, Recommendations

OPTION SP61	SERIES AVAILABILITY: N2A, N2P
<p><b>General Description:</b> This option provides conformable, soft copper lead ribbons and a 0.0005 in (0.013 mm) thick encapsulation layer of polyimide film. The encapsulation layer provides excellent protection for the gage during handling and installation. It also contributes greatly to environmental protection, though supplementary coatings are still recommended for field use. Gages with Option SP61 will normally show better long-term stability than open-faced gages which are “waterproofed” only after installation. A good part of the reason for this is that the encapsulation layer prevents contamination of the grid surface from fingerprints or other agents during handling and installation. The presence of such contaminants will cause some loss in gage stability, even though the gage is subsequently coated with protective compounds. <b>Leads:</b> 0.010 wide x 0.002 in thick (0.25 x 0.05 mm) soft copper ribbons. Leads are approximately 0.8 in (20 mm) long. <b>Solder:</b> +430°F (+220°C) tin-silver alloy. The solder is confined to small, well-defined areas at the end of each ribbon. <b>Temperature Limit:</b> +400°F (+200°C). <b>Grid Protection:</b> Entire gage is encapsulated. A short extension of the backing is left uncovered at the leadwire end to prevent contact between the leadwires and the specimen surface. <b>Size:</b> Matrix size is unchanged. <b>Strain Range:</b> Strain range will usually be reduced by the addition of Option SP61. <b>Flexibility:</b> Gages with Option SP61 are not as conformable as standard gages. <b>Resistance Tolerance:</b> Resistance tolerance is normally doubled by the addition of Option SP61.</p>	

### 2.7 Characteristics of Standard Catalog Options on EA-Series Gages

As in other aspects of strain gage selection, the choice of options ordinarily involves a variety of compromises. For instance, an option which maximizes a particular gage performance parameter such as fatigue life may at the same time require greater skill in installing the gage. Because of the many interactions between installation attributes and performance parameters associated with the options, the relative merits of all standard options are summarized qualitatively in the chart on page 60 as an aid to option selection. For comparison purposes, the corresponding characteristics of the CEA Series are given in the right-most column of the table.

Since, in strain measurement for stress analysis, the standard options are most frequently applied to EA-Series strain gages, the information supplied in this section is directed primarily toward such option applications.

When contemplating the application of an EA-Series gage with an option, the first consideration should usually be whether there is an equivalent CEA-Series gage that will satisfy the test requirements. Comparing, for example, an

EA-Series gage equipped with Option W and a similar CEA-Series pattern, it will be found that the latter is characterized by lower cost, greater flexibility and conformability, and superior fatigue life. The only possible advantages for the selection of Option W are the wider variety of available patterns and the occasional need for large soldering terminals.

It should also be noted that many standard strain gage types, without options, are normally available from stock; while gages with options are commonly manufactured to order, and may thus involve a minimum order requirement.

In the following table, the respective performance parameters for an open-faced EA-Series gage without options are arbitrarily assigned a value of 5. Numbers greater than 5 indicate a particular parameter is improved by addition of the option, while smaller numbers indicate a reduction in performance.

Installation Attribute or Performance Parameter	Standard Options					CEA Series
	W	E	SE	L	LE	
Overall Ease of Gage Installations	8	7	6	5	6	10
Ease of Leadwire Attachment	10	8	7	7	8	10
Protection of Grid from Environmental Attack	8	8	8	5	8	8
Cyclic Strain Indurance	2	7	8	3	4	4
Elongation Capability	2	3	3	4	3	3
Resistance Tolerance	3	3	3	5	3	3
Reinforcement Effects	2	3	3	5	3	3

## Strain Gage Selection: Criteria, Procedures, Recommendations

### 3.0 Gage Selection Procedure

The performance of a strain gage in any given application is affected by every element in the design and manufacture of the gage. Micro-Measurements offers a great variety of gage types for meeting the widest range of strain measurement needs. Despite the large number of variables involved, the process of gage selection can be reduced to only a few basic steps. From the following diagram that explains the gage designation code, it is evident that there are but five parameters to select, not counting options. These are: the gage series, the S-T-C number, the gage length and pattern, and the resistance.

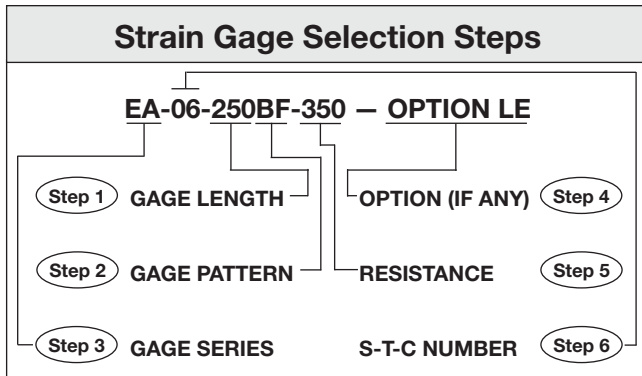

Of the preceding parameters, the gage length and pattern are normally the first and second selections to be made, based on the space available for gage mounting and the nature of the stress field in terms of biaxiality and expected strain gradient. A good starting point for initial consideration of gage length is 0.125 in (3 mm). This size offers the widest variety of choices from which to select remaining gage parameters such as pattern, series and resistance. The gage and its solder tabs are large enough for relatively easy handling and installation. At the same time, gages of this length provide performance capabilities comparable to those of larger gages.

The principal reason for selecting a longer gage would commonly be one of the following: (a) greater grid area for better heat dissipation; (b) improved strain averaging on inhomogeneous materials such as fiber-reinforced composites; or (c) slightly easier handling and installation [for gage lengths up to 0.50 in (13 mm)]. On the other hand, a shorter gage length may be necessary when the object is to measure localized peak strains in the vicinity of a stress concentration, such as a hole or shoulder. The same is true, of course, when the space available for gage mounting is very limited.

In selecting the gage pattern, the first consideration is whether a single-grid gage or rosette is required (see Section 2.5). Single-grid gages are available with different aspect

#### CONSIDERATIONS FOR PARAMETER SELECTION

##### Selection Step: 1

Parameter: **Gage Length**

- strain gradients
- area of maximum strain
- accuracy required
- static strain stability
- maximum elongation
- cyclic endurance
- heat dissipation
- space for installation
- ease of installation

##### Selection Step: 2

Parameter: **Gage Pattern**

- strain gradients (in-plane and normal to surface)
- biaxiality of stress
- heat dissipation
- space for installation
- ease of installation
- gage resistance availability

##### Selection Step: 3

Parameter: **Gage Series**

- type of strain measurement application (static, dynamic, post-yield, etc.)
- operating temperature
- test duration
- cyclic endurance
- accuracy required
- ease of installation

##### Selection Step: 4

Parameter: **Options**

- type of measurement (static, dynamic, post-yield, etc.)
- installation environment – laboratory or field
- stability requirements
- soldering sensitivity of substrate (plastic, bone, etc.)
- space available for installation
- installation time constraints

##### Selection Step: 5

Parameter: **Gage Resistance**

- heat dissipation
- leadwire desensitization
- signal-to-noise ratio

##### Selection Step: 6

Parameter: **S-T-C Number**

- test specimen material
- operating temperature range
- accuracy required

(length-to-width) ratios and various solder tab arrangements for adaptability to differing installation requirements. Two-element 90-degree rosettes, when applicable, can also be selected from a number of different grid and solder tab configurations. With three-element rosettes (rectangular or delta), the primary choice in pattern selection, once the gage



## Strain Gage Selection: Criteria, Procedures, Recommendations

length has been determined, is between planar and stacked construction, as described in *Section 2.5*.

The format of our strain gage data book is designed to simplify selection of the gage length and pattern. Similar patterns available in each gage length are grouped together, and listed in order of size. The strain gages in the main listing (large pictures) are the most widely used for stress analysis applications. This section should always be reviewed first to locate an appropriate gage.

With an initial selection of the gage size and pattern completed, the next step is to select the gage series, thus determining the foil and backing combination, and any other features common to the series. This is accomplished by referring to the earlier chart, which gives the recommended gage series for specific test “profiles”, or sets of test requirements. If the gage series is to have a standard option applied, the option should be tentatively specified at this time, since the availability of the desired option on the selected gage pattern in that series requires verification during the procedure outlined in the following paragraph.

After selecting the gage series (and option, if any), reference is made again to our Precision Strain Gages Data Book to record the gage designation of the desired gage size and pattern in the recommended series. If this combination is not listed as available in the catalog, a similar gage pattern in the same size group, or a slightly different size in an equivalent pattern, can usually be selected for meeting the installation and test requirements. In extreme cases, it may be necessary to select an alternate series and repeat this process. Quite frequently, and especially for routine strain measurement, more than one gage size and pattern combination will be suitable for the specified test conditions. In these cases, it is wise to select a gage from the main listings (large pictures) to eliminate the likelihood of extended delivery time or a minimum order requirement.

As noted under the gage pattern discussion on page 55, there are often advantages from selecting the 350-ohm resistance if this resistance is compatible with the instrumentation to be used. This decision may be influenced, however, by cost considerations, particularly in the case of very small gages. Some reduction in fatigue life can also be expected for the high-resistance small gages. Finally, in recording the complete gage designation, the S-T-C number should be inserted from the list of available numbers for each alloy given in this Tech Note.

This completes the gage selection procedure. In each step of the procedure, the Strain Gage Selection Checklist provided in *Section 4.0* should be referred to as an aid in accounting for the test conditions and requirements which could affect the selection.

### 4.0 Strain Gage Selection Checklist

This checklist is provided as a convenient, rapid means for helping make certain that no critical requirement of the test profile which could affect gage selection is overlooked. It should be borne in mind in using the checklist that the “considerations” listed apply to relatively routine and conventional stress analysis situations, and do not embrace exotic applications involving nuclear radiation, intense magnetic fields, extreme centrifugal forces, and the like.

### 5.0 Gage Selection Examples

In this section, three examples are given of the gage-selection procedure in representative stress analysis situations. An attempt has been made to provide the principal reasons for the particular choices which are made. It should be noted, however, that an experienced stress analyst does not ordinarily proceed in the same step-by-step fashion illustrated in these examples. Instead, simultaneously keeping in mind the test conditions and environment, the gage installation constraints, and the test requirements, the analyst reviews our strain gage data book and quickly segregates the more likely candidates from among the available gage-pattern and series combinations in the appropriate sizes. The selection criteria are then refined in accordance with the particular strain-measurement task to converge on the gage or gages to be specified for the test program. Whether formally or otherwise, the knowledgeable practitioner does so in the light of parameter selection considerations such as those itemized in the preceding checklist.

#### A. Design Study of a Pressure Vessel

Strain measurements are to be made on a scaled-down plastic model of a pressure vessel. The model will be tested statically at, or near, room temperature; and, although the tests may be conducted over a period of several months, individual tests will take only a few hours to run.

#### Gage Selection:

1. *Gage Length* — Very short gage lengths should be avoided in order to minimize heat dissipation problems caused by the low thermal conductivity of the plastic. The model is quite large, and apparently free of severe strain gradients; therefore, a 0.25-in (6.3-mm) gage length is specified, because the widest selection of gage patterns is available in this length.
2. *Gage Pattern* — In some areas of the model, the directions of the principal axes are obvious from considerations of symmetry, and single-grid gages can be employed. Of the patterns available in the selected gage length, the 250BF pattern is a good compromise

## Strain Gage Selection: Criteria, Procedures, Recommendations

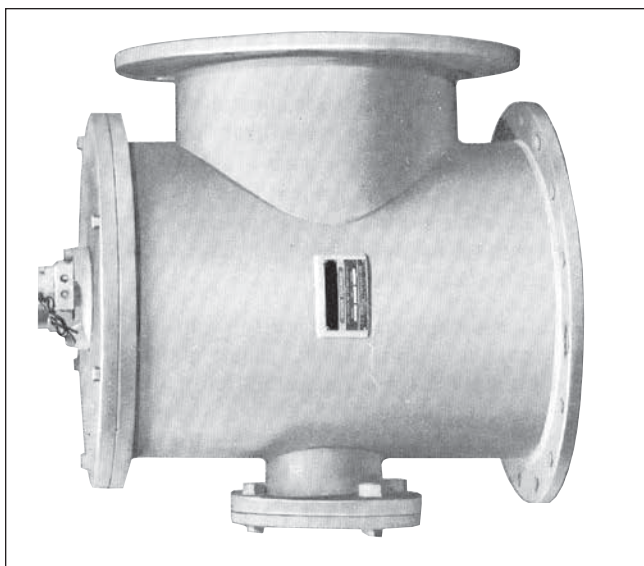

because of its high grid resistance which will help minimize heat dissipation problems.

In other areas of the model, the directions of the principal axes are not known, and a three-element rosette will be required. For this purpose, a “planar” rosette should be selected, since a stacked rosette would contribute significantly to reinforcement and heat dissipation problems. Because of its high-resistance grid, the 250RD pattern is a good choice.

3. *Gage Series* — The polyimide (E) backing is preferred because its low elastic modulus will minimize reinforcement of the plastic model. Because the normal choice of grid alloy for static strain measurement at room temperature is the A alloy, the EA Series should be selected for this application.
4. *Options* — Excessive heat application to the test model during leadwire attachment could damage the material. Option L (preattached leads) is therefore selected so that the instrument cable can be attached directly to the leads without the application of a soldering iron to the gage proper. Option L is preferable over Options LE and P because the encapsulation in the latter options would add reinforcement.
5. *Resistance* — In this case, the resistance was determined in Step 2 when the higher resistance alternative was selected from among the gage patterns; i.e., in selecting the 250BF over the 250BG, and the 250RD over the 250RA. The selected gage resistance is thus 350 ohms.
6. *S-T-C Number* — Ideally, the gages should be self-temperature-compensated to match the model material, but this is not always feasible, since plastics — particularly reinforced plastics — vary widely in thermal expansion coefficient. For unreinforced plastic, S-T-C 30, 40 or 50 should usually be selected.

If a mismatch between the model material and the S-T-C number is necessary, S-T-C 13 should be selected (because of stock status), and the test performed at constant temperature.

### Gage Designations:

From the above steps, the strain gages to be used are:

- EA-30-250BF-350/Option L (single-grid)
- EA-30-250RD-350/Option L (rosette)

### B. Dynamic Stress Analysis Study of a Spur Gear in an Hydraulic Pump

Strain measurements are to be made at the root of the gear tooth while the pump is operating. The fillet radius at the tooth root is 0.125 in (or about 3 mm) and test temperatures are expected to range from 0° to +180°F (–20° to +80°C).

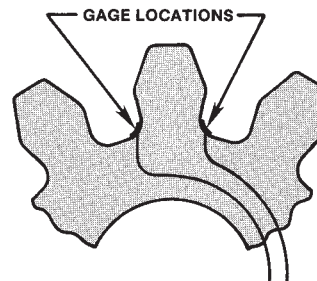

### Gage Selection:

1. *Gage Length* — A gage length which is small with respect to the fillet radius should be specified for this application. A length of 0.015 in (0.38 mm) is preferable, but reference to our strain gage data book indicates that such a choice severely limits the available gage patterns and grid alloys. Anticipating problems which would otherwise be encountered in Steps 2 and 3, a gage length of 0.031 in (0.8 mm) is selected.
2. *Gage Pattern* — Because the gear is a spur gear, the directions of the principal axes are known, and single-grid gages can be employed. A gage pattern with both solder tabs at the same end should be selected so that leadwire connections can be located in the clearance area along the root circle between adjacent teeth. In the light of these considerations, the 031CF pattern is chosen for the task.
3. *Gage Series* — Low strain levels are expected in this application; and, furthermore, the strain signals must be transmitted through slip rings or through a telemetry system to get from the rotating component to the stationary instrumentation. Isoelastic (D alloy) is preferred for its higher gage factor (nominally 3.2,

## Strain Gage Selection: Criteria, Procedures, Recommendations

in contrast to 2.1 for A and K alloys). Because the gage must be very flexible to conform to the small fillet radius, the E backing is the most suitable choice. The maximum test temperature is not a consideration in this case, since it is well within the recommended temperature range for any of the standard backings. The combination of the E backing and the D alloy defines the ED gage series.

4. *Options* — For protection of the gage grid in the test environment, Option E, encapsulation, should be specified. Because of the limited clearance between the outside diameter of one gear and the root circle of the mating gear, a particularly thin gage installation must be made; and very small leadwires will be attached to the gage tabs at 90° to the grid direction, and run over the sides of the gear for connection to larger wires. This requirement necessitates attachment of the small leadwires after gage bonding, and prevents the use of preattached leads.
5. *Resistance* — In the ED-Series version of the 031CF gage pattern, our strain gage data book lists the resistance as 350 ohms. The higher resistance should usually be selected whenever the choice exists, and will be advantageous in this instance in improving the signal-to-noise ratio when slip rings are used.
6. *S-T-C Number* — D alloy is not subject to self-temperature-compensation, nor is compensation needed for these tests since only dynamic strain is to be measured. In the ED-Series designation the two-digit S-T-C number is replaced by the letters DY for “dynamic.”

### Gage Designation:

Combining the results of the above selection procedure, the gage to be employed is:

ED-DY-031CF-350/Option E

### C. Flight-Test Stress Analysis of a Titanium Aircraft Wing Tip Section — With, and Without, a Missile Module Attached

The operating temperature range for strain measurements is from -65° to +450°F (-55° to +230°C), and will be a dominant factor in the gage selection.

### Gage Selection:

1. *Gage Length* — Preliminary design studies using the PhotoStress® photoelastic coating technique indicate that a gage length of 0.062 in (1.6 mm) represents the best compromise in view of the strain gradients, areas of peak strain, and space for gage installation.

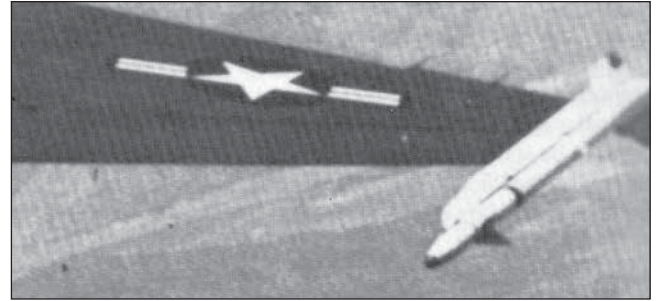

2. *Gage Pattern* — With information about the stress state and directions of principal axes gained from the photoelastic coating studies, there are some areas of the wing tip where single-grid gages and two-element “tee” rosettes can be employed. In other locations, where principal strain directions vary with the nature of the flight maneuver, 45-degree rectangular rosettes are required.

The strain gradients are sufficiently steep that stacked rosettes should be selected. From our strain gage data book, the foregoing requirements suggest the selection of 060WT and 060WR gage patterns for the stacked rosettes, and the 062AP pattern for the single-grid gage. In making this selection, attention was given to the fact that all three patterns are available in the WK Series, which is compatible with the specified operating temperature range.

3. *Gage Series* — The maximum operating temperature, along with the requirement for static as well as dynamic strain measurement, clearly dictates use of K alloy for the grid material. Either the SK or WK Series could be selected, but the WK gages are preferred because they have integral leadwires.
4. *Options* — For ease of gage installation, Option W, with integral soldering terminals, is advantageous. This option is not applicable to stacked rosettes, however, and is therefore specified for only the single-grid gages.
5. *Resistance* — When available, as in this case, 350-ohm gages should be specified because of the benefits associated with the higher gage resistance.
6. *S-T-C Number* — The titanium alloy used in the wing tip section is the 6Al-4V type, with a thermal expansion coefficient of  $4.9 \times 10^{-6}$  per °F ( $8.8 \times 10^{-6}$  per °C). K alloy of S-T-C number 05 is the appropriate choice.

### Gage Designations:

WK-05-062AP-350/Option W  
WK-05-060WT-350  
WK-05-060WR-350