



MOTOROLA

Order this document by MC34080/D

# High Slew Rate, Wide Bandwidth, JFET Input Operational Amplifiers

These devices are a new generation of high speed JFET input monolithic operational amplifiers. Innovative design concepts along with JFET technology provide wide gain bandwidth product and high slew rate. Well-matched JFET input devices and advanced trim techniques ensure low input offset errors and bias currents. The all NPN output stage features large output voltage swing, no deadband crossover distortion, high capacitive drive capability, excellent phase and gain margins, low open loop output impedance, and symmetrical source/sink AC frequency response.

This series of devices is available in fully compensated or decompensated ( $A_{VCL} \geq 2$ ) and is specified over a commercial temperature range. They are pin compatible with existing Industry standard operational amplifiers, and allow the designer to easily upgrade the performance of existing designs.

- Wide Gain Bandwidth: 8.0 MHz for Fully Compensated Devices  
16 MHz for Decompensated Devices
- High Slew Rate: 25 V/ $\mu$ s for Fully Compensated Devices  
50 V/ $\mu$ s for Decompensated Devices
- High Input Impedance:  $10^{12} \Omega$
- Input Offset Voltage: 0.5 mV Maximum (Single Amplifier)
- Large Output Voltage Swing:  $-14.7$  V to  $+14$  V for  
 $V_{CC}/V_{EE} = \pm 15$  V
- Low Open Loop Output Impedance:  $30 \Omega$  @ 1.0 MHz
- Low THD Distortion: 0.01%
- Excellent Phase/Gain Margins:  $55^\circ/7.6$  dB for Fully Compensated Devices

## ORDERING INFORMATION

Op Amp Function	Fully Compensated	$A_{VCL} \geq 2$ Compensated	Operating Temperature Range	Package
Single	MC34081BD	MC34080BD	$T_A = 0^\circ$ to $+70^\circ\text{C}$	SO-8
	MC34081BP	MC34080BP		Plastic DIP
Dual	MC34082P	MC34083BP		Plastic DIP
Quad	MC34084DW	MC34085BDW	$T_A = 0^\circ$ to $+70^\circ\text{C}$	SO-16L
	MC34084P	MC34085BP		Plastic DIP

## PIN CONNECTIONS

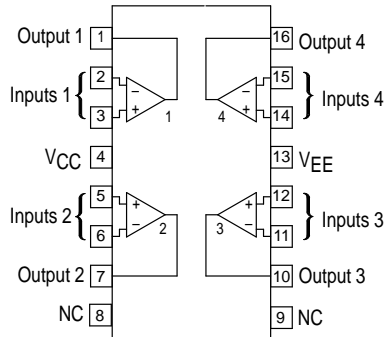

# MC34080 thru MC34085

## HIGH PERFORMANCE JFET INPUT OPERATIONAL AMPLIFIERS

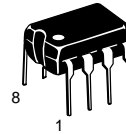

**P SUFFIX**  
PLASTIC PACKAGE  
CASE 626



**D SUFFIX**  
PLASTIC PACKAGE  
CASE 751  
(SO-8)

## PIN CONNECTIONS

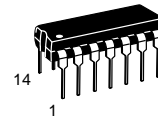
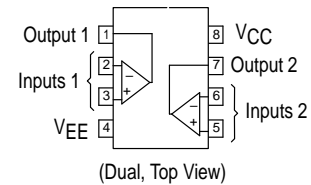
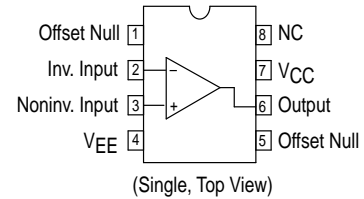

**P SUFFIX**  
PLASTIC PACKAGE  
CASE 646

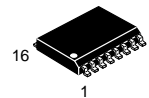

**DW SUFFIX**  
PLASTIC PACKAGE  
CASE 751G  
(SO-16L)

## PIN CONNECTIONS

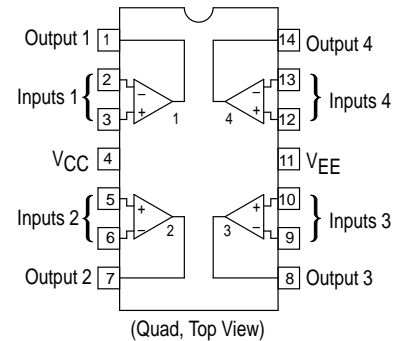

# MC34080 thru MC34085

## MAXIMUM RATINGS

Rating	Symbol	Value	Unit
Supply Voltage (from $V_{CC}$ to $V_{EE}$ )	$V_S$	+44	V
Input Differential Voltage Range	$V_{IDR}$	(Note 1)	V
Input Voltage Range	$V_{IR}$	(Note 1)	V
Output Short Circuit Duration (Note 2)	$t_{SC}$	Indefinite	sec
Operating Ambient Temperature Range	$T_A$	0 to +70	°C
Operating Junction Temperature	$T_J$	+125	°C
Storage Temperature Range	$T_{stg}$	-65 to +165	°C

**NOTES:** 1. Either or both input voltages must not exceed the magnitude of  $V_{CC}$  or  $V_{EE}$ .  
 2. Power dissipation must be considered to ensure maximum junction temperature ( $T_J$ ) is not exceeded.

## Representative Schematic Diagram

(Each Amplifier)

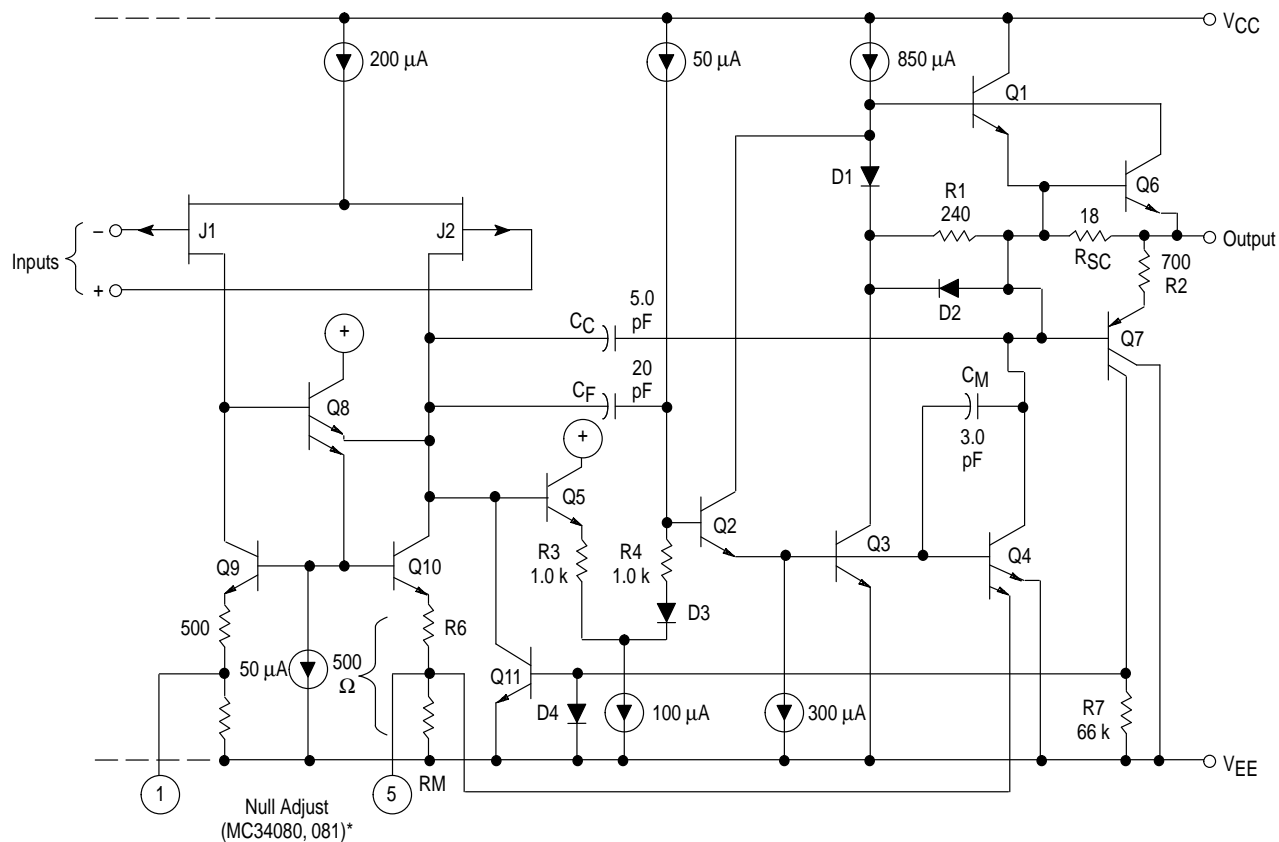

\*Pins 1 & 5 (MC34080, 081) should *not* be directly grounded or connected to  $V_{CC}$ .

## MC34080 thru MC34085

**DC ELECTRICAL CHARACTERISTICS** ( $V_{CC} = +15\text{ V}$ ,  $V_{EE} = -15\text{ V}$ ,  $T_A = T_{\text{low}}$  to  $T_{\text{high}}$  [Note 3], unless otherwise noted.)

Characteristics	Symbol	Min	Typ	Max	Unit
Input Offset Voltage (Note 4) Single $T_A = +25^\circ\text{C}$ $T_A = 0^\circ$ to $+70^\circ\text{C}$ (MC34080B, MC34081B) Dual $T_A = +25^\circ\text{C}$ $T_A = 0^\circ$ to $+70^\circ\text{C}$ (MC34082, MC34083) Quad $T_A = +25^\circ\text{C}$ $T_A = 0^\circ$ to $+70^\circ\text{C}$ (MC34084, MC34085)	$V_{IO}$	—	0.5	2.0	mV
		—	—	4.0	
		—	1.0	3.0	
		—	—	5.0	
		—	6.0	12	
		—	—	14	
Average Temperature Coefficient of Offset Voltage	$\Delta V_{IO}/\Delta T$	—	10	—	$\mu\text{V}/^\circ\text{C}$
Input Bias Current ( $V_{CM} = 0$ Note 5) $T_A = +25^\circ\text{C}$ $T_A = 0^\circ$ to $+70^\circ\text{C}$	$I_{IB}$	—	0.06	0.2	nA
		—	—	4.0	
Input Offset Current ( $V_{CM} = 0$ Note 5) $T_A = +25^\circ\text{C}$ $T_A = 0^\circ$ to $+70^\circ\text{C}$	$I_{IO}$	—	0.02	0.1	nA
		—	—	2.0	
Large Signal Voltage Gain ( $V_O = \pm 10\text{ V}$ , $R_L = 2.0\text{ k}$ ) $T_A = +25^\circ\text{C}$ $T_A = T_{\text{low}}$ to $T_{\text{high}}$	$A_{VOL}$	25	80	—	V/mV
		15	—	—	
Output Voltage Swing $R_L = 2.0\text{ k}$ , $T_A = +25^\circ\text{C}$ $R_L = 10\text{ k}$ , $T_A = +25^\circ\text{C}$ $R_L = 10\text{ k}$ , $T_A = T_{\text{low}}$ to $T_{\text{high}}$	$V_{OH}$	13.2	13.7	—	V
		13.4	13.9	—	
		13.4	—	—	
$R_L = 2.0\text{ k}$ , $T_A = +25^\circ\text{C}$ $R_L = 10\text{ k}$ , $T_A = +25^\circ\text{C}$ $R_L = 10\text{ k}$ , $T_A = T_{\text{low}}$ to $T_{\text{high}}$	$V_{OL}$	—	-14.1	-13.5	
		—	-14.7	-14.1	
		—	—	-14.0	
Output Short Circuit Current ( $T_A = +25^\circ\text{C}$ ) Input Overdrive = 1.0 V, Output to Ground Source Sink	$I_{SC}$	20	31	—	mA
		20	28	—	
Input Common Mode Voltage Range $T_A = +25^\circ\text{C}$	$V_{ICR}$	(VEE +4.0) to (VCC - 2.0)			V
Common Mode Rejection Ratio ( $R_S \leq 10\text{ k}$ , $T_A = +25^\circ\text{C}$ )	CMRR	70	90	—	dB
Power Supply Rejection Ratio ( $R_S = 100\ \Omega$ , $T_A = 25^\circ\text{C}$ )	PSRR	70	86	—	dB
Power Supply Current Single $T_A = +25^\circ\text{C}$ $T_A = T_{\text{low}}$ to $T_{\text{high}}$ Dual $T_A = +25^\circ\text{C}$ $T_A = T_{\text{low}}$ to $T_{\text{high}}$ Quad $T_A = +25^\circ\text{C}$ $T_A = T_{\text{low}}$ to $T_{\text{high}}$	$I_D$	—	2.5	3.4	mA
		—	—	4.2	
		—	4.9	6.0	
		—	—	7.5	
		—	9.7	11	
		—	—	13	

**NOTES:** (continued)

3.  $T_{\text{low}} = 0^\circ\text{C}$  for MC34080B  
                                   MC34081B  
                                   MC34084  
                                   MC34085  
 $T_{\text{high}} = +70^\circ\text{C}$  for MC34080B  
                                   MC34081B  
                                   MC34084  
                                   MC34085

4. See application information for typical changes in input offset voltage due to solderability and temperature cycling.

5. Limits at  $T_A = +25^\circ\text{C}$  are guaranteed by high temperature ( $T_{\text{high}}$ ) testing.

# MC34080 thru MC34085

**AC ELECTRICAL CHARACTERISTICS** ( $V_{CC} = +15\text{ V}$ ,  $V_{EE} = -15\text{ V}$ ,  $T_A = +25^\circ\text{C}$ , unless otherwise noted.)

Characteristics	Symbol	Min	Typ	Max	Unit
Slew Rate ( $V_{in} = -10\text{ V}$ to $+10\text{ V}$ , $R_L = 2.0\text{ k}\Omega$ , $C_L = 100\text{ pF}$ ) Compensated $A_V = +1.0$ $A_V = -1.0$ Decompensated $A_V = +2.0$ $A_V = -1.0$	SR	20 — 35 —	25 30 50 50	— — — —	V/ $\mu\text{s}$
Settling Time (10 V Step, $A_V = -1.0$ ) To 0.10% ( $\pm 1/2$ LSB of 9-Bits) To 0.01% ( $\pm 1/2$ LSB of 12-Bits)	$t_s$	— —	0.72 1.6	— —	$\mu\text{s}$
Gain Bandwidth Product ( $f = 200\text{ kHz}$ ) Compensated Decompensated	GBW	6.0 12	8.0 16	— —	MHz
Power Bandwidth ( $R_L = 2.0\text{ k}\Omega$ , $V_O = 20\text{ V}_{pp}$ , THD = 5.0%) Compensated $A_V = +1.0$ Decompensated $A_V = -1.0$	BWp	— —	400 800	— —	kHz
Phase Margin (Compensated) $R_L = 2.0\text{ k}\Omega$ $R_L = 2.0\text{ k}\Omega$ , $C_L = 100\text{ pF}$	$\phi_m$	— —	55 39	— —	De-grees
Gain Margin (Compensated) $R_L = 2.0\text{ k}\Omega$ $R_L = 2.0\text{ k}\Omega$ , $C_L = 100\text{ pF}$	$A_m$	— —	7.6 4.5	— —	dB
Equivalent Input Noise Voltage $R_S = 100\ \Omega$ , $f = 1.0\text{ kHz}$	$e_n$	—	30	—	nV/ $\sqrt{\text{Hz}}$
Equivalent Input Noise Current ( $f = 1.0\text{ kHz}$ )	$i_n$	—	0.01	—	pA/ $\sqrt{\text{Hz}}$
Input Capacitance	$C_i$	—	5.0	—	pF
Input Resistance	$r_i$	—	$10^{12}$	—	$\Omega$
Total Harmonic Distortion $A_V = +10$ , $R_L = 2.0\text{ k}\Omega$ , $2.0 \leq V_O \leq 20\text{ V}_{pp}$ , $f = 10\text{ kHz}$	THD	—	0.05	—	%
Channel Separation ( $f = 10\text{ kHz}$ )	—	—	120	—	dB
Open Loop Output Impedance ( $f = 1.0\text{ MHz}$ )	$Z_o$	—	35	—	$\Omega$

**Figure 1. Input Common Mode Voltage Range versus Temperature**

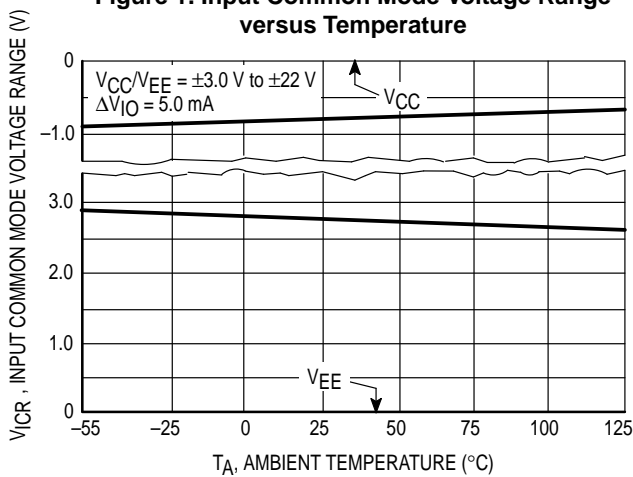

**Figure 2. Input Bias Current versus Temperature**

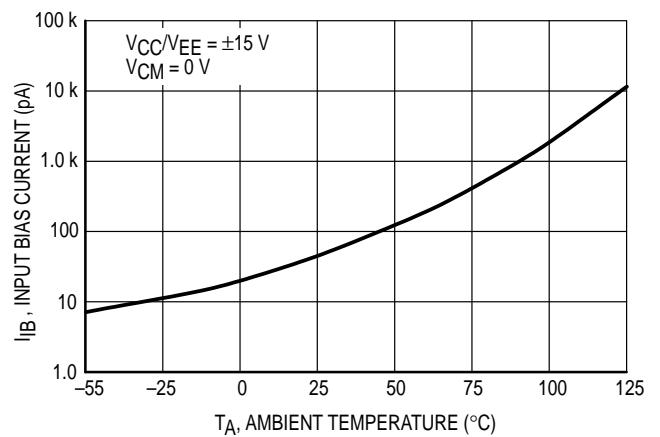

Figure 3. Input Bias Current versus Input Common Mode Voltage

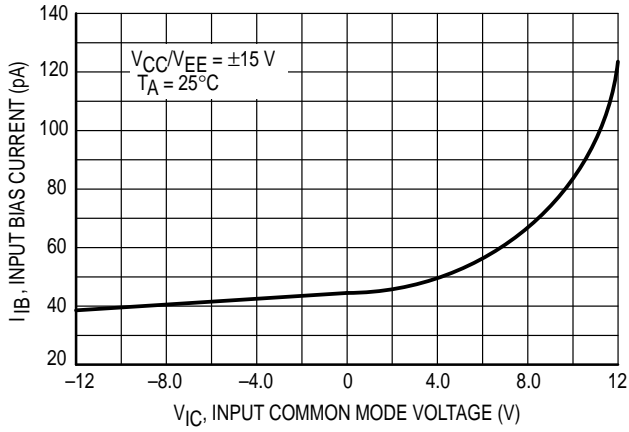

Figure 4. Output Voltage Swing versus Supply Voltage

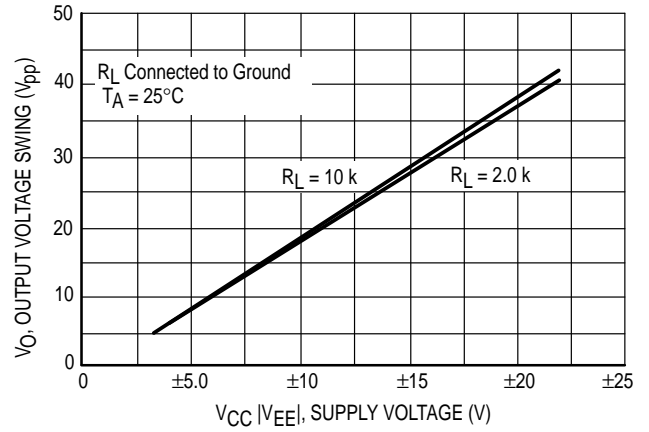

Figure 5. Output Saturation versus Load Current

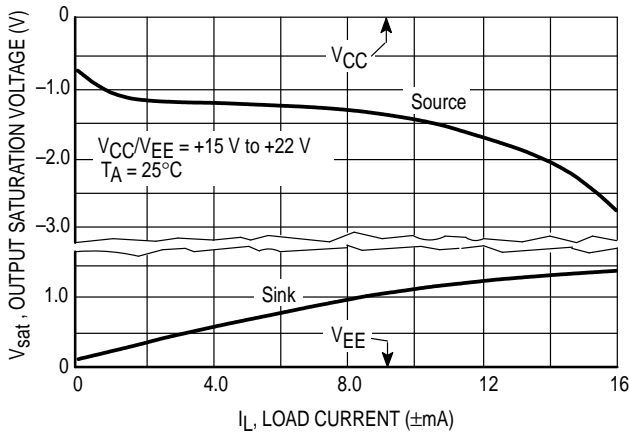

Figure 6. Output Saturation versus Load Resistance to Ground

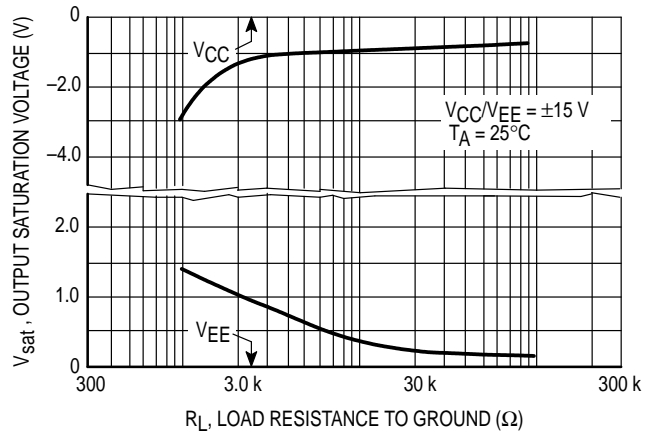

Figure 7. Output Saturation versus Load Resistance to V<sub>CC</sub>

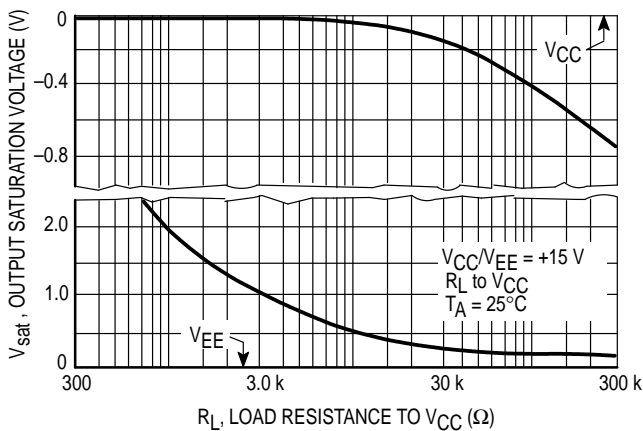

Figure 8. Output Short Circuit Current versus Temperature

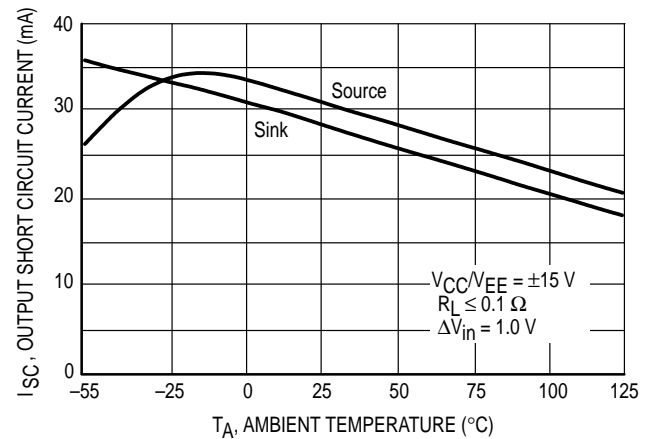

Figure 9. Output Impedance versus Frequency

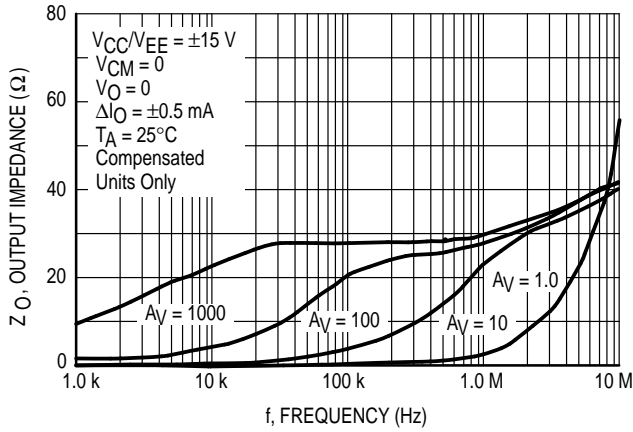

Figure 10. Output Impedance versus Frequency

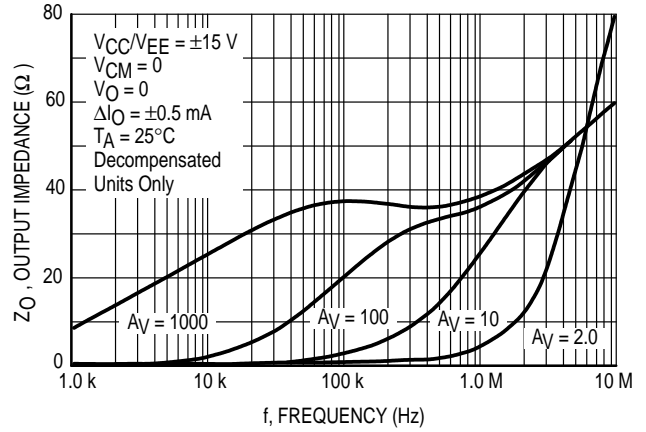

Figure 11. Output Voltage Swing versus Frequency

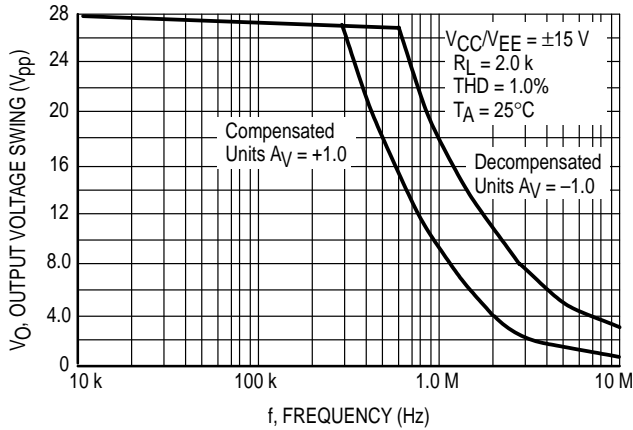

Figure 12. Output Distortion versus Frequency

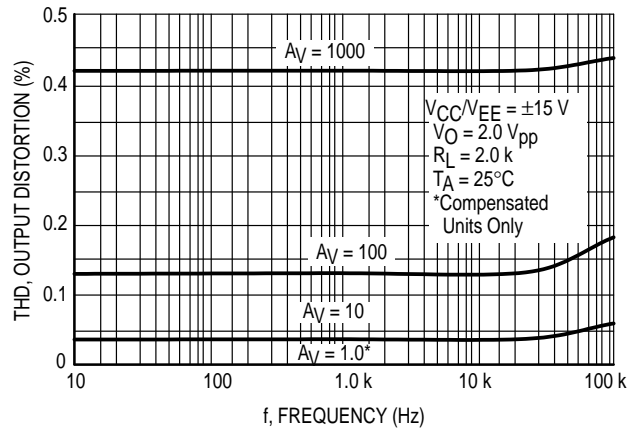

Figure 13. Open Loop Voltage Gain versus Temperature

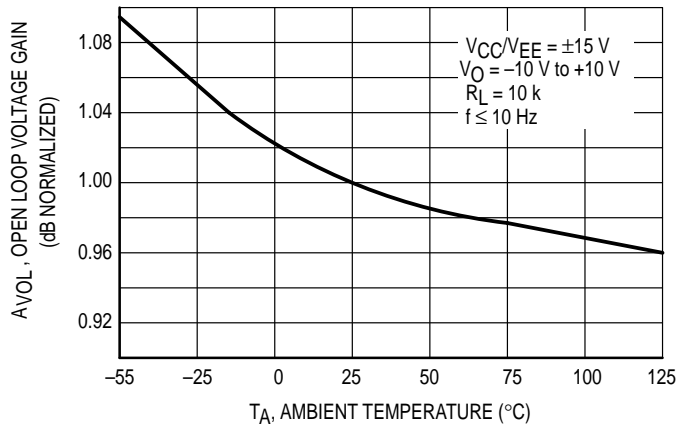

Figure 14. Open Loop Voltage Gain and Phase versus Frequency

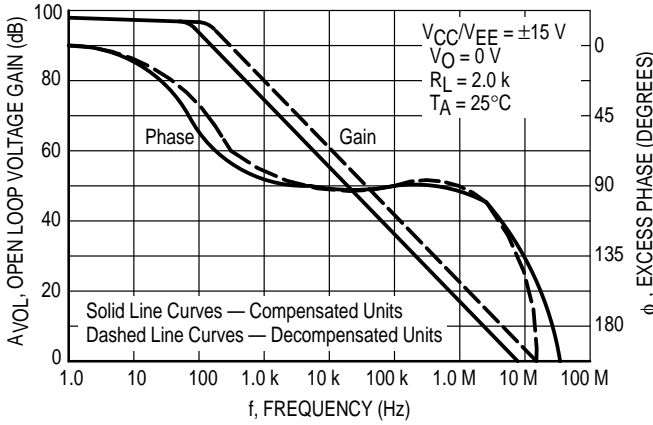

Figure 15. Open Loop Voltage Gain and Phase versus Frequency

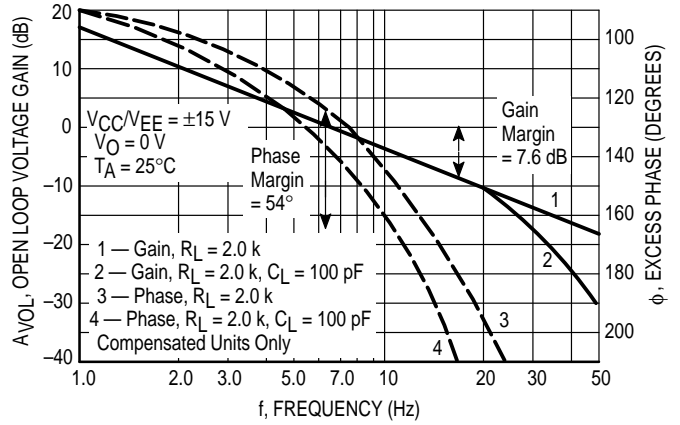

Figure 16. Open Loop Voltage Gain and Phase versus Frequency

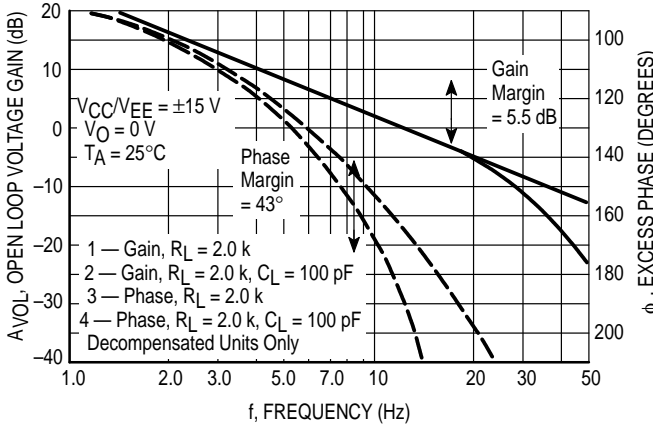

Figure 17. Normalized Gain Bandwidth Product versus Temperature

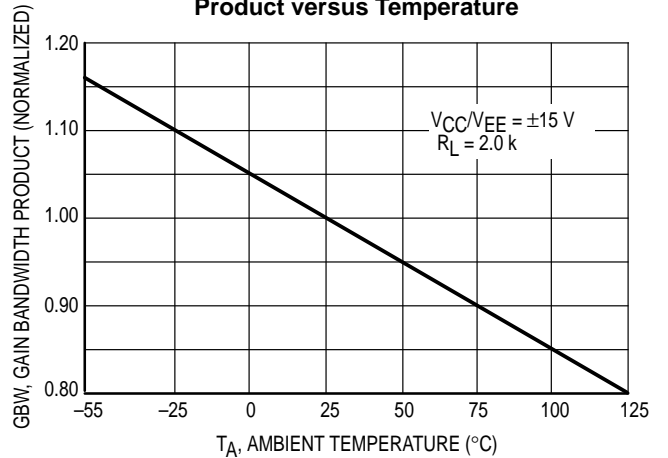

Figure 18. Percent Overshoot versus Load Capacitance

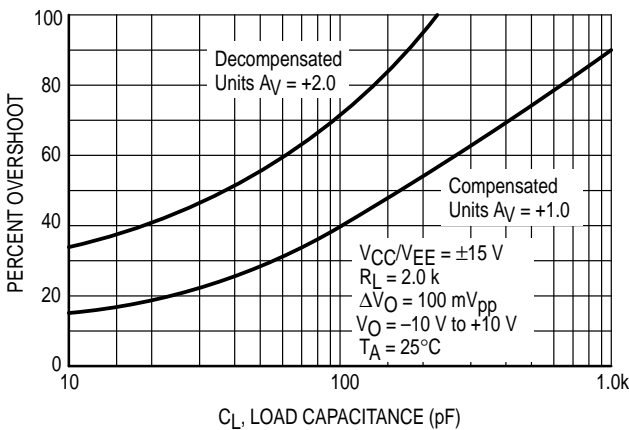

Figure 19. Phase Margin versus Load Capacitance

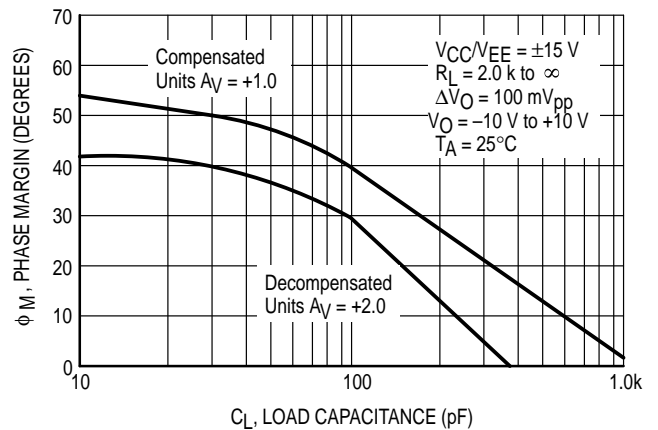

Figure 20. Gain Margin versus Load Capacitance

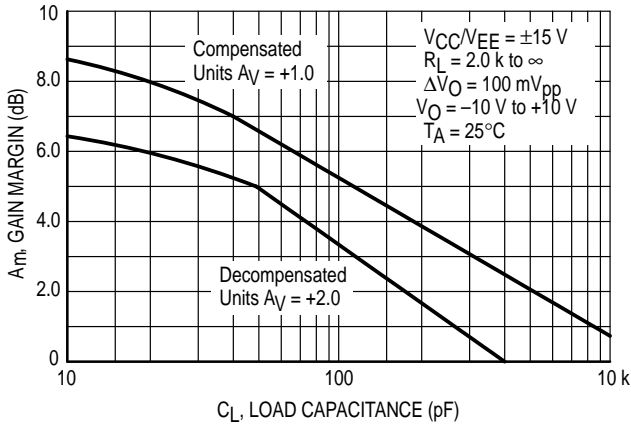

Figure 21. Phase Margin versus Temperature

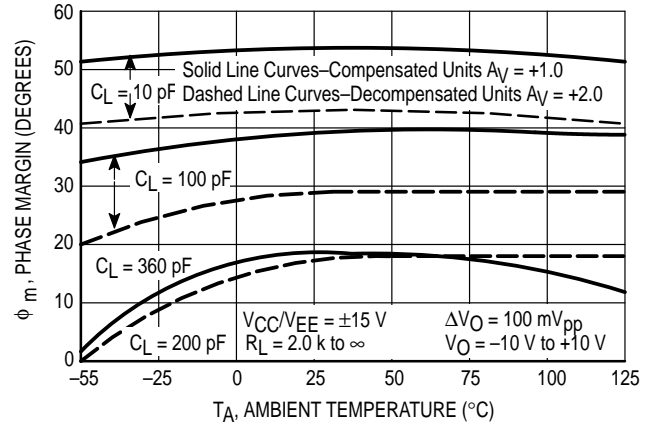

Figure 22. Gain Margin versus Temperature

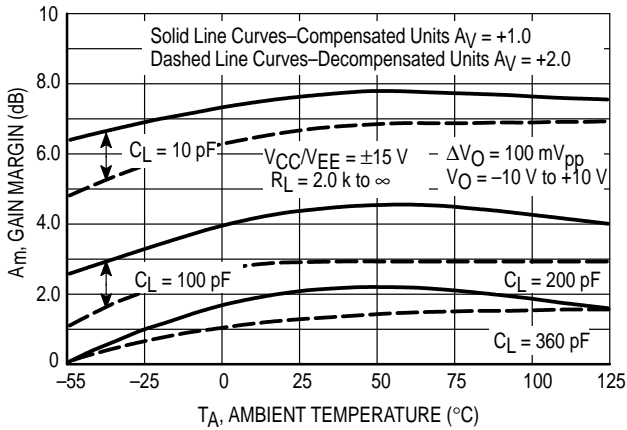
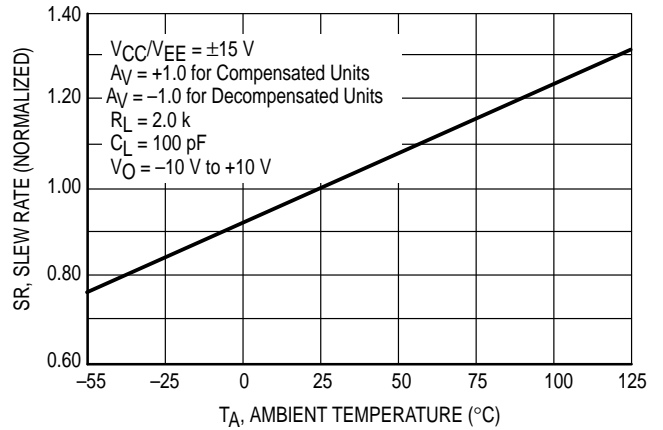

Figure 23. Normalized Slew Rate versus Temperature





# MC34080 thru MC34085

## MC34084 Transient Response

$A_V = +1.0$ ,  $R_L = 2.0 \text{ k}$ ,  $V_{CC}/V_{EE} = \pm 15 \text{ V}$ ,  $T_A = 25^\circ\text{C}$

Figure 24. Small Signal

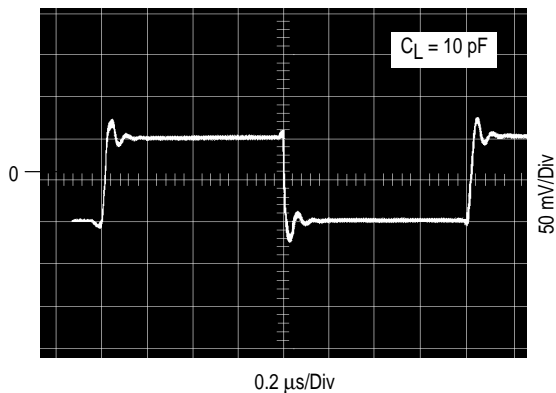
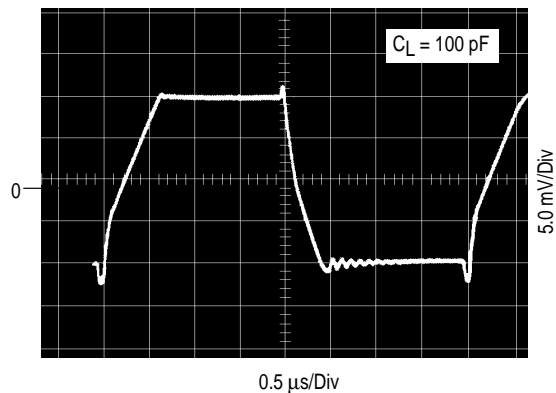

Figure 25. Large Signal



## MC34085 Transient Response

$A_V = +2.0$ ,  $R_L = 2.0 \text{ k}$ ,  $V_{CC}/V_{EE} = \pm 15 \text{ V}$ ,  $T_A = 25^\circ\text{C}$

Figure 26. Small Signal

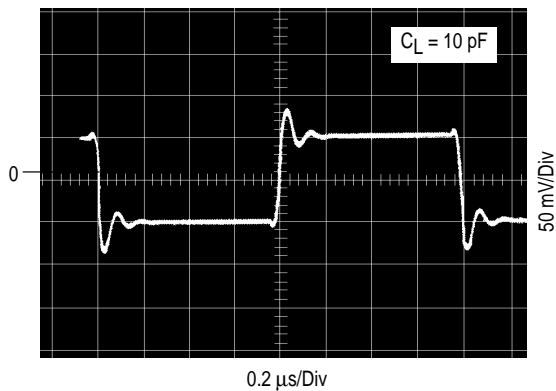

Figure 27. Large Signal

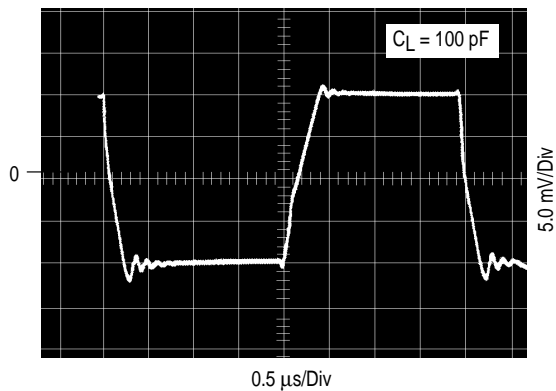

Figure 28. Common Mode Rejection Ratio versus Frequency

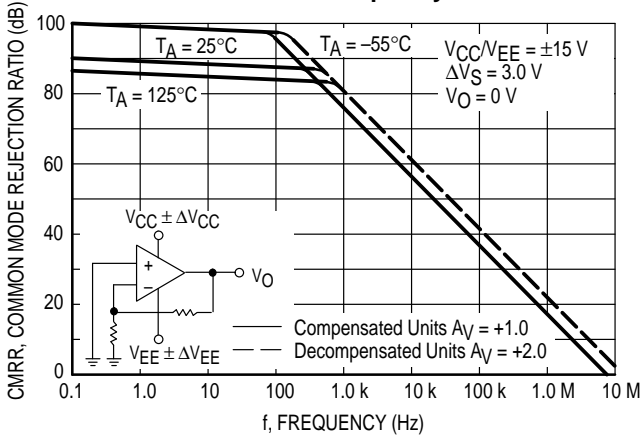

Figure 29. Power Supply Rejection Ratio versus Frequency

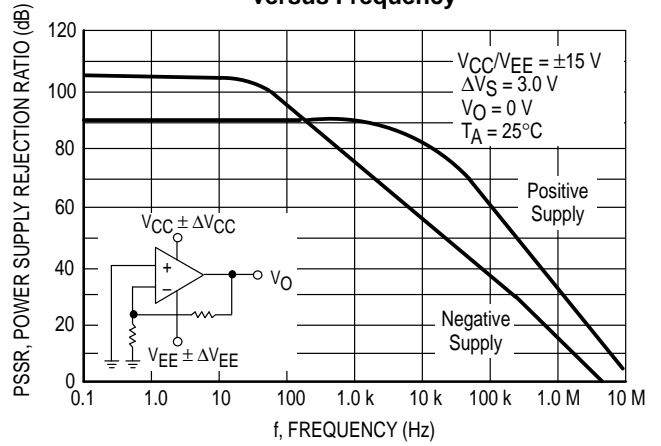

Figure 30. Power Supply Rejection Ratio versus Temperature

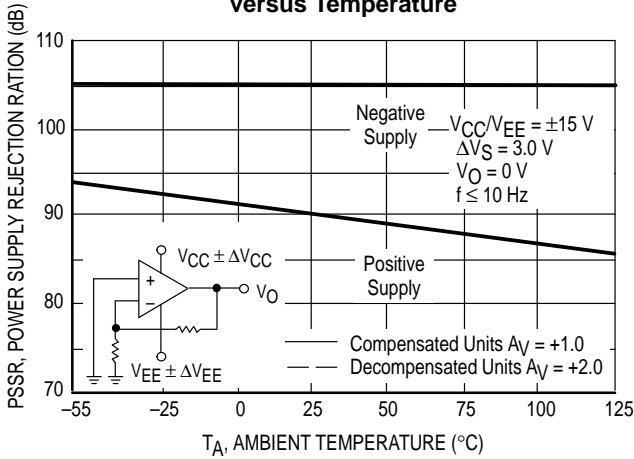

Figure 31. Normalized Supply Current versus Supply Voltage

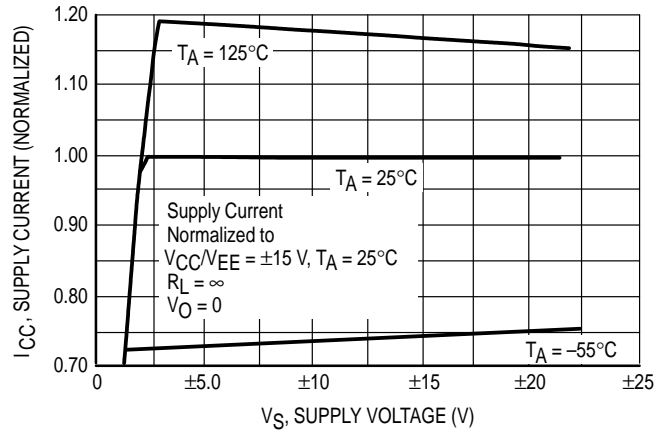

Figure 32. Channel Separation versus Frequency

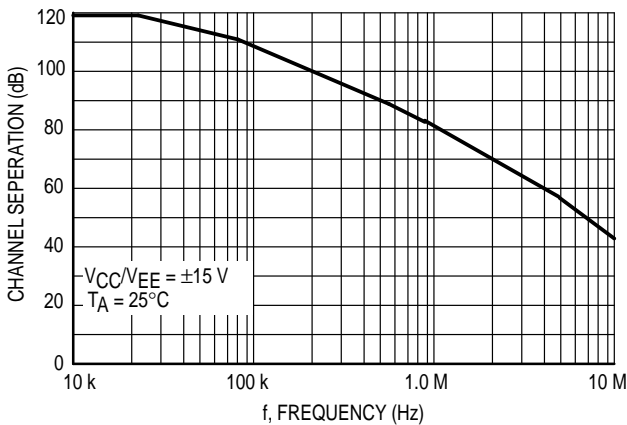
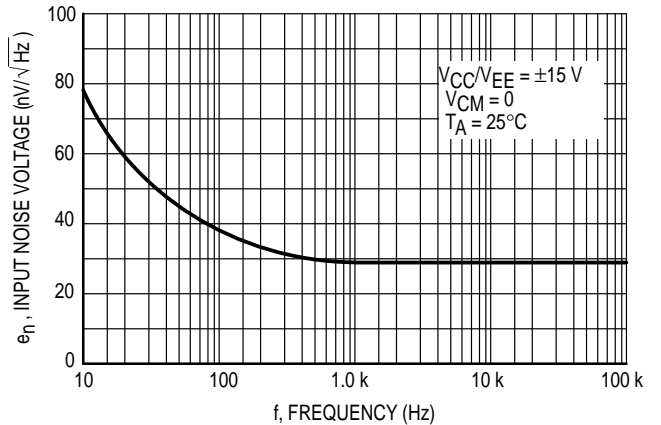

Figure 33. Spectral Noise Density



# MC34080 thru MC34085

## APPLICATIONS INFORMATION

The bandwidth and slew rate of the MC34080 series is nearly double that of currently available general purpose JFET op-amps. This improvement in AC performance is due to the P-channel JFET differential input stage driving a compensated miller integration amplifier in conjunction with an all NPN output stage.

The all NPN output stage offers unique advantages over the more conventional NPN/PNP transistor Class AB output stage. With a 10 k load resistance, the op amp can typically swing within 1.0 V of the positive rail ( $V_{CC}$ ), and within 0.3 V of the negative rail ( $V_{EE}$ ), providing a 28.7 p-p swing from  $\pm 15$  V supplies. This large output swing becomes most noticeable at lower supply voltages. If the load resistance is referenced to  $V_{CC}$  instead of ground, the maximum possible output swing can be achieved for a given supply voltage. For light load currents, the load resistance will pull the output to  $V_{CC}$  during the positive swing and the NPN output transistor will pull the output very near  $V_{EE}$  during the negative swing. The load resistance value should be much less than that of the feedback resistance to maximize pull-up capability.

The all NPN transistor output stage is also inherently fast, contributing to the operation amplifier's high gain-bandwidth product and fast settling time. The associated high frequency output impedance is 50  $\Omega$  (typical) at 8.0 MHz. This allows driving capacitive loads from 0 pF to 300 pF without oscillations over the military temperature range, and over the full range of output swing. The 55°C phase margin and 7.6 dB gain margin as well as the general gain and phase characteristics are virtually independent of the sink/source output swing conditions. The high frequency characteristics of the MC34080 series is especially useful for active filter applications.

The common mode input range is from 2.0 V below the positive rail ( $V_{CC}$ ) to 4.0 V above the negative rail ( $V_{EE}$ ). The amplifier remains active if the inputs are biased at the positive rail. This may be useful for some applications in that single supply operation is possible with a single negative supply. However, a degradation of offset voltage and voltage gain may result.

Phase reversal does not occur if either the inverting or noninverting input (or both) exceeds the positive common mode limit. If either input (or both) exceeds the negative common mode limit, the output will be in the high state. The

input stage also allows a differential up to  $\pm 44$  V, provided the maximum input voltage range is not exceeded. The supply voltage operating range is from  $\pm 5.0$  V to  $\pm 22$  V.

For optimum frequency performance and stability, careful component placement and printed circuit board layout should be exercised. For example, long unshielded input or output leads may result in unwanted input-output coupling. In order to reduce the input capacitance, resistors connected to the input pins should be physically close to these pins. This not only minimizes the input pole for optimum frequency response, but also minimizes extraneous "pickup" at this node.

Supply decoupling with adequate capacitance close to the supply pin is also important, particularly over temperature, since many types of decoupling capacitors exhibit large impedance changes over temperature.

Primarily due to the JFET inputs of the op amp, the input offset voltage may change due to temperature cycling and board soldering. After 20 temperature cycles ( $-55^\circ$  to  $165^\circ\text{C}$ ), the typical standard deviation for input offset voltage is 559  $\mu\text{V}$  in the plastic packages. With respect to board soldering ( $260^\circ\text{C}$ , 10 seconds), the typical standard deviation for input offset voltage is 525  $\mu\text{V}$  in the plastic package. Socketed devices should be used over a minimal temperature range for optimum input offset voltage performance.

Figure 34. Offset Nulling Circuit

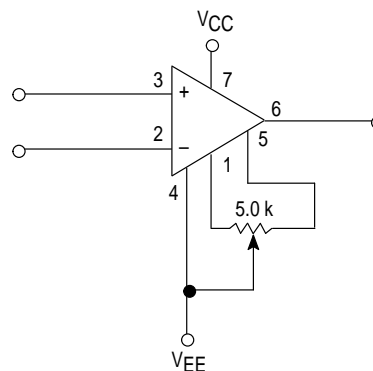

# MC34080 thru MC34085

## OUTLINE DIMENSIONS

### P SUFFIX PLASTIC PACKAGE CASE 626-05 ISSUE K

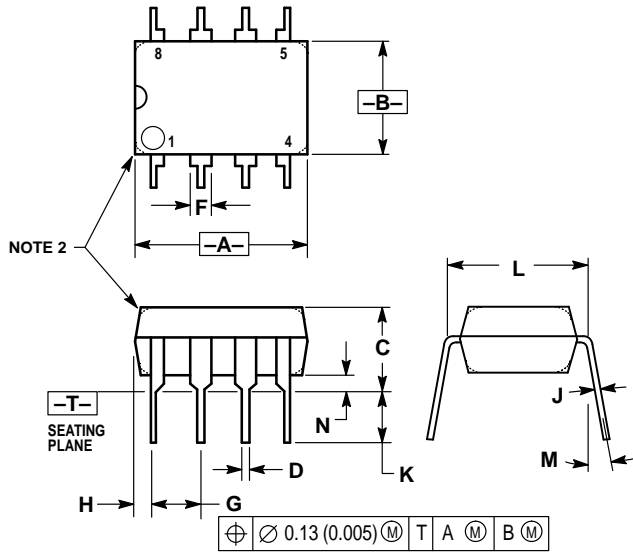

NOTES:

1. DIMENSION L TO CENTER OF LEAD WHEN FORMED PARALLEL.
2. PACKAGE CONTOUR OPTIONAL (ROUND OR SQUARE CORNERS).
3. DIMENSIONING AND TOLERANCING PER ANSI Y14.5M, 1982.

DIM	MILLIMETERS		INCHES	
	MIN	MAX	MIN	MAX
A	9.40	10.16	0.370	0.400
B	6.10	6.60	0.240	0.260
C	3.94	4.45	0.155	0.175
D	0.38	0.51	0.015	0.020
F	1.02	1.78	0.040	0.070
G	2.54 BSC		0.100 BSC	
H	0.76	1.27	0.030	0.050
J	0.20	0.30	0.008	0.012
K	2.92	3.43	0.115	0.135
L	7.62 BSC		0.300 BSC	
M	—	10°	—	10°
N	0.76	1.01	0.030	0.040

### D SUFFIX PLASTIC PACKAGE CASE 751-05 (SO-8) ISSUE R

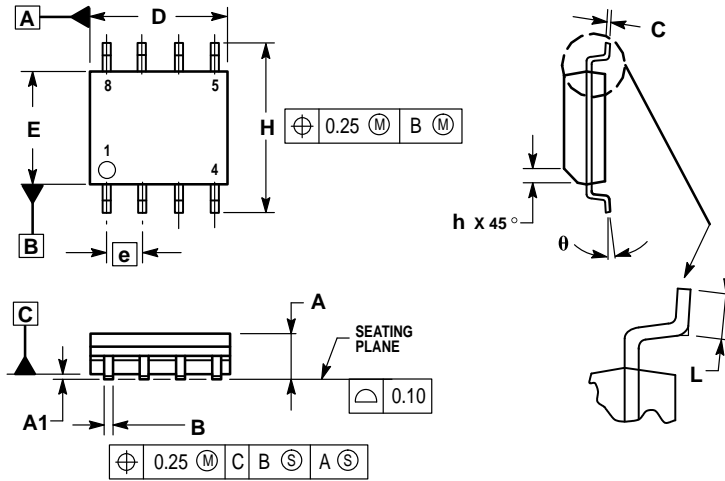

NOTES:

1. DIMENSIONING AND TOLERANCING PER ASME Y14.5M, 1994.
2. DIMENSIONS ARE IN MILLIMETERS.
3. DIMENSION D AND E DO NOT INCLUDE MOLD PROTRUSION.
4. MAXIMUM MOLD PROTRUSION 0.15 PER SIDE.
5. DIMENSION B DOES NOT INCLUDE MOLD PROTRUSION. ALLOWABLE DAMBAR PROTRUSION SHALL BE 0.127 TOTAL IN EXCESS OF THE B DIMENSION AT MAXIMUM MATERIAL CONDITION.

DIM	MILLIMETERS	
	MIN	MAX
A	1.35	1.75
A1	0.10	0.25
B	0.35	0.49
C	0.18	0.25
D	4.80	5.00
E	3.80	4.00
e	1.27 BSC	
H	5.80	6.20
h	0.25	0.50
L	0.40	1.25
θ	0°	7°

# MC34080 thru MC34085

## OUTLINE DIMENSIONS

### P SUFFIX PLASTIC PACKAGE CASE 646-06 ISSUE L

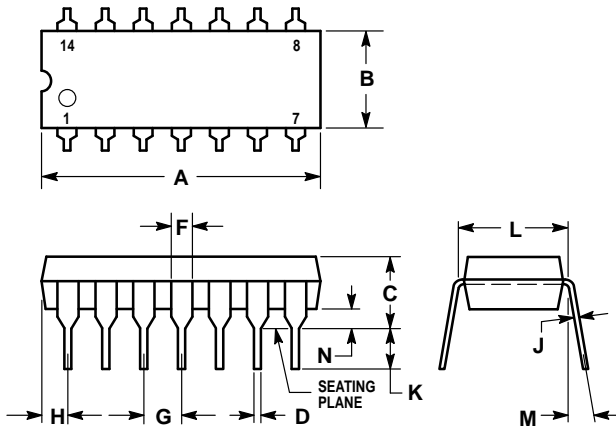

NOTES:

- LEADS WITHIN 0.13 (0.005) RADIUS OF TRUE POSITION AT SEATING PLANE AT MAXIMUM MATERIAL CONDITION.
- DIMENSION L TO CENTER OF LEADS WHEN FORMED PARALLEL.
- DIMENSION B DOES NOT INCLUDE MOLD FLASH.
- ROUNDED CORNERS OPTIONAL.

DIM	INCHES		MILLIMETERS	
	MIN	MAX	MIN	MAX
A	0.715	0.770	18.16	19.56
B	0.240	0.260	6.10	6.60
C	0.145	0.185	3.69	4.69
D	0.015	0.021	0.38	0.53
F	0.040	0.070	1.02	1.78
G	0.100 BSC		2.54 BSC	
H	0.052	0.095	1.32	2.41
J	0.008	0.015	0.20	0.38
K	0.115	0.135	2.92	3.43
L	0.300 BSC		7.62 BSC	
M	0°	10°	0°	10°
N	0.015	0.039	0.39	1.01

### DW SUFFIX PLASTIC PACKAGE CASE 751G-02 (SO-16L) ISSUE A

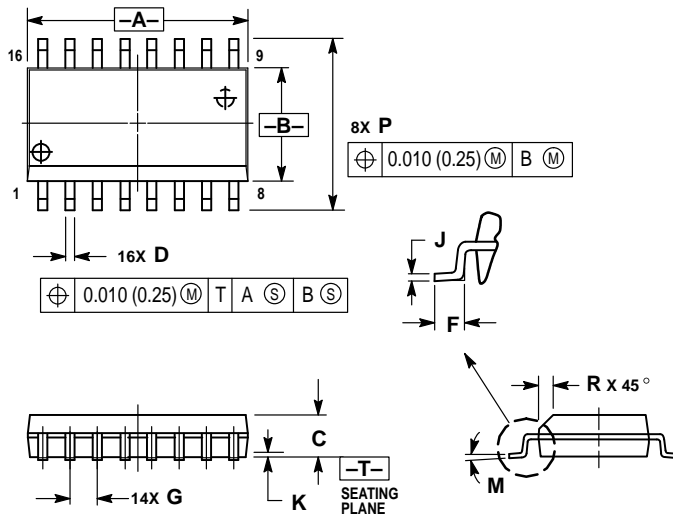

NOTES:

- DIMENSIONING AND TOLERANCING PER ANSI Y14.5M, 1982.
- CONTROLLING DIMENSION: MILLIMETER.
- DIMENSIONS A AND B DO NOT INCLUDE MOLD PROTRUSION.
- MAXIMUM MOLD PROTRUSION 0.15 (0.006) PER SIDE.
- DIMENSION D DOES NOT INCLUDE DAMBAR PROTRUSION. ALLOWABLE DAMBAR PROTRUSION SHALL BE 0.13 (0.005) TOTAL IN EXCESS OF D DIMENSION AT MAXIMUM MATERIAL CONDITION.

DIM	MILLIMETERS		INCHES	
	MIN	MAX	MIN	MAX
A	10.15	10.45	0.400	0.411
B	7.40	7.60	0.292	0.299
C	2.35	2.65	0.093	0.104
D	0.35	0.49	0.014	0.019
F	0.50	0.90	0.020	0.035
G	1.27 BSC		0.050 BSC	
J	0.25	0.32	0.010	0.012
K	0.10	0.25	0.004	0.009
M	0°	7°	0°	7°
P	10.05	10.55	0.395	0.415
R	0.25	0.75	0.010	0.029

**MC34080 thru MC34085**

**NOTES**

**MC34080 thru MC34085**

**NOTES**

# MC34080 thru MC34085

Motorola reserves the right to make changes without further notice to any products herein. Motorola makes no warranty, representation or guarantee regarding the suitability of its products for any particular purpose, nor does Motorola assume any liability arising out of the application or use of any product or circuit, and specifically disclaims any and all liability, including without limitation consequential or incidental damages. "Typical" parameters which may be provided in Motorola data sheets and/or specifications can and do vary in different applications and actual performance may vary over time. All operating parameters, including "Typicals" must be validated for each customer application by customer's technical experts. Motorola does not convey any license under its patent rights nor the rights of others. Motorola products are not designed, intended, or authorized for use as components in systems intended for surgical implant into the body, or other applications intended to support or sustain life, or for any other application in which the failure of the Motorola product could create a situation where personal injury or death may occur. Should Buyer purchase or use Motorola products for any such unintended or unauthorized application, Buyer shall indemnify and hold Motorola and its officers, employees, subsidiaries, affiliates, and distributors harmless against all claims, costs, damages, and expenses, and reasonable attorney fees arising out of, directly or indirectly, any claim of personal injury or death associated with such unintended or unauthorized use, even if such claim alleges that Motorola was negligent regarding the design or manufacture of the part. Motorola and  are registered trademarks of Motorola, Inc. Motorola, Inc. is an Equal Opportunity/Affirmative Action Employer.

#### How to reach us:

**USA/EUROPE/Locations Not Listed:** Motorola Literature Distribution;  
P.O. Box 20912; Phoenix, Arizona 85036. 1-800-441-2447 or 602-303-5454

**JAPAN:** Nippon Motorola Ltd.; Tatsumi-SPD-JLDC, 6F Seibu-Butsuryu-Center,  
3-14-2 Tatsumi Koto-Ku, Tokyo 135, Japan. 03-81-3521-8315

**MFAX:** RMFAX0@email.sps.mot.com - TOUCHTONE 602-244-6609  
**INTERNET:** <http://Design-NET.com>

**ASIA/PACIFIC:** Motorola Semiconductors H.K. Ltd.; 8B Tai Ping Industrial Park,  
51 Ting Kok Road, Tai Po, N.T., Hong Kong. 852-26629298



**MOTOROLA**



MC34080/D

