

DL7100/DL7200

Digital Oscilloscope

USER'S MANUAL

Product Registration

Thank you for purchasing YOKOGAWA products.

YOKOGAWA provides registered users with a variety of information and services.

Please allow us to serve you best by completing the product registration form accessible from our homepage.

<http://www.yokogawa.com/tm/>

Foreword

Thank you for purchasing the YOKOGAWA DL7100/DL7200 Digital Oscilloscope. This User's Manual contains useful information about the instruments' functions and operating procedures as well as precautions that should be observed during use. To ensure proper use of the instrument, please read this manual thoroughly before operating it. Keep the manual in a safe place for quick reference whenever a question arises. Three manuals are provided with the instrument, including this User's Manual.

Manual Name	Manual No.	Description
DL7100/DL7200 User's Manual	IM 701410-01E	Describes all functions (except for the communications function) and their operation procedures for the instrument.
DL7100/DL7200 Communication User's Manual	IM 701410-11E	Describes the functions for the communication interface.
DL7100/DL7200 Operation Guide	IM 701410-02E	Describes basic operations only.

Notes

- The contents of this manual are subject to change without prior notice as a result of improvements in the instrument's performance and functions. Display contents illustrated in this manual may differ slightly from what actually appears on your screen.
- Every effort has been made in the preparation of this manual to ensure the accuracy of its contents. However, should you have any questions or find any errors, please contact your nearest YOKOGAWA representative listed on the back cover of this manual.
- Copying or reproduction of all or any part of the contents of this manual without YOKOGAWA's permission is strictly prohibited.
- A guarantee card is attached to the instrument. The card will not be reissued, so please read it carefully and keep it in a safe place.
- The TCP/IP software of this product and the document concerning the TCP/IP software have been developed/created by YOKOGAWA based on the BSD Networking Software, Release 1 that has been licensed from California University.

Trademarks

- Microsoft, MS-DOS, Windows, and Windows NT are either registered trademarks or trademarks of Microsoft Corporation in the United States and/or other countries.
- Adobe, Adobe Acrobat, and PostScript are trademarks or registered trademarks of Adobe Systems Incorporated.
- For purposes of this manual, the TM and ® symbols do not accompany their respective trademark names or registered trademark names.
- All other company and product names used in this manual are trademarks or registered trademarks of their respective companies.

Revisions

1st Edition: August 1999
2nd Edition: August 2000
3rd Edition: July 2001

Checking the Contents of the Package

Unpack the box and check the contents before operating the instrument. If the wrong instrument or accessories have been delivered, if some accessories are missing or if they appear abnormal, contact the dealer from which you purchased them.

DL7100/DL7200 Main Body

Check that the model name and suffix code given on the name plate of the rear panel match those on your order. Whenever you contact the dealer from which you purchased the instrument, tell him your unit's serial No.

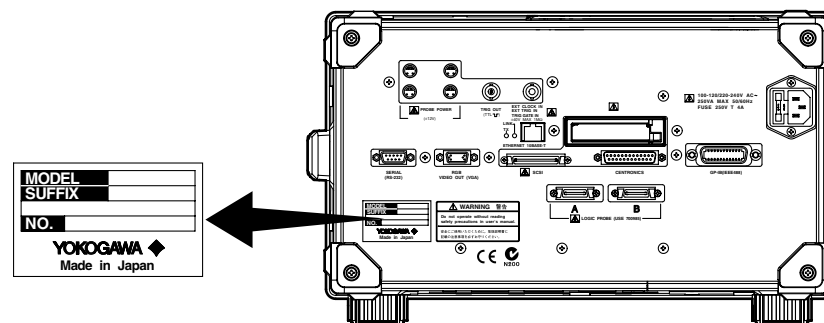

MODEL	SUFFIX	SPECIFICATIONS
701410		1 GS/s, 2 MW/CH model
701420		1 GS/s, 4 MW/CH model
701430		2 GS/s, 4 MW/CH model
701440		2 GS/s, 16 MW/CH model
Power cord	-D	UL/CSA standard power cord (A1006WD) Maximum rated voltage: 125 V, maximum rated current: 7 A
	-F	VDE standard power cord (A1009WD) Maximum rated voltage: 250 V, maximum rated current: 10 A
	-Q	BS standard power cord (A1054WD) Maximum rated voltage: 250 V, maximum rated current: 10 A
	-R	SAA standard power cord (A1024WD) Maximum rated voltage: 240 V, maximum rated current: 10 A
Options	/B5	Built - in printer*1
	/N1	Logic input for 701410*2
	/N2	Logic input for 701420*2
	/N3	Logic input for 701430*2
	/N4	Logic input for 701440*2
	/C9	PC Card interface*3
	/C10	Ethernet + PC Card interface*3
	/F7	CAN Bus signal analysis function*4
	/E2	Two passive probes
	/E3	Two FET probes

*1 1 printer roll (B9850NX) included

*2 Logic probe (700985) is not included. The number of logic probes for acquiring the waveform data depends on the model.

*3 You can select option /C9 or /C10.

*4 Option available only on the 701430 and 701440. For details on the operating procedures, handling precautions, and other information, see the DL7200 CAN Bus Analysis Function User's Manual (IM701430-51E).

Example: UL/CSA standard power cord, and full options → 701410-D/B5/N1/E2/E3

No. (Instrument No.)

When contacting the dealer from which you purchased your instrument, please quote the instrument No.

Standard Accessories

The following standard accessories are supplied with the instrument. Make sure that all items are present and undamaged.

Power cord (one of the following power cords is supplied according to the instrument's suffix codes)

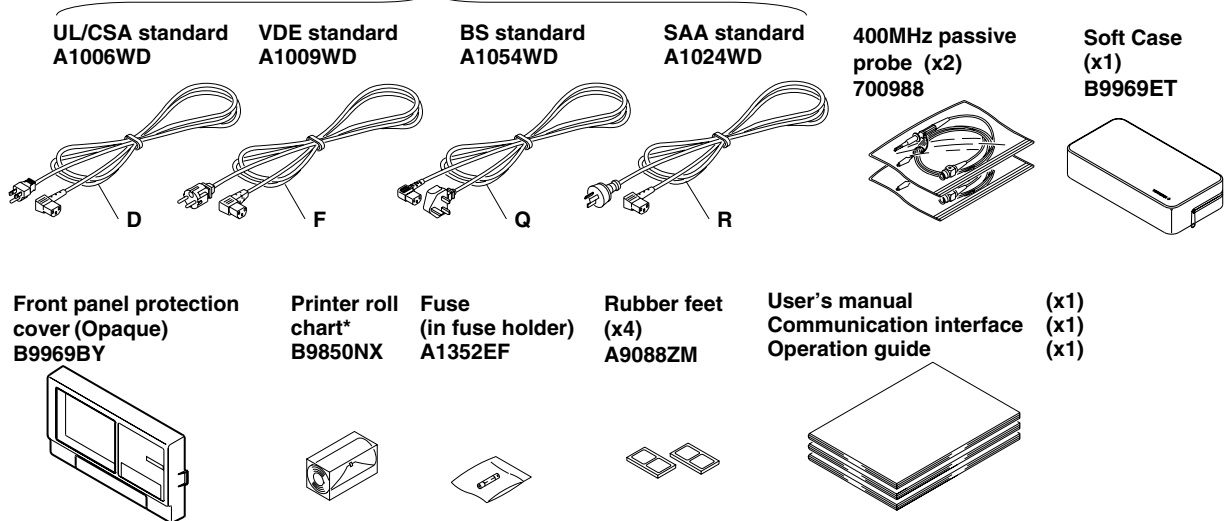

* A roll chart will be supplied only when the instrument is equipped with a built - in printer.

Optional Accessories

The following optional accessories are available. On receiving these optional accessories, make sure that all the items that you ordered have been supplied and that they are undamaged.

If you have any questions regarding optional accessories, or if you wish to place an order, contact the dealer from whom you purchased the instrument.

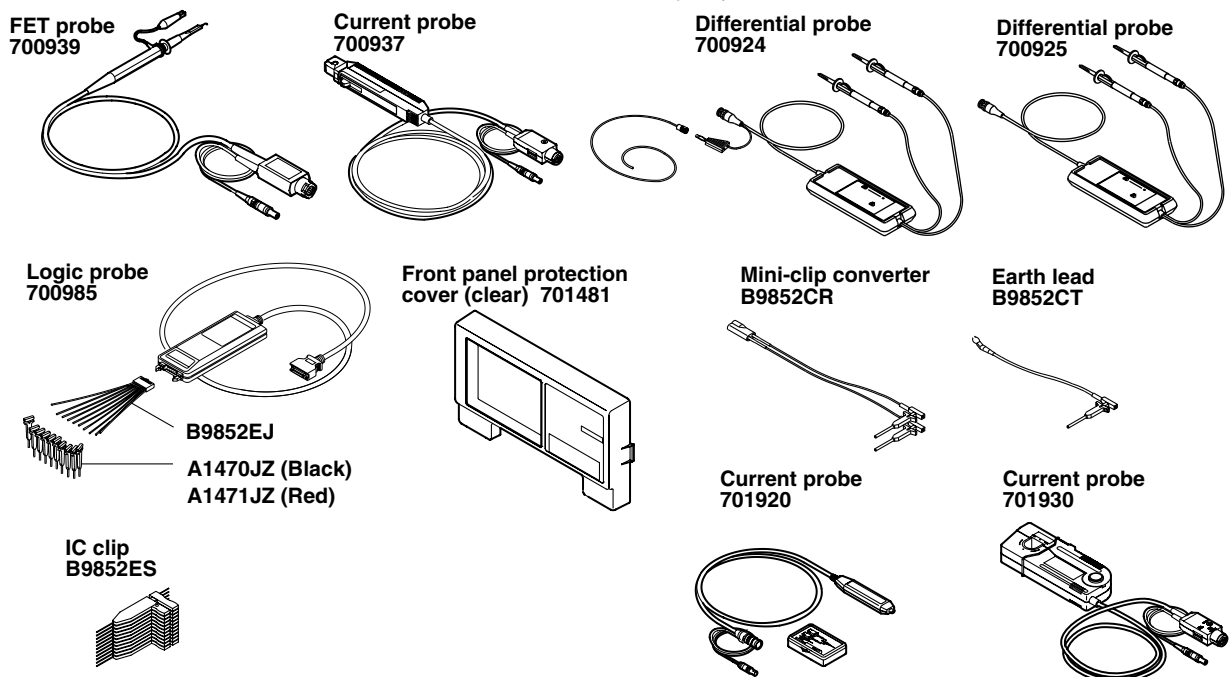

Checking the Contents of the Package

Optional Spare Parts

The following optional spare parts are available. On receiving these optional spare parts, make sure that all the items that you ordered have been supplied and that they are undamaged.

If you have any questions regarding optional spare parts, or if you wish to place an order, contact the dealer from whom you purchased the instrument.

Part Name	Part No.	Minimum Q'ty	Remarks
Roll chart	B9850NX	5	Thermo-sensible paper, Total length: 30 m
400 MHz passive probe	700988	1	Input impedance: 10 M Ω , Length: 1.5 m
Fuse	A1352EF	2	4 A, 250 V

Safety Precautions

This instrument is an IEC safety class I instrument (provided with terminal for protective grounding).

The following general safety precautions must be observed during all phases of operation, service and repair of this instrument. If this instrument is used in a manner not specified in this manual, the protection provided by this instrument may be impaired. Also, YOKOGAWA Electric Corporation assumes no liability for the customer's failure to comply with these requirements.

The following symbols are used on this instrument.



To avoid injury, death of personnel or damage to the instrument, the operator must refer to an explanation in the User's Manual or Service Manual.



Function grounding terminal (This terminal should not be used as a "Protective grounding terminal.")



Alternating current



ON (power)



OFF (power)



In - position of a bistable push control



Out - position of a bistable push control

Make sure to comply with the following safety precautions. Not complying might result in injury, death of personnel or damage to the instrument.

WARNING

Power Supply

Ensure the source voltage matches the voltage of the power supply before turning ON the power.

Power Cord and Plug

To prevent an electric shock or fire, be sure to use the power cord supplied by YOKOGAWA. The main power plug must be plugged in an outlet with protective grounding terminal. Do not invalidate protection by using an extension cord without protective grounding.

Protective Grounding

The protective grounding terminal must be connected to ground to prevent an electric shock before turning ON the power.

Necessity of Protective Grounding

Never cut off the internal or external protective grounding wire or disconnect the wiring of protective grounding terminal. Doing so poses a potential shock hazard.

Defect of Protective Grounding and Fuse

Do not operate the instrument when protective grounding or fuse might be defective.

Fuse

To prevent a fire, make sure to use fuses with specified standard (voltage, current, type). Before replacing the fuses, turn off the power and disconnect the power source. Do not use a different fuse or short - circuit the fuse holder.

Do not Operate in an Explosive Atmosphere

Do not operate the instrument in the presence of flammable liquids or vapors. Operation of any electrical instrument in such an environment constitutes a safety hazard.

Do not Remove Any Covers

There are some areas with high voltages. Do not remove any cover if the power supply is connected. The cover should be removed by qualified personnel only.

External Connection

To ground securely, connect the protective grounding before connecting to measurement or control unit. Also, when touching the circuit, turn off the power to the circuit and check that there is no voltage being generated.

To prevent the possibility of electric shock and accidents when making measurements, connect the ground of the probe and input connector to the earth ground potential of the item to be measured.

How to Use this Manual

Structure of the Manual

This User's Manual consists of 16 chapters, an Appendix and an Index as described below.

Chapter	Title	Content
1	Functions	Introduces the unit's features, functions, and operating principles. Please read this information to familiarize yourself with the unit's capabilities. This chapter does not present operational details.
2	Name and Use of Each Part	Briefly explains the significance and use of the unit's controls, connectors, and screen displays. Includes page references to help you find detailed information quickly.
3	Before Starting Observation and Measurement of Waveforms	Presents safety precautions, and explains how to install, connect up, and switch on the unit. Also explains how to connect the probes and how to set the date.
4	Common Operations	Explains basic operations, including acquisition start/stop, automatic setup, parameter reset, snapshots, trace clearing, and calibration.
5	Vertical and Horizontal Axes	Explains settings related to vertical (voltage) and horizontal (time) axes. Vertical-axis settings include channel on/off, input coupling, probe attenuation, and voltage sensitivity.
6	Triggering	Explains how to set up and use triggers to control timing of waveform acquisition. Includes description of trigger modes, trigger types, trigger source, and trigger level.
7	Acquisition and Display	Explains acquisition parameters (acquisition mode, sampling mode, record length, history), and use of overlapping (accumulated) waveform display.
8	Display	Explains display format, interpolation, zoom, X-Y display, graticule, and other display-related parameters.
9	Waveform Analysis	Explains cursor-based measurements, automatic measurements, statistical processing, mathematical operations, and GO/NO-GO determinations.
10	Output of Screen Data	Explains how to print screen data to internal printer, or to a printer connected through the centronics interface, and how to store screen display to the storage medium.
11	Data Saves and Loads Storage medium	Explains how to save and reload waveform data and settings to floppy disk, or external SCSI device. Also explains related disk operations, including disk formatting, file copying, and file deletion.
12	Rear - Panel Input/Output	Explains external-trigger input, external-clock input, trigger output, and RGB video output.
13	Ethernet Communications (Optional)	Explains saving to a network drive, getting files from a floppy disk, external SCSI device, or PC card (optional), outputting to a network printer, and receiving email transmissions.
14	Other Operations	Explains how to set the display colors, display language, click sound, and back light.
15	Troubleshooting, Maintenance, and Inspection	Gives troubleshooting advice; explains screen messages and self-test operation.
16	Specifications	Lists the unit's main specifications.
	Appendix	Appendix 1 shows the relationships between time axis, sampling rate, and record length. Appendix 2 explains waveform area calculation. Appendix 3 gives the format for ASCII file headers. Appendix 4 presents a list of default settings.
	Index	Index of contents.

Conventions Used in this Manual

Unit

k Denotes "1000." Example: 100 kS/s

K Denotes "1024."

Example: 720 KB (storage capacity of a floppy disk)

Used Characters

Alphanumerics enclosed in double quotation marks usually refer to characters and set values that appear on the screen and panel.

The SHIFT + xxx key refers to first pressing the SHIFT key (the indicator above the SHIFT key lights), and then pressing the xxx key to obtain another, specified, function.

Note

The following symbol marks are used to attract the operator's attention.



Affixed to the instrument, indicating that for safety, the operator should refer to the User's Manual.

WARNING

Describes precautions that should be observed to prevent the danger of injury or death to the user.

CAUTION

Describes precautions that should be observed to prevent damage to the instrument.

Note

Provides information that is important for proper operation of the instrument.

Titles Used for Descriptions of Operations

The following titles are used in chapters 3 to 14 to distinguish instruction from descriptions.

Function

Describes settings and restrictions relating to the operation. A detailed description of the function is not provided. For a detailed description of the function, refer to Chapter 1.

Operating Procedure

Carry out steps in the order shown. The operating procedures are given with the assumption that you are not familiar with the operation. Thus, it may not be necessary to carry out all the steps when changing settings.

Contents

Checking the Contents of the Package	ii
Safety Precautions	v
How to Use this Manual	vii
Chapter 1 Functions	
1.1 Block Diagram	1-1
1.2 Setting the Vertical and Horizontal Axes	1-2
1.3 Setting a Trigger	1-7
1.4 Setting the Acquisition and Display Conditions	1-13
1.5 Analyzing the Waveform	1-20
1.6 Other Useful Functions	1-26
Chapter 2 Name and Use of Each Part	
2.1 Front Panel/Rear Panel	2-1
2.2 Operation Keys/Jog Shuttle/Knobs	2-2
2.3 Screens	2-5
Chapter 3 Precautions During Use	
3.1 Precautions During Use	3-1
△ 3.2 Installation	3-3
△ 3.3 Connecting the Power Cord	3-5
△ 3.4 Connecting a Probe	3-7
△ 3.5 Compensating the Probe (Phase Correction)	3-10
3.6 Setting the Date and Time	3-11
△ 3.7 Connecting the Logic Probe (Optional)	3-12
Chapter 4 Common Operations	
4.1 Entering Values and Character Strings	4-1
4.2 Initializing Settings	4-4
4.3 Performing Auto Setup	4-5
4.4 Starting/Stopping Waveform Acquisition	4-7
4.5 The Snapshot and Clear Trace Functions	4-8
4.6 Calibration	4-9
4.7 Using the Help Function	4-11

Chapter 5 Vertical and Horizontal Axes

5.1	Turning Channels ON/OFF	5-1
5.2	Setting the Vertical Position of a Waveform	5-2
5.3	Selecting Input Coupling	5-3
5.4	Selecting Probe Attenuation	5-4
5.5	Setting the Offset Voltage	5-5
5.6	The Preset Function	5-6
5.7	Setting the Bandwidth	5-8
5.8	Setting V/div	5-9
5.9	Using the Linear Scaling Function	5-11
5.10	Turning ON/OFF the Logic Input and Setting the Threshold Level.	5-12
5.11	Selecting the Timebase	5-14
5.12	Setting T/div	5-16

Chapter 6 Triggering

6.1	Setting the Trigger Mode	6-1
6.2	Setting the Trigger Delay	6-2
6.3	Setting the Trigger Position	6-3
6.4	Setting the Hold Off Time	6-4
6.5	Setting the Edge Trigger (SIMPLE)	6-6
6.6	Setting the External Trigger (SIMPLE)	6-8
6.7	Generating Triggers on the Power Signal (SIMPLE)	6-10
6.8	Setting the A/EB(n) Trigger (ENHANCED)	6-11
6.9	Setting the A Delay B Trigger (ENHANCED)	6-14
6.10	Setting the Pattern Trigger (ENHANCED)	6-17
6.11	Setting the Width (Pulse<Time, Pulse>Time, T1<Pulse<T2, Time Out) Trigger (ENHANCED)	6-21
6.12	Setting the OR Trigger	6-25
6.13	Setting the Window Trigger (ENHANCED)	6-27
6.14	Setting the TV Trigger (ENHANCED)	6-29
6.15	Setting the Logic Trigger (ENHANCED, Optional)	6-32
6.16	Setting the Action-On Trigger	6-35

Chapter 7 Acquisition and Display

7.1	Setting the Record Length	7-1
7.2	Acquisition Mode	7-2
7.3	Using Sequential Store Function	7-5
7.4	Box Average Mode	7-7
7.5	Using Interleave Mode	7-9
7.6	Setting Repetitive Sampling Mode ON/OFF	7-10
7.7	Using the History Memory	7-12
7.8	Searching the Historical Data Using Zone (History Search Function)	7-15
7.9	Searching the Historical Data Using Parameter (History Search Function)	7-18

Chapter 8 Display

8.1	Changing the Display Format	8-1
8.2	Setting the Interpolation Method	8-3
8.3	Changing the Graticule	8-5
8.4	Turning Display of the Scaling Value ON/OFF	8-6
8.5	Setting the Waveform Labels	8-7
8.6	Accumulated Waveform Display	8-8
8.7	X-Y Waveform Display	8-10
8.8	Zooming the Waveform	8-12
8.9	Search Data Using Search and Zoom Function	8-14
8.10	Analyzing and Searching SPI Signals	8-28

Chapter 9 Waveform Analysis

9.1	Measuring Waveforms Using Cursors	9-1
9.2	Automated Measurement of Waveform Parameters	9-10
9.3	Statistical Processing	9-17
9.4	Adding, Subtracting, and Multiplying Waveforms	9-22
9.5	Binary Computation	9-24
9.6	Inverting the Waveform Display	9-26
9.7	Differentiating and Integrating Waveforms	9-28
9.8	Displaying the Power Spectrum	9-30
9.9	Smoothing	9-32
9.10	Phase-Shifted Display	9-33
9.11	GO/NO-GO Operation Using the Measurement of Waveform Parameters	9-34
9.12	GO/NO-GO Determination Using Zones	9-38

Chapter 10 Output of Screen Data

10.1	Loading Paper Roll in Built-in Printer (Optional)	10-1
10.2	Outputting to the Built-in Printer (Optional)	10-3
△	10.3 Outputting Screen Image to an External Printer Connector	10-6
10.4	Storing Screen Image to the Recording Storage Medium	10-9

Chapter 11 Data Saves and Loads the Recording Medium

11.1	Floppy Disks	11-1
△	11.2 PC Card (Optional)	11-2
11.3	Connecting MO Disk Drives or Hard Disks to the SCSI Port	11-3
△	11.4 Formatting the Recording Medium	11-4
11.5	Changing the SCSI ID Number	11-9
△	11.6 Saving/Loading Waveform Data	11-10
△	11.7 Saving/Loading Setup Data	11-18
△	11.8 Saving Snap Shot Waveforms	11-22
△	11.9 Saving the Results of the Automated Measurement of Waveform Parameters	11-25
△	11.10 Outputting the Detailed Analysis List of the SPI Signal	11-27
△	11.11 Changing the File Attributes, Deleting Files	11-28
△	11.12 Copying Files	11-31
11.13	Changing the Recording Medium, Directory Name, and File Name and Creating a Directory	11-34

Chapter 12 Rear Panel Input/Output

△ 12.1 External Trigger Input (EXT TRIG IN), External Clock Input (EXT CLOCK IN) 12-1
 △ 12.2 Trigger Output (TRIG OUT) 12-2
 △ 12.3 RGB Video Signal Output (RGB VIDEO OUT) 12-4

Chapter 13 Ethernet Communications (Optional)

13.1 Connecting the DL7100/DL7200 to a Personal Computer 13-1
 13.2 Configuring the Ethernet Interface (TCP/IP) 13-2
 13.3 Saving Waveform and Setting Data to a Network Drive 13-5
 13.4 Saving Screen Image Data to a Network Drive 13-7
 13.5 Sending Screen Image Data to a Network Printer 13-9
 13.6 Using the Mail Function (Fixed Interval) 13-11
 13.7 Using the Mail Function (Action Mail Function) 13-13
 13.8 Accessing DL7100/DL7200 Drives from a Personal computer or Workstation 13-15
 13.9 Viewing the Ether Option and MAC Address 13-17
 13.10 Other Settings 13-18

Chapter 14 Other Operations

14.1 Setting the Screen Color and Brightness 14-1
 14.2 Changing the Message Language and Click Sound 14-4
 14.3 Turning OFF the Backlight and Setting the Brightness of the Backlight 14-5
 14.4 Setting the Trigger Gate 14-6
 14.5 Canceling the Offset 14-7

Chapter 15 Troubleshooting, Maintenance and Inspection

15.1 Troubleshooting 15-1
 15.2 Messages and Corrective Actions 15-2
 15.3 Self-Diagnostic Test (Self Test) 15-7
 15.4 Checking the System Condition 15-11
 △ 15.5 Replacing the Power Fuse 15-12
 15.6 Recommended Replacement Parts 15-13

Chapter 16 Specification

16.1 Input Section 16-1
 16.2 Trigger Section 16-2
 16.3 Time Axis 16-4
 16.4 Display 16-4
 16.5 Functions 16-4
 16.6 Rear Panel Input/Output 16-7
 16.7 GP-IB Interface 16-8
 16.8 Serial (RS-232) Interface 16-8
 16.9 Centronics Interface 16-8
 16.10 SCSI Interface 16-8
 16.11 Built-in Printer (Optional) 16-9
 16.12 Built-in Floppy Disk Drive 16-9
 16.13 PC Card Interface (Optional) 16-9
 16.14 Ethernet Communications Specifications (Optional) 16-9
 16.15 General 16-10
 16.16 External Dimensions 16-13

Appendix

Appendix 1 Relationship between the Time Axis Setting, Sample Rate and Record Length . App-1
Appendix 2 How to Calculate the Area of a Waveform App-22
Appendix 3 ASCII Header File Format App-24
Appendix 4 List of Defaults App-28

Index

1
2
3
4
5
6
7
8
9
10
11
12
13
14
15
16
App
Index

1.1 Block Diagram

System Configuration

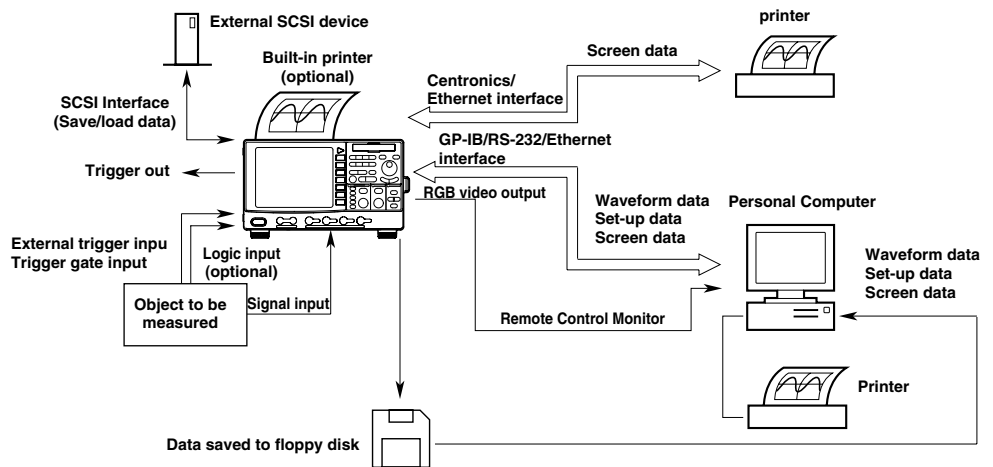

Block Diagram

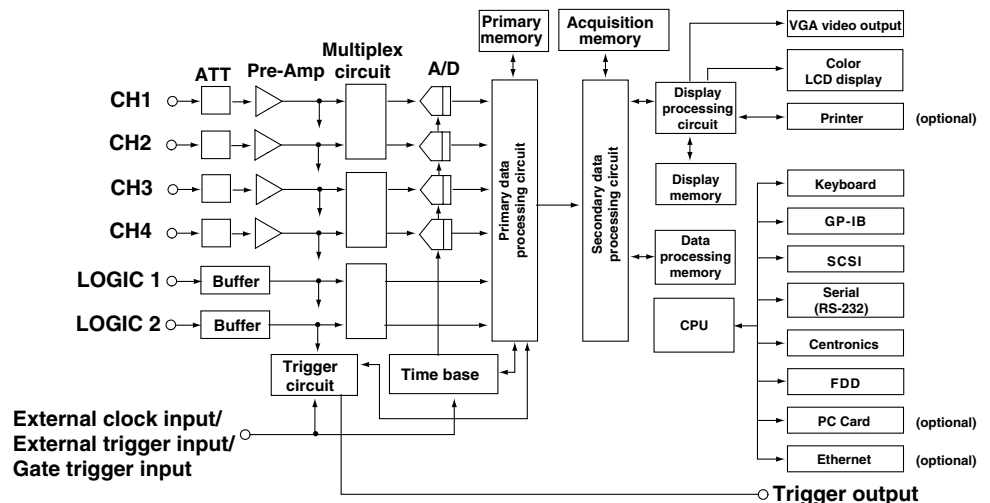

Signal flow

The signals to be measured enter at the input terminals and pass first to the attenuator (ATT) and preamplifier. Adjusted vertical-axis characteristics (voltage and amplitude) in accordance with the settings for input coupling, probe attenuation, V/div, and offset value are passed to the multiplexer. The multiplexer outputs each signal to the corresponding A/D converter in accordance with the time-axis settings.

The A/D converter converts the voltages into digital values. The Primary Processing Circuit then writes converted values into the primary memory at the appropriate sampling rate (as determined by the time-axis setting).

The secondary processing circuit performs averaging and other types of processing on the data in the primary memory and writes the resultant data to the acquisition memory. The data written to the acquisition memory is then converted to waveform display data by the secondary processing circuit and transferred to the waveform processing circuit by which the data are stored in the display memory. Waveforms are displayed on the screen based on the data stored in the display memory.

1.2 Setting the Vertical and Horizontal Axes

Offset Voltage < Section 5.5 >

When observing a voltage riding on top of a predetermined voltage, an offset voltage can be applied to eliminate the predetermined voltage so that only the changes in the original signal can be observed with higher voltage sensitivity.

Normally, the offset voltage does not affect the cursor measurement values, automated measurement of waveform parameters, and computed values. However, you can turn ON offset to apply offset voltage to them.

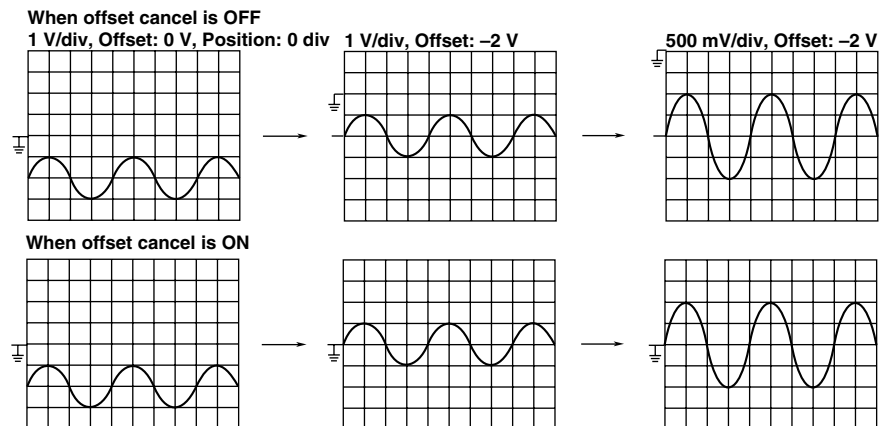

Input Coupling < Section 5.3 >

When you only want to observe the amplitude of an alternating current signal, eliminating the direct current components from the input signal makes observation easier. You may also want to check the ground level or observe the input signal waveform with the offset voltage removed. In these cases, you can change the input coupling setting. This will switch the coupling method, which determines how the input signal is input to the vertical control circuit (voltage axis).

The input coupling method can be chosen from the following:

AC 1 M Ω

The input signal is sent through a capacitor to the attenuator in the vertical control circuit. This method can be used when you just want to observe the amplitude of the alternating current signal, eliminating the DC components from the input signal.

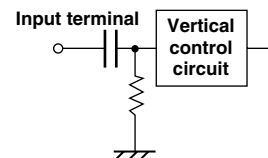

DC 1 M Ω

The input signal is sent directly to the attenuator in the vertical control circuit. This method can be used when you want to observe both the DC and AC components of the vertical input signal.

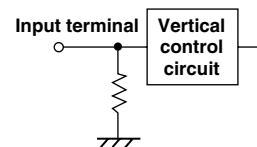

GND

The ground signal, not the input signal, is connected to the attenuator in the vertical control circuit. This method enables observation of the ground level on the screen.

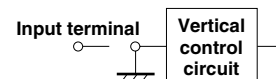

DC 50 Ω

This is the same as DC 1 M Ω described above, except the input impedance is 50 Ω . Please be aware of the maximum input voltage.

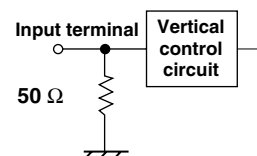

Probe Attenuation < Section 5.4 >

A probe is usually used to connect the circuit to be measured to an input terminal. Use of a probe provides the following advantages.

- the voltage and current of the circuit to be measured are not disturbed.
- a signal can be input without distortion.
- the measurement voltage range of the oscilloscope can be widened.

A 400 MHz passive probe is supplied with the instrument. The probe attenuates the input signal by 1/10. When a probe is used, the probe attenuation must match the instrument's attenuation setting so that the input voltage can be measured directly. Set the instrument's attenuation to 10 : 1 if the supplied probe is to be used.

In addition to 10 : 1, attenuations of 1 : 1, 100 : 1 and 1000 : 1 are provided. When you use a probe other than the one supplied with the instrument, set the instrument's attenuation so that it matches the probe's attenuation.

Bandwidth Limit < Section 5.7 >

High frequency noise of 20 MHz or higher, or 100 MHz or higher can be eliminated from the input signal.

Vertical Sensitivity < Section 5.8 >

The V/div (vertical sensitivity) setting is used to adjust the amplitude of the displayed waveform so that the waveform can be observed easily.

The V/div setting is made by setting the voltage value per division on the screen grid.

The vertical sensitivity setting operates by switching to a different attenuator (attenuation rate). The setting changes in steps (1 V/div → 2 V/div → 5 V/div ...).

In addition, by performing computations on the digital data acquired using the voltage sensitivity above, the waveform can be displayed at a sensitivity of 0.4 (or 0.5) to 10 times the voltage sensitivity that was used to acquire the data (Variable).

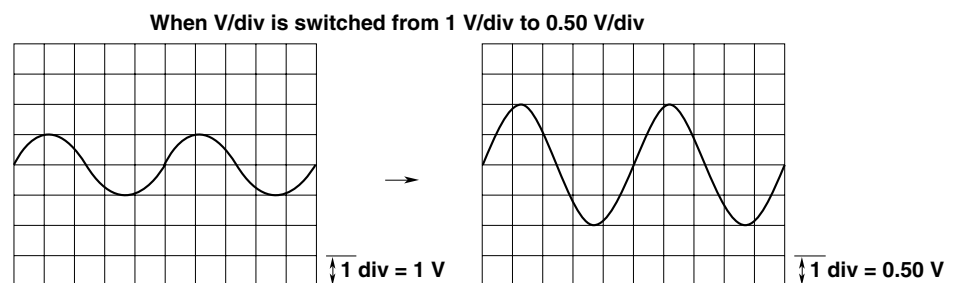
**Note****Vertical sensitivity and measurement resolution**

To get precise readings, it is recommended that you set the vertical sensitivity so that the waveform's maximum and minimum amplitudes are close to the top and bottom of the screen.

Note that the instrument uses 8-bit A/D converters. Incoming signals are sampled at a resolution of 255 levels (LSB), or 32 levels per division.

Effective data range

The instrument uses 8-bit A/D converters. Assuming that output values range from 0 to 255, the vertical center line of the display corresponds to a value of 128. Because the A/D converter reaches full range at 255, screen level 256 is not used.

Note also that the instrument treats an A/D output value of 0 as if it were a 1.

The screen's effective display range extends approximately 5.29 divisions in each direction from the screen's center line.

However, if the vertical axis position is moved while the data acquisition is stopped, the effective data range also moves by the same amount.

1.2 Setting the Vertical and Horizontal Axes

Vertical Position < Section 5.2 >

Since a total of eight input waveforms can be displayed, they may overlap each other, making observation difficult. In this case, the waveforms can be moved in the vertical direction so that they can be observed more easily.

The vertical position can be set to any value in the range between ± 4 div.

Changing the V/div setting, the vertical axis setting is rescaled with respect to the vertical position.

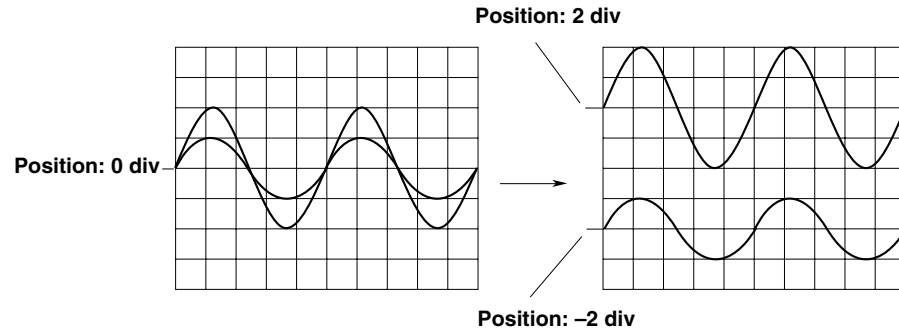

Time Axis < Sections 5.11 and 5.12 >

Selection of the timebase

With the default settings, sampling timing is controlled by the clock signal output from the timebase circuit of the instrument (refer to the Block Diagram of the instrument, section 1.1). The sampling timing can be controlled by an external clock signal instead of the clock signal from the timebase circuit.

An external clock signal can be input to the EXT CLOCK IN terminal on the rear panel. This external clock function is useful when you are observing a signal whose period varies or when you are observing a waveform by synchronizing it with the clock signal to be measured.

Setting the time axis

When using the internal clock, set the time axis scale as a time duration per division of the grid. The setting range is 1 ns/div to 50 s/div. The time range in which waveform is displayed is “time axis setting x 10,” as the display range along the horizontal axis is 10 divisions.

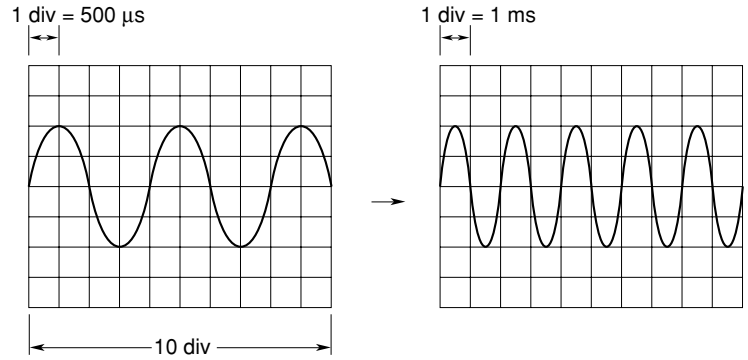

Note

Display of time axis direction

The sampled data is read into the acquisition memory, and a waveform is displayed based on this data. The number of data stored into the acquisition memory differs depending on settings such as time axis settings, trigger mode, and acquisition mode.

The number of display lines in the time axis direction on a 10 - div screen is 500 lines.

Processing therefore varies according to record length, as described immediately below. (for more details on the relation between time axis, acquisition mode, record length of acquisition memory and displayed record length, refer to Appendix 1).

- If displayed record length exceeds number of screen display points, multiple data points are connected with a line and displayed at the same time axis position.
- If displayed record length is less than number of screen display points, the oscilloscope interpolates the data to generate the display. (See section 1.4)

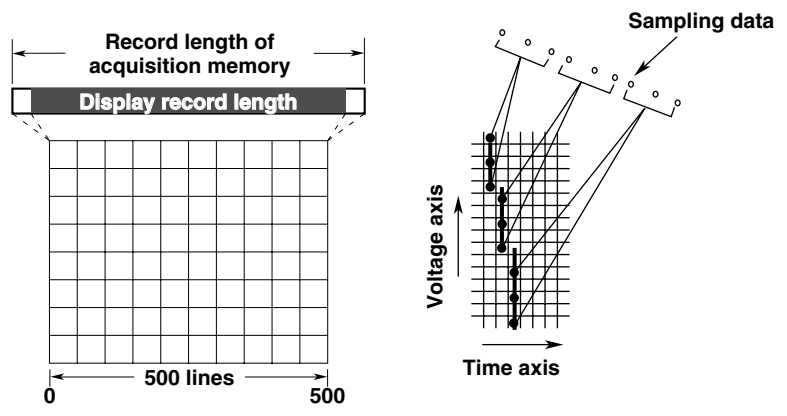

Relationship between the time axis setting, sample rate and record length

Changing the time axis causes corresponding changes in the sampling rate and the acquisition record length. For more detailed information, refer to Appendix 1.

1.2 Setting the Vertical and Horizontal Axes

Relationship between time axis setting and sampling mode

The sampling method (sampling mode) for an input signal changes according to the time axis setting as described hereafter. But note that the time - axis range over which this feature is actually available will vary according to the maximum displayable record length, as shown in Appendix 1.

• Real - time sampling mode

Changing the time axis causes a corresponding change in the sampling rate. The maximum sampling rate for the DL7100 is 1 GS/s (or 500 MS/s if interleave mode is OFF). For details of interleave mode, refer to section 1.4), and 2 GS/s for the DL7200 (or 1 GS/s if interleave mode is OFF).

The input signal is sampled sequentially, and data is stored in the acquisition memory.

In this mode, the waveform can only be displayed correctly at frequencies up to half the sample rate, due to Nyquist's theorem*. The sample rate is expressed in S/s (number of samples per second). Thus, this mode is suitable for observation of a waveform which fluctuates more slowly than the sample rate.

- * If the sample rate is higher than the frequency of the input signal, high frequency components will be lost. In this case, a phenomenon in which high frequency components change to lower frequency components occurs, due to Nyquist's theorem. This phenomenon is called aliasing. Aliasing can be avoided by setting the acquisition mode to envelope mode and acquiring the waveform.

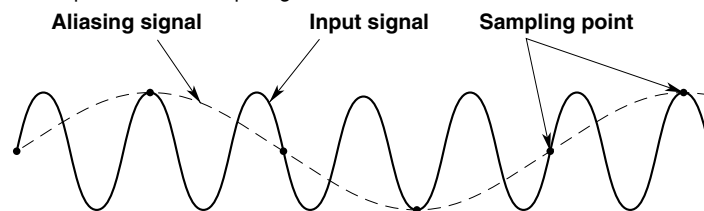

• Repetitive sampling mode

To enable this mode, you must set the time axis so that the sampling rate is greater than 1 GS/s (interleave ON: 2 GS/s) for the DL7100, or greater than 2 GS/s for the DL7200 (interleave ON: 5 GS/s). Under this mode, the oscilloscope produces a single waveform by taking samples over several periods of a repetitive signal, so that the sampling rate appears higher than it actually is. An apparent sample rate of up to 100 GS/s can be used.

Furthermore, even in the real-time sampling mode, if the sample rate exceeds 1 GS/s for the DL7100 (interleave ON: 2 GS/s) or 2 GS/s for the DL7200 (interleave ON: 5 GS/s) due to the time axis and the displayed record length settings, the sampling mode automatically changes to repetitive sampling.

There are two repetitive sampling methods: sequential sampling, in which a signal is sampled sequentially at a fixed interval, and random sampling, in which a signal is sampled at random to produce a waveform. This instrument uses a random sampling method which also enables observation of the waveform up to the trigger point (trigger position, refer to section 1.3).

Time axis setting and roll mode display

If the time axis is set within a certain range (refer to Appendix 1), then the display will not be updated by trigger anymore (update mode), but the mode will switch to roll mode when new data is acquired. In roll mode, the oldest data is deleted, and the waveform shifts from right to left on the screen. A waveform can be observed in the same way as it is recorded on a pen recorder. This mode is useful when you are observing a signal which repeats or which fluctuates slowly. This mode is also useful when you want to detect glitches (fast spikes on a waveform) which occur intermittently.

- * Rolling display also operates during single - start acquisition, although trigger occurrence causes the waveform to stop.

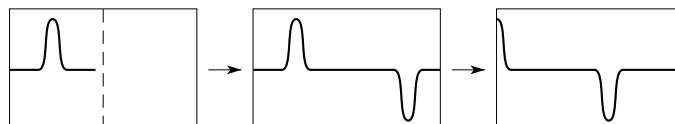

1.3 Setting a Trigger

Trigger Type < Chapter 6 >

There are two principal trigger types which you can use with the instrument.

Simple trigger

Enhanced trigger

Simple trigger → Sections 6.5 to 6.7

This is an edge trigger and the one which is used normally.

Enhanced trigger → Sections 6.8 to 6.15

This is a complex trigger. The following eight types of enhanced trigger are available.

A→B(n) trigger

A Delay B trigger

Pattern trigger

Width trigger

OR Trigger

Window trigger

TV trigger

Logic trigger (Optional)

Edge trigger → Section 6.5

The edge trigger is the simplest type of trigger and uses a single trigger source to activate a trigger. A trigger is activated when the trigger source exceeds (rises above) or drops (falls) below the preset trigger level*.

In addition to input signals (CH1 to CH4), the external trigger input signal, the commercial power supply signal that is used by the instrument can be used as a trigger source.

* "A trigger is activated" refers to the condition in which trigger conditions are satisfied and a waveform is displayed.

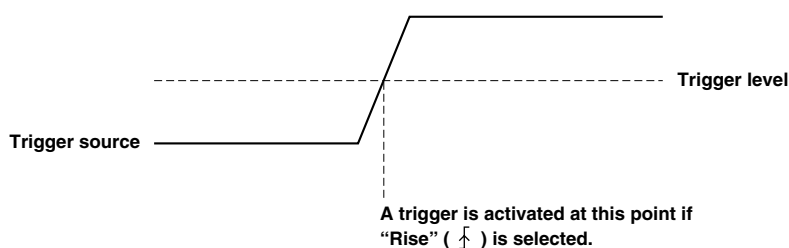

A → B(n) trigger (Enhanced Trigger) → Section 6.8

This function activates a trigger the nth time condition B becomes true after condition A has become true.

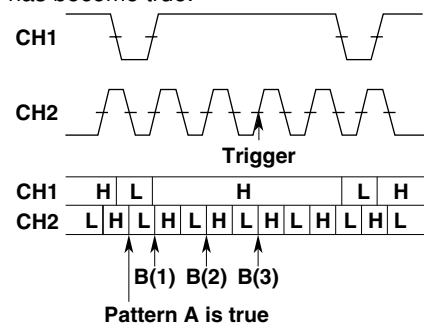

When pattern A: CH1 = L, CH2 = L, Enter, When patternB: CH1 = H, CH2 = H, Enter, n = 3

1.3 Setting a Trigger

A delay B trigger (Enhanced Trigger) → Section 6.9

This function activates a trigger the first time condition B becomes true after condition A becomes true and the specified time elapses.

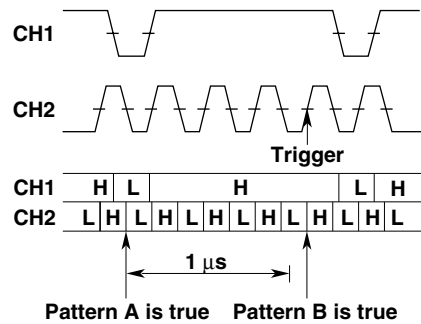

When pattern A: CH1 = L, CH2 = L, Enter, When patternB: CH1 = H, CH2 = H, Enter, Delay = 1 ms

Pattern trigger → Section 6.10

Multiple trigger sources are selected, and a trigger is activated when all of the trigger conditions set for each trigger source become true or false. Trigger conditions are established by setting combinations of the state (High or Low) of each trigger source. Furthermore, one of the trigger sources can be used as the clock signal, and triggering is synchronized with this clock signal.

Example: a trigger is activated when CH1: L, CH2: L, CH3: L and CH4: L

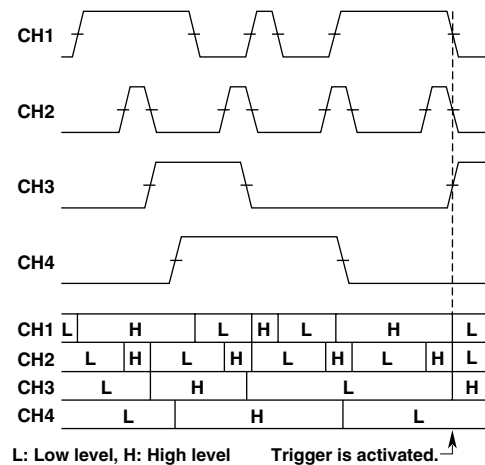

Pulse Width Trigger → Section 6.11

The time period during which the specified condition is met or not met is compared with the specified time period. The trigger condition is set with the AND of the signal state of each channel (High, Low, or Don't Care) or the AND of the window conditions of each channel (IN, OUT, or Don't Care).

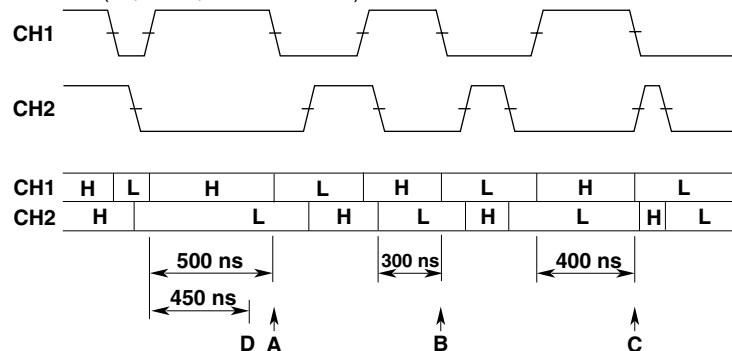

The description of the figure above is as follows.

If CH1 = H, CH2 = L, CH3 = X, CH4 = X, Condition = True, Time = 350 ns:

The trigger is activated at point B if Pulse < Time.

The trigger is activated at points A and C if Pulse > Time.

The trigger is activated at point C if $T1 < \text{Pulse} < T2$ where Time1 = 350 ns, Time2 = 450 ns.

The trigger is activated at point D if "Time out" is specified where Time = 450 ns.

OR trigger (Enhanced Trigger) → Section 6.12

A trigger is activated when any of the edge trigger conditions specified on CH1 to CH4 or the window condition is met. A trigger can be activated by either the rising edge of CH1 or CH2.

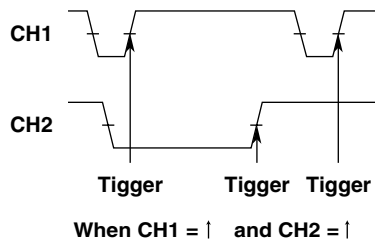

Window Trigger (Enhanced Trigger) → Section 6.13

A certain voltage range (window) is set and a trigger is activated when the trigger source level enters this voltage range (IN) or exits from this voltage range (OUT).

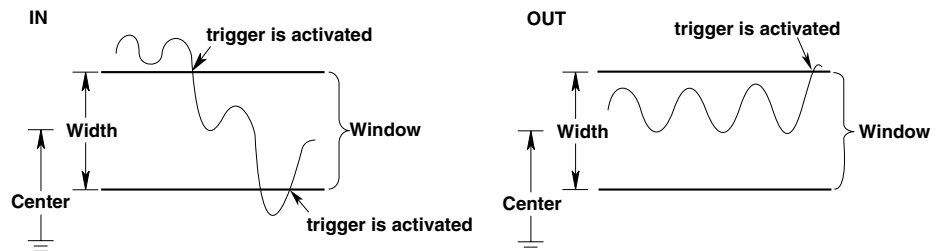

TV Trigger (Enhanced Trigger) → Section 6.14

The TV trigger is used when you are observing a video signal, and is compatible with NTSC, PAL and HDTV broadcasting systems.

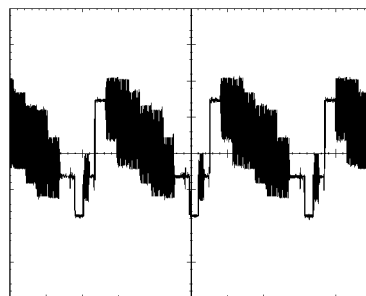

1.3 Setting a Trigger

Logic Trigger (ENHANCED, Optional) → Section 6.15

There are 2 input connectors, A and B, and 8 logic inputs for every POD being connected.

While the combined condition of “H,” “L,” and “Don’t care” for POD A and B (16 inputs) is satisfied, a trigger is activated at the rise or fall of the clock channel.

If the clock channel is not specified, a trigger is activated depending on whether or not the combined conditions of the logic input are met.

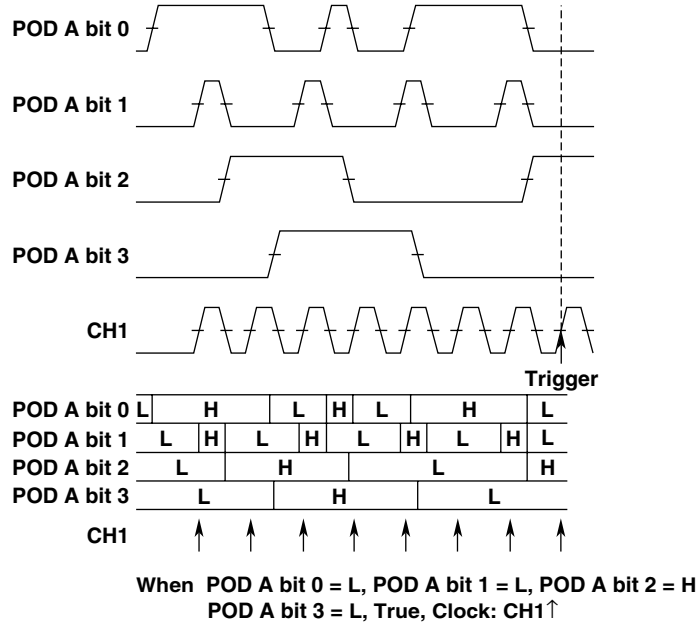

Trigger Mode < Section 6.1 >

Conditions for updating displayed waveforms are set. The following five types of trigger mode are available:

Auto mode

Displayed waveforms are updated each time a trigger is activated within a specified time (approximately 100 ms, referred to as the time-out period) and are updated automatically after each time-out period.

Auto-level mode

Waveforms are displayed in the same way as in Auto mode if a trigger is activated within the time-out period. If no trigger is activated, the center value of the amplitude of the trigger source (page 1 - 7) is detected and the trigger level is changed automatically to this center value, then a (edge) trigger is activated to update the displayed waveforms.

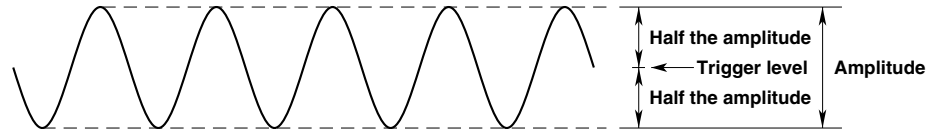

Normal mode

Displayed waveforms are updated only when a trigger is activated. Displayed waveforms will not be updated if no trigger is activated.

Single mode

When a trigger is activated, displayed waveforms are updated only once, then acquisition stops. This mode is useful when you are observing a single-shot signal.

Single (N) mode

This mode is useful when using the sequential store function (refer to page 7 - 5). Waveforms are acquired and stored in different memory areas each time a trigger is activated, then acquisition stops, and the waveforms are displayed. Acquisition is performed the specified number of times. Acquired waveforms can be displayed together, or they can be displayed individually. This mode is useful when you want to detect a sudden abnormality in a waveform.

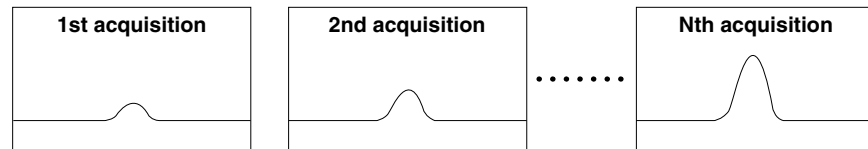
**Action-On Trigger < Section 6.1 >**

The displayed waveform can be output to the optional built-in printer, buzzer, or saved to a floppy disk each time a trigger is activated. Also sends a mail (Ethernet Communications + PC card Interface Optional).

Trigger Coupling < Sections 6.5 and 6.8 to 6.13 >

Input coupling can also be switched for trigger sources as it is for input signals. Select the type of input coupling which is most suitable for the trigger source signal.

The following two types of input coupling are available for trigger source signals.

- DC : The trigger source signal is used as the trigger source without any processing.
- AC : The trigger source signal is used as the trigger source after the DC content has been removed from it. A trigger can always be activated if the trigger level is set to 0 V as long as the signal's amplitude is one division or more.

HF Rejection < Sections 6.5 and 6.8 to 6.13 >

Set HF rejection to ON when you want to remove high frequencies exceeding 15 kHz or 20 MHz from the trigger source. This prevents a trigger from being activated unexpectedly due to high frequency noise.

Trigger Hysteresis < Sections 6.5 and 6.8 to 6.13 >

If the trigger level width is not sufficient, the trigger point fluctuates each time a trigger is activated if noise is present in the trigger source, thereby resulting in unstable displayed waveforms. To solve this problem, a specified margin (hysteresis) can be added to the selected trigger level.

The hysteresis level can be chosen from " $\overline{\Delta}$ " and " Δ ." If " $\overline{\Delta}$ " is selected, a wide hysteresis level is provided to eliminate fluctuation in the trigger point, thereby resulting in a stable displayed waveform. However, in this case, the trigger points become uncertain. Thus, select " Δ " if you want to activate a trigger to detect small fluctuations in a waveform.

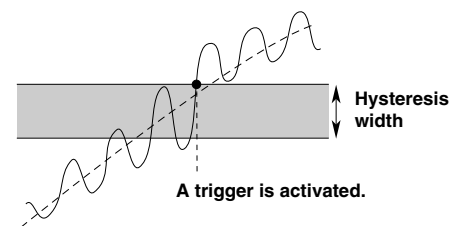
**Trigger Source and Trigger Level < Sections 6.5 to 6.13 >**

Trigger source : Selects the signal for the selected trigger type. The external trigger signal or the commercial power supply signal can also be used a trigger source.

Trigger level : Sets the voltage level used to judge trigger conditions such as trigger slope (rise/fall of a signal).

Trigger Hold-off < Section 6.4 >

The trigger hold-off function temporarily stops detection of the next trigger once a trigger has been activated. For example, when observing a pulse train signal, such as a PCM code, display of the waveform can be synchronized with repetitive cycles; or when using the history memory function, you may want to change the repetitive period, as shown below.

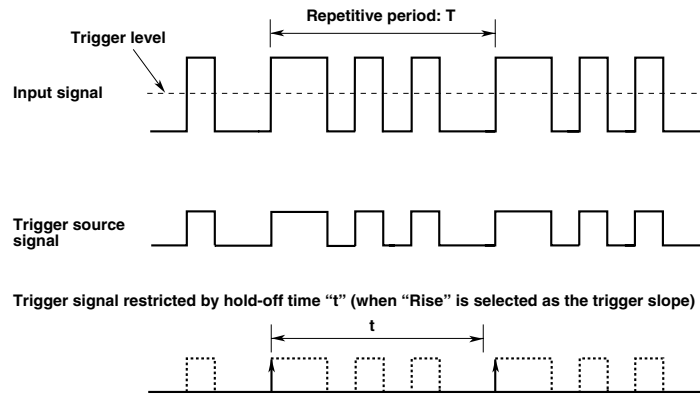

Trigger Delay < Section 6.2 >

Normally, the waveform around the trigger point is displayed. However the trigger delay function enables display of a waveform which has been acquired after a specified time (called the delay time) has elapsed following activation of a trigger.

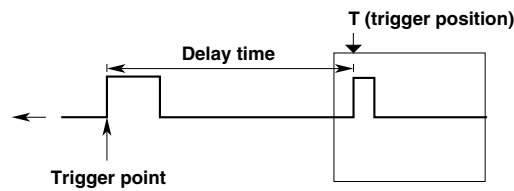

Trigger Position < Section 6.3 >

The trigger position indicates which position of the waveform in the acquisition memory will actually be displayed on the screen. The trigger point refers to the point at which a trigger is activated. In case the trigger delay (to be explained here after) is set to 0s, the trigger point and the trigger position refer to the same location. You use this setting to select how much pre-trigger area and how much post-trigger area to show on the display.

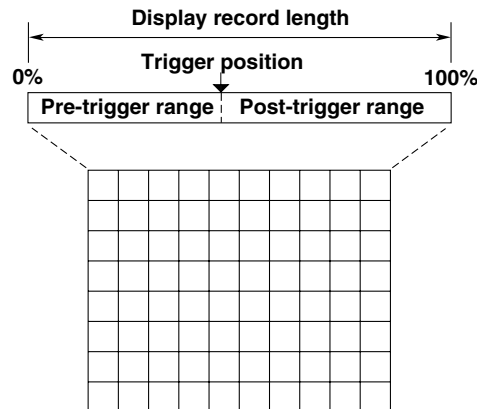

1.4 Setting the Acquisition and Display Conditions

Record Length < Section 7.1 >

The term “record length” refers to the number of data points (per channel) acquired in the acquisition memory. “Displayed record length” refers to the number of these data points that are actually displayed on the screen. (Note that sampling rate and record length will vary according to the time-axis setting; see page 1 - 5) The DL7100 lets you set the record length to any of the following: 1 kWord, 10 kWord, 50 kWord, 100 kWord, 250 kWord, 500 kWord, 1 MWord, 2 MWord, 4 MWord, or 8 MWord, or even 16 MWord with the DL7200.

In most cases the displayed record length is identical to the (acquisition) record length. For certain time-axis settings, however, the lengths become different. For details, refer to Appendix 1.

Interleave Mode < Section 7.5 >

This mode doubles the amount of memory per channel, while cutting the number of channels in half. If you are using an 8 - channel model, for example, then setting this mode ON will disable use of CH2 and CH4, while reassigning the memory for those channels to CH1 and CH3.

This mode doubles the maximum settings for history memory, sequential store, and record length.

Furthermore, because the maximum sample rate can be increased by sampling the input signal using two A/D converters, real-time sampling at a rate of 1 GS/s for the DL7100 or 2 GS/s for the DL7200 becomes possible.

For the relationship between the interleave mode, time axis, record length, and sample rate, see appendix 1, “Relationship between the Time Axis Setting, Sample Rate, and Record length.”

Acquisition Modes < Sections 7.2 and 7.4 >

When storing sampled data in the acquisition memory (refer to “Signal flow” in section 1.1), it is possible to perform processing on specified data and display the resultant waveform. The following data processing methods are available.

Normal mode

In this mode, sampled data are stored in the acquisition memory without processing.

Averaging mode

Averaging is a process in which waveforms are acquired repeatedly to obtain the average of waveform data of the same timing (the same time in relation to the trigger point).

If this mode is active, the instrument takes the linear or exponential average of incoming data and writes the results into acquisition memory. The averaged data is then used to generate the display. You can set the attenuation constant to a value from 2 to 256 (in 2n steps), and the averaging count to a value from 2 to 65536.

Exponential averaging (count = Infinite)

$$A_n = \frac{1}{N} \{(N - 1) A_{n-1} + X_n\}$$

A_n: Value obtained after nth averaging

X_n: nth measured value

N : Attenuation constant
(2 to 256, in steps of 2ⁿ)

Linear averaging (count = 2 to 65536)

$$A_N = \frac{\sum_{n=1}^N X_n}{N}$$

X_n: nth measured value

N : Number of averaging times
(Acquisition count,
in steps of 2ⁿ)

This averaging process is useful when you want to eliminate random noise.

1.4 Setting the Acquisition and Display Conditions

Envelope mode

In normal mode and averaging mode, the sample rate (the number of times data is acquired per second in the acquisition memory) drops if T/div is increased (refer to Appendix 1 "Relationship between the time axis setting, sample rate and record length"). However, in the envelope mode, the maximum and minimum values are determined at every time interval from the data sampled at 400 MS/s for the DL7100 (interleave mode: 800 MS/s or 1 GS/s) or 800 MS/s for the DL7200 (interleave mode: ON or OFF). The time interval used to determine the values is the twice the sampling interval of the normal mode. The maximum and minimum values are paired and acquired in the acquisition memory.

Envelope mode is useful when you want to avoid aliasing (section 1.2), since the sample rate is kept high irrespective of the time axis setting (T/div). Furthermore, envelope mode is also useful when you want to detect glitches (pulsing signals which rise very fast) or display an envelope of a modulating signal.

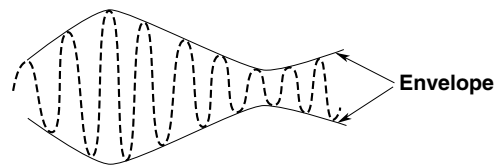

Box average

Taking the data sampled at 400 MS/s for the DL7100 (interleave mode: 800 MS/s) or 800 MS/s with the DL7200 (interleave mode: ON or OFF), the moving averages of certain number of data points are determined as shown in the following figure. These data are acquired in the acquisition memory and displayed. Box averaging is useful for eliminating the small amount of noise on the input signal. It is also effective in removing the noise from a signal acquired only once.

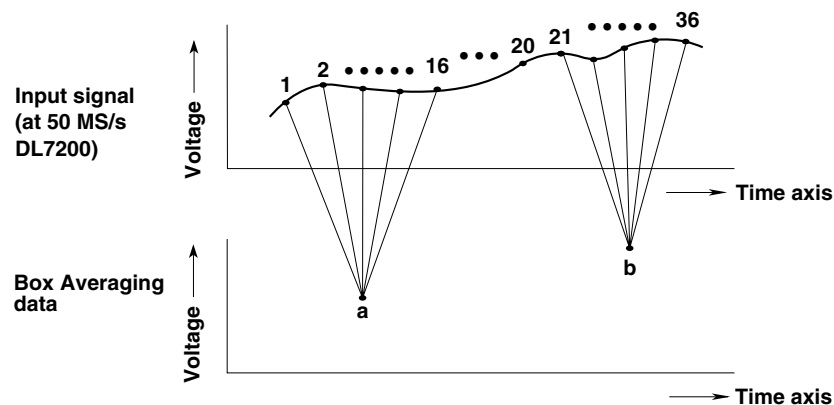

Sequential Store < Section 7.3 >

In the real-time sampling mode, waveform data will be stored in the acquisition memory only a set number of times, and all waveforms can be displayed. This stops automatically after acquisition. The maximum acquisition count available with the feature varies depending on the instrument and the record length.

The range for the DL7100 is 2 to 2048 times, or 2 to 4096 times for the DL7200.

Once the specified number of waveforms have been stored, you can display any of the waveforms individually or all of them together, so that it is possible to derive a time series of the waveform variation. The drawings below illustrate how stored data can be displayed (assuming sequential storage of 100 waveforms).

Display example in case count = 100 times

**Displaying all waveforms
(ALL)**

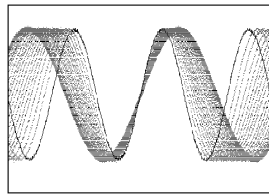

**Displaying newest waveform
(Selected Record No. = 0)**

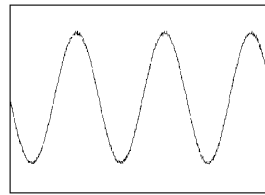

**Displaying oldest waveform
(Selected Record No. = -99)**

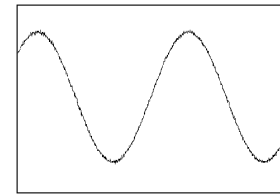
**Sampling Mode < Section 7.6 >**

As explained earlier in "Relationship between the time axis setting and sampling mode" (page 1 - 6), data sampling can be performed either in real-time or in repetitive sampling mode depending on the time axis and record length. The available time - axis range under repetitive mode varies according to the acquisition settings. For details, refer to Appendix 1.

Accumulated Waveform Display < Section 8.6 >

This mode holds each waveform on the screen for a time that is longer than the update cycle, so that multiple waveforms are overlapped. The waveform age can be identified by color.

The following two modes are available.

- **Persist** : Overlaps the display of waveforms using the display color of each channel.
- **Color** : Overlaps the display of waveforms using 8 colors which signify the frequency of occurrence of the data values.

This function is useful when you want to observe jitters and temporary turbulence in waveforms.

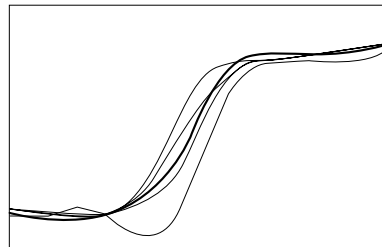

History Memory < Section 7.7 >

The oscilloscope automatically retains the last N waveforms recorded. The value of N varies in the range 2 to 2048 for the DL7100 and 2 to 4096 for the DL7200 depending on the record length and interleave mode. The oscilloscope retains all waveforms for the first N triggers; then, for each subsequent trigger, the oscilloscope overwrites the oldest stored waveform. You are free to switch the display from the current (newest) waveform to any of other N-1 waveforms in the history. The illustration below shows how data can be displayed, assuming N = 1024.

Saved waveform data of previous 1024 triggers

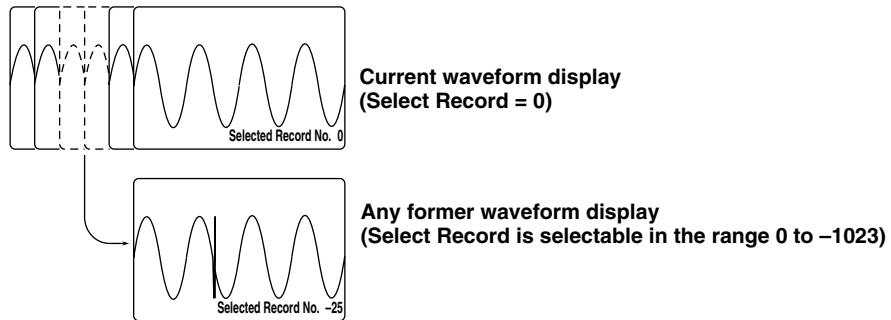

In addition, a particular waveform can be found from the past waveforms that are held.

Display Settings < Chapter 8 >

Display format → Section 8.1

- You can display waveforms from different channels in different windows. You can choose to use 1 window (Single), 2 windows (Dual), 3 windows (Triad), 4 windows (Quad) or 6 windows (Hexa).
- You can select either of the following two methods for assigning channels to windows.
 - Auto : Channels that are set to ON are displayed in order of channel number, with the lowest channel displayed in the top window.
 - Fixed : Channels are displayed in order of channel number, regardless of whether ON or OFF.
 - User : Arbitrarily assign the channels to the split screens, regardless of whether or not the channel display is turn ON.

Graticule → Section 8.3

Use this feature to select use of grid, frame, or “cross” graticule.

Scale values → Section 8.4

The values at right and left ends of the horizontal axis and the upper and lower limits (scale values) of the vertical axis of each channel can be displayed.

Waveform labels → Section 8.5

You can assign an arbitrary label (up to 8 characters) to each waveform.

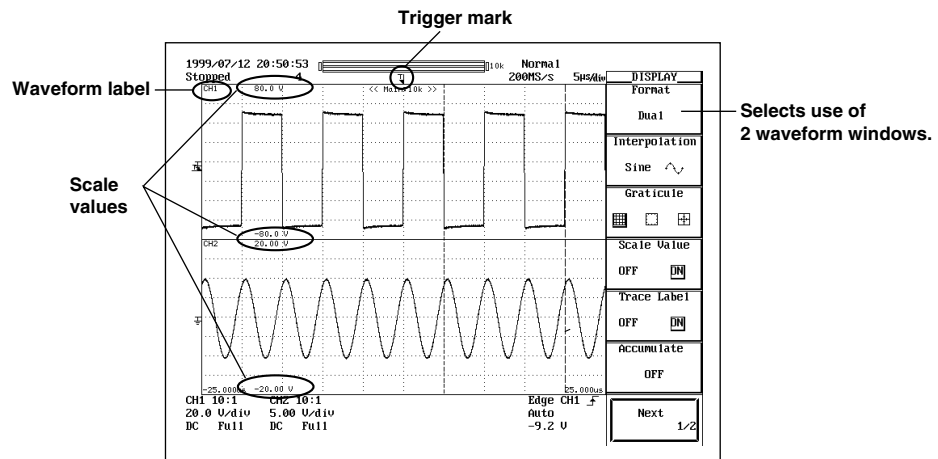

Display Interpolation < Section 8.2 >

This feature selects the type of interpolation applied in areas where there are less than 500 sample points (Less than 250 points in the zoom window when zooming on the waveform using Main & Z1 & Z2) per 10 time-axis divisions. (These areas are referred to as interpolation areas.) Three settings are available.

Line interpolation

Interpolates between two dots using a straight line.

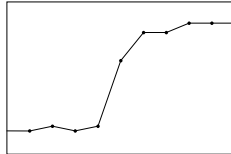
**Sine interpolation**

Generates interpolation data using the function $\frac{\sin x}{x}$ then interpolates between two dots using the resulting sine curve. Sine interpolation is suitable for observation of sine waves.

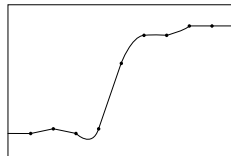
**Pulse interpolation**

Interpolates between two dots using a step.

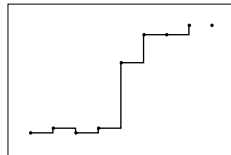
**No interpolation**

Displays measurements as discrete dots, without interpolation.

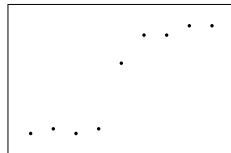

X-Y Waveform Display < Section 8.7 >

This feature plots the voltage values of one input waveform (on the X axis) against the voltage values of the others (on the Y axis, which have their display turned ON). The X-Y plot lets you view the relationship between the signal voltages. The X-Y waveforms and normal waveforms (a waveform displayed using voltage and time axes) can be displayed simultaneously.

Use of this X-Y waveform display function enables measurement of the phase angle between two sine wave signals. For example, two X-Y sine waveforms are displayed to obtain an X-Y waveform (called a Lissajous waveform), from which the phase angle can be obtained.

Lissajous waveform

Phase angle 0°			
Phase angle 45°			
Phase angle 90°			
Frequency ratio (X : Y)	1 : 1	1 : 2	1 : 3

Expanded Waveform < Section 8.8 >

Waveforms can be expanded in the time axis direction. This function is useful when you want to change the T/div setting after the waveform has been displayed in single mode or when you want to extend the acquisition time to observe a particular part of the waveform thoroughly.

Zooming is not available on areas with less than 11 data points.

You set the zoom position according to its time-axis location.

Zoom display arrangement

You can display one or two zoom windows on the screen. Four display arrangements are available, as follows:

Main : Main area

Z1, Z2 : Zoom area

<Main>		<Main>		<Z1>	<Z1>
<Z1>	<Z2>	<Z1> or <Z2>		<Z2>	or <Z2>

If you display the “main” area (normal waveform display) together with one or both zoom windows, the main area will include vertical lines (or “zoom boxes”) indicating the zoom area (s). The center of the zoom area corresponds to the center of the zoom box.

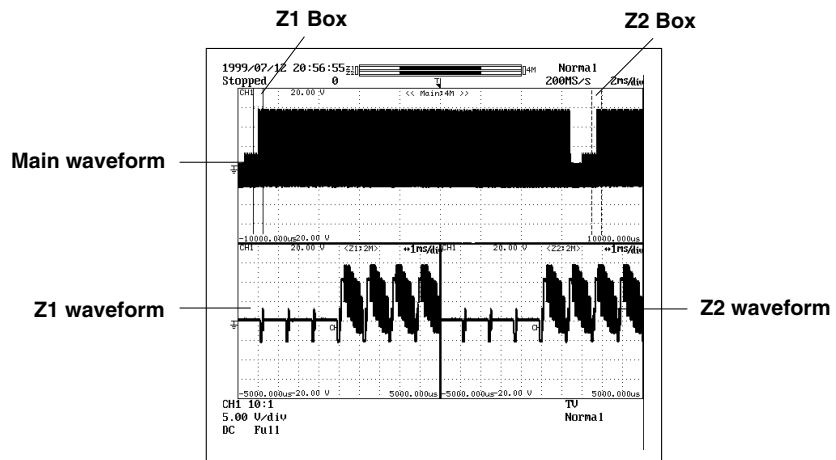

1.5 Analyzing the Waveform

Linear Scaling < Section 5.9 >

It is possible to append a scaling constant A, an offset value B and a unit to the measurement value X of cursor or automated measurements. Linear scaling is useful, when applying a voltage divider ratio to the measurement values. Linear scaling is also handy when you want to your scope to automatically convert the measured voltage results into the (for example, current or temperature) measurement unit of your signal source.

$$Y(\text{UNIT}) = AX + B \quad Y = \text{result of linear scaling}$$

Cursor Measurements < Section 9.1 >

You can use the following cursor types to analyze the waveform data.

- V cursors (Vertical)
 - Two vertical broken lines (V cursors) are displayed. The time from the trigger position to each V cursor and the time difference between the V cursors are measured. In addition, the voltage of the signal at each cursor position and the voltage difference between the cursors are measured.
- H cursors (Horizontal)
 - Two horizontal broken lines (H cursors) are displayed. The values in the vertical direction of each H cursor and the difference between the two are measured.
- Marker cursors (Markers)
 - Use this feature to place one or two markers onto the waveform. You can then read the voltage value and time value (relative to trigger position) at each marker, and the voltage difference and time span between the markers.
- Angle Cursors (Degree)
 - Set the measurement zero point and the end point and then using the angle corresponding to the width between the two as a reference, measure the angle of the two angle cursors.

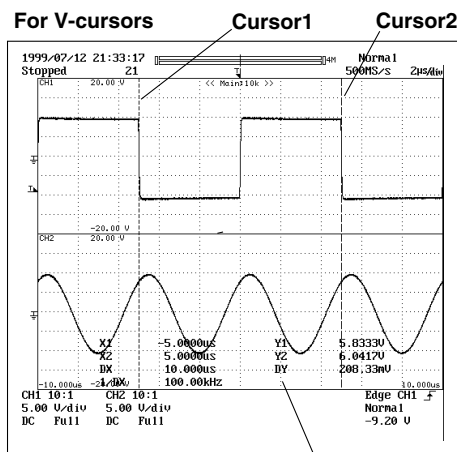

Measurement value of cursor

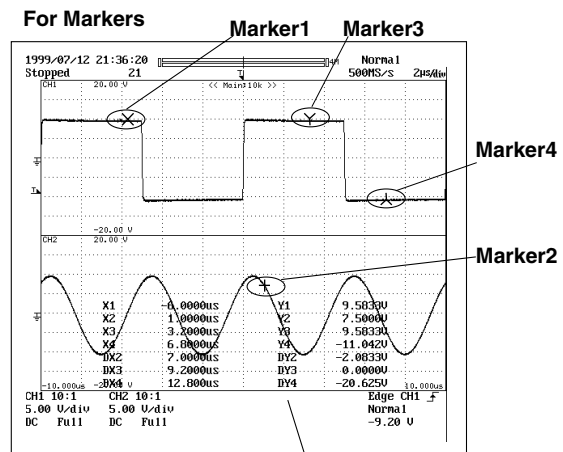

Measurement value of cursor

Automated Measurements < Sections 9.2 and 9.3 >

Automatic measurement of waveform parameters → Section 9.2

This feature automatically measures selected waveform parameters, such as rise time and pulse width. You can select parameters separately for each channel, although you are limited to a total of 12 parameters to display. There are 27 parameters available for selection.

Statistical Processing → Section 9.3

Statistical processing is performed on the automated measured values described above. The following five statistics are determined on the two measured values of automated measurement parameters.

Maximum value

Minimum value

Average value

Standard deviation

Number of measured values used in the statistical processing

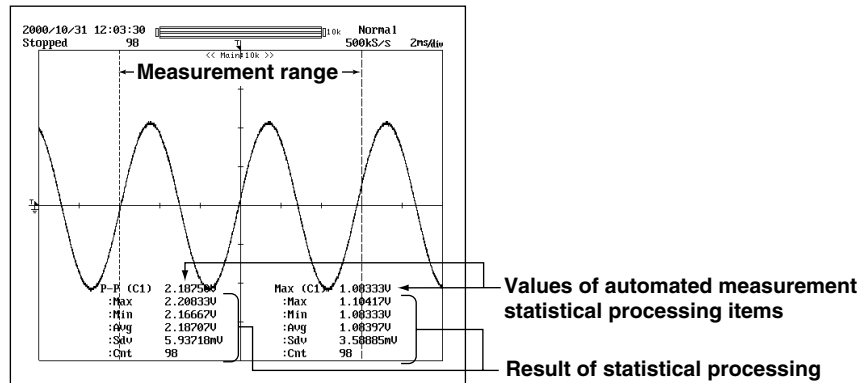

The following three methods are available in the statistical processing.

- Normal statistical processing
Statistical processing is performed on all acquired waveforms while acquiring waveforms.
- Statistical processing for each period
Divides the displayed waveform using a period that is automatically calculated and determined and performs statistical processing on the measured values over the determined period. Statistical processing is performed from the oldest measured data of the displayed waveform.

Example in which CH1 is selected as the waveform for determining the period

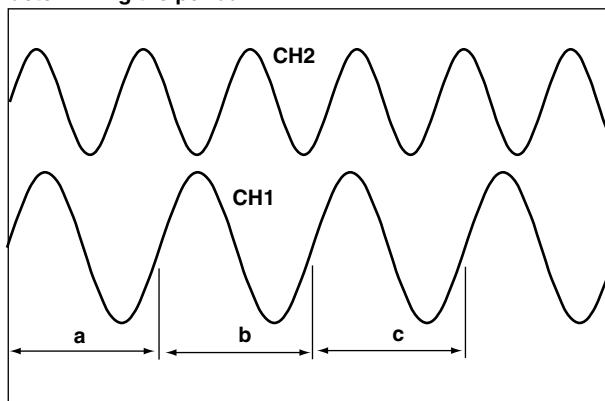

Measures the parameters of automated measurement in the ranges a, b, and c and performs statistical processing of the parameters in the order a, b, and c.

The parameters of automated measurement of other channels are also measured in the ranges a, b, and c. The automated measurement can also be performed using the period of each waveform as the range.

- Statistical processing of historical data
Performs automated measurement of waveform parameters on the waveform that is acquired using the history memory function and performs statistical processing. Statistical processing is performed starting with the oldest waveform.

Waveform Math < Chapter 9 >

Addition, subtraction, and multiplication → Section 9.4

Addition, subtraction, and multiplication can be performed between CH1 and CH1 to CH4, CH2 and CH1 to CH4, CH3 and CH1 to CH4 or Math1, and CH4 and CH1 to CH4 or Math1. The result is displayed as waveform Math1 or Math2.

Addition and subtraction are useful for comparing signals with the standard signal, checking the signal logic, and comparing signal phases. Multiplication is useful for checking power signals by applying voltage and current signals.

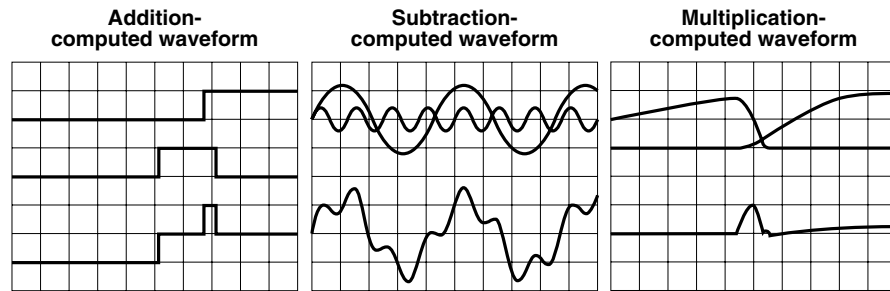

Binarization → Section 9.5

Converts the selected waveform into a binarized waveform. All voltages below the threshold become 0, while voltages above the threshold become 1. This operation is available for CH1 to CH4, and the Math1 waveform.

Inverted display → Section 9.6

By multiplying the measured data by -1 , the waveforms are displayed with the voltage axis inverted. This operation can be performed on CH1 to CH4, and Math1.

Differentiation and Integration → Section 9.7

Differentiates or integrates the waveform on the specified channel. This operation can be performed on CH1 to CH4, and Math1.

Scaling of Math1 and Math2 waveforms → Sections 9.4 to 9.8

The instrument normally auto scales when displaying the computed waveform, but manual scaling can also be selected.

If you select auto scaling, the most suitable upper and lower limits that are best suited for displaying the waveforms are determined from the voltage axis, the offset voltage, the type of computation and other factors of the waveform being computed.

If you select manual scaling, then the upper and lower limits of the computed waveform display can be set to any desired values.

Phase-shifted addition, subtraction, and multiplication → Section 9.10

Displays the phase-shifted waveforms of CH1 to CH4 or performs a computation using the phase-shifted waveforms.

Power Spectrum Display < Section 9.8 >

FFT (Fast Fourier Transform) computation can be performed on the input signal to display its power spectrum. This is useful when you want to check the frequency distribution of the input signal.

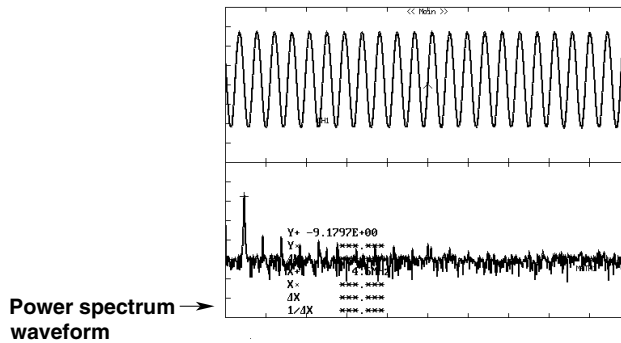

Three time windows are available: a Rectangular window, a Hanning window, and a Flattop window.

The rectangular window is effective for transient signals, such as an impulse wave, which attenuate completely within the time window. The Hanning window allows continuity of the signal by gradually attenuating the parts of the signal located near the ends of the time window down to the “0” level. Hence, it is effective for continuous signals. The frequency resolution of the Hanning window is higher than that of the flat top window. However, the level accuracy of the spectrum of the flat top window is higher than that of the Hanning window. When the waveform being analyzed is a continuous-type signal, select the appropriate window that suits the application.

FFT computation generates 1000 or 10000 measurement data points, but only half points are displayed on the screen.

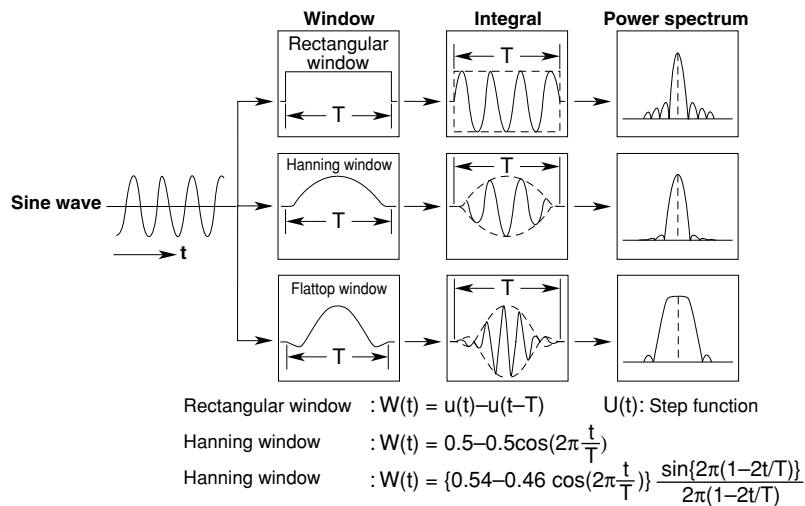

[FFT function]

When the complex result of FFT computation is $G = R + jI$, the power spectrum can be expressed as follows.

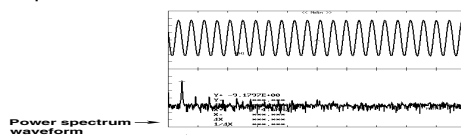

Data Search (History Search Function) < Sections 7.8 and 7.9 >

This feature can be used to search waveforms that match the specified conditions from the acquired measurement data.

History memory search using zone → Section 7.8

Searches waveforms that did or did not pass the specified area from the history memory.

Waveform that was saved using the history memory function

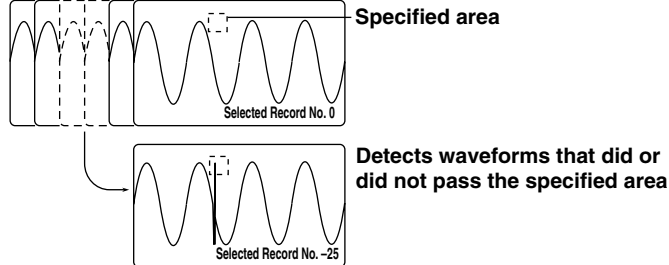

History memory search using Waveform Parameters → Section 7.9

Searches waveforms that did or did not satisfy the specified condition from the history memory. Applicable to DL7100 with software (ROM) version 1.21 or later. See section 15.4, "Checking the System Condition."

Data Search (Search and Zoom Function) < Section 8.9 and 8.10 >

Edge search

Searches for a particular section of the current displayed waveform by counting the number of times the value went above (rising) or below (falling) the specified level from the start point of the search. The section of the waveform that is found to meet this condition is displayed in the zoom window using the zoom rate.

Start point of the search

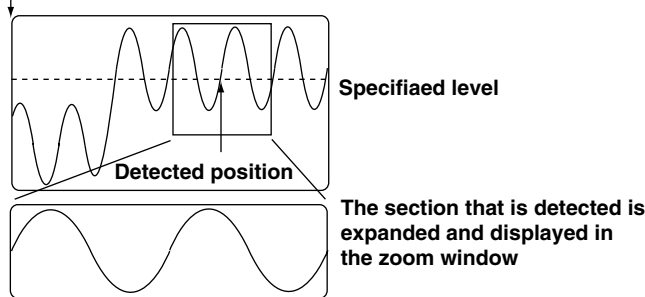

When the edge is set to rising and the count is set to 3

Serial Pattern search (Section 8.9)

Searches for a particular section of the current displayed waveform. Searches sections of the waveform with the same pattern as the specified waveform pattern (High, Low, Don't Care). The waveform patterns are detected using the rising and falling edges of the channel specified as the clock channel or over a certain time interval. The section of the waveform that is found is displayed in the zoom window using the zoom rate.

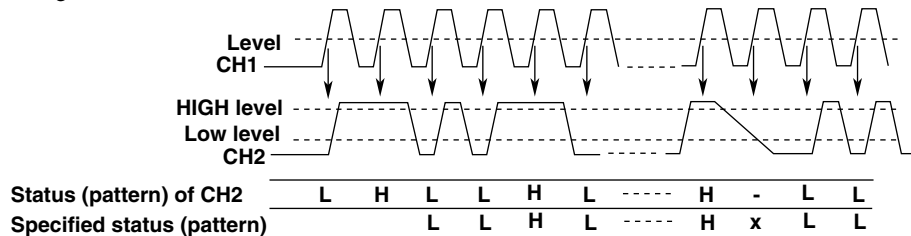

Conditions : Searches sections of the waveform with the same status (up to 64 patterns) as the specified waveform pattern
 Clock channel : CH1
 Timing to check the status : Rising
 Channel on which to perform the search : CH2

Parallel Pattern search (Section 8.9)

Search for specific portions of the currently displayed waveform.
 Search for parts of waveform patterns identical to those previously set in CH1-CH4, Math1, Math2, PodA, PodB (High, Low, Don't Care). Search by the pattern of each bit in PodA and PodB. (Applicable to DL7100 with software (ROM) version 1.21 or later. See section 15.4, "Checking the System Condition.")

Pulse Width search (Section 8.9)

Search for specific portions of the currently displayed waveform.
 From the search start position, search for a portion of the waveform containing a pulse which is longer or shorter than a previously defined length of time. Expand the retrieved portion of the waveform per the zooming factor and display it in the waveform zoom display window. (Applicable to DL7100 with software (ROM) version 1.11 or later. See section 15.4, "Checking the System Condition.")

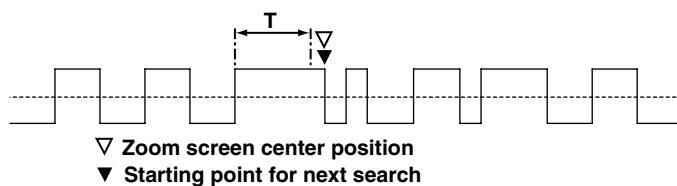

Conditions: Pulse > T
 Pulse: the length of time a specified condition is fulfilled
 T: a specified length of time

In the example above, the search finds a portion of the waveform which satisfies the condition and is longer than the specified length of time.

Auto Scroll (Section 8.9)

The zoom box scrolls automatically in a designated direction. You can stop the zoom box while checking zoomed waveforms. (Applicable to DL7100 with software (ROM) version 1.21 or later. See section 15.4, "Checking the System Condition.")

Analyzing and Searching SPI Signals (Section 8.10)

SPI stands for Serial Peripheral Interface. It is a serial interface proposed by Motorola. Data transmission is carried out using three signal wires, clock signal, data output, and data input. By adding a chip select signal (CS), a master device can control the output of a slave device.

Data is transmitted in units of bytes (8 bits) by synchronizing to the clock signal. The DL7100/DL7200 can analyze the SPI signal in 1-byte unit and search patterns. (Supported by products with software (ROM) version 3.01 or later. See section 15.4, "Checking the System Condition (Overview).")

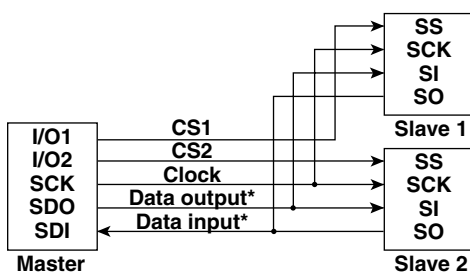

* Input and output as seen from the master device.

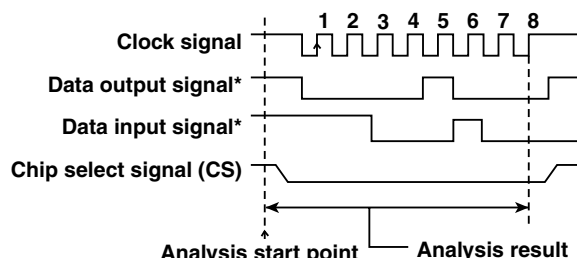

Analysis result
 Byte number: 0
 Data output signal*: 08
 Data input signal*: C4
 Chip select signal: L level

1.6 Other Useful Functions

Initialization < Section 4.2 >

This function resets the key settings to the factory settings (default settings), and is useful when complex settings have been made and you want to cancel all of them at once.

However, settings related to communications and the SCSI ID are not reset.

Auto Set-up < Section 4.3 >

This function makes settings automatically such as vertical sensitivity, time axis and trigger settings, to suit the signal to be measured. This is useful when the signal to be measured is unknown. However, there might be particular signals for which the auto set-up function may not work properly.

Snapshot < Section 4.5 >

If single start is not selected, a waveform is updated at the specified intervals or is displayed in roll mode. Thus, to retain the currently displayed waveform, acquisition must be stopped. Use of the snapshot function allows the currently displayed waveforms to remain temporarily on the screen without acquisition being stopped. To activate this function, just press the SNAP SHOT key without stopping acquisition. The currently displayed waveform will be retained. This waveform is called a snapshot waveform. The snapshot waveform is displayed in white color unlike the updated waveform, making comparison between the two easier.

Snapshot waveforms are screen image data, so they cannot be used for cursor measurement or automated measurement. However, screen image data output (hard copy) is possible.

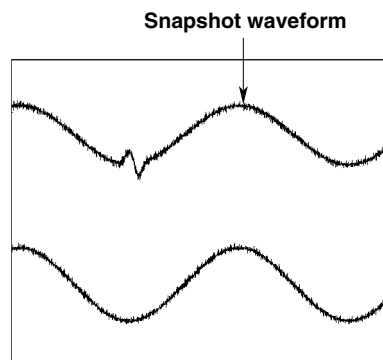

Clear Trace < Section 4.5 >

This function clears all waveforms other than the loaded waveforms and restarts the averaging, repetitive sampling, and accumulation in a signal operation.

Preset < Section 5.6 >

This function automatically sets the V/div, input coupling, trigger level, and other parameters to appropriate values for the TTL or ECL signal (or any arbitrary value specified). The function can also set the parameters to values suitable for the specifications of the 700937 current probe and the 701930 current probe. The 700937 current probe is supported by software (ROM) version 1.21 or later on the DL7100 (see section 15.4, "Checking the System Condition"). The 701930 current probe is supported by products with software (ROM) version 1.21 or later (see section 15.4, "Checking the System Condition").

GO/NO-GO Determination < Section 9.11 >

The GO/NO-GO function is useful when you want to inspect signals and track down abnormal symptoms on a production line making electronic equipment. Two determinations are available with GO/NO-GO operation using the Measurement of Waveform Parameters and using the zone (Applicable to DL7100 with software (ROM) version 1.21 or later. See section 15.4, "Checking the System Condition."). This function detects whether an automatically measured value falls within the specified range, and responds accordingly, either by sounding the buzzer, saving the waveform data to internal memory or disk, printing out the screen image (option), or Sending a mail (Ethernet + PC Card Interface option).

Displayed-data output functions < Chapter 10 >

You can use these functions to print the screen image to the (optional) built - in printer, an external centronics printer or a network printer, to save the image data to the storage medium (floppy disk, external SCSI device, PC Card (optional) or network drive (Ethernet + PC Card Interface Optional)).

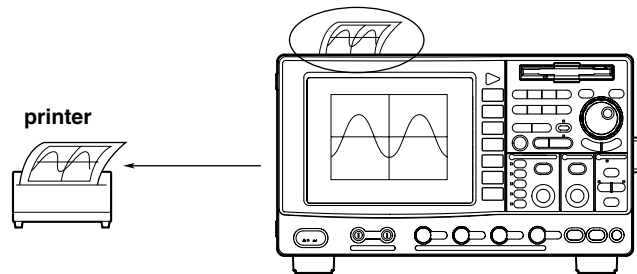
**Note**

The instrument provides a function which enables you to use the keyboard displayed on the screen to enter and display a comment. If you enter a comment which indicates the contents of the displayed waveforms before printing a hard - copy, it will help you to distinguish between different print outs.

Recording Medium saves and loads < Chapter 11 >

The instrument standard configuration includes a built-in floppy drive and SCSI connector, and the optional configuration includes PC Card Interface and Ethernet connector. You can also choose to install an optional MO drive. It is also possible to save data to an external SCSI device, PC Card or Network Drive.

You can save data in any of the following formats: HP-GL command format, Postscript, TIFF, and BMP. This means that you can easily insert the saved images into documents produced by conventional DTP software packages.

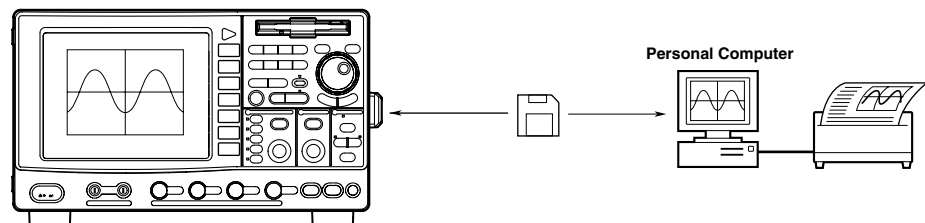

Ethernet Communications (Optional) < Chapter 13 >

Saving to a network drive (FTP client function)

You can save, delete, and copy waveform data and setting information onto the hard drives of devices on the network such as PCs and workstations just as you would onto internal floppy disks and hard disks. You can also save screen image data. Since the DL is running the client in this situation, you must carry out these procedures with a PC or workstation running the FTP server function.

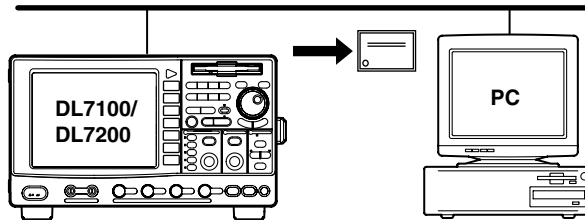

File retrieval from the DL7100/DL7200 floppy or hard drive (FTP server function)

You can download files from the internal floppy disk or hard disk of the DL7100/DL7200 using a networked PC or workstation. Since the DL is acting as the FTP server in this situation, the PC must be acting as the client.

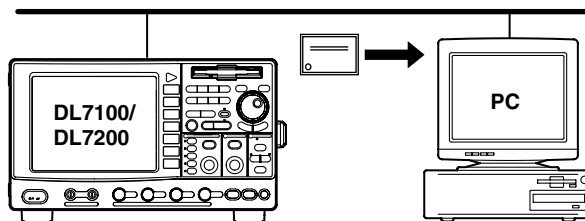

Outputting to a network printer (LPR client function)

You can print screen images to a network printer just as you would to the DL7100/DL7200's built-in printer, or to a printer with a Centronics interface.

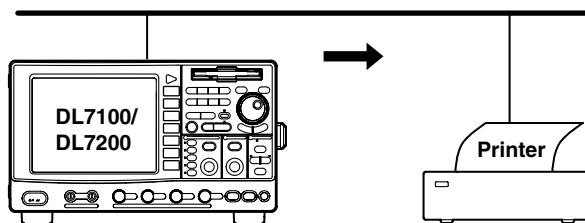

Mail transmission (SMTP client function)

You can send transmissions to a given email address at specified intervals. Using this function, you can periodically transmit such information as GO/NO-GO results and the measurement rate.

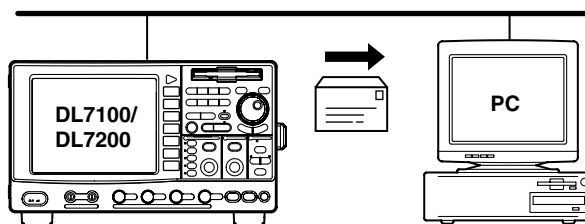

Communications < Interface User's Manual (IM701410-11E) >

The instrument is equipped with a GP-IB interface as standard. The interface enables you to send waveform data to a personal computer for analysis, as well as to perform waveform measurement while controlling the instrument using an external controller.

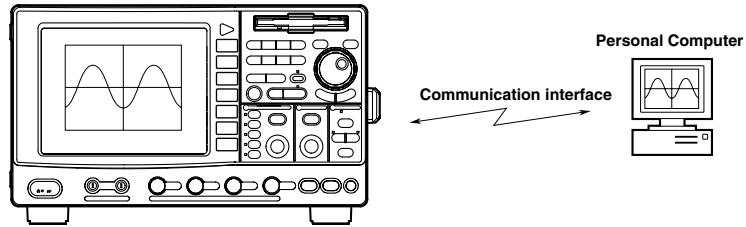

2.1 Front Panel/Rear Panel

Menu keys (Page 2-3)
Press a key to display the corresponding menu.

ESC key
Closes pop-up menu or soft-key menu.

LCD screen

Ground connector
Ground connection used for probe calibration.

COMP output (Page 3-9) ⚠
Outputs probe compensation signal.

Power switch (Page 3-6)

Ethernet connector (Chapter 13, optional)

External trigger/clock/trigger gate input terminal (Pages 5-14, 6-8 and 12-1) ⚠

Trigger output terminal (Page 12-2)

Power connectors for the probes (Page 3-8) ⚠
Provides power to YOKOGAWA's FET probes or current probes.

Serial port (RS-232) connector
For details about communication functions, refer to the instrument Communication Interface Manual (IM701410-11E).

RGB VIDEO OUT terminal (Page 12-4)

Top View

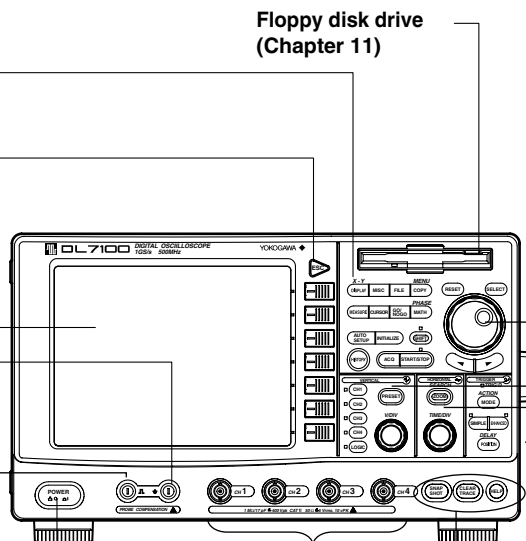

Floppy disk drive (Chapter 11)

Jog shuttle
Changes the selected value or moves the cursor. The more the shuttle ring (outer ring) is turned, the more the setting increment increases.

VERTICAL group (Page 2-2)
Menu group used to make settings for the vertical axis.

HORIZONTAL group (Page 2-2)
Menu group used to make settings for the horizontal axis.

TRIGGER group (Page 2-2)
Menu group used to make trigger settings.

Menu keys (Page 2-3)
Press a key to display the corresponding menu.

Input terminals (Page 3-7) ⚠
Used to connect a probe.

SCSI connector ⚠
Connects to an external hard disk, MO disk, or other external SCSI storage device.

PC Card slot (Page 11-2, optional)

Centronics connector ⚠
Connects to a printer with a Centronics interface.

Power connector ⚠
(Page 3-5)

GP-IB connector
For details about communication functions, refer to the instrument GP-IB Interface Manual (Doc. IM701410-11E).

Logic Input connectors (Page 3-11, optional) ⚠

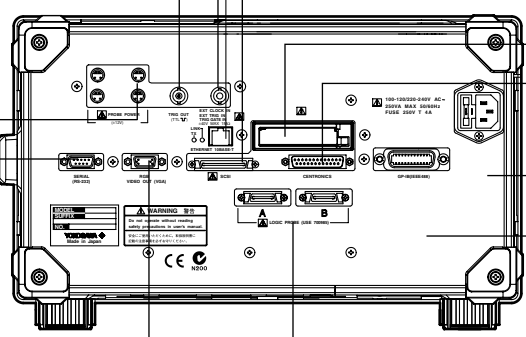

Built-in printer (optional)

Handle
Use the handle to lift and carry the unit.

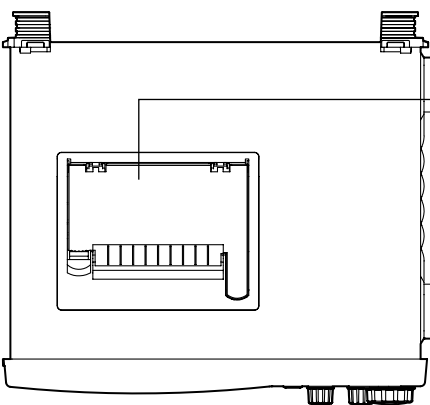

2.2 Operation Keys/Jog Shuttle/Knobs

VERTICAL Group

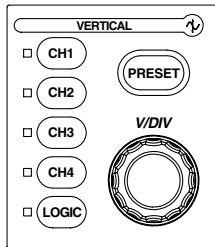

CH1 to CH4 keys (Section 5.1 to 5.9)

Displays a menu used to turn ON/OFF the display on each channel, set the vertical position, coupling, probe attenuation, offset voltage, bandwidth limit, expansion/reduction of the vertical axis, linear scaling, and waveform labels. In addition, by pressing this key before operating the V/DIV knob, the channel that is to be controlled by the V/DIV knob can be selected.

LOGIC key (Section 5.10)

Displays a menu which is used to turn the display ON/OFF and set the threshold level and waveform label for the optional logic input.

PRESET key (Section 5.6)

Displays the preset menu that sets the V/div, input coupling, probe attenuation and trigger level to the optimum TTL or ECL level (or preset level) automatically. This preset menu allows you to set all channels at once.

V/DIV knob (Section 5.8)

Turning this knob during acquisition (i.e. while the START indicator is lit) sets the voltage axis sensitivity. Before turning this knob, be sure to select the channel you want to adjust by pressing the corresponding channel key (CH1 to CH4).

HORIZONTAL Group

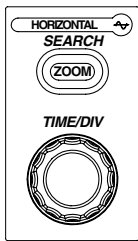

TIME/DIV knob (Section 5.12)

Use this knob to set the time scale. If you change the scale while acquisition is suspended, the new value becomes effective when acquisition resumes.

(SHIFT +) ZOOM key (Section 8.8 to 8.10)

Displays a menu related to the waveform zoom display.

Pressing the ZOOM key after pressing the SHIFT key displays a menu related to data searching (Search and Zoom Function).

TRIGGER Group

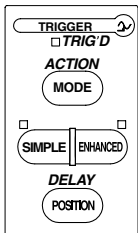

(SHIFT +) MODE key (Section 6.1 and 6.16)

Displays a menu used to select the trigger mode.

Pressing the MODE key after pressing the SHIFT key displays a menu related to action-on-trigger.

SIMPLE key (Section 6.4 to 6.7)

Displays the menu for the simple trigger mode, which provides normal triggers such as the edge trigger. Simple trigger mode is selected when the indicator located above this key is lit.

ENHANCED key (Section 6.4 and 6.8 to 6.15)

Displays the menu for enhanced trigger mode, which provides complex triggers such as the pattern trigger. Enhanced trigger mode is selected when the indicator located above this key is lit.

(SHIFT +) POSITION key (Section 6.2 to 6.3)

Used to set the trigger position.

You can set the trigger delay by pressing the POSITION key after pressing the SHIFT key.

TRG'D indicator

Lights up when a trigger is activated.

Other Menus

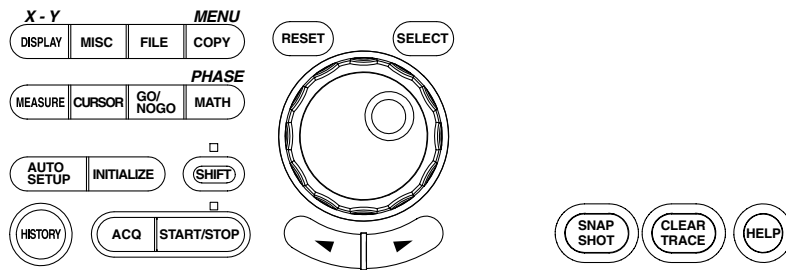
**DISPLAY key (Chapter 8)**

Displays the screen display menu.

Press SHIFT + DISPLAY to produce the menu for X-Y display setup.

MISC key (Section 3.6 and 11.5, Chapter 13, IM701410-11E)

Displays the menu for selecting GO/NO-GO determination, communication interface, system configuration settings, system status check, screen saver setting, and the self-diagnostic function.

The "Network" item has been added to the menu on page 1/2 for the DL7200 and the DL7100 firmware version 2.01 and later. Therefore the "Graphic Color" item that appeared on page 1/2 of the DL7100 prior to firmware version 2.01 is now displayed on page 2/2.

FILE key (Chapter 11)

Displays a menu that you use to save to, load from, or execute file operations on floppy disk, MO disk, or external SCSI device.

SHIFT + COPY key (Chapter 10)

Used for printing out a hard copy of the screen data.

If you press SHIFT + COPY, the screen displays a menu that you can use to print or save the screen image. For the save location, you can select any of the following: internal printer (optional), centronics or floppy disk.

MEASURE key (Section 9.2 and 9.3)

Displays the menu for performing automatic measurement of waveform parameters.

CURSOR key (Section 9.1)

Displays the menu for cursor measurement.

SHIFT + MATH key (Section 9.4 to 9.10)

Displays the menu for waveform computation.

Pressing the MATH key after pressing the SHIFT key displays a menu used to shift the phase.

GO/NO-GO key (Section 9.11 and 9.12)

Displays a menu related to GO/NO-GO.

AUTO SETUP key (Section 4.3)

Displays the auto setup menu used to configure the instrument according to the input signal value.

INITIALIZE key (Section 4.2)

Displays the initialization menu which can be used to reset the key settings to their factory setting values.

SHIFT key

Used to make the functions that are marked in purple on the panel operative. Pressing this key activates shift mode, and pressing it again releases shift mode. While the indicator above this key is lit, shift mode is active.

HISTORY key (Section 7.7 to 7.9)

Displays a menu used to recall data using the history memory function.

2.2 Operation Keys/Jog Shuttle/Knobs

ACQ key (Section 7.1 to 7.5)

Displays the acquisition method menu.

START/STOP key (Section 4.4)

Starts or stops acquisition according to the selected trigger mode. The indicator above this key is lit during acquisition.

Jog and shuttle dials (“jog shuttle”)

You use these dials to set numerical values, move the measurement cursors, select items from menus, and perform other such selection operations.

The jog dial changes the value in fixed steps as you rotate it. With the shuttle dial, the step size increases as you turn the dial further.

RESET key

Resets values that you have changed using the jog or shuttle dial.

SELECT key

Activates the menu item that you have highlighted using the jog or shuttle dial.

Arrow keys (< > keys)

Use these keys to shift the column position of the numerical value to be set by the jog or shuttle dial.

SNAP SHOT key (Section 4.5)

Repeats acquisition while retaining the currently displayed waveform on the screen.

CLEAR TRACE key (Section 4.5)

Deletes the currently displayed waveform.

HELP key (Section 4.7)

Turns the help window ON or OFF.

2.3 Screens

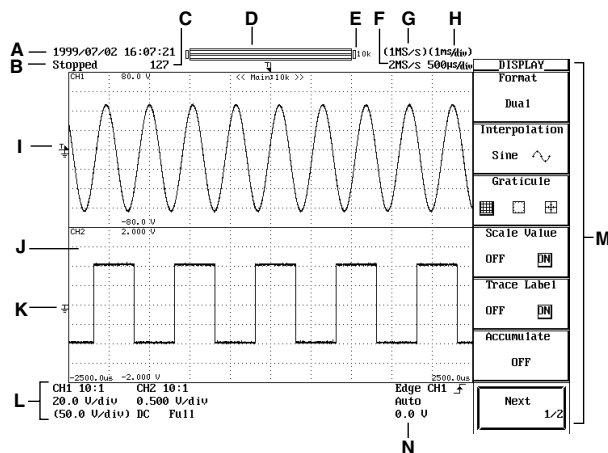

A Date and time

For the procedures used to set the date and time, see section 3.6, “Setting the Date and Time.”

B Operation state

Displays “Running” when data acquisition is in progress and “Stopped” when it is stopped.

C Waveform acquisition state and the number of acquisitions

Waiting for Trigger : trigger wait state

Pre... : pre-trigger

Post... : post-trigger

Value : the number of waveforms acquired

D Display position

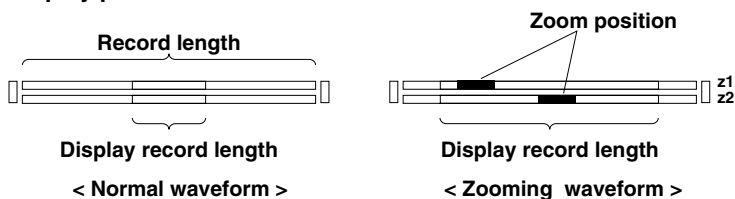

E Record length

F Sample rate

G Sampling mode

Varies depending on the T/div and record length settings.

Normal/Env/Avg/BoxAvg : Realtime sampling mode

Norm: Rep : Repetitive sampling mode

Avg: Rep : Repetitive sampling mode in the averaging mode

H T/div setting that has been changed after waveform acquisition

I Trigger level

J Display format

1, 2, 3, 4, and 6 windows are possible (see page 8-1).

K Ground level

L Probe attenuation, V/div (The V/div setting after the data are acquired are indicated inside the parentheses.), input coupling, and bandwidth limit settings

M Soft key menu

N Trigger level, trigger mode, trigger type, and trigger source settings

Note

In some cases, up to 0.02% of the total number of pixels of the LCD can be defective.

3.1 Precautions During Use

Safety Precautions

When you are using this instrument, read the “Safety Precautions” given on page v thoroughly, as well as the following points.

Do not remove the cover from the instrument

Some parts of the instrument use high voltages, which are extremely dangerous. When the instrument needs internal inspection or adjustment, contact your dealer or nearest YOKOGAWA representative, as listed on the back cover of this manual.

In case of irregularity

If you notice smoke or unusual odors coming from the instrument, immediately turn OFF the power and unplug the power cord. If such an irregularity occurs, contact your dealer or the nearest YOKOGAWA representative, as listed on the back cover of this manual.

Power cord

Nothing should be placed on the power cord; also, it should be kept away from any heat sources. When unplugging the power cord from the AC outlet, never pull the cord itself. Always hold the plug and pull it. If the power cord is damaged, contact your dealer. Refer to page ii for the part number to use when placing an order.

General Handling Precautions

Observe the following precautions when handling the instrument.

Never place anything on top of the instrument

Never place other equipment or objects containing water on top of the instrument, otherwise a breakdown may occur.

Do not cause shock to the input connectors or probes

Shock to the input connectors or probes may turn into electrical noise and enter the instrument via the signal lines.

Do not damage the LCD screen

Since the LCD screen is very vulnerable and can be easily scratched, do not allow any sharp objects near it. Also it should not be exposed to vibrations and shocks.

When the instrument is not going to be used for a long period, unplug the power cord from the AC outlet

3.1 Precautions During Use

When carrying the instrument

First, remove the power cord and other cables. When carrying the instrument, hold the handle located on the side panel on the right when facing the front of the instrument (see below).

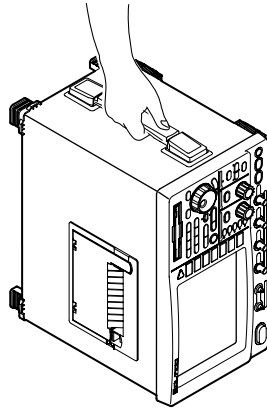

Cleaning

When cleaning the case or the operation panel, unplug the power cord from the plug first, then wipe with a dry, soft, clean cloth. Do not use volatile chemicals such as benzene or thinner for cleaning, as this may lead to discoloration or deformation.

3.2 Installation



WARNING

Do not place the oscilloscope on its back.

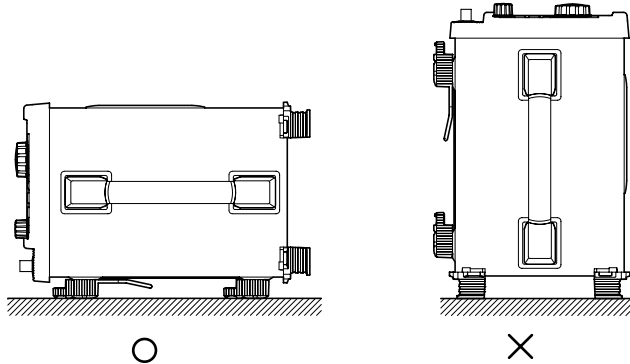

Installation Conditions

The instrument must be installed in a place where the following conditions are met.

Flat horizontal location

Set the oscilloscope in the proper direction and in a level and stable place. If placed in an uneven or unstable place, printing quality decreases. Note that the oscilloscope can be tilted forwards on the stand.

Well - ventilated location

Vent holes are situated on the bottom. In addition, vent holes for the cooling fans are also situated on the left sides. To prevent a rise in the internal temperature, the vent holes should not be blocked and sufficient clearance should be maintained around them. If your unit includes an internal printer, leave additional space.

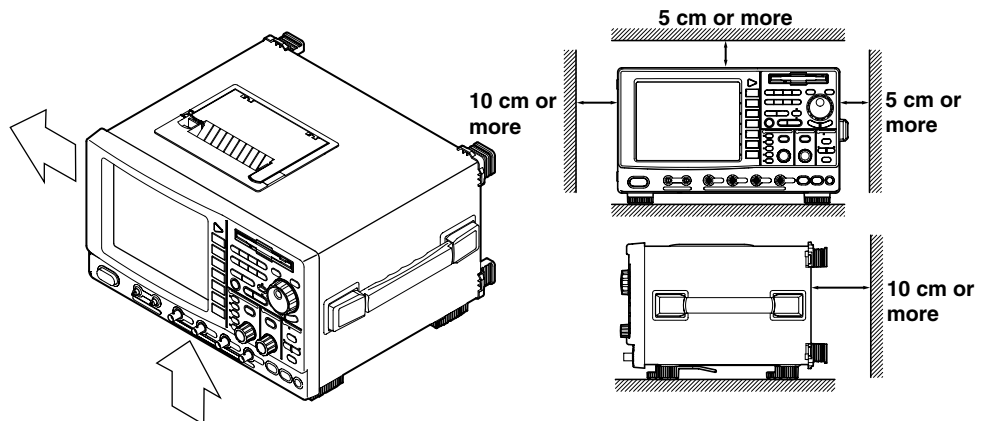

3.2 Installing

Ambient temperature and humidity

Ambient temperature: 5 to 40°C

Ambient humidity: 20 to 80% RH (when not using the printer)

35 to 80% RH (when using the printer)

No condensation should be allowed.

Note

- To ensure high measurement accuracy, the instrument should only be used under the following conditions.
Ambient temperature: 23 ±2°C
Ambient humidity: 55 ±10% RH
 - Internal condensation may occur if the instrument is moved to another place where both the ambient temperature and humidity are higher, or if the temperature changes rapidly. In such cases allow the instrument to acclimatize to its new environment for at least one hour before starting operation.
-

Never install the instrument in the following places.

In direct sunlight or near heat sources

Where an excessive amount of soot, steam, dust or corrosive gases are present

Near magnetic field sources

Near high voltage equipment or power lines

Where the level of mechanical vibration is high

In an unstable place

Installation Position

Place the instrument in a horizontal position or tilted using the stand, as shown below. When you use the stand, pull it forwards until it locks. To return the stand to its original position, push it backwards.

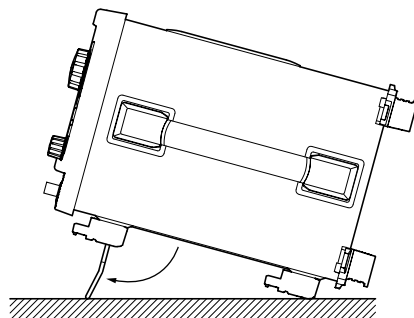

Rubber feet

When using the instrument in the tilted position, attach two rubber stoppers to the rear feet to prevent the instrument from sliding.

3.3 Connecting the Power Cord

Before Connecting the Power

Make sure that you observe the following points before connecting the power. Failure to do so may cause electric shock or damage to the instrument.



WARNING

- Connect the power cord after confirming that the voltage of the power supply complies to the rated electric power voltage for the instrument.
- Connect the power cord after confirming that the instrument power switch is OFF.
- Always use protective ground to prevent electric shock. Connect the instrument power cord to the 3-pin power outlet with grounding terminal.
- Do not use non-grounding extension cords or other measures that defect the protective grounding.
- Never use an extension cord that does not have a protective grounding, otherwise the protection feature will be invalidated.

Connecting the Power Cord

1. Make sure that POWER switch is OFF.
2. Plug the power cord into the power connector socket on the rear panel of the instrument.
3. Plug the other end of the power cord into an AC outlet that meets the following conditions. The AC outlet must be of 3-pin type with a protective grounding terminal.

Rated supply voltage:	100 to 120 VAC/220 to 240 VAC
Permitted supply voltage range:	90 to 132 VAC/198 to 264 VAC
Rated supply voltage frequency:	50/60 Hz
Permitted supply voltage frequency range:	48 to 63 Hz
Maximum power consumption (when the built-in printer is used):	290 VA

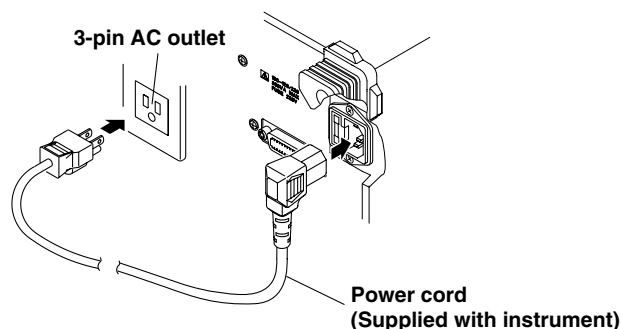

3.3 Connecting the Power Cord

Turning the Power ON or OFF

Items to be checked before turning ON the power

Check that the instrument is installed correctly as instructed in Section 3.2 "Installing" (page 3 - 3).

Check that the power cord is connected correctly as shown in Section 3.3 "Connecting the Power Cord" (page 3 - 5).

Turning the power ON/OFF

POWER switch: The power is turned ON and OFF alternately as the switch is pressed.

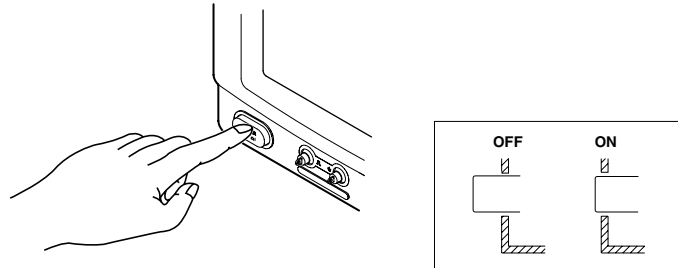

Response at Power ON

Self test and calibration start automatically when the power switch is turned ON.; if the check results are satisfactory, the normal waveform display screen will appear.

Note

Wait at least 10 seconds after turning the power OFF before turning it back ON again.

If calibration does not start when the power is turned ON, or if the normal waveform display screen does not appear, check the following points.

- Check that the power cord is plugged in properly.
- Check that the correct voltage is being supplied from the AC outlet. (Refer to page 3 - 5)
- Check that the fuse is not blown. (Refer to page 15 - 12)

If there is still no power even after the above points have been checked, contact your nearest YOKOGAWA representative as listed on the back cover of this manual.

For Accurate Measurement

Turn the power switches ON and allow the unit to warm up for at least 30 minutes.

After warm-up is complete, perform calibration. (Refer to Page 4 - 9.)

Response at Power OFF

Settings made prior to turning OFF the power are retained (even if the power cord is removed). This allows display of waveforms using those saved settings the next time the power is turned ON.

Note

The settings are backed up by a lithium battery. The battery lasts for approximately 5 years if it is used at an ambient temperature of 23°C. When the battery voltage drops below the specified level, a message will appear on the screen. In this case, the battery needs to be replaced immediately. The battery cannot be replaced by the user, so contact the nearest YOKOGAWA representative listed on the back cover of this manual.

3.4 Connecting a Probe

Input Terminals

A probe (or an input cable such as a BNC cable) must be connected to one of the input terminals* (CH1 to CH4) located on the lower section of the front panel.

The input impedance is $1\text{ M}\Omega \pm 1.0\%$ and approximately 20 pF or $50\ \Omega \pm 1.0\%$.

* The number of input terminals varies according to machine model.



CAUTION

- The maximum allowable input voltage is 400 V (DC + AC peak) or 282 Vrms when the frequency is 1 kHz or less. Never input a voltage exceeding this level, as it could damage the input section of the instrument. If the frequency exceeds 1 kHz, the input section may be damaged even when the voltage is below 400 V.
- The maximum allowable input voltage is 5 Vrms or 10 Vpeak when using 50- Ω input. Never input voltage exceeding this level, as it could damage the input section of this instrument.



Points to Note when Connecting a Probe

- When connecting a probe to the instrument for the first time, perform phase correction of the probe as described in the next section on page 3 - 9. Failure to do so may result in unstable gain across different frequencies, thereby preventing correct measurement. Calibration must be performed for each channel.
- If the object to be measured is connected to the instrument directly, without using a probe, correct measurement cannot be performed due to the load effect.

Probe

Specifications for the probe (700988) supplied with the instrument (after calibration)

Item	Specifications Setting 10 : 1	Setting 1 : 1	Conditions
Input impedance/ capacitance	$10\text{ M}\Omega \pm 2\%$, approx. 14 pF	$1\text{ M}\Omega \pm 1.0\%$, approx. 150 pF	When used with this instrument
Attenuation ratio	$10 : 1 \pm 3\%$	—	When used with this instrument
Frequency band	DC to 400 MHz	DC to 6 MHz	When used with this instrument
Rise time	900 ps or less	58 ns or less	When used with this instrument
Maximum input voltage	600 V (DC + AC peak) or 424 Vrms, Frequency is 100 kHz or lower	*1	—
Connector type	BNC	BNC	—
Total length	1.5 m	1.5 m	—

*1 When the probe's attenuation is "1 : 1," never input voltage exceeding the maximum input voltage of this instrument.

3.4 Connecting a Probe

When using a probe other than the one supplied with the instrument

- To measure a signal which contains harmonics of approximately 500 MHz, use a probe with a frequency band of 500 MHz or higher.
- Correct measured values cannot be displayed if the probe's attenuation ratio is not "1 : 1," "10 : 1," "100 : 1" or "1000 : 1."

Setting the probe attenuation

Follow the operating procedure given in Section 5.4 "Selecting Probe Attenuation" (page 5 - 4) so that the probe's attenuation matches the one displayed under "Probe" in the soft key menu. If they do not match, measured values cannot be read correctly.

When using the FET probe (700939), the current probe (700937 or 701930), or the differential probe (701920)

When using YOKOGAWA's FET probe (700939), current probe (700937 or 701930), or differential probe (701920) use the power supply for the probe provided on the rear panel of the instrument.



CAUTION

- Use the power connectors for the probes on the rear panel only for powering probes 700939, 700937, 701930, or 701920. Using the power connectors for any other purpose can damage DL7100/DL7200 or the device that is connected.
- Do not use a current outside the range that this instrument can supply. Such act can cause damage to the instrument.

Precautions to be taken when using the FET probe (700939), current probe (700937 or 701930), or differential probe (701920)

When connecting the FET probe (700939) or the current probe (700937 or 701930) to the probe power supply terminal on the rear panel, make sure that the current does not exceed the range shown below.

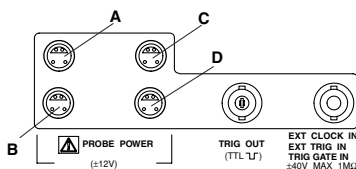

Given terminals A through D

- (Current consumption of A) + (Current consumption of B) ≤ 400 mA
- (Current consumption of C) + (Current consumption of D) ≤ 400 mA
- (Total current consumption of A through D) ≤ 600 mA

When using the current probe (700937 or 701930), the number of probes that can be used is limited by the current generated by the device under measurement. Examples of current consumption measurement of an active probes that can be connected to the DL1740 are shown below.

Current probe (700937)

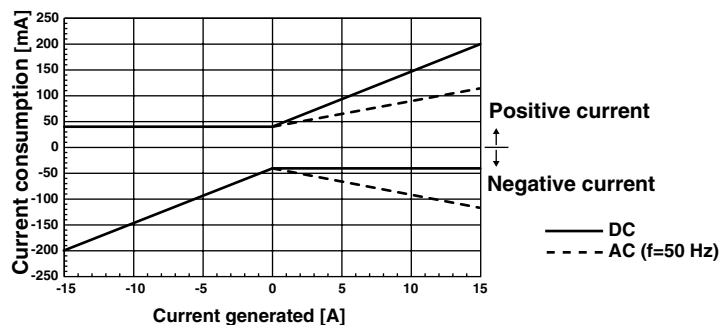

Current probe (701930)

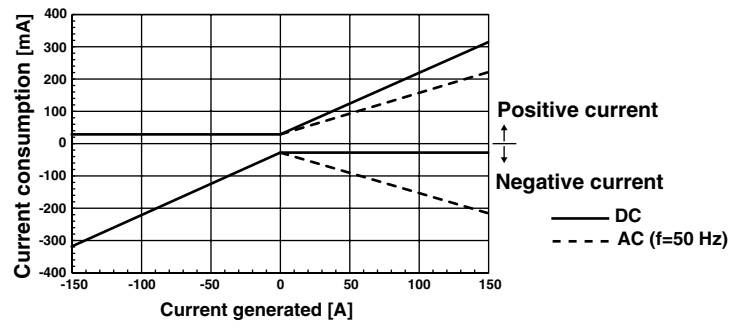

The positive and negative power supply of the FET probe (700939) or the differential probe (701920) is 125 mA at the maximum.

3.5 Compensating the Probe (Phase Correction)



CAUTION

Never apply an external voltage to the COMP terminal, as damage to the instrument may result.

Operating Procedure

1. Turn ON the power switch.
2. Connect the probe to the input terminal to which the signal is to be applied.
3. Touch the probe's tip against the probe compensation signal output terminal and connect the grounding wire to the functional earth terminal.
4. Perform auto set-up using the procedure described on page 4 - 5.
5. Insert a screwdriver into the trimmer adjusting hole in the probe and turn the trimmer so that the displayed waveform becomes square.

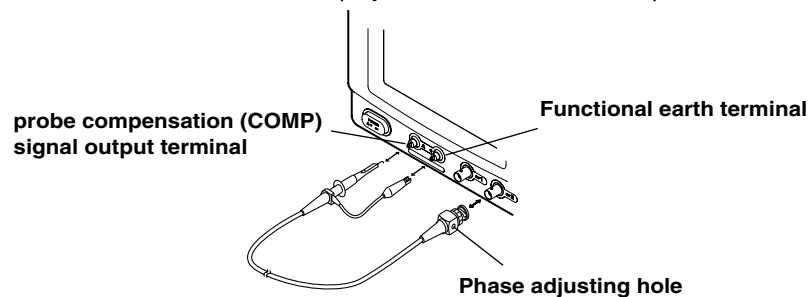

Explanation

Reason for probe compensation

If the probe's input capacitance is outside the specified range, the gain will not be constant across different frequencies, preventing display of the correct waveforms. The input capacitance varies depending on the probe used, so the variable capacitor (trimmer) provided on the probe must be adjusted.

Probe compensation must be performed when the probe is to be used for the first time. Moreover, the appropriate input capacitance varies according to which channel is used, so probe compensation is required when the probe is switched from one channel to another.

Calibration signal

A probe compensation signal (square waveform) of the following characteristics is output from the CAL terminal on the front panel.

Frequency: approx. 1 kHz

Amplitude: approx. 1 V

Waveform differences

Correct waveform

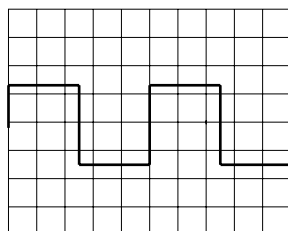

Over-compensated (gain is too high at high frequency)

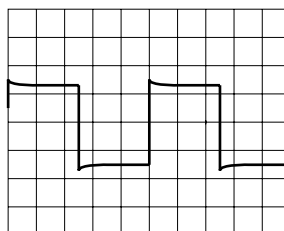

Under-compensated (gain is too low at high frequency)

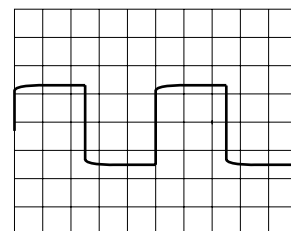

3.6 Setting the Date and Time

Function

Date (YY / MM / DD)

The last two digits of the year are used to set the year (YY).

Time (HH : MM : SS)

The 24 - hour clock is used.

Note

- The date and time are backed up by the built-in lithium battery.
- Leap years are taken into account.

Operating Procedure

Displaying the System Configuration Menu

1. Press the MISC key
2. Press the "System Config" soft key to display the system configuration menu.
3. Press the "Date/Time" soft key to display the date and time display/setting menu.

Turning ON/OFF the date and time display

4. Select "ON" or "OFF" using the "SELECT" key.

Setting the Date and Time

5. Turn the jog shuttle to move the cursor to "Year."
6. Press the "SELECT" key to display the "Year" input box.
7. Set the year using the jog shuttle.
8. In a similar fashion, set the "Month," "Day," "Hour," "Minute," and "Second."
9. Turn the jog shuttle to move the cursor to "Set" and press the "SELECT" key to confirm the settings.

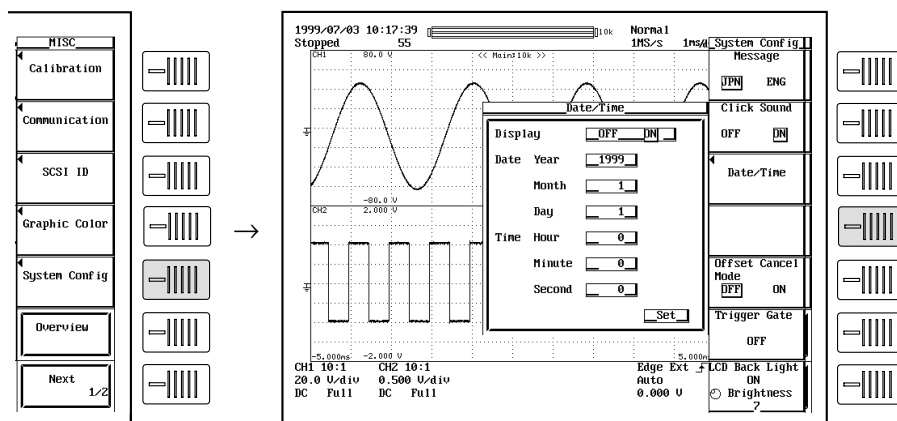

3.7 Connecting the Logic Probe (Optional)



CAUTION

- The maximum input voltage is ± 40 V (DC + AC peak) or 28 Vrms at a frequency of 1 kHz or less. Voltage exceeding this limit may cause damage to the logic probe or the instrument. When the frequency is above 1 kHz, voltages less than this maximum voltage may also cause damage.
- The 8 input lines on each POD have a common ground. In addition, the ground for the instrument and the ground for each POD are also common. Do not connect inputs which differ from the common voltage, as doing so may cause damage to the main unit, logic probe, or to other connected instruments.
- Make sure to turn off the instrument when connecting or removing the 26-pin connector.

Logic Input Connector

Connect the logic probe (700985) to any of the logic probe input connectors (2 connectors indicated POD A through POD D) located on the lower left section of the rear panel.

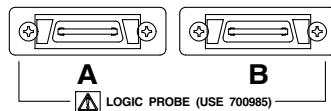

About the Logic Probe

The logic probe (700985) is a probe for connecting to the logic input connectors of the instrument. For connecting to the point of measurement, use the accessory connecting leads (B9852EJ + A1470JZ, A1471JZ). Also, do not alter the connecting leads. Doing so may cause the leads from satisfying the specification.

There are 8 logic inputs for every POD. The threshold level is selected from TTL/ECL/ User in the instrument menu (refer to section 5.11).

Specifications

Items	Specifications	Conditions
Maximum toggle frequency	80 MHz	When use with this instrument
Number of inputs	8	When use with this instrument
Maximum input voltage	± 40 V (DC + AC peak) or 28 Vrms	Frequency is 1 kHz or lower
Maximum sampling rate	1 GS/s (DL7100), 2 GS/s (DL7200)	When use with this instrument
Threshold level*	± 10 V with 0.1 V resolution	When use with this instrument
Threshold accuracy*	$\pm (100 \text{ mV} + 3\% \text{ of the setting})$	When use with this instrument
Minimum input voltage	500 mVp-p	When use with this instrument
Input resistance	approx. 1 M Ω	
Input capacitance	approx. 15 pF	
Preset threshold	TTL = 1.4 V, ECL = -1.3 V	When use with this instrument

* As measured under standard operating conditions (see page 16 - 10) after warm up.

Operating Procedure

1. Attach the accessory connecting lead (B9852EJ + A1470JZ, A1471JZ) to the logic probe, and lock the connector by clamping the lever inwards. To release the connecting lead, pull both levers outwards.
2. Turn OFF the instrument.
3. Connect the 26 pin connectors of the logic probe to the logic connector on the rear panel.
4. Turn ON the instrument.

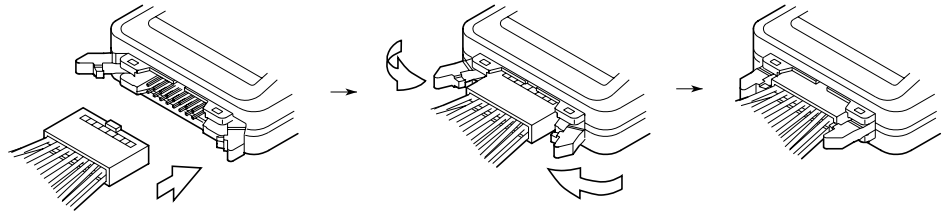

Note

The input signal is at "L level" when the logic probe is not connected to the instrument

4.1 Entering Values and Character Strings

Entering a Value

Direct entry using the special knob

The following knobs can be used to enter values directly simply by turning them.
V/DIV and TIME/DIV knobs

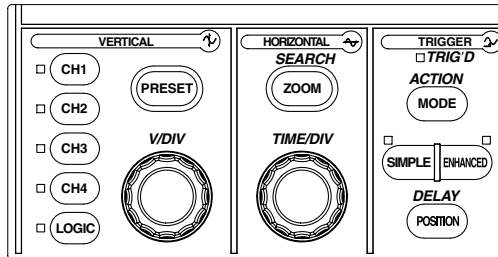

Note

When setting the voltage sensitivity before turning the V/DIV knob, the channel for which you are going to use the knob must be selected using one of the keys CH1 to CH4.

Entry using the jog shuttle

Before using the jog shuttle to enter a value, you must select the desired parameter by pressing the corresponding soft key. The shuttle ring (the outer ring of the shuttle) allows you to enter values in larger steps than the jog dial. The size of the step depends on the angle by which the shuttle ring is turned. For some parameters you can use the arrow keys below the jog shuttle to shift from one digit to the next.

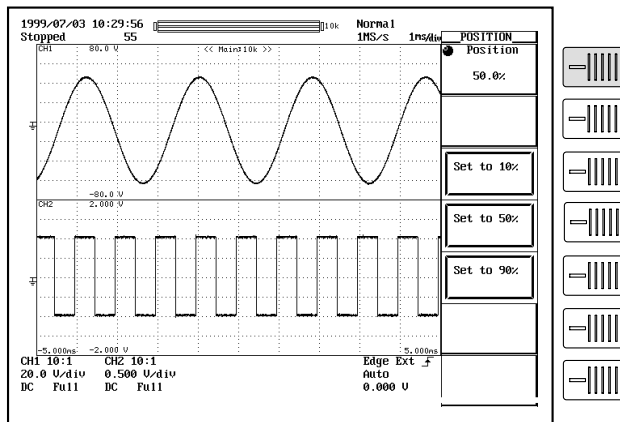

Note

If you make an incorrect change with the jog shuttle, you can undo the change by pressing the RESET key.

4.1 Entering Values and Character Strings

Entering a Character String

Date/time, file name and comment can be entered using the keyboard displayed on the screen. Operate the keyboard using the jog shuttle, SELECT key and arrow key to enter a character string as follows.

Keyboard operation

1. Turn the jog shuttle and move the cursor to the character you wish to enter. (On DL7200, and DL7100 with firmware version 2.01 or later, the “▲” and “▼” soft keys can be used to move the cursor up and down.)
If a character string is already entered, use the arrow keys to move the cursor to the position at which you wish to enter the character.
2. Press the “SELECT” key to confirm the character entry.
3. Repeat steps 1 and 2 to enter all the characters.
4. After selecting “ENT” on the keyboard and pressing the “SELECT” key, the character string is confirmed and the keyboard disappears. (On DL7200, and DL7100 with firmware version 2.01 or later, the “ENT” soft key can be used to confirm the string (and hide the keyboard). At this point, the confirmed string is temporarily stored.)
If the “RESET” key is pressed before confirming the character string, the entire string is cleared.

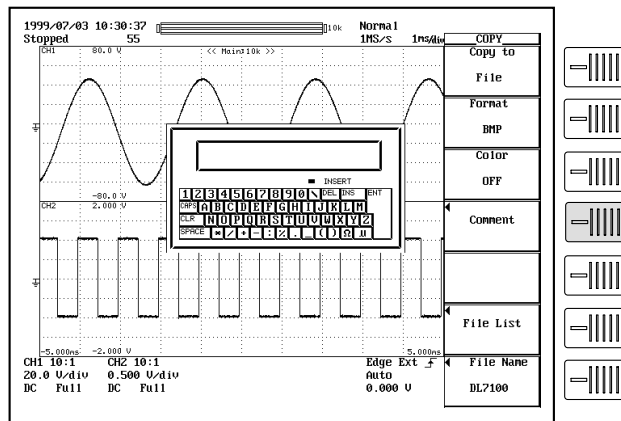

Applicable to DL7100 prior to firmware version 2.01.

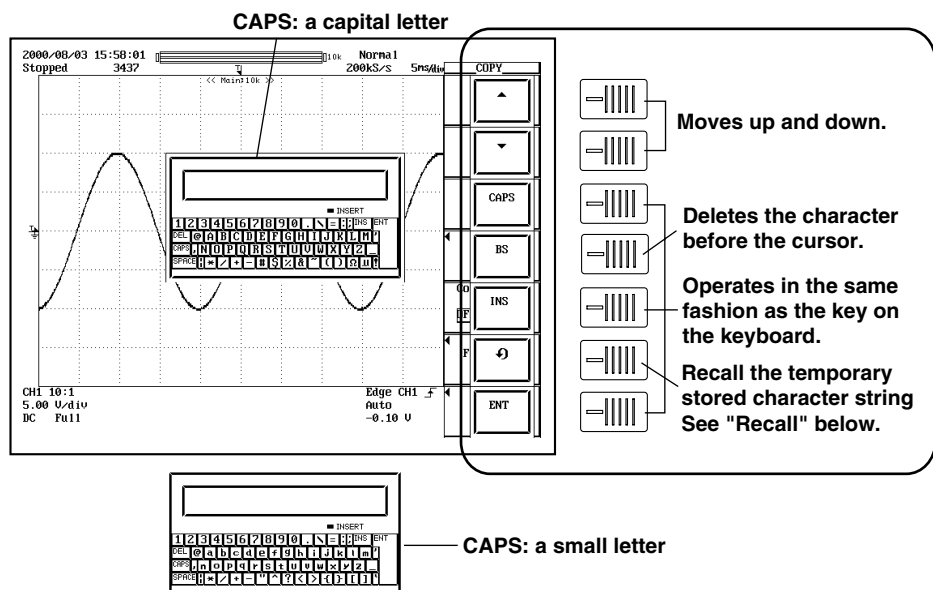

Applicable to DL7200 and DL7100 with firmware version 2.01 or later.

• **Operation to temporarily store character strings (Applicable to DL7200, and DL7100 with firmware version 2.01 or later)**

The strings that are previously confirmed are sequentially sent to the subsequent memories. When the number of confirmed strings exceeds eight, the strings are deleted in order starting from the oldest string. Ⓜ 0 through Ⓜ 7 symbols do not appear on the screen.

Symbol indicating the memory storing the string	Ⓜ 0	Ⓜ 1	Ⓜ 2	Ⓜ 7	
When string "AA" is confirmed first	Stores AA					
When string "BB" is confirmed next	Stores BB	Moves and stores AA				
When string "CC" is confirmed next	Stores CC	Moves and stores BB	Moves and stores AA			
.....						
When string "HH" is confirmed next	Stores HH	Moves and stores GG	Moves and stores FF	Moves and stores AA	
When string "JJ" is confirmed next	Stores JJ	Moves and stores HH	Moves and stores GG	Moves and stores BB	Deletes AA

• **Recall (Applicable to DL7200, and DL7100 with firmware version 2.01 or later) (Note that the string that is displayed in the entry box of the keyboard is overwritten when a string is recalled using the procedure in step 1 below.)**

1. Every time the Ⓜ soft key is pressed, strings that are temporary stored (strings that have been entered previously) appear in order in the input box of the keyboard. When the eight strings that are temporarily stored are displayed, the most recent string is displayed again.
2. Make appropriate corrections to the recalled string and confirm it according to steps 1 to 4 that were described above in "Entering a Character string." At this point, the confirmed string is temporarily stored.

Keys other than characters

- DEL : Deletes the character at the cursor.
- INS : Switches between insert and overwrite modes. The indicator will be lit during insert mode.
- CLR : Deletes all displayed characters.
- SPACE: Enters a space.
- ENT : Confirms the displayed characters.
- CAPS : Toggles upper-case and lower-case characters.

Number of characters and types available

Number of characters	Available characters
Date, time	Specified number 0 to 9 (/ :)
File name	1 to 8 0 to 9, A to Z, %, _, (,)
Display image comment	0 to 20 All characters (including space)
File comment	0 to 25 All characters (including space)
Mail address	0 to 40 All characters (including space)

Note

- Comments and file names can both contain both upper and lower case letters. However, file names are NOT case sensitive. The following five file names are not allowed due to MS - DOS restrictions.
AUX, CON, PRN, NUL and CLOCK
- You cannot enter two or more atmarks "@" in succession.

4.2 Initializing Settings

Function

The initialization function allows you to reset parameter values which have been set using panel keys to the default (factory settings). This is very convenient when you have to cancel the previous settings or when you have to restart measurement from the beginning.

Initialization

Initialization means resetting parameters to their factory setting values. For details on factory settings, refer to the Appendix.

Settings which cannot be initialized

Date and time

Communication interface related settings

SCSI ID number (except when initializing at power up, or initializing with the SHIFT + INITIALIZE keys)

Cancelling initialization

If you have performed initialization by mistake, press the “Undo” soft key. This will restore the previous settings used before the initialization was performed.

Initialization at power ON

Turning the power switch ON while holding down the RESET key will start initialization. This also initializes settings relating to the communication interface and SCSI ID number setting. If settings are initialized using this method, you will not be able to restore the previous settings.

Operating Procedure

Performing initialization

1. Press the INITIALIZE key.
2. Press the “Initialize” soft key to start initialization.

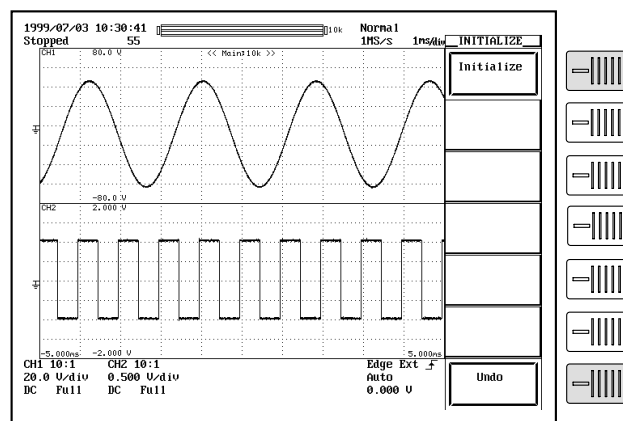

Canceling initialization

3. Press the “Undo” soft key. This will restore the previous settings that were in effect before initialization.

Note

The “Undo” operation remains available only while power stays on.

4.3 Performing Auto Setup

Function

The key settings such as V/div, T/div, and trigger levels are automatically set to optimum values for the input signal.

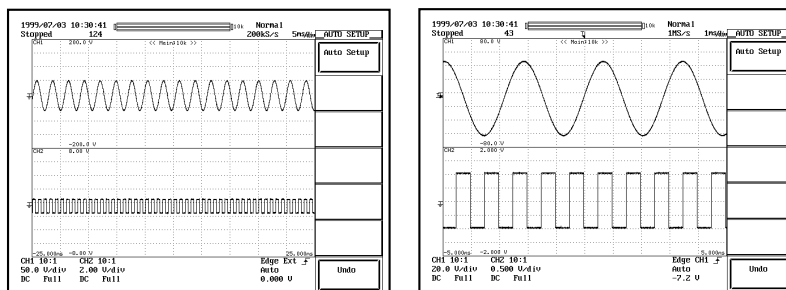

Before auto setup

After auto setup

The center position after auto setup

The center position after auto setup is set to 0 V.

Target channels

Auto setup is performed on all channels.

Canceling auto setup

By pressing the “Undo” soft key, the settings can be set back to the values that existed immediately before auto setup was performed. However, settings which existed before auto setup are erased when the power is turned OFF. In this case, the “Undo” operation will have no effect. If you initialize the settings after auto setup, settings which existed before auto setup are erased.

Waveforms that can be automatically set up

Frequency : Approx. 50 Hz or more

Maximum absolute input value

: Approx. 20 mV or more (assuming 1 : 1 probe attenuation)

Type : Repetitive waveforms that are not complex

When the input coupling is set to “DC.”

Note

- The auto setup function may not operate properly in some cases such as when the waveform contains a large DC offset or high frequency components.
- The auto set-up function cannot be used on input waveforms.

4.3 Performing Auto Setup

Settings made by auto set-up

Waveform acquisition and display

Acquisition mode	Normal
Acquisition count	Infinite
Record length	10 k
Interleave mode	OFF
Timebase	Int
Accumulation mode	OFF
Zoomed waveforms	Traces set ON for display

Vertical - axis settings

V/div	Set to a value so that the absolute value of the input waveform is between 1.6 div to 4 div. (approximately)
Offset voltage	0 V (If Adjust Mode is 0 V)
Coupling	Other than DC 50 Ω: DC 1 MΩ, DC 50 Ω: DC 50 Ω (DC 1 MΩ on DL7100 prior to firmware version 2.01)
Bandwidth	FULL
Display ON/OFF	Turns ON the channels of which the absolute value of the amplitude is at least 20 mV (1 : 1)
Position	0 div

Horizontal - axis settings

T/div	Set so that screen displays 1.6 to 4 periods of the auto - setup waveform with the shortest period.
-------	---

Trigger settings

Trigger mode	Auto
Trigger type	Simple
Trigger source	Channel with the longest period and an amplitude of at least 1 div
Trigger level and slope	Level is 1/2 the trigger source amplitude. Slope is "rising."
Trigger coupling	The center level of the maximum and minimum values/ rising
HF rejection	OFF
Hysteresis	$\frac{\Delta}{\Delta}$
Holdoff time	80 ns
Trigger position	50%
Trigger delay	0 s
Trigger gate	OFF

Math setting

scalling	OFF
----------	-----

Automatic setup affects only the settings listed above. All other settings remain unchanged.

Operating Procedure

Selecting the center position and channels, performing auto setup

1. Press the "AUTO SETUP" key.
 2. Press the "Auto Setup" soft key to perform auto setup.
- When auto set-up is executed, waveform acquisition starts automatically.

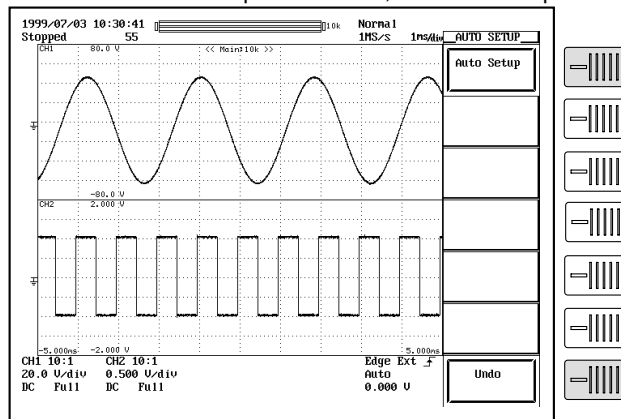

Canceling auto setup

3. Press the "Undo" soft key to restore the settings that existed immediately before auto setup.

4.4 Starting/Stopping Waveform Acquisition

Function

The START/STOP key is pressed when starting or stopping waveform acquisition.

- When the indicator to the upper right of the START/STOP key is ON, waveform acquisition is started.
- When the indicator to the upper right of the START/STOP key is OFF, waveform acquisition is stopped. "Stopped" is displayed on the upper left corner of the screen.

Operation when the acquisition mode is set to averaging mode

- When the waveform acquisition is stopped, the averaging process also stops.
- When the waveform acquisition is restarted, a new averaging process starts.

START/STOP operation while accumulation is in progress

When the waveform acquisition is stopped, accumulation is temporarily suspended.

When the waveform acquisition is restarted, accumulation resumes.

Conditions in which the START/STOP key is disabled

- When the instrument is in the remote mode, controlled via communication.
- When the instrument is printing or auto setup is in progress.

Note

- Pressing the FILE or HISTORY key while the waveform acquisition is in progress stops the waveform acquisition.
- If the waveform acquisition conditions are changed and the acquisition is restarted, previously acquired data are cleared.
- The snapshot function can also be used to retain the waveforms that are currently displayed on the screen. The display can be updated without having to stop the waveform acquisition (see next page).

Operating Procedure

1. Pressing the "START/STOP" key starts or stops the waveform acquisition. Waveform acquisition is in progress when the indicator above the key is lit.

4.5 The Snapshot and Clear Trace Functions

< For a description of this function, refer to page 1 - 26 >

Function

Snapshot

This function retains the waveforms currently displayed on the screen. It also enables update of the display without stopping acquisition. Hence it is very useful when you want to compare waveforms.

The following operations are not available for snapshot waveforms.

- Cursor measurements and automatic measurements
- Zoom and math operations

The snapshot waveforms can be saved or loaded in bitmap format.

For details, see Section 11.8 "Saving Snap Shot Waveforms."

Clear trace

This function clears every waveform currently displayed on the screen.

If the trace is cleared while waveform acquisition is in progress, it is restarted from the first trace.

The loaded waveform is not cleared. To clear the loaded waveform, perform the unload operation.

The SNAP SHOT key and CLEAR TRACE key are not operative in the following cases.

- The instrument is in remote state, controlled via the communication interface.
- The instrument is in operation, for example, it is in the process of printing out or performing auto set-up, determining GO/NO-GO, performing action on trigger, or searching data.

Operating Procedure

Snapshot

Press the SNAP SHOT key. The snap shot process will start.

Clear trace

Press the CLEAR TRACE key. The clear trace process will start.

Averaging and measurement will also be started from the scratch. (The count is reset to "0.")

4.6 Calibration

Function

Calibration

The following parameters can be calibrated. Perform calibration when highly accurate measurements are required.

Ground level offset

A/D converter gain

Trigger threshold

Time axis for repetitive sampling mode

The oscillation frequency of the startup oscillator for the pulse width trigger.

Points for attention

- Always allow the instrument to warm up for at least 30 minutes after the power is turned ON before starting calibration. If calibration is performed immediately after the power is turned ON, the calibration may be inaccurate due to drift caused by fluctuation in the temperature of the instrument.
- Calibration must be performed when the temperature of the instrument is stable and is between 5°C and 40°C (preferably at 23°C ±2°C).
When performing calibration, remove the input signals. Otherwise, proper calibration may not result.

Note

- The above calibration is performed automatically when power is turned ON.
- If the V/div knob has been turned, perform calibration for all parameters except the time axis for repetitive sampling mode.

Auto Calibration (AUTO Cal)

After turning ON the power, when the T/div setting is changed, or when waveform acquisition is started, calibration is performed automatically after the times shown below elapse.

After 3 minutes

After 10 minutes

After 30 minutes

Once every hour

If DL7100 is auto-calibrated while input takes place, it is recommended that you disconnect the input and then repeat calibration.

Deskew

Corrects the CH1 to CH4, POD A, and POD B delays.

Deskew Time setting range

The correction time is set within the following range.

–100 ns to 100 ns

Operating Procedure

Performing calibration

1. Press the MISC key. The MISC menu will appear.
2. Press the "Calibration" soft key.
3. Press the "AUTO Cal" soft key to select either "ON" or "OFF."
4. Press the "Deskew" soft key to select either "ON" or "OFF."
5. If "ON" is selected in step 4, select the desired channel.
Pressing the "Target CH" soft key displays a menu used to select the channel.
6. Press the soft key corresponding to the desired channel to select the channel.
7. Turn the jog shuttle to set the Deskew Time.
8. Press the "Cal Exec" soft key to start calibration.

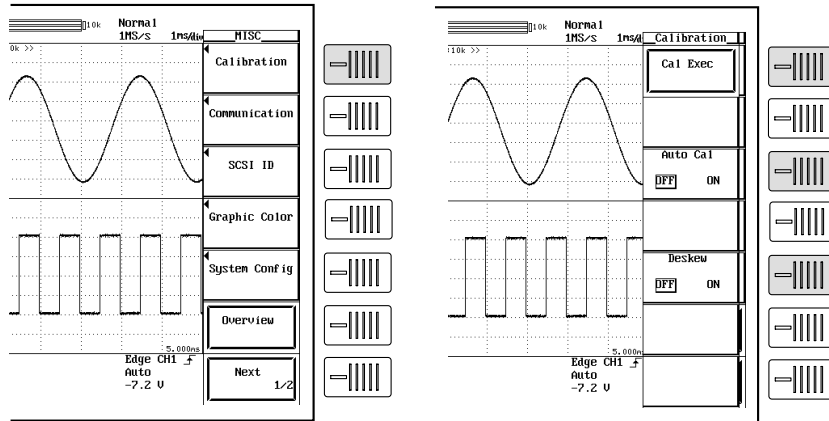

4.7 Using the Help Function

Function

Displaying a help window

Pressing the HELP key displays the soft key menu which was in effect before the HELP key was pressed, or displays a help window which contains information related to jog shuttle menu settings.

If a key is pressed or the jog shuttle is turned while a help window is displayed, the help window relating to the displayed soft key menu or the jog shuttle menu will appear.

Clearing the help window

Pressing the HELP key again while a help window is displayed will clear the help window.

Operating Procedure

1. Press the HELP key.
2. Press the function key or soft key corresponding to the function for which you want help.

Clearing the help window

3. Press the HELP key again to close the window.

5.1 Turning Channels ON/OFF

Function

Channels CH1 to CH4 can be displayed simultaneously.
When turned ON, the indicators to the left of the channel keys light.

Note

- The screen can be split into up to six display areas (Refer to page 8 - 1). A scaling value and waveform label name for each display area (refer to page 8 - 6, 8 - 7) can also be displayed.
- If a waveform or waveforms are loaded from history memory, store memory or floppy disk, the input waveform cannot be displayed. To compare waveforms, use the snapshot function.
- When the logic input is turned ON, a window for the logic waveforms opens.

Operating Procedure

1. Press one of the CH1 to CH4 keys or LOGIC key to select the desired channel.
2. Press the "Display" (for [CH1]-[CH4]) or "Mode" (for [LOGIC]) soft key to select "ON" or "OFF."

The "CH1" to "CH4" or "LOGIC" key can be pressed twice to turn the channels ON or OFF.

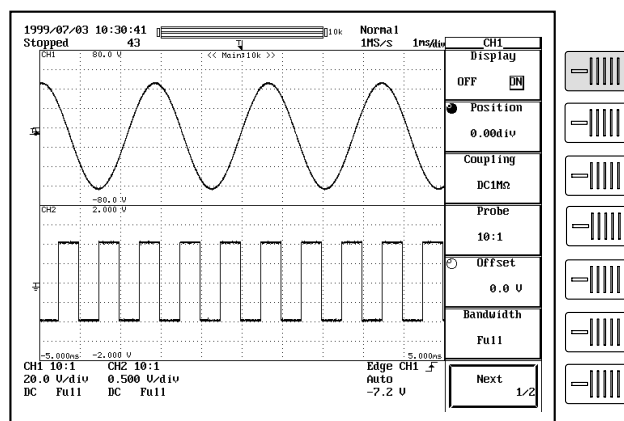

5.2 Setting the Vertical Position of a Waveform

Function

< For a description of this function, refer to page 1 - 4 >

Range of movement

The vertical position can be moved in the range between ± 4 div from the center position in the waveform display frame.

Setting resolution

0.01 div

Confirming the vertical position

For input waveforms and computed waveforms, the ground level and vertical position are marked on the left of the waveform display frame.

500 mV/div, Offset: -1 V, Offset Cancel: OFF, Position: 0 div

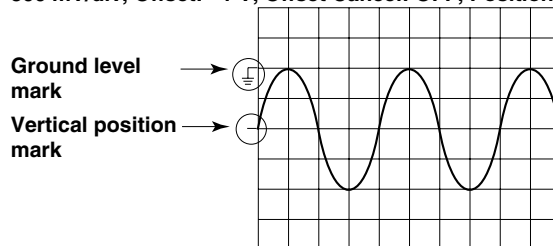

Note

- The data which go out of the waveform display frame from moving the vertical position are handled as overflow data.
- If the display waveform goes out of the waveform display frame from moving the vertical position during the waveform acquisition is starting, a chopped waveform is displayed as shown in the following figure even if the vertical position is returned to its original position after stopping the acquisition.

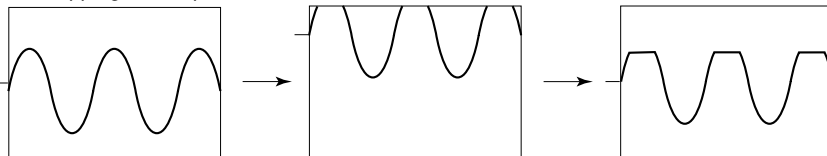

- If the vertical position is moved, the effective data range also changes. For details, see page 1-3.

Operating Procedure

1. Press one of the keys from CH1 to CH4 to select the desired channel.
2. Press the "Position" soft key to set the jog shuttle action to "Position."
3. Turn the jog shuttle to set the vertical position.
You can change the setting a digit using the arrow keys (located below the jog shuttle).

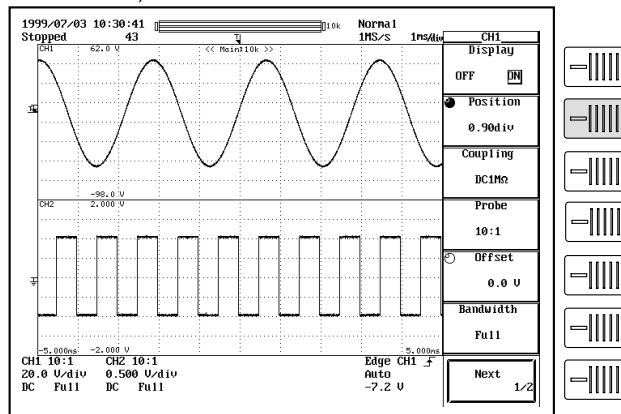

5.3 Selecting Input Coupling

< For a description of this function, refer to page 1 - 2 >

Function

Input coupling

The following three types of input coupling are available.

AC 1 M Ω : Acquires and displays only the AC content of the input signal.

DC 1 M Ω : Acquires and displays both the DC and the AC content of the input signal (1 M Ω).

DC 50 Ω : Acquires and displays both the DC and the AC content of the input signal (50 Ω).

GND : Checks the ground level.

Input coupling and frequency characteristic

The frequency characteristic when "AC" or "DC" is selected is shown below.

Note that low - frequency signals and low - frequency contents are not acquired if "AC 1 M Ω " is selected.

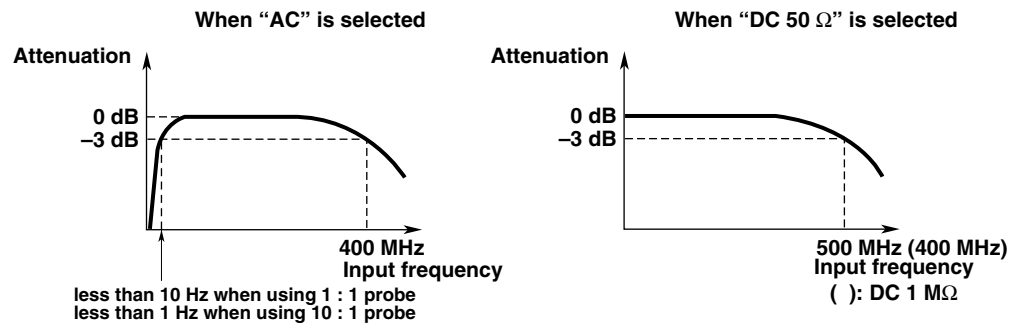

CAUTION

The maximum input voltage when the frequency is less than or equal to 1 kHz is 400 V (DC+ACpeak) when using 1-M Ω input and 5 Vrms or 10 Vpeak when using 50- Ω input. Applying a voltage that exceeds these values can damage the input section. When the frequency exceeds 1 kHz, voltages below these values can also sometimes damage the input section.

Operating Procedure

1. Press one of the keys from "CH1" to "CH4" to select the channel.
 2. Press the "Coupling" soft key to display the menu used to select the coupling.
 3. Press the soft key corresponding to the desired coupling.
- If "DC 50 Ω " is selected, a confirmation menu is displayed. Press the "Set to DC 50 Ω " or "Cancel" soft key.

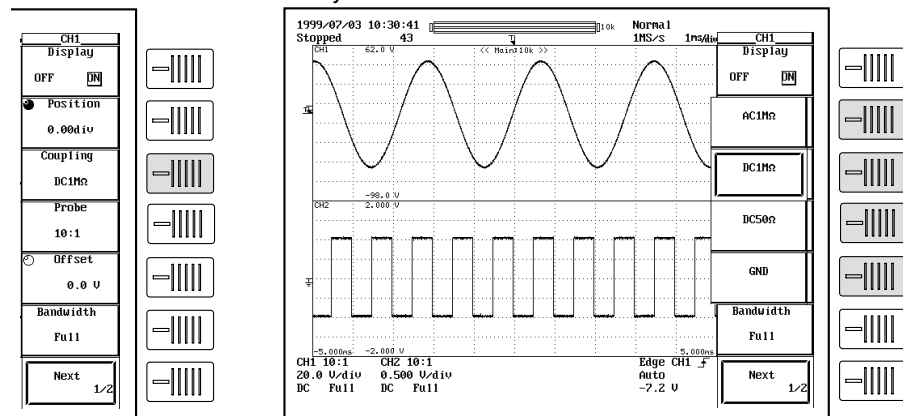

5.4 Selecting Probe Attenuation

< For a description of this function, refer to page 1 - 3 >

Function

Probe attenuation for each channel can be selected from the following.
1 : 1, 10 : 1, 100 : 1, or 1000 : 1

Note

If an incorrect attenuation has been selected, V/div will also be incorrect. If you set the attenuation to 1 : 1 when using a 10 : 1 probe, for example, the displayed value for automatically measured amplitude will be 1/10 the true value.

Operating Procedure

1. Press one of the keys CH1 to CH4 to select the desired channel.
2. Press the "Probe" soft key to display the menu used to select the attenuation.
3. Press the soft key corresponding to the desired attenuation.

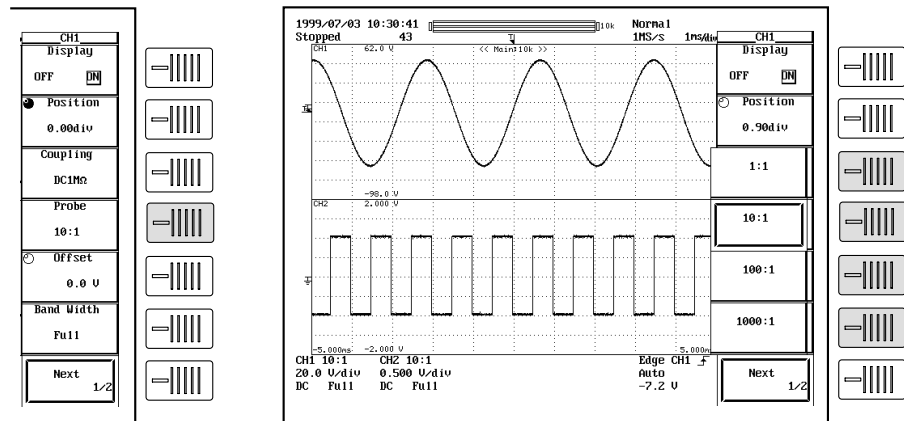

5.5 Setting the Offset Voltage

< For a description of this function, refer to page 1 - 2 >

Function

The offset voltage setting applies to all input couplings (AC 1 M Ω , DC 1 M Ω , DC 50 Ω , and GND couplings).

Offset voltage setting range

Sensitivity Range (Probe = 1 : 1)	Offset Voltage Setting Range
2 mV/div to 50 mV/div	-1.0 V to 1.0 V
0.1 V/div to 0.5 V/div	-10.0 V to 10.0 V
1 V/div to 10 V/div	-100.0 V to 100.0 V (DC 50 Ω : 1 V/div only)

The setting resolution is 0.01 div. If the voltage scale is 2 mV/div, for example, the setting resolution will be 0.2 mV.

Canceling the offset voltage

You can return the offset to 0V by pressing the RESET key.

Points for attention

- Setting the offset voltage while acquisition is stopped will change the display position only. The newly set offset voltage will come into effect when acquisition is restarted.
- You can select whether or not the offset voltage is reflected in the results of cursor measurements, automatic measurements, or math computations.
- If you change the probe attenuation, the offset changes proportionally to reflect the new attenuation rate.
- Changing the voltage sensitivity does usually not affect the offset value. Only if the change would cause the offset to go out of range, the offset moves to the nearest range limit. If you then return to the original sensitivity, the offset returns to its original setting as well (provided that you have not explicitly changed the value in the meantime).

Operating Procedure

Setting the offset value

1. Press one of the keys from "CH1" to "CH4" to select the channel.
2. Press the "Offset" soft key.
3. Turn the jog shuttle to set the offset value.

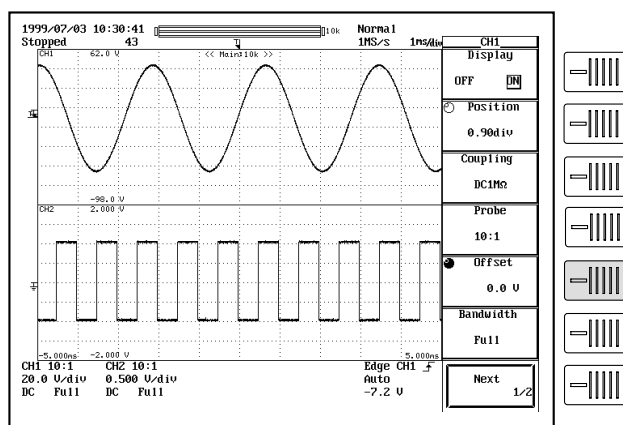

Canceling the offset value (set to 0 V)

Press the "RESET" key to set the offset value to 0 V.

5.6 The Preset Function

Function

The preset function automatically sets each key setting, such as the V/div, input coupling and trigger level, to the optimum value for measurement of TTL or ECL signals (or to an arbitrary value). Also, you can automatically set the appropriate values for use with the current probe 700937 (sold separately: Applicable to DL7100 with software (ROM) version 1.21 or later. See section 15.4, "Checking the System Condition."). This function allows you to make settings for a selected channel or for all channels at the same time.

Settings made by a preset

	TTL	ECL	User
Input coupling	DC 1 MΩ	DC 1 MΩ	DC 1 MΩ
Trigger coupling	DC	DC	DC
Probe	1 : 1, 10 : 1, 100 : 1 or 1000 : 1 is available.		
V/div	1 V/div*1	200 mV/div*1	Arbitrary*2
Offset voltage	2.5 V	-1.3 V	Arbitrary*2
Trigger level	1.4 V	-1.3 V	Arbitrary*2

*1 2 V/div when probe setting is 1000 : 1.

*2 For details about the setting ranges, see Sections 5.5, 5.8, and 6.5.

	Current (700937)	Current (701930)*3
Input coupling*3	DC 1MΩ	DC 1MΩ
Probe	1 : 1	1 : 1
Linear Scaling	ON	ON
Linear Scaling Coefficient	ValueA: +1.0000E+01 ValueB: 0.0000E+00	ValueA: +1.0000E+02 ValueB: 0.0000E+00
Units	A	A
Scale Value Display	ON	ON

*3 Supported by products with software (ROM) version 3.01 or later. See section 15.4, "Checking the System Condition."

Operating Procedure

Selecting the channel

1. Press the "PRESET" key.
2. Press the "Select" soft key to display the channel menu.
3. Press the soft key corresponding to the desired channel. Pressing "All" will select all the channels.

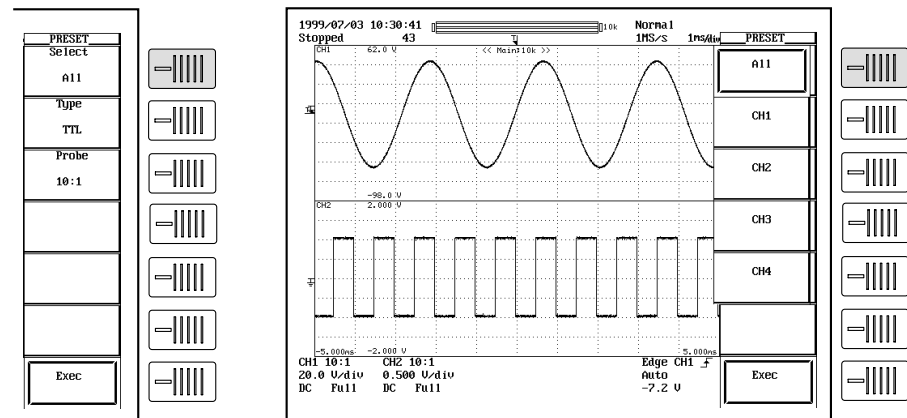

Selecting the preset type

4. Press the “Type” soft key to display the preset type selection menu.
5. Set the type by pressing the soft key corresponding to “TTL,” “ECL,” “User,” “Current (700937),” or “Current (7001930).”

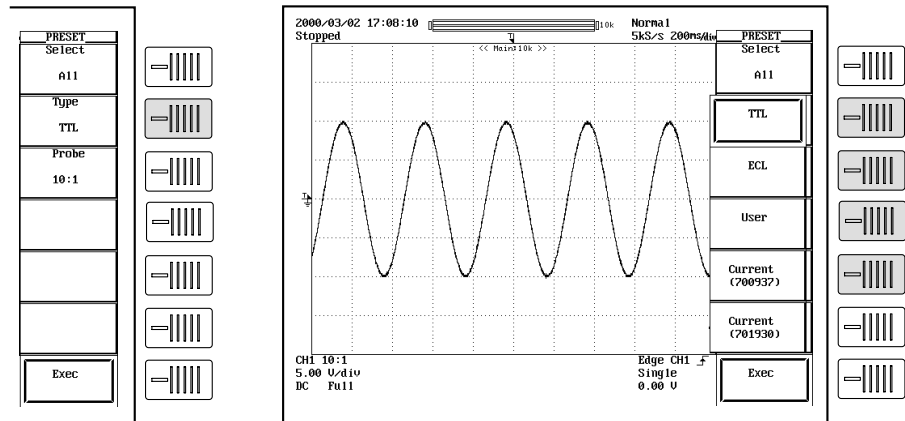

Selecting the probe attenuation (for TTL, ECL, or User Preset)

6. Press the “Probe” soft key to display a menu used to select the attenuation.
7. Press the soft key corresponding to the desired attenuation.

Setting the V/div, offset voltage, and trigger level (when the preset type is User)

8. Press the “Type” soft key to display the preset type selection menu, Press the soft key corresponding to “User.”
9. Press the soft key corresponding to “V/div” to highlight the jog shuttle icon.

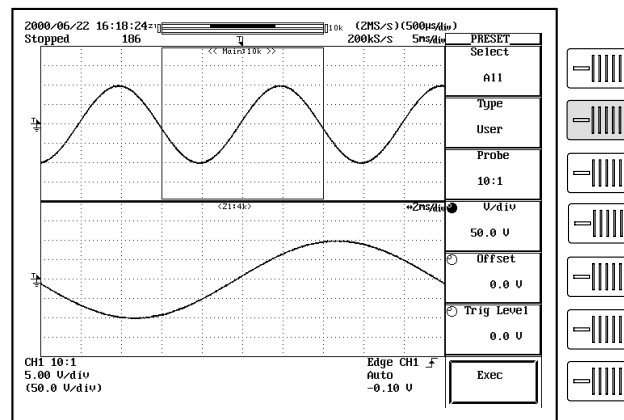

10. Turn the jog shuttle to set the V/div value.
11. Press the [appropriate] soft key to select “Offset,” then turn the jog shuttle to set the “Offset” value.
12. In a similar fashion, set the “Trigger Level.”

Executing the preset

13. Press the “Exec” soft key to execute the preset.

5.7 Setting the Bandwidth

< For a description of this function, refer to page 1 - 3 >

Function

Use this function to remove high frequency components (20 MHz or more or 100 MHz or more) from the input signal.
The bandwidth is set for each channel.

Bandwidth

Two frequency bandwidths, "20 MHz" and "100 MHz" are available. The following figure shows how the bandwidth affects the frequency characteristics. When "Full" is selected, the bandwidth is 500 MHz (50 Ω input) or 400 MHz (1 MΩ input).

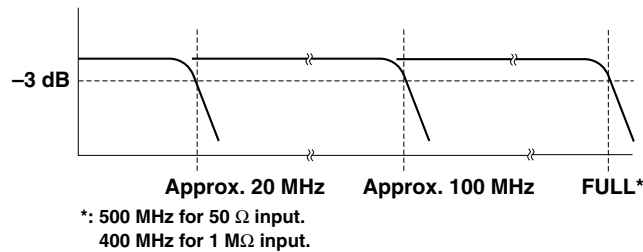

Operating Procedure

1. Press one of the keys from "CH1" to "CH4" to select the channel.
2. Press the "Bandwidth" soft key to display the bandwidth menu.
3. Press a soft key corresponding to "20 MHz," "100 MHz," or "Full" to select the bandwidth.
4. Repeat steps 1 to 3 as necessary to set other channels.

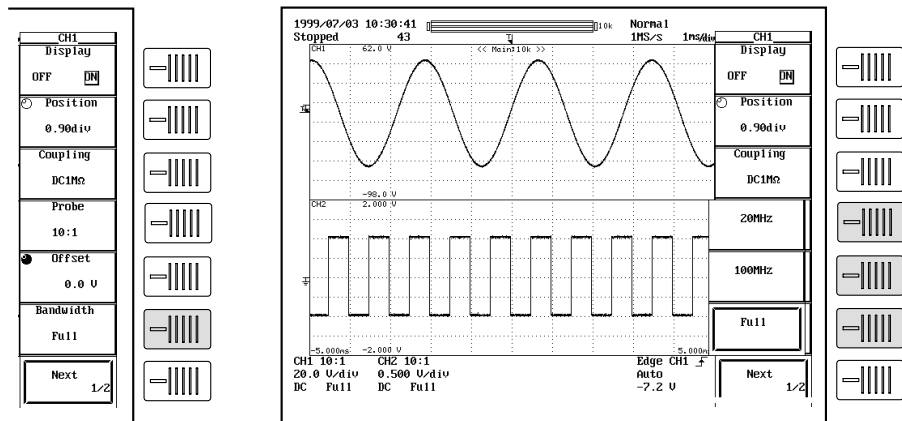

Note

The bandwidth is set for each channel. Set the bandwidth on all necessary channels.

5.8 Setting V/div

< For a description of this function, refer to page 1 - 3 >

Function

The V/div (voltage axis sensitivity) setting is used to adjust the amplitude of the displayed waveform so that the waveform can be observed easily. The V/div setting is made by setting the voltage value per division on the screen grid.

- There are two methods available in setting the V/div.

Setting the V/div using the V/div knob

The settings are “1 V/div,” “2 V/div,” “5 V/div,” and their tenfold multiples.

This setting will become the reference for the range that can be set using the “Variable” parameter (described next) and the resolution.

V/div setting range

The V/div setting range for each probe attenuation value is shown in the table below.

Probe attenuation	Setting range (DC 1 M Ω)	Setting range (DC 50 Ω)
1 : 1	2 mV/div to 10 V/div	2 mV/div to 1 V/div
10 : 1	20 mV/div to 0.1 kV/div	20 mV/div to 10 V/div
100 : 1	0.2 V/div to 1 k V/div	0.2 V/div to 0.1 kV/div
1000 : 1	2 V/div to 10 k V/div	2 V/div to 1 kV/div

- Setting the V/div using the “Variable” parameter in the CH menu

You can set the V/div using a resolution that is finer than the resolution provided by the V/div knob and vertically expand or reduce the displayed waveform.

The waveform acquisition can be started with the changed V/div setting.

Range

The following table shows the range when the probe attenuation setting is 10 : 1.

V/div setting with V/div knob	Setting range of variable	Setting resolution
20 mV	2.0 mV to 50.0 mV	0.2 mV
50 mV	5.0 mV to 100.0 mV	0.5 mV
100 mV	10 mV to 200 mV	1 mV
200 mV	20 mV to 500 mV	2 mV
500 mV	50 mV to 1000 mV	5 mV
1 V	0.10 V to 2.00 V	0.01 V
2 V	0.20 V to 5.00 V	0.02 V
5 V	0.50 V to 10.00 V	0.05 V
10 V	1.0 V to 20.0 V	0.1 V
20 V	2.0 V to 50.0 V	0.2 V
50 V	5.0 V to 100.0 V	0.5 V
100 V	10 V to 200 V	1 V

* When the probe attenuation is “1 : 1,” “100 : 1,” and “1000 : 1,” the values are 1/10, 10, and 100 times, respectively.

Operating Procedure

Setting the V/div using the V/div knob

1. Press one of the keys from “CH1” to “CH4” to select the channel.
2. Turn the V/DIV knob to set the V/div value.

Note

- Changing the V/DIV setting while the waveform acquisition is stopped will not change the displayed waveform. The new V/div value takes effect the next time waveform acquisition is started.
- When the waveform acquisition is stopped, the cursor measurement value and automated measurement of waveform parameters will show values using the old V/div setting even if the V/DIV knob is turned.

Setting the V/div using the “Variable” parameter

1. Press one of the keys from “CH1” to “CH4” to select the channel.
2. Press the “Next 1/2” soft key.
3. Press the “Variable” soft key.
4. Turn the jog shuttle to set the V/div value.

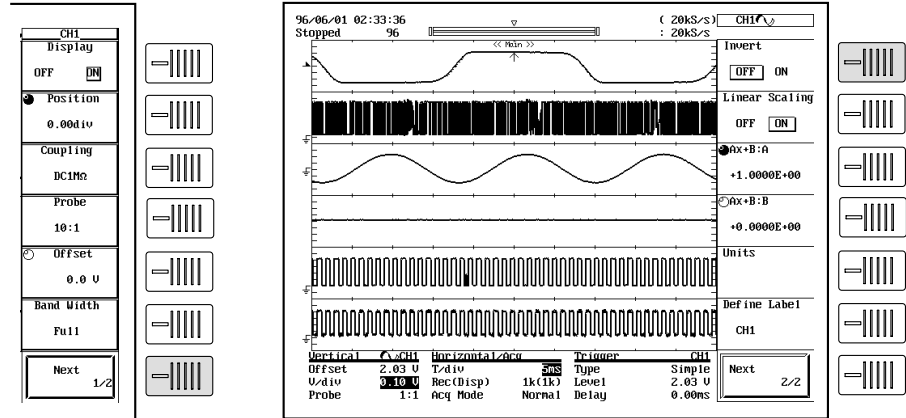

Note

- If the V/div setting is changed by rotating the V/DIV knob, the “Variable” value is set to the modified V/div value.
- If Variable is reset with the “RESET” key, the V/div setting returns to the value set with the V/div knob.

5.9 Using the Linear Scaling Function

< For a description of this function, refer to page 1 - 20 >

Function

This function lets you apply linear scaling to the measurement values. If you set this feature ON, the screen displays the scaled results rather than the original measurements. The scaling relationship is

$$Y = AX + B$$

where X is the measurement value and Y is the scaled value. Note that you can select the dimensional unit for the scaled display.

Scaling coefficient (A) and offset (B)

Range for A, B : -9.9999E+30 to +9.9999E+30

Default A : 1.0000E+00

B : 0.0000E+00

Dimensional unit

Unit identifier (alphanumeric string) of up to four characters.

Displaying the scale value

The linearly scaled values of the upper and lower limits of the vertical axis of each channel can be displayed. (See section 8.4, "Turning ON/OFF the Scale Value Display.")

Operating Procedure

1. Press one of the keys from "CH1" to "CH4" to select the channel.
2. Press the "Next 1/2" soft key.
3. Press the "Linear Scale AX+B" soft key to select "ON."
4. Press the "A B" soft key.
5. Turn the jog shuttle to set the value of A.
You can use the arrow keys to move between the digits.
6. In a similar fashion, set the value B.
7. If necessary, press the "Units" soft key to display the keyboard and enter the unit.

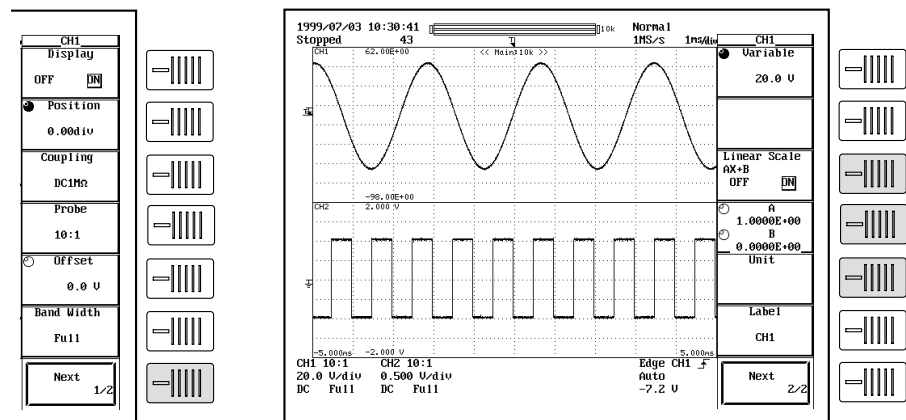

Note

- Linear scaling is not available for the following waveforms.
Snapshot waveforms
Accumulated waveforms (except for newest waveform)
- You can set linear scaling separately for each channel.
- The A and B values remain in memory after you switch the linear scaling function OFF, and are restored if you switch the function back on.
- Mathematical computations operate with respect to the scaling results.

5.10 Turning ON/OFF the Logic Input and Setting the Threshold Level.

Function

Turns ON/OFF the optional logic input bits and sets the threshold level.

Turning ON/OFF the logic input

When the logic input is turned ON, a window for the logic waveforms opens.

Selecting the bits to display

You can set which bits to display for each pod.

When all the bits on either POD A or POD B are turned OFF, the vertical display range of the other pod widens.

Threshold level

Select the threshold level of the input signal for each pod from the following three types.

TTL : 1.4 V

ECL : -1.3 V

User : Arbitrary (in 0.1 V steps, ± 10 V)

Defining the waveform label

The waveform label for each bit can be set using up to 8 characters.

Precautions to be taken when using the logic probe

- If the acquisition mode is set to "Average" or "Box Average" when using the logic input, only the analog waveforms will be averaged or box averaged.
- When the interleave mode is turned ON, Pod B cannot be used.

Operating Procedure

Turning ON/OFF the logic input

1. Press the "LOGIC" key.
2. Press the "Mode" soft key to select "ON" or "OFF."

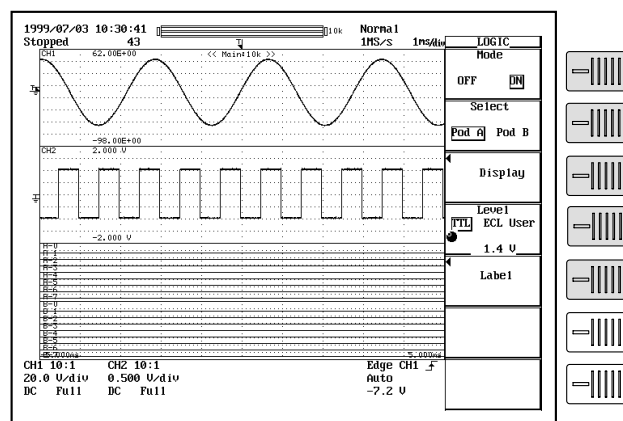

Selecting the pod to set

3. Press the "Select" soft key to select "Pod A" or "Pod B."

Turning each bit ON/OFF

4. Pressing the “Display” soft key displays a dialog box used to turn ON/OFF each bit.
5. You can select the bit using the jog shuttle and press the “SELECT” key to select “ON” or “OFF.”

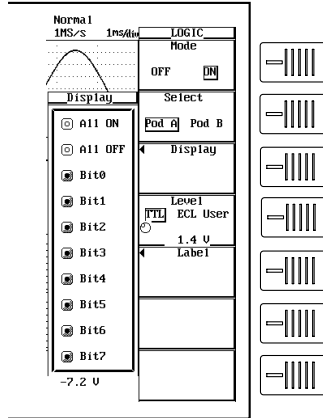

Selecting the threshold level

6. Press the “Level” soft key to select “TTL,” “ECL,” or “User.”
7. When “User” is selected, set the threshold level using the jog shuttle. Even if “TTL” or “ECL” is selected in step 6, if the threshold level is changed with the jog shuttle, the level is automatically changed to “User.”

Setting the label

8. Pressing the “Label” soft key displays a label setting dialog box used to set each bit.
9. Select the desired bit with the jog shuttle and press the “SELECT” key to display a keyboard.
10. Use the keyboard to enter the waveform label.
11. Repeat steps 9 and 10 as necessary.
12. Pressing the “ESC” key closes the dialog box.

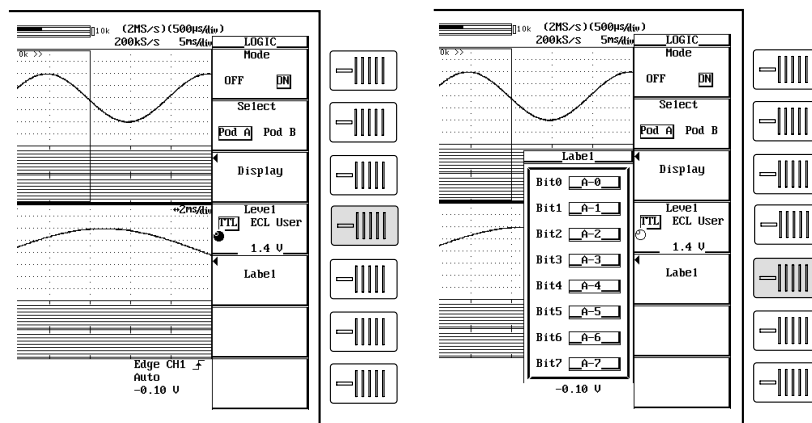

5.11 Selecting the Timebase

< For a description of this function, refer to page 1 - 4 >

Function

Selectable Timebases

The timebase can be selected from the following three types.

- INT Internal clock signal
- EXT IN Clock signal input to the EXT TRIG IN/EXT CLOCK IN/TRIG GATE IN terminal

When “EXT IN” is selected

Input a clock signal to the EXT TRIG IN/EXT CLOCK IN terminal on the rear panel. The clock signal must conform to the specifications given below.

Item	Specifications
Connector type	BNC
Maximum permissible input voltage	± 40 V (DC + ACpeak) or 28 Vrms, 10 kHz or less
Frequency range	40 Hz to 20 MHz (continuous clock only)
Minimum input level	0.1Vp-p
Input impedance	Approx. 1 M Ω and 15 pF
Threshold level	± 2 V (in 5 mV resolution)
Sampling jitter	1.25 ns or less
Minimum pulse width	10 ns or more for both High and Low levels

[Input terminal]



CAUTION

If a clock signal exceeding the above maximum permissible input voltage is input to the EXT TRIG IN/EXT CLOCK IN/TRIG GATE IN terminal, damage to the internal circuits of the instrument may result.

Points to note when sampling using an external clock

- The clock signal must be continuous. No burst signal is allowed.
- Only real - time sampling mode is available.
- Envelope mode and Box Average mode cannot be set.
- Display of waveforms is not possible in roll mode.
- No function to divide the clock signal is available.
- Since the time axis setting cannot be changed, expand the time axis if you want to change the display range. For a description of expanding waveforms, refer to section 8.8.
- The trigger delay cannot be set.
- The deskew function cannot be used.
- It is not possible to set a calibration deskew time.
- The time measured by the cursor measurement or automated measurement function is expressed in the number of pulses of the clock signal. No units are displayed.

Operating Procedure

1. Press the ACQ key.
2. Press the "Time Base" soft key to select "Int" or "Ext."

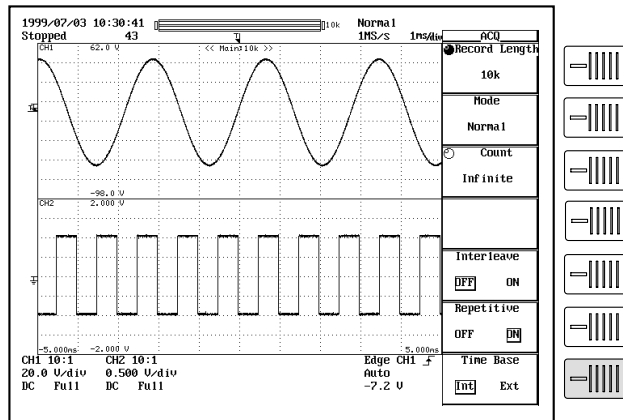

Threshold setting (for EXT clock)

3. If you have selected use of an external clock, you must now set the threshold level. This setting is identical to the trigger-level setting; refer to Section 6.5, "Setting the Edge Trigger," for the procedure. Note that you must set the trigger source to EXT before setting the level.

5.12 Setting T/div

< For a description of this function, refer to page 1 - 5 >

Function

The T/div setting is made by setting the time per division on the screen grid.

Setting range

Record Length is 10 kW or more : 1 ns/div to 50 s/div(1 - 2 - 5 steps)

Record Length is 1 kW : 1 ns/div to 5 s/div(1 - 2 - 5 steps)

T/div and sampling mode

Use of repetitive sampling mode lets you get the sample rate of 1 GS/s and above with the DL7100 (or 100 GS/s and above if interleave is also ON), or 2 GS/s and above with the DL7200 (or 5 GS/s if interleave is ON). But note that the allowable time - scale settings vary according to record length, machine model, and other factors. For details, see Appendix 1.

T/div and roll mode

When acquisition count is infinite, acquisition mode is not average, or the trigger mode is auto, auto level, or single, roll mode display is enabled at the following T/div settings.

Record Length	T/div
1 kW	50 ms/div to 5 s/div
10 kW to 1 MW	50 ms/div to 50 s/div
2 MW	100 ms/div to 50 s/div
4 MW	200 ms/div to 50 s/div
8 MW	500 ms/div to 50 s/div
16 MW (701440 (DL7200) only)	1 s/div to 50 s/div

Operating Procedure

1. Turn the TIME/DIV knob to set the desired T/div.

Note

- Turning the TIME/DIV knob while acquisition is stopped displays the new T/div value in parentheses on the upper right of the screen. The new setting will come into effect the next time the acquisition is started.
- When repetitive sampling mode is OFF (see Section 7.6), the maximum sampling rate for the DL7100 is 500 MS/s (or 1 GS/s when interleave mode is ON), and 1 GS/s for the DL7200 (or 2 GS/s when interleave mode is ON).
- Even when the repetitive sampling is turned OFF, there are cases in which the mode automatically changes to the repetitive sampling mode when the T/div is changed. For the relationship between the T/div setting and the sample rate, see appendix 1, "Relationship between the Time Axis Setting, Sample Rate, and Record length."

6.1 Setting the Trigger Mode

Function

< For a description of this function, refer to page 1 - 10 >

Auto mode

If the trigger condition is met within the 100-ms timeout period, the waveform is updated on each trigger occurrence. If the trigger condition is not met after the timeout period elapses, the waveform is automatically updated. If the time axis setting is in the range in which the display mode is set to roll mode, the display is set to roll mode.

Auto level mode

- If a trigger occurs within the timeout period, the waveform is displayed in the same fashion as in the auto mode. If a trigger does not occur within the timeout period, the center value of the amplitude of the trigger source is detected, trigger level is automatically changed to the center value, and the trigger is generated to update the displayed waveform. The auto-level mode is valid only if the trigger is a simple trigger and the trigger source is CH1 to CH4. For all other cases, the operation is the same as the auto mode.
- If the time axis setting is in the range in which the display mode is set to roll mode, the display is set to roll mode.

Normal mode

The display is updated only when the trigger conditions are met. The display will not be updated if no trigger is caused. Therefore, to check the waveform or ground level when no trigger is detected, use auto mode.

Single Mode

The display is updated once when the trigger conditions are met and the waveform acquisition stops.

In the time axis setting range in which the display mode is set to roll mode, the display is set to roll mode. When a trigger occurs, the specified record length of data is acquired and the displayed waveform stops.

Single (N) mode

The display is updated according to the number of times specified when the trigger conditions are met and the waveform acquisition stops. This mode is used when acquiring a waveform using the sequential store function. If the repetitive mode turn ON, this mode is automatically changed to single mode.

Note

The trigger mode setting applies to both simple and enhanced triggers.

Operating Procedure

1. Press the "MODE" key.
2. Press the soft key corresponding to the desired mode to set the trigger mode.
3. If "Single(N)" is selected, turn the jog shuttle to set the number of times to acquire the waveform.

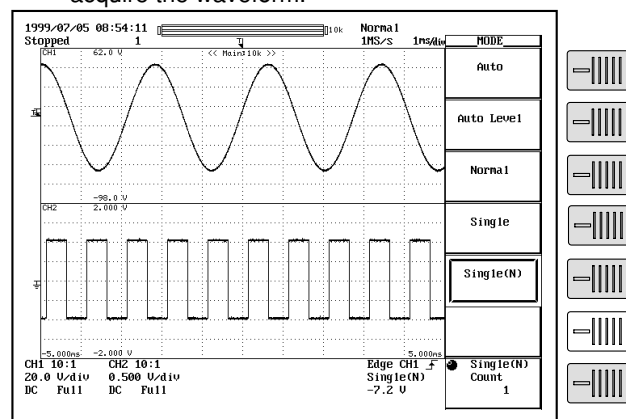

6.2 Setting the Trigger Delay

< For a description of this function, refer to page 1 - 12 >

Function

Although the display usually shows the waveform before and after the trigger point, using the delay function, it is possible to display the acquired waveform after a fixed time period elapses.

Setting range for trigger delay

0 to 4 s (Resolution is 1 ÷ sample rate)

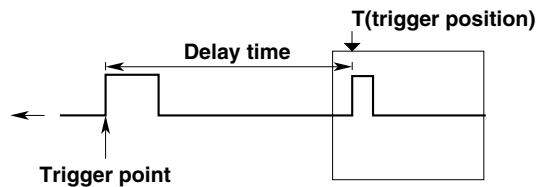

Points for attention

- When T/div is changed, the trigger delay remains unchanged. However, its position in relation to the overall record length changes.
- If the timebase is provided by an external clock, the trigger delay is fixed at 0s (no delay).

Operating Procedure

1. Press the “SHIFT” key to set the keys in the shifted condition. Functions marked in purple on the panel become active.
2. Press the “POSITION” key.
3. Turn the jog shuttle to set the trigger delay. You can use the arrow keys to move between the digits. In addition, pressing the “RESET” key resets the delay to “0 s.”

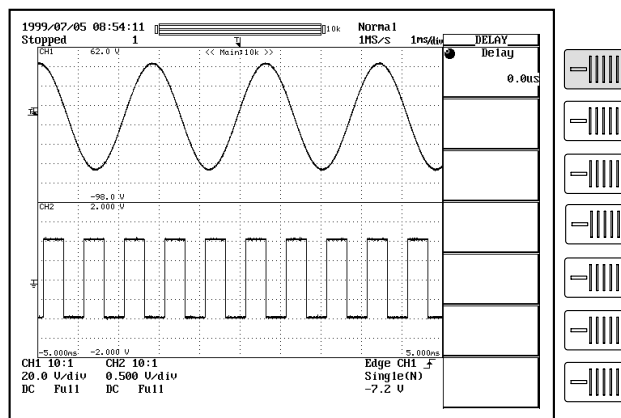

6.3 Setting the Trigger Position

< For a description of this function, refer to page 1 - 12 >

Function

Trigger position

The trigger position is the waveform position that results when the trigger delay is added to the trigger point. If the trigger delay is 0 s, therefore, the trigger position is equivalent to the trigger point. You can select the location of the trigger position on the screen.

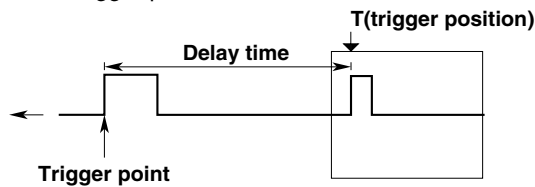

Setting range for trigger position

0 to 100% of record length, in 1% steps

Position marker

A position marker (▣ marker) appears above the bar at the top of the screen. The marker indicates the trigger position with respect to the total record length. You can shift the trigger position to the right or left on the screen.

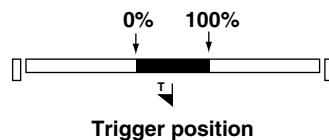

Points for attention

- If you change the trigger position while waveform acquisition is suspended, the new setting will not become effective until acquisition is resumed and the waveform is updated.
- Note that cursor time measurements are with respect to the trigger position. Changing the trigger position therefore changes the measurement values (except during roll-mode display).
- When you change the T/div setting, the time axis setting is rescaled with respect to the trigger position.

Operating Procedure

1. Press the "POSITION" key.
2. Turn the jog shuttle to set the trigger position.
You can use the arrow keys to move between the digits.
If you wish to select 10%, 50%, or 90%, you can press the corresponding soft key.
In addition, pressing the "RESET" key, resets the position to "50%."

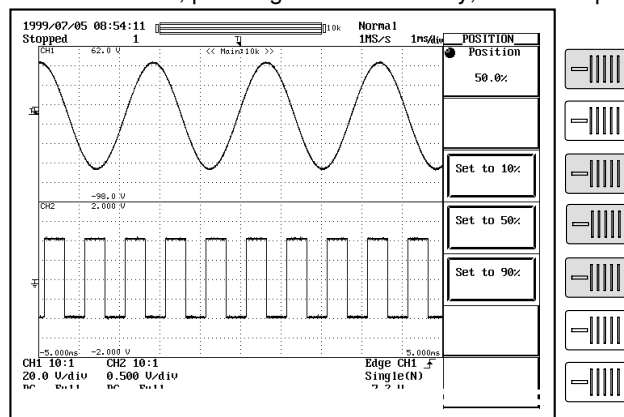

6.4 Setting the Hold Off Time

< For a description of this function, refer to page 1 - 12 >

Function

This function prevents a trigger from being activated for a specified time, even if the trigger conditions are met during this time. The following two methods can be used to prevent the trigger. This is useful when you wish to activate the trigger in sync with a signal that is periodic as shown in the figure below.

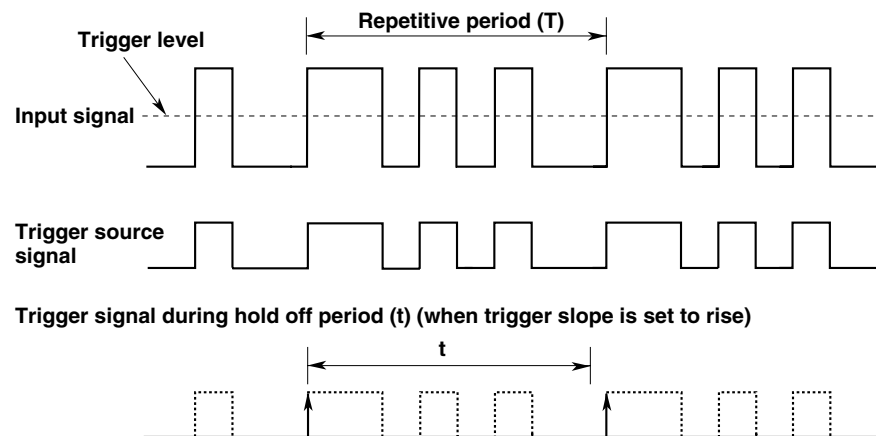

Hold off time setting range

80 ns to 10 s (default: 80 ns).

The setting resolution is 20 ns.

Points for attention

- Updating of the waveform may be slow in repetitive sampling mode. In this case set the hold off time to a smaller value.
- If holdoff time is set to 100 ms or above, the trigger mode should be set to "normal."
- When used with the A→B(n) or A Delay B trigger, the holdoff time operates with respect to condition A only.

Operating Procedure

During simple trigger

1. Press the "SIMPLE" key.
2. If the jog shuttle control is not set to "Hold Off," press the "Hold Off" soft key.
3. Turn the jog shuttle to set the hold off period.
You can use the arrow keys to move between the digits. In addition, pressing the "RESET" key, resets the value to "0.08 us (0.08 μ s.)"

During enhanced trigger

1. Press the "ENHANCED" key.
2. If the jog shuttle control is not set to "Hold Off," press the "Hold Off" soft key.
3. Turn the jog shuttle to set the hold off period.
You can use the arrow keys to move between the digits. In addition, pressing the "RESET" key, resets the value to "0.08 us (0.08 μ s.)"

Simple trigger

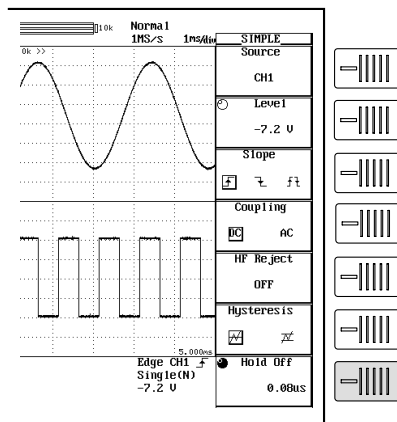

Enhanced trigger

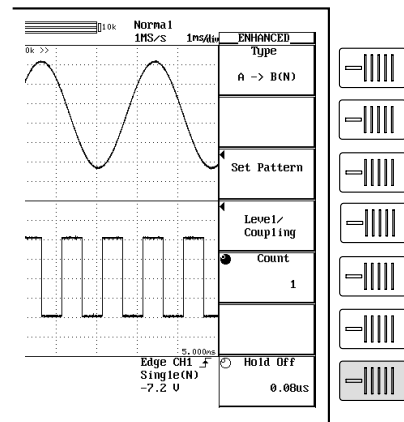

Note

The hold off time setting applies to simple trigger and enhanced trigger.

6.5 Setting the Edge Trigger (SIMPLE)

< For a description of this function, refer to page 1 - 7 >

Function

An edge trigger is generated when the trigger source signal crosses a specified level.

Selecting the trigger source

Select from the following list of choices.

- CH1 to CH4
- Ext (EXT TRIG IN terminal on the rear panel, see section 6.6, "Setting the External Trigger (SIMPLE)")
- Line (power signal, see section 6.7, "Generating a Trigger Using the Power Signal (SIMPLE)")

Setting the trigger level

Range : 8 div within the screen

Resolution : 0.01 div

For example, the resolution is 0.02 mV when the V/DIV setting is 2 mV/div.

You can also reset the trigger level to the current offset voltage with one key operation.

Setting the trigger slope

Select the trigger activation method relative to changes in trigger source level from the following three choices.

- ↗ : Activated when the trigger source changes from below the trigger level to above the trigger level (rising).
- ↘ : Activated when the trigger source changes from above the trigger level to below the trigger level (falling).
- ↕ : Activated on either a rising edge or falling edge.

Setting the trigger coupling

Select from the following list of choices.

- AC : Uses a signal that is obtained by removing the DC component from the trigger source signal.
- DC : Uses the trigger source signal as the trigger signal.

Setting the HF rejection

Set to "15 kHz" or "20 MHz" when you wish to use a signal source that is obtained by removing the high frequency components (frequency components greater than or equal to approximately 15 kHz or 20 MHz) from the trigger signal as the trigger source.

Setting the hysteresis

Assigns a width to the trigger level so that the trigger is not activated by small changes in the trigger signal.

⚡ : Approximately 0.3 div* of hysteresis around the trigger level.

⚡ : Approximately 1 div* of hysteresis around the trigger level.

*: The value above are estimated values. They are not strictly guaranteed.

Setting the hold off

See section 6.4, "Setting the Hold Off Time."

Operating Procedure

Setting the trigger source

1. Press the “SIMPLE” key.
2. Pressing the “Source” soft key to display the trigger source menu.
3. Press the soft key corresponding to the channel to be set as the trigger source.

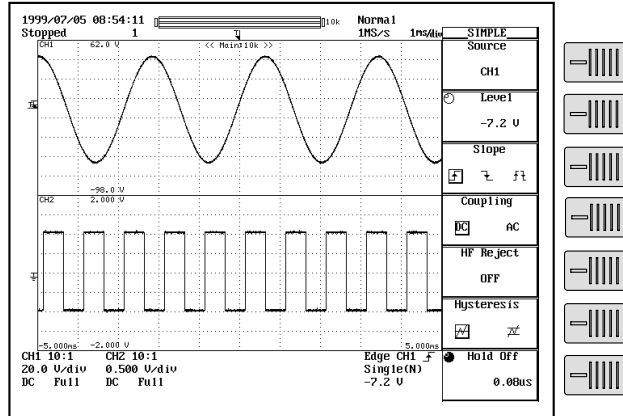

Setting the trigger level

4. If the jog shuttle control is not set to “Level,” press the “Level” soft key.
5. Turn the jog shuttle to set the trigger level.
You can use the arrow keys to move between the digits. In addition, pressing the “RESET” key resets the trigger level to the current offset voltage value.

Note

The trigger level setting applies to simple trigger and enhanced trigger.

Setting the trigger slope

6. Press the “Slope” soft key to select “f,” “ \downarrow ,” or “f \downarrow .”

Setting the trigger coupling

7. Press the “Coupling” soft key to select “DC” or “AC.”

Note

The trigger coupling setting applies to simple trigger and enhanced trigger.

Setting the HF rejection

8. Press the “HF Reject” soft key to display an HF rejection menu.
9. Press the soft key corresponding to the desired frequency to select HF rejection.

Setting the hysteresis

10. Press the “Hysteresis” soft key to select “ \wedge ” or “ ∇ .”

Setting the hold off

11. Set the hold off time according to the procedures given in 6.4, “Setting the Hold Off Time.”

6.6 Setting the External Trigger (SIMPLE)

Function

The external signal that is input through the EXT TRIG IN terminal on the rear panel of this instrument can be used to generate triggers.

Note

For details related to the specifications of the EXT TRIG IN terminal, see page 12 - 1.

Selecting the trigger source

Select Ext.

Setting the trigger level

Range : ± 2 V

Resolution : 5 mV

Setting the trigger slope

Select the trigger activation method relative to changes in trigger source level from the following three choices.

\uparrow : Activated when the trigger source changes from below the trigger level to above the trigger level (rising).

\downarrow : Activated when the trigger source changes from above the trigger level to below the trigger level (falling).

\updownarrow : Activated on either a rising edge or falling edge.

Setting the probe attenuation

When applying a trigger input signal to the EXT TRIG IN terminal via a probe, select an attenuation that matches the probe attenuation.

1 : 1, 10 : 1

Setting the hold off

See section 6.4, "Setting the Hold Off Time."

Operating Procedure

Setting the trigger source

1. Press the “SIMPLE” key.
2. Pressing the “Source” soft key to display the trigger source menu.
3. Press the “Ext” soft key.

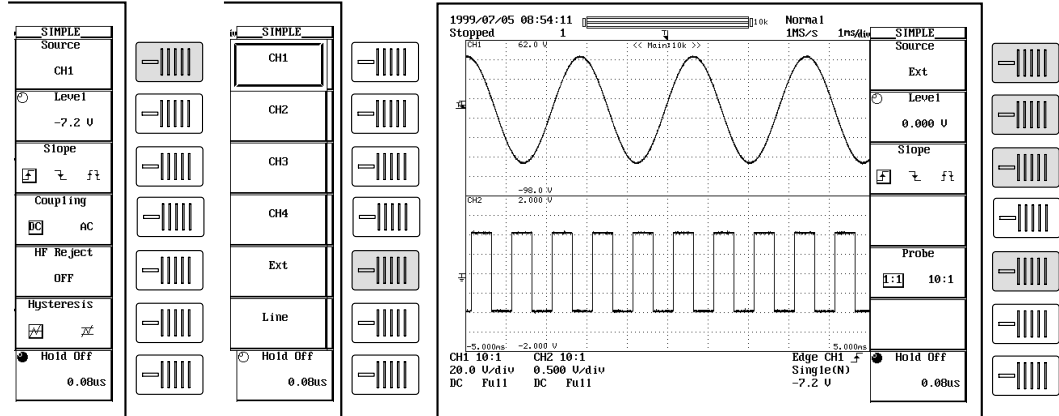

Setting the trigger level

4. If the jog shuttle control is not set to “Level,” press the “Level” soft key.
5. Turn the jog shuttle to set the trigger level.
You can use the arrow keys to move between the digits. In addition, pressing the “RESET” key, sets the trigger level to 0 V.

Setting the trigger slope

6. Press the “Edge” soft key to select “f,” “ \downarrow ,” or “f \downarrow .”

Setting the probe attenuation

7. Press the “Probe” soft key to select “1 : 1” or “10 : 1.”

Setting the hold off

8. Set the hold off time according to the procedures given in 6.4, “Setting the Hold Off Time.”

6.7 Generating Triggers on the Power Signal (SIMPLE)

Function

Triggers can be generated on the rising edge of the power signal that is being supplied to the instrument. Waveforms can be observed in sync with the commercial power supply frequency (50 Hz or 60 Hz).

Operating Procedure

Setting the trigger source

1. Press the "SIMPLE" key.
2. Press the "Source" soft key to display the trigger source menu.
3. Press the "Line" soft key.

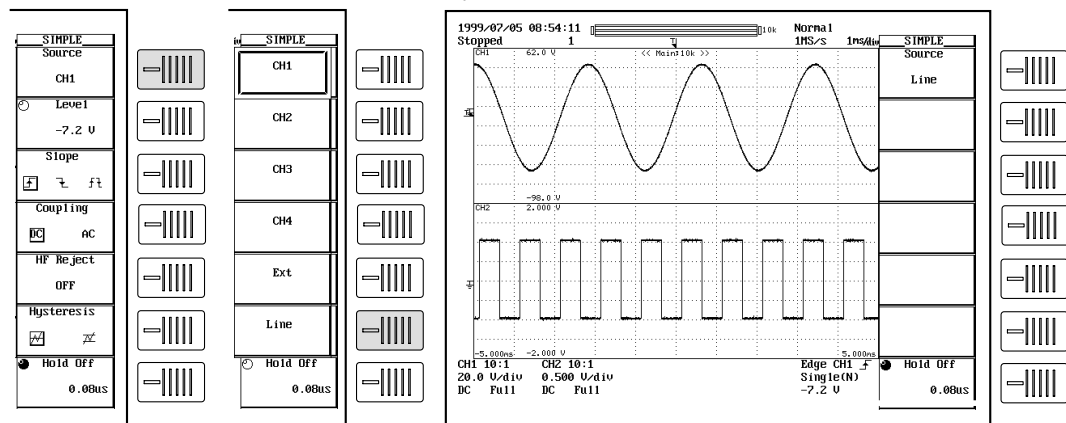

Setting the hold off

4. Set the hold off time according to the procedures given in 6.4, "Setting the Hold Off Time."

6.8 Setting the A→B(n) Trigger (ENHANCED)

< For a description of this function, refer to page 1 - 7 >

Function

This function activates a trigger on the nth time condition B becomes true after condition A becomes true.

Setting Conditions A and B

- **Channel status**

Select the status of the channel from the following three choices.

H : Above the specified trigger level

L : Below the specified trigger level

X : Don't care

- **Condition**

Select from the following two conditions.

Enter : Trigger is activated when all channels meet the specified status.

Exit : Trigger is activated when at least one channel no longer meets the specified status.

The number of times pattern B is to be met

1 to 10^8 times

Setting the trigger level

Range : 8 div within the screen

Resolution : 0.01 div

For example, the resolution is 0.02 mV when the V/DIV setting is 2 mV/div.

Setting the hysteresis

Assigns a width to the trigger level so that the trigger is not activated on small changes.

 : Approximately 0.3 div* of hysteresis around the trigger level.

 : Approximately 1 div* of hysteresis around the trigger level.

*: The value above are estimated values. They are not strictly guaranteed.

Setting the trigger coupling

Select from the following list of choices.

AC : Uses a signal that is obtained by removing the DC component from the trigger source signal as the trigger signal.

DC : Uses the trigger source signal as the trigger signal.

Turning ON/OFF the HF rejection

Select "15 kHz" or "20 MHz" when you wish to use a signal source that is obtained by removing the high frequency components (frequency components greater than or equal to approximately 15 kHz or 20 MHz) from the trigger signal as the trigger source.

Setting the hold off

See section 6.4, "Setting the Hold Off Time."

Note

- If you wish to use only one pattern condition to activate the trigger, use the pattern trigger. If the status for condition A and condition B are set to Xs (Don't care), the trigger will not be activated.

6.8 Setting the A→B(n) Trigger (ENHANCED)

Operating Procedure

Setting the trigger type

1. Press the “ENHANCED” key.
2. Pressing the “Type” soft key to display the trigger type menu.
3. Press the “A→B(N)” soft key.

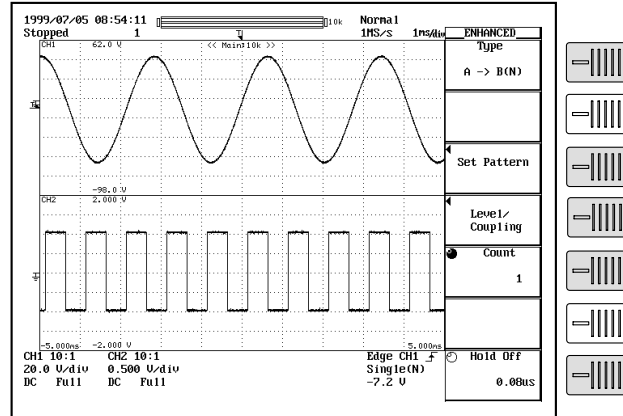

Setting the status and condition for conditions A and B

4. Pressing the “Set Pattern” soft key displays a menu used to set the status and condition for conditions A and B.

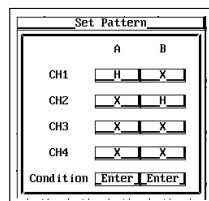

5. Set condition A. Turn the jog shuttle to move the cursor to the channel to which the status of condition A will be set.
6. Press the “SELECT” key several times to select “H,” “L,” or “X.”
7. Turn the jog shuttle to move the cursor to the “Condition” position of condition A.
8. Press the “SELECT” key several times to select “Enter” or “Exit.”
9. In a similar fashion, set condition B.

Setting the level

10. Pressing the “Level/Coupling” soft key displays a menu used to set the level, coupling, hysteresis, and HF rejection.

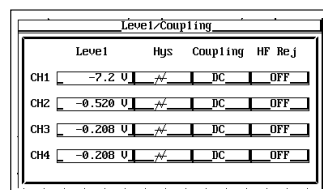

11. Turn the jog shuttle to move the cursor to the channel on which the level is to be set.
12. Press the “SELECT” key to display the level setting menu.
13. Turn the jog shuttle to set the level.
You can use the arrow keys to move between the digits. In addition, pressing the “RESET” key sets the trigger level to 0 V.

Setting the hysteresis

14. Turn the jog shuttle to move the cursor to the channel on which hysteresis is to be set.
15. Press the "SELECT" key to select " \overline{A} " or " \overline{B} "

Setting the trigger coupling

16. Turn the jog shuttle to move the cursor to the channel on which the coupling is to be set.
17. Press the "SELECT" key to select "DC" or "AC."

Setting the HF rejection

18. Turn the jog shuttle to move the cursor to the channel on which the HF rejection (HF Rej) is to be set.
19. Press the "SELECT" key to select "OFF," "20 MHz," or "15 kHz."

Setting the number of times condition B is to be met

20. If the jog shuttle control is not set to "Count," press the "Count" soft key.
21. Turn the jog shuttle to set the count.
You can use the arrow keys to move between the digits. Pressing the "RESET" key resets the value to 1.

Setting the hold off

22. Set the hold off time according to the procedures given in 6.4, "Setting the Hold Off Time."

Note

-
- The status setting of conditions A and B applies to all trigger types.
 - The trigger level, hysteresis, trigger coupling, and HF rejection settings apply to simple trigger and enhanced trigger.
-

6.9 Setting the A Delay B Trigger (ENHANCED)

< For a description of this function, refer to page 1 - 8 >

Function

This function activates a trigger the first time condition B becomes true after condition A becomes true and the specified time elapses.

Setting Conditions A and B

- **Channel status**

Select the status of the channel from the following three choices.

H : Above the specified trigger level

L : Below the specified trigger level

X : Don't care

- **Condition**

Enter : Trigger is activated when all channels meet the specified status.

Exit : Trigger is activated when at least one channel no longer meets the specified status.

Delay time

0 to 5 s (resolution: 1 ns)

Setting the trigger level

Range : 8 div within the screen

Resolution : 0.01 div

For example, the resolution is 0.02 mV when the V/DIV setting is 2 mV/div.

Setting the hysteresis

Sets a width to the trigger level so that the trigger is not activated on small changes.

∇ : Approximately 0.3 div* of hysteresis around the trigger level.

∇ : Approximately 1 div* of hysteresis around the trigger level.

*: The value above are estimated values. They are not strictly guaranteed.

Setting the trigger coupling

Select from the following list of choices.

AC : Uses a signal that is obtained by removing the DC component from the trigger source signal as the trigger signal.

DC : Uses the trigger source signal as the trigger signal.

Turning ON/OFF the HF rejection

Select "15 kHz" or "20 MHz" when you wish to use a signal source that is obtained by removing the high frequency components (frequency components greater than or equal to approximately 15 kHz or 20 MHz) from the trigger signal as the trigger source.

Setting the hold off

See section 6.4, "Setting the Hold Off Time."

Note

- If you wish to use only one pattern condition to activate the trigger, use the pattern trigger. If the status for condition A and condition B are set to Xs (Don't care), the trigger will not be activated.

Operating Procedure

Setting the trigger type

1. Press the “ENHANCED” key.
2. Pressing the “Type” soft key to display the trigger type menu.
3. Press the “A Delay B” soft key.

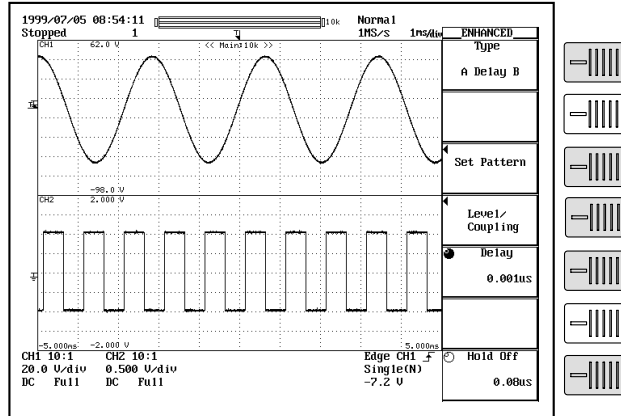

Setting the status and condition for conditions A and B

4. Pressing the “Set Pattern” soft key displays a menu used to set the status and condition for conditions A and B.

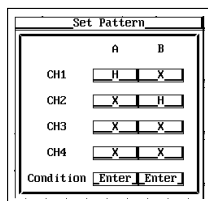

5. Set condition A. Turn the jog shuttle to move the cursor to the channel to which the status of condition A will be set.
6. Press the “SELECT” key several times to select “H,” “L,” or “X.”
7. Turn the jog shuttle to move the cursor to the “Condition” position of condition A.
8. Press the “SELECT” key several times to select “Enter” or “Exit.”
9. In a similar fashion, set condition B.

6.9 Setting the A Delay B Trigger (ENHANCED)

Setting the level, hysteresis, trigger coupling, and HF rejection

10. Pressing the “Level/Coupling” soft key displays a menu used to set the level, coupling, hysteresis, and HF rejection.

The setting also applies to A→B(N) trigger. See page 6 - 13.

Setting the delay time

11. If the jog shuttle control is not set to “Delay,” press the “Delay” soft key.
12. Turn the jog shuttle to set the delay time.

You can use the arrow keys to move between the digits. Pressing the “RESET” key resets the value to 0.003 μ s.

Setting the hold off

13. Set the hold off time according to the procedures given in 6.4, “Setting the Hold Off Time.”

Note

- The status setting of condition A and B applies to all trigger types.
 - The trigger level, hysteresis, trigger coupling, and HF rejection settings apply to simple trigger and enhanced trigger.
-

6.10 Setting the Pattern Trigger (ENHANCED)

< For a description of this function, refer to page 1 - 8 >

Function

This function activates the trigger when all conditions set to multiple trigger sources become true or when all conditions become false.

Setting the trigger source and trigger status.

- **Set the trigger status of the trigger source from the following three choices.**

H : The trigger source level is greater than or equal to the trigger level.

L : The trigger source level is less than or equal to the trigger level.

X : Do not set as a trigger source.

- **Selecting the clock channel: Clock CH**

- Select "None" if the trigger is not to be activated in sync with the signal.

- Select the clock channel from "CH1" to "CH4" if the trigger is to be activated in sync with the signal.

- Select the trigger slope from the following.

↗ : Rising

↘ : Falling

Selecting the trigger condition

When activating the trigger only on the status pattern

Select the trigger condition from the following list of choices.

Enter : Trigger is activated when the specified combination (pattern) is met.

Exit : Trigger is activated when the specified pattern is no longer met.

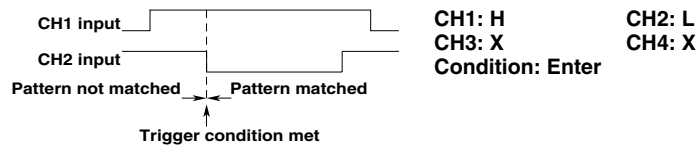

When activating the trigger in sync with the clock channel

Set the trigger condition from the following list of choices.

True : Trigger is activated on the rising or falling edge of the clock channel while the status pattern is being matched.

False : Trigger is activated on the rising or falling edge of the clock channel while the status pattern match condition is not satisfied.

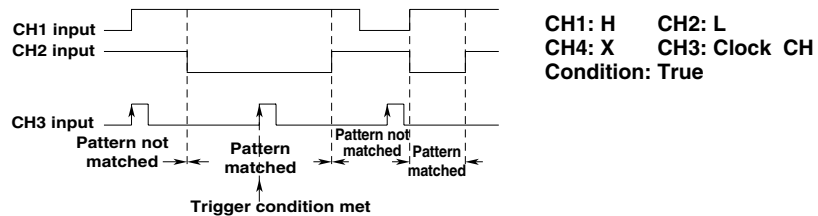

6.10 Setting the Pattern Trigger (ENHANCED)

Setting the trigger level

Range : 8 div within the screen

Resolution : 0.01 div

For example, the resolution is 0.02 mV when the V/DIV setting is 2 mV/div.

Sets a width to the trigger level so that the trigger is not activated on small changes.

 : Approximately 0.3 div* of hysteresis around the trigger level.

 : Approximately 1 div* of hysteresis around the trigger level.

*: The value above are estimated values. They are not strictly guaranteed.

Setting the trigger coupling

Select from the following list of choices.

AC : Uses a signal that is obtained by removing the DC component from the trigger source signal as the trigger signal.

DC : Uses the trigger source signal as the trigger signal.

Turning the HF rejection ON/OFF

Select "15 kHz" or "20 MHz" when you wish to use a signal source that is obtained by removing the high frequency components (frequency components greater than or equal to approximately 15 kHz or 20 MHz) from the trigger signal as the trigger source.

Setting the hold off

See section 6.4, "Setting the Hold Off Time."

Precautions to be taken when setting the pattern trigger

- When the trigger type setting is changed, the pattern trigger setting is no longer valid. However, if the pattern trigger is selected again, the previous settings are enabled.
- Even if the trigger mode is set to auto level mode, the operation will be in auto mode.
- Set the trigger status on all trigger sources. If the channel selected is a clock channel, select the trigger slope.
- When activating the trigger in sync with the clock signal, specify at least 1 ns for the pattern to setup and at least 1 ns for the hold time.

Operating Procedure

Setting the trigger type

1. Press the “ENHANCED” key.
2. Press the “Type” soft key to display the trigger type menu.
3. Press the “Pattern” soft key.

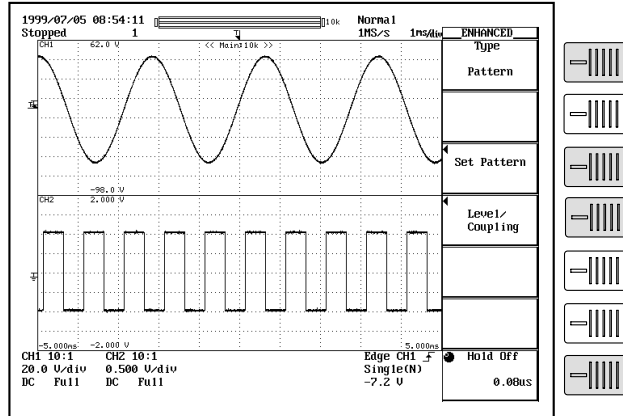

Setting the status and condition

4. Pressing the “Set Pattern” soft key to display a menu used to set the status and condition.

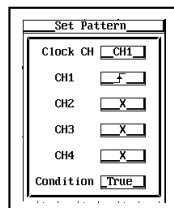

When activating the trigger only on the status pattern

5. Turn the jog shuttle to move the cursor to “Clock CH.”
 6. Press the “SELECT” key to display the clock channel setting menu.
 7. Turn the jog shuttle to select “None.”
 8. Press “ESC” and turn the jog shuttle to move the cursor to the channel on which the status is to be set.
 9. Press the “SELECT” key several times to select “H,” “L,” “X.”
 10. Turn the jog shuttle to move the cursor to “Condition.”
 11. Press the “SELECT” key several times to select “Enter” or “Exit.”
- Go to step 14.

When activating the trigger in sync with the clock channel

5. Turn the jog shuttle to move the cursor to “Clock CH.”
6. Press the “SELECT” key to display the clock channel setting menu.
7. Turn the jog shuttle to set the clock channel.
8. Press “ESC” and turn the jog shuttle to move the cursor to the channel that was set as the clock channel.
9. Press the “SELECT” key several times to select “ \overline{H} ” or “ \overline{L} .”
10. Turn the jog shuttle to move the cursor to the channel to which the status to be set.
11. Press the “SELECT” key several times to select “H,” “L,” or “X.”
12. Turn the jog shuttle to move the cursor to “Condition.”
13. Press the “SELECT” key several times to select “True” or “False.”

6.10 Setting the Pattern Trigger (ENHANCED)

Setting the level, hysteresis, trigger coupling, and HF rejection of the clock CH

14. Pressing the “Level/Coupling” soft key displays a menu used to set the level, coupling, hysteresis, and HF rejection.

The setting also applies to the A→B(N) trigger. See page 6-13.

Setting the hold off

15. Set the hold off time according to the procedures given in 6.4, “Setting the Hold Off Time.”

Note

The trigger level, hysteresis, trigger coupling, and HF rejection settings apply to simple trigger and enhanced trigger.

6.11 Setting the Width (Pulse<Time, Pulse>Time, T1<Pulse<T2, Time Out) Trigger (ENHANCED)

< For a description of this function, refer to page 1 - 8 >

Function

Pulse > Time : When the time during which the status pattern is met is longer than the specified pulse width, the trigger is activated when the condition changes.

Pulse < Time : When the time during which the status pattern is met is shorter than the specified pulse width, the trigger is activated.

T1<Pulse<T2 : When the time during which the status pattern is met is in between the two specified pulse widths, the trigger is activated.

Time Out : The trigger is activated when the time during which the status pattern is met becomes longer than the specified pulse width.

The point at which the trigger is activated differs between Pulse > Time and Time Out as indicated in the figure below.

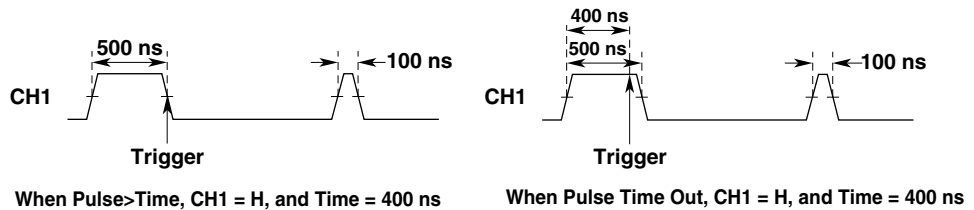

Pulse<Time setup example

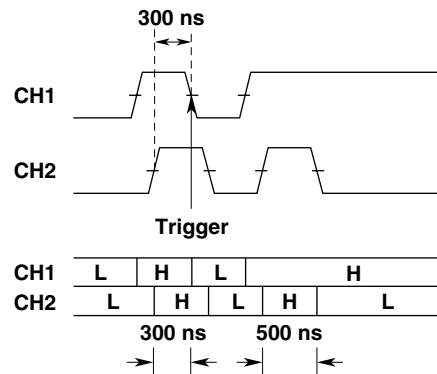

Pulse<Time, Condition: CH1 = H, CH2 = H, Time = 400 ns

Conditions of each channel

When the window trigger turned OFF, the conditions become the same as the A→B(n) trigger. See page 6 - 11.

When the window is ON (IN/OUT/X), they become the same as the window trigger.

For details regarding the window trigger, see section 6.13, "Setting the Window Trigger."

Pulse width

1 ns to 1 s

Precautions to be taken when setting the Pulse>Time or Pulse Time Out trigger

The trigger may not operate properly if the time between two pulses is less than 2 ns or if the pulse width is less than 2 ns. The time accuracy of the pulse width in the standard operating condition after calibration is $\pm(0.5\% \text{ of the setting}^* + 1 \text{ ns})$.

*: When set to T1<Pulse<T2, the value of T2.

6.11 Setting the Width (Pulse<Time, Pulse>Time, T1<Pulse<T2, Time Out) Trigger (ENHANCED)

Correlation with the window trigger

When the Window is turned ON, a trigger is activated based on the time period during which the parallel pattern of the window condition of each channel is met or not met.

Setting the trigger level

Range : 8 div within the screen

Resolution : 0.01 div

For example, the resolution is 0.02 mV when the V/DIV setting is 2 mV/div.

Setting the hysteresis

Sets a width to the trigger level so that the trigger is not activated on small changes.

$\overline{\Delta}$: Approximately 0.3 div* of hysteresis around the trigger level.

$\underline{\Delta}$: Approximately 1 div* of hysteresis around the trigger level.

*: The value above are estimated values. They are not strictly guaranteed.

Setting the trigger coupling

Select from the following list of choices.

AC : Uses a signal that is obtained by removing the DC component from the trigger source signal as the trigger signal.

DC : Uses the trigger source signal as the trigger signal.

Turning ON/OFF the HF rejection

Select "15 kHz" or "20 MHz" when you wish to use a signal source that is obtained by removing the high frequency components (frequency components greater than or equal to approximately 15 kHz or 20 MHz) from the trigger signal as the trigger source.

Setting the hold off

See section 6.4, "Setting the Hold Off Time."

Operating Procedure

Setting the trigger type

1. Press the “ENHANCED” key.
2. Pressing the “Type” soft key to display the trigger type menu.
3. Press the “Width” soft key.

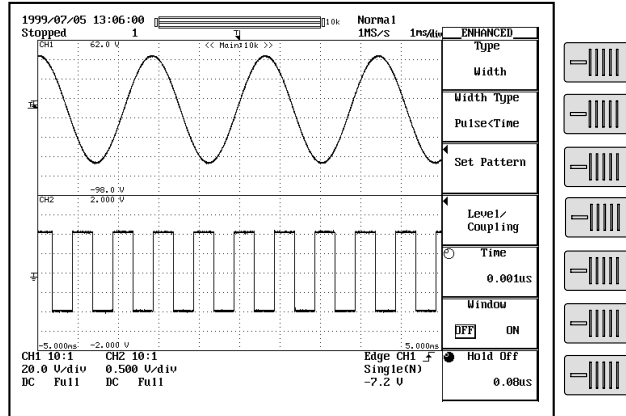

Setting the width type

4. Pressing the “Width Type” soft key displays a menu used to select the width type.

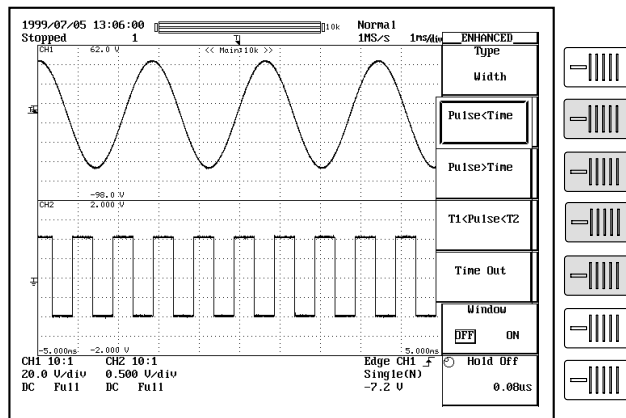

5. Press the soft key corresponding to the desired type from “Pulse > Time,” “Pulse < Time,” “T1 < Pulse < T2,” or “Time Out.”

6.11 Setting the Width (Pulse<Time, Pulse>Time, T1<Pulse<T2, Time Out) Trigger (ENHANCED)

Setting the conditions of each channel

6. Press the "Set Pattern" soft key to display the trigger setting menu.

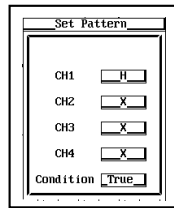

7. Turn the jog shuttle to move the cursor to the channel to be set.
8. Press the "SELECT" key several times to select "H," "L," or "X (when the "Window" is ON, "IN," "OUT," or "X")."
9. Turn the jog shuttle to move the cursor to "Condition."
10. Press the "SELECT" key several times to select "True" or "False."

Setting the level, hysteresis, trigger coupling, and HF rejection

11. Pressing the "Level/Coupling" soft key displays a menu used to set the level, coupling, hysteresis, and HF rejection.

The setting also applies to A→B(N) trigger. See page 6 - 2 to 6 - 13.

When the "Window" is ON, set the window position, width, trigger coupling, and HF rejection. The settings are the same as the window trigger. See section 6.13, "Setting the Window Trigger."

Note

The trigger level, hysteresis, trigger coupling, and HF rejection settings apply to simple trigger and enhanced trigger.

Setting the pulse width

12. If the jog shuttle control is not set to "Time" press the "Time" soft key.
If the "Width Type" is "T1 < Pulse < T2," press the "Time1/Time2" soft key.
13. Turn the jog shuttle to set the pulse width.
You can use the arrow keys to move between the digits. Pressing the "RESET" key resets the pulse width to "0.001 us" (Time2 is reset to 0.002 us).

Setting the window

14. Press the "Window" soft key to select either "ON" or "OFF."
When the Window is turned OFF, a trigger is activated on the time period over which the parallel pattern of the channel state ("H," "L," and "X") is met or not met.
When the Window is turned ON, a trigger is activated on the time period over which the parallel pattern of the window condition of each channel is met or not met.

Setting the hold off

15. Set the hold off time according to the procedures given in 6.4, "Setting the Hold Off Time."

6.12 Setting the OR Trigger

< For a description of this function, refer to page 1 - 9 >

Function

This function activates a trigger on the OR of each channel's edge trigger.

Setting the edge trigger of each channel

Select from the following.

- ↗ : Rising
- ↘ : Falling
- : Don't care

Setting the trigger level

Range : 8 div within the screen

Resolution : 0.01 div

For example, the resolution is 0.02 mV when the V/DIV setting is 2 mV/div.

Setting the hysteresis

Sets a width to the trigger level so that the trigger is not activated on small changes.

∇ : Approximately 0.3 div* of hysteresis around the trigger level.

∇∇ : Approximately 1 div* of hysteresis around the trigger level.

*: The value above are estimated values. They are not strictly guaranteed.

Setting the trigger coupling

Select from the following list of choices.

AC : Uses a signal that is obtained by removing the DC component from the trigger source signal as the trigger signal.

DC : Uses the trigger source signal as the trigger signal.

Turning ON/OFF the HF rejection

Select "15 kHz" or "20 MHz" when you wish to use a signal source that is obtained by removing the high frequency components (frequency components greater than or equal to approximately 15 kHz or 20 MHz) from the trigger signal as the trigger source.

Setting the hold off

See section 6.4, "Setting the Hold Off Time."

Correlation with the window trigger

If the window is turned ON, the trigger is activated when either the OR trigger or the window trigger becomes true. For details related to window trigger, see section 6.13, "Setting the Window Trigger."

Operating Procedure

Setting the trigger type

1. Press the “ENHANCED” key.
2. Press the “Type” soft key to display the trigger type menu.
3. Press the “OR” soft key.

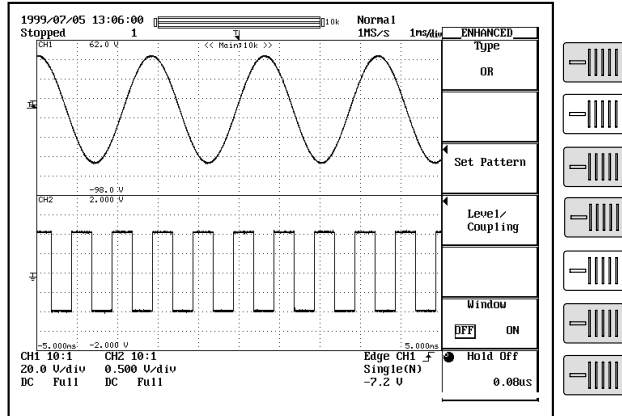

Setting the edge trigger of each channel

4. Press the “Set Pattern” soft key to display the trigger setting menu.

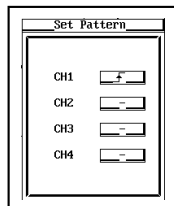

5. Turn the jog shuttle to move the cursor to the channel to be set.
6. Press the “SELECT” key several times to select “f,” “r,” or “—” (when the “Window” is ON, “IN,” “OUT,” or “—”).

Setting the level, hysteresis, trigger coupling, and HF rejection

7. Pressing the “Level/Coupling” soft key displays a menu used to set the level, coupling, hysteresis, and HF rejection.
 The setting also applies to A→B(N) trigger. See page 6 - 13.
 When the “Window” is ON, set the window position, width, trigger coupling, and HF rejection. The settings are the same as the window trigger. See section 6.13, “Setting the Window Trigger.”

Note

The trigger level, hysteresis, trigger coupling, and HF rejection settings apply to simple trigger and enhanced trigger.

Setting the window

8. Press the “Window” soft key to select either “ON” or “OFF.”
 If “OFF” is selected, triggers are activated on the OR of the channel edge.
 If “ON” is selected, triggers are activated on the OR of the channel's window conditions.

Setting the hold off

9. Set the hold off time according to the procedures given in 6.4, “Setting the Hold Off Time.”

6.13 Setting the Window Trigger (ENHANCED)

< For a description of this function, refer to page 1 - 9 >

Function

This function sets up a window trigger for the CH1 to CH4 input signal.

Trigger condition

- **Width trigger**

IN : The time during the trigger source enters the window is trigger duration.

OUT : The time during the trigger source exits the window is trigger duration.

- **OR trigger**

IN : Trigger is activated when the trigger source enters the window (the area between two preset levels).

OUT : Trigger is activated when the trigger source exits the window.

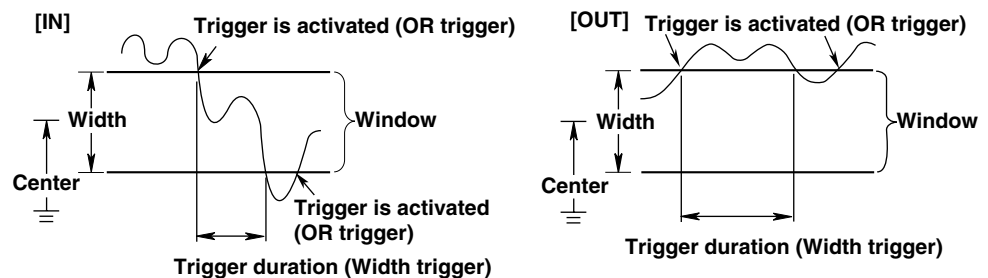

Window setting

Define the window by its center level and width.

“Center” setting range : Anywhere within the 8 screen divisions, in resolution of 0.01 div. (Example: If the scale is 1 V/div, resolution is 0.01 V).

“Width” setting range : Up to ± 4 div from center, in resolution of 0.02 div. (Example: If the scale is 1 V/div, resolution is 0.02 V).

Note

If you set the window so that the top or bottom is off the screen, the trigger will occur at the level for the corresponding screen edge (the level at ± 4 divisions from screen center) rather than at the “missing” top or bottom. Therefore it is recommended not to exceed ± 4 div when setting the window.

Setting the trigger coupling

Select from the following list of choices.

AC : Uses a signal that is obtained by removing the DC component from the trigger source signal as the trigger signal.

DC : Uses the trigger source signal as the trigger signal.

Turning ON/OFF the HF rejection

Select “15 kHz” or “20 MHz” when you wish to use a signal source that is obtained by removing the high frequency components (frequency components greater than or equal to approximately 15 kHz or 20 MHz) from the trigger signal as the trigger source.

Setting the hold off

See section 6.4, “Setting the Hold Off Time.”

6.13 Setting the Window Trigger (ENHANCED)

Correlation with the OR trigger or Width trigger

“OR” and “Width” are the trigger types on which the window trigger can be used. When using the window trigger of a single channel, set the window conditions of all other channels to “-” or “x.”

Operating Procedure

Setting the trigger type

1. Press the “ENHANCED” key.
2. Pressing the “Type” soft key displays the trigger type menu.
3. Press the “OR” or “Width” soft key.

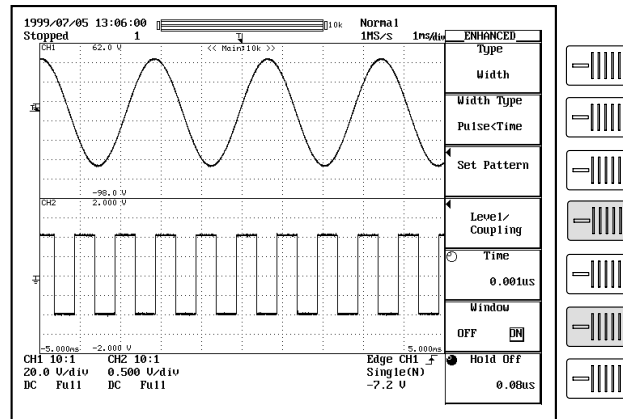

Setting the window trigger

4. Press the “Window” soft key to select “ON.”
Set the status and trigger conditions of each channel according to the procedures given in section 6.11, “Setting the Width (Pulse<Time, Pulse>Time, T1<Pulse<T2, Time Out)” or 6.12, “Setting the OR Trigger (ENHANCED).”

Setting the center level, window width, trigger coupling, and HF rejection

5. Pressing the “Level/Coupling” soft key displays a dialog box used to set the center level, window width, trigger coupling, and HF rejection.
6. Turn the jog shuttle to move the cursor to the channel on which to set the window center level (Center).
7. Press the “SELECT” key to display the center level menu.
8. Turn the jog shuttle to set the center level.
You can use the arrow keys to move between the digits. Pressing the “RESET” key sets the window center level to “0 V.”
9. Turn the jog shuttle to move the cursor to the channel on which to set the window width.
10. Press the “SELECT” key to display the window width menu.
11. Turn the jog shuttle to set the window width.
You can use the arrow keys to move between the digits. Pressing the “RESET” key resets the value to the initial value.

Setting the trigger coupling and HF rejection

12. The coupling and HF rejection settings also apply to the A→B(N) trigger. See page 6 - 13.

6.14 Setting the TV Trigger (ENHANCED)

< For a description of this function, refer to page 1 - 9 >

Function

This function lets you set a trigger for video signal input into Channel 1. Settings and functions are as follows.

Broadcasting systems with which the TV trigger can be used

NTSC, PAL, HDTV

Selecting the field Number: Field

- 1 Detects a field in which the vertical synchronizing pulse and the line start at the same time.
- 2 Detects a field in which the vertical synchronizing pulse starts 1/2H (H: horizontal scan time) after the line starts.
- X Detects both of the above types of field.

Selecting the line Number: Line

A trigger is activated at the beginning of the selected line.

- **NTSC: 5 to 1054**

Field 1 starts at line No. "5." (Field 2 starts at line No. "268.")

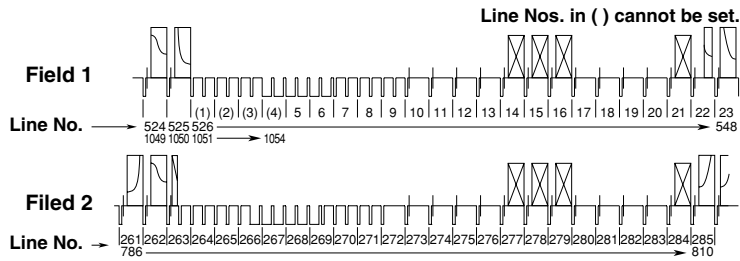

- **PAL: 2 to 1251**

Field 1 starts at line No. "2." (Field 2 starts at line No. "315.")

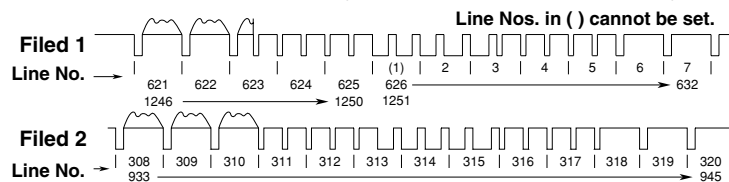

- **HDTV: 2 to 2251**

Field 1 starts at line No. "2." (Field 2 starts at line No. "565.")

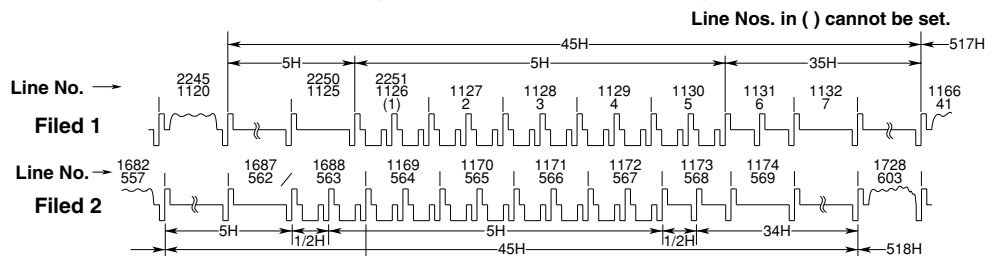

6.14 Setting the TV Trigger (ENHANCED)

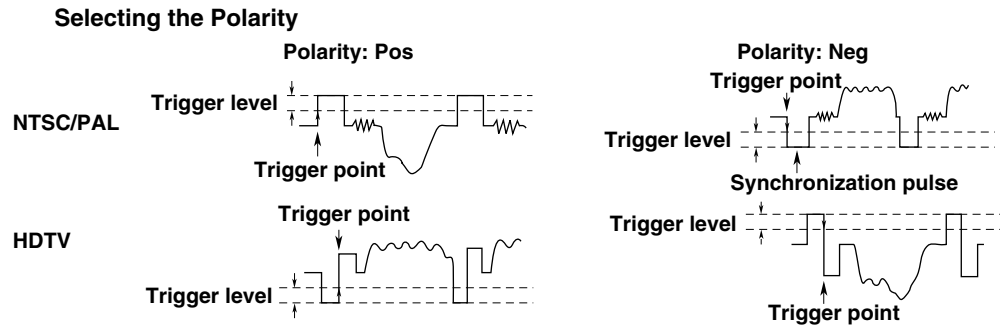

Setting the trigger level: Level

Set the difference between the beginning of the synchronization pulse and the level at which the trigger level is judged.

The setting range is from 0.1 div to 2.0 div. The setting resolution is 0.1 div.

The default setting is 0.1 div.

Setting frame skip: Frame

This is a function for skipping frames when the color burst is inverted on every frame.

You can select how many frames to skip from the following choices.

Frame1 : Trigger every frame at the specified field.

Frame2 : Trigger every two frames at the specified field.

Frame4 : Trigger every four frames at the specified field.

Frame8 : Trigger every eight frames at the specified field.

Other settings

Refer to sections 6.1 and 6.6 for details about how to set the trigger mode and the holdoff time.

Operating Procedure

Inputting the video signal

Connect the probe (cable) used to input the video signal to the CH1 input terminal.

Selecting the TV trigger

1. Press the “ENHANCED” key.
2. Pressing the “Type” soft key displays the trigger type menu.
3. Press the “TV” soft key.

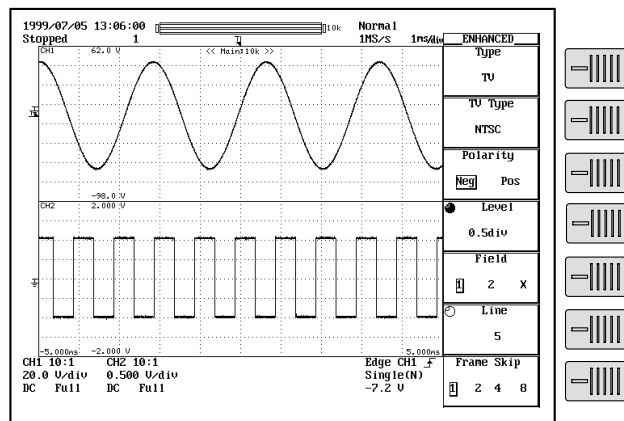

Selecting the broadcasting system of the video signal to be monitored

4. Press the “TV Type” soft key to display a menu used to select the broadcasting system.
5. Press the soft key corresponding to the desired broadcasting system to select “NTSC,” “PAL,” “HDTV.”

Selecting the polarity

6. Press the “Polarity” soft key to select the polarity.

Setting the trigger level

7. If the jog shuttle control is not set to “Level,” press the “Level” soft key.
8. Turn the jog shuttle to set the trigger level.
You can use the arrow keys to move between the digits. Pressing the “RESET” key sets the trigger level to “0.5 div.”

Selecting the field number

9. Press the “Field” soft key several times to select the number.

Selecting the line number

10. If the jog shuttle control is not set to “Line,” press the “Line” soft key.
11. Turn the jog shuttle to set the line.
You can use the arrow keys to move between the digits. Pressing the “RESET” key sets the line to “5” (NTSC) or “2” (PAL/HDTV.)

Selecting frame skip

12. Press the “Frame Skip” soft key several times to select frame skip.

6.15 Setting the Logic Trigger (ENHANCED, Optional)

< For a description of this function, refer to page 1 - 10 >

Function

While the combined condition of H, L, and Don't care of POD A and B (16 inputs) is satisfied, a trigger is activated on the edge of clock channel.

Setting the logic condition

- **Condition of each POD**

H : Above the specified threshold level.

L : Below the specified threshold level.

X : Don't care

For the threshold level, see section 5.10, "Turning ON/OFF the Logic Input and Setting the Threshold Level."

Selecting the clock channel: Clock CH

- Select "None" if the trigger is not to be activated in sync with the signal.
- Select the clock channel from "CH1" to "CH4" if the trigger is to be activated in sync with the signal.
- Select the trigger slope from the following.
 - ↗ : Rising
 - ↘ : Falling

Selecting the trigger condition

- **When activating the trigger only on the status pattern**

Select the trigger condition from the following list of choices.

Enter : Trigger is activated when the specified combination (pattern) is met.

Exit : Trigger is activated when the specified pattern is no longer met.

- **When activating the trigger in sync with the clock channel**

Set the trigger condition from the following list of choices.

True : Trigger is activated on the rising or falling edge of the clock channel while the status pattern is being satisfied.

False : Trigger is activated on the rising or falling edge of the clock channel while the status pattern is not being satisfied.

Operating Procedure

Setting the trigger type

1. Press the “ENHANCED” key.
2. Pressing the “Type” soft key displays the trigger type menu.
3. Press the “Logic” soft key.

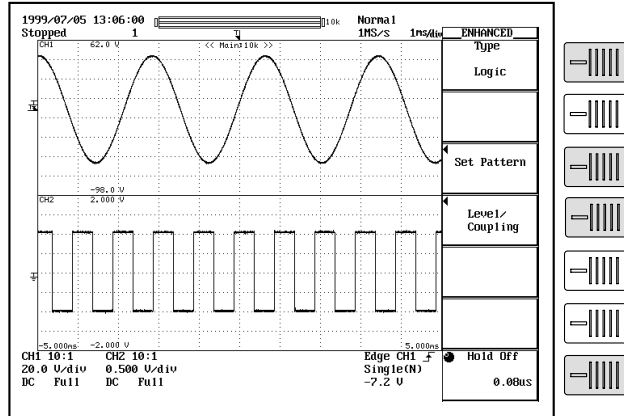

Setting the status and condition

4. Pressing the “Set Pattern” soft key displays a menu used to set the status and condition.

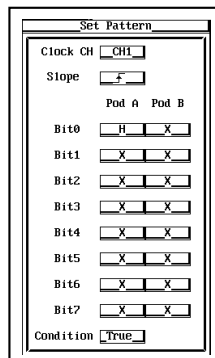

When activating the trigger only on the status pattern

5. Turn the jog shuttle to move the cursor to “Clock CH.”
6. Press the “SELECT” key to display the clock channel menu.
7. Turn the jog shuttle to select “None.”
8. Press “ESC” key and turn the jog shuttle to move the cursor to the channel on which the status is to be set.
9. Press the “SELECT” key several times to “H,” “L,” or “X.”
10. Turn the jog shuttle to move the cursor to “Condition.”
11. Press the “SELECT” key several times to select “Enter” or “Exit.”
Go to step 14.

6.15 Setting the Logic Trigger (ENHANCED, Optional)

When activating the trigger in sync with the clock channel

5. Turn the jog shuttle to move the cursor to "Clock CH."
6. Press the "SELECT" key to display the clock channel menu.
7. Turn the jog shuttle to set the clock channel.
8. Press the "ESC" key and turn the jog shuttle to move the cursor to the channel that was set as the clock channel.
9. Press the "SELECT" key several times to select "┐" or "└"
10. Turn the jog shuttle to move the cursor to the channel to which the status is to be set.
11. Press the "SELECT" key several times to "H," "L," or "X."
12. Turn the jog shuttle to move the cursor to "Condition."
13. Press the "SELECT" key several times to select "True" or "False."

Setting the level, hysteresis, trigger coupling, and HF rejection of the clock CH

14. Pressing the "Level/Coupling" soft key displays a menu used to set the level, coupling, hysteresis, and HF rejection.
The setting also applies to A→B(N) trigger. See page 6 - 13.

Setting the hold off

15. Set the hold off time according to the procedures given in 6.4, "Setting the Hold Off Time."

Note

- The trigger level, hysteresis, trigger coupling, and HF rejection settings apply to simple trigger and enhanced trigger.
 - When activating the trigger in sync with the clock channel (CH1 to CH4), allow a setup time that is greater than or equal to 20 ns and a hold time that is greater than or equal to -14 ns for the logic pattern with respect to the clock. (Value at the tip of the of the logic probe with respect to the input BNC of CH1 to CH4.)
-

6.16 Setting the Action-On Trigger

< For a description of this function, refer to page 1 - 11 >

Function

Operation to perform when the trigger is activated:

The specified operation from the following list is performed every time a trigger is activated.

- Hard Copy : Outputs the screen image data to the destination (printer, Centronics, file, or Net Print (Ethernet + PC Card interface optional)) that was specified in "Copy to" of the Copy setting menu.
- Save to File: Saves the waveform data to the recording medium (FD or SCSI and so on) specified in the File menu.
- Buzzer : Sounds an alarm.
- Send Mail : Sends a mail (Ethernet + PC Card Interface optional): For details, see section 13.7, "Using the Mail Function (Action Mail Function)."

Note

When the action-on-trigger is started, the specified operation is performed when the trigger is activated in the normal mode regardless of the trigger mode setting.

Number of operations: ACQ Count

- 1 to 65536 : Repeats the operation the specified number of times.
- Infinite : Repeats the operation until the waveform acquisition is stopped.

"Save to File"/"Hard Copy" operation

Operates according to the settings in the "FILE" or "COPY" menu.

File name of the "Hard Copy" when the copy destination is "File" or "Save to File."

Saved using "AUTO Name." For details, see section 10.4, "Storing Screen Image to the Recording Medium" or section 11.6, "Saving/Loading Waveform Data."

Precautions to be taken when setting the action-on-trigger

- Action-on-trigger cannot be used when the action mode is "Average" or "Box Average."
The settings cannot be changed during action-on-trigger.

Trigger mode

The trigger mode is set to "Single."

6.16 Setting the Action-On Trigger

Operating Procedure

1. Press the "SHIFT" key to set the keys in the shifted condition. Functions marked in purple on the panel become active.
2. Press the "MODE" key.

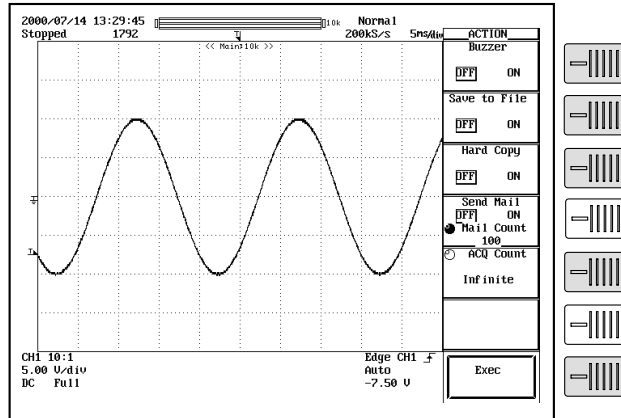

Turning ON/OFF the action

3. Press the soft key corresponding to the action you wish to enable and select "ON."

Selecting the number of waveform acquisitions

4. Turn the jog shuttle to set the waveform acquisition count. You can use the arrow keys to move between the digits. In addition, pressing the "RESET" key sets the count to "Infinite."

Executing the action-on-trigger

5. Pressing the "Exec" soft key starts the waveform acquisition and executes the action-on-trigger.

Aborting the action-on-trigger

6. Pressing the "Abort" soft key or the "START/STOP" key to stops the waveform acquisition and aborts the action-on-trigger.

7.1 Setting the Record Length

< For a description of this function, refer to page 1 - 13 >

Function

The record length sets the amount of data to be written into the acquisition memory. The maximum length depends upon the machine model. Available length settings are as follows:

DL7100 8 M/CH model : 1 k, 10 k, 50 k, 100 k, 250 k, 500 k, 1 M, 2 M, 4 M, (8 M)
2 M/CH model : 1 k, 10 k, 50 k, 100 k, 250 k, 500 k, 1 M, (2 M)

DL7200 16 M/CH model: 1 k, 10 k, 50 k, 100 k, 250 k, 500 k, 1 M, 2 M, 4 M, 8 M, (16 M)
4 M/CH model : 1 k, 10 k, 50 k, 100 k, 250 k, 500 k, 1 M, 2 M, (4 M)

(Value in parenthesis is available only if interleave mode is ON.)

Setting precautions

- Sampling rate and displayed record length vary according to the T/div setting. For details, see Appendix 1.
- Waveform computation and linear averaging cannot be performed for the following record lengths.
 - If 8 M/CH model (DL7100) : 4 MW when interleave mode is OFF
: 8 MW when interleave mode is ON
 - If 16 M/CH model (DL7200): 8 MW when interleave mode is OFF
: 16 MW when interleave mode is ON

Operating Procedure

1. Press the ACQ key.
2. Press the "Record Length" soft key to set the jog shuttle action to Record Length.
3. Select the length by turning the jog shuttle. Choose 1 k to 8 M (or 16 M for the DL7200).

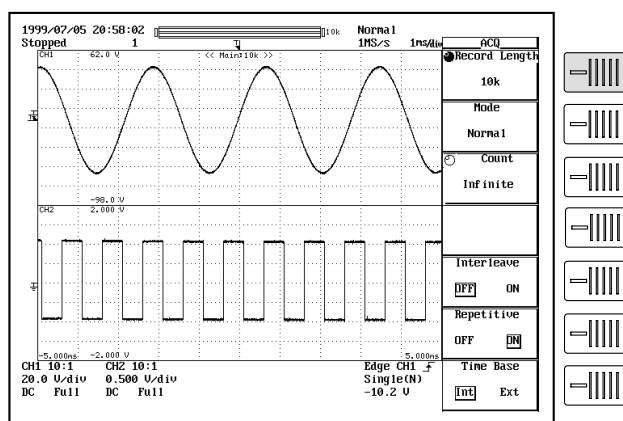

7.2 Acquisition Mode

< For a description of this function, refer to page 1 - 13 >

Function

You can select any of five acquisition modes, as follows. The default selection is Normal.

Normal

The instrument writes sample data into acquisition memory without performing special processing.

Envelope

The instrument finds the maximum and minimum sampled values per interval of 400 MS/s for the DL7100 (1 GS/s or 800 MS/s: interleave mode ON), and 1 GS/s or 800 MS/s with the DL7200 (interleave mode ON or OFF). It then writes these values into acquisition memory, and generates an "envelope" waveform showing max/min levels for each point.

- **Setting restriction**

This mode can be selected in normal mode when the time axis is 200 MS/s or lower for the DL7100 (500 MS/s for the interleave mode) or 500 MS/s or lower for the DL7200 (interleave mode ON or OFF). For all other cases, the acquisition mode is set to normal even if envelope is specified.

Average

The instrument calculates average values and writes these into the acquisition memory. If the acquisition count is set to Infinite, the instrument uses exponential averaging, and you are required to set a Weight value. If the count is set to a numerical value (from 2 to 65536), the instrument calculates simple averages using the specified number of readings.

Exponential averaging (count=Infinite)

$$A_n = \frac{1}{N} \{(N-1)A_{n-1} + X_n\}$$

A_n : Value obtained after nth averaging

X_n : nth measured value

N : Attenuation constant
(2 to 256, in steps of 2ⁿ)

Linear averaging (count=2 to 65536)

$$A_N = \frac{\sum_{n=1}^N X_n}{N}$$

X_n : nth measured value

N : Number of averaging times
(Acquisition count,
in steps of 2ⁿ)

Exponential averaging cannot be used when trigger mode is single or single (N).

Simple averaging cannot be used with repetitive sampling. Maximum record length is 2 M (4 M) Word for the DL7100, or 4 M (8 M) Word for the DL7200 during simple averaging. (Value in parenthesis is available only if interleave mode is ON.)

For more information about the relationship when roll mode or repetitive sampling mode is active or trigger mode is single or single (N), refer to Appendix 1.

Box Average

For details, see Section 7.4.

Acquisition count

The available count settings are indicated below. If you set the value to Infinite, acquisition will continue until you switch it off with the START/STOP key.

The default count is Infinite. The acquisition count cannot be changed during measurement.

- For Normal, Envelope, or BoxAverage mode
2 to 65536 (in steps of 1), Infinite
- For Average mode
2 to 65536 (in steps of 2^n), Infinite

Important information about the averaging mode

- Average mode is useful when working with repetitive waveforms.
- Correct averaging is not possible if the waveform has imperfect triggering, since synchronization will be poor and the displayed waveform will be distorted. When working with this type of signal, set the trigger mode to Normal, so that the waveform display is updated only when the trigger occurs. (See page 6.1.)
- Roll mode display is disabled during averaging.
- If you stop waveform acquisition by pressing the START/STOP key, the averaging process also stops. Averaging restarts from the beginning when acquisition resumes.
- If you are using simple averaging, the DL7100 terminates acquisition automatically when it completes the specified number of acquisitions (as set by the acquisition count).
- For the logic input (option), the operation is the same as in the normal mode.
- During repetitive sampling mode, only the exponential averaging is performed.

Operating Procedure

Setting the acquisition mode

1. Press the “ACQ” key.
2. Press the “Mode” soft key to display the acquisition mode menu.
3. Press the soft key corresponding to the desired mode ranging from “Normal” to “Box Average.”

You may not be able to select some modes depending on the record length and sample rate settings.

Setting the acquisition count

4. Press the “Count” soft key.
- This is not available when the trigger mode is Single or Single (N).

5. Turn the jog shuttle to set the acquisition count.

You can use the arrow keys to move between the digits.

In addition, pressing the “RESET” key sets the count to “Infinite.”

When the acquisition mode is “Average” and you have selected “Infinite,” go to step 6.

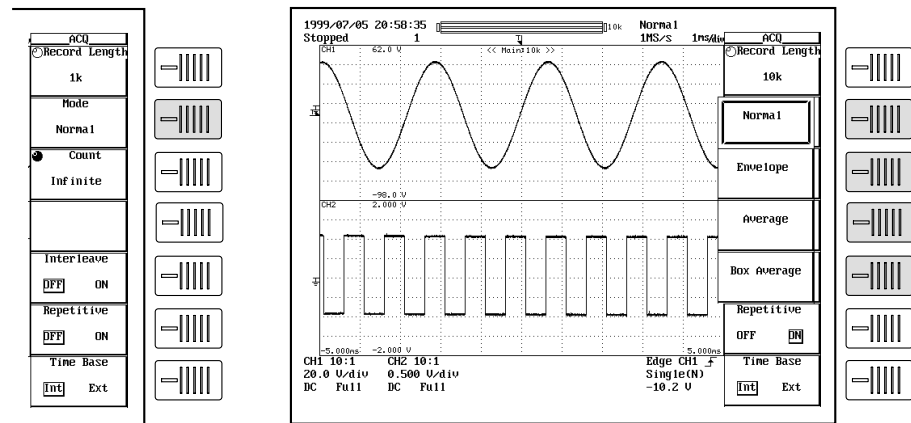

Setting the attenuation (when the acquisition mode is “Average” and the count is set to “Infinite”)

6. Press the “Weight” soft key.
7. Turn the jog shuttle to set the attenuation.

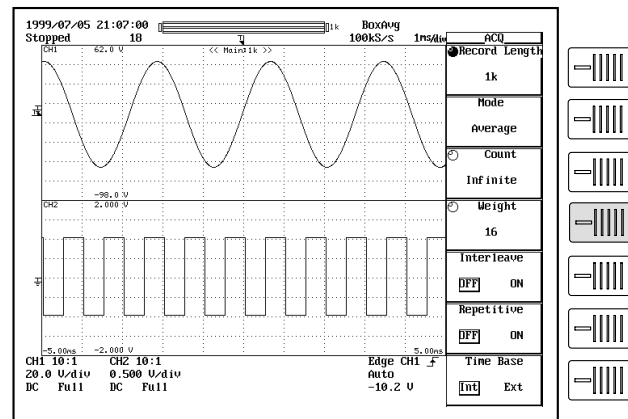

7.3 Using Sequential Store Function

< For a description of this function, refer to page 1 - 15 >

Function

By setting the trigger mode to “Single(N),” the sequential store function can be used.

Acquisition count

Available numerical settings are as follows. The setting range varies according to the record length.

- **DL7100**

Record length	Normal mode		Box average mode	
	8 MW/CH model	2 MW/CH model	8 MW/CH model	2 MW/CH model
1 kWord	1 to 1024 (2048)	1 to 512 (1024)	1 to 1024 (2048)	1 to 256 (512)
10 kWord	1 to 128 (256)	1 to 64 (128)	1 to 128 (256)	1 to 32 (64)
50 kWord	1 to 32 (64)	1 to 16 (32)	1 to 32 (64)	1 to 8 (16)
100 kWord	1 to 16 (32)	1 to 8 (16)	1 to 16 (32)	1 to 4 (8)
250 kWord	1 to 8 (16)	1 to 4 (8)	1 to 8 (16)	1 to 2 (4)
500 kWord	1 to 4 (8)	1 to 2 (4)	1 to 4 (8)	1 (2)
1 MWord	1 to 2 (4)	1 (2)	1 to 2 (4)	— (1)
2 MWord	1 (2)	— (1)	1 (2)	—
4 MWord	1 (1)	—	— (1)	—
8 MWord	— (1)	—	—	—

* () = This setting available only when interleave mode is ON.

- **DL7200**

Record length	Normal mode		Box average mode	
	16 MW/CH model	4 MW/CH model	16 MW/CH model	4 MW/CH model
1 kWord	1 to 2048 (4096)	1 to 1024 (2048)	1 to 2048 (4096)	1 to 512 (1024)
10 kWord	1 to 256 (512)	1 to 128 (256)	1 to 256 (512)	1 to 64 (128)
50 kWord	1 to 64 (128)	1 to 32 (64)	1 to 64 (128)	1 to 16 (32)
100 kWord	1 to 32 (64)	1 to 16 (32)	1 to 32 (64)	1 to 8 (16)
250 kWord	1 to 16 (32)	1 to 8 (16)	1 to 16 (32)	1 to 4 (8)
500 kWord	1 to 8 (16)	1 to 4 (8)	1 to 8 (16)	1 to 2 (4)
1 MWord	1 to 4 (8)	1 to 2 (4)	1 to 4 (8)	1 (2)
2 MWord	1 to 2 (4)	1 (2)	1 to 2 (4)	— (1)
4 MWord	1 (2)	— (1)	1 (2)	—
8 MWord	1 (1)	—	— (1)	—
16 MWord	— (1)	—	—	—

* () = This setting available only when interleave mode is ON.

Waveform display method

You can recall waveforms from memory in the same way as you do when working with the history function. For details, refer to Section 7.7, “Using the History Memory.”

Restrictions and precautions

- You can not use this mode together with repetitive sampling or roll mode.
- If you stop waveform acquisition by pressing the START/STOP key, sequential storage also stops. It then restarts again from the beginning when acquisition resumes.

Operating Procedure

Setting the trigger mode

1. Press the "MODE" key.
2. Press the "Single(N)" soft key to set the trigger mode to Single(N).
3. Turn the jog shuttle to set the "Single(N) Count."

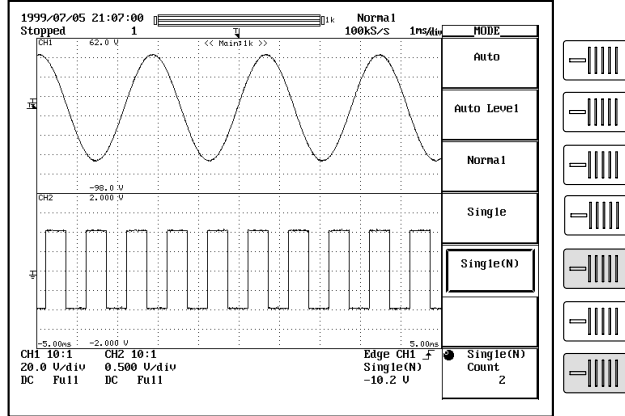

7.4 Box Average Mode

< For a description of this function, refer to page 1 - 14 >

Function

Under most conditions the instrument samples the input signal at a true (internal) sampling rate of 400 MS/s for the DL7100 (1GS/s or 800 MS/s during interleave mode), or 1 GS/s or 800 MS/s for the DL7200 (interleave mode ON or OFF), extracts values from this "sample stream" at the effective sample rate required by the T/div setting, and writes the extracted values into the acquisition memory.

When you use box-average mode, however, the operation is different. Instead of pulling values from the sample stream, the instrument computes average values for adjacent groups of true sampling data (read at 500 MS/s), and writes the resulting averages into acquisition memory. The following drawing illustrates the process.

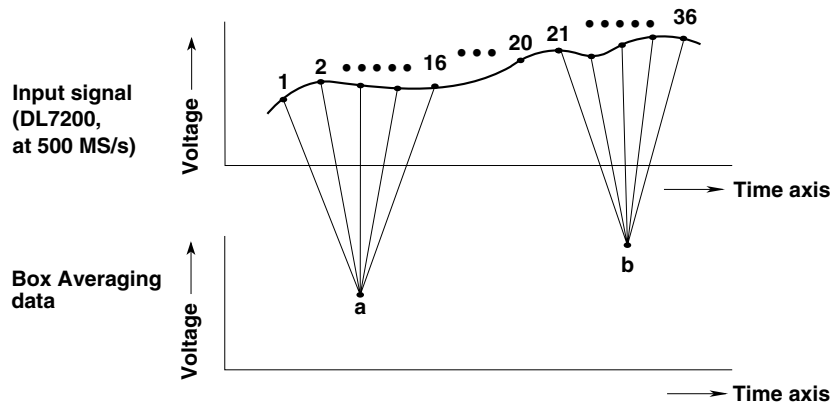

Data samples used for averages

	Interleave OFF	Interleave ON
500 MS/s	—	2 points every 2 points of 1 GS/s
200 MS/s	2 points every 2 points of 400 MS/s	4 points every 4 points of 800 MS/s
100 MS/s	4 points every 4 points of 400 MS/s	8 points every 8 points of 800 MS/s
50 MS/s	8 points every 8 points of 400 MS/s	16 points every 20 points of 800 MS/s
20 MS/s	16 points every 20 points of 400 MS/s	32 points every 40 points of 800 MS/s
10 MS/s	32 points every 40 points of 400 MS/s	64 points every 80 points of 800 MS/s
5 MS/s	64 points every 80 points of 400 MS/s	128 points every 200 points of 800 MS/s
2 MS/s	128 points every 200 points of 400 MS/s	256 points every 400 points of 800 MS/s
1 MS/s	256 points every 400 points of 400 MS/s	256 points every 800 points of 800 MS/s
500 kS/s or less	256 points every 800* points of 400 MS/s	256 points every 1600* points of 800 MS/s

*: Re-sampling interval is shifted by the sample rate. The maximum number of data points to perform BoxAverage process is 256.

Record-length setting limit

DL7100 If 8 MW/CH model : Not above 2 MWord (4 MWord with interleave ON)
 If 2 MW/CH model : Not above 500 kWord (1 MWord with interleave ON)
 DL7200 If 16 MW/CH model : 4 MWord or less (not above 8 MWord with interleave ON)
 If 4 MW/CH model : 1 MWord or less (not above 2 MWord with interleave ON)

Sampling-rate setting limit

Not above 200 MS/s for the DL7100 (or 500 MS/s with interleave ON), and not above 500 MS/s for the DL7200 (with interleave ON or OFF).

If the sample rate exceeds 200 MS/s for the DL7100 (500 MS/s when interleave is ON), or 500 MS/s for the DL7200 (with interleave ON or OFF) the mode is set to normal mode even if box average is specified.

7.4 Box Average Mode

Operating Procedure

1. Press the "ACQ" key.
2. Press the "Mode" soft key to display the acquisition mode menu.
3. Press the soft key corresponding to "Box Average" to select it.

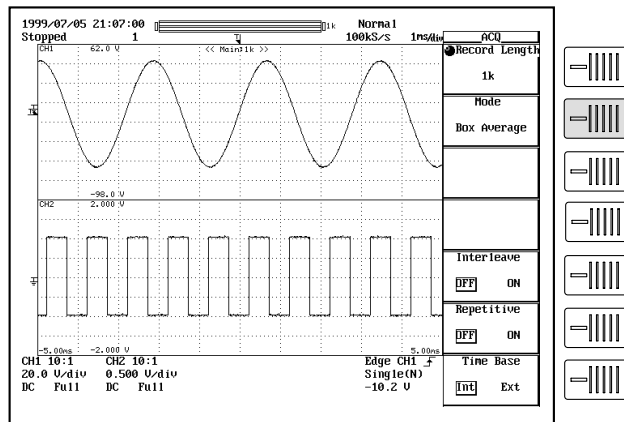

7.5 Using Interleave Mode

< For a description of this function, refer to page 1 - 13 >

Function

This mode doubles the amount of memory per channel, while cutting the number of channels in half. In particular, this mode doubles the maximum settings for history memory, sequential store, and record length, and allows you to set realtime sampling rate to 1 GS/s, for the DL7100, and 2 GS/s with the DL7200.

Setting interleave ON, however, CH2 and CH4 are disabled. When using the logic input option, POD B cannot be used.

For details about restrictions on sampling rate and record length while interleave is ON, see Appendix 1.

Operating Procedure

1. Press the "ACQ" key.
2. Press the "Interleave" soft key to select "ON" or "OFF."

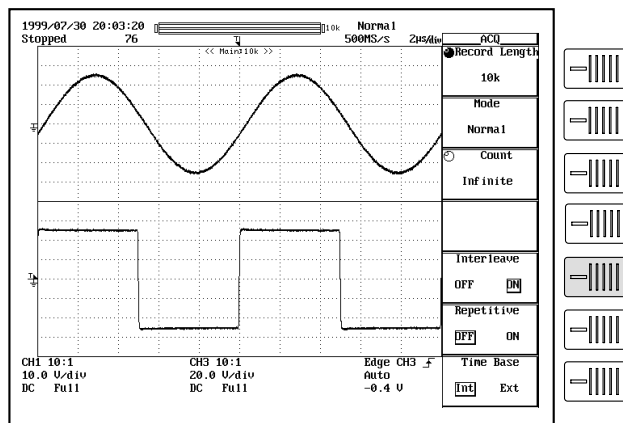

7.6 Setting Repetitive Sampling Mode ON/OFF

< For a description of this function, refer to pages 1 - 6 and 1 - 15 >

Function

You can select whether or not to use repetitive sampling. However, if the record length on the DL7200 is set to 16 MWord, you cannot turn ON repetitive sampling mode. If the repetitive sampling mode is ON, the sampling rate (for certain T/div settings) is set to 1 GS/s or above on the DL7100 (2 GS/s or above when the interleave mode is ON), or 2 GS/s or above on the DL7200 (5 GS/s or above when the interleave mode is ON). If repetitive sampling mode is OFF, the maximum available sampling rate is 500 MS/s for the DL7100 (or 1 GS/s with interleave ON), or 1 GS/s for the DL7200 (2 GS/s with interleave ON), and the instrument will add interpolation to the displayed waveform if the number of display points is less than 500. However, even if the repetitive sampling is turned OFF, the mode is set to repetitive sampling depending on the time axis setting.

T/div for repetitive sampling

If repetitive mode is ON, the sampling mode is switched to the repetitive sampling for T/div settings as follows:

Available T/div setting varies according to the record length or the machine model.

• DL7100

Record length	T/div
1 kWord	1 ns/div to 100 ns/div (1 ns/div to 50 ns/div)
10 kWord	1 ns/div to 1 μ s/div (1 ns/div to 500 ns/div)
50 kWord	1 ns/div to 5 μ s/div (1 ns/div to 2 μ s/div)
100 kWord	1 ns/div to 10 μ s/div (1 ns/div to 5 μ s/div)
250 kWord	1 ns/div to 20 μ s/div (1 ns/div to 10 μ s/div)
500 kWord	1 ns/div to 50 μ s/div (1 ns/div to 20 μ s/div)
1 MWord	1 ns/div to 100 μ s/div (1 ns/div to 50 μ s/div)
2 MWord	1 ns/div to 200 μ s/div (1 ns/div to 100 μ s/div)
4 MWord	1 ns/div to 500 μ s/div (1 ns/div to 200 μ s/div)
8 MWord	— (1 ns/div to 500 μ s/div)

*: With 2 MW/CH model: You cannot use repetitive sampling if the record length is set 1 MWord or above.

*: Values in parentheses above are available only if interleave mode is ON.

• DL7200

Record length	T/div
1 kWord	1 ns/div to 50 ns/div (1 ns/div to 20 ns/div)
10 kWord	1 ns/div to 500 ns/div (1 ns/div to 200 ns/div)
50 kWord	1 ns/div to 2 μ s/div (1 ns/div to 1 μ s/div)
100 kWord	1 ns/div to 5 μ s/div (1 ns/div to 2 μ s/div)
250 kWord	1 ns/div to 10 μ s/div (1 ns/div to 5 μ s/div)
500 kWord	1 ns/div to 20 μ s/div (1 ns/div to 10 μ s/div)
1 MWord	1 ns/div to 50 μ s/div (1 ns/div to 20 μ s/div)
2 MWord	1 ns/div to 100 μ s/div (1 ns/div to 50 μ s/div)
4 MWord	1 ns/div to 200 μ s/div (1 ns/div to 100 μ s/div)
8 MWord	1 ns/div to 500 μ s/div (1 ns/div to 200 μ s/div)
16 MWord	— (1 ns/div to 5 μ s/div)

*: With 4 MW/CH model, record length is 2 MWord with interleave mode OFF.

() = setting range when interleave mode is ON.

Restriction

During repetitive sampling, waveform acquisition is not possible when the trigger mode is Single (N).

Operating Procedure

1. Press the "ACQ" key.
2. Press the "Repetitive" soft key to select "ON" or "OFF."

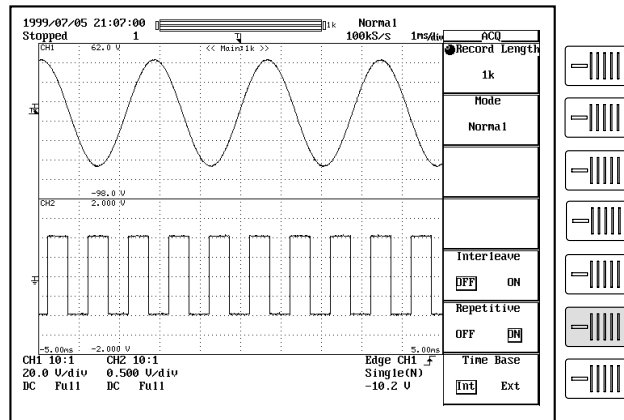

7.7 Using the History Memory

< For a description of this function, refer to page 1 - 16 >

Function

The acquisition memory retains waveform records generated by the most recent triggers. If a trigger is activated beyond the number of triggers that can be held, the oldest waveform data are cleared. Once the history becomes full, each new trigger causes loss of the oldest waveform record in the memory.

Selected Record Number

You can display any waveform from the history by entering its record number. The newest (current) waveform is Record 0, the immediately previous waveform is Record -1, and so on. The range for the selected record number is therefore [0 to – (retained waveforms –1)]. The number of retained waveforms (triggers) depends on the record length, as follows:

- **DL7100**

Record length	Count (8 MW/CH model)	Count (2 MW/CH model)
1 kWord	1 to 1024 (2048)	1 to 1024 (2048)
10 kWord	1 to 128 (256)	1 to 128 (256)
50 kWord	1 to 32 (64)	1 to 32 (64)
100 kWord	1 to 16 (32)	1 to 16 (32)
250 kWord	1 to 8 (16)	1 to 8 (16)
500 kWord	1 to 4 (8)	1 to 4 (8)
1 MWord	1 to 2 (4)	1 to 2 (4)
2 MWord	1 (2)	— (2)
4 MWord	1 (1)	—
8 MWord	— (1)	—

*: For each count of the trigger, only the displayed waveform is preserved; past waveform data is not preserved.

() = The setting range when interleave mode is ON.

When performing box averaging, the available setting range is 2 MWord or less for 8 MW/CH models (or 4 MWord or less with interleave mode ON), and 500 kWord or less for 2 MW/CH models (or 1 MWord or less with interleave mode ON).

- **DL7200**

Record length	Count (16 MW/CH model)	Count (4 MW/CH model)
1 kWord	1 to 2048 (4096)	1 to 2048 (4096)
10 kWord	1 to 256 (512)	1 to 256 (512)
50 kWord	1 to 64 (128)	1 to 64 (128)
100 kWord	1 to 32 (64)	1 to 32 (64)
250 kWord	1 to 16 (32)	1 to 16 (32)
500 kWord	1 to 8 (16)	1 to 8 (16)
1 MWord	1 to 4 (8)	1 to 4 (8)
2 MWord	1 to 2 (4)	1 to 2 (4)
4 MWord	1 (2)	— (2)
8 MWord	1 (1)	—
16 MWord	— (1)	—

*: For each count of the trigger, only the displayed waveform is preserved; past waveform data is not preserved.

() = The setting range when interleave mode is ON.

When performing box averaging, the available setting range is 4 MWord or less for 16 MW/CH models (or 8 MWord or less with interleave mode ON), and 1 MWord or less for 4 MW/CH models (or 2 MWord or less with interleave mode ON).

Display

- Set to One to display the selected record only.
Select the waveform to be displayed using “Select Record” from the specified range between “Start Record” and “End Record.”
- Set to All to generate overlapped display of all history records from the Start Record Number to the End Record Number. The waveform corresponding to the Selected Record Number will appear brighter than the other waveforms.

Show Map (A list of time stamps)

You can list the number of the waveform data stored in the acquisition memory and the trigger times.

One screen displays 75 data points of information. You can scroll through the data using the jog shuttle.

Precautions and Restrictions

- You cannot use the history function while the acquisition mode is set to Average. (Displayed history records will be meaningless.)
- The history memory function cannot be used in the repetitive sampling mode.
- If you suspend waveform acquisition before the current record has been fully read, the record will not be recorded in the history.
- You cannot use the history function while roll mode is selected.
- History records are not lost when waveform acquisition is stopped and then restarted, provided that acquisition conditions remain unchanged.
- If you change the acquisition settings, history memory is cleared when you restart acquisition using the new settings.
- If the “CLEAR TRACE” key is pressed during waveform acquisition or after the waveform acquisition is stopped, data in the history memory are cleared when the data acquisition is restarted.

Precautions to be taken when recalling data from the history memory

- Acquisition will stop when the history memory menu is displayed. It is not possible to recall waveform data from the history memory while acquisition is in progress.
- Acquisition can be restarted while the history memory menu is displayed. However, it is not possible to change history memory settings such as “Selected Record No.,” while acquisition is in progress.
- Settings are restricted by the following formula.
$$\text{End Record No.} \leq \text{Selected Record No.} \leq \text{Start Record No.}$$
- If you load a waveform record from floppy disk, or external storage device, the loaded waveform becomes Record 0. In the case of multiple records (sequential store), the records will be loaded sequentially, with the latest record as “0.”
- Computation and automatic measurement of waveform parameters are always performed on the currently displayed waveform, i.e. the waveform identified by the record number designated for “Selected Record No.” Analysis of old data is possible as long as the history memory content remains unchanged after acquisition is restarted.
- In roll mode only the record most recently acquired when acquisition was stopped will be loaded into record No. 0.
- The trigger time is displayed in the Show Map.
- Turning OFF the power will delete the entire contents of the history memory.

Operating Procedure

Recalling data from the history memory

1. Press the "HISTORY" key.
2. Press the "Select Record" soft key.
3. Turn the jog shuttle to set the record number that you wish to recall. Specify a record number in the range Start Record to End Record.
4. Press the "Display Mode" soft key to select "One" or "All." Go to step 5 if you selected "All." Otherwise, go to step 8.

Setting the accumulation range (when "Display Mode" is "ALL")

5. Press the "Start Record" soft key.
6. Turn the jog shuttle to set the first record number to be accumulated.
7. In a similar fashion, set the "End Record."

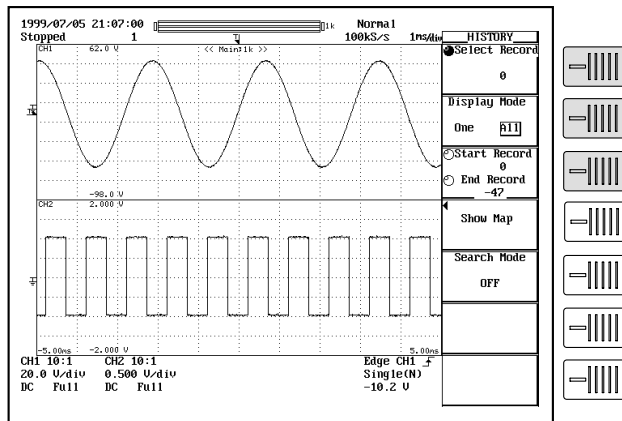

Display a list of time stamps

8. Pressing the "Show Map" soft key displays a list of acquired data numbers and the trigger time

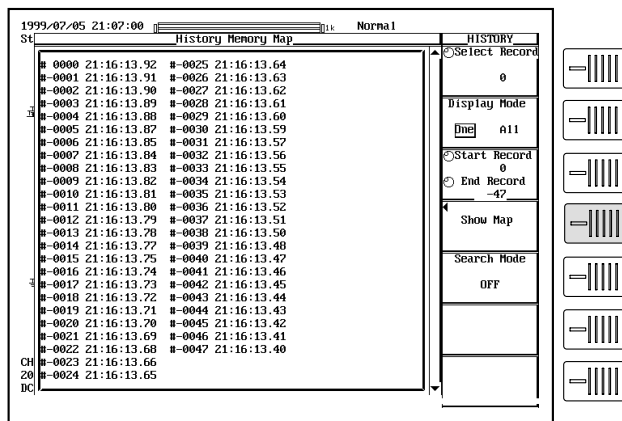

9. Turn the jog shuttle to select the waveform to be displayed and press the "SELECT" key.

7.8 Searching the Historical Data Using Zone (History Search Function)

< For a description of this function, refer to page 1 - 24 >

Function

You can search for a waveform that matches the specified conditions from the past waveforms in the acquisition memory and display it.

Search parameters

Four types of search parameters can be registered in Zone1 to Zone4. You can change the channel that is to be searched, the search condition, and the search range for each search zone.

Search condition: Condition

IN : Searches for waveforms that pass through the specified search window.
OUT : Searches for waveforms that do not pass through the specified window.
OFF : Do not search for waveforms.

Source channel: Source

Search is carried out on the channel that is specified as the Source. Waveforms of other channels are also displayed.

The vertical range of the search window (Upper/Lower)

The range is ± 4 div. The resolution is 0.01 div.
Upper must always be greater than or equal to Lower.

The horizontal range of the search window (Left/Right)

The range is ± 5 div. The resolution is (10 div/displayed record length).
Right must always be greater than or equal to left.

Search range

The search range is between the Start Record and the End record.

Search logic: Logic

AND : Searches for waveforms that meet all search conditions from Zone1 to Zone4.
OR : Searches for waveforms that meet any one of the search conditions from Zone1 to Zone4.

Search order

The search is carried out from the newest waveform to the oldest waveform.

Show Map (A list of time stamps)

Only the waveforms that are found are displayed in Show Map. If the "Search Mode" is turned OFF, all waveforms are displayed.

Operating Procedure

Selecting the search mode

1. Press the “HISTORY” key.
2. Pressing the “Search Mode” soft key displays the search mode selection menu.
3. Press the soft key corresponding to “Zone.”

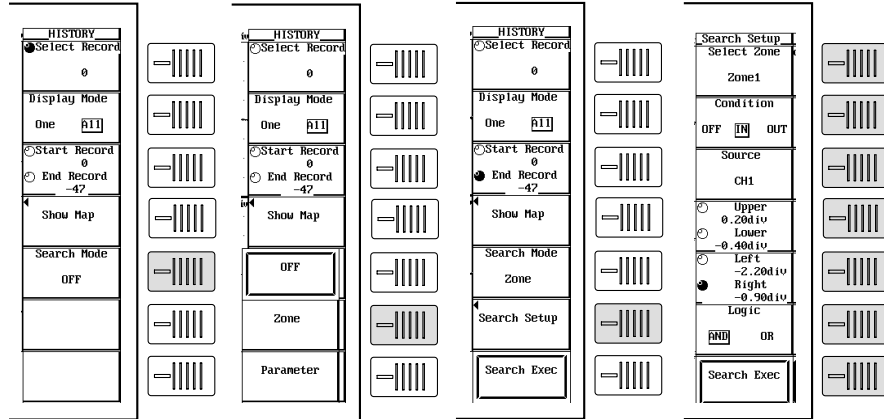

Selecting the search zone (Select Zone)

4. Pressing the “Search Setup” soft key to displays the search condition setting menu.
5. Press the “Select Zone” soft key to display the search condition selection menu.
6. Press one of the soft keys from to “Zone1” to “Zone4.”

Setting the search conditions (Condition)

7. Press the “Condition” soft key several times to select “OFF,” “IN,” or “OUT.” Selecting “IN” or “OUT” displays a search window in the area displaying the “Source” channel.

Setting the source channel (Source)

8. Pressing the “Source” soft key displays the source channel selection menu.
9. Press the soft key corresponding to the desired channel to select the source channel.

Setting the search window

10. Press the “Upper Lower” soft key.
11. Turn the jog shuttle to set the top of the search range. You can use the arrow keys to move between the digits. Pressing the “RESET” key resets the value to the default value.
12. Press the “Upper Lower” soft key.
13. Turn the jog shuttle to set the end of the search range. You can use the arrow keys to move between the digits. Pressing the “RESET” key resets the value to the default value.
14. By controlling both “Upper” and “Lower” using the jog shuttle, you can move the search window up and down without changing the vertical width.
15. In a similar fashion, set the horizontal range of the search window.
16. Repeat steps 6 to 15 to set Zone1 to Zone4.

Setting the logic

17. Press the “Logic” soft key to select “AND” or “OR.”

7.8 Searching the Historical Data Using Zone (History Search Function)

Executing the search

18. Press the "Search Exec" soft key to execute the search.

Displaying the waveforms that are found

19. Press the "ESC" key to return to the HISTORY menu.
Display the waveform according to the procedures given on page 7 - 13.
Show Map displays a list of waveforms that are found.

Resetting the search results

20. Turn OFF the Search Mode in the HISTORY menu or turn OFF Zone 1 to Zone 4 and execute the search to reset the search results.

7.9 Searching the Historical Data Using Parameter (History Search Function)

< For a description of this function, refer page 1 - 24 >

Function

Search for waveforms from the history memory function and display only the waveforms that fulfill specified conditions of particular parameters. (Applicable to the DL7100 with software (ROM) version 1.21 or later. See section 15.4, "Checking the System Condition.")

Search Criterion

You can store various kinds of search criteria in Param1-Param4. Within those four search criteria, you can specify the channel to be searched, the search conditions, and the searching range.

Condition

- IN : Search for a waveform entering the specified range of the specified parameter.
- OUT : Search for a waveform extending outside the specified range of the specified parameter.
- OFF : Do not search for a waveform.

Item Setup

Assign search parameters to each source channel. Choose (only) one of the automated waveform measurement parameters.

Condition Range (Upper/Lower)

Set the range that defines the specified parameter's condition.

Logic Search

- AND : Search for waveforms fulfilling all of the search criterion in Param1- Param4.
- OR : Search for waveforms fulfilling at least one of the search criterion in Param1- Param4.

Parameter Measuring Range (T-Range 1/T-Range 2)

Set the measuring range of the specified parameter. This is the portion of the waveform used to determine the values of the parameter.

Search Range

The search range extends from the "Start Record" to the "End Record" (see page 7 - 15).

Search Method

Search in order starting with the newest waveform.

Show-Map (Timestamp List)

Only searched waveforms are displayed in Show-Map. When "Search Mode" is OFF, all waveforms are displayed.

Operating Procedure

Select the Search Mode

1. Press the “History” key.
2. Press the “Search Mode” soft key to display the search mode selection menu.
3. Press the soft key corresponding to the parameter you wish to select.

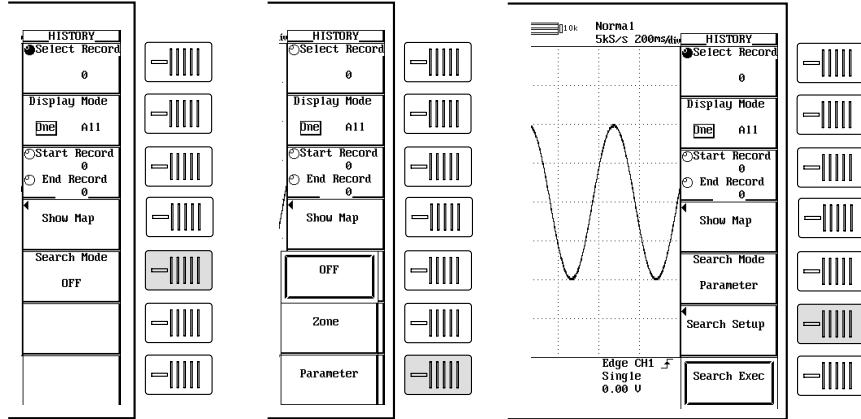

Select the Search Criteria (Select Param)

4. Press the “Search Setup” soft key to display the Search Criteria Setting menu.

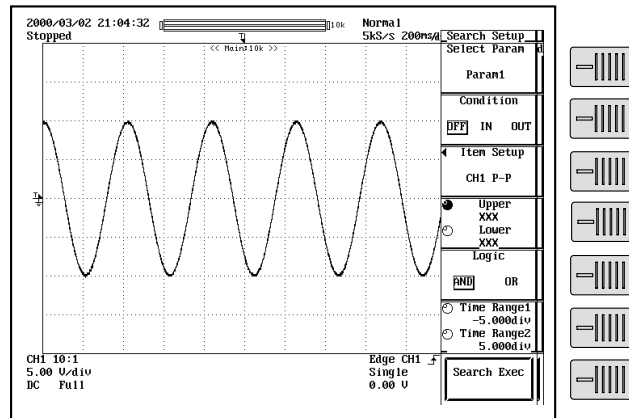

5. Press the “Select Param” soft key to display the search criteria selection menu.
6. Press one of the soft keys for “Param1” - “Param4” to select the search criterion.

Setting the Condition

7. Press the “Condition” soft key repeatedly to select “OFF,” “ON,” or “OUT.”

Setting the Parameter (Item Setup)

8. Press the “Item Setup” soft key to display the parameter selection menu.
9. Press the soft key corresponding to the channel that you wish to set as the source channel for the parameter search.
10. Use the jog shuttle to highlight the parameter to be used in the search, then press the “SELECT” key to assign the parameter to the channel.

7.9 Searching the Historical Data Using Parameter (History Search Function)

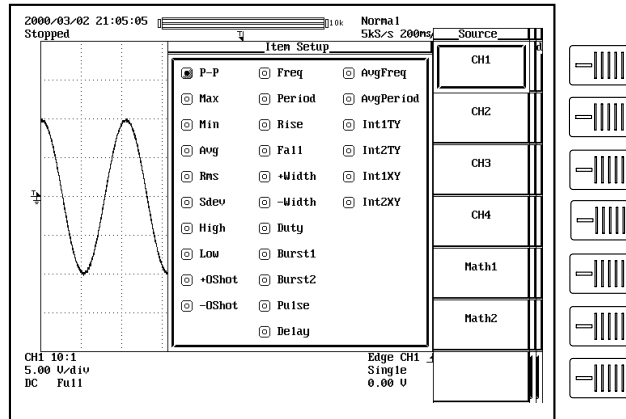

Set the Condition Range

11. Press the “Upper Lower” soft key to highlight the “Upper” jog shuttle icon.
12. Turn the jog shuttle to set the upper edge of the condition range. Use the arrow keys to move between the digits. Press the “RESET” key to return to the initial value (“XXX”).
13. Press the “Upper Lower” soft key to highlight the “Lower” jog shuttle icon.
14. Turn the jog shuttle to set the lower edge of the condition range. Use the arrow keys to move between the digits. Press the “RESET” key to return to the initial value (“XXX”).
15. Repeat steps 6 - 14 to set Param1 through Param4.

Setting the Logic

16. Press the “Logic” soft key to select “AND” or “OR.”

Setting the Parameter Measuring Range

17. Press the “Time Range1/Time Range2” soft key to highlight “Time Range1.”
18. Turn the jog shuttle to set the left edge of the measuring range. Use the arrow keys to move between the digits. Press the “RESET” key to return to the initial value (“XXX”).
19. Press the “Time Range1/Time Range2” soft key to highlight “Time Range2.”
20. Turn the jog shuttle to set the right edge of the measuring range. Use the arrow keys to move between the digits. Press the “RESET” key to return to the initial value (“XXX”).

Executing the Search

21. Press the “Searchexec” soft key to execute the search.

Displaying the Searched Waveform

22. Press the “ESC” key to return to the “HISTORY” menu. Display the waveform using the procedure on page 7 - 14. The waveforms indexed in Show-Map are displayed in a list.

Resetting the Search Results

23. If you set the Search Mode to OFF in the HISTORY menu, or if you perform a search with all of the parameters (Param1-Param4) set to OFF, the search results will be reset.

8.1 Changing the Display Format

< For a description of this function, refer to page 1 - 24 >

Function

Main Format

- Single : 1 waveform window Quad : 4 waveform windows
- Dual : 2 waveform windows Hexa : 6 waveform windows
- Triad : 3 waveform windows

Mapping

- Auto : Windows are arranged from top to bottom in order: CH1, CH2,..., Math1, Math2. But no windows are shown for channels for which display is set OFF.
- Fixed : Channels are displayed regardless of whether display is set ON or OFF, in order of channel number. The Math2 window is at the bottom, with the Math1 window directly above it.
- User : Assign numbers from 0 to 5 to CH1, CH2, ..., Math1, and Math2. The display position varies depending on the assigned numbers.

CH1,
CH2, CH4

Fixed (If CH3 = OFF)

CH1, CH4
CH2,

Auto (If CH3 = OFF)

0, 2, 4
1, 3, 5

User

The number of points that can be displayed vertically for each channel varies as follows according to the display format. However, the vertical resolution remains unchanged.

- Single(□) : 384 (240) points Quad() : 96 (60) points
- Dual(□) : 192 (120) points Hexa(☐) : 64 (40) points
- Triad(☐) : 128 (80) points

The value inside the parentheses applies when logic inputs are being displayed.

The display area of the login input is as follows.

- When either POD A or POD B is ON 144 points
- When both POD A and POD B are ON 72 points × 2

8.1 Changing the Display Format

Operating Procedure

1. Press the “DISPLAY” key.
2. Pressing the “Format” soft key displays the format menu.
3. Press the soft key corresponding to the desired format.

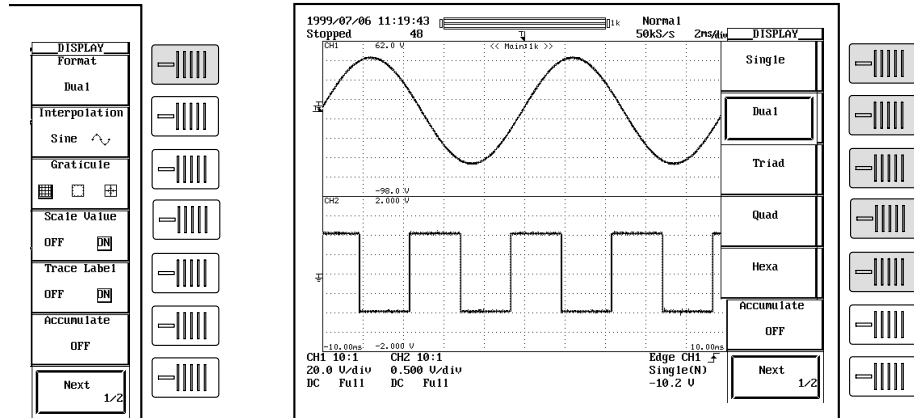

4. Press the “Next 1/2” soft key to display the “Next 2/2” menu.
Press the “Mapping” soft key to select “Auto,” “Fixed,” or “User.”

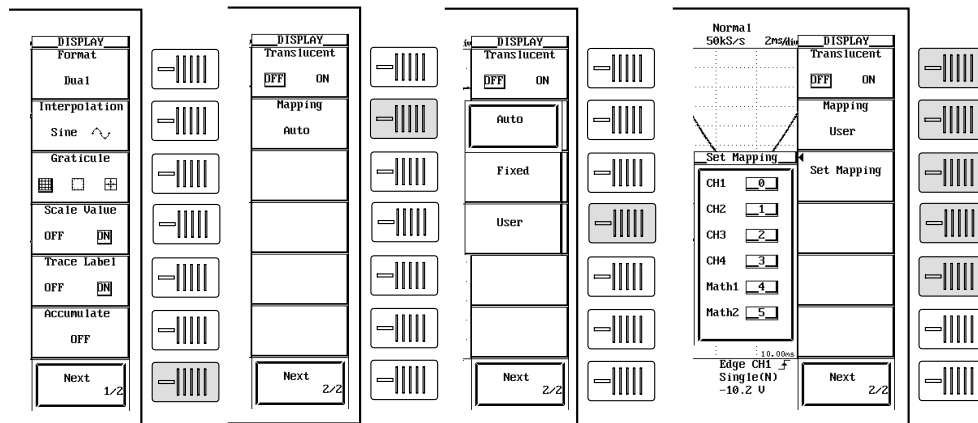

5. Pressing the “Set Mapping” soft key displays a menu used to assign the waveforms.
6. Turn the jog shuttle to move the cursor to the desired channel.
7. Pressing the “SELECT” key displays a menu used to set the number.
8. Turn the jog shuttle to select a number. Pressing the “ESC” key closes the menu.
9. Repeat steps 5 to 7 as necessary.

8.2 Setting the Interpolation Method

< For a description of this function, refer to page 1 - 17 >

Function

Interpolate

Any area along the time axis having less than 500 points per 10 divisions (less than 250 points in the Z1 and Z2 window when displaying Main & Z1 & Z2) is recognized as an interpolation area. If you leave interpolation off, these points will appear as discrete dots (so that the display will show gaps between dots or vertical lines). If you set interpolation on, however, the DL7100 will connect the points. Three interpolation settings are available.

Sine (📈) : Interpolates between two dots using a sin x/x function.

Line (—) : Interpolates between two dots in a straight line.

PULSE (⋯) : Draws a horizontal line to a point directly above or below the next data point and then interpolates using two dots so that the end of the horizontal line is connected to the next data point by a vertical line.

OFF (⋯) : No interpolation

Outside the interpolation area

If interpolation is set to Sine, Line, or Pulse the instrument draws lines between points that are aligned vertically.

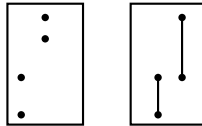

Interpolate : OFF Sine/Line/Pulse

Within the interpolation area

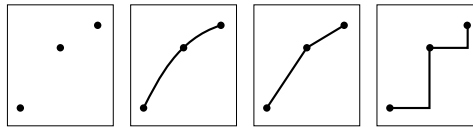

Interpolate : OFF Sine Line Pulse

8.2 Setting the Interpolation Method

Operating Procedure

Set the interpolation method

1. Press the "DISPLAY" key.
2. Press the "Interpolate" soft key displays the interpolation method menu.
3. Press the soft key corresponding to the desired interpolation method.

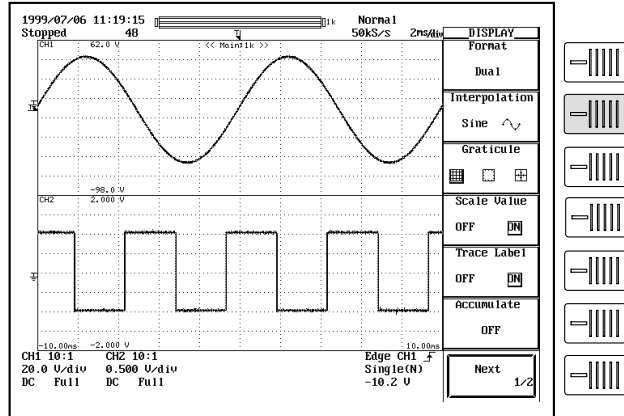

8.3 Changing the Graticule

< For a description of this function, refer to page 1 - 16 >

Function

The graticule type can be selected from the following 3 types.

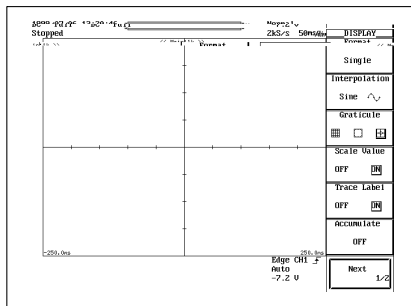
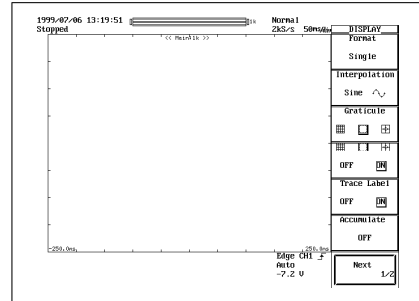
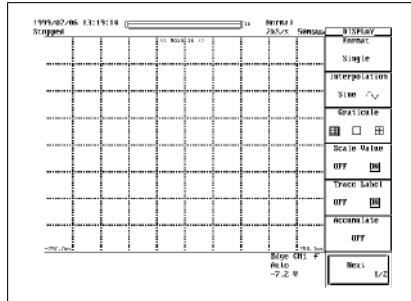

Operating Procedure

1. Press the "DISPLAY" key.
2. Press the "Graticule" soft key to select one of the three graticule types.

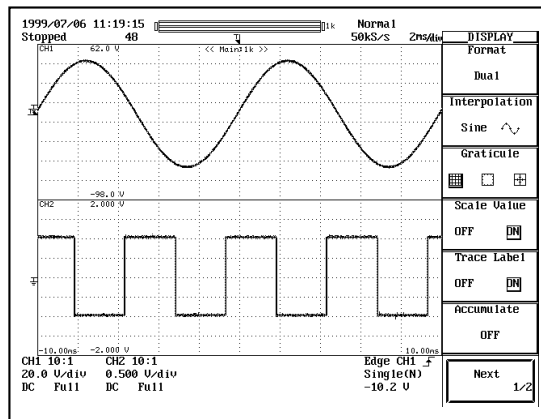

8.4 Turning Display of the Scaling Value ON/OFF

< For a description of this function, refer to page 1-16 >

Function

You can display the upper and lower limits of the vertical and horizontal axes of each channel.

Operating Procedure

Turning ON/OFF the scale values

1. Press the "DISPLAY" key.
2. Press the "Scale Value" soft key to select "ON" or "OFF."

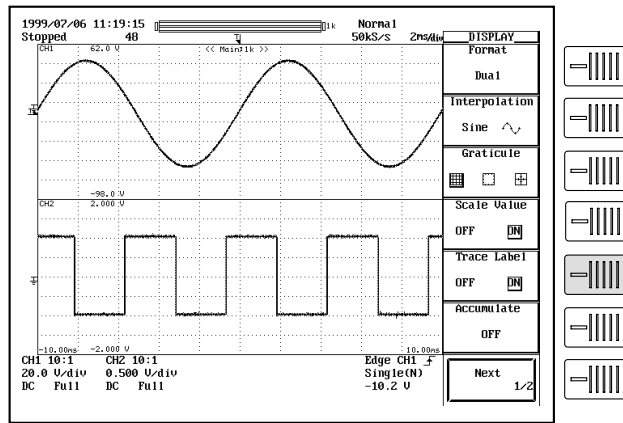

Changing how the dialog box is displayed

3. Press the "NEXT" soft key.
4. Press the "Translucent" soft key to select "ON" or "OFF." If "ON" is selected, the dialog box is displayed semi-transparent showing the display underneath.

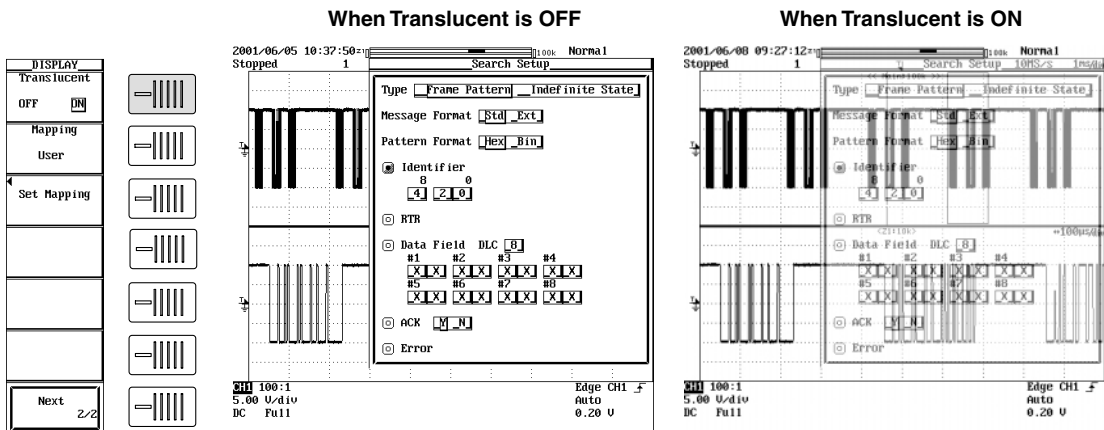

8.5 Setting the Waveform Labels

< For a description of this function, refer to page 1 - 16 >

Function

Label display ON/OFF (Trace Label)

Use this parameter to select whether or not to include waveform labels (channel identification labels) on the display.

Entering customized labels

You can use the Define Label feature to enter customized labels for each channel. Each label is a character string of up to eight alphanumeric. You can set the label display ON/OFF using the Trace Label function; the label appears in the scale-value display and with measurement results.

Operating Procedure

Setting the waveform label

1. Press one of the keys from “CH1” to “CH4” or “TLOG” to select the desired channel.
2. Press the “Next 1/2” soft key to display the “Next 2/2” menu.
3. Press the “Label” soft key to display a keyboard, and enter the waveform label according to the procedures described in page 4-2.

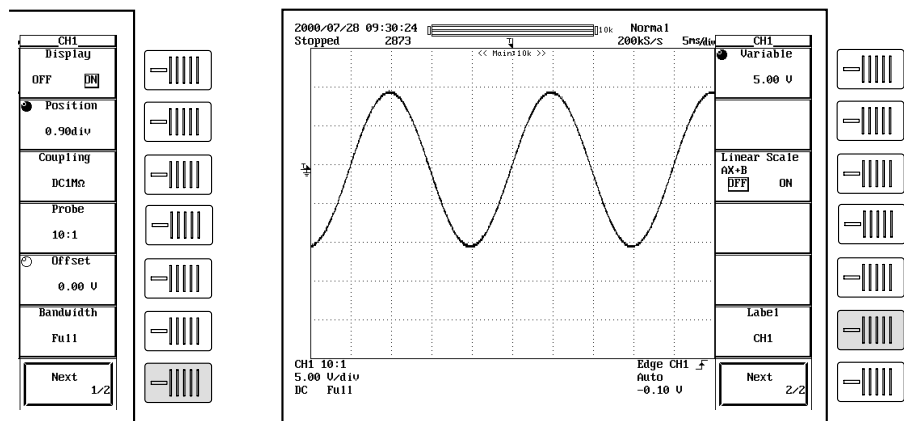

Turning ON/OFF the waveform label

4. Press “DISPLAY” key.
5. Press the “Trace Label” soft key to select “ON” or “OFF.”

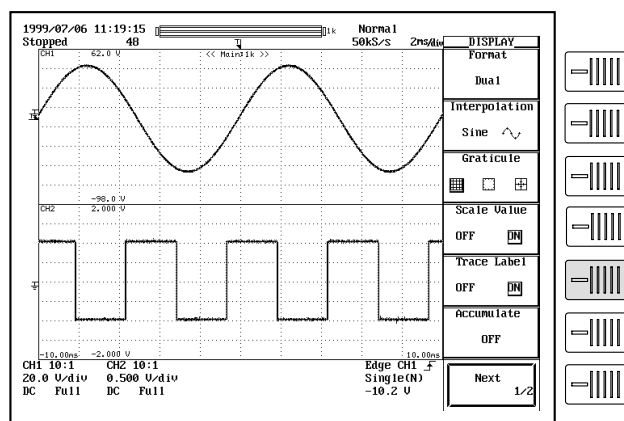

8.6 Accumulated Waveform Display

< For a description of this function, refer to page 1 - 15 >

Function

During normal operation, the display is updated every time the trigger is activated making it difficult to capture transient conditions such as sudden distortion of waveforms. By using the accumulate function, the waveform display of the acquired data remains on the screen for the specified time.

Accumulate mode

Persist: Accumulate using each channel color. Displayed for the specified time period by gradually lowering the brightness.

Color : Accumulate using eight colors that indicate the frequency of waveforms in the data.

Accumulation period (during Persist mode)

When using the persistence mode, select the period over which waveforms are accumulated from the list below. If you select infinite, the accumulation is carried out infinitely. The default value is 100 ms.

100 ms, 200 ms, 500 ms, 1 s, 2 s, 5 s, 10 s, 20 s, 50 s, and Infinite

Grade width (for color grade mode)

In color grade mode, the frequency of data value occurrence is indicated in eight colors as illustrated below. The grade width can be set within the range given below. The default setting is 16.

Overlapping display is performed indefinitely in color grade mode.

2 to 2048 (steps of 2^n)

Higher frequency

↑	red	28 or more	red	896 or more
	pink	24 to 27	pink	768 to 895
	orange	20 to 23	orange	640 to 767
	yellow	16 to 19	yellow	512 to 639
	white	12 to 15	white	384 to 511
	cyan	8 to 11	cyan	256 to 383
	green	4 to 7	green	128 to 255
	blue	1 to 3	blue	1 to 127
	black	0	black	0

When grade width = 4

When grade width = 128

For example, a dot which has appeared on the screen 100 times is displayed in red if the grade width is 4, or in blue if the grade width is 128.

Points for attention

- Automatic measurement of waveform parameters and GO/NO-GO judgment are performed on the latest waveform.
- When displaying all waveforms in the history memory during accumulation, the historical waveforms are displayed using the specified accumulation mode. However the waveform display becomes slow.
- When printing accumulated waveforms using the optional built-in printer, they are printed using two tones.
- Only the latest waveform can be output to an external printer.
- If the waveform acquisition is forcibly stopped by pressing the START/STOP key, the accumulation is temporarily suspended. When the acquisition is restarted, the display is cleared and accumulation continues.

Operating Procedure

Selecting averaging mode

1. Press the "DISPLAY" key.
2. Press the "Accumulate" soft key to display the accumulate mode menu.
3. Press the corresponding to the desired accumulate mode.
Proceed to step 4 if you have selected "Persist," or to step 5 if you have selected "Color."

Setting the accumulative time (when "Persist" has been selected)

4. Turn the jog shuttle to set the desired accumulative time.

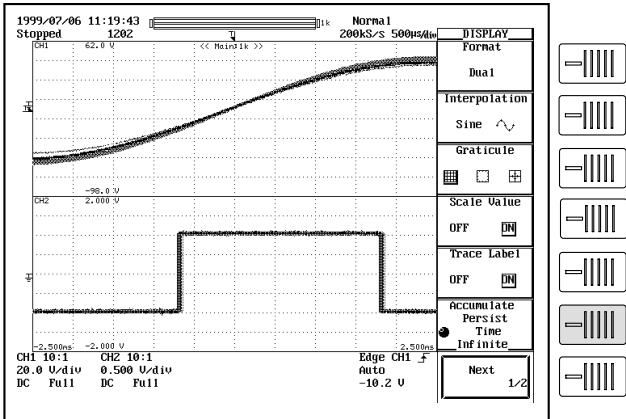

Setting the grade width (when "Color" has been selected)

5. Turn the jog shuttle to set the desired color width.

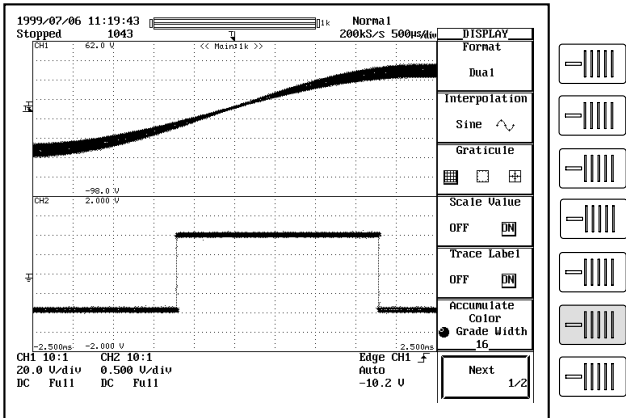

8.7 X-Y Waveform Display

< For a description of this function, refer to page 1 - 18 >

Function

Selecting the X-axis mode

Single : Set the X-axis trace of XY1 and XY2 common.

Dual : Set the X-axis trace individually for XY1 and XY2.

Assigning X (horizontal) and Y (vertical) axes

The channels that can be assigned to the X axis and Y axis depending on the X-axis mode as follows:

X axis mode	X-Y	X axis	Y axis
Single	XY1	CH1 to CH4, Math1, Math2	CH1, CH2, Math 1
	XY2	CH1 to CH4, Math1, Math2	CH3, CH4, Math 2
Dual	XY1	CH1, CH2, Math1	CH1, CH2, Math 1
	XY2	CH3, CH4, Math2	CH3, CH4, Math 2

Number of X-Y waveforms that can be displayed

The number of X-Y waveforms that can be displayed is two (XY1, XY2). The display of each X-Y waveform can be turned ON/OFF.

Selecting the display format: Mode

You can choose from the following three display formats.

T-Y&X-Y : The top window displays normal (T-Y) waveforms. The bottom window displays X-Y waveforms.

X-Y : Displays only X-Y waveforms.

T-Y : Displays only T-Y waveforms.

Selecting the X-Y waveform display range: Start Point/End Point

The X-Y display shows the range selected on the T-Y waveform.

You can set the start (fine dashed line) and end (coarse dashed line) positions in the range -5 to +5 div from the center of the waveform display frame. The start and end positions are not displayed on the X-Y waveform.

The resolution is as follows.

Resolution: $T/\text{div} \times 10/\text{displayed record length}$

Precautions to be taken when displaying X-Y waveforms

- The divided windows of the T-Y waveform display when using the T-Y & X-Y format are displayed in accordance with the "Format" setting specified with the DISPLAY key.
- The zoom function applies only to T-Y waveforms. In addition, Main, Z1, or Z2 can be selected for the T-Y waveform display.
- When expanding the X-Y waveform, change the "Variable" parameter of each channel. The waveform can be expanded or reduced artificially.

Operating Procedure

1. Press the “SHIFT” key to set the keys in the shifted condition. Functions marked in purple on the panel become active.
2. Press the “DISPLAY” key.

Selecting the display format

3. Press the “Mode” soft key to display the mode selection menu.
4. Press the “T-Y,” “X-Y,” or “T-Y&X-Y” soft key to set the mode.

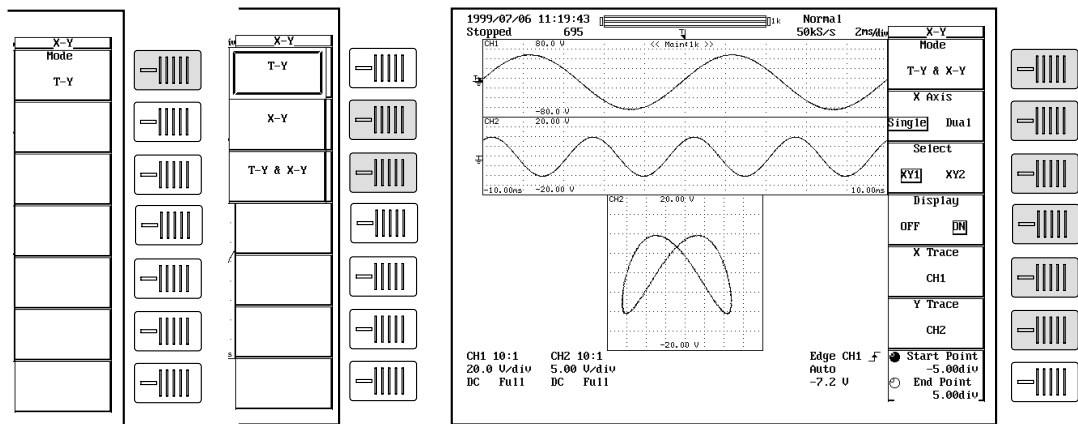

Continue with steps 5 - 12 below if you selected “X-Y” or “T-Y&X-Y.”

Selecting the X-axis mode

5. Press the “X Axis” soft key to select “Single” or “Dual.”

Selecting the X-Y waveform

6. Press the “Select” soft key to select the desired X-Y waveform.
7. Press the “Display” soft key to select whether or not to display the X-Y waveform that was selected in step 4.

Setting the X and Y axes

8. Pressing the “X Trace” soft key displays the channel menu.
9. Press the soft key corresponding to the desired channel that you wish to set to the X axis.
10. In a similar fashion, set the Y axis by pressing the “Y Trace” soft key.

Setting the display range

11. Press the “Start Point/End Point” soft key. Turn the jog shuttle to set the display start position.
12. In a similar fashion, press the “Start Point/End Point” soft key to set the display end position.

8.8 Zooming the Waveform

< For a description of this function, refer to page 1 - 18 >

Function

The zoomed waveform of two locations can be displayed simultaneously (dual zoom). You can also select which channel to zoom. Note that if the number of displayed points is less than or equal to 50 (or 40), zooming is not possible.

Selecting the display mode of zoomed waveforms: Mode

- Main : Displays only the main (unzoomed) waveform.
Z1 Only : Displays only the zoomed waveform of zoom box Z1.
Z2 Only : Displays only the zoomed waveform of zoom box Z2.
Main&Z1 : Displays the main waveform in the top window and zoomed waveform of zoom box 1 in the bottom window.
Main&Z2 : Displays the main waveform in the top window and zoomed waveform of zoom box 2 in the bottom window.
Z1&Z2 : Displays the zoomed waveform of zoom box 1 in the top window and the zoomed waveform of zoom box 2 in the bottom window.
Main&Z1&Z2 : Displays the main waveform in the top window, the zoomed waveform of zoom box 1 in the lower left window and the zoomed waveform of zoom box 2 in the lower right window

Selecting the zoomed trace: Allocation

The traces (CH1 to CH4, Math1, Math2, POD A, POD B) whose "Allocation" is turned ON are zoomed. If the allocation is OFF, the trace is not zoomed. You cannot allocate channels whose display is turned OFF.

Display format of zoomed waveforms

Similar to the main waveform, six types of display formats are available. You cannot set different formats for Z1 and Z2.

Main*, Single, Dual, Triad, Quad, Hexa

*: Selecting Main results in the same format as when "Format" is specified for "DISPLAY."

Zoom rate

- The maximum zoom rate varies depending on the displayed record length.
Maximum zoom rate = displayed record length ÷ 50 (or 40)
Note that the displayed record length is not necessarily the same as the record length of the acquisition memory.
For details regarding the displayed record length, see appendix 1, "Relationship between the Time Axis Setting, Sample Rate, and Record length."
- You can change the zoom rate for Z1 and Z2 (zoomed waveforms of two locations).

Zoom position: Z1 Position and Z2 Position

- The zoom position can be set by specifying the zoom center position (center of the zoom box) in the range -5 to +5 div with the center of the waveform display frame set to 0 div. When the record length of the DL7200 is 16 Mwords, the zoom position can be set only in the range in which the edge of the waveform matches the edge of the window. The selectable steps are as follows:
Zoom position resolution = T/div × 10 ÷ display record length
- The zoom box enclosed by solid lines is Z1 and the one enclosed by dashed lines is Z2. Since each box is independent, you can set the position separately.

Changing the range of the automated measurement of waveform parameters

Sets the range of the automated measurement of waveform parameters to the zoom range of Z1 or Z2. This is valid even if the automated measurement of waveform parameters is turned OFF.

Operating Procedure

Selecting the display mode

1. Press the “ZOOM” key.
2. Pressing the “Mode” soft key displays the display format menu.
3. Press the soft key corresponding to the desired display format.

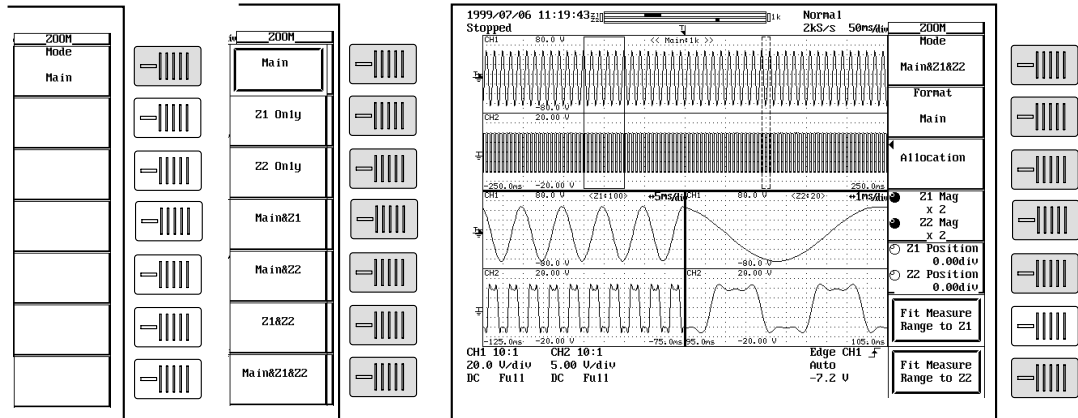

Selecting the display format of zoomed waveforms.

4. Pressing the “Format” soft key displays the format menu.
5. Press the soft key corresponding to the desired format.

Selecting the zoomed trace

6. Pressing the “Allocation” soft key displays the zoomed trace setting menu.
7. Turn the jog shuttle to move the cursor to the desired trace.
8. Press the “SELECT” key to select the trace.
Selecting “All ON” selects all traces that are currently displayed.

Setting the zoom rate

9. Press the “Z1 Mag/Z2 Mag” soft key.
Turn the jog shuttle to set the zoom rate of Z1 zoom box.
10. In a similar fashion, press the “Z2 Mag” soft key to set the zoom rate of Z2 zoom box.

Selecting the zoom position

11. Press the “Z1Position/Z2Position” soft key.
Turn the jog shuttle to set the zoom position of Z1 zoom box.
12. In a similar fashion, press the “Z2Position” soft key to set the zoom position of Z2 zoom box.
By setting the jog shuttle control to both “Z1Position” and “Z2Position,” the zoom positions of both Z1 and Z2 can be moved simultaneously.

Changing the range of the automated measurement of waveform parameters

13. Press the “Fit Measure Range to Z1” or “Fit Measure Range to Z2” soft key (depending on the display format of the zoom waveform) to set the range of the automated measurement of waveform parameters to the zoom range of Z1 or Z2, respectively.

8.9 Search Data Using Search and Zoom Function

< For a description of this function, refer to page 1 - 24 >

Function

When the data acquisition is stopped, a section of the waveform can be searched and displayed expanded.

Search method: Type

The following six search methods are available.

- Edge : Searches by counting the number of times the waveform goes above (rising) or below (falling) a specified level from the starting point.
- Serial pattern : Searches sections that have the same waveform pattern (High, Low, Don't care) as the specified pattern.
- Parallel Pattern : Search using a previously set pattern in CH1-CH4, Math1, Math2, PodA, or PodB. Search using the pattern of each bit in PodA and PodB. (Applicable to DL7100 with software (ROM) version 1.21 or later. See section 15.4, "Checking the System Condition.")
- Pulse Width : Search a specific part of the currently displayed waveform. From the search start position, search for pulses which fulfill certain conditions whose durations are shorter or longer than a previously specified length of time. The searched part of the waveform is expanded by a previously set zoom factor, and displayed in the waveform zoom window. (Applicable to DL7100 with software (ROM) version 1.11 or later. See section 15.4, "Checking the System Condition.")
- Auto Scroll : The zoom box automatically scrolls in a specified direction. You can stop the zoom box while checking the zoomed waveform in the bottom window. (Applicable to DL7100 with software (ROM) version 1.21 or later. See section 15.4, "Checking the System Condition.")
- SPI : See section 8.10, "Analyzing and Searching SPI Signals."

Search condition: Setup

• When the type is edge

- Source : Select the channel to be searched. You can also select Math1 and Math2.
- Level : Set the level used to determine the rising or falling edge. The range is 8 div within the screen. The resolution is 0.01 div.
- Polarity : Select the polarity from the following list.
- ↕ : Search by the number of times the waveform passes from below the specified level to above the specified level.
 - ↕ : Search by the number of times the waveform passes from above the specified level to below the specified level.
- Hys : Set the hysteresis. The range is 0.3 div to 4 div.
- Count : Set the number of times ↕ or ↕ is to be met. The range is 1 to 1000000.
- Start Point: Set the starting position of the search. The range is from -5 to 5 div.

• When the type is serial pattern

- Clock CH : Select the clock channel, from CH1 to CH4, that is used as a timing reference in checking the pattern. When None is selected, the pattern is checked at a predetermined interval.

When CH1 to CH4 is set as the clock channel

Level : Set the level used to determine the rising or falling edge. The range is 8 div within the screen. The resolution is 0.01 div.

Polarity : Select the polarity from the following list.

↕ : Check the pattern when the waveform changes from below the specified level to above the specified level.

↕ : Check the pattern when the waveform changes from above the specified level to below the specified level.

Hys : Set the hysteresis. The range is 0.3 div to 4 div.

When None is set as the clock channel

Interval : Set the interval at which to check the pattern.

Source : Select the channel to be searched. You can also select Math1 and Math2.

For logic input, select the bit to use as the source.

Thr Upper : Set the level used to determine Low (L).

Thr Lower : Set the level used to determine High (H).

Pattern : Four different types of patterns can be registered. Set the pattern with 64 bits of H, L, X (Don't care) symbols.

H: When the value is greater than or equal to Thr Lower (1 for logic input).

L: When the value is less than or equal to Thr Upper (0 for logic input).

X: Do not determine.

Start Point: Set the start position of the search. The range is from -5 to 5 div.

- **When the Type is Parallel Pattern**

Clock CH : Select a clock channel from CH1-CH4 that will provide the standard timing for checking the patterns. Select NONE to check the patterns of all the data.

Channels Specified as Clock Channels

Level : Set the level for determining rising and falling. The range for the setting is an on-screen 8 div, and the resolution is 0.01 div.

Pattern : Choose from the following:

↕ : Check the pattern when the waveform changes from above to below the specified level.

↕ : Checks the pattern when the waveform changes from below to above the specified level.

Hysteresis: Set the hysteresis. The range for the setting is 0.3-0.4 div.

Channels Other than Clock Channels

Pattern : Set using the H, L, or X (don't care) symbols. Set each bit when using logic input.

H: When the value is greater than the level (1 for logic input)

L: When the value is less than the level (0 for logic input)

X: Do not determine.

Level : Set the levels to determine H and L.

Hysteresis: Set the hysteresis. The range for this setting is 0.3 div-4 div.

Start Point: Set the starting position for the search. The range for this setting is -5 to 5 div.

8.9 Search Data Using Search and Zoom Function

- **When the Type is Pulse Width**

- Type : Select the relationship between the specified time and the measured waveform.
- Pulse < Time : search the part in which the time that fulfills the conditions below is shorter than a specified time.
- Pulse > Time : search the part in which the time that fulfills the conditions below is longer than a specified time.
- T1 < Pulse < T2 : search the part in which the time that fulfills the conditions below lies between two specified times.
- Timeout : search the part in which the time that fulfills the conditions below lies outside of a specified time. The portion shown in the zoom display is different than Pulse > Time.
- Source : Select the source channel for the search. You can also select Math1 and Math2.
- Level : Set the level for determining High and Low. The setting range is an on-screen 8 div, and the resolution is 0.01 div.
- Polarity : Choose from the following:
High : When the waveform is higher than the specified level.
Low : When the waveform is lower than the specified level.
- Hysteresis: Set the hysteresis. The range for this setting is 0.3 div-4 div.
- Time : Set the determination time, "T." The range for this setting is 1/sample rate - display range.
- Start Point: Set the starting position for the search. The range for this setting is -5 to 5 div.

Display position of the searched waveform: Result Window

When the zoom mode is set to Z1 & Z2 or Main & Z1 & Z2, you can select whether to display the searched waveform in the Z1 or Z2 window.

Search count

The search can be carried out up to 1000 times. When the type is edge, the rising or falling edge is counted from the previous search position. In addition, the past search results can also be displayed.

Changing the zoom rate and position

The search results are displayed in the zoomed waveform display area. As in the zoomed waveform, the zoom rate and position can be changed.

Precautions to be taken when searching

- Searching is not possible while the data acquisition is in progress.
- Searching is not possible on the computed results of the power spectrum.
- The search result is void if the following operation, are carried out:
 - Starting data acquisition.
 - Changing the Search Setup setting.
 - Shifting the phase of the source or the clock.
- Searching is not possible when setting CH2 or CH4 as the clock channel while in interleave mode.
- Searching is not possible when all patterns are set to "X."
- Patterns from undisplayed waveforms will not be referenced during searches.

Determination when Using the Edge for the Search

When the peak immediately after the rising edge of the waveform is less than or equal to the upper limit of the hysteresis or when the peak immediately after the falling edge is greater than or equal to the lower limit of the hysteresis, it is determined as false (not counted as a specified edge).

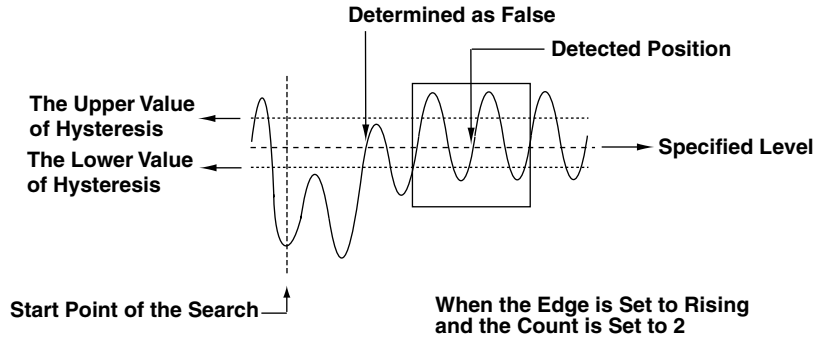

Determination when searching using a serial pattern

The points between the Thr Upper and Thr Lower are always determined to be true (matches the specified status). If such point is included at the time the pattern is checked, a message is displayed as a notification.

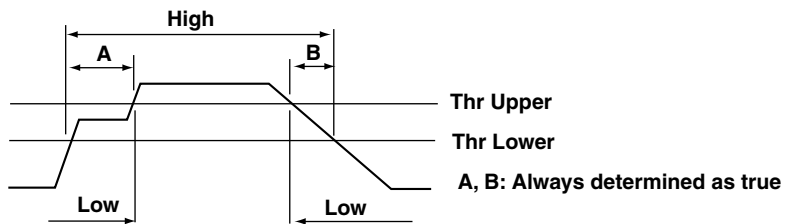

Search start point when searching using a serial pattern

The search start point is as follows when Clock CH is set to None.

On the screen, the first rising or falling edge to the right of the specified Start Point becomes the reference. The search start point is set to 1/2 the specified interval right of the reference point. However, if the Start Point and the search start point described above are separated by an interval larger than the specified interval, the search start point is set back in units of the specified interval to a point so that the interval between the Start Point and the search start point is within the specified interval. (The search start point must be to the right of the start point in this case.) Within the hysteresis range of Clock CH, the rising or falling edge cannot be checked.

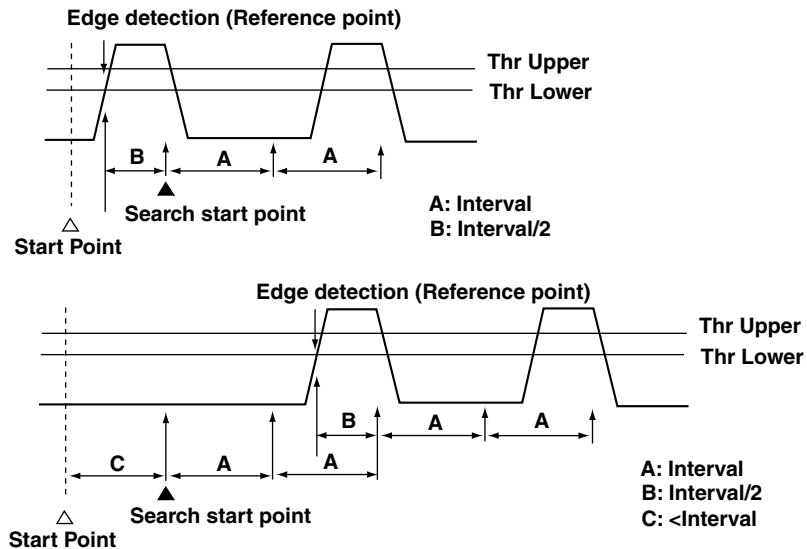

8.9 Search Data Using Search and Zoom Function

Defermination During a Parallel Pattern Search

The hysteresis points are normally evaluated as true (conforming to the specified status).

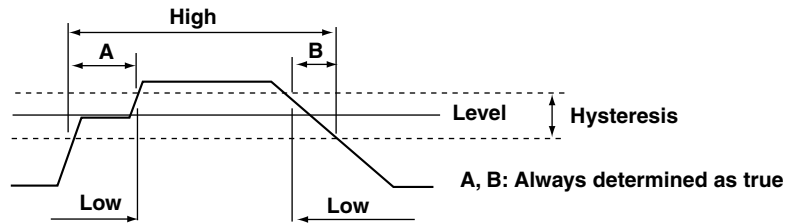

Display Position for Pulse Width Searches

The position of the waveform displayed in the zoom screen will change in the following manner depending on the "Type" setting:

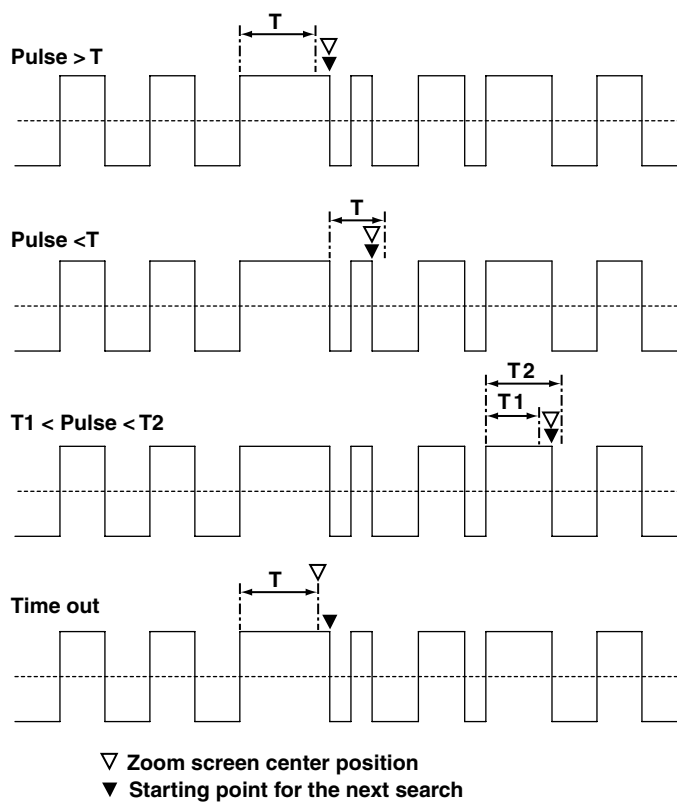

Auto Scroll

Set the scroll speed choosing from one of 7 steps. The higher the number, the faster the scrolling. You cannot set any settings other than Direction speed while auto scrolling.

Operating Procedure

When searching using the edge

1. Press the "SHIFT" key to set the keys in the shifted condition. Functions marked in purple on the panel become active.
2. Press the "ZOOM" key.

Selecting the search method (Type)

3. Pressing the "Type" soft key displays the search method menu.
4. Press the soft key corresponding to "Edge" to select the search method.

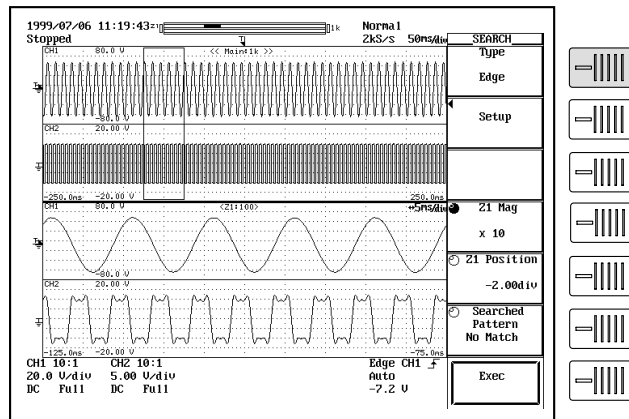

Setting the search condition

5. Pressing the "Setup" soft key displays the search condition setting dialog box. Turn the jog shuttle to select the parameter. Pressing the "SELECT" key displays a menu used to set the item or changes the selected item.

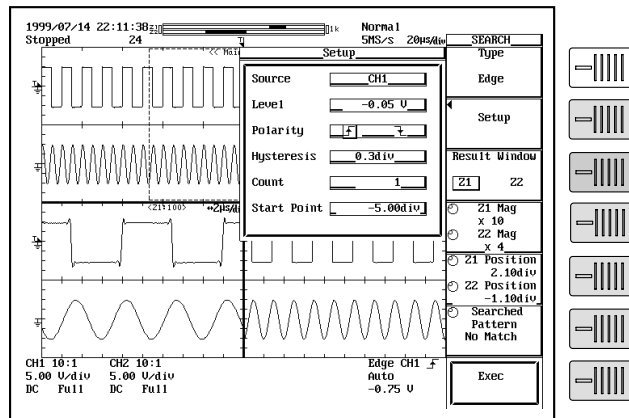

Setting the Source

6. Turn the jog shuttle to move the cursor to the channel to be searched and press the "SELECT" key.

Setting the Level

7. Turn the jog shuttle to set the level and press the "SELECT" key. You can use the arrow keys to move between the digits. Pressing "RESET" key resets the level to "0 V."

Setting the Polarity

8. Press the "SELECT" key to select "F" or "┘."

8.9 Search Data Using Search and Zoom Function

- **Setting the hysteresis**

9. Turn the jog shuttle to set the hysteresis and press the "SELECT" key. You can use the arrow keys to move between the digits.
Pressing "RESET" key resets the hysteresis to "0.3 div."

- **Setting the Count**

10. Turn the jog shuttle to set the count and press the "SELECT" key. You can use the arrow keys to move between the digits.
Pressing "RESET" key resets the count to "0."

- **Setting the Start Point**

11. Turn the jog shuttle to set the start position of the search. Press the "SELECT" key. You can use the arrow keys to move between the digits.
Pressing "RESET" key sets the position to "-5 div."
12. Press "ESC" key close the search condition setting dialog box.

Setting the display position of the search results

13. Press the "Result Window" soft key to select "Z1" or "Z2."

Executing the search

14. Pressing the "Exec" soft key starts the search. The search results are displayed in the zoomed waveform display position selected in step 12.
You can search 1000 times using the same conditions.

Displaying the previous search results

15. Press the "Searched Pattern" soft key.
16. Turn the jog shuttle to select the number of the search result to be displayed.
Newer search results are displayed with higher numbers (result 2 is newer than result 1).

When searching using a serial pattern

1. Press the “SHIFT” key to set the keys in the shifted condition. Functions marked in purple on the panel become active.
2. Press the “ZOOM” key.

Selecting the search method (Type)

3. Pressing the “Type” soft key displays the search method menu.
4. Press the soft key corresponding to “SerialPattern” to select the search method.

Setting the search conditions

5. Pressing the “Setup” soft key displays the search condition setting dialog box. Turn the jog shuttle to select the parameter. Pressing the “SELECT” key displays a menu used to set the item or changes the selected item.

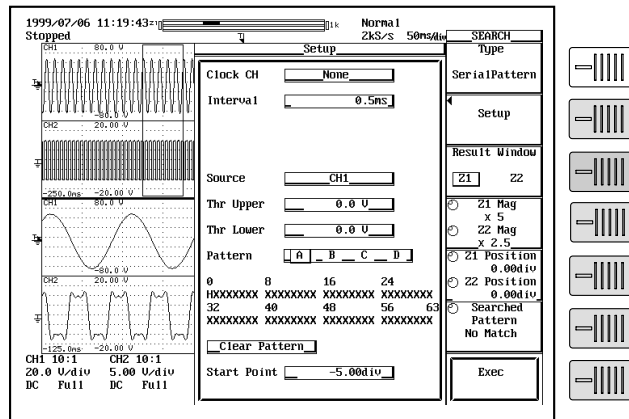

Setting the Clock CH

6. Turn the jog shuttle to move the cursor to the clock channel and press the “SELECT” key. If you selected CH1 to CH4, go to step 7. If you selected None, go to step 10.

Setting the Level

7. Turn the jog shuttle to set the level and press the “SELECT” key. You can use the arrow keys to move between the digits. Pressing “RESET” key resets the level to “0 V.”

Setting the Polarity

8. Press the “SELECT” key to select “ \uparrow ” or “ \downarrow .”

Setting the hysteresis

9. Turn the jog shuttle to set the hysteresis and press the “SELECT” key. You can use the arrow keys to move between the digits. Pressing “RESET” key resets the hysteresis to “0.3 div.”

Setting the interval

10. Turn the jog shuttle to set the interval at which to check the pattern and press the “SELECT” key. You can use the arrow keys to move between the digits. Pressing “RESET” key resets the interval to the default value.

Setting the Source

11. Turn the jog shuttle to move the cursor to the channel to be searched and press the “SELECT” key.

8.9 Search Data Using Search and Zoom Function

- **Set the Thr Upper**

12. Turn the jog shuttle to set the level used to determine Low and press the "SELECT" key. You can use the arrow keys to move between the digits. Pressing "RESET" key resets the level to "0 V."

- **Set the Thr Lower**

13. Turn the jog shuttle to set the level used to determine High and press the "SELECT" key. You can use the arrow keys to move between the digits. Pressing "RESET" key resets the level to "0 V."

- **Set the Pattern**

14. Press the "SELECT" key to select the pattern number "A" to "D."
15. Turn the jog shuttle to move the cursor to the desired bit position.
16. Press the "SELECT" key to select "H," "L," or "X." If you click "Clear Pattern" all bits are set to "X."
17. Set other pattern numbers as necessary.

- **Setting the Start Point**

18. Turn the jog shuttle to set the start position of the search. Press the "SELECT" key. You can use the arrow keys to move between the digits. Pressing "RESET" key sets the position to "-5.000000 div."
19. Press "ESC" key close the search condition setting dialog box.

Setting the display position of the search results

20. Press the "Result Window" soft key to select "Z1" or "Z2."

Executing the search

21. Pressing the "Exec" soft key starts the search. The search results are displayed in the zoomed waveform display position selected in step 20. You can search 10 times using the same conditions.

Displaying the previous search results

22. Press the "Searched Pattern" soft key.
23. Turn the jog shuttle to select the number of the search result to be displayed. Newer search results are displayed with higher numbers (result 2 is newer than result 1).

Changing the zoom rate and position

24. As in the zoomed waveform, you can change the zoom rate of Z1 and Z2 by pressing the "Z1 Mag/Z2 Mag" soft key and turning the jog shuttle.
25. As in the zoomed waveform, you can move the section that is being zoomed by pressing the "Z1 Position/Z2 Position" soft key and turning the jog shuttle.

When Performing a Parallel Pattern Search

1. Press the “Shift” key to activate shift mode.
The functions printed in purple letters on the front panel become activated.
2. Press the “Zoom” key.

Selecting the Search Method Type

3. Press the “Type” soft key to display the search method selection menu.
4. Press the soft key corresponding to “Parallel Pattern” to select the search method.

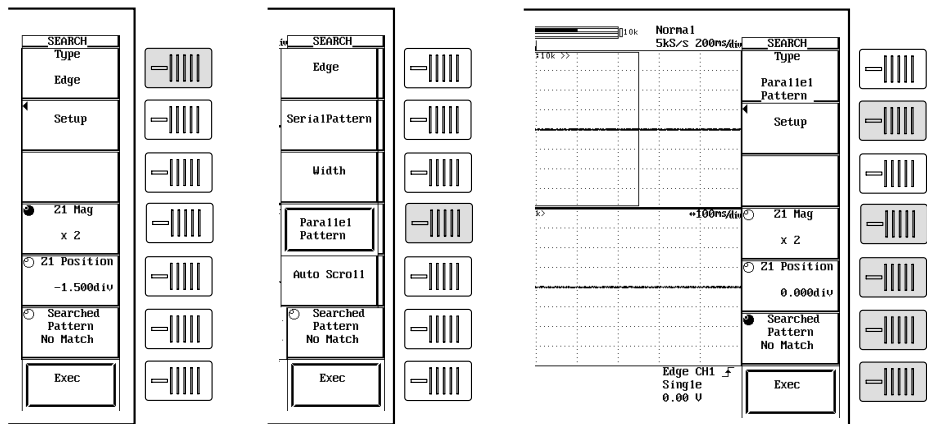

Setting the Search Criteria

5. Press the “Setup” soft key to display the search criteria settings dialog box.
Turn the jog shuttle to select the setting item. When you press the “SELECT” key, the settings menu for the selected item is displayed, or the selected value is changed.

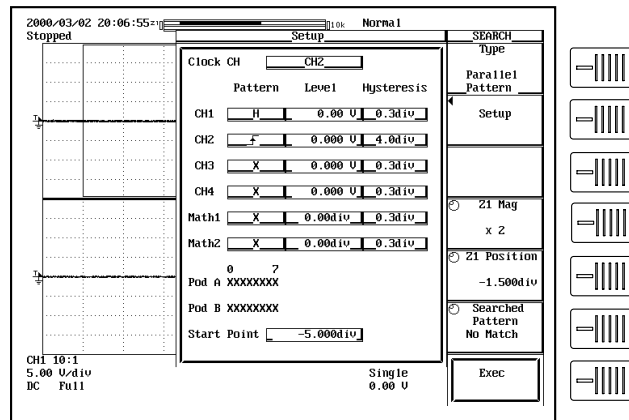

- **Setting the Clock CH**

6. Move the cursor over to the clock channel with the jog shuttle, then press the “SELECT” key. When selecting CH1-CH4, proceed to step 7. If you select “None,” skip to step 10.

- **Setting the Clock Channel Pattern**

7. Use the jog shuttle to move the cursor to the Pattern of the channel set as the clock channel. Press the “SELECT” key to select “rising” or “falling.”

- **Setting the Clock CH Level**

8. Use the jog shuttle to move the cursor to the Level of the channel set as the clock channel. Press the “SELECT” key, then use the jog shuttle to set the level, and press the “SELECT” key again. Use the arrow keys to move between the digits. If you press the “RESET” key, the setting will be restored to “0 V.”

8.9 Search Data Using Search and Zoom Function

- **Setting the Hysteresis of the Clock Channel**
 9. Use the jog shuttle to move the cursor to the Hysteresis of the channel set as the clock channel. Press the “SELECT” key, use the jog shuttle to set the hysteresis, then press the “SELECT” key again. Use the arrow keys to move between the digits. If you press the “RESET” key, the setting will be restored to “0.3 div.”
- **Setting the Pattern for Each Channel**
 10. Use the jog shuttle to move the cursor to the Pattern of the channel you wish to set, or the bits of PODA and POBB. Press the “SELECT” key to select “H,” “L,” or “X.”
- **Setting the Level for Each Channel**
 11. Use the jog shuttle to move the cursor to the Level of the channel you wish to set. Press the “SELECT” key, then use the jog shuttle to set the Level and press the “SELECT” key again. Use the arrow keys to move between the digits. If you press the “RESET” key, the setting will be restored to “0 V.”
- **Setting the Hysteresis for Each Channel**
 12. Use the jog shuttle to move the cursor to the Hysteresis of the channel you wish to set. Press the “SELECT” key, then use the jog shuttle to set the hysteresis, and press the “SELECT” key again. Use the arrow keys to move between the digits. If you press the “RESET” key, the setting will be restored to “0.3 div.”
- **Setting the Start Point**
 13. Use the jog shuttle to move the cursor to the start point, then press the “SELECT” key. Use the jog shuttle to select the start point, then press the “SELECT” key again. Use the arrow keys to move between the digits. If you press the “RESET” key, the setting will be restored to “–5 div.”
 14. Press the “ESC” key to close the dialog box.

Setting the Display Position for the Search Results (When Zoom Mode is Z1&Z2 or Main&Z1&Z2)

15. Press the “Results Window” soft key to select “Z1” or “Z2.”

Executing the Search

16. Press the “Exec” soft key to perform the search. The results are displayed in the zoom waveform display position selected in step 15. You can perform a search using the same search criteria 1000 times.

Displaying Previous Search Results

17. Press the “Searched Pattern” soft key to highlight the jog shuttle icon.
18. Turn the jog shuttle to select the number of the search results to be displayed. The most recent search has the highest number.

Changing the Zooming Factor and Position

19. As you did with the zoomed waveform, press the “Z1 Mag/Z2 Mag” soft key, then turn the jog shuttle to change the zooming factor of Z1 and Z2.
20. As you did with the zoomed waveform, press the “Z1 Position/Z2 Position” soft key, then turn the jog shuttle to change the position of the zoom box for Z1 and Z2.

When Performing a Pulse Width Search

1. Press the “SHIFT” key to activate shift mode. The functions printed in purple letters on the front panel become activated.
2. Press the “ZOOM” key.

Selecting the Search Method

3. Press the “Type” soft key to display the search method selection menu.
4. Press the soft key corresponding to “Width” to select the search method.

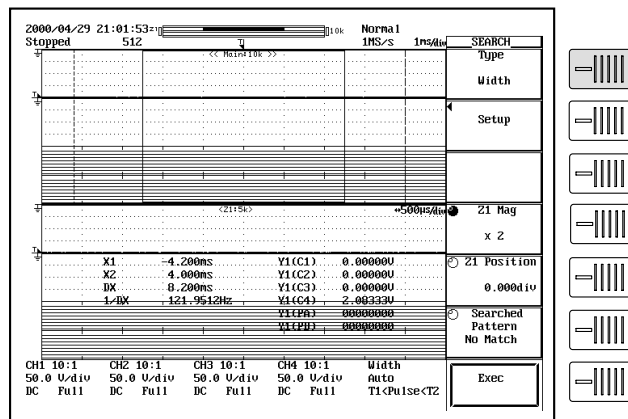

Setting the Search Criteria

5. When you press the “Setup” soft key the search criteria settings dialog box is displayed. Turn the jog shuttle to select a setting item. Press the “SELECT” key to display the setting menu for the selected item, or change the current setting.

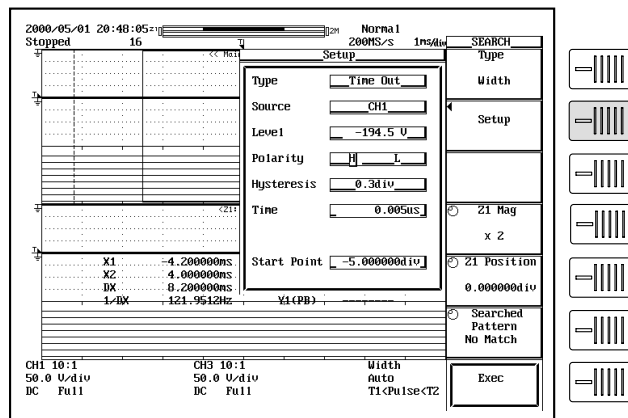

- **Setting the Type**

6. Use the jog shuttle to choose either “Pulse < Time,” “Pulse > Time,” “T1 < Pulse < T2,” or “Time Out,” then press the “SELECT” key.

- **Setting the Source**

7. Use the jog shuttle to move the cursor to the desired source channel then press “SELECT.”

- **Setting the Level**

8. Use the jog shuttle to set the level, then press the “SELECT” key. Use the arrows to move between the digits. Pressing the “RESET” key restores the value to “0 V.”

8.9 Search Data Using Search and Zoom Function

- **Setting the Polarity**

9. Press the SELECT key to select “H” or “L.”

- **Setting the Hysteresis**

10. Use the jog shuttle to set the hysteresis, then press the “SELECT” key. Use the arrow keys to move the arrows between the digits. Pressing the “RESET” key restores the value to “0.3 div.”

- **Setting the Time**

11. Use the jog shuttle to set the count, then press the “SELECT” key. Use the arrow keys to move the arrows between the digits. Pressing the “RESET” key restores the value to the minimum resolution (1/sample rate). Set Time1 and Time2 if you selected “T1<Pulse<T2” in step 6.

- **Setting the Start Point**

12. Use the jog shuttle to set the search start position, then press the “SELECT” key. Use the arrow keys to move the arrows between the digits. Pressing the “RESET” key restores the value to “-5 div.”
13. Press the “ESC” key to close the dialog box.

Setting the Search Results Display Position (When Zoom Mode is Z1&Z2 or Main&Z1&Z2)

14. Press the “Result Window” soft key to select “Z1” or “Z2.”

Executing the Search

15. Press the “Exec” soft key to perform the search. The search results are displayed in the zoom waveform display position selected in step 14.

Displaying Previous Search Results

16. Press the “Searched Pattern” soft key to highlight the jog shuttle icon.
17. Turn the jog shuttle to select one of the displayed search results numbers. The higher the number the more recent the search result.

When Performing an Auto Scroll Search

1. Press the “Shift” key to activate the shift mode.
2. Press the “Zoom” key.

Selecting the Search Method (Type)

3. Press the “Type” soft key to display the search method selection menu.
4. Press the “Auto Scroll” soft key to select the search method.

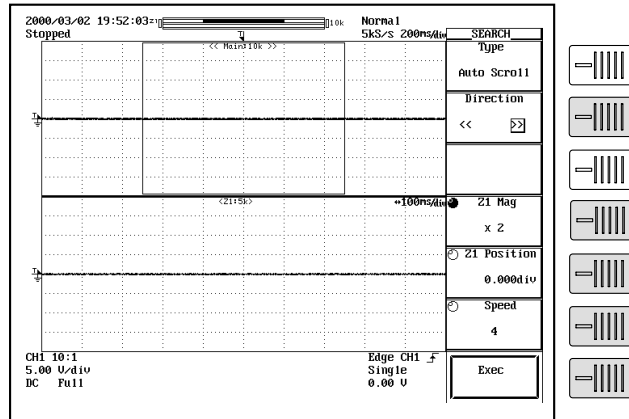

Selecting the Scroll Direction

5. Press the “Direction” soft key to set the scrolling direction.

Setting the Search Results Display Position (When Zoom Mode is Z1&Z2 or Main&Z1&Z2)

6. Press the “Results Window” soft key to select “Z1” or “Z2.”

Changing the Zooming Factor and Position

7. As you did with the zoomed waveform, press the “Z1 Mag/Z2 Mag” soft key, then turn the jog shuttle to change the part which is expanded and displayed in Z1 and Z2.
8. As you did with the zoomed waveform, press the “Z1 Position/Z2 Position” soft key, then turn the jog shuttle to change the part which is expanded and displayed in Z1 and Z2.

Setting the Scroll Speed

9. Press the “Speed” soft key, then use the jog shuttle to set the scroll speed from “1” - “7.”

Executing the Scroll

10. Press the “Exec” soft key to perform the Scroll. Press the key again to stop the Scroll.

8.10 Analyzing and Searching SPI Signals

< For a description of this function, refer to page 1 - 25 >

Function

The analysis and search functions of the SPI signal can be used on products with software (ROM) version 3.01 or later. See section 15.4, "Checking the System Condition."

Analyzing SPI Signals

Input Channel for SPI Signals

Connect the signal wires of the SPI to the following terminals on the DL7100/DL7200.

- CH1: Clock signal
- CH2 and CH3: Data input/output signal (Data1 and Data2)^{*1}
- CH4 and PodA^{*2}: Chip select signal. The chip select signal is used to specify the section of the data input/output signal to be analyzed and the target slave device. For details on the settings, see the next section "Setting the Analysis Conditions."

^{*1} CH2 and CH3 can be connected to either the data input signal or the data output signal. The DL7100/DL7200 handles the data of the signal connected to CH2 and CH3 as Data1 and Data2, respectively.

^{*2} Can be connected on products with the login input (option).

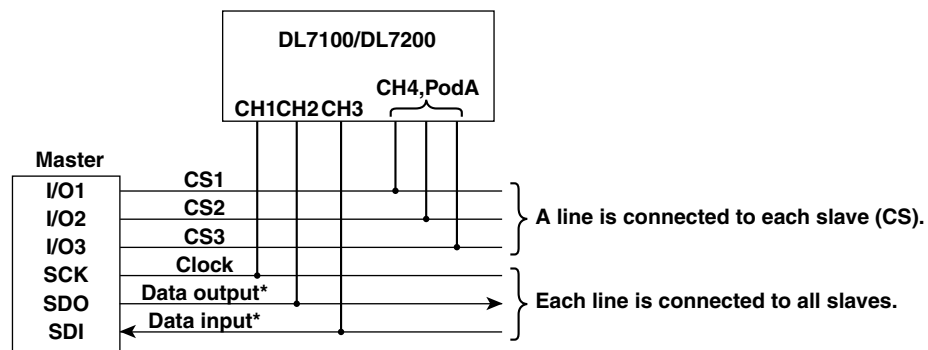

* As seen from the master device

Setting the Analysis Conditions

• Setting the clock signal: Clock (CH1)

Specify the following items.

- Level
Set the level used to determine the rising or falling edge of the signal. The range is 8 div within the screen. The resolution is 0.01 div.
- Hysteresis
Set the hysteresis. The range is 0.3 div to 4 div.
- Polarity
Select the polarity from the following:
 - ↗: Reads the data input/output signal when the signal changes from below the specified level to above the specified level.
 - ↘: Reads the data input/output signal when the signal changes from above the specified level to below the specified level.

- **Setting the data signal: Data1 (CH2), Data2 (CH3)**

Set the level used to determine the signal level (0, 1, or indefinite) of Data1 and Data2.

- Thr Upper

Signal exceeding this level is determined to be 1.

- Thr Lower

Signal below this level is determined to be 0.

- Thr Lower \leq data signal \leq Thr Upper

Determined as indefinite data.

If indefinite data is found, "*" is displayed in the Data1 or Data2 display box at the byte where the indefinite data exists on the display screen of analysis results.

- **Setting the chip select signal: CS**

You can select the chip select signal from CH4 or Bit 0 through Bit 7 of logic input (option) PodA. You can also select the state of the selected signal when analysis is to be performed.

- **Selecting the chip select signal**

- CH

Selects CH4. You must set the level used to determine "H" or "L" of the CH4 signal.

- PodA

Can be selected on products with the logic input (option). Select from Bit 0, Bit 1, Bit 2, Bit 3, Bit 4, Bit 5, Bit 6, and Bit 7.

- **Selecting the signal state (Enable State)**

Enable State

Select from "H," "L," "X," and "-." When the chip select signal is in the selected state, the DL7100/DL7200 analyzes the data input/output signal. This condition is called the enabled state.

- H

Analyzes the data input/output signal when the chip select signal is H.

- L

Analyzes the data input/output signal when the chip select signal is L.

- X

This can be used only when a single chip select signal is selected. All data input/output signals are analyzed. The byte boundary of the analyzed signal is the point where the chip select signal changes from H to L or L to H.

- -

This can be used when the chip select signal is not selected. All data input/output signals are analyzed. The data input/output signal that is delimited byte-wise is analyzed from the "reference point" described in the next section.

Priority exists in the chip select signals. When multiple chip select signals are enabled simultaneously, the data input/output signal of the slave corresponding to the chip select signal of the highest priority is analyzed. The priority is CH4, Bit 0, Bit 1, ..., and Bit 7 of PodA from the highest priority.

- **Setting the reference point**

Select the reference point used to start the analysis from the following:

- Trigger Position: Set the reference point to the trigger position.

- Manual: Set the reference point in the range of -5 to +5 divisions.

Analysis Example of Signals by Enable States

Reference point

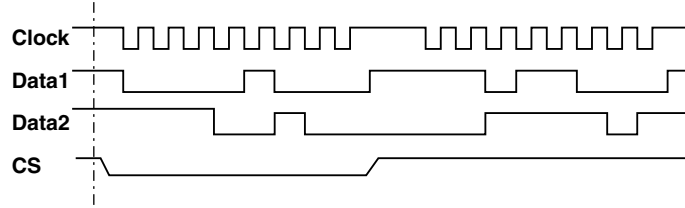

When the clock is set to rising edge and CS is set to L

- Byte number (No.): 0 : 0
- Data1 value (Dt1): 08 : 08
- Data2 value (Dt2): E4 : E4
- Enable state of the chip select signal (CS) : L

When the clock is set to rising edge and CS is set to H

- Byte number (No.) : 0
- Data1 value (Dt1) : D8
- Data2 value (Dt2) : 3D
- Enable state of the chip select signal (CS) : H

When the clock is set to rising edge and CS is set to X

- Byte number (No.) : 0 1
- Data1 value (Dt1) : 08 D8
- Data2 value (Dt2) : E4 3D
- Enable state of the chip select signal (CS) : L H

• **Setting the bit order**

Select MSB or LSB according to the data flowing through the bus.

- MSBFirst
Select this when the data input/output signal is flowing through the bus MSB first.
- LSBFirst
Select this when the data input/output signal is flowing through the bus LSB first.

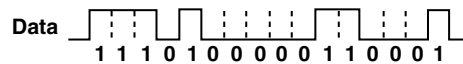

When set to MSBFirst E831
When set to LSBFirst 71C8

Displaying the Analysis Result

When analysis is performed, the analysis results are displayed at the bottom of the waveform screen.

- **List of analysis results**

The following four items are listed at the bottom of the screen.

- No.

Up to 40000 numbers can be displayed. Depending on whether the chip select signal is set, the position of the 0th byte varies as follows:

- When the chip select signal is not set

The first detected byte after the reference point

- When the chip select signal is set

Byte containing the reference point. However, if the reference point is located between two bytes, the first detected byte after the reference point.

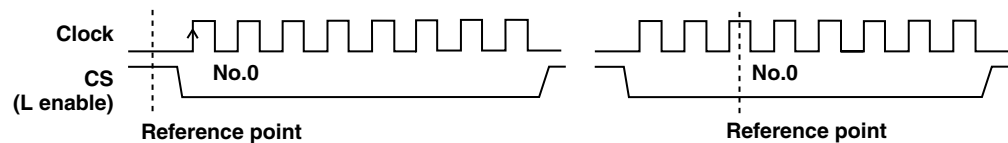

- Dt1, Dt2

The data of Data1 and Data2 is displayed using hexadecimal notation. However, if a byte of data is less than 8 bits, the data is not displayed. If indefinite data exists, "*" is displayed. Indefinite data is considered to be the same value as the previous bit for the analysis. If the first data is indefinite, it is considered to be 0.

- CS

Displays the state of the chip select signal.

- When the chip select signal is not set: Displays blank.

- When a single chip select signal is set: Displays "H" or "L."

- When multiple chip select signals are set: Displays the channel number of the highest priority among the enabled chip select signals. (The order of priority is CH4, Bit 0, Bit 1, Bit 2, Bit 3, Bit 4, Bit 5, Bit 6, and Bit 7.)

Note

- You can select (highlight) an arbitrary byte in the list of analysis results and move the Zoom Position to the head of that byte. In addition, if you move the Zoom Position, the highlighting moves to the corresponding byte in the list of analysis results.
- If one or more chip select signals are set and the chip select signal waveform on the Main screen does not contain points of change from H to L or L to H, the data input/output signal is not analyzed.

- **Displaying the detailed analysis list**

The analysis result can be listed on the entire screen. The detail display also shows the time from the trigger position to the head of each byte.

Searching SPI Signals

Performing a Pattern Search (Search Setup)

You can specify a data pattern of Data1 or Data2 in units of bytes and search the waveform. When a waveform that matches the pattern is found, the Zoom Position moves to that point and displays the searched waveform in the Zoom window. You can also search indefinite data. Pattern search and indefinite data search cannot be executed simultaneously.

Setting

- Type: Specify the type of data to be searched.
- Data Pattern: Search a data pattern of Data1 or Data2.
- Indefinite State: Search for indefinite data.

If you selected Data Pattern, set the following item.

- Pattern Format: Specify the pattern display format.
 - Hex: Hexadecimal display
 - Bin: Binary display
- Source: Set the target waveform to perform the pattern search to Data1 or Data2.
- Data Byte: Set the number of data bytes from 1 to 8.
- Data Pattern: You can set the search pattern using hexadecimal or binary format. The bit order is set to the format that was specified for the analysis. If the specified bit contains an X, it is displayed as "\$" in hexadecimal format.

Note

- Indefinite data is always considered to be matched to the specified status.
- If analysis is performed on a channel of which a CS is selected, the data is considered to be delimited at the point where the state of the CS signal changes. In this case, data search is also performed by considering the data to be delimited at that point. For example, when a 5-byte data shown in the following figure is analyzed, the search operation varies depending on the CS channel specification during the analysis.
 - When analysis is performed by specifying a CS channel (where Enable State = L) Data search across two CS intervals cannot be performed. Therefore, search is not possible by setting Data Byte to 4 or 5.
 - When analysis is performed without specifying the CS channel Independent of the chip select interval. Search can be performed by setting Data Byte to 4 or 5.

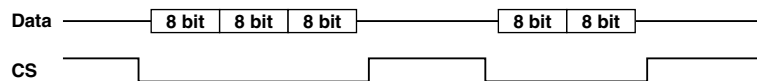

Executing the search (Next, Previous)

Press the execution key corresponding to the direction in which the search is to be performed from the current selected byte.

- Next: Searches for data after the selected byte.
- Previous: Searches for data before the selected byte.

Note

The contents of the detailed analysis list can be output to a file in ASCII format. See section 11.10, "Outputting the detailed Analysis List of the SPI Signal."

Displaying the Search Result

Displays the searched waveform in the Zoom window.

When searching indefinite data

The Zoom Position moves to the head of the indefinite data.

When searching patterns

The Zoom Position moves to the head of the byte that matched the specified pattern.

At the same time, the highlighting in the list of analysis results at the bottom of the screen moves to the byte corresponding to the Zoom Position.

Operating Procedure**Showing the SPI Bus Signal Analysis Function Screen**

1. Press the "SHIFT" key to set the keys in the shifted condition. Functions marked in purple on the panel become active.
2. Press the "ZOOM" key.

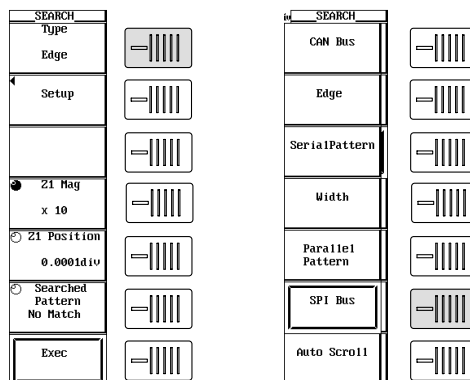

3. Press the "Type" soft key to display the search method selection menu.
4. Press the soft key corresponding to "SPI Bus" to select the search method.

Note

The item to be analyzed is the history data of CH2 and CH3.

8.10 Analyzing and Searching SPI Signals

Performing the Analysis

5. Press the “Analyze Setup” soft key to display a dialog box for setting the analysis conditions. Turn the jog shuttle to select the item. Press the “SELECT” key to display a menu used to set the item or change the selected item.

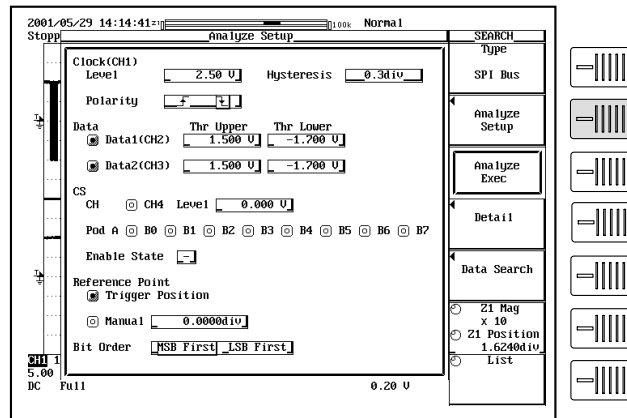

• Setting the clock

6. Turn the jog shuttle to move the cursor to “Level” and press the “SELECT” key.
7. Turn the jog shuttle to set the level.
You can move between the digits using the arrow keys. Pressing the “RESET” key resets the level to “0.00 V.”
8. Turn the jog shuttle to move the cursor to “Hysteresis” and press the “SELECT” key.
9. Turn the jog shuttle to set the hysteresis.
You can move between the digits using the arrow keys. Pressing the “RESET” key resets the hysteresis to “0.3div.”
10. Turn the jog shuttle to move the cursor to “Polarity.”
11. Press the “SELECT” key to select “F” or “L.”

• Setting the data

12. As necessary, turn the jog shuttle to move the cursor to Data1 (CH2) and turn it ON.
13. Turn the jog shuttle to move the cursor to “Thr Upper” or “Thr Lower” of Data1 and press the “SELECT” key.
14. Turn the jog shuttle to set the level used to determine high or low.
You can move between the digits using the arrow keys. Pressing the “RESET” key resets the level to “0.000 V.”
15. As necessary, turn the jog shuttle to move the cursor to Data2 (CH3) and turn it ON.
16. Carry out steps 13 and 14 in a similar fashion.

Note

Data1 (CH2) cannot be set when interleave mode is ON.

• **Setting the CS**

17. Turn the jog shuttle to select from “CH,” “Pod A,” “CH4,” “B0,” “B1,” “B2,” “B3,” “B4,” “B05,” “B6,” and “B7,” and turn it ON. If you turned “CH4” ON, proceed to step 18. If you selected “Pod A,” proceed step 20.

Note

- The “Pod A” channel is selectable only on models with logic input (option).
- Data1 (CH2) cannot be set when interleave mode is ON.

18. Turn the jog shuttle to move the cursor to “Level” and press the “SELECT” key.
19. Turn the jog shuttle to set the level.
You can move between the digits using the arrow keys. Pressing the “RESET” key resets the level to “0.000 V.”
20. Turn the jog shuttle to move the cursor to “Enable State.”
21. Press the “SELECT” key to select “H,” “L,” or “X.”
If the channel was not turned ON in the CS setting, “-” is displayed.

• **Setting the reference point**

22. Turn the jog shuttle and turn ON “Trigger Position” or “Manual.” If you turned ON “Trigger Position,” proceed to step 25.
23. Turn the jog shuttle to move the cursor to “Manual” and press the “SELECT” key.
24. Turn the jog shuttle to set the reference point.
You can move between the digits using the arrow keys. Pressing the “RESET” key resets the level to “0.0000div.”

• **Setting the bit order**

25. Turn the jog shuttle to move the cursor to “Bit Order.”
26. Press the “SELECT” key to select “MSBFirst” or “LSBFirst.”
27. Press the “ESC” key to close the dialog box.

Executing the Analysis

28. Press the “Analyze Exec” soft key to execute the analysis. The analysis result is listed at the bottom of the screen.

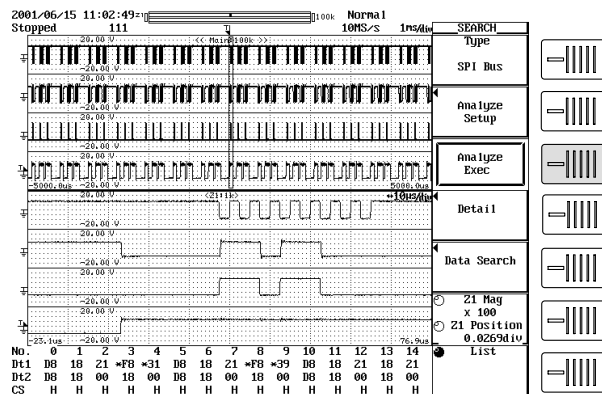

8.10 Analyzing and Searching SPI Signals

29. If the jog shuttle control is not set to "List," press the "List" soft key.
 30. Turn the jog shuttle to select an arbitrary byte from the list of analysis results. The selected byte appears highlighted.
- **Setting the zoom ratio**
 31. Press the "Z1 Mag/Z1 Position" soft key to set the jog shuttle control Z1 Mag." Turn the jog shuttle to set the zoom ratio of the Z1 zoom box.
 - **Setting the zoom position**
 32. Press the "Z1 Mag/Z1 Position" soft key to set the jog shuttle control to "Z1Position." Turn the jog shuttle to set the zoom position of the Z1 zoom box. The highlighted display of the list at the bottom of the screen moves to the zoom position frame.

Displaying the Detailed Analysis List

33. Press the "Detail" soft key to display the analysis result dialog box. At this point, the highlighted display is located at the same position as the highlighted byte of the list of analysis results in step 30.

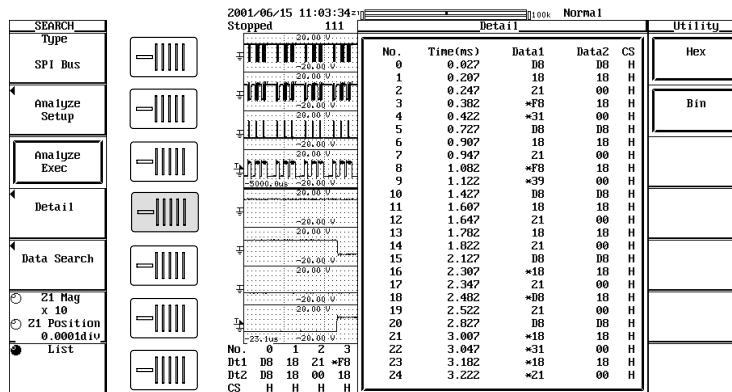

34. Press the "Hex" or "Bin" soft key to select the data format. Data1 and Data2 are displayed using the selected format.

Note

If indefinite data is present, "*" is displayed in the Data1 and Data2 columns.

35. Press the "ESC" key to close the dialog box.

Performing Pattern Searches

36. Press the “Data Search” soft key followed by the “Search Setup” soft key to display a dialog box used to set the search conditions.
Turn the jog shuttle to select the item. Press the “SELECT” key to display a menu used to set the item or change the selected item.

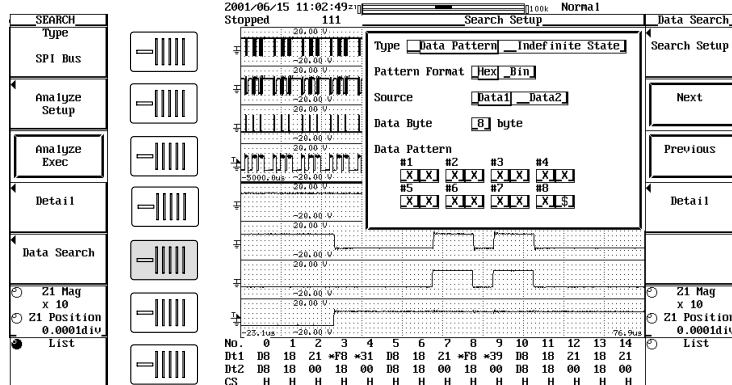

- **Setting the type**

37. Turn the jog shuttle to move the cursor to “Type.”
38. Press the “SELECT” key to select “Data Pattern” or “Indefinite State.” If you selected “Indefinite State,” proceed step 47.

- **Setting the pattern format**

39. Turn the jog shuttle to move the cursor to “Pattern Format.”
40. Press the “SELECT” key to select “Hex” or “Bin.” Data The pattern display changes to the selected format.

- **Setting the source**

41. Turn the jog shuttle to move the cursor to “Source.”
42. Press the “SELECT” key to select “Data1” or “Data2.”

- **Setting the data byte**

43. Turn the jog shuttle to move the cursor to “Data Byte” and press the “SELECT” key.
44. Turn the “jog shuttle” to select a value from “1” to “8.” Pressing the “RESET” key will reset the value to “8.”

- **Setting the data pattern**

45. Turn the jog shuttle to move the cursor to the desired bit of “Data Pattern” and press the “SELECT” key.
46. If you selected “Hex” for Pattern Format, turn the jog shuttle to select a value from “0” to “F” and “X” and press the “SELECT” key. Pressing the “RESET” key will reset the value to “X.”
If you selected “Bin” for Pattern Format, press the “SELECT” key the appropriate number of times to select “0,” “1,” or “X.”
47. Press the “ESC” key to close the dialog box.

- **Executing the pattern search**

48. Press the “Next” or “Previous” soft key. The Zoom Position moves to the head of the byte containing the specified pattern, and the waveform is displayed in the Zoom screen.

9.1 Measuring Waveforms Using Cursors

< For a description of this function, refer to page 1 - 20 >

Function

Restrictions

Cursor measurements cannot be made on the following waveforms.

- Snapshot waveforms
- Accumulated waveforms other than the newest waveform

Cursor types and measurement items: Type

- When the X-Y waveform is not displayed
 - Marker cursors: Move the cursor on the waveform data and measure the waveform data values.
M1 (Marker 1) to M4 (Marker 4) can be set on different waveforms.
 - Y1 to Y4 : The Y-axis values of M1 to M4
 - DY2 : The difference between the Y-axis values of M1 and M2
 - DY3 : The difference between the Y-axis values of M1 and M3
 - DY4 : The difference between the Y-axis values of M1 and M4
 - X1 to X4 : The X-axis values of M1 to M4
 - DX2 : The difference between the X-axis values of M1 and M2
 - DX3 : The difference between the X-axis values of M1 and M3
 - DX4 : The difference between the X-axis values of M1 and M4
 - H (Horizontal) cursor: Measures the Y-axis value at the cursor
 - Y1 : The Y-axis value at Cursor1
 - Y2 : The Y-axis value at Cursor2
 - DY : The difference between the Y-axis values at Cursor1 and Cursor2
 - V (Vertical) cursor: Measures the X-axis value at the cursor
When measuring the logic waveform with the V Cursor, select a binary or 16-base measurement value. Also choose the order of the data.
 - X1 : The X-axis value at Cursor1
 - X2 : The X-axis value at Cursor2
 - DX : The difference between the Y-axis values at Cursor1 and Cursor2
 - 1/DX : The inverse or the difference between the Y-axis values at Cursor1 and Cursor2
 - Y1 : The Y-axis value at Cursor1
 - Y2 : The Y-axis value at Cursor2
 - DY : The difference between the Y-axis values at Cursor1 and Cursor2
 - Angle cursor (Degree):
Set the measurement zero point (position of reference cursor Ref1) and the end point (position of the reference cursor Ref2) on the X-axis within the screen and assign an angle corresponding to the width of Ref1 and Ref2. Using this angle as a reference, this function measures the angle of the two angle cursors (Cursor1 and Cursor2).
 - DX1 : The angle of Cursor1 from Ref1
 - DX2 : The angle of Cursor2 from Ref1
 - DDX : The angle difference between Cursor1 and Cursor2
 - DY1 : The Y-axis value of Cursor1
 - DY2 : The Y-axis value of Cursor2
 - DDY : The difference between the Y-axis values of Cursor1 and Cursor2
 Range of reference width: 1 to 720°

9.1 Measuring Waveforms Using Cursors

- **When the X-Y waveform is displayed**
 - H (Horizontal) cursor: Measures the Y-axis value at the cursor
 - Y1 : The Y-axis value at Cursor1
 - Y2 : The Y-axis value at Cursor2
 - DY : The difference between the Y-axis values of Cursor1 and Cursor2
 - V (Vertical) cursor: Measures the X-axis value at the cursor
 - X1 : The X-axis value at Cursor1
 - X2 : The X-axis value at Cursor2
 - DX : The difference between the X-axis values of Cursor1 and Cursor2
 - Marker cursors: Move the cursor on the waveform data and measure the waveform data values.
 - Y1 to Y4 : The Y-axis values of M1 to M4
 - T : The time from the trigger point at the cursor
 - X : The X-axis value of the cursor
 - Y : The Y-axis value of the cursor

Movement range of the cursors

- When the X-Y waveform is displayed
 - H Cursors can be moved in the range from -4 to $+4$ div from the center of the screen. The resolution is 0.01 V/div.
 - V Cursors, marker cursors, and angle cursors can be moved in the range from -5 to $+5$ div from the center of the screen. The resolution is as follows.
Resolution: $T/\text{div} \times 10/\text{displayed record length}$
- When the X-Y waveform is displayed
 - The H and V cursors can be set in the range of -4 to $+4$ divisions with the center of the waveform display frame at 0 division. The resolution is 0.01 V/div. The marker cursor can be set in the range of -5 to $+5$ divisions with the center of the waveform display frame at 0 division. The resolution is $T/\text{div} \times 10/\text{displayed record length}$.

Cursor Display Method (V Cursor): Format

Measurement values can be displayed in base 2 or base 16.

Binary : Base 2

Hexadecimal : Base 16

(Applicable to DL7100 with software (ROM) version 1.11 or later. See section 15.4, "Checking the System Condition.")

Arrangement of the Cursor Data (V Cursor): Order

Select the order of each bit. Choose either PodA: bit0-bit7, PodB: bit0-7, or PodA: bit7-bit0, PodB: bit7-bit0. (Applicable to DL7100 with software (ROM) version 1.11 or later. See section 15.4, "Checking the System Condition.")

Combining Cursor Data (V Cursor)

You can combine data from PodA and PodB and treat it as 16 bit data. If there is an OFF bit, it is displayed as "—" for data that was originally binary, and omitted for data that was originally base 16. (Applicable to DL7100 with software (ROM) version 1.11 or later. See section 15.4, "Checking the System Condition.")

An Example of Cursor Measurement (V Cursor)

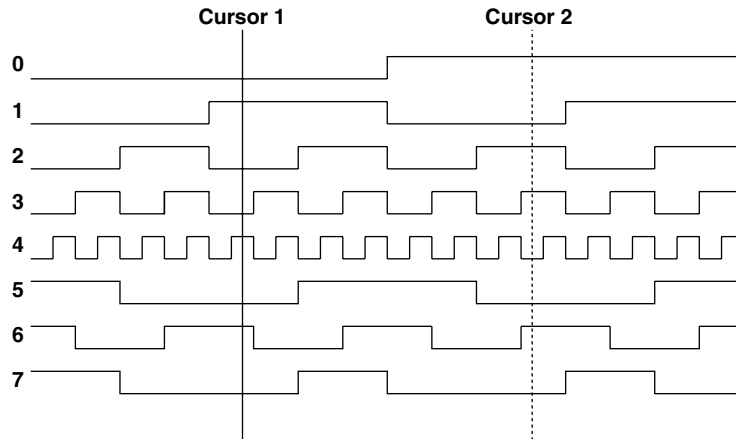

In the above example, when the arrangement of the data is A0-A7 B0-B7:

Binary Y1: 01001010 Y2: 10110010

Hexadecimal Y1: 4A Y2: B2

When the arrangement is B7 - B0 A7 - A0:

Binary Y1: 01010010 Y2: 01001101

Hexadecimal Y1: 52 Y2: 4D

The following is an example with the occurrence of an OFF bit:

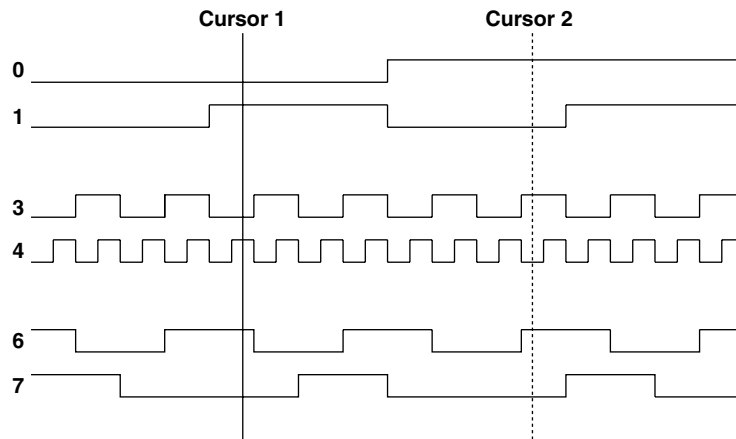

When the arrangement is A0-A7 B0 - B7:

Binary Y1: 01-01-10 Y2: 10-10-10

Hexa Y1: 16 Y2: 2A

When the arrangement is B7-B0 A7-A0:

Binary Y1: 01-10-10 Y2: 01-01-01

Hexa Y1: 1A Y2: 15

9.1 Measuring Waveforms Using Cursors

The following is an example showing combined data:

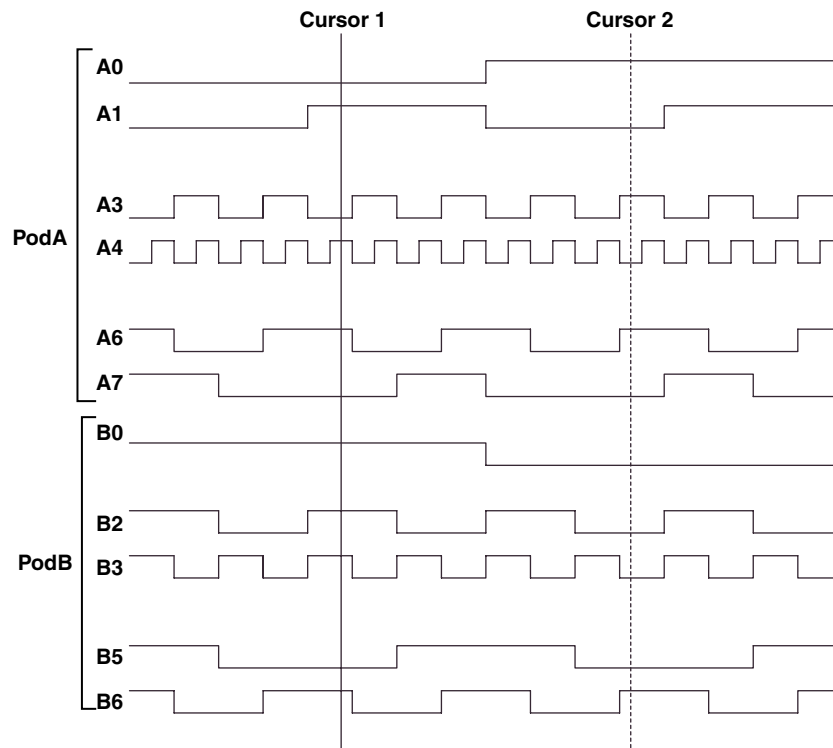

When the arrangement is A0-A7 B0-B7:

Binary Y1: 01-01-101-11-01 Y2: 10-10-100-00-01-

Hexa Y1: 2DD Y2: 541

When the arrangement is B7-B0 A7-A0:

Binary Y1: -10-11-101-10-10 Y2: -10-00-001-01-01

Hexa Y1: 5DA Y2: 415

Cursor Jump (only when the X-Y waveform is not displayed)

You can make Marker cursors, V cursors, and angle cursors jump to the center of the zoom window. The cursors can be jumped in the following manner.

For marker cursors

to Z1 : Make the selected marker jump to the Z1 window.

to Z2 : Make the selected marker jump to the Z2 window.

V cursor and angle cursor

Cursor1 to Z1 : Make Cursor1 jump to the Z1 window

Cursor1 to Z2 : Make Cursor1 jump to the Z2 window

Cursor2 to Z1 : Make Cursor2 jump to the Z1 window

Cursor2 to Z2 : Make Cursor2 jump to the Z2 window

Notes when making cursor measurements

- The time axis values are measured from the trigger position.
- The measured value will be displayed as “***” if the measurement is not possible.
- Logic waveforms (optional) cannot be measured using marker cursors and H cursors.

Operating Procedure

Selecting the cursor type

1. Press the “CURSOR” key.
2. Press the “Type” soft key to display the cursor type menu.
3. Press the soft key corresponding to the desired cursor type to select the cursor.

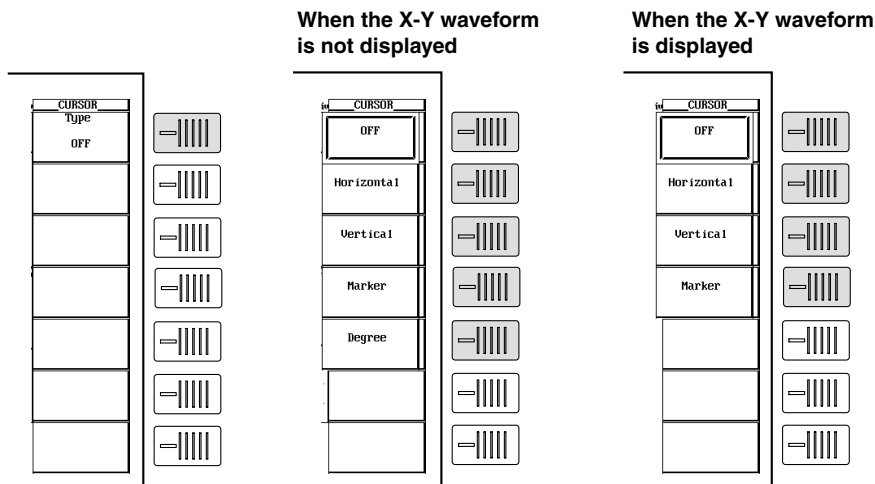

For H (Horizontal) cursors (when the X-Y waveform is not displayed)

- **Selecting the waveform to be measured**
 Refer to steps 1-3 to set the “Type” to “Horizontal.”
 4. Pressing the “Trace” soft key displays the waveform menu.
 5. Press the soft key corresponding to the desired waveform.

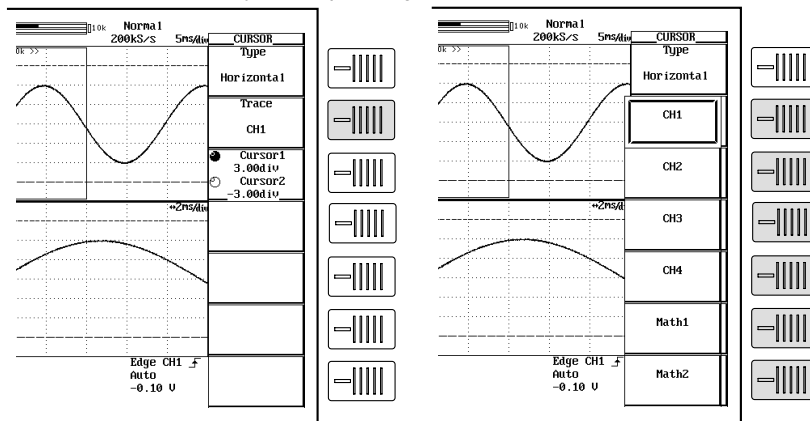

For H (Horizontal) Cursors (when the X-Y waveform is displayed)

- **Selecting the waveform to be measured**
 Refer to steps 1-3 to set the “Type” to “Horizontal.”
 4. Press the “Trace” soft key to select the waveform to be measured.
 5. Proceed to step 6.

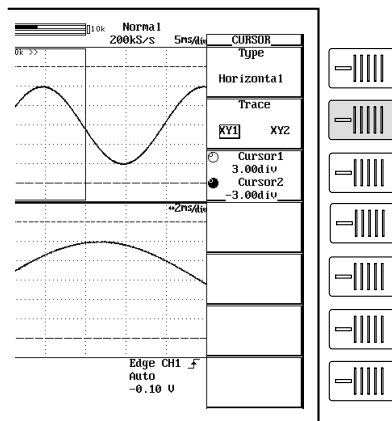

9.1 Measuring Waveforms Using Cursors

- **Moving the cursor**

6. Press the “Cursor1/Cursor2” soft key to set the jog shuttle control to “Cursor1.”
7. Turn the jog shuttle to move Cursor1.
8. Move “Cursor2” in a similar fashion.

If the jog shuttle control is set to both Cursor1 and Cursor2, both cursors are moved.

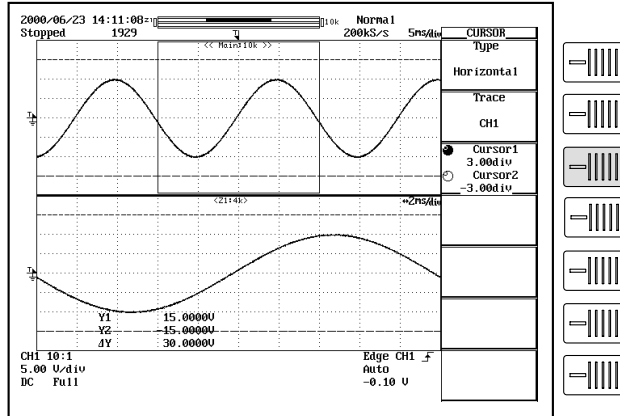

For V (Vertical) Cursors (when the X-Y waveform is not displayed)

- **Selecting the Waveform to be Measured**

Refer to steps 1 - 3 to set the “Type” to “Vertical.”

4. Press the “Trace” soft key to display the waveform selection menu.
5. Press the soft key corresponding to the desired waveform to select it. If you select “PodA&PodB,” PodA and PodB data will be combined and displayed. If you select “PodA,” “PodB,” or “PodA&PodB,” proceed to step 6. Otherwise skip to step 12.
6. Press the “Logic Setup” soft key to display the settings dialog box for logic waveforms.

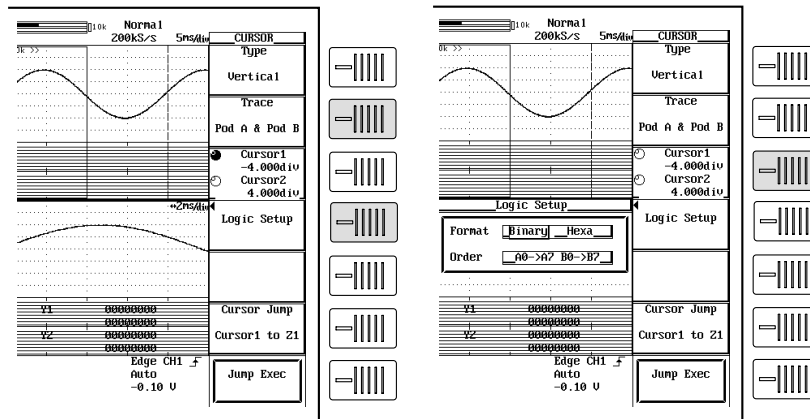

7. Move the cursor to “Format” using the jog shuttle.
8. Press the “SELECT” key to choose either “Binary” or “Hexa.”
9. Move the cursor to “Order” using the jog shuttle.
10. Press the “SELECT” key to display the data order selection menu.
11. Use the jog shuttle to choose a data order, then press the “SELECT” key.

Note

When the T/div is not set to repetitive sampling mode and the averaging mode is not set to averaging mode, the sampled data may not appear on the V cursor on the interpolated display area (when less than 500 points of data exist within 10 divisions horizontally or when less than 250 points of data exist in the Z1Z2 display area for Main&Z1&Z2 waveform zoom). In this case, the V cursor value indicates the value of the nearest sampled data to the right of the cursor (For interpolated display, the sampled data is highlighted).

However, the marker cursor is always displayed over the sampled data.

For V (Vertical) Cursors (when the X-Y waveform is displayed)

• **Selecting the waveform to be measured**

Refer to steps 1-3 to set the “Type” to “Vertical.”

4. Press the “Trace” soft key to select the waveform to be measured.
5. Proceed to step 12.

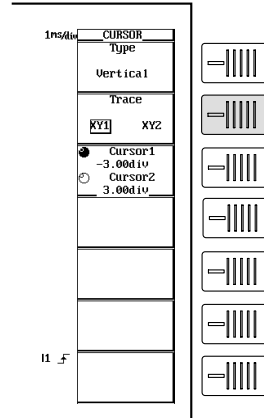

• **Moving the Cursor**

12. Press the “Cursor1/Cursor2” soft key to highlight the jog shuttle icon for Cursor1.
13. Move Cursor1 using the jog shuttle.
14. In the same manner, move Cursor2. If you highlight the jog shuttle icon for Cursor1 and Cursor2, you can move them at the same time.

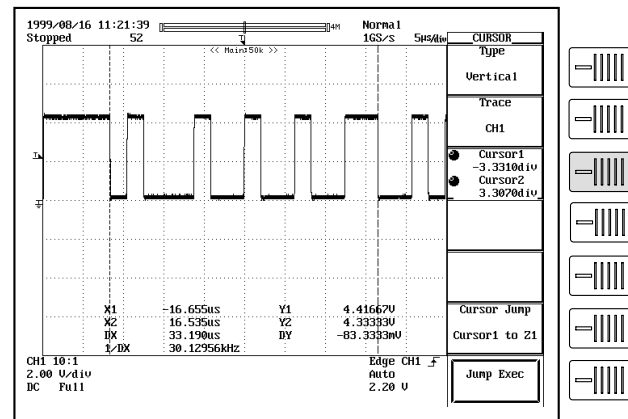

9.1 Measuring Waveforms Using Cursors

For marker cursors (when the X-Y waveform is not displayed)

- **Selecting the marker**

Follow steps 1 - 3 to set the "Type" to "Marker."

4. Press the "Select" soft key to select a marker from "M1" to "M4."

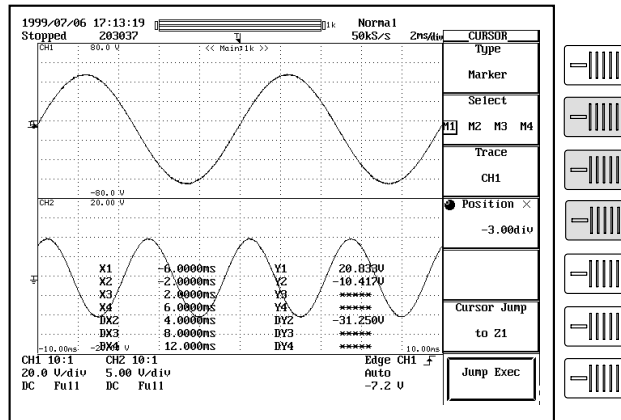

- **Selecting the waveform to be measured**

5. Pressing the "Trace" soft key displays the waveform menu.

6. Press the soft key corresponding to the desired waveform.

- **Moving the cursor**

7. Turn the jog shuttle to move the cursor. As the cursor is moved, the displayed value of "Position" changes.

For Marker Cursors (when the X-Y waveform is displayed)

- **Selecting the marker**

Refer to steps 1-3 to set the "Type" to "Marker."

- **Selecting the waveform to be measured**

4. Press the "Trace" soft key to select the waveform to be measured.

- **Moving the cursor**

5. Turn the jog shuttle to move the cursor. As the cursor is moved, the displayed value of "Position" changes.

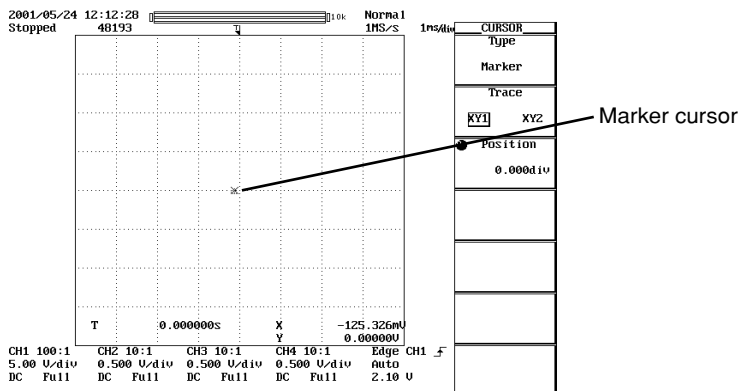

For angle cursors (Degree)

The angle cursors can be set only when the X-Y waveform is not displayed.

- **Selecting the waveform to be measured**

Follow steps 1 - 3 to set the "Type" to "Degree."

4. Pressing the "Trace" soft key displays the waveform menu.

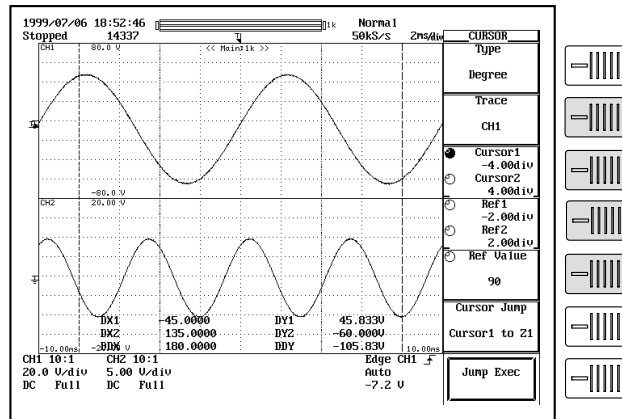

5. Press the soft key corresponding to the desired waveform.

• **Moving the cursor**

6. Press the “Cursor1/Cursor2” soft key to set the jog shuttle control to “Cursor1.”
7. Turn the jog shuttle to move Cursor1.
8. Move “Cursor2” in a similar fashion.

If the jog shuttle control is set to both Cursor1 and Cursor2, both cursors are moved.

• **Moving the reference cursor**

9. Press the “Ref1/Ref2” soft key to set the jog shuttle control to “Ref1.”
10. Turn the jog shuttle to move Ref1.
11. Move “Ref2” in a similar fashion.

If the jog shuttle control is set to both Ref1 and Ref2, both cursors are moved.

• **Setting the reference angle**

12. Press the “Ref Value” soft key.
13. Turn the jog shuttle to set the reference angle.

Cursor jump (for V-Cursor, Marker Cursor, and Angle Cursor)

(only when the X-Y waveform is not displayed)

Follow steps 1 - 3 to set the “Type” to “Vertical,” “Marker,” or “Degree.”

4. Pressing the “Cursor Jump” soft key displays a menu used to select the cursor you wish to jump and the jump destination.
5. Press the soft key corresponding to the desired jump type and select the cursor to jump and the jump destination.
6. Pressing the “Jump Exec” soft key moves the cursor to the jump destination.

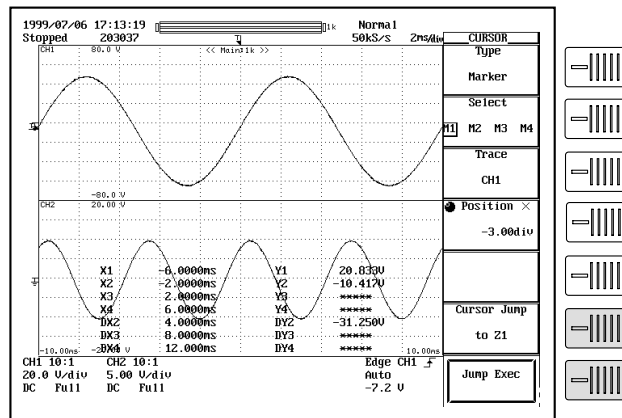

Note

The menu varies depending on the cursor type.

9.2 Automated Measurement of Waveform Parameters

< For a description of this function, refer to page 1 - 20 >

Function

This function allows automated measurement of various parameters of the data stored in the acquisition memory. Up to 2400 data points of the result of the automated measurement can also be saved to a file. (See section 11.9, "Saving the Results of the Automated Measurement of Waveform Parameters.")

Restrictions

Automated measurement of waveform parameters cannot be performed on the following waveforms.

- Snapshot waveforms
- Accumulated waveforms other than the newest waveform
- Logic input waveforms

Auto measurement mode

ON : Measures the specified item.

Statistics : Performs statistical computation on the measured result of the specified item. See section 9.3, "Statistical Processing."

Selecting the High/Low method: High-Low Mode

"High" and "Low" correspond to the 100% level and the 0% level, respectively, that are used to measure rise and fall times and other parameters. Select one of the two methods used to set the High and Low levels.

- Auto
Based on the frequency of voltage levels of the waveform within the measurement range, the higher amplitude level is set to "High" and the lower amplitude level is set to "Low" taking into account the occurrences of ringing and spikes. This method is most suitable for measuring square waves and pulse waves.
- MAX-MIN
The maximum and minimum values within the measurement range are set to "High" and "Low," respectively. This method is most suitable for measuring sine waves and saw waves. It is not suited to the measurement of waveforms that have ringing and spikes.

Setting the distal, proximal, and mesial values: Distal/Prox Mode

Select the appropriate method to set the two levels that are to be used as reference for such measurements as rise and fall times.

- %
The distal, mesial, and proximal values are set in terms of percentages when "High" of any trace (CH1 to CH4, Math1, Math2) and "Low" are taken to be 100% and 0%, respectively.
- Unit
Set the distal, mesial, and proximal values of any trace (CH1 to CH4, Math1, Math2) to arbitrary voltage values.

Setting the measurement range: Time Range

With the default setting, the ± 5 div of the time axis display frame is the measurement range. However, this range can be shortened. The measurement range is set using two vertical cursors. The position of the fine dashed line is the measurement start point and the position of the coarse dashed line is the end point.

Measurement Parameters: Items

You can select among the 26 types of measurement parameters shown below and delay between channel. Up to 24000 combinations of parameters of all traces (CH1 to CH4, Math1, Math2) can be saved. The parameters that can be displayed are as follows.

Auto Measurement Mode	Displayed Parameters
ON	Up to 12 parameters from all traces. The parameters of channels having smaller channel numbers have precedence. The parameters that appear higher in the parameter setting menu have precedence.
Statistics	The statistics of up to 2 parameters for all traces are displayed. Channels having smaller channel numbers have precedence.

• Voltage-axis parameters

- P-P : Peak to peak value (MAX - MIN) [V]
- Max : Maximum voltage [V]
- Min : Minimum voltage [V]
- Rms : Root mean square value $(1/\sqrt{n})(\sum(x_i)^2)^{1/2}$ [V]
- Avg : Average voltage $(1/n)\sum x_i$ [V]
- Sdev: Standard deviation $(SDv)^* (1/n(\sum x_i^2 - (\sum x_i)^2/n))^{1/2}$
- Oshot : Undershoot value $(-Ovr)^* (LOW - MIN)/(HIGH - LOW) \times 100$ [%]
- +Oshot : Overshoot value $(+Ovr)^* (MAX - HIGH)/(HIGH - LOW) \times 100$ [%]
- High : High level voltage [V]
- Low : Low level voltage [V]

* () shows the corresponding name at the measurement item setting screen.

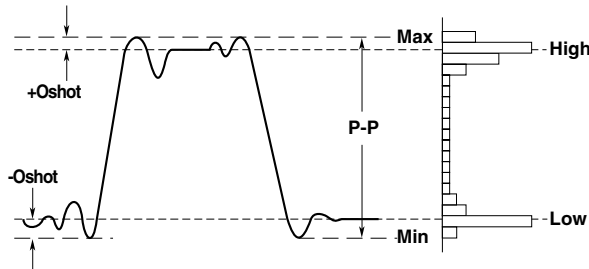

• Time-axis parameters

- Rise : Rise time [s]
- Fall : Fall time [s]
- Freq : Frequency [Hz], 1/PERIOD
- Period : Period [s]
- Avg Freq : Mean frequency in measuring range [Hz]
- Avg Period : Mean period in measuring range [s]
- +Width : Width (s) greater than the mesial value $(+Wd)^*$
- Width : Width (s) smaller than the mesial value $(-Wd)^*$
- Duty : Duty ratio + Width/Period x 100 [%]

* () shows the corresponding neme at the measurement item setting screen.

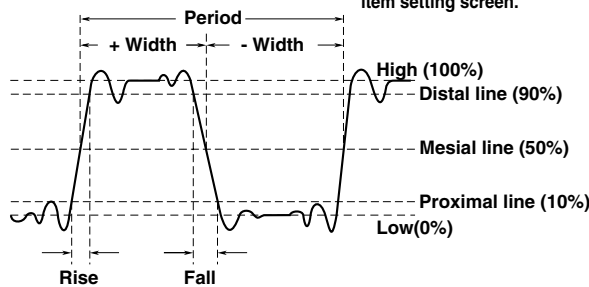

9.2 Automated Measurement of Waveform Parameters

Pulse : Pulse Count (PlsN) **Set the measurement range (Time Range) to match the pulse width of the signal being measured.**
When Pulse=3

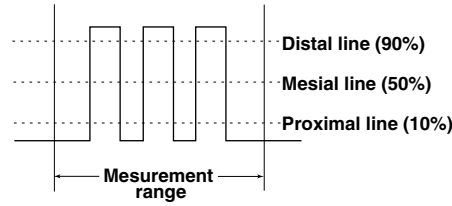

Burst1, Burst2: Burst width (Bst1, Bst2) **Set the measurement range (Time Range) to match the burst width of the signal being measured.**

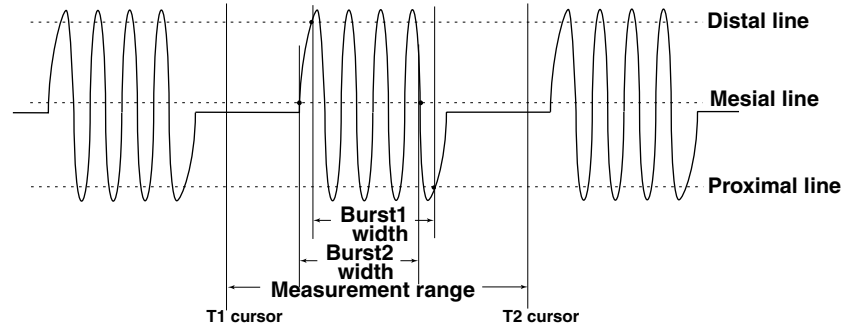

- Other measurement parameters
 - Int1TY : The area under the positive amplitude
 - Int2TY : (The area under the positive amplitude) - (the area under the negative amplitude)
 - Int1XY : The summation of the triangular area of the X-Y waveform
 - Ing2XY : The summation of the trapezoidal area of the X-Y waveform
 - * For details regarding the area calculations, see Appendix 2, "How to Calculate the Area of a Waveform."

Delay between channels: Delay Setup

The time difference between the rising or falling edges of traces waveform or trigger point is called delay between channels.

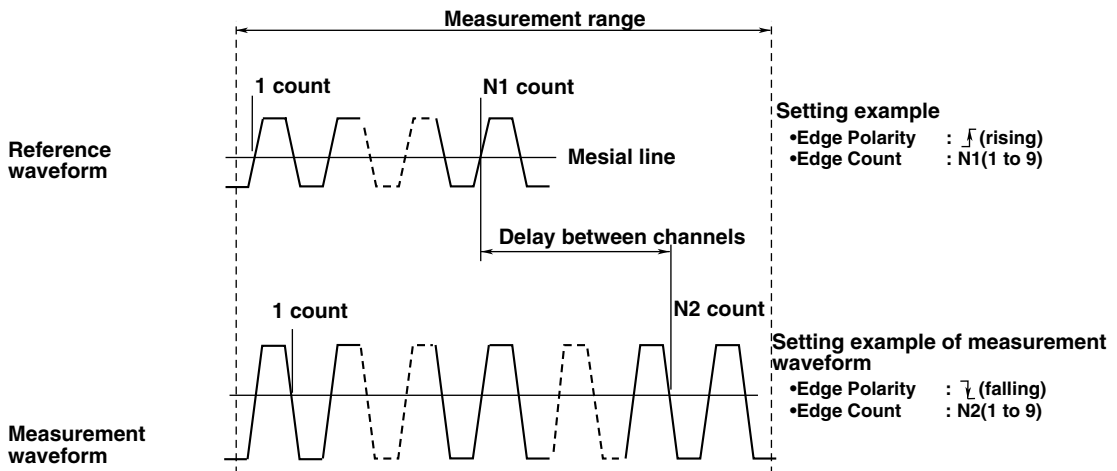

- If “Mode” is set to “Time” or “Degree,” measurements will be made. The default setting is “OFF.”
 - Time : Display the delay between channels as a time
 - Degree : Display the delay between channels as a degree
(Applicable to DL7100 with software (ROM) version 1.11 or later. See section 15.4, “Checking the System Condition.”)
Degree = Delay (s)/Period (s) × 360 (deg) The period is that of a standard waveform.
- Select rising “ \uparrow ” or falling “ \downarrow ” for the slope of the edge to be detected in “Edge Polarity.” The default setting is rising “ \uparrow .”
- Set the number of edges to detect before actually considering it a detection point in “Edge Count.” The range is an integer from 1 to 9. The default setting is “1.”
- The voltage level at the detection point is the mesial point.
- The parameter name when the measured value is displayed is (Dly).

Note

When “Mode” is set to “Degree” and the reference waveform is Trig, the measured values are displayed as “***.”

Setting Proximal, Mesial, and Distal: Dist/Prox Mode

- Unit : According to Dist/Prox Mode setting.
- Proximal range : 0 to 100 (resolution: 1%) or voltage corresponding to ± 8 div (resolution: $V/\text{div} \times 1/100$)
- Mesial range : 0 to 100 (resolution: 1%) or voltage corresponding to ± 8 div (resolution: $V/\text{div} \times 1/100$)
- Distal range : 0 to 100 (resolution: 1%) or voltage corresponding to ± 8 div (resolution: $V/\text{div} \times 1/100$)

Notes when making automated measurement of waveform parameters

- The measured value will be displayed as “****” if the measurement is not possible.
- If the waveform is of small amplitude, measurements may not produce correct results.
- If there are two or more cycles of a waveform in the measurement range, the measurement is made on the first waveform.
- Automated measurements cannot be made on logic waveforms. All measured values will be displayed as “****” in this case.

1 cycle mode

This mode is used to compute items related to the voltage axis or the area over one cycle after determining the cycle. This is suited to items such as Rms and Avg that produce errors depending on the measurement range.

This does not affect the items related to the time axis or the area of the X-Y waveforms.

9.2 Automated Measurement of Waveform Parameters

Operating Procedure

1. Press the "MEASURE" key.
2. Press the "Mode" soft key to display the automated measurement mode menu.
3. Press the soft key corresponding to "ON" to set the automated measurement mode.

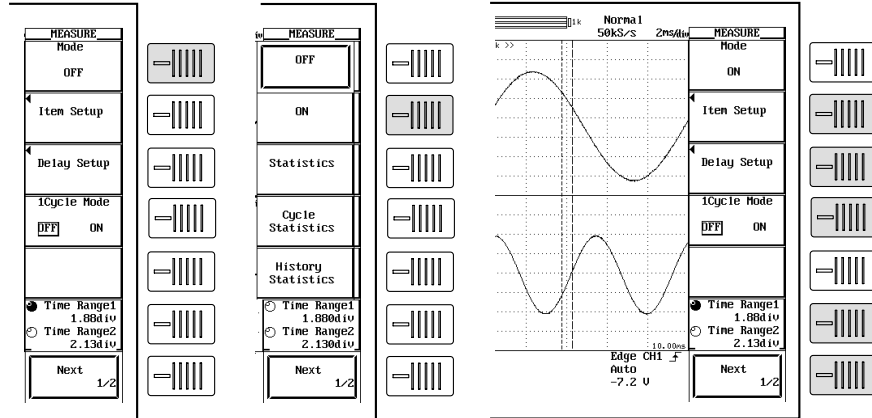

Selecting the measurement parameter

4. Press the "Item Setup" soft key to display the measurement parameter dialog box and the measurement channel dialog box.

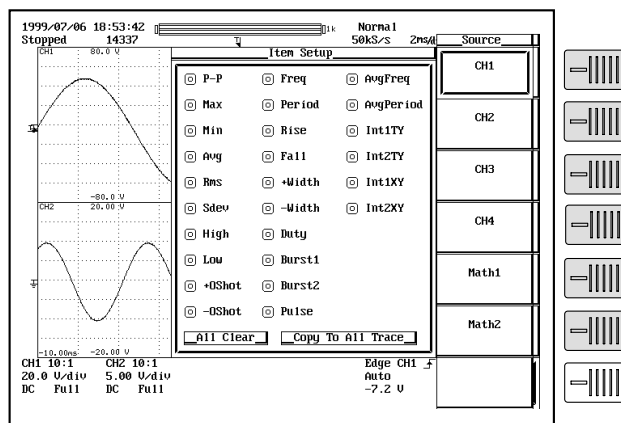

5. Press the soft key corresponding to the desired measurement channel.
6. Turn the jog shuttle to move the cursor to the parameter you wish to turn ON. You can turn OFF all parameters at once by selecting "All Clear." You can copy the current parameter settings to all traces by selecting "Copy to All Trace."
7. Press the "SELECT" key to turn ON the parameter
8. Repeat steps 5 to 7 as necessary.

Setting the delay (Delay Setup)

9. Press the “Delay Setup” soft key to display the delay setting menu and the measurement channel dialog box.

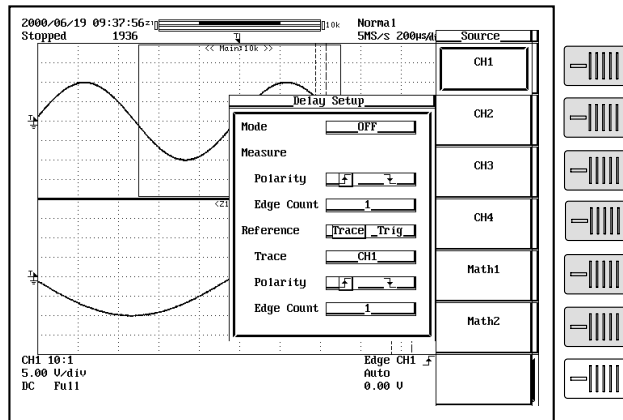

10. Press the soft key corresponding to the desired measurement channel.
11. Turn the jog shuttle to move the cursor to “Mode.”
12. Press the “SELECT” key to select “ON.”
13. Turn the jog shuttle to move the cursor to “Polarity” under “Measure.”
14. Press the “SELECT” key to select whether to measure the rising edge (“ \uparrow ”) or the falling edge (“ \downarrow ”).
15. Turn the jog shuttle to move the cursor to “Edge Count” under “Measure.”
16. Press the “SELECT” key, and turn the jog shuttle to select on which rising or falling edge to make measurements.
17. Turn the jog shuttle to move the cursor to “Reference.”
18. Press the “SELECT” key to select whether the trace or the trigger is to be the reference.
19. Turn the jog shuttle to move the cursor to “Trace.”
20. Pressing the “SELECT” key displays the reference waveform menu.
21. Turn the jog shuttle to select the reference waveform, then press the “SELECT” key.
22. Turn the jog shuttle to move the cursor to “Polarity” under “Reference.”
23. Press the “SELECT” key to select whether to make the rising (“ \uparrow ”) or the falling (“ \downarrow ”) edge the reference.
24. Turn the jog shuttle to move the cursor to “Edge Count” under “Reference.”
25. Press the “SELECT” key to select which rising or falling edge to make the reference.

Setting the 1 cycle mode

26. Press the “1 Cycle Mode” soft key to select “ON” or “OFF.”

Setting the measurement range

27. Press the “Time Range1/Time Range2” soft key to set the jog shuttle control to “Time Range1.”
28. Turn the jog shuttle to set the start of the measurement range.
29. Press the “Time Range1/Time Range2” soft key to set the jog shuttle control to “Time Range2.”
30. Turn the jog shuttle to set the end of the measurement range.

9.2 Automated Measurement of Waveform Parameters

Selecting the target waveform for distal, mesial, and proximal points

- Press the “Next 1/2” soft key to display the “Next 2/2” menu.

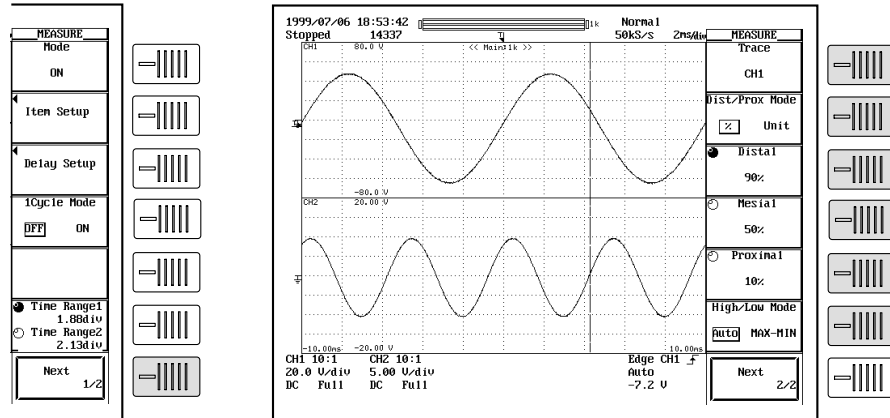

- Press the “Trace” soft key to display the measured waveform menu.
- Press the soft key corresponding to the desired waveform.

Setting the distal, mesial, and proximal unit (Dist/Prox Mode)

- Press the “Next 1/2” soft key to display the “Next 2/2” menu.
- Press the “Dist/Prox Mode” soft key to select the distal, mesial, proximal unit.

Setting the distal, mesial, and proximal points (Distal, Mesial, Proximal)

- Press the “Next 1/2” soft key to display the “Next 2/2” menu.
- Press the “Distal,” “Mesial,” or “Proximal” soft key.
- Turn the jog shuttle to set the distal, mesial, or proximal point.

Setting the High/Low point

- Press the “Next 1/2” soft key to display the “Next 2/2” menu.
- Press the “High/Low Mode” soft key to select “Auto” or “MAX-MIN.”

9.3 Statistical Processing

< For a description of this function, refer to page 1 - 21 >

Function

Statistical processing

In statistical computation, statistics are measured on the data over the number of times automated measurements were made for each item.

Statistical Processing by Period

(Applicable to DL7100 with software (ROM) version 1.21 or later. See section 15.4, "Checking the System Condition.")

Carry out statistical processing on current history data. Calculate starting from the oldest data, then perform the statistical processing on each period range. The method for period calculation is the same for that of a normal waveform parameter. Depending on the which waveform is used for the period calculation, you can select whether to apply the waveform's period to all the waveforms in the calculation, or to use each individual waveform's period for its own calculation.

CH1-CH4, Math1, Math2 : Apply the period of the specified channel to all the waveforms and perform statistical processing.

Own : Use each individual waveform's own period for its statistical processing.

Statistical processing is performed on old data that has been divided up by period. You cannot perform this operation in conjunction with 1 cycle mode. Also, you cannot measure the following parameters:

Waveform for Period Search : Avg. Freq., Avg. Period, PlsN (pulse count) k, Int1XY(area), Int2XY(area), Delay.

Other Waveforms : Int1XY(area), Int2XY(area), Delay

Statistical Processing of History Data

(Applicable to DL7100 with software (ROM) version 1.21 or later. See section 15.4, "Checking the System Condition.")

Perform statistical processing on each waveform read in using the history memory function. Statistical processing is done starting from the oldest data. The range for statistical processing is the waveform displayed in "ShowMap." You can combine this function with Delay and 1 cycle mode.

Waveform

CH1 to CH4, Math1, Math2

Measurement parameters

The parameters given on page 9 - 11 and 9 - 12. Up to two parameters can be computed.

Statistics

Displays the following statistics on the selected measurement parameters.

- Max : Maximum value
- Min : Minimum value
- Avg : Average value
- Sdv : Standard deviation
- Cnt : Number of samples

Statistical range

Same as those of normal automated measurements (See page 9 - 10).

The display of the results of the statistical processing

One parameter per channel is displayed in order from the channel having the smallest channel number that has measurement parameters turned ON. A maximum of two parameters from all channels can be displayed.

Displaying Statistical Processing Results

One parameter name is displayed as a heading for each channel item. The channels items are displayed in order, starting from the lowest channel number which has been set for statistical processing. A maximum of two items can be displayed on the screen. The statistical processing results are displayed in a list. Old data and waveforms are assigned a number, and the statistical processing results are displayed for each number. The maximum and minimum values of each parameter are indicated by an up-arrow (maximum value) or a down-arrow (minimum value). If the same value occurs more than once, the oldest data is the one displayed. With the statistical processing of history data, the number of results that can be listed is 24000. Since the newest history waveform parameters are the ones displayed when the number of data exceeds 24000, there may be maximum and minimum values which lie outside of the displayed range.

Note about Statistical Processing

While executing a statistical process, all soft keys other than “Measure Abort” are inactive.

Operating Procedure

Statistical Processing

1. Press the “MEASURE” key.
2. Press the “Mode” soft key to display the automated measurement mode menu.
3. Press the soft key corresponding to “Statistics” to set the automated measurement mode.
4. Press the “Item Setup” soft key to display the measurement parameter menu and the measurement channel menu.

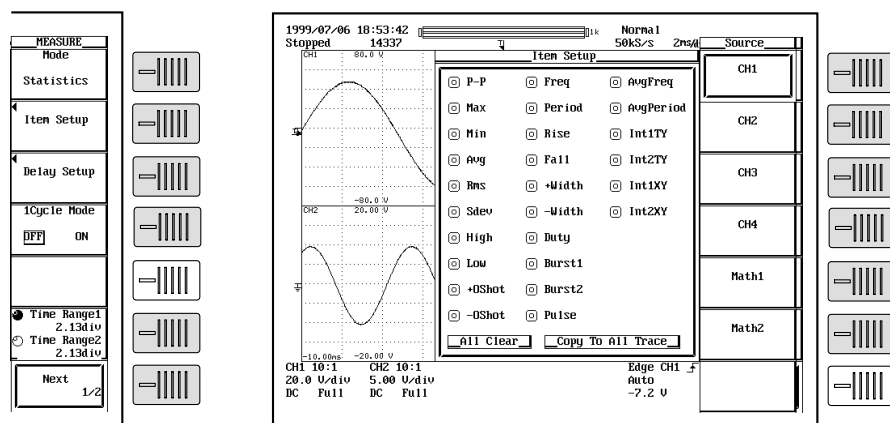

5. Press the soft key corresponding to the desired measurement channel.
6. Turn the jog shuttle to move the cursor to the parameter you wish to turn ON. You can turn OFF all parameters at once by selecting “All Clear.” You can copy the current parameter settings to all traces by selecting “Copy to All Trace.”

7. Press the “SELECT” key to select ON.
8. Repeat steps 5 to 7 as necessary.

The setting of other parameters is the same as that of normal automated measurements (See pages 9 - 14 to 9 - 16).

Statistical Processing by Period

(Applicable to DL7100 with software (ROM) version 1.21 or later. See section 15.4, “Checking the System Condition.”)

1. Press the “MEASURE” key.
2. Press the “Mode” soft key to display the automatic measurement mode selection menu.
3. Press the soft key corresponding to “Cycle Statistics” to set the automatic measurement mode.
4. Press the “Item Setup” soft key to display the measuring item dialog box and the measurement source channel selection menu.

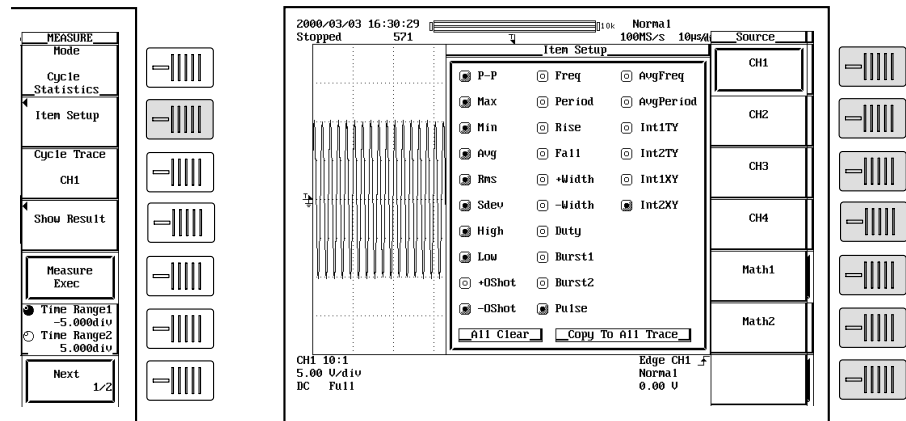

5. Press the soft key corresponding to the desired measurement source channel to select it.
6. Using the jog shuttle, move the cursor to the item that you wish to set to ON. If you select “All Clear,” all items are turned OFF. If you select “Copy to All Trace,” you can copy the current settings to all the traces.
7. Press the “SELECT” key to turn ON an item.
8. Repeat steps 5 - 7 as many times as necessary. Press ESC to return to the automatic measurement mode selection menu.
9. Press the “Cycle Trace” soft key to display the period waveform selection menu.
10. Press the soft key corresponding to the source channel for the period. If “Own” is selected, each waveform’s own period is used for its statistical processing.

The other settings are the same as for normal automatic measurement (please see page 9 - 11 to 9 - 13).

11. Press the “Measure Exec” soft key to perform the statistical processing. Press the key again to stop statistical processing.
12. Press the “Show Results” soft key to display a list of the statistical processing results. Use the arrow keys to scroll the list horizontally, and the jog shuttle to scroll vertically.

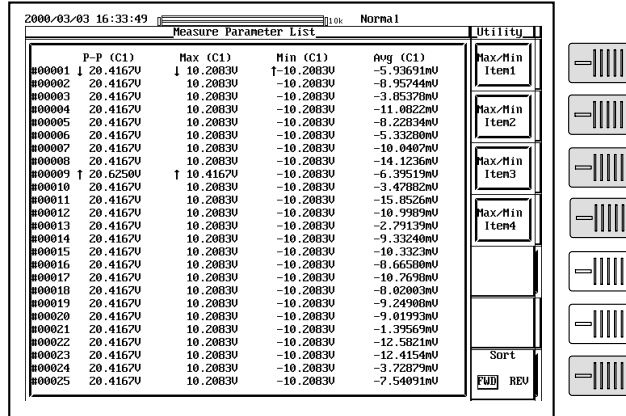

Press the “Max/Min Item1” – “Max/Min Item4” soft keys to move the cursor to the maximum and minimum values. From the left of the displayed parameters are Item1, Item2, Item3, and Item4. You can change the order to ascending or descending with the “Sort” soft key.

Statistical Processing with History Data

(Applicable to DL7100 with software (ROM) version 1.21 or later. See section 15.4, “Checking the System Condition.”)

1. Press the “MEASURE” key.
2. Press the “Mode” soft key to display the automatic measurement mode selection menu.
3. Press the soft key corresponding to “HistoryStatistics” to set the automatic measurement mode.
4. Press the “Item Setup” soft key to display the measurement item dialog box and the measuring source channel selection menu.

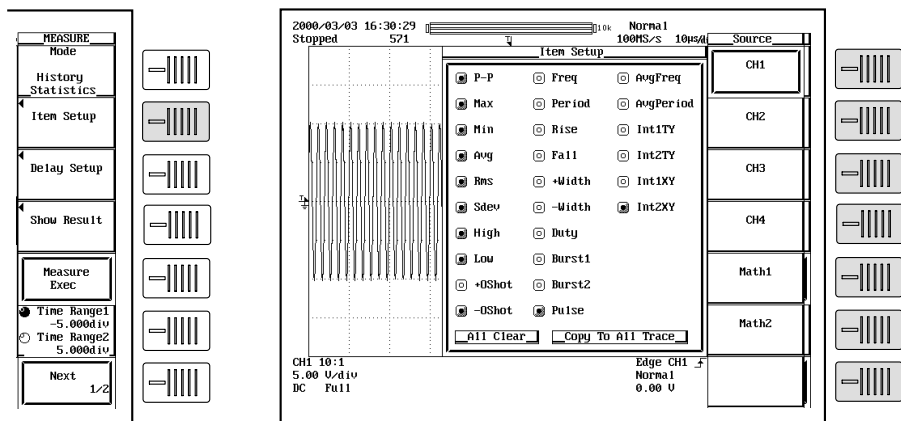

5. Press the soft key corresponding to the measuring source channel to select it.
6. Using the jog shuttle, move the cursor to the item you wish to turn ON. If you select “All Clear,” you can turn OFF all the items at once. If you select “Copy to All Trace,” you can copy the current settings to all of the traces.
7. Press the “SELECT” key to turn ON the item.

8. Repeat steps 5 - 7 as many times as necessary. Press the "ESC" key to return to the automatic measurement mode selection menu.

The other settings are the same as for normal automatic measurement.

9. Press the "Measure Exec" soft key to execute the statistical processing. Press the key again to stop the statistical processing.
10. Press the "Show Result" soft key to list the statistical processing results. Use the arrow keys to scroll the list horizontally, and the jog shuttle to scroll it vertically. Press the "Max/Min Item1" – "Max/Min Item4" soft keys to move the cursor to the maximum and minimum values of each parameter. From the left side of the displayed parameter is Item1, Item2, Item3, and Item4. Press the "SELECT" key to list the history waveform indicated by the cursor.

9.4 Adding, Subtracting, and Multiplying Waveforms

< For a description of this function, refer to page 1 - 22 >

Function

Addition, subtraction, and multiplication can be performed between the following channels.

Math1: CH1 + (CH1 to CH4), CH2 + (CH1 to CH4)

Math2: CH3 + (CH1 to CH4, Math1), CH4 + (CH1 to CH4, Math1)

Math1 and Math2 can be computed simultaneously.

+ computed waveform

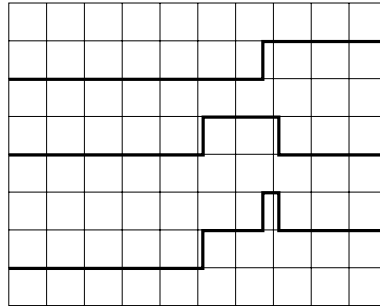

- computed waveform

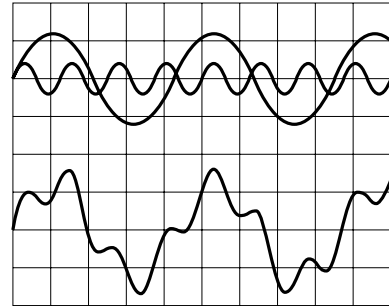

Waveform addition

Waveform subtraction

Scaling

Set the upper and lower limits on computations.

Auto : The upper and lower limits are set according to the computed result.

Manual : The upper and lower limits can be set arbitrarily. The range is $-9.9999E+30$ to $9.9999E+30$.

Unit

Unit can be set arbitrarily using up to four characters. The specified characters are reflected in the scale values.

Smoothing

See section 9.9, "Smoothing."

About linear scaling

When performing computation on a channel that has linear scaling set, the computation is performed on the scaled value.

Maximum record length

DL7100 : 2 MWord (4 MWord: interleave mode ON)

DL7200 : 4 MWord (8 MWord: interleave mode ON)

Operating Procedure

Turn ON/OFF the display

1. Press the "MATH" key.
2. Press the "Math1 Display" soft key and select ON to display Math1 and OFF to not display Math1.

Selecting the channel on which to perform computation

3. Press the "Math1 Setup" soft key to display the computation dialog box.

4. Turn the jog shuttle to move the cursor to "Source1."
5. Pressing the "SELECT" key displays the channel menu.
6. Turn the jog shuttle to select the channel on which to perform the computation and press the "SELECT" key.

Setting the operator

7. Turn the jog shuttle to move the cursor to "Operation."
8. Pressing the "SELECT" key displays the operator setting menu.

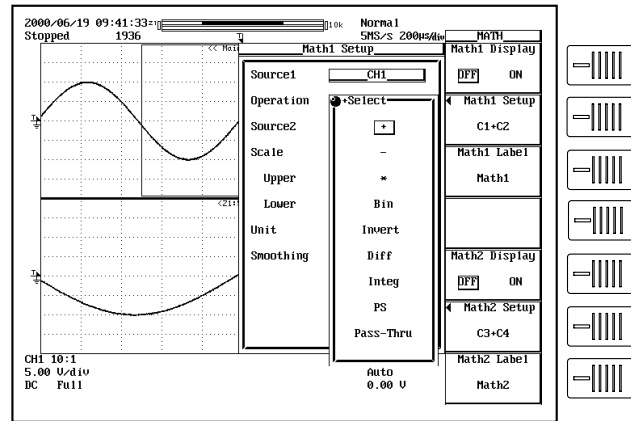

9. Turn the jog shuttle to select "+," "-", or "*" and press the "SELECT" key.

Selecting the channel on which to perform computation

10. Similar to steps 5 to 7, set "Source2."

Scaling

11. Turn the jog shuttle to move the cursor to "Scale."
12. Press the "SELECT" key to select "Auto" or "Manual." If you select "Auto," go to step 17.
13. If you selected "Manual," turn the jog shuttle to move the cursor to "Upper."
14. Pressing the "SELECT" key displays a menu used to set the upper limit of the waveform display.
15. Turn the jog shuttle to set the upper limit and press the "SELECT" key.
16. Set the lower limit in a similar fashion.

Note

If "Upper" or "Lower" is set after selecting "Auto," scaling is automatically changed to "Manual."

Setting the units

17. Turn the jog shuttle to move the cursor to "Unit."
18. Using the keyboard that appears when the "SELECT" key is pressed enter the unit using four characters or less.

Smoothing

19. Turn the jog shuttle to move the cursor to "Smoothing."
20. Press the "SELECT" key to select "ON" or "OFF."

Note

For details regarding smoothing, see section 9.9, "Smoothing."

Entering Labels

21. Press the "Math1 Label" soft key to display the keyboard, then enter a label. See 8.5, "Setting the Waveform Labels" for information about displaying labels. (Applicable to DL7100 with software (ROM) version 1.11 or later. See section 15.4, "Checking the System Condition.")

Set Math2 in a similar manner as necessary.

9.5 Binary Computation

< For a description of this function, refer to page 1 - 22 >

Function

This function converts CH1 to CH4 or Math1 waveform to a digital signal (1 s and 0 s) according to the specified threshold level.

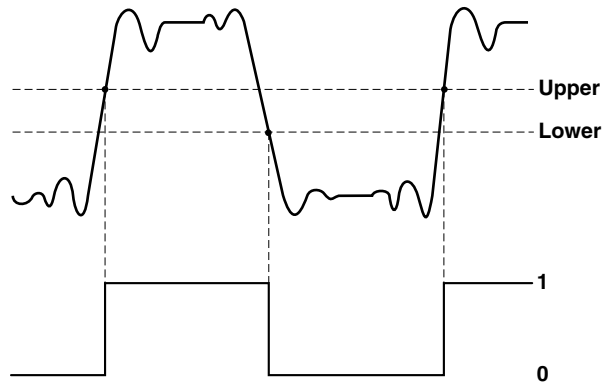

Unit

Unit can be set arbitrarily using up to four characters. The specified characters are reflected in the scale values.

Smoothing

See section 9.9, "Smoothing."

Maximum record length

DL7100 : 2 MWord (4 MWord: interleave mode ON)

DL7200 : 4 MWord (8 MWord: interleave mode ON)

Operating Procedure

Turning the display ON/OFF

1. Press the "MATH" key.
2. Press the "Math1 Display" soft key and select ON to display Math1 and OFF to not display Math1.

Setting the operator

3. Press the "Math1 Setup" soft key to display the computation dialog box.

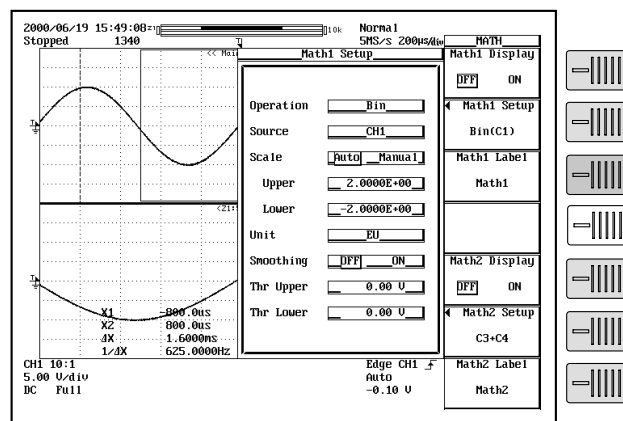

4. Turn the jog shuttle to move the cursor to "Operation."
5. Pressing the "SELECT" key displays the operator setting menu.
6. Turn the jog shuttle to select "Bin" and press the "SELECT" key.

Selecting the channel on which to perform computation

7. Turn the jog shuttle to move the cursor to "Source."
8. Pressing the "SELECT" key displays the channel setting menu.
9. Turn the jog shuttle to select the channel on which to perform computation and press the "SELECT" key.

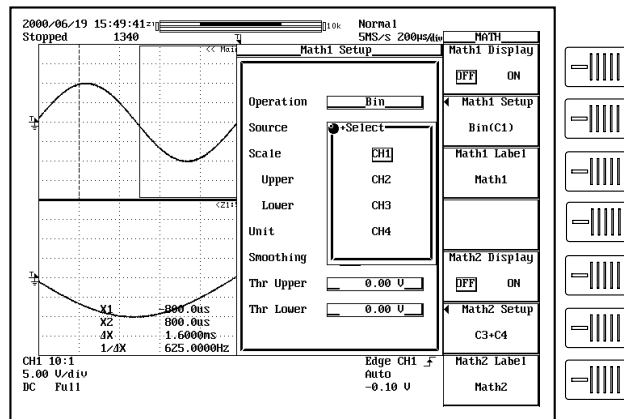

Scaling

The upper limit and lower limit of scaling are fixed to +2 and -2, respectively.

Setting the units

10. Turn the jog shuttle to move the cursor to "Unit."
11. Using the keyboard that appears when the "SELECT" key is pressed enter the unit using four characters or less.

Smoothing

12. Turn the jog shuttle to move the cursor to "Smoothing."
13. Press the "SELECT" key to select "ON" or "OFF."

Note

For details regarding smoothing, see section 9.9, "Smoothing."

Entering Labels

(Applicable to DL7100 with software (ROM) version 1.21 or later. See section 15.4, "Checking the System Condition.")

14. Press the "Math Label 1" soft key to display the keyboard, then enter a label. See 8.5, "Setting the Waveform Labels" for information on displaying Labels.

Setting the threshold level

15. Turn the jog shuttle to move the cursor to "Thr Upper."
16. Pressing the "SELECT" key displays the threshold level setting menu.
17. Turn the jog shuttle to select the threshold level and press the "SELECT" key.
18. Set "Thr Lower" in a similar fashion.

Set Math2 in a similar manner as necessary.

9.6 Inverting the Waveform Display

< For a description of this function, refer to page 1 - 22 >

Function

Waveforms that can be inverted

The waveform is inverted by multiplying CH1 to CH4 and Math1 by -1 .

Scaling

Set the upper and lower limits on computations.

Auto : The upper and lower limits are set according to the computed result.

Manual : The upper and lower limits can be set arbitrarily. The range is $-9.9999E+30$ to $9.9999E+30$.

Units

Units can be set arbitrarily using up to four characters. The specified characters are reflected in the scale values.

Smoothing

See section 9.9, "Smoothing."

Maximum record length

DL7100 : 2 MWord (4 MWord: interleave mode ON)

DL7200 : 4 MWord (8 MWord: interleave mode ON)

Operating Procedure

Turning ON/OFF the display

1. Press the "MATH" key.
2. Press the "Math1 Display" soft key and select ON to display Math1 and OFF to not display Math1.

Setting the operator

3. Press the "Math1 Setup" soft key to display the computation dialog box.

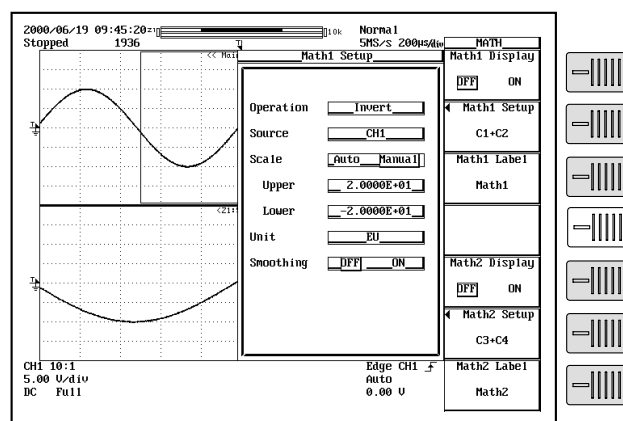

4. Turn the jog shuttle to move the cursor to "Operation."
5. Pressing the "SELECT" key displays the operator setting menu.
6. Turn the jog shuttle to select "Invert" and press the "SELECT" key.

Selecting the waveform to be inverted

7. Turn the jog shuttle to move the cursor to "Source."
8. Pressing the "SELECT" key displays the channel setting menu.
9. Turn the jog shuttle to select the channel on which to perform computation and press the "SELECT" key.

Scaling

10. Turn the jog shuttle to move the cursor to "Scale."
11. Press the "SELECT" key to select "Auto" or "Manual."
12. If you selected "Manual," turn the jog shuttle to move the cursor to "Upper."
13. Pressing the "SELECT" key displays a menu used to display the upper limit of the waveform.
14. Turn the jog shuttle to select the upper limit and press the "SELECT" key.
15. Set the lower limit in a similar fashion.

Setting the unit

16. Turn the jog shuttle to move the cursor to "Unit."
17. Using the keyboard that appears when the "SELECT" key is pressed enter the unit using four characters or less.

Smoothing

18. Turn the jog shuttle to move the cursor to "Smoothing."
19. Press the "SELECT" key to select "ON" or "OFF."

Note

For details regarding smoothing, see section 9.9, "Smoothing."

Entering Labels

(Applicable to DL7100 with software (ROM) version 1.11 or later. See section 15.4, "Checking the System Condition.")

20. Press the "Math1 Label" soft key to display the keyboard. See 8.5, "Setting Waveform Labels" for information about displaying labels.

Set Math2 in a similar manner as necessary.

9.7 Differentiating and Integrating Waveforms

< For a description of this function, refer to page 1 - 22 >

Function

Waveforms to be differentiated or integrated

CH1 to CH4 and Math1 waveforms can be differentiated or integrated.

Scaling

Set the upper and lower limits on computations.

Auto : The upper and lower limits are set according to the computed result.

Manual : The upper and lower limits can be set arbitrarily. The range is $-9.9999E+30$ to $9.9999E+30$.

Units

Units can be set arbitrarily using up to four characters. The specified characters are reflected in the scale values.

Smoothing

See section 9.9, "Smoothing."

Maximum record length

DL7100 : 2 MWord (4 MWord: interleave mode ON)

DL7200 : 4 MWord (8 MWord: interleave mode ON)

Operating Procedure

Turning ON/OFF the display

1. Press the "MATH" key.
2. Press the "Math1 Display" soft key and select ON to display Math1 and OFF to not display Math1.

Setting the operator

3. Press the "Math1 Setup" soft key to display the computation dialog box.

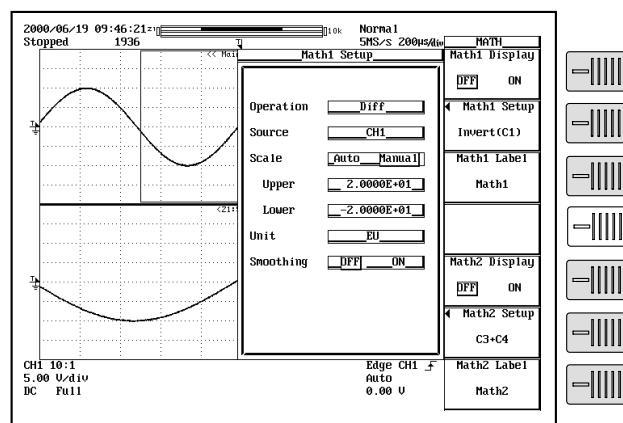

4. Turn the jog shuttle to move the cursor to "Operation."
5. Press the "SELECT" key to display the operator setting menu.
6. Turn the jog shuttle to select "Diff"(differentiation) or "Integ"(integration) and press the "SELECT" key.

Setting the channel on which to perform computation

7. Turn the jog shuttle to move the cursor to "Source."
8. Pressing the "SELECT" key displays the channel setting menu.
9. Turn the jog shuttle to select the channel on which to perform computation and press the "SELECT" key.

Scaling

10. Turn the jog shuttle to move the cursor to "Scale."
11. Press the "SELECT" key to select "Auto" or "Manual."
12. If you selected "Manual," turn the jog shuttle to move the cursor to "Upper."
13. Press the "SELECT" key to display a menu used to set the upper limit of the waveform.
14. Turn the jog shuttle to select the upper limit and press the "SELECT" key.
15. Set the lower limit in a similar fashion.

Setting the unit

16. Turn the jog shuttle to move the cursor to "Unit."
17. Using the keyboard that appears when the "SELECT" key is pressed enter the unit using four characters or less.

Smoothing

18. Turn the jog shuttle to move the cursor to "Smoothing."
19. Press the "SELECT" key to select "ON" or "OFF."

Note

For details regarding smoothing, see section 9.9, "Smoothing."

Entering Labels

(Applicable to DL7100 with software (ROM) version 1.11 or later. See section 15.4, "Checking the System Condition.")

20. Press the "Math1 Label" soft key to display the keyboard. See section 8.5, "Setting the Waveform Labels" for information about displaying labels.

Set Math2 in a similar manner as necessary.

9.8 Displaying the Power Spectrum

< For a description of this function, refer to page 1 - 23 >

Function

This function displays the power spectrum of CH1 to CH4 and Math1 waveforms.

Number of computing points: Point

Select 1000 or 10000.

Using the number of computing points from the specified "Start point," an FFT is performed and the power spectrum is displayed.

Selecting the time window: Window

Select from the following windows.

Rect (rectangular) : Best suited to transient signals that attenuate completely within the time window.

Hanning (Hanning) : Best suited to continuous and non-periodic signals

Flattop (flat top) : Best suited when you wish to improve the accuracy of the level even if the frequency resolution is to be compromised.

Notes when displaying power spectrums

- Cannot be executed if the displayed record length is less than number of computation points (Point).

Maximum record length

DL7100 : 2 MWord (4 MWord: interleave mode ON)

DL7200 : 4 MWord (8 MWord: interleave mode ON)

Operating Procedure

Turning ON/OFF the display

1. Press the "MATH" key.
2. Press the "Math1 Display" soft key and select ON to display Math1 and OFF to not display Math1.

Setting the operator

3. Press the "Math1 Setup" soft key to display the computation dialog box.

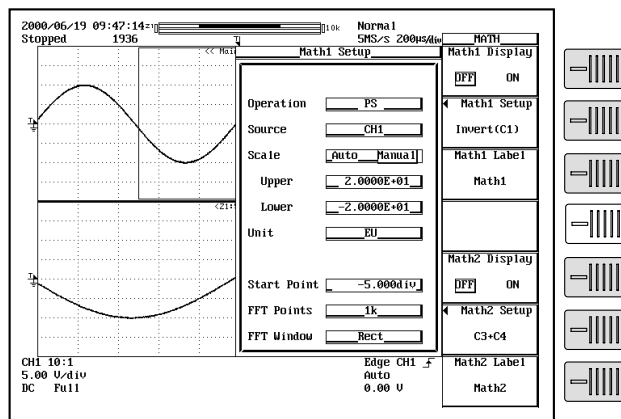

4. Turn the jog shuttle to move the cursor to "Operation."
5. Press the "SELECT" key to display the operator setting menu.
6. Turn the jog shuttle to select "PS" and press the "SELECT" key.

Selecting the channel on which to perform computation

7. Turn the jog shuttle to move the cursor to "Source."
8. Press the "SELECT" key to display the channel setting menu.
9. Turn the jog shuttle to select the channel on which to perform computation and press the "SELECT" key.

Scaling

10. Turn the jog shuttle to move the cursor to "Scale."
11. Press the "SELECT" key to select "Auto" or "Manual."
12. If you select "Manual," turn the jog shuttle to move the cursor to "Upper."
13. Pressing the "SELECT" key displays a menu used to set the upper limit of the waveform display.
14. Turn the jog shuttle to select the upper limit and press the "SELECT" key.
15. Set the lower limit in a similar fashion.

Setting the unit

16. Turn the jog shuttle to move the cursor to "Unit."
17. Using the keyboard that appears when the "SELECT" key is pressed enter the unit using four characters or less.

Setting the start point

18. Turn the jog shuttle to move the cursor to "Start Point."
19. Pressing the "SELECT" key displays a menu used to set the FFT start point.
20. Turn the jog shuttle to set the start point and press the "SELECT" key.

Setting the number of FFT points

21. Turn the jog shuttle to move the cursor to "FFT Points."
22. Pressing the "SELECT" key displays a menu used to select the number of points on which to take the FFT.
23. Turn the jog shuttle to select "1k" or "10k" and press the "SELECT" key.

Selecting the time window

24. Turn the jog shuttle to move the cursor to "FFT Window."
25. Pressing the "SELECT" key displays the time window menu.
26. Turn the jog shuttle to select "Rect," "Hanning," or "FlatTop" and press the "SELECT" key.

Entering Labels

- (Applicable to DL7100 with software (ROM) version 1.11 or later. See section 15.4, "Checking the System Condition.")
27. Press the "Math1 Label" soft key to display the keyboard. See section 8.5, "Setting the Waveform Labels" for information about displaying labels.

9.9 Smoothing

Function

The moving average is determined every five data samples, and the waveform is displayed based on the results. Since this process is performed on the data stored in the acquisition memory, it can be executed even when the waveform acquisition is stopped. This smoothing process has the following frequency characteristics with respect to the sample rate. The -3dB point is at approximately 13% of the sample rate.

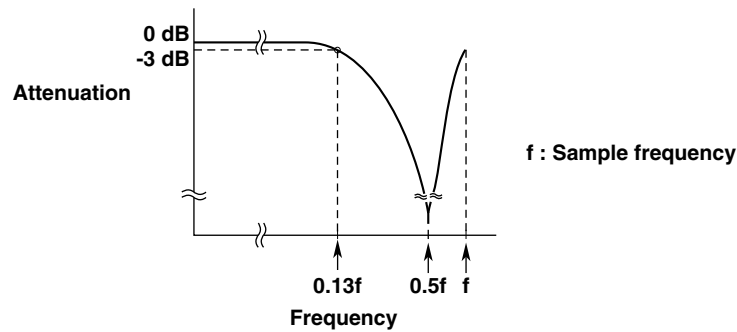

Operating Procedure

Turning ON/OFF the display

1. Press the "MATH" key.
2. Press the "Math1 Display" soft key and select ON to display Math1 and OFF to not display Math1.

Setting the operator

3. Press the "Math1 Setup" soft key to display the computation dialog box. To smooth the measured data, set "Operation" to "Through."

Note

If an operator other than "Through" is selected, the computation is performed on the smoothed value.

Smoothing

4. Turn the jog shuttle to move the cursor to "Smoothing."
5. Press the "SELECT" key to select "ON."

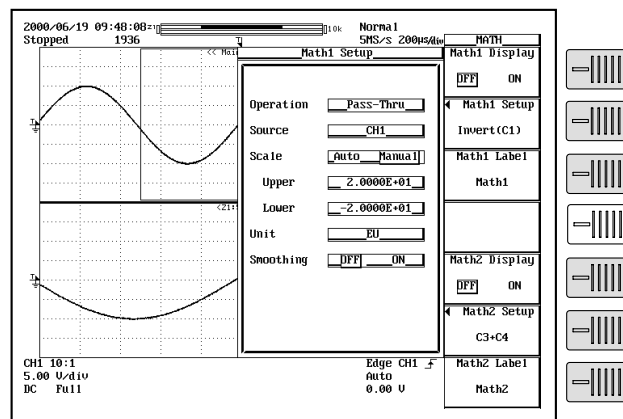

9.10 Phase-Shifted Display

< For a description of this function, refer to page 1 - 22 >

Function

The phase of CH1 to CH4 waveforms is shifted and the result is displayed. Computation can also be carried out on phase-shifted waveforms.

Allowable shift range

The phase can be shifted in the following range.

Time value between $-(\text{record length}/2)$ to $(\text{record length}/2)$ (resolution: $1/\text{sample rate}$)

The sample rate varies depending on the record length or T/div setting. When the record length is 16 Mword, the phase cannot be shifted. For details, see Appendix 1, "Relationship between the Time Axis Setting, Sample Rate, and Record length."

Notes when shifting the phase

If you change the T/div setting after shifting the phase, the shift on the screen does not change, but the specified time value change in accordance with the T/div setting.

Record length

Maximum record length is 8 Mword.

Operating Procedure

Setting the computation mode

1. Press the "SHIFT" key to set the keys in the shifted condition. Functions marked in purple on the panel become active.
2. Press the "MATH" key.
3. Press the "Mode" soft key to select "ON" or "OFF."
4. Press the soft key corresponding to the channel whose phase is to be shifted.
5. Turn the jog shuttle to set the shifted time.

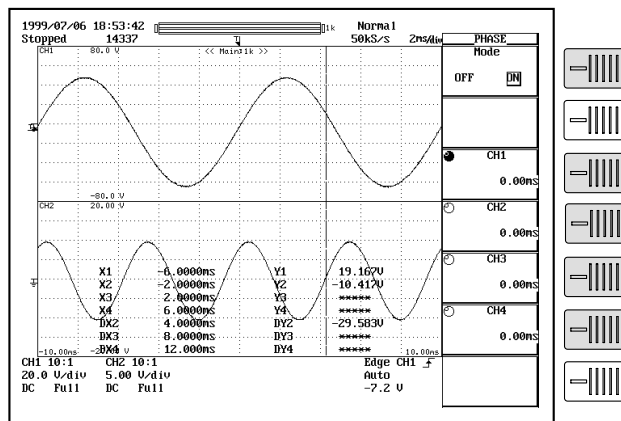

9.11 GO/NO-GO Operation Using the Measurement of Waveform Parameters

< For a description of this function, refer to page 1 - 27 >

Function

Waveform parameters that can be determined using GO/NO-GO operation (Item)

This function is applicable to all of the waveform parameters (27 items). Up to 4 types of parameters can be determined simultaneously.

Mode

OFF : Does not perform GO/NO-GO determination

ON : Performs GO/NO-GO determination

Upper and lower limits of parameters: Upper/Lower

The upper and lower limits depends on the parameters. They can be set in the range – 9.9999E+30 to 9.9999E+30.

Setting the “Condition”

IN : When the value is inside the upper and lower limits.

OUT : When the value is outside the upper or lower limits.

Setting the Logic

AND : Executes the “Action” when all parameter conditions (1 to 4 types) are met.

OR : Executes the “Action” when any one of the parameter conditions (1 to 4 types) is met.

Action to take when the condition is met (not met): Set Action

Buzzer : Sounds the buzzer.

Save to File : Saves the waveform data to the storage medium (FD, SCSI and so on) specified in the FILE menu.

Hard copy : Outputs the screen image data to the destination (Printer, Centronics, File, Net Print (Ethernet + PC Card interface optional)) specified by “Copy to” in the Copy setting menu.

Send Mail : Sends a mail (Ethernet + PC Card Interface optional). For details, see section 13.7, “Using the Mail Function (Action Mail Function).”

Number of Actions: Sequence

Single : Executes the “Action” once and terminates.

Continue : Repeats the execution of the “Action” up to the number of acquisition count specified in ACQ Count (until the acquisition is stopped if infinite is specified).

Number of waveform acquisitions: ACQ Count

Set the number of waveform acquisitions.

Infinite : Continues until the waveform acquisition is stopped with the “START/STOP” key.

1 to 65536 : Stops when the specified number of waveforms is acquired.

Executing/Aborting GO/NO-GO operation

The operation starts when the “Exec” soft key is pressed. Waveform acquisition is automatically stopped when the determination is complete. To forcibly stop the operation, press the START/STOP key or press the “Abort” soft key.

“Save to File”/“Hard Copy” operation

Operates according to the settings in the “File” menu or the “Copy” menu.

File name when “Action” is set to “Save to File” or “Hard Copy”

The file is saved with “AutoName” under the “File” menu or the “Copy” menu. For details, see section 10.4, “Outputting to Storage Medium” or section 11.6, “Saving/ Loading Waveform Data.”

Notes when performing GO/NO-GO determination

- The determination results (the number of successes and failures) are displayed.
- All keys other than the START/STOP key and the “Abort” soft key are disabled during the determination.
- When GO/NO-GO determination is executed, the trigger mode is automatically changed to “Single.”
- Determination is not possible when the acquisition mode is set to Average.

Operating Procedure

Setting the mode

1. Press the “GO/NO-GO” key.
2. Press the “Mode” soft key to display a menu used to set the GO/NO-GO determination mode.
3. Press the soft key corresponding to “Parameter” to set the GO/NO-GO determination mode.

Setting Param1

4. Pressing the “Setup” soft key displays the determination criteria menu.

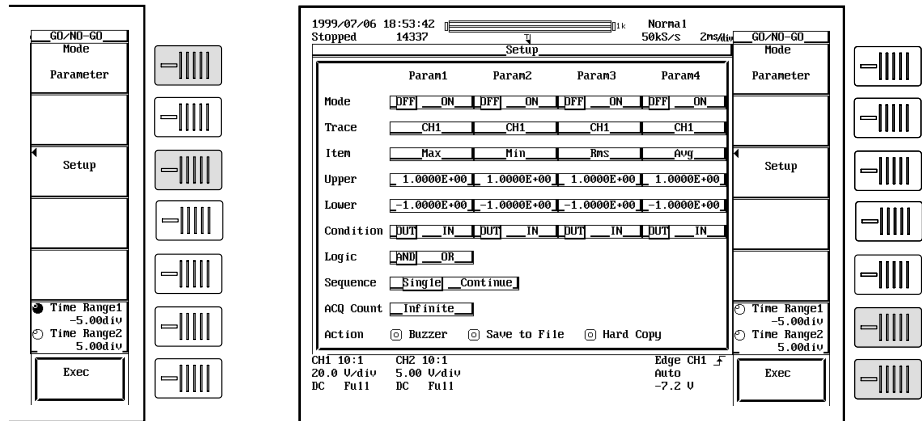

5. Turn the jog shuttle to move the cursor to “Mode” of Param1.
6. Press the “SELECT” key to select “ON” or “OFF.” If “OFF” is selected, Param1 will be excluded from the determination criteria.
7. Turn the jog shuttle to move the cursor to “Trace.”
8. Press the “SELECT” key to display the channel menu.
9. Turn the jog shuttle to select the channel and press the “SELECT” key.
10. Turn the jog shuttle to move the cursor to “Item.”
11. Press the “SELECT” key to display the automated measurement item menu.
12. Turn the jog shuttle to select the item and press the “SELECT” key.
13. Turn the jog shuttle to move the cursor to “Upper.”
14. Press the “SELECT” key to display the upper limit setting menu.
15. Turn the jog shuttle to select the upper limit and press the “SELECT” key.
16. Set the lower limit in a similar fashion.
17. Turn the jog shuttle to move the cursor to “Condition.”
18. Press the “SELECT” key to select “IN” or “OUT.”
19. Set Param2 to Param4 as necessary.

Setting the Logic

20. Turn the jog shuttle to move the cursor to "Logic."
21. Press the "SELECT" key to select "AND" or "OR."

Setting the Sequence

22. Turn the jog shuttle to move the cursor to "Sequence."
23. Press the "SELECT" key to select "Single" or "Continue."

Setting the ACQ Count

24. Turn the jog shuttle to move the cursor to "ACQ Count."
25. Press the "SELECT" key to display a menu used to set the number of waveform acquisitions.
26. Turn the jog shuttle to set the number of waveform acquisitions and press the "SELECT" key.

Selecting the action to take when the condition is not met

27. Turn the jog shuttle to move the cursor to "Action."
28. Press the "SELECT" key to turn ON/OFF the action.

Setting the determination range

29. Press the "Time Range1/Time Range2" soft key to set the jog shuttle control to "Time Range1."
30. Turn the jog shuttle to set the start point of the determination range.
31. In a similar fashion, set the end point of the determination range with "Time Range2."

Executing the GO/NO-GO determination

32. Press the "Exec" soft key to execute the GO/NO-GO determination.
When the determination terminates, the waveform acquisition is automatically stopped.
To forcibly stop the operation, press the START/STOP key or the "Abort" soft key to stop the acquisition.

9.12 GO/NO-GO Determination Using Zones

< For a description of this function, refer to page 1 - 27 >

Function

Create zones using a standard waveform as a base, and from those zones let GO/NO-GO be determined by whether a waveform extends outside or inside of the zone. (Applicable to DL7100 with software (ROM) version 1.21 or later. See section 15.4, "Checking the System Condition.")

Waveform for "GO/NO-GO" Determination/Determination Criteria: Setup

You can select a waveform from input signals (CH1-CH4) and from math waveforms (Math1, Math2). You can use multiple waveforms for GO/NO-GO determination. Select from the following determination standards for each waveform:

IN : When the specified waveform enters the zone.
OUT : When the specified waveform is outside the zone.
OFF : Do not determine.

Selecting the Reference Waveform: Target Trace

Select a reference waveform for creating a zone. The basic waveform will be displayed as a trace, and you can select from the following types:

Input signal waveform
Math waveform

Creating a Determination Zone: Redraw/New

You can set up to six determination zones. The following are the setting ranges:

Up-down setting range : ± 8 div from the reference waveform
Left-right setting range : ± 5 div from the center of the screen

Zones are assigned to waveforms in the following manner:

Zone1 : CH1 Zone2 : CH2 Zone3 : CH3
Zone4 : CH4 Zone5 : Math1 Zone6 : Math2

The screen displays the active zones depending on the settings in Setup.

Setting Logic

AND : when all parameter conditions 1 through 6 are met, the GO/NO-GO "Action" is performed
OR : when at least one parameter condition from 1 - 6 are met, the GO/NO-GO "Action" is performed

Action when Conditions are Met: Set Action

Buzzer : Alarm beep sound.
Save to File : Save waveform data to the storage media specified in the storage FILE menu (FD, SCSI and so on).
Hard copy : Output screen image data to the destination specified in the Copy setting menu (Printer, Centronics, File, Net Print (Ethernet + PC Card interface optional)).
Send Mail : Send a mail (Ethernet + PC Card Interface optional). For details, see section 13.7, "Using the Mail Function (Action Mail Function)."

"Action" Count: Sequence

Single : Conclude after one instance of the "Action."
Continue : Repeat the "Action" the number of times specified as the sampling count in ACQ Count (if set to Infinite, the "Action" repeats until determination stops).

Waveform Sampling Count: ACQ Count

Set the waveform sampling count.

Infinite : Sampling continues until determination stops, or until the “Start/Stop” key or “Abort” soft key is pressed.

1-65536 : Sampling stops after the specified count has been reached.

Start/Stop GO/NO-GO Determination

Press the “Exec” soft key to execute the determination. Determination will stop automatically when finished, or you can press the START/STOP key or “Abort” soft key to force a stop.

“Save to File”/“Hard Copy” Action

The “Action” is performed based on the FILE menu or Copy settings.

Filenames When Action is “Save to File” or “Hard Copy”

The data is saved according to the “Auto Name” given in the “File” menu or the “Copy” menu. See 10.4, “Storing Screen Image to the Recording Medium” and 11.6, “Saving and Retrieving Waveform Data” for details.

Notes about GO/NO-GO Determination

Determination results (number of successes, failures) are displayed on screen.

Functions other than the START/STOP key and “Abort” soft key are inactive during determination.

When performing GO/NO-GO determination, trigger mode is automatically set to Single. Determination is not possible when acquisition mode is set to Average.

Note

The zone waveform you created is stored as setting information onto the floppy disk etc.

Operating Procedure

Setting the Mode

1. Press the GO/NO-GO key.
2. Press the "Mode" soft key to display the GO/NO-GO determination mode setting menu.
3. Press the soft key corresponding to a zone to set the GO/NO-GO determination mode.

Creating a Determination Zone

4. Press the "ToEditMenu" soft key.
5. Press the "New" soft key to display the zone creation reference waveform selection menu.
6. Press the soft key corresponding to the reference waveform to display the zone editing menu.

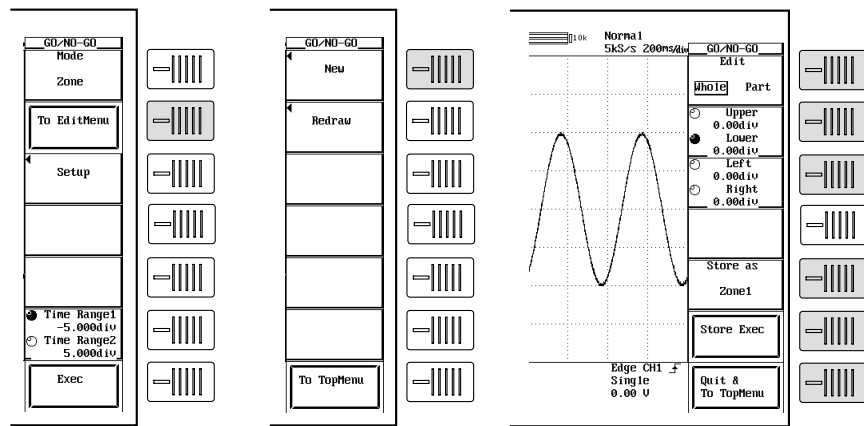

Editing All Zones

7. When "Edit" is set to something other than "Whole," press the "Edit" key and select "Whole."

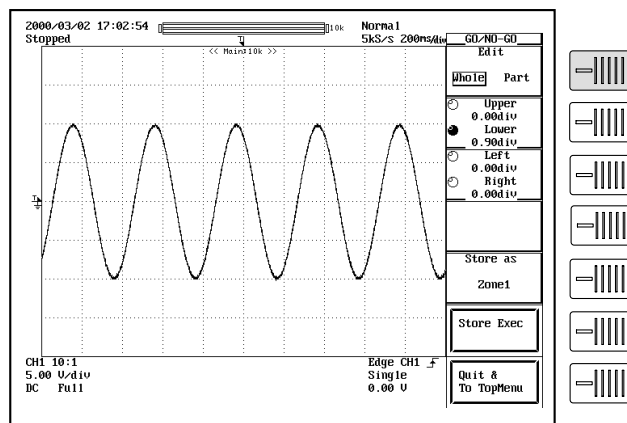

8. Press the “Upper/Lower” or “Left/Right” soft keys to select the zone setting direction.
9. Turn the jog shuttle to create a zone.
10. Repeat steps 8 and 9 to edit the zones.

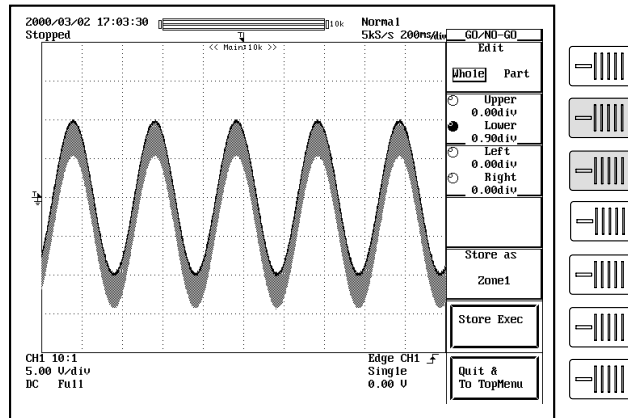

11. Press the “Store As” soft key to open the store as setting menu for the edited zone.
12. Press the soft key corresponding to a storage location from Zone1 to Zone6 to select it.
13. Press the “Store Exec” soft key to save the zone. Proceed to step 14 to edit a partial zone, or skip to step 22 to quit.

Editing a Partial Zone

14. Press the “Edit” soft key to select “Part.”
15. Press the “TimeRange1/TimeRange2” soft key to select the right or left cursor.
16. Turn the jog shuttle to set the right and left edges of the partial zone.
17. Press the “Upper/Lower” soft key to select the direction for setting the zone, then use the jog shuttle to create the zone.
18. Repeat steps 15 – 17 to edit the zone.

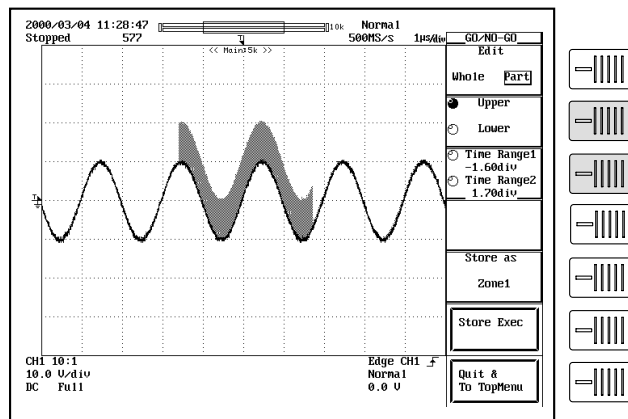

19. Press the “Store As” soft key to open the store as setting menu for the edited zone.
20. Press the soft key corresponding to a storage location Zone1 – Zone6 to select it
21. Press the “Store Exec” soft key to save the zone.

Quit Zone Editing

22. Press the “Quit & To TopMenu” soft key to return to the menu in step 3. If you press the “Quit & To TopMenu” soft key before pressing the “Store Exec” soft key, the settings made up to that point will be inactive, and you will return to the menu in step 3.

Editing Existing Zones

Edit zones that have been previously created.

23. In step 5, press the “Redraw” soft key.
24. Repeat steps 6 – 22 to edit the zones.

Selecting a Determination Waveform

25. Press the “Setup” soft key to display the Setup menu.

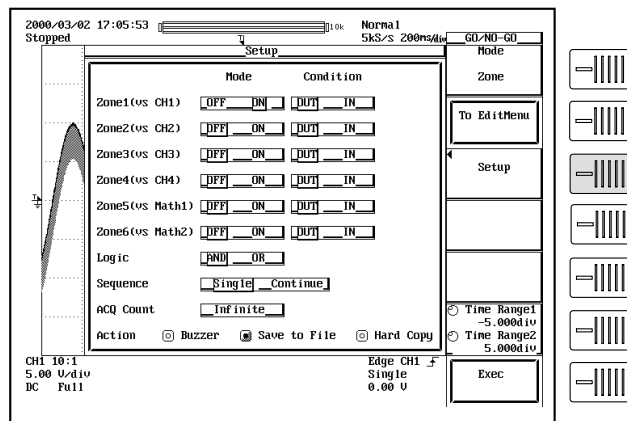

26. Use the jog shuttle to move the cursor to Mode in Zone1.
27. Press the “SELECT” key to select “On” or “Off.”
28. Use the jog shuttle to move the cursor to the Condition in Zone1.
29. Press the “SELECT” key to select “In” or “Out.”
30. Set Zone2 – Zone6 as necessary.

Setting the Logic

31. Move the cursor to “Logic” with the jog shuttle.
32. Press the “SELECT” key to select “AND” or “OR.”

Setting the Sequence

33. Use the jog shuttle to move the cursor to “Sequence.”
34. Press the “SELECT” key to select “Single,” or “Continue.”

Setting the ACQ Count

35. Use the jog shuttle to move the cursor to “ACQ Count.”
36. Press the “SELECT” key to display the waveform acquisition count setting menu.
37. Use the jog shuttle to set the waveform acquisition count, then press the “SELECT” key.

Selecting the Action for Condition Not Met

38. Use the jog shuttle to move the cursor to “Action.”
39. Press the “SELECT” key to turn action ON or OFF.

Setting the Determination Range

40. Press the “Time Range1/Time Range2” soft key to highlight the “TimeRange1” jog shuttle icon.
41. Use the jog shuttle to set the head of the determination range.
42. In the same manner, set the tail of the range to “Time Range2.”

Executing Determination

43. Press the “Exec” soft key to execute the determination. The “Exec” key changes to the “Abort” soft key. When the determination is completed, acquisition automatically stops. You can force a stop by pressing the “START/STOP” key or the “Abort” soft key.

10.1 Loading Paper Roll in Built-in Printer (Optional)

Printer Roll Chart

Use only YOKOGAWA's roll charts. When you are using the printer for the first time, use the roll chart supplied with the instrument. When your roll charts have run out, purchase more from your dealer or YOKOGAWA sales offices listed on the back cover of this manual.

Part No. : B9850NX
Specification : Thermo-sensible, 30 m
Minimum quantity : 5 rolls

Handling the Roll Chart

Thermosensible roll charts produce color using a thermal reaction, therefore the following precautions must be taken.

Storage precautions

The roll chart begins to develop color at approximately 70°C. It is very sensitive to heat, damp, light and chemicals both before and after use.

- Keep roll charts in a dry, cool and dark place.
- Once the package is opened, use the roll chart as soon as possible.
- If the roll chart is left in contact with plastic films containing plasticizer (for instance, vinyl chloride film, cellophane tape etc.) for a long period of time, discoloration will occur on the recording area of the chart due to the plasticizer. If you are going to keep the roll chart in a holder, for instance, use a polypropylene holder.
- When you use adhesive on the roll chart, never use adhesive which contains an organic solvent such as alcohol or ether, otherwise color may develop on the chart.
- When you are going to store recorded roll charts for a long period of time, we suggest you make a copy of the charts since discoloration may occur.

Usage precautions

- Use only YOKOGAWA's genuine roll charts.
- Do not touch the roll chart with sweaty hands, otherwise it may become stained with your fingerprints, and information may be lost.
- Do not rub the surface of the roll chart strongly with a firm object, color development may occur due to frictional heat.
- Do not allow chemicals or oil to come into contact with the roll chart, otherwise color development or loss of information may result.

10.1 Loading Paper Roll in Built-in Printer (Optional)

Operating Procedure

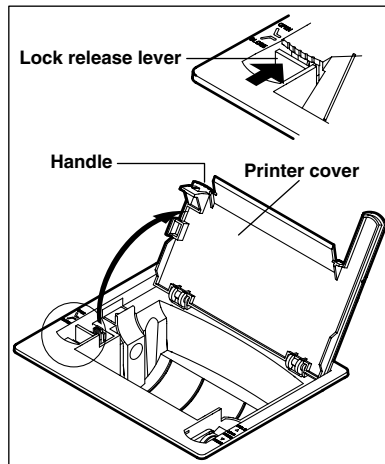

While pushing the lock release lever towards “OPEN” lift the handle on the left of the printer cover and open the cover.

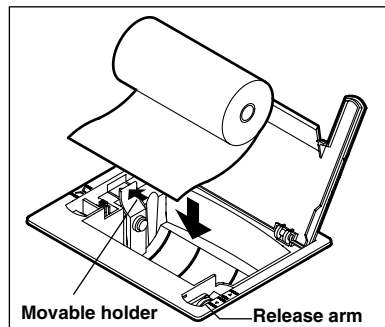

Move the release arm, located on the right near the front, to the “MAN FEED” position. Have the inner side of the roll paper (the side that is not glossy) showing on top for the following procedure. While pressing the movable holder, located on the left of the roll chart storage space, to the left, set the core of the roll paper to the holder on the right. Then, release the movable holder.

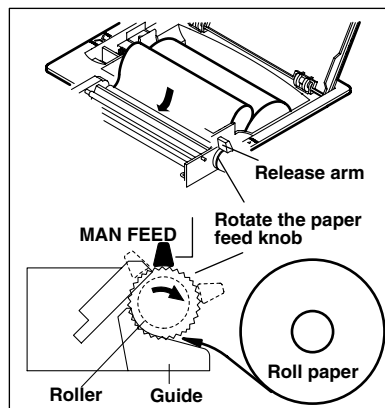

Insert the edge of the roll paper evenly in the space between the roller and the black guide, then rotate the paper feed knob away from you until about 10 cm of the roll sheet is showing from the top of the roller.

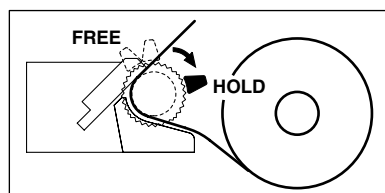

Move the release arm to the “FREE” position and straighten out the roll sheet. Then, move the release arm to the “HOLD” position. The printing will fail with an error message if the release arm is in the “FREE” or “MAN FEED” position during operation.

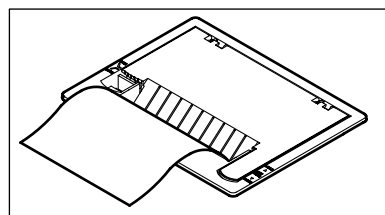

Pull the printer cover back to its original position and close the cover. Make sure that the edge of the roll sheet is showing from the opening of the printer cover. Push the printer cover down firmly until it clicks into place.

Note

After loading the roll paper, the paper feed may be unstable. Print out 2 or 3 screen images before using the printer in your work.

10.2 Outputting to the Built-in Printer (Optional)

Function

Output format

In addition to normal size, long copy is possible in which the displayed waveform is magnified 2 to 500000 times before printing. The magnification ratio varies depending on the T/div and record length settings.

Outputting optional information

Outputs the results of the setup information at the same time as the waveform.

Comments

You can output a comment string consisting of up to 20 characters in the lower section.

Print range

Set the range to output to the printer from -5 div to 5 div (-4 div to 4 div for the 16 MW/CH model).

Preview

The output image can be previewed using the specified output format.

Precautions to be taken when printing with the built-in printer

- Printing is not possible while the waveform acquisition is in progress.
- When displaying a waveform using the history memory function, only the waveform selected for "Selected Record No." is long copied.
- Long copy is not possible when displaying X-Y waveforms.
- Long copy of snapshot waveforms and accumulated waveforms are not possible.

Operating Procedure

Selecting the printer

1. Press the "SHIFT" key to set the keys in the shifted condition. Functions marked in purple on the panel become active.
2. Press the "COPY" key.
3. The "Copy to" soft key displays the output medium menu. ("Net Print" is displayed for DL7200 and DL7100 with Ethernet + PC Card interface optional.)
4. Press the soft key corresponding to "Printer."

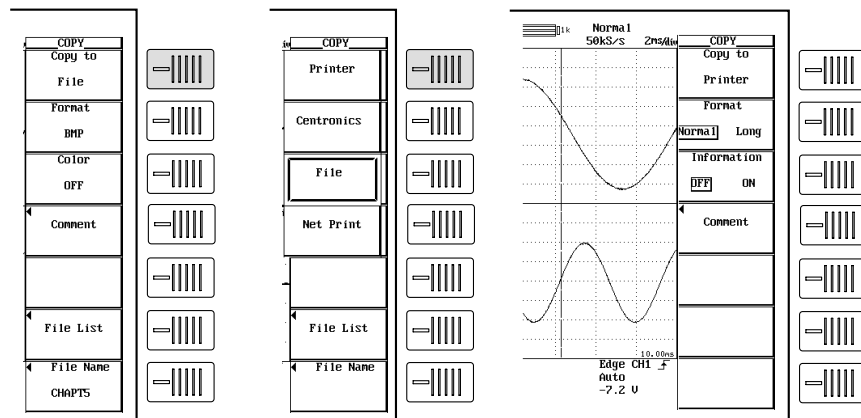

10.2 Outputting to the Built-in Printer (Optional)

Setting the output format

5. Press the “Format” soft key to select “Normal” or “Long.”
6. Press the “Information” soft key to select “ON” or “OFF.”

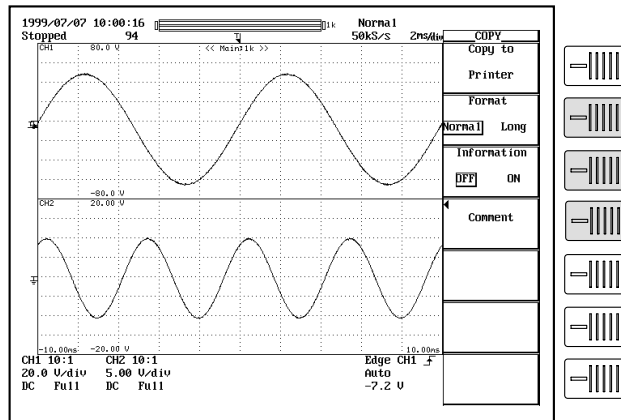

Setting comments

7. Press the “Comment” soft key to display a keyboard.
8. Enter comments according to the procedures described in page 4 - 2.

Setting the magnification ratio (when the output format is set to “Long”)

9. If you selected “Long” in step 5, set the magnification ratio using the jog shuttle. Press the “Mag” soft key to set the jog shuttle control to “Mag.”
10. Turn the jog shuttle to set the magnification ratio. The number of output pages is displayed according to the ratio.

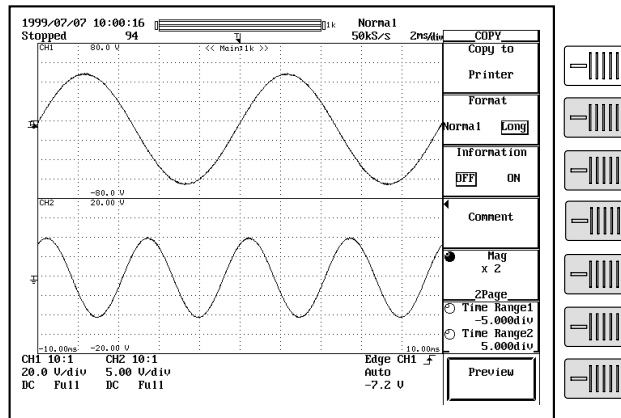

Setting the output range (when the output format is set to “Long”)

11. If you selected “Long” in step 5, set the output range. Press the “Time Range1/Time Range2” soft key to set the jog shuttle control to “Time Range1.”
12. Turn the jog shuttle to set the start point of the output range.
13. In a similar fashion, set the end point of the output range in “Time Range2.”

Previewing (long copy)

14. Press the “Preview” soft key to display the output image on the screen.
15. Turning the jog shuttle changes the displayed page.
16. Pressing the “Quit” soft key to returns to the original screen.

Executing print out

17. Pressing the “COPY” key outputs a hard copy of the screen.
Pressing the “COPY” key again aborts the output.

Output Example when Mag is set to “Long”

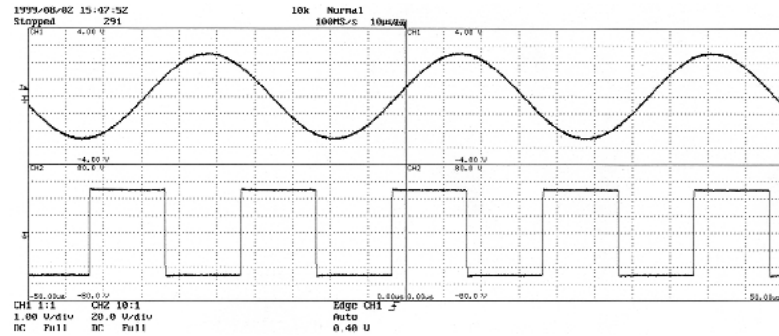

10.3 Outputting Screen Image to an External Printer Connector

Function

The screen image data can be printed to an external printer via the Centronics connector on this instrument, and can be printed to a Network printer via Ethernet interface (Ethernet + PC Card interface optional). For details, see Section 13.5, "Sending Screen Image to a Network Printer."

CAUTION

To connect the external printer and the instrument, use a 25-pin DSUB cable compatible to the IBM-PC. An improper connection can damage the instrument or other instruments that are connected.

Centronics Interface Specifications

Pin configuration of Centronics connector

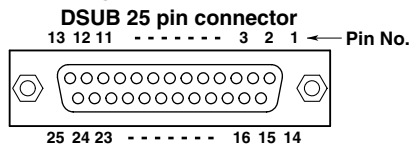

Pin No.	Signal name	Input/Output	Property	Pin No.	Signal name	Input/Output	Property
1	STROBE	Output	Negative	14	AFDXT(Auto feed transfer)	Output	Negative
2	DATA0(Print data bit0)	Output	(LSB)	15	ERROR	Input	Negative
⋮	⋮	⋮	⋮	16	INIT(Initializing of printer)	Output	Negative
9	DATA7(Print data bit7)	Output	(MSB)	17	SLCTIN(Select in)	Output	Negative
10	ACK(Acknowledge)	Input	Negative	18	GND		
11	BUSY	Input	Positive	⋮	⋮		
12	PE(Paper empty)	Input	Positive	25	GND		
13	SLCT(Select)	Input	Positive				

Format

Select the output command format used in the communication with the external printer from the following list of choices.

- ESC-P
- PCL5
- LIPS3
- BJ (Can be used on printers that support the BJC-35V native commands)
- ESC-P2 (Can be used on printers that support ESC/P raster commands.)

Printing resolution when using the BJ format

Select 180 dpi, 300 dpi, or 360 dpi. (About 300 dpi, applicable to DL7100 with software (ROM) version 1.21 or later. See section 15.4, "Checking the System Condition.")

Resolution when Outputting to a BJ Printer

You can set the resolution when printing screen image data on a centronics-compatible BJ printer. Continuing with step 9 on page 10 - 7, press the "Resolution" soft key to open the resolution settings menu. Set the resolution by pressing the "180 dpi," "300 dpi," or "360 dpi" soft key.

Comment

You can output a comment string consisting of up to 20 characters at the bottom section of the screen.

Color

Select the color mode.

- ON : Outputs using the same image color as the screen (except no background, grids are output in black).
- OFF : Outputs using the same image as printing with the built-in printer.

Notes when outputting screen images to external printers

- Proper printing may not be possible on some printers. If printing does not work after checking and adjusting the printer settings, contact the printer manufacturer.
- You can also print to an external printer connected to a PC. To do so, save the screen image data to a floppy disk as described in section 10.4, "Storing Screen Image to the Recording Medium." Then, load the data on the PC and print the information.

Note

The DL7100/DL7200 does not recognize paper shortages and printer errors of the external printer. If you print in such conditions, press the COPY key to abort the printing.

Operating Procedure

Selecting the "Centronics"

1. Press the "SHIFT" key to set the keys in the shifted condition. Functions marked in purple on the panel become active.
2. Press the "COPY" key.
3. Press the "Copy to" soft key to display the output medium menu.
4. Press the soft key corresponding to "Centronics."

Selecting the type

5. Press the "Format" soft key to display the output command type menu.
6. Press the soft key corresponding to the type of command to be selected.

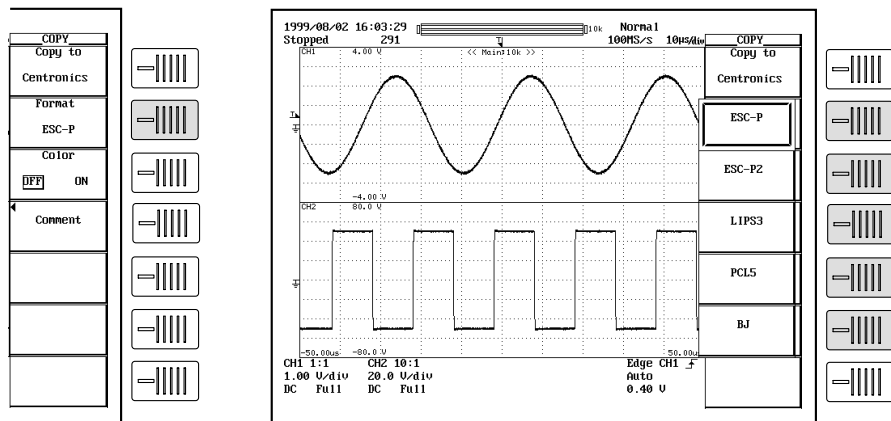

Setting the color

7. Press the "Color" soft key to select "ON" or "OFF."

Setting comments

8. Press the "Comment" soft key to display a keyboard.
9. Enter comments according to the procedures described in page 4 - 2.

10.3 Outputting Screen Image to an External Printer Connector

Setting the Resolution

10. Press the "Resolution" soft key to display the resolution setting menu.
11. Set the resolution by pressing the soft key for "180 dpi," "300 dpi," or "360 dpi."
(About 300 dpi, applicable to DL7100 with software (ROM) version 1.21 or later.
See section 15.4, "Checking the System Condition.")

Note

If you select ND0 in File List, you can output Network.

Executing the printout

12. Pressing the "COPY" key outputs a hard copy of the screen.
Pressing the "COPY" key again aborts the output.

10.4 Storing Screen Image to the Recording Storage Medium

The screen image can be outputted to storage medium (a floppy disk, an external SCSI device, PC Card (optional) or Network drive (Ethernet + PC Card interface optional)). For details, see Section 13.4, "Saving Screen Image Data to a Network Drive."

Function

Output data format

You can save the output data in the following formats. The file extensions and file sizes (reference value) that are automatically assigned are also listed.

Output Data Format	Extension	File Size*
TIFF	*.TIF	38,574 bytes (approx. 300 Kbytes)
BMP	*.BMP	38,462 bytes (approx. 300 Kbytes)
Post Script	*.PS	79,061 bytes (approx. 300 Kbytes)

*: When the color is turned OFF (reference value)

The file sizes inside the parentheses are the sizes when the color is ON.

Color (for TIFF and BMP)

Select ON, ON(Revers), or OFF.

ON : outputs in 256 colors

ON (Revers) : Background color is not output

ON (GRAY) : outputs in 16 shade greyscale. (Applicable to DL7100 with software (ROM) version 1.11 or later. See section 15.4, "Checking the System Condition.")

OFF : outputs in Black & White

Comments

You can add a comment string consisting of up to 20 characters on the screen and save the information.

Data compression (For BMP files)

BMP format can be compressed into LZW and RLE formats, respectively, and output. However, if color is OFF, data in BMP format cannot be compressed.

Floppy disk and external SCSI device/PC Card (optional)

Floppy disk and external SCSI device/PC Card (optional) are described in chapter 11. For the procedures related to formatting, see chapter 11.

Auto naming function

If you use "Auto Naming," files are automatically created with three digit numbers from "000" to "999" in their file name. You can place a common name in front of the numbers (up to 5 characters, specified in File Name).

Note

You can enter up to eight characters for the common name, but the last three characters are discarded.

Notes when outputting the file

- The maximum number of files that can be saved using the auto naming function is 1000.
- When the total number of files and directories in one directory exceeds 2400, the file list will no longer be displayed.

10.4 Storing Screen Image to the Recording Storage Medium

Operating Procedure

Selecting the "File"

1. Press the "SHIFT" key to set the keys in the shifted condition. Functions marked in purple on the panel become active.
2. Press the "COPY" key.
3. Press the "Copy to" soft key to display the output medium menu. ("Net Print" is displayed with DL7200 and DL7100 of firmware version 2.01 or later.)
4. Press the soft key corresponding to "File."

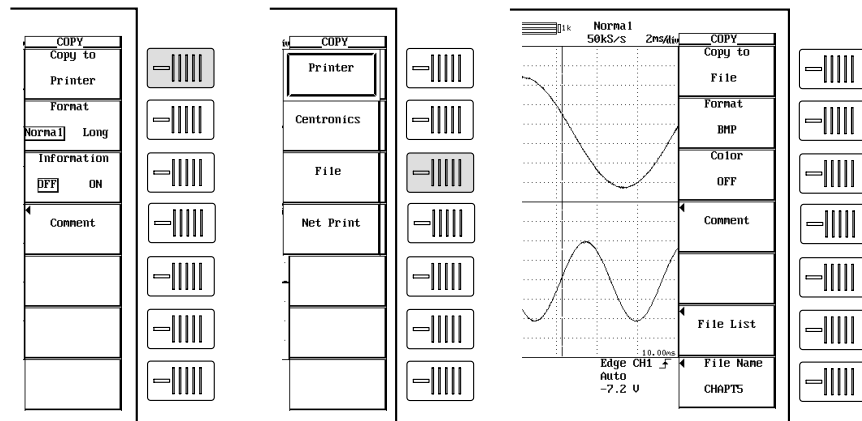

Selecting the type

5. Press the "Format" soft key to display the output command type menu.
6. Press the soft key corresponding to the type of command to be selected.

Setting the color (for TIFF and BMP)

7. Press the "Color" soft key to select "ON," "ON(Revers)," "ON(Gray)," or "OFF." (Applicable to DL7100 with software (ROM) version 1.11 or later. See section 15.4, "Checking the System Condition.")

Setting comments

8. Press the "Comment" soft key to display a keyboard.
9. Enter comments according to the procedures described in page 4 - 2.

Setting the compression (for TIFF and BMP (color is ON))

10. Press the "Compression" soft key select "ON" or "OFF." (When "Compression" is "ON," you cannot output to Network Drive.)

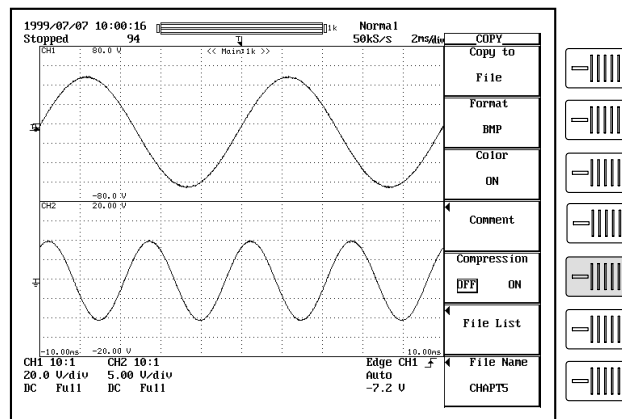

Setting the output destination

11. Press the “File List” soft key to display the output destination setting menu.

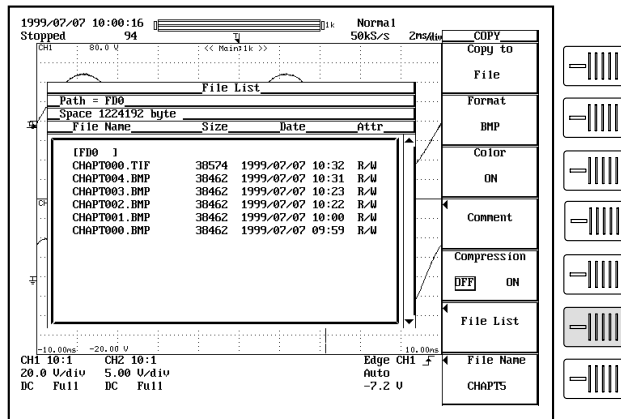

12. Turn the jog shuttle to select the save destination. The floppy disk inserted in the built-in drive or external SCSI devices are displayed in brackets []. Directories are displayed in angle brackets < >.
13. Pressing the “SELECT” key displays the contents of the selected recording medium or the directory. For details related to setting the output destination, see page 11 - 15.

Selecting the file name

14. Press the “File Name” soft key to display the file name setting menu.

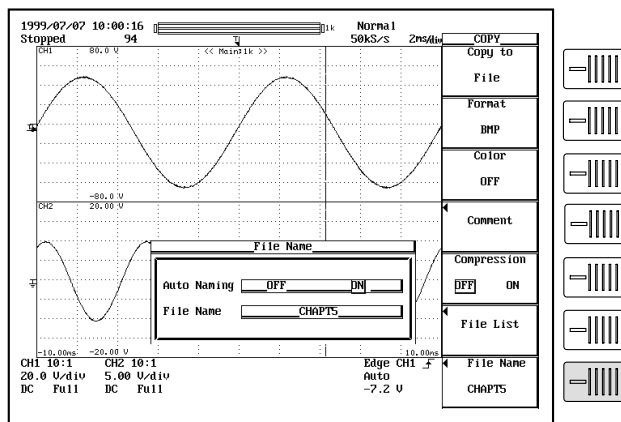

15. Turn the jog shuttle to move the cursor to “Auto Naming.”
16. Press the “SELECT” key to select “ON” or “OFF.”
17. Turn the jog shuttle to move the cursor to “File Name.”
18. Pressing the “SELECT” key displays a keyboard. Enter the file name using up to eight characters according to the procedures given on page 4 - 2. If you turned ON the auto naming function, the first five characters are valid.

Executing the output

19. Pressing the “COPY” key outputs a hard copy of the screen. Pressing the “COPY” key aborts the output.

11.1 Floppy Disks

Floppy Disks that can be Used

The following types of 3.5-inch floppy disk can be used. Floppy disks can be formatted on this instrument.

2HD : 1.2 MB or 1.44 MB (MS-DOS format)

2DD : 640 KB or 720 KB (MS-DOS format)

Inserting a floppy disk into the drive

Hold the floppy disk with the label facing up, and insert it with the shutter section facing the drive. Insert the floppy disk until the eject button pops out.

Removing the floppy disk from the drive

Check that the access indicator is not lit, then press the eject button.

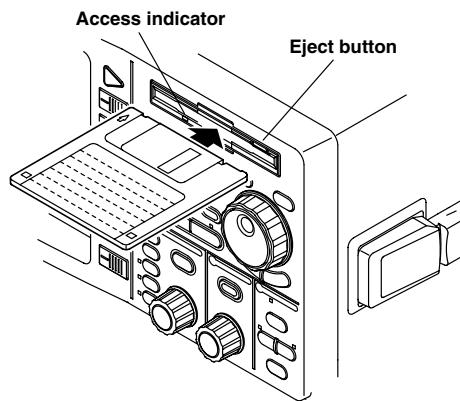

CAUTION

Removing the floppy disk while the access indicator is lit can damage the drive's magnetic head or destroy the data on the disk.

General handling precautions

For general handling precautions, see the instruction that came with the floppy disk.

11.2 PC Card (Optional)

PC Cards that can be Used

The following types of cards can be used .

Flash ATA Cards (PC Card TYPEII)

Compact Flash (Using the adapter for PC Card TYPEII)

For details, purchase more from your dealer or YOKOGAWA sales offices listed on the back cover of this manual.

Note

You must use a PC card-compatible PC when using a PC card. Also, the PC cards listed above may not work properly depending on the type of computer you are using. Please check compatibility before working with PC cards.

Inserting the PC Card

Insert the PC Card face up into the PC Card slot. The PC Card slot is located on the back of the instrument.

Removing the PC Card

After confirming that the PC Card is not being accessed, press the PC Card eject button next to the PC Card slot.

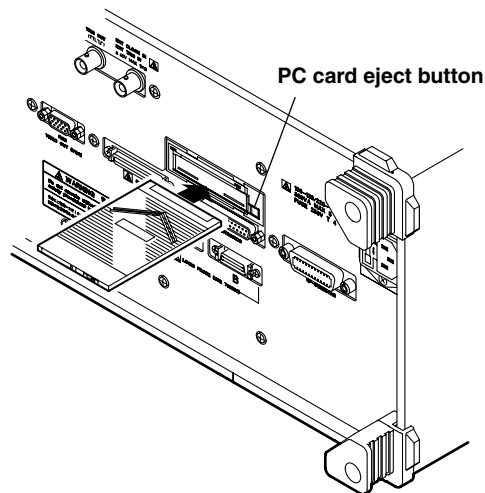

CAUTION

- Wait at least 1 second after inserting the card before removing it. Removing the card too quickly may cause damage to the instrument.
 - Removing the PC Card while this instrument access the PC Card can destroy the data on the disk.
-

11.3 Connecting MO Disk Drives or Hard Disks to the SCSI Port

SCSI Specifications

Item	Specification
Interface standard	SCSI (Small Computer System Interface), ANSI X3.131-1986
Connector type	50-pin half pitch (pin type)
Connector pin assignments	Unbalanced (single-ended), see below

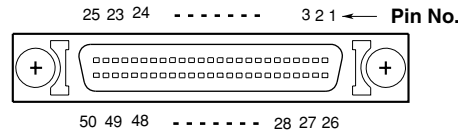

Pin No.	Signal	Pin No.	Signal
1 to 12	GND	38	TERMPWR
13	NC	39, 40	GND
14 to 25	GND	41	-ATN
26	-DB0	42	GND
27	-DB1	43	-BSY
28	-DB2	44	-ACK
29	-DB3	45	-RST
30	-DB4	46	-MSG
31	-DB5	47	-SEL
32	-DB6	48	-C/D
33	-DB7	49	-REQ
34	-DBP	50	-I/O
35 to 37	GND		

Items necessary for connection

Cable

Use a commercially sold cable that is 3 m or less in length, that has a ferrite core on each end of the cable, and that has a characteristic impedance between 90 and 132 Ω.

Connection procedure

1. Connect the SCSI cable to the SCSI connector on the rear panel of the instrument.
2. Turn ON the SCSI device and the instrument (in that order).
If you need to format the medium, follow the procedures given in the next section 11.4, "Formatting the Recording Medium."

SCSI devices that can be connected

Most SCSI devices (MO disk drive and hard disk) can be connected to the instrument, but there are some exceptions.

For details on which devices can be connected, please ask your YOKOGAWA dealer.

For general handling precautions for the connected SCSI device, see the instruction manual that is provided with the device.

Note

- When connecting multiple SCSI devices in a chain, attach a SCSI terminator to the device at the other end of the chain.
- Hard disks (including the internal hard disk) that are formatted with the instrument cannot be read using the NEC PC-9800 Series computers.

11.4 Formatting the Recording Medium

CAUTION

- Never remove the medium (disk) or turn OFF the power while the access indicator or the floppy disk icon is blinking. This can damage the medium or destroy the data on the medium.
 - When the instrument cannot read a pre-formatted medium, reformat the formatting the medium. All data will be erased.
-

Function

Formatting a floppy disk

When using a new floppy disk, you must format it first. Select the appropriate format for the floppy disk from the following choices.

2DD 640K

Formats the 2DD floppy disk to 640 KB/8 sectors.

2DD 720K

Formats the 2DD floppy disk to 720 KB/9 sectors.

2HD 1.2M

Formats the 2HD floppy disk to 1.2 MB/8 sectors.

2HD 1.44M

Formats the 2HD floppy disk to 1.44 MB/18 sectors.

Formatting PC Card (optional)

Use IBM compatible formatting.

Formatting a disk

The formats of media connected via SCSI (option) are as follows.

MO/PD

Semi-IBM format. Handled as removable disk.

Zip/JAZ

Hard disk format. Handled as fixed disk.

Hard disk format

The hard disk format is IBM compatible.

Selecting the format mode

When formatting a medium in an external SCSI device, the following format modes are available.

Normal

Executes physical format and logical format.

Quick

Executes only the logical format.

Selecting the number of partitions

You can set partitions on the external SCSI device or PC Card (optional), except for removable disk.

The number of partitions can be selected from the range 1 to 5.

Information about the medium

The following information is listed for the selected medium.

Media Name : Name of the medium
Media Size : Total capacity
Used Space : Used space
Vacant Space : Free space
Partition Size : Number of partitions

Note

- Formatting a medium containing data erases the data completely.
 - The time it takes to format a floppy disk is approximately one and a half minutes.
 - A floppy disk cannot be formatted if it is write protected.
 - Never format when the instrument is connected to a PC via a SCSI cable.
 - Floppy disks having a format other than the ones listed in this section cannot be used.
 - If an error message appears after the format operation, the floppy disk may be damaged.
 - Disks formatted to MS-DOS format on a PC can also be used.
 - The Quick (logical) format only clears (initializes) the directory entry and FAT information. If you need to check for bad sectors, do a physical format (Normal).
 - When data are written to an external SCSI device that has bad sectors, access error (604 Media failure) may occur in which case no more data can be written. When you are using a medium for the first time or if the medium can no longer be read, do a "Normal" format. If you want to format a disk that you have been using before, do a "Quick" format.
 - This function can not be used in conjunction with FTP server function, FTP client function, or LPR client function.
-

Operating Procedure

1. Press the "FILE" key.
2. Press the "Utility" soft key to display the utility setting menu and the file list dialog box.

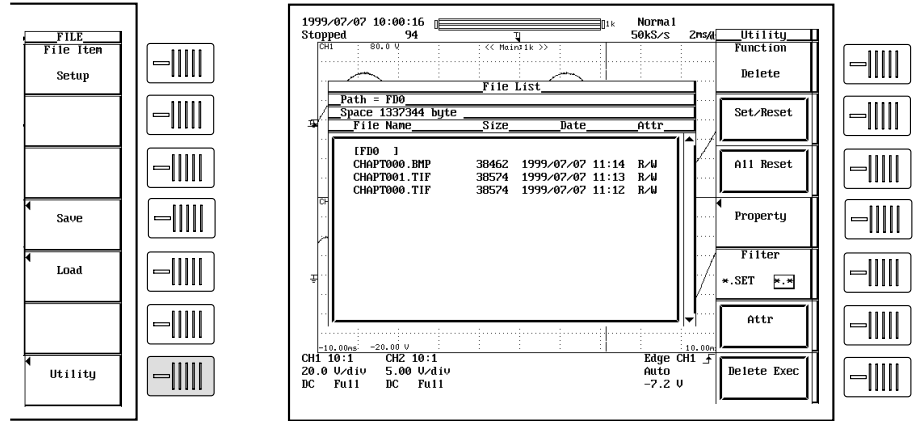

Selecting the medium to be formatted

3. Press the "Function" soft key to display the file function menu.
4. Press the "Format" soft key to display a list of media in the file list dialog box. ("Net Drive" cannot be formatted.)
5. Turn the jog shuttle to select the medium to be formatted.
If no external SCSI devices are detected and only the floppy disk is inserted in the drive, only "FDD" is displayed.

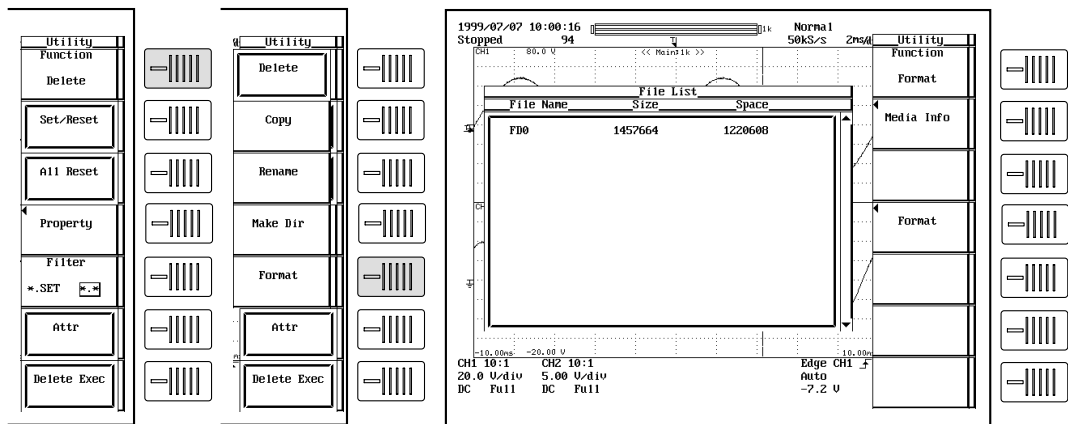

Selecting the FD format

6. Press the "Format" soft key to display the format menu.
 7. Turn the jog shuttle to select a format from "2DD 640K" to "2HD 1.44M."
- Go to step 9.

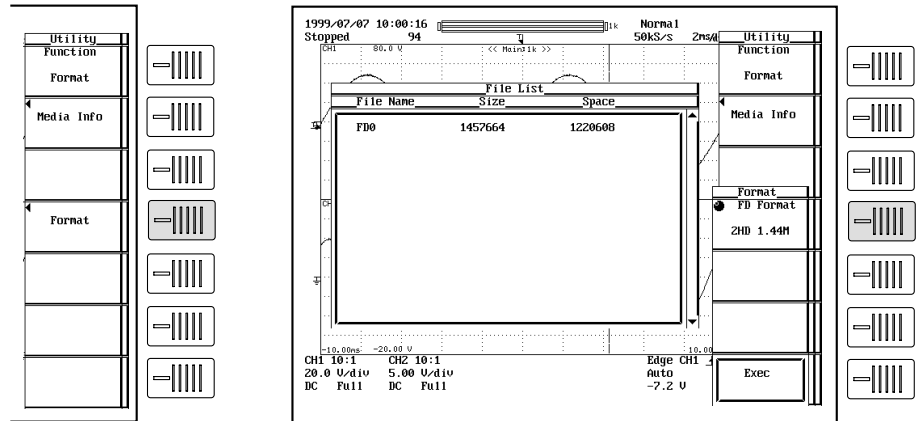

Selecting the format type for the SCSI device/PC Card (optional)

6. Press the "Format" soft key to display the format menu.

Selecting the number of partitions

7. Turn the jog shuttle to select a value from "1" to "5."

Selecting the format type

8. Press the "Format Type" soft key to select "Normal" or "Quick."

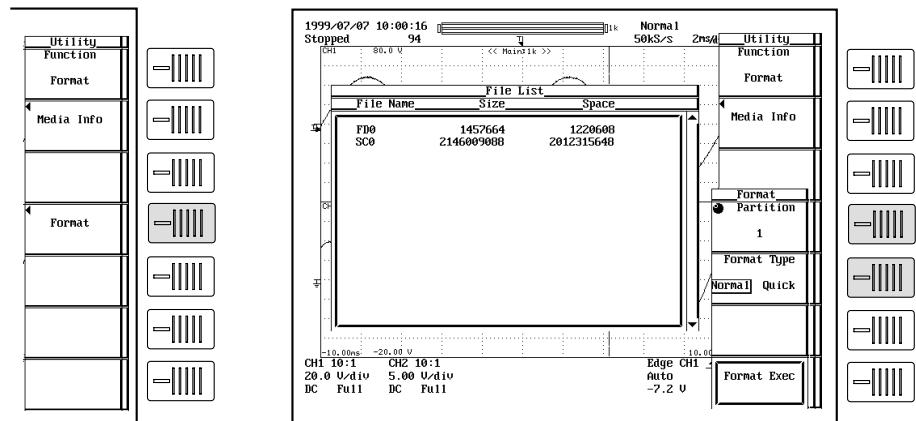

Executing/Canceling the format operation (OK/Cancel)

9. Pressing the “Exec” soft key displays the alert dialog box.
10. Turn the jog shuttle to select “OK” or “Cancel.”
11. Select “OK” and press the “SELECT” key to start the format operation.
Selecting “Cancel” and pressing the “SELECT” key cancels the format operation.

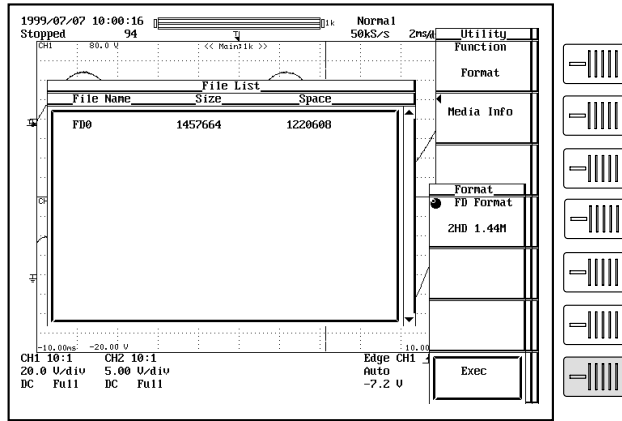

Viewing the media information

Follow steps 1 – 5 on page 11 – 6 to Select a media.

6. Press the “Media Info” soft key to display information about the medium that was selected in step 5.

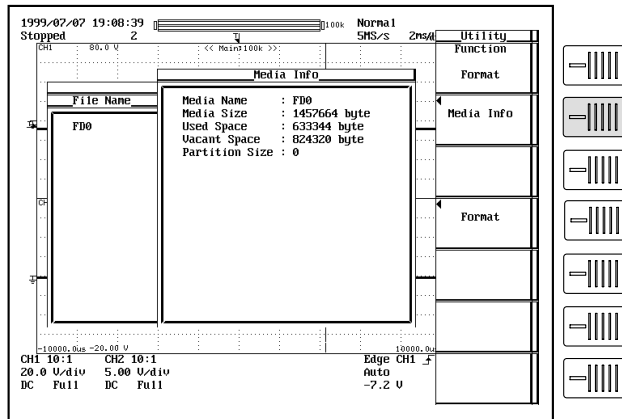

11.5 Changing the SCSI ID Number

Function

The SCSI ID number is used to distinguish between the various devices connected to the SCSI chain. Make sure not to use duplicate ID numbers on any of the connected devices.

Range of SCSI ID numbers

Select this instrument's ID (Own ID) from the range 0 to 7. The default ID is 7.

Note

- Assign numbers that are different from the ID numbers of the external SCSI devices attached to the instrument.
- When changing the SCSI ID number, make sure to press the "Initialize SCSI" soft key.
- The SCSI ID numbers of external SCSI devices are automatically detected at power up.
- If an ID number is changed, make sure to execute "Initialize SCSI" in order to detect the new ID number.

Operating Procedure

1. Press the "MISC" key.
2. Pressing the "SCSI ID" soft key displays the SCSI number setting menu.
3. Press the "Own ID" soft key.
4. Turn the jog shuttle to select a value from "0" to "7."
5. Press the "Initialize SCSI" soft key. The ID number is changed to the new number.

An icon blinks at the upper right of the screen while the change is being made. When the change is complete, the icon disappears.

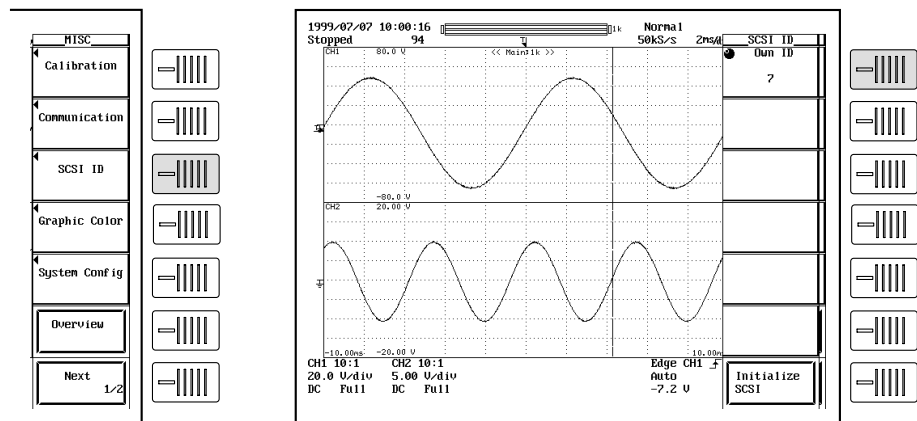

11.6 Saving/Loading Waveform Data

Function

CAUTION

Never remove the medium (disk) or turn OFF the power while the access indicator or the floppy disk icon is blinking. This can damage the medium or destroy the data on the medium.

Selecting the data type, file extension, data size

Binary

- The sampled data in the acquisition memory are saved in binary format.
- The data that are saved can be loaded to display the waveform and compute numerical data.
- A header file is automatically created. The header file is used when analyzing the waveform on a PC. The header file cannot be opened using this instrument. For the header file format, see Appendix 3, "ASCII Header File Format."
- The file extension is ".WVF." The file extension of the header file is ".HDR."
- When saving waveform data in binary format, a header file is automatically created with the extension ".HDR." When the DL7200 is used to copy, delete, change filenames, or change file ownership of waveform data files (files with the extension, ".WVF"), the header files are automatically updated to reflect the changes. Do not delete the header file only or the waveform data file only as this may cause a system malfunction.

ASCII

- The sampled data in the acquisition memory are saved in ASCII format. The data can be used to analyze the waveform on a PC.
- Data in this format cannot be loaded on this instrument.
- The file extension is ".CSV."

Float

- The sampled data in the acquisition memory are saved in 32-bit floating point format. The data can be used to analyze the waveform on a PC.
- Data in this format cannot be loaded on this instrument.
- The file extension is ".FLD."

Data size

The following list shows the data size when the record length is set to 100 kword, waveform data of CH1 to CH4 are saved, and MATH1 and MATH2 are turned OFF

Data Type	Extension	Data Size (Bytes)
Binary	.WVF	Approx. 800 K ((100 kWord + 32) × 4 channels × number of history waveform × 2)
	.HDR	Approx. 2 K (approx. 3 K if Math1 and Math2 are ON.)
ASCII	.CSV	Approx. 6 M (depends on the input signal condition.) It takes more than 10 minutes to save the file.
Float	.FLD	Approx. 1.6 M ((100 kWord + 32) × 4 channels × number of history waveform × 4)

Selecting the waveform to be saved

- You can save all waveforms or the specified waveforms from CH1 to CH4, Math1, Math2, Pod A, and Pod B.
- The vertical and horizontal axes and trigger settings of the waveform being saved are also saved.
- For waveforms that are loaded using the history memory function, you can select whether to save all of the history data or just the current displayed waveform on the screen.
- You can also save only the search results of the data in the history memory. For details regarding data search of the history memory, see sections 7.8 to 7.9.
- For snap shot waveforms, see section 11.8, “Saving the Snap Shot Waveforms.”

Selecting the range of the waveform to be saved

Select the range (region) of the waveform from the following list of choices. Only the data that have been saved by selecting “Binary” in the earlier section “Selecting the data type, file extension, data size” can be loaded in this instrument.

- **Main**
The range of the normal (Main) waveform. It is the range defined by the displayed record length (range displayed on the screen).
- **Z1**
The range of zoom waveform Z1.
- **Z2**
The range of zoom waveform Z2.
- **Z1 & Z2**
The range of zoom waveform Z1 & Z2.

Data compression

- You can select whether or not to P-P compress the waveform data before saving.
- Data that are saved using P-P compression cannot be loaded.
- Power spectrum computation data cannot use P-P compression.

Selecting the medium and directory

The recording media that can be used to save and load waveform data are displayed in the File List dialog box.

Display example of recording media

“FD0” : Floppy disk

“SC5” : SCSI device with an ID number of 5

“SC5_1” : Partition 1 of the SCSI device with an ID number of 5

“CA0” : PC Card

“CA0_1” : Partition 1 of PC Card

File name and comments

- You must specify a file name. Comments can be omitted.
- You cannot save to a file name that is already in use in the same directory (no overwriting).

Number and types of characters that can be used

Item	Number of characters	Characters that can be used
File name	1 to 8 chars.	0 to 9, A to Z, %, _, () (parenthesis), -(minus sign)
Comment	0 to 25 chars.	All characters (including spaces),

Auto naming function

When "Auto Naming" is turned ON, files with three digit numbers from 000 to 999 are automatically created. Specify the common name (maximum of five characters, specify at the Filename item) that is placed before the three digit number.

Specifying the files to display in the File List dialog box

You can specify the type of files to display.

- `"*.WVF," "*.CSV," or "*.FLD"`
Displays only the files that have the same file format as the file being saved.
- `*.*`
Displays all files on the medium.

Properties

Lists the file name extension, file size, the date it was saved, the attributes, and the comment for the selected file.

Unload

If the loaded waveform is being displayed, newly acquired waveform is not displayed even if the data acquisition is started. In order to display the newly acquired waveforms, loaded data must be unloaded from the appropriate channels.

Note

- You cannot save or load while the data acquisition is in progress.
 - If you change the file extension on a PC, for an example, you will not be able to load that file.
 - A maximum of 36 characters can be displayed in "Path."
 - File names are not case sensitive. Comments are case sensitive. In addition, the following file names cannot be used due to limitations of MS-DOS.
AUX, CON, PRN, NUL, CLOCK
 - When using the GP-IB or serial interface (RS-232) commands to enter a file name, the following symbols that do not exist on the keyboard of this instrument can be used.
! # \$ ' - ^ @ ~ { }
 - The waveform data loaded from a file overwrites the data in the acquisition memory. Once the memory is overwritten, the old data cannot be recovered. It is recommended that the current waveform data be saved before loading data from a file.
 - Loaded waveforms are cleared only if "Unload," "Initialize," or "Auto Setup" is executed or the data acquisition conditions are changed.
 - When the total number of files and directories in one directory exceeds 2400, the file list will no longer be displayed.
 - This function can not be used in conjunction with FTP server function, FTP client function, or LPR client function.
-

Data format when storing multiple records

When multiple records are stored (history memory, for example), the following data format is used.

ASCII format: CR+LF is inserted between records.

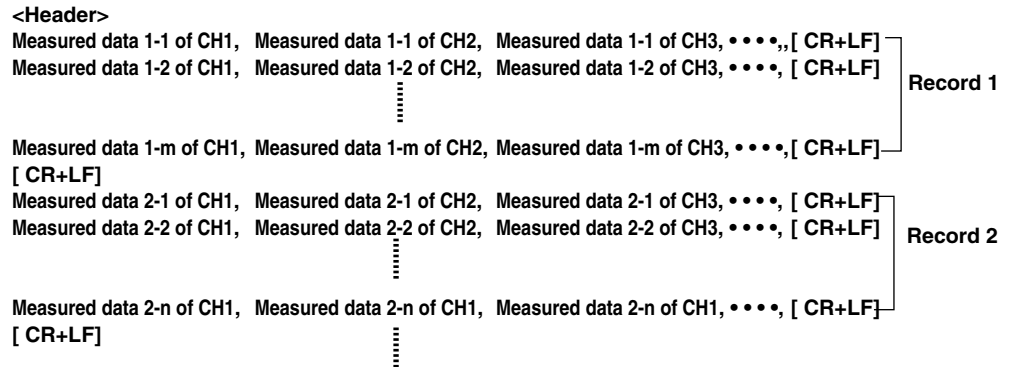

Float format: Stored in blocks of channels.

Measured data of record 1 of CH1
Measured data of record 2 of CH1
⋮
Measured data of record N of CH1
Measured data of record 1 of CH2
Measured data of record 2 of CH2
⋮
Measured data of record N of CH2
⋮

Operating Procedure

1. Press the FILE key.
2. Press the “File Item” soft key to display the file time setting menu.
3. Press the soft key corresponding to “Waveform.”

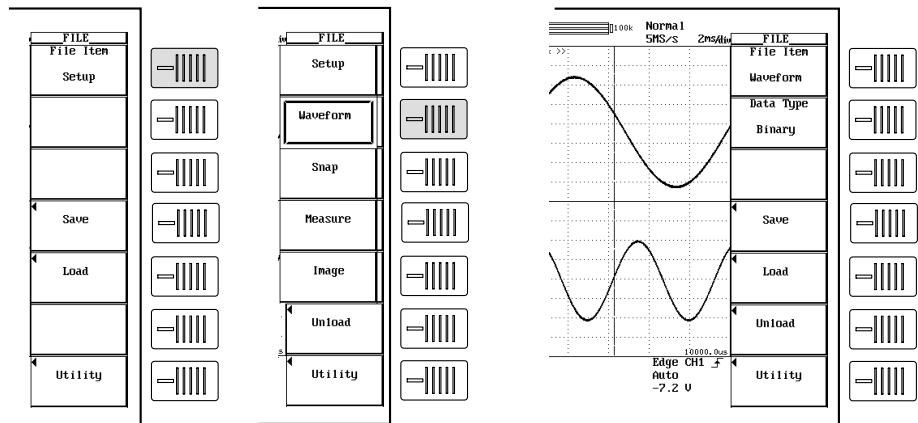

Saving the waveform data

• **Selecting the data type**

4. Pressing the “Data Type” soft key displays the data type menu.
5. Press the one of the soft keys corresponding to “Binary,” “ASCII,” or “Float” to select the data type.

Data saved in “Binary” are only the data that can be loaded as described later in this chapter.

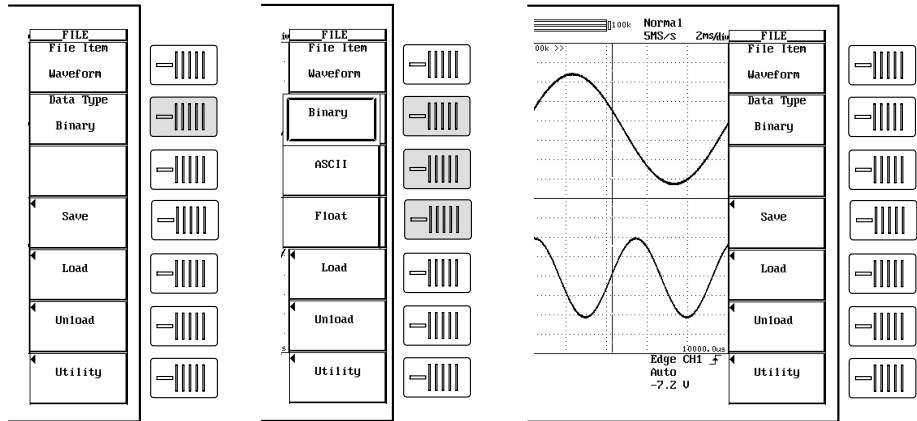

• **Selecting the waveform to be saved.**

6. Pressing the “Save” soft key displays the save setting menu.
7. Pressing the “Trace” soft key displays the waveform menu.
8. Press the soft key corresponding to the channel you wish to save.
Pressing the soft key corresponding to “Next” displays the selections on the next page.

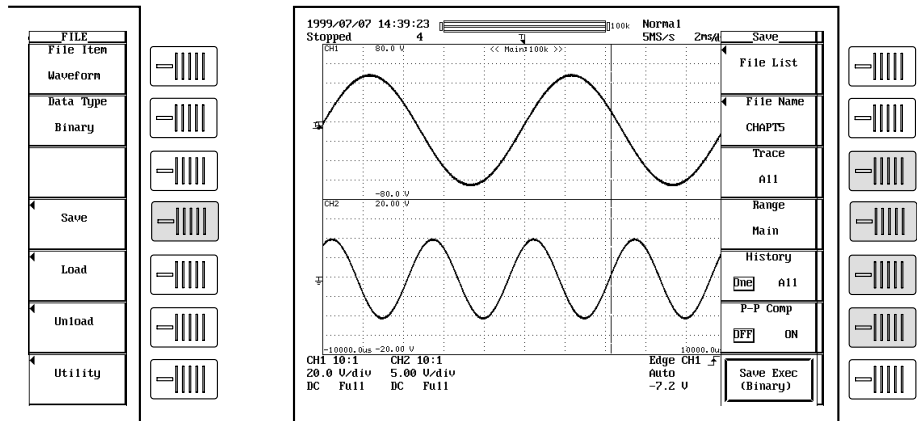

• **Selecting the range of the waveform to be saved**

9. Press the “Range” soft key to display the save range selection menu.
10. Press one of the “Main” to “Z1 & Z2” soft keys to select the range of waveforms to be saved.

Data saved by specifying “Main” are only the data that can be loaded as described later in this chapter.

After searching data in the history memory, selecting “All” stores only the waveforms that are found.

11. Press the “History” soft key to select whether to save all the data in the history memory (All) or only the currently displayed waveform (One).

• **Compressing the data and saving**

12. Press the “P-P Comp” soft key to select “ON” (compress and save) or “OFF” (do not compress and save).

Compressed data cannot be loaded.

If “P-P Comp” is turned ON when saving waveform data, only the maximum and minimum values of the multiple data points existing at the same time position are saved. In this way, the file size can be reduced.

• **Selecting the destination medium/directory**

13. Press the “File List” soft key to display the file list dialog box.
14. Turn the jog shuttle to select the save destination medium (displayed with parentheses).
15. Press the “SELECT” key to confirm the selection.

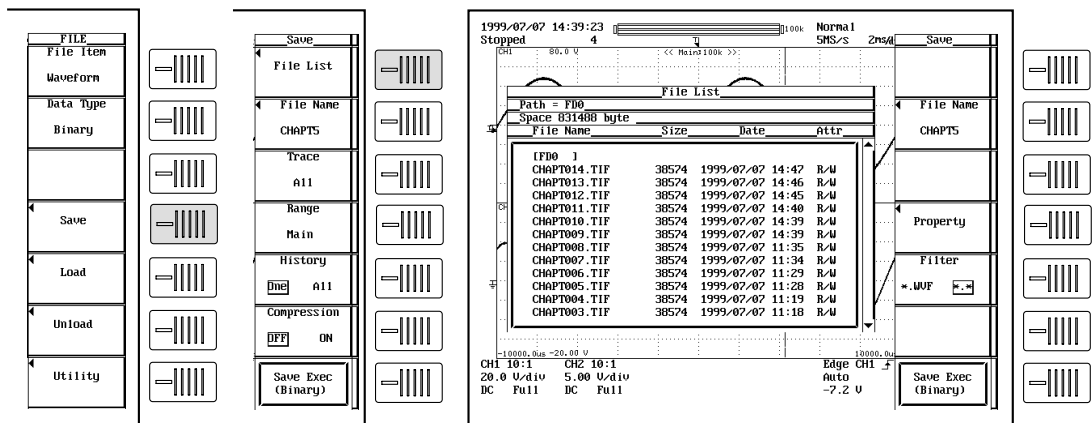

• **Selecting the destination directory**

(Use this only when there are directories on the medium.)

16. Turn the jog shuttle to select the save destination directory (displayed with < >).
17. Press the “SELECT” key to confirm the selection.

The “Path=___” box on the top left corner of the File List dialog box displays the selected medium/directory.

Selecting <..> moves to a higher level directory.

• **Setting the file name/comment**

18. Pressing the “File Name” soft key displays the file name setting menu.

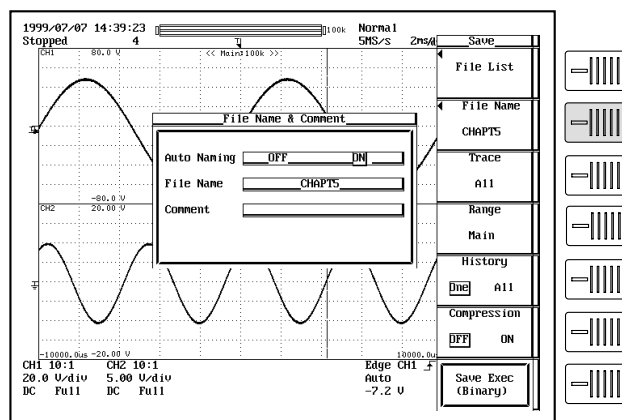

19. Turn the jog shuttle to select “Auto Naming.”
20. Press the “SELECT” key to select “ON” or “OFF.”
21. Turn the jog shuttle to select “File Name.”
22. Press the “SELECT” key to display a keyboard.

11.6 Saving/Loading Waveform Data

23. Enter the file name according to the procedures given in page 4 - 2.
 24. Turn the jog shuttle to select "Comment."
 25. Press the "SELECT" key to display a keyboard.
 26. Enter the file comment according to the procedures given in page 4 - 2.
 27. Press the ESC key to close the file name setting dialog box.
- **Saving the file**
 28. Press the "Save Exec" soft key to save the file to the directory indicated in "Path=___." The name of the "Save Exec" soft key changes to "Abort."

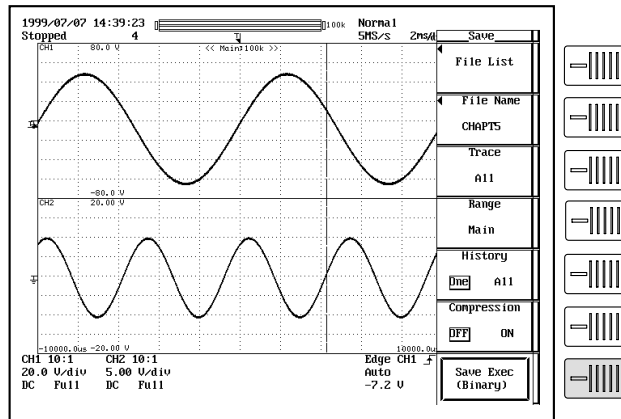

- **Canceling the saving operation**
 29. Press the "Abort" soft key to cancel the save operation. The name of the "Abort" soft key changes to "Save Exec."
- **Specifying the file to be displayed in the File List dialog box and viewing its properties**
 30. In the File List dialog box, press the "Filter" soft key to select "*.extension" or "* * *".
 31. In the File List dialog box, turn the jog shuttle to select the desired file.
 32. Press the "Property" soft key to display the properties of the selected file.
 33. Press the "ESC" key to close the window displaying the properties.

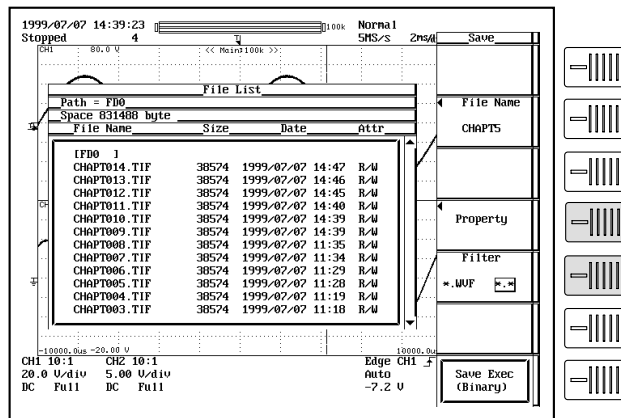

Loading the waveform data

Set the data type to “Binary.” For the procedures, see steps 4 and 5 in the section “Saving the Waveform Data” on page 11 - 14.

- Pressing the “Load” soft key displays the load setting menu and the file list dialog box.

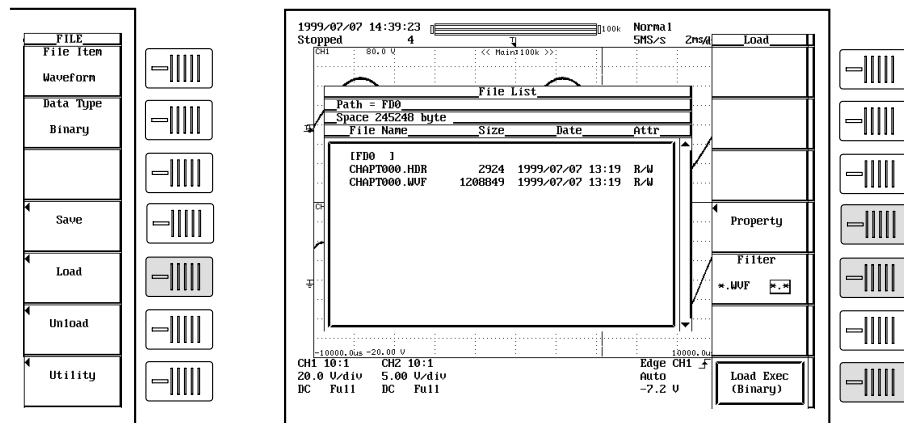

- **Selecting the source medium/directory**

- Select the directory according to steps 13 to 17 on page 11 - 15.

- **Selecting the file to be loaded**

- Turn the jog shuttle to select a file.

- **Loading the file**

- Press the “Load Exec” soft key to load the file from the directory indicated in “Path=___.” The name of the “Load Exec” soft key changes to “Abort.”

- **Canceling the loading operation**

- Press the “Abort” soft key to cancel the loading operation. The name of the “Abort” soft key changes to “Load Exec.”

- **Specifying the file to be displayed in the File List dialog box, viewing the properties**

The procedures are the same as steps 30 and 31 on page 11 - 16.

Unloading waveforms

- Continuing from step 5 in “Saving the waveform data,” press the “Unload” soft key to display the Unload menu.
- Pressing the “Trace” soft key displays a menu used to select the channels to be unloaded.
- Press the soft key corresponding to the desired channel to select the channel. If “All” is selected, all channels are unloaded.
- Press the “Unload Exec” soft key to display a confirming message.
- Select “OK” using the jog shuttle and press the “SELECT” key to execute the unload operation. The display does not change. However, when data acquisition is started, the waveform is updated.

11.7 Saving/Loading Setup Data

Function

CAUTION

Never remove the medium (disk) or turn OFF the power while the access indicator or the floppy disk icon is blinking. This can damage the medium or destroy the data on the medium.

Setup data that are saved

The setup data of each key existing at the time of the saving operation are saved. However, date and time, communication parameters, and SCSI ID numbers are not saved.

Number of bytes necessary in saving the setup data

Approx. 13 Kbytes

Selecting the medium and directory

The recording media that can be used to save and load waveform data are displayed in the File List dialog box.

- **Display example of recording media**

- “FD0” : Floppy disk
- “SC5” : SCSI device with an ID number of 5
- “SC5_1” : Partition 1 of the SCSI device with an ID number of 5
- “CA0” : PC Card
- “CA0_1” : Partition 1 of the PC Card

File name and comments

You must specify a file name. Comments can be omitted.

You cannot save to a file name that is already in use in the same directory (no overwriting).

Number and types of characters that can be used

Item	Number of chars.	Characters that can be used
File name	1 to 8 chars.	0 to 9, A to Z, %, _, () (parenthesis), -(minus sign)
Comment	0 to 25 chars.	All characters (including spaces),

- **Notes when saving setup data**

You cannot save while the data acquisition is in progress. Press the START/STOP key to stop the acquisition.

The maximum number of files that can saved to one directory is 1000.

File name extension

The File name extension “.set” is automatically appended to the file.

Auto naming function

When “Auto Naming” is turned ON, files with three digit numbers from 000 to 999 are automatically created. Specify the common name (maximum of five characters, specify at the Filename item) that is placed before the three digit number.

Specifying the files to display in the File List dialog box

You can specify the type of files to display.

- *.SET
Displays only the setup data files.
- *.*
Displays all files on the medium.

Properties

Lists the file name.extension, file size, the date it was saved, the attributes, and the comment for the selected file.

Note

- You cannot save or load while the data acquisition is in progress.
- If you change the file extension on a PC, for an example, you will not be able to load that file.
- A maximum of 36 characters can be displayed in "Path."
- File names are not case sensitive. Comments are case sensitive. In addition, the following file names cannot be used due to limitations of MS-DOS.
AUX, CON, PRN, NUL, CLOCK
- When using the GP-IB or serial interface (RS-232) commands to enter a file name, the following symbols that do not exist on the keyboard of this instrument can be used.
! # \$ ' - ^ @ ~ { }
- When the setup parameters are loaded from a file, the setup parameters of each key are overwritten with the loaded settings and cannot be set back to their previous settings. It is recommended that the current setup parameters be saved before loading setup parameters from a file.
- The date and time, communication parameters and SCSI ID numbers are not saved. Therefore, when setup parameters are loaded from a file, these parameters do not change.
- When the total number of files and directories in one directory exceeds 2400, the file list will no longer be displayed.
- This function can not be used in conjunction with FTP server function, FTP client function, or LPR client function.

Operating Procedure

1. Press the FILE key.
2. Press the "File Item" soft key to display the file item setting menu.
3. Press the soft key corresponding to "Setup."

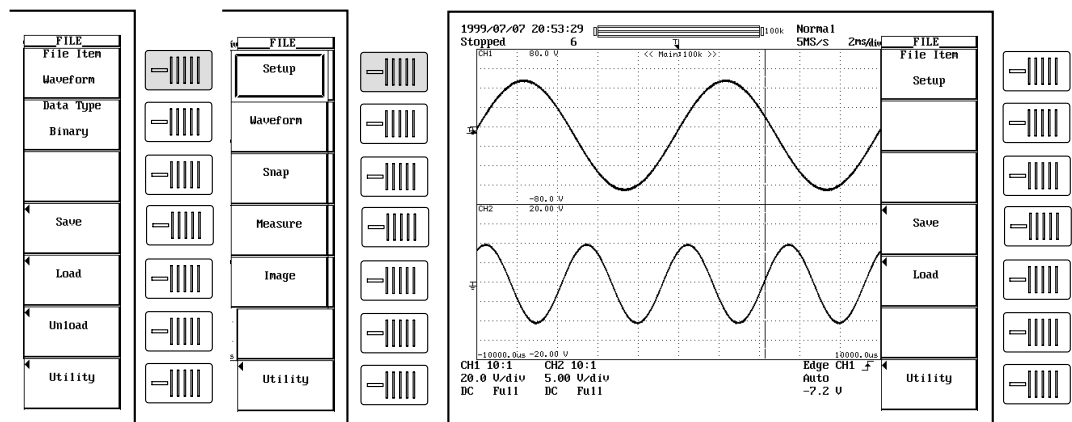

Selecting the setup data

- **Selecting the destination medium**

4. Press the “Save” soft key to display the save setting menu.

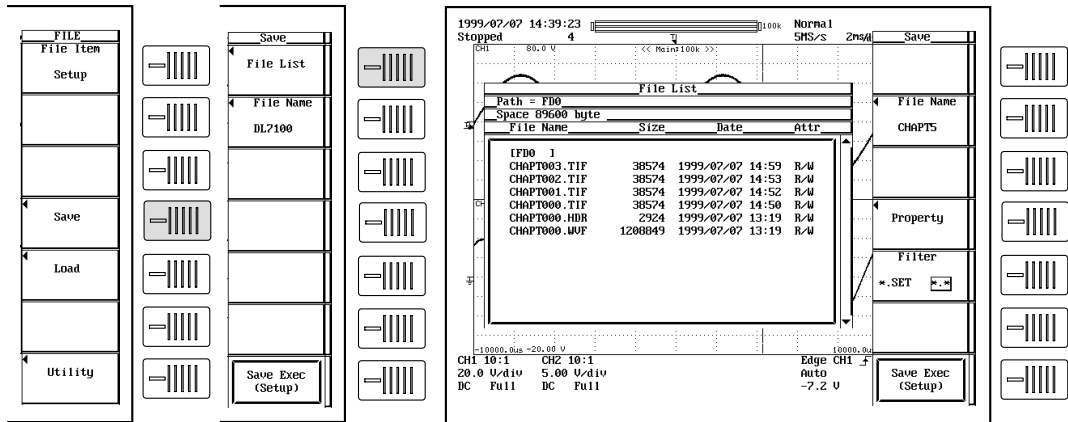

5. Press the “File List” soft key to display the file list dialog box.
6. Turn the jog shuttle to select the save destination medium (displayed with parentheses).
7. Press the “SELECT” key to confirm the selection.

- **Selecting the destination directory**

(Use this only when there are directories on the medium.)

8. Turn the jog shuttle to select the save destination directory (displayed with < >).
9. Press the “SELECT” key to confirm the selection.

The “Path=___” box on the top left corner of the File List dialog box displays the selected medium/directory.

Selecting <..> moves to a higher level directory.

- **Setting the file name/comment**

10. Press the “File Name” soft key to display the file name setting menu.

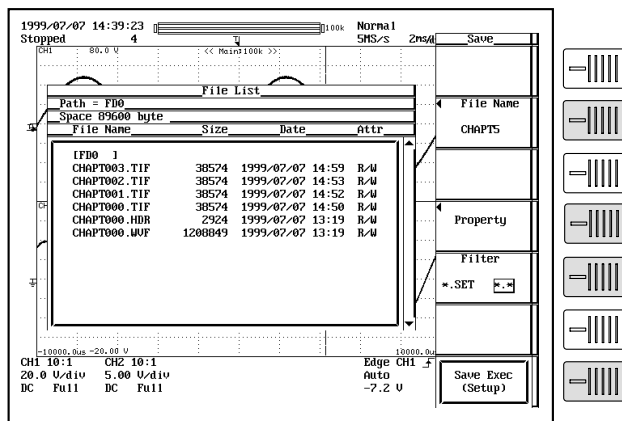

11. Turn the jog shuttle to select “Auto Naming.”
12. Press the “SELECT” key to select “ON” or “OFF.”
13. Turn the jog shuttle to select “File Name.”
14. Press the “SELECT” key to display a keyboard.
15. Enter the file name according to the procedures given in page 4 - 2.
16. Turn the jog shuttle to select “Comment.”
17. Press the “SELECT” key to display a keyboard.
18. Enter the file comment according to the procedures given in page 4 - 2.
19. Press the ESC key to close the file name setting dialog box.

- **Saving the file**
 20. Press the “Save Exec” soft key to save the file to the directory indicated in “Path=___.” The name of the “Save Exec” soft key changes to “Abort.”
- **Canceling the saving operation**
 21. Press the “Abort” soft key to cancel the save operation. The name of the “Abort” soft key changes to “Save Exec.”
- **Specifying the file to be displayed in the File List dialog box, and viewing its properties**
 22. In the File List dialog box, press the “Filter” soft key to select “*.SET” or “*.*.”
 23. In the File List dialog box, turn the jog shuttle to select the desired file.
 24. Pressing the “Property” soft key displays information regarding the selected file.
 25. Pressing the “ESC” key closes the window displaying the information.

Loading the setup data

Display the menu used to save/load setup data according to steps 1 to 3.

4. Press the “Load” soft key to display the load setting menu and the file list dialog box.

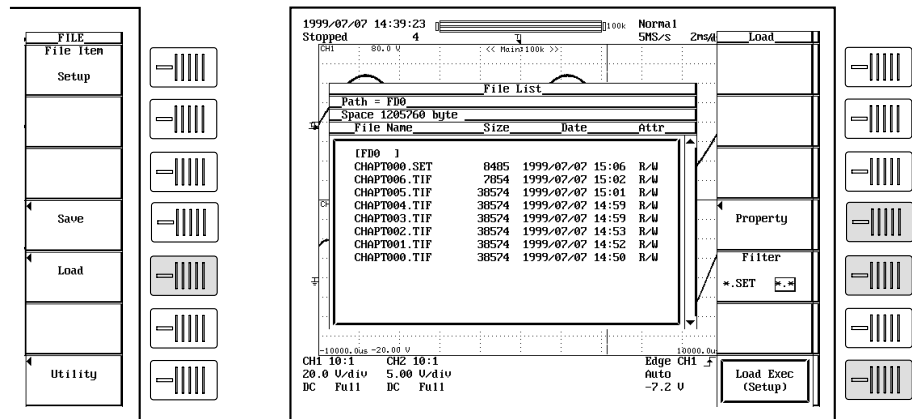

- **Selecting the source medium/directory**
 5. Select the directory according to steps 13 to 17 on page 11 - 15.
- **Selecting the file to be loaded**
 6. Turn the jog shuttle to select a file.
- **Loading the file**
 7. Press the “Load Exec” soft key to load the file from the directory indicated in “Path=___.” The name of the “Load Exec” soft key changes to “Abort.”
- **Canceling the loading operation**
 8. Press the “Abort” soft key to cancel the loading operation. The name of the “Abort” soft key changes to “Load Exec.”
- **Specifying the file to be displayed in the File List dialog box, viewing the properties**

The procedures are the same as steps 21 to 24 on this page.

11.8 Saving Snap Shot Waveforms

Function

CAUTION

Never remove the medium (disk) or turn OFF the power while the access indicator or the floppy disk icon is blinking. This can damage the medium or destroy the data on the medium.

You can take snap shots of the waveform and save the image to the file. You can also load the snap shot waveform.

Data size

Approx. 40 K Bytes

File name extension

The file name extension is “.SNP.”

The selection of the medium and directory, file name, comments, auto naming function, specification of the files to be displayed in the File List dialog box, and properties are the same as those for saving/loading normal waveform data. For explanation and procedures, see section 11.6, “Saving/Loading Waveform Data.”

Clearing the waveform

The loaded snap shot waveform is cleared when unload, initialize, or auto setup is performed.

Note

This function can not be used in conjunction with FTP server function, FTP client function, or LPR client function.

Operating Procedure

1. Press the FILE key.
2. Pressing the “File Item” soft key displays the file item setting menu.
3. Press the soft key corresponding to “Snap.”

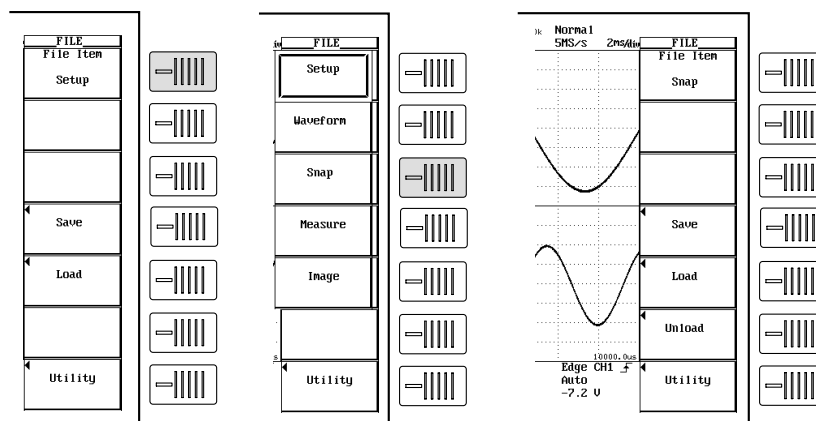

Saving snap shot waveforms

- **Selecting the destination medium/directory**
The procedures are the same as steps 13 to 17 in section 11.6, "Saving/Loading Waveform Data."
- **Setting the file name/comment**
The procedures are the same as steps 18 to 27 in section 11.6, "Saving/Loading Waveform Data."
- **Saving the file**
 4. Press the "Save Exec" soft key to save the file to the directory indicated in "Path=___." The name of the "Save Exec" soft key changes to "Abort."
- **Canceling the saving operation**
 5. Press the "Abort" soft key to cancel the saving operation. The name of the "Abort" soft key changes to "Save Exec."
- **Specifying the file to be displayed in the File List dialog box, viewing the properties**
The procedures are the same as steps 30 to 33 in section 11.6, "Saving/Loading Waveform Data."

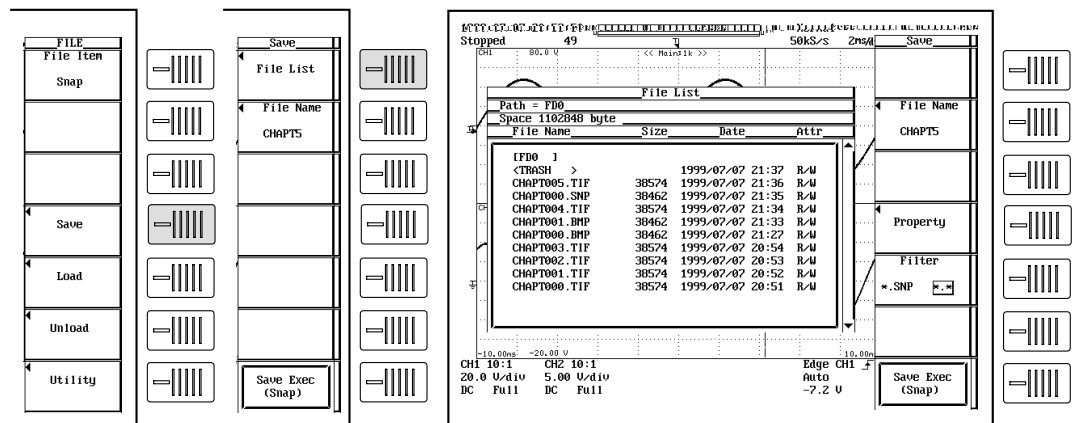

Loading snap shot waveforms

Follow steps 1 - 3 on page 11 - 22 to select snapshot data waveforms.

4. Pressing the "Load" soft key displays the load setting menu and the file list dialog box.

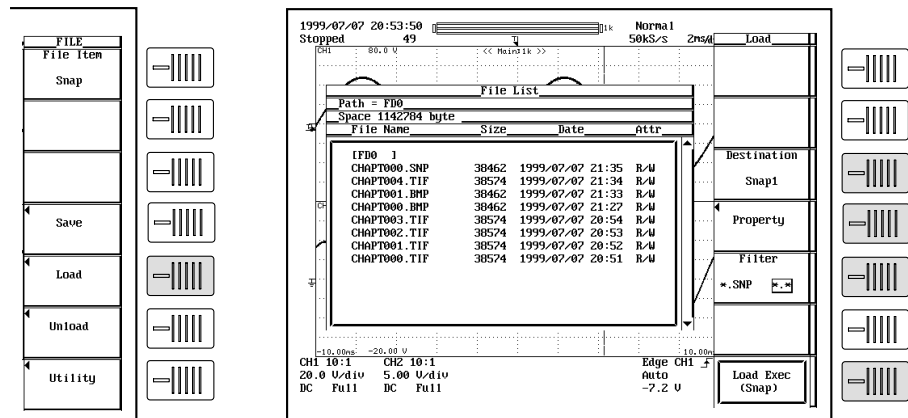

11.8 Saving Snap Shot Waveforms

- **Selecting the source medium/directory**

The procedures are the same as steps 13 to 17 in section 11.6, "Saving/Loading Waveform Data."

- **Selecting the file to be loaded**

5. Turn the jog shuttle to select a file.

- **Selecting the snap shot waveform to be loaded**

6. Press the "Destination" soft key to display a menu used to select the snapshot waveform.

7. Press the soft key corresponding to the desired snapshot waveform to make the selection.

- **Loading the file**

8. Press the "Load Exec" soft key to load the file from the directory indicated in "Path=___." The name of the "Load Exec" soft key changes to "Abort."

- **Canceling the loading operation**

9. Press the "Abort" soft key to cancel the loading operation. The name of the "Abort" soft key changes to "Load Exec."

- **Specifying the file to be displayed in the File List dialog box, viewing the properties**

The procedures are the same as steps 30 to 33 in section 11.6, "Saving/Loading Waveform Data."

Clearing the waveform

4. Press the "Unload" soft key to display a menu used to select the waveform to be cleared.

5. Press the "Trace" soft key and press the soft key corresponding to the waveform to be cleared.

6. Pressing the "Unload Exec" soft key clears the selected waveform.

11.9 Saving the Results of the Automated Measurement of Waveform Parameters

Function

CAUTION

Never remove the medium (disk) or turn OFF the power while the access indicator or the floppy disk icon is blinking. This can damage the medium or destroy the data on the medium.

The results of the automated measurement of waveform parameters can be saved in CSV format (.CSV file extension) to a floppy disk or external SCSI device. A CSV file is a comma-separated format file. The CSV file is one of the common file formats used to exchange data between spreadsheet and database applications. The data that are saved are the measurement results of the parameters that are specified in the automated measurement of waveform parameters.

Notes when saving the results of the automated measurement of waveform parameters

The restrictions are as follows.

- Up to (24000/the number of items that are turned ON) data points before the point at which the save operation is executed are saved. However, the data points that are saved are limited to those that are acquired after fixing Time/div, Volt/div, and Measure settings.

- Output example

```
“DL7100”
“CH1 P-P,” “CH1 Max,” “CH1 Min,” “CH2 P-P”
“V,” “V,” “V,” “V”
0.199E+00, 0.199E+00, 0.000E+00, 0.02E-06      Oldest data
0.207E+00, 0.207E+00, 0.000E+00, 0.02E-06
0.377E+00, 0.152E+00, -0.125E+00, 0.02E-06
. . . . .
. . . . .
. . . . .
. . . . .      Newest data
```

For information related to the automated measurement of waveform parameters, see section 9.2, “Automated Measurement of Waveform Parameters.”

Data size

Data size = Number of item × 15 × number of history waveform

File name extension

The file name extension is “.CSV.”

The selection of the medium and directory, file name, comments, auto naming function, specification of the files to be displayed in the File List dialog box, and properties are the same as those for saving/loading normal waveform data. For explanation and procedures, see section 11.6, “Saving/Loading Waveform Data.”

11.9 Saving the Results of the Automated Measurement of Waveform Parameters

Note

This function can not be used in conjunction with FTP server function, FTP client function, or LPR client function.

Operating Procedure

1. Press the FILE key.
2. Press the "File Item" soft key to display the file item setting menu.
3. Press the soft key corresponding to "Measure."

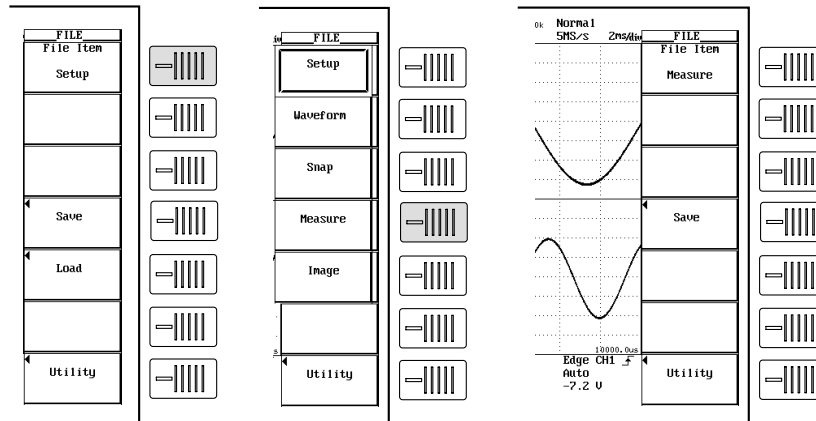

Selecting the destination medium/directory

The procedures are the same as steps 13 to 17 in section 11.6, "Saving/Loading Waveform Data."

Setting the file name/comment

The procedures are the same as steps 18 to 27 in section 11.6, "Saving/Loading Waveform Data."

4. Press the "Save Exec" soft key to save the file to the directory indicated in "Path=___." The name of the "Save Exec" soft key changes to "Abort."

Canceling the saving operation

5. Press the "Abort" soft key to cancel the saving operation. The name of the "Abort" soft key changes to "Save Exec."

Specifying the file to be displayed in the File List dialog box, viewing the properties

The procedures are the same as steps 30 to 33 in section 11.6, "Saving/Loading Waveform Data."

11.10 Outputting the Detailed Analysis List of the SPI Signal

Function

The analysis results of the SPI signal can be output to a file in ASCII format. The contents of the detailed analysis list described in section 8.10, “Analyzing and Searching SPI Signals” can be output to a file as-is. The extension is .txt.

The file size is shown below.

$$\text{File Size} = (\text{number of bytes per data}^{*1} \times \text{number of analysis results}) + 44 \text{ bytes}^{*2}$$

*1 The number of bytes per data varies depending on the data.

- 40 bytes minimum (Data2) For analysis data without CS.
- 44 bytes maximum (CS) For data under multiple CS analysis with CS set to CH4

*2 The data size of the title is 44 bytes.

Operating Procedure

1. Press the FILE key.

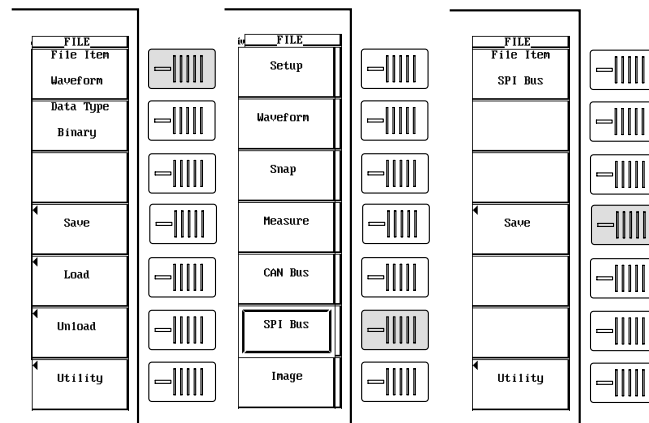

2. Press the “File Item” soft key to display the File Item menu.
3. Press the soft key corresponding to “SPI.”
4. Press the soft key corresponding to “Save.”
5. See steps 13 to 33 in section 11.6, “Saving/Loading Waveform Data.”

11.11 Changing the File Attributes, Deleting Files

Function

CAUTION

Never remove the medium (disk) or turn OFF the power while the access indicator or the floppy disk icon is blinking. This can damage the medium or destroy the data on the medium.

Selecting the medium and directory

The recording media that can be used to save and load waveform data are displayed in the File List dialog box.

Display example of recording media

- "FD0" : Floppy disk
- "SC5" : SCSI device with an ID number of 5
- "SC5_1" : Partition 1 of the SCSI device with an ID number of 5
- "CA0" : PC Card
- "CA0_1" : Partition 1 of PC Card

Selecting the file attributes (excepting Net Drive)

Select the attributes for each file from the following choices.

R/W

Read and write possible.

R

Read only. Cannot write to the file or delete the file.

Selecting the files to be deleted

You can delete all files that have a "*" mark to the left of the file name. There are two methods available to select the files that are to be deleted.

Selecting the files one at a time

Place "*" marks to the left of the file names one at a time, using the "Set/Reset" soft key.

Selecting all files at once

Selecting a file or directory and pressing the "All Set" key places "*" marks on every file in the directory containing the selected file or directory.

Specifying the file to be displayed in the File List dialog box

You can specify the type of files to display.

- *+extension
Displays only the data file that was selected in the File Item setting menu and the data type menu.
- *.*
Displays all the files on the medium.

Properties

Lists the file name.extension, file size, the date it was saved, the attributes, and the comment for the selected file.

Note

- You cannot delete files while data acquisition is in progress
- Deleted data cannot be recovered. Make sure not to erase the wrong files.
- Directories can be deleted if there are no files in them.
- If an error occurs while deleting multiple files, the files after the error will not be deleted.
- Directory attributes cannot be changed.
- This function can not be used in conjunction with FTP server function, FTP client function, or LPR client function.

Operating Procedure

1. Press the FILE key.
2. Press the “Utility” soft key to display the utility setting menu and the file list dialog box.

Selecting the destination medium/directory

The procedures are the same as steps 13 to 17 in section 11.6, “Saving/Loading Waveform Data.”

Changing the file attributes

3. Turn the jog shuttle to select a file.
4. Pressing the “Attr” soft key changes the attribution of the selected file.
5. Pressing the “Function” soft key displays the file function menu.
6. Press the soft key corresponding to “Delete.”

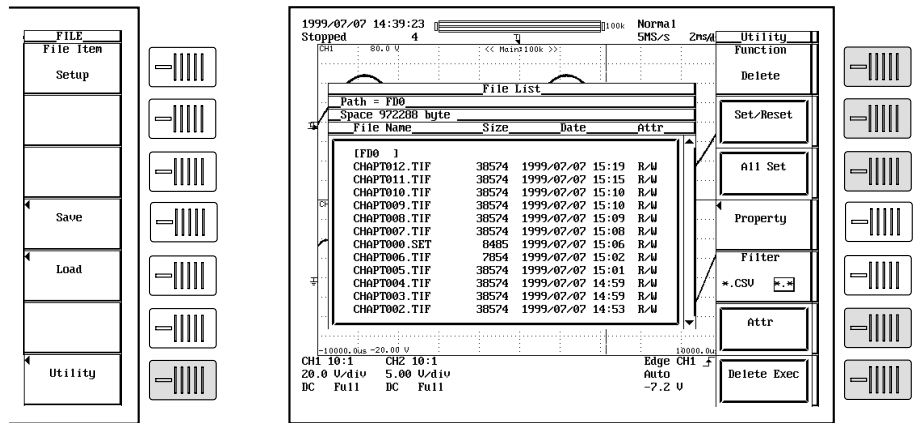

Selecting the files to be deleted one at a time

7. Turn the jog shuttle to select a file.
8. Pressing the “Set/Reset” key places “*” marks to the left of the selected file. The file will be deleted. Then pressing the “Set/Reset” key again removes “*” marks to the left of the selected file. The file will not be deleted.

11.11 Changing the File Attributes, Deleting Files

Selecting all files to be deleted

9. Turn the jog shuttle to select a file, a directory, or a medium.
10. Press the "All Set" key to place "*" marks to the left of every file in the directory containing the selected file or directory. These files will be deleted. The name of the "All Set" soft key changes to "All Reset."
11. Pressing the "All Set" key removes "*" marks to the left of every file in the directory containing the selected file or directory. These files will not be deleted. The name of the "All Reset" soft key changes to "All Set."

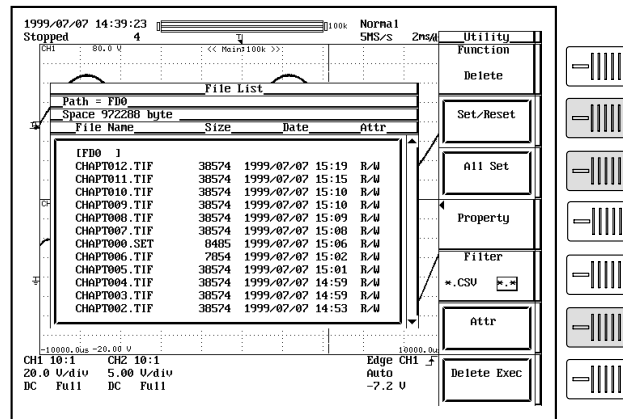

Deleting the files

12. Press the "Delete Exec" soft key. All files with the "*" marks are deleted.

Specifying the file to be displayed in the File List dialog box, viewing the properties

The procedures are the same as steps 30 to 33 in section 11.6, "Saving/Loading Waveform Data."

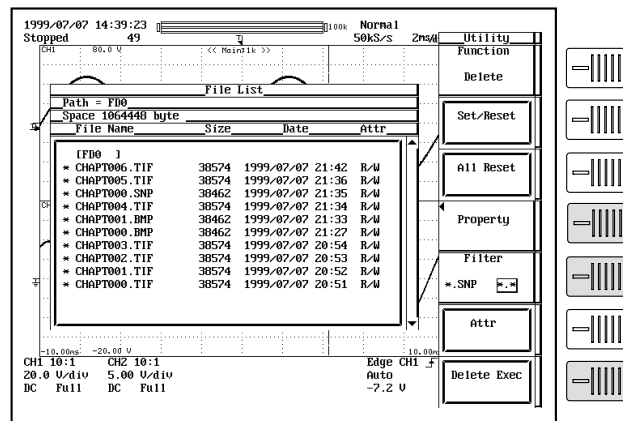

11.12 Copying Files

Function

CAUTION

Never remove the medium (disk) or turn OFF the power while the access indicator or the floppy disk icon is blinking. This can damage the medium or destroy the data on the medium.

Selecting the copy source files

You can copy all files that have a "*" mark to the left of the file name. There are two methods available to select the files that are to be copied.

Selecting the files one at a time

Place "*" marks to the left of the file names one at a time, using the "Set/Reset" soft key.

Selecting all files at once

Selecting a file or directory and pressing the "All Set" key places "*" marks on every file in the directory containing the selected file or directory.

Specifying the file to be displayed in the File List dialog box

You can specify the type of files to display.

- *+extension

Displays only the data file that was selected in the File Item setting menu and the data type menu.

- *.*

Displays all the files on the medium.

Properties

Lists the file name.extension, file size, the date it was saved, the attributes, and the comment for the selected file.

Note

- You cannot copy files while the data acquisition is in progress.
 - If an error occurs while copying multiple files, the files after the error will not be copied.
 - Directory attributes cannot be changed.
 - If a file with the same name exists at the destination, copying is not allowed.
 - You cannot copy the same files to another directory immediately after copying those files. You must again select the files you wish to copy.
 - This function can not be used in conjunction with FTP server function, FTP client function, or LPR client function.
-

Operating Procedure

1. Press the FILE key.
2. Press the "Utility" soft key to display the utility setting menu and the file list dialog box.
3. Press the "Function" soft key to display the file function menu.
4. Press the soft key corresponding to "Copy."

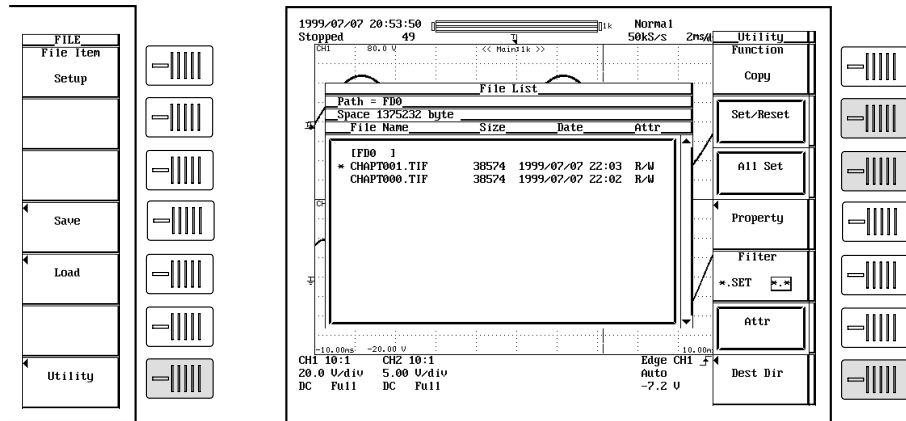

Selecting the source medium/directory

5. The procedures are the same as steps 13 to 17 in section 11.6, "Saving/Loading Waveform Data."

Selecting the source file one at a time

6. Turn the jog shuttle to select a file.
7. Press the "Set/Reset" soft key. If an "*" mark is displayed to the left of the file name in the File List dialog box, the file will be copied. If you press the "Set/Reset" soft key, the "*" mark to the left of the file name disappears. This file will not be copied. Go to step 11.

Selecting all copy source files at once

8. Turn the jog shuttle to select a file, a directory, or a medium.
9. Pressing the "All Set" soft key places "*" mark to the left of every file in the directory containing the selected file or directory. These directories and files will be copied. The name of the "All Set" soft key changes to "All Reset."

Resetting all selected copy source

10. Pressing the "All Set" soft key removes "*" marks to the left of every file in the directory containing the selected file or directory. The directories and files will not be copied. The name of the "All Reset" soft key changes to "All Set."

Selecting the copy destination

11. Press the "Dest Dir" soft key. The copy execution menu and the copy destination file list dialog box appear.

Selecting the destination medium/directory

12. The procedures are the same as steps 13 to 17 in section 11.6, "Saving/Loading Waveform Data."

Executing the copy operation

13. Press the “Copy Exec” soft key to copy all source files that have “*” marks.

Specifying the file to be displayed in the File List dialog box and viewing its properties

The procedures are the same as steps 30 to 33 in section 11.6, “Saving/Loading Waveform Data.”

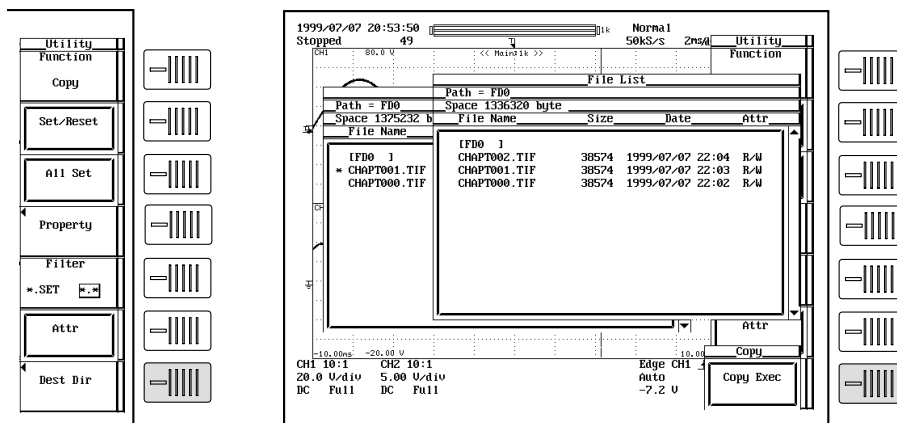

11.13 Changing the Recording Medium, Directory Name, and File Name and Creating a Directory

Function

CAUTION

Never remove the medium (disk) or turn OFF the power while the access indicator or the floppy disk icon is blinking. This can damage the medium or destroy the data on the medium.

Selecting the medium and directory

The recording media that can be used to save and load waveform data are displayed in the File List dialog box.

Display example of recording media

“FD0” : Floppy disk
“SC5” : SCSI device with an ID number of 5
“SC5_1” : Partition 1 of the SCSI device with an ID number of 5
“CA0” : PC Card
“CA0_1” : Partition 1 of PC Card

Selecting the file attributes

Select the attributes for each file from the following choices.

R/W

Read and write possible.

R

Read only. Cannot write to the file or delete the file.

Changing the recording medium/directory/file name

Number and types of characters that can be used

Item	Number of characters	Characters that can be used
File name	1 to 8 chars.	0 to 9, A to Z, %, _ , () (parenthesis), -(minus sign)
Comment	0 to 25 chars.	All characters (including spaces),

Creating a directory

A new directory can be created on a medium. See above for the assignment of the directory name when creating a new directory.

Specifying the file to be displayed in the File List dialog box

You can specify the type of files to display.

- *+extension
Displays only the data file that was selected in the File Item setting menu and the data type menu.
- *.*
Displays all the files on the medium.

Properties

Lists the file name extension, file size, the date it was saved, the attributes, and the comment for the selected file.

Note

- You cannot rename a medium/directory/file or create a new directory while the data acquisition is in progress (START/STOP indicator is ON).
- Directory attributes cannot be changed.
- If a file with the same name exists in the same directory, renaming is not allowed.
- If a directory with the same name exists in the same directory, the directory cannot be created.
- This function can not be used in conjunction with FTP server function, FTP client function, or LPR client function.

Operating Procedure

1. Press the FILE key.
2. Press the “Utility” soft key to display the utility setting menu and the file list dialog box.
3. Press the “Function” soft key to display the file function menu.
4. Press the soft key corresponding to “Rename.”

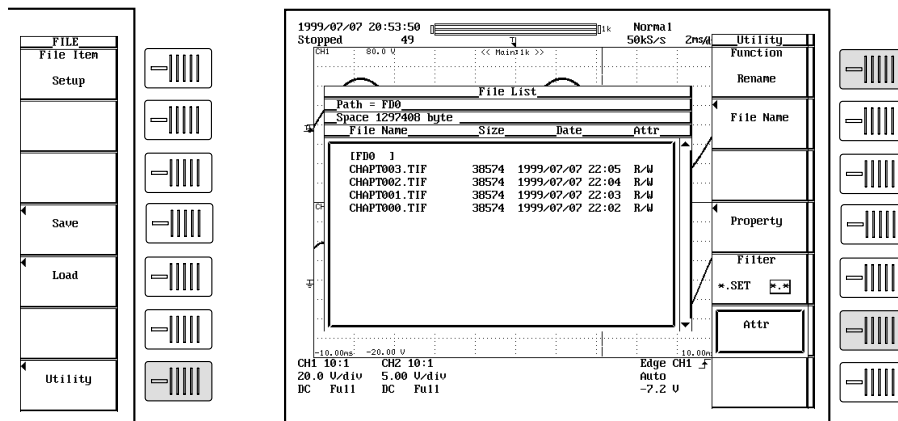

Changing the recording medium/directory/file name

- **Selecting the medium/directory**
 5. The procedures are the same as steps 13 to 17 in section 11.6, “Saving/Loading Waveform Data.”
- **Changing the file attributes**
 6. The procedures are the same as steps 6 and 7 in section 11.10, “Changing the File Attributes, Deleting Files.”
- **Changing the recording medium/directory/file name (except Net Drive)**
 7. Turn the jog shuttle to select the recording medium, directory, or file.
 8. Press the “File Name” soft key to display a keyboard. The name of the recording medium/directory/file is displayed in the entry box of the keyboard.
 9. Enter the recording medium/directory/file name according to the procedures given in page 4 - 2.

11.13 Changing the Recording Medium, Directory Name, and File Name and Creating a Directory

- **Specifying the file to be displayed in the File List dialog box, viewing the properties**

The procedures are the same as steps 30 to 33 in section 11.6, “Saving/Loading Waveform Data.”

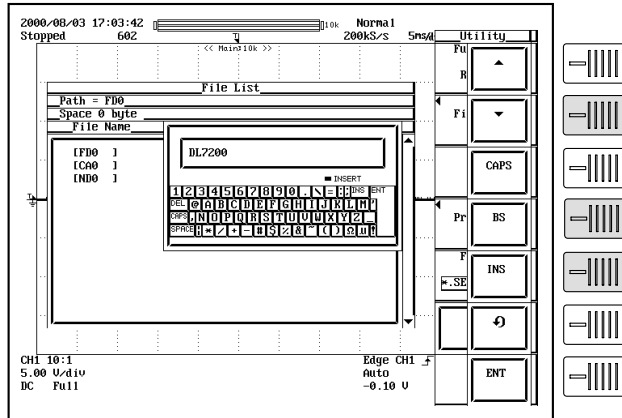

Creating a Directory

Follow steps 1 – 3 on page 11 - 34 to display the file function selection menu.

4. Press the soft key corresponding to “Make Dir.”
- **Selecting the medium/directory**
 5. The procedures are the same as steps 13 to 17 in section 11.6, “Saving/Loading Waveform Data.”
 - **Creating the directory**
 6. Turn the jog shuttle to select a medium or a directory.
 7. Press the “Dir Name” soft key to display a keyboard.
 8. Enter the recording medium/directory/file name according to the procedures given on page 4 - 2.
 - **Specifying the file to be displayed in the File List dialog box, viewing the properties**
- The procedures are the same as steps 30 to 33 in section 11.6, “Saving/Loading Waveform Data.”

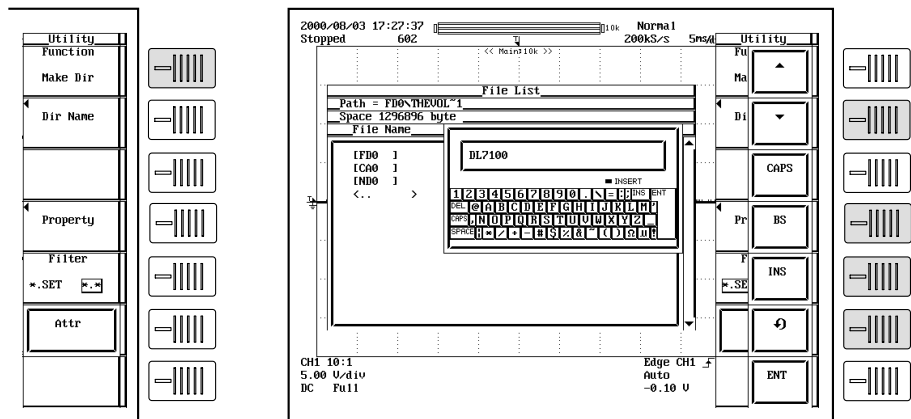

12.1 External Trigger Input (EXT TRIG IN), External Clock Input (EXT CLOCK IN)



CAUTION

Never apply signals that do not meet the following specifications as this may damage the instrument (due to overvoltage, for example).

EXT TRIG IN terminal



This terminal is used when an external signal is used as a trigger source (See page 6 - 2).

Specifications

Connector type	: BNC
Maximum input voltage	: ± 40 V(DC + ACpeak) or 28 Vrms when the frequency is less than or equal to 10 kHz
Frequency range	: DC to 100 MHz
Input impedance	: Approx. 1 M Ω , approx. 15 pF
Input range	: ± 2 V
Trigger sensitivity	: 0.1 Vp-p
Trigger level	: ± 2 V (5 mV resolution)

EXT CLOCK IN Terminal



The EXT TRIG IN terminal can also be used as an external clock input terminal. If you wish to drive the instrument with an external clock, connect a clock signal to this terminal.

Specifications

Connector type	: BNC
Maximum input voltage	: ± 40 V(DC + ACpeak) or 28 Vrms when the frequency is less than or equal to 10 kHz
Frequency range	: 40 Hz to 20 MHz
Input impedance	: Approx. 1 M Ω , approx. 15 pF
Input range	: ± 2 V
Threshold level	: ± 2 V (5 mV resolution)
Minimum input amplitude	: 0.1 Vp-p
Minimum pulse width	: At least 10 ns for both High and Low

12.2 Trigger Output (TRIG OUT)

CAUTION

Never apply an external voltage to the TRIG OUT terminal. This may damage the instrument.

TRIG OUT Terminal



TRIG OUT
(TTL ⌋)

This trigger outputs a TTL level signal when a trigger occurs. The signal level is normally high, but goes low when a trigger occurs.

Specifications

Connector type	: BNC
Output level	: TTL
Output logic	: ⌋ (negative)
Output delay time	: 50 ns or less
Output hold time	: 1 μ s min at low level, 100 ns min at high level

Output Circuit Diagram

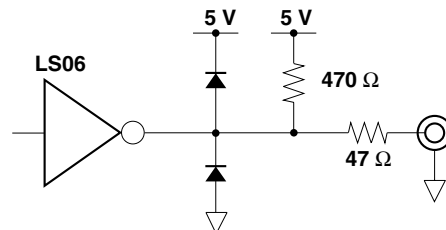

Timing Chart

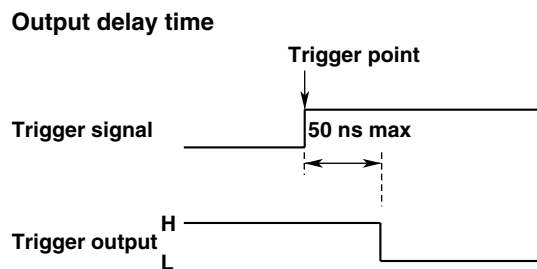

Low level/high level hold time

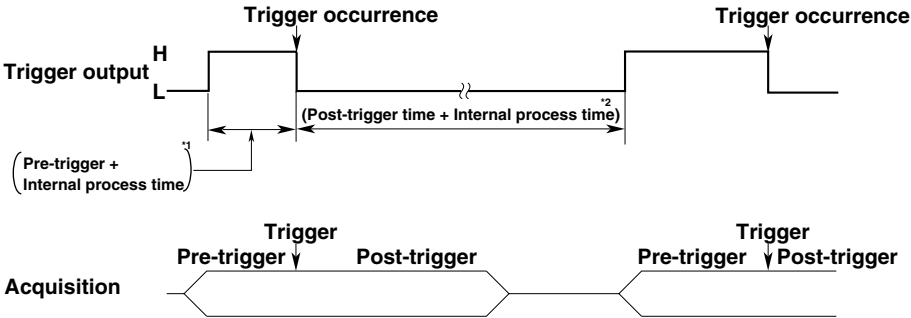

*1: HIGH (high level) period
Indicates the pre-trigger and internal processing time. 100 ns minimum.
*2: LOW (low level) period
Indicates the post-trigger and internal processing time. 1 μs minimum.

12.3 RGB Video Signal Output (RGB VIDEO OUT)

CAUTION

- When making a connection, turn OFF the DL7100 and the monitor.
- Never short circuit the RGB VIDEO OUT terminal or apply an external voltage. This may damage the instrument.

RGB VIDEO OUT terminal

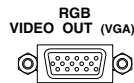

Through RGB output, the contents displayed on the instrument can be displayed on an external monitor. Monitors that can be connected are VGA monitors or multi-synchronous monitors that can display VGA.

Specifications

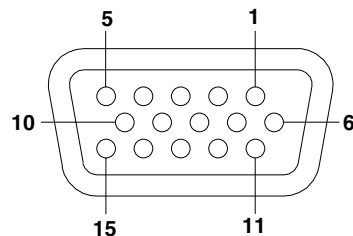

D-Sub 15-pin receptacle

Pin No.	Signal	Specification
1	Red	0.7 Vp-p
2	Green	0.7 Vp-p
3	Blue	0.7 Vp-p
4	—	
5	—	
6	GND	
7	GND	
8	GND	
9	—	
10	GND	
11	—	
12	—	
13	Horizontal synchronous signal	Approx. 31.3 kHz, TTL negative logic
14	Vertical synchronous signal	Approx. 60 Hz, TTL negative logic
15	—	

Connecting the monitor

1. Turn OFF the DL7100 and the monitor.
2. Connect the monitor to the DL7100 using an analog RGB cable.
3. Turn ON the DL7100 and the monitor. The instrument's screen is displayed on the monitor.

Note

- The RGB VIDEO OUT terminal outputs RGB video signal at all times.
- The picture on the monitor may flicker if the DL7100 or another instrument is brought too close to the monitor.
- The ends of the screen may be cut off on some monitors.

13.1 Connecting the DL7100/DL7200 to a Personal Computer

< For a description of this function, refer to page 1 - 28 >

Connection Method

Connection to a Network

The DL7100/DL7200 uses a 10BASE-T type Ethernet connector. Use an adapter such as a hub shown below to connect to the network. If you have a different connector type, use the appropriate adapter for that connector type.

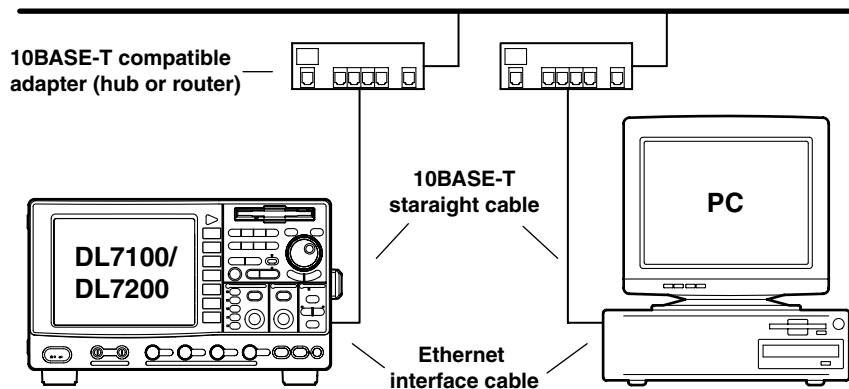

One-to-one Connection to a Personal Computer

Make the connection using a hub as shown below.

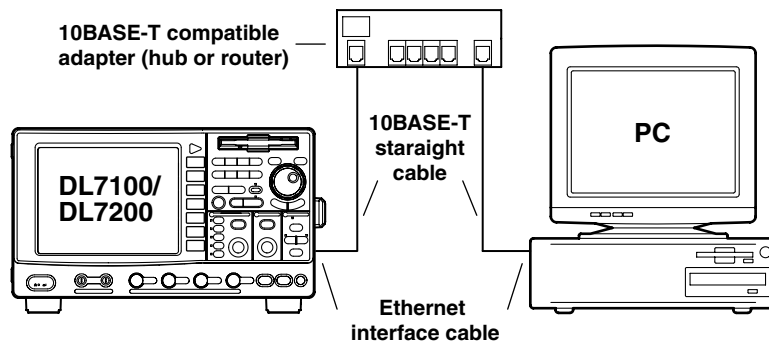

Note:

When making a one-to-one connection to a Personal Computer, the network card in the Personal Computer should be a 10BASE-T or a 10BASE-T/100BASE-T auto-switching card.

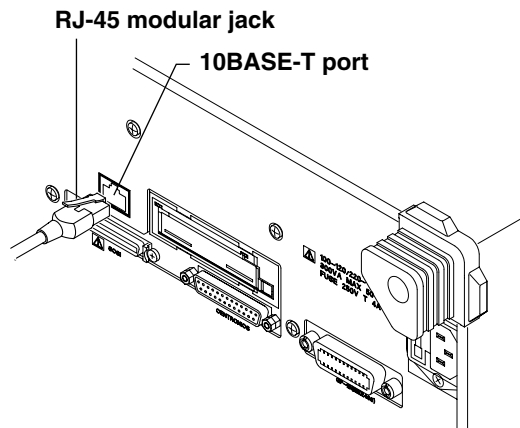

13.2 Configuring the Ethernet Interface (TCP/IP)

< For a description of this function, refer to page 1 - 28 >

Function

The following configurations must be made in order to use the Ethernet functions of the DL7100/DL7200:

Setting the IP Address, Subnet Mask, Default Gateway, DHCP, and DNS

Confirm these settings with the administrator of the system or network on which the DL7100/DL7200 will be used.

DHCP (Dynamic Host Configuration Protocol)

When using DHCP, you can automatically make the following settings:

IP address, subnet mask, default gateway, and DNS.

To use DHCP, you must have DHCP Server installed on the network.

Please ask your network administrator whether you can use DHCP.

When using DHCP, you are given a new IP address each time you turn the power ON so you'll need to be careful when using the FTP server on the DL7100/DL7200.

IP Address (Internet Protocol Address)

Assign an IP address to the DL7100/DL7200. The default setting is "0.0.0.0."

The IP address is used to distinguish between the various devices connected to the internet when communicating using the TCP/IP protocol. The address is a 32-bit string normally expressed with four values (0-255), each separated by a period (for example, "192.168.111.24"). You must obtain a unique IP address from your network administrator. The settings can be automatically configured in environments that use DHCP.

Subnet Mask

Specify the mask that is used to determine the network address from the IP address.

The default setting is "255.255.255.0." Consult the network administrator for the setting value. In some cases, this setting may not be necessary. The settings can be automatically configured in environments that use DHCP.

Default Gateway

Set the IP address of the gateway (default gateway) for communicating with machines on different segments (network groups). The default setting is "0.0.0.0." Consult the network administrator for the setting value. In some cases, this setting may not be necessary. The settings can be automatically configured in environments that can use DHCP.

DNS (Domain Name System)

The DNS is a system that correlates the host/domain name to the IP address. (Given AAA.BBBBB.co.jp, AAA is the hostname, and BBBB.co.jp is the domain name.) The host/domain name can be used instead of the IP address when accessing the network. In the case of the DL7100/DL7200, you can also specify the host by name instead of by IP address when using the network drive and printer functions. Set the domain name, the DNS server address (default is "0.0.0.0"), and the domain suffix. In DHCP environments, these settings can be configured automatically.

• **DNS Server**

Up to two DNS servers can be specified (primary and secondary). If the primary server is down, the secondary server is used to search the host name domain name and IP address.

• **Domain Suffix**

If the IP address corresponding to the “domain name” described in the previous paragraph is not found on the DNS server, then there is a system to allow addresses to be searched under a different domain name. Set this other domain name as a domain suffix. Up to two domain suffixes can be specified “Domain Suffix1” (primary) and “Domain Suffix2” (secondary).

Note

- To change this menu setting, you must restart the DL7100/DL7200.
- When the Ethernet cable is not connected, if you turn ON the power to the DL7100/DL7200 while [DCHP] is ON, there is a possibility of malfunction in the communications or file functions. Turn [DHCP] OFF and restart the instrument.

Operating Procedure

1. Press the “MISC” key.
2. Press the “Network” soft key to display the Network menu.
3. Press the “TCP/IP Setup” soft key to display the TCP/IP settings menu.

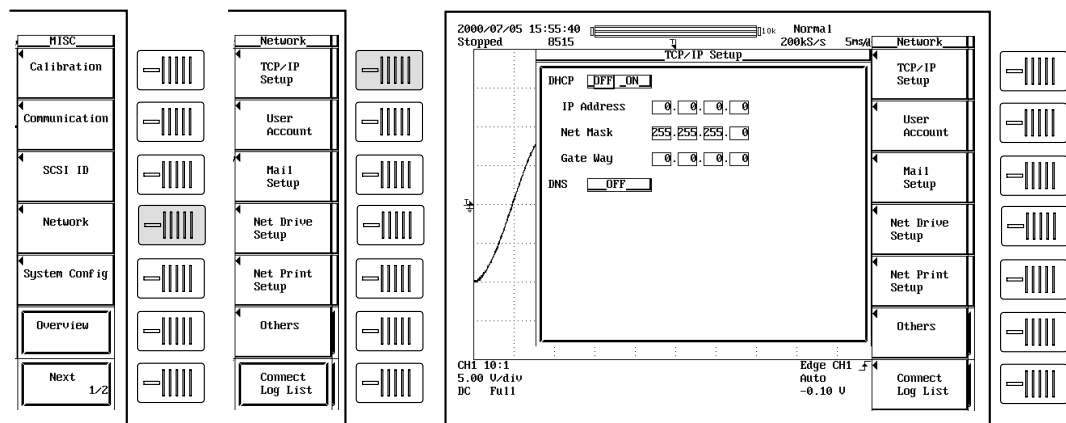

DHCP ON/OFF

4. Move the cursor to “DHCP” using the jog shuttle and press the SELECT key to turn DHCP ON or OFF. If you select ON, then it is not necessary to the set the IP address, subnet mask, and default gateway. If you wish to set up the DNS, please skip to step 11. If you do not wish to set up the DNS, check the network cable connection and restart the DL7100/DL7200. The IP address, subnet mask, and default gateway are automatically set.

Setting the IP Address

- Set the IP address if you turned DHCP OFF in step 4.
5. Move the cursor to the “IP Address” field with the jog shuttle, and press the SELECT key to display the settings menu.
 6. Enter the IP address values from 0 to 255 using the jog shuttle.

13.2 Configuring the Ethernet Interface (TCP/IP)

Setting the Subnet Mask

Set the subnet mask if you turned DHCP OFF in step 4.

7. Move the cursor to the "Net Mask" field using the jog shuttle, and press the SELECT key to display the settings menu.
8. Enter the subnet mask address values from 0 to 255 using the jog shuttle.

Setting the Default Gateway

Set the default gateway if you turned DHCP OFF in step 4.

9. Move the cursor to the "Gate Way" field with the jog shuttle, and press the SELECT key to display the settings menu.
10. Enter the default gateway address values from 0 to 255 using the jog shuttle.

Setting the DNS

11. Move the cursor to "DNS" by turning the jog shuttle.
12. Press the SELECT key to display the DNS setting menu.
13. Press the SELECT key to set the DNS to ON, OFF, or AUTO. ("AUTO" available only when DHCP is ON.) DNS is set to AUTO, the domain name and DNS server name are automatically set by restarting the instrument. If DNS is set to ON, the domain name, DNS server name, and domain suffix are displayed. If DNS is set to OFF, check the network cable connection and restart the DL7100/DL7200.

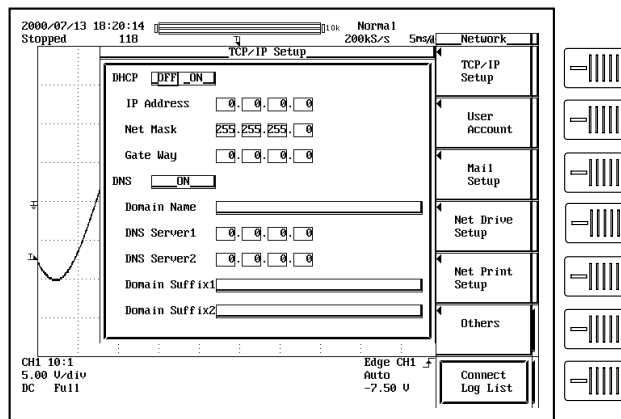

14. Move the cursor to "Domain Name" by turning the jog shuttle.
15. Press the SELECT key to display the keyboard.
16. Follow the procedure on page 4 - 2 of the user's manual and input the domain name.
17. Move the cursor with the jog shuttle to the "DNS Server 1" field, and press the SELECT key to display the setting menu.
18. Set the primary DNS server values from 0 to 255 using the jog shuttle.
19. In the same manner, set the secondary DNS server in the "DNS Server 2" field.
20. Move the cursor to "Domain Suffix1" by turning the jog shuttle.
21. Press the SELECT key to display the keyboard.
22. Follow the procedure on page 4 - 2 of the user's manual and input the primary domain suffix.
23. In the same manner, set the secondary domain suffix in the "domain suffix 2" field.

Turning the Power ON/OFF

24. You must restart the DL7100/DL7200 for the settings to take affect. After all the settings are complete, turn the power to the DL7100/DL7200 OFF, then back ON again.

13.3 Saving Waveform and Setting Data to a Network Drive

< For a description of this function, refer to page 1 - 28 >

Function

You can save data such as waveform and settings files to network drives via Ethernet in the same manner as with floppy disks or PC Card (optional).

- Saving time to Network drive

UNIX work station [OS: Solaris 2.6] (not corresponding to seek command)

Waveform 500 kW [1 MByte] : 4.08 s

Waveform 8 MW [16 MByte] : 30.76 s

Tiny FTPD 0.52a (corresponding to seek command)

Waveform 500 kW[1 MByte] : 10.53 s

Waveform 8 MW [16 MByte] : 61.98 s

Serv-U 2.5e (corresponding to seek command)

Waveform 500 kW [1 MByte] : 4.89 s

Waveform 8 MW [16 MByte] : 26.13 s

Operating Procedure

1. Press the "MISC" key.
2. Press the "Network" soft key and press the "Net Drive Setup" soft key to display the settings menu.
3. Use the jog shuttle to move the cursor to "FTP Server," then press the "SELECT" key to display the keyboard.
4. Follow the procedure on page 4 - 2 to enter an FTP address. When using DNS, you can specify it by name.
5. Use the jog shuttle to move the cursor to "Login Name," then press the "SELECT" key to display the keyboard.
6. Follow the procedure on page 4 - 2 to enter a login name of 15 characters or less.
7. Use the jog shuttle to move the cursor to "Password," then press the "SELECT" key to display the keyboard.
8. Follow the procedure on page 4 - 2 to enter a password of 15 characters or less for the login name. If the login name is "anonymous," you don't need to enter a password.

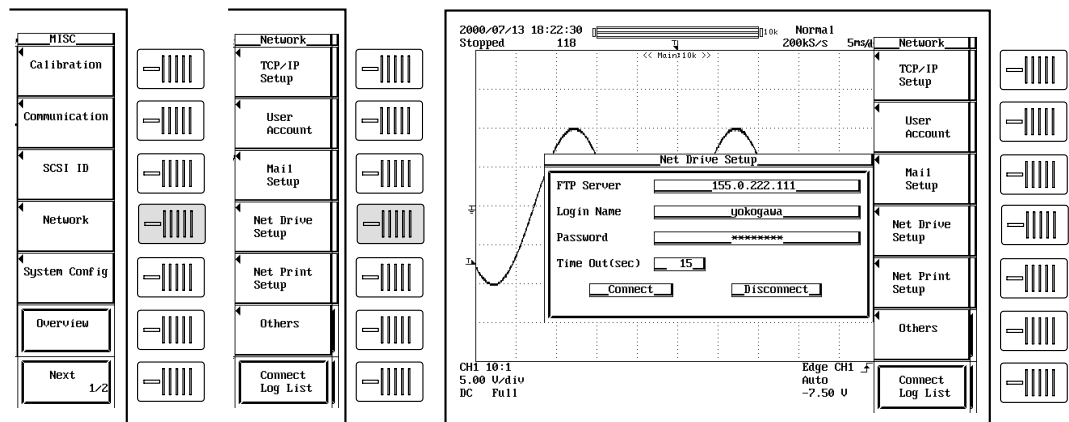

13.3 Saving Waveform and Setting Data to a Network Drive

9. Use the jog shuttle to move the cursor to "Timeout." Press the "SELECT" key to set the timeout time.
10. Use the jog shuttle to move the cursor to "Connect," then press the "SELECT" key to make the connection. If the connection has been made successfully the "📁" icon appears in the upper right part of the screen.
11. Press the "FILE" key and press the "Utility" soft key to display the File List.
12. Use the jog shuttle to move the cursor to "NDO" (Net Drive Zero).

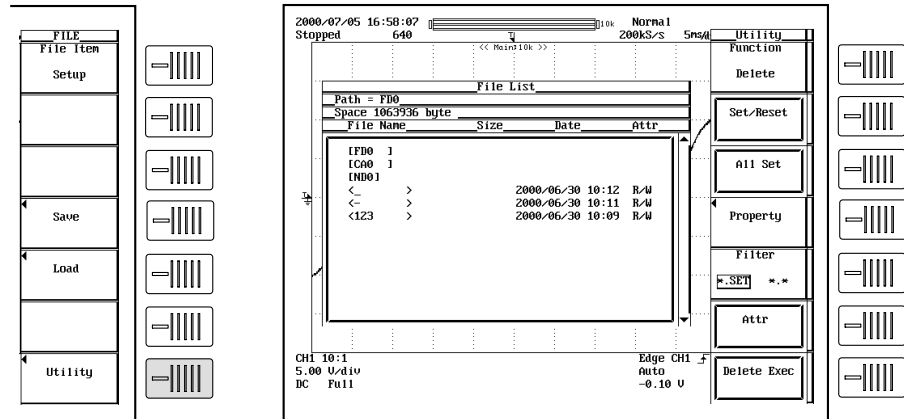

13. For the remaining procedures, please refer to "11.7 Saving / Loading Setup Data" through "11.12 Changing the Recording Medium/Directory/File Name and Creating a Directory."

Note

- You must run FTP server software on PCs and workstations that will be connected to the network. Also, please note the following regarding the server software:
 - Use UNIX format for list output (character strings returned by "dir").
 - Make the home directory and its subdirectories writable.
 - You can't change to a higher directory than the home directory.
 - The newest file is not necessarily displayed at the top of the file list.
 - You cannot access files or directories having names longer than nine or more characters.
 - Depending on the server, the "< . . >" notation for the top directory may not be displayed.
- In the following cases, the time information in a file list will not be displayed accurately.
 - When Windows NT uses an AM or PM timestamp.
 - When using a server that returns kanji or other non-ASCII character strings in a list.
- The following are not possible.
 - Turning file protect ON and OFF on saved files.
 - Formatting a network drive.
 - Copying between network drives.
 - Renaming a file on the network.
- This function can not be used in conjunction with FTP server function.
- Before saving data to a network drive, you must configure TCP/IP (see "13.2 Configuring the Ethernet Interface(TCP/IP)").
- When connected to the network, you must disconnect then reconnect for settings to take effect.
- When you are disconnected by the server when using the FTP client, you will be automatically reconnected if you perform a file operation (save, load etc.) This is the same if "NDO" is selected for "Save to File" when using an action trigger or GO/NO-GO.
- The Ethernet communication function and the GP-IB function cannot be used simultaneously.
- The FTP function cannot be used between two YOKOGAWA digital oscilloscopes. For example, using one DL7200 as an FTP server and another DL7200 as an FTP client is not possible.

13.4 Saving Screen Image Data to a Network Drive

< For a description of this function, refer to page 1 - 28 >

Function

You can save a screen image to a network drive via Ethernet just as you would to a floppy disk or PC Card (optional).

Operating Procedure

1. Press the "MISC" key.
2. Press the "Network" soft key and press the "Net Drive Setup" soft key to display the settings menu.
3. Use the jog shuttle to move the cursor to "FTP Server," then press the "SELECT" key to display the keyboard.
4. Follow the procedure on page 4 - 2 to enter the FTP server address. If you are using DNS, you can specify it by name.
5. Use the jog shuttle to move the cursor to "Login Name," then press the "SELECT" key to display the keyboard.
6. Follow the procedures on page 4 - 2 to enter a login name of 15 characters or less.
7. Use the jog shuttle to move the cursor to "Password," then press the "SELECT" key to display the keyboard.
8. Follow the procedure on page 4 - 2 to enter the password of 15 characters or less for the login name.

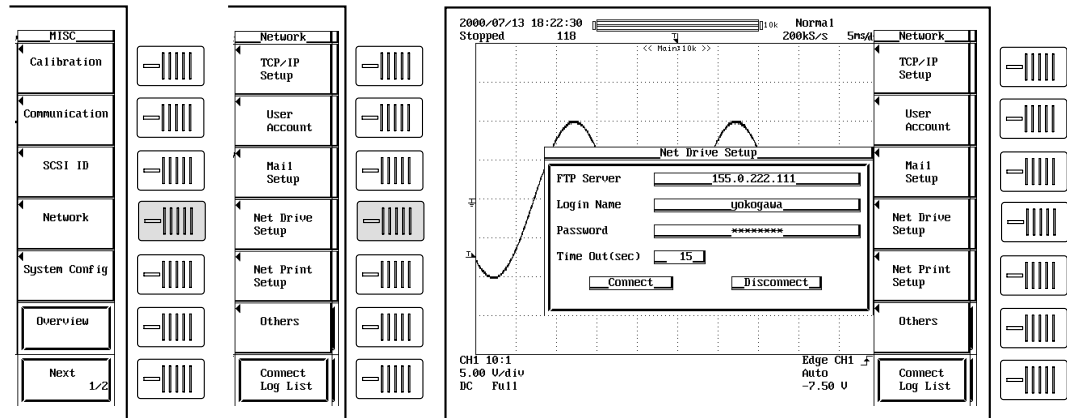

9. Use the jog shuttle to move the cursor to "Timeout," then press the "SELECT" key to set the timeout time.
10. Use the jog shuttle to move the cursor to "Connect," then press the "SELECT" key to make the connection. If the connection was made successfully, the  icon appears in the upper right of the screen.
11. Press the "SHIFT" key to set the keys in the shifted condition. Functions marked in purple on the panel become active.
12. Press the "COPY" key, then press the "Copy to" soft key.
13. Press the "FILE" soft key to select "File."
14. Press the "File List" soft key to display the "File List," and select "ND0" (Net Drive Zero).

13.4 Saving Screen Image Data to a Network Drive

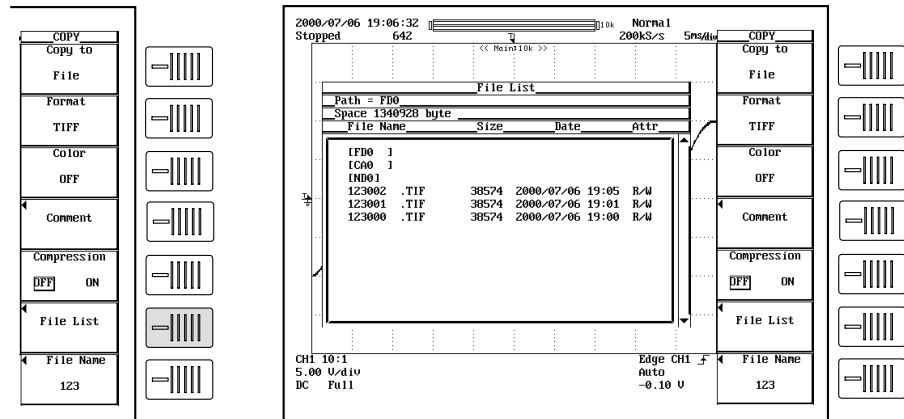

15. For the remaining procedures, please refer to sections “11.7 Saving/Loading Setup Data” through “11.12 Changing the Recording Medium/Directory/File Name and Creating a Directory.”

Note

- You must run FTP server software on PCs and workstations that will be connected to the network. Also, please note the following regarding the server software:
 - Use UNIX format for list output (character strings returned by “dir”).
 - Make the home directory and its subdirectories writable.
 - You can't change to a higher directory than the home directory.
 - The newest file is not necessarily displayed at the top of the file list.
 - You cannot access files or directories having names longer than nine or more characters.
 - Depending on the server, the “< . . .>” notation for the top directory may not be displayed.
- In the following cases, the time information in a file list will not be displayed accurately:
 - When Windows NT uses an AM or PM timestamp.
 - When using a server that returns kanji or other non-ASCII character strings in a list.
- The following are not possible.
 - Turning file protect ON and OFF on saved files.
 - Formatting a network drive.
 - Copying between network drives.
 - Renaming a file on the network.
- This function can not be used in conjunction with FTP server function.
- Before saving data to a network drive, you must configure TCP/IP (see “13.2 Configuring the Ethernet Interface(TCP/IP)”).
- When connected to the network, you must disconnect then reconnect for settings to take effect.
- When you are disconnected by the server when using the FTP client, you will be automatically reconnected if you perform a file operation (save, load etc.) This is the same if “NDO” is selected for “Save to File” when using an action trigger or GO/NO-GO.
- The Ethernet communication function and the GP-IB function cannot be used simultaneously.
- The FTP function cannot be used between two YOKOGAWA digital oscilloscopes. For example, using one DL7200 as an FTP server and another DL7200 as an FTP client is not possible.

13.5 Sending Screen Image Data to a Network Printer

< For a description of this function, refer to page 1 - 28 >

Function

You can send screen images to a network printer via Ethernet.

Compatible Printer Formats

PostScript / ESC-P / BJ / LIPS3 / PCL5 / ESC-P2

Operating Procedure

1. Press the “MISC” key.
2. Press the “Network” soft key, then press the “Net Print Setup” soft key to display the settings menu.

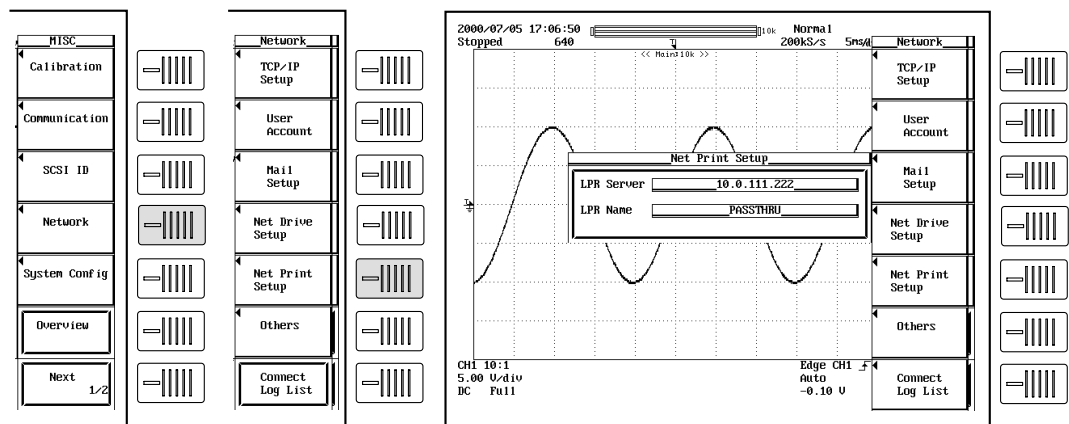

3. Use the jog shuttle to move the cursor to “LPR Server,” then press the “SELECT” key to display the keyboard.
4. Follow the procedures on page 4 - 2 to enter the printer server address. If you are using a DNS, specify it by name.
5. Use the jog shuttle to move the cursor to “LPR Name,” then press the “SELECT” key to display the keyboard.
6. Follow the procedure on page 4 - 2 to enter the printer name.
7. Press the “SHIFT” key to set the keys in the shifted condition. Functions marked in purple on the panel become active.
8. Press the “COPY” key.
9. Press the “Copy to” soft key to select “Net Print.”

13.5 Sending Screen Image Data to a Network Printer

10. For the remaining procedures, please refer to “10.3 Outputting Screen Image to an External Printer Connector.”
 However, when “NetPrint” is selected, “Post Script” is added to the “Format” item.

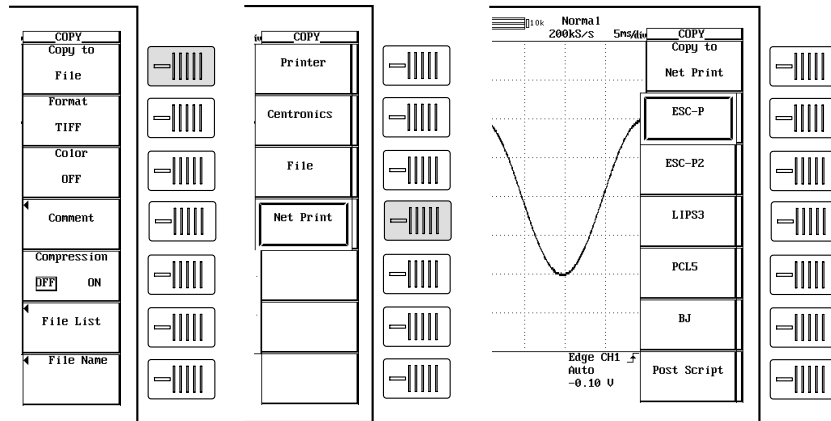

Note

- Before working with this function, enter the TCP/IP settings as described in “Configuring the Ethernet Interface.”
- You can output to any TCP/IP compatible printer.
- This function can not be used in conjunction with FTP server function or File operation.
- The Ethernet communication function and the GP-IB function cannot be used simultaneously.

13.6 Using the Mail Function (Fixed Interval)

< For a description of this function, refer to page 1 - 28 >

Function

You can transmit DL7100/DL7200 status information to a specified email address at periodic intervals via Ethernet.

Time of Transmission

Set the time at which a transmission will be sent.

Transmission Interval

Off / 1H / 2H / 3H / 4H / 6H / 8H / 12H / 24H

Information Transmitted from the DL7100/DL7200

Acquisition status (Start/Stop, Trigger, Condition, Acquisition Count).

Error information (the error number, and the English error message text, corrective action, up to 16 messages).

GO/NOGO Success/Fail Information (only when GO/NO-GO is used)

Measurement information (only when measurement is calculated and GO/NO-GO is used)

Sample Transmission:

[Comment] aaaaaa

[ACQ Status] Stopped 162

[GO/NOGO Status] Success: 140 Fail: 21

Max (C1) 4.16667V

SDv (C2) 697.941mV

Freq(C3) 500.0000kHz

+Wd (C4) 1.00us>

ErrNo 004 Exit from GO/NO-GO mode.

ErrNo 806 Cannot change settings during GO/NO-GO.
Stop the GO/NO-GO.

ErrNo 004 Exit from GO/NO-GO mode.

ErrNo 806 Cannot change settings during GO/NO-GO.
Stop the GO/NO-GO.

ErrNo 602 No SCSI device or no media inserted.
Check the SCSI device connection and
the SCSI ID, and make sure that the storage
medium is inserted (if applicable).

Operating Procedure

1. Press the "MISC" key.
2. Press the "Network" soft key to display the "Network" menu.
3. Press the "Mail Setup" soft key to display the mail settings menu.

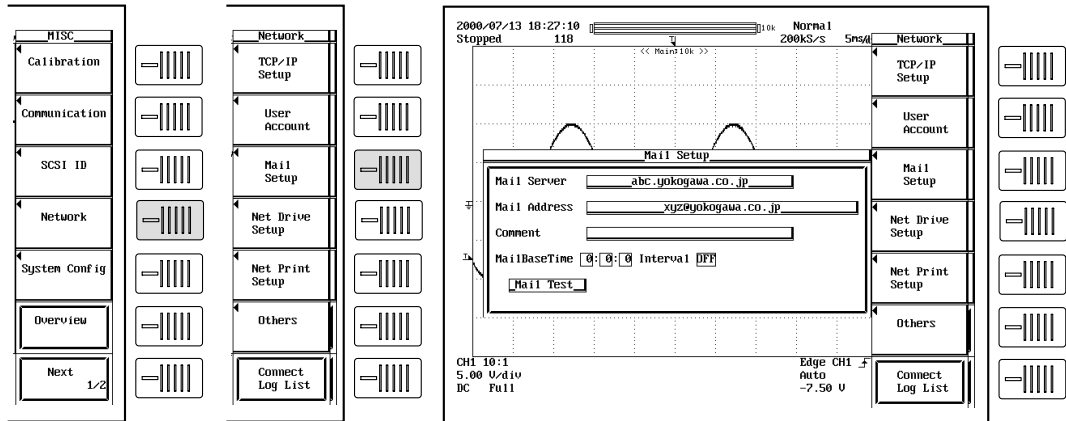

4. Move the cursor to "Mail Server" using the jog shuttle, then press the "SELECT" key to display the keyboard.
5. Follow the procedure on page 4 - 2 of the instruction manual and enter the mail server name. If you are using a DNS, specify it by name.
6. Move the cursor to "Mail Address" using the jog shuttle, then press the "SELECT" key to display the keyboard.
7. Follow the procedure on page 4 - 2 of the instruction manual and enter the mail address of 40 characters or less.
8. If necessary, move the cursor to "Comment" using the jog shuttle, then press the "SELECT" key to display the keyboard.
9. Follow the procedure on page 4 - 2 of the instruction manual to enter a comment.
10. Move the cursor to "Mail Base Time" using the jog shuttle, then press the "SELECT" key to display the keyboard.
11. Follow the procedure on page 4 - 2 of the instruction manual and enter the mail transmission time.
12. Move the cursor to "Interval" using the jog shuttle, then press the "SELECT" key to select the mail interval. If "Interval" is selected OFF, you can not send a mail.
13. Move the cursor to "Mail Test" with the jog shuttle, then press the "SELECT" key to send a test transmission to the specified mail recipient.

Note

- The sender address of the mail is set to the same address as the specified recipient address.
- The most recent items of the error history appear at the top.
- Before using this function, refer to "13.2 Configuring the Ethernet Interface(TCP/IP)" and enter the TCP/IP settings.
- If you set "Interval" to "OFF" in the "Mail Base Time" setting, e-mail messages cannot be sent.
- The Ethernet communication function and the GP-IB function cannot be used simultaneously.
- The mail function is an SMTP client function. Mail can be sent or forwarded, but not received.

13.7 Using the Mail Function (Action Mail Function)

< For a description of this function, refer to page 1 - 28 >

Function

You can have reports with time, and other information sent by email as the result of a GO/NO-GO action trigger.

Transmitted Information

Acquisition status (Start/Stop, acquisition count)

Trigger time

GO/NO-GO Success/Fail information (only when GO/NO-GO is used)

Main cause of failure (only when GO/NO-GO is used)

Measurement information (only when measurement is calculated and GO/NO-GO is used)

Sample Transmission Report

[Comment] aaaaaa

[ACQ Status] Stopped 1

[Trigger Date and Time] 2000/07/17 17:28:59.38

[GO/NOGO Status] Success: 9 Fail: 1

[NOGO Factor] Param4(Ch4,tWd)

Max (C1) 4.16667V

SDv (C2) 697.941mV

Freq(C3) 500.0000kHz

+Wd (C4) 1.00us>

13.7 Using the Mail Function (Action Mail Function)

Operating Procedure

1. Press the "GO/NO-GO" key.
2. Press the "MODE" soft key, then select "Zone" or "Parameter."
3. Press the "Setup" soft key to display the GO/NO-GO setting menu.
4. Use the jog shuttle to move the cursor to "Action," and select "Send Mail."
5. Select "Mail Count" to set a limit for the number of mails that are sent.
6. Press the "Exec" soft key to start GO/NO-GO.

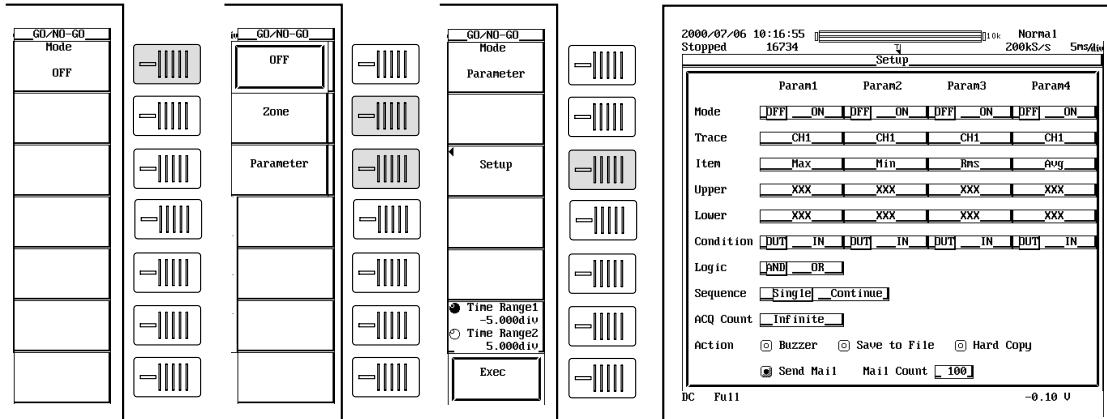

Note

- The email destination is the Mail Address set in "Misc," "Network," "MailSetup."
- The message "To:" and "From:" will be the same.
- This function can be used in conjunction with "13.6 Using the Mail Function (Fixed Interval)". Turn the "Mail Interval" OFF only when using the action mail function.
- Before working with this function, enter the TCP/IP settings as described in "Configuring the Ethernet Interface."
- The Ethernet communication function and the GP-IB function cannot be used simultaneously.
- The mail function is an SMTP client function. Mail can be sent or forwarded, but not received.

13.8 Accessing DL7100/DL7200 Drives from a Personal computer or Workstation

< For a description of this function, refer to page 1 - 28 >

Function

You can access the DL7100/DL7200's internal hard drive, floppy drive, PC Card, or SCSI devices from a personal computer or workstation via Ethernet. In order to access these devices, you must be running FTP client software. Please see "13.11 Approved Software" for a compatible FTP client.

- Rooding time from Network drive
 - UNIX work station [OS: Solaris 2.6] (not corresponding to seek command)
 - Waveform 500 kW [1 MByte]: 11.90 s
 - Waveform 8 MW [16 MByte]: 410.20 s
 - Tiny FTPD 0.52a (corresponding to seek command)
 - Waveform 500 kW [1 MByte]: 11.93 s
 - Waveform 8 MW [16 MByte]: 268.55 s
 - Serv-U 2.5e (corresponding to seek command)
 - Waveform 500 kW [1 MByte]: 4.06 s
 - Waveform 8 MW [16 MByte]: 169.17 s
- * Surveyed value of History All rooding time
 - Tiny FTPD 0.52a (corresponding to seek command)
 - Waveform 1024 sheets: 3,604.09 s
 - Serv-U 2.5e (corresponding to seek command)
 - Waveform 1024 sheets: 1,639.87 s

Operating Procedure

1. Press the "MISC" key.
2. Press the "Network" soft key to display the "Network" menu.
3. Press the "User Account" soft key to display the account settings menu.

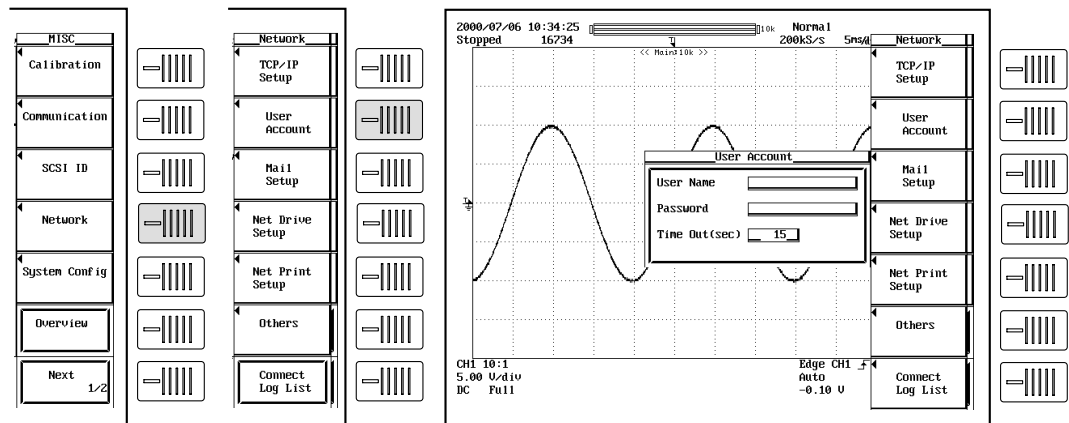

4. Move the cursor to "User Name" using the jog shuttle, then press the SELECT key to display the keyboard.
5. Follow the procedure on page 4 - 2 of the instruction manual and enter the user name. If you do not wish to limit access, use the "anonymous" setting. If access is to be limited, enter a user name of 15 characters or less.
6. Move the cursor to "Password" using the jog shuttle, then press the SELECT key to display the keyboard.

13.8 Accessing DL7100/DL7200 Drives from a Personal computer or Workstation

7. Follow the procedure on page 4 - 2 of the user's manual and enter the password. Enter the same password again. If the user name is set to "anonymous," it is not necessary to enter a password.
8. Move the cursor to "Timeout" using the jog shuttle, then press the "SELECT" key.
9. Enter the Timeout time using the jog shuttle. If the DL7100/DL7200 is not being accessed at the Timeout time, the connection to the network will be automatically closed.
10. Execute the FTP client software from a Personal computer or workstation. Perform file operations using the username specified in step 5.
11. When you press the "Connection Logging List" soft key, the 25 most recent access times, user names, and IP addresses are displayed.

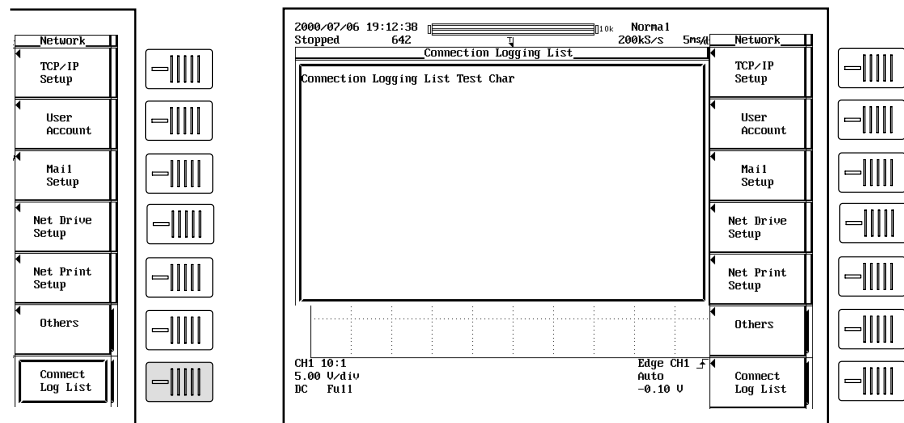

Note

- The DL7100/DL7200 can only support one client.
- When the DL7100/DL7200 is being accessed from a PC or workstation (i.e. when it's logged on), "PC" is displayed in the upper right part of the screen.
- This function can not be used in conjunction with FTP client function, LPR client function, or File operation.
- The floppy disk is displayed as "FD0" in the root directory. Other devices connected via SCSI are displayed as SCn (where "n" is the SCSI ID number).
- The log is cleared when the power is turned OFF.
- Before accessing a drive, refer to "13.2 Configuring the Ethernet Interface(TCP/IP)" and enter the TCP/IP settings.
- You must restart the DL7100/DL7200 for the settings to take effect.
- The Ethernet communication function and the GP-IB function cannot be used simultaneously.
- The FTP function cannot be used between two YOKOGAWA digital oscilloscopes. For example, using one DL7200 as an FTP server and another DL7200 as an FTP client is not possible.
- In the case below, the waveform data and the menu display may differ.
 - When loading waveform data from the DL7200 to the DL7100.
 - When loading waveform data from the DL7100 to the DL7200.

13.9 Viewing the Ether Option and MAC Address

Function

You can check for the factory default MAC address and the inclusion of the Ethernet option.

Operating Procedure

1. Press the "MISC" key.
2. Press the "Overview" soft key.
"Ether : Yes/No" indicates the inclusion or omission of the Ethernet option, "MAC : 000064_823_015 (as in the figure below)" shows you the MAC address.

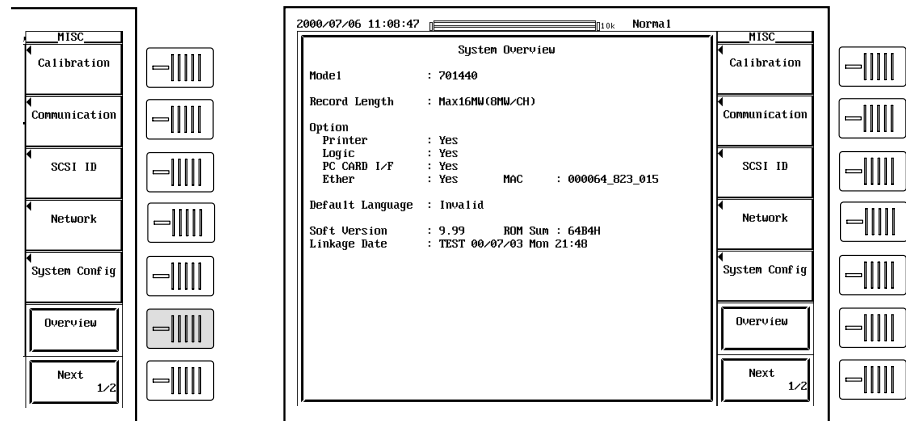

Note

- These are only displayed if the Ethernet option is installed.
- If your MAC address is displayed "XXXXXX_XXX_XXX," contact your nearest YOKOGAWA dealer.

13.10 Other Settings

Function

Enter various settings specific to FTP client, LPR, and SMTP. Normally it is not necessary to enter these settings. Items to be set: FTP Passive, LPR Timeout, SMTP Timeout.

Operating Procedure

1. Press the "MISC" key.
2. Press the "Network" soft key to display the "Network" menu.
3. Press the "Others" soft key to display the "Others" settings menu.
4. Use the jog shuttle to move the cursor to "FTP passive," then press the "SELECT" key to select ON or OFF.
5. Next, move the cursor with the jog shuttle to "LPR Timeout" or "SMTP Timeout" and press the "SELECT" key to display the settings menu for that setting item.
6. Use the jog shuttle to enter the time. The server will be automatically disconnected from the network if there is no response from it within the time specified in these settings.

14.1 Setting the Screen Color and Brightness

Function

Screen Color

You can set arbitrary colors for the following items. The colors are set using R (red), G (green), and B (blue) ratios from 0 to 15.

Menu screen

Fore	: Selected menu item
Back	: Background
Focus	: Selected cursor
Select	: Selected menu
Dialog	: Dialog box
Shadow	: Background color of the selected menu
Line	: Lines on the menu screen

Waveform

CH1 to Pod B	: Waveform
Back	: Background color of the waveform display area

Others

Snap	: Snap shot waveform
Snap1 to 4	: Loaded snap shot waveforms
Grid	: Grid
Cursor	: Cursor
Maker	: Marker

Brightness

You can set the brightness for the following items from 1 to 15 steps.

Menu	: Menu screen
Waveform	: Waveform
Snap	: Snap shot waveform
Grid	: Grid
Cursor	: Cursor

14.1 Setting the Screen Color

Operating Procedure

1. Press the "MISC" key
2. Press the "Graphic Color" soft key to display a menu used to set the display color and brightness. (With the DL7200 or the DL7100 firmware version 2.01 or later, "Graphic Color" is displayed when you press the "Next 1/2" soft key.)
3. Press the "Mode" soft key to display a menu used to select the settings.

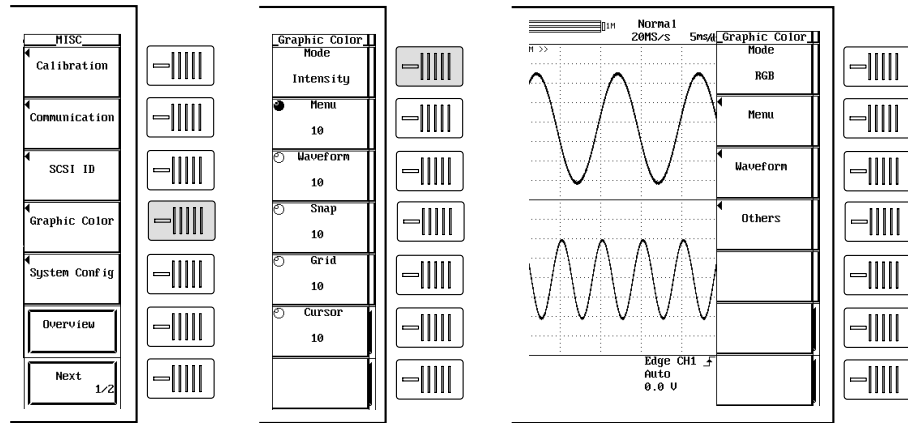

Setting the color

4. Press the soft key corresponding to "RGB" to display the display color setting menu.
5. Press the "Menu" soft key to display a dialog box used to set the display color of the menu items.
6. Turn the jog shuttle to move the cursor to the desired item.
7. Press the "SELECT" key to display the color setting menu.
8. Turn the jog shuttle to set the color.
9. Press the "SELECT" key to close the color setting menu.
10. Press the "ESC" key to close the dialog box used to set the display color of the menu items.
11. In a similar fashion, set the colors for the "Waveform" and "Others" items.

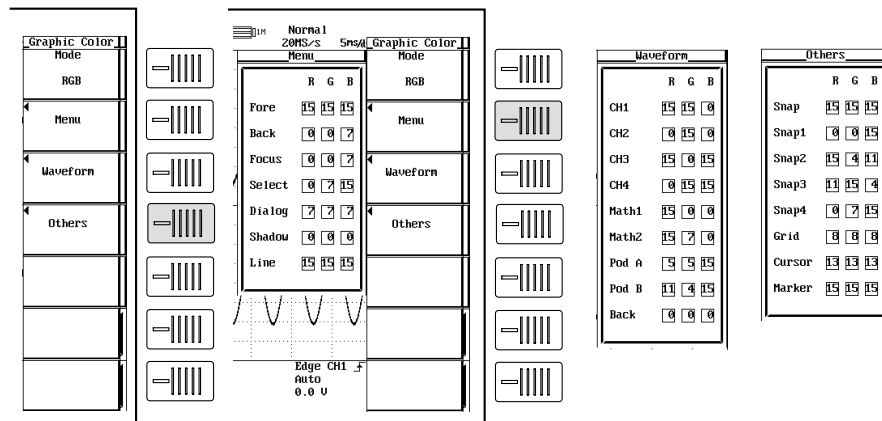

Setting the brightness

- Press the soft key corresponding to "Intensity" to display the brightness setting menu.

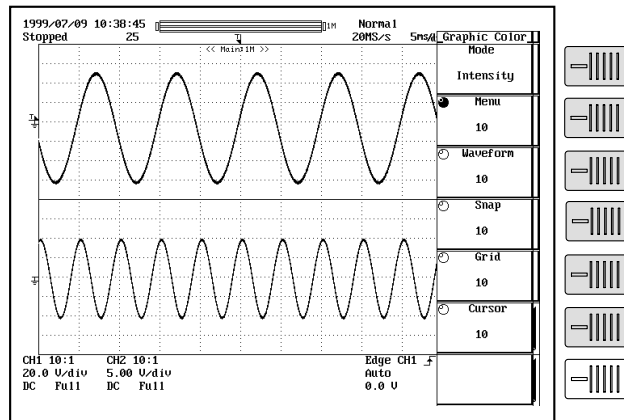

- Press the "Menu" soft key.
- Turn the jog shuttle to set the brightness of the menu screen.
- In a similar fashion, set the brightness for "Waveform," "Snap," "Grid," and "Cursor" items.

14.2 Changing the Message Language and Click Sound

Function

Selecting the message language

A message appears when an error occurs. You can set whether to display these messages in English or Japanese. The message codes are the same for both languages.

For messages, see page 15 - 2.

Turning ON/OFF the click sound

Set whether or not to make click sounds when the jog shuttle is turned. The default setting is ON.

Operating Procedure

1. Press the "MISC" key.
2. Press the "System Config" soft key to display the system configuration menu.

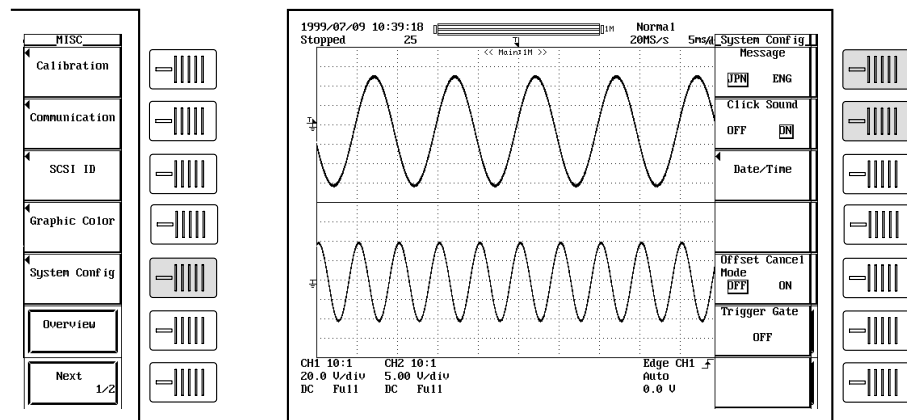

Selecting the message language

3. Press the "Message" soft key to select "ENG" or "JPN."

Setting the click sound

3. Press the "Click Sound" soft key to select "ON" or "OFF."

14.3 Turning OFF the Backlight and Setting the Brightness of the Backlight

Function

Turning ON/OFF the backlight (LCD OFF)

Turns ON/OFF the LCD backlight. If a key is pressed when the backlight is OFF, the screen returns to the measurement screen.

Automatically turning OFF the backlight (Auto OFF)

The backlight automatically turns OFF, if there is no key operation for the specified time.

Brightness of the backlight (Brightness)

You can also change the brightness of the backlight.

The lifetime of the backlight can be prolonged by dimming the backlight or turning OFF the backlight when it is not necessary.

Operating Procedure

1. Press the "MISC" key.
2. Press the "Next1/2" soft key.
3. Press the "LCD" soft key to display the backlight ON/OFF menu.

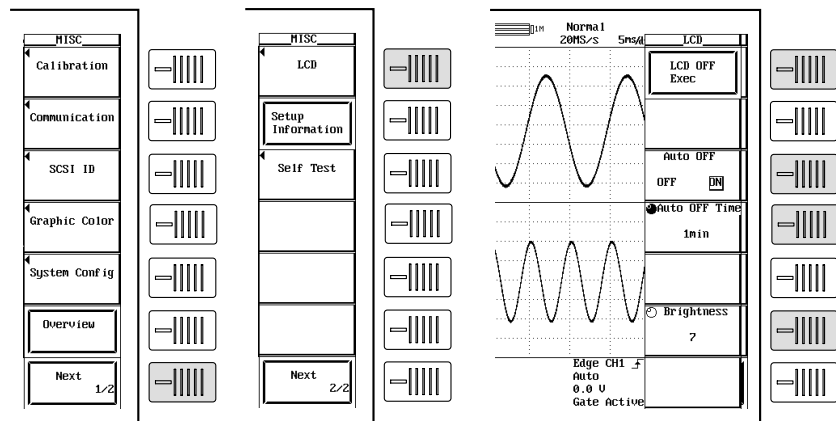

Setting auto off

4. Press the "Auto OFF" soft key to select either "ON" or "OFF."
5. If "Auto OFF" is turned "ON," press the "Auto OFF Time" soft key. Using the jog shuttle, set the time at which the backlight will automatically turn OFF.

Setting the brightness of the backlight

6. Using the jog shuttle, adjust the brightness of the backlight.

Turning OFF the backlight

7. Press the "LCD OFF Exec" soft key to turn OFF the backlight. Press any key to return to the measurement screen.

14.4 Setting the Trigger Gate

Function

The trigger gate is used to set the timing to enable the specified trigger conditions.

OFF : Waveforms are acquired when the trigger conditions are met.

Active High : When the external signal is Low, waveforms are not acquired even if the trigger conditions are met. When the external signal is High, waveforms are acquired when the trigger conditions are met.

Active Low : When the external signal is High, waveforms are not acquired even if the trigger conditions are met. When the external signal is Low, waveforms are acquired when the trigger conditions are met.

When trigger gate is active, A→B(N) trigger and A delay B trigger can not be specified.

Level

High and low are determined based on the external trigger level. See page 6 - 8.

The external signal is applied to the terminal on the rear panel that is shared between external triggers, external clock, and trigger gate.

TRIG GATE IN Terminal



EXT CLOCK IN
EXT TRIG IN
TRIG GATE IN
±40 V MAX 1 MΩ

The EXT TRIG IN terminal or EXT CLOCK IN terminal is also used as a trigger gate terminal. If you wish to enable the trigger using an external signal, apply an external signal to this terminal.

Specifications

- Connector type : BNC
- Maximum input voltage : ±40 V(DC + ACpeak) or 28 Vrms when the frequency is less than or equal to 10 kHz
- Frequency range : DC to 50 MHz
- Input impedance : Approx. 1 MΩ, approx. 15 pF
- Input range : ±2 V
- Minimum input amplitude : 0.1 Vp-p
- Minimum pulse width : At least 10 ns for both High and Low

Operating Procedure

1. Press the "MISC" key.
2. Press the "System Config" soft key to display the system configuration menu.
3. Press the "Trigger Gate" soft key to select "Active High," "Active Low," or "OFF." The default setting is "OFF."

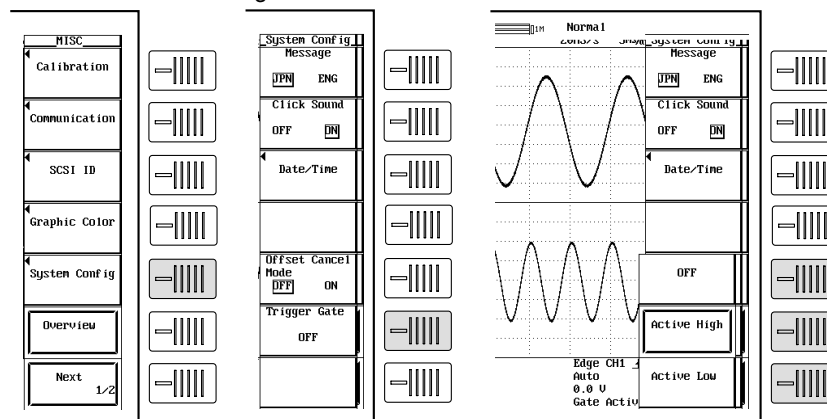

14.5 Canceling the Offset

Function

You can select whether or not the offset voltage that is specified for each channel is reflected in the results of computations and automated measurement of waveform parameters.

OFF : Does not reflect the offset voltages in the results of computations and automated measurement of waveform parameters.

The vertical position of the display screen corresponds to the offset voltage.

ON : Reflect the offset voltages in the results of computations and automated measurement of waveform parameters.

The waveform that has unneeded offset voltage (DC voltage) removed from the input signal can be observed. In this case, the vertical position becomes 0 V.

Note

- Offset cancel applies to all channels.
- To set whether or not to cancel the offset for each channel, use linear scaling.

Operating Procedure

1. Press the "MISC" key.
 2. Press the "System Config" soft key to display the system configuration menu.
 3. Press the "Offset Cancel Mode" soft key to select "ON" or "OFF."
- The default value is "OFF."

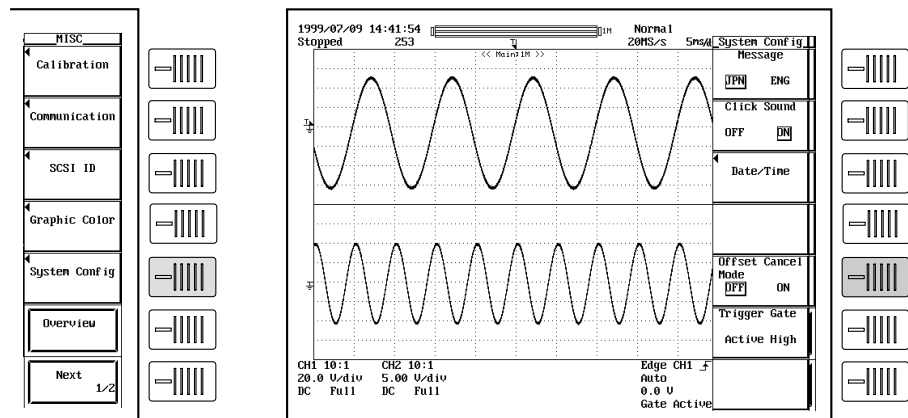

15.1 Troubleshooting

Troubleshooting

For corrective actions when a message appears on the screen, read the following pages.

If servicing is required or if the instrument does not operate properly after taking the following corrective actions, contact your nearest YOKOGAWA dealer as listed on the back cover of this manual.

Problem	Possible Cause	Corrective Action	Reference Page
The power cannot be turned ON.	The source voltage is outside the rated range.	Use a correct power supply.	3 - 5
Nothing is displayed.	The backlight is turned OFF. The screen colors are not appropriate.	Press any key. Select appropriate colors for the screen.	14 - 5 14 - 1
The display is abnormal.	The system is not operating correctly.	Turn ON the power again.	3 - 6
The waveform display is not updated.	Loaded waveform data from an external storage medium.	Unload the loaded waveform.	11 - 16
Keys do not work.	The instrument is in the remote mode. Other causes.	Press the SHIFT + CLEAR TRACE key activate local mode. Execute a key test. If the test fails, servicing is required.	— 15 - 7
Triggering does not occur.	The trigger gate is enabled. The trigger settings are not appropriate.	Turn OFF the trigger gate. Set correct trigger settings.	14 - 6 Chapter 6
The measured values are odd.	Did not allow adequate warm-up time. The instrument has not been calibrated. The probe's phase has not been corrected. The probe attenuation is not correct. An offset voltage is added. Other causes	Allow at least 30 minutes for the instrument to warm-up after turning ON the power. Perform calibration. Correct the phase properly. Set to the correct value. Set the offset voltage to zero. Perform calibration. If the measured values are still odd, servicing is required.	— 4 - 9 3 - 7 5 - 4 5 - 2 4 - 9
Cannot output to the printer.	The printer head is damaged or worn out.	Servicing is required.	—
Cannot save to the medium.	The medium has not been formatted. The medium is write protected. Insufficient space on the medium.	Format the medium. Remove the write protection from the medium. Delete unnecessary files or use a new medium.	11 - 4 — 11 - 27
The instrument cannot be configured or controlled via the communication interface.	The address used in the program is different from the actual address. The GP-IB interface is not being used according to the electrical and mechanical specifications.	Use the same address in the program and the instrument. Comply with the specifications.	Communication Interface User's Manual (IM701410-11E)

15.2 Messages and Corrective Actions

Error Messages

If an error occurs during operation, an error code may appear on the screen. This section describes the meanings of the error messages and the corrective actions which they require. The messages can be displayed either in English or Japanese (see page 14 - 4). If the corrective action requires servicing, contact your nearest YOKOGAWA dealer as listed on the back cover of this manual for repairs.

In addition to the error messages listed in this section, there are also communication related error messages (0 to 500, 912 to 915). These messages are described in the Communication Interface User's Manual (IM701410-11E).

Status Messages

Code	Message	Discription	Reference Page
0	Aborted hard copy.		10 - 3
1	Aborted file operation.		Chapter 11
4	Completed GO/NO-GO.		Section 9.11 and 9.12
10	Set to remote mode by communication commands	Press SHIFT+ CLEAR TRACE to change to local mode.	—
11	Local lockout by communication commands	To allow key operation, release the lockout using communication commands	—
13	All settings will be initialized. Power up with the RESET key depressed.		4 - 4
21	Completed action-on-trigger.		6 -35
22	Executed unload		11 - 17, 11 - 24
23	Release the Preview mode.		10 - 3
24	Some of the channels are set to 50-Ω DC input. To keep the settings, press the SELECT key. Pressing any other key will change the settings to 1-MΩ DC input.		5 - 3
25	Aborted the search		7 - 14, 8 - 14
26	Executed the search, but no record was found that matched the conditions.		7 - 14
27	Executed the search, but no record was found that matched the pattern.		8 - 14
28	Pattern contains points that are between Thr Lower and Thr Upper.		8 - 14
29	FFT will be performed on all records. Abort the operation by setting the history Display Mode to One.	—	
30	Aborted the recalculation of the FFT.	—	
31	The logic option is not installed on this model.	—	
32	Aborted statistical measurement processing.	—	9 - 17
33	Aborted the analysis.	—	—
34	Data not detected. Execute again after changing the settings or reacquiring the waveform.	—	—
35	The corresponding field was not found.	—	8 - 29, 8 - 34
36	The frame contains indefinite data (greater than Thr Lower but less than Thr Upper).	—	—

Error in Execution (600 to 799)

Code	Message	Corrective Action	Reference Page
601	Invalid file name or SCSI ID	Check the file name and the SCSI ID.	11 - 9, 11 - 11
602, 603	No SCSI device or no media inserted	Check the SCSI device connection, the SCSI ID number, and the existence of a medium in the drive.	11 - 3, 11 - 9
604	Media failure	Check the medium.	—
605	File not found	Check the filename and the medium.	Chapter 11
606	Media is protected	Set the disk's write protect switch to OFF.	—
607	Media failure	Check the medium.	—
608 to 610	Invalid file name or SCSI ID	Check the file name and the SCSI ID.	11 - 9
611, 612	Media full	Delete unnecessary files or use another disk. The number of bytes necessary is given in the pages indicated on the right.	11 - 28
613	Cannot delete a directory if there are files in the directory.	Delete all files in the directory before deleting the directory.	11 - 28
614	File is protected	Clear the write disable (*) mark.	11 - 28
615	Physical format error	Reformat the medium. If the same error occurs, this instrument cannot format the medium.	11 - 4
616 to 620	File system failure	Check using another medium. If the same message still appears, servicing is required.	—
621	File is damaged	Check the file.	—
622 to 641, 656 to 663	File system failure	Check using another medium. If the same message still appears, servicing is required.	—
642	No media exists in SCSI device	Check that the medium is correctly inserted into the SCSI device	—
646 to 653	Media failure	Check the medium	—
654	Media failure	Check the floppy disk's format type.	11 - 4
665	Cannot load this file format	Files stored on other models (DL/AG series) cannot be loaded.	—
666	File is now being accessed. Wait a moment.	Execute after accessing is finished.	—
667	Cannot be executed while running	Press the START/STOP key to stop the waveform acquisition.	4 - 7
668	Cannot find '.HDR' file	Check the file.	11 - 10
669	The specified file cannot be loaded on this ROM version or this model.	Upgrade the ROM version (upper compatible). Data saved on the 8 MWord/CH model cannot be loaded by the 2 MWord/CH model.	—
671	Save data not found	Check the presence of data to be stored.	—
673	SCSI controller failure	Check the built-in MO or terminator connection.	—
676	Unknown file format.	Check whether the data file in a format that is supported. Change the file extension.	11 - 34
677	P-P compression cannot be used to save FFT waveforms	Turn OFF the P-P compression.	11 - 11, 11 - 14
679	Data that have been P-P compressed and saved cannot be loaded.	—	—
680	Illegal printer head position	Set the release arm to the "HOLD" position.	10 - 2
681	Paper empty	Load a paper roll.	10 - 2
682	Printer over heat	Turn OFF the power immediately. Servicing is required.	—
683	Printer over heat	Turn OFF the power immediately. Servicing is required.	—
684	Printer is not installed	Check that the printer is installed.	ii
685	Printer time out	Servicing is required.	—
686	Centronics printer is error	Turn the power of the printer from OFF to On.	—

15.2 Error Messages and Corrective Actions

Code	Message	Corrective Action	Reference Page
687	Centronics printer is offline	—	—
688	Centronics printer is out of paper	—	—
689	Centronics printer is in use	—	—
690	Cannot detect Centronics printer	Turn ON the printer check connectors.	—
691	Printer failure Service is required	Servicing is required.	—
701	Cannot be executed while running	Press the START/STOP key to stop the waveform acquisition.	4 - 7
703	There is no undo-data	Cannot undo because the data were cleared during initialization or auto setup.	4 - 4 4 - 5
704	Cannot be executed while running	Press the START/STOP key to stop the waveform acquisition.	4 - 7
707	Can't start while data out. Wait a moment.	Wait until data output is complete.	Chapter 10
711	Cannot access file while hard-copying. Wait a moment.	Wait until the hard copy completes.	10 - 3
712	Cannot compress this hardcopy image Turn off the compression switch	Turn OFF the compression setting.	10 - 9, 10 - 11
713	Calibration failure.Failed CH: * Disconnect the input and execute again. If it fails again, servicing is necessary.	Servicing is required.	—
726	Cannot start when loading waveform data that have been saved in the history All mode, Unload the loaded files from the FILE menu.	Unload the files.	11 - 17
727	Insufficient output data. Increase Mag or widen the Time Range interval.	Increase Mag or widen the Time Range interval.	10 - 4
728	Hard copying Abort or wait until it is complete.	Pressing the "Copy" key again aborts the operation.	10 - 5
729	Calibration cannot be performed while waveform data are loaded. Unload the loaded files from the FILE menu.	Unload the waveform.	11 - 17
730	Pattern is not specified.	Set at least one search pattern not to X.	8 - 17
731	Cannot start when waveform data that have been acquired in the linear average mode are loaded. Unload the loaded files from the FILE menu.	Unload the waveform.	11 - 17
732	Cannot be executed while computation is in progress.	Aborted when Math/Display is turned Off.	9 - 22
733	Failed to measure statistics. The target waveform data exists or the measured waveform data may not exist. If Cycle Statistics is specified, the instrument may be configured in a way that fails to detect the cycle.	Check to see that waveform data to be measured exists and that there is at least one cycle of waveform within the measurement range.	Section 9.3
735	The file Item is inappropriate. Select Waveform, Snap or Measure.	Select Waveform, Snap or Measure.	Section 11.6,11.8 and 11.9
736	Analyzes data does not exist. Execute the analysis.	Execute the analysis.	8 - 29, 8 - 34
750	Cannot connect with ftp server.	Confirm the network settings and connection.	Chapter 13
751	Has not connect with ftp server yet.	Confirm the network settings and connection.	Chapter 13
752	This ftp function in not supported.	—	Chapter 13
753	FTP Error: Rwd	Confirm the network settings and connection.	Chapter 13
754	FTP Error: Cwd	Confirm the network settings and connection.	Chapter 13
755	FTP Error: Rm	Confirm the network settings and connection.	Chapter 13
756	FTP Error: List	Confirm the network settings and connection.	Chapter 13
757	FTP Error: Mkdir	Confirm the network settings and connection.	Chapter 13

Code	Message	Corrective Action	Reference Page
758	FTP Error: Rmdir	Confirm the network settings and connection.	Chapter 13
759	FTP Error: Get	Confirm the network settings and connection.	Chapter 13
760	FTP Error: Put	Confirm the network settings and connection.	Chapter 13
761	FTP Error: GetData	Confirm the network settings and connection.	Chapter 13
762	FTP Error: PutData	Confirm the network settings, connection, and disk capacity.	Chapter 13
763	FTP Error: AppendData	Confirm the network settings, connection, and disk capacity.	Chapter 13
764	FTP Error: Client Handle	Confirm the network settings and connection.	Chapter 13
765	FTP Error: Others	Confirm the network settings and connection.	Chapter 13
785	Cannot send data to a network printer.	Confirm the network settings and connection.	Chapter 13
786	Cannot send a mail.	Confirm the network settings and connection.	Chapter 13

Error in Setting (800 to 899)

Code	Message	Corrective Action	Reference Page
800	Illegal date-time	Set a correct date and time	3 - 10 4 - 2
801	Illegal file name	The file name contains characters that are not allowed or the file name is restricted in MS-DOS.	4 - 2
804	Cannot change this parameter while running	Press the START/STOP key to the waveform acquisition.	4 - 7
806	GO/NO-GO executing. Please press stop-key	All keys other than the START/STOP key are disabled during GO/NO-GO determination.	9 - 34
814	Duplicated Name	Set a different label.	8 - 7
819	Cannot change when Channel Display is OFF or Math settings are invalid	Turn ON the channel display or set Math operation.	5 - 1 Sections 9.4 to 9.9
821	Cannot change when ExtClock is active	Change the timebase to Internal.	5 - 14
829	Cannot change when all bits of Logic Display are OFF	Turn ON the bits you wish to display.	5 - 12
836	Settings cannot be changed during action-on-trigger. Abort action-on-trigger.	Select Abort or press the START/STOP key.	4 - 7 6 - 35
840	Cannot set the acquisition mode is Average when the trigger mode is set to Single or Single(N).	Change the acquisition mode or the trigger mode.	6 - 1 7 - 2
841	It is not possible to make a setting that will result in the repetitive mode when the trigger mode is set to Single (N).	Setting or set the trigger mode to a different mode.	5 - 16 7 - 2
842	A→B(N) and A Delay B cannot be specified when the Trigger Gate is active.	Turn OFF the trigger gate.	14 - 6
843	The trigger mode cannot be set to Single or Single (N) when the acquisition mode is set to Average.	Change the acquisition mode or the trigger mode.	6 - 1 7 - 2
846	The trigger mode cannot be set to Single (N) during repetitive sampling mode.	Turn OFF the repetitive sampling mode, lower the T/div setting, or shorten the record length.	5 - 16, 7 - 1 7 - 9
847	Cannot be set during repetitive sampling mode.	Turn OFF the repetitive sampling mode, lower the T/div setting, or shorten the record length.	5 - 16, 7 - 1 7 - 9
848	Not possible during the interleave mode.	Turn OFF the interleave mode.	7 - 9
850	The acquisition mode cannot be set in the current acquisition mode.	Change the record length.	7 - 1
851	Computation cannot be carried out at the current record length.	Change the record length.	7 - 1
852	The operation is not possible when waveforms are loaded. Unload the loaded files from the FILE menu.	Unload the files.	11 - 17

15.2 Error Messages and Corrective Actions

Code	Message	Corrective Action	Reference Page
853	Cannot be configured or executed during the search operation.	Abort the search.	7 - 14
854	Search pattern does not exist. Execute the search.	Change the search conditions.	8 - 14
855	Cannot be configured or executed during the history search operation.	Abort the search.	7 - 14
856	The record cannot be selected	Check the record number using Show Map.	7 - 14
857	History record does not exist.	History record is not created in the average mode, repetitive sampling mode, or roll mode.	7 - 2 7 - 9
858	Settings cannot be changed or executed during FFT recalculation. Abort the operation by setting the history Display Mode to One.	Set the history Display Mode to One.	7 - 14
860	Cannot be configured or executed while updating the history all display. Aborted when history display mode is set to One.	Set the history Display Mode to One.	7 - 14
861	Cannot output color in this format.	Turn OFF the color.	Section 10.3
862	Zones cannot be edited in the following cases: <ul style="list-style-type: none"> • When the main windows is not displayed. • When the target waveform is not displayed. 	Display the main window and the target waveform.	Section 9.12
863	The zone waveform does not exist.	Display the zone waveform.	Section 9.12
864	The zone is being edited. To perform other operations, select Quit to exit zone editing.	Select Quit to exit zone editing.	Section 9.12
865	Zones determination is not possible in the following cases: <ul style="list-style-type: none"> • When the main window is not displayed. • When the target waveform is not displayed. • When the zone waveform does not exist. 	Display the main window and the target window and create the zone waveform.	Section 9.12
868	Processing statistics. To perform other operations, abort the statistical processing.	Abort statistical processing.	Section 9.3
869	Cannot be specified. Invalid byte or bit.	Increase the number of data bytes.	8 - 32, 8 - 37
870	Cannot be set when CS channels are not specified.	Select a CS channel.	8 - 29 to 8 - 31, 8 - 35

System Operation Errors (900 to 908, 912 to 914)

Code	Message	Corrective Action	Reference Page
901	Backup failure	Check the condition of the built-in lithium battery using the overview screen. Servicing is required.	—
906	Fan stopped ; Turn off immediately	Turn OFF the power immediately. Servicing is required.	—
907	Backup battery is flat	Servicing is required to replace the battery.	—
912	Fatal error in Communication-driver	Servicing is required.	—

Note

When servicing is required, double-check by initializing the instrument.

15.3 Self-Diagnostic Test (Self Test)

Function

Memory test

This test checks the internal ROM. The ROM is functioning correctly, if "Pass" is displayed. If "Failed" is displayed, contact your nearest YOKOGAWA dealer as listed on the back cover of this manual.

Key test

Tests whether or not the front panel keys are operating correctly. If the name of the key that is pressed is highlighted, then it is operation correctly. If it does not, contact your nearest YOKOGAWA dealer as listed on the back cover of this manual.

Floppy disk drive test

This test checks the floppy disk drive. If "Failed" is displayed, contact your nearest YOKOGAWA dealer as listed on the back cover of this manual.

SCSI test

This test checks SCSI. If "Failed" is displayed, contact your nearest YOKOGAWA dealer as listed on the back cover of this manual.

Accuracy test

This test checks A/D accuracy. If "Failed" is displayed, contact your nearest YOKOGAWA dealer as listed on the back cover of this manual.

Printer test

This test checks the optional built-in printer. The printer is functioning correctly if gray shading is printed properly. If it is not, contact your nearest YOKOGAWA dealer as listed on the back cover of this manual.

PC Card test

Test whether the PC card is in normal condition. If "Failed" is displayed after completing the test, please contact the Yokogawa Engineering Service center printed on the back of this manual.

15.3 Self-Diagnostic Test (Self Test)

Operating Procedure

Displaying the self test menu

1. Press the "MISC" key.
2. Press the "Next 1/2" soft key to display the self test soft key menu.
3. Press the "Self test" soft key to display the self test menu.
Go to step 4 for a memory test, step 9 for a key test, step 13 for a printer test, and step 16 for a floppy disk drive test, a SCSI test, or a accuracy test.

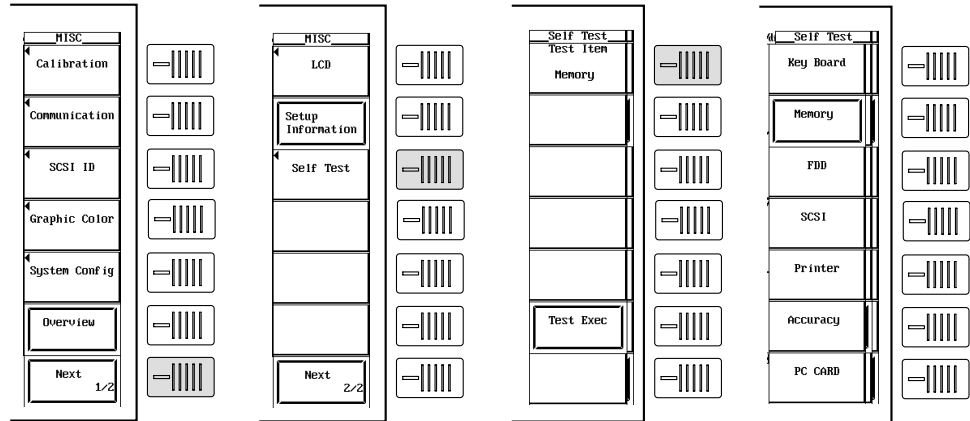

Execute the memory test

4. Press the "Test Item" soft key to display the test item menu.
5. Press the soft key corresponding to the memory to be tested.
6. Pressing the "Test Exec" soft key executes the memory test.

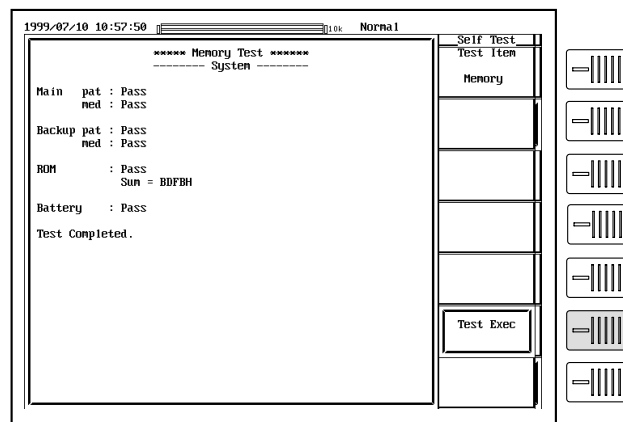

Executing the key test

7. After step 3, press the "Test Item" soft key to display the test item menu.
8. Press the soft key corresponding to the key board to be test.
9. Pressing the "Test Exec" soft key executes the key test.
10. Press all the keys. To terminate the key test, press the "ESC" key twice.

Testing the soft keys

- 11. Pressing the “Soft Key” soft key displays a keyboard.
- 12. Using the jog shuttle and the “SELECT” key, check that the characters on the keyboard can be entered correctly. Pressing the “ESC” key twice clears the keyboard.

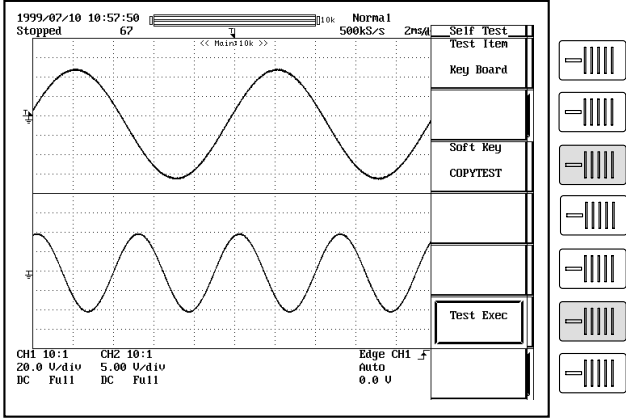

Executing the printer test

- 13. After step 3, press the “Test Item” soft key to display the test item menu.
- 14. Press the soft key corresponding to the printer to be test.
- 15. Press the “Test Exec” soft key to execute the printer test.

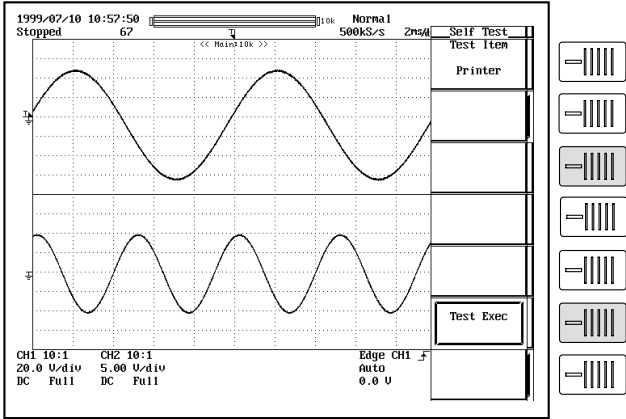

15.3 Self-Diagnostic Test (Self Test)

Testing the FDD, SCSI, PC Card (optional), or Accuracy

16. After step 3, press the "Test Item" soft key to display the test item menu.
17. Press the soft key corresponding to the FDD, SCSI, PC Card, or Accuracy to be test.
18. Press the "Test Exec" soft key to execute the floppy disk drive test, SCSI test, or Accuracy test.

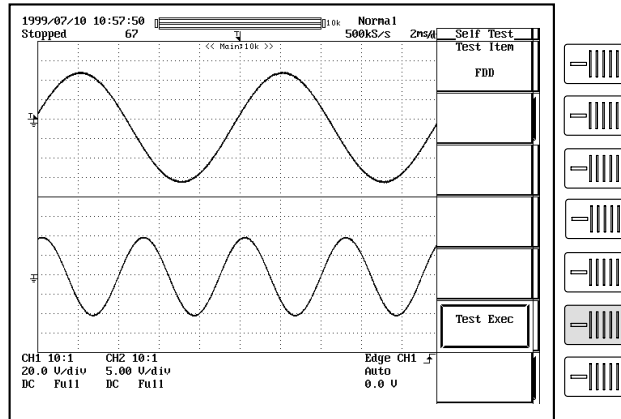

Note

- Insert a floppy disk before executing FDD test.
 - Please note the following when performing the SCSI self-test:
 - Only test unpartitioned SCSI devices
 - Set the SCSI ID to "5"
 - The PC Card self-test cannot be performed on a PC Card that has partitions.
-

15.4 Checking the System Condition

This function allows you to check the ROM version, model, and installed options. The screen is shown in the procedure.

1. Press the “MISC” key.
2. Press the “Overview” soft key to display the overview screen.
Pressing any key clears the overview screen.

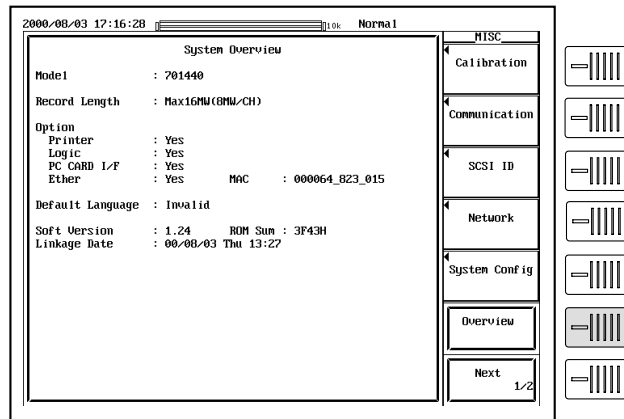

Note

- Backup battery
Displays “OK” if the built-in lithium battery is normal, “Empty” if the battery is flat. If “Empty” is displayed, contact your nearest YOKOGAWA dealer as listed on the back cover of this manual.

15.5 Replacing the Power Fuse



WARNING

- To prevent the possibility of fire, use only a fuse having the specified rating (voltage, current, and type).
 - Make sure to turn OFF the instrument and unplug the power cord before replacing the fuse.
 - Never short the fuse holder.
-

Specified Rating

The power fuse used on this instrument is specified as follows.

- Maximum rated voltage : 250 V
- Maximum rated current : 4 A
- Type : Time lag
- Standard : VDE/SEMKO/UL/CSA/SEV certified
- Part number : A1352EF

Replacement Procedures

Follow the procedures below to replace the power fuse.

1. Turn OFF the power switch.
2. Unplug the power cord from the power outlet.
3. Press the dented fuse holder section of the power connector with a Philips screwdriver, for example, and turn it in the direction of the arrow in order to remove the fuse holder.
4. Remove the burned out fuse from the tip of the fuse holder.
5. Place a new fuse in the fuse holder, and place the fuse holder back in its original position.

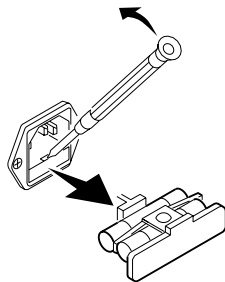

15.6 Recommended Replacement Parts

The three-year warranty applies only to the main unit of the instrument (starting from the day of delivery) and does not cover any other items such as expendable items (items which wear out). Contact your nearest YOKOGAWA dealer for replacement parts.

Parts Name	Limited Life
Built-in printer	Under normal usage, 120 rolls of paper (part No.: B9850NX)
LCD back light	Approx. 25000 hours when used continuously

The following parts are wear out parts. We recommend you replace them periodically as indicated below. Contact your nearest YOKOGAWA dealer for replacement parts.

Parts Name	Recommended Replacement Period
Cooling fan	3 years
Backup battery (Lithium Battery)	5 years

16.1 Input Section

Item	Specifications
Number of input channels	4 (CH1 to CH4)
Input coupling settings	AC 1 M Ω , DC 1 M Ω , DC 50 Ω , GND
Input connector	BNC
Input impedance	1 M Ω \pm 1.0%, approx. 20 pF 50 Ω \pm 1.0% (V SWR 1.4 or less (DC to 500 MHz))
Voltage-axis sensitivity setting	1 M Ω input : 2 mV/div to 10 V/div (1 - 2 - 5 steps) 50 Ω input : 2 mV/div to 1 V/div (1 - 2 - 5 steps)
Maximum input voltage	1 M Ω input (at 1 kHz or less) : 400 V (DC + AC peak) (282 Vrms CATII) 50 Ω input : 5 Vrms or less and 10 Vpeak or less
DC offset range (max) (At 1 : 1 probe attenuation)	2 mV/div to 50 mV/div : \pm 1 V 100 mV/div to 500 mV/div : \pm 10 V 1 V/div to 10 V/div : \pm 100 V
Vertical (voltage) axis precision	
DC precision* ¹	: \pm (1.5% of 8 div + offset voltage precision)
Offset axis precision* ¹	2 mV/div to 50 mV/div : \pm (1% of set value + 0.2 mV) 100 mV/div to 500 mV/div : \pm (1% of set value + 2 mV) 1 V/div to 10 V/div : \pm (1% of set value + 20 mV)
Frequency characteristics* ^{1*2} (-3dB point when sine wave of amplitude \pm 4 div is input)	50 Ω input 1 V/div to 10 mV/div : DC to 500 MHz 5 mV/div to 2 mV/div : DC to 400 MHz 1 M Ω input (defined at the tip of the probe when using the passive probe 700988) 10 V/div to 10 mV/div : DC to 400 MHz 5 mV/div to 2 mV/div : DC to 300 MHz
-3dB point for AC coupling used	Not above 10 Hz (When using the 10 : 1 probe (standard accessory), 1 Hz or less)
Interchannel skew (with identical settings)	above 1 ns
Residual noise* ³	Larger of \pm 1.25 mV or \pm 0.15 div (typical* ⁴)
Interchannel isolation (at identical voltage sensitivity, DC to 500 MHz)	-34 dB (typical* ⁴)
A/D conversion resolution	8 bits (24 LSB/div)
Probe attenuation settings	1 : 1, 10 : 1, 100 : 1, 1000 : 1
Bandwidth	100 MHz or 20 MHz band limit ON/OFF
Maximum sample rate	Realtime sampling mode With interleave ON : 1 GS/s With interleave OFF : 500 MS/s Repetitive sampling mode : 100 GS/s
Maximum record length	701410 With interleave ON : 2 MWords/CH With interleave OFF : 1 MWords/CH 701420 With interleave ON : 8 MWords/CH With interleave OFF : 4 MWords/CH 701430 With interleave ON : 4 MWords/CH With interleave OFF : 2 MWords/CH 701440 With interleave ON : 16 MWords/CH With interleave OFF : 8 MWords/CH

*1 As measured following calibration (after 30-minute warmup), with internal-clock timebase, under standard operating conditions as described on page 16 - 10.

*2 For repetitive events
The frequency region for single shot is DC to sampling frequency/2.5 or the frequency region for the repetitive event, whichever is less.

*3 Measured under following conditions: input block shorted; 10 kWord record length; Normal acquisition mode; accumulation OFF; 1 : 1 probe attenuation

*4 Typical (or average) value; not guaranteed.

16.2 Trigger Section

Item	Specifications
Trigger mode	Auto, auto level, normal, single, single(N)
Trigger source	CH1 to CH4, EXT ,LINE
Trigger coupling	CH1 to CH4 : DC/AC EXT : DC
HF rejection	20 kHz or 15 kHz band limit ON/OFF for trigger source (CH1 to CH4)
Trigger hysteresys	Select the trigger hysteresys width (CH1 to CH4)
Trigger level setting range	CH1 to CH4 : ± 4 div from screen center (0.01 div resolution) EXT : ± 2 V (5 mV resolution)
Trigger level precision* ¹	CH1 to CH4* ¹ : $\pm(1$ div + 10% of trigger level) EXT* ² : $\pm(50$ mV + 10% of trigger level)
External-trigger probe attenuation	1 : 1, 10 : 1
Trigger sensitivity* ²	CH1 to CH4 : 1 divp - p (at DC to 500 MHz) EXT : 100 mVp-p (at DC to 100 MHz)
Trigger position	Can be set in 1% increments of record length
Trigger delay setting range	0 to 4 s
Holdoff - time range	80 ns to 10 s
Trigger slope	Rise, Fall, Rise/Fall (with edge trigger)

Trigger type	<p>Edge : Activate the trigger on the edge of a single trigger source.</p> <p>A → B(N) : Trigger occurs Nth time condition B becomes true after condition A becomes true. Count : 1 to 10⁸ Condition A : Enter, Exit Condition B : Enter, Exit</p> <p>A Delay B : Trigger occurs first time condition B becomes true after specified delay following condition A true. Delay : 3 ns to 5 s Condition A : Enter, Exit Condition B : Enter, Exit</p> <p>OR : Trigger occurs on the OR of trigger conditions that are specified on multiple trigger sources. The trigger condition can either be edge or window. Rise (IN), Fall (OUT), or Don't care can be specified on each channel from CH1 to CH4.</p> <p>Pattern : Trigger occurs on the edge of the clock channel based on the True/False condition of the parallel pattern that is specified on multiple trigger sources. If the clock channel is set to Don't care, then the trigger occurs only on the True/False condition (Enter/Exit) of the parallel pattern. The parallel pattern is the AND of the channel states of each channel.</p> <p>Pulse Width : Trigger occurs on the width of the True/False condition of the parallel pattern that is specified on multiple trigger sources. The parallel pattern is the AND of the channel states of each channel or the AND of the window conditions of each channel. [Pulse>Time] : Triggers when the width above is greater than Time. [Pulse<Time] : Triggers when the width above is less than Time. [T1<Pulse<T2] : Triggers when the width above is greater than T1 and less than T2. [Time Out] : Triggers when the width above exceeds Time. Time range : 1 ns to 1 s Time accuracy*1 : ±(0.5% of setting*3 + 1 ms) Minimum detectable time*2 : 2 ns (typical value*4)</p> <p>TV : Trigger for video signal, in NTSC, PAL, or HDTV (studio "high vision") format. Input channel must be CH1. User can select field no. and line no.</p> <p>Logic : Trigger occurs when the logic condition is met, or on Edge OR condition of the analog inputs while the logic condition is being met. The logic condition is the parallel pattern set using High, Low, and Don't care across POD A and B (16 inputs).</p> <ul style="list-style-type: none"> • Conditions A and B are parallel pattern conditions that are set separately to High, Low, or "Don't care" for each channel (CH1 to CH4) and for EXT input.
Trigger gate	<p>The trigger is activated only when the trigger conditions are met while the input applied to the trigger gate input terminal (TRIG GATE IN) is active. Select High or Low for the active level.</p>

*1 As measured immediately after calibration, under standard operating conditions (see page 16 - 10), with machine warmed up.

*2 As measured under standard operating conditions (see page 16 - 10) after warmup.

*3 When set to T1<Pulse<T2, the value of T2.

*4 Typical (or average) value; not guaranteed.

16.3 Time Axis

Item	Specifications
Time axis range	1 ns/div to 50 s/div (record length is 10 k Words or more) 1 ns/div to 5 s/div (record length is 1 k Words)
Time base precision ^{*1}	±(0.005%)
Time axis precision ^{*1}	±(0.005% + 500 ps + 1 digit) ^{*2}
EXT CLOCK IN	Connector type BNC Maximum input voltage ±40 VDC + ACpeak or 28Vrms, 10 kHz or less Input frequency range 40 Hz to 20 MHz (continuous clock only) Sampling jitter not above ±1.25 ns Minimum input level 0.1 Vp-p Threshold level ±2 V (5 mV resolution) Input impedance Approx. 1 MΩ, 15 pF Minimum pulse width At least 10 ns (for both High and Low)

*1 As measured under standard operating conditions (see page 16 - 10) after warm up.

*2 1 digit may be unreliable depending on the sampling.

16.4 Display

Item	Specifications
Display	8.4 - inch (approx. 21.3 cm) color TFT liquid crystal display
Screen size	170.9 mm (width) × 129.6 mm (height)
Total picture elements *	640 × 480 dots
Waveform picture elements	500 × 384 dots

* Liquid crystal display may include defects of about 0.02% of all picture elements.

16.5 Functions

Acquisition / display functions

Item	Specifications
Acquisition mode	Select from five modes: Normal, Averaging, Sequential Store, Envelope, Box Average.
Sampling mode	Select realtime or repetitive sampling. (Availability depends on time-axis settings.)
Record length	DL7100: 1 kWords, 10 kWords, 50 kWords, 100 kWords, 250 kWords, 500 kWords, 1 MWords, 2 MWords, 4 MWords (701420), 8 MWords (701420) DL7200: 1 kWords, 10 kWords, 50 kWords, 100 kWords, 250 kWords, 500 kWords, 1 MWords, 2 MWords, 4 MWords, 8 MWords (701440), 16 MWords (701440)
Zoom	Can zoom up to 2 time-axis ranges of displayed waveform(s).
Display format	1, 2, 3, 4, or 6 waveform windows
Interpolation	Display samples using dot display, "sine" interpolation, linear interpolation, or pulse interpolation.
Graticule	Select from three graticule types.
Auxiliary display items	Select display or nondisplay of scale values, waveform labels.
X - Y display	Display two X - Y waveforms
Accumulation	Displays multiple iterations of waveform, in either "persistence mode" or "color-grade mode."
Snapshot	Freezes current waveform on screen. Saves or loads the snapshot waveforms in bitmap format.
Trace clear	Removes currently displayed waveform.

Vertical/horizontal axis setting functions

Item	Specifications
Channel ON/OFF	Independent ON/OFF for each channel (CH1 to CH4).
Vertical-axis Expand/reduce	Axis can be expanded or reduced while acquisition is suspended.
Input filter	Set 20 MHz or 100 MHz band limit ON/OFF independently for each channel (CH1 to CH4).
Vertical position setting	Waveforms can be moved vertically in the range ± 4 div from the center of the waveform display frame.
Linear scaling	Set scaling coefficient, offset, and unit separately for each channel (CH1 to CH4).
Roll mode	The roll display mode is enabled when the trigger mode is auto, auto-level, or single and the time axis is as follows. 1 MW or less : 50 ms/div to 50 s/div (except 50 ms/div to 5 s/div for 1 kW) 2 MW : 100 ms/div to 50 s/div At 4 MW : 200 ms/div to 50 s/div At 8 MW : 500 ms/div to 50 s/div At 16 MW (only 701440): 1 s/div to 50 s/div

Analysis Functions

Item	Specifications
SPI Signal Analysis Search Function*	Analyze and search the data by inputting CLOCK to CH1, DATA1 to CH2, DATA2 to CH3, and CS signal to CH4 or bit 0 to 7 of the logic input (option) PodA. Analysis Function : Display the conditions of DATA1, DATA2, and CS through serial data in units of bytes (8 bits). The result of the analysis can be output to a file. Search Function : Search indefinite data or a specified data pattern based on the analysis result.
Search and Zoom Function	Search for, then expand and display a portion of the displayed waveform. Choose from the following five search methods. Edge : count the rising or falling edges, and automatically search either edge. Serial Pattern : automatically search a serial pattern (up to 64 bits) with a synchronized or unsynchronized clock. Parallel Pattern : automatically search a parallel pattern from CH1-CH4, MATH1, MATH2, or 16-bit logic (optional). (Supported by DL7100 software (ROM) version 1.21 and later.) Pulse Width : automatically search for parts where a pulse width meets specified conditions. (Supported by DL7100 software (ROM) version 1.11 and later.) Auto Scroll : automatically scroll the zoom position (Supported by DL7100 software (ROM) version 1.21 and later.)
History Search Function	You can search for and display waveforms from the history memory that satisfy specified conditions. Choose from the following two search methods. Zone : Set an area on the screen, then extract and display only those waveforms that pass through the area (Pass mode), or do not pass through the area (Bypass mode). Parameter : Extract and display only the automatic measurement results of the waveform parameters which meet the specified conditions.(Supported by DL7100 software (ROM) version 1.21 and later.)
Cursor measurement function	Allows selection of cursor type from Marker, Horiz, Vert, H&V, and degree.
Automatic measurement of waveform parameters function	Measures the following waveform parameters automatically. For parameters P-P to Int2XY, the Cycle mode can be specified in which the measurement is made over 1 cycle. P - P, Max, Min, Ave, Rms, Sdev, High, Low, +OShot, -OShot, Int1TY, Int2TY, Int1XY, Int2XY, Freq, Period, Rise, Fall, +Width, -Width, +Duty, -Duty, Burst1, Burst2, pulse, Aug Period, Delay. The following statistical processing operations are also available. Parameters : Above parameters Statistical items : Min, Max, Avg, Cnt, Sdv

* Limited to products with software (ROM) version 3.01 or later.

16.5 Functions

Item	Specifications
Computing functions	<p>+, -, x, binary computation, differentiation, integration, power spectrum, inversion</p> <p>The maximum record length that can be computed is as follows:</p> <p>701410 Possible at all record lengths.</p> <p>701420 When the interleave mode is ON : 4 MWords When the interleave mode is OFF : 2 MWords</p> <p>701430 Possible at all record lengths.</p> <p>701440 When the interleave mode is ON : 8 MWords When the interleave mode is OFF : 4 MWords</p> <p>However, select the range for the power spectrum (1 kWords/10 kWords).</p>
Phase shift	The phase of CH1 to CH4 can be shifted for monitoring. Computation is performed using the phase-shifted result. Maximum record length: 8 MWords
GO/NO-GO function	Judgment is made on the automatically measured value of waveform parameters and the results are output to the printer or to a floppy disk/external SCSI device or buzzer send a mail.*

*: Ethernet + PC Card interface (optional)

Screen Data Output Functions

Item	Specifications
Built-in printer (optional)	Outputs hard copy of screen.
External printer	Print the screen image to an external parallel printer (via Centronics interface or Ethernet* ¹). Supports ESC/P, SC/P2, LIPS3, PCL5, BJ commands, and PostScript (Ethernet optional* ¹).
Floppy disk/SCSI /Network drive* ¹ /PC Card* ²	Output data formats : PostScript, TIFF, BMP

*1: Ethernet + PC Card interface (optional)

*2: PC Card (optional)

Data Storage Functions

Item	Specifications
History memory	<p>Interleave mode ON : Retain max. 2048 (DL7100) or 4096 (DL7200) waveforms recorded.</p> <p>Interleave mode OFF : Retain max. 1028 waveforms recorded.</p>
Floppy/SCSI /Network drive* ¹ /PC Card* ²	Save and restore waveform data, settings, other data.

*1: Ethernet + PC Card interface (optional)

*2: PC Card (optional)

Other Functions

Item	Specifications
Initialization function	Automatically resets key settings to the factory settings.
Auto set-up function	Automatically sets key settings to the optimum values for the input signals.
Preset function	Sets V/div and trigger level etc. to the optimum values for TTL or ECL signal measurement, for the user settings and the current probe 700937 (sold separately: Applicable to DL7100 with software (ROM) version 1.21 or later. See section 15.4, "Checking the System Condition."
Action on Trigger	Hard Copy, Save to File, Buzzer and Send Mail are performed every time a trigger is activated.
Send Mail*	Sending mails for DL7100/DL7200 condition via Ethernet.
Calibration	Auto calibration and manual calibration are possible.
Environment setting function	Allows setting of screen color, date/time, message language, click sound ON/OFF.
Probe Compensation signal output function	Outputs a square calibration waveform signal (approx. 1 Vp-p, approx. 1 kHz) from the Probe compensation signal output terminal on the front panel.
Overview function	Shows system configuration.
Self test function	Allows memory test, key test and printer test.
Help function	Displays help about settings.

* Ethernet + PC Card interface (optional)

16.6 Rear Panel Input/Output

Item	Specifications
External trigger input* ¹ (EXT TRIG IN)	Connector type : BNC
	Input bandwidth : DC to 100 MHz ²
Trigger Gate input* ¹ (TRIG GATE IN)	Input impedance : Approx.1 MΩ, 15 pF
	Input range : ±1 V
	Maximum input voltage : ±40 V (DC + AC peak) or 28Vrms, 10 kHz or less
	Trigger level : ±2 V (5 mV measurement resolution)
Trigger output (TRIG OUT)	Connector type : BNC
	Output level : TTL
	Output logic : negative logic
	Output delay time : 50 ns max.
	Output hold time : 1 μs min. for low level, 100 ns min. for high level
RGB video signal output (RGB VIDEO OUT)	Connector type : D-Sub 15-pin socket
	Output type : VGA compatible
Logic input* ² (optional)	Logic probe : 700985 (8 bits input)
	Connector type : Half pitch 26 - pin
	Maximum toggle frequency* ³ : 80 MHz
	Number of inputs : 16 (Using two logic probes)
	Maximum input voltage : ±40 V (DC + AC peak) or 28 Vrms, 1 kHz or less
	Maximum sampling rate : When the interleave mode is ON : 1 GS/s (DL7100) 2 GS/s (DL7200)
	: When the interleave mode is OFF: 500 MS/s (DL7100) 1 GS/s (DL7200)
	Threshold level : ±10 V (0.1 V setting resolution)
	Threshold accuracy* ³ : ±(0.1 V + 3% of the setting)
	Minimum input voltage* ³ : 500 mVp-p
	Input resistance : approx. 1 MΩ, approx. 15 pF
	Preset threshold : TTL = 1.4 V, ECL = -1.3 V
Power connectors for the probes	Number of output : 4
	Output voltage : ±12 V
	Usable probe : FET probe 700939, Current probe 700937, 701930, Differential probe 701920

*1 The EXT TRIG IN terminal also operates as an EXT CLOCK IN terminal. Specifications for external - clock input appear on page 16 - 3.

*2 The input frequency range when used as a trigger gate is DC to 50 MHz.

*3 As measured under standard operating conditions (see page 16 - 10) after warm up.

16.7 GP-IB Interface

Item	Specifications
Electrical and mechanical specifications	Conforms to IEEE St'd 488-1978 (JIS C 1901-1987).
Interface functions	SH1, AH1, T5, L4, SR1, RL1, PP0, DC1, DT0, C0
Protocol	Conforms to IEEE St'd 488.2-1992.
Code	ISO (ASCII) code
Mode	Addressable/Talk only mode
Address setting	Listener and talker addresses 0 to 30 are settable.
Remote mode clear	Remote mode can be cleared by pressing the SHIFT+CLEAR key (except when local lockout has been set).

For details refer to the Communication Interface User's Manual (IM701410-11E).

16.8 Serial (RS-232) Interface

Item	Specifications
Connector type	Half pitch interface cable (D-Sub 9-pin plug)
Electrical specifications	Conforms to EIA 574 Standard (EIA-232 (RS-232) Standard for 9-pin)
Connection format	point to point
Communication format	full duplex
Synchronizing format	Start-stop asynchronous transmission.
Baud rate	1200/2400/4800/9600/19200

For details refer to the Communication Interface User's manual (IM0701410-11E).

16.9 Centronics Interface

Item	Specifications
Connector type	Centronics interface connector (DSUB 25-pin receptacle): IBM-PC compatible
Electrical specifications	Conforms to Centronics specifications.
Printers which support	ESC/P, PCL5, ESC/P raster, LIPS3, BJ

16.10 SCSI Interface

Item	Specifications
Standard	SCSI (Small Computer System Interface) ANSI X3.131-1986
Connector	Half - pitch 50 - pin
Connector pin assignments	Unbalanced (single end)

16.11 Built-in Printer (Optional)

Item	Specifications
Printing system	Thermal line dot method
Dot density	6 dots/mm
Paper width	112 mm

16.12 Built-in Floppy Disk Drive

Item	Specifications
No. of drives	1
Drive size	3.5 inch
Capacity	640 KB/720 KB/1.2 MB/1.44 MB

16.13 PC Card Interface (Optional)

Item	Specifications
No. of slots	1
Supported card	Flash ATA card (PC card TYPE II)

16.14 Ethernet Communications Specifications (Optional)

Item	Specifications
Communication Port #	1
Electrical-Mechanical Specifications	IEEE 802.3 standards
Transmission Method	Ethernet (10BASE-T)
Transmission Rate	10 Mbps
Communication Protocol	TCP/IP
Supported Services	FTP server, FTP client (network drive), LPR client (network printer), SMTP client (mail transmission), DHCP, DNS.
Connector Type	RJ-4S connector

16.15 General

Item	Specifications
Standard operating conditions	Ambient temperature : 23 ±2°C Ambient humidity : 55 ±10% RH Power voltage and frequency : Less than 1% of the rated voltage/frequency fluctuation:
Warm-up time	30 min. or more
Storage conditions	Temperature : -20 to 60°C Humidity : 20 to 80% RH (no condensation allowed)
Operating conditions	Temperature : 5 to 40°C Humidity : 20 to 80% RH (without a printer) 35 to 80% RH (with a printer)
Storage altitude	3000 m or below
Operating altitude	2000 m or below
Rated supply voltage	100 to 120 VAC/220 to 240 VAC
Permissible supply voltage range	90 to 132 VAC/198 to 264 VAC
Rated supply voltage frequency	50/60 Hz
Permissible supply voltage frequency	48 to 63 Hz
Fuse	250 V 4 A time lag; VDE/SEMKO/UL/CSA/SEV approved.
Maximum power consumption	290 VA
Withstand voltage (between power supply and case)	1.5 k VAC for 1 minute
Insulation resistance (between power supply and case)	10 MΩ or more at 500 VDC
External dimensions (details on next page)	373 (W) × 211 (H) × 306 (D) mm (with printer cover closed, handles and projections excluded)
Weight (including printer)	Approx. 9 kg
Cooling method	Forced air cooling, air discharged from side
Installation position	Horizontal (when a stand is used)
Battery back - up Battery life:	Set-up data and internal clock are backed up by a built-in lithium battery. Approx. 5 years (at ambient temperature of 23°C)
Accessories	<ul style="list-style-type: none"> • 1 power cord • 400 MHz passive probes (1 probe for each channel on model) • Electrical fuses (2 fuses, including spare mounted in fuse holder) • Softcase: B9969ET (1) • 1 roll of printer paper (Only on models with "/B5" suffix) • 2 rubber pads, for rear legs • Front cover (1) • User's manual (this manual) • Operation Guide • Communication Interface Manual

Item	Specifications	
Safety standard	Complying standard	EN61010-1
	Overvoltage category	(Installation category) II*1
	Pollution degree	2*2
Emission	Complying standard	<ul style="list-style-type: none"> • EN61326 Class A, C-Tick AS/NZS 2064 (apply for 701410, 701420, 701430, 701440, 700988, 700939, 700985) This product is a Class A (for commercial environment) product. Operation of this product in a residential area may cause radio interference in which case the user is required to correct the interference.
	Cable requirement	<ul style="list-style-type: none"> • External trigger input/ External clock input/Trigger gate input terminal Use a BNC cable*3. Attach a ferrite core (TDK: ZCAT2035-0930A, YOKOGAWA: A1190MN) on each end. • Trigger output terminal Same as the above external trigger input terminal. • Video output connector Use a D-Sub 15-pin VGA shielded cable*3 and attach a ferrite core (TDK: ZCAT2035-0930A, YOKOGAWA: A1190MN) on each end. • RS-232 connector Use an RS-232 shielded cable*3 and attach a ferrite core (TDK: ZCAT2035-0930A, YOKOGAWA: A1190MN) on each end. • Centronics interface connector Use a shielded cable*3 for the connection. • SCSI connector Use a SCSI shielded cable*3 and attach a ferrite core (TDK: ZCAT2035-0930A, YOKOGAWA: A1190MN) on each end.

16.15 General

Item	Specifications
Immunity*1	<p>Complying standard EN61326 (apply for 701410, 701420, 701430, 701440, 700988, 700939, 700985)</p> <p>Influence in the immunity environment (performance criteria A)</p> <ul style="list-style-type: none"> • Noise increase <ul style="list-style-type: none"> · $\leq \pm 80$ mV, when using 700988 · $\leq \pm 400$ mV, when using 700939 · No influence, when using 700985 <p>Test condition</p> <p>When using 700988 500 MS/s (701410,701420) or 1 GS/s (701430, 701440) 20 mV/div PeakDetect (Envelope) Mode 20 MHz BWL, input 1 MΩ, Probe factor 10 : 1</p> <p>When using 700939 500 MS/s (701410,701420) or 1 GS/s (701430, 701440) 50 mV/div PeakDetect (Envelope) Mode 20 MHz BWL, input 50 Ω, Probe factor 10:1</p> <p>When using 700985 500 MS/s (701410,701420) or 1 GS/s (701430, 701440) PeakDetect (Envelope) Mode</p> <p>Cable requirement The same as those for the emission cable.</p>

*1 "Overvoltage category(Installation category)" describes a number which defines a transient overvoltage condition. It implies the regulation for impulse withstand voltage. "II" applies to electrical equipment which is supplied from the fixed installation like distribution board.

*2 "Pollution degree" describes the degree to which a solid, liquid, or gas which deteriorates dielectric strength or surface resistivity is adhering. "2" applies to normal indoor atmosphere. Normally, only non-conductive pollution occurs.

*3 The cable length is less than 3 m.

16.16 External Dimensions

Dimensions: mm

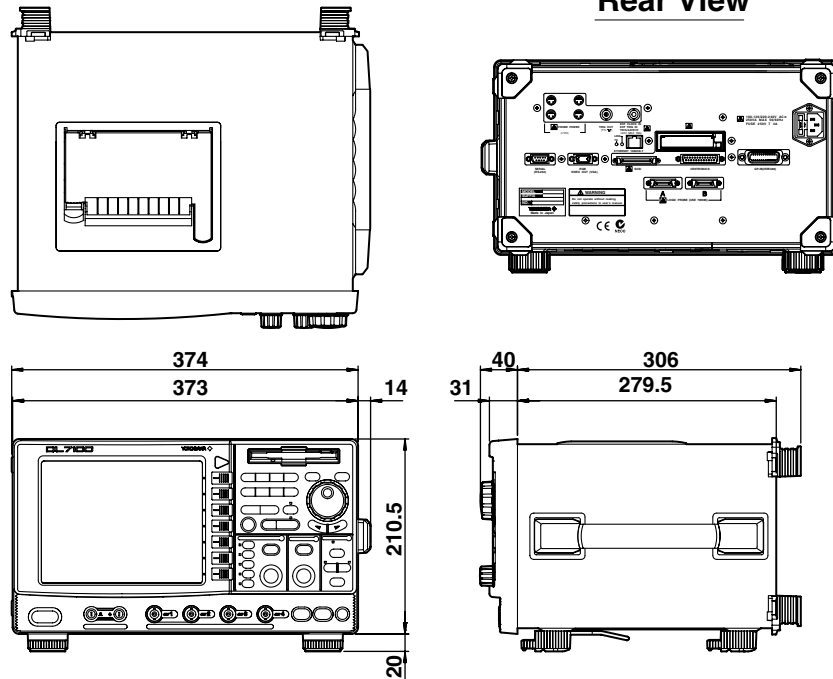

Unless otherwise specified, tolerance is $\pm 3\%$.
(Tolerance is always $\pm 0.3\text{mm}$ when the dimension is under 10mm.)

Appendix 1 Relationship between the Time Axis Setting, Sample Rate and Record Length

Record length: 1 k words (DL7100)

Rep: Repetitive sampling mode

Setting T/div	When Mode other than Envelope Mode is Active								When Envelope Mode is Active			
	Interleave mode OFF				Interleave Mode ON				Interleave mode OFF		Interleave Mode ON	
	Rep: [OFF]		Rep: [ON]		Rep: [OFF]		Rep: [ON]		Sample rate (S/s)	Displayed record len gth (word)	Sample rate (S/s)	Displayed record len gth (word)
	Sample rate (S/s)	Displayed record len gth (word)	Sample rate (S/s)	Displayed record len gth (word)	Sample rate (S/s)	Displayed record len gth (word)	Sample rate (S/s)	Displayed record len gth (word)	Sample rate (S/s)	Displayed record len gth (word)	Sample rate (S/s)	Displayed record len gth (word)
50 s	It is not possible to set these T/div.											
20 s												
10 s												
5 s	20	1 k	20	1 k	20	1 k	20	1 k	400 M	1 k	800 M	1 k
2 s	50	1 k	50	1 k	50	1 k	50	1 k	400 M	1 k	800 M	1 k
1 s	100	1 k	100	1 k	100	1 k	100	1 k	400 M	1 k	800 M	1 k
500 ms	200	1 k	200	1 k	200	1 k	200	1 k	400 M	1 k	800 M	1 k
200 ms	500	1 k	500	1 k	500	1 k	500	1 k	400 M	1 k	800 M	1 k
100 ms	1 k	1 k	1 k	1 k	1 k	1 k	1 k	1 k	400 M	1 k	800 M	1 k
50 ms	2 k	1 k	2 k	1 k	2 k	1 k	2 k	1 k	400 M	1 k	800 M	1 k
20 ms	5 k	1 k	5 k	1 k	5 k	1 k	5 k	1 k	400 M	1 k	800 M	1 k
10 ms	10 k	1 k	10 k	1 k	10 k	1 k	10 k	1 k	400 M	1 k	800 M	1 k
5 ms	20 k	1 k	20 k	1 k	20 k	1 k	20 k	1 k	400 M	1 k	800 M	1 k
2 ms	50 k	1 k	50 k	1 k	50 k	1 k	50 k	1 k	400 M	1 k	800 M	1 k
1 ms	100 k	1 k	100 k	1 k	100 k	1 k	100 k	1 k	400 M	1 k	800 M	1 k
500 μs	200 k	1 k	200 k	1 k	200 k	1 k	200 k	1 k	400 M	1 k	800 M	1 k
200 μs	500 k	1 k	500 k	1 k	500 k	1 k	500 k	1 k	400 M	1 k	800 M	1 k
100 μs	1 M	1 k	1 M	1 k	1 M	1 k	1 M	1 k	400 M	1 k	800 M	1 k
50 μs	2 M	1 k	2 M	1 k	2 M	1 k	2 M	1 k	400 M	1 k	800 M	1 k
20 μs	5 M	1 k	5 M	1 k	5 M	1 k	5 M	1 k	400 M	1 k	800 M	1 k
10 μs	10 M	1 k	10 M	1 k	10 M	1 k	10 M	1 k	400 M	1 k	800 M	1 k
5 μs	20 M	1 k	20 M	1 k	20 M	1 k	20 M	1 k	400 M	1 k	800 M	1 k
2 μs	50 M	1 k	50 M	1 k	50 M	1 k	50 M	1 k	400 M	1 k	800 M	1 k
1 μs	100 M	1 k	100 M	1 k	100 M	1 k	100 M	1 k	400 M	1 k	800 M	1 k
500 ns	200 M	1 k	200 M	1 k	200 M	1 k	200 M	1 k	400 M	1 k	800 M	1 k
200 ns	500 M	1 k	500 M	1 k	500 M	1 k	500 M	1 k			1 G	1 k
100 ns	500 M	500	1 G	1 k	1 G	1 k	1 G	1 k	Changes to normal mode, even when envelope mode has been set.			
50 ns	500 M	250	2 G	1 k	1 G	500	2 G	1 k				
20 ns	500 M	100	5 G	1 k	1 G	200	5 G	1 k				
10 ns	10 G	1 k	10 G	1 k	10 G	1 k	10 G	1 k				
5 ns	20 G	1 k	20 G	1 k	20 G	1 k	20 G	1 k				
2 ns	50 G	1 k	50 G	1 k	50 G	1 k	50 G	1 k				
1 ns	100 G	1 k	100 G	1 k	100 G	1 k	100 G	1 k				

*: For the setting enclosed by the bold line, repetitive sampling is active.

Appendix 1 Relationship between the Time Axis Setting, Sample Rate and Record Length

Record length: 10 k words (DL7100)

Rep: Repetitive sampling mode

Setting T/div	When Mode other than Envelope Mode is Active								When Envelope Mode is Active			
	Interleave mode OFF				Interleave Mode ON				Interleave mode OFF		Interleave Mode ON	
	Rep: [OFF]		Rep: [ON]		Rep: [OFF]		Rep: [ON]		Sample rate (S/s)	Displayed record length (word)	Sample rate (S/s)	Displayed record length (word)
	Sample rate (S/s)	Displayed record length (word)	Sample rate (S/s)	Displayed record length (word)	Sample rate (S/s)	Displayed record length (word)	Sample rate (S/s)	Displayed record length (word)				
50 s	20	10 k	20	10 k	20	10 k	20	10 k	400 M	10 k	800 M	10 k
20 s	50	10 k	50	10 k	50	10 k	50	10 k	400 M	10 k	800 M	10 k
10 s	100	10 k	100	10 k	100	10 k	100	10 k	400 M	10 k	800 M	10 k
5 s	200	10 k	200	10 k	200	10 k	200	10 k	400 M	10 k	800 M	10 k
2 s	500	10 k	500	10 k	500	10 k	500	10 k	400 M	10 k	800 M	10 k
1 s	1 k	10 k	1 k	10 k	1 k	10 k	1 k	10 k	400 M	10 k	800 M	10 k
500 ms	2 k	10 k	2 k	10 k	2 k	10 k	2 k	10 k	400 M	10 k	800 M	10 k
200 ms	5 k	10 k	5 k	10 k	5 k	10 k	5 k	10 k	400 M	10 k	800 M	10 k
100 ms	10 k	10 k	10 k	10 k	10 k	10 k	10 k	10 k	400 M	10 k	800 M	10 k
50 ms	20 k	10 k	20 k	10 k	20 k	10 k	20 k	10 k	400 M	10 k	800 M	10 k
20 ms	50 k	10 k	50 k	10 k	50 k	10 k	50 k	10 k	400 M	10 k	800 M	10 k
10 ms	100 k	10 k	100 k	10 k	100 k	10 k	100 k	10 k	400 M	10 k	800 M	10 k
5 ms	200 k	10 k	200 k	10 k	200 k	10 k	200 k	10 k	400 M	10 k	800 M	10 k
2 ms	500 k	10 k	500 k	10 k	500 k	10 k	500 k	10 k	400 M	10 k	800 M	10 k
1 ms	1 M	10 k	1 M	10 k	1 M	10 k	1 M	10 k	400 M	10 k	800 M	10 k
500 μs	2 M	10 k	2 M	10 k	2 M	10 k	2 M	10 k	400 M	10 k	800 M	10 k
200 μs	5 M	10 k	5 M	10 k	5 M	10 k	5 M	10 k	400 M	10 k	800 M	10 k
100 μs	10 M	10 k	10 M	10 k	10 M	10 k	10 M	10 k	400 M	10 k	800 M	10 k
50 μs	20 M	10 k	20 M	10 k	20 M	10 k	20 M	10 k	400 M	10 k	800 M	10 k
20 μs	50 M	10 k	50 M	10 k	50 M	10 k	50 M	10 k	400 M	10 k	800 M	10 k
10 μs	100 M	10 k	100 M	10 k	100 M	10 k	100 M	10 k	400 M	10 k	800 M	10 k
5 μs	200 M	10 k	200 M	10 k	200 M	10 k	200 M	10 k	400 M	10 k	800 M	10 k
2 μs	500 M	10 k	500 M	10 k	500 M	10 k	500 M	10 k			1 G	10 k
1 μs	500 M	5 k	1 G	10 k	1 G	10 k	1 G	10 k				
500 ns	500 M	2.5 k	2 G	10 k	1 G	5 k	2 G	10 k	Changes to normal mode, even when envelope mode has been set.			
200 ns	500 M	1 k	5 G	10 k	1 G	2 k	5 G	10 k				
100 ns	500 M	500	10 G	10 k	1 G	1 k	10 G	10 k				
50 ns	500 M	250	20 G	10 k	1 G	500	20 G	10 k				
20 ns	500 M	100	50 G	10 k	1 G	200	50 G	10 k				
10 ns	100 G	10 k	100 G	10 k	100 G	10 k	100 G	10 k				
5 ns	100 G	5 k	100 G	5 k	100 G	5 k	100 G	5 k				
2 ns	100 G	2 k	100 G	2 k	100 G	2 k	100 G	2 k				
1 ns	100 G	1 k	100 G	1 k	100 G	1 k	100 G	1 k				

*: For the setting enclosed by the bold line, repetitive sampling is active.

Appendix 1 Relationship between the Time Axis Setting, Sample Rate and Record Length

Record length: 50 k words (DL7100)

Rep: Repetitive sampling mode

Setting T/div	When Mode other than Envelope Mode is Active								When Envelope Mode is Active			
	Interleave mode OFF				Interleave Mode ON				Interleave mode OFF		Interleave Mode ON	
	Rep: [OFF]		Rep: [ON]		Rep: [OFF]		Rep: [ON]		Sample rate (S/s)	Displayed record length (word)	Sample rate (S/s)	Displayed record length (word)
	Sample rate (S/s)	Displayed record length (word)	Sample rate (S/s)	Displayed record length (word)	Sample rate (S/s)	Displayed record length (word)	Sample rate (S/s)	Displayed record length (word)	Sample rate (S/s)	Displayed record length (word)	Sample rate (S/s)	Displayed record length (word)
50 s	100	50 k	100	50 k	100	50 k	100	50 k	400 M	50 k	800 M	50 k
20 s	200	40 k	200	40 k	200	40 k	200	40 k	400 M	40 k	800 M	40 k
10 s	500	50 k	500	50 k	500	50 k	500	50 k	400 M	50 k	800 M	50 k
5 s	1 k	50 k	1 k	50 k	1 k	50 k	1 k	50 k	400 M	50 k	800 M	50 k
2 s	2 k	40 k	2 k	40 k	2 k	40 k	2 k	40 k	400 M	40 k	800 M	40 k
1 s	5 k	50 k	5 k	50 k	5 k	50 k	5 k	50 k	400 M	50 k	800 M	50 k
500 ms	10 k	50 k	10 k	50 k	10 k	50 k	10 k	50 k	400 M	50 k	800 M	50 k
200 ms	20 k	40 k	20 k	40 k	20 k	40 k	20 k	40 k	400 M	40 k	800 M	40 k
100 ms	50 k	50 k	50 k	50 k	50 k	50 k	50 k	50 k	400 M	50 k	800 M	50 k
50 ms	100 k	50 k	100 k	50 k	100 k	50 k	100 k	50 k	400 M	50 k	800 M	50 k
20 ms	200 k	40 k	200 k	40 k	200 k	40 k	200 k	40 k	400 M	40 k	800 M	40 k
10 ms	500 k	50 k	500 k	50 k	500 k	50 k	500 k	50 k	400 M	50 k	800 M	50 k
5 ms	1 M	50 k	1 M	50 k	1 M	50 k	1 M	50 k	400 M	50 k	800 M	50 k
2 ms	2 M	40 k	2 M	40 k	2 M	40 k	2 M	40 k	400 M	40 k	800 M	40 k
1 ms	5 M	50 k	5 M	50 k	5 M	50 k	5 M	50 k	400 M	50 k	800 M	50 k
500 μs	10 M	50 k	10 M	50 k	10 M	50 k	10 M	50 k	400 M	50 k	800 M	50 k
200 μs	20 M	40 k	20 M	40 k	20 M	40 k	20 M	40 k	400 M	40 k	800 M	40 k
100 μs	50 M	50 k	50 M	50 k	50 M	50 k	50 M	50 k	400 M	50 k	800 M	50 k
50 μs	100 M	50 k	100 M	50 k	100 M	50 k	100 M	50 k	400 M	50 k	800 M	50 k
20 μs	200 M	40 k	200 M	40 k	200 M	40 k	200 M	40 k	400 M	40 k	800 M	40 k
10 μs	500 M	50 k	500 M	50 k	500 M	50 k	500 M	50 k			1 G	50 k
5 μs	500 M	25 k	1 G	50 k	1 G	50 k	1 G	50 k	Changes to normal mode, even when envelope mode has been set.			
2 μs	500 M	10 k	2 G	40 k	1 G	20 k	2 G	40 k				
1 μs	500 M	5 k	5 G	50 k	1 G	10 k	5 G	50 k				
500 ns	500 M	2.5 k	10 G	50 k	1 G	5 k	10 G	50 k				
200 ns	500 M	1 k	20 G	40 k	1 G	2 k	20 G	40 k				
100 ns	500 M	500	50 G	50 k	1 G	1 k	50 G	50 k				
50 ns	500 M	250	100 G	50 k	1 G	500	100 G	50 k				
20 ns	500 M	100	100 G	20 k	1 G	200	100 G	20 k				
10 ns	100 G	10 k	100 G	10 k	100 G	10 k	100 G	10 k				
5 ns	100 G	5 k	100 G	5 k	100 G	5 k	100 G	5 k				
2 ns	100 G	2 k	100 G	2 k	100 G	2 k	100 G	2 k				
1 ns	100 G	1 k	100 G	1 k	100 G	1 k	100 G	1 k				

*: For the setting enclosed by the bold line, repetitive sampling is active.

Appendix 1 Relationship between the Time Axis Setting, Sample Rate and Record Length

Record length: 100 k words (DL7100)

Rep: Repetitive sampling mode

Setting T/div	When Mode other than Envelope Mode is Active								When Envelope Mode is Active			
	Interleave mode OFF				Interleave Mode ON				Interleave mode OFF		Interleave Mode ON	
	Rep: [OFF]		Rep: [ON]		Rep: [OFF]		Rep: [ON]		Sample rate (S/s)	Displayed record length (word)	Sample rate (S/s)	Displayed record length (word)
	Sample rate (S/s)	Displayed record length (word)	Sample rate (S/s)	Displayed record length (word)	Sample rate (S/s)	Displayed record length (word)	Sample rate (S/s)	Displayed record length (word)				
50 s	200	100 k	200	100 k	200	100 k	200	100 k	400 M	100 k	800 M	100 k
20 s	500	100 k	500	100 k	500	100 k	500	100 k	400 M	100 k	800 M	100 k
10 s	1 k	100 k	1 k	100 k	1 k	100 k	1 k	100 k	400 M	100 k	800 M	100 k
5 s	2 k	100 k	2 k	100 k	2 k	100 k	2 k	100 k	400 M	100 k	800 M	100 k
2 s	5 k	100 k	5 k	100 k	5 k	100 k	5 k	100 k	400 M	100 k	800 M	100 k
1 s	10 k	100 k	10 k	100 k	10 k	100 k	10 k	100 k	400 M	100 k	800 M	100 k
500 ms	20 k	100 k	20 k	100 k	20 k	100 k	20 k	100 k	400 M	100 k	800 M	100 k
200 ms	50 k	100 k	50 k	100 k	50 k	100 k	50 k	100 k	400 M	100 k	800 M	100 k
100 ms	100 k	100 k	100 k	100 k	100 k	100 k	100 k	100 k	400 M	100 k	800 M	100 k
50 ms	200 k	100 k	200 k	100 k	200 k	100 k	200 k	100 k	400 M	100 k	800 M	100 k
20 ms	500 k	100 k	500 k	100 k	500 k	100 k	500 k	100 k	400 M	100 k	800 M	100 k
10 ms	1 M	100 k	1 M	100 k	1 M	100 k	1 M	100 k	400 M	100 k	800 M	100 k
5 ms	2 M	100 k	2 M	100 k	2 M	100 k	2 M	100 k	400 M	100 k	800 M	100 k
2 ms	5 M	100 k	5 M	100 k	5 M	100 k	5 M	100 k	400 M	100 k	800 M	100 k
1 ms	10 M	100 k	10 M	100 k	10 M	100 k	10 M	100 k	400 M	100 k	800 M	100 k
500 μs	20 M	100 k	20 M	100 k	20 M	100 k	20 M	100 k	400 M	100 k	800 M	100 k
200 μs	50 M	100 k	50 M	100 k	50 M	100 k	50 M	100 k	400 M	100 k	800 M	100 k
100 μs	100 M	100 k	100 M	100 k	100 M	100 k	100 M	100 k	400 M	100 k	800 M	100 k
50 μs	200 M	100 k	200 M	100 k	200 M	100 k	200 M	100 k	400 M	100 k	800 M	100 k
20 μs	500 M	100 k	500 M	100 k	500 M	100 k	500 M	100 k	400 M	100 k	800 M	100 k
10 μs	500 M	50 k	1 G	100 k	1 G	100 k	1 G	100 k			1 G	100 k
5 μs	500 M	25 k	2 G	100 k	1 G	50 k	2 G	100 k	Changes to normal mode, even when envelope mode has been set.			
2 μs	500 M	10 k	5 G	100 k	1 G	20 k	5 G	100 k				
1 μs	500 M	5 k	10 G	100 k	1 G	10 k	10 G	100 k				
500 ns	500 M	2.5 k	20 G	100 k	1 G	5 k	20 G	100 k				
200 ns	500 M	1 k	50 G	100 k	1 G	2 k	50 G	100 k				
100 ns	500 M	500	100 G	100 k	1 G	1 k	100 G	100 k				
50 ns	500 M	250	100 G	50 k	1 G	500	100 G	50 k				
20 ns	500 M	100	100 G	20 k	1 G	200	100 G	20 k				
10 ns	100 G	10 k	100 G	10 k	100 G	10 k	100 G	10 k				
5 ns	100 G	5 k	100 G	5 k	100 G	5 k	100 G	5 k				
2 ns	100 G	2 k	100 G	2 k	100 G	2 k	100 G	2 k				
1 ns	100 G	1 k	100 G	1 k	100 G	1 k	100 G	1 k				

*: For the setting enclosed by the bold line, repetitive sampling is active.

Appendix 1 Relationship between the Time Axis Setting, Sample Rate and Record Length

Record length: 250 k words (DL7100)

Rep: Repetitive sampling mode

Setting T/div	When Mode other than Envelope Mode is Active								When Envelope Mode is Active			
	Interleave mode OFF				Interleave Mode ON				Interleave mode OFF		Interleave Mode ON	
	Rep: [OFF]		Rep: [ON]		Rep: [OFF]		Rep: [ON]		Sample rate (S/s)	Displayed record length (word)	Sample rate (S/s)	Displayed record length (word)
	Sample rate (S/s)	Displayed record length (word)	Sample rate (S/s)	Displayed record length (word)	Sample rate (S/s)	Displayed record length (word)	Sample rate (S/s)	Displayed record length (word)				
50 s	500	250 k	500	250 k	500	250 k	500	250 k	400 M	250 k	800 M	250 k
20 s	1 k	200 k	1 k	200 k	1 k	200 k	1 k	200 k	400 M	200 k	800 M	200 k
10 s	2 k	200 k	2 k	200 k	2 k	200 k	2 k	200 k	400 M	200 k	800 M	200 k
5 s	5 k	250 k	5 k	250 k	5 k	250 k	5 k	250 k	400 M	250 k	800 M	250 k
2 s	10 k	200 k	10 k	200 k	10 k	200 k	10 k	200 k	400 M	200 k	800 M	200 k
1 s	20 k	200 k	20 k	200 k	20 k	200 k	20 k	200 k	400 M	200 k	800 M	200 k
500 ms	50 k	250 k	50 k	250 k	50 k	250 k	50 k	250 k	400 M	250 k	800 M	250 k
200 ms	100 k	200 k	100 k	200 k	100 k	200 k	100 k	200 k	400 M	200 k	800 M	200 k
100 ms	200 k	200 k	200 k	200 k	200 k	200 k	200 k	200 k	400 M	200 k	800 M	200 k
50 ms	500 k	250 k	500 k	250 k	500 k	250 k	500 k	250 k	400 M	250 k	800 M	250 k
20 ms	1 M	200 k	1 M	200 k	1 M	200 k	1 M	200 k	400 M	200 k	800 M	200 k
10 ms	2 M	200 k	2 M	200 k	2 M	200 k	2 M	200 k	400 M	200 k	800 M	200 k
5 ms	5 M	250 k	5 M	250 k	5 M	250 k	5 M	250 k	400 M	250 k	800 M	250 k
2 ms	10 M	200 k	10 M	200 k	10 M	200 k	10 M	200 k	400 M	200 k	800 M	200 k
1 ms	20 M	200 k	20 M	200 k	20 M	200 k	20 M	200 k	400 M	200 k	800 M	200 k
500 μs	50 M	250 k	50 M	250 k	50 M	250 k	50 M	250 k	400 M	250 k	800 M	250 k
200 μs	100 M	200 k	100 M	200 k	100 M	200 k	100 M	200 k	400 M	200 k	800 M	200 k
100 μs	200 M	200 k	200 M	200 k	200 M	200 k	200 M	200 k	400 M	200 k	800 M	200 k
50 μs	500 M	250 k	500 M	250 k	500 M	250 k	500 M	250 k			1 G	250 k
20 μs	500 M	100 k	1 G	200 k	1 G	200 k	1 G	200 k	Changes to normal mode, even when envelope mode has been set.			
10 μs	500 M	50 k	2 G	200 k	1 G	100 k	2 G	200 k				
5 μs	500 M	25 k	5 G	250 k	1 G	50 k	5 G	250 k				
2 μs	500 M	10 k	10 G	200 k	1 G	20 k	10 G	200 k				
1 μs	500 M	5 k	20 G	200 k	1 G	10 k	20 G	200 k				
500 ns	500 M	2.5 k	50 G	250 k	1 G	5 k	50 G	250 k				
200 ns	500 M	1 k	100 G	200 k	1 G	2 k	100 G	200 k				
100 ns	500 M	500	100 G	100 k	1 G	1 k	100 G	100 k				
50 ns	500 M	250	100 G	50 k	1 G	500	100 G	50 k				
20 ns	500 M	100	100 G	20 k	1 G	200	100 G	20 k				
10 ns	100 G	10 k	100 G	10 k	100 G	10 k	100 G	10 k				
5 ns	100 G	5 k	100 G	5 k	100 G	5 k	100 G	5 k				
2 ns	100 G	2 k	100 G	2 k	100 G	2 k	100 G	2 k				
1 ns	100 G	1 k	100 G	1 k	100 G	1 k	100 G	1 k				

*: For the setting enclosed by the bold line, repetitive sampling is active.

Appendix 1 Relationship between the Time Axis Setting, Sample Rate and Record Length

Record length: 500 k words (DL7100)

Rep: Repetitive sampling mode

Setting T/div	When Mode other than Envelope Mode is Active								When Envelope Mode is Active			
	Interleave mode OFF				Interleave Mode ON				Interleave mode OFF		Interleave Mode ON	
	Rep: [OFF]		Rep: [ON]		Rep: [OFF]		Rep: [ON]		Sample rate (S/s)	Displayed record length (word)	Sample rate (S/s)	Displayed record length (word)
	Sample rate (S/s)	Displayed record length (word)	Sample rate (S/s)	Displayed record length (word)	Sample rate (S/s)	Displayed record length (word)	Sample rate (S/s)	Displayed record length (word)				
50 s	1 k	500 k	1 k	500 k	1 k	500 k	1 k	500 k	400 M	500 k	800 M	500 k
20 s	2 k	400 k	2 k	400 k	2 k	400 k	2 k	400 k	400 M	400 k	800 M	400 k
10 s	5 k	500 k	5 k	500 k	5 k	500 k	5 k	500 k	400 M	500 k	800 M	500 k
5 s	10 k	500 k	10 k	500 k	10 k	500 k	10 k	500 k	400 M	500 k	800 M	500 k
2 s	20 k	400 k	20 k	400 k	20 k	400 k	20 k	400 k	400 M	400 k	800 M	400 k
1 s	50 k	500 k	50 k	500 k	50 k	500 k	50 k	500 k	400 M	500 k	800 M	500 k
500 ms	100 k	500 k	100 k	500 k	100 k	500 k	100 k	500 k	400 M	500 k	800 M	500 k
200 ms	200 k	400 k	200 k	400 k	200 k	400 k	200 k	400 k	400 M	400 k	800 M	400 k
100 ms	500 k	500 k	500 k	500 k	500 k	500 k	500 k	500 k	400 M	500 k	800 M	500 k
50 ms	1 M	500 k	1 M	500 k	1 M	500 k	1 M	500 k	400 M	500 k	800 M	500 k
20 ms	2 M	400 k	2 M	400 k	2 M	400 k	2 M	400 k	400 M	400 k	800 M	400 k
10 ms	5 M	500 k	5 M	500 k	5 M	500 k	5 M	500 k	400 M	500 k	800 M	500 k
5 ms	10 M	500 k	10 M	500 k	10 M	500 k	10 M	500 k	400 M	500 k	800 M	500 k
2 ms	20 M	400 k	20 M	400 k	20 M	400 k	20 M	400 k	400 M	400 k	800 M	400 k
1 ms	50 M	500 k	50 M	500 k	50 M	500 k	50 M	500 k	400 M	500 k	800 M	500 k
500 μs	100 M	500 k	100 M	500 k	100 M	500 k	100 M	500 k	400 M	500 k	800 M	500 k
200 μs	200 M	400 k	200 M	400 k	200 M	400 k	200 M	400 k	400 M	400 k	800 M	400 k
100 μs	500 M	500 k	500 M	500 k	500 M	500 k	500 M	500 k			1 G	500 k
50 μs	500 M	250 k	1 G	500 k	1 G	500 k	1 G	500 k	Changes to normal mode, even when envelope mode has been set.			
20 μs	500 M	100 k	2 G	400 k	1 G	200 k	2 G	400 k				
10 μs	500 M	50 k	5 G	500 k	1 G	100 k	5 G	500 k				
5 μs	500 M	25 k	10 G	500 k	1 G	50 k	10 G	500 k				
2 μs	500 M	10 k	20 G	400 k	1 G	20 k	20 G	400 k				
1 μs	500 M	5 k	50 G	500 k	1 G	10 k	50 G	500 k				
500 ns	500 M	2.5 k	100 G	500 k	1 G	5 k	100 G	500 k				
200 ns	500 M	1 k	100 G	200 k	1 G	2 k	100 G	200 k				
100 ns	500 M	500	100 G	100 k	1 G	1 k	100 G	100 k				
50 ns	500 M	250	100 G	50 k	1 G	500	100 G	50 k				
20 ns	500 M	100	100 G	20 k	1 G	200	100 G	20 k				
10 ns	100 G	10 k	100 G	10 k	100 G	10 k	100 G	10 k				
5 ns	100 G	5 k	100 G	5 k	100 G	5 k	100 G	5 k				
2 ns	100 G	2 k	100 G	2 k	100 G	2 k	100 G	2 k				
1 ns	100 G	1 k	100 G	1 k	100 G	1 k	100 G	1 k				

*: For the setting enclosed by the bold line, repetitive sampling is active.

Appendix 1 Relationship between the Time Axis Setting, Sample Rate and Record Length

Record length: 1 M words (DL7100)

Rep: Repetitive sampling mode

Setting T/div	When Mode other than Envelope Mode is Active								When Envelope Mode is Active			
	Interleave mode OFF ^{*2}				Interleave Mode ON				Interleave mode OFF		Interleave Mode ON	
	Rep: [OFF]		Rep: [ON]		Rep: [OFF]		Rep: [ON]		Sample rate (S/s)	Displayed record length (word)	Sample rate (S/s)	Displayed record length (word)
	Sample rate (S/s)	Displayed record length (word)	Sample rate (S/s)	Displayed record length (word)	Sample rate (S/s)	Displayed record length (word)	Sample rate (S/s)	Displayed record length (word)	Sample rate (S/s)	Displayed record length (word)	Sample rate (S/s)	Displayed record length (word)
50 s	2 k	1 M	2 k	1 M	2 k	1 M	2 k	1 M	400 M	1 M	800 M	1 M
20 s	5 k	1 M	5 k	1 M	5 k	1 M	5 k	1 M	400 M	1 M	800 M	1 M
10 s	10 k	1 M	10 k	1 M	10 k	1 M	10 k	1 M	400 M	1 M	800 M	1 M
5 s	20 k	1 M	20 k	1 M	20 k	1 M	20 k	1 M	400 M	1 M	800 M	1 M
2 s	50 k	1 M	50 k	1 M	50 k	1 M	50 k	1 M	400 M	1 M	800 M	1 M
1 s	100 k	1 M	100 k	1 M	100 k	1 M	100 k	1 M	400 M	1 M	800 M	1 M
500 ms	200 k	1 M	200 k	1 M	200 k	1 M	200 k	1 M	400 M	1 M	800 M	1 M
200 ms	500 k	1 M	500 k	1 M	500 k	1 M	500 k	1 M	400 M	1 M	800 M	1 M
100 ms	1 M	1 M	1 M	1 M	1 M	1 M	1 M	1 M	400 M	1 M	800 M	1 M
50 ms	2 M	1 M	2 M	1 M	2 M	1 M	2 M	1 M	400 M	1 M	800 M	1 M
20 ms	5 M	1 M	5 M	1 M	5 M	1 M	5 M	1 M	400 M	1 M	800 M	1 M
10 ms	10 M	1 M	10 M	1 M	10 M	1 M	10 M	1 M	400 M	1 M	800 M	1 M
5 ms	20 M	1 M	20 M	1 M	20 M	1 M	20 M	1 M	400 M	1 M	800 M	1 M
2 ms	50 M	1 M	50 M	1 M	50 M	1 M	50 M	1 M	400 M	1 M	800 M	1 M
1 ms	100 M	1 M	100 M	1 M	100 M	1 M	100 M	1 M	400 M	1 M	800 M	1 M
500 μs	200 M	1 M	200 M	1 M	200 M	1 M	200 M	1 M	400 M	1 M	800 M	1 M
200 μs	500 M	1 M	500 M	1 M	500 M	1 M	500 M	1 M			1 G	1 M
100 μs	500 M	500 k	1 G	1 M	1 G	1 M	1 G	1 M				
50 μs	500 M	250 k	2 G	1 M	1 G	500 k	2 G	1 M				
20 μs	500 M	100 k	5 G	1 M	1 G	200 k	5 G	1 M				
10 μs	500 M	50 k	10 G	1 M	1 G	100 k	10 G	1 M				
5 μs	500 M	25 k	20 G	1 M	1 G	50 k	20 G	1 M				
2 μs	500 M	10 k	50 G	1 M	1 G	20 k	50 G	1 M				
1 μs	500 M	5 k	100 G	1 M	1 G	10 k	100 G	1 M				
500 ns	500 M	2.5 k	100 G	500 k	1 G	5 k	100 G	500 k				
200 ns	500 M	1 k	100 G	200 k	1 G	2 k	100 G	200 k				
100 ns	500 M	500	100 G	100 k	1 G	1 k	100 G	100 k				
50 ns	500 M	250	100 G	50 k	1 G	500	100 G	50 k				
20 ns	500 M	100	100 G	20 k	1 G	200	100 G	20 k				
10 ns	100 G	10 k	100 G	10 k	100 G	10 k	100 G	10 k				
5 ns	100 G	5 k	100 G	5 k	100 G	5 k	100 G	5 k				
2 ns	100 G	2 k	100 G	2 k	100 G	2 k	100 G	2 k				
1 ns	100 G	1 k	100 G	1 k	100 G	1 k	100 G	1 k				

*1: For the setting enclosed by the bold line, repetitive sampling is active.

*2: 2 MWord model: Box average cannot be specified.

Changes to normal mode, even when envelope mode has been set.

Appendix 1 Relationship between the Time Axis Setting, Sample Rate and Record Length

Record length: 2 M words^{*4} (DL7100)

Rep: Repetitive sampling mode

Setting T/div	When Mode other than Envelope Mode is Active								When Envelope Mode is Active			
	Interleave mode OFF				Interleave Mode ON ^{*3}				Interleave mode OFF		Interleave Mode ON	
	Rep: [OFF]		Rep: [ON]		Rep: [OFF]		Rep: [ON]		Sample rate (S/s)	Displayed record length (word)	Sample rate (S/s)	Displayed record length (word)
	Sample rate (S/s)	Displayed record length (word)	Sample rate (S/s)	Displayed record length (word)	Sample rate (S/s)	Displayed record length (word)	Sample rate (S/s)	Displayed record length (word)				
50 s	5 k	2.5 M ^{*2}	5 k	2.5 M ^{*2}	5 k	2.5 M ^{*2}	5 k	2.5 M ^{*2}	400 M	2.5 M ^{*2}	800 M	2.5 M ^{*2}
20 s	10 k	2 M	10 k	2 M	10 k	2 M	10 k	2 M	400 M	2 M	800 M	2 M
10 s	20 k	2 M	20 k	2 M	20 k	2 M	20 k	2 M	400 M	2 M	800 M	2 M
5 s	50 k	2.5 M ^{*2}	50 k	2.5 M ^{*2}	50 k	2.5 M ^{*2}	50 k	2.5 M ^{*2}	400 M	2.5 M ^{*2}	800 M	2.5 M ^{*2}
2 s	100 k	2 M	100 k	2 M	100 k	2 M	100 k	2 M	400 M	2 M	800 M	2 M
1 s	200 k	2 M	200 k	2 M	200 k	2 M	200 k	2 M	400 M	2 M	800 M	2 M
500 ms	500 k	2.5 M ^{*2}	500 k	2.5 M ^{*2}	500 k	2.5 M ^{*2}	500 k	2.5 M ^{*2}	400 M	2.5 M ^{*2}	800 M	2.5 M ^{*2}
200 ms	1 M	2 M	1 M	2 M	1 M	2 M	1 M	2 M	400 M	2 M	800 M	2 M
100 ms	2 M	2 M	2 M	2 M	2 M	2 M	2 M	2 M	400 M	2 M	800 M	2 M
50 ms	5 M	2.5 M ^{*2}	5 M	2.5 M ^{*2}	5 M	2.5 M ^{*2}	5 M	2.5 M ^{*2}	400 M	2.5 M ^{*2}	800 M	2.5 M ^{*2}
20 ms	10 M	2 M	10 M	2 M	10 M	2 M	10 M	2 M	400 M	2 M	800 M	2 M
10 ms	20 M	2 M	20 M	2 M	20 M	2 M	20 M	2 M	400 M	2 M	800 M	2 M
5 ms	50 M	2.5 M ^{*2}	50 M	2.5 M ^{*2}	50 M	2.5 M ^{*2}	50 M	2.5 M ^{*2}	400 M	2.5 M ^{*2}	800 M	2.5 M ^{*2}
2 ms	100 M	2 M	100 M	2 M	100 M	2 M	100 M	2 M	400 M	2 M	800 M	2 M
1 ms	200 M	2 M	200 M	2 M	200 M	2 M	200 M	2 M	400 M	2 M	800 M	2 M
500 μs	500 M	2.5 M ^{*2}	500 M	2.5 M ^{*2}	500 M	2.5 M ^{*2}	500 M	2.5 M ^{*2}			1 G	2.5 M ^{*2}
200 μs	500 M	1 M	1 G	2 M	1 G	2 M	1 G	2 M				
100 μs	500 M	500 k	2 G	2 M	1 G	1 M	2 G	2 M				
50 μs	500 M	250 k	5 G	2.5 M ^{*2}	1 G	500 k	5 G	2.5 M ^{*2}				
20 μs	500 M	100 k	10 G	2 M	1 G	200 k	10 G	2 M				
10 μs	500 M	50 k	20 G	2 M	1 G	100 k	20 G	2 M				
5 μs	500 M	25 k	50 G	2.5 M ^{*2}	1 G	50 k	50 G	2.5 M ^{*2}				
2 μs	500 M	10 k	100 G	2 M	1 G	20 k	100 G	2 M				
1 μs	500 M	5 k	100 G	1 M	1 G	10 k	100 G	1 M				
500 ns	500 M	2.5 k	100 G	500 k	1 G	5 k	100 G	500 k				
200 ns	500 M	1 k	100 G	200 k	1 G	2 k	100 G	200 k				
100 ns	500 M	500	100 G	100 k	1 G	1 k	100 G	100 k				
50 ns	500 M	250	100 G	50 k	1 G	500	100 G	50 k				
20 ns	500 M	100	100 G	20 k	1 G	200	100 G	20 k				
10 ns	100 G	10 k	100 G	10 k	100 G	10 k	100 G	10 k				
5 ns	100 G	5 k	100 G	5 k	100 G	5 k	100 G	5 k				
2 ns	100 G	2 k	100 G	2 k	100 G	2 k	100 G	2 k				
1 ns	100 G	1 k	100 G	1 k	100 G	1 k	100 G	1 k				

Changes to normal mode, even when envelope mode has been set.

- *1: For the setting enclosed by the bold line, repetitive sampling is active.
- *2: Because acquisition size is 2 MWords, the waveform is displayed over 8 divisions of the time axis only.
Note that the trigger position setting percentage in this case with respect to the 8 division length (100% = 8 divisions).
- *3: 2 MWord model: Box average cannot be specified.
- *4: 2 MWord model: Record length cannot be set to 2 MWord when interleave mode is OFF.

Appendix 1 Relationship between the Time Axis Setting, Sample Rate and Record Length

Record length: 4 M words*4 (DL7100)

Rep: Repetitive sampling mode

Setting T/div	When Mode other than Envelope Mode is Active								When Envelope Mode is Active			
	Interleave mode OFF ³				Interleave Mode ON				Interleave mode OFF		Interleave Mode ON	
	Rep: [OFF]		Rep: [ON]		Rep: [OFF]		Rep: [ON]		Sample rate (S/s)	Displayed record length (word)	Sample rate (S/s)	Displayed record length (word)
	Sample rate (S/s)	Displayed record length (word)	Sample rate (S/s)	Displayed record length (word)	Sample rate (S/s)	Displayed record length (word)	Sample rate (S/s)	Displayed record length (word)				
50 s	10 k	5 M ²	10 k	5 M ²	10 k	5 M ²	10 k	5 M ²	400 M	5 M ²	800 M	5 M ²
20 s	20 k	4 M	20 k	4 M	20 k	4 M	20 k	4 M	400 M	4 M	800 M	4 M
10 s	50 k	5 M ²	50 k	5 M ²	50 k	5 M ²	50 k	5 M ²	400 M	5 M ²	800 M	5 M ²
5 s	100 k	5 M ²	100 k	5 M ²	100 k	5 M ²	100 k	5 M ²	400 M	5 M ²	800 M	5 M ²
2 s	200 k	4 M	200 k	4 M	200 k	4 M	200 k	4 M	400 M	4 M	800 M	4 M
1 s	500 k	5 M ²	500 k	5 M ²	500 k	5 M ²	500 k	5 M ²	400 M	5 M ²	800 M	5 M ²
500 ms	1 M	5 M ²	1 M	5 M ²	1 M	5 M ²	1 M	5 M ²	400 M	5 M ²	800 M	5 M ²
200 ms	2 M	4 M	2 M	4 M	2 M	4 M	2 M	4 M	400 M	4 M	800 M	4 M
100 ms	5 M	5 M ²	5 M	5 M ²	5 M	5 M ²	5 M	5 M ²	400 M	5 M ²	800 M	5 M ²
50 ms	10 M	5 M ²	10 M	5 M ²	10 M	5 M ²	10 M	5 M ²	400 M	5 M ²	800 M	5 M ²
20 ms	20 M	4 M	20 M	4 M	20 M	4 M	20 M	4 M	400 M	4 M	800 M	4 M
10 ms	50 M	5 M ²	50 M	5 M ²	50 M	5 M ²	50 M	5 M ²	400 M	5 M ²	800 M	5 M ²
5 ms	100 M	5 M ²	100 M	5 M ²	100 M	5 M ²	100 M	5 M ²	400 M	5 M ²	800 M	5 M ²
2 ms	200 M	4 M	200 M	4 M	200 M	4 M	200 M	4 M	400 M	4 M	800 M	4 M
1 ms	500 M	5 M ²	500 M	5 M ²	500 M	5 M ²	500 M	5 M ²			1 G	5 M ²
500 μs	500 M	2.5 M ²	1 G	5 M ²	1 G	5 M ²	1 G	5 M ²	Changes to normal mode, even when envelope mode has been set.			
200 μs	500 M	1 M	2 G	4 M	1 G	2 M	2 G	4 M				
100 μs	500 M	500 k	5 G	5 M ²	1 G	1 M	5 G	5 M ²				
50 μs	500 M	250 k	10 G	5 M ²	1 G	500 k	10 G	5 M ²				
20 μs	500 M	100 k	20 G	4 M	1 G	200 k	20 G	4 M				
10 μs	500 M	50 k	50 G	5 M ²	1 G	100 k	50 G	5 M ²				
5 μs	500 M	25 k	100 G	5 M ²	1 G	50 k	100 G	5 M ²				
2 μs	500 M	10 k	100 G	2 M	1 G	20 k	100 G	2 M				
1 μs	500 M	5 k	100 G	1 M	1 G	10 k	100 G	1 M				
500 ns	500 M	2.5 k	100 G	500 k	1 G	5 k	100 G	500 k				
200 ns	500 M	1 k	100 G	200 k	1 G	2 k	100 G	200 k				
100 ns	500 M	500	100 G	100 k	1 G	1 k	100 G	100 k				
50 ns	500 M	250	100 G	50 k	1 G	500	100 G	50 k				
20 ns	500 M	100	100 G	20 k	1 G	200	100 G	20 k				
10 ns	100 G	10 k	100 G	10 k	100 G	10 k	100 G	10 k				
5 ns	100 G	5 k	100 G	5 k	100 G	5 k	100 G	5 k				
2 ns	100 G	2 k	100 G	2 k	100 G	2 k	100 G	2 k				
1 ns	100 G	1 k	100 G	1 k	100 G	1 k	100 G	1 k				

- *1: For the setting enclosed by the bold line, repetitive sampling is active.
- *2: Because acquisition size is 4 MWords, the waveform is displayed over 8 divisions of the time axis only.
Note that the trigger position setting percentage in this case with respect to the 8 division length (100% = 8 divisions).
- *3: Box average, linear average, or computation cannot be specified.
- *4: 2 MWord model :Record length cannot be set to 4 MWord when interleave mode is OFF.

Appendix 1 Relationship between the Time Axis Setting, Sample Rate and Record Length

Record length: 8 M words^{*4} (only for 8 M Word model) (DL7100)

Box average, linear averaging, or computation cannot be specified.

Rep: Repetitive sampling mode

Setting T/div	When Mode other than Envelope Mode is Active								When Envelope Mode is Active			
	Interleave mode OFF ^{*3}				Interleave Mode ON				Interleave mode OFF		Interleave Mode ON	
	Rep: [OFF]		Rep: [ON]		Rep: [OFF]		Rep: [ON]		Sample rate (S/s)	Displayed record len gth (word)	Sample rate (S/s)	Displayed record len gth (word)
	Sample rate (S/s)	Displayed record len gth (word)	Sample rate (S/s)	Displayed record len gth (word)	Sample rate (S/s)	Displayed record len gth (word)	Sample rate (S/s)	Displayed record len gth (word)				
50 s					20 k	10 M ^{*2}	20 k	10 M ^{*2}			800 M	10 M ^{*2}
20 s					50 k	10 M ^{*2}	50 k	10 M ^{*2}			800 M	10 M ^{*2}
10 s					100 k	10 M ^{*2}	100 k	10 M ^{*2}			800 M	10 M ^{*2}
5 s					200 k	10 M ^{*2}	200 k	10 M ^{*2}			800 M	10 M ^{*2}
2 s					500 k	10 M ^{*2}	500 k	10 M ^{*2}			800 M	10 M ^{*2}
1 s					1 M	10 M ^{*2}	1 M	10 M ^{*2}			800 M	10 M ^{*2}
500 ms					2 M	10 M ^{*2}	2 M	10 M ^{*2}			800 M	10 M ^{*2}
200 ms					5 M	10 M ^{*2}	5 M	10 M ^{*2}			800 M	10 M ^{*2}
100 ms					10 M	10 M ^{*2}	10 M	10 M ^{*2}			800 M	10 M ^{*2}
50 ms					20 M	10 M ^{*2}	20 M	10 M ^{*2}			800 M	10 M ^{*2}
20 ms					50 M	10 M ^{*2}	50 M	10 M ^{*2}			800 M	10 M ^{*2}
10 ms					100 M	10 M ^{*2}	100 M	10 M ^{*2}			800 M	10 M ^{*2}
5 ms					200 M	10 M ^{*2}	200 M	10 M ^{*2}			800 M	10 M ^{*2}
2 ms					500 M	10 M ^{*2}	500 M	10 M ^{*2}			800 M	10 M ^{*2}
1 ms					1 G	10 M ^{*2}	1 G	10 M ^{*2}			1 G	10 M ^{*2}
500 μs					1 G	5 M	2 G	10 M ^{*2}	This record length cannot be used when interleave is ON.	This record length cannot be used when interleave is ON.	Changes to normal mode, even when envelope mode has been set.	
200 μs					1 G	2 M	5 G	10 M ^{*2}				
100 μs					1 G	1 M	10 G	10 M ^{*2}				
50 μs					1 G	500 k	20 G	10 M ^{*2}				
20 μs					1 G	200 k	50 G	10 M ^{*2}				
10 μs					1 G	100 k	100 G	10 M ^{*2}				
5 μs					1 G	50 k	100 G	5 M				
2 μs					1 G	20 k	100 G	2 M				
1 μs					1 G	10 k	100 G	1 M				
500 ns					1 G	5 k	100 G	500 k				
200 ns					1 G	2 k	100 G	200 k				
100 ns					1 G	1 k	100 G	100 k				
50 ns					1 G	500	100 G	50 k				
20 ns					1 G	200	100 G	20 k				
10 ns					100 G	10 k	100 G	10 k				
5 ns					100 G	5 k	100 G	5 k				
2 ns					100 G	2 k	100 G	2 k				
1 ns					100 G	1 k	100 G	1 k				

*1: For the setting enclosed by the bold line, repetitive sampling is active.

*2: Because acquisition size is 8 MWords, the waveform is displayed over 8 divisions of the time axis only. Note that the trigger position setting percentage in this case with respect to the 8 division length (100% = 8 divisions).

*3: Box average, linear average, or computation cannot be specified.

*4: 2 MWord model: Record length cannot be set to 8 MWord when interleave mode is OFF.

Appendix 1 Relationship between the Time Axis Setting, Sample Rate and Record Length

Record length: 1 k words (DL7200)

Rep: Repetitive sampling mode

Setting T/div	When Mode other than Envelope Mode is Active								When Envelope Mode is Active			
	Interleave mode OFF				Interleave Mode ON				Interleave mode OFF		Interleave Mode ON	
	Rep: [OFF]		Rep: [ON]		Rep: [OFF]		Rep: [ON]		Sample rate (S/s)	Displayed record length (word)	Sample rate (S/s)	Displayed record length (word)
	Sample rate (S/s)	Displayed record length (word)	Sample rate (S/s)	Displayed record length (word)	Sample rate (S/s)	Displayed record length (word)	Sample rate (S/s)	Displayed record length (word)	Sample rate (S/s)	Displayed record length (word)	Sample rate (S/s)	Displayed record length (word)
50 s	It is not possible to set these T/div.											
20 s												
10 s												
5 s	20	1 k	20	1 k	20	1 k	20	1 k	800 M	1 k	800 M	1 k
2 s	50	1 k	50	1 k	50	1 k	50	1 k	800 M	1 k	800 M	1 k
1 s	100	1 k	100	1 k	100	1 k	100	1 k	800 M	1 k	800 M	1 k
500 ms	200	1 k	200	1 k	200	1 k	200	1 k	800 M	1 k	800 M	1 k
200 ms	500	1 k	500	1 k	500	1 k	500	1 k	800 M	1 k	800 M	1 k
100 ms	1 k	1 k	1 k	1 k	1 k	1 k	1 k	1 k	800 M	1 k	800 M	1 k
50 ms	2 k	1 k	2 k	1 k	2 k	1 k	2 k	1 k	800 M	1 k	800 M	1 k
20 ms	5 k	1 k	5 k	1 k	5 k	1 k	5 k	1 k	800 M	1 k	800 M	1 k
10 ms	10 k	1 k	10 k	1 k	10 k	1 k	10 k	1 k	800 M	1 k	800 M	1 k
5 ms	20 k	1 k	20 k	1 k	20 k	1 k	20 k	1 k	800 M	1 k	800 M	1 k
2 ms	50 k	1 k	50 k	1 k	50 k	1 k	50 k	1 k	800 M	1 k	800 M	1 k
1 ms	100 k	1 k	100 k	1 k	100 k	1 k	100 k	1 k	800 M	1 k	800 M	1 k
500 μs	200 k	1 k	200 k	1 k	200 k	1 k	200 k	1 k	800 M	1 k	800 M	1 k
200 μs	500 k	1 k	500 k	1 k	500 k	1 k	500 k	1 k	800 M	1 k	800 M	1 k
100 μs	1 M	1 k	1 M	1 k	1 M	1 k	1 M	1 k	800 M	1 k	800 M	1 k
50 μs	2 M	1 k	2 M	1 k	2 M	1 k	2 M	1 k	800 M	1 k	800 M	1 k
20 μs	5 M	1 k	5 M	1 k	5 M	1 k	5 M	1 k	800 M	1 k	800 M	1 k
10 μs	10 M	1 k	10 M	1 k	10 M	1 k	10 M	1 k	800 M	1 k	800 M	1 k
5 μs	20 M	1 k	20 M	1 k	20 M	1 k	20 M	1 k	800 M	1 k	800 M	1 k
2 μs	50 M	1 k	50 M	1 k	50 M	1 k	50 M	1 k	800 M	1 k	800 M	1 k
1 μs	100 M	1 k	100 M	1 k	100 M	1 k	100 M	1 k	800 M	1 k	800 M	1 k
500 ns	200 M	1 k	200 M	1 k	200 M	1 k	200 M	1 k	800 M	1 k	800 M	1 k
200 ns	500 M	1 k	500 M	1 k	500 M	1 k	500 M	1 k	1 G	1 k	1 G	1 k
100 ns	1 G	1 k	1 G	1 k	1 G	1 k	1 G	1 k	Changes to normal mode, even when envelope mode has been set.			
50 ns	1 G	500	2 G	1 k	2 G	1 k	2 G	1 k				
20 ns	1 G	200	5 G	1 k	2 G	400	5 G	1 k				
10 ns	1 G	100	10 G	1 k	2 G	200	10 G	1 k				
5 ns	20 G	1 k	20 G	1 k	20 G	1 k	20 G	1 k				
2 ns	50 G	1 k	50 G	1 k	50 G	1 k	50 G	1 k				
1 ns	100 G	1 k	100 G	1 k	100 G	1 k	100 G	1 k				

*: For the setting enclosed by the bold line, repetitive sampling is active.

Appendix 1 Relationship between the Time Axis Setting, Sample Rate and Record Length

Record length: 10 k words (DL7200)

Rep: Repetitive sampling mode

Setting T/div	When Mode other than Envelope Mode is Active								When Envelope Mode is Active			
	Interleave mode OFF				Interleave Mode ON				Interleave mode OFF		Interleave Mode ON	
	Rep: [OFF]		Rep: [ON]		Rep: [OFF]		Rep: [ON]		Sample rate (S/s)	Displayed record length (word)	Sample rate (S/s)	Displayed record length (word)
	Sample rate (S/s)	Displayed record length (word)	Sample rate (S/s)	Displayed record length (word)	Sample rate (S/s)	Displayed record length (word)	Sample rate (S/s)	Displayed record length (word)				
50 s	20	10 k	20	10 k	20	10 k	20	10 k	800 M	10 k	800 M	10 k
20 s	50	10 k	50	10 k	50	10 k	50	10 k	800 M	10 k	800 M	10 k
10 s	100	10 k	100	10 k	100	10 k	100	10 k	800 M	10 k	800 M	10 k
5 s	200	10 k	200	10 k	200	10 k	200	10 k	800 M	10 k	800 M	10 k
2 s	500	10 k	500	10 k	500	10 k	500	10 k	800 M	10 k	800 M	10 k
1 s	1 k	10 k	1 k	10 k	1 k	10 k	1 k	10 k	800 M	10 k	800 M	10 k
500 ms	2 k	10 k	2 k	10 k	2 k	10 k	2 k	10 k	800 M	10 k	800 M	10 k
200 ms	5 k	10 k	5 k	10 k	5 k	10 k	5 k	10 k	800 M	10 k	800 M	10 k
100 ms	10 k	10 k	10 k	10 k	10 k	10 k	10 k	10 k	800 M	10 k	800 M	10 k
50 ms	20 k	10 k	20 k	10 k	20 k	10 k	20 k	10 k	800 M	10 k	800 M	10 k
20 ms	50 k	10 k	50 k	10 k	50 k	10 k	50 k	10 k	800 M	10 k	800 M	10 k
10 ms	100 k	10 k	100 k	10 k	100 k	10 k	100 k	10 k	800 M	10 k	800 M	10 k
5 ms	200 k	10 k	200 k	10 k	200 k	10 k	200 k	10 k	800 M	10 k	800 M	10 k
2 ms	500 k	10 k	500 k	10 k	500 k	10 k	500 k	10 k	800 M	10 k	800 M	10 k
1 ms	1 M	10 k	1 M	10 k	1 M	10 k	1 M	10 k	800 M	10 k	800 M	10 k
500 μs	2 M	10 k	2 M	10 k	2 M	10 k	2 M	10 k	800 M	10 k	800 M	10 k
200 μs	5 M	10 k	5 M	10 k	5 M	10 k	5 M	10 k	800 M	10 k	800 M	10 k
100 μs	10 M	10 k	10 M	10 k	10 M	10 k	10 M	10 k	800 M	10 k	800 M	10 k
50 μs	20 M	10 k	20 M	10 k	20 M	10 k	20 M	10 k	800 M	10 k	800 M	10 k
20 μs	50 M	10 k	50 M	10 k	50 M	10 k	50 M	10 k	800 M	10 k	800 M	10 k
10 μs	100 M	10 k	100 M	10 k	100 M	10 k	100 M	10 k	800 M	10 k	800 M	10 k
5 μs	200 M	10 k	200 M	10 k	200 M	10 k	200 M	10 k	800 M	10 k	800 M	10 k
2 μs	500 M	10 k	500 M	10 k	500 M	10 k	500 M	10 k	1 G	10 k	1 G	10 k
1 μs	1 G	10 k	1 G	10 k	1 G	10 k	1 G	10 k	Changes to normal mode, even when envelope mode has been set.			
500 ns	1 G	5 k	2 G	10 k	2 G	10 k	2 G	10 k				
200 ns	1 G	2 k	5 G	10 k	2 G	4 k	5 G	10 k				
100 ns	1 G	1 k	10 G	10 k	2 G	2 k	10 G	10 k				
50 ns	1 G	500	20 G	10 k	2 G	1 k	20 G	10 k				
20 ns	1 G	200	50 G	10 k	2 G	400	50 G	10 k				
10 ns	1 G	100	100 G	10 k	2 G	200	100 G	10 k				
5 ns	100 G	5 k	100 G	5 k	100 G	5 k	100 G	5 k				
2 ns	100 G	2 k	100 G	2 k	100 G	2 k	100 G	2 k				
1 ns	100 G	1 k	100 G	1 k	100 G	1 k	100 G	1 k				

*: For the setting enclosed by the bold line, repetitive sampling is active.

Appendix 1 Relationship between the Time Axis Setting, Sample Rate and Record Length

Record length: 50 k words (DL7200)

Rep: Repetitive sampling mode

Setting T/div	When Mode other than Envelope Mode is Active								When Envelope Mode is Active			
	Interleave mode OFF				Interleave Mode ON				Interleave mode OFF		Interleave Mode ON	
	Rep: [OFF]		Rep: [ON]		Rep: [OFF]		Rep: [ON]		Sample rate (S/s)	Displayed record length (word)	Sample rate (S/s)	Displayed record length (word)
	Sample rate (S/s)	Displayed record length (word)	Sample rate (S/s)	Displayed record length (word)	Sample rate (S/s)	Displayed record length (word)	Sample rate (S/s)	Displayed record length (word)				
50 s	100	50 k	100	50 k	100	50 k	100	50 k	800 M	50 k	800 M	50 k
20 s	200	40 k	200	40 k	200	40 k	200	40 k	800 M	40 k	800 M	40 k
10 s	500	50 k	500	50 k	500	50 k	500	50 k	800 M	50 k	800 M	50 k
5 s	1 k	50 k	1 k	50 k	1 k	50 k	1 k	50 k	800 M	50 k	800 M	50 k
2 s	2 k	40 k	2 k	40 k	2 k	40 k	2 k	40 k	800 M	40 k	800 M	40 k
1 s	5 k	50 k	5 k	50 k	5 k	50 k	5 k	50 k	800 M	50 k	800 M	50 k
500 ms	10 k	50 k	10 k	50 k	10 k	50 k	10 k	50 k	800 M	50 k	800 M	50 k
200 ms	20 k	40 k	20 k	40 k	20 k	40 k	20 k	40 k	800 M	40 k	800 M	40 k
100 ms	50 k	50 k	50 k	50 k	50 k	50 k	50 k	50 k	800 M	50 k	800 M	50 k
50 ms	100 k	50 k	100 k	50 k	100 k	50 k	100 k	50 k	800 M	50 k	800 M	50 k
20 ms	200 k	40 k	200 k	40 k	200 k	40 k	200 k	40 k	800 M	40 k	800 M	40 k
10 ms	500 k	50 k	500 k	50 k	500 k	50 k	500 k	50 k	800 M	50 k	800 M	50 k
5 ms	1 M	50 k	1 M	50 k	1 M	50 k	1 M	50 k	800 M	50 k	800 M	50 k
2 ms	2 M	40 k	2 M	40 k	2 M	40 k	2 M	40 k	800 M	40 k	800 M	40 k
1 ms	5 M	50 k	5 M	50 k	5 M	50 k	5 M	50 k	800 M	50 k	800 M	50 k
500 μs	10 M	50 k	10 M	50 k	10 M	50 k	10 M	50 k	800 M	50 k	800 M	50 k
200 μs	20 M	40 k	20 M	40 k	20 M	40 k	20 M	40 k	800 M	40 k	800 M	40 k
100 μs	50 M	50 k	50 M	50 k	50 M	50 k	50 M	50 k	800 M	50 k	800 M	50 k
50 μs	100 M	50 k	100 M	50 k	100 M	50 k	100 M	50 k	800 M	50 k	800 M	50 k
20 μs	200 M	40 k	200 M	40 k	200 M	40 k	200 M	40 k	800 M	40 k	800 M	40 k
10 μs	500 M	50 k	500 M	50 k	500 M	50 k	500 M	50 k	1 G	50 k	1 G	50 k
5 μs	1 G	50 k	1 G	50 k	1 G	50 k	1 G	50 k	Changes to normal mode, even when envelope mode has been set.			
2 μs	1 G	20 k	2 G	40 k	2 G	40 k	2 G	40 k				
1 μs	1 G	10 k	5 G	50 k	2 G	20 k	5 G	50 k				
500 ns	1 G	5 k	10 G	50 k	2 G	10 k	10 G	50 k				
200 ns	1 G	2 k	20 G	40 k	2 G	4 k	20 G	40 k				
100 ns	1 G	1 k	50 G	50 k	2 G	2 k	50 G	50 k				
50 ns	1 G	500	100 G	50 k	2 G	1 k	100 G	50 k				
20 ns	1 G	200	100 G	20 k	2 G	400	100 G	20 k				
10 ns	1 G	100	100 G	10 k	2 G	200	100 G	10 k				
5 ns	100 G	5 k	100 G	5 k	100 G	5 k	100 G	5 k				
2 ns	100 G	2 k	100 G	2 k	100 G	2 k	100 G	2 k				
1 ns	100 G	1 k	100 G	1 k	100 G	1 k	100 G	1 k				

*: For the setting enclosed by the bold line, repetitive sampling is active.

Appendix 1 Relationship between the Time Axis Setting, Sample Rate and Record Length

Record length: 100 k words (DL7200)

Rep: Repetitive sampling mode

Setting T/div	When Mode other than Envelope Mode is Active								When Envelope Mode is Active			
	Interleave mode OFF				Interleave Mode ON				Interleave mode OFF		Interleave Mode ON	
	Rep: [OFF]		Rep: [ON]		Rep: [OFF]		Rep: [ON]		Sample rate (S/s)	Displayed record length (word)	Sample rate (S/s)	Displayed record length (word)
	Sample rate (S/s)	Displayed record length (word)	Sample rate (S/s)	Displayed record length (word)	Sample rate (S/s)	Displayed record length (word)	Sample rate (S/s)	Displayed record length (word)				
50 s	200	100 k	200	100 k	200	100 k	200	100 k	800 M	100 k	800 M	100 k
20 s	500	100 k	500	100 k	500	100 k	500	100 k	800 M	100 k	800 M	100 k
10 s	1 k	100 k	1 k	100 k	1 k	100 k	1 k	100 k	800 M	100 k	800 M	100 k
5 s	2 k	100 k	2 k	100 k	2 k	100 k	2 k	100 k	800 M	100 k	800 M	100 k
2 s	5 k	100 k	5 k	100 k	5 k	100 k	5 k	100 k	800 M	100 k	800 M	100 k
1 s	10 k	100 k	10 k	100 k	10 k	100 k	10 k	100 k	800 M	100 k	800 M	100 k
500 ms	20 k	100 k	20 k	100 k	20 k	100 k	20 k	100 k	800 M	100 k	800 M	100 k
200 ms	50 k	100 k	50 k	100 k	50 k	100 k	50 k	100 k	800 M	100 k	800 M	100 k
100 ms	100 k	100 k	100 k	100 k	100 k	100 k	100 k	100 k	800 M	100 k	800 M	100 k
50 ms	200 k	100 k	200 k	100 k	200 k	100 k	200 k	100 k	800 M	100 k	800 M	100 k
20 ms	500 k	100 k	500 k	100 k	500 k	100 k	500 k	100 k	800 M	100 k	800 M	100 k
10 ms	1 M	100 k	1 M	100 k	1 M	100 k	1 M	100 k	800 M	100 k	800 M	100 k
5 ms	2 M	100 k	2 M	100 k	2 M	100 k	2 M	100 k	800 M	100 k	800 M	100 k
2 ms	5 M	100 k	5 M	100 k	5 M	100 k	5 M	100 k	800 M	100 k	800 M	100 k
1 ms	10 M	100 k	10 M	100 k	10 M	100 k	10 M	100 k	800 M	100 k	800 M	100 k
500 μs	20 M	100 k	20 M	100 k	20 M	100 k	20 M	100 k	800 M	100 k	800 M	100 k
200 μs	50 M	100 k	50 M	100 k	50 M	100 k	50 M	100 k	800 M	100 k	800 M	100 k
100 μs	100 M	100 k	100 M	100 k	100 M	100 k	100 M	100 k	800 M	100 k	800 M	100 k
50 μs	200 M	100 k	200 M	100 k	200 M	100 k	200 M	100 k	800 M	100 k	800 M	100 k
20 μs	500 M	100 k	500 M	100 k	500 M	100 k	500 M	100 k	1 G	100 k	1 G	100 k
10 μs	1 G	100 k	1 G	100 k	1 G	100 k	1 G	100 k	Changes to normal mode, even when envelope mode has been set.			
5 μs	1 G	50 k	2 G	100 k	2 G	100 k	2 G	100 k				
2 μs	1 G	25 k	5 G	100 k	2 G	40 k	5 G	100 k				
1 μs	1 G	10 k	10 G	100 k	2 G	20 k	10 G	100 k				
500 ns	1 G	5 k	20 G	100 k	2 G	10 k	20 G	100 k				
200 ns	1 G	2 k	50 G	100 k	2 G	4 k	50 G	100 k				
100 ns	1 G	1 k	100 G	100 k	2 G	2 k	100 G	100 k				
50 ns	1 G	500	100 G	50 k	2 G	1 k	100 G	50 k				
20 ns	1 G	200	100 G	20 k	2 G	400	100 G	20 k				
10 ns	1 G	100	100 G	10 k	2 G	200	100 G	10 k				
5 ns	100 G	5 k	100 G	5 k	100 G	5 k	100 G	5 k				
2 ns	100 G	2 k	100 G	2 k	100 G	2 k	100 G	2 k				
1 ns	100 G	1 k	100 G	1 k	100 G	1 k	100 G	1 k				

*: For the setting enclosed by the bold line, repetitive sampling is active.

Appendix 1 Relationship between the Time Axis Setting, Sample Rate and Record Length

Record length: 250 k words (DL7200)

Rep: Repetitive sampling mode

Setting T/div	When Mode other than Envelope Mode is Active								When Envelope Mode is Active			
	Interleave mode OFF				Interleave Mode ON				Interleave mode OFF		Interleave Mode ON	
	Rep: [OFF]		Rep: [ON]		Rep: [OFF]		Rep: [ON]		Sample rate (S/s)	Displayed record length (word)	Sample rate (S/s)	Displayed record length (word)
	Sample rate (S/s)	Displayed record length (word)	Sample rate (S/s)	Displayed record length (word)	Sample rate (S/s)	Displayed record length (word)	Sample rate (S/s)	Displayed record length (word)	Sample rate (S/s)	Displayed record length (word)	Sample rate (S/s)	Displayed record length (word)
50 s	500	250 k	500	250 k	500	250 k	500	250 k	800 M	250 k	800 M	250 k
20 s	1 k	200 k	1 k	200 k	1 k	200 k	1 k	200 k	800 M	200 k	800 M	200 k
10 s	2 k	200 k	2 k	200 k	2 k	200 k	2 k	200 k	800 M	200 k	800 M	200 k
5 s	5 k	250 k	5 k	250 k	5 k	250 k	5 k	250 k	800 M	250 k	800 M	250 k
2 s	10 k	200 k	10 k	200 k	10 k	200 k	10 k	200 k	800 M	200 k	800 M	200 k
1 s	20 k	200 k	20 k	200 k	20 k	200 k	20 k	200 k	800 M	200 k	800 M	200 k
500 ms	50 k	250 k	50 k	250 k	50 k	250 k	50 k	250 k	800 M	250 k	800 M	250 k
200 ms	100 k	200 k	100 k	200 k	100 k	200 k	100 k	200 k	800 M	200 k	800 M	200 k
100 ms	200 k	200 k	200 k	200 k	200 k	200 k	200 k	200 k	800 M	200 k	800 M	200 k
50 ms	500 k	250 k	500 k	250 k	500 k	250 k	500 k	250 k	800 M	250 k	800 M	250 k
20 ms	1 M	200 k	1 M	200 k	1 M	200 k	1 M	200 k	800 M	200 k	800 M	200 k
10 ms	2 M	200 k	2 M	200 k	2 M	200 k	2 M	200 k	800 M	200 k	800 M	200 k
5 ms	5 M	250 k	5 M	250 k	5 M	250 k	5 M	250 k	800 M	250 k	800 M	250 k
2 ms	10 M	200 k	10 M	200 k	10 M	200 k	10 M	200 k	800 M	200 k	800 M	200 k
1 ms	20 M	200 k	20 M	200 k	20 M	200 k	20 M	200 k	800 M	200 k	800 M	200 k
500 μs	50 M	250 k	50 M	250 k	50 M	250 k	50 M	250 k	800 M	250 k	800 M	250 k
200 μs	100 M	200 k	100 M	200 k	100 M	200 k	100 M	200 k	800 M	200 k	800 M	200 k
100 μs	200 M	200 k	200 M	200 k	200 M	200 k	200 M	200 k	800 M	200 k	800 M	200 k
50 μs	500 M	250 k	500 M	250 k	500 M	250 k	500 M	250 k	1 G	250 k	1 G	250 k
20 μs	1 G	200 k	1 G	200 k	1 G	200 k	1 G	200 k	Changes to normal mode, even when envelope mode has been set.			
10 μs	1 G	100 k	2 G	200 k	2 G	200 k	2 G	200 k				
5 μs	1 G	50 k	5 G	250 k	2 G	100 k	5 G	250 k				
2 μs	1 G	20 k	10 G	200 k	2 G	40 k	10 G	200 k				
1 μs	1 G	10 k	20 G	200 k	2 G	20 k	20 G	200 k				
500 ns	1 G	5 k	50 G	250 k	2 G	10 k	50 G	250 k				
200 ns	1 G	2 k	100 G	200 k	2 G	4 k	100 G	200 k				
100 ns	1 G	1 k	100 G	100 k	2 G	2 k	100 G	100 k				
50 ns	1 G	500	100 G	50 k	2 G	1 k	100 G	50 k				
20 ns	1 G	200	100 G	20 k	2 G	400	100 G	20 k				
10 ns	1 G	100	100 G	10 k	2 G	200	100 G	10 k				
5 ns	100 G	5 k	100 G	5 k	100 G	5 k	100 G	5 k				
2 ns	100 G	2 k	100 G	2 k	100 G	2 k	100 G	2 k				
1 ns	100 G	1 k	100 G	1 k	100 G	1 k	100 G	1 k				

*: For the setting enclosed by the bold line, repetitive sampling is active.

Appendix 1 Relationship between the Time Axis Setting, Sample Rate and Record Length

Record length: 500 k words (DL7200)

Rep: Repetitive sampling mode

Setting T/div	When Mode other than Envelope Mode is Active								When Envelope Mode is Active			
	Interleave mode OFF				Interleave Mode ON				Interleave mode OFF		Interleave Mode ON	
	Rep: [OFF]		Rep: [ON]		Rep: [OFF]		Rep: [ON]		Sample rate (S/s)	Displayed record length (word)	Sample rate (S/s)	Displayed record length (word)
	Sample rate (S/s)	Displayed record length (word)	Sample rate (S/s)	Displayed record length (word)	Sample rate (S/s)	Displayed record length (word)	Sample rate (S/s)	Displayed record length (word)				
50 s	1 k	500 k	1 k	500 k	1 k	500 k	1 k	500 k	800 M	500 k	800 M	500 k
20 s	2 k	400 k	2 k	400 k	2 k	400 k	2 k	400 k	800 M	400 k	800 M	400 k
10 s	5 k	500 k	5 k	500 k	5 k	500 k	5 k	500 k	800 M	500 k	800 M	500 k
5 s	10 k	500 k	10 k	500 k	10 k	500 k	10 k	500 k	800 M	500 k	800 M	500 k
2 s	20 k	400 k	20 k	400 k	20 k	400 k	20 k	400 k	800 M	400 k	800 M	400 k
1 s	50 k	500 k	50 k	500 k	50 k	500 k	50 k	500 k	800 M	500 k	800 M	500 k
500 ms	100 k	500 k	100 k	500 k	100 k	500 k	100 k	500 k	800 M	500 k	800 M	500 k
200 ms	200 k	400 k	200 k	400 k	200 k	400 k	200 k	400 k	800 M	400 k	800 M	400 k
100 ms	500 k	500 k	500 k	500 k	500 k	500 k	500 k	500 k	800 M	500 k	800 M	500 k
50 ms	1 M	500 k	1 M	500 k	1 M	500 k	1 M	500 k	800 M	500 k	800 M	500 k
20 ms	2 M	400 k	2 M	400 k	2 M	400 k	2 M	400 k	800 M	400 k	800 M	400 k
10 ms	5 M	500 k	5 M	500 k	5 M	500 k	5 M	500 k	800 M	500 k	800 M	500 k
5 ms	10 M	500 k	10 M	500 k	10 M	500 k	10 M	500 k	800 M	500 k	800 M	500 k
2 ms	20 M	400 k	20 M	400 k	20 M	400 k	20 M	400 k	800 M	400 k	800 M	400 k
1 ms	50 M	500 k	50 M	500 k	50 M	500 k	50 M	500 k	800 M	500 k	800 M	500 k
500 μs	100 M	500 k	100 M	500 k	100 M	500 k	100 M	500 k	800 M	500 k	800 M	500 k
200 μs	200 M	400 k	200 M	400 k	200 M	400 k	200 M	400 k	800 M	400 k	800 M	400 k
100 μs	500 M	500 k	500 M	500 k	500 M	500 k	500 M	500 k	1 G	500 k	1 G	500 k
50 μs	1 G	500 k	1 G	500 k	1 G	500 k	1 G	500 k	Changes to normal mode, even when envelope mode has been set.			
20 μs	1 G	200 k	2 G	400 k	2 G	400 k	2 G	400 k				
10 μs	1 G	100 k	5 G	500 k	2 G	200 k	5 G	500 k				
5 μs	1 G	50 k	10 G	500 k	2 G	100 k	10 G	500 k				
2 μs	1 G	20 k	20 G	400 k	2 G	40 k	20 G	400 k				
1 μs	1 G	10 k	50 G	500 k	2 G	20 k	50 G	500 k				
500 ns	1 G	5 k	100 G	500 k	2 G	10 k	100 G	500 k				
200 ns	1 G	2 k	100 G	200 k	2 G	4 k	100 G	200 k				
100 ns	1 G	1 k	100 G	100 k	2 G	2 k	100 G	100 k				
50 ns	1 G	500	100 G	50 k	2 G	1 k	100 G	50 k				
20 ns	1 G	200	100 G	20 k	2 G	400	100 G	20 k				
10 ns	1 G	100	100 G	10 k	2 G	200	100 G	10 k				
5 ns	100 G	5 k	100 G	5 k	100 G	5 k	100 G	5 k				
2 ns	100 G	2 k	100 G	2 k	100 G	2 k	100 G	2 k				
1 ns	100 G	1 k	100 G	1 k	100 G	1 k	100 G	1 k				

*: For the setting enclosed by the bold line, repetitive sampling is active.

Appendix 1 Relationship between the Time Axis Setting, Sample Rate and Record Length

Record length: 1 M words (DL7200)

Rep: Repetitive sampling mode

Setting T/div	When Mode other than Envelope Mode is Active								When Envelope Mode is Active			
	Interleave mode OFF ²				Interleave Mode ON				Interleave mode OFF		Interleave Mode ON	
	Rep: [OFF]		Rep: [ON]		Rep: [OFF]		Rep: [ON]		Sample rate (S/s)	Displayed record length (word)	Sample rate (S/s)	Displayed record length (word)
	Sample rate (S/s)	Displayed record length (word)	Sample rate (S/s)	Displayed record length (word)	Sample rate (S/s)	Displayed record length (word)	Sample rate (S/s)	Displayed record length (word)				
50 s	2 k	1 M	2 k	1 M	2 k	1 M	2 k	1 M	800 M	1 M	800 M	1 M
20 s	5 k	1 M	5 k	1 M	5 k	1 M	5 k	1 M	800 M	1 M	800 M	1 M
10 s	10 k	1 M	10 k	1 M	10 k	1 M	10 k	1 M	800 M	1 M	800 M	1 M
5 s	20 k	1 M	20 k	1 M	20 k	1 M	20 k	1 M	800 M	1 M	800 M	1 M
2 s	50 k	1 M	50 k	1 M	50 k	1 M	50 k	1 M	800 M	1 M	800 M	1 M
1 s	100 k	1 M	100 k	1 M	100 k	1 M	100 k	1 M	800 M	1 M	800 M	1 M
500 ms	200 k	1 M	200 k	1 M	200 k	1 M	200 k	1 M	800 M	1 M	800 M	1 M
200 ms	500 k	1 M	500 k	1 M	500 k	1 M	500 k	1 M	800 M	1 M	800 M	1 M
100 ms	1 M	1 M	1 M	1 M	1 M	1 M	1 M	1 M	800 M	1 M	800 M	1 M
50 ms	2 M	1 M	2 M	1 M	2 M	1 M	2 M	1 M	800 M	1 M	800 M	1 M
20 ms	5 M	1 M	5 M	1 M	5 M	1 M	5 M	1 M	800 M	1 M	800 M	1 M
10 ms	10 M	1 M	10 M	1 M	10 M	1 M	10 M	1 M	800 M	1 M	800 M	1 M
5 ms	20 M	1 M	20 M	1 M	20 M	1 M	20 M	1 M	800 M	1 M	800 M	1 M
2 ms	50 M	1 M	50 M	1 M	50 M	1 M	50 M	1 M	800 M	1 M	800 M	1 M
1 ms	100 M	1 M	100 M	1 M	100 M	1 M	100 M	1 M	800 M	1 M	800 M	1 M
500 μs	200 M	1 M	200 M	1 M	200 M	1 M	200 M	1 M	800 M	1 M	800 M	1 M
200 μs	500 M	1 M	500 M	1 M	500 M	1 M	500 M	1 M	1 G	1 M	1 G	1 M
100 μs	1 G	1 M	1 G	1 M	1 G	1 M	1 G	1 M	Changes to normal mode, even when envelope mode has been set.			
50 μs	1 G	500 k	2 G	1 M	2 G	1 M	2 G	1 M				
20 μs	1 G	200 k	5 G	1 M	2 G	400 k	5 G	1 M				
10 μs	1 G	100 k	10 G	1 M	2 G	200 k	10 G	1 M				
5 μs	1 G	50 k	20 G	1 M	2 G	100 k	20 G	1 M				
2 μs	1 G	20 k	50 G	1 M	2 G	40 k	50 G	1 M				
1 μs	1 G	10 k	100 G	1 M	2 G	20 k	100 G	1 M				
500 ns	1 G	5 k	100 G	500 k	2 G	10 k	100 G	500 k				
200 ns	1 G	2 k	100 G	200 k	2 G	4 k	100 G	200 k				
100 ns	1 G	1 k	100 G	100 k	2 G	2 k	100 G	100 k				
50 ns	1 G	500	100 G	50 k	2 G	1 k	100 G	50 k				
20 ns	1 G	200	100 G	20 k	2 G	400	100 G	20 k				
10 ns	1 G	100	100 G	10 k	2 G	200	100 G	10 k				
5 ns	100 G	5 k	100 G	5 k	100 G	5 k	100 G	5 k				
2 ns	100 G	2 k	100 G	2 k	100 G	2 k	100 G	2 k				
1 ns	100 G	1 k	100 G	1 k	100 G	1 k	100 G	1 k				

*: For the setting enclosed by the bold line, repetitive sampling is active.

Appendix 1 Relationship between the Time Axis Setting, Sample Rate and Record Length

Record length: 2 M words (DL7200)

Rep: Repetitive sampling mode

Setting T/div	When Mode other than Envelope Mode is Active								When Envelope Mode is Active			
	Interleave mode OFF*3				Interleave Mode ON				Interleave mode OFF		Interleave Mode ON	
	Rep: [OFF]		Rep: [ON]		Rep: [OFF]		Rep: [ON]		Sample rate (S/s)	Displayed record length (word)	Sample rate (S/s)	Displayed record length (word)
	Sample rate (S/s)	Displayed record length (word)	Sample rate (S/s)	Displayed record length (word)	Sample rate (S/s)	Displayed record length (word)	Sample rate (S/s)	Displayed record length (word)				
50 s	5 k	2.5 M ²	5 k	2.5 M ²	5 k	2.5 M ²	5 k	2.5 M ²	800 M	2.5 M ²	800 M	2.5 M ²
20 s	10 k	2 M	10 k	2 M	10 k	2 M	10 k	2 M	800 M	2 M	800 M	2 M
10 s	20 k	2 M	20 k	2 M	20 k	2 M	20 k	2 M	800 M	2 M	800 M	2 M
5 s	50 k	2.5 M ²	50 k	2.5 M ²	50 k	2.5 M ²	50 k	2.5 M ²	800 M	2.5 M ²	800 M	2.5 M ²
2 s	100 k	2 M	100 k	2 M	100 k	2 M	100 k	2 M	800 M	2 M	800 M	2 M
1 s	200 k	2 M	200 k	2 M	200 k	2 M	200 k	2 M	800 M	2 M	800 M	2 M
500 ms	500 k	2.5 M ²	500 k	2.5 M ²	500 k	2.5 M ²	500 k	2.5 M ²	800 M	2.5 M ²	800 M	2.5 M ²
200 ms	1 M	2 M	1 M	2 M	1 M	2 M	1 M	2 M	800 M	2 M	800 M	2 M
100 ms	2 M	2 M	2 M	2 M	2 M	2 M	2 M	2 M	800 M	2 M	800 M	2 M
50 ms	5 M	2.5 M ²	5 M	2.5 M ²	5 M	2.5 M ²	5 M	2.5 M ²	800 M	2.5 M ²	800 M	2.5 M ²
20 ms	10 M	2 M	10 M	2 M	10 M	2 M	10 M	2 M	800 M	2 M	800 M	2 M
10 ms	20 M	2 M	20 M	2 M	20 M	2 M	20 M	2 M	800 M	2 M	800 M	2 M
5 ms	50 M	2.5 M ²	50 M	2.5 M ²	50 M	2.5 M ²	50 M	2.5 M ²	800 M	2.5 M ²	800 M	2.5 M ²
2 ms	100 M	2 M	100 M	2 M	100 M	2 M	100 M	2 M	800 M	2 M	800 M	2 M
1 ms	200 M	2 M	200 M	2 M	200 M	2 M	200 M	2 M	800 M	2 M	800 M	2 M
500 μs	500 M	2.5 M ²	500 M	2.5 M ²	500 M	2.5 M ²	500 M	2.5 M ²	1 G	2.5 M ²	1 G	2.5 M ²
200 μs	1 G	2 M	1 G	2 M	1 G	2 M	1 G	2 M	Changes to normal mode, even when envelope mode has been set.			
100 μs	1 G	1 M	2 G	2 M	2 G	2 M	2 G	2 M				
50 μs	1 G	500 k	5 G	2.5 M ²	2 G	1 M	5 G	2.5 M ²				
20 μs	1 G	200 k	10 G	2 M	2 G	400 k	10 G	2 M				
10 μs	1 G	100 k	20 G	2 M	2 G	200 k	20 G	2 M				
5 μs	1 G	50 k	50 G	2.5 M ²	2 G	100 k	50 G	2.5 M ²				
2 μs	1 G	20 k	100 G	2 M	2 G	40 k	100 G	2 M				
1 μs	1 G	10 k	100 G	1 M	2 G	20 k	100 G	1 M				
500 ns	1 G	5 k	100 G	500 k	2 G	10 k	100 G	500 k				
200 ns	1 G	2 k	100 G	200 k	2 G	4 k	100 G	200 k				
100 ns	1 G	1 k	100 G	100 k	2 G	2 k	100 G	100 k				
50 ns	1 G	500	100 G	50 k	2 G	1 k	100 G	50 k				
20 ns	1 G	200	100 G	20 k	2 G	400	100 G	20 k				
10 ns	1 G	100	100 G	10 k	2 G	200	100 G	10 k				
5 ns	100 G	5 k	100 G	5 k	100 G	5 k	100 G	5 k				
2 ns	100 G	2 k	100 G	2 k	100 G	2 k	100 G	2 k				
1 ns	100 G	1 k	100 G	1 k	100 G	1 k	100 G	1 k				

*1: For the setting enclosed by the bold line, repetitive sampling is active.

*2: Because acquisition size is 2 MWords, the waveform is displayed over 8 divisions of the time axis only. Note that the trigger position setting percentage in this case with respect to the 8 division length (100% = 8 divisions).

*3: 4 MWord model: Box average cannot be specified.

Appendix 1 Relationship between the Time Axis Setting, Sample Rate and Record Length

Record length: 4 M words*4 (DL7200)

Rep: Repetitive sampling mode

Setting T/div	When Mode other than Envelope Mode is Active								When Envelope Mode is Active			
	Interleave mode OFF				Interleave Mode ON ³				Interleave mode OFF		Interleave Mode ON	
	Rep: [OFF]		Rep: [ON]		Rep: [OFF]		Rep: [ON]		Sample rate (S/s)	Displayed record len gth (word)	Sample rate (S/s)	Displayed record len gth (word)
	Sample rate (S/s)	Displayed record len gth (word)	Sample rate (S/s)	Displayed record len gth (word)	Sample rate (S/s)	Displayed record len gth (word)	Sample rate (S/s)	Displayed record len gth (word)				
50 s	10 k	5 M ²	10 k	5 M ²	10 k	5 M ²	10 k	5 M ²	800 M	5 M ²	800 M	5 M ²
20 s	20 k	4 M	20 k	4 M	20 k	4 M	20 k	4 M	800 M	4 M	800 M	4 M
10 s	50 k	5 M ²	50 k	5 M ²	50 k	5 M ²	50 k	5 M ²	800 M	5 M ²	800 M	5 M ²
5 s	100 k	5 M ²	100 k	5 M ²	100 k	5 M ²	100 k	5 M ²	800 M	5 M ²	800 M	5 M ²
2 s	200 k	4 M	200 k	4 M	200 k	4 M	200 k	4 M	800 M	4 M	800 M	4 M
1 s	500 k	5 M ²	500 k	5 M ²	500 k	5 M ²	500 k	5 M ²	800 M	5 M ²	800 M	5 M ²
500 ms	1 M	5 M ²	1 M	5 M ²	1 M	5 M ²	1 M	5 M ²	800 M	5 M ²	800 M	5 M ²
200 ms	2 M	4 M	2 M	4 M	2 M	4 M	2 M	4 M	800 M	4 M	800 M	4 M
100 ms	5 M	5 M ²	5 M	5 M ²	5 M	5 M ²	5 M	5 M ²	800 M	5 M ²	800 M	5 M ²
50 ms	10 M	5 M ²	10 M	5 M ²	10 M	5 M ²	10 M	5 M ²	800 M	5 M ²	800 M	5 M ²
20 ms	20 M	4 M	20 M	4 M	20 M	4 M	20 M	4 M	800 M	4 M	800 M	4 M
10 ms	50 M	5 M ²	50 M	5 M ²	50 M	5 M ²	50 M	5 M ²	800 M	5 M ²	800 M	5 M ²
5 ms	100 M	5 M ²	100 M	5 M ²	100 M	5 M ²	100 M	5 M ²	800 M	5 M ²	800 M	5 M ²
2 ms	200 M	4 M	200 M	4 M	200 M	4 M	200 M	4 M	800 M	4 M	800 M	4 M
1 ms	500 M	5 M ²	500 M	5 M ²	500 M	5 M ²	500 M	5 M ²	1 G	5 M ²	1 G	5 M ²
500 μs	1 G	5 M ²	1 G	5 M ²	1 G	5 M ²	1 G	5 M ²	Changes to normal mode, even when envelope mode has been set.			
200 μs	1 G	2 M	2 G	4 M	2 G	4 M	2 G	4 M				
100 μs	1 G	1 M	5 G	5 M ²	2 G	2 M	5 G	5 M ²				
50 μs	1 G	500 k	10 G	5 M ²	2 G	1 M	10 G	5 M ²				
20 μs	1 G	200 k	20 G	4 M	2 G	400 k	20 G	4 M				
10 μs	1 G	100 k	50 G	5 M ²	2 G	200 k	50 G	5 M ²				
5 μs	1 G	50 k	100 G	5 M ²	2 G	100 k	100 G	5 M ²				
2 μs	1 G	20 k	100 G	2 M	2 G	40 k	100 G	2 M				
1 μs	1 G	10 k	100 G	1 M	2 G	20 k	100 G	1 M				
500 ns	1 G	5 k	100 G	500 k	2 G	10 k	100 G	500 k				
200 ns	1 G	2 k	100 G	200 k	2 G	4 k	100 G	200 k				
100 ns	1 G	1 k	100 G	100 k	2 G	2 k	100 G	100 k				
50 ns	1 G	500	100 G	50 k	2 G	1 k	100 G	50 k				
20 ns	1 G	200	100 G	20 k	2 G	400	100 G	20 k				
10 ns	1 G	100	100 G	10 k	2 G	200	100 G	10 k				
5 ns	100 G	5 k	100 G	5 k	100 G	5 k	100 G	5 k				
2 ns	100 G	2 k	100 G	2 k	100 G	2 k	100 G	2 k				
1 ns	100 G	1 k	100 G	1 k	100 G	1 k	100 G	1 k				

- *1: For the setting enclosed by the bold line, repetitive sampling is active.
- *2: Because acquisition size is 4 MWords, the waveform is displayed over 8 divisions of the time axis only. Note that the trigger position setting percentage in this case with respect to the 8 division length (100% = 8 divisions).
- *3: 4 MWord model: Box average cannot be specified.
- *4: 4 MWord model: Record length cannot be set to 4 MWord when interleave mode is OFF.

Appendix 1 Relationship between the Time Axis Setting, Sample Rate and Record Length

Record length: 8 M words^{*4} (DL7200)

Rep: Repetitive sampling mode

Setting T/div	When Mode other than Envelope Mode is Active								When Envelope Mode is Active			
	Interleave mode OFF ^{*3}				Interleave Mode ON				Interleave mode OFF		Interleave Mode ON	
	Rep: [OFF]		Rep: [ON]		Rep: [OFF]		Rep: [ON]		Sample rate (S/s)	Displayed record len gth (word)	Sample rate (S/s)	Displayed record len gth (word)
	Sample rate (S/s)	Displayed record len gth (word)	Sample rate (S/s)	Displayed record len gth (word)	Sample rate (S/s)	Displayed record len gth (word)	Sample rate (S/s)	Displayed record len gth (word)	Sample rate (S/s)	Displayed record len gth (word)	Sample rate (S/s)	Displayed record len gth (word)
50 s	20 k	10 M ^{*2}	20 k	10 M ^{*2}	20 k	10 M ^{*2}	20 k	10 M ^{*2}	800 M	10 M ^{*2}	800 M	10 M ^{*2}
20 s	50 k	10 M ^{*2}	50 k	10 M ^{*2}	50 k	10 M ^{*2}	50 k	10 M ^{*2}	800 M	10 M ^{*2}	800 M	10 M ^{*2}
10 s	100 k	10 M ^{*2}	100 k	10 M ^{*2}	100 k	10 M ^{*2}	100 k	10 M ^{*2}	800 M	10 M ^{*2}	800 M	10 M ^{*2}
5 s	200 k	10 M ^{*2}	200 k	10 M ^{*2}	200 k	10 M ^{*2}	200 k	10 M ^{*2}	800 M	10 M ^{*2}	800 M	10 M ^{*2}
2 s	500 k	10 M ^{*2}	500 k	10 M ^{*2}	500 k	10 M ^{*2}	500 k	10 M ^{*2}	800 M	10 M ^{*2}	800 M	10 M ^{*2}
1 s	1 M	10 M ^{*2}	1 M	10 M ^{*2}	1 M	10 M ^{*2}	1 M	10 M ^{*2}	800 M	10 M ^{*2}	800 M	10 M ^{*2}
500 ms	2 M	10 M ^{*2}	2 M	10 M ^{*2}	2 M	10 M ^{*2}	2 M	10 M ^{*2}	800 M	10 M ^{*2}	800 M	10 M ^{*2}
200 ms	5 M	10 M ^{*2}	5 M	10 M ^{*2}	5 M	10 M ^{*2}	5 M	10 M ^{*2}	800 M	10 M ^{*2}	800 M	10 M ^{*2}
100 ms	10 M	10 M ^{*2}	10 M	10 M ^{*2}	10 M	10 M ^{*2}	10 M	10 M ^{*2}	800 M	10 M ^{*2}	800 M	10 M ^{*2}
50 ms	20 M	10 M ^{*2}	20 M	10 M ^{*2}	20 M	10 M ^{*2}	20 M	10 M ^{*2}	800 M	10 M ^{*2}	800 M	10 M ^{*2}
20 ms	50 M	10 M ^{*2}	50 M	10 M ^{*2}	50 M	10 M ^{*2}	50 M	10 M ^{*2}	800 M	10 M ^{*2}	800 M	10 M ^{*2}
10 ms	100 M	10 M ^{*2}	100 M	10 M ^{*2}	100 M	10 M ^{*2}	100 M	10 M ^{*2}	800 M	10 M ^{*2}	800 M	10 M ^{*2}
5 ms	200 M	10 M ^{*2}	200 M	10 M ^{*2}	200 M	10 M ^{*2}	200 M	10 M ^{*2}	800 M	10 M ^{*2}	800 M	10 M ^{*2}
2 ms	500 M	10 M ^{*2}	500 M	10 M ^{*2}	500 M	10 M ^{*2}	500 M	10 M ^{*2}	1 G	10 M ^{*2}	1 G	10 M ^{*2}
1 ms	1 G	10 M ^{*2}	1 G	10 M ^{*2}	1 G	10 M ^{*2}	1 G	10 M ^{*2}	Changes to normal mode, even when envelope mode has been set.			
500 μs	1 G	5 M	2 G	10 M ^{*2}	2 G	10 M ^{*2}	2 G	10 M ^{*2}				
200 μs	1 G	2 M	5 G	10 M ^{*2}	2 G	4 M	5 G	10 M ^{*2}				
100 μs	1 G	1 M	10 G	10 M ^{*2}	2 G	2 M	10 G	10 M ^{*2}				
50 μs	1 G	500 k	20 G	10 M ^{*2}	2 G	1 M	20 G	10 M ^{*2}				
20 μs	1 G	200 k	50 G	10 M ^{*2}	2 G	400 k	50 G	10 M ^{*2}				
10 μs	1 G	100 k	100 G	10 M ^{*2}	2 G	200 k	100 G	10 M ^{*2}				
5 μs	1 G	50 k	100 G	5 M	2 G	100 k	100 G	5 M				
2 μs	1 G	20 k	100 G	2 M	2 G	40 k	100 G	2 M				
1 μs	1 G	10 k	100 G	1 M	2 G	20 k	100 G	1 M				
500 ns	1 G	5 k	100 G	500 k	2 G	10 k	100 G	500 k				
200 ns	1 G	2 k	100 G	200 k	2 G	4 k	100 G	200 k				
100 ns	1 G	1 k	100 G	100 k	2 G	2 k	100 G	100 k				
50 ns	1 G	500	100 G	50 k	2 G	1 k	100 G	50 k				
20 ns	1 G	200	100 G	20 k	2 G	400	100 G	20 k				
10 ns	1 G	100	100 G	10 k	2 G	200	100 G	10 k				
5 ns	100 G	5 k	100 G	5 k	100 G	5 k	100 G	5 k				
2 ns	100 G	2 k	100 G	2 k	100 G	2 k	100 G	2 k				
1 ns	100 G	1 k	100 G	1 k	100 G	1 k	100 G	1 k				

- *1: For the setting enclosed by the bold line, repetitive sampling is active.
- *2: Because acquisition size is 8 MWords, the waveform is displayed over 8 divisions of the time axis only. Note that the trigger position setting percentage in this case with respect to the 8 division length (100% = 8 divisions).
- *3: Box average, linear average, or computation cannot be specified.
- *4: 4 MWord model: Record length cannot be set to 8 MWord when interleave mode is OFF.

Appendix 1 Relationship between the Time Axis Setting, Sample Rate and Record Length

Record length: 16 M words^{*4} (only for 16 M Word model) (DL7200)

Rep: Repetitive sampling mode

Setting T/div	When Mode other than Envelope Mode is Active								When Envelope Mode is Active			
	Interleave mode OFF ^{*3}				Interleave Mode ON				Interleave mode OFF		Interleave Mode ON	
	Rep: [OFF]		Rep: [ON]		Rep: [OFF]		Rep: [ON]		Sample rate (S/s)	Displayed record length (word)	Sample rate (S/s)	Displayed record length (word)
	Sample rate (S/s)	Displayed record length (word)	Sample rate (S/s)	Displayed record length (word)	Sample rate (S/s)	Displayed record length (word)	Sample rate (S/s)	Displayed record length (word)				
50 s	Record length cannot be set to 16 Mword when interleave mode is OFF.				50 k	25 M ^{*2}	Repetitive sampling mode cannot be ON when record length is set to 16 Mword.		Record length cannot be set to 16 Mword when interleave mode is OFF.		800 M	25 M ^{*2}
20 s					100 k	20 M ^{*2}					800 M	20 M ^{*2}
10 s					200 k	20 M ^{*2}					800 M	20 M ^{*2}
5 s					500 k	25 M ^{*2}					800 M	25 M ^{*2}
2 s					1 M	20 M ^{*2}					800 M	20 M ^{*2}
1 s					2 M	20 M ^{*2}					800 M	20 M ^{*2}
500 ms					5 M	25 M ^{*2}					800 M	25 M ^{*2}
200 ms					10 M	20 M ^{*2}					800 M	20 M ^{*2}
100 ms					20 M	20 M ^{*2}					800 M	20 M ^{*2}
50 ms					50 M	25 M ^{*2}					800 M	25 M ^{*2}
20 ms					100 M	20 M ^{*2}					800 M	20 M ^{*2}
10 ms					200 M	20 M ^{*2}					800 M	20 M ^{*2}
5 ms					500 M	25 M ^{*2}					1 G	25 M ^{*2}
2 ms					1 G	20 M ^{*2}					Changes to normal mode, even when envelope mode has been set.	
1 ms					2 G	20 M ^{*2}						
500 μs					2 G	10 M						
200 μs					2 G	4 M						
100 μs					2 G	2 M						
50 μs					2 G	1 M						
20 μs					2 G	400 k						
10 μs					2 G	200 k						
5 μs					2 G	100 k						
2 μs					2 G	40 k						
1 μs					2 G	20 k						
500 ns					2 G	10 k						
200 ns					2 G	4 k						
100 ns					2 G	2 k						
50 ns					2 G	1 k						
20 ns					2 G	400						
10 ns					2 G	200						
5 ns	100 G	5 k										
2 ns	100 G	2 k										
1 ns	100 G	1 k										

*1: For the setting enclosed by the bold line, repetitive sampling is active.

*2: Because acquisition size is 16 MWords, When the display record length is 20 MWord, the waveform is displayed over 8 divisions of the time axis only, when the display record length is 25 MWord, over 6.4 divisions.
 Note that the trigger position setting percentage in this case with respect to the 8 division length (100% = 8 divisions) or 6.4 division length (100% = 6.4 divisions).

*3: Box average, linear average, or computation cannot be specified.

*4: 4 MWord model: Record length cannot be set to 16 MWord when interleave mode is OFF.

Appendix 2 How to Calculate the Area of a Waveform

“Integ1TY”

Total area for positive side only: S_1+S_2

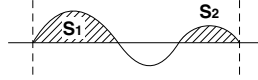

“Integ2TY”

Total area for both positive and negative sides: $S_1+S_3-S_2$

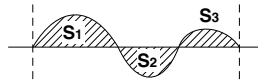

“Integ1XY”

(1) Multiple loops

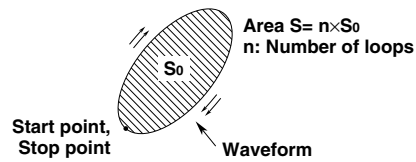

(2) Non-closed curve

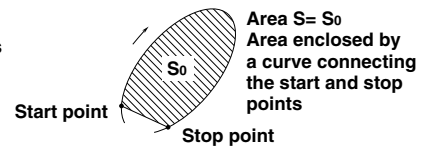

(3) Loop tracing the shape of "8"

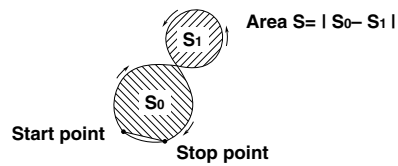

(4) Spiral loop

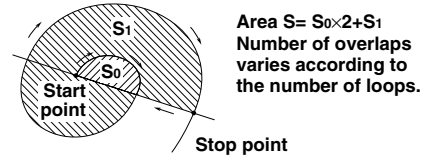

“Integ2XY”

(1) When only one Y data corresponds to X data

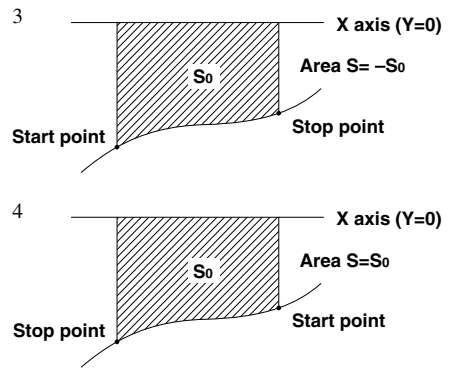
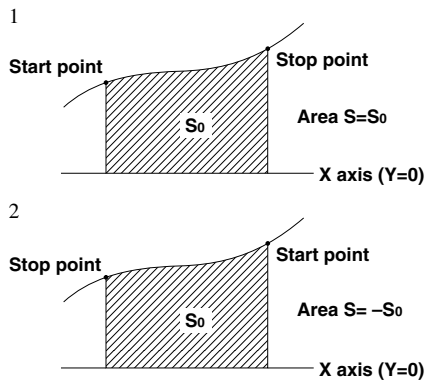

(2) When the waveform extends into the negative side

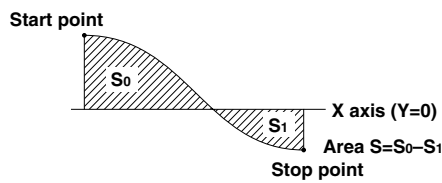

(2) When two or more Y data correspond to X data

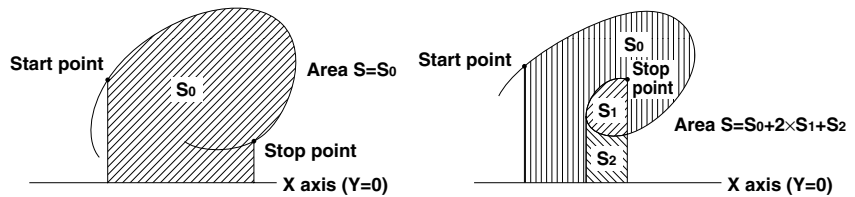

Appendix 3 ASCII Header File Format

//YOKOGAWA ASCII FILE FORMAT

\$PublicInfo

FormatVersion 1.01
Model DL7100
Endian Big
DataFormat TRACE
GroupNumber 3
TraceTotalNumber 10
DataOffset 0

\$Group1

TraceNumber 4
BlockNumber 1
TraceName CH1 CH2 CH3 CH4
BlockSize 1002 1002 1002 1002
VResolution 1.5625000E+00 1.5625000E+00 1.5625000E+00 1.5625000E+00
VOffset 0.0000000E+00 0.0000000E+00 0.0000000E+00 0.0000000E+00
VDataType IS2 IS2 IS2 IS2
VUnit V V A V
VPlusOverData 32768 32768 32768 32768
VMinusOverData -32769 -32769 -32769 -32769
VIllegalData -32769 -32769 -32769 -32769
VMaxData 32767 32767 32767 32767
VMinData -32768 -32768 -32768 -32768
HResolution 5.0000000E-09 5.0000000E-09 5.0000000E-09 5.0000000E-09
HOffset -2.5000000E-06 -2.5000000E-06 -2.5000000E-06 -2.5000000E-06
HUnit s s s s
Date 2000/07/25 2000/07/25 2000/07/25 2000/07/25
Time 01:45:00.00 01:45:00.00 01:45:00.00 01:45:00.00

\$Group2

TraceNumber 2
BlockNumber 1
TraceName MATH1 MATH2
BlockSize 1002 1002
VResolution 6.1035156E-03 1.2207031E+00
VOffset -7.7000000E+01 2.0000000E+04
VDataType IS2 IS2
VUnit DB V
VPlusOverData 32768 32768
VMinusOverData -32769 -32769
VIllegalData -32769 -32769
VMaxData 32767 32767
VMinData -32768 -32768
HResolution 2.0000000E-01 5.0000000E-09
HOffset 0.0000000E+00 -2.5000000E-06
HUnit Hz s

Date	2000/07/25	2000/07/25		
Time	01:45:00.00	01:45:00.00		
 \$PrivateInfo				
ModelVersion	1.20			
DisplayBlockSize	10020	10020	10020	10020
DisplayPointNo.	1	1	1	1
PhaseShift	0	0	0	0

Note

The same header file format is used by all YOKOGAWA measuring instruments, so it may contain some data which is not necessary for the instrument.

• **\$Publicinfo (common information)**

FormatVersion:	Version No. of header file format
Model:	Model name
Endian:	Endian mode (Big/Ltl)* ¹
DataFormat:	Storage format (Trace / Block) of binary file waveform data * ²
GroupNumber:	Number of the \$Group
TraceTotalNumber:	Total number of selected waveforms
DataOffset:	Start position of binary file waveform data * ³

- **\$Group1 (group information)**

- TraceNumber: Number of waveforms in the group
- BlockNumber: Number of blocks in the group *4
- TraceName: Name of each waveform
- BlockSize: Data size of each block of waveform
- VResolution: Resolution coefficient of Y axis conversion equation for each waveform *5
- VOffset: Offset coefficient of Y axis conversion equation for each waveform
- VDataType: Type of binary file waveform data for each waveform *6
- VUnit: Units used for Y axis of each waveform (no effect on data)
- VPlusOverData: Data error occurs when binary data for a waveform exceeds this value.
- VMinusOverData: Data error occurs when binary data for a waveform is below this value.
- VMaxData: Maximum value of binary data for each waveform
- VMinData: Minimum value of binary data for each waveform
- HResolution: Resolution coefficient of X axis conversion equation for each waveform *7
- HOffset: Offset coefficient of X axis conversion equation for each waveform
- HUnit: Units used for X axis for each waveform (no effect on data)
- Date: Date when waveform acquisition was completed
- Time: Time when waveform acquisition was completed

For *1 to *7, refer to the next page.

- **\$Privateinfo (information indigenous to model)**

- ModelVersion: Version No. of the model
- MathBlockNo.: Block No. of block to be computed
- FormMath1: Waveform for Math1 and its contents
- FormMath2: Waveform for Math2 and its contents
- DisplayBlockSize: Length of the data displayed on the screen (display record length)
- DisplayPointNo: Value which indicates which point of the memory is the left end of the display record length (display offset is 1 when record length = display record length)
- PhaseShift: Phase information (lead: -, delay: +)

* Calculation of the actual display offset of the phase-shifted waveform =
DisplayPointNo. - PhaseShift

Creation of ASCII Header File

When waveform data (Waveform) is stored on a floppy disk, the following files will be created automatically in the DL_WAVE directory.

- Waveform data file (*.WVF)
- ASCII header file (*.HDR)

The waveform data file can be recalled to the instrument using the file menu, but the ASCII header file cannot; therefore it cannot be viewed on the instrument. However, it can be used when you analyze the waveform using a personal computer.

***1: Endian mode for storage**

Big: Data for Motorola 68000 series
Ltl: Data for Intel 86 series

***2: Binary file storage format**

Trace: Groups into blocks, each block for a single waveform.
Block: Groups into blocks, each block for a given time interval.

***3: Binary file start position**

Offset from the beginning of the file

***4: Maximum number of blocks per group**

Maximum number of blocks applies if the number of blocks varies between waveforms.

***5: Y axis conversion equation for each waveform**

Y axis value = VResolution x Raw data + VOffset

***6: Data type**

ISn: n-byte signed integer
IUn: n-byte unsigned integer
FSn: n-byte signed real number
FUn: n-byte unsigned real number
Bm: m-byte data

***7: X axis conversion equation for each waveform**

X axis value = HResolution x (Data No. -1) + HOffset

Appendix 4 List of Defaults

Menu key	soft key	Default setting
CH1 to 4		
	Display	ON
	Position	0.00 div
	Cupling	DC 1 M Ω
	Probe	10:1
	Offset	0V
	Band Width	Full
	Variable	50 V
	Linear Scale	OFF
	Label	CHCH4
V/div		
		50 V/div
T/div		
		1 Ms/s
PRESET		
	Select	All
	Type	TTL
	Prove	10 : 1
ACQ		
	Record Length	10 k
	Mode	Normal
	Count	Infinite
	Interleave	OFF
	Repetitive	OFF
	Time Base	Int
TRIGGER		
	SIMPLE	
	Source	CH1
	Level	0.0 V
	Slope	Rise
	Coupling	DC
	HF Rejection	OFF
	Hysteresis	∇
	Hold Off	0.08 μ s
HISTORY		
	Select Record	0
	Display Mode	One
	Start Record	0
	End Record	latest
	Show Map No.	1
	Search Mode	OFF
FILE		
	File Item	Set up
	File Name	
	Auto Naming	ON
COPY(MENU)		
	Copy to	Printer
	Format	Normal
	Information	OFF

Menu key	soft key	Default setting
MEASURE		
	Mode	OFF
	Item Setup	
	Source	CH1
	Item	OFF
	Delay Setup	
	Source	CH1
	Mode	OFF
	1 cycle mode	OFF
	Time Range 1	-5.000 div
	Time Range 2	5.000 div
	Trace	CH1
	Distal	90%
	Mesial	50%
	Proximal	10%
	High/Low Mode	AUTO
CURSOR		
	Type	OFF
MATH		
	Math 1 Display	OFF
	Math 1 Setup	C1+C2
	Math 1 Label	Math1
	Math 2 Display	OFF
	Math 2 Setup	C3+C4
	Math 2 Label	Math2
DISPLAY		
	Format	Quad
	Interpolation	Sin
	Graticule	Grid
	Scale Value	OFF
	Trace Label	OFF
	Accumulate	OFF
	Translucent	OFF
	Mapping	Auto
ZOOM		
	Mode	Main
POSITON/DELAY		
	Position	50.0%
DELAY		
	Delay	0.0 μ s
GO/NO-GO		
	Mode	OFF
SEARCH		
	Type	CAN Bus
	Z1 Mag	$\times 2$
	Z position	0.000 div
ACTION		
	Buzzer	OFF
	Save to File	OFF
	Hard Copy	OFF
	Send Mail	OFF
	ACQ Count	infinite

Index

Symbols

1/DX 9-1

A

A Delay B Trigger 1-8, 6-14
 A/EB(n) Trigger 1-7, 6-11
 accumulate 8-8
 Accumulated 1-15
 Accumulation period 8-8
 ACQ key 2-4
 Acquisition count 7-3, 7-5
 Acquisition Mode 7-2
 Acquisition Modes 1-13
 Action-On Trigger 1-11
 Action-On-Trigger 6-35
 Active High 14-6
 Active Low 14-6
 Addition 1-22
 All Set 11-28
 Allocation 8-12
 Analyzing and Searching SPI Signals 1-25
 Analyzing SPI Signals 8-28
 Angle Cursors 1-20
 ASCII 11-10
 Attenuation 5-4
 Attr 11-29
 Auto 8-1, 9-10
 Auto level mode 6-1
 Auto measurement mode 9-10
 Auto mode 1-10, 6-1
 Auto OFF 14-5
 Auto Scroll 1-25, 8-14
 Auto Set-up 1-26
 auto setup 4-5
 AUTO SETUP key 2-3
 Auto-level mode 1-10
 automated measurement 11-25
 Automated Measurement of Waveform Parameters 9-10
 Automated Measurements 1-20
 Average 7-2
 Averaging mode 1-13

B

Backlight 14-5
 Bandwidth 5-8

Bandwidth Limit 1-3
 Binarization 1-22
 Binary 11-10
 Binary Computation 9-24
 Block Diagram 1-1
 BMP 10-9
 Box Average 7-7
 Box average 1-14
 BoxAverage 7-2
 Brightness 14-1
 Brightness of the Backlight 14-5
 Built-in printer 2-1
 Buzzer 6-35, 9-34, 9-38

C

Canceling the Offset 14-7
 Center 6-27
 Centronics 10-6
 Centronics connector 2-1
 CH1 to CH4 keys 2-2
 Changing Directory 11-34, 11-35, 11-36
 Changing File Name 11-34, 11-35, 11-36
 Changing the Recording Medium 11-34, 11-35, 11-36
 Clear Trace 1-26
 Clear trace 4-8
 CLEAR TRACE key 2-4
 Click Sound 14-4
 Clock CH 6-17
 Color 8-8
 Communications 1-29
 COMP output 2-1
 Compensating the Probe 3-10
 Configuring the Ethernet Interface 13-2
 Connecting the Power Cord 3-5
 Connection to a Network 13-1
 COPY key 2-3
 Copying Files 11-31, 11-32, 11-33
 Creating a directory 11-34
 CSV format 11-25
 Cursor Jump 9-4
 CURSOR key 2-3
 Cursor Measurements 1-20
 Cursors 9-1

D

Data compression 11-11
 Data search 1-24

Index

Data size 11-10
Date and Time 3-11
DDX 9-1
DDY 9-1
Default Gateway 13-2
Degree 9-1
Delay 9-12
delay 6-2
Deleting Files 11-28, 11-29, 11-30
DHCP 13-2
Differentiating 9-28
Differentiation 1-22
Display Format 8-1
Display format 1-16
DISPLAY key 2-3
Display of the Scaling Value 8-6
Display position 2-5
Displayed-data output functions 1-27
distal 9-10
DNS 13-2
DNS Server 13-3
Domain Suffix 13-3
Dual 8-1, 8-10
DX2 9-1
DX3 9-1
DX4 9-1
DY2 9-1
DY3 9-1
DY4 9-1

E

ECL 5-12
Edge 8-14
Edge search 1-24
Edge Trigger 1-7
edge trigger 6-6
ENHANCED key 2-2
Enhanced trigger 1-7
Entering a Character String 4-2
Entering a Value 4-1
Envelope 7-2
Envelope mode 1-14
ESC key 2-1
Ether Option 13-17
Ethernet Communications 1-28
Expanded Waveform 1-18
exponential average 1-13
Ext 6-6
EXT CLOCK IN Terminal 12-1

EXT IN 5-14
EXT TRIG IN terminal 12-1
External Trigger 6-8
External trigger/clock input terminal 2-1

F

File Attributes 11-28, 11-29, 11-30
file attributes 11-34
FILE key 2-3
File Size 10-9
Fixed 8-1
Flattop 9-30
Flattop window 1-23
Float 11-10
Floppy disk drive 2-1
Floppy Disks 11-1
format 11-4

G

GO/NO-GO 9-34
GO/NO-GO Determination 1-27
GO/NO-GO key 2-3
GP-IB connector 2-1
Grade width 8-8
Graticule 1-16, 8-5
Ground Connector 2-1
Ground level 2-5

H

H cursors 1-20
Hanning 9-30
Hanning window 1-23
Hard Copy 6-35
Hard copy 9-34, 9-38
HDTV 6-29
Help 4-11
HELP key 2-4
Hexa 8-1
HF Rejection 1-11
HF rejection 6-6
HISTORY key 2-3
History Memory 1-16, 7-12
History memory search 1-24
History Search Function 1-24, 7-15, 7-18
Hold off Time 6-4
Hold-off 1-12
Horizontal 9-1
hysteresis 6-6

I

Initialization	1-26, 4-4
INITIALIZE key	2-3
Input coupling	1-2, 5-3
Input Terminals	3-7
Input terminals	2-1
Installation Conditions	3-3
INT	5-14
Integrating	9-28
Integration	1-22
Interleave	7-9
Interleave mode	1-13
Interpolation	1-17, 8-3
Inverted display	1-22
IP Address	13-2

J

Jog shuttle	2-1
-------------------	-----

K

Keyboard operation	4-2
--------------------------	-----

L

Label	8-7
LCD screen	2-1
Line	6-6, 8-3
Line interpolation	1-17
linear average	1-13
Linear Scaling	1-20, 5-11
Load 11-10, 11-11, 11-12, 11-13, 11-14, 11-15, 11-16, 11-17, 11-18, 11-19, 11-20, 11-21	
Logic I/O connectors	2-1
logic input	5-12
LOGIC key	2-2
Logic Probe	3-12
Logic Trigger	1-10, 6-32
long copy	10-3

M

MAC Address	13-17
Mail Function (Action Mail Function)	13-13
Mail Function (Fixed Interval)	13-11
Main	8-12
Main&Z1	8-12
Main&Z1&Z2	8-12
Main&Z2	8-12
Marker	9-1

Marker cursors	1-20
MATH key	2-3
MAX-MIN	9-10
MEASURE key	2-3
Measurement Parameters	9-11
Menu keys	2-1
mesial	9-10
Message Language	14-4
MISC key	2-3
MODE key	2-2
multiplication	1-22

N

name plate	ii
No interpolation	1-17
Normal mode	1-10, 1-13, 6-1
NTSC	6-29

O

Offset Cancel Mode	14-7
Offset Voltage	1-2
Offset voltage	5-5
One-to-one Connection to a Personal Computer	13-1
Operation state	2-5
Optional Accessories	iii
OR Trigger	6-25
OR trigger	1-9
Output format	10-3
Outputting Screen Image	10-6

P

PAL	6-29
Parallel Pattern	8-14
Parallel Pattern search	1-25
Pattern Trigger	1-8, 6-17
PC Card	11-2
Persist	8-8
Phase-shifted addition	1-22
Phase-shifted Display	9-33
POSITION key	2-2
position marker	6-3
Post... ..	2-5
Power connector	2-1
Power connectors	2-1
power signal	6-10
Power Spectrum	1-23
power spectrum	9-30
Power switch	2-1
Pre... ..	2-5

Index

Preset 1-26
preset 5-6
PRESET key 2-2
Printer Roll Chart 10-1
Probe 3-7
Probe Attenuation 1-3
probe compensation signal 3-10
proximal 9-10
PULSE 8-3
Pulse < Time 6-21
Pulse > Time 6-21
Pulse interpolation 1-17
Pulse Width 8-14
Pulse Width search 1-25
Pulse Width Trigger 1-8

Q

Quad 8-1

R

R 11-28
R/W 11-28
Real - time sampling mode 1-6
Recommended Replacement Parts 15-13
Record Length 1-13
record length 7-1
Rect 9-30
Rectangular window 1-23
Repetitive Sampling Mode 7-10
Repetitive sampling mode 1-6
RESET key 2-4
Response at Power ON 3-6
RGB VIDEO OUT terminal 12-4
roll mode 1-6, 5-16
RS-232 2-1

S

Sampling Mode 1-15
Sampling mode 2-5
Save 11-10, 11-11, 11-12, 11-13, 11-14, 11-15, 11-16, 11-17,
11-18, 11-19, 11-20, 11-21
Save to File 6-35, 9-34, 9-38
Saving Data to a Network Drive 13-7
Saving Snap Shot Waveforms 11-22, 11-23, 11-24
Saving Waveform to a Network Drive 13-5
Scale values 1-16
Scaling 1-22
Screen Color 14-1
SCSI 11-3

SCSI connector 2-1
SCSI ID Number 11-9
Search and Zoom Function 1-24, 8-14
Search condition 7-15
Search Data 8-14
search for a waveform 7-15
Search logic 7-15
Search parameters 7-15
Searching SPI Signals 8-32
SELECT key 2-4
Send Mail 6-35, 9-34, 9-38
Sending Data to a Network Printer 13-9
Sequential Store 7-5
serial No. ii
Serial pattern 8-14
Serial pattern search 1-24
Serial port 2-1
Set/Reset 11-28
SHIFT key 2-3
Show Map 7-13
SIMPLE key 2-2
Simple trigger 1-7
Sine 8-3
Sine interpolation 1-17
Single 8-1, 8-10
Single (N) mode 1-11, 6-1
Single Mode 6-1
Single mode 1-10
Smoothing 9-32
SNAP SHOT key 2-4
Snapshot 1-26, 4-8
Source channel 7-15
Spare Parts iv
SPI 1-25
Standard Accessories iii
START/STOP key 2-4
Statistic 9-10
Statistical processing 1-21
Storing Screen Image 10-9
Subnet Mask 13-2
subtraction 1-22
System Configuration 1-1

T

T-Y 8-10
T-Y&X-Y 8-10
T/div 5-16
T1<Pulse<T2 6-21
Threshold level 5-12

TIFF	10-9
Time Axis	1-4
Time Out	6-21
Time Range	9-10
time window	9-30
TIME/DIV knob	2-2
timebase	1-4
TRG'D indicator	2-2
Triad	8-1
TRIG GATE IN Terminal	14-6
TRIG OUT Terminal	12-2
Trigger Coupling	1-11
trigger coupling	6-6
Trigger Dela	1-12
trigger delay	6-2
Trigger Gate	14-6
Trigger Hysteresis	1-11
Trigger level	2-5
Trigger Mode	1-10, 6-1
Trigger output terminal	2-1
Trigger Position	1-12
trigger position	6-3
trigger slope	6-6
Trigger Type	1-7
TTL	5-12
TV Trigger	1-9, 6-29

U

User	5-12, 8-1
------------	-----------

V

V cursors	1-20
V/div	5-9
V/DIV knob	2-2
Variable	5-9
Vertical	9-1
Vertical Position	1-4, 5-2
Vertical Sensitivity	1-3
voltage axis sensitivity	5-9

W

Waiting for Trigger	2-5
Waveform Labels	8-7
Waveform labels	1-16
waveform parameters	11-25
Width	6-27
Width trigger	6-21
Window Trigger	1-9
window trigger	6-27

X

X-Y	8-10
X-Y Waveform	8-10
X-Y Waveform Display	1-18
X1	9-1

Y

Y1	9-1
----------	-----

Z

Z1 Only	8-12
Z1&Z2	8-12
Z2 Only	8-12
ZOOM key	2-2
Zoom position	8-12
Zoom rate	8-12
Zooming	8-12