



**AO3402**

**N-Channel Enhancement Mode Field Effect Transistor**

**General Description**

The AO3402 uses advanced trench technology to provide excellent  $R_{DS(ON)}$ , low gate charge and operation with gate voltages as low as 2.5V. This device is suitable for use as a load switch or in PWM applications.

**Features**

- $V_{DS}$  (V) = 30V
- $I_D$  = 4 A
- $R_{DS(ON)} < 55m\Omega$  ( $V_{GS} = 10V$ )
- $R_{DS(ON)} < 70m\Omega$  ( $V_{GS} = 4.5V$ )
- $R_{DS(ON)} < 110m\Omega$  ( $V_{GS} = 2.5V$ )

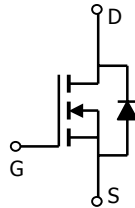
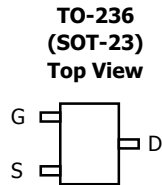

**Absolute Maximum Ratings  $T_A=25^\circ\text{C}$  unless otherwise noted**

Parameter	Symbol	Maximum	Units
Drain-Source Voltage	$V_{DS}$	30	V
Gate-Source Voltage	$V_{GS}$	$\pm 12$	V
Continuous Drain Current <sup>A</sup>	$T_A=25^\circ\text{C}$	4	A
	$T_A=70^\circ\text{C}$	3.4	
Pulsed Drain Current <sup>B</sup>	$I_{DM}$	15	
Power Dissipation <sup>A</sup>	$T_A=25^\circ\text{C}$	1.4	W
	$T_A=70^\circ\text{C}$	1	
Junction and Storage Temperature Range	$T_J, T_{STG}$	-55 to 150	$^\circ\text{C}$

**Thermal Characteristics**

Parameter	Symbol	Typ	Max	Units
Maximum Junction-to-Ambient <sup>A</sup>	$R_{\theta JA}$	70	90	$^\circ\text{C/W}$
Maximum Junction-to-Ambient <sup>A</sup>		Steady-State	100	
Maximum Junction-to-Lead <sup>C</sup>	$R_{\theta JL}$	63	80	$^\circ\text{C/W}$

Electrical Characteristics ( $T_J=25^\circ\text{C}$  unless otherwise noted)

Symbol	Parameter	Conditions	Min	Typ	Max	Units
<b>STATIC PARAMETERS</b>						
$BV_{DSS}$	Drain-Source Breakdown Voltage	$I_D=250\mu\text{A}$ , $V_{GS}=0\text{V}$	30			V
$I_{DSS}$	Zero Gate Voltage Drain Current	$V_{DS}=24\text{V}$ , $V_{GS}=0\text{V}$ $T_J=55^\circ\text{C}$			1 5	$\mu\text{A}$
$I_{GSS}$	Gate-Body leakage current	$V_{DS}=0\text{V}$ , $V_{GS}=\pm 12\text{V}$			100	nA
$V_{GS(th)}$	Gate Threshold Voltage	$V_{DS}=V_{GS}$ , $I_D=250\mu\text{A}$	0.6	1	1.4	V
$I_{D(ON)}$	On state drain current	$V_{GS}=4.5\text{V}$ , $V_{DS}=5\text{V}$	10			A
$R_{DS(ON)}$	Static Drain-Source On-Resistance	$V_{GS}=10\text{V}$ , $I_D=4\text{A}$ $T_J=125^\circ\text{C}$		45 66	55 80	$\text{m}\Omega$
		$V_{GS}=4.5\text{V}$ , $I_D=3\text{A}$		55	70	$\text{m}\Omega$
		$V_{GS}=2.5\text{V}$ , $I_D=2\text{A}$		83	110	$\text{m}\Omega$
$g_{FS}$	Forward Transconductance	$V_{DS}=5\text{V}$ , $I_D=4\text{A}$		8		S
$V_{SD}$	Diode Forward Voltage	$I_S=1\text{A}$ , $V_{GS}=0\text{V}$		0.8	1	V
$I_S$	Maximum Body-Diode Continuous Current				2.5	A
<b>DYNAMIC PARAMETERS</b>						
$C_{iss}$	Input Capacitance	$V_{GS}=0\text{V}$ , $V_{DS}=15\text{V}$ , $f=1\text{MHz}$		390		pF
$C_{oss}$	Output Capacitance			54.5		pF
$C_{rSS}$	Reverse Transfer Capacitance			41		pF
$R_g$	Gate resistance	$V_{GS}=0\text{V}$ , $V_{DS}=0\text{V}$ , $f=1\text{MHz}$		3		$\Omega$
<b>SWITCHING PARAMETERS</b>						
$Q_g$	Total Gate Charge	$V_{GS}=4.5\text{V}$ , $V_{DS}=15\text{V}$ , $I_D=4\text{A}$		0.6		nC
$Q_{gs}$	Gate Source Charge			1.38		nC
$Q_{gd}$	Gate Drain Charge			4.34		nC
$t_{D(on)}$	Turn-On Delay Time	$V_{GS}=10\text{V}$ , $V_{DS}=15\text{V}$ , $R_L=3.75\Omega$ , $R_{GEN}=6\Omega$		3.3		ns
$t_r$	Turn-On Rise Time			1		ns
$t_{D(off)}$	Turn-Off Delay Time			21.7		ns
$t_f$	Turn-Off Fall Time			2.1		ns
$t_{rr}$	Body Diode Reverse Recovery Time	$I_F=4\text{A}$ , $dI/dt=100\text{A}/\mu\text{s}$		12		ns
$Q_{rr}$	Body Diode Reverse Recovery Charge	$I_F=4\text{A}$ , $dI/dt=100\text{A}/\mu\text{s}$		6.3		nC

A: The value of  $R_{\theta JA}$  is measured with the device mounted on 1in<sup>2</sup> FR-4 board with 2oz. Copper, in a still air environment with  $T_A=25^\circ\text{C}$ . The value in any a given application depends on the user's specific board design. The current rating is based on the  $t \leq 10\text{s}$  thermal resistance rating.

B: Repetitive rating, pulse width limited by junction temperature.

C: The  $R_{\theta JA}$  is the sum of the thermal impedance from junction to lead  $R_{\theta JL}$  and lead to ambient.

D: The static characteristics in Figures 1 to 6, 12, 14 are obtained using 80 $\mu\text{s}$  pulses, duty cycle 0.5% max.

E: These tests are performed with the device mounted on 1 in<sup>2</sup> FR-4 board with 2oz. Copper, in a still air environment with  $T_A=25^\circ\text{C}$ . The SOA curve provides a single pulse rating.

TYPICAL ELECTRICAL AND THERMAL CHARACTERISTICS

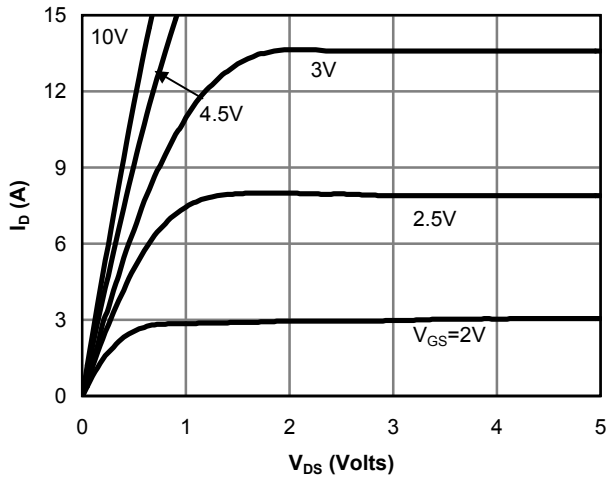

Fig 1: On-Region Characteristics

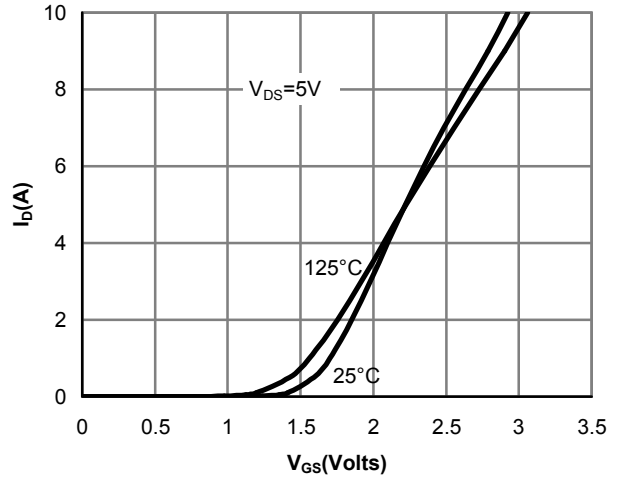

Figure 2: Transfer Characteristics

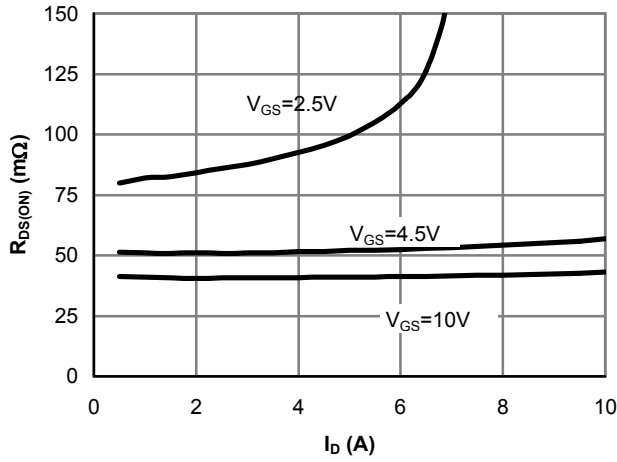

Figure 3: On-Resistance vs. Drain Current and Gate Voltage

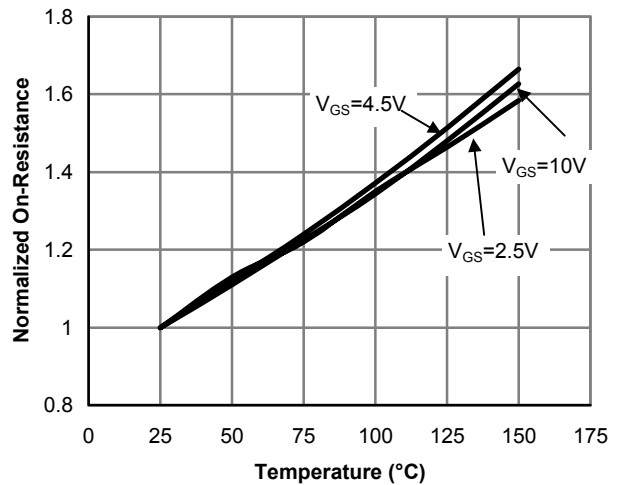

Figure 4: On-Resistance vs. Junction Temperature

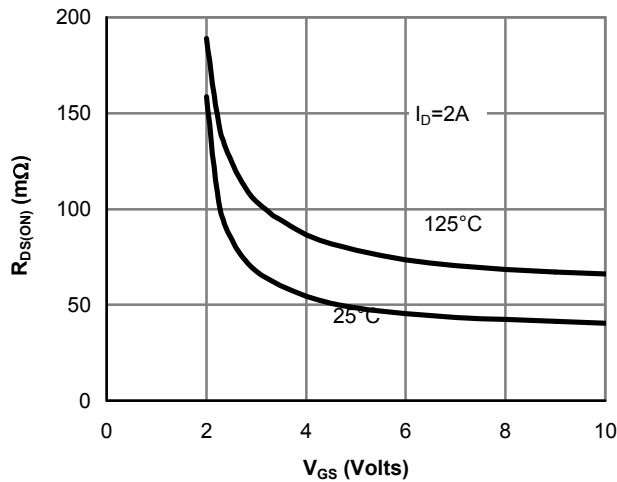

Figure 5: On-Resistance vs. Gate-Source Voltage

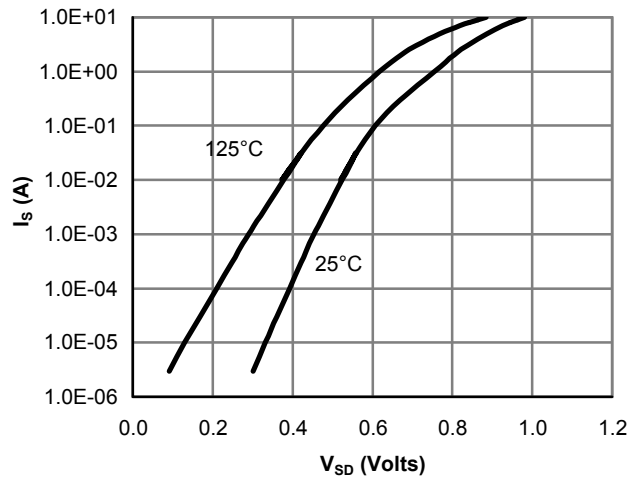

Figure 6: Body-Diode Characteristics

TYPICAL ELECTRICAL AND THERMAL CHARACTERISTICS

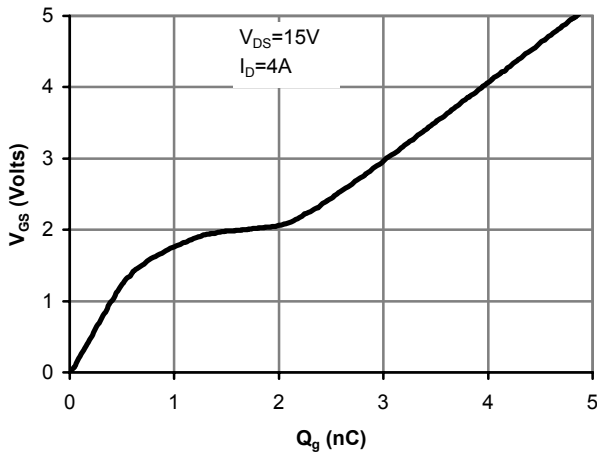

Figure 7: Gate-Charge Characteristics

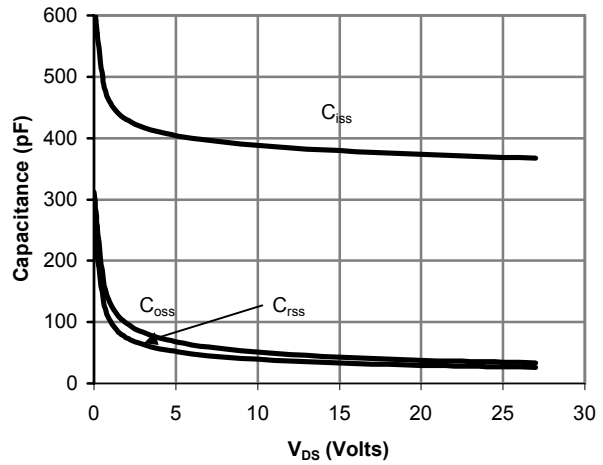

Figure 8: Capacitance Characteristics

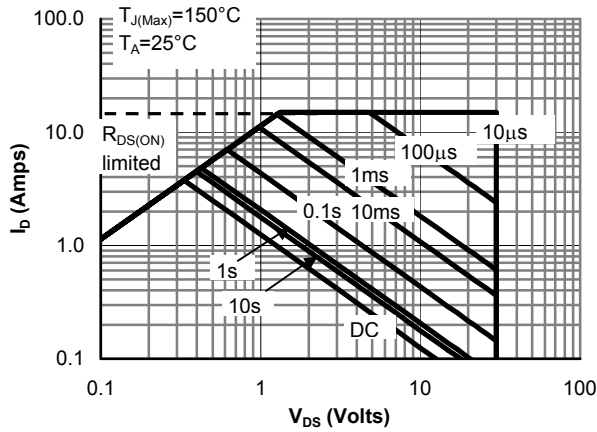

Figure 9: Maximum Forward Biased Safe Operating Area (Note E)

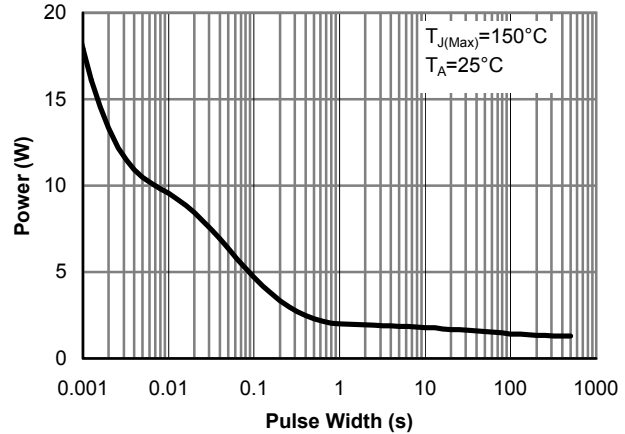

Figure 10: Single Pulse Power Rating Junction-to-Ambient (Note E)

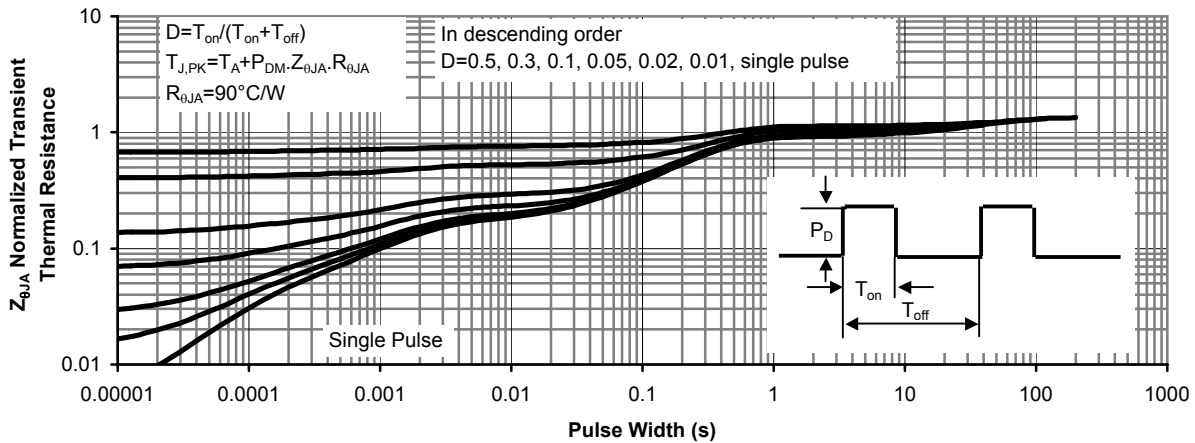
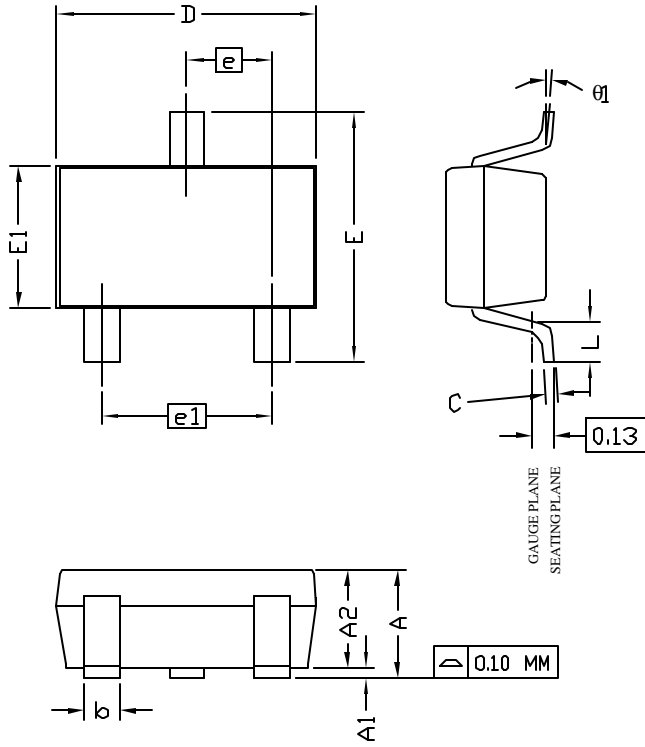

Figure 11: Normalized Maximum Transient Thermal Impedance



**ALPHA & OMEGA**  
SEMICONDUCTOR, INC.

## SOT-23 Package Data



SYMBOLS	DIMENSIONS IN MILLIMETERS		
	MIN	NOM	MAX
A	1.00	—	1.25
A1	0.00	—	0.10
A2	1.00	1.10	1.15
b	0.35	0.40	0.50
C	0.10	0.15	0.25
D	2.80	2.90	3.04
E	2.60	2.80	2.95
E1	1.40	1.60	1.80
e	—	0.95 BSC	—
e1	—	1.90 BSC	—
L	0.40	—	0.60
$\theta 1$	1°	5°	8°

- NOTE:
- LEAD FINISH: 150 MICRONS (3.8 um) MIN. THICKNESS OF Tin/Lead (SOLDER) PLATED ON LEAD
  - TOLERANCE = 0.100 mm (4 mil) UNLESS OTHERWISE SPECIFIED
  - COPLANARITY : 0.1000 mm
  - DIMENSION L IS MEASURED IN GAGE PLANE

### PACKAGE MARKING DESCRIPTION

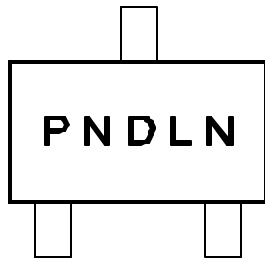

NOTE:  
P N - PART NUMBER CODE.  
D - YAER AND WEEK CODE.  
L N - ASSEMBLY LOT CODE, FAB AND ASSEMBLY LOCATION CODE.

### SOT-23 PART NO. CODE

PART NO.	CODE
AO3400	A0
AO3401	A1

### RECOMMENDED LAND PATTERN

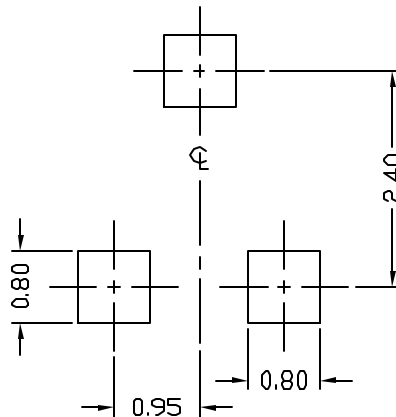



SOT-23 Carrier Tape

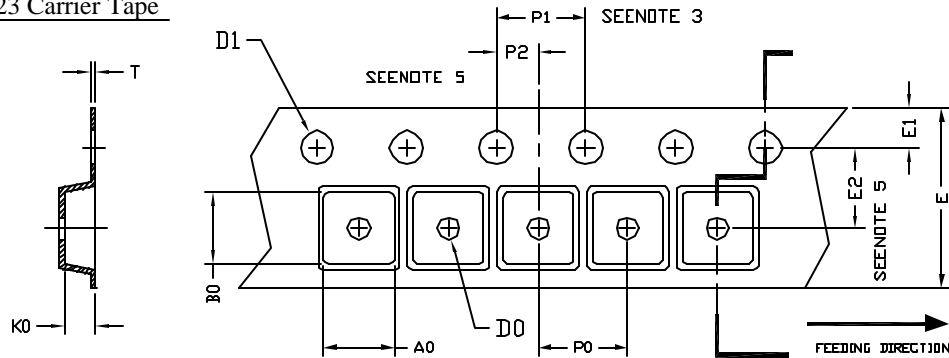

UNIT: MM

PACKAGE	A0	B0	K0	D0	D1	E	E1	E2	P0	P1	P2	T
SOT-23 (8 mm)	3.15 ±0.10	3.20 ±0.10	1.40 ±0.10	1.00 MIN	1.30 +0.10	8.00 ±0.30	1.75 ±0.10	3.50 ±0.05	4.00 ±0.10	4.00 ±0.10	2.00 ±0.05	0.25 ±0.05

SOT-23 Reel

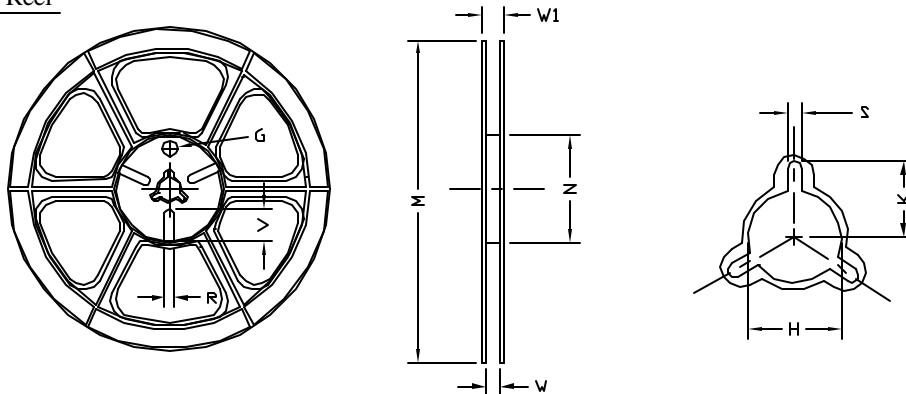

UNIT: MM

TAPE SIZE	REEL SIZE	M	N	W	W1	H	K	S	G	R	V
8 mm	φ180	φ180.00 ±0.50	φ60.50	9.00 ±0.30	11.40 ±1.00	φ13.00 +0.50 -0.20	10.60	2.00 ±0.50	φ9.00	5.00	18.00

SOT-23 Tape

Leader / Trailer  
& Orientation

