

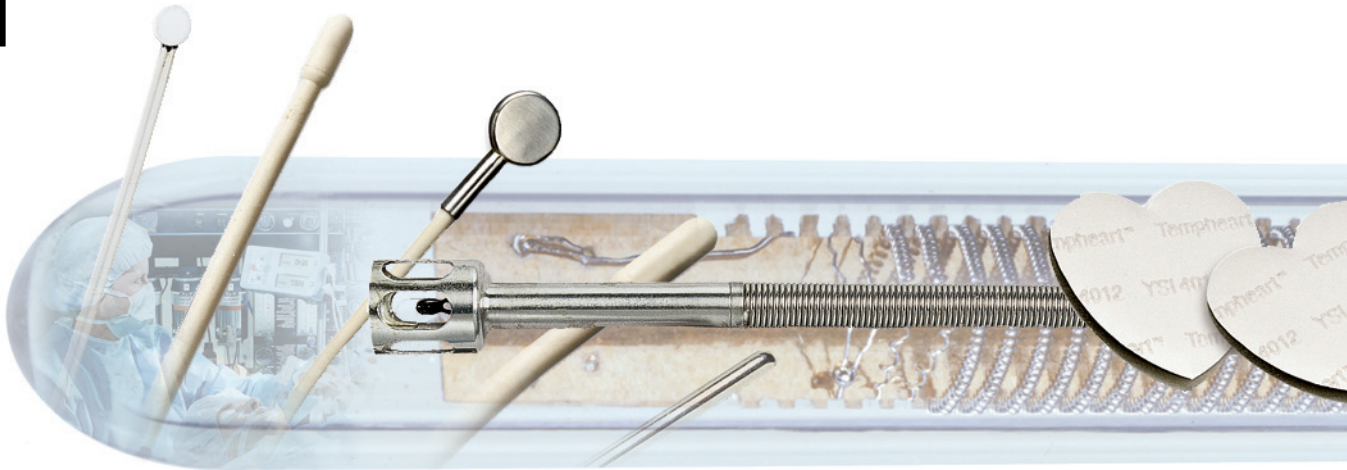

YSI Precision Thermistors & Probes



Introduction

Thermistor Components

Special Test Services

Configure to Order Probes

YSI 400 and 700 Series Reusable Probes

YSI 4600 Precision Thermometers

Technical Information

Thermistors at YSI

YSI developed the first interchangeable thermistor probes in 1955 and the first line of precision interchangeable thermistors in 1961. In 1982, we introduced the first precision interchangeable glass-encapsulated thermistors. We have improved these products and expanded them into a full line of precision thermistors.

What Are Thermistors?

The name is derived from the device's major characteristic – it's a thermally sensitive resistor. There are two major types: NTC, with a negative temperature coefficient of resistance; and PTC, with a positive temperature coefficient. YSI manufactures NTC thermistors, which exhibit a steep drop in resistance as temperature increases, providing high sensitivity to temperature changes. The resistance changes approximately three orders of magnitude in a 100°C range. This provides a means to measure very small temperature variations very accurately.

How We Manufacture Thermistors

Manufacturing precision thermistors involves ceramics technology, solid state chemistry, electronics and precision temperature measurement.

Thermistors are mixed metal oxide semiconductors. We prepare them by intimately mixing fine powders of transition metal oxides, pressing them into disks under high pressure, and firing the disks at high temperature. In the high-temperature firing process, called sintering, the metal oxides undergo a solid state chemical reaction, forming an electrically active material called a spinel. Spinel of transition metal oxides, such as nickel, manganese and iron, exhibit large changes in resistance with small changes in temperature.

After sintering, we apply electrical contacts and attach leads. To protect thermistors from environmental damage, we encapsulate them in epoxy or glass.

The electrical properties are controlled by composition, sintering temperature and oxygen partial pressure. The material constant beta (or slope) and the resistivity (ohm-cm) are established by the manufac-

turing process. To achieve interchangeability over an extended temperature range, the material constant beta must be tightly controlled. YSI maintains variability in beta of less than 0.3%.

The resistance (ohm) is a function of the resistivity and the physical dimensions of the device. Although the slope and resistivity are fixed by composition and firing temperature, the resistance can be adjusted by varying the dimensions. YSI uses this property in a patented process to manufacture precision interchangeable thermistors.

The Advantages of Thermistors

- **Sensitivity**—A thermistor is much more sensitive to temperature change than other sensors. A typical thermistor changes 1,290 ohms per degree at 25°C.
- **Interchangeability**—YSI thermistors are available with interchangeabilities to $\pm 0.05^\circ\text{C}$, not just at a single point but over a temperature range from 0 to 70°C. This is a result of precise process control and extreme attention to quality.
- **Two-Wire Connection**—No reference junction compensation necessary as with thermocouples. The thermistor's inherent higher resistance allows for longer lead length without introducing significant errors compared to platinum RTDs, which must operate in a 3-wire or 4-wire mode.
- **Ruggedness**—The NASA qualification program includes numerous tests of ruggedness, which YSI thermistors continue to pass. NASA has deemed YSI thermistors worthy of qualification for extended space flight.
- **Hermetic Seal**—YSI glass-encapsulated thermistors achieve a hermetic seal between the environment and the thermistor disk. This permits measurement in severe moisture environments without concern for silver migration.
- **Flexibility**—YSI thermistors come in a great variety of resistances, slope characteristics, lead configurations and encapsulation materials. The charts that follow will help you determine which thermistor will perform best in your application.

YSI Capabilities

This catalog describes YSI thermistors, probes and assemblies for laboratory, medical, industrial and process temperature measurement, control, indication and compensation. You may purchase YSI thermistors unmounted or as complete temperature sensing assemblies.

YSI manufactures thermistors and thermistor probe assemblies for use in diverse fields of temperature sensing: from neonatal infant monitoring to tracking the temperature of astronauts in space; from measurement of temperature in the ocean to maintaining critical temperature parameters of satellites; from one-time use in a disposable medical probe to decades in buried telecommunications cables.

We can provide you with the proper thermistor for the job as well as help you design the appropriate probe configuration for your critical temperature applications.

• **Custom Profiles**—When standard thermistors or probes just do not meet your requirements, YSI can help. We have 45 years of experience helping engineers develop temperature measurement solutions. Put our applications engineering staff to work for you.

• **Special Testing**—We have a special test section for thermistors requiring extraordinary or specific verification of characteristics. Our NASA qualification process includes long-term age testing, burn-in, vibration, impact, humidity, high-temperature and low-temperature exposure.

Our precision temperature measurement capabilities extend past the millikelvin range. The constant-temperature baths we use for verifying thermistor calibration have stabilities and accuracies better than ± 5 millikelvin ($\pm 0.005^\circ\text{C}$).

• **NIST Traceability**—Our thermistor temperature measurements are directly traceable to the National Institute of Standards and Technology (NIST). We maintain a world-class temperature calibration laboratory for thermistor reference probes and standard platinum resistance thermometers. It's the only laboratory outside Germany with DKD (*Deutscher Kalibrierdienst*) accreditation from the PTB, Germany's equivalent of our NIST.

• **SPRTs**—YSI also manufactures the world's working standard of temperature, the traditional standard platinum resistance thermometer (SPRT).

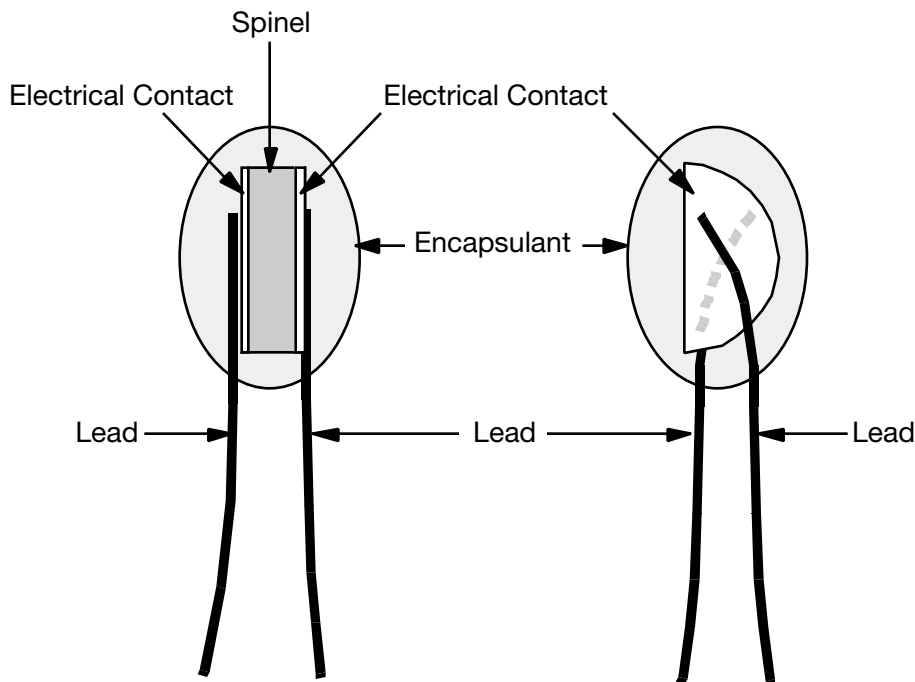

The internal construction of a YSI thermistor

For more information,
contact us at 800 747-5367 or
937 427-1231 • Fax 937 427-1640
Info@YSI.com • www.YSI.com

Comparative Sensor Table

We specialize in thermistor-based temperature measurement. The chart tells you how thermistors compare with other temperature measurement methods. When **accuracy** and **sensitivity** are important, thermistors are the best choice.

	Thermistor 100 ohms to 1 megohms at 25°C	Thermocouple B, R, S, E, T, J, K	Platinum 100, 200, 500, 1,000 ohms at 0°C	Integrated Circuit Temperature Sensor
Sensitivity Units	3.3 to 53K ohms/°C at 25°C	7 to 62 $\mu\text{V}/^\circ\text{C}$	0.00385 and 0.00392 ohms/ohm/°C	1 $\mu\text{A}/^\circ\text{C}$
Standard Accuracy (°C)				
Interchangeability	± 0.05 to $\pm 0.2^\circ\text{C}$	± 0.8 to $\pm 4.4^\circ\text{C}$	$\pm 0.3^\circ\text{C}$	± 0.6 to $\pm 5.0^\circ\text{C}$
Stability at 100°C	0.02°C/ month (epoxy) 0.02°C/year (glass)	Depends on environment	0.05°C/year (film) 0.002°C/year (wire)	0.1°C/month
Power Required	Stable voltage or current	Self-powered	Stable voltage or current	4 to 30 V
Minimum Practical Span	1°C	100°C	25°C	25°C
Temperature Range	-100 to +250°C	-100 to +1750°C	-200 to +750°C	-55 to +150°C
Reference	None	Cold junction	None	None
Ruggedness	Very rugged	Large wire diameter very rugged	Rugged	Very Rugged
Maximum Power (self-heat) for Stated Accuracy	50 μW	NA (susceptible to amplifier bias current error)	500 μW	Offset error is supply voltage dependent
Sensitivity				
Hysteresis over Range	<0.01°C	>1°C	0.01°C	Not available
Repeatability over Range	<0.01°C	$\pm 0.5^\circ\text{C}$	<0.01°C	$\pm 0.1^\circ\text{C}$
Lead Wire Configuration	2-wire	Thermocouple or extension wire	2-, 3-, 4-wire	2-wire

For more information,
contact us at **800 747-5367** or
937 427-1231 • Fax 937 427-1640
Info@YSL.com www.YSL.com

Characteristics of YSI Thermistors

YSI Series	55000	46000	45000	44900	44000	Thermilinear
Coefficient	Negative	Negative	Negative	Negative	Negative	Negative
Resistance Ratio 25°C/125°C	23.51 to 29.26	23.51 to 29.26	23.51 to 29.26	23.51 to 29.26	11.49 to 61.96	NA
Maximum Operating Temperature (°C)	200°C	250°C	250°C	150°C	150°C	150°C
Recommended Operating Range	-80 to +200°C	-80 to +200°C	-80 to +200°C	-80 to +90°C	-80 to + 120°C	-30 to + 100°C
Dissipation Constant	6 mW/°C in oil min 1.5 mW/°C in air min	10 mW/°C in oil min 4 mW/°C in air min	10 mW/°C in oil min 4 mW/°C in air min	8 mW/°C in oil min 1 mW/°C in air typical	8 mW/°C in oil min 1 mW/°C in air typical	8 mW/°C in oil min 1 mW/°C in air typical
Thermal Time Constant	1.5 sec max in oil	2.5 sec max in oil	2.5 sec max in oil	1.0 sec max in oil	1.0 sec max in oil	1.0 sec max in oil
Resistance Available @ 25°C	2252-30K Ω	2252-30K Ω	2252-30K Ω	2252-30K Ω	100 Ω-1 megΩ	NA
Stability	0.12°C/10 mo @ 100°C 0.15°C/10 mo @ 150°C	0.01°C/10 mo. @ 100°C 0.05°C/10 mo. @ 150°C	0.05°C/10 mo. @ 100°C 0.11°C/10 mo. @ 150°C	<0.2°C/10 mo. @ 100°C	<0.2°C/10 mo @ 100°C	<0.2°C/10 mo @ 100°C
Interchangeability 0 to 70°C	±0.1, ±0.2°C	±0.05, ±0.1 ±0.2°C	±0.2°C	±0.1, ±0.2°C	±0.1, ±0.2°C	±0.15°C others available
Size	0.095" w x 0.125" l max	0.125" w x 0.25" l max	0.125" w x 0.25" l max	0.095" w x 0.187" l max	0.095" w x 0.187" l max	0.110" w x 0.150" l max
Resistance to Moisture	Hermetic	Hermetic	Hermetic	MIL 23648 90-98% 10 days	90% noncondensing not for high moisture	90% noncondensing not for high moisture
Lead Material	Gold plated Dumet	Gold plated Dumet	Gold plated Dumet	Tinned copper	Tinned copper	Insulated tinned copper

SECTION 1
*Thermistor
Components*

Precision Interchangeable Thermistors • YSI 44000 Series

High-Temperature Hermetic Thermistors • YSI 45000 Series

Super-Stable Thermistors • YSI 46000 Series

GEM (Glass-Encapsulated Material) Thermistors • YSI 55000 Series

NASA Space-Qualified Thermistors • YSI 44900 Series

Interchangeability Tolerance Data

Thermilinear Components

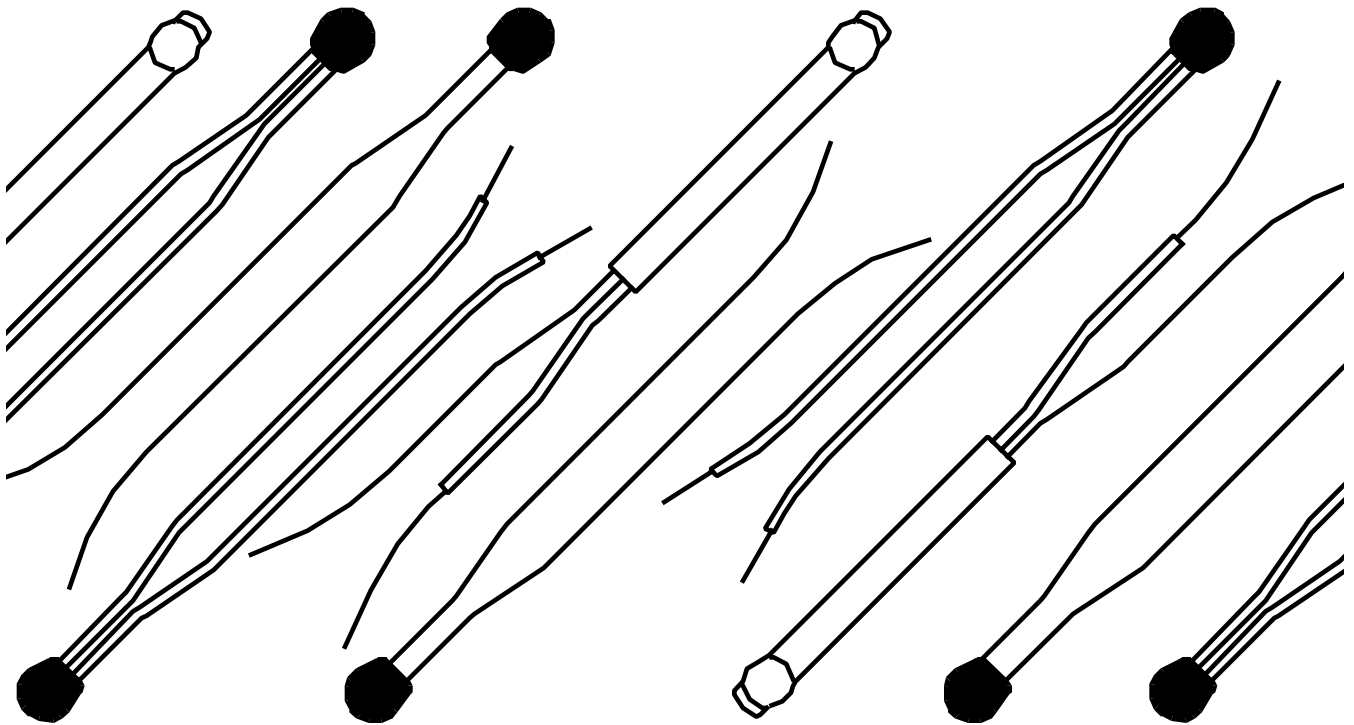

Precision Interchangeable Thermistors

- **YSI 44000 Series Epoxy-Encapsulated for General Use**
- **YSI 44100 Series with Teflon Sheath for Harsh Environments**

YSI thermistors provide highly accurate and stable temperature sensing for measurement, control, indication and compensation. The tight interchangeability of our precision components allows precise measurement without calibration of circuitry to match individual components.

We offer two interchangeability tolerances – $\pm 0.2^{\circ}\text{C}$, $\pm 0.1^{\circ}\text{C}$ – and two configurations – epoxy-encapsulated and epoxy-encapsulated with Teflon sheath.

Choose epoxy-encapsulated components for applications where cost, flexibility and a wide range of resistance values are important. The YSI 44000 Series is available in both $\pm 0.2^{\circ}\text{C}$ and $\pm 0.1^{\circ}\text{C}$ interchangeability tolerances.

YSI 44000 Series Thermistors

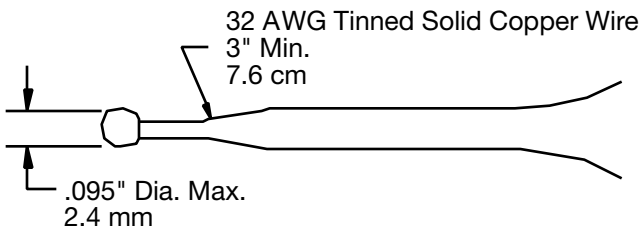

Teflon-sheathed thermistors allow exposure to hostile environments such as conductive or corrosive liquids and particulate suspensions. A stiff wire in the tube lets you form the thermistor leads to various shapes with slight finger pressure. We make the YSI 44100 Series in various resistances in $\pm 0.2^{\circ}\text{C}$ tolerances.

YSI thermistors are fabricated using proprietary processes designed to achieve highly accurate stable thermistors with each production lot. Comparing stability and accuracy specifications will highlight the advantages of the YSI process. When accuracy is important today and in the future, there is only one choice, YSI.

YSI 44100 Series Thermistors with Teflon Sheath

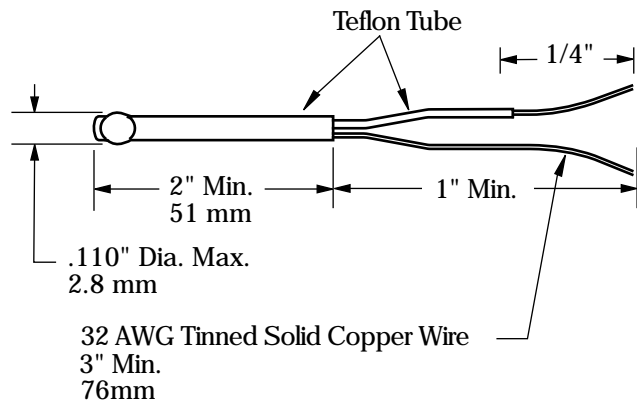

For more information,
contact us at **800 747-5367** or
937 427-1231 • Fax 937 427-1640
Info@YSI.com • **www.YSI.com**

Specifications

Time Constant: 1 sec max for standard thermistors, 2.5 sec max for Teflon-sheathed thermistors, when suspended by their leads in a well-stirred oil bath. In still air, 10 sec max for standard thermistors, 25 sec max for Teflon-sheathed thermistors.

Dissipation Constant: 8 mW/°C min when suspended by their leads in a well-stirred oil bath, or 1 mW/°C in still air.

Stability: YSI thermistors are chemically stable and not significantly affected by aging or exposure to strong nuclear radiation. The table shows typical stability for a representative thermistor, the YSI 44005.

Operating Temperature	Typical Thermometric Drift	
	10 months	100 months
0°C	<0.01°C	<0.01°C
25°C	<0.01°C	<0.02°C
100°C	0.20°C	0.32°C
150°C	1.5°C	not recommended

Resistance/Temperature Data: A °C/°F resistance versus temperature table in 1°C increments is in the Technical Information Section.

Interchangeability Tolerance Data: Tables on pages 17 and 18 show nominal resistance values, ohms per degree, and tolerance at select temperatures over the operating range.

Temperature Probe Assemblies: YSI 44000 Series Thermistors may be installed in many of the probes described in the [Configure-to-Order Probe Section](#).

Maximum Power: 30 mW at 25°C to 1 mW at 125°C short-term.

How to Order

Please order from your YSI representative or YSI Customer Service.

	Ordering Part Numbers		Zero Power Resistance Ω at 25°C	Beta 0-50°C (K)	Ratio Ω 25/125°C	Maximum Working Temperature	Best Storage & Working Temperature	Mix	
	Standard	Teflon							
±0.2°C Interchangeability Tolerance 0 to 70°C	44001A	44101A	100	2854	11.49	100°C	-80-+50°C	L	
	44002A	44102A	300	3118	15.15	100°C	-80-+50°C	L	
	44003A	44103A	1000	3271	17.33	100°C	-80-+50°C	L	
	44004	44104	2252	3891	29.26	150°C	-80-+120°C	B	
	44005	44105	3000	3891	29.26	150°C	-80-+120°C	B	
	44007	44107	5000	3891	29.26	150°C	-80-+120°C	B	
	44017	44117	6000	3891	29.26	150°C	-80-+120°C	B	
	44016	44116	10K	3891	29.26	150°C	-80-+120°C	B	
	44006	44106	10K	3574	23.51	150°C	-80-+120°C	H	
	44008	44108	30K	3810	29.15	150°C	-80-+120°C	H	
	44011	44111	100K	3988	34.82	150°C	-80-+120°C	H	
	44014	44114	300K	4276	46.02	150°C	-80-+120°C	H	
	44015	44115	1 meg	4582	61.96	150°C	-80-+120°C	H	
	±0.1°C Interchangeability Tolerance 0 to 70°C	44035	—	1000	3271	17.33	100°C	-80-+50°C	L
		44033	—	2252	3891	29.26	75°C	-80-+75°C	B
44030		—	3000	3891	29.26	75°C	-80-+75°C	B	
44034		—	5000	3891	29.26	75°C	-80-+75°C	B	
44036		—	10K	3891	29.26	75°C	-80-+75°C	B	
44037		—	6K	3891	29.26	75°C	-80-+75°C	B	
44031		—	10K	3574	23.51	75°C	-80-+75°C	H	
44032		—	30K	3810	29.15	75°C	-80-+75°C	H	

High-Temperature Hermetic Thermistors

• YSI 45000 Series

YSI 45000 Series Thermistors are manufactured with glass hermetic encapsulation, providing stability over a wide range of operating temperatures. We've designed this series for elevated temperatures or for high humidity (95% or above). You may substitute these thermistors for the YSI 44000 Series with no circuit changes.

Replacement of the standard epoxy coating with glass hermetic encapsulation provides significant advantages.

- Improved resistance to humid environments
- Excellent high-temperature stability
- Interchangeability at high temperature
- Wide operating range: -80 to +250°C
- Higher power handling capabilities

YSI 45000 Series thermistors come in a range of resistance values, and $\pm 0.2^\circ\text{C}$ interchangeability tolerance. For further information on glass thermistor performance in severe moisture environments, see page 11, [Tests Show Thermistor Stability](#).

For more information, contact us at **800 747-5367** or **937 767-7241** • Fax 937 767-9353
Info@YSI.com • www.YSI.com

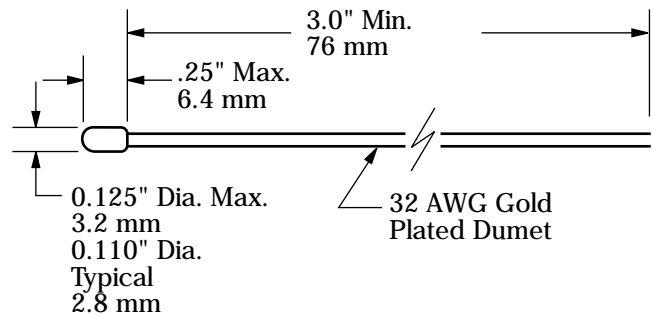

Specifications

Time Constant: 2.5 sec max when suspended by its leads in a well-stirred oil bath, 20 sec max in still air.

Dissipation Constant: 10 mW/°C min when suspended by its leads in a well-stirred oil bath, or 4 mW/°C in still air.

Stability: Typical thermistor stability at 100°C is 0.05°C for 10 months.

Resistance/Temperature Data: A °C/°F resistance versus temperature table is in the Technical Information Section.

Temperature Probe Assemblies: YSI 45000 Series Thermistors may be installed in many of the probes described in the [Configure to Order Probe Section](#).

Interchangeability Tolerance Data: Table on page 17 shows nominal resistance values, ohms per degree, and tolerance at select temperatures over the operating range.

Maximum Power: 50 mW at 25°C derated to 2 mW at 125°C.

How to Order

Please order from your YSI representative or YSI Customer Service.

	Ordering Part Numbers	Zero Power Resistance Ω at 25°C	Beta 0 to 50°C β (K)	Ratio Ω 25/125°C	Maximum Working Temperature	Mix
$\pm 0.2^\circ\text{C}$	45004	2252	3891	29.26	200°C	B
Interchangeability	45005	3000	3891	29.26	200°C	B
Tolerance	45007	5000	3891	29.26	250°C	B
0 to 70°C	45017	6K	3891	29.26	250°C	B
	45006	10K	3574	23.51	250°C	H
	45016	10K	3891	29.26	250°C	B
	45008	30K	3810	29.15	250°C	H

Super-Stable Thermistors

• YSI 46000 Series

YSI 46000 Series components represent the state of the art in long-term stability performance. By coupling glass hermetic encapsulation with 100% resistance shift screening, we offer stability never before realized with thermistor components.

We offer YSI 46000 Series thermistors with interchangeability tolerances as tight as $\pm 0.05^{\circ}\text{C}$, as well as $\pm 0.1^{\circ}\text{C}$ and $\pm 0.2^{\circ}\text{C}$.

Many leading aerospace companies have recognized the advantages of these parts, developing their own specifications for qualifying, screening and using these thermistors in high-reliability applications. We welcome your inquiry on special measurement points and [special test services](#).

• Tests Show Thermistor Stability

YSI 45000 and 46000 Series Thermistors offer unparalleled stability and moisture resistance in thermistor components. The data from the three tests we performed demonstrate that YSI glass thermistors are the device of choice in extreme environments.

High-Temperature Testing

The first was static high-temperature testing. All thermistors show some increase in resistance over time; the higher the temperature, the greater the shift. We placed YSI glass thermistors in an isothermal 150°C environment for extended time testing. On average, they shifted less than 0.040°C in 5,000 hours.

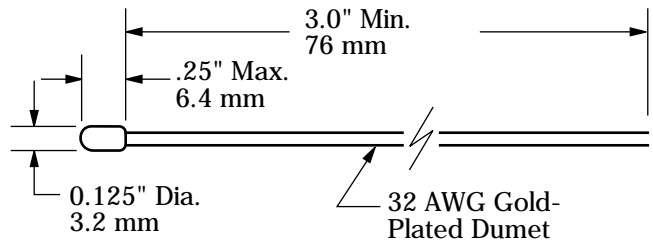
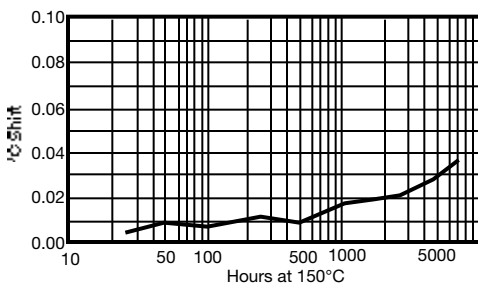

Differential Dew Point Cycling

The second test was cycling from ambient to below the dew point. Moisture is a major cause of failure in standard non-hermetic thermistors. This test exposed the thermistors to multiple cycles with 11 minutes below the dew point and 11 minutes at ambient. After over 3,500 cycles, we saw no appreciable shifts.

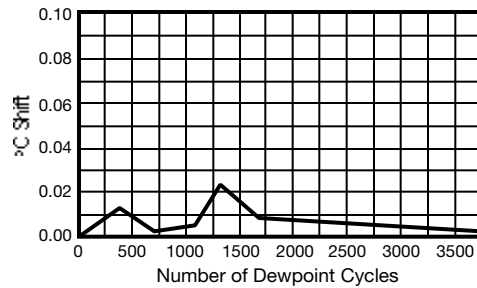

High-Temperature Cycling

The last, and most rigorous test, was thermal cycling. This cycle consisted of 11 minutes at ambient and 11 minutes at 200°C . We ran several hundred cycles. Shifts after 700 cycles averaged less than 0.2°C .

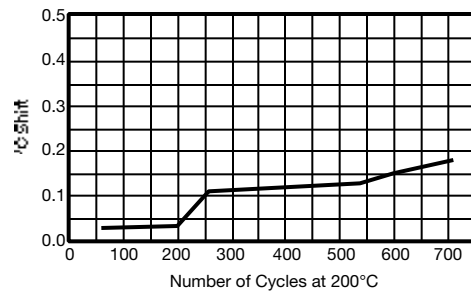

Specifications

Time Constant: 2.5 sec max when suspended by its leads in a well-stirred oil bath, 20 sec max in still air.

Dissipation Constant: 10 mW/°C min when suspended by its leads in a well-stirred oil bath, or 4 mW/°C in still air.

Resistance/Temperature Data: A °C/°F resistance versus temperature table is in the Technical Information Section.

Interchangeability Tolerance Data: Tables on pages 17, 18 and 19 show nominal resistance values, ohms per degree, and tolerance at select temperatures over the operating range.

Temperature Probe Assemblies: YSI 46000 Series Thermistors may be installed in many of the probes described in the [Configure to Order Probe Section](#).

Typical Thermometric Drift

Operating Temperature	Typical Thermometric Drift	
	10 months	100 months
25°C	<0.01°C	<0.01°C
70°C	<0.01°C	<0.01°C
100°C	0.02°C	0.03°C
150°C	0.05°C	0.08°C
200°C	0.22°C	0.60°C

How to Order

Please order from your YSI representative or YSI Customer Service.

	Ordering Part Numbers	Zero Power Resistance Ω at 25°C	Beta 0 to 50°C β (K)	Ratio Ω 25 / 125°C	Maximum Working Temperature	Mix
±0.2°C Interchangeability Tolerance 0 to 70°C	46004	2252	3891	29.26	200°C	B
	46005	3000	3891	29.26	200°C	B
	46007	5000	3891	29.26	200°C	B
	46017	6K	3891	29.26	200°C	B
	46006	10K	3574	23.51	200°C	H
	46016	10K	3891	29.26	200°C	B
	46008	30K	3810	29.15	200°C	H
±0.1°C Interchangeability Tolerance 0 to 70°C	46033	2252	3891	29.26	200°C	B
	46030	3000	3891	29.26	200°C	B
	46034	5000	3891	29.26	200°C	B
	46037	6K	3891	29.26	200°C	B
	46031	10K	3574	23.51	200°C	H
	46036	10K	3891	29.26	200°C	B
	46032	30K	3810	29.15	200°C	H
±0.05°C Interchangeability Tolerance 0 to 70°C	46043	2252	3891	29.26	200°C	B
	46040	3000	3891	29.26	200°C	B
	46044	5000	3891	29.26	200°C	B
	46047	6000	3891	29.26	200°C	B
	46041	10K	3574	23.51	200°C	H
	46046	10K	3891	29.26	200°C	B

GEM Thermistors

(Glass-Encapsulated Material)

• YSI 55000 Series

This thermistor product line from YSI combines the benefits of our high accuracy and super-stable thermistors with low-cost automated assembly technology. The result is a unique product line that defines a new cost versus performance model.

YSI GEM Thermistors use a specially formulated glass material which provides a hermetic package rugged enough for most industrial applications. The product has high-temperature capability, to 200°C, and improved stability compared to epoxy- or plastic- encapsulated thermistors. Automated manufacturing of the YSI 55000 Series allows us unprecedented process control in thermistor calibration and glass encapsulation.

A Variety of Types

- Interchangeability tolerance levels— $\pm 0.2^{\circ}\text{C}$, $\pm 0.1^{\circ}\text{C}$
- Standard resistances—2252 Ω to 30K Ω at 25°C
- 3 standard slopes— B mix and 2 H mixes

Performance Advantages

- Excellent long-term stability
- Broad temperature range to 200°C
- Hermetically sealed in glass
- Price/performance leader

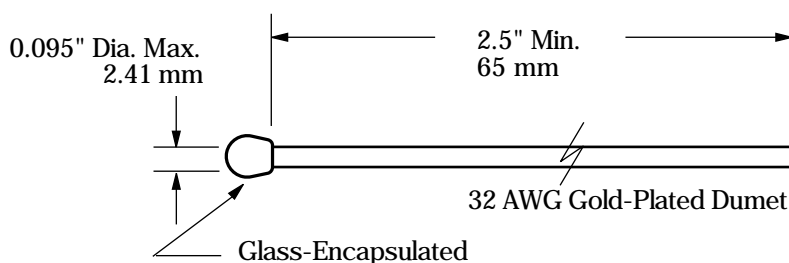

Qualification Testing

The YSI GEM Thermistor has been evaluated using MIL R-23648 specifications. The thermistor has passed requirements for insulation resistance, thermal shock, vibration, shock, moisture resistance, immersion, resistance to solder heat and short-time overload. High quality and reliability are achieved by combining the standard YSI thermistor fabrication process with a new proprietary process for glass encapsulation.

Applications

The YSI GEM Thermistor is ideal for applications which require high stability up to 200°C and are subject to a high-moisture environment. Temperature compensation for sensitive electronic circuits such as precision clocks, communications devices, and medical and scientific instruments achieve improved results with the YSI GEM Thermistor. YSI applications engineering can assist you in selecting the best thermistor for your application.

The YSI GEM Thermistor has the performance characteristics which directly compete with thin platinum RTDs. The thermistor's superior resolution, high resistance values and ruggedness are available in a low-cost package, making the YSI GEM the obvious choice for many applications.

The YSI GEM Thermistor is effective when combined with our Configure-to-Order (CTO) probe offerings. The high stability and temperature characteristics can be packaged in all CTO Probe styles, providing the flexibility to purchase a solution to the most demanding temperature measurement needs. See section 3 for Configure-to-Order probes.

For more information,
contact us at **800 747-5367** or
937 427-1231 • Fax 937 427-1640
Info@YSI.com • **www.YSI.com**

Specifications

Time Constant: 1.5 sec max for GEM Thermistors, in a well-stirred oil bath. In still air, 15 sec max for GEM Thermistors.

Dissipation Constant: 6 mW/°C min when suspended by their leads in a well-stirred oil bath, or 1.5 mW/°C in still air.

Stability: YSI thermistors are chemically stable and not significantly affected by aging or exposure to strong nuclear radiation. The table shows typical stability for a YSI 55016.

Operating Temperature	Typical Thermometric Drift 10 months
0°C	<0.01°C
25°C	<0.01°C
100°C	0.12°C
150°C	0.15°C
200°C	0.20°C

Resistance/Temperature Data: A °C/°F resistance versus temperature table is in the Technical Information Section.

Interchangeability Tolerance Data: Tables on pages 17 and 18 show nominal resistance values, ohms per degree, and tolerance at select temperatures over the operating range.

Temperature Probe Assemblies: YSI 55000 Series Thermistors may be installed in many of the probes described in the [Configure to Order Probe Section](#).

Maximum Power: 30 mW at 25°C to 1 mW at 125°C short-term.

How to Order

Please order from your YSI representative or YSI Customer Service.

	Ordering Part Numbers	Zero Power Resistance Ω at 25°C	Beta 0-50°C (K)	Ratio Ω 25/125°C	Short Term Temperature	Best Working Temperature	Mix
±0.2°C Interchangeability Tolerance 0 to 70°C	55004	2252	3891	29.26	250°C	-80--+200°C	B
	55005	3000	3891	29.26	250°C	-80--+200°C	B
	55007	5000	3891	29.26	250°C	-80--+200°C	B
	55017	6000	3891	29.26	250°C	-80--+200°C	B
	55006	10K	3574	23.51	200°C	-80--+150°C	H
	55016	10K	3891	29.26	250°C	-80--+200°C	B
±0.1°C Interchangeability Tolerance 0 to 70°C	55008	30K	3810	29.15	200°C	-80--+150°C	H
	55033	2252	3891	29.26	250°C	-80--+125°C	B
	55030	3000	3891	29.26	250°C	-80--+125°C	B
	55034	5000	3891	29.26	250°C	-80--+125°C	B
	55037	6000	3891	29.26	250°C	-80--+125°C	B
	55036	10K	3891	29.26	250°C	-80--+125°C	B
	55031	10K	3574	23.51	200°C	-80--+100°C	H
	55032	30K	3810	29.15	200°C	-80--+100°C	H

For more information,
contact us at **800 747-5367** or
937 767-7241 • Fax 937 767-9353
Info@YSI.com • www.YSI.com

NASA Space-Qualified Thermistors

- **YSI 44900 Series**
- **Goddard Space Flight Center GSFC S-311-P-18**

NASA has qualified YSI epoxy-encapsulated thermistors for use in extended space flight. The Goddard Space Flight Center issued GSFC S-311-P-18 in 1974 to specify the performance requirements for these thermistors. We re-qualify a group of thermistors every year and screen every thermistor before stocking.

Re-qualification includes the following tests that are referenced in MIL R-23648.

- Short time load
- Thermal shock
- Insulation resistance
- Resistance to soldering heat
- Low-temperature storage
- High-temperature storage
- Dissipation constant
- Thermal time constant
- Terminal strength
- Moisture resistance
- High-temperature exposure
- High-frequency vibration
- Medium-impact shock
- Immersion

We screen every YSI 44900 Series Thermistor according to this specification. Screening includes visual and mechanical requirements, thermal shock, high-temperature storage, insulation resistance and additional resistance versus temperature analysis.

This qualification and screening gives you confidence that the component will perform to the rigorous requirements of space flight or other application. Customers often submit their own specifications that use our testing capabilities in combinations not in the Goddard specification.

Thermistors procured in compliance with GSFC-311-P-18 are identified by a specific Goddard part number with a 311P18 prefix, a dash number for resistance and range, a lead code and a lead length code. We stock components with S style leads 7.6 cm long. Please contact YSI Customer Service when ordering other lead styles or lengths.

Special Test Services

We offer special test services to qualify parts per customer source control drawings. All YSI thermistors and probes can be custom built and tested to meet the most stringent qualification requirements.

Specifications

Standard Configuration: YSI 44900 Series Thermistors are provided to the specifications shown on the drawings. Each unit is color-coded to indicate resistance value and marked with a green dot between the leads to indicate successful acceptance testing.

Configuration Options: On special order, YSI 44900 Series Thermistors are available with a wide variety of options, including leads of various lengths, special lead materials, insulated leads and as fully-encased units. Space-qualified thermistors also may be installed in many of the probes described in the [Configure to Order Probe Section](#).

Time Constant: 1 sec max when suspended by its leads in a well-stirred oil bath.

Dissipation Constant: 8 mW/°C min when suspended by its leads in a well-stirred oil bath, or 1 mW/°C in still air.

Resistance/Temperature Data: A °C/°F resistance versus temperature table is in the Technical Information Section.

Interchangeability Tolerance Data: Tables on pages 17 and 18 show nominal resistance values, ohms per degree, and tolerance at select temperatures over the operating range.

Outgas: YSI 44900 Series Thermistors are tested in accordance with ASTM E-595-90, 0.66% TML 0.01% CVCVM, 0.10% WVR.

Cage Code: 1L9U5

Bare Lead Thermistor

Green Acceptance Dot

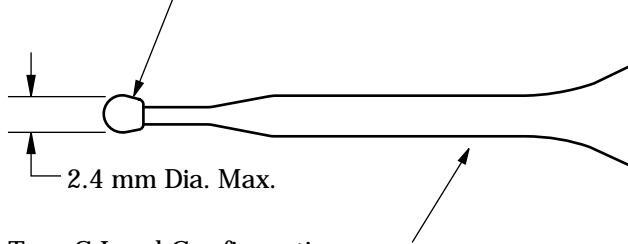

Type S Lead Configuration
32 AWG Tinned Solid Copper Wire
7.6 cm Min.

Type N Lead Configuration

32 AWG Solid Nickel Wire
7.6 cm Min.

Insulated Lead Thermistor

Green Acceptance Dot

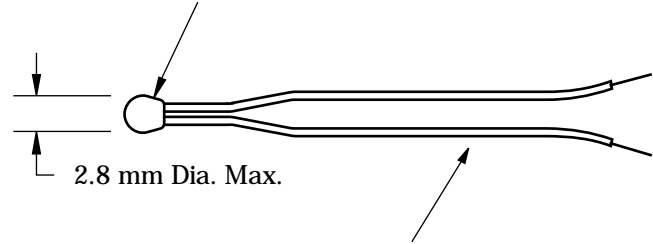

Type A Lead Configuration
28 AWG Stranded Tefzel-Insulated Wire
7.6 cm Min.

Type T Lead Configuration

28 AWG Stranded Teflon-Insulated Wire
7.6 cm Min.

Teflon Covered Thermistor

Green Acceptance Dot

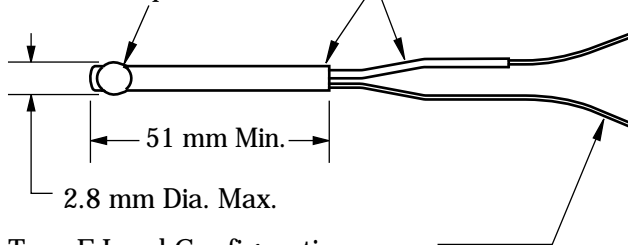

Type E Lead Configuration
32 AWG Tinned Solid Copper Wire
7.6 cm Min.

For more information,
contact us at **800 747-5367** or
937 427-1231 • Fax 937 427-1640
Info@YSI.com • **www.YSI.com**

	Ordering Part Number	GSFC S311P18 Number	Basic YSI Thermistor	Zero Power Resistance Ω at 25°C	Beta 0-50°C (K)	Operating & Storage Temperature*	Color Code Body	End	Mix
±0.2°C Interchangeability Tolerance 0 to 70°C	44901	-01S7R6	44004	2252	3891	-55-+90°C	black	yellow	B
	44903	-03S7R6	44005	3000	3891	-55-+90°C	black	green	B
	44905	-05S7R6	44007	5000	3891	-55-+90°C	black	violet	B
	44907	-07S7R6	44006	10K	3574	-55-+90°C	black	blue	H
	44909	-09S7R6	44008	30K	3810	-55-+90°C	black	gray	H
±0.1°C Interchangeability Tolerance 0 to 70°C	44902	-02S7R6	44033	2252	3891	-55-+70°C	orange	orange	B
	44904	-04S7R6	44030	3000	3891	-55-+70°C	orange	black	B
	44906	-06S7R6	44034	5000	3891	-55-+70°C	orange	yellow	B
	44908	-08S7R6	44031	10K	3574	-55-+70°C	orange	brown	H
	44910	-10S7R6	44032	30K	3810	-55-+70°C	orange	red	H

*Thermistors with ±0.2°C interchangeability tolerance may have short-term operating temperature excursions to 150°C; thermistors with ±0.1°C interchangeability tolerance may have short-term operating temperature excursions to 100°C.

±0.2°C Interchangeability Tolerance Data

The table shows nominal resistance values, ohms per degree (sensitivity), and tolerances in °C and percent for the YSI Thermistor Series.

YSI Series	Description
440__	Epoxy-Encapsulated
450__	High-Temperature Hermetic Thermistors
460__	Super-Stable Thermistors
550__	GEM Glass-Encapsulated Thermistors

The first three digits of the YSI model number specify the series of thermistor. The last two digits specify the thermistor type.

Example: 44016, 45016, 46016, 55016, all define YSI B Mix 10K Thermistors.

Thermistor	__01	__02	__03	__04	__05	__07	__17	__16	__06	__08	__11	__14	__15
-80°C													
Nom Res	14470	67660	2788K	1660K	2211K	3685K	4423K	7371K	3558K				
Ohms/°	960	4880	20700	142K	189K	315K	379K	63K	262K				
Tol °C	0.60	0.60	0.60	1.00	1.00	1.00	1.00	1.00	1.00				
Tol %	4.10%	4.50%	4.64%	8.60%	8.60%	8.50%	8.60%	8.60%	7.40%				
-40°C													
Nom Res	1374	5198	19640	75790	101K	168300	201900	336500	239800	884600	3356K		
Ohms/°	69	284.5	1115	5045	6710	11250	13450	22400	14200	53700	209K		
Tol °C	0.40	0.40	0.40	0.40	0.40	0.40	0.40	0.40	0.40	0.40	0.40		
Tol %	2.01%	2.19%	2.28%	2.66%	2.66%	2.66%	2.66%	2.66%	2.37%	2.50%	2.49%		
0°C													
Nom Res	239.2	777.5	2710	7355	9796	16330	19600	32660	29490	94980	333100	1088K	3966K
Ohms/°	9.1	32.05	117	376	500	835	1K	1670	1370	4695	17150	58K	226K
Tol °C	0.20	0.20	0.20	0.20	0.20	0.20	0.20	0.20	0.20	0.20	0.20	0.20	0.20
Tol %	0.76%	0.83%	0.86%	1.02%	1.02%	1.02%	1.02%	1.02%	1.02%	0.93%	1.00%	1.03%	1.10%
25°C													
Nom Res	100	300	1K	2252	3K	5K	6K	10K	10K	30K	100K	300K	1000K
Ohms/°	3.2	10.55	37.05	99	131.5	219	264	438	402.5	1290	4495	14500	51650
Tol °C	0.20	0.20	0.20	0.20	0.20	0.20	0.20	0.20	0.20	0.20	0.20	0.20	0.20
Tol %	0.64%	0.70%	0.74%	0.88%	0.88%	0.88%	0.88%	0.88%	0.81%	0.86%	0.90%	0.97%	1.03%
40°C													
Nom Res	63.1	181.4	589.5	1200	1598	2663	3197	5329	5592	16150	52190	149400	473200
Ohms/°	1.85	5.8	19.85	48.5	64.5	107	129.5	215	208	640	2175	6700	22800
Tol °C	0.20	0.20	0.20	0.20	0.20	0.20	0.20	0.20	0.20	0.20	0.20	0.20	0.20
Tol %	0.61%	0.64%	0.67%	0.80%	0.80%	0.80%	0.80%	0.80%	0.74%	0.80%	0.83%	0.90%	0.96%
70°C													
Nom Res	28.3	75.2	233	394.5	525.4	875.7	1051	1752	1990	5359	16370	42850	123300
Ohms/°	0.7	2	6.6	13.5	17.95	29.95	36	60	63.5	182.5	585	1655	5150
Tol °C	0.36	0.36	0.36	0.20	0.20	0.20	0.20	0.20	0.20	0.20	0.20	0.20	0.20
Tol %	0.88%	0.96%	1.02%	0.68%	0.68%	0.68%	0.68%	0.68%	0.64%	0.68%	0.71%	0.77%	0.84%
100°C													
Nom Res	14.3	35.8	106.4	152.8	203.8	339.6	407.1	678.5	816.8	2069	6005	14480	38200
Ohms/°	0.3	0.9	2.6	4.45	5.95	9.95	11.85	19.75	22.55	61	187	490	1380
Tol °C	1.00	1.00	1.00	0.30	0.30	0.30	0.30	0.30	0.30	0.30	0.30	0.30	0.30
Tol %	2.09%	2.26%	2.41%	0.88%	0.88%	0.88%	0.88%	0.88%	0.83%	0.88%	0.93%	1.02%	1.09%
150°C													
Nom Res				41.9	55.6	92.7	111.6	186.1	237	550.2	1481	3186	7447
Ohms/°				0.9	1.3	2.17	2.4	4	5.3	13.3	38	88	222
Tol °C				1.00	1.00	1.00	1.00	1.00	1.00	1.00	1.00	1.00	1.00
Tol %				2.30%	2.33%	2.30%	2.30%	2.30%	2.22%	2.35%	2.57%	2.71%	2.93%
200°C													
Nom Res				14.9	19.8	32.9	39.6	65.9	86.5	186.7			
Ohms/°				0.25	0.40	0.60	0.70	1.20	1.55	3.65			
Tol °C				1.30	1.30	1.30	1.30	1.30	1.30	1.30			
Tol %				2.40%	2.40%	2.40%	2.40%	2.40%	2.40%	2.40%			

±0.05°C Interchangeability Tolerance Data

The table shows nominal resistance values, ohms per degree (sensitivity), and tolerances in °C and percent, for the YSI Thermistor Series.

YSI Series	Description
460_ _	Super-Stable Thermistors

The first three digits of the YSI model number specify the series of thermistor. The last two digits specify the thermistor type.

Example: 46046 defines a YSI B Mix 10K Thermistor.

Thermistor	46043	46040	46044	46047	46046	46041
-80°C						
Nom Res	1660K	2211K	3685K	4423K	7371K	3558K
Ohms/°	142K	189K	315K	379K	630K	262K
Tol °C	1.00	1.00	1.00	1.00	1.00	1.00
Tol %	8.60%	8.60%	8.50%	8.60%	8.60%	7.40%
-40°C						
Nom Res	75790	101K	168.3K	201.9K	336.5K	239.8K
Ohms/°	5045	6710	11250	13450	22400	14200
Tol °C	0.20	0.20	0.20	0.20	0.20	0.40
Tol %	1.33%	1.33%	1.33%	1.33%	1.33%	2.37%
0°C						
Nom Res	7355	9796	16.33K	19.6K	32.66K	29.49K
Ohms/°	376	500	835	1000	1670	1370
Tol °C	0.05	0.05	0.05	0.05	0.05	0.05
Tol %	0.26%	0.26%	0.26%	0.26%	0.26%	0.23%
25°C						
Nom Res	2252	3K	5K	6K	10K	10K
Ohms/°	99	131.5	219	264	438	402.5
Tol °C	0.05	0.05	0.05	0.05	0.05	0.05
Tol %	0.22%	0.22%	0.22%	0.22%	0.22%	0.21%
40°C						
Nom Res	1200	1598	2663	3197	5329	5592
Ohms/°	48.5	64.5	107	129.5	215	208
Tol °C	0.05	0.05	0.05	0.05	0.05	0.05
Tol %	0.20%	0.20%	0.20%	0.20%	0.20%	0.18%
70°C						
Nom Res	394.5	525.4	875.7	1051	1752	1990
Ohms/°	13.5	17.95	29.95	36	60	63.5
Tol °C	0.05	0.05	0.05	0.05	0.05	0.05
Tol %	0.17%	0.17%	0.17%	0.17%	0.17%	0.16%
100°C						
Nom Res	152.8	203.8	339.6	407.1	678.5	816.8
Ohms/°	4.45	5.95	9.95	11.85	19.75	22.55
Tol °C	0.15	0.15	0.15	0.15	0.15	0.30
Tol %	0.44%	0.44%	0.44%	0.44%	0.44%	0.83%
150°C						
Nom Res	41.9	55.6	92.7	111.6	186.1	237
Ohms/°	0.9	1.3	2.17	2.4	4	5.3
Tol °C	1.00	1.00	1.00	1.00	1.00	1.00
Tol %	2.30%	2.33%	2.30%	2.30%	2.30%	2.22%
200°C						
Nom Res	14.9	19.8	32.9	39.6	65.9	86.5
Ohms/°	0.25	0.40	0.60	0.70	1.20	1.55
Tol °C	1.30	1.30	1.30	1.30	1.30	1.30
Tol %	2.40%	2.40%	2.40%	2.40%	2.40%	2.40%

For more information,
 contact us at **800 747-5367** or
937 427-1231 • Fax 937 427-1640
Info@YSI.com • www.YSI.com

YSI Thermilinear Components

YSI Thermilinear Components are ideal for applications requiring linear electrical response to temperature change. Each Thermilinear Network consists of two sub-components – a thermistor component and a resistor set. The benefits of linear response are:

- Easy to design in
- Low-cost electrical circuit
- High-resolution measurement

The active element is the thermistor component, made from two YSI precision thermistors with three leads, epoxy encapsulated, to form the YSI 44018 and 44019A sensors; and three thermistors with four leads to form the YSI 44020 sensor.

The resistor set consists of two precision metal film resistors for use with the YSI 44018 and 44019A thermistor components, and three resistors for use with YSI 44020 thermistor components.

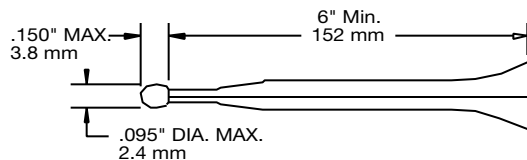

YSI 44018 Thermilinear Component

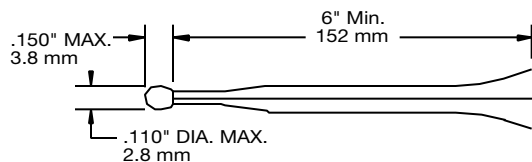

YSI 44019A Thermilinear Component

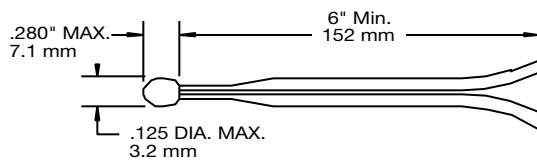

YSI 44020 Thermilinear Component

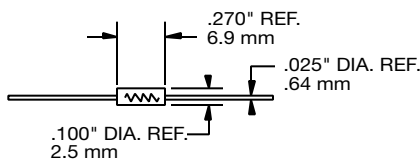

YSI 44300 Series Resistor

The combination of thermistor component and resistor set is called a Thermilinear Network. For example, a YSI 44018 thermistor component plus a YSI 44301 resistor set become a YSI 44201 Thermilinear Network. The Thermilinear Network may be used as a temperature sensor for linear voltage versus temperature or linear resistance versus temperature.

Sensitivity is 400 times greater than a thermocouple, with outputs as high as 30 mV/°C. Output voltage applied to a recorder or digital voltmeter will produce a precise, sensitive, direct-reading thermometer.

How to Use YSI Thermilinear Networks

To understand how a Thermilinear Network functions, first consider what happens when a single thermistor is shunted with a fixed resistor.

As shown in the R versus T charts, the thermistor has an approximately logarithmic, negative temperature characteristic. To make the R/T characteristic more nearly linear, the rate of resistance change must decrease as the temperature decreases. A single shunt resistor will do this.

If this shunt combination is supplied with a constant current, the voltage change across the combination will be linear with resistance change and temperature.

These two components can be reconnected with the resistor in series with the thermistor to form a voltage divider (half bridge) which, when connected across a constant voltage source, will yield a linear output voltage versus temperature across either the resistor or thermistor.

These circuits, although useful because of their simplicity, are restricted to very narrow temperature ranges, usually 25°C or less. As the range is extended, the fixed resistor will be too large at the high temperature end and too small at the low temperature end.

The solution is to add one or more thermistors to the circuit to compensate the first linearizing resistor already in the network.

Thermilinear Lead Color

Thermistor	T1	T2	T3	Common	Type
44018	Brown	Red	-	Green	IV
44019	Brown	Red	-	Green	IV
44020	Red	Green	Blue	Brown	IV

General Theory

Resistance Mode

Resistance mode operation is achieved by configuring the components as shown in the figures below.

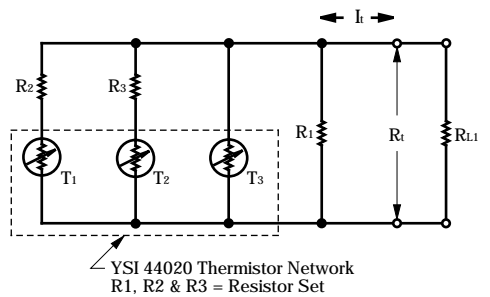
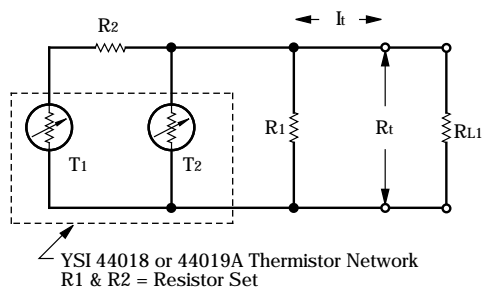

Different networks may be created by changing resistor values. Each Thermilinear Network has a unique resistance versus temperature relationship. This relationship is defined by the formula:

$$R_T = mT + b$$

- Where: R_T = total circuit resistance
- m = change in resistance per degree (slope)
- T = temperature in degrees C
- b = resistance at 0° (0° offset or intercept)

The slope and intercept values for standard networks are on the following pages. Non-standard range values are in the Technical Information Section.

Variation from this calculated value by actual thermistor network values is defined as the linearity deviation. The lower the linearity deviation, the more closely the actual network values track the calculated values.

Voltage Mode

Voltage mode operation is achieved by configuring the components as shown in the figures below.

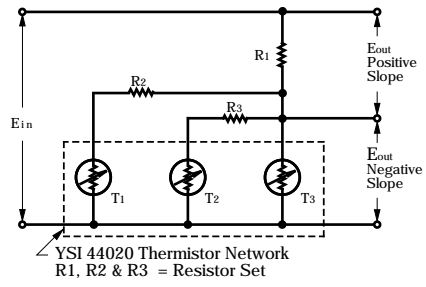
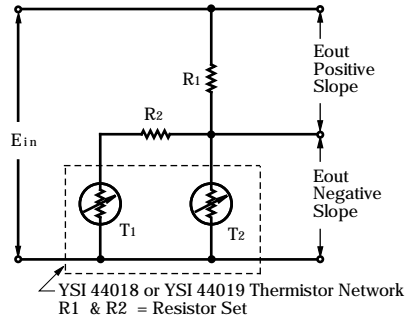

Since each network has a unique resistance versus temperature relationship, it follows that each will have a different sensitivity in the voltage mode. This relationship may be defined as

$$E_{out} = (mE_{in}) T + (bE_{in})$$

- Where: E_{out} = voltage output
- m = voltage change per degree (slope)
- E_{in} = input voltage
- T = temperature in degrees C
- b = voltage at 0° and 1 volt E_{in} (0° offset or intercept)

The values for these slope and intercept values are on the same pages as the resistance mode values. How to use these equations in circuit development is in the [Technical Information Section](#).

For more information,
 contact us at **800 747-5367** or
937 427-1231 • Fax 937 427-1640
Info@YSI.com • **www.YSI.com**

YSI Thermilinear Component Specifications

Component	Maximum Operating Temperature	Accuracy & Interchangeability
YSI 44018	105°C (220°F)	±0.15°C

YSI Thermilinear Network Specifications

YSI Networks Using 44018

44201	Linear Range 0 to +100°C	Linearity Deviation ±0.216°C
44018	Resistance Mode $R_t = (-17.115)T + 2768.23$	
$T_1 = 6,000 \Omega @ 25^\circ\text{C}$ $T_2 = 30,000 \Omega @ 25^\circ\text{C}$	E_o Positive Mode $E_{out} = (+0.0053483 E_{in})T + 0.13493 E_{in}$	E_o Negative Mode $E_{out} = (-0.0053483 E_{in})T + 0.86507 E_{in}$
44301	E_{in} Max I_t Max 2.0V 625 µA	Min RL 10 MΩ
$R_1 = 3200 \Omega$ $R_2 = 6250 \Omega$	Resistor Error ±0.14°C @ 0°C, ±0.03°C @ +100°C	
44202	Linear Range -5 to +45°C	Linearity Deviation ±0.065°C
44018	Resistance Mode $R_t = (-32.402)T + 4593.39$	
$T_1 = 6,000 \Omega @ 25^\circ\text{C}$ $T_2 = 30,000 \Omega @ 25^\circ\text{C}$	E_o Positive Mode $E_{out} = (+0.0056846 E_{in})T + 0.194142 E_{in}$	E_o Negative Mode $E_{out} = (-0.0056846 E_{in})T + 0.805858 E_{in}$
44302	E_{in} Max I_t Max 3.5V 615 µA	Min RL 10 MΩ
$R_1 = 5700 \Omega$ $R_2 = 12,000 \Omega$	Resistor Error ±0.12°C @ -5°C, ±0.07°C @ +45°C	
44203	Linear Range -30 to +50°C	Linearity Deviation ±0.16°C
44018	Resistance Mode $R_t = (-127.096)T + 12175$	
$T_1 = 6,000 \Omega @ 25^\circ\text{C}$ $T_2 = 30,000 \Omega @ 25^\circ\text{C}$	E_o Positive Mode $E_{out} = (+0.0067966 E_{in})T + 0.34893 E_{in}$	E_o Negative Mode $E_{out} = (-0.0067966 E_{in})T + 0.65107 E_{in}$
44303	E_{in} Max I_t Max 3.0V 475 µA	Min RL 10 MΩ
$R_1 = 18,700 \Omega$ $R_2 = 35,250 \Omega$	Resistor Error ±0.12°C @ -30°C, ±0.02°C @ +50°C	
44204	Linear Range -2 to +38°C	Linearity Deviation ±0.03°C
44018	Resistance Mode $R_t = (-32.1012)T + 4603.11$	
$T_1 = 6,000 \Omega @ 25^\circ\text{C}$ $T_2 = 30,000 \Omega @ 25^\circ\text{C}$	E_o Positive Mode $E_{out} = (+0.00563179 E_{in})T + 0.192437 E_{in}$	E_o Negative Mode $E_{out} = (-0.00563179 E_{in})T + 0.807563 E_{in}$
44304	E_{in} Max I_t Max 4.0V 685 µA	Min RL 10 MΩ
$R_1 = 5,700 \Omega$ $R_2 = 12,400 \Omega$	Resistor Error ±0.13°C @ -2°C, ±0.08°C @ +38°C	

For more information,
contact us at **800 747-5367** or
937 427-1231 • Fax 937 427-1640
Info@YSI.com • www.YSI.com

YSI Thermilinear Component Specifications

Component	Maximum Operating Temperature	Accuracy & Interchangeability
YSI 44019A	85°C (185°F)	±0.4°C (0 to 85°C), ±0.8°C (0 to -55°C)
YSI 44020	55°C (131°F)	±0.1°C

YSI Thermilinear Network Specifications

YSI Network Using 44019A

44211A	Linear Range -55 to +85°C	Linearity Deviation ±1.1°C
44019A	Resistance Mode $R_t = (-17.99)T + 2339$	
$T_1 = 1,000 \Omega @ 25^\circ\text{C}$ $T_2 = 10,000 \Omega @ 25^\circ\text{C}$	E_o Positive Mode $E_{out} = (+0.005068 E_{in})T + 0.3411 E_{in}$	E_o Negative Mode $E_{out} = (-0.005068 E_{in})T + 0.6589 E_{in}$
44311A	E_{in} Max I_t Max $R_1 = 3550 \Omega$ 2.0V 833 μA $R_2 = 6025 \Omega$	Min RL 10 M Ω
	Resistor Error ±0.18°C @ -55°C, ±0.02°C @ +85°C	

YSI Network Using 44020

44212	Linear Range -50 to +50°C	Linearity Deviation ±0.09°C
44020	Resistance Mode $R_t = (-129.163)T + 13698.23$	
$T_1 = 2,000 \Omega @ 25^\circ\text{C}$ $T_2 = 15,000 \Omega @ 25^\circ\text{C}$ $T_3 = 45,000 \Omega @ 25^\circ\text{C}$	E_o Positive Mode $E_{out} = (+0.00559149 E_{in})T + 0.40700 E_{in}$	E_o Negative Mode $E_{out} = (-0.00559149 E_{in})T + 0.59300 E_{in}$
44312	E_{in} Max I_t Max $R_1 = 23,100 \Omega$ 3.5V 700 μA $R_2 = 88,200 \Omega$ $R_3 = 38,000 \Omega$	Min RL 10 M Ω
	Resistor Error ±0.15°C @ -50°C, ±0.03°C @ +50°C	

Thermilinear Definitions

Thermilinear Component YSI 44018, 44019A or 44020 thermistor.

Resistor Set YSI 44301, 44302, 44303, 44304, 44311A or 44312 resistor sets consist of 2 resistors (3 for 44312) used with a Thermilinear component to create a Thermilinear Network.

Thermilinear Network A Thermilinear component and corresponding resistor set.

Linear Range Temperature range over which linearity deviation applies.

Linearity Deviation Deviation, in degrees, between actual network values and calculated straight line. This is stated as worst case; actual deviation is roughly sinusoidal about the calculated nominal.

Resistance Mode Formula for calculating R vs T.

E_o Negative Mode Formula for calculating the voltage across thermistor/resistor parallel network (bottom of bridge).

E_o Positive Mode Formula for calculating the voltage across R₁ (top of bridge).

E_{in} Max & I_t Max Values below which thermistors exhibit minimal self heating; determined using 8mW/°C dissipation. E_{in} max and I_t max values may be exceeded 5 times without damaging probe.

Load Resistance Minimum, RL The minimum recommended resistive impedance. Lower values may adversely affect linearity and other performance characteristics of the network.

Resistor Error Possible circuit error in degrees induced by ±0.1% fixed resistors.

YSI 44018 Thermilinear Composite

Maximum Operating Temperature: 105°C (220°F)

Accuracy and Interchangeability: ±0.15°C when incorporated in a standard YSI Thermilinear Network.

Time Constant, Maximum: 1 sec in well-stirred oil, 10 sec in still air. Time constant is the time required for thermistor to indicate 63% of a newly impressed temperature.

Dissipation Constant, Minimum: 1mW/°C in still air, 8mW/°C in well stirred oil. Dissipation constant is the power in milliwatts required to raise a thermistor 1°C above surrounding temperature.

Color Code: Brown epoxy body, gray end.

Storage Temperature: -80 to +105°C (-112 to +221°F).

Resistance versus Temperature: -30 to +100°C

Resistance versus Temperature Data

Temp °C	T1 Res. Ohms	T2 Res. Ohms
-30	106.2K	481.0K
29	99.82K	453.5K
28	93.88K	427.7K
27	88.32K	403.5K
26	83.12K	380.9K
25	78.26K	359.6K
24	73.72K	339.6K
23	69.46K	320.9K
22	65.48K	303.3K
21	61.74K	286.7K
20	58.26K	271.2K
19	54.98K	256.5K
18	51.90K	242.8K
17	49.02K	229.8K
16	46.32K	217.6K
15	43.78K	206.2K
14	41.40K	195.4K
13	39.16K	185.2K
12	37.04K	175.6K
11	35.06K	166.6K
10	33.20K	158.0K
9	31.49K	150.0K
8	29.80K	142.4K
7	28.24K	135.2K
6	26.78K	128.5K
5	25.45K	122.1K
4	24.10K	116.0K
3	22.88K	110.3K
2	21.72K	104.9K
-1	20.62K	99.80K
0	19.59K	94.98K
+1	18.62K	90.41K
2	17.70K	86.09K
3	16.83K	81.99K
4	16.01K	78.11K
5	15.24K	74.44K
6	14.50K	70.96K
7	13.81K	67.66K
8	13.15K	64.53K
9	12.53K	61.56K

Temp °C	T1 Res. Ohms	T2 Res. Ohms
10	11.94K	58.75K
11	11.38K	56.07K
12	10.85K	53.54K
13	10.35K	51.13K
14	9878	48.84K
15	9428	46.67K
16	9000	44.60K
17	8594	42.64K
18	8210	40.77K
19	7844	38.99K
20	7496	37.30K
21	7166	35.70K
22	6852	34.17K
23	6554	32.71K
24	6270	31.32K
25	6000	30.00K
26	5744	28.74K
27	5500	27.54K
28	5266	26.40K
29	5046	25.31K
30	4834	24.27K
31	4634	23.28K
32	4442	22.33K
33	4260	21.43K
34	4084	20.57K
35	3918	19.74K
36	3760	18.96K
37	3610	18.21K
38	3466	17.49K
39	3328	16.80K
40	3196	16.15K
41	3070	15.52K
42	2950	14.92K
43	2836	14.35K
44	2726	13.80K
45	2620	13.28K
46	2520	12.77K
47	2424	12.29K
48	2334	11.83K
49	2246	11.39K

Temp °C	T1 Res. Ohms	T2 Res. Ohms
50	2162	10.97K
51	2080	10.57K
52	2004	10.18K
53	1930	9807
54	1859	9450
55	1792	9109
56	1727	8781
57	1664	8467
58	1605	8166
59	1547	7876
60	1493	7599
61	1440	7332
62	1389	7076
63	1341	6830
64	1294	6594
65	1249	6367
66	1207	6149
67	1165	5940
68	1126	5738
69	1087	5545
70	1051	5359
71	1016	5180
72	981.8	5007
73	949.4	4842
74	918.0	4682
75	888.0	4529
76	859.0	4381
77	831.2	4239
78	804.4	4102
79	773.6	3970
80	753.8	3843
81	729.8	3720
82	706.8	3602
83	684.4	3489
84	663.0	3379
85	642.4	3273
86	622.6	3172
87	603.4	3073
88	584.4	2979
89	567.0	2887

Temp °C	T1 Res. Ohms	T2 Res. Ohms
90	549.8	2799
91	533.2	2714
92	517.2	2632
93	501.8	2552
94	486.8	2476
95	472.4	2402
96	458.6	2331
97	445.2	2262
98	432.2	2195
99	419.6	2131
100	407.6	2069

YSI 44019A Thermilinear Composite

Maximum Operating Temperature: 85°C (185°F). Not recommended for long-term continuous use above 50°C (122°F).

Accuracy and Interchangeability: ±0.4°C (0 to 85°C); ±0°C (0 to -55°C) when incorporated in a YSI Thermilinear Network.

Time Constant Maximum: 1 sec in well-stirred oil, 10 sec in still air. Time constant is the time required for a thermistor to indicate 63% of a newly impressed temperature.

Dissipation Constant, Minimum: 8 mW/°C in well-stirred oil, 1 mW/°C in still air. Dissipation constant is the power in milliwatts to raise a thermistor 1°C above surrounding temperature.

Color Code: Brown epoxy body, white end.

Storage Temperature: -80 to +50°C (-112 to +122°F).

Resistance versus Temperature: -55 to +85°C

Resistance versus Temperature Data

Temp °C	T1 Res. Ohms	T2 Res. Ohms
-60		
59		
58		
57		
56		
-55	48.32K	607.8K
54	45.36K	569.6K
53	42.60K	534.1K
52	40.03K	501.0K
51	37.63K	470.1K
50	35.39K	441.3K
49	33.30K	414.5K
48	31.35K	389.4K
47	29.52K	366.0K
46	27.81K	344.1K
45	26.22K	323.7K
44	24.72K	304.6K
43	23.32K	286.7K
42	22.01K	270.0K
41	20.79K	254.4K
40	19.64K	239.8K
39	18.56K	226.0K
38	17.54K	213.2K
37	16.59K	201.1K
36	15.70K	189.8K
35	14.86K	179.2K
34	14.07K	169.3K
33	13.30K	160.0K
32	12.63K	151.2K
31	11.97K	143.0K
30	11.35K	135.2K
29	10.77K	127.9K
28	10.22K	121.1K
27	9705	114.6K
26	9218	108.6K
25	8758	102.9K
24	8323	97.49K
23	7914	92.43K
22	7527	87.66K
21	7161	83.16K

Temp °C	T1 Res. Ohms	T2 Res. Ohms
20	6815	78.91K
19	6489	74.91K
18	6180	71.13K
17	5887	67.57K
16	5611	64K
15	5349	61.02K
14	5101	58.01K
13	4866	55.17K
12	4643	52.48K
11	4432	49.94K
10	4232	47.54K
9	4042	45.27K
8	3862	43.11K
7	3691	41.07K
6	3529	39.14K
5	3374	37.31K
4	3228	35.57K
3	3088	33.93K
2	2956	32.37K
-1	2830	30.89K
0	2710	29.49K
+1	2596	28.15K
2	2487	26.89K
3	2384	25.69K
4	2286	24.55K
5	2192	23.46K
6	2102	22.43K
7	2017	21.45K
8	1936	20.52K
9	1859	19.63K
10	1785	19.79K
11	1714	17.98K
12	1674	17.55K
13	1582	16.49K
14	1521	15.79K
15	1462	15.13K
16	1406	14.50K
17	1353	13.90K
18	1302	13.33K
19	1253	12.79K

Temp °C	T1 Res. Ohms	T2 Res. Ohms
20	1206	12.26K
21	1161	11.77K
22	1118	11.29K
23	1077	10.84K
24	1038	10.41K
25	1000	10000
26	963.9	9605
27	929.4	9227
28	896.3	8867
29	864.5	8523
30	834.0	8194
31	804.8	7880
32	776.8	7569
33	749.9	7291
34	724.1	7016
35	699.4	6752
36	675.6	6500
37	652.7	6258
38	630.8	6026
39	609.7	5805
40	589.5	5592
41	570.0	5389
42	551.2	5193
43	533.2	5006
44	515.9	4827
45	499.2	4655
46	483.2	4489
47	467.8	4331
48	452.9	4179
49	438.6	4033
50	424.8	3893
51	411.6	3758
52	398.8	3629
53	386.5	3504
54	374.7	3385
55	363.2	3270
56	352.2	3160
57	341.6	3054
58	331.3	2952
59	321.5	2854

Temp °C	T1 Res. Ohms	T2 Res. Ohms
60	311.9	2760
61	302.7	2669
62	293.9	2582
63	285.3	2487
64	277.0	2417
65	269.0	2339
66	261.3	2264
67	253.9	2191
68	246.7	2122
69	239.7	2055
70	233.0	1990
71	226.5	1928
72	220.2	1868
73	214.1	1810
74	208.3	1754
75	202.6	1700
76	197.1	1648
77	191.8	1598
78	186.7	1549
79	181.7	1503
80	176.9	1458
81	172.2	1414
82	167.7	1372
83	163.3	1332
84	159.1	1293
85	154.9	1255

For more information,
 contact us at **800 747-5367** or
937 427-1231 • Fax 937 427-1640
Info@YSI.com • **www.YSI.com**

YSI 44020 Thermilinear Composite

Maximum Operating Temperature: 55°C (131°F)

Accuracy and Interchangeability: ±0.1°C when incorporated in a YSI Thermilinear Network.

Time Constant, Maximum: 1 sec in well-stirred oil, 10 sec in still air. Time constant is the time required for a thermistor to indicate 63% of a newly impressed temperature.

Dissipation Constant, Minimum: 8 mW/°C in well-stirred oil, 1 mW/°C in still air. Dissipation constant is the power in milliwatts to raise a thermistor 1°C above surrounding temperature.

Color Code: Red epoxy body, black end.

Storage Temperature: -80 to +120°C (-112 to +250°C).

Resistance versus Temperature: -50 to +50°C.

Resistance versus Temperature Data

Temp °C	T1 Res. Ohms	T2 Res. Ohms	T3 Res. Ohms
-50	134.1K	662.1K	2540K
49	124.9K	621.8K	2376K
48	116.4K	584.2K	2223K
47	108.5K	549.1K	2081K
46	101.2K	516.3K	1949K
45	94.41K	485.7K	1826K
44	88.14K	457.0K	1712K
43	82.33K	430.2K	1605K
42	76.94K	405. .	1506K
41	71.93K	381.7K	1413K
40	67.29K	359.7K	1327K
39	62.97K	339.2K	1246K
38	58.96K	319.9K	1171K
37	55.22K	301.8K	1101K
36	51.75K	284.9K	1035K
35	48.52K	269.0K	973.7K
34	45.51K	254.0K	916.3K
33	42.71K	240.0K	862.6K
32	40.09K	226.9K	812.3K
31	37.65K	214.5K	765.3K
30	35.38K	202.9K	721.2K
29	33.25K	192.0K	698.0K
28	31.27K	181.7K	641.3K
27	29.42K	172.0K	605.0K
26	27.69K	162.9K	571.0K
25	26.07K	154.4K	539.1K
24	24.56K	146.3K	509.2K
23	23.14K	138.7K	481.1K
22	21.81K	131.5K	454.7K
21	20.57K	124.8K	429.9K
20	19.41K	118.4K	406.5K
19	18.31K	112.4K	384.6K
18	17.29K	106.7K	364.0K
17	16.33K	101.4K	344.6K
16	15.43K	96.34K	326.3K
15	14.58K	91.56K	309.1K
14	13.79K	87.05K	292.9K
13	13.04K	92.79K	277.7K
12	12.34K	78.76K	263.3K
11	11.68K	74.94K	249.8K

Temp °C	T1 Res. Ohms	T2 Res. Ohms	T3 Res. Ohms
10	11.06K	71.34K	237.0K
9	10.48K	67.92K	224.9K
8	9928	64.69K	213.5K
7	9410	61.63K	202.8K
6	8922	58.73K	192.6K
5	8463	55.98K	183.1K
4	8029	53.38K	174.0K
3	7621	50.91K	165.4K
2	7236	48.57K	157.4K
1	6873	46.35K	149.7K
0	6529	44.24K	142.5K
+1	6205	42.24K	135.5K
2	5899	40.34K	129.1K
3	5610	38.54K	123.0K
4	5337	36.82K	117.2K
5	5078	35.20K	111.7K
6	4834	33.65K	106.4K
7	4603	32.18K	101.5K
8	4384	30.78K	96.79K
9	4177	29.45K	92.34K
10	3980	28.18K	88.12K
11	3794	26.98K	84.11K
12	3618	25.83K	80.30K
13	3451	24.73K	76.69K
14	3293	23.70K	73.26K
15	3143	22.71K	69.99K
16	3000	21.76K	66.90K
17	2865	20.86K	63.95K
16	3000	21.76K	66.90K
17	2865	20.86K	63.95K
18	2736	20.00K	61.15K
19	2614	19.18K	58.49K

Temp °C	T1 Res. Ohms	T2 Res. Ohms	T3 Res. Ohms
20	2499	18.40K	55.95K
21	2389	17.66K	53.54K
22	2284	16.95K	51.25K
23	2185	16.27K	49.06K
24	20.90	15.62K	46.98K
25	2000	15.00K	45.00K
26	1915	14.41K	43.11K
27	1833	13.84K	41.31K
28	1756	13.30K	39.60K
29	1682	12.79K	37.96K
30	1611	12.30K	36.40K
31	1544	11.82K	34.91K
32	1480	11.37K	33.50K
33	1420	10.94K	32.14K
34	1362	10.53K	30.85K
35	1306	10.13K	29.61K
36	1253	9752	28.43K
37	1203	9390	27.31K
38	1155	9042	26.23K
39	1109	8710	25.20K
40	1065	8391	24.22K
41	1023	8085	23.28K
42	983.1	7792	22.38K
43	944.9	7511	21.52K
44	908.3	7242	20.70K
45	873.4	6984	19.91K
46	839.9	6736	19.16K
47	808.0	6498	18.44K
48	777.4	6270	17.75K
49	748.1	6051	17.09K
50	720.1	5840	16.45K

For more information,
 contact us at **800 747-5367** or
937 427-1231 • Fax 937 427-1640
Info@YSI.com • **www.YSI.com**

SECTION 2 Special Test Services

- YSI Facilities
- Custom Specifications
- Thermistor Calibration
- ISO 9001 Certification
- Platinum RTD Calibration
- Standard Platinum Resistance Thermometers

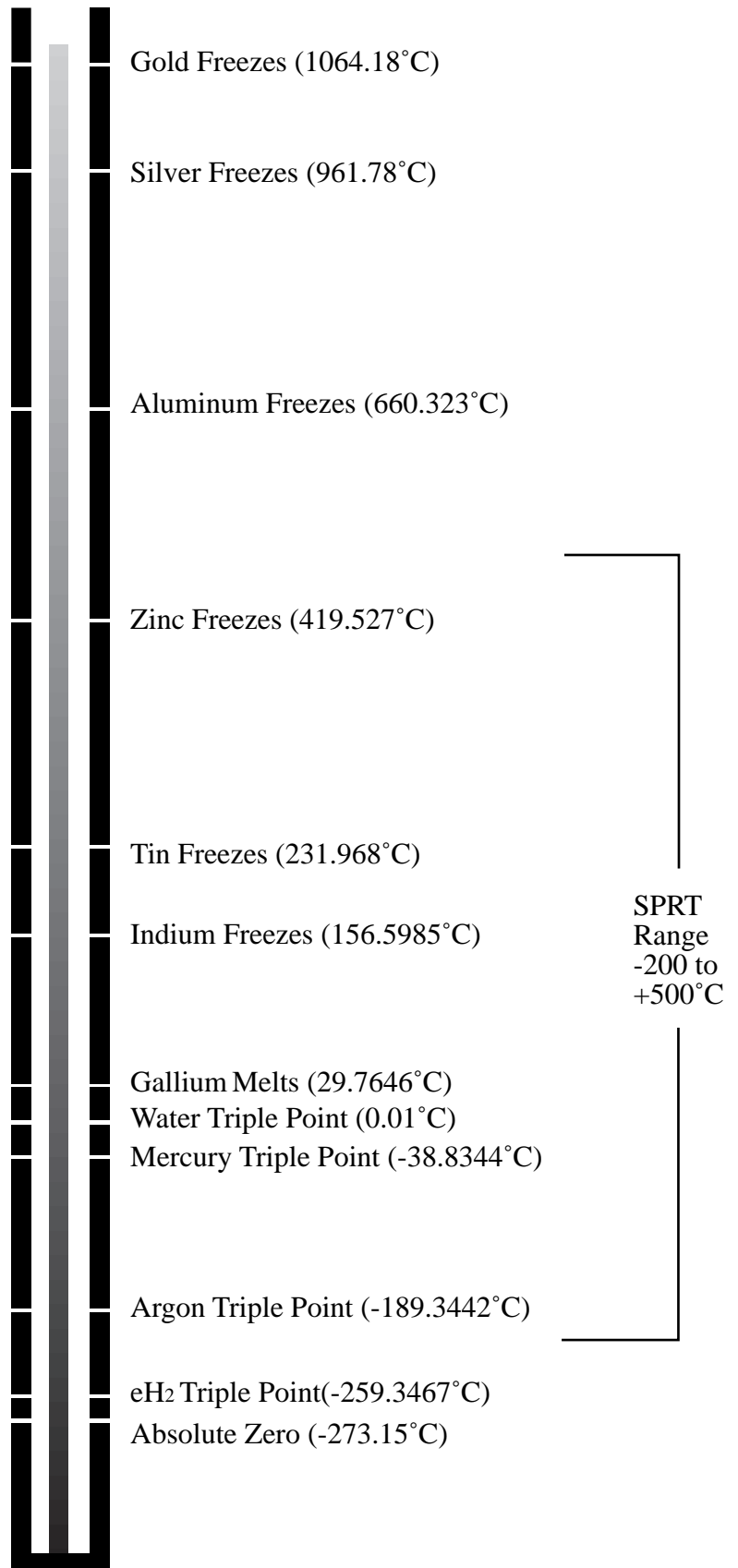

ITS-90 Scale

Special Test Services

Our Facilities

We have the facilities to qualify our thermistors to meet NASA specification GSFC S-311-P-18. We can also perform tests defined in MIL R-23648.

YSI has resistance temperature measurement capabilities to determine the resistance of thermistors from -60 to +125°C. Resolution is normally at least 1 part per 10,000 for the zero power resistance measurement. All temperature measurements are traceable to the National Institute of Standards and Technology (NIST).

Custom Specifications

Many leading aerospace companies have developed their own specifications for qualifying, screening and using thermistors in high-reliability applications. We welcome your inquiry on special measurement points or screening tests that use our capabilities, whether listed in MIL PRF-23648, GSFC-311-P-18 or your own requirements.

Thermistor Calibration

YSI will calibrate thermistors and thermistor probes based on ITS-90. All calibrations are traceable to NIST or derived from accepted values of physical constants. We furnish a certificate of calibration and a certificate of traceability with every thermistor we calibrate. We calibrate thermistor reference probes in NIST traceable constant temperature baths and with fixed points. Standard calibration temperatures are -40, 0, +25, +40, +70, +100 and +125°C.

ISO 9001 Certification

YSI has received ISO 9001 quality standard registration. The ISO 9001 standard includes quality management and quality assurance and is the most comprehensive standard in the series developed by the International Organization for Standardization (ISO) in Geneva.



Platinum RTD Calibration

YSI will calibrate platinum RTDs based on ITS-90. All calibrations are traceable to NIST. We furnish a certificate of calibration and a certificate of traceability with every RTD we calibrate. Standard calibration temperatures are -40, 0, +25, +40, +70, +100 and +125°C.

We can also calibrate your RTD at any reference point of ITS-90 between -189 and +420°C.

Standard Platinum Resistance Thermometers

These traditional Standard Platinum Resistance Thermometers (SPRTs) are the world's working standard of temperature. We have been building them since 1981 from a Leeds and Northrup design.

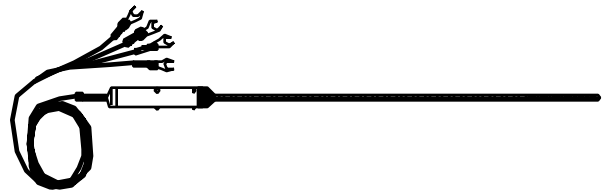









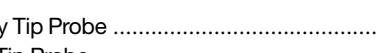

Made from carefully wound helices of reference-grade platinum, these thermometers are highly stable over long periods and measure from -200 to +500°C. Resistance is about 25.5 ohms at 0°C.

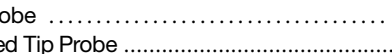
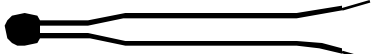

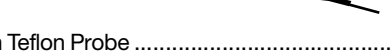
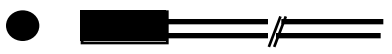

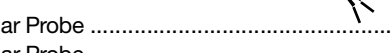
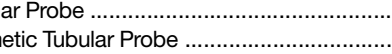
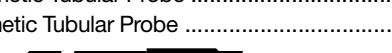
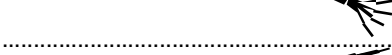

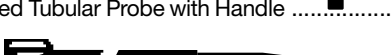

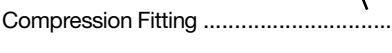

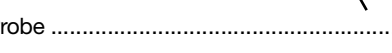

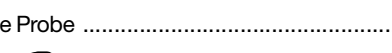
We will calibrate any SPRT in good condition manufactured by L & N or YSI. We can often repair broken thermometers as well.

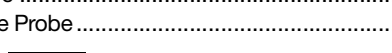
For more information,
contact us at **800 747-5367** or
937 427-1231 • Fax 937 427-1640
Info@YSI.com • **www.YSI.com**

SECTION 3

Configure-to-Order Thermistor Probes

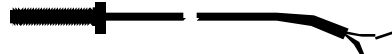
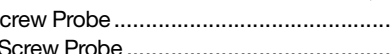
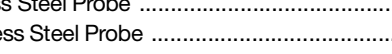
-  YSI 010 Round Epoxy Tip Probe
-  YSI 011 Round PVC Tip Probe
-  YSI 012 Epoxy Tip Probe
-  YSI 013 Acrylic Coated Tip Probe
-  YSI 014 Thermistor with Leads Probe
-  YSI 015 Thermistor in Teflon Probe
-  YSI 016 Radial Lead Thermistor
-  YSI 030 1/8" OD Tubular Probe
-  YSI 031 3/8" OD Tubular Probe
-  YSI 032 1/4" OD Tubular Probe
-  YSI 033 1/8" OD Hermetic Tubular Probe
-  YSI 034 3/16" OD Hermetic Tubular Probe
-  YSI 035 1/4" OD Hermetic Tubular Probe
-  YSI 036 Pyrex Probe
-  YSI 038 1/4" OD Pointed Tubular Probe with Handle
-  YSI 050 Bird Cage Air Probe
-  YSI 051 Air Probe for Compression Fitting
-  YSI 052 Waterproof Airway Probe
-  YSI 070 Underwater Probe

-  YSI 071 Deepwater Probe
-  YSI 080 Banjo Surface Probe
-  YSI 081 Surface Probe
-  YSI 082 Small Surface Probe
-  YSI 083 Attachable Surface Probe
-  YSI 084 Spade Lug Probe
-  YSI 085 Flag Lug Probe
-  YSI 090 8-32 Brass Screw Probe
-  YSI 091 10-32 Brass Screw Probe
-  YSI 093 8-32 Stainless Steel Probe
-  YSI 094 10-32 Stainless Steel Probe
-  YSI 096 1/8" Brass Pipe Plug Probe
-  YSI 100 1/8" Tubular Probe with Fitting
-  YSI 101 3/16" Tubular Probe with Fitting
-  YSI 102 1/4" Tubular Probe with Fitting
-  YSI 190 1/8" Stainless Steel Plug Probe

About Configure-to-Order Probes

YSI Configure-to-Order probes offer the flexibility of custom design at the price of standard parts. Match any YSI Precision Interchangeable Thermistor with cable and sheath options to create a custom probe for your temperature measurement application.

The following pages detail the materials we use, time constants and explain how to construct a probe to meet your requirements.

Operating Temperatures

If you plan to use your probe above 100°C, you must select options that can withstand higher temperatures. Probes with glass thermistors, stainless steel sheaths and Teflon cable are rated to 200°C.

Thermistor Components

Choose thermistors from Section 1. You may design probes to use any YSI thermistor.

YSI 44000 Series Thermistors

- Cost-effective
- $\pm 0.2^\circ\text{C}$ or $\pm 0.1^\circ\text{C}$ interchangeability

YSI 44000 Series Thermilinear Components

- Linear outputs

YSI 45000 Series Thermistors

- Stable
- High operating temperature

YSI 46000 Series Thermistors

- Unsurpassed long-term stability
- $\pm 0.2^\circ\text{C}$ to $\pm 0.05^\circ\text{C}$ interchangeability

YSI 55000 GEM Series Thermistors

- Low cost hermetic
- Up to 200°C

Probe Materials

Epoxy—We match epoxies to design requirements.

Stainless Steel—316SS. Tubular probes have rolled ends and uniform wall thickness throughout, hermetic tips and a medical grade polished finish.

Glass—The YSI 036 glass probe is Pyrex. The tip is melted to form a hermetic seal.

Teflon—We use FEP Teflon for the YSI 015.

Aluminum—We use 2024 T4 in the YSI 083 probe.

Brass—Screws and fittings per ASTM B16 and ASTM B453.

Options

Compression Fitting—A compression fitting sized to fit the tubular probe. Available in $1/8$, $1/4$, $1/2$ NPT threads. Specify by thread size.

FEP—Sealed end Teflon tubing over the stainless steel sheath to protect from caustic materials. FEP is compatible with compression fitting option.

Terminations



Stripped and Tinned Leads (ST)



#6 Spade Lugs (SP)

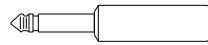

$1/4$ " Phone Plug (PH)

Termination Table

For probe styles using multiple thermistors

Thermistors	No. of Conductors		
	2	3	4
T1	Blk	Blk	Blk
T2	—	Wht	Wht
T3	—	—	Grn
Com	Wht/Red	Red	Red

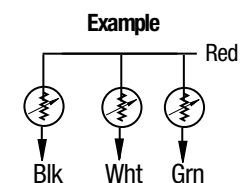

Phone Plug Termination

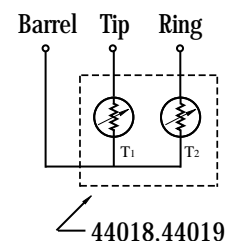
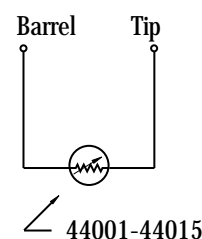

Cable & Lead Styles

Type	Description	Temperature Range	Color Available	Gauge	Conductor/Shield	Typical Outer Diameter			
						1-wire	2-wire	3-wire	4-wire
RP	Round PVC	-40 to +105°C		24 AWG	stranded/-	-		0.147"	0.170"
RPS	Round PVC	-55 to +105°C		24 AWG	stranded/foil	-	0.150"	0.160"	0.180"
RPM	Round PVC	-55 to +105°C		28 AWG	stranded/-	-	0.100"	0.115"	0.135"
RT	Round TFE Teflon	-65 to +200°C		26 AWG	stranded/-	-	0.105"	0.125"	0.125"
RTS	Round TFE Teflon	-65 to +200°C		26 AWG	stranded/braid	-	0.120"	0.126"	0.136"
RN	Round SJO Neoprene	+60°C max		18 AWG	stranded/-	-	0.300"	0.330"	0.355"
RNS	Round SJO Neoprene	+60°C max		18 AWG	stranded/braid	-	0.295"	0.340"	0.340"
FPE	Flat PE	-60 to +105°C		28 AWG	stranded/-		.035" x .082"	.035" x .082"	-
FP	Flat PVC	-40 to +105°C		24 AWG	stranded/-	-	.058" x .115"	.044" x .150"	
FT	Flat TFE Teflon	-65 to +200°C		30 AWG	stranded/-	-	.032" x .80"	.032" x .125"	
IA	Individual Tefzel®	-65 to +150°C		28AWG	stranded/-	0.028"	-	.-	-
IP	Individual PVC	-55 to +105°C	C	28 AWG	stranded/-	0.034"	-	-	-
IPL	Individual PVC	-40 to +80°C	C	22 AWG	stranded/-	0.057"	-	-	-
IPM	Individual PVC	-55 to +105°C		32 AWG	stranded/-	0.028"	-	-	-
IT	Individual TFE Teflon	-60 to +200°C	C	28 AWG	stranded/-	0.027"	-	-	-
ITL	Individual TFE Teflon	-60 to +200°C	C	24 AWG	stranded/-	0.036"	-	-	-
ITM	Individual TFE Teflon	-60 to +200°C		32 AWG	stranded/-	0.021"	-	-	-
IV	Individual varnish-insulated	-40 to +180°C		32 AWG	solid/-	0.008"	-	-	-
IC	Individual tinned copper	NA		32 AWG	solid/-	0.008"	-	-	-
ID	Individual Dumet	NA		32 AWG	solid/-	0.008"	-	-	-

Note: Lead length tolerance is -0 to +10%

For more information,
 contact us at 800 747-5367 or
 937 427-1231 • Fax 937 427-1640
 Info@YSL.com • www.YSL.com

How to Order Configure-to-Order Probes

You can easily configure your own probe from our many thermistor, sheath and cable options. We've created an example below of how to do it yourself.

1. Choose the probe style that matches your application. Turn to the page in this section that lists the options for that style. For our example, we've chosen the YSI 032.
2. Select the thermistor that best suits your need from the choices on the probe page.
3. Select the probe (sheath) length (L_1) in inches.
4. Select a cable or lead type to match your requirements.

5. If you're using individual leads, and color coding is important, enter those colors here. Non-Thermilinear parts are supplied with black individual leads.

6. Select the length of cable (L_2) in inches.

7. Indicate cable termination: ST, PH, SP.

8. Choose an option if required; the options are FEP (Teflon sheath) and/or Compression Fitting (Specify thread).

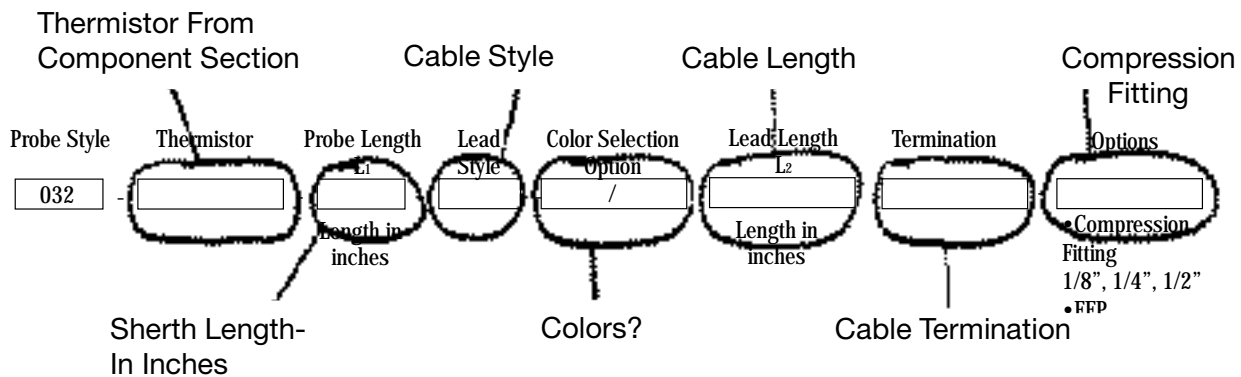
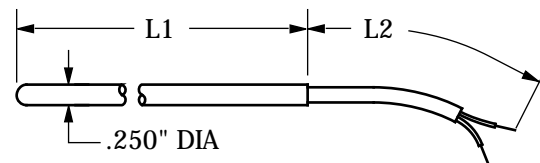

We Build OEM Probes

If you don't find a Configure-to-Order probe that suits your application, we can design probes specifically for your application.

For more information,
contact us at 800 747-5367 or
937 427-1231 • Fax 937 427-1640
Info@YSI.com • www.YSI.com

YSI 010 Round Epoxy Tip Probe

The **YSI 010** probe provides a good mix of ruggedness, flexibility and response time. Epoxy encapsulation provides high compression strength and the PVC cable provides abrasion protection.

This design is excellent for pot-in-place applications such as analytical instruments and supplying temperature data of test subjects for compensation. This probe is not designed for long wet immersion; use the YSI 070 and 071 instead.

Typical Time Constant: 5.0 seconds
Temperature Range: -40 to 105°C

YSI 011 Round PVC Tip Probe

The **YSI 011** probe combines ruggedness, flexibility and short response time. The vinyl plastisol encapsulation protects against mechanical shock. The PVC cable construction provides abrasion protection.

Since the thermistor and cable are constructed from the same material, the seal is as good as the cable. This design is excellent for applications such as environmental temperatures and supplying temperature data of test subjects for compensation. This design will tolerate many days of immersion without internal water shunts.

Typical Time Constant: 2.0 seconds
Temperature Range: -40 to 105°C

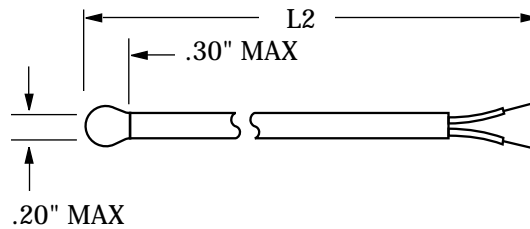

Probe Style	Thermistor	Probe Length L ₁	Lead Style	Lead Length L ₂	Termination
<input type="text"/>	- <input type="text"/>	- <input type="text"/> NA	- <input type="text"/>	- <input type="text"/>	- <input type="text"/>
		Length in inches		Length in inches	

Cable	Code	Color Available	44000 except Thermilinear	45000/46000	55000	44018/44019A	44020	Minimum Length	Maximum Length	Stripped & Tinned (ST)	Phone Plug (PB)	#6 Spade Lugs (SP)
Round PVC	RP	•	•	•	•	•	3"	1200"	•	•	•	•
Round Shielded PVC	RPS	•	•	•	•	•	3"	1200"	•	•	•	•
Round Miniature PVC	RPM	•	•	•	•	•	3"	1200"	•	•	•	•

YSI 012 Epoxy Tip Probe

The **YSI 012** probe is similar to the YSI 010 probe. The YSI 012 offers parallel leads and a faster response time. Its shape allows it to be inserted in areas which are an integral part of the sample environment.

This style permits more accurate measurements of surfaces than the YSI 010 style because the lead may be placed in contact with the surface more effectively. Since the primary thermal transfer path is through the conductor (lead), it's important to have several inches of the lead at the sample temperature.

Use glass thermistors with FPE cable if long-term immersion is planned.

Typical Time Constant: 3.0 seconds

Temperature Range: Thermistor and cable dependent

YSI 013 Acrylic Coated Tip Probe

The **YSI 013** probe is a low-cost probe assembly using an ultraviolet curable acrylic coating material. Low cost is achieved through automation of the thermistor coating process. The acrylic material has good moisture resistance, which allows the probe to be used in high humidity environments and for short-term immersion. The HDPE (high-density polyethylene) cable and acrylic material have been tested for biocompatibility and are resistant to gamma radiation sterilization. This is appropriate for medical applications where a moderate temperature range and biocompatibility are required.

Typical Time Constant: 3.0 seconds

Temperature Range: -60 to 105°C

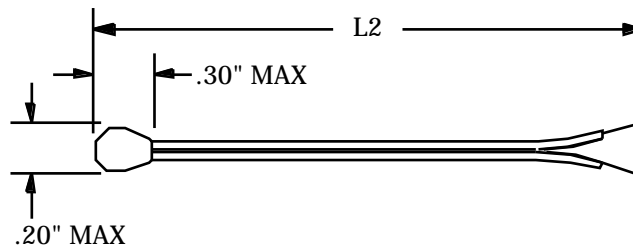

Probe Style	Thermistor	Probe Length L ₁	Lead Style	Lead Length L ₂	Termination
<input type="text"/>	<input type="text"/>	NA	<input type="text"/>	<input type="text"/>	<input type="text"/>
		Length in inches		Length in inches	

	Cable	Lead Style	Thermistor	Lead Length L ₂	Termination							
	Code	Color Available	440000 except Thermilinear	45000/46000	55000	44018/44019A	44020	Minimum Length	Maximum Length	Stripped & Tinned (ST)	Phone Plug (PH)	#6 Spade Lugs (SP)
YSI 012	Flat PVC	FP	•	•	•	•	1"	120"	•	•	•	•
	Flat TFE Teflon	FT	•	•	•	•	1"	120"	•	•	•	•
	Flat FPE	FPE	•	•	•	•	1"	60"	•	•	•	•
YSI 013	Flat FPE	FPE	•	•	•	•	1"	36"	•	•	•	•

YSI 015 Thermistor in Teflon Probe

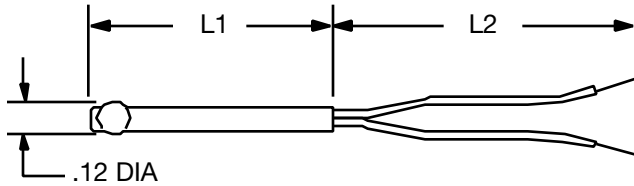

The **YSI 015** probe's design allows it to resist attack from almost all chemicals in the industrial environment. The exceptions are hydrofluoric acid, alkaline metals and a few other compounds. While Teflon is highly water-vapor-permeable, it's extremely resistant to attack by ionized compounds. The specific heat of Teflon is quite high, making the YSI 015 a poor choice for gas temperature measurement.

A frequent application of the YSI 015 probe is temperature measurement and control of plating baths. When mounting the YSI 015 probe in a chemically active environment, prevent splashing into the back of the tube.

Typical Time Constant: 2.5 seconds

Temperature Range: Thermistor and cable dependent

Probe Style - Thermistor - Probe Length L₁ - Lead Style - Color Selection Option - Lead Length L₂ - Termination

- - - - / - -

Length in inches
min = 1"
max = 24"

Length in inches

	Lead Style	Thermistor	Lead Length L ₂	Termination
Individual PVC	IP	44018/44019	Minimum Length	#6 Spade Lugs (SP)
Individual Miniature PVC	IPM	44020	Maximum Length	Phone Plug (PP)
Individual TFE Teflon	IT	44018/44019	Stripped & Tinned (SY)	#6 Spade Lugs (SP)
Individual Miniature TFE Teflon	ITM	44020	Phone Plug (PP)	#6 Spade Lugs (SP)
Individual Varnish-Insulated	IV	44018/44019	Stripped & Tinned (SY)	#6 Spade Lugs (SP)
Individual Tinned Copper	IC	44020	Phone Plug (PP)	#6 Spade Lugs (SP)
Individual Tefzel	IA	44018/44019	Stripped & Tinned (SY)	#6 Spade Lugs (SP)

YSI 016 Radial Leaded Thermistor

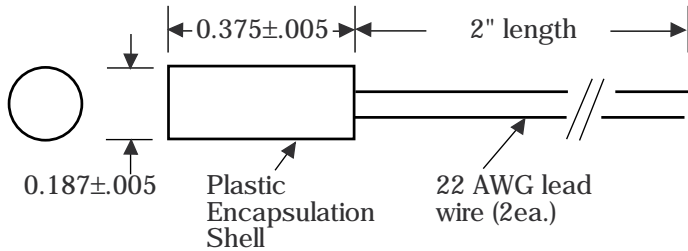

The **YSI 016** Radial Leaded Thermistor has been designed to allow use of automatic lead forming/insertion equipment. This style allows the use of any non-Thermilinear thermistor. The thermistor is potted into a 0.187" diameter, 0.375" long cylindrical potting cup. Leads are 22 AWG silver plated copper, 2" long. This component is an excellent choice for on-board temperature compensation, or other PC board application.

Typical Time Constant: 3.0 seconds
Temperature Range: -40 to 120°C

Probe Style	Thermistor	Probe Length L ₁	Lead Style	Color Selection Option	Lead Length L ₂	Termination
		NA	IC	/	2	ST
		Length in inches			Length in inches	

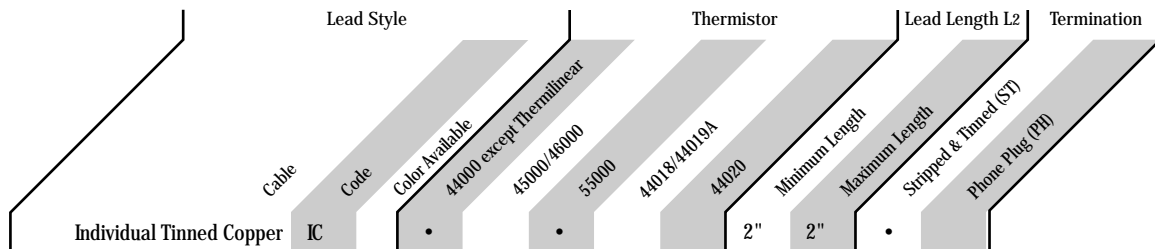

For more information,
contact us at 800 747-5367 or
937 427-1231 • Fax 937 427-1640
Info@YSI.com • www.YSI.com

YSI 030

1/8" OD

Tubular Probe

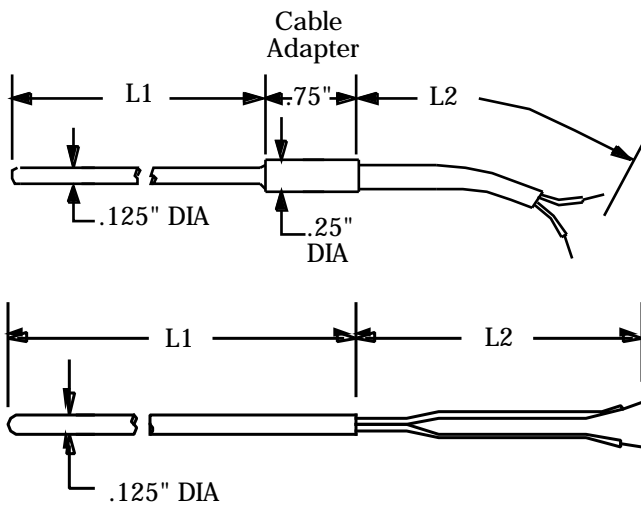

The **YSI 030** tubular probe is a 1/8" diameter 316 stainless steel assembly. Its primary application is measurement and control sensing in wet environments. Internal construction reduces stem effect errors by increasing the thermal path at the thermistor. Immersion depths will significantly affect measurement accuracy. To establish the appropriate immersion depth, follow the instructions in the [Technical Information Section](#). The optional compression fitting simplifies insertion in a process flow.

Typical Time Constant: 3.0 seconds

Temperature Range: Thermistor and cable dependent

Probe Style	Thermistor	Probe Length L1	Lead Style	Color Selection Option	Lead Length L2	Termination	Options
<input type="text"/>	- <input type="text"/>	- <input type="text"/>	- <input type="text"/>	- <input type="text"/> / <input type="text"/>	- <input type="text"/>	- <input type="text"/>	- <input type="text"/>
		Length in inches min = 1/2" max = 18"			Length in inches		<ul style="list-style-type: none"> • Compression Fitting 1/8", 1/4", 1/2" • FEP

Cable	Code	Lead Style				Thermistor	Lead Length L2		Termination
		.75" Long Adapter	Color Available	44000 except Thermilinear	55000		Minimum Length	Maximum Length	
Round PVC	RP	•	•	•	•	3"	1200"	•	•
Round Shielded PVC	RPS	•	•	•	•	3"	1200"	•	•
Round Miniature PVC	RPM	•	•	•	•	3"	1200"	•	•
Round TFE Teflon	RT	•	•	•	•	3"	1200"	•	•
Round Shielded TFE Teflon	RTS	•	•	•	•	3"	1200"	•	•
Individual PVC	IP	•	•	•	•	1"	48"	•	•
Individual Large PVC	IPL	•	•	•	•	1"	48"	•	•
Individual Miniature PVC	IPM	•	•	•	•	1"	48"	•	•
Individual TFE Teflon	IT	•	•	•	•	1"	48"	•	•
Individual Large TFE Teflon	ITL	•	•	•	•	1"	48"	•	•
Individual Miniature TFE Teflon	ITM	•	•	•	•	1"	48"	•	•
Individual Tefzel	IA	•	•	•	•	1"	48"	•	•

Lead Colors Available

Black: Blk	Green: Grn
Brown: Brn	Blue: Blu
Red: Red	Violet: Vio
Orange: Org	Gray: Gry
Yellow: Yel	White: Wht

YSI 031

3/16" OD Tubular Probe

YSI 032

1/4" OD Tubular Probe

The **YSI 031** and **YSI 032** tubular probes are 3/16" or 1/4" diameter 316 stainless steel assemblies. Their primary application is measurement and control sensing in wet environments. Internal construction reduces stem effect errors by increasing the thermal path at the thermistor. Immersion depths will significantly affect measurement accuracy. To establish the appropriate immersion depth, follow the instructions in the Technical Information Section. The optional compression fitting simplifies insertion in a process flow.

YSI 031 Typical Time Constant: 3.8 seconds
Temperature Range: Thermistor and cable dependent

YSI 032 Typical Time Constant: 4.5 seconds
Temperature Range: Thermistor and cable dependent

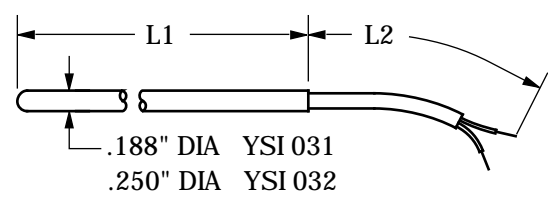

Probe Style - Thermistor - Probe Length L1 - Lead Style - Color Selection Option - Lead Length L2 - Termination - Options

Length in inches
min = 1/2"
max = 18"

Length in inches

- Compression Fitting 1/8", 1/4", 1/2"
- FEP

Cable	Lead Style Code	Color Available	44000 except Thermilinear	45000/46000	55000	44018/44019A	44020	Thermistor	Lead Length L2	Termination
Round PVC	RP	•	•	•	•	•	•	3"	1200"	•
Round Miniature PVC	RPM	•	•	•	•	•	•	3"	1200"	•
Round TFE Teflon	RT	•	•	•	•	•	•	3"	1200"	•
Round Shielded TFE Teflon	RTS	•	•	•	•	•	•	3"	1200"	•
Individual PVC	IP	•	•	•	•	•	•	1"	48"	•
Individual Large PVC	IPL	•	•	•	•	(032 only)	•	1"	48"	•
Individual Miniature PVC	IPM	•	•	•	•	•	•	1"	48"	•
Individual TFE Teflon	IT	•	•	•	•	•	•	1"	48"	•
Individual Large TFE Teflon	ITL	•	•	•	•	•	•	1"	48"	•
Individual Miniature TFE Teflon	ITM	•	•	•	•	•	•	1"	48"	•
Individual Tefzel	IA	•	•	•	•	•	•	1"	48"	•

Lead Colors Available
 Black: Blk Green: Grn
 Brown: Brn Blue: Blu
 Red: Red Violet: Vio
 Orange: Org Gray: Gry
 Yellow: Yel White: Wht

YSI 033

1/8" OD Hermetic Tubular Probe

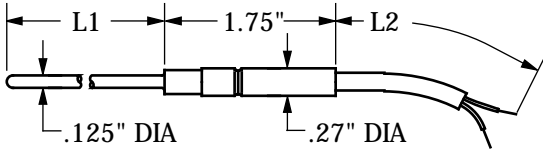

For more information,
 contact us at 800 747-5367 or
 937 427-1231 • Fax 937 427-1640
 Info@YSI.com • www.YSI.com

The **YSI 033** probe has the same properties as the YSI 030 with the notable exception of being hermetically sealed. The hermetic seal prevents condensation of water at the sensor or leads and eliminates electrical shunt error.

The transfer rate of water vapor is a function of the differential vapor pressure. At 0°C and 100% RH the condensing vapor pressure is 4.58 mm Hg and at 20°C and 50% RH the vapor pressure is 8.77 mm Hg. The differential pressure is 4.19 mm Hg. This is approximately 0.8 PSIG, which is significant over time. Multiple cycle and life studies (ask for document TD001) demonstrate the value of this probe style for stability in long-term cooling fluid systems. Compression fitting adaptability enhances the YSI 033 probe's versatility.

Typical Time Constant: 3.0 seconds

Temperature Range: Thermistor and cable dependent

Probe Style	Thermistor	Probe Length L1	Lead Style	Color Selection Option	Lead Length L2	Termination	Options
32				/			
		Length in inches min = 1" max = 18"			Length in inches		<ul style="list-style-type: none"> • Compression Fitting 1/8", 1/4", 1/2" • FEP

Cable	Lead Style Code	Color Available	44000 except Thermilinear	55000	44018/44019A	44020	Thermistor	Lead Length L2	Termination
Round PVC	RP	•	•	•	•	•	3"	1200"	•
Round Shielded PVC	RPS	•	•	•	•	•	3"	1200"	•
Round Miniature PVC	RPM	•	•	•	•	•	3"	1200"	•
Round TFE Teflon	RT	•	•	•	•	•	3"	1200"	•
Round Shielded TFE Teflon	RTS	•	•	•	•	•	3"	1200"	•
Individual PVC	IP	•	•	•	•	•	1"	48"	•
Individual Large PVC	IPL	•	•	•	•	•	1"	48"	•
Individual Miniature PVC	IPM	•	•	•	•	•	1"	48"	•
Individual TFE Teflon	IT	•	•	•	•	•	1"	48"	•
Individual Large TFE Teflon	ITL	•	•	•	•	•	1"	48"	•
Individual Miniature TFE Teflon	ITM	•	•	•	•	•	1"	48"	•
Individual Tefzel	IA	•	•	•	•	•	1"	48"	•

Lead Colors Available	
Black: Blk	Green: Grn
Brown: Brn	Blue: Blu
Red: Red	Violet: Vio
Orange: Org	Gray: Gry
Yellow: Yel	White: Wht

YSI 034

3/16" OD Hermetic Tubular Probe

YSI 035

1/4" OD Hermetic Tubular Probe

The **YSI 034** and **YSI 035** are hermetically sealed, which prevents condensation at the sensor or leads and eliminates electrical shunt error. The transfer rate of water vapor is a function of the differential vapor pressure. At 0°C and 100% RH the condensing vapor pressure is 4.58 mm Hg and at 20°C and 50% RH the pressure is 8.77 mm Hg. The differential pressure is 4.19 mm Hg. This is approximately 0.8 PSIG, which is significant over time. Multiple cycle and life studies (ask for document TD001) demonstrate the value of this probe for stability in long-term cooling fluid applications. Compression fitting adaptability enhances the YSI 034 probe's versatility.

YSI 034 Typical Time Constant: 3.8 seconds
Temperature Range: Thermistor and cable dependent

YSI 035 Typical Time Constant: 4.5 seconds
Temperature Range: Thermistor and cable dependent

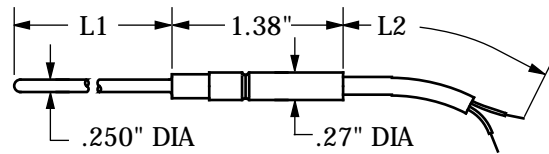
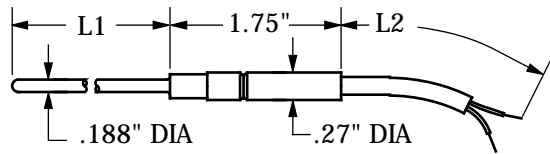

Probe Style	Thermistor	Probe Length L1	Lead Style	Color Selection Option	Lead Length L2	Termination	Options
<input type="text"/>	- <input type="text"/>	- <input type="text"/>	- <input type="text"/>	- <input type="text"/> / <input type="text"/>	- <input type="text"/>	- <input type="text"/>	- <input type="text"/>
		Length in inches min = 1" max = 24"			Length in inches		<ul style="list-style-type: none"> • Compression Fitting 1/8", 1/4", 1/2" • FEP

Lead Style	Thermistor	Lead Length L2	Termination
Cable			
Code			
Color Available			
44000 except Thermlinear			
45000/46000			
55000			
44018/44019A			
44020			
Minimum Length			
Maximum Length			
Stripped & Tinned (ST)			
Phone Plug (PH)			
#6 Spade Lugs (SP)			
Round PVC	RP	3"	1200"
Round Shielded PVC	RPS	3"	1200"
Round Miniature PVC	RPM	3"	1200"
Round TFE Teflon	RT	3"	1200"
Round Shielded TFE Teflon	RTS	3"	1200"
Individual PVC	IP	1"	48"
Individual Large PVC	IPL	1"	48"
Individual Miniature PVC	IPM	1"	48"
Individual TFE Teflon	IT	1"	48"
Individual Large TFE Teflon	ITL	1"	48"
Individual Miniature TFE Teflon	ITM	1"	48"
Individual Tefzel	IA	1"	48"

Lead Colors Available
 Black: Blk Green: Grn
 Brown: Brn Blue: Blu
 Red: Red Violet: Vio
 Orange: Org Gray: Gry
 Yellow: Yel White: Wht

YSI 036 Pyrex Probe

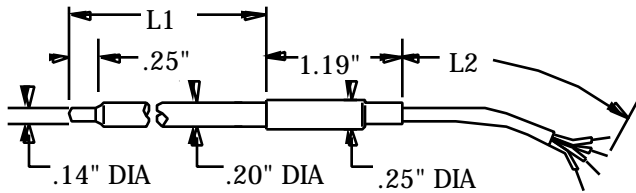

The **YSI 036** is a Pyrex-sheathed probe designed primarily for applications in wet chemistry. This glass probe is frequently used for measurement and control of temperatures in glass reactor systems. Pyrex is limited by its solubility and reaction in hydrofluoric acid and strong bases. In EPA-type applications, sample-to-sample carryover must be prevented.

The immersion depth of the tip may have a major effect on accuracy and repeatability. Refer to the Technical Information Section for guidelines to minimize stem effect error.

Pyrex is fragile. Use of compression fittings is feasible but they require Teflon ferrules (not available from YSI). We recommend stainless steel tubular probes (YSI 030-035), where practical.

Typical Time Constant: 4.2 seconds

Temperature Range: Thermistor and cable dependent

Probe Style - Thermistor - Probe Length L₁ - Lead Style - Color Selection Option - Lead Length L₂ - Termination

Length in inches
min = 1"
max = 18"

Length in inches

Cable	Lead Style Code	Color Available	44000 except Thermilinear	45000/46000	55000	44018/44019A	44020	Thermistor	Minimum Length	Maximum Length	Lead Length L ₂	Termination
Round PVC	RP	•	•	•	•	•	•	3"	1200"	•	•	•
Round Shielded PVC	RPS	•	•	•	•	•	•	3"	1200"	•	•	•
Round Miniature PVC	RPM	•	•	•	•	•	•	3"	1200"	•	•	•
Round TFE Teflon	RT	•	•	•	•	•	•	3"	1200"	•	•	•
Round Shielded TFE Teflon	RTS	•	•	•	•	•	•	3"	1200"	•	•	•
Individual PVC	IP	•	•	•	•	•	•	1"	48"	•	•	•
Individual Large PVC	IPL	•	•	•	•	•	•	1"	48"	•	•	•
Individual Miniature PVC	IPM	•	•	•	•	•	•	1"	48"	•	•	•
Individual TFE Teflon	IT	•	•	•	•	•	•	1"	48"	•	•	•
Individual Large TFE Teflon	ITL	•	•	•	•	•	•	1"	48"	•	•	•
Individual Miniature TFE Teflon	ITM	•	•	•	•	•	•	1"	48"	•	•	•
Individual Tefzel	IA	•	•	•	•	•	•	1"	48"	•	•	•

Lead Colors Available

Black: Blk	Green: Grn
Brown: Brn	Blue: Blu
Red: Red	Violet: Vio
Orange: Org	Gray: Gry
Yellow: Yel	White: Wht

YSI 038

1/4" OD Pointed Tubular Probe with Handle

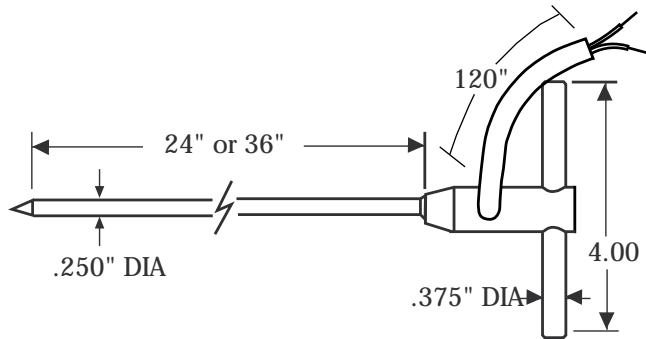

The **YSI 038** style probe is specially designed for measurement of internal temperature of various materials. The pointed tip and T handle aid in insertion. The detachable cable offers easy replacement in high wear situations. Although the cable attachment point is not waterproof, the probe is widely used in streambed temperature measurement and other environmental applications. Measurement of meat temperature is another common use.

Typical Time Constant: 4.5 seconds
Temperature Range: 105°C at cable exit

Probe Style	Thermistor	Probe Length L ₁	Lead Style	Color Selection Option	Lead Length L ₂	Termination
<input type="text"/>	<input type="text"/>	24 or 36 Length in inches	<input type="text"/>	<input type="text"/> / <input type="text"/>	120 Length in inches	<input type="text"/>

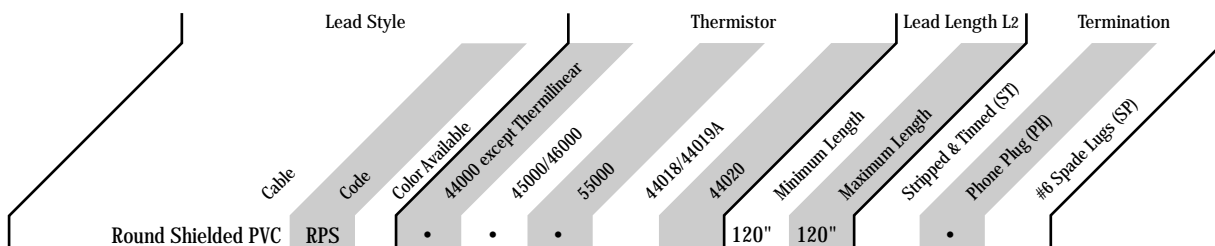

For more information,
 contact us at 800 747-5367 or
 937 427-1231 • Fax 937 427-1640
 Info@YSI.com • www.YSI.com

YSI 051 Air Probe for Compression Fitting

The **YSI 051** probe is designed to measure temperature in dry gas pipes and lines. The YSI 051 has the fastest response time of any standard probe that will pass through a compression fitting.

While the thermistor is sealed with an insulating epoxy, the seal is not useful in aqueous solutions and should not be immersed. For exposure to wet or abrasive environments, use either the YSI 030 or the YSI 052.

While the sensor is shielded from radiant energy, the cage may reradiate energy to the thermistor if exposed to direct sunlight and bias the measurement.

Typical Time Constant: 2.0 seconds

Temperature Range: Thermistor and cable dependent

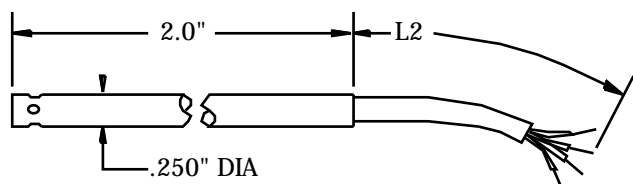

YSI 052 Waterproof Airway Probe

The **YSI 052** probe is a completely enclosed gas temperature probe. Its primary benefit is pressure-resistant construction with fast response time. Applications include measurement in wet, abrasive or pressurized gas streams. The YSI 052 is also used to measure air temperature in fluidized baths. It has been used to measure wet air float transport of powdered coal, plastic and freeze dried foods. Stem effect may reduce accuracy and repeatability; see the Technical Information Section for guidelines on minimizing stem effect error.

Typical Time Constant: 3.0 seconds

Temperature Range: Thermistor and cable dependent

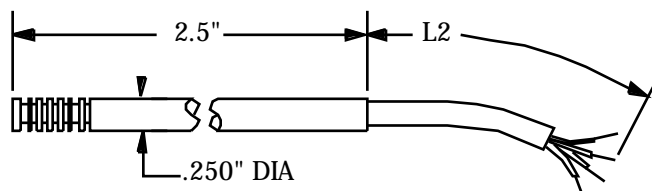

Probe Style - Thermistor - Probe Length L₁ - Lead Style - Color Selection Option - Lead Length L₂ - Termination - Options

- - - - - - -

Length in inches

Length in inches

- Compression Fitting 1/8", 1/4", 1/2"

Cable	Lead Style Code	Color Available	Thermistor	Lead Length L ₂	Termination			
		44000 except Thermilinear	45000/46000	44018/44019A	Minimum Length			
					Maximum Length			
					Stripped & Tinned (ST)			
					Phone Plug (PB)			
					#6 Spade Lugs (SP)			
Round PVC	RP	•	•	3"	1200"	•	•	•
Round Shielded PVC	RPS	•	•	3"	1200"	•	•	•
Round Miniature PVC	RPM	•	•	3"	1200"	•	•	•
Round TFE Teflon	RT	•	•	3"	1200"	•	•	•
Round Shielded TFE Teflon	RTS	•	•	3"	1200"	•	•	•
Individual PVC	IP	•	•	1"	48"	•	•	•
Individual Large PVC	IPL	•	•	1"	48"	•	•	•
Individual Miniature PVC	IPM	•	•	1"	48"	•	•	•
Individual TFE Teflon	IT	•	•	1"	48"	•	•	•
Individual Large TFE Teflon	ITL	•	•	1"	48"	•	•	•
Individual Miniature TFE Teflon	ITM	•	•	1"	48"	•	•	•
Individual Tefzel	IA	•	•	1"	48"	•	•	•

Lead Colors Available

Black: Blk	Green: Grn
Brown: Brn	Blue: Blu
Red: Red	Violet: Vio
Orange: Org	Gray: Gry
Yellow: Yel	White: Wht

YSI 070 Underwater Probe

The **YSI 070** probe is designed for long-term burial in soil, concrete or other high-wetness environments. This provides a high-integrity seal as well as mechanical protection to the thermistor itself.

For best long-term performance we recommend glass-encapsulated thermistors ([YSI 45000](#), [46000](#), [55000](#)).

While not designed for deepwater immersion, the YSI 070 is frequently used to measure the temperature of bogs, wetlands and wells. It can withstand the pounding punishment of burial in interstate roadways and airport runways.

It's potted in urethane in a polyvinyl cap.

Typical Time Constant: 15.0 seconds

Temperature Range: 60°C max

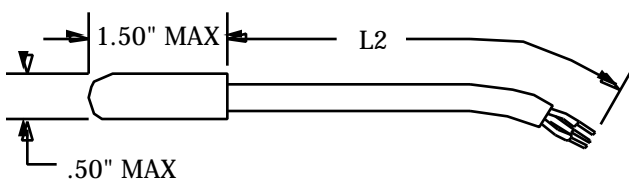

YSI 071 Deepwater Probe

The **YSI 071** probe is designed for long-term immersion at considerable depth. It has a stainless/neoprene vulcanized seal with a molded external splice protector. This assembly method provides a high-integrity seal as well as mechanical protection to the leads and the thermistor.

For best long-term performance we recommend glass-encapsulated thermistors ([YSI 45000](#), [46000](#), [55000](#)).

It's designed for deepwater immersion and is frequently used to measure the temperature of deepwater reservoirs, wetlands and wells. Multiple-year immersion at 2,000 feet is feasible. Several such installations are in place for thermal gradient power generation tests. The YSI 071 can withstand the forces of pier mounting in high-wave environments.

Typical Time Constant: 5.0 seconds

Temperature Range: 60°C max

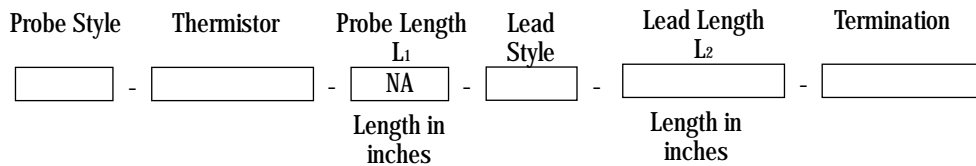
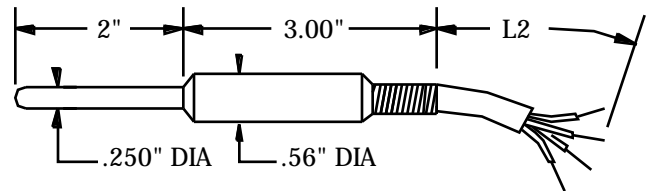

Cable	Code	Color Available	44000 except Thermilinear	45000/46000	55000	44018/44019A	44020	Minimum Length	Maximum Length	Stripped & Tinned (ST)	Phone Plug (PH)	#6 Spade Lugs (SP)
Round SJO Neoprene	RN	•	•	•	•	•	•	3"	2000"	•	•	•
Round Shielded SJO Neoprene	RNS	•	•	•	•	•	•	3"	2000"	•	•	•

YSI 083 Attachable Surface Probe

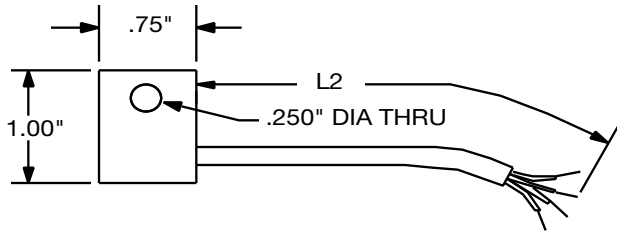

The **YSI 083** surface-temperature probe is designed for bolt-in-place applications. This is our most rugged surface temperature probe. With the use of a thermal transfer compound, the YSI 083 will collect accurate temperature data because it's in intimate contact with the body to be measured.

The YSI 083 is frequently used to measure, monitor and control temperatures of small motors, heat exchangers and fluid pumping systems.

All flat surface sensors require good surface contact while protecting the noncontact surface from high levels of radiant energy. This can be accomplished by placing a reflective surface between the sensor and the source.

Typical Time Constant: 8.0 seconds

Temperature Range: Thermistor and cable dependent

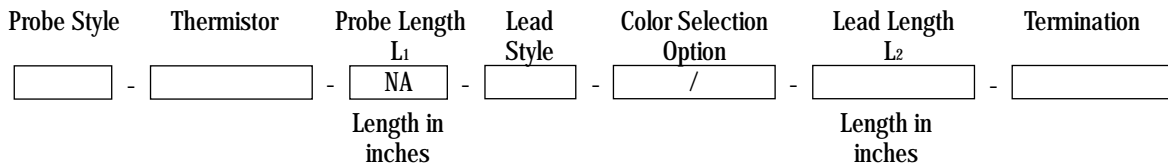

Cable	Lead Style Code	Color Available	44000 except Thermilinear	45000/46000	55000	44018/44019A	44020	Thermistor	Minimum Length	Maximum Length	Stripped & Tinned (ST)	Phone Plug (PP)	Termination
Round PVC	RP	•	•	•	•	•	•	3"	1200"	•	•	•	•
Round Miniature PVC	RPM	•	•	•	•	•	•	3"	1200"	•	•	•	•
Round TFE Teflon	RT	•	•	•	•	•	•	3"	1200"	•	•	•	•
Round Shielded TFE Teflon	RTS	•	•	•	•	•	•	3"	1200"	•	•	•	•
Individual PVC	IP	•	•	•	•	•	•	1"	48"	•	•	•	•
Individual Large PVC	IPL	•	•	•	•	•	•	1"	48"	•	•	•	•
Individual Miniature PVC	IPM	•	•	•	•	•	•	1"	48"	•	•	•	•
Individual TFE Teflon	IT	•	•	•	•	•	•	1"	48"	•	•	•	•
Individual Large TFE Teflon	ITL	•	•	•	•	•	•	1"	48"	•	•	•	•
Individual Miniature TFE Teflon	ITM	•	•	•	•	•	•	1"	48"	•	•	•	•
Individual Tefzel	IA	•	•	•	•	•	•	1"	48"	•	•	•	•

Lead Colors Available

Black: Blk Green: Grn
 Brown: Brn Blue: Blu
 Red: Red Violet: Vio
 Orange: Org Gray: Gry
 Yellow: Yel White: Wht

For more information,
 contact us at 800 747-5367 or
 937 427-1231 • Fax 937 427-1640
 Info@YSI.com • www.YSI.com

YSI 085 Flag Lug Probe

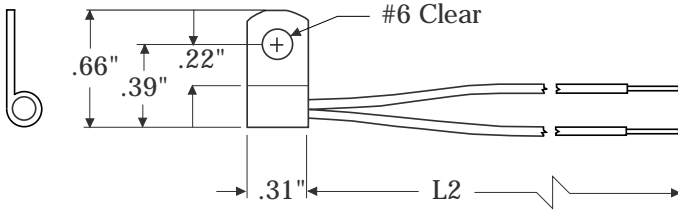

The **YSI 085** is an attachable surface temperature probe in a flag lug configuration. The flag is made of tin-plated copper and the mounting hole is a #6.

This probe can be used in a variety of surface temperature applications. All flat surface sensors require good surface contact while protecting the noncontact surface from high levels of radiant energy. This can be accomplished by placing a reflective surface between the sensor and the source.

Typical Time Constant: 3.1 seconds

Temperature Range: Thermistor and cable dependent

Probe Style	Thermistor	Probe Length L1	Lead Style	Color Selection Option	Lead Length L2	Termination
<input type="text"/>	<input type="text"/>	<input type="text" value="NA"/>	<input type="text"/>	<input style="width: 50px;" type="text" value=" / "/>	<input type="text"/>	<input type="text"/>
		Length in inches			Length in inches	

Cable	Code	Lead Style			Thermistor		Lead Length L2		Termination			
		Color Available	44000 except Thermilinear	45000/46000	53000	44018/44019A	44020	Minimum Length	Maximum Length	Stripped & Tinned (ST)	Phone Plug (PH)	#6 Spade Lugs (SP)
Round PVC	RP	•	•	•	•	•	3"	120"	•	•	•	•
Round Shielded PVC	RPS	•	•	•	•	•	3"	120"	•	•	•	•
Round Miniature PVC	RPM	•	•	•	•	•	3"	120"	•	•	•	•
Round TFE Teflon	RT	•	•	•	•	•	3"	120"	•	•	•	•
Round Shielded TFE Teflon	RTS	•	•	•	•	•	3"	120"	•	•	•	•
Flat PVC	FP	•	•	•	•	•	1"	120"	•	•	•	•
Flat TFE Teflon	FT	•	•	•	•	•	1"	120"	•	•	•	•
Individual PVC	IP	•	•	•	•	•	1"	48"	•	•	•	•
Individual Large PVC	IPL	•	•	•	•	•	1"	48"	•	•	•	•
Individual Miniature PVC	IPM	•	•	•	•	•	1"	48"	•	•	•	•
Individual TFE Teflon	IT	•	•	•	•	•	1"	48"	•	•	•	•
Individual Large TFE Teflon	ITL	•	•	•	•	•	1"	48"	•	•	•	•
Individual Miniature TFE Teflon	ITM	•	•	•	•	•	1"	48"	•	•	•	•
Individual Tefzel	IA	•	•	•	•	•	1"	48"	•	•	•	•

For more information,
contact us at 800 747-5367 or
937 427-1231 • Fax 937 427-1640
Info@YSI.com • www.YSI.com

YSI 090 8-32 Brass Screw Probe

The **YSI 090** probe is a thermistor mounted in a 8-32 brass hex head bolt. The design is especially useful for measuring relatively thick samples that are under vibration. The lead should not be excessively flexed in high-vibration environments. Brass provides an excellent thermal pathway and is much less susceptible than stainless steel to spurious heat source errors.

Typical Time Constant: 2.0 seconds
Temperature Range: Thermistor and cable dependent

YSI 093 8-32 Stainless Steel Probe

The **YSI 093** probe is a thermistor mounted in a 8-32 stainless steel hex head bolt. The design is especially useful for measuring relatively thick samples which are under vibration. The lead should not be excessively flexed in high vibration environments. Stainless steel provides a poorer thermal pathway than brass and may be susceptible to spurious heat source errors.

Typical Time Constant: 2.5 seconds
Temperature Range: Thermistor and cable dependent

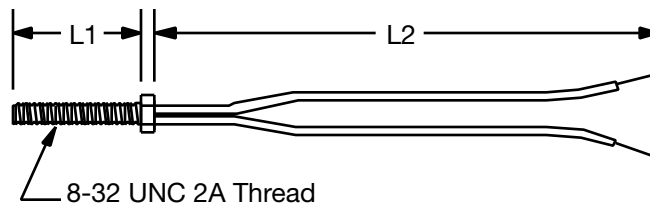

Probe Style	Thermistor	Probe Length L ₁	Lead Style	Color Selection Option	Lead Length L ₂	Termination
<input type="text"/>	- <input type="text"/>	- <input type="text"/>	- <input type="text"/>	- <input type="text"/> / <input type="text"/>	- <input type="text"/>	- <input type="text"/>
		1/8" or 1/4"			Length in inches	

	Cable	Lead Style Code	Thermistor Color Available	Thermistor 44000 except Thermilinear	Thermistor 55000, 1/4" only	Thermistor 44018	Lead Length L ₂ Minimum Length	Lead Length L ₂ Maximum Length	Termination Stripped & Tinned (ST)	Termination Phone Plug (PH)	Termination #8 Spade Lugs (SP)
Flat TFE Teflon	FT	•	•	•	•	•	1"	120"	•	•	•
Individual PVC	IP	•	•	•	•	•	1"	1"	•	•	•
Individual Miniature PVC	IPM	•	•	•	•	•	1"	48"	•	•	•
Individual TFE Teflon	IT	•	•	•	•	•	1"	48"	•	•	•
Individual Large TFE Teflon	ITL	•	•	•	•	•	1"	48"	•	•	•
Individual Miniature TFE Teflon	ITM	•	•	•	•	•	1"	48"	•	•	•
Individual Tefzel	IA	•	•	•	•	•	1"	48"	•	•	•

Lead Colors Available

Black: Blk	Green: Grn
Brown: Brn	Blue: Blu
Red: Red	Violet: Vio
Orange: Org	Gray: Gry
Yellow: Yel	White: Wht

For more information,
 contact us at 800 747-5367 or
 937 427-1231 • Fax 937 427-1640
 Info@YSI.com • www.YSI.com

YSI 096

1/8" Brass

Pipe Plug Probe

The **YSI 096** probe is a thermistor mounted in a 1/8" NPT brass pipe plug. The pipe plug design allows easy application in piping systems. The lead should not be excessively flexed in high vibration environments. While brass is an excellent conductor, unless care is taken, the wall temperature rather than the sample temperature will be measured.

Typical Time Constant: 10.0 seconds

Temperature Range: Thermistor and cable dependent

YSI 190

1/8" Stainless Steel

Plug Probe

The **YSI 190** probe is a thermistor mounted in a 1/8" NPT stainless steel pipe plug. The pipe plug design allows easy application in piping systems. The lead should not be excessively flexed in high vibration environments. Since stainless steel is not a good thermal conductor, unless care is taken, the wall temperature rather than the sample temperature will be measured.

Typical Time Constant: 15.0 seconds

Temperature Range: Thermistor and cable dependent

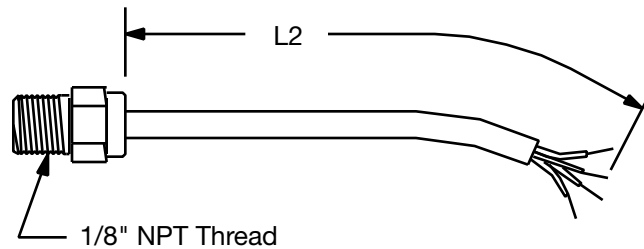

Probe Style	Thermistor	Probe Length L ₁	Lead Style	Color Selection Option	Lead Length L ₂	Termination
<input type="text"/>	<input type="text"/>	NA	<input type="text"/>	<input type="text"/>	<input type="text"/>	<input type="text"/>
		Length in inches			Length in inches	

	Cable	Lead Style	Thermistor	Lead Length L ₂	Termination				
	Code	Color Available	44018/44019A	44020	Minimum Length	Maximum Length	Stripped & Tinned (ST)	Phone Plug (PH)	#6 Spade Jugs (SP)
Round PVC	RP	•	•	•	•	•	•	•	•
Round Shielded PVC	RPS	•	•	•	•	•	•	•	•
Round Miniature PVC	RPM	•	•	•	•	•	•	•	•
Round TFE Teflon	RT	•	•	•	•	•	•	•	•
Round Shielded TFE Teflon	RTS	•	•	•	•	•	•	•	•
Flat PVC	FP	•	•	•	•	•	•	•	•
Flat TFE Teflon	FT	•	•	•	•	•	•	•	•
Individual PVC	IP	•	•	•	•	•	•	•	•
Individual Large PVC	IPL	•	•	•	•	•	•	•	•
Individual Miniature PVC	IPM	•	•	•	•	•	•	•	•
Individual TFE Teflon	IT	•	•	•	•	•	•	•	•
Individual Large TFE Teflon	ITL	•	•	•	•	•	•	•	•
Individual Miniature TFE Teflon	ITM	•	•	•	•	•	•	•	•
Individual Tefzel	IA	•	•	•	•	•	•	•	•

Lead Colors Available

Black: Blk	Green: Grn
Brown: Brn	Blue: Blu
Red: Red	Violet: Vio
Orange: Org	Gray: Gry
Yellow: Yel	White: Wht

YSI 100

1/8" Tubular Probe with Fitting

YSI 101

3/16" Tubular Probe with Fitting

YSI 102

1/4" Tubular Probe with Fitting

The **YSI 100, 101, 102** are stainless steel tubular probes with 1/8" NPT fittings. This design has a high tolerance for pressure and tolerates high flow rates for short periods. The stainless steel construction provides protection from stress corrosion and cavitation etching. Applications include accurate readings in pipelines.

YSI 100 Typical Time Constant: 3.0 seconds
YSI 101 Typical Time Constant: 3.4 seconds
YSI 102 Typical Time Constant: 4.5 seconds
Temperature Range: Thermistor and cable dependant

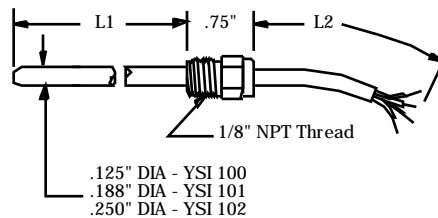

Probe Style	Thermistor	Probe Length L ₁	Lead Style	Color Selection Option	Lead Length L ₂	Termination	Options
<input type="text"/>	- <input type="text"/>	- <input type="text"/>	- <input type="text"/>	- <input type="text"/> / <input type="text"/>	- <input type="text"/>	- <input type="text"/>	- <input type="text"/>
		Length in inches min = 1/2" max = 24"			Length in inches		• FEP

Cable	Code	Color Available	44000 except Thermilinear	55000	44018/44019A	Thermistor	Minimum Length	Maximum Length	Stripped & Tinned (ST)	Phone Plug (PH)	#6 Spade Lugs (SP)	Termination
Round PVC	RP	•	•	•	•	3"	120"	•	•	•	•	•
Round Shielded PVC	RPS	•	•	•	•	3"	120"	•	•	•	•	•
Round Miniature PVC	RPM	•	•	•	•	3"	120"	•	•	•	•	•
Round TFE Teflon	RT	•	•	•	•	3"	120"	•	•	•	•	•
Round Shielded TFE Teflon	RTS	•	•	•	•	3"	120"	•	•	•	•	•
Flat PVC	FP	•	•	•	•	1"	120"	•	•	•	•	•
Flat TFE Teflon	FT	•	•	•	•	1"	120"	•	•	•	•	•
Individual PVC	IP	•	•	•	•	1"	48"	•	•	•	•	•
Individual Large PVC	IPL	•	•	•	•	1"	48"	•	•	•	•	•
Individual Miniature PVC	IPM	•	•	•	•	1"	48"	•	•	•	•	•
Individual TFE Teflon	IT	•	•	•	•	1"	48"	•	•	•	•	•
Individual Large TFE Teflon	ITL	•	•	•	•	1"	48"	•	•	•	•	•
Individual Miniature TFE Teflon	ITM	•	•	•	•	1"	48"	•	•	•	•	•
Individual Tefzel	IA	•	•	•	•	1"	48"	•	•	•	•	•

Lead Colors Available
 Black: Blk Green: Grn
 Brown: Brn Blue: Blu
 Red: Red Violet: Vio
 Orange: Org Gray: Gry
 Yellow: Yel White: Wht

For more information,
 contact us at 800 747-5367 or
 937 427-1231 • Fax 937 427-1640
 Info@YSI.com • www.YSI.com

SECTION 4
YSI Series 400 and
YSI 700 Standard
Reusable Probes

- **General-Purpose and Tubular Probes**
- **Surface Probes** and Autoclavable Probes
- **Gas and Airway Probes**
- **Technical Data**

YSI Standard Reusable Temperature Probes

We offer two series of precision probes for manufacturing, research and medicine.

- Every probe traceable to the NIST
- Substitute any probe in either series for any other in the same series with no loss of accuracy
- YSI reusable probes are the world standard for medical use in humans
- YSI Series 700 Probes provide linear response
- Made without latex to reduce allergic reactions
- Probes are electrically-isolated
- Durable molded phone plugs
- Extension leads available

Applications

- Incubators
- Cuvettes
- Patient monitoring
- Environmental control
- Research labs
- Many industrial uses

General-Purpose Probes

YSI 401 & 701 General-Purpose

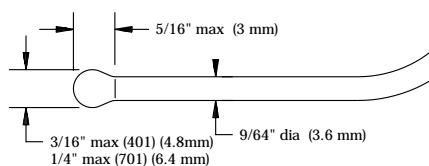

- Rugged vinyl probe
- For air, sub-soil and short-term water
- Time constant 401: 7 sec; 701: 9 sec
- Range 401: -40 to +100°C; 701: -30 to +100°C

For more information,
contact us at **800 747-5367** or
937 427-1231 • Fax **937 427-1640**
Info@YSI.com • www.YSI.com

YSI 402 & 702A Small Vinyl

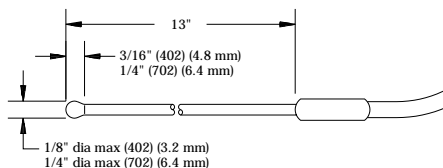

- Smaller, flexible versions of YSI 401 and 701
- For patient monitoring with a quicker response time
- Time constant 402: 3.2 sec; 702A: 3.6 sec
- Range 402: -40 to +100°C; 702A: -30 to +100°C
- Rectal temperatures of small animals

YSI 423 Small Nylon

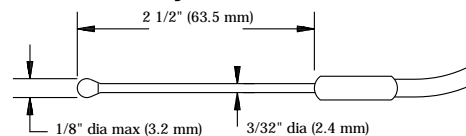

- Epoxy tip, nylon tube
- Fastest response time of general-purpose probes
- For cuvette, research, shallow immersion
- Time constant 1.4 sec
- Range -40 to +100°C

Tubular Probes

YSI 403 & 703 Stainless Steel Tubular

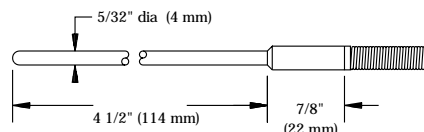

- Sheath compatible with many fluids
- Quick and durable
- Time constant 403: 3.4 sec; 703: 3.6 sec
- Range 403: -40 to +150°C; 703: -30 to +150°C

YSI 451 Teflon Tubular

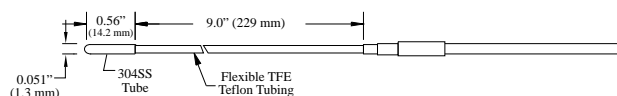

- Can be fed through an 18- gauge thin-wall hypo. needle
- Short-term immersion in small liquid samples
- Time constant 3.1 sec
- Range: ±0.1°C from 0 to +70°C

YSI 404 & 704 Pyrex Tubular

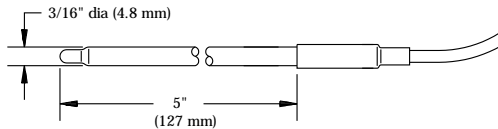

- Chemically inert for immersion
- Thermometric titrations, freezing points
- Time constant 4.2 sec
- Range 404: -40 to +150°C; 704: -30 to +150°C

YSI 406 Small Tubular

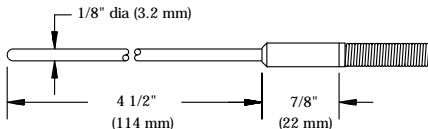

- Similar to YSI 403 but thinner and faster
- Time constant 2.5 sec
- Range -40 to +150°C

YSI 410 & 710 Tubular with NPT Fitting

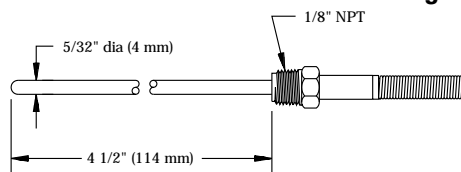

- For use in pipes and vessels
- 316 stainless steel withstands 500 psi
- Time constant 3.4 sec
- Range 410: -40 to +150°C; 710: -40 to +150°C

YSI 416 Autoclavable Tubular

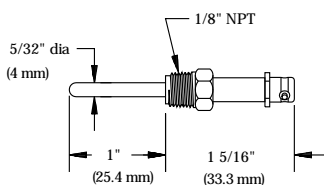

- Stainless steel fitting and sheath; detachable lead
- Not electrically isolated
- Time constant 3.4 sec
- Range -40 to +150°C

YSI 418 Pointed Tubular

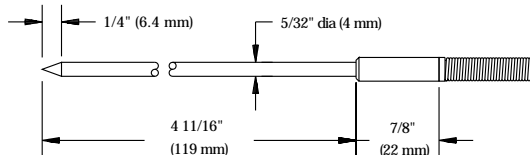

- For semi-solids such as meat, fruit, tobacco, rubber
- 316 stainless steel
- Time constant 3.7 sec: Range -40 to +150°C

YSI 433 Pointed Tubular

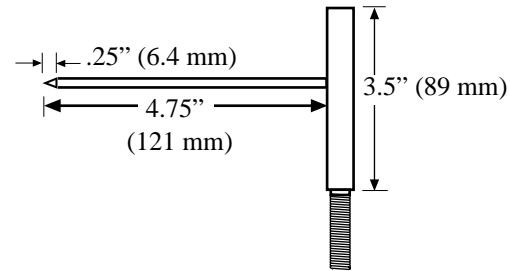

- For semi-solids such as meat and fruit
- 316 stainless steel
- Time constant 3.7 sec
- Range -40 to +150°C

Surface Probes

YSI 408 & 708 Banjo Surface

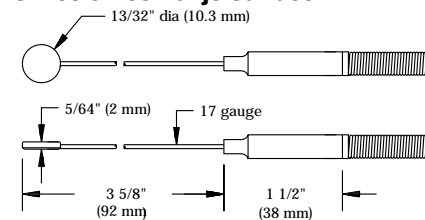

- For industrial, process and medical use
- Handle simplifies use
- Time constant 408: 0.6 sec; 708: 1.0 sec
- Range 408: -40 to +150°C; 708: -30 to +100°C

YSI 409A & 709A High-Temperature

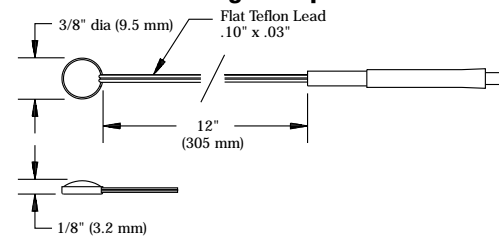

- 12" Teflon leads
- Stainless steel disc with epoxy back protects probe from environment
- Time constant 1.1 sec
- Range 409A: -40 to +150°C; 709A: -30 to +100°C

YSI 409B & 709B Rugged Surface

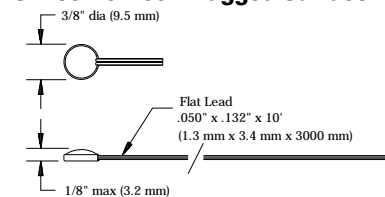

- More rugged than YSI 409A and 709A
- Vinyl-covered leads; time constant 1.1 sec
- Range 409B: -40 to +100°C; 709B: -30 to +100°C

YSI 427 & 729 Small Surface

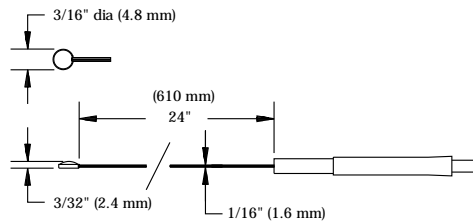

- Similar to YSI 421 but not autoclavable and leads not detachable
- Time constant 0.3 sec
- Range 427: -40 to +150°C; 729: -30 to +100°C

Gas Temperature Probes

YSI 405 Gas

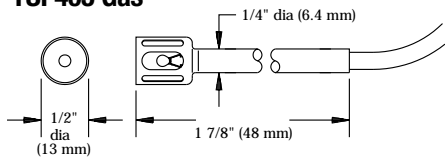

- Thermistor protected by stainless steel cage
- For low humidity such as incubators, test rooms, gas streams
- Time constant 10 sec in 3 ft/sec air at 0% RH
- Range -40 to +150°C

YSI 441A Airway

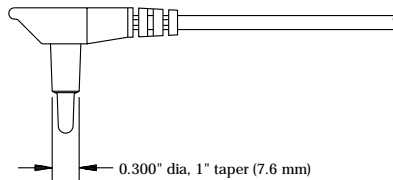

- For anesthesia, respiratory care, in-line measurement
- Time constant 30 sec (worst case in air)
- Range 0 to 50°C

Technical Data

YSI Series 400 Probes

Temperature Range: -40 to +150°C (-40 to +300°F) except as specified. Lead wires may be subjected to 100°C.

Interchangeability: ±0.25°C at -40°C; ±0.10°C from 0 to 70°C; ±0.21°C at 100°C; ±0.40°C at 150°C

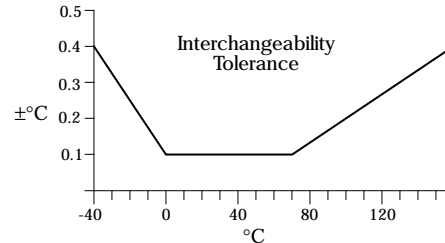

Time Constant: Derived from measurements in water at 3 feet per second. A probe requires approximately 5 time constants to read 99% of a total change.

Leads: Non-detachable 10' vinyl-covered shielded wire, except as noted. Junction between probe and leads should not be immersed. Detachable leads are not water-resistant. Extension leads available:

YSI 4010 10' Extension Lead

YSI 4025 25' Extension Lead

YSI 4050 50' Extension Lead

Termination: Right-angle molded phone plug, except as specified. Gray plugs are 2-conductor.

Electrical Isolation: Sensing elements and lead wires are electrically isolated from the outer probe surfaces, except as noted.

Cleaning: All probes are EtO-sterilizable.

YSI Series 700 Probes

Temperature Range: -30 to +100°C (-22 to +212°F), except as specified. Lead wires may be subjected to 100°C.

Interchangeability: ±0.15°C from -30 to +100°C

Time Constant: Derived from measurements in water at 3 feet per second. A probe requires approximately 5 time constants to read 99% of a total change.

Leads: Non-detachable 10' vinyl-covered shielded wire, except as noted. Junction between probe and leads should not be immersed. Detachable leads are not water-resistant. Extension leads available:

YSI 7010 10' Extension Lead

YSI 7025 25' Extension Lead

YSI 7050 50' Extension Lead

Termination: Right-angle molded phone plug, except as specified. Black plugs are 3-conductor.

Electrical Isolation: Sensing elements and lead wires are electrically isolated from the outer probe surfaces, except as noted.

Cleaning: All probes are EtO-sterilizable.

Resistance or Voltage Outputs: You may combine a YSI Series 700 Probe with two fixed resistors for a linear response to temperature in either a resistance or voltage mode. YSI offers 4 standard networks for the range -30 to +100°C. Special networks are also available. For more information, call YSI Customer Service.

YSI Series 400AC Probes

Temperature Range: -40 to +130°C (-40 to +266°F), except as specified. Lead wires may be subjected to 100°C.

Interchangeability: ±0.2°C from -40 to +70; ± 0.1°C from 0 to 50°C.

Sterilization: Steam autoclave (20 minutes at 121-123°C). See probe instructions for additional cleaning and sterilizing information.

Leads: Non-detachable 10' thermoplastic elastomer-covered wire.

Termination: Right-angle molded phone plug. Beige plugs are 2-conductor.

Autoclavable Probes (qualified for medical use)

YSI 401AC General Purpose

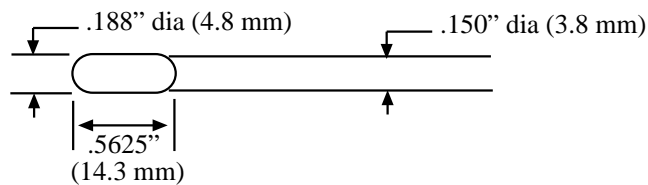

- Long-term immersion
- Time constant 10 sec
- Range -40 to +130°C

YSI 402AC General-Purpose

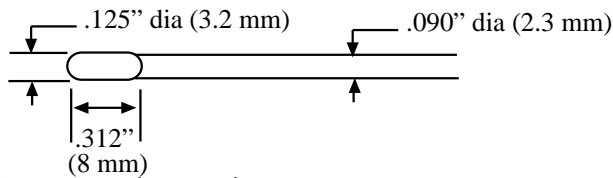

- Long-term immersion
- Time constant 6 sec
- Range -40 to +130°C

YSI 409AC Surface

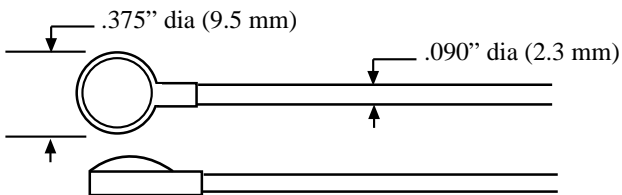

- Measurement in high-moisture environments
- Time constant 18 sec
- Range -40 to +130°C

SECTION 5
*YSI 4600 Precision
Thermometer*

- High-Precision with Standard Probes for Labs, the Manufacturing Floor and the Field
- Affordable Metrology-Level Measurement



YSI 4600 Series Precision Thermometers

Our new handheld YSI 4600 Series Precision Thermometers take metrology-level temperature measurement to the laboratory, the manufacturing floor and the field, at an affordable price.

Three Versions for a Range of Applications

We make three versions of the thermometer to address a broad range of temperature measurement applications.

The **YSI 4600** gives you high-precision and the convenience of a wide selection of off-the-shelf YSI 400 Series Probes.

The **YSI 4610** offers higher system accuracy with interchangeable probes.

The **YSI 4600S** provides metrology-level accuracy because we calibrate each unit with a specific probe.

All Versions Include These Features

- Resolution to 0.01°C
- RS232 port
- NIST traceability
- °F or °C readout
- Hold
- Min/max
- ΔT
- Store

YSI 4600–Flexibility and Precision

The YSI 4600 is a precision thermometer for use with standard YSI 400 Series Probes over the wide range -40 to +150°C. It's ideal for applications requiring system accuracy and flexibility.

The instrument offers high accuracy, $\pm 0.015^\circ\text{C}$, from 0 to 50°C; system accuracy is $\pm 0.115^\circ\text{C}$ with over 20 styles of YSI 400 Series Probes.

- Stainless steel tubular
- Air/gas
- Vinyl tip
- Catheter

Use the YSI 4600 to measure–

- Gas & air
- Liquids
- Semi-solids & solids

YSI 4610–Higher Accuracy with Interchangeable Probes

The YSI 4610 offers extremely high system accuracy when you use the YSI interchangeable probes that we test and calibrate just for this thermometer. System accuracy is $\pm 0.05^\circ\text{C}$ from 20 to 50°C with two special probes—a catheter probe and a vinyl tip general-purpose probe. The temperature range is 0 to 70°C.

- Analytical instrument calibration
- Field service
- Process validation
- Data acquisition

YSI 4600S–Transfer Standard

The YSI 4600S offers metrology-level accuracy over user-defined temperature ranges. Each system is calibrated with a matched probe (built using a YSI 46000 Super-Stable Glass Thermistor) appropriate for your application. Single-point and 4-point NIST traceable calibrations are available. System accuracy as tight as $\pm 0.025^\circ\text{C}$ between 0 to 50°C is obtainable with a 4-point calibration. Contact YSI for calibration details.

- Metrology labs
- Testing labs
- Critical process monitoring
- Transfer standard

About calibration

We provide every YSI temperature product with a Certificate of Traceability, indicating that it was calibrated during manufacture with standards traceable to the National Institute of Standards and Technology.

Specifications

Accuracy and Temperature Range

YSI 4600 Thermometer—System accuracy with YSI 400 Series Probes

±0.350°C at -40°C

±0.115°C from 0 to 50°C

±0.125°C at 70°C

±0.275°C at 100°C

±0.720°C at 150°C

YSI 4610 Thermometer—System accuracy with YSI 4610 Series Probes

±0.05°C from 20 to 50°C

±0.1°C at 0°C

±0.1°C at 70°C

YSI 4600S Thermometer—System accuracy with YSI Configure-to-Order Probe

±0.025°C from 0 to 50°C

System accuracy from -40 to 125°C depends on specified calibration.

Resolution: 0.01°C from -40 to +102°C;

0.02°C from 102 to 150°C

Repeatability: 0.0002 to 0.01°C (-20 to +100°C) typical for one week at constant ambient temperature.

Reading rate: 2 readings per second

Display: 4 1/2-digit LCD

Battery Life: 20 hours typical (9V alkaline cell included)

Battery Indicator: Displays flashing battery symbol when less than 5% of life remains

Temperature Units: °F or °C selected from keypad

Auto Shutoff: 10 minutes with battery power and no RS232 communications

Mating Connection: 1/4" phone jack

Operating Conditions: 10 to 40°C; 0 to 85% RH

Size: 21_H x 10_W x 3.8_D cm, 0.34 kg;

8.25_H x 4.00_W x 1.50_D inches, 12 oz

Thermometers

YSI 4600 Precision Thermometer (uses YSI 400 Series Probes)

YSI 4610 High-Accuracy Thermometer (uses YSI 4610 Series Interchangeable Probes)

YSI 4600S Thermometer & Probe (calibrated with a Configure-to-Order Probe)

Accessories

YSI 4651 RS232 Cable

YSI 4652 Carrying Case

YSI 4654 Tripod

YSI 4661 Battery Eliminator, US

YSI 400 Series Probes for YSI 4600 Thermometer

YSI 401 Vinyl Tip General-Purpose Probe

YSI 402 Small Vinyl Tip General-Purpose Probe

YSI 403 Stainless Steel Tubular Probe

YSI 404 Glass Tubular Probe

YSI 406 Small SS Tubular Probe

YSI 410 Tubular Probe with NPT Fitting

YSI 416 Autoclavable Tubular Probe

YSI 418 Pointed Tubular Probe

YSI 408 Banjo Surface Probe

YSI 409A High-Temperature Surface Probe

YSI 409B Surface Probe

YSI 421 Autoclavable Surface Probe

YSI 427 Small Surface Probe

YSI 405 Air/Gas Probe

YSI 451 1 mm Flexible General-Purpose Probe

YSI 4610 Series Probes for the YSI 4610 Thermometer

YSI 4611 1 mm Flexible General-Purpose Probe

YSI 4612 Small Flexible General-Purpose Probe

YSI Configure-to-Order Probes for the YSI 4600S Thermometer

For optimal long-term performance, we recommend using YSI 46000 Super-Stable Glass Thermistors with the YSI 4600S system. These thermistors are available in Configure-to-Order Probes.

SECTION 6

Technical Information

- **Thermistor Theory**
- **Assuring Accurate Measurement**
- **Basic Thermilinear Applications**
- **How to Use Thermilinears**
- **Custom Thermilinear Ranges**
- **Resistance versus Temperature Tables**
- **Glossary**

Thermistor Theory

NTC thermistor materials are prepared by heating mixtures of metal oxides to high temperatures so that the oxides combine chemically to form the spinel crystallographic structure. The name derives from the mineral spinel, $MgAl_2O_4$, which has this structure. In this structure Mg occupies tetrahedral, or A sites, in the crystal lattice and Al occupies octahedral, or B sites. This is a normal spinel, with one 2+ metal ion on the A site, two 3+ metal ions on the B sites and four oxygens. This is commonly written $Mg[Al_2]O_4$, where the elements in the bracket represent the B sites.

An inverse spinel has half the trivalent ion on the A sites and the divalent ion on the B sites, such as nickel ferrite, $Fe[NiFe]O_4$. Various degrees of inversion can occur depending on the metal ions, the temperature of reaction, and any annealing cycles to which the material is subjected. A common thermistor material is nickel manganite, a partially inverse spinel with manganese present on the B sites in 3+ and 4+ states.

These types of materials are referred to as valence-controlled semiconductors. Conduction occurs when ions having multiple valence states occupy equivalent crystallographic sites. They must be the same element and differ in valence by one unit and occupy B sites. The conduction mechanism is a thermally activated electron hopping process, in which the electrons hop from one cation (Mn^{3+}) to another (Mn^{4+}) in the B lattice sites under the influence of a potential gradient across the material.

The conductivity is a product of charge density and mobility. Charge density is determined by the number of charge carriers, the density of B sites and the probability of a B site being active. The mobility is determined by the distance between the nearest neighbor B sites, the activation energy (needed for the electron to move from one site to another) and a frequency factor (how often it tries to jump). Charge carriers are also produced by other defects such as non-stoichiometry and grain boundaries.

By considering the effects of all the above factors, an expression for conductivity can be derived:

$$\sigma = \sigma_{\infty} e^{(-q/kT)}$$

where S_{∞} is the infinite temperature conductivity (which includes consideration of charge density and mobility), $-q$ is the activation energy, k is Boltzmann's constant, and T the absolute temperature. For thermistors, the resistivity s (and hence resistance) is of more interest and the above becomes

$$\sigma = \sigma_{\infty} e^{(q/kT)}$$

Beta Constant

By replacing resistivity with resistance values and combining the activation energy and Boltzmann's constant terms, the familiar thermistor expression is obtained

$$R = A e^{(\beta/T)}$$

where A includes dimensional factors and infinite temperature resistance, β is the material constant beta and T is the absolute temperature.

One can determine the beta constant by measuring the resistance at two temperatures and using the above equation,

$$R_1/R_2 = e^{(\beta/T_1 - \beta/T_2)}$$

$$\ln(R_1/R_2) = \beta(1/T_1 - 1/T_2)$$
$$\beta = \ln(R_1/R_2) / (1/T_1 - 1/T_2)$$

Alpha Temperature Coefficient of Resistance

The temperature coefficient of resistance a is determined by

$$a = 1/R \cdot dR/dT$$

and is usually expressed in terms of % change in resistance per degree.

The coefficient of resistance and the material constant β are related to each other by

$$a = (-\beta/T^2)$$

Beta and a are two different ways of expressing the same property.

R versus T Approximation Methods

Although the expression $R = A e^{(\beta/T)}$ gives good agreement with empirical data over short temperature spans, a better method of interpolation over larger temperature ranges is necessary for accurate temperature measurements.

Thermistor accuracy depends on the precision and uncertainty of the calibration system used. The precision of the measurement statement, however, is in large part due to the method of approximation and interpolation. The approximation methods outlined below provide several choices for maximum simplicity while allowing for precise interpolation.

Narrow Range Approximation Methods

The following table shows two approximation methods, the applicable temperature range and range of deviation from nominal resistance.

Equation	Temperature Range	Deviation
$\ln(R_T) = \frac{A}{T}$	very small	—
$R_T = A^{(B/T)}$	-20 to +120°C	+0.94, -0.82°C

Steinhart and Hart

The Steinhart and Hart equation is an empirical expression that has been determined to be the best mathematical expression for the resistance-temperature relationship of a negative temperature coefficient thermistor. It is usually found explicit in T:

$$1/T = a + b (\ln R) + c (\ln R)^3 \quad (1)$$

where: T = Kelvin units (°C + 273.15)
a, b, c = coefficients derived from measurement
ln R = natural logarithm of resistance in ohms

To find a, b and c, measure a thermistor at three temperatures. The temperatures should be evenly spaced, and at least 10°C apart. Use the three temperatures and resistances to solve three simultaneous equations.

$$1/T_1 = a + b (\ln R_1) + c (\ln R_1)^3$$

$$1/T_2 = a + b (\ln R_2) + c (\ln R_2)^3$$

$$1/T_3 = a + b (\ln R_3) + c (\ln R_3)^3$$

The equations allow you to derive a, b and c for any temperature range. We have calculated these coefficients for the range 0 to 100°C with 50°C as the intermediate point. These are listed below for your use.

Coefficients derived from 0, 50 and 100°C catalog resistance

Thermistor type	25°C resistance	a	b	c
001A	100 Ω	0.0017709	0.0003406	1.479E-07
002A	300 Ω	0.0015632	0.0003108	9.747E-08
003A	1 KΩ	0.001313	0.0002906	1.023E-07
004	2252 Ω	0.0014733	0.0002372	1.074E-07
005	3 KΩ	0.0014051	0.0002369	1.019E-07
007	5 KΩ	0.001262	0.0002359	9.411E-08
017	6 KΩ	0.0012473	0.000235	9.439E-08
016	10 KΩ	0.0011303	0.0002339	8.863E-08
006	10 KΩ	0.0010295	0.0002391	1.568E-07
008	30 KΩ	0.0009354	0.0002211	1.275E-07
011	100 KΩ	0.0008253	0.0002045	1.144E-07
014	300 KΩ	0.0008207	0.0001848	1.014E-07
015	1 MEGΩ	0.0008142	0.000167	8.819E-08

Knowing a, b and c for the thermistor allows you to use the Steinhart and Hart equation in two ways. If resistance is known and temperature is desired, use equation (1) above. If the temperature is known and expected resistance is desired, use equation (2) below. Remember that T is in Kelvin units.

$$R = e^{[(\beta - (\alpha/2))^{1/3} - (\beta + (\alpha/2))^{1/3}]} \quad (2)$$

where

$$\alpha = (a - (1/T))/c \quad \text{and} \quad \beta = \left[\left(\frac{b}{3c} \right)^3 + \frac{\alpha^2}{4} \right]^{1/2}$$

It should be noted that these values of alpha and beta are not related to the alpha and beta used with single term exponential equations.

The ability to precisely interpolate for a given temperature from measurements at known fixed-points depends in part on the closeness of those points. Fixed-points such as the water triple point, mercury triple point, gallium melting point and indium freezing point provide a solid basis for the interpolation.

For practical reasons some of the R vs. T tables have small interpolation differences when random values from the tables are used in the above equations, particularly over large temperature spans.

For more information,
contact us at 800 747-5367 or
937 767-7241 • Fax 937 767-9353
Info@YSL.com • www.YSL.com

Spreadsheet Program

The following spreadsheet program (Lotus 123) allows calculation of the Steinhart and Hart coefficients, using three resistances at three temperatures. It calculates resistance, dR/dT or determines the temperature for a known resistance.

Labels start with an apostrophe ('). Brackets indicate data you must enter. Other cells are formulas.

B1: 'Temp.(C)
C1: 'Resistance
D1: 'T (K)
E1: 'ln(R)
A2: 'Low
B2: [Input low temperature in °C]
C2: [Input low temp. resistance in ohms]
D2: +B2+273.15
E2: @LN(C2)
A3: 'Mid
B3: [Input mid temperature in °C]
C3: [Input mid temp. resistance in ohms]
D3: +B3+273.15
E3: @LN(C3)
A4: 'High
B4: [Input high temperature in °C]
C4: [Input high temp. resistance in ohms]
D4: +B4+273.15
E4: @LN(C4)
A6: 'ln(R1)-ln(R2)
B6: +E2-E3
A7: 'ln(R1)-ln(R3)
B7: +E2-E4
A8: '(1/T1)-(1/T2)
B8: 1/D2-1/D3
A9: '(1/T1)-(1/T3)
B9: 1/D2-1/D4
A11: 'Coefficients: a=
B11: 1/D2-B13*E2^3-B12*E2
A12: 'b=
B12: (B8-B13*(E2^3-E3^3))/B6
A13: 'c=
B13: (B8-B6*B9/B7)/((E2^3-E3^3)-B6*(E2^3-E4^3)/B7)
A15: 'Solving for R, given T:
A16: 'Degrees C=
B16: [Input known temperature in °C]

C16: +B16+273.15
D16: (B11-(1/C16))/B13
E16: '=A
D17: @SQRT((B12/(3*B13))^3+(D16^2)/4)
E17: '=B
A18: 'Resistance (Ohm)=
B18: @EXP((D17-(D16/2))^(1/3)-(D17+(D16/2))^(1/3))
A19: 'dR/dT=
B19: -1*B18/(C16^2*(B12+3*B13*(@LN(B18))^2))
A20: '%dR/dT=
B20: +B19/B18*100
A23: 'Solving for T, given R:
A24: 'Ohms=
B24: [Input known resistance in ohms]
A26: 'Temperature (C)=
B26: 1/(B11+B12*@LN(B24)+B13*(@LN(B24))^3)-273.15

For more information,
contact us at **800 747-5367** or
937 427-1231 • Fax 937 427-1640
Info@YSL.com • www.YSL.com

How to Use Thermilinears

We present a general description of Thermilinear Networks in the Thermilinear Component Section of the catalog. The examples below describe general circuit development that may be used with YSI Thermilinear Networks.

Voltage Mode

You can develop a thermometer circuit without active circuitry using the voltage mode. The voltage mode configuration is based on a voltage divider (figure 1) or Wheatstone bridge (figure 2). We consider both circuits together in the following example since the bridge is an extension of the voltage divider.

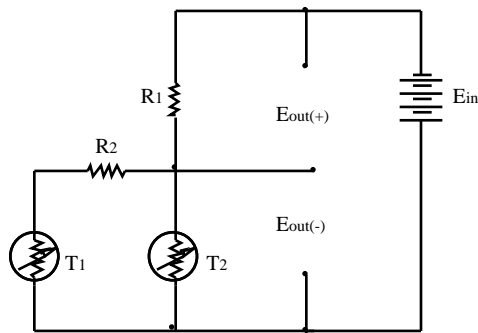

Figure 1

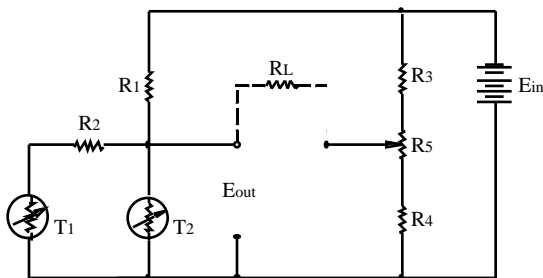

Figure 2

Voltage Mode Circuit Design Example

The range and output slope must be established first. The signs and units must be known. The example will be:

range: 0 to 100°C

output slope: -10 mV/°C (negative slope)

We use the YSI 44201 network in the example. This network has a temperature range of 0 to 100°C, includes the YSI 44018 Thermilinear composite and the YSI 44301 resistor set. We've taken design data from the YSI Thermilinear Network Specification pages.

$$R_1 = 3200 \Omega$$

$$R_2 = 6250 \Omega$$

$$E_o = (-0.0053483E_{in})t + 0.86507E_{in}$$

$$\begin{aligned} & \text{sensitivity constant} \\ & = (\delta/\delta)/E_{in} \\ & = -0.0053483 \end{aligned}$$

$$\begin{aligned} & \text{output voltage at } 0^\circ\text{C per volt in} \\ & = E_{o0^\circ\text{C}}/\delta E_{in} \\ & = +0.86507 \end{aligned}$$

$$R_t = (-17.115)t + 2768.23$$

$$\begin{aligned} & -\delta R \\ & R_t @ 0^\circ\text{C} \end{aligned}$$

1. Determine input voltage that results in the desired voltage sensitivity (-10mV/°C in this example). This is equal to the voltage sensitivity per degree divided by the sensitivity constant.

$$\begin{aligned} E_{in} & = (\delta E/\delta t) (\delta/\delta)/E_{in} \\ & = -0.01 \text{ V}/^\circ\text{C} \div -0.0053483/^\circ\text{C} \\ & = 1.869753 \text{ V} \end{aligned}$$

2. Determine output voltage (E_{out}). The general equation is given with the temperature as the variable.

$$\begin{aligned} E_{out} & = [((\delta/\delta T)/E_{in}) \times E_{in}] \times t + (\delta E_{o0^\circ\text{C}}/E_{in} \times E_{in}) \\ @ 0^\circ\text{C} & = -0.0053483/^\circ\text{C} \times 1.869753 \text{ V} \times 0^\circ\text{C} + \\ & 0.86507 \times 1.869753 \text{ V} = 1.617467 \text{ V} \end{aligned}$$

3. Power dissipation. Calculate self-heat to evaluate the effect of power on measurement accuracy. Self-heat is most severe for the higher resistance thermistor (T_2) at high temperature. A $30K \Omega @ 25^\circ C$ thermistor has a resistance of 2069Ω at $100^\circ C$.

$$P = E^2 / 4 R$$

Where:

P = power dissipation in watts

E = voltage at the maximum temperature

R = resistance of the higher resistance thermistor at the maximum temperature

$$P = 0.617467^2 / 4 \cdot 2069 \Omega = 0.000184 \text{ Watts}$$

The dissipation constant is used to turn this into a temperature unit. We will assume for the example that the component is immersed in flowing water. The dissipation constant for a YSI 44018 is $8 \text{ mW}/^\circ C$ ($0.008 \text{ W}/^\circ C$) in flowing water.

$$\text{Self-heat error} = 0.000184 \text{ W} / 4 \cdot 0.008 \text{ W}/^\circ C = 0.023^\circ C$$

The resistors R_3 , R_4 and R_5 are selected next. The goal is to pick these resistors to achieve 0 V out at $0^\circ C$. The first thing that must be done is to determine the resistance of T_1 , R_2 and T_2 at $0^\circ C$. The total of these resistances will be called R_{cal} . R_{cal} will be calculated by first calculating the total resistance for the left half of the bridge, R_t and then subtracting the effect of R_1 . For this example, the equation for R_t is found in the data table for the YSI 44201 network.

$$R_t = (17.115 \Omega/^\circ C) \times t^\circ C + 2768.23 \Omega$$

$$\begin{aligned} @ 0^\circ C &= (-17.115 \Omega/^\circ C) \times 0^\circ C + 2768.23 \Omega \\ &= 2768.23 \end{aligned}$$

$$\begin{aligned} @ 100^\circ C &= (-17.115 \Omega/^\circ C) \times 100^\circ C + 2768.23 \Omega \\ &= 1056.73 \end{aligned}$$

$$\begin{aligned} @ 100^\circ C &= -0.0053483/^\circ C \times 1.869753 \text{ V} \times 100^\circ C + \\ &0.86507 \times 1.869753 \text{ V} = 0.617467 \text{ V} \end{aligned}$$

For more information,
contact us at 800 747-5367 or
937 427-1231 • Fax 937 427-1640
Info@YSI.com • www.YSI.com

Now R_{cal} is calculated with the following formula:

$$\frac{1}{R_{cal}} = \frac{1}{R_t} - \frac{1}{R_1}$$

$$\frac{1}{R_{cal@0^\circ C}} = \frac{1}{R_{t@0^\circ C}} - \frac{1}{R_1}$$

$$\frac{1}{R_{cal@0^\circ C}} = \frac{1}{R_{t@0^\circ C}} - \frac{1}{R_1}$$

For the example:

$$\frac{1}{R_{cal@0^\circ C}} = \frac{1}{2768.23 \Omega} - \frac{1}{3200 \Omega} = 0.000048742$$

$$R_{cal@0^\circ C} = 1 / 0.000048742 = 20516.3 \Omega$$

A ratio calculation is done to determine the values for R_3 and R_4 .

$$\frac{R_1}{R_{cal@0^\circ C}} = \frac{R_3}{R_4}$$

Another resistor, R_5 , is introduced at this time. This is the zero control. The total resistance of this resistor is to be equal to two times the tolerance of the larger of R_3 and R_4 . When making circuit calculations, it is assumed that half of R_5 's resistance is included with R_3 and the other half with R_4 .

R_4 is chosen by the designer and R_3 is calculated based on the selection of R_4 . For the example:

$$\text{choose } R_4 = 4990 \pm 1\% \text{ (approximately } \pm 50 \Omega)$$

$$R_5 = 2 \times 50 = 100$$

$R_3 + R_5/2$ is substituted for R_3 in the ratio equation above.

$R_4 + R_5/2$ is substituted for R_4 in the ratio equation above.

Solve the ratio equation:

$$\begin{aligned} R_3 = R_5/2 &= [R_1 \times (R_4 + R_5/2)] / R_{cal@0^\circ C} \\ R_3 &= [(R_1 \times (R_4 + R_5/2)) / R_{cal@0^\circ C}] - R_5/2 \\ &= [(3200 \Omega \times (4990 \Omega + 50 \Omega)) / 20516.3 \Omega] - 100/2 = \\ &736.1 \Omega \end{aligned}$$

A standard resistor value is selected that is near to this calculated value. 732Ω is selected for the example. The last step is to ascertain that the null value of the circuit falls within the adjustment range of the control.

$$R_x = ((R_3 + R_4 + R_5) \times E_{out@0^\circ}) - R_4$$

Where:

R_x = the part of the control added to R_4 . This is not to exceed $R_5/2$.

For the example:

$$R_x = ((732 + 4990 + 100) \times 0.86507) - 4990 = 46.44 \Omega$$

Since $R_x < R_5/2$, the resistor selections are acceptable.

Resistive Mode Operations

Using the Thermilinear Network in the resistive mode requires energizing the network with a constant current. This can be done by connecting the network in the feedback loop of an operational amplifier (below).

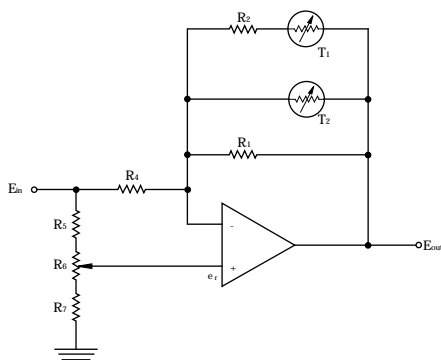

Figure 3

The general transfer function for this circuit is:

$$E_{out} = \left[1 + \frac{R_1}{R_4}\right] e_r - \frac{R_1}{R_4} E_{in}$$

Where: R_t = Resistance of the network in the resistive mode

(feedback resistance)

e_r = voltage at the positive input

As in the voltage mode, the range and output slope must be established. The signs and units must be known.

range: 30 to 100°F

output slope: -10mV/°C (negative slope)

We use the YSI 44204 Network in the example. This network has a temperature range of 30 to 100°F, includes the YSI 44018 Thermilinear composite and the YSI 44304 resistor set. We've taken design data from YSI Thermilinear Network Specification pages.

R_4 must be calculated for this circuit. As seen in the equation above, zero output occurs when $R_t = R_4$ and $E_{in} = 2e_r$. Zero degrees can be placed at any reasonable point, either inside or outside the intended range of the circuit.

This example sets $R_4 = R_t$ at 0°F, which is outside the range. This means that the equation above may not be used, and the R_t equation must be used. The equation for the YSI 44204 Network is:

$$R_t = (-17.834)t + 5173.7$$



R_t @ 0°F

since $t = 0^\circ\text{F}$, $R_t = 5173.7 \Omega = R_4$

R_5 , R_6 and R_7 are selected to achieve a voltage divider so that e_r can be set at one half of E_{in} .

The value of E_{in} is given by:

$$E_{in} = \frac{2dE(R_t@0^\circ\text{F})}{dR}$$

Where: dE = The change in E_o per degree

dR = The change in network resistance per degree

substituting numbers from the example:

$$E_{in} = \frac{2 \times 0.01 \times 5173.7}{17.834} = 5.802$$

Power Dissipation

A method to determine power dissipation is described in the voltage mode circuit design example.

The excitation voltage (E_{in}) must be stable for supply and temperature variations because the current requirement is constant in this example. A series variable resistance can be used for setting E_{in} to produce the correct full scale output.

Two-Wire System

A 3-wire sensor can be reduced to a 2-wire sensor (below) if R_2 is connected at the sensor end of the cable in either the voltage or resistive mode. Note R_1 is connected to the other end of the cable. Resistance errors due to very long leads may then be subtracted from R_1 .

Multiplexing

One resistor set may serve any number of Thermilinear Composites for monitoring at several locations as shown below.

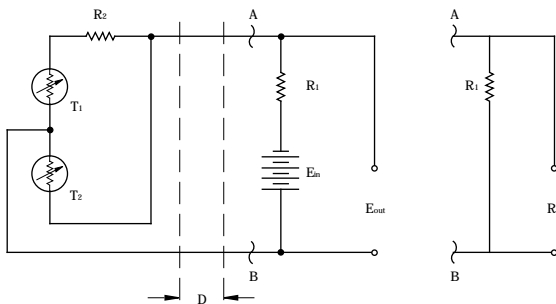

Figure 4

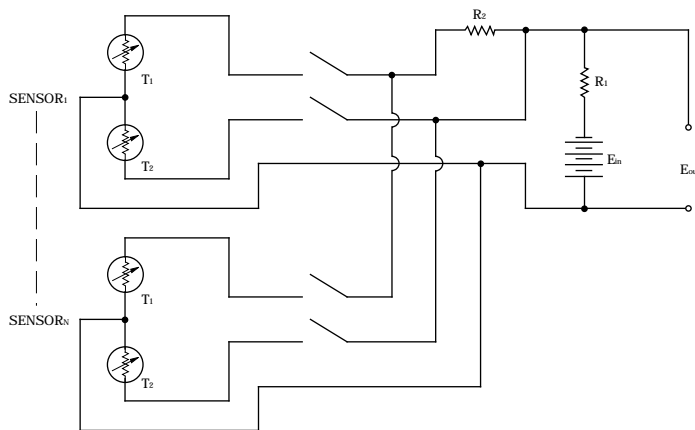

Figure 5

For more information,
contact us at **800 747-5367** or
937 427-1231 • Fax 937 427-1640
Info@YSI.com • **www.YSI.com**

Technical Publications

Technical Manuals/Documents

- TD001 Thermistor Probes for Severe Moisture Environments
- TD002 Measurement Science Conference Tutorial
- TD003 Temperature Compensation Using Thermistor Networks
- TD004 Goddard Specification S-311-P-18
- TD005 Reproducibility, Stability and Linearization of Thermistor Resistance Thermometers
- TD006 YSI 46000 and YSI 47000 Series Thermistors
- TD007 Aging Phenomena in Nickel-Manganese Oxide Thermistors
- TD008 Practical Design Techniques Tame Thermistor Design
- TD009 Thermistor Aging Phenomenon Due to Temperature Cycling
- TD010 All About Thermistors
- TD011 Long-Term Thermistor Stability at an Elevated Temperature
- TD012 Glass Thermistor Notebook
- TD013 Thermistors Compensate Gain TC

Technical Notes

- TN001 Statement of Qualification Requirements Based on Similarity to YSI 44900 Series Parts
- TN004 Thermistor-Specific Heat
- TN005 Glass Thermistor Leads
- TN006 Humidity Resistance of Oxycast Epoxy Compared to EC210
- TN007 Material Recommendation for Potting Thermistors
- TN008 Materials for MSFC-SPEC-1443 Outgas Testing
- TN009 Outgas Testing on Oxycast 6850FTLV
- TN010 EC210 Replacement
- TN011 YSI 44018 Special Range Values
- TN012 Thermistor Test Data Life Tests
- TN013 Thermistor Reliability and Accuracy at High Pressure
- TN014 NBS Study on YSI 403 Probe with YSI 44012 Thermistor TN015 CE Mark and YSI Thermistors
- TN015 CE Mark and YSI Thermistors

Technical Applications

- TA001 Thermistor Self-Heat Mode
- TA003 YSI 4600 Serial Interface
- TA004 Thermistor A/D Converter Circuit

Assuring Accurate Measurement

You can ensure the accuracy of your measurement by avoiding the common errors explained below.

Immersion Stem Effect

An error source frequently ignored is stem effect. It can be the source of very large errors. Stem effect occurs when a portion of the probe is at a temperature other than the temperature of the sample.

Here's a simple method for determining stem effect. Slowly insert the probe into a sample at approximately the test temperature while observing the readout to determine when there's no further change with further insertion. When no further change is observed, stem effect error is eliminated.

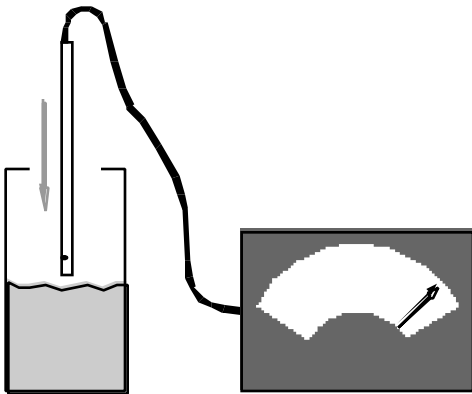

How to Eliminate Immersion Stem Effect

1. Immersion should be at least 10 times the diameter of the probe.
2. The sample volume should be no less than 1,000 times the mass of the sensor.

Dissipation Error (Self-Heat)

Power application to a thermistor may induce a temperature change in the sensor. This change is called dissipation or self-heat error. You may reduce dissipation error by limiting the power applied to a thermistor during a measurement.

The graph curves represent 10 mk (0.010°C) of self-heat for a 1kΩ (YSI 44003A), 10kΩ (YSI 44006) and 100kΩ (YSI 44011) thermistor at a specific temperature when a specific voltage is applied. The dissipation constant is 1mW/°C in still air.

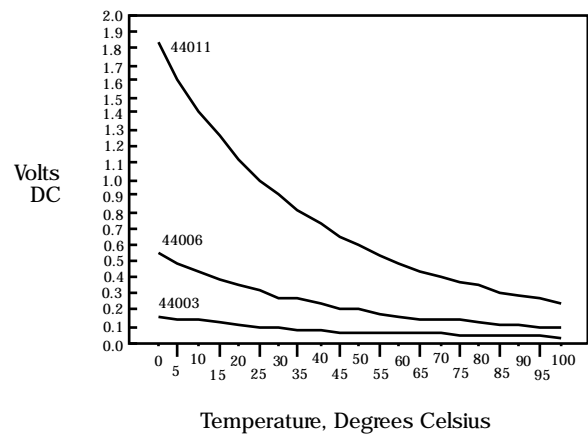

Gas Stream Error

A major source of error in the measurement of low-flow gas streams is another sort of stem effect. In this case, the leads conduct better than the sample and transfer heat to the thermistor. Mounting the thermistor on its own leads and having as much of the leads exposed to the sample as possible will improve the accuracy of the measurement. A very low mass form for lead support exposes a greater length of lead to the sample.

In still air, self-heat from over application of power to the thermistor can contribute significantly to the error. If the thermistor is self-heated, any change in air flow will change its resistance and its apparent temperature.

Radiant Error

Radiant energy directed on the sensor may cause radiant error. This error, similar to stem effect, is common and significant when measuring in direct sunlight or other radiant source. Inserting a reflective surface between the radiant source and the sensor-lead combination reduces error.

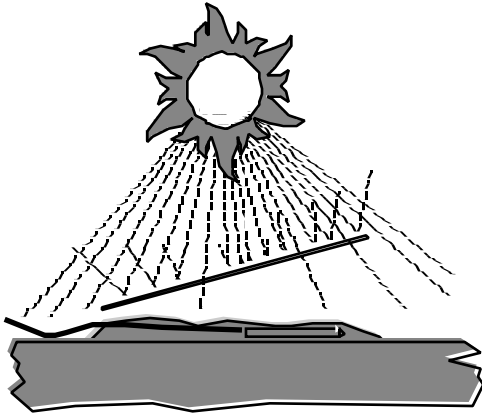

Pipe Error

Pipe error may occur if a significant temperature differential exists between the pipe wall and the fluid or gas. Flow rate and immersion depth of the probe will significantly affect the accuracy of the measurement. The drawing below illustrates this effect. The two probes on the right are measuring pipe temperature; the probe on the left is measuring the temperature of the flow.

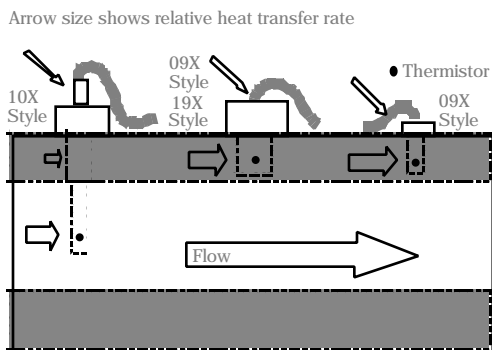

For more information,
contact us at **800 747-5367** or
937 427-1231 • Fax 937 427-1640
Info@YSI.com • www.YSI.com

Thermistor Applications

Complete Heating & Cooling Automatic Thermostat

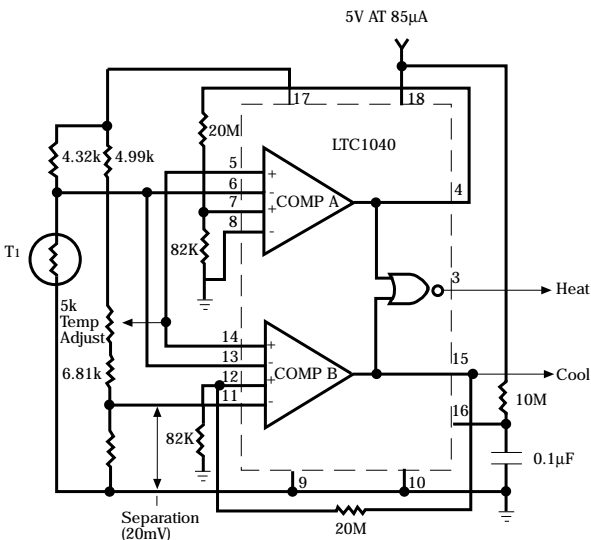

T1 Thermistor #44007
Yellow Springs Instrument Co., Inc.
Hysteresis = $5V \times 82k = 20mV$
20M

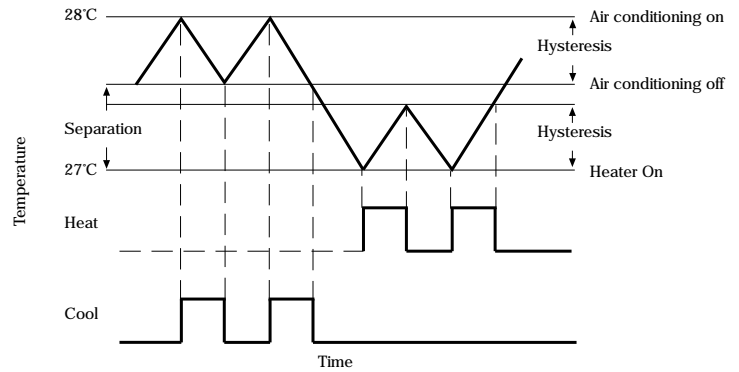

Reprinted with the permission of Linear Technology Corporation—LTC 1040 1990 Linear Databook Volume 1.

Micropower Thermocouple Signal Conditioner with Cold Junction Compensation

Half Bridge with A/D Converter

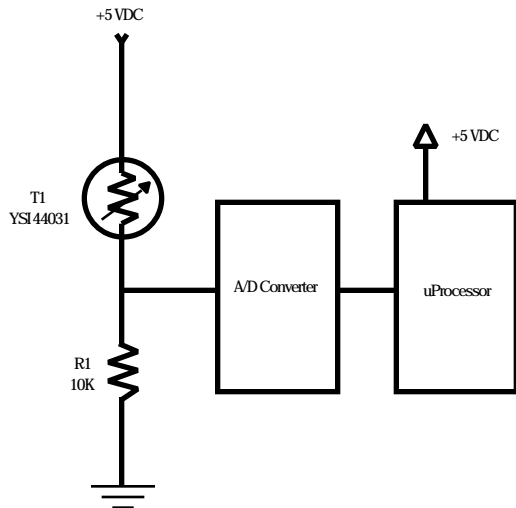

This circuit provides a low cost method of achieving precise temperature measurements when a microprocessor and A/D convertor are available. The half bridge interface provides a voltage which the A/D converts to counts. The microprocessor uses a lookup table which quickly converts the A/D counts to a temperature value. This eliminates the need to implement thermistor equations in code or use a floating point library.

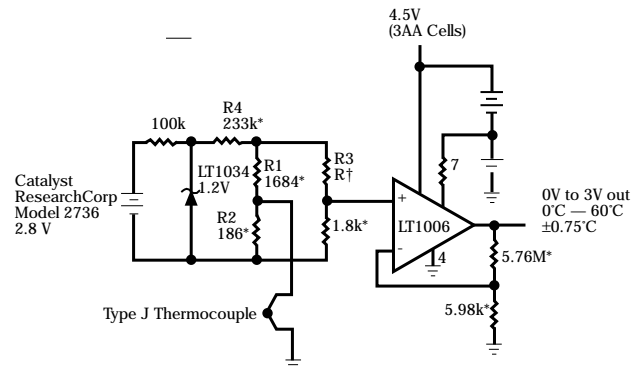

Total Power Consumption $\leq 500\mu W$
* = TRW MAR-60.1%
R1 = Yellow Springs Inst. Co
Model 44007 5k @25°C

Reprinted with the permission of Linear Technology Corporation—LTC 1006 Linear Databook Volume 1.

Custom Thermilinear Ranges

This page lists Thermilinear ranges developed for custom applications. Below are ranges developed for applications in °C. Please note that the user supplies the range resistors.

YSI 44018 Custom Thermilinear Ranges in °C

No.	Temperature Range °C	Linearity Deviation °C	R _i Variables		E _{out} Variables			
			R ₁	R ₂	Slope (m)	Intercept (b)	Slope (m)	Intercept (b)
1	-40 to +70	1.20	17290	35250	-112.6240	11457.50	-0.0065138	0.662664
2	-30 to +50	0.16	18700	35250	-127.0960	12175.00	-0.0067965	0.651070
3	-30 to +55	0.31	18900	37000	-128.3340	12326.50	-0.0067902	0.651290
4	-30 to +60	0.37	14000	25500	-91.2740	9626.57	-0.0065196	0.687610
5	-30 to +70	0.96	14500	30000	-94.4784	10013.90	-0.0065158	0.690610
6	-25 to +55	0.20	16000	31000	-106.6430	10786.10	-0.0066652	0.674130
7	-5 to +45	0.06	5700	12000	-32.4020	4593.39	-0.0056846	0.805858
8	-5 to +50	0.08	5690	11600	-32.6089	4577.55	-0.0057309	0.804490
9	-5 to +125	1.11	2610	5230	-13.3552	2304.34	-0.0051169	0.882889
10	-2 to +38	0.03	5700	12400	-32.1012	4603.11	-0.0056318	0.807563
11	0 to 10	0.00	42000	67900	-310.7530	21849.50	-0.0073988	0.520226
12	0 to 30	0.04	11680	22960	-73.8485	8358.02	-0.0063226	0.715584
13	0 to 40	0.27	5900	12400	-28.5226	4442.72	-0.0048347	0.753067
14	0 to 60	0.14	7775	14800	-47.0450	5938.37	-0.0060508	0.763770
15	0 to 100	0.22	3200	6250	-17.1150	2768.23	-0.0053483	0.865070
16	0 to 120	0.81	2610	5230	-13.3552	2304.34	-0.0051169	0.882889
17	5 to 130	0.88	2130	4635	-10.6233	1936.67	-0.0049874	0.909235
18	15 to 35	0.01	4400	10100	-23.5611	3687.77	-0.0053547	0.838130
19	15 to 45	0.03	4380	9450	-23.8370	3660.60	-0.0054422	0.835753
20	15 to 65	0.07	6739	12252	-39.8117	5225.63	-0.0059080	0.775471
21	20 to 32	0.00	4400	10100	-23.5181	3686.65	-0.0053450	0.837875
22	20 to 65	0.06	2500	5360	-12.6473	2234.19	-0.0050589	0.893676
23	20 to 120	0.23	1696	3383	-8.2913	1577.55	-0.0048887	0.930159
24	22 to 42	0.02	5445	10800	-30.8702	4388.70	-0.0056694	0.806006
25	28 to 64	0.04	1900	4300	-9.1144	1750.58	-0.0047970	0.921358
26	35 to 135	0.27	1175	2375	-5.4353	1133.10	-0.0046257	0.964340
27	45 to 75	0.04	2000	3900	-9.8670	1816.00	-0.0049335	0.908000
28	45 to 125	0.19	1030	2050	-4.6619	1002.50	-0.0045261	0.973301
29	50 to 100	0.05	2500	4530	-12.8234	2202.82	-0.0051294	0.881120
30	55 to 65	0.00	2000	3900	-9.8319	1813.85	-0.0049159	0.906924

For more information,
 contact us at **800 747-5367** or
937 427-1231 • Fax 937 427-1640
Info@YSI.com • www.YSI.com

Resistance versus Temperature -80 to -11°C

Thermistor Mix		Resistance (Ω at 25°C)																					
		L Mix		L Mix		L Mix		B Mix		B Mix		B Mix		B Mix		H Mix		H Mix		H Mix		H Mix	
Ω at 25°C		100	300	1000	2252	3000	5000	6000	10,000	10,000	30,000	100,000	300,000	1 MEG									
°F	°C																						
-112.0	-80	14.47K	67.66K	278.8K	1660K	2211K	3685K	4423K	7371K	3558K													
110.2	79	13.51K	62.78K	258.1K	1518K	2022K	3371K	4044K	6741K	3296K													
108.4	78	12.62K	58.29K	239.1K	1390K	1851K	3086K	3703K	6172K	3055K													
106.6	77	11.80K	54.15K	221.7K	1273K	1696K	2827K	3392K	5653K	2833K													
104.8	76	11.04K	50.34K	205.6K	1167K	1555K	2592K	3109K	5182K	2629K													
103.0	75	10.33K	46.83K	190.8K	1071K	1426K	2378K	2853K	4756K	2440K													
101.2	74	9672	43.58K	177.2K	982.8K	1309K	2182K	2618K	4364K	2266K													
99.4	73	9061	40.59K	164.7K	902.7K	1202K	2005K	2405K	4008K	2106K													
97.6	72	8494	37.82K	153.1K	829.7K	1105K	1843K	2211K	3684K	1957K													
95.8	71	7966	35.26K	142.5K	763.1K	1016K	1695K	2033K	3389K	1821K													
-94.0	-70	7475	32.9K	132.6K	702.3K	935.4K	1560K	1871K	3119K	1694K													
92.2	69	7018	30.71K	123.5K	646.7K	861.4K	1436K	1723K	2872K	1577K													
90.4	68	6592	28.68K	115.1K	595.9K	793.7K	1323K	1588K	2646K	1469K													
88.6	67	6195	26.8K	107.3K	549.4K	731.8K	1220K	1464K	2440K	1369K													
86.8	66	5825	25.06K	100.1K	506.9K	675.2K	1126K	1351K	2251K	1276K													
85.0	65	5479	23.45K	93.48K	467.9K	623.3K	1039K	1247K	2078K	1190K													
83.2	64	5157	21.95K	87.3K	432.2K	575.7K	959.9K	1152K	1919K	1111K													
81.4	63	4856	20.55K	81.58K	399.5K	532.1K	887.2K	1064K	1774K	1037K													
79.6	62	4575	19.26K	76.28K	369.4K	492.1K	820.5K	984.2K	1640K	968.4K													
77.8	61	4312	18.05K	71.35K	341.8K	455.3K	759.2K	910.7K	1518K	904.9K													
-76.0	-60	4066	16.93K	66.78K	316.5K	421.5K	702.9K	843.3K	1405K	845.9K													
74.2	59	3835	15.89K	62.53K	293.2K	390.5K	651.1K	781.2K	1302K	791.1K													
72.4	58	3620	14.92K	58.59K	271.7K	361.9K	603.5K	723.9K	1206K	740.2K													
70.6	57	3418	14.02K	54.92K	252K	335.7K	559.7K	671.4K	1119K	692.8K													
68.8	56	3229	13.17K	51.5K	233.8K	311.5K	519.4K	622.9K	1038K	648.8K													
67.0	55	3051	12.39K	48.32K	217.1K	289.2K	482.2K	578.4K	964K	607.8K													
65.2	54	2885	11.65K	45.36K	201.7K	268.6K	447.9K	537.4K	895.6K	569.6K													
63.4	53	2729	10.97K	42.6K	187.4K	249.7K	416.3K	499.3K	832.1K	534.1K													
61.6	52	2582	10.33K	40.03K	174.3K	232.2K	387.1K	464.4K	774K	501K													
59.8	51	2445	9730	37.63K	162.2K	216K	360.2K	432.1K	720.2K	470.1K													
-58.0	-50	2315	9171	35.39K	151K	201.1K	335.3K	402.3K	670.5K	441.3K													
56.2	49	2194	8647	33.3K	140.6K	187.3K	312.3K	374.6K	624.3K	414.5K													
54.4	48	2079	8158	31.35K	131K	174.5K	291K	349K	581.7K	389.4K													
52.6	47	1972	7699	29.52K	122.1K	162.7K	271.3K	325.3K	542.2K	366K													
50.8	46	1870	7270	27.81K	113.9K	151.7K	253K	303.5K	505.8K	344.1K													
49.0	45	1775	6867	26.22K	106.3K	141.6K	236.2K	283.2K	472.0K	323.7K													
47.2	44	1685	6489	24.72K	99.26K	132.2K	220.5K	264.5K	440.8K	304.6K													
45.4	43	1600	6135	23.32K	92.72K	123.5K	205.9K	247K	411.7K	286.7K													
43.6	42	1521	5803	22.01K	86.65K	115.4K	192.5K	230.9K	384.8K	270K													
41.8	41	1445	5491	20.79K	81.02K	107.9K	180K	215.9K	359.8K	254.4K													
-40.0	-40	1374	5198	19.64K	75.79K	101K	168.3K	201.9K	336.5K	239.8K	884.6K	3356K											
38.2	39	1307	4922	18.56K	70.93K	94.48K	157.5K	189K	315K	226K	830.9K	3147K											
36.4	38	1244	4663	17.54K	66.41K	88.46K	147.5K	176.9K	294.9K	213.2K	780.8K	2951K											
34.6	37	1184	4420	16.59K	62.21K	82.87K	138.2K	165.7K	276.2K	201.1K	733.9K	2769K											
32.8	36	1127	4191	15.7K	58.3K	77.66K	129.5K	155.3K	258.9K	189.8K	690.2K	2599K											
31.0	35	1073	3975	14.86K	54.66K	72.81K	121.4K	145.6K	242.7K	179.2K	649.3K	2440K											
29.2	34	1023	3772	14.07K	51.27K	68.3K	113.9K	136.6K	227.7K	169.3K	611K	2292K											
27.4	33	974.9	3580	13.33K	48.11K	64.09K	106.9K	128.2K	213.6K	160K	575.2K	2154K											
25.6	32	929.6	3400	12.63K	45.17K	60.17K	100.3K	120.3K	200.6K	151.2K	541.7K	2025K											
23.8	31	886.6	3230	11.97K	42.42K	56.51K	94.22K	113K	188.4K	143K	510.4K	1904K											
-22.0	-30	846.0	3069	11.35K	39.86K	53.1K	88.53K	106.2K	177K	135.2K	481K	1791K											
20.2	29	807.5	2918	10.77K	37.47K	49.91K	83.22K	99.83K	166.4K	127.9K	453.5K	1685K											
18.4	28	771.0	2775	10.22K	35.24K	46.94K	78.26K	93.89K	156.5K	121.1K	427.7K	1586K											
16.6	27	736.4	2640	9705	33.15K	44.16K	73.62K	88.32K	147.2K	114.6K	403.5K	1494K											
14.8	26	703.6	2512	9218	31.2K	41.56K	69.29K	83.13K	138.5K	108.6K	380.9K	1407K											
13.0	25	672.5	2392	8758	29.38K	39.13K	65.24K	78.28K	130.5K	102.9K	359.6K	1326K											
11.2	24	643.0	2278	8323	27.67K	36.86K	61.45K	73.72K	122.9K	97.49K	339.6K	1250K											
9.4	23	614.9	2170	7914	26.07K	34.73K	57.9K	69.46K	115.8K	92.43K	320.9K	1178K											
7.6	22	588.3	2068	7527	24.58K	32.74K	54.58K	65.49K	109.1K	87.66K	303.3K	1111K											
5.8	21	563.0	1972	7161	23.18K	30.87K	51.47K	61.76K	102.9K	83.16K	286.7K	1049K											
-4.0	-20	538.9	1880	6815	21.87K	29.13K	48.56K	58.27K	97.11K	78.91K	271.2K	989.8K											
2.2	19	516.1	1794	6489	20.64K	27.49K	45.83K	54.99K	91.65K	74.91K	256.5K	934.6K											
0.4	18	494.3	1712	6180	19.48K	25.95K	43.27K	51.9K	86.5K	71.13K	242.8K	882.7K											
1.4	17	473.6	1634	5887	18.4K	24.51K	40.86K	49.02K	81.71K	67.57K	229.8K	834K											
3.2	16	454.0	1561	5611	17.39K	23.16K	38.61K	46.33K	77.22K	64.2K	217.6K	788.2K											
5.0	15	435.2	1491	5349	16.43K	21.89K	36.49K	43.77K	72.96K	61.02K	206.2K	745.2K											
6.8	14	417.4	1424	5101	15.54K	20.7K	34.5K	41.4K	69.01K	58.01K	195.4K	704.7K											
8.6	13	400.4	1361	4866	14.7K	19.58K	32.63K	39.17K	65.28K	55.17K	185.2K	666.7K											
10.4	12	384.2	1302	4643	13.91K	18.52K	30.88K	37.06K	61.77K	52.48K	175.6K	630.9K											
12.2	11	368.8	1245	4432	13.16K	17.53K	29.23K	35.06K	58.44K	49.94K	166.6K	597.2K											

Resistance versus Temperature -10 to +59°C

Thermistor Mix		L Mix	L Mix	L Mix	B Mix	B Mix	B Mix	B Mix	B Mix	H Mix	H Mix	H Mix	H Mix	H Mix	
Ω at 25°C		100	300	1000	2252	3000	5000	6000	10,000	10,000	30,000	100,000	300,000	1MEG	
°F	°C														
+14.0	-10	354.1	1191	4232	12.46K	16.60K	27.67K	33.20K	55.33K	47.54K	158K	565.5K			
15.8	9	340.0	1140	4042	11.81K	15.72K	26.21K	31.47K	52.44K	45.27K	150K	535.6K			
17.6	8	326.7	1091	3862	11.19K	14.90K	24.83K	29.81K	49.69K	43.11K	142.4K	507.5K			
19.4	7	313.9	1045	3691	10.60K	14.12K	23.54K	28.24K	47.07K	41.07K	135.2K	481K			
21.2	6	301.7	1001	3529	10.05K	13.39K	22.32K	26.78K	44.63K	39.14K	128.5K	456K			
23.0	5	290.1	958.9	3374	9.530K	12.70K	21.17K	25.40K	42.34K	37.31K	122.1K	432.4K			
24.8	4	278.9	919.0	3228	9.050K	12.05K	20.08K	24.10K	40.17K	35.57K	116K	410.2K			
26.6	3	268.3	881.0	3088	8.590K	11.44K	19.06K	22.88K	38.13K	33.93K	110.3K	389.3K			
28.4	2	258.2	844.8	2956	8.150K	10.86K	18.10K	21.72K	36.19K	32.37K	104.9K	369.4K			
+30.2	-1	248.5	810.3	2830	7.741K	10.31K	17.19K	20.62K	34.37K	30.89K	99.80K	350.7K			
32.0	0	239.2	777.5	2710	7355	9796	16.33K	19.60K	32.66K	29.49K	94.98K	333.1K	1088K	3966K	
+33.8	+1	230.3	746.2	2596	6989	9310	15.52K	18.62K	31.03K	28.15K	90.41K	316.4K	1030K	3740K	
35.6	2	221.9	716.3	2487	6644	8851	14.75K	17.70K	29.50K	26.89K	86.09K	300.6K	975.3K	3529K	
37.4	3	213.8	687.8	2384	6319	8417	14.03K	16.84K	28.06K	25.69K	81.99K	285.7K	923.8K	3330K	
39.2	4	206.0	660.6	2286	6011	8006	13.34K	16.02K	26.69K	24.55K	78.11K	271.6K	875.2K	3144K	
41.0	5	198.6	634.6	2192	5719	7618	12.70K	15.24K	25.40K	23.46K	74.44K	258.3K	829.5K	2969K	
42.8	6	191.5	609.9	2102	5444	7252	12.09K	14.50K	24.17K	22.43K	70.96K	245.7K	786.3K	2804K	
44.6	7	184.6	586.2	2017	5183	6905	11.51K	13.81K	23.02K	21.45K	67.66K	233.8K	745.6K	2649K	
46.4	8	178.1	563.6	1936	4937	6576	10.96K	13.15K	21.92K	20.52K	64.53K	222.5K	707.2K	2504K	
48.2	9	171.9	542.1	1859	4703	6265	10.44K	12.53K	20.88K	19.63K	61.56K	211.9K	671K	2367K	
50.0	10	165.9	521.5	1785	4482	5971	9951	11.94K	19.90K	18.79K	58.75K	201.7K	636.8K	2238K	
51.8	11	160.1	501.7	1714	4273	5692	9486	11.38K	18.97K	17.98K	56.07K	192.2K	604.5K	2117K	
53.6	12	154.6	482.9	1647	4074	5427	9046	10.85K	18.09K	17.22K	53.54K	183.1K	574K	2003K	
55.4	13	149.3	464.9	1582	3886	5177	8628	10.35K	17.26K	16.49K	51.13K	174.5K	545.2K	1896K	
57.2	14	144.2	447.6	1521	3708	4939	8232	9879	16.47K	15.79K	48.84K	166.3K	518K	1795K	
59.0	15	139.4	431.2	1462	3539	4714	7857	9429	15.71K	15.13K	46.67K	158.6K	492.3K	1700K	
60.8	16	134.7	415.4	1406	3378	4500	7500	9000	15K	14.50K	44.60K	151.3K	468K	1610K	
62.6	17	130.2	400.2	1353	3226	4297	7162	8595	14.33K	13.90K	42.64K	144.3K	444.9K	1525K	
64.4	18	125.9	385.8	1302	3081	4105	6841	8209	13.68K	13.33K	40.77K	137.7K	423.2K	1446K	
66.2	19	121.7	371.9	1253	2944	3922	6536	7844	13.07K	12.79K	38.99K	131.4K	402.6K	1370K	
68.0	20	117.7	358.6	1206	2814	3748	6247	7497	12.50K	12.26K	37.30K	125.5K	383.1K	1299K	
69.8	21	113.9	345.9	1161	2690	3583	5972	7167	11.94K	11.77K	35.70K	119.8K	364.6K	1232K	
71.6	22	110.2	333.7	1118	2572	3426	5710	6853	11.42K	11.29K	34.17K	114.5K	347.1K	1169K	
73.4	23	106.7	322.0	1077	2460	3277	5462	6554	10.92K	10.84K	32.71K	109.4K	330.6K	1110K	
75.2	24	103.3	311.8	1038	2354	3135	5225	6272	10.45K	10.41K	31.32K	104.5K	314.9K	1053K	
77.0	25	100.0	300.0	1000	2252	3000	5000	6000	10.00K	10.00K	30.00K	100.0K	300.0K	1000K	
78.8	26	96.9	289.7	963.9	2156	2872	4787	5744	9574	9605	28.74K	95.51K	285.9K	949.7K	
80.6	27	93.8	279.8	929.4	2064	2750	4583	5499	9165	9227	27.54K	91.34K	272.5K	902.2K	
82.4	28	90.9	270.3	896.3	1977	2633	4389	5267	8779	8867	26.4K	87.38K	259.8K	857.2K	
84.2	29	88.1	261.1	864.5	1894	2523	4204	5046	8410	8523	25.31K	83.6K	247.8K	814.7K	
86.0	30	85.4	252.4	834.0	1815	2417	4029	4836	8060	8194	24.27K	80.00K	236.4K	774.5K	
87.8	31	82.8	243.9	804.8	1739	2317	3861	4633	7722	7880	23.28K	76.58K	225.6K	736.5K	
89.6	32	80.3	235.9	776.8	1667	2221	3702	4441	7402	7579	22.33K	73.32K	215.3K	700.5K	
91.4	33	77.8	228.1	749.9	1599	2130	3549	4260	7100	7291	21.43K	70.22K	205.5K	666.4K	
93.2	34	75.5	220.6	724.1	1533	2042	3404	4084	6807	7016	20.57K	67.26K	196.2K	634.1K	
95.0	35	73.2	213.4	699.4	1471	1959	3266	3919	6532	6752	19.74K	64.44K	187.4K	603.6K	
96.8	36	71.1	206.5	675.6	1412	1880	3134	3762	6270	6500	18.96K	61.75K	179K	574.6K	
98.6	37	69.0	199.8	652.7	1355	1805	3008	3610	6017	6258	18.21K	59.19K	171K	547.2K	
100.4	38	67.0	193.4	630.8	1301	1733	2888	3466	5777	6026	17.49K	56.75K	163.5K	521.2K	
102.2	39	65.0	187.3	609.7	1249	1664	2773	3328	5546	5805	16.8K	54.42K	156.3K	496.6K	
104.0	40	63.1	181.4	589.5	1200	1598	2663	3197	5329	5592	16.15K	52.19K	149.4K	473.2K	
105.8	41	61.3	175.7	570.0	1152	1535	2559	3069	5116	5389	15.52K	50.07K	142.9K	451K	
107.6	42	59.6	170.2	551.2	1107	1475	2459	2949	4916	5193	14.92K	48.04K	136.7K	430K	
109.4	43	57.9	164.9	533.2	1064	1418	2363	2835	4725	5006	14.35K	46.11K	130.8K	410K	
111.2	44	56.2	159.8	515.9	1023	1363	2272	2726	4543	4827	13.8K	44.26K	125.1K	391.1K	
113.0	45	54.7	154.9	499.2	983.8	1310	2184	2621	4369	4655	13.28K	42.5K	119.8K	373.1K	
114.8	46	53.1	150.1	483.2	946.2	1260	2101	2521	4202	4489	12.77K	40.81K	114.7K	356.1K	
116.6	47	51.7	145.6	467.8	910.2	1212	2021	2425	4042	4331	12.29K	39.2K	109.8K	339.8K	
118.4	48	50.2	141.2	452.9	875.8	1167	1944	2333	3889	4179	11.83K	37.66K	105.2K	324.4K	
120.2	49	48.9	137.0	438.6	842.8	1123	1871	2246	3743	4033	11.39K	36.19K	100.8K	309.8K	
122.0	50	47.5	132.9	424.8	811.3	1081	1801	2162	3603	3893	10.97K	34.78K	96.54K	295.9K	
123.8	51	46.2	128.9	411.6	781.1	1040	1734	2081	3469	3758	10.57K	33.44K	92.52K	282.7K	
125.6	52	45.0	125.1	398.8	752.2	1002	1670	2004	3340	3629	10.18	32.15K	88.69K	270.1K	
127.4	53	43.8	121.5	386.5	724.5	965.0	1608	1930	3217	3504	9807	30.92K	85.04K	258.1K	
129.2	54	42.6	117.9	374.7	697.9	929.6	1549	1859	3099	3385	9450	29.74K	81.55K	246.7K	
131.0	55	41.5	114.5	363.2	672.5	895.8	1493	1792	2986	3270	9109	28.61K	78.22K	235.9K	
132.8	56	40.4	111.2	352.2	648.1	863.3	1439	1727	2878	3160	8781	27.53K	75.04K	225.6K	
134.6	57	39.3	108.0	341.6	624.8	832.2	1387	1665	2774	3054	8467	26.5K	72.01K	215.8K	
136.4	58	38.3	105.0	331.3	602.4	802.3	1337	1605	2675	2952	8166	25.5K	69.11K	206.4K	
138.2	59	37.3	102.0	321.5	580.9	773.7	1290	1548	2580	2854	7876	24.56K	66.34K	197.5K	

Resistance versus Temperature 60 to 129°C

Thermistor Mix		L Mix	L Mix	L Mix	B Mix	B Mix	B Mix	B Mix	B Mix	H Mix	H Mix	H Mix	H Mix	H Mix
Ω at 25°C		100	300	1000	2252	3000	5000	6000	10,000	10,000	30,000	100,000	300,000	1 MEG
°F	°C													
140.0	60	36.4	99.1	311.9	560.3	746.3	1244	1493	2488	2760	7599	23.65K	63.7K	189.1K
141.8	61	35.4	96.3	302.7	540.5	719.9	1200	1440	2400	2669	7332	22.77K	61.17K	181K
143.6	62	34.5	93.7	293.9	521.5	694.7	1158	1389	2316	2582	7076	21.94K	58.75K	173.3K
145.4	63	33.7	91.1	285.3	503.3	670.4	1117	1341	2235	2497	6830	21.14K	56.44K	166K
147.2	64	32.8	88.6	277.0	485.8	647.1	1079	1294	2157	2417	6594	20.37K	54.23K	159K
149.0	65	32.0	86.1	269.0	469.0	624.7	1041	1250	2083	2339	6367	19.63K	52.12K	152.3K
150.8	66	31.2	83.8	261.3	452.9	603.3	1006.0	1207	2011	2264	6149	18.93K	50.1K	146K
152.6	67	30.4	81.5	253.9	437.4	582.6	971.1	1165	1942	2191	5940	18.25K	48.17K	139.9K
154.4	68	29.7	79.3	246.7	422.5	562.8	938.0	1126	1876	2122	5738	17.6K	46.32K	134.1K
156.2	69	29.0	77.2	239.7	408.2	543.7	906.3	1088	1813	2055	5545	16.97K	44.54K	128.6K
158.0	70	28.3	75.2	233.0	394.5	525.4	875.7	1051	1752	1990	5359	16.37K	42.85K	123.3K
159.8	71	27.6	73.2	226.5	381.2	507.8	846.4	1016	1693	1928	5180	15.8K	41.23K	118.3K
161.6	72	26.9	71.3	220.2	368.5	490.9	818.3	981.8	1636	1868	5007	15.25K	39.67K	113.5K
163.4	73	26.3	69.4	214.1	356.2	474.7	791.2	949.0	1582	1810	4842	14.72K	38.18K	108.9K
165.2	74	25.6	67.6	208.3	344.5	459.0	765.1	917.9	1530	1754	4682	14.21K	36.75K	104.5K
167.0	75	25.0	65.9	202.6	333.1	444.0	740.0	887.5	1479	1700	4529	13.72K	35.39K	100.3K
168.8	76	24.5	64.2	197.1	322.3	429.5	715.9	858.7	1431	1648	4381	13.25K	34.08K	96.31K
170.6	77	23.9	62.5	191.8	311.8	415.6	692.7	830.7	1385	1598	4239	12.79K	32.82K	92.48K
172.4	78	23.3	60.9	186.7	301.7	402.2	670.3	803.8	1340	1549	4102	12.36K	31.62K	88.82K
174.2	79	22.8	59.4	181.7	292.0	389.3	648.8	778.0	1297	1503	3970	11.94K	30.46K	85.32K
176.0	80	22.3	57.9	176.9	282.7	376.9	628.1	753.2	1255	1458	3843	11.54K	29.35K	81.98K
177.8	81	21.8	56.5	172.2	273.7	364.9	608.2	729.2	1215	1414	3720	11.15K	28.29K	78.78K
179.6	82	21.3	55.1	167.7	265.0	353.4	588.9	706.0	1177	1372	3602	10.78K	27.27K	75.71K
181.4	83	20.8	53.7	163.3	256.7	342.2	570.4	683.9	1140	1332	3489	10.42K	26.29K	72.78K
183.2	84	20.3	52.4	159.1	248.6	331.5	552.6	662.3	1104	1293	3379	10.08K	25.35K	69.98K
185.0	85	19.9	51.1	154.9	240.9	321.2	535.4	641.8	1070	1255	3273	9744	24.45K	67.29K
186.8	86	19.4	49.9	151.0	233.4	311.3	518.8	621.8	1036	1218	3172	9424	23.59K	64.72K
188.6	87	19.0	48.7	147.1	226.2	301.7	502.8	602.7	1004	1183	3073	9117	22.76K	62.26K
190.4	88	18.6	47.5	143.4	219.3	292.4	487.4	584.3	973.8	1149	2979	8821	21.96K	59.91K
192.2	89	18.2	46.4	139.8	212.6	283.5	472.6	566.4	944.1	1116	2887	8536	21.19K	57.65K
194.0	90	17.8	45.3	136.2	206.1	274.9	458.2	549.1	915.2	1084	2799	8261	20.45K	55.48K
195.8	91	17.4	44.2	132.8	199.9	266.6	444.4	532.6	887.7	1053	2714	7996	19.75K	53.41K
197.6	92	17.0	43.2	129.5	193.9	258.6	431.0	516.6	861.0	1023	2632	7741	19.07K	51.42K
199.4	93	16.6	42.1	126.3	188.1	250.9	418.2	501.2	835.3	994.2	2552	7496	18.41K	49.52K
201.2	94	16.3	41.2	123.2	182.5	243.4	405.7	486.2	810.4	966.3	2476	7259	17.78K	47.69K
203.0	95	15.9	40.2	120.2	177.1	236.2	393.7	471.8	786.4	939.3	2402	7030	17.18K	45.94K
204.8	96	15.6	39.3	117.3	171.9	229.3	382.1	458.0	763.3	913.2	2331	6810	16.6K	44.26K
206.6	97	15.3	38.4	114.4	166.9	222.6	370.9	444.7	741.1	887.9	2262	6598	16.04K	42.65K
208.4	98	15.0	37.5	111.7	162.0	216.1	360.1	431.6	719.4	863.4	2195	6393	15.5K	41.1K
210.2	99	14.6	36.7	109.0	157.3	209.8	349.7	419.1	698.5	839.7	2131	6195	14.98K	39.62K
212.0	100	14.3	35.8	106.4	152.8	203.8	339.6	407.1	678.5	816.8	2069	6005	14.48K	38.2K
213.8	101				148.4	197.9	329.8	395.4	659.0	794.6	2009	5821	14K	36.84K
215.6	102				144.2	192.2	320.4	384.2	640.3	773.1	1950	5643	13.54K	35.53K
217.4	103				140.1	186.8	311.3	373.3	622.1	752.3	1894	5472	13.09K	34.27K
219.2	104				136.1	181.5	302.5	362.6	604.4	732.1	1840	5307	12.66K	33.06K
221.0	105				132.3	176.4	294.0	352.5	587.5	712.6	1788	5147	12.25K	31.91K
222.8	106				128.6	171.4	285.7	342.6	571.0	693.6	1737	4993	11.86K	30.79K
224.6	107				125.0	166.7	277.8	333.0	555.1	675.3	1688	4844	11.47K	29.72K
226.4	108				121.6	162.0	270.1	324.0	540.0	657.5	1640	4700	11.11K	28.69K
228.2	109				118.2	157.6	262.6	314.9	524.9	640.3	1594	4561	10.75K	27.71K
230.0	110				115.0	153.2	255.4	306.4	510.7	623.5	1550	4427	10.41K	26.76K
231.8	111				111.8	149.0	248.4	297.9	496.4	607.3	1507	4297	10.08K	25.84K
233.6	112				108.8	145.0	241.6	289.9	483.1	591.6	1465	4172	9763	24.96K
235.4	113				105.8	141.1	235.1	281.9	469.8	576.4	1425	4051	9456	24.12K
237.2	114				103.0	137.2	228.7	274.4	457.4	561.6	1386	3933	9161	23.31K
239.0	115				100.2	133.6	222.6	267.0	444.9	547.3	1348	3820	8876	22.52K
240.8	116				97.6	130.0	216.7	260.0	433.4	533.4	1311	3711	8601	21.77K
242.6	117				95.0	126.5	210.9	253.1	421.8	519.9	1276	3605	8336	21.05K
244.4	118				92.5	123.2	205.3	246.4	410.7	506.8	1241	3502	8080	20.35K
246.2	119				90.0	119.9	199.9	239.8	399.6	494.1	1208	3403	7832	19.68K
248.0	120				87.7	116.8	194.7	233.7	389.4	481.8	1176	3307	7594	19.03K
249.8	121				85.4	113.8	189.6	227.5	379.2	469.8	1145	3214	7364	18.41K
251.6	122				83.2	110.8	184.7	221.7	369.4	458.2	1114	3124	7142	17.81K
253.4	123				81.1	107.9	179.9	216.1	360.1	446.9	1085	3038	6927	17.23K
255.2	124				79.0	105.2	175.3	210.5	350.8	435.9	1057	2953	6720	16.68K
257.0	125				77.0	102.5	170.8	205.2	341.9	425.3	1029	2872	6519	16.14K
258.8	126				75.0	99.9	166.4	199.8	333.0	414.9	1002	2793	6326	15.62K
260.6	127				73.1	97.3	162.2	194.8	324.6	404.9	976.3	2717	6139	15.12K
262.4	128				71.3	94.9	158.1	190.0	316.6	395.1	951.1	2643	5958	14.64K
264.2	129				69.5	92.5	154.1	185.2	308.6	385.6	926.7	2571	5784	14.18K

Resistance versus Temperature 130 to 199°C

Thermistor Mix		L Mix	L Mix	L Mix	B Mix	B Mix	B Mix	B Mix	B Mix	H Mix	H Mix	H Mix	H Mix	H Mix	
Ω at 25°C		100	300	1000	2252	3000	5000	6000	10,000	10,000	30,000	100,000	300,000	1 MEG	
°F	°C														
266.0	130				67.8	90.2	150.3	180.6	301.1	376.4	903.0	2501	5615	13.74K	
267.8	131				66.1	87.9	146.5	176.1	293.5	367.4	880.0	2434	5452	13.31K	
269.6	132				64.4	85.7	142.9	171.6	286.0	358.7	857.7	2369	5294	12.89K	
271.4	133				62.9	83.6	139.4	167.6	279.3	350.3	836.1	2306	5141	12.49K	
273.2	134				61.3	81.6	136.0	163.3	272.2	342.0	815.0	2244	4994	12.1K	
275.0	135				59.8	79.6	132.6	159.3	265.5	334.0	794.6	2185	4851	11.73K	
276.8	136				58.4	77.6	129.4	155.6	259.3	326.3	774.8	2128	4713	11.37K	
278.6	137				57.0	75.8	126.3	151.9	253.1	318.7	755.6	2072	4580	11.02K	
280.4	138				55.6	73.9	123.2	148.1	246.9	311.3	736.9	2018	4450	10.69K	
282.2	139				54.3	72.2	120.3	144.7	241.1	304.2	718.8	1965	4325	10.36K	
284.0	140				53.0	70.4	117.4	141.2	235.3	297.2	701.2	1914	4204	10.05K	
285.8	141				51.7	68.8	114.6	137.7	229.6	290.4	684.1	1865	4087	9746	
287.6	142				50.5	67.1	111.9	134.5	224.2	283.8	667.5	1817	3974	9455	
289.4	143				49.3	65.5	109.2	131.3	218.9	277.4	651.3	1770	3864	9173	
291.2	144				48.2	64.0	106.7	128.4	214.0	271.2	635.6	1725	3757	8901	
293.0	145				47.0	62.5	104.2	125.2	208.7	265.1	620.3	1681	3654	8637	
294.8	146				45.9	61.1	101.8	122.3	203.8	259.2	605.5	1639	3555	8383	
296.6	147				44.9	59.6	99.4	119.6	199.4	253.4	591.1	1598	3458	8137	
298.4	148				43.8	58.3	97.1	116.7	194.5	247.8	577.1	1558	3364	7899	
300.2	149				42.8	56.9	94.9	114.0	190.1	242.3	563.5	1519	3274	7669	
302.0	150				41.8	55.6	92.7	111.5	185.9	237.0	550.2	1481	3186	7447	
303.8	151				40.9	54.5	90.8	109.0	181.7	231.7	537.7				
305.6	152				40.0	53.3	88.8	106.5	177.5	226.6	525.1				
307.4	153				39.1	52.1	86.8	104.1	173.5	221.7	512.9				
309.2	154				38.2	50.9	84.9	101.8	169.6	216.9	501.0				
311.0	155				37.3	49.7	82.9	99.4	165.7	212.2	489.3				
312.8	156				36.5	48.7	81.1	97.3	162.1	207.6	478.1				
314.6	157				35.7	47.6	79.3	95.1	158.5	203.2	467.2				
316.4	158				34.9	46.5	77.6	93.0	155.0	198.8	456.6				
318.2	159				34.1	45.5	75.9	91.0	151.6	194.6	446.2				
320.0	160				33.4	44.5	74.2	89.0	148.3	190.5	436.1				
321.8	161				32.7	43.5	72.6	87.1	145.1	186.5	426.3				
323.6	162				32.0	42.6	71.0	85.2	141.9	182.6	416.7				
325.4	163				31.3	41.7	69.5	83.3	138.4	178.7	407.4				
327.2	164				30.6	40.8	68.0	81.5	135.8	175.0	398.3				
329.0	165				29.9	39.9	66.4	79.7	132.8	171.4	389.5				
330.8	166				29.3	39.0	65.1	78.1	130.1	167.8	380.8				
332.6	167				28.7	38.2	63.7	76.4	127.3	164.4	372.4				
334.4	168				28.1	37.4	62.3	74.8	124.6	161.0	364.3				
336.2	169				27.5	36.6	61.0	73.2	122.0	157.7	356.3				
338.0	170				26.9	35.8	59.7	71.7	119.4	154.5	348.6				
339.8	171				26.3	35.1	58.5	70.1	116.9	151.4	341.0				
341.6	172				25.9	34.3	57.3	68.7	114.5	148.3	333.6				
343.4	173				25.2	33.6	56.1	67.3	112.1	145.3	326.4				
345.2	174				24.7	32.9	54.9	65.9	109.8	142.4	319.4				
347.0	175				24.2	32.2	53.8	64.5	107.5	139.6	312.7				
348.8	176				23.7	31.6	52.7	63.2	105.3	136.8	305.9				
350.6	177				23.2	30.9	51.6	61.9	103.2	134.1	299.4				
352.4	178				22.8	30.3	50.5	60.7	101.1	131.5	293.1				
354.2	179				22.3	29.7	49.5	59.4	99.0	128.9	286.9				
356.0	180				21.9	29.1	48.6	58.2	97.1	126.3	281.0				
357.8	181				21.4	28.5	47.5	57.1	95.1	123.9	275.0				
359.6	182				21.0	27.9	46.6	55.9	93.2	121.5	269.3				
361.4	183				20.6	27.4	45.6	54.8	91.3	119.1	263.7				
363.2	184				20.2	26.8	44.7	53.7	89.5	116.8	258.3				
365.0	185				19.8	26.3	43.8	52.7	87.8	114.6	253.0				
366.8	186				19.4	25.8	43.0	51.6	86.0	112.4	247.7				
368.6	187				19.0	25.3	42.1	50.6	84.3	110.2	242.7				
370.4	188				18.6	24.8	41.3	49.6	82.7	108.1	237.7				
372.2	189				18.3	24.3	40.5	48.6	81.1	106.1	232.9				
374.0	190				17.9	23.8	39.7	47.7	79.5	104.1	228.2				
375.8	191				17.6	23.4	39.0	46.8	78.0	102.2	223.6				
377.6	192				17.2	22.9	38.2	45.9	76.5	100.2	219.1				
379.4	193				16.9	22.5	37.5	45.0	75.1	98.4	214.7				
381.2	194				16.6	22.1	36.8	44.2	73.7	96.6	210.4				
383.0	195				16.3	21.7	36.1	43.4	72.3	94.8	206.2				
384.8	196				16.0	21.3	35.5	42.6	70.9	93.0	202.1				
386.6	197				15.7	20.9	34.8	41.8	69.6	91.3	198.2				
388.4	198				15.4	20.5	34.2	41.0	68.3	89.7	194.2				
390.2	199				15.1	20.2	33.5	40.2	67.1	88.0	190.4				

Resistance versus Temperature 200 to 250°C

Thermistor Mix		<i>L Mix</i>		<i>L Mix</i>		<i>B Mix</i>		<i>B Mix</i>		<i>B Mix</i>		<i>B Mix</i>		<i>B Mix</i>		<i>H Mix</i>		<i>H Mix</i>		<i>H Mix</i>		<i>H Mix</i>		<i>H Mix</i>				
Ω at 25°C		100	300	1000	2252	3000	5000	6000	10,000	10,000	30,000	100,000	300,000	1 MEG														
°F	°C																											
392.0	200				14.9	19.8	32.9	39.6	65.9	86.5	186.7																	
393.8	201						32.3	38.8	64.7	84.9	183.1																	
395.6	202						31.7	38.1	63.5	83.3	179.5																	
397.4	203						31.2	37.4	62.3	81.9	176.0																	
399.2	204						30.6	36.7	61.2	80.4	172.6																	
401.0	205						30.0	36.0	60.1	79.0	169.3																	
402.8	206						29.5	35.4	59.0	77.6	166.1																	
404.6	207						29.0	34.8	58.0	76.2	162.9																	
406.4	208						28.5	34.2	57.0	74.9	159.8																	
408.2	209						28.0	33.6	56.0	73.6	156.8																	
410.0	210							27.5	33.0	55.0	72.3	153.8																
411.8	211							27.0	32.4	54.0	71.0	150.9																
413.6	212							26.5	31.8	53.1	69.8	148.1																
415.4	213							26.1	31.3	52.1	68.6	145.3																
417.2	214							25.6	30.7	51.2	67.4	142.6																
419.0	215							25.1	30.2	50.3	66.2	139.9																
420.8	216							24.7	29.7	49.5	65.1	137.3																
422.6	217							24.3	29.2	48.6	64.0	134.8																
424.4	218							23.9	28.7	47.8	62.9	132.3																
426.2	219							23.5	28.2	47.0	61.8	129.9																
428.0	220							23.1	27.7	46.2	60.8	127.5																
429.8	221							22.7	27.2	45.4	59.8	125.2																
431.6	222							22.3	26.8	44.7	58.8	122.9																
433.4	223							22.0	26.3	43.9	57.8	120.7																
435.2	224							21.6	25.9	43.2	56.8	118.5																
437.0	225							21.3	25.5	42.5	55.9	116.3																
438.8	226							20.9	25.0	41.8	55.0	114.3																
440.6	227							20.5	24.6	41.1	54.1	112.2																
442.4	228							20.2	24.2	40.4	53.2	110.2																
444.2	229							19.9	23.8	39.7	52.3	108.3																
446.0	230							19.5	23.4	39.1	51.5	106.4																
447.8	231							19.2	23.1	38.5	50.6	104.5																
449.6	232							18.9	22.7	37.8	49.9	102.6																
451.4	233							18.6	22.3	37.2	49.0	100.8																
453.2	234							18.3	22.0	36.6	48.2	99.1																
455.0	235							18.0	21.6	36.0	47.4	97.3																
456.8	236							17.7	21.3	35.5	46.7	95.7																
458.6	237							17.4	20.9	34.9	46.0	94.0																
460.4	238							17.1	20.6	34.4	45.2	92.4																
462.2	239							16.9	20.3	33.8	44.5	90.8																
464.0	240							16.6	20.0	33.3	43.8	89.2																
465.8	241							16.3	19.6	32.8	43.1	87.7																
467.6	242							16.1	19.3	32.2	42.4	86.2																
469.4	243							15.8	19.0	31.7	41.8	84.8																
471.2	244							15.6	18.7	31.3	41.1	83.3																
473.0	245							15.3	18.5	30.8	40.5	81.9																
474.8	246							15.1	18.2	30.3	39.9	80.5																
476.6	247							14.9	17.9	29.8	39.3	79.2																
478.4	248							14.6	17.6	29.4	38.7	77.9																
480.2	249							14.4	17.4	28.9	38.1	76.6																
482.0	250							14.2	17.1	28.5	37.5	75.3																

For more information,
 contact us at 800 747-5367 or
 937 767-7241 • Fax 937 767-9353
 Info@YSI.com • www.YSI.com

Glossary

316SS A stainless steel containing approximately 2% Mn, 2% Mo, 12% Ni and 17% Cr, with the balance Fe and trace C, S, P and Si.

Absolute zero The lowest possible temperature; the temperature at which thermal energy is at a minimum. Defined as 0 Kelvin or -273.15°C .

Accuracy Measure of the closeness of a reading to the actual value.

Ambient range In general, the human environmental range, -20 to $+50^{\circ}\text{C}$. The industrial application ambient range is 0 to 70°C , the military range is -55 to $+125^{\circ}\text{C}$.

Ambient temperature Temperature of the background or surrounding environment.

Ampere (A) SI unit of electric current.

AWG American Wire Gauge.

Beta value An indicator of the shape of the resistance vs temperature curve.

$$\beta = \ln(R_T/R_{T_0}) / (1/T - 1/T_0)$$

Calibration Documenting a sensor's value as determined by a precise measurement.

Celsius (Centigrade, $^{\circ}\text{C}$) A temperature scale defined by setting the ice point of water at 0°C and the boiling point of water at 100°C .

CE Mark Signifies product acceptance by the European Community. The Joint European Standards Institution.

Control point The temperature at which the controlled system is to be maintained.

Current (I) The rate of flow of an electric charge, usually expressed in amperes.

Current proportioning A type of temperature controller which provides a control current proportional to the difference between the measured temperature and the control point.

Direct current (dc) Current that flows in one direction only. The type of current that is supplied by batteries.

Degree ($^{\circ}$) An increment of a temperature scale. The size of a degree is different in different temperature scales; for example, $1^{\circ}\text{C} = 1.8^{\circ}\text{F}$

De-rated A deliberate reduction in the rating of a component to improve reliability.

Deviation The difference between an observed and a fixed value; the difference between the observed temperature and the set point of the controller.

Dielectric Any material capable of sustaining a steady electric field; an insulator.

Differential The difference between the temperature at which a controller turns heat off and the temperature at which the heat is turned on, in degrees.

Dissipation constant The ratio of power dissipation to temperature rise induced when current is applied to a thermistor (e.g. $8\text{mW}^{\circ}\text{C}$ represents a 1°C temperature rise for every 8mW of power dissipated).

Drift A slow variation of any performance characteristic of a device or circuit.

Dumet A copper-clad, nickel-iron alloy with a thermal expansion closely matching that of glass. Provides hermetic seals in soft glasses.

emf Electromotive force. Difference of electrical potential that drives currents through circuits. Unit is the volt.

Epoxy A flexible resin used in coatings and adhesives. Also called epoxy resin.

Error The difference between the correct or desired value and the actual reading.

Fahrenheit A temperature scale defined by setting the freezing point of water at 32°C and the boiling point of water at 212°C .

Galvanometer An instrument that measures small electrical currents by means of deflecting magnetic coils.

Ground A conducting path between an electrical circuit and the earth or some conductor serving in its place.

GSFC S-311-P-18 A specification issued by the Goddard Space Flight Center covering thermistors for use in space flight.

Heat Energy in the process of transferring between a system and its surroundings as a result of temperature differences.

Heat transfer The process whereby thermal energy flows from a high energy body to a low energy body via conduction, convection or radiation.

Hermetic Airtight

Hysteresis The retardation or lagging of an effect behind the cause of the effect.

ID Inside diameter.

Input impedance The small signal impedance measured between the input terminals of a network.

Insulation resistance The resistance between two conductors, or between a conductor and ground, when they are separated only by insulating material.

Interchangeable Able to substitute one sensor for another while maintaining consistent readings.

Interchangeability error A measurement error that can occur if two or more probes are used to make the same measurement. It is caused by a slight variation in characteristics of different probes.

Isothermal Occurring at constant temperature.

ITS-90 International Temperature Scale of 1990.

Kelvin (K) An absolute temperature scale based on the Celsius scale; the thermodynamic temperature scale. One kelvin is the same temperature interval as one degree Celsius, and $0\text{K} = -273.15^\circ\text{C}$.

Linearity deviation The difference between the actual response of a device and its theoretical straight-line approximation.

Maximum operating temperature The temperature above which a device will not safely operate.

Maximum power rating The maximum power that a device can safely handle.

Metrology The science of measuring.

Mica A transparent mineral used to make the cross supporting the platinum wire windings in an SPRT. One of the best electrical insulators.

Microamp (μA) One millionth of an ampere, 10^{-6} A.

MIL-R-23648 The US Department of Defense general specification for thermistors.

Milliamp (mA) One thousandth of an ampere, 10^{-3} A.

Millivolt (mV) One thousandth of a volt, 10^{-3} V.

Negative temperature coefficient (NTC) Decreasing resistance with increasing temperature.

NIST National Institute of Standards and Technology. The US government agency that defines measurement standards in the United States.

NPT National Pipe Thread.

OD Outer diameter.

Offset The difference in temperature between the set point and the actual process temperature.

Ohms (Ω) SI unit of electrical resistance.

Ohm's law A relationship between voltage (emf), current and resistance in an electrical component carrying direct current. $E = IR$.

On/Off controller A temperature controller that turns a heater fully on or fully off.

Operating Range The specified range over which a device is expected to operate.

Platinum resistance element An element made of platinum whose resistance varies with temperature.

Positive temperature coefficient (PTC) Increasing resistance with increasing temperature.

Power (p) Rate of doing work, in Watts (W).

Probe Usually refers to a sensing element built into a housing that is physically suitable for insertion into the environment or substance to be measured.

PVC Polyvinyl chloride.

Range An area between two limits within which a sensor or instrument is operational; the extent of the sensor's or instrument's capabilities.

Rankine ($^\circ\text{R}$) An absolute temperature scale based on the Fahrenheit scale, where one degree Rankine is the same temperature interval as one degree Fahrenheit, and $0^\circ\text{R} = -459.67^\circ\text{F}$.

Repeatability The ability of a sensor or instrument to give the same reading or output under repeated identical conditions.

Resistance (R) The resistance to the flow of electric current measured in ohms (Ω).

Resistance ratio The ratio of the resistance of a thermistor at two different temperatures, usually resistance at 25°C to resistance at 125°C (R_{25}/R_{125}).

Resistor An electrical component designed to provide a known resistance.

Response time The time required to change the output of an electronic circuit after a sudden change in input. Used by YSI as the time required to sense 90% of a temperature change. See Time Constant.

Selection The examination of a device for compliance to a specific characteristic, usually associated with size or measurement tolerance.

Self-heating The effect of driving, usually resistive devices, at a level which induces a bias in the measured value.

Sensitivity The minimum change in temperature to which the instrument or sensor will respond.

Set point The temperature which a controller is set to maintain.

SI System Internationale. The standard metric system of units.

Sinter To form small particles into larger particles, cakes or masses by heating without liquifying.

SMD Surface-mount device.

SMT Surface-mount thermistor.

Solid wire A wire with no stranding.

Span The difference between the upper and lower limits of a range.

SPRT Standard Platinum Resistance Thermometer. A primary temperature standard calibrated to fixed-points of nature such as the triple-point of water.

Stability The ability of an instrument or sensor to maintain a constant output given a constant input.

Steinhart & Hart equation An equation which calculates resistance as a function of temperature for negative temperature coefficient thermistors.

Stranded wire Wire whose conductor is woven from individual wires or strands.

Teflon DuPont trademark name for polytetrafluoroethylene. Used to insulate electrical conductors. Noted for its chemical inertness and heat resistance.

Temperature A measure of the degree of hotness or coolness of some sample. Temperature is to heat, what voltage is to power.

Temperature scale The scale assigned to allow determination of temperature. The International Practical Temperature Scale is reviewed for fit to the thermodynamic scale at approximately 20-year intervals. There are four practical scales, Celsius °C, Kelvin K, Fahrenheit °F, Rankine °R, and one theoretical scale, the Thermodynamic Temperature Scale. The scales differ in end points and value of divisions.

Thermal conductivity The ability of a material to conduct thermal energy.

Thermal expansion An increase in size due to an increase in temperature.

Thermal gradient The distribution of a differential temperature through a body or across a surface.

Thermal shock The shock which results when a body is subject to sudden changes in temperature.

Thermilinear component Two or three thermistor disks built into one bead which, when used in a network, provides a linear resistance vs temperature curve.

Thermilinear network One Thermilinear component and two or three resistors that can be wired to provide linear resistance response to temperature.

Thermistor A temperature-sensitive resistor made of metal oxides sintered into a disk which exhibits a large change in resistance for a small change in temperature.

Time constant The time required for a sensor to register 63.3% of a change in temperature.

Tolerance The range between allowable maximum and minimum values.

UL Underwriters Laboratories, Inc. An independent laboratory that establishes standards for commercial and industrial products.

Volt (E) SI unit of electrical potential difference.

Voltage An electrical potential measured in volts.

Voltage divider Usually a series of resistors used to divide the supply voltage in proportion to the value of each resistor in the string.

Watt SI unit of power.

Wheatstone bridge A network of four resistances, an emf source and a galvanometer connected so that when the four resistances are matched, the galvanometer will show a zero deflection or null reading.

Zero power resistance The resistance of a thermistor with no power being dissipated.

Sales Policy

New Accounts

To quickly qualify for open account status, please supply this information to our credit manager:

- Dun & Bradstreet rating or Duns number
- Two credit references from vendors
- Bank reference
- Name of chief executive officer or president
- Name of treasurer
- Name of controller
- Credit limit desired

Terms of Sale

Net 30 days from invoice date. We observe these terms rigidly. Failure to meet them may result in non-acceptance of new orders. Shipping prepaid and added, FOB Yellow Springs, Ohio.

OEM and Contract Discounts

Qualification for OEM discounts requires that these conditions be met:

- Use of YSI product in a fashion that's integral with the product—wired in.
- Description of application in the simplest non-proprietary terms.
- Expected use rate
- Permission to advertise if use is not proprietary.
- We will negotiate all agreements based on product and volume. Basically all purchases of similar products may be mixed for discount. Delivery schedules are a significant factor in developing the terms of a purchase agreement.
- Contact your local manufacturers' representative or YSI Customer Service.

Order Change and Cancellation

Our terms for order cancellation or change are:

- Any cancellation of orders for stock products after order entry must be 30 days before shipping date.
- Any cancellation after order entry of build-to-order or build-to-specification products will be subject to a minimum \$50 or 15% charge, whichever is greater
- Any order for which material or labor have been expended will carry cancellation charges equal to the percentage completed or \$50, whichever is greater.
- Any customer change which adds cost to the manufacture of products will be charged at normal overhead and profit.

Returned Goods

We will accept for return certain of our products.

- Cataloged thermistors
- Certain other products which have been negotiated before order placement.

Return for credit requires:

- Customer Service gives prior approval, RA number and shipping instructions
- Products are in new condition
- Products are not obsolete

Minimum Orders

Our minimum order requirements are:

- For thermistor components, 100 pieces. For smaller quantities, contact our distributors or stocking representatives.
- For all types of sensor assemblies (mixed), \$75.

Exceptional Service

Expected delivery for manufactured-to-order products is normally 4 weeks. When standard delivery needs to be improved with certainty, we offer exceptional service.

A. Two-week delivery assuming material availability for all pre-engineered products.

B. Best possible delivery will include full force effort (overtime) to complete and ship the product in minimum time.

Additional charges for A service are 25% of the normal price and 50% for B service.

On occasion, because of material shortages, exceptional service will be unable to meet your needs. Call Customer Service to establish that materials are available.

Limited Warranty

We warrant our products against defects in materials and workmanship when the products are used according to their ratings and specifications. Our maximum liability is limited to repair or replacement (at our option) of defective products.

For sensors, sensor assemblies and special products, the warranty period is 1 year from shipment date. We will handle warranty repairs and replacements expeditiously. Contact Customer Service for instructions and best turn-around time.

For more information,
contact us at **800 747-5367** or
937 427-1231 • Fax 937 427-1640
Info@YSI.com • www.YSI.com

Contacting the YSI Precision Temperature Group

For order placement and product information:

Ph 800.747.5367 (US)
937.427.1231, Option 1
Fax: 937 427-1640
Email: bpetrus@ysis.com (Bob Petrus)
phenry@ysis.com (Phyllis Henry)

YSI Precision Temperature Group accepts purchase orders (with approved credit), payment in advance (via Visa or Mastercard) and checks. Special payment terms are available for international orders.

YSI Precision Temperature Group takes orders direct, sells through distributors, and has Manufacturer's Representatives located throughout the United States. Small quantity orders, particularly thermistors, should be forwarded to the nearest distributor. Below is a list of YSI Distributors and Manufacturer's Representatives in the United States. If you are located outside the U.S., please contact YSI Temperature Products Customer Service for your nearest Distributor or to purchase direct.

YSI Precision Temperature Group

Thermistor Distributors

YSI distributors stock YSI Precision Thermistors and Thermilinear components. Orders for less than 100 units must be directed to them.

Andruss-Peskin Corp.
P.O. Box 268
63 S. Main St.
Natick, MA 01760-0268
(508) 653-3919
800 878-3919
Fax: (508) 651-1924

RDP Corporation
5877 Huberville Avenue
Dayton, OH 45431
(937) 253-6175
Fax: (937) 254-1951

BJ Wolfe Enterprises
5321 Derry Ave., Unit E
Agoura Hills, CA 91301
818 889-8412
800 554-1224
Fax: 818 889-8417

Computer Aided Solutions
8588 Mayfield Road
Chesterland, OH 44026
(440) 729-2570
Fax: (440) 729-2257

RJM Sales
454 Park Avenue
Scotch Plains, NJ 07076
800 752-9055
(908) 322-7880
Fax: (908) 322-2160

Finnan Engineered Prod.
1149 Bellamy Rd. N., Unit 22
Scarborough, Ontario
M1H 1H7
(416) 438-6070
Fax: (416) 438-8739

Newark Electronics
4810 N. Ravenswood
Chicago, IL 60624
(800) 367-3573
Fax: (312) 275-9050

Thermx of California
31363 Medallion Drive
Hayward, CA 94544
800 300-1161
(510) 441-7566
Fax: (510) 441-2414

YSI Precision Temperature Group

Manufacturer's Representatives

Manufacturer's Representatives are available in your area for technical and purchasing support of YSI Precision Temperature Group products.

Analog Associates
Oakland, CA 94602
510 531-8896
Fax: 510 531-8897
Email: analog@ccnet.com
www.analogassociates.com

Quadra Sales Corporation
Beaverton, OR 97008
503 626-7550
Fax: 503 626-6960
Email: quadraor@aol.com
www.quadrasales.com

Sales Technology Inc.
Ft. Collins, CO 80525
303 530-9409
Fax: 970 663-0809
Email: bobshil@aol.com

Andruss-Peskin Corp.
Natick, MA 01760-0268
508 653-3919
800 878-3919
Fax: 508 651-1924
Email:
sales@andruss-peskin.com
www.andruss-peskin.com

Quantum Measurements
Hoover, AL 35226
205 824-3380
Fax: 205 824-3315
Email: qmcglenn@aol.com

Advanced Industrial Sys
Chesterfield, MO 63005
314 532-2477
Fax: 314 532-7385
Email: sales@advindsys.com
www.advindsys.com

Quantum Measurements
Lutz, FL 33549
813 909-8322
Fax: 813 909-8622
Email: qmcfl@aol.com

EQS Systems
Chesterland, OH 44026
440 729-2222
800 729-8084
Fax: 440 729-2257
Email: sales@eqssystem.com
www.eqssystem.com

Quantum Measurements
Smyrna, GA 30080
770 433-0093
Fax: 770 433-9254
Email: qmcrandy@aol.com

K-Technologies, Inc.
Minneapolis, MN 55431
612 835-7615
Fax: 612 835-0180
Email: jkresse@hotmail.com

RJM Sales
Scotch Plains, NJ 07076
908 322-7880
800 752-9055
Fax: 908 322-2160
Email: rjmnj@aol.com
www.rjmsales.com

Quadra Sales Corporation
Bothell, WA 98011
425 489-3428
Fax: 425 486-5784
Email: quadrawa@aol.com
www.quadrasales.com

RJM Sales
Chadds Ford, PA 19317
610 358-4014
Fax: 610 358-3776
Email: rjmpa@aol.com
www.rjmsales.com

Technical Component Sales of
Southern California
Costa Mesa, CA 92626
714 444-2276
Fax: 714 444-2278
Email:
techcompsales@earthlink.net
www.sensortek.com

Canada -
Hoskin Scientific Ltd.
Vancouver, BC, V5T 1J7
604 872-7894
Fax: 604 872-0281
Email: salesv@hoskin.ca

Hoskin Scientific Ltd.
Burlington, Ontario, L7L 5L6
905 333-5510
Fax: 905 333-4976
Email: salesb@hoskin.ca

Hoskin Scientific Ltd.
Montreal, Quebec, H4P 2L1
514 735-5267
Fax: 514 735-3454
Email: salesm@hoskin.ca