

UNITED STATES DEPARTMENT OF COMMERCE
Alexander B. Trowbridge, Secretary
NATIONAL BUREAU OF STANDARDS A. V. Astin, Director



TECHNICAL NOTE 430
ISSUED OCTOBER 9, 1967

**Designs for Surveillance of the Volt Maintained
by a Small Group of Saturated Standard Cells**

W. G. Eicke

Electricity Division
Institute for Basic Standards
National Bureau of Standards
Washington, D.C. 20234

J. M. Cameron

Applied Mathematics Division
Institute for Basic Standards
National Bureau of Standards
Washington, D.C. 20234

NBS Technical Notes are designed to supplement the Bureau's regular publications program. They provide a means for making available scientific data that are of transient or limited interest. Technical Notes may be listed or referred to in the open literature.

FOREWORD

When a local standard such as that for electromotive force is maintained by a group of standards, procedures must be established to provide evidence that the group has maintained its original value. One also needs methods for the transfer of the value to test items that provide efficient use of measurement effort while monitoring the measurement process and providing information for updating the values of process parameters. Solutions to the more general problem of transferring the value from laboratory to laboratory and of maintaining agreement among laboratories depend on the existence of control within the laboratories.

This note is one of a number of contemplated reports having the general aim of providing methods for the surveillance of measurement processes with emphasis on the amount and kind of information needed for the estimation and control of the uncertainty in measurement.

August 1967

M. B. Wallenstein
Acting Director,
Institute for Basic
Standards

Designs for Surveillance of the Volt Maintained by a Small Group of Saturated Standard Cells

W. G. Eicke
Electricity Division
Electrochemistry Section

and

J. M. Cameron
Applied Mathematics Division
Statistical Engineering Laboratory

This technical note describes a procedure for maintaining surveillance over a small group of saturated standard cells. The measurement process is briefly discussed and the principle of left-right balance as a means of eliminating certain systematic errors is developed. Specific designs and their analysis for intercomparing 3, 4, 5 and 6 cells in a single temperature controlled environment are given. Procedures for setting up control charts on the appropriate parameters are given, and a technique is described for detecting certain types of systematic errors.

Key words: Control charts, experiment design, saturated standard cells, standard cells calibration, statistics, voltage standard.

I. INTRODUCTION

At the local level the primary standard of electromotive force is maintained by a group of saturated standard cells, the same type of cell used to maintain the National unit of electromotive force. Many laboratories use groups containing from 3 to 6 cells mounted in either a temperature controlled air or oil bath. The cells are in general calibrated by the National Bureau of Standards at periodic intervals and the mean emf of the group is assumed to remain constant between calibrations. Since such calibrations are done infrequently (at intervals of one year or more) some technique must be employed to maintain surveillance over the local unit between calibrations.

Starting with assigned values for each of the cells of the group as a given set of reference points, one can check on the relative stability of the cells by measuring differences among them. One could measure all possible differences and have equal precision in the knowledge of the values of all cells or one could pick a favorite cell and compare all others with this one (but this leads to high precision in the knowledge of the selected cell and relatively low precision in all others). For small groups it is quite practical to measure all possible differences, but as the group size increases the number of measurements would increase rapidly with N , where N is the group size. As N increases compromise schemes that lead to equal precision in the knowledge of each cell can be used. One such design is given in [1] for a group of 20 cells in which only 40 differences are measured (instead of 190 if all $N(N-1)/2$ were measured).

This note discusses methods for maintaining surveillance of groups containing three, four, five, or six cells in a single temperature controlled enclosure. The procedures suggested are designed to yield information on:

1. the stability of the differences in emf among the group,
2. the components of variability and dependence of the measurement process precision on environmental influences or procedural changes,
3. possible systematic errors and estimation of the accuracy of the process.

Furthermore, they tend to maximize the yield of useful information per measurement.

II. The Measurement Technique

The opposition method [3] is usually employed in the intercomparison of saturated standard cells. In this method the small difference between two cells connected in series opposition is measured using a suitable instrument. The instrument is usually a potentiometer designed for the measurement of very small emfs [2].

In the ideal situation the difference in emf as measured by the potentiometer is:

$$\Delta E = V_1 - V_2 \quad (1)$$

where V_1 and V_2 are the emfs of the two cells being compared.

However in the real situation there may be spurious emfs in the circuit. In general these can be classified into two categories:

1. Those emfs that remain constant, or relatively so, in relation to the interval over which a complete set of measurements is made.
2. Those emfs that vary rapidly (referenced to the interval over which a complete set of measurements is made).

If the emfs are of the second type they will have the effect of decreasing the precision of the process. On the other hand if they are of the first type they will have the effect of introducing a systematic error, thereby making the measurement

$$\Delta E = V_1 - V_2 + P \quad (2)$$

where P is the constant emf. It is possible to estimate P by taking a second measurement

$$\Delta E' = V_2 - V_1 + P \quad (3)$$

and summing the two

$$2P = \Delta E + \Delta E' \quad (4)$$

The difference between eqs. (2) and (3) gives

$$\Delta E - \Delta E' = 2(V_1 - V_2) \quad (5)$$

an estimate of $V_1 - V_2$ free of P . The pair of measurements (eqs. (2) and (3)) are get to be "left-right" balanced. That is if there is a positional effect it is balanced out of the final result. This technique is analogous to that used to eliminate the inequality of balance arms at precise weighing on a two pan equal arm balance. In order to designate the cell positions from the operational point of view they are frequently designated as unknown and reference: Relative to the input terminals of the measuring instrument they are as shown in fig. 1. In the next section the principle of "left-right" balance will be extended to groups containing three or more cells.

III. Designs for Groups of 3, 4, 5, or 6 Cells

Experimental designs of groups of 3, 4, 5, and 6 cells are given in Appendix A. The designs presented have been selected to be (1) efficient from the standpoint of the operator making measurement (2) statistically efficient, in the sense of minimum standard deviation of the estimated cell values, and (3) relatively easy to analyze using conventional desk calculators. All of the analyses presented are the least square solutions for the associated design assuming that the sum of the differences from the mean of all is zero. For groups of 3, 4, 5, total left-right balance has been achieved and the estimate of the "left-right" effect is

$$\hat{P} = 1/n \sum_{i=1}^n y_i \quad (6)$$

where n is the number of measurements and y the observed difference in emf between two cells.* For the case of six cells left-right balance is achieved for only the first 12 measurements

* In terms of the notation of fig. 1 y is the observed ΔE .

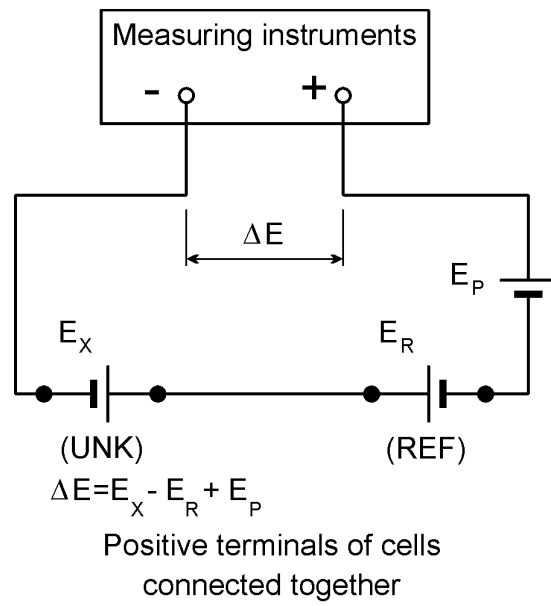
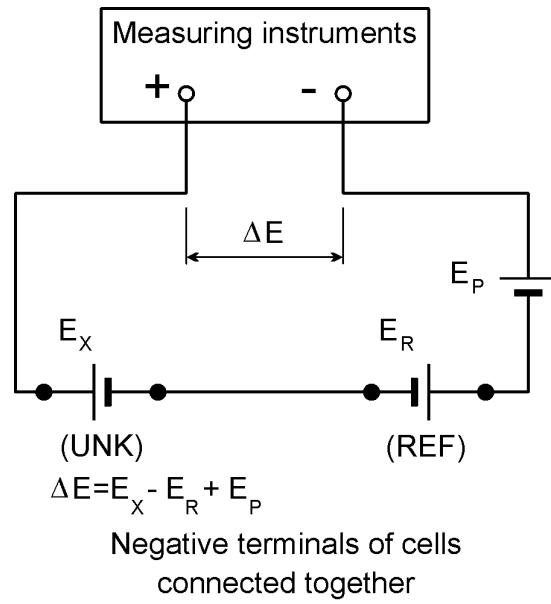

Figure 1

Two ways in which cells can be connected in series-opposition.

For each size group the design and its analysis are given as a complete entity, with the left half giving the general procedure and the right half a numerical example. The suggested order for making the measurements requires moving one set of leads at a time thereby minimizing the possibility of connecting the wrong cells.

The definitions of the symbols used in the tables are as follows:

Symbol	Definition
V_i	The emf of the <u>ith</u> cell
M	The group mean
M^*	The mean of
v_i	The difference $V_i - M$
y_i	The <u>ith</u> measured difference
\hat{P}	The calculated circuit residual
Q_i	A sum of those y 's that involve the <u>ith</u> cell
\hat{v}_i	The calculated <u>ith</u> v
\hat{y}_i	The predicted y_i calculated from \hat{v} and \hat{P}
d_i	Deviations, $(y_i - \hat{y}_i)$
s	The standard deviation of a single observation

For all of the designs given in Appendix A the assumption is that the mean of the whole group is known and serves as the restraint in the least square solution. In the next section, procedures for changing the restraint will be given. The analysis produces the following basic information which can be used to monitor the process:

3. The emf of each cell (or the difference from the group mean)
4. The residual emf, \hat{P}
5. The standard deviation of a single observation
6. The deviation of each observation from the predicted value

The frequency with which these intercomparisons should be run may vary considerably depending on the particular installation. Once it is established that the process is in a state of control then one intercomparison each week should be sufficient.

IV. Change of Restraint

In the previous section it was assumed that the mean for the whole group was known, such as would be the case if the group had been assigned values by the National Bureau of Standards. Because only differences in emf are measured, this average value is the restraint on the values which provide the "ground zero" to which the cell values are related.

When one or more of the cells show a change so large as to be inconsistent with its assigned value, it becomes necessary to remove these cells from the defining group. Evidence of such changes would be discovered from control charts on either the cell values or control charts on differences between cells (see the next section on control charts).

To illustrate, let us assume that the assigned values for the 5th and 6th cells of the example in Table A-4 had been 1.0182536 and 1.0182501 instead of the values (1.0182416, 1.0182381) given in Section 1 of the table. This is a change of +12.0 μ V in each cell so that the new emf values for the cells would be as shown in the following table.

Table 1-A
(Table A-4 Sec. 4)

Cell	Assigned values V_i	\hat{v}_i	Emf of' cell $M + \hat{v}_i$	Difference from assigned.
1	1.0182605	10.47	1.01826445	3.95
2	2655	15.62	26960	4.10
3	2466	-3.40	25058	3.98
4	2476	-2.29	25169	4.09
5	2536*	-8.37	24561	-7.99
6	2501*	-12.04	24194	-8.16

Average = 1.01825398 = M

These values differ by 12 μ V from the data of Table A-4

The last two cells are obviously inconsistent with their assigned values, so that one would want to remove these from the restraint and establish “ground zero” with the first four cells.

To do this one calculates

1. \bar{V}_A : the average of the assigned value of the cells to be retained in the restraint as shown in column 2 of the table below; and \bar{v} : the average of the \hat{v} 's to be retained in the restraint.
2. \hat{v}_i : the cell estimates as given in section 4 and copied into column 3 below; and
3. adds $\bar{V}_A - \bar{v}$ to each of the \hat{v}_i to give the cell values, \hat{V}_i as shown in column 4.

Table 1-B
(Table A-4 Sec. 4)

Cell	Assigned values V_i	\hat{v}_i	Emf of cell $\bar{V}_A - \bar{v} + \hat{v}_i = \hat{V}_i$
1	1.0182605	10.47	1.01826042
2	2655	15.62	26557
3	2466	-3.40	24655
4	2476	-2.29	24766
Average = 1.01825505 = \bar{V}_A		$\bar{v} = +5.10$	
5	1.0182536	-8.37	24158
6	2501	-12.04	23792

The cell values are now expressed in terms of the average of the “good” cells as the reference point. The misbehaving cells would ordinarily continue to be measured in the hope that they would stabilize at some new value.

V. Control Charts

Control charts [5], [6] on process parameters such as the cell values and standard deviations of a single observation provide an effective means of determining whether or not the process is in a state of statistical control. Control charts for each cell (or difference between cells), process precision (standard deviation of an observation), and the residual emf P should be maintained. These charts provide the verification of that part of the uncertainty statement that deals with bounds for the effect of random error. Such statements say in effect "If this measurement process is used a large number of times, the values obtained for a single quantity will vary within the stated limits." The charts permit one to demonstrate the validity of such statements on current data.

For each run one will have values for each of the cells, the standard deviation, and the residual emf. To check on the state of control of the measurement process and on the stability of the cells, one would study the sequence of values for these parameters. Control charts on the cells can be established on the emf of the cells, the difference between successive cells (e.g. cell 1-cell 2, cell 2-cell 3, cell 3-cell 4, etc.), or both. The former has the difficulty that it is not sensitive to a change in the emf of a single cell. However, by following the differences between successive cells (i.e. 1st minus 2nd, 2nd minus 3rd and so on) one has an easily interpreted set of results even though the successive differences are not independent. A single "bad" cell will show up as out of control on two successive differences, whereas the remaining differences are unaffected.

In order to establish control limits one has to know the precision of the measurement process (see discussion on measurement processes in ref. [7]). However, under the assumption that the standard deviation, s , of the process is known one can, for a given design, write down the standard deviations of the individual cell emfs, the difference between two cells, and for the residual P . One can use three times the appropriate standard deviation as control limits. For the designs given the values for setting limits are shown in Table 2.

Unfortunately, when starting such surveillance the process precision, s , is usually not known and must be estimated from the available data. In this case one would pool a number, m , of individual standard deviations using the formula

$$s_p^2 = 1/m \sum_{i=1}^m s_i^2 \quad (7)$$

for a particular design. This might entail making several runs a week for the first month or so to obtain starting control limits. After about 100 degrees of freedom have been accumulated a new value of s_p should be calculated and the control limits revised. For such a large number of degrees of freedom s_p approaches s very closely. Using s_p , and the control limits from the factors in Table 2, a control chart on the standard deviation of the process (i.e. on s as computed in Appendix A) should be constructed.

It is also desirable to maintain a control chart on the residual emf using the limits given in Table 2. Initially the accepted value of P would be taken as zero. However, if after repeated measurements the value of P is other than zero and constant, the central value and control limits should be adjusted accordingly.

The start of each type of control chart is shown in Fig. 2. For the charts on the cells the central values for both cells and difference between cells should be based on the assigned values. The chart can either be kept on a run number or a time basis. The latter has the advantage that one can estimate rate of drift if any cell shows a trend.

Table 2

Factors for Setting the 3 σ Control Limits for the Designs in Appendix A

No. of Cells Excluded from group mean	Number of Cells in Group			
	3	4	5	6
	Cells values			
0	1.000	0.9186	1.2000	1.1260
1*	0.8660	0.8660	1.1619	1.1071
	1.500	1.2247	1.5000	1.3512
2*	0.0	0.750	1.0954	1.0794
	1.7320	1.2990	1.5492	1.3839
3*	---	0	0.9487	1.0000
	---	1.5000	1.6432	1.4392
	Residual (P)			
	1.2247	0.8660	0.9487	0.8018
	Successive differences ($\hat{v}_i - \hat{v}_{i+1}$)			
	1.7321	1.500	1.8974	(1)
Standard deviation				
Upper limit	1.945	1.585	1.737	1.552
Central line	0.888	0.950	0.933	0.963

* The upper figures are for those cells included in the mean and the lower figures are for those cells excluded from the mean.

1. For differences (1-2) (2-3) (4-5) (5-6) the limit is 1.7321.

For differences (4-5) (6-1) the limit is 1.7525.

To compute control limit multiply s or pooled s_p by the appropriate factor and add or subtract as required.

If a cell should “go bad” and be removed from the mean, but still kept in the group, then the limits should be altered accordingly (see Table 2). It is important to bear in mind that the control charts on the cells only indicate change in the emf of cells relative to each other. If the whole group is changing it will not show up in any of the charts and can only be ascertained by comparison with other cells whose values are known. This situation does occur because small groups of cells are usually from the same manufacturer and lot, and therefore have similar aging characteristics.

VI. Systematic Errors

Ideally a measurement process should be free of systematic error, however, this is not often the case. In fact, the residual P is a systematic error. Its effect on the values of the cells is readily removed and its magnitude estimated using the suggested designs. Other systematic errors are not so easily detected. Indications of their presence in some cases can be obtained by analysis of deviations from two or more successive designs run on the same group of cells.

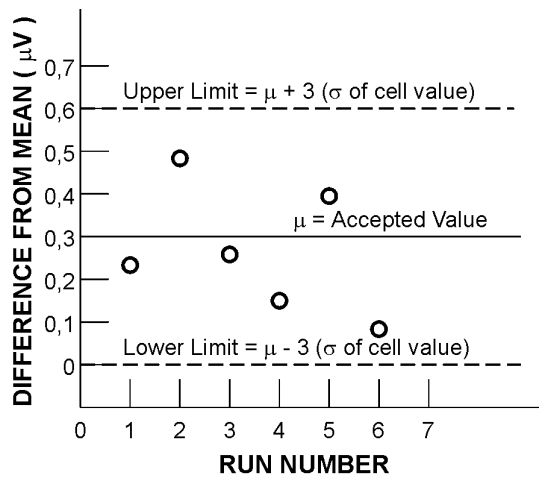

Control Chart for value of cell.

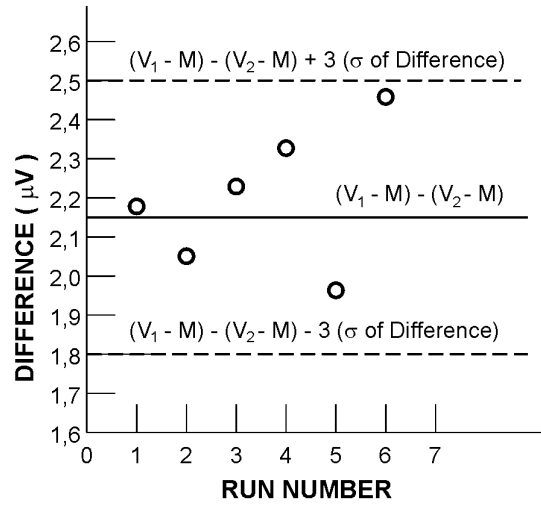

Control Chart for the difference between successive cells.

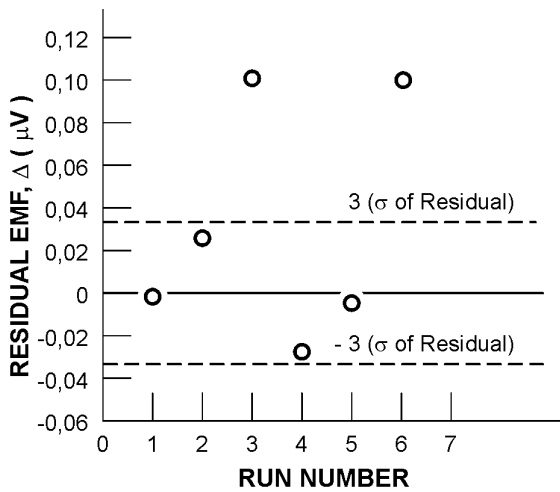

Control Chart for residual.

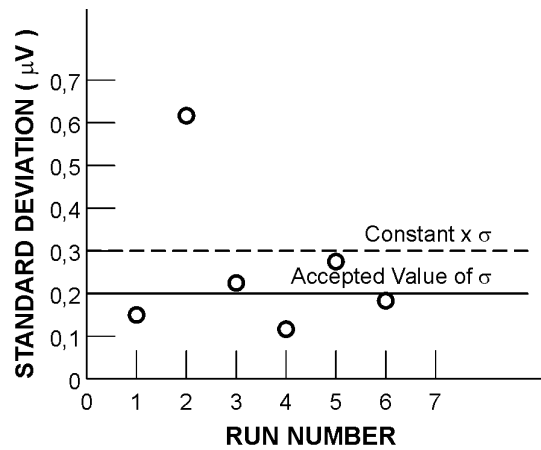

Control Chart for standard deviation of a single observation.

Figure 2

Typical control charts for maintaining surveillance over a group of standard cells.

Detection is based on the assumption that the deviations for a particular observation (cell 1-cell 2, cell 1-cell 3, etc.) are independent in successive runs.

If the magnitude and sign of corresponding deviations from successive runs tend to agree then one would suspect the presence of a systematic error. Such an analysis can be done on 5 and 6 cell groups graphically by plotting the deviations of one run as a function of the second run. If the deviations tend to fall on a straight line having slope 1 and passing through the origin, then one would suspect a systematic error. If there is none then the points would be distributed randomly. Figure 3 shows an example with no systematic error present. Figure 4 was created from the data of Figure 3 by adding 0.3 μV to the absolute value of each observation to simulate an offset error such as failing to correct for the instrument zero. The presence of such a systematic error will (1) cause the deviations to string along the line, (2) inflate the standard deviation, and (3), introduce a bias into each calculated \hat{v}_i . The magnitude of the latter will depend on the particular set of observations. Instead of the model for a single observation being

$$E(y_{ij}) = X_i - X_j + P$$

as in the case of Figure 3, and as assumed in the appendix, it is now

$$E(y_{ij}) = X_i - X_j + P + \frac{y_{ij}}{|y_{ij}|} \times C$$

where C is the zero offset.

For sets with less than 5 cells one would examine the deviations of successive runs for patterns. If the deviations for a given observation have the same sign and approximately the same magnitude, one would suspect a possible systematic error. Studies are being conducted to develop relatively simple tests that may be used to detect the presence of many types of systematic errors.

The cause or causes of systematic errors will depend on a particular measuring system.

Some possible causes are:

1. Failure to make applicable corrections
2. Zero offset
3. Operator reading bias
4. Operator setting bias
5. Leakage currents

This list is by no means complete, but merely suggests some possible causes.

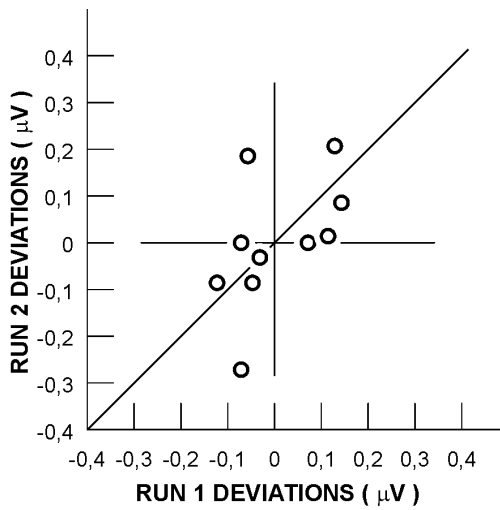

Figure 3 Youden plot for two runs without systematic error.

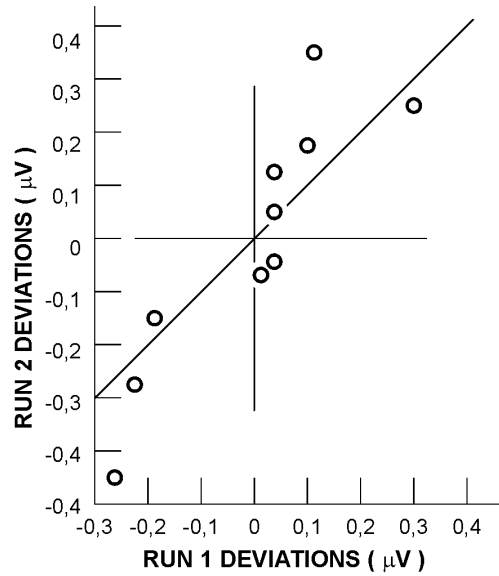

Figure 4 Youden plot for two runs with systematic error.

REFERENCES

- [1] Hamer, W. J., "The Volt Standard" Moves To Gaithersburg, Maryland, J. Wash. Acad. of Sci. 56 (1966), pp. 101-108.
- [2] Harris, F. K., Electrical Measurements, J. Wiley & Sons (1952), pp. 168-185.
- [3] Hamer, W. J., Standard Cells-Their Construction, Maintenance, and Characteristics, NBS Monograph 84 (1965), pp. 8-10.
- [4] Hamer, W. J., ibid. pp. 5-8.
- [5] ASTM Manual on Quality Control of Materials, Special Technical Publication 15-C, Part 3, January 1951.
- [6] Natrella, M. G., Experimental Statistics, NBS Handbook 91 (1963), pp. 18-1, 18-4.
- [7] Pontius, P. E., Measurement Philosophy of the Pilot Program for Mass Measurement, NBS Technical Note 288, May 1966.

APPENDIX A

Designs for Groups of 3, 4, 5 and 6 Saturated Standard Cells

APPENDIX A
Designs for Groups of 3, 4, 5 and 6 Saturated Standard Cells

TABLE A-1

THE INTERCOMPARISON OF A GROUP OF THREE SATURATED STANDARD CELLS

	Example																											
<p>1. <u>Given:</u> The emfs of three saturated standard cells (V_1, V_2 and V_3) are assigned by calibrating them in terms of a known standard of electromotive force. The mean of the group is</p> $M = 1/3 \sum_{i=1}^3 V_i$ <p>and the difference from the mean of each cell is</p> $v_i = (V_i - M)$	<p>1. <u>From an NBS Report of Calibration:</u></p> <table style="width: 100%; border: none;"> <tr> <td style="padding-right: 20px;">$V_1 = 1.0182571$</td> <td>$v_1 = -1.2\text{i V}$</td> </tr> <tr> <td>$V_2 = 1.0182535$</td> <td>$v_2 = -4.8\text{i V}$</td> </tr> <tr> <td>$V_3 = 1.0182643$</td> <td>$v_3 = +6.0\text{i V}$</td> </tr> <tr> <td>Mean = 1.0182583</td> <td>sum = 0</td> </tr> </table>	$V_1 = 1.0182571$	$v_1 = -1.2\text{i V}$	$V_2 = 1.0182535$	$v_2 = -4.8\text{i V}$	$V_3 = 1.0182643$	$v_3 = +6.0\text{i V}$	Mean = 1.0182583	sum = 0																			
$V_1 = 1.0182571$	$v_1 = -1.2\text{i V}$																											
$V_2 = 1.0182535$	$v_2 = -4.8\text{i V}$																											
$V_3 = 1.0182643$	$v_3 = +6.0\text{i V}$																											
Mean = 1.0182583	sum = 0																											
<p>2. associated with the measuring process then the expected value of a single observation is</p> $E(y) = \sum_j -V_k P$ <p style="text-align: center;">$j \neq k$; for j and k</p> <p style="text-align: center;">j and k the following schedule of measurements is convenient and requires changing the connections to only one cell at a time.</p> <table border="1" style="width: 100%; border-collapse: collapse; margin-top: 10px;"> <thead> <tr> <th style="text-align: center;">Measurement</th> <th style="text-align: center;">Cell in UNK position*</th> <th style="text-align: center;">Cell in REF position*</th> </tr> </thead> <tbody> <tr><td style="text-align: center;">y_1</td><td style="text-align: center;">1</td><td style="text-align: center;">2</td></tr> <tr><td style="text-align: center;">y_2</td><td style="text-align: center;">1</td><td style="text-align: center;">3</td></tr> <tr><td style="text-align: center;">y_3</td><td style="text-align: center;">2</td><td style="text-align: center;">3</td></tr> <tr><td style="text-align: center;">y_4</td><td style="text-align: center;">2</td><td style="text-align: center;">1</td></tr> <tr><td style="text-align: center;">y_5</td><td style="text-align: center;">3</td><td style="text-align: center;">1</td></tr> <tr><td style="text-align: center;">y_6</td><td style="text-align: center;">3</td><td style="text-align: center;">2</td></tr> </tbody> </table> <p>* See Fig. 1 for definition of positions.</p>	Measurement	Cell in UNK position*	Cell in REF position*	y_1	1	2	y_2	1	3	y_3	2	3	y_4	2	1	y_5	3	1	y_6	3	2	<p>2. <u>Observations:</u></p> <table style="width: 100%; border: none; margin-top: 10px;"> <tr><td style="padding-right: 20px;">$y_1 = +4.8\text{i V}$</td></tr> <tr><td>$y_2 = -6.6\text{i V}$</td></tr> <tr><td>$y_3 = -10.6\text{i V}$</td></tr> <tr><td>$y_4 = -3.4\text{i V}$</td></tr> <tr><td>$y_5 = +7.4\text{i V}$</td></tr> <tr><td>$y_6 = +0.4\text{i V}$</td></tr> </table>	$y_1 = +4.8\text{i V}$	$y_2 = -6.6\text{i V}$	$y_3 = -10.6\text{i V}$	$y_4 = -3.4\text{i V}$	$y_5 = +7.4\text{i V}$	$y_6 = +0.4\text{i V}$
Measurement	Cell in UNK position*	Cell in REF position*																										
y_1	1	2																										
y_2	1	3																										
y_3	2	3																										
y_4	2	1																										
y_5	3	1																										
y_6	3	2																										
$y_1 = +4.8\text{i V}$																												
$y_2 = -6.6\text{i V}$																												
$y_3 = -10.6\text{i V}$																												
$y_4 = -3.4\text{i V}$																												
$y_5 = +7.4\text{i V}$																												
$y_6 = +0.4\text{i V}$																												
<p>3. <u>Estimation of \hat{P}:</u></p> $\hat{P} = 1/6 \sum_{i=1}^6 y_i$	<p>3.</p> $\hat{P} = 1/6(+4.8 - 6.6 - 10.6 - 3.4 + 7.4 + 10.4)$ $\hat{P} = +0.333\text{i V}$																											
<p>4. <u>Estimation of \hat{v}_i</u></p> $\hat{v}_1 = \hat{V}_1 - M = 1/6(y_1 + y_2 - y_4 - y_5)$ $\hat{v}_2 = \hat{V}_2 - M = 1/6(-y_1 + y_3 + y_4 - y_6)$ $\hat{v}_3 = \hat{V}_3 - M = 1/6(-y_2 - y_3 + y_5 + y_6)$ <p><u>Arithmetic Check:</u> $\sum \hat{v}_i = 0$ (within round off)</p>	<p>4.</p> $\hat{v}_1 = 1/6(+4.8 - 6.6 + 3.4 - 7.4) = -0.967\text{i V}$ $\hat{v}_2 = 1/6(-4.8 - 10.6 - 3.4 - 10.4) = -4.867\text{i V}$ $\hat{v}_3 = 1/6(+6.6 + 10.6 + 7.4 + 10.4) = +5.833\text{i V}$ <p><u>Check:</u></p> $\sum \hat{v}_i = -0.967 - 4.867 + 5.833 = -0.001\mu\text{V}$																											

Table A-1 Continued

5. Calculation of \hat{y} 's the predicted y 's:

$$\hat{y}_1 = \hat{v}_1 - \hat{v}_2 + \hat{P}$$

$$\hat{y}_2 = \hat{v}_1 - \hat{v}_3 + \hat{P}$$

$$\hat{y}_3 = \hat{v}_2 - \hat{v}_3 + \hat{P}$$

$$\hat{y}_4 = \hat{v}_2 - \hat{v}_1 + \hat{P}$$

$$\hat{y}_5 = \hat{v}_3 - \hat{v}_1 + \hat{P}$$

$$\hat{y}_6 = \hat{v}_3 - \hat{v}_2 + \hat{P}$$

Arithmetic Check: $\sum \hat{y}_i = 6\hat{P}$

5.

$$\hat{y}_1 = -0.967 + 4.867 + 0.333 = +4.233\text{i V}$$

$$\hat{y}_2 = -0.967 - 5.833 + 0.333 = -6.467\text{i V}$$

$$\hat{y}_3 = -4.867 - 5.833 + 0.333 = -10.367\text{i V}$$

$$\hat{y}_4 = -4.867 + 0.967 + 0.333 = -3.567\text{i V}$$

$$\hat{y}_5 = +5.833 + 0.967 + 0.333 = +7.133\text{i V}$$

$$\hat{y}_6 = +5.833 + 4.867 + 0.333 = +11.033\text{i V}$$

Check: $\sum \hat{y}_i = +1.998\mu\text{V}$

6. Calculation of deviations ($d_i = y_i - \hat{y}_i$):

$$d_1 = y_1 - \hat{y}_1$$

$$d_2 = y_2 - \hat{y}_2$$

$$d_3 = y_3 - \hat{y}_3$$

$$d_4 = y_4 - \hat{y}_4$$

$$d_5 = y_5 - \hat{y}_5$$

$$d_6 = y_6 - \hat{y}_6$$

Check: $\sum_{i=1}^6 d_i = 0$
(within round off)

6.

$$d_1 = +4.8 - 4.233 = +0.567\mu\text{V}$$

$$d_2 = -6.6 + 6.467 = -0.133\mu\text{V}$$

$$d_3 = -10.6 + 10.367 = -0.233\mu\text{V}$$

$$d_4 = -3.4 + 3.567 = +0.167\mu\text{V}$$

$$d_5 = +7.4 - 7.133 = +0.267\mu\text{V}$$

$$d_6 = +10.4 - 11.033 = -0.633\mu\text{V}$$

$$\sum d_i = +0.002\mu\text{V}$$

7. The standard deviation of a single observation (s) is:

$$s = \sqrt{\sum_{i=1}^6 d_i^2}$$

where 3 represents the number of degrees of freedom in this error estimate

7.

$$s = \sqrt{\frac{0.8933}{3}} = 0.55\mu\text{V}$$

8. Emf value of the cell's.

The emf's of the cells are calculated by restoring the mean value to give

$$\hat{V}_i = \hat{v}_i + M$$

8. Mean (from section 1): 1.01825830

$$\hat{V}_1 = 1.01825830 - 0.00000097 = 1.01825733$$

$$\hat{V}_2 = 1.01825830 - 0.00000487 = 1.01825343$$

$$\hat{V}_3 = 1.01825830 + 0.00000583 = 1.01826413$$

TABLE A-2

THE INTERCOMPARISON OF A GROUP OF 4 CELLS

	Example																																																			
<p>1. <u>Given:</u> The emfs of four saturated standard cells (V_1, V_2, V_3 and V_4) are assigned by calibrating them in terms of a known standard of electromotive force. The mean of the group is</p> $M = 1/4 \sum_{i=1}^4 V_i$ <p>and the difference from the mean of each cell is</p> $v_i = (V_i - M)$	<p>1. <u>From an NBS Report of Calibration:</u></p> <table style="width:100%; border: none;"> <tr> <td style="padding-right: 20px;">$V_1 = 1.0182459$</td> <td>$v_1 = -4.1\text{i V}$</td> </tr> <tr> <td>$V_2 = 1.0182488$</td> <td>$v_2 = -1.2\text{i V}$</td> </tr> <tr> <td>$V_3 = 1.0182526$</td> <td>$v_3 = +2.6\text{i V}$</td> </tr> <tr> <td>$V_4 = 1.0182527$</td> <td>$v_4 = +2.7\text{i V}$</td> </tr> <tr> <td>Mean = 1.0182500</td> <td>sum = 0</td> </tr> </table>	$V_1 = 1.0182459$	$v_1 = -4.1\text{i V}$	$V_2 = 1.0182488$	$v_2 = -1.2\text{i V}$	$V_3 = 1.0182526$	$v_3 = +2.6\text{i V}$	$V_4 = 1.0182527$	$v_4 = +2.7\text{i V}$	Mean = 1.0182500	sum = 0																																									
$V_1 = 1.0182459$	$v_1 = -4.1\text{i V}$																																																			
$V_2 = 1.0182488$	$v_2 = -1.2\text{i V}$																																																			
$V_3 = 1.0182526$	$v_3 = +2.6\text{i V}$																																																			
$V_4 = 1.0182527$	$v_4 = +2.7\text{i V}$																																																			
Mean = 1.0182500	sum = 0																																																			
<p>2. Assuming that there is a small constant emf P associated with the measuring process then the expected value of a single observation is</p> $E(y_i) = V_j - V_k + P$ <p>$j \neq k$; for j and $k = 1, 2, 3, 4$.</p> <p>For all possible values of j and k the following schedule of measurements is convenient and requires changing the connections to only one cell at a time.</p> <table border="1" style="width:100%; border-collapse: collapse; margin-top: 10px;"> <thead> <tr> <th style="width:20%;">Measurement</th> <th style="width:20%;">Cell in UNK position*</th> <th style="width:20%;">Cell in REF position*</th> </tr> </thead> <tbody> <tr><td>y_1</td><td>1</td><td>2</td></tr> <tr><td>y_2</td><td>1</td><td>3</td></tr> <tr><td>y_3</td><td>2</td><td>3</td></tr> <tr><td>y_4</td><td>2</td><td>4</td></tr> <tr><td>y_5</td><td>3</td><td>4</td></tr> <tr><td>y_6</td><td>3</td><td>1</td></tr> <tr><td>y_7</td><td>3</td><td>2</td></tr> <tr><td>y_8</td><td>4</td><td>2</td></tr> <tr><td>y_9</td><td>4</td><td>1</td></tr> <tr><td>y_{10}</td><td>4</td><td>3</td></tr> <tr><td>y_{11}</td><td>2</td><td>1</td></tr> <tr><td>y_{12}</td><td>1</td><td>4</td></tr> </tbody> </table> <p>* See Fig. 1 for definition of positions.</p>	Measurement	Cell in UNK position*	Cell in REF position*	y_1	1	2	y_2	1	3	y_3	2	3	y_4	2	4	y_5	3	4	y_6	3	1	y_7	3	2	y_8	4	2	y_9	4	1	y_{10}	4	3	y_{11}	2	1	y_{12}	1	4	<p>2. <u>Observations:</u></p> <table style="width:100%; border: none; margin-top: 10px;"> <tr><td>$y_1 = -3.1\text{i V}$</td></tr> <tr><td>$y_2 = -6.9\text{i V}$</td></tr> <tr><td>$y_3 = -3.8\text{i V}$</td></tr> <tr><td>$y_4 = -4.0\text{i V}$</td></tr> <tr><td>$y_5 = -0.4\text{i V}$</td></tr> <tr><td>$y_6 = +6.3\text{i V}$</td></tr> <tr><td>$y_7 = +3.3\text{i V}$</td></tr> <tr><td>$y_8 = +3.4\text{i V}$</td></tr> <tr><td>$y_9 = +6.4\text{i V}$</td></tr> <tr><td>$y_{10} = -0.2\text{i V}$</td></tr> <tr><td>$y_{11} = +2.7\text{i V}$</td></tr> <tr><td>$y_{12} = -7.0\text{i V}$</td></tr> </table>	$y_1 = -3.1\text{i V}$	$y_2 = -6.9\text{i V}$	$y_3 = -3.8\text{i V}$	$y_4 = -4.0\text{i V}$	$y_5 = -0.4\text{i V}$	$y_6 = +6.3\text{i V}$	$y_7 = +3.3\text{i V}$	$y_8 = +3.4\text{i V}$	$y_9 = +6.4\text{i V}$	$y_{10} = -0.2\text{i V}$	$y_{11} = +2.7\text{i V}$	$y_{12} = -7.0\text{i V}$
Measurement	Cell in UNK position*	Cell in REF position*																																																		
y_1	1	2																																																		
y_2	1	3																																																		
y_3	2	3																																																		
y_4	2	4																																																		
y_5	3	4																																																		
y_6	3	1																																																		
y_7	3	2																																																		
y_8	4	2																																																		
y_9	4	1																																																		
y_{10}	4	3																																																		
y_{11}	2	1																																																		
y_{12}	1	4																																																		
$y_1 = -3.1\text{i V}$																																																				
$y_2 = -6.9\text{i V}$																																																				
$y_3 = -3.8\text{i V}$																																																				
$y_4 = -4.0\text{i V}$																																																				
$y_5 = -0.4\text{i V}$																																																				
$y_6 = +6.3\text{i V}$																																																				
$y_7 = +3.3\text{i V}$																																																				
$y_8 = +3.4\text{i V}$																																																				
$y_9 = +6.4\text{i V}$																																																				
$y_{10} = -0.2\text{i V}$																																																				
$y_{11} = +2.7\text{i V}$																																																				
$y_{12} = -7.0\text{i V}$																																																				
<p>3. <u>Estimation of P:</u></p> $\hat{P} = 1/12 \sum_{i=1}^{12} y_i$	<p>3.</p> $\hat{P} = 1/12 \begin{pmatrix} -3.1 - 6.9 - 3.8 - 4.0 - 0.4 + 6.3 + \\ 3.3 + 3.4 + 6.4 - 0.2 + 2.7 - 7.0 \end{pmatrix}$ $\hat{P} = -0.275\text{i V}$																																																			

Table A-2 Continued 4. Estimation of v_i :

$$\hat{v}_1 = \hat{V}_1 - M = 1/8(y_1 + y_2 - y_6 - y_9 - y_{11} + y_{12})$$

$$\hat{v}_2 = \hat{V}_2 - M = 1/8(-y_1 + y_3 + y_4 - y_7 - y_8 + y_{11})$$

$$\hat{v}_3 = \hat{V}_3 - M = 1/8(-y_2 - y_3 + y_5 + y_6 + y_7 - y_{10})$$

$$\hat{v}_4 = \hat{V}_4 - M = 1/8(-y_4 - y_5 + y_8 + y_9 + y_{10} - y_{12})$$

Arithmetic Check: $\sum_{i=1}^4 \hat{v}_i = 0$ (within round off)

4.

$$\hat{v}_1 = 1/8(-3.1 - 6.9 - 6.3 - 6.4 - 2.7 - 7.0) = -4.051\text{V}$$

$$\hat{v}_2 = 1/8(+3.1 - 3.8 - 4.0 - 3.3 - 3.4 + 2.7) = -1.088\mu\text{V}$$

$$\hat{v}_3 = 1/8(+6.9 + 3.8 - 0.4 + 6.3 + 3.3 + 0.2) = +2.512\mu\text{V}$$

$$\hat{v}_4 = 1/8(+4.0 + 0.4 + 3.4 + 6.4 - 0.2 + 7.0) = +2.625\mu\text{V}$$

Check: $\sum \hat{v}_i = -4.050 - 1.087 + 2.512 + 2.625 = +0.001\mu\text{V}$

5. Calculation of y 's, the predicted y 's:

$$\hat{y}_1 = \hat{v}_1 - \hat{v}_2 + \hat{P}$$

$$\hat{y}_2 = \hat{v}_1 - \hat{v}_3 + \hat{P}$$

$$\hat{y}_3 = \hat{v}_2 - \hat{v}_3 + \hat{P}$$

$$\hat{y}_4 = \hat{v}_2 - \hat{v}_4 + \hat{P}$$

$$\hat{y}_5 = \hat{v}_3 - \hat{v}_4 + \hat{P}$$

$$\hat{y}_6 = \hat{v}_3 - \hat{v}_1 + \hat{P}$$

$$\hat{y}_7 = \hat{v}_3 - \hat{v}_2 + \hat{P}$$

$$\hat{y}_8 = \hat{v}_4 - \hat{v}_2 + \hat{P}$$

$$\hat{y}_9 = \hat{v}_4 - \hat{v}_1 + \hat{P}$$

$$\hat{y}_{10} = \hat{v}_4 - \hat{v}_3 + \hat{P}$$

$$\hat{y}_{11} = \hat{v}_2 - \hat{v}_1 + \hat{P}$$

$$\hat{y}_{12} = \hat{v}_1 - \hat{v}_4 + \hat{P}$$

Arithmetic Check: $\sum \hat{y}_i = 12\hat{P}$

5.

$$\hat{y}_1 = -4.050 + 1.088 + 0.275 = -3.237\text{V}$$

$$\hat{y}_2 = -4.050 - 2.512 - 0.275 = -6.837\text{V}$$

$$\hat{y}_3 = -1.088 - 2.512 - 0.275 = -3.875\text{V}$$

$$\hat{y}_4 = -1.088 - 2.625 - 0.275 = -3.988\mu\text{V}$$

$$\hat{y}_5 = +2.512 - 2.625 - 0.275 = -0.388\mu\text{V}$$

$$\hat{y}_6 = +2.512 + 4.050 - 0.275 = +6.287\mu\text{V}$$

$$\hat{y}_7 = +2.512 + 1.088 - 0.275 = +3.325\mu\text{V}$$

$$\hat{y}_8 = +2.625 + 1.088 - 0.275 = +3.438\mu\text{V}$$

$$\hat{y}_9 = +2.625 + 4.050 - 0.275 = +6.400\mu\text{V}$$

$$\hat{y}_{10} = +2.625 - 2.512 - 0.275 = -0.162\mu\text{V}$$

$$\hat{y}_{11} = -1.088 + 4.050 - 0.275 = +2.687\mu\text{V}$$

$$\hat{y}_{12} = -4.050 - 2.625 - 0.275 = -6.950\mu\text{V}$$

sum:

$$\sum \hat{y}_i = \left(\begin{array}{l} -3.237 - 6.837 - 3.875 - 3.988 - 0.388 + \\ 6.287 + 3.325 + 3.438 + 6.400 - 0.162 + \\ 2.687 - 6.950 \end{array} \right) = -3.300\mu\text{V}$$

6. Calculation of deviations ($d_i = y_i - \hat{y}_i$):

$$d_1 = y_1 - \hat{y}_1$$

$$d_2 = y_2 - \hat{y}_2$$

$$d_3 = y_3 - \hat{y}_3$$

$$d_4 = y_4 - \hat{y}_4$$

$$d_5 = y_5 - \hat{y}_5$$

$$d_6 = y_6 - \hat{y}_6$$

$$d_7 = y_7 - \hat{y}_7$$

$$d_8 = y_8 - \hat{y}_8$$

$$d_9 = y_9 - \hat{y}_9$$

$$d_{10} = y_{10} - \hat{y}_{10}$$

$$d_{11} = y_{11} - \hat{y}_{11}$$

$$d_{12} = y_{12} - \hat{y}_{12}$$

Arithmetic Check: $\sum_{i=1}^{12} d_i = 0$
(within round off)

6.

$$d_1 = -3.1 + 3.237 = +0.137\mu\text{V}$$

$$d_2 = -6.9 + 6.837 = -0.063\mu\text{V}$$

$$d_3 = -3.8 + 3.875 = +0.075\mu\text{V}$$

$$d_4 = -4.0 + 3.988 = -0.012\mu\text{V}$$

$$d_5 = -0.4 + 0.388 = -0.012\mu\text{V}$$

$$d_6 = +6.3 - 6.287 = +0.013\mu\text{V}$$

$$d_7 = +3.3 - 3.325 = -0.025\mu\text{V}$$

$$d_8 = +3.4 - 3.438 = -0.038\mu\text{V}$$

$$d_9 = +6.4 - 6.400 = 0\mu\text{V}$$

$$d_{10} = -0.2 + 0.162 = -0.038\mu\text{V}$$

$$d_{11} = +2.7 - 2.687 = +0.013\mu\text{V}$$

$$d_{12} = -7.0 + 6.950 = -0.050\mu\text{V}$$

$$\sum d_i = \left(\begin{array}{l} +0.137 - 0.063 + 0.075 - 0.012 - 0.012 + \\ 0.013 - 0.025 - 0.038 + 0 - 0.038 + 0.013 - \\ 0.050 \end{array} \right) = 0\mu\text{V}$$

7. The standard deviation of a single observation (s) is:

$$s = \sqrt{\frac{\sum_{i=1}^{12} d_i^2}{8}}$$

where 8 represents the number of degrees of freedom in this error estimate

7.

$$s = \sqrt{\frac{0.035}{8}} = 0.066\mu\text{V}$$

8. Emf value of the cell's.

The emf's of the cells are calculated by restoring the mean value to give

$$\hat{V}_i = \hat{v}_i + M$$

8. Mean (from section 1):

1.01825000

$$\hat{V}_1 = 1.01825000 - 0.00000405 = 1.01824595$$

$$\hat{V}_2 = 1.01825000 - 0.00000109 = 1.01824891$$

$$\hat{V}_3 = 1.01825000 + 0.00000251 = 1.01825251$$

$$\hat{V}_4 = 1.01825000 + 0.00000262 = 1.01825262$$

TABLE A-3

THE INTERCOMPARISON OF A GROUP OF 5 CELLS

	Example																																											
<p>1. <u>Given:</u> The emfs of five saturated standard cells (V_1, V_2, V_3, V_4 and V_5) are assigned by calibrating them in terms of a known standard of electromotive force. The mean of the group is</p> $M = 1/5 \sum_{i=1}^5 V_i$ <p>and the difference from the mean of each cell is</p> $v_i = (V_i - M)$	<p>1. <u>From an NBS Report of Calibration:</u></p> <table style="width:100%; border: none;"> <tr> <td style="width:50%;">$V_1 = 1.0182538$</td> <td style="width:50%;">$v_1 = +0.8\text{i V}$</td> </tr> <tr> <td>$V_2 = 1.0182531$</td> <td>$v_2 = +0.1\text{i V}$</td> </tr> <tr> <td>$V_3 = 1.0182518$</td> <td>$v_3 = -1.2\text{i V}$</td> </tr> <tr> <td>$V_4 = 1.0182532$</td> <td>$v_4 = +0.2\text{i V}$</td> </tr> <tr> <td>$V_5 = 1.0182531$</td> <td>$v_5 = +0.1\text{i V}$</td> </tr> <tr> <td>Mean = 1.0182530</td> <td>sum = 0</td> </tr> </table>	$V_1 = 1.0182538$	$v_1 = +0.8\text{i V}$	$V_2 = 1.0182531$	$v_2 = +0.1\text{i V}$	$V_3 = 1.0182518$	$v_3 = -1.2\text{i V}$	$V_4 = 1.0182532$	$v_4 = +0.2\text{i V}$	$V_5 = 1.0182531$	$v_5 = +0.1\text{i V}$	Mean = 1.0182530	sum = 0																															
$V_1 = 1.0182538$	$v_1 = +0.8\text{i V}$																																											
$V_2 = 1.0182531$	$v_2 = +0.1\text{i V}$																																											
$V_3 = 1.0182518$	$v_3 = -1.2\text{i V}$																																											
$V_4 = 1.0182532$	$v_4 = +0.2\text{i V}$																																											
$V_5 = 1.0182531$	$v_5 = +0.1\text{i V}$																																											
Mean = 1.0182530	sum = 0																																											
<p>2. Assuming that there is a small constant emf P associated with the measuring process then the expected value of a single observation is</p> $E(y_i) = V_j - V_k + P$ <p>$j \neq k$; for j and $k = 1, 2, 3, 4, 5$.</p> <p>For all possible values of j and k the following schedule of measurements is convenient and requires changing the connections to only one cell at a time.</p> <table border="1" style="width:100%; border-collapse: collapse; margin-top: 10px;"> <thead> <tr> <th style="width:20%;">Measurement</th> <th style="width:30%;">Cell in UNK position*</th> <th style="width:30%;">Cell in REF position*</th> </tr> </thead> <tbody> <tr><td>y_1</td><td>1</td><td>2</td></tr> <tr><td>y_2</td><td>1</td><td>3</td></tr> <tr><td>y_3</td><td>2</td><td>3</td></tr> <tr><td>y_4</td><td>2</td><td>4</td></tr> <tr><td>y_5</td><td>3</td><td>4</td></tr> <tr><td>y_6</td><td>3</td><td>5</td></tr> <tr><td>y_7</td><td>4</td><td>5</td></tr> <tr><td>y_8</td><td>4</td><td>1</td></tr> <tr><td>y_9</td><td>5</td><td>1</td></tr> <tr><td>y_{10}</td><td>5</td><td>2</td></tr> </tbody> </table> <p>* See Fig. 1 for definition of positions.</p>	Measurement	Cell in UNK position*	Cell in REF position*	y_1	1	2	y_2	1	3	y_3	2	3	y_4	2	4	y_5	3	4	y_6	3	5	y_7	4	5	y_8	4	1	y_9	5	1	y_{10}	5	2	<p>2. <u>Observations:</u></p> <table style="width:100%; border: none; margin-top: 10px;"> <tr><td>$y_1 = +0.5\text{i V}$</td></tr> <tr><td>$y_2 = +1.6\text{i V}$</td></tr> <tr><td>$y_3 = +0.9\text{i V}$</td></tr> <tr><td>$y_4 = -0.4\text{i V}$</td></tr> <tr><td>$y_5 = -1.5\text{i V}$</td></tr> <tr><td>$y_6 = -1.3\text{i V}$</td></tr> <tr><td>$y_7 = 0\text{i V}$</td></tr> <tr><td>$y_8 = -0.8\text{i V}$</td></tr> <tr><td>$y_9 = -1.0\text{i V}$</td></tr> <tr><td>$y_{10} = -0.2\text{i V}$</td></tr> </table>	$y_1 = +0.5\text{i V}$	$y_2 = +1.6\text{i V}$	$y_3 = +0.9\text{i V}$	$y_4 = -0.4\text{i V}$	$y_5 = -1.5\text{i V}$	$y_6 = -1.3\text{i V}$	$y_7 = 0\text{i V}$	$y_8 = -0.8\text{i V}$	$y_9 = -1.0\text{i V}$	$y_{10} = -0.2\text{i V}$
Measurement	Cell in UNK position*	Cell in REF position*																																										
y_1	1	2																																										
y_2	1	3																																										
y_3	2	3																																										
y_4	2	4																																										
y_5	3	4																																										
y_6	3	5																																										
y_7	4	5																																										
y_8	4	1																																										
y_9	5	1																																										
y_{10}	5	2																																										
$y_1 = +0.5\text{i V}$																																												
$y_2 = +1.6\text{i V}$																																												
$y_3 = +0.9\text{i V}$																																												
$y_4 = -0.4\text{i V}$																																												
$y_5 = -1.5\text{i V}$																																												
$y_6 = -1.3\text{i V}$																																												
$y_7 = 0\text{i V}$																																												
$y_8 = -0.8\text{i V}$																																												
$y_9 = -1.0\text{i V}$																																												
$y_{10} = -0.2\text{i V}$																																												
<p>3. <u>Estimation of P:</u></p> $\hat{P} = 1/10 \sum_{i=1}^{10} y_i$	<p>3.</p> $\hat{P} = 1/10 \left(\begin{matrix} +0.5+1.6+0.9-0.4-1.5-1.3+ \\ 0-0.8-1.0-0.2 \end{matrix} \right)$ $\hat{P} = -0.22\text{i V}$																																											
<p>4. Estimation of v_i</p> $\hat{v}_1 = \hat{V}_1 - M = 1/5 (y_1 + y_2 - y_8 - y_9)$ $\hat{v}_2 = \hat{V}_2 - M = 1/5 (-y_1 + y_3 + y_4 - y_{10})$ $\hat{v}_3 = \hat{V}_3 - M = 1/5 (-y_2 - y_3 + y_5 + y_6)$ $\hat{v}_4 = \hat{V}_4 - M = 1/5 (-y_4 - y_5 + y_7 + y_8)$ $\hat{v}_5 = \hat{V}_5 - M = 1/5 (-y_6 - y_7 + y_9 + y_{10})$ <p><u>Arithmetic Check:</u> $\sum_{i=1}^5 \hat{v}_i = 0$ (within round off)</p>	<p>4.</p> $\hat{v}_1 = 1/5 (+0.5+1.6+0.8+1.0) = +0.78\text{i V}$ $\hat{v}_2 = 1/5 (-0.5+0.9-0.4+0.2) = +0.04\mu\text{V}$ $\hat{v}_3 = 1/5 (-1.6-0.9-1.5-1.3) = -1.06\mu\text{V}$ $\hat{v}_4 = 1/5 (+0.4+1.5+0-0.8) = +0.22\mu\text{V}$ $\hat{v}_5 = 1/5 (+1.3+0-1.0-0.2) = +0.02\mu\text{V}$ <p><u>Check:</u></p> $\sum \hat{v}_i = +0.78+0.04-1.06+0.22+0.02 = 0\mu\text{V}$																																											

Table A-3 Continued

5. Calculation of \hat{y} 's the predicted y 's:

$$\begin{aligned}\hat{y}_1 &= \hat{v}_1 - \hat{v}_2 + \hat{P} \\ \hat{y}_2 &= \hat{v}_1 - \hat{v}_3 + \hat{P} \\ \hat{y}_3 &= \hat{v}_2 - \hat{v}_3 + \hat{P} \\ \hat{y}_4 &= \hat{v}_2 - \hat{v}_4 + \hat{P} \\ \hat{y}_5 &= \hat{v}_3 - \hat{v}_4 + \hat{P} \\ \hat{y}_6 &= \hat{v}_3 - \hat{v}_5 + \hat{P} \\ \hat{y}_7 &= \hat{v}_4 - \hat{v}_5 + \hat{P} \\ \hat{y}_8 &= \hat{v}_4 - \hat{v}_1 + \hat{P} \\ \hat{y}_9 &= \hat{v}_5 - \hat{v}_1 + \hat{P} \\ \hat{y}_{10} &= \hat{v}_5 - \hat{v}_2 + \hat{P}\end{aligned}$$

Check: $\sum \hat{y}_i = 10\hat{P}$

6. Calculation of deviation's ($d_i = y_i - \hat{y}_i$):

$$\begin{aligned}d_1 &= y_1 - \hat{y}_1 \\ d_2 &= y_2 - \hat{y}_2 \\ d_3 &= y_3 - \hat{y}_3 \\ d_4 &= y_4 - \hat{y}_4 \\ d_5 &= y_5 - \hat{y}_5 \\ d_6 &= y_6 - \hat{y}_6 \\ d_7 &= y_7 - \hat{y}_7 \\ d_8 &= y_8 - \hat{y}_8 \\ d_9 &= y_9 - \hat{y}_9 \\ d_{10} &= y_{10} - \hat{y}_{10}\end{aligned}$$

Check: $\sum_{i=1}^{10} d_i = 0$ (within round off)

7. The standard deviation of a single observation (s) is:

$$s = \sqrt{\frac{\sum_{i=1}^{10} d_i^2}{5}}$$

where 5 represents the number of degrees of freedom in this error estimate

8. Emf value of the cell's.

The emf's of the cells are calculated by restoring the mean value to give

$$\hat{V}_i = \hat{v}_i + M$$

5.

$$\begin{aligned}\hat{y}_1 &= +0.78 - 0.04 - 0.22 = +0.52 \text{ i V} \\ \hat{y}_2 &= +0.78 + 1.06 - 0.22 = +1.62 \text{ i V} \\ \hat{y}_3 &= +0.04 + 1.06 - 0.22 = +0.88 \text{ i V} \\ \hat{y}_4 &= +0.04 - 0.22 - 0.22 = -0.4 \mu\text{V} \\ \hat{y}_5 &= -1.06 - 0.22 - 0.22 = -1.50 \mu\text{V} \\ \hat{y}_6 &= -1.06 - 0.02 - 0.22 = -1.30 \mu\text{V} \\ \hat{y}_7 &= +0.22 - 0.02 - 0.22 = -0.02 \mu\text{V} \\ \hat{y}_8 &= +0.22 - 0.78 - 0.22 = -0.78 \mu\text{V} \\ \hat{y}_9 &= +0.02 - 0.78 - 0.22 = -0.98 \mu\text{V} \\ \hat{y}_{10} &= +0.02 - 0.04 - 0.22 = -0.24 \mu\text{V}\end{aligned}$$

Check:

$$\begin{aligned}\sum \hat{y}_i &= \left(\begin{array}{l} +0.52 + 1.62 + 0.88 - 0.4 - 1.50 - \\ 1.30 - 0.02 - 0.78 - 0.98 - 0.24 \end{array} \right) = -2.20 \mu\text{V} \\ \sum \hat{y}_i &= 10 \times (-0.22) = -2.20 \text{ i V}\end{aligned}$$

6.

$$\begin{aligned}d_1 &= +0.5 - 0.52 = -0.02 \mu\text{V} \\ d_2 &= +1.6 - 1.62 = -0.02 \mu\text{V} \\ d_3 &= +0.9 - 0.88 = +0.02 \mu\text{V} \\ d_4 &= -0.4 + 0.4 = 0 \mu\text{V} \\ d_5 &= -1.5 + 1.50 = 0 \mu\text{V} \\ d_6 &= -1.3 + 1.30 = 0 \mu\text{V} \\ d_7 &= 0 + 0.02 = +0.02 \mu\text{V} \\ d_8 &= -0.8 + 0.78 = -0.02 \mu\text{V} \\ d_9 &= -1.0 + 0.98 = -0.02 \mu\text{V} \\ d_{10} &= -0.2 + 0.24 = +0.04 \mu\text{V}\end{aligned}$$

Check: $\sum d_i = \left(\begin{array}{l} -0.02 - 0.02 + 0.02 + 0 + 0 + \\ 0 + 0.02 - 0.02 - 0.02 + 0.04 \end{array} \right) = 0 \mu\text{V}$

7.

$$s = \sqrt{\frac{0.004}{5}} = 0.028 \mu\text{V}$$

8. Mean (from section 1):

1.01825300

$$\begin{aligned}\hat{V}_1 &= 1.01825300 + 0.00000078 = 1.01825378 \\ \hat{V}_2 &= 1.01825300 + 0.00000004 = 1.01825304 \\ \hat{V}_3 &= 1.01825300 - 0.00000106 = 1.01825194 \\ \hat{V}_4 &= 1.01825300 + 0.00000022 = 1.01825322 \\ \hat{V}_5 &= 1.01825300 + 0.00000002 = 1.01825302\end{aligned}$$

TABLE A-4

THE INTERCOMPARISON OF A GROUP OF 6 CELLS

1. Given: The emfs of six saturated standard cells (V_1, V_2, V_3, V_4, V_5 and V_6) are assigned by calibrating them in terms of a known standard of electromotive force. The mean of the group is

$$M = 1/6 \sum_{i=1}^6 V_i$$

and the difference from the mean of each cell is

$$v_i = (V_i - M)$$

1. From an NBS Report of Calibration:

$V_1 = 1.0182605$	$v_1 = +10.521 \text{ V}$
$V_2 = 1.0182655$	$v_2 = +15.521 \text{ V}$
$V_3 = 1.0182466$	$v_3 = -3.381 \text{ V}$
$V_4 = 1.0182476$	$v_4 = -2.381 \text{ V}$
$V_5 = 1.0182416$	$v_5 = -8.381 \text{ V}$
$V_6 = 1.0182381$	$v_6 = -11.881 \text{ V}$
Mean = 1.01824998	sum = 0

Example

2. Assuming that there is a small constant emf P associated with the measuring process then the expected value of a single observation is

$$E(y_i) = V_j - V_k + P$$

$j \neq k$; for j and $k = 1, 2, 3, 4, 5, 6$.

For all possible values of j and k the following schedule of measurements is convenient and requires changing the connections to only one cell at a time.

2. Observations:

Measurement	Cell in UNK position*	Cell in REF position*
y_1	1	2
y_2	1	3
y_3	2	3
y_4	2	4
y_5	3	4
y_6	3	5
y_7	4	5
y_8	4	6
y_9	5	6
y_{10}	5	1
y_{11}	6	1
y_{12}	6	2
y_{13}	1	4
y_{14}	2	5
y_{15}	3	6

$y_1 = -5.41 \text{ V}$
$y_2 = +13.71 \text{ V}$
$y_3 = +18.81 \text{ V}$
$y_4 = +17.71 \text{ V}$
$y_5 = -1.31 \text{ V}$
$y_6 = +4.81 \text{ V}$
$y_7 = +5.91 \text{ V}$
$y_8 = +9.51 \text{ V}$
$y_9 = +3.51 \text{ V}$
$y_{10} = -19.11 \text{ V}$
$y_{11} = -22.71 \text{ V}$
$y_{12} = -27.91 \text{ V}$
$y_{13} = +12.51 \text{ V}$
$y_{14} = +23.71 \text{ V}$
$y_{15} = +8.41 \text{ V}$

Table A-4 Continued

3. Create a set of sums Q_i , S and T :

$$\begin{aligned} Q_1 &= (y_1 + y_2 - y_{10} - y_{11} + y_{13}) \\ Q_2 &= (-y_1 + y_3 + y_4 - y_{12} + y_{14}) \\ Q_3 &= (-y_2 - y_3 + y_5 + y_6 + y_{15}) \\ Q_4 &= (-y_4 - y_5 + y_7 + y_8 - y_{13}) \\ Q_5 &= (-y_6 - y_7 + y_9 + y_{10} - y_{14}) \\ Q_6 &= (-y_8 - y_9 + y_{11} + y_{12} - y_{15}) \end{aligned}$$

$$S = Q_1 + Q_2 + Q_3$$

T = sum all measurements

$$\text{Arithmetic Check: } \sum_{i=1}^6 Q_i = 0$$

3.

$$\begin{aligned} Q_1 &= (-5.4 + 13.7 + 19.1 + 22.7 + 12.5) = +62.6 \text{ i V} \\ Q_2 &= (+5.4 + 18.8 + 17.7 + 27.9 + 23.7) = +93.5 \text{ i V} \\ Q_3 &= (-13.7 - 18.8 - 1.3 + 4.8 + 8.4) = -20.6 \text{ i V} \\ Q_4 &= (-17.7 + 1.3 + 5.9 + 9.5 - 12.5) = -13.5 \text{ i V} \\ Q_5 &= (-4.8 - 5.9 + 3.5 - 19.1 - 23.7) = -50.0 \text{ i V} \\ Q_6 &= (-9.5 - 3.5 - 22.7 - 27.9 - 8.4) = -72.0 \text{ i V} \end{aligned}$$

$$S = (62.6 + 93.5 - 20.6) = 135.5$$

$$T = \left(\begin{array}{l} -5.4 + 13.7 + 18.8 + 17.7 - 1.3 + \\ 4.8 + 5.9 + 9.5 + 3.5 - 19.1 - \\ 22.7 - 27.9 + 12.5 + 23.7 + 8.4 \end{array} \right) = 42.1 \text{ i V}$$

Check:

$$\sum_{i=1}^6 Q_i = (+62.6 + 93.5 - 20.6 - 13.5 - 50.0 - 72.0) = 0 \text{ i V}$$

4. Calculate \hat{P} :

$$\hat{P} = \frac{3T - S}{42}$$

4.

$$\hat{P} = \frac{126.3 - 135.5}{42} = -0.219 \text{ i V}$$

5. Calculate \hat{v} 's:

$$\begin{aligned} \hat{v}_1 &= 1/6(Q_1 - \hat{P}) \\ \hat{v}_2 &= 1/6(Q_2 - \hat{P}) \\ \hat{v}_3 &= 1/6(Q_3 - \hat{P}) \\ \hat{v}_4 &= 1/6(Q_4 + \hat{P}) \\ \hat{v}_5 &= 1/6(Q_5 + \hat{P}) \\ \hat{v}_6 &= 1/6(Q_6 + \hat{P}) \end{aligned}$$

$$\text{Check: } \sum_{i=1}^6 \hat{v}_i = 0$$

5.

$$\begin{aligned} \hat{v}_1 &= 1/6(+62.6 + 0.219) = +10.470 \text{ i V} \\ \hat{v}_2 &= 1/6(+93.5 + 0.219) = +15.620 \text{ i V} \\ \hat{v}_3 &= 1/6(-20.6 + 0.219) = -3.397 \\ \hat{v}_4 &= 1/6(-13.5 - 0.219) = -2.286 \text{ i V} \\ \hat{v}_5 &= 1/6(-50.0 - 0.219) = -8.370 \text{ i V} \\ \hat{v}_6 &= 1/6(-72.0 - 0.219) = -12.036 \text{ i V} \end{aligned}$$

Check:

$$\sum_{i=1}^6 \hat{v}_i = 1/6 \left(\begin{array}{l} +62.819 + 93.719 - 20.819 - 13.781 - \\ 50.219 - 72.219 \end{array} \right) = 0 \mu\text{V}$$

6. Calculation of \hat{y} 's, the predicted y 's:

$$\begin{aligned} \hat{y}_1 &= \hat{v}_1 - \hat{v}_2 + \hat{P} \\ \hat{y}_2 &= \hat{v}_1 - \hat{v}_3 + \hat{P} \\ \hat{y}_3 &= \hat{v}_2 - \hat{v}_3 + \hat{P} \\ \hat{y}_4 &= \hat{v}_2 - \hat{v}_4 + \hat{P} \\ \hat{y}_5 &= \hat{v}_3 - \hat{v}_4 + \hat{P} \\ \hat{y}_6 &= \hat{v}_3 - \hat{v}_5 + \hat{P} \\ \hat{y}_7 &= \hat{v}_4 - \hat{v}_5 + \hat{P} \\ \hat{y}_8 &= \hat{v}_4 - \hat{v}_6 + \hat{P} \\ \hat{y}_9 &= \hat{v}_5 - \hat{v}_6 + \hat{P} \\ \hat{y}_{10} &= \hat{v}_5 - \hat{v}_1 + \hat{P} \\ \hat{y}_{11} &= \hat{v}_6 - \hat{v}_1 + \hat{P} \\ \hat{y}_{12} &= \hat{v}_6 - \hat{v}_2 + \hat{P} \\ \hat{y}_{13} &= \hat{v}_1 - \hat{v}_4 + \hat{P} \\ \hat{y}_{14} &= \hat{v}_2 - \hat{v}_5 + \hat{P} \\ \hat{y}_{15} &= \hat{v}_3 - \hat{v}_6 + \hat{P} \end{aligned}$$

6.

$$\begin{aligned} \hat{y}_1 &= +10.470 - 15.620 - 0.219 = -5.369 \text{ i V} \\ \hat{y}_2 &= +10.470 + 3.397 - 0.219 = +13.648 \text{ i V} \\ \hat{y}_3 &= +15.620 + 3.397 - 0.219 = +18.798 \text{ i V} \\ \hat{y}_4 &= +15.620 + 2.286 - 0.219 = +17.687 \mu\text{V} \\ \hat{y}_5 &= -3.397 + 2.286 - 0.219 = -1.330 \mu\text{V} \\ \hat{y}_6 &= -3.397 + 8.370 - 0.219 = +4.754 \mu\text{V} \\ \hat{y}_7 &= -2.286 + 8.370 - 0.219 = +5.865 \mu\text{V} \\ \hat{y}_8 &= -2.286 + 12.036 - 0.219 = +9.531 \mu\text{V} \\ \hat{y}_9 &= -8.370 + 12.036 - 0.219 = +3.447 \mu\text{V} \\ \hat{y}_{10} &= -8.370 - 10.470 - 0.219 = -19.059 \mu\text{V} \\ \hat{y}_{11} &= -12.036 - 10.470 - 0.219 = -22.725 \mu\text{V} \\ \hat{y}_{12} &= -12.036 - 15.620 - 0.219 = -27.875 \mu\text{V} \\ \hat{y}_{13} &= +10.470 + 2.286 - 0.219 = +12.537 \mu\text{V} \\ \hat{y}_{14} &= +15.620 + 8.370 - 0.219 = +23.771 \mu\text{V} \\ \hat{y}_{15} &= -3.397 + 12.036 - 0.219 = +8.420 \mu\text{V} \end{aligned}$$

Table A-4 Continued

7. Calculation of deviations ($d_i = y_i - \hat{y}_i$):

$$\begin{aligned} d_1 &= y_1 - \hat{y}_1 \\ d_2 &= y_2 - \hat{y}_2 \\ d_3 &= y_3 - \hat{y}_3 \\ d_4 &= y_4 - \hat{y}_4 \\ d_5 &= y_5 - \hat{y}_5 \\ d_6 &= y_6 - \hat{y}_6 \\ d_7 &= y_7 - \hat{y}_7 \\ d_8 &= y_8 - \hat{y}_8 \\ d_9 &= y_9 - \hat{y}_9 \\ d_{10} &= y_{10} - \hat{y}_{10} \\ d_{11} &= y_{11} - \hat{y}_{11} \\ d_{12} &= y_{12} - \hat{y}_{12} \\ d_{13} &= y_{13} - \hat{y}_{13} \\ d_{14} &= y_{14} - \hat{y}_{14} \\ d_{15} &= y_{15} - \hat{y}_{15} \end{aligned}$$

7.

$$\begin{aligned} d_1 &= -5.4 + 5.369 = -0.031\mu\text{V} \\ d_2 &= +13.7 - 13.648 = +0.052\mu\text{V} \\ d_3 &= +18.8 - 18.798 = +0.002\mu\text{V} \\ d_4 &= +17.7 - 17.687 = +0.013\mu\text{V} \\ d_5 &= -1.3 + 1.330 = +0.030\mu\text{V} \\ d_6 &= +4.8 - 4.754 = +0.046\mu\text{V} \\ d_7 &= +5.9 - 5.865 = +0.035\mu\text{V} \\ d_8 &= +9.5 - 9.531 = -0.031\mu\text{V} \\ d_9 &= +3.5 - 3.447 = +0.053\mu\text{V} \\ d_{10} &= -19.1 + 19.059 = -0.041\mu\text{V} \\ d_{11} &= -22.7 + 22.725 = +0.025\mu\text{V} \\ d_{12} &= -27.9 + 27.875 = -0.025\mu\text{V} \\ d_{13} &= +12.5 - 12.537 = -0.037\mu\text{V} \\ d_{14} &= +23.7 - 23.771 = -0.071\mu\text{V} \\ d_{15} &= +8.4 - 8.420 = -0.020\mu\text{V} \end{aligned}$$

8. The standard deviation of a single observation (s) is:

$$s = \sqrt{\frac{\sum_{i=1}^{15} d_i^2}{9}}$$

where 9 represents the degrees of freedom for error

8.

$$s = \sqrt{\frac{0.021590}{9}} = 0.0490\mu\text{V}$$

9. Emf value of the cells.

The emf's of the cells are calculated by restoring the mean value to give

$$\hat{V}_i = \hat{v}_i + M$$

9. Mean (from section 1): 1.01824998

$$\begin{aligned} \hat{V}_1 &= 1.01824998 + 0.00001047 = 1.01826045 \\ \hat{V}_2 &= 1.01824998 + 0.00001562 = 1.01826560 \\ \hat{V}_3 &= 1.01824998 - 0.00000340 = 1.01824658 \\ \hat{V}_4 &= 1.01824998 - 0.00000229 = 1.01824769 \\ \hat{V}_5 &= 1.01824998 - 0.00000837 = 1.01824161 \\ \hat{V}_6 &= 1.01824998 - 0.00001204 = 1.01823794 \end{aligned}$$