

GIGABYTE™

MC62-G40

AMD Ryzen™ Threadripper™ PRO Workstation Board

User Manual

Rev. 1.0

Copyright

© 2021 GIGA-BYTE TECHNOLOGY CO., LTD. All rights reserved.

The trademarks mentioned in this manual are legally registered to their respective owners.

Disclaimer

Information in this manual is protected by copyright laws and is the property of GIGABYTE.

Changes to the specifications and features in this manual may be made by GIGABYTE without prior notice. No part of this manual may be reproduced, copied, translated, transmitted, or published in any form or by any means without GIGABYTE's prior written permission.

Documentation Classifications

In order to assist in the use of this product, GIGABYTE provides the following types of documentation:

- User Manual: detailed information & steps about the installation, configuration and use this product (e.g. motherboard, server barebones), covering hardware and BIOS.
- User Guide: detailed information about the installation & use of an add-on hardware or software component (e.g. BMC firmware, rail-kit) compatible with this product.
- Quick Installation Guide: a short guide with visual diagrams that you can reference easily for installation purposes of this product (e.g. motherboard, server barebones).

Please see the support section of the online product page to check the current availability of these documents

For More Information

For related product specifications, the latest firmware and software, and other information, please visit our website at: <http://www.gigabyte.com>.

For GIGABYTE distributors and resellers, additional sales & marketing materials are available from our reseller portal: <http://reseller.b2b.gigabyte.com>

For further technical assistance, please contact your GIGABYTE representative or visit <http://esupport.gigabyte.com/> to create a new support ticket.

For any general sales or marketing enquires, you may message GIGABYTE server directly by email: server.grp@gigabyte.com.

 **WARNING**

- **INGESTION HAZARD:** This product contains a button cell or coin battery.
- **DEATH** or serious injury can occur if ingested.
- A swallowed button cell or coin battery can cause **Internal Chemical Burns** in as little as **2 hours**.
- **KEEP** new and used batteries **OUT OF REACH OF CHILDREN**
- **Seek immediate medical attention** if a battery is suspected to be swallowed or inserted inside any part of the body.



- Battery type: CR2032, voltage rating: +3VDC.
- Non-rechargeable batteries are not to be recharged.
- Remove and immediately recycle or dispose of used batteries, batteries from equipment not used for an extended period of time according to local regulations and keep away from children. Do NOT dispose of batteries in household trash or incinerate.
- Even used batteries may cause severe injury or death.
- Do not force discharge, recharge, disassemble, heat above (manufacturer's specified temperature rating) or incinerate. Doing so may result in injury due to venting, leakage or explosion resulting in chemical burns.
- For treatment information, call a local poison control center.
- The product contains non-replaceable batteries.

Table of Contents

MC62-G40 Motherboard Layout.....	6
Block Diagram	8
Chapter 1 Hardware Installation	9
1-1 Installation Precautions	9
1-2 Product Specifications.....	10
1-3 Installing and Removing the CPU and Heat Sink.....	12
1-4 Installing and Removing Memory.....	13
1-4-1 8-Channel Memory Configuration	13
1-4-2 Installing and Removing a Memory Module	14
1-5 Installing and Removing the M.2 SSD Module.....	15
1-6 Installing and Removing the M.2 WiFi Module.....	15
1-7 Back Panel Connectors.....	16
1-8 Internal Connectors.....	18
1-9 Jumper Settings	26
Chapter 2 BIOS Setup	27
2-1 The Main Menu	29
2-2 Advanced Menu	32
2-2-1 Trusted Computing	33
2-2-2 AST2600 Super IO Configuration.....	35
2-2-3 S5 RTC Wake Settings.....	37
2-2-4 Serial Port Console Redirection	38
2-2-5 CPU Configuration.....	42
2-2-6 PCI Subsystem Settings.....	43
2-2-7 USB Configuration.....	45
2-2-8 Network Stack Configuration	47
2-2-9 NVMe Configuration	48
2-2-10 SATA Configuration.....	49
2-2-11 Graphic Output Configuration.....	50
2-2-12 AMD Mem Configuration Status	51
2-2-13 Tls Auth Configuration	52
2-2-14 iSCSI Configuration	53
2-2-15 Intel(R) I210 Gigabit Network Connection	54
2-2-16 Intel X550 10GBASE-T Network Connection	56
2-2-17 VLAN Configuration.....	58
2-2-18 MAC IPv4 Network Configuration.....	59
2-2-19 MAC IPv6 Network Configuration.....	60

2-3	AMD CBS Menu.....	61
2-3-1	CPU Common Options	62
2-3-2	DF Common Options.....	64
2-3-3	UMC Common Options	67
2-3-4	NBIO Common Options.....	75
2-3-5	FCH Common Options	79
2-3-6	SOC Miscellaneous Control	80
2-3-7	Chipset Common Options	81
2-4	AMD PBS Menu.....	82
2-4-1	RAS.....	83
2-5	Chipset Setup Menu.....	85
2-5-1	North Bridge	86
2-6	Server Management Menu.....	87
2-6-1	System Event Log	89
2-6-2	View FRU Information	90
2-6-3	BMC VLAN Configuration.....	91
2-6-4	BMC Network Configuration.....	92
2-6-5	IPv6 BMC Network Configuration	93
2-7	Security Menu	94
2-7-1	Secure Boot	95
2-8	Boot Menu.....	97
2-9	Save & Exit Menu.....	99
2-10	BIOS Recovery	100
2-11	BIOS POST Beep code (AMI standard).....	101
2-11-1	PEI Beep Codes	101
2-11-2	DXE Beep Codes	101

MC62-G40 Motherboard Layout

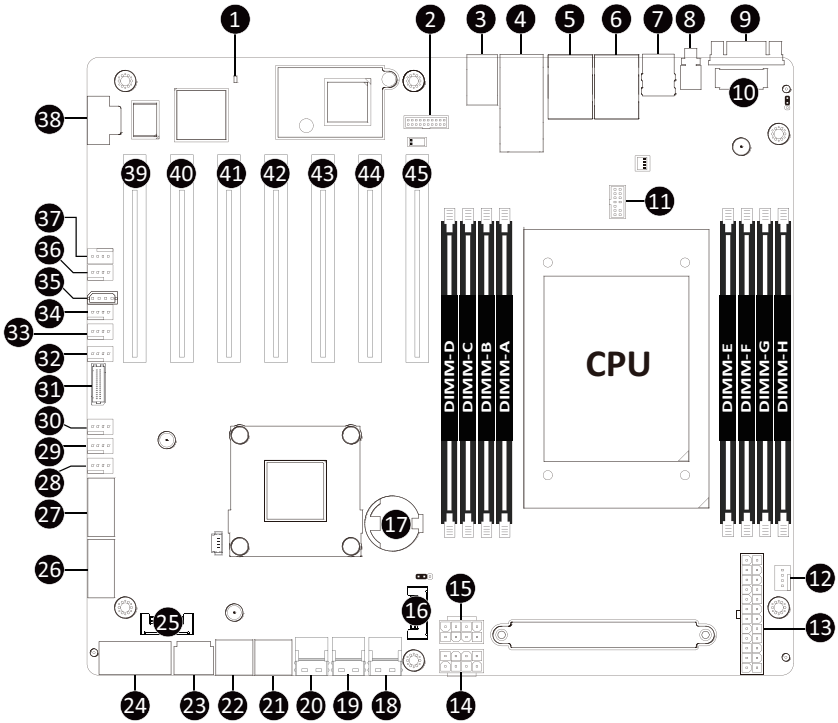

Item	Code	Description
1	LED_BMC	BMC Firmware Readiness LED
2	CN_NCSI	NCSI Connector
3	Audio	Audio Connectors
4	10G_LAN	10GbE LAN Ports
5	USB3_MLAN1	Server Management LAN Port (Top)/ USB 3.2 Ports (Bottom)
6	USB3_LAN_1	GbE LAN Port (Top)/ USB 3.2 Ports (Bottom)
7	R_USB32C/USB32A	USB 3.2 Type A Port (Top)/ USB 3.2 Type C Port (Bottom)
8	SW_ID	ID Button with LED
9	VGA_1	VGA Port
10	M2E1	M.2 Slot (WiFi/BT Module, Support NGFF-2230)
11	TPM1	TPM Connector
12	CPU_FAN	CPU Fan Connector
13	ATX	2x12 Pin Main Power Connector
14	P12V_AUX1	2x4 Pin 12V Power Connector (for CPU)
15	P12V_AUX2	2x4 Pin 12V Power Connector (for PCIe)
16	P_X4_M2_A	M.2 Slot (PCIe Gen4 x4, Support NGFF-2280)
17	BAT	Battery Socket
18	SL_CN1	SlimLine SAS 4i Connector (SATA III/PCIe Gen4 x4 Signal)
19	SL_CN2	SlimLine SAS 4i Connector (SATA III/PCIe Gen4 x4 Signal)
20	SL_CN3	SlimLine SAS 4i Connector (SATA III/PCIe Gen4 x4 Signal)
21	SATA_0_1	SATA III 6Gb/s Connector #0/#1
22	SATA_2_3	SATA III 6Gb/s Connector #2/#3
23	PMBUS1	PMBus Connector
24	FP_1	Front Panel Header
25	P_X4_M2_B	M.2 Slot (PCIe Gen4 x4, Support NGFF-2280)
26	FUSB30_2	Front Panel USB 3.2 Connector #2
27	FUSB30_1	Front Panel USB 3.2 Connector #1
28	SYS_FAN7	System Fan Connector #7
29	SYS_FAN8	System Fan Connector #8
30	SYS_FAN6	System Fan Connector #6
31	BP_1	HDD Back Plane Board Connector
32	SYS_FAN1	System Fan Connector #1
33	SYS_FAN2	System Fan Connector #2
34	SYS_FAN3	System Fan Connector #3
35	IPMB	IPMB Connector
36	SYS_FAN4	System Fan Connector #4
37	SYS_FAN5	System Fan Connector #5
38	COM1	Serial Port Connector
39	PCIEX16_1	PCIe x16 Slot (Gen4 x16)
40	PCIEX8_2	PCIe x16 Slot (Gen4 x8)
41	PCIEX16_3	PCIe x16 Slot (Gen4 x16)
42	PCIEX16_4	PCIe x16 Slot (Gen4 x16)
43	PCIEX16_5	PCIe x16 Slot (Gen4 x16)
44	PCIEX16_6	PCIe x16 Slot (Gen4 x16)
45	PCIEX16_7	PCIe x16 Slot (Gen4 x16)

Block Diagram

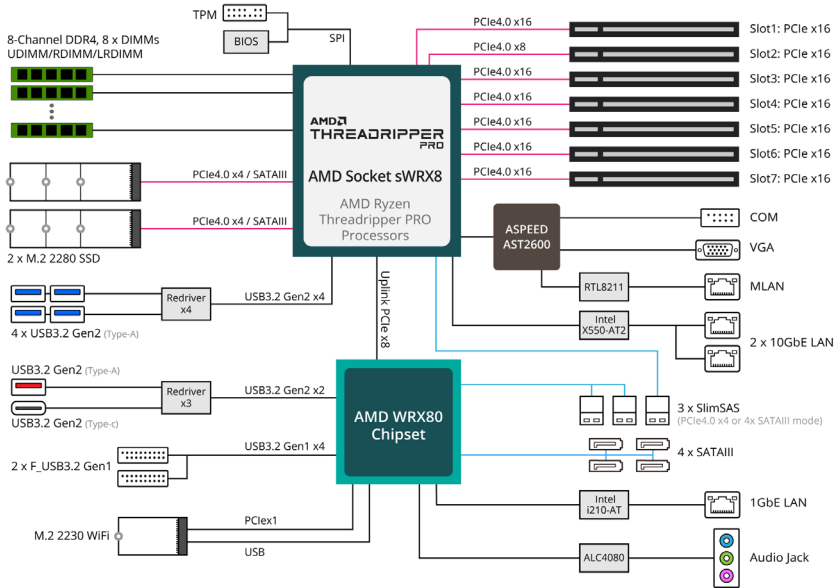

Chapter 1 Hardware Installation

1-1 Installation Precautions

The motherboard contains numerous delicate electronic circuits and components which can become damaged as a result of electrostatic discharge (ESD). Prior to installation, carefully read the user's manual and follow these procedures:











- Prior to installation, do not remove or break motherboard S/N (Serial Number) sticker or warranty sticker provided by your dealer. These stickers are required for warranty validation.
- Always remove the AC power by unplugging the power cord from the power outlet before installing or removing the motherboard or other hardware components.
- When connecting hardware components to the internal connectors on the motherboard, make sure they are connected tightly and securely.
- When handling the motherboard, avoid touching any metal leads or connectors.
- It is best to wear an electrostatic discharge (ESD) wrist strap when handling electronic components such as a motherboard, CPU or memory. If you do not have an ESD wrist strap, keep your hands dry and first touch a metal object to eliminate static electricity.
- Prior to installing the motherboard, please have it on top of an antistatic pad or within an electrostatic shielding container.
- Before unplugging the power supply cable from the motherboard, make sure the power supply has been turned off.
- Before turning on the power, make sure the power supply voltage has been set according to the local voltage standard.
- Before using the product, please verify that all cables and power connectors of your hardware components are connected.
- To prevent damage to the motherboard, do not allow screws to come in contact with the motherboard circuit or its components.
- Make sure there are no leftover screws or metal components placed on the motherboard or within the computer casing.
- Do not place the computer system on an uneven surface.
- Do not place the computer system in a high-temperature environment.
- Turning on the computer power during the installation process can lead to damage to system components as well as physical harm to the user.
- If you are uncertain about any installation steps or have a problem related to the use of the product, please consult a certified computer technician.

1-2 Product Specifications



NOTE:

We reserve the right to make any changes to the product specifications and product-related information without prior notice.

 Form Factor	<ul style="list-style-type: none"> ◆ CEB ◆ 305W x 267D (mm)
 CPU	<ul style="list-style-type: none"> ◆ AMD Ryzen™ Threadripper™ Pro 3000WX processors ◆ Processor up to 64-core, 128 threads; TDP up to 280W
 Chipset	<ul style="list-style-type: none"> ◆ AMD WRX80
 Memory	<ul style="list-style-type: none"> ◆ 8 x DIMM slots ◆ DDR4 memory supported only ◆ 8 channel memory architecture ◆ Support for 3200/2933/2666/2400/2133 MHz; ECC & non-ECC; buffered & unbuffered; UDIMM, RDIMM, 3DS R-DIMM, LRDIMM ◆ Total up to 2TB of system memory (256GB single LRDIMM capacity) <p>NOTE: When installing memory modules, make sure to begin with the first socket of each channel, such as DIMM_P0_A0, DIMM_P0_B0, DIMM_P0_C0, DIMM_P0_D0</p>
 LAN	<ul style="list-style-type: none"> ◆ 2 x 10GbE LAN (Intel® X550-AT2) ◆ 1 x GbE LAN (Intel® i210) ◆ 1 x 10/100/1000 Management LAN
 Video	<ul style="list-style-type: none"> ◆ Integrated in Aspeed® AST2600 ◆ 2D Video Graphic Adapter with PCIe bus interface ◆ 1920x1200@60Hz 32bpp
 Audio	<ul style="list-style-type: none"> ◆ Realtek® ALC4080 HD audio codec ◆ Supports 7.1 channel configurations ◆ 3 ports Audio Jack (Audio in/Audio out/Mic)
 Storage Interface	<ul style="list-style-type: none"> ◆ 4 x SATA III 6Gb/s ports ◆ 2 x M.2 slot for storage (PCIe Gen4 x4 or SATA III 6Gb/s) ◆ 3 x SlimSAS ports (PCIe Gen4 x4 or 4x SATA III 6Gb/s each)
 RAID	<ul style="list-style-type: none"> ◆ RAID 0, RAID 1, RAID5 and RAID 10
 Expansion Slots	<ul style="list-style-type: none"> ◆ Slot_7: 1 x PCIe x16 (Gen4 x16) slot ◆ Slot_6: 1 x PCIe x16 (Gen4 x16) slot ◆ Slot_5: 1 x PCIe x16 (Gen4 x16) slot ◆ Slot_4: 1 x PCIe x16 (Gen4 x16) slot ◆ Slot_3: 1 x PCIe x16 (Gen4 x16) slot ◆ Slot_2: 1 x PCIe x16 (Gen4 x8) slot ◆ Slot_1: 1 x PCIe x16 (Gen4 x16) slot ◆ 2 x M.2 slot: <ul style="list-style-type: none"> - M-key - PCIe Gen4 x4 or 4x SATA 6Gb/s - Supports NGFF-2242/2280 cards

	Expansion Slots (Continued)	<ul style="list-style-type: none"> ◆ 1 x M.2 slot for Wi-Fi: <ul style="list-style-type: none"> - E-key - Supports NGFF-2230 card ◆ 3 x U.2 connector: <ul style="list-style-type: none"> - SlimSAS type - PCIe Gen4 x4 or 4x SATA III 6Gb/s
	Internal I/O Connectors	<ul style="list-style-type: none"> ◆ 1 x 24-pin ATX main power connector ◆ 2 x 8-pin ATX 12V power connector ◆ 1 x CPU fan header ◆ 1 x PCH fan header ◆ 8 x System fan headers ◆ 2 x USB 3.0 headers for 4 ports ◆ 1 x PMBus connector ◆ 4 x SATA III 6Gb/s ports ◆ 2 x M.2 slot for storage ◆ 1 x M.2 slot for Wi-Fi ◆ 3 x U.2 connector ◆ 1 x Front panel header ◆ 1 x Back plane board header ◆ 1 x PMBus header ◆ 1 x IPMB header ◆ 1 x TPM header ◆ 1 x COM header
	Rear I/O Connectors	<ul style="list-style-type: none"> ◆ 1 x VGA ◆ 1 x ID Button ◆ 2 x USB 3.2 gen2 (Type-A + Type-C®) ◆ 1 x RJ45 (GbE LAN) ◆ 1 x MLAN ◆ 4 x USB 3.2 gen2 Type-A ◆ 2 x RJ45 (red) (10GbE LAN) ◆ 1 x 3 in 1 Audio jacks
	TPM	<ul style="list-style-type: none"> ◆ 1 x TPM header with SPI interface ◆ Optional TPM2.0 kit: CTM010
	Board Management	<ul style="list-style-type: none"> ◆ Aspeed® AST2600 management controller ◆ GIGABYTE Management Console (AMI MegaRAC SP-X) web interface
	Operating Properties	<ul style="list-style-type: none"> ◆ Operating temperature: 10°C to 40°C ◆ Operating humidity: 8-80% (non-condensing) ◆ Non-operating temperature: -40°C to 60°C ◆ Non-operating humidity: 20%-95% (non-condensing)

1-3 Installing and Removing the CPU and Heat Sink



Read the following guidelines before you begin to install the CPU:

- Make sure that the motherboard supports the CPU.
- Always turn off the computer and unplug the power cord from the power outlet before installing the CPU to prevent hardware damage.
- Unplug all cables from the power outlets.
- Disconnect all telecommunication cables from their ports.
- Place the system unit on a flat and stable surface.
- Open the system according to the instructions.



WARNING!

Failure to properly turn off the server before you start installing components may cause serious damage. Do not attempt the procedures described in the following sections unless you are a qualified service technician.

Follow these instructions to Install the CPU:

1. Loosen the three captive screws in sequential order (1→2→3) securing the CPU cover.
 2. Flip open the CPU cover.
 3. Remove the CPU cap with CPU from the CPU frame using the handle on the CPU cap.
 4. Using the handle on the CPU cap insert the new CPU cap with CPU installed into the CPU frame.
- Note:** Ensure that the CPU is installed in the CPU cap in the correct orientation, with the gold triangle on the CPU aligned to the top left corner of the CPU cap.
5. Flip the CPU frame with CPU installed into place in the CPU socket.

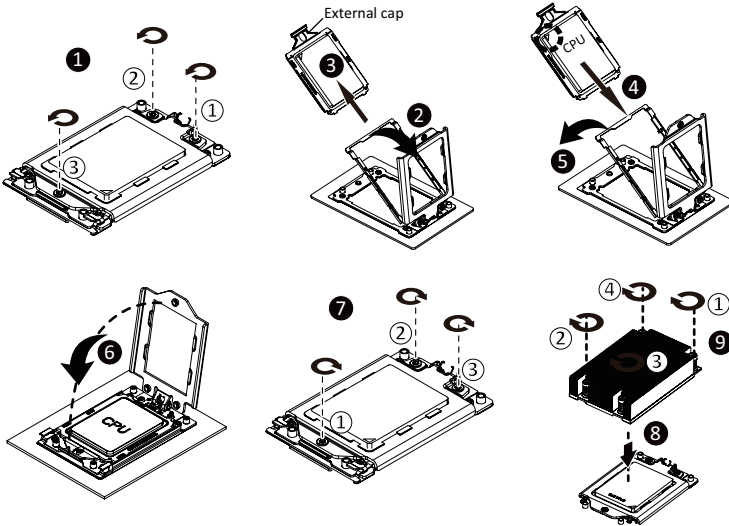

1-4 Installing and Removing Memory



Read the following guidelines before you begin to install the memory:

- Make sure that the motherboard supports the memory. It is recommended that memory of the same capacity, brand, speed, and chips be used.
- Always turn off the computer and unplug the power cord from the power outlet before installing the memory to prevent hardware damage.
- Memory modules have a foolproof design. A memory module can be installed in only one direction. If you are unable to insert the memory, switch the direction.

1-4-1 8-Channel Memory Configuration

This motherboard provides 8 DDR4 memory sockets and supports 8-Channel Technology. After the memory is installed, the BIOS will automatically detect the specifications and capacity of the memory.

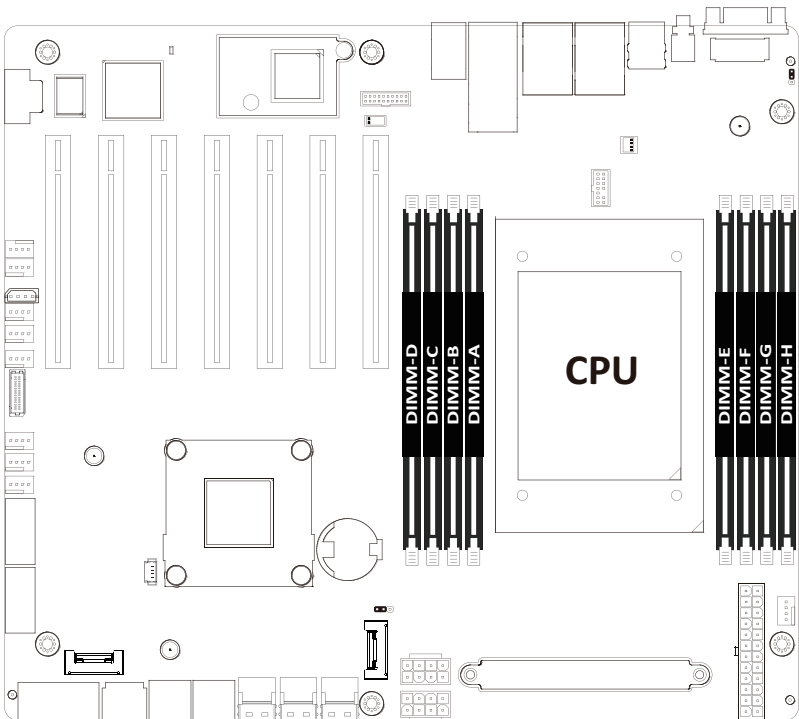

1-4-2 Installing and Removing a Memory Module



Before installing a memory module, make sure to turn off the computer and unplug the power cord from the power outlet to prevent damage to the memory module.

Be sure to install DDR4 DIMMs on to this motherboard.

Follow these instructions to install a DIMM module:

1. Insert the DIMM memory module vertically into the DIMM slot and push it down.
2. Close the plastic clip at both edges of the DIMM slots to lock the DIMM module.
3. Reverse the installation steps when you want to remove the DIMM module.

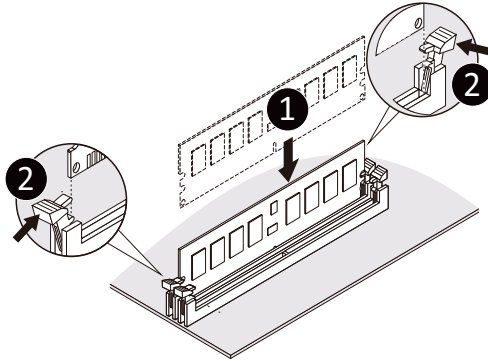

Note:

- 8 Channel DDR4 up to 3200MHz Memory Support
- Supports 1 DIMM per Channel
- Support for UDIMM (ECC), RDIMM, 3DS RDIMM.

1-5 Installing and Removing the M.2 SSD Module

Follow the steps below to install an optional M.2 SSD module on your motherboard.

Step1. Insert the M.2 SSD module into the slot.

Step2. Secure it with the screw, tightening as necessary to fasten the M.2 SSD module in place.

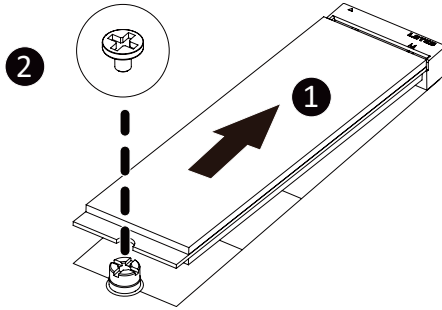

1-6 Installing and Removing the M.2 WiFi Module

Follow the steps below to install a M.2 WiFi module on your motherboard.

Step1. Carefully Insert the M.2 WiFi module into the slot.

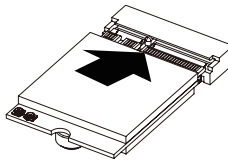

Step2. Secure it with the screw, tightening as necessary to fasten the M.2 WiFi module in place.

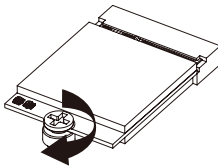

1-7 Back Panel Connectors

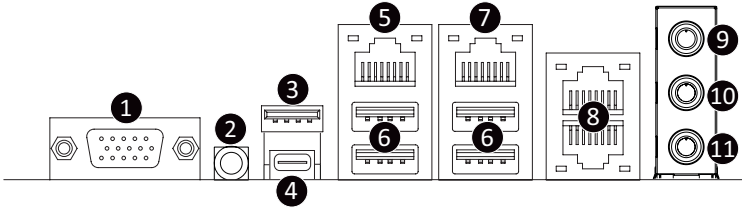

1 VGA Port

Connect to a monitor device.

2 ID button with LED

When the system identification is active, the ID LED on the front/ back panel glows blue.

3 USB 3.2 Type-A Port

The USB port supports the USB 3.2 specification. Use this port for USB devices such as a USB keyboard/mouse, USB printer, USB flash drive etc.

4 USB 3.2 Type-C Port

The USB port supports the USB 3.2 specification. Use this port for USB devices such as a USB keyboard/mouse, USB printer, USB flash drive etc.

5 GbE LAN Port

The Gigabit Ethernet LAN port provides Internet connection at up to 1 Gbps data rate. See the section below for a description of the states of the LAN port LEDs.

6 USB 3.2 Ports

The USB port supports the USB 3.2 specification. Use this port for USB devices such as a USB keyboard/mouse, USB printer, USB flash drive etc.

7 10/100/1000 Server Management LAN Port

The LAN port provides Internet connection with data transfer speeds of 10/100/1000Mbps. This port is the dedicated LAN port for Server Management.

8 10GbE LAN Ports

The 10 Gigabit Ethernet LAN port provides Internet connection at up to 10 Gbps data rate. See the section below for a description of the states of the LAN port LEDs.

9 Line In Jack (Blue)

The default Line in jack. Use this audio jack for line in devices such as an optical drive, walkman, etc

10 Line Out Jack (Green)

The default Line Out jack. Use this audio jack for a headphone or 2-channel speaker. This jack can be used to connect front speakers in a 4/5.1/7.1-channel audio configuration.

11 Mic In Jack (Pink)

The default MIC In jack. A microphone can be connected to the MIC In jack.

LAN and ID Button LEDs

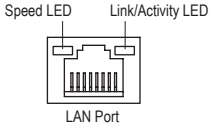

10GbE LAN LED:

State	Description
Yellow On	5Gbps, 2.5Gbps, 1Gps data rate
Green On	10Gbps data rate
Off	100Mbps data rate

10/100/1000 LAN LED:

State	Description
Yellow On	1Gbps data rate
Green On	100Mbps data rate
Off	10Mbps data rate

ID button/LED:

State	Description
Blue On	System identification is active
Off	System identification is disabled



- When removing the cable connected to a back panel connector, first remove the cable from your device and then remove it from the motherboard.
- When removing the cable, pull it straight out from the connector. Do not rock it side to side to prevent an electrical short inside the cable connector.

1-8 Internal Connectors

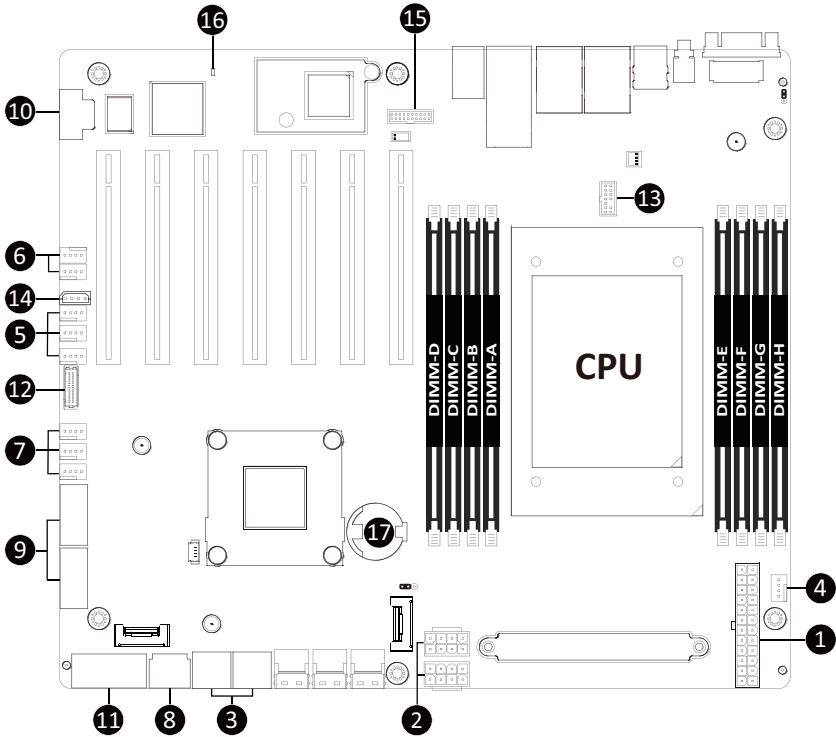

1) ATX	11) FP_1
2) P12V_AUX1/P12V_AUX2	12) BP_1
3) SATA_0_1/SATA_2_3	13) TPM1
4) CPU_FAN	14) IPMB
5) SYS_FAN1/2/3	15) CN_NCSI
6) SYS_FAN4/5	16) LED_BMC
7) SYS_FAN6/7/8	17) BAT
8) PMBUS1	
9) FUSB30_1/FUSB30_2	
10) COM1	



Read the following guidelines before connecting external devices:

- First make sure your devices are compliant with the connectors you wish to connect.
- Before installing the devices, be sure to turn off the devices and your computer. Unplug the power cord from the power outlet to prevent damage to the devices.
- After installing the device and before turning on the computer, make sure the device cable has been securely attached to the connector on the motherboard.

1/2) ATX/P12V_AUX1/P12V_AUX2

(2x12 Main Power Connector & 2x4 12V Power Connector)

With the use of the power connector, the power supply can supply enough stable power to all the components on the motherboard. Before connecting the power connector, first make sure the power supply is turned off and all devices are properly installed. The power connector possesses a foolproof design. Connect the power supply cable to the power connector in the correct orientation. The 12V power connector mainly supplies power to the CPU. If the 12V power connector is not connected, the computer will not start.



To meet expansion requirements, it is recommended that a power supply that can withstand high power consumption be used (500W or greater). If a power supply is used that does not provide the required power, the result can lead to an unstable or unbootable system.

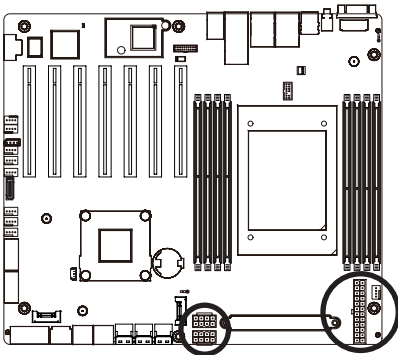

P12V_AUX1/ P12V_AUX2

Pin No.	Definition
1	GND
2	GND
3	GND
4	GND
5	+12V
6	+12V
7	+12V
8	+12V

ATX

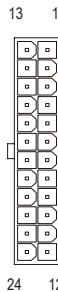

Pin No.	Definition	Pin No.	Definition
1	3.3V	13	3.3V
2	3.3V	14	-12V
3	GND	15	GND
4	+5V	16	PS_ON
5	GND	17	GND
6	+5V	18	GND
7	GND	19	GND
8	Power Good	20	-5V
9	5VSB	21	+5V
10	+12V	22	+5V
11	+12V	23	+5V
12	3.3V	24	GND

3) SATA_0_1/SATA_2_3 (SATA III 6Gb/s Connectors)

The SATA connectors conform to SATA III 6Gb/s standard and are compatible with SATA 3Gb/s standard. Each SATA connector supports a single SATA device.

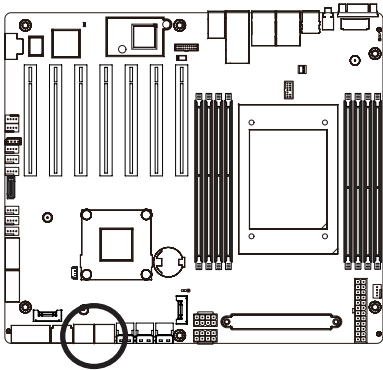

SATA3	SATA1
SATA2	SATA0



Pin No.	Definition
1	GND
2	TXP
3	TXN
4	GND
5	RXN
6	RXP
7	GND

4/5/6/7) CPU_FAN/SYS_FAN1/SYS_FAN2/SYS_FAN3/SYS_FAN4/SYS_FAN5/SYS_FAN6/ SYS_FAN7/SYS_FAN8 (CPU FAN/System FAN Headers)

The motherboard has one 4-pin CPU fan header (CPU_FAN), and two 4-pin (SYS_FAN) system fan headers. Most fan headers possess a foolproof insertion design. When connecting a fan cable, be sure to connect it in the correct orientation (the black connector wire is the ground wire). The motherboard supports CPU fan speed control, which requires the use of a CPU fan with fan speed control design. For optimum heat dissipation, it is recommended that a system fan be installed inside the chassis.

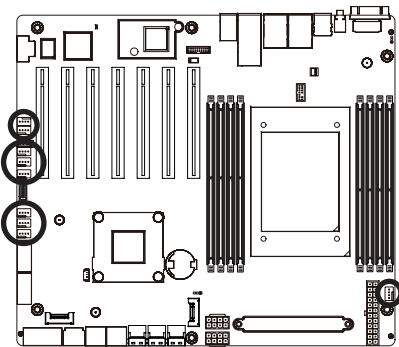

Pin No.	Definition
1	GND
2	+12V
3	Sense
4	Speed Control



- Be sure to connect fan cables to the fan headers to prevent your CPU and system from overheating. Overheating may result in damage to the CPU or the system may hang.
- These fan headers are not configuration jumper blocks. Do not place a jumper cap on the headers.

8) PMBus Connector

The Power Management Bus (PMBus) is a variant of the System Management Bus (SMBus) which is targeted at digital management of power supplies.

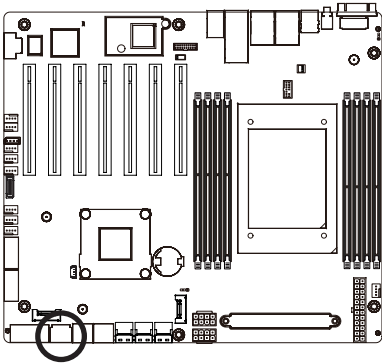

Pin No.	Definition
1	PMBus Clock
2	PMBus Data
3	PMBus Alert
4	GND
5	3.3V Sense

9) FUSB30_1/ FUSB30_2 (USB 3.2 Connector)

The connector/header conform to USB 3.2 specification. Each USB connector/header can provide two USB ports via an optional USB bracket. For purchasing the optional USB bracket, please contact the local dealer.

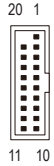
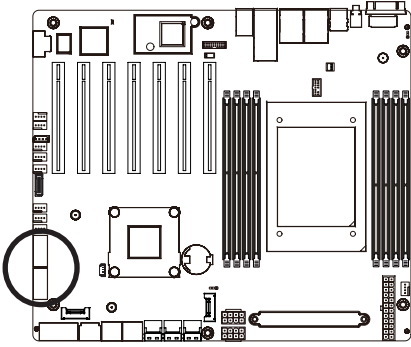

Pin No.	Definition	Pin No.	Definition
1	Power	11	IntA_P2_D+
2	IntA_P1_SSRX-	12	IntA_P2_D-
3	IntA_P1_SSRX+	13	GND
4	GND	14	IntA_P2_SSTX+
5	IntA_P1_SSTX-	15	IntA_P2_SSTX-
6	IntA_P1_SSTX+	16	GND
7	GND	17	IntA_P2_SSRX+
8	IntA_P1_D-	18	IntA_P2_SSRX-
9	IntA_P1_D+	19	Power
10	NC	20	No Pin

10) COM1 (Serial Port Cable Connector)

The COM header can provide one serial port via an optional COM port cable. For purchasing the optional COM port cable, please contact the local dealer.

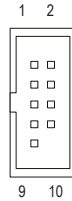
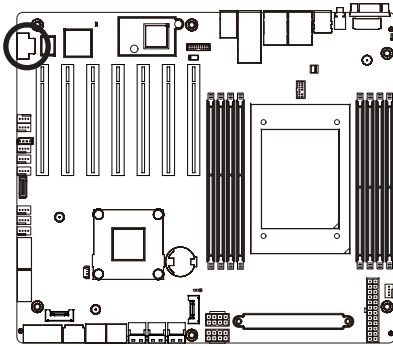

Pin No.	Definition
1	NDCD-
2	NSIN
3	NSOUT
4	NDTR-
5	GND
6	NDSR-
7	NRTS-
8	NCTS-
9	NRI-
10	No Pin

11) FP_1 (Front Panel Header)

Connect the power switch, reset switch, speaker, chassis intrusion switch/sensor and system status indicator on the chassis to this header according to the pin assignments below. Note the positive and negative pins before connecting the cables.

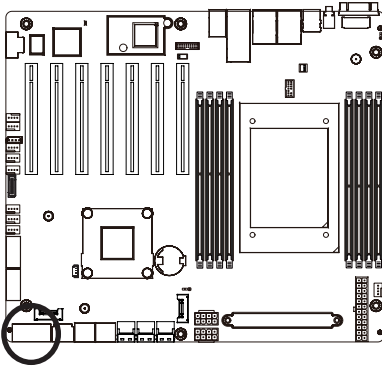

Pin No.	Definition	Pin No.	Definition
1	Power LED+	2	5V Standby
3	No Pin	4	ID LED+
5	Power LED-	6	ID LED-
7*	HDD LED+	8	System Status LED+
9*	HDD LED-	10	System Active LED-
11	Power Button	12	LAN1 Active LED+
13	GND	14	LAN1 Link LED-
15	Reset Button	16	SMBus Data
17	GND	18	SMBus Clock
19	ID Button	20	Case Open
21	GND	22	LAN2 Active LED+
23	NMI Switch	24	LAN2 Link LED-

*Note: Pin 7 & Pin 9 are reserved for Gigabyte systems.



The front panel design may differ by chassis. A front panel module mainly consists of power switch, reset switch, power LED, hard drive activity LED, speaker etc. When connecting your chassis front panel module to this header, make sure the wire assignments and the pin assignments are matched correctly.

12) BP_1 (HDD Backplane Board Header)

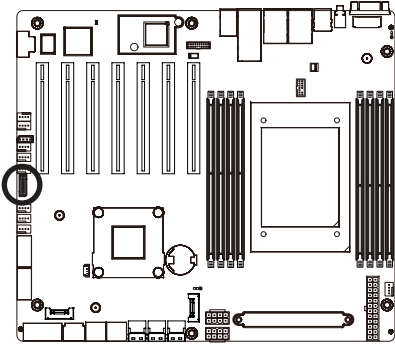

Pin No.	Definition	Pin No.	Definition
1	HP_ALERT_L	2	BPMI DIN/OUT
3	GND	4	BPMI DIN/IN
5	BPMI_LOAD	6	GND
7	BPMI_CLK	8	PLD_Program_EN
9	GLED_AMB_N	10	GLED_GRN_N
11	FAN_IRQ_N	12	Reserved
13	BP_SCL	14	GND
15	BP_SDA	16	BP_RST_N
17	SMB_U2_TMP_SCL	18	GND
19	SMB_U2_TMP_SDA	20	I2C_DEV_RST
21	PH_HP_SCL0	22	GND
23	PH_HP_SDA0	24	GND
25	PH_HP_SCL1	26	GND
27	PH_HP_SDA1	28	GND
15	P3V3_AUX	30	P3V3_AUX

13) TPM1 (Trusted Platform Module Connector)

Trusted Platform Module (TPM) is an international standard for a secure cryptoprocessor, a dedicated microcontroller designed to secure hardware through integrated cryptographic keys.

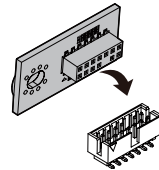
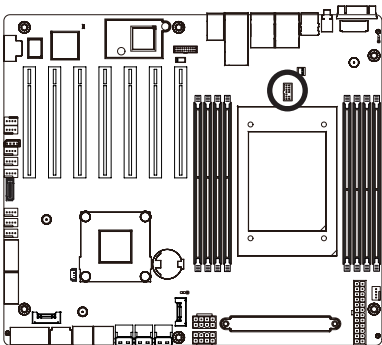

Pin No.	Definition	Pin No.	Definition
1	Clock	8	NC
2	P_3V3_AUX	9	NC
3	LPC_RST	10	No Pin
4	NC	11	NC
5	SPI_MISO	12	GND
6	IRQ_SPI	13	SPI_CS_N
7	SPI_MOSI	14	GND

14) IPMB (Intelligent Platform Management Bus) Connector

The Intelligent Platform Management Bus Communications Protocol defines a byte-level transport for transferring Intelligent Platform Management Interface Specification (IPMI) messages between intelligent I2C devices.

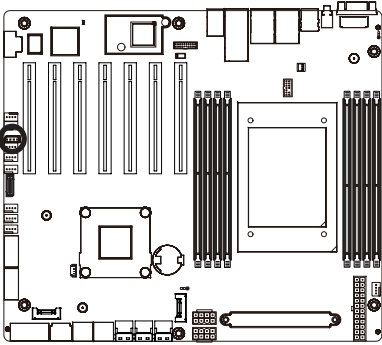

Pin No.	Definition
1	Clock
2	GND
3	Data
4	VCC

15) CN_NCSI (NCSI Connector)

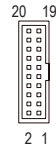
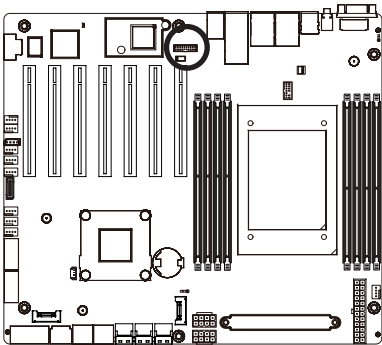

Pin No.	Definition	Pin No.	Definition
1	NCSI_CLK	2	GND
3	NCSI_RX_D0	4	GND
5	NCSI_RX_D1	6	GND
7	NCSI_CRD_DV	8	GND
9	NCSI_RX_ER	10	GND
11	P3V3_AUX	12	GND
13	NCSI_TX_D1	14	GND
15	NCSI_TX_D0	16	GND
17	NCSI_TX_EN	18	GND
19	NCSI_PRESENT	20	P3V3_AUX

16) LED_BMC (BMC Firmware Readiness LED)

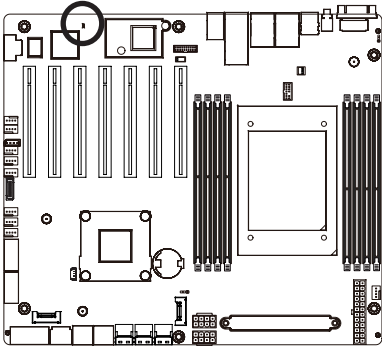

State	Description
On	BMC firmware is initial
Blink	BMC firmware is ready
Off	AC loss

17) BAT (Battery Socket)

The battery provides power to keep the values (such as BIOS configurations, date, and time information) in the CMOS when the computer is turned off. Replace the battery when the battery voltage drops to a low level, or the CMOS values may not be accurate or may be lost.

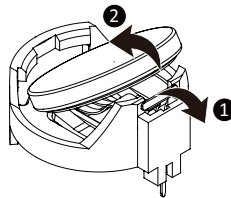
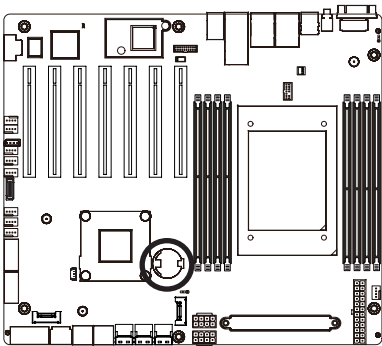

- Always turn off your computer and unplug the power cord before replacing the battery.
- Replace the battery with an equivalent one. Danger of explosion if the battery is replaced with an incorrect model.
- Contact the place of purchase or local dealer if you are not able to replace the battery by yourself or uncertain about the battery model.
- Used batteries must be handled in accordance with local environmental regulations.

1-9 Jumper Settings

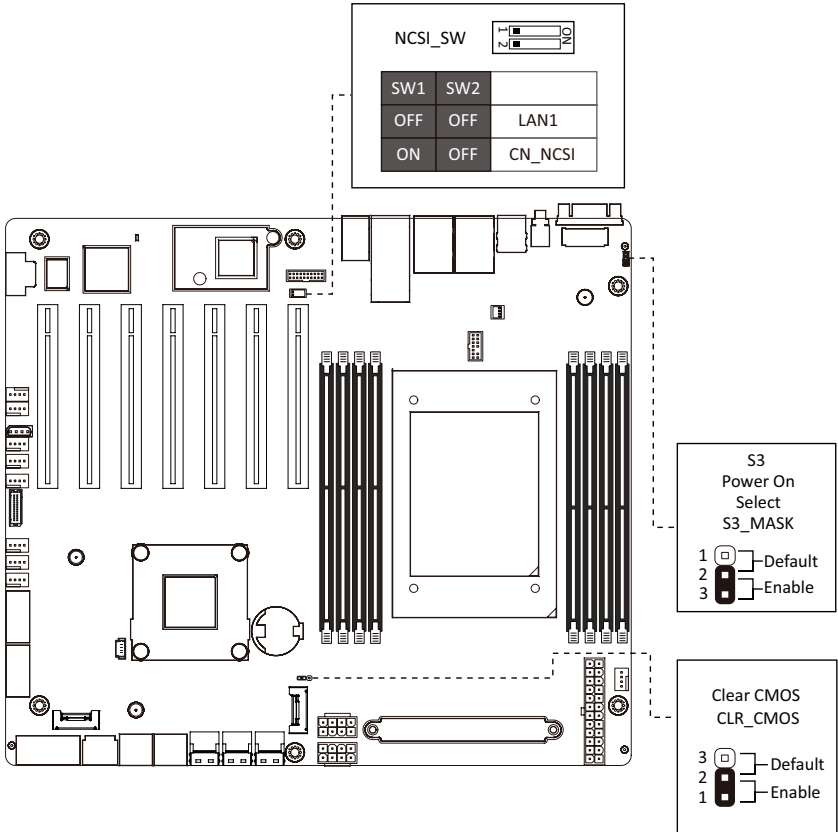

Jumper Name	Jumper Setting
Clear CMOS	1-2: Normal operation. (Default) 2-3: Clear CMOS data.
S3 Power On Select	1-2: Keep initial power on. (Default) 2-3: Stop initial power on when BMC is not ready.

Chapter 2 BIOS Setup

BIOS (Basic Input and Output System) records hardware parameters of the system in the EFI on the motherboard. Its major functions include conducting the Power-On Self-Test (POST) during system startup, saving system parameters, loading the operating system etc. The BIOS includes a BIOS Setup program that allows the user to modify basic system configuration settings or to activate certain system features. When the power is turned off, the battery on the motherboard supplies the necessary power to the CMOS to keep the configuration values in the CMOS.

To access the BIOS Setup program, press the key during the POST when the power is turned on.



- BIOS flashing is potentially risky, if you do not encounter any problems when using the current BIOS version, it is recommended that you don't flash the BIOS. To flash the BIOS, do it with caution. Inadequate BIOS flashing may result in system malfunction.
- It is recommended that you not alter the default settings (unless you need to) to prevent system instability or other unexpected results. Inadequately altering the settings may result in system's failure to boot. If this occurs, try to clear the CMOS values and reset the board to default values. (Refer to the **Exit** section in this chapter or introductions of the battery/clearing CMOS jumper in Chapter 1 for how to clear the CMOS values.)

BIOS Setup Program Function Keys

<<-><->>	Move the selection bar to select the screen
<↑><↓>	Move the selection bar to select an item
<+>	Increase the numeric value or make changes
<->	Decrease the numeric value or make changes
<Enter>	Execute command or enter the submenu
<Esc>	Main Menu: Exit the BIOS Setup program Submenus: Exit current submenu
<F1>	Show descriptions of general help
<F3>	Restore the previous BIOS settings for the current submenus
<F9>	Load the Optimized BIOS default settings for the current submenus
<F10>	Save all the changes and exit the BIOS Setup program

■ **Main**

This setup page includes all the items of the standard compatible BIOS.

■ **Advanced**

This setup page includes all the items of AMI BIOS special enhanced features.

(ex: Auto detect fan and temperature status, automatically configure hard disk parameters.)

■ **AMD CBS**

This setup page includes the common items for configuration of AMD motherboard-related information.

■ **AMD PBS Option**

This setup page includes the common items for configuration of AMD CPM RAS related settings.

■ **Chipset**

This setup page includes all the submenu options for configuring the functions of the North Bridge.

■ **Server Management**

Server additional features enabled/disabled setup menus.

■ **Security**

Change, set, or disable supervisor and user password. Configuration supervisor password allows you to restrict access to the system and BIOS Setup.

A supervisor password allows you to make changes in BIOS Setup.

A user password only allows you to view the BIOS settings but not to make changes.

■ **Boot**

This setup page provides items for configuration of the boot sequence.

■ **Save & Exit**

Save all the changes made in the BIOS Setup program to the CMOS and exit BIOS Setup. (Pressing <F10> can also carry out this task.)

Abandon all changes and the previous settings remain in effect. Pressing <Y> to the confirmation message will exit BIOS Setup. (Pressing <Esc> can also carry out this task.)

2-1 The Main Menu

Once you enter the BIOS Setup program, the Main Menu (as shown below) appears on the screen. Use arrow keys to move among the items and press <Enter> to accept or enter other sub-menu.

Main Menu Help

The on-screen description of a highlighted setup option is displayed on the bottom line of the Main Menu.

Submenu Help

While in a submenu, press <F1> to display a help screen (General Help) of function keys available for the menu. Press <Esc> to exit the help screen. Help for each item is in the Item Help block on the right side of the submenu.



- When the system is not stable as usual, select the **Restore Defaults** item to set your system to its defaults.
- The BIOS Setup menus described in this chapter are for reference only and may differ by BIOS version.

```
Aptio Setup Utility - Copyright (C) 2021 American Megatrends, Inc.
Main  Advanced  AMD CBS  AMD PBS  Option  Chipset  Server Mgmt  Security  Boot  Save & Exit

BIOS Information
Project Name                MD62-G40-00
Project Version             F04a
Build Date and Time         09/09/2021 18:45:37

BMC Information
BMC Firmware Version        13.01.29

Processor Information
CPU Brand String            AMD Ryzen Threadripper PRO
                           3995WX 64-Cores
CPU Speed                   2733 MHz
Processor Core              64
Microcode Patch             830104D

Memory Information
Total Memory                16384 MB
Memory Frequency            2400 MT/s

VR Information
Version                     0013

AGESA PI Version
PI Version                  1.0.0.6

++: Select Screen
↑↓: Select Item
Enter: Select
+/-: Change Opt.
F1: General Help
F3: Previous Values
F9: Optimized Defaults
F10: Save & Exit
ESC: Exit

Version 2.20.1276. Copyright (C) 2021 American Megatrends, Inc.
```

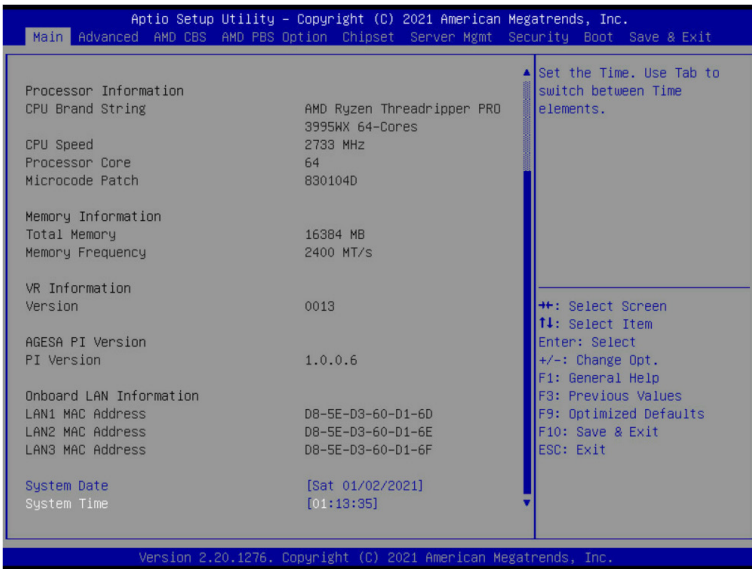

Parameter	Description
BIOS Information	
Project Name	Displays the project name information.
Project Version	Displays version number of the BIOS setup utility.
Build Date and Time	Displays the date and time when the BIOS setup utility was created.
BMC Information ^(Note1)	
BMC Firmware Version ^(Note1)	Displays BMC firmware version information.
Processor Information	
CPU Brand String/ CPU Speed / Processor Core / Microcode Patch	Displays the technical specifications for the installed processor(s).
Memory Information	
Total Memory ^(Note2)	Displays the total memory size of the installed memory.
Memory Frequency ^(Note2)	Displays the frequency information of the installed memory.
VR Information Version	Displays VR version information.

(Note1) Functions available on selected models.

(Note2) This section will display capacity and frequency information of the memory that the customer has installed.

Parameter	Description
AGESA PI Version	
PI Version	Displays AGESA PI version information.
Onboard LAN Information	
LAN# MAC Address ^(Note3)	Displays LAN MAC address information.
System Date	Sets the date following the weekday-month-day-year format.
System Time	Sets the system time following the hour-minute-second format.

(Note3) The number of LAN ports listed will depend on the motherboard / system model.

2-2 Advanced Menu

The Advanced Menu displays submenu options for configuring the function of various hardware components. Select a submenu item, then press <Enter> to access the related submenu screen.

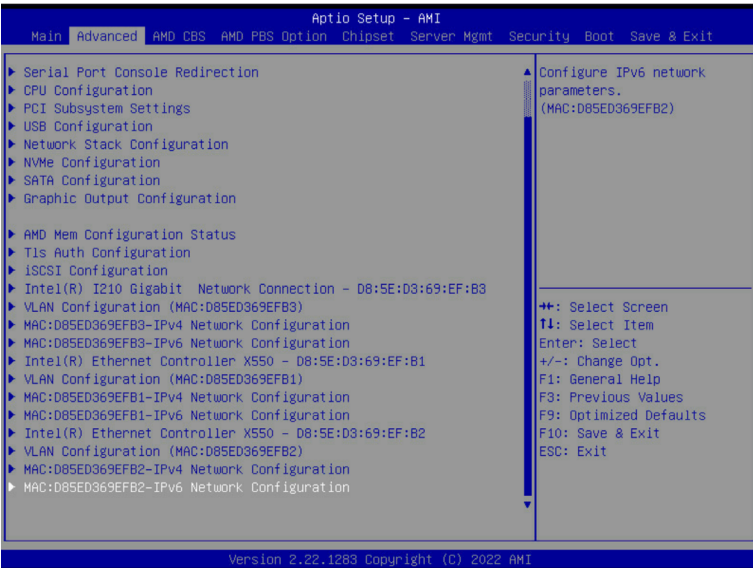
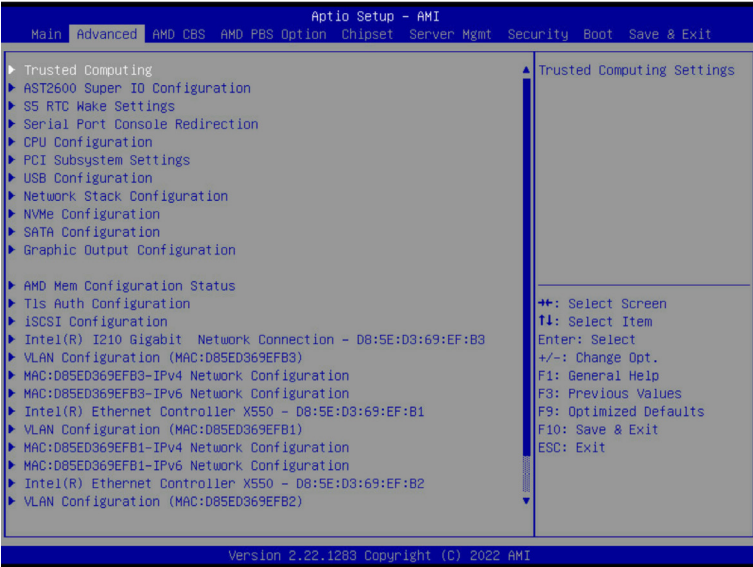

2-2-1 Trusted Computing

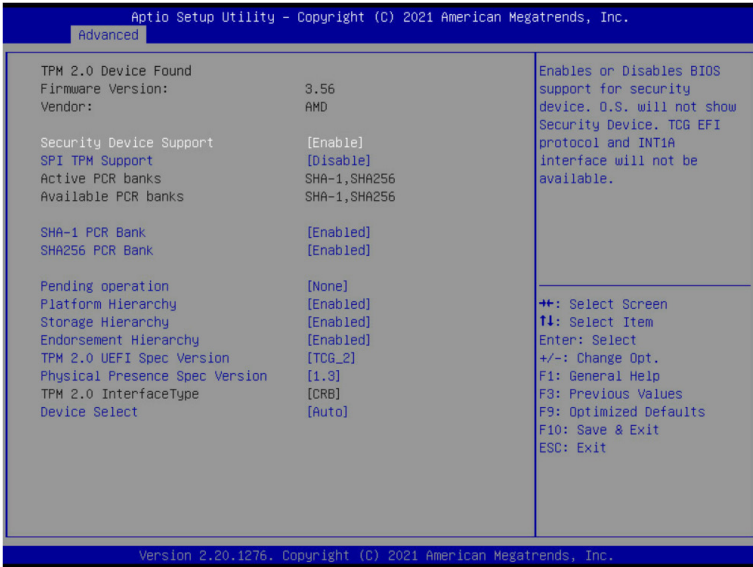

Parameter	Description
TPM20 Device Found	
Firmware Version	Displays the firmware version information.
Vendor	Displays the vendor information.
Security Device Support	Enable/Disable BIOS support for security device. OS will not show security device. TCG EFI protocol and INT1A interface will not be available. Options available: Enable, Disable. Default setting is Enable .
SPI TPM Support	Enable/Disable SPI TPM Support. Options available: Enable, Disable. Default setting is Disable .
Active PCR banks	Displays active Platform Configuration Register (PCR) banks.
Available PCR banks	Displays available PCR banks.
SHA-1 PCR Bank	Enable/Disable SHA-1 PCR bank. Options available: Enabled, Disabled. Default setting is Enabled .
SHA256 PCR Bank	Enable/Disable SHA256 PCR bank. Options available: Enabled, Disabled. Default setting is Enabled .

Parameter	Description
Pending operation	Schedule an operation for the security device. NOTE: Your computer will reboot during restart in order to change the state of a security device. Options available: None, TPM Clear. Default setting is None .
Platform Hierarchy	Enable/Disable platform hierarchy. Options available: Enabled, Disabled. Default setting is Enabled .
Storage Hierarchy	Enable/Disable storage hierarchy. Options available: Enabled, Disabled. Default setting is Enabled .
Endorsement Hierarchy	Enable/Disable endorsement hierarchy. Options available: Enabled, Disabled. Default setting is Enabled .
TPM2.0 UEFI Spec Version	Selects the TCG2 spec version support. Options available: TCG_1_2, TCG_2. Default setting is TCG2 .
Physical Presence Spec Version	Selects the physical presence spec version. Options available: 1.2, 1.3. Default setting is 1.3 .
TPM 20 InterfaceType	Displays the TPM 2.0 interface type.
Device Select	Selects the TPM device. Options available: TPM 1.2, TPM 2.0, Auto. Default setting is Auto .

2-2-2 AST2600 Super IO Configuration

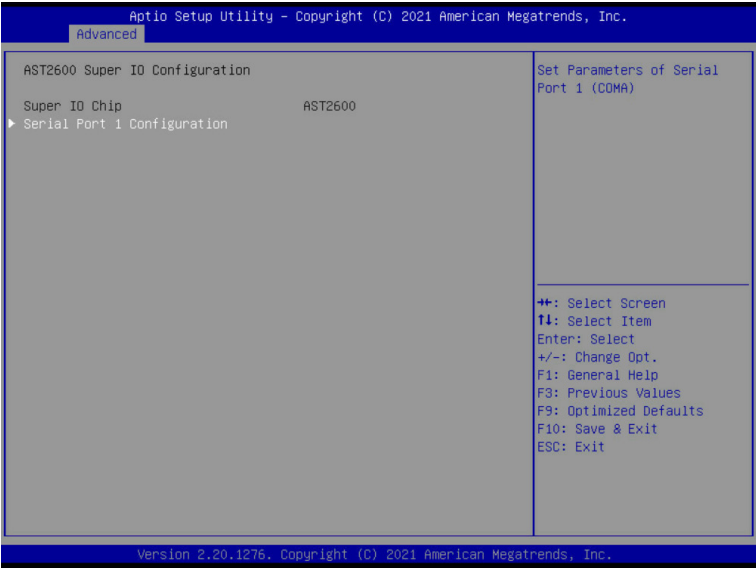

Parameter	Description
AST2600 Super IO Configuration	
Super IO Chip	Displays the super IO chip information
Serial Port 1 Configuration	Press [Enter] for configuration of advanced items.

2-2-2-1 Serial Port 1 Configuration

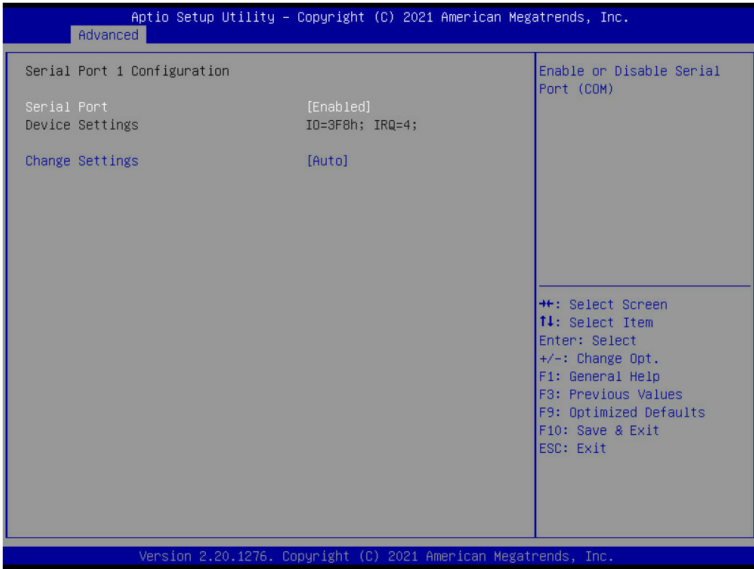

Parameter	Description
Serial Port 1 Configuration	
Serial Port ^(Note1)	Enable/Disable the Serial Port (COM). When set to Enabled allows you to configure the Serial port 1 settings. When set to Disabled, displays no configuration for the serial port. Options available: Enabled, Disabled. Default setting is Enabled .
Devices Settings ^(Note2)	Displays the Serial Port 1 device settings.
Change Settings ^(Note2)	Select an optimal settings for Super IO Device. Options available for Serial Port 1: Auto IO=3F8h; IRQ=4; IO=3F8h; IRQ=3, 4, 5, 6, 7, 9, 10, 11, 12; IO=2F8h; IRQ=3, 4, 5, 6, 7, 9, 10, 11, 12; IO=3E8h; IRQ=3, 4, 5, 6, 7, 9, 10, 11, 12; IO=2E8h; IRQ=3, 4, 5, 6, 7, 9, 10, 11, 12; Default setting is Auto .

(Note1) Advanced items prompt when this item is defined.

(Note2) This item appears when **Serial Port** is set to **Enabled**.

2-2-3 S5 RTC Wake Settings

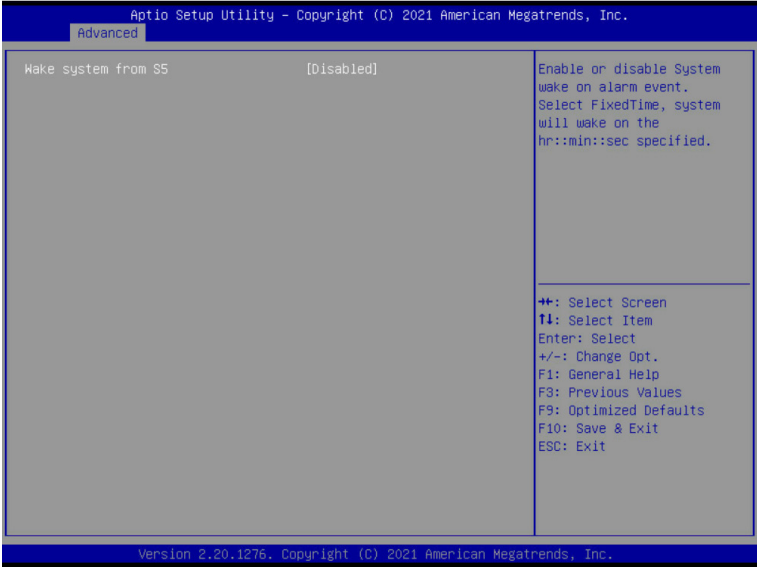

Parameter	Description
Wake System from S5	Enable/Disable system wake on alarm event. Options available: Disabled, Fixed Time. When Fixed Time is selected, system will wake on the hr::min::sec specified. Default setting is Disabled .

2-2-4 Serial Port Console Redirection

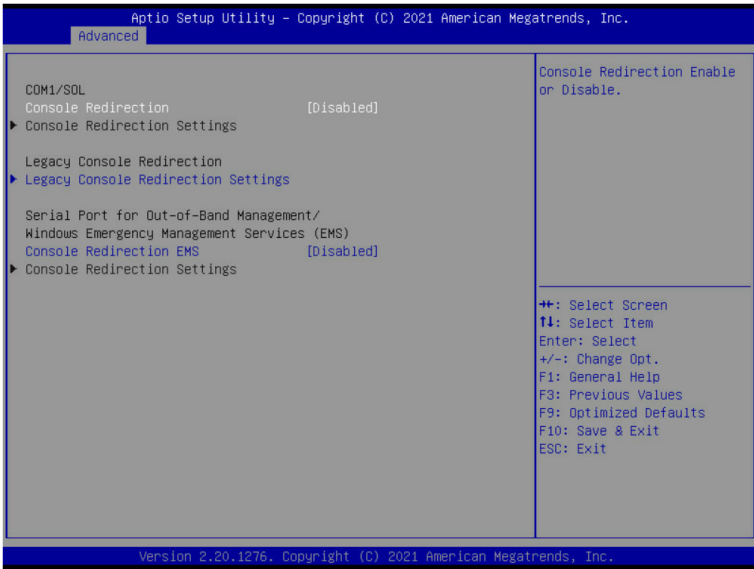

Parameter	Description
COM1/Serial Over LAN ^(Note)	<p>Select whether to enable console redirection for specified device. Console redirection enables the users to manage the system from a remote location.</p> <p>Options available: Enabled, Disabled. Default setting is Disabled.</p>
COM1/Serial Over LAN Console Redirection Settings	<p>Press [Enter] to configure advanced items.</p> <p>Please note that this item is configurable when COM1/Serial Over LAN Console Redirection is set to Enabled.</p> <ul style="list-style-type: none"> ◆ Terminal Type <ul style="list-style-type: none"> – Selects a terminal type to be used for console redirection. – Options available: VT100, VT100+, ANSI, VT-UTF8. Default setting is ANSI. ◆ Bits per second <ul style="list-style-type: none"> – Selects the transfer rate for console redirection. – Options available: 9600, 19200, 38400, 57600, 115200. Default setting is 115200. ◆ Data Bits <ul style="list-style-type: none"> – Selects the number of data bits used for console redirection. – Options available: 7, 8. Default setting is 8.

(Note) Advanced items prompt when this item is defined.

Parameter	Description
COM1/Serial Over LAN Console Redirection Settings (continued)	<ul style="list-style-type: none"> ◆ Parity <ul style="list-style-type: none"> – A parity bit can be sent with the data bits to detect some transmission errors. – Even: parity bit is 0 if the num of 1's in the data bits is even. – Odd: parity bit is 0 if num of 1's in the data bits is odd. – Mark: parity bit is always 1. Space: Parity bit is always 0. – Mark and Space Parity do not allow for error detection. – Options available: None, Even, Odd, Mark, Space. Default setting is None. ◆ Stop Bits <ul style="list-style-type: none"> – Stop bits indicate the end of a serial data packet. (A start bit indicates the beginning). The standard setting is 1 stop bit. Communication with slow devices may require more than 1 stop bit. – Options available: 1, 2. Default setting is 1. ◆ Flow Control <ul style="list-style-type: none"> – Flow control can prevent data loss from buffer overflow. When sending data, if the receiving buffers are full, a 'stop' signal can be sent to stop the data flow. Once the buffers are empty, a 'start' signal can be sent to re-start the flow. Hardware flow control uses two wires to send start/stop signals. – Options available: None, Hardware RTS/CTS. Default setting is None. ◆ VT-UTF8 Combo Key Support <ul style="list-style-type: none"> – Enable/Disable the VT-UTF8 Combo Key Support. – Options available: Enabled, Disabled. Default setting is Enabled. ◆ Recorder Mode <ul style="list-style-type: none"> – When this mode enabled, only texts will be send. This is to capture Terminal data. – Options available: Enabled, Disabled. Default setting is Disabled. ◆ Resolution 100x31 <ul style="list-style-type: none"> – Enable/Disable extended terminal resolution. – Options available: Enabled, Disabled. Default setting is Enabled. ◆ Putty KeyPad <ul style="list-style-type: none"> – Selects FunctionKey and KeyPad on Putty. – Options available: VT100, LINUX, XTERMR6, SC0, ESCN, VT400. Default setting is VT100.

Parameter	Description
Legacy Console Redirection	
Legacy Console Redirection Settings	<p>Press [Enter] to configure advanced items.</p> <ul style="list-style-type: none"> ◆ Redirection COM Port <ul style="list-style-type: none"> – Selects a COM port for Legacy serial redirection. – Default setting is COM1/SOL. ◆ Resolution <ul style="list-style-type: none"> – Selects the number of rows and columns used in Console Redirection for legacy OS support. – Options available: 80x24, 80x25. Default setting is 80x24. ◆ Redirect After POST <ul style="list-style-type: none"> – When Bootloader is selected, then Legacy Console Redirection is disabled before booting to legacy OS. When Always Enable is selected, then Legacy Console Redirection is enabled for legacy OS. – Options available: Always Enable, BootLoader. Default setting is Always Enable.
Serial Port for Out-of-Band Management / Windows Emergency Management Services (EMS) Console Redirection ^(Note)	<p>EMS console redirection allows the user to configure Console Redirection Settings to support Out-of-Band Serial Port management.</p> <p>Options available: Enabled, Disabled. Default setting is Disabled.</p>
Serial Port for Out-of-Band EMS Console Redirection Settings	<p>Press [Enter] to configure advanced items.</p> <p>Please note that this item is configurable when Serial Port for Out-of-Band Management EMS Console Redirection is set to Enabled.</p> <ul style="list-style-type: none"> ◆ Out-of-Band Mgmt Port <ul style="list-style-type: none"> – Microsoft Windows Emergency Management Service (EMS) allows for remote management of a Windows Server OS through a serial port. – Default setting is COM1/SOL. ◆ Terminal Type EMS <ul style="list-style-type: none"> – Selects a terminal type to be used for console redirection. – Options available: VT100, VT100+, ANSI, VT-UTF8. Default setting is VT-UTF8. ◆ Bits per second EMS <ul style="list-style-type: none"> – Selects the transfer rate for console redirection. – Options available: 9600, 19200, 38400, 57600, 115200. Default setting is 115200.

(Note) Advanced items prompt when this item is defined.

Parameter	Description
Serial Port for Out-of-Band EMS Console Redirection Settings(continued)	<ul style="list-style-type: none">◆ Flow Control EMS<ul style="list-style-type: none">– Flow control can prevent data loss from buffer overflow. When sending data, if the receiving buffers are full, a 'stop' signal can be sent to stop the data flow. Once the buffers are empty, a 'start' signal can be sent to re-start the flow. Hardware flow control uses two wires to send start/stop signals.– Options available: None, Hardware RTS/CTS, Software Xon/Xoff. Default setting is None.

2-2-5 CPU Configuration

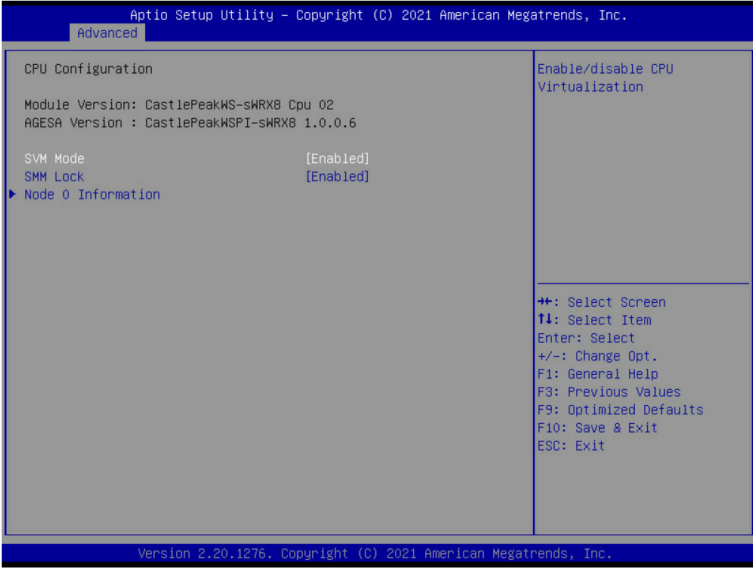

Parameter	Description
CPU Configuration	
Module Version	Displays the module version information.
AGESA Version	Displays the AGESA version information.
SVM Mode	Enable/Disable the CPU Virtualization. Options available: Enabled, Disabled. Default setting is Enabled .
SMM Lock	Enable/Disable the CPU Lock. Options available: Enabled, Disabled. Default setting is Enabled .
Node 0 Information	Press [Enter] to view the information related to CPU 0.

2-2-6 PCI Subsystem Settings

Aptio Setup Utility - Copyright (C) 2021 American Megatrends, Inc.

Advanced

PCI Bus Driver Version	A5.01.21	▲ Enable or disable SATA HotPlug ▼
SATA Hot Plug	[Disabled]	
SL_SAS_1 Control	[PCIe x4]	
SL_SAS_2 Control	[PCIe x4]	
SL_SAS_3 Control	[PCIe x4]	
PCIe_1	[Auto]	
PCIe_1 I/O ROM	[Enabled]	
PCIe_2	[Auto]	
PCIe_2 I/O ROM	[Enabled]	
PCIe_3	[Auto]	
PCIe_3 I/O ROM	[Enabled]	
PCIe_4	[Auto]	▲ If system has SR-IOV capable PCIe Devices, this option Enables or Disables Single Root IO Virtualization Support. ▼
PCIe_4 I/O ROM	[Enabled]	
PCIe_5	[Auto]	
PCIe_5 I/O ROM	[Enabled]	
Onboard LAN Controller	[Enabled]	
Onboard LAN1 I/O ROM	[Enabled]	
Onboard LAN2 I/O ROM	[Enabled]	
Onboard LAN3 Controller	[Enabled]	
Onboard LAN3 I/O ROM	[Enabled]	
WiFi Card Controller	[Enabled]	
PCI Devices Common Settings:		
Above 4G Decoding	[Enabled]	
SR-IOV Support	[Disabled]	

Version 2.20.1276. Copyright (C) 2021 American Megatrends, Inc.

Aptio Setup Utility - Copyright (C) 2021 American Megatrends, Inc.

Advanced

PCIe_4	[Auto]	▲ If system has SR-IOV capable PCIe Devices, this option Enables or Disables Single Root IO Virtualization Support. ▼
PCIe_4 I/O ROM	[Enabled]	
PCIe_5	[Auto]	
PCIe_5 I/O ROM	[Enabled]	
PCIe_6	[Auto]	
PCIe_6 I/O ROM	[Enabled]	
PCIe_7	[Auto]	
PCIe_7 I/O ROM	[Enabled]	
Onboard LAN Controller	[Enabled]	
Onboard LAN1 I/O ROM	[Enabled]	
Onboard LAN2 I/O ROM	[Enabled]	
Onboard LAN3 Controller	[Enabled]	
Onboard LAN3 I/O ROM	[Enabled]	
WiFi Card Controller	[Enabled]	
PCI Devices Common Settings:		
Above 4G Decoding	[Enabled]	
SR-IOV Support	[Disabled]	

Version 2.20.1276. Copyright (C) 2021 American Megatrends, Inc.

Parameter	Description
PCI Bus Driver Version	Displays the PCI Bus Driver version information.
SATA Hot Plug	Enable/Disable SATA Hot Plug. Options available: Enabled, Disabled. Default setting is Disabled .
SL_SAS_# Control ^(Note1)	Change Slimline SAS function to SATA/NVMe setting. Options available: Disabled, SATA, PCIe x4. Default setting is PCIe x4 .
PCIe_# ^(Note2)	Change the PCIe lanes. Options available: Disabled, Auto, x8, x4x4, x16, x8x8, x8x4x4, x4x4x8, x4x4x4x4. Default setting is Auto .
PCI_# I/O ROM ^(Note2)	When enabled, this setting will initialize the device expansion ROM for the related PCI-E slot. Options available: Enabled, Disabled. Default setting is Enabled .
Onboard LAN Controller ^(Note3)	Enable/Disable the onboard LAN devices. Options available: Enabled, Disabled. Default setting is Enabled .
Onboard LAN I/O ROM ^(Note3)	Enable/Disable the onboard LAN devices, and initializes device expansion ROM. Options available: Enabled, Disabled. Default setting is Enabled .
WiFi Card Controller	Enable/Disable WiFi Card Controller. Options available: Enabled, Disabled. Default setting is Enabled .
PCI Devices Common Settings	
Above 4G Decoding	Enable/Disable memory mapped I/O to 4GB or greater address space (Above 4G Decoding). Options available: Enabled, Disabled. Default setting is Enabled .
SR-IOV Support	If the system has SR-IOV capable PCIe devices, this item Enable/Disable Single Root IO Virtualization Support. Options available: Enabled, Disabled. Default setting is Disabled .

(Note1) This section is dependent on the available Slimline SAS controller.

(Note2) This section is dependent on the available PCIe Slot.

(Note3) This section is dependent on the available LAN controller.

2-2-7 USB Configuration

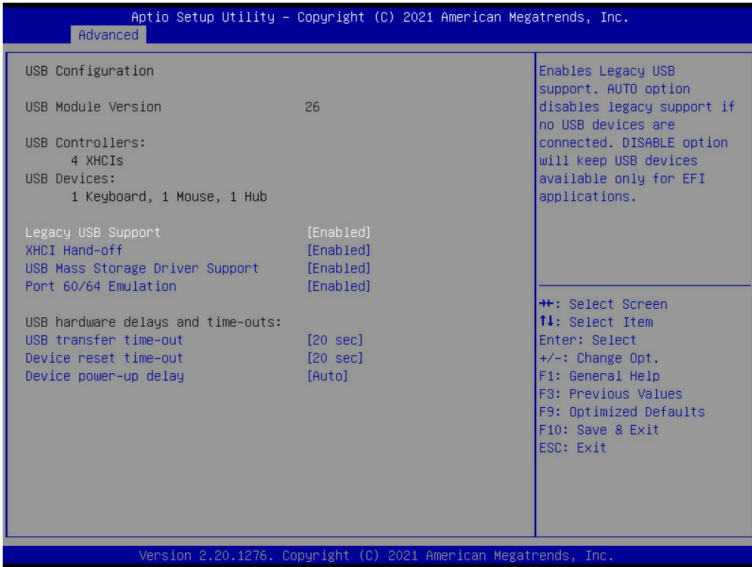

Parameter	Description
USB Configuration	
USB Module Version	Displays the USB module version information.
USB Controllers	Displays the supported USB controllers.
USB Devices:	Displays the USB devices connected to the system.
Legacy USB Support	Enable/Disable the Legacy USB support function. AUTO option disables legacy support if no USB devices are connected. DISABLE option will keep USB devices available only for EFI applications. Options available: Auto, Enabled, Disabled. Default setting is Enabled .
XHCI Hand-off	Enable/Disable the XHCI (USB 3.0) Hand-off support. Options available: Enabled, Disabled. Default setting is Enabled .
USB Mass Storage Driver Support ^(Note)	Enable/Disable the USB Mass Storage Driver Support. Options available: Enabled, Disabled. Default setting is Enabled .
Port 60/64 Emulation	Enables the I/O port 60h/64h emulation support. This should be enabled for the complete USB Keyboard Legacy support for non-USB aware OS. Options available: Enabled, Disabled. Default setting is Enabled .

(Note) This item is present only if you attach USB devices.

Parameter	Description
USB hardware delays and time-outs	
USB transfer time-out	Selects the time-out value for USB Control/Bulk/Interrupt transfers. Options available: 1 sec, 5 sec, 10 sec, 20 sec. Default setting is 20 sec .
Device reset time-out	Selects the time-out value during a USB mass storage device reset. Options available: 10 sec, 20 sec, 30 sec, 40 sec. Default setting is 20 sec .
Device power-up delay	Maximum time the device will take before it properly reports itself to the Host Controller. "Auto" uses default value: for a Root port it is 100 ms, for a Hub port the delay is taken from Hub descriptor. Options available: Auto, Manual. Default setting is Auto .

2-2-8 Network Stack Configuration

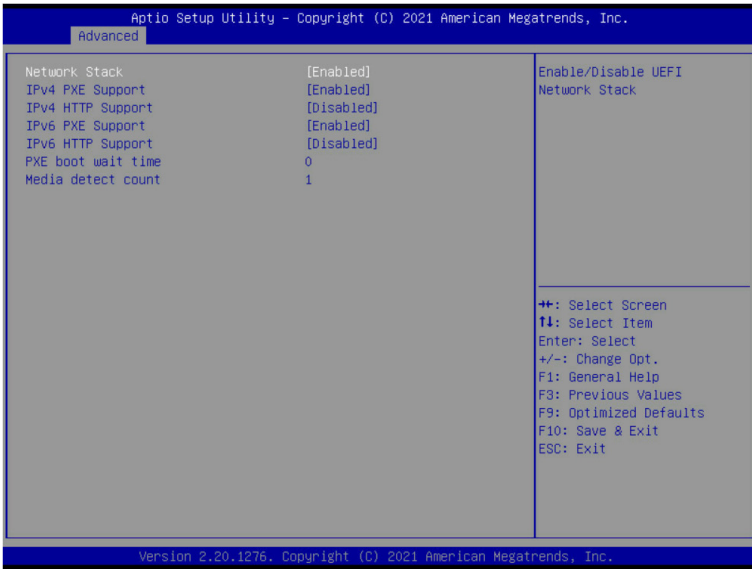

Parameter	Description
Network Stack	Enable/Disable the UEFI network stack. Options available: Enabled, Disabled. Default setting is Enabled .
Ipv4 PXE Support ^(Note)	Enable/Disable the Ipv4 PXE feature. Options available: Enabled, Disabled. Default setting is Enabled .
Ipv4 HTTP Support ^(Note)	Enable/Disable the Ipv4 HTTP feature. Options available: Enabled, Disabled. Default setting is Disabled .
Ipv6 PXE Support ^(Note)	Enable/Disable the Ipv6 PXE feature. Options available: Enabled, Disabled. Default setting is Enabled .
Ipv6 HTTP Support ^(Note)	Enable/Disable the Ipv6 HTTP feature. Options available: Enabled, Disabled. Default setting is Disabled .
PXE boot wait time ^(Note)	Wait time in seconds to press ESC key to abort the PXE boot. Press the <+> / <-> keys to increase or decrease the desired values.
Media detect count ^(Note)	Number of times the presence of media will be checked. Press the <+> / <-> keys to increase or decrease the desired values.

(Note) This item appears when **Network Stack** is set to **Enabled**.

2-2-9 NVMe Configuration

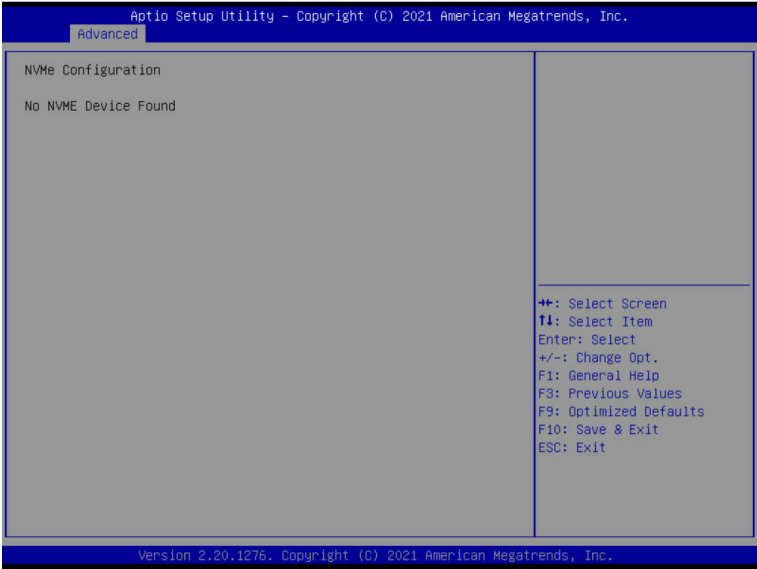

Parameter	Description
NVMe Configuration	Displays the NVMe devices connected to the system.

2-2-10 SATA Configuration

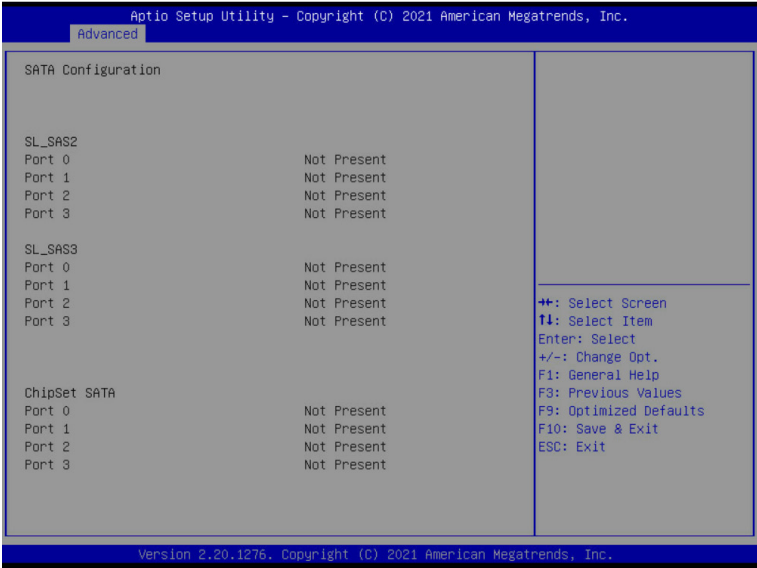

Parameter	Description
SATA Configuration	Displays the installed HDD devices information. System will automatically detect HDD type.

2-2-11 Graphic Output Configuration

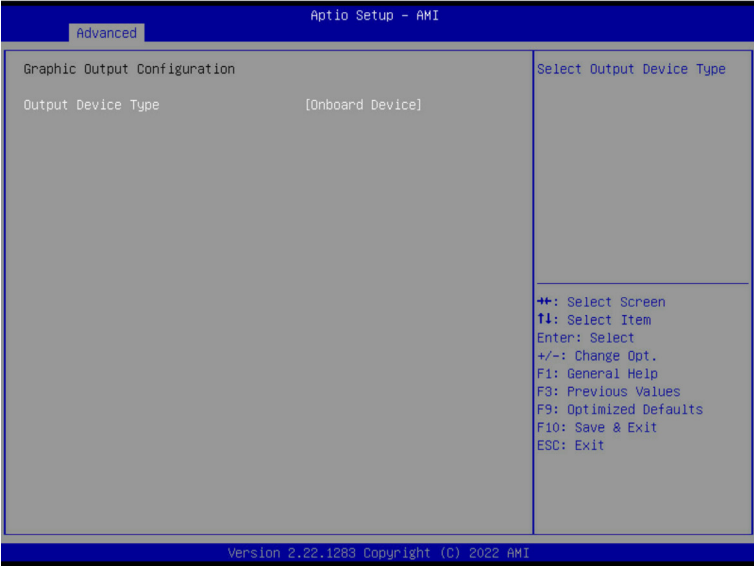

Parameter	Description
Output Device Type	Selects output device type. Options available: First loaded Device, Onboard Device, External Device, Specific Device. Default setting is Onboard Device .

2-2-12 AMD Mem Configuration Status

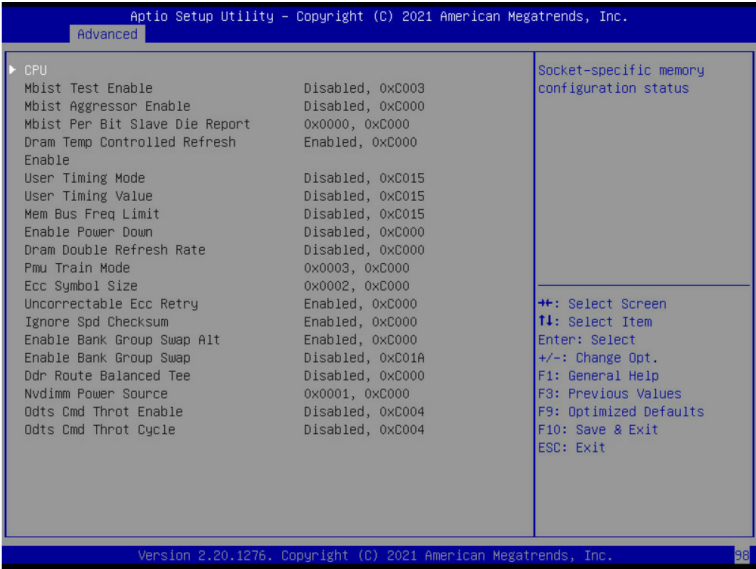

Parameter	Description
CPU	Press [Enter] to view the memory configuration status related to CPU.

2-2-13 Tls Auth Configuration

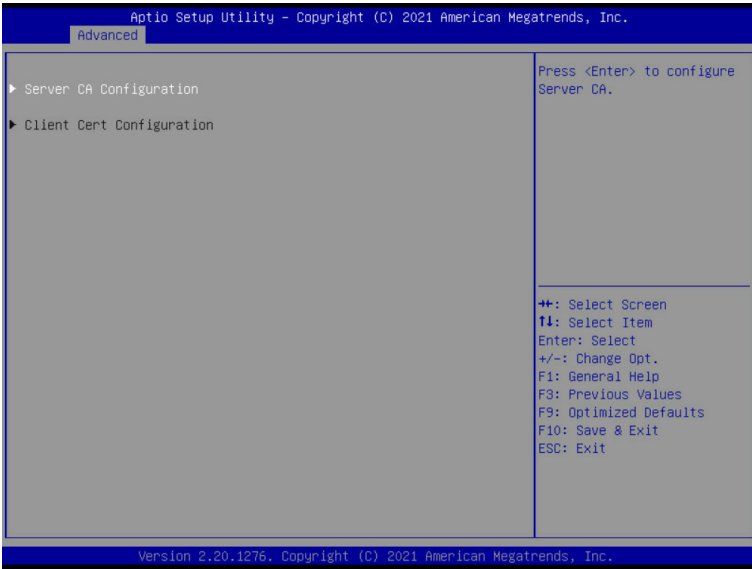

Parameter	Description
Server CA Configuration	<p>Press [Enter] for configuration of advanced items.</p> <ul style="list-style-type: none"> ◆ Enroll Cert <ul style="list-style-type: none"> – Press [Enter] to enroll a certificate <ul style="list-style-type: none"> • Enroll Cert Using File • Cert GUID Input digit character in 1111111-2222-3333-4444-1234567890ab format. – Commit Changes and Exit – Discard Changes and Exit ◆ Delete Cert
Client Cert Configuration	Press [Enter] for configuration of advanced items.

2-2-14 iSCSI Configuration

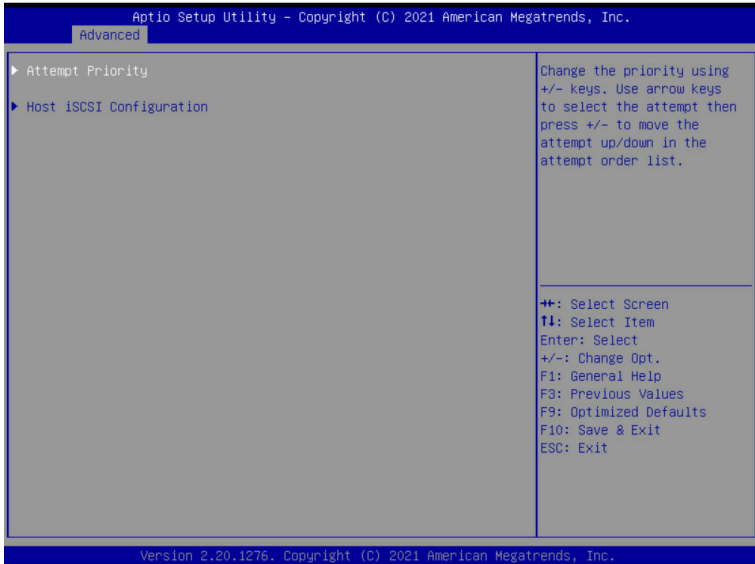

Parameter	Description
Attempt Priority	<p>Press [Enter] to configure advanced items.</p> <ul style="list-style-type: none"> ◆ Attempt Priority <ul style="list-style-type: none"> – Change the priority using +/- keys. Use arrow keys to select the attempt then press +/- to move the attempt up/down in the attempt order list. ◆ Commit Changes and Exit
Host iSCSI Configuration	<p>Press [Enter] to configure advanced items.</p> <ul style="list-style-type: none"> ◆ iSCSI Initiator Name <ul style="list-style-type: none"> – Press [Enter] and name iSCSI Initiator. Only IQN format is accepted. Range: from 4 to 223 ◆ Add an Attempt ◆ Delete Attempts ◆ Change Attempt Order

Parameter	Description
NIC Configuration	<p>Press [Enter] to configure advanced items.</p> <ul style="list-style-type: none"> ◆ Link Speed <ul style="list-style-type: none"> – Allows for automatic link speed adjustment. – Options available: Auto Negotiated, 10 Mbps Half, 10 Mbps Full, 100 Mbps Half, 100 Mbps Full. Default setting is Auto Negotiated. ◆ Wake On LAN <ul style="list-style-type: none"> – Enables power on of the system via LAN. Note that configuring Wake on LAN in the operating system does not change the value of this setting, but does override the behavior of Wake on LAN in OS controlled power states. – Options available: Disabled, Enabled. Default setting is Enabled.
Blink LEDs	<p>Identifies the physical network port by blinking the associated LED. Press the numeric keys to adjust desired values (up to 15 seconds).</p>
UEFI Driver	Displays the technical specifications for the Network Interface Controller.
Adapter PBA	Displays the technical specifications for the Network Interface Controller.
Device Name	Displays the technical specifications for the Network Interface Controller.
Chip Type	Displays the technical specifications for the Network Interface Controller.
PCI Device ID	Displays the technical specifications for the Network Interface Controller.
PCI Address	Displays the technical specifications for the Network Interface Controller.
Link Status	Displays the technical specifications for the Network Interface Controller.
MAC Address	Displays the technical specifications for the Network Interface Controller.
Virtual MAC Address	Displays the technical specifications for the Network Interface Controller.

Parameter	Description
NIC Configuration	<p>Press [Enter] to configure advanced items.</p> <ul style="list-style-type: none"> ◆ Link Speed <ul style="list-style-type: none"> – Allows for automatic link speed adjustment. – Default setting is Auto Negotiated. ◆ Wake On LAN <ul style="list-style-type: none"> – Enables power on of the system via LAN. Note that configuring Wake on LAN in the operating system does not change the value of this setting, but does override the behavior of Wake on LAN in OS controlled power states. – Options available: Disabled, Enabled. Default setting is Enabled.
Blink LEDs	Identifies the physical network port by blinking the associated LED. Press the numeric keys to adjust desired values (up to 15 seconds).
UEFI Driver	Displays the technical specifications for the Network Interface Controller.
Adapter PBA	Displays the technical specifications for the Network Interface Controller.
Device Name	Displays the technical specifications for the Network Interface Controller.
Chip Type	Displays the technical specifications for the Network Interface Controller.
PCI Device ID	Displays the technical specifications for the Network Interface Controller.
PCI Address	Displays the technical specifications for the Network Interface Controller.
Link Status	Displays the technical specifications for the Network Interface Controller.
MAC Address	Displays the technical specifications for the Network Interface Controller.
Virtual MAC Address	Displays the technical specifications for the Network Interface Controller.

2-2-17 VLAN Configuration

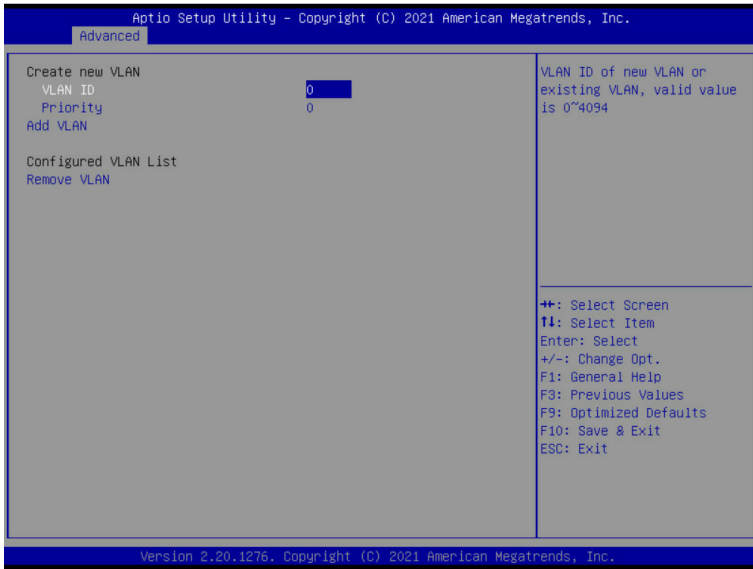

Parameter	Description
Enter Configuration Menu	<p>Press [Enter] to configure advanced items.</p> <ul style="list-style-type: none"> ◆ Create new VLAN ◆ VLAN ID <ul style="list-style-type: none"> – Sets VLAN ID for a new VLAN or an existing VLAN. – Press the <+> / <-> keys to increase or decrease the desired values. – The valid range is from 0 to 4094. ◆ Priority <ul style="list-style-type: none"> – Sets 802.1Q Priority for a new VLAN or an existing VLAN. – Press the <+> / <-> keys to increase or decrease the desired values. – The valid range is from 0 to 7. ◆ Add VLAN <ul style="list-style-type: none"> – Press [Enter] to create a new VLAN or update an existing VLAN. ◆ Configured VLAN List ◆ Remove VLAN <ul style="list-style-type: none"> – Press [Enter] to remove an existing VLAN.

2-2-18 MAC IPv4 Network Configuration

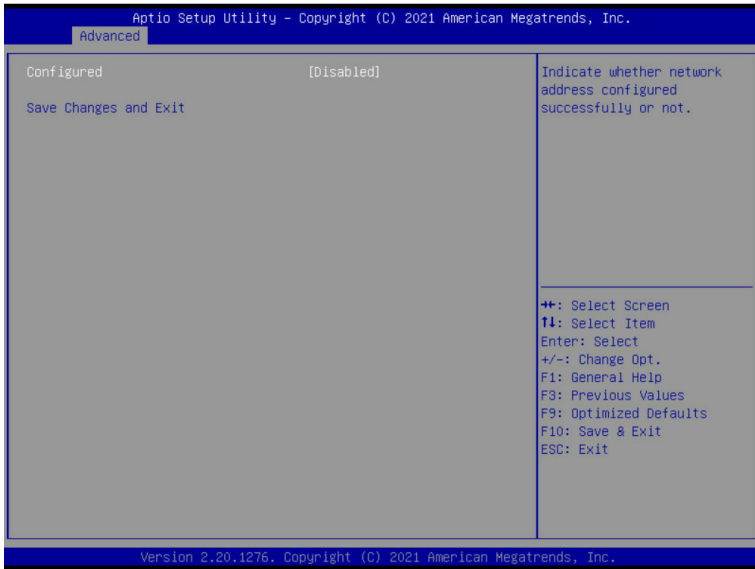

Parameter	Description
Configured	Indicates whether network address is configured successfully or not. Options available: Enabled, Disabled. Default setting is Disabled .
Enable DHCP ^(Note)	Options available: Enabled, Disabled. Default setting is Disabled .
Local IP Address ^(Note)	Press [Enter] to configure local IP address.
Local NetMask ^(Note)	Press [Enter] to configure local NetMask.
Local Gateway ^(Note)	Press [Enter] to configure local Gateway
Local DNS Servers ^(Note)	Press [Enter] to configure local DNS servers
Save Changes and Exit	Press [Enter] to save all configurations.

(Note) This item appears when **Configured** is set to **Enabled**.

2-2-19 MAC IPv6 Network Configuration

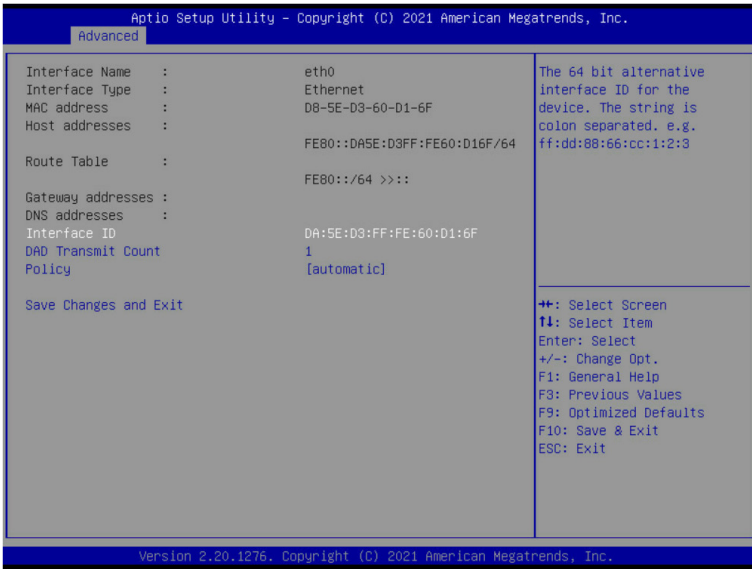

Parameter	Description
Enter Configuration Menu	<p>Press [Enter] to configure advanced items.</p> <ul style="list-style-type: none"> ◆ Displays the MAC Address information. ◆ Interface ID <ul style="list-style-type: none"> – The 64 bit alternative interface ID for the device. The string is colon separated. e.g. ff:dd:88:66:cc:1:2:3. ◆ DAD Transmit Count <ul style="list-style-type: none"> – The number of consecutive Neighbor solicitation messages sent while performing Duplicate Address Detection on a tentative address. A value of zero indicates that Duplicate Address Detection is not performed. ◆ Policy <ul style="list-style-type: none"> – Options available: automatic, manual. Default setting is automatic. ◆ Save Changes and Exit <ul style="list-style-type: none"> – Press [Enter] to save all configurations.

2-3 AMD CBS Menu

AMD CBS menu displays submenu options for configuring the CPU-related information that the BIOS automatically sets. Select a submenu item, then press [Enter] to access the related submenu screen.

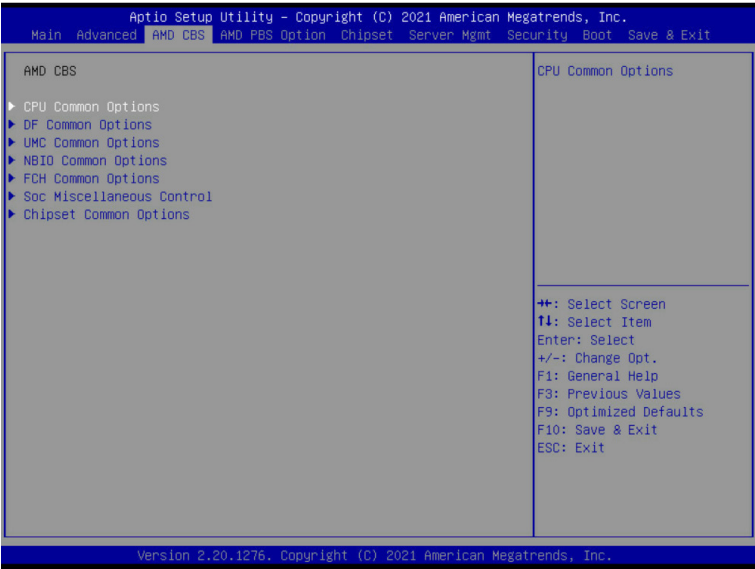

2-3-1 CPU Common Options

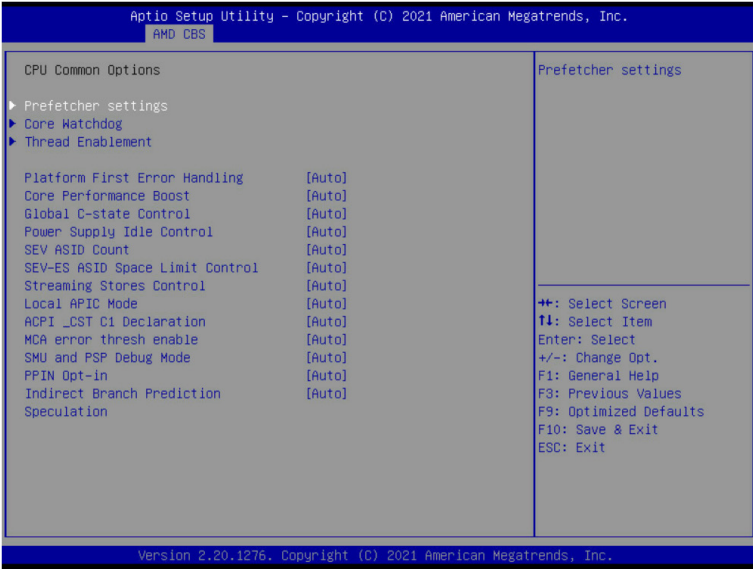

Parameter	Description
CPU Common Options	
Prefetcher settings	<p>Press [Enter] for configuration of advanced items.</p> <ul style="list-style-type: none"> ◆ L1 Stream HW Prefetcher <ul style="list-style-type: none"> – Options available: Auto, Enable, Disable. Default setting is Auto. ◆ L2 Stream HW Prefetcher <ul style="list-style-type: none"> – Options available: Auto, Enable, Disable. Default setting is Auto.
Core Watchdog	<p>Press [Enter] for configuration of advanced items.</p> <ul style="list-style-type: none"> ◆ Core Watchdog Timer Enable <ul style="list-style-type: none"> – Enable/Disable CPU Watchdog Timer. – Options available: Auto, Enabled, Disabled. Default setting is Auto. ◆ Core Watchdog Timer Interval^(Note) <ul style="list-style-type: none"> – Specifies the CPU Watchdog Timer interval. – Default setting is Auto. ◆ Core Watchdog Timer Severity^(Note) <ul style="list-style-type: none"> – Specifies the CPU Watchdog Timer Severity. – Options available: Auto, No Error, Transparent, Corrected, Deferred, Uncorrected, Fatal. Default setting is Auto.
Thread Enablement	<p>Press [Enter] for configuration of advanced items.</p> <ul style="list-style-type: none"> ◆ SMT Control <ul style="list-style-type: none"> – Enable/Disable Symmetric Multithreading. – Options available: Auto, Disable. Default setting is Auto.

(Note) This item appears when **Core Watchdog Timer Enable** is set to **Enabled**.

Parameter	Description
Platform First Error Handling	Enable/Disable PFEH, cloak individual banks, and mask deferred error interrupts from each bank. Options available: Auto, Enabled, Disabled. Default setting is Auto .
Core Performance Boost	Enable/Disable the Core Performance Boost function. Options available: Auto, Disabled. Default setting is Auto .
Global C-State Control	Controls the IO based C-state generation and DF C-states. Options available: Auto, Enabled, Disabled. Default setting is Auto .
Power Supply Idle Control	Configures the Power Supply Idle Control. Options available: Auto, Low Current Idle, Typical Current Idle. Default setting is Auto .
SEV ASID Count	Specifies the maximum valid ASID, which affects the maximum system physical address space. Options available: Auto, 253 ASIDs, 509 ASIDs. Default setting is Auto .
SEV-ES ASID Space Limit Control	Space limit control for SEV-ES ASIDs. Options available: Auto, Manual. Default setting is Auto .
Streaming Stores Control	Enable/Disable the Streaming Stores functionality. Options available: Auto, Enabled, Disabled. Default setting is Auto .
Local APIC Mode	Options available: Compatibility, xAPIC, x2APIC, Auto. Default setting is Auto .
ACPI_CST C1 Declaration	Determines whether or not to declare the C1 state to the OS.. Options available: Auto, Enabled, Disabled. Default setting is Auto .
MCA error thresh enable	Enable MCA error thresholding. Options available: Auto, False, True. Default setting is Auto .
SMU and PSP Debug Mode	When this option is enabled, specific uncorrected errors detected by the PSP FW or SMU FW will hand and not reset the system. Options available: Auto, Enabled, Disabled. Default setting is Auto .
PPIN Opt-in	Enable/Disable the PPIN feature. Options available: Auto, Enabled, Disabled. Default setting is Auto .
Indirect Branch Prediction Speculation	Enabled: Enter system memory is covered. Options available: Disabled, Enabled, Auto. Default setting is Auto .

2-3-2 DF Common Options

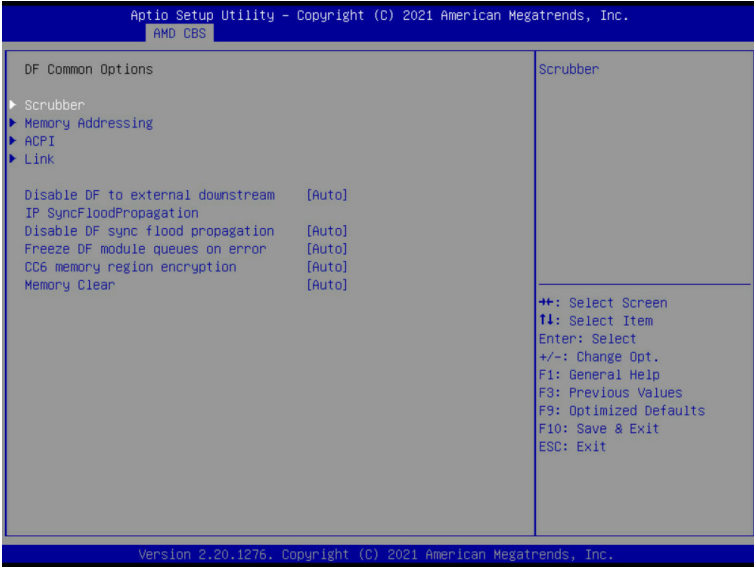

Parameter	Description
DF Common Options	
Scrubber	<p>Press [Enter] for configuration of advanced items.</p> <ul style="list-style-type: none"> ◆ DRAM scrub time <ul style="list-style-type: none"> – Provide a value that is the number of hours to scrub memory. – Options available: Auto, Disabled, 1 hour, 4 hours, 8 hours, 16 hours, 24 hours, 48 hours. Default setting is Auto. ◆ Poison scrubber control <ul style="list-style-type: none"> – Enable/Disable the Poison scrubber control feature. – Options available: Auto, Enabled, Disabled. Default setting is Auto. ◆ Redirect scrubber control <ul style="list-style-type: none"> – Enable/Disable the Redirect scrubber control feature. – Options available: Auto, Enabled, Disabled. Default setting is Auto. ◆ Redirect scrubber limit <ul style="list-style-type: none"> – Sets the redirect scrubber limit. – Options available: Auto, 2, 4, 8, Infinite. Default setting is Auto.
Memory Addressing	<p>Press [Enter] for configuration of advanced items.</p> <ul style="list-style-type: none"> ◆ NUMA nodes per socket <ul style="list-style-type: none"> – Specifies the number of desired NUMA nodes per socket. – Options available: Auto, NPS0, NPS1, NPS2, NPS4. Default setting is Auto. ◆ Memory interleaving <ul style="list-style-type: none"> – Enable/Disable the Memory interleaving feature. – Options available: Auto, Disabled. Default setting is Auto.

Parameter	Description
Memory Addressing (continued)	<ul style="list-style-type: none"> ◆ Memory interleaving size <ul style="list-style-type: none"> – Controls the memory interleaving size. This determines the starting address of the interleave (bit 8, 9, 10 or 11). – Options available: Auto, 256Bytes, 512Bytes, 1KB, 2KB. Default setting is Auto. ◆ 1TB remap <ul style="list-style-type: none"> – Enable/Disable to remap DRAM out of the space just below the 1TB boundary. The ability to remap depends on DRAM configuration, NPS, and interleaving selection, and may not always be possible. – Options available: Auto, Do not remap, Attempt to remap. Default setting is Auto. ◆ DRAM map inversion <ul style="list-style-type: none"> – Enable/Disable the DRAM map inversion function. – Options available: Auto, Enabled, Disabled. Default setting is Auto.
ACPI	<p>Press [Enter] for configuration of advanced items.</p> <ul style="list-style-type: none"> ◆ ACPI SRAT L3 Cache As NUMA Domain <ul style="list-style-type: none"> – Enable/Disable report each L3 cache as a NUMA Domain to the OS. – Options available: Auto, Enabled, Disabled. Default setting is Auto. ◆ ACPI SLIT Distance Control <ul style="list-style-type: none"> – Determines how the SLIT distances are declared. – Options available: Auto, Manual. Default setting is Auto. ◆ ACPI SLIT remote relative distance <ul style="list-style-type: none"> – Sets the remote socket distance for 2P systems as near (2.8) or far (3.2). – Options available: Auto, Near, Far. Default setting is Auto.
Link	<p>Press [Enter] for configuration of advanced items.</p> <ul style="list-style-type: none"> ◆ GMI encryption control <ul style="list-style-type: none"> – Enable/Disable GMI link encryption. – Options available: Auto, Enabled, Disabled. Default setting is Auto. ◆ xGMI encryption control <ul style="list-style-type: none"> – Enable/Disable xGMI link encryption. – Options available: Auto, Enabled, Disabled. Default setting is Auto. ◆ CAKE CRC perf bounds Control <ul style="list-style-type: none"> – Options available: Auto, Manual. Default setting is Auto. ◆ 4-link xGMI max speed <ul style="list-style-type: none"> – Specifies the max speed of 4-link xGMI. Default setting is Auto. ◆ 3-link xGMI max speed <ul style="list-style-type: none"> – Specifies the max speed of 3-link xGMI. Default setting is Auto. ◆ xGMI TXEQ Mode <ul style="list-style-type: none"> – Configures xGMI TXEQ/RX vetting Mode. – Options available: Auto, TXEQ_Disabled, TXEQ_Lane, TXEQ_Link, TXEQ_RX_Vet. Default setting is Auto.

Parameter	Description
Disable DF to external IP sync flood propagation	Enable/Disable SyncFlood to UMC & downstream slaves. Options available: Auto, Sync flood disabled, Sync flood enabled. Default setting is Auto .
Disable DF sync flood propagation	Enable/Disable DF Sync Flood propagation. Options available: Auto, Sync flood disabled, Sync flood enabled. Default setting is Auto .
Freeze DF module queues on error	Options available: Auto, Enabled, Disabled. Default setting is Auto .
CC6 memory region encryption	Controls whether or not the CC6 save/restor memory is encrypted. Options available: Auto, Enabled, Disabled. Default setting is Auto .
Memory Clear	Enable/Disable the Memory Clear feature. Options available: Auto, Enabled, Disabled. Default setting is Auto .

2-3-3 UMC Common Options

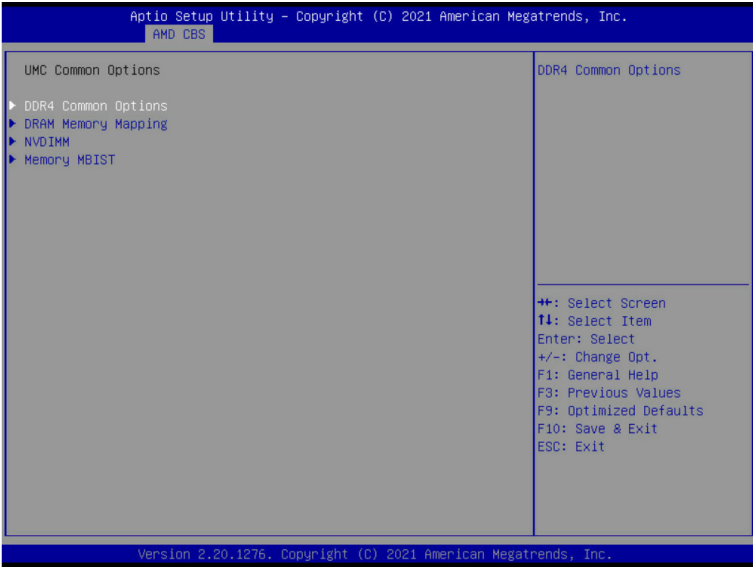

Parameter	Description
UMC Common Options	
DDR4 Common Options	Press [Enter] for configuration of advanced items.
DRAM Memory Mapping	Press [Enter] for configuration of advanced items.
NVDIMM	Press [Enter] for configuration of advanced items.
Memory MBIST	Press [Enter] for configuration of advanced items.

2-3-3-1 DDR4 Common Options

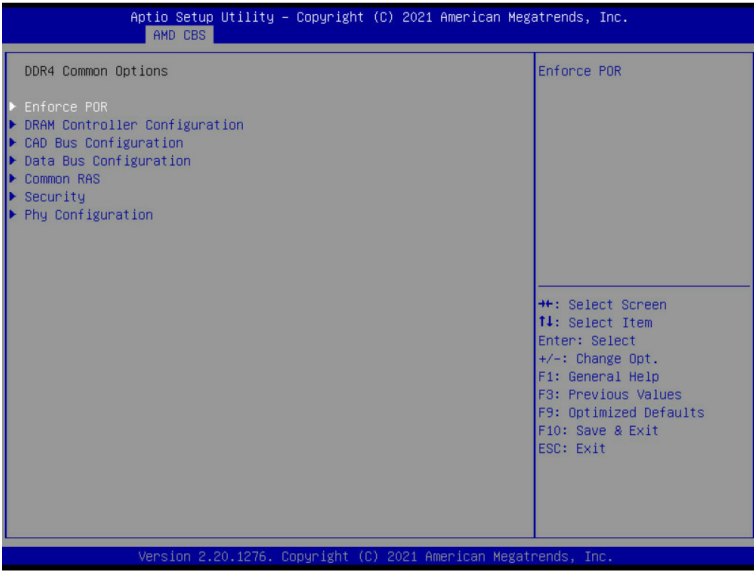

Parameter	Description
DDR4 Common Options	
Enforce POR	<p>Press [Enter] to enable / disable restrictions for DDR4 frequency and voltage programming. Memory speeds will be capped at AMD guidelines.</p> <ul style="list-style-type: none"> ◆ Decline ◆ Accept <ul style="list-style-type: none"> – Overclock <ul style="list-style-type: none"> » Enable/Disable Memory Overclock Settings » Options available: Auto, Enabled. Default setting is Auto. <p>Press [Enter] for configuration of advanced items.</p> <ul style="list-style-type: none"> ◆ DRAM Power Options <ul style="list-style-type: none"> – Power Down Enable <ul style="list-style-type: none"> » Enable/Disable DDR power down mode. » Options available: Auto, Enabled, Disabled. Default setting is Auto.
DRAM Controller Configuration	<ul style="list-style-type: none"> ◆ Cmd2T <ul style="list-style-type: none"> – Selects the Cmd2T mode on ADDR/CMD. – Options available: Auto, 1T, 2T. Default setting is Auto. ◆ Gear Down Mode <ul style="list-style-type: none"> – Enable/Disable the Gear Down Mode function. – Options available: Auto, Enabled, Disabled. Default setting is Auto.

Parameter	Description
CAD Bus Configuration	<p>Press [Enter] for configuration of advanced items.</p> <ul style="list-style-type: none"> ◆ CAD Bus Timing User Controls <ul style="list-style-type: none"> – Setup time on CAD bus signals to Auto or Manual. – Options available: Auto, Manual. Default setting is Auto. ◆ CAD Bus Drive Strength User Controls <ul style="list-style-type: none"> – Drive Strength on CAD bus signals to Auto or Manual. – Options available: Auto, Manual. Default setting is Auto.
Data Bus Configuration	<p>Press [Enter] for configuration of advanced items.</p> <ul style="list-style-type: none"> ◆ Data Bus Configuration User Controls <ul style="list-style-type: none"> – Specifies the mode for drive strength to Auto or Manual. – Options available: Auto, Manual. Default setting is Auto.
Common RAS	<p>Press [Enter] for configuration of advanced items.</p> <ul style="list-style-type: none"> ◆ Data Poisoning <ul style="list-style-type: none"> – Enable/Disable the Data Poisoning function. – Options available: Auto, Enabled, Disabled. Default setting is Auto. ◆ DRAM Post Package Repair <ul style="list-style-type: none"> – Enable/Disable the DRAM Post Package Repair function. – Options available: Enable, Disable, Default. Default setting is Default. ◆ RCD Parity <ul style="list-style-type: none"> – Enable/Disable the RCD Parity function. – Options available: Auto, Enabled, Disabled. Default setting is Auto. ◆ DRAM Address Command Parity Retry <ul style="list-style-type: none"> – Enable/Disable the DRAM Address Command Parity Retry function. – Options available: Auto, Enabled, Disabled. Default setting is Auto. ◆ Max Parity Error Replay <ul style="list-style-type: none"> – Configures the Max Parity Error Replay. (0~0x3f). – Default setting is 8. – Please note that this item is configurable when DRAM Address Command Parity Retry is set to Enabled. ◆ Disable Memory Error Injection <ul style="list-style-type: none"> – Options available: False, True. Default setting is True. ◆ ECC Configuration <ul style="list-style-type: none"> – DRAM ECC Symbol Size <ul style="list-style-type: none"> » Configures the DRAM ECC Symbol Size. » Options available: Auto, x4, x8, x16. Default setting is Auto. – DRAM ECC Enable <ul style="list-style-type: none"> » Enable/Disable DRAM ECC. When set to Auto, it will set ECC to enable. » Options available: Auto, Enabled, Disabled. Default setting is Auto. – DRAM UECC Retry <ul style="list-style-type: none"> » Enable/Disable DRAM UECC Retry. » Options available: Auto, Enabled, Disabled. Default setting is Auto.

Parameter	Description
Security	<p>Press [Enter] for configuration of advanced items.</p> <ul style="list-style-type: none"> ◆ TSME <ul style="list-style-type: none"> – Enable/Disable transparent secure memory encryption. – Options available: Auto, Enabled, Disabled. Default setting is Auto. ◆ Data Scramble <ul style="list-style-type: none"> – Enable/Disable Data Scrambling. – Options available: Auto, Enabled, Disabled. Default setting is Auto.
Phy Configuration	<p>Press [Enter] for configuration of advanced items.</p> <ul style="list-style-type: none"> ◆ PMU Training <ul style="list-style-type: none"> – DFE Read Training <ul style="list-style-type: none"> » Perform 2D Read Training with DFE on. » Options available: Auto, Enable, Disable. Default setting is Auto. – FFE Write Training <ul style="list-style-type: none"> » Perform 2D Write Training with FFE on. » Options available: Auto, Enable, Disable. Default setting is Auto. – PMU Pattern Bits Control <ul style="list-style-type: none"> » Options available: Auto, Manual. Default setting is Auto. – MR6VrefDQ Control <ul style="list-style-type: none"> » Options available: Auto, Manual. Default setting is Auto. – CPU Vref Training Seed Control <ul style="list-style-type: none"> » Options available: Auto, Manual. Default setting is Auto.

2-3-3-2 DRAM Memory Mapping

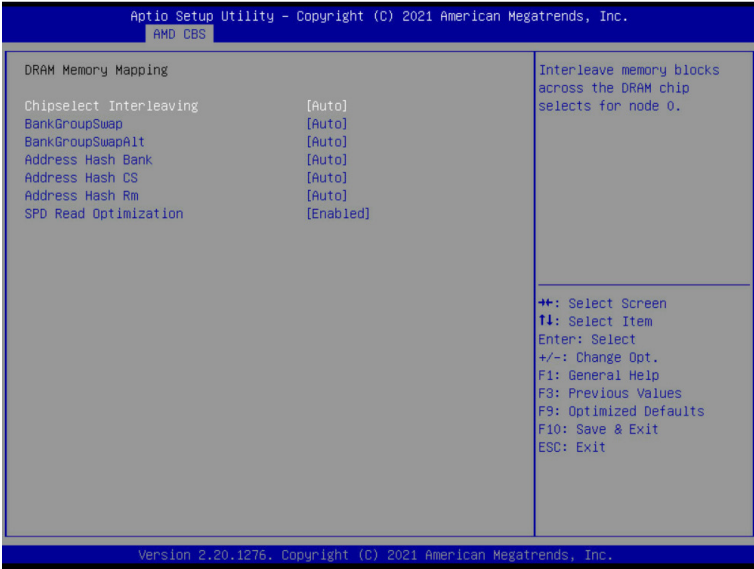

Parameter	Description
DRAM Memory Mapping	
Chipselect Interleaving	Interleave memory blocks across the DRAM chip selects for node 0. Options available: Auto, Disabled. Default setting is Auto .
BankGroupSwap	Configures the BankGroupSwap. BankGroupSwap (BGS) is a new memory mapping option in AGESA that alters how applications get assigned to physical locations within the memory modules. When this option sets to Auto, it is null: No help string. Options available: Auto, Enabled, Disabled. Default setting is Auto .
BankGroupSwapAlt	Configures the BankGroupSwapAlt. Options available: Auto, Enabled, Disabled. Default setting is Auto .
Address Hash Bank	Enable/Disable bank address hashing. Options available: Auto, Enabled, Disabled. Default setting is Auto .
Address Hash CS	Enable/Disable CS address hashing. Options available: Auto, Enabled, Disabled. Default setting is Auto
Address Hash Rm	Enable/Disable RM address hashing. Options available: Auto, Enabled, Disabled. Default setting is Auto
SPD Read Optimization	Enable/Disable SPD Read Optimization. Options available: Auto, Enabled, Disabled. Default setting is Auto

2-3-3-3 NVDIMM

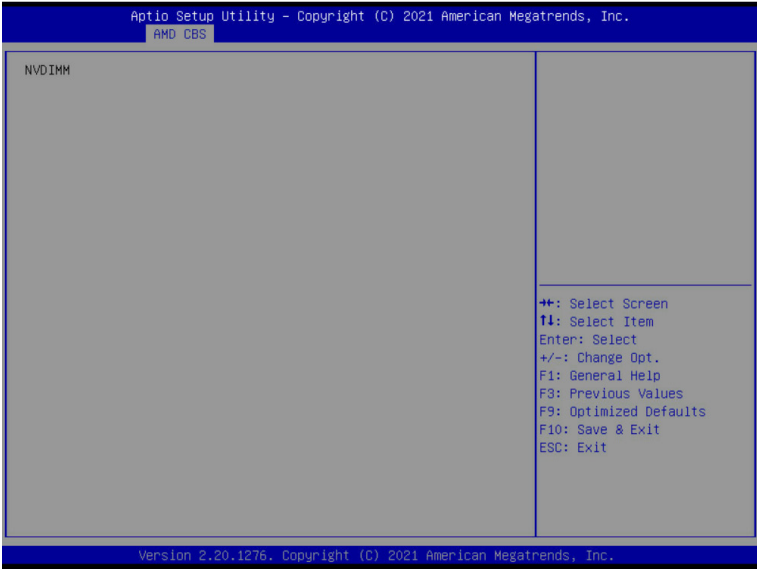

Parameter	Description
NVDIMM	Displays the information of the devices/controllers if installed

2-3-3-4 Memory MBIST



Parameter	Description
Memory MBIST	
MBIST Enable	Enable/Disable the Memory MBIST function. Options available: Enabled, Disabled. Default setting is Disabled .
MBIST Test Mode ^(Note)	Selects MBIST Test Mode. Interface Mode: Tests Single and Multiple CS transactions and Basic Connectivity. Data Eye Mode: Measures Voltage vs. Timing. Options available: Auto, Both, Interface Mode, Data Eye Mode. Default setting is Auto .
MBIST Aggressors ^(Note)	Enable/Disable MBIST Aggressor test. Options available: Auto, Enabled, Disabled. Default setting is Auto .
MBIST Per Bit Slave Die Reporting ^(Note)	Enable/Disable to report 2D data eye results in ABL log for each DQ, Chipselect, and Channel. Options available: Auto, Enabled, Disabled. Default setting is Auto .
Data Eye	Press [Enter] to configure advanced items. <ul style="list-style-type: none"> ◆ Pattern Select <ul style="list-style-type: none"> – Options available: PRBS, SSO, Both. Default setting is PRBS. ◆ Pattern Length <ul style="list-style-type: none"> – Determines the pattern length. The possible options are N=3....12.

(Note) This item is available when **MBIST Enable** is set to **Enabled**.

Parameter	Description
Data Eye (Continued)	<ul style="list-style-type: none"> ◆ Aggressor Channel <ul style="list-style-type: none"> – This item helps read the aggressors channels. – Options available: Disabled, 1 Aggressor Channel, 3 Aggressor Channels, 7 Aggressor Channels. Default setting is 1 Aggressor Channel. ◆ Aggressor Static Lane Control <ul style="list-style-type: none"> – Enable/Disable the Aggressor Static Lane Control function. – Options available: Enabled, Disabled. Default setting is Disabled. ◆ Aggressor Static Lane Select Upper 32 bits^(Note1) ◆ Aggressor Static Lane Select Lower 32 bits^(Note1) ◆ Aggressor Static Lane Select ECC^(Note1) ◆ Aggressor Static Lane Value^(Note1) ◆ Target Static Lane Control <ul style="list-style-type: none"> – Enable/Disable the Target Static Lane Control function. – Options available: Enabled, Disabled. Default setting is Disabled. ◆ Target Static Lane Select Upper 32 bits^(Note2) ◆ Target Static Lane Select Lower 32 bits^(Note2) ◆ Target Static Lane Select ECC^(Note2) ◆ Target Static Lane Value^(Note2) ◆ Worst Case Margin Granularity <ul style="list-style-type: none"> – Options available: Per Chip Select, Per Nibble. Default setting is Per Chip Select. ◆ Read Voltage Sweep Step Size <ul style="list-style-type: none"> – Options available: 1, 2, 4. Default setting is 1. ◆ Read Timing Sweep Step Size <ul style="list-style-type: none"> – Options available: 1, 2, 4. Default setting is 1. ◆ Write Voltage Sweep Step Size <ul style="list-style-type: none"> – Options available: 1, 2, 4. Default setting is 1. ◆ Write Timing Sweep Step Size <ul style="list-style-type: none"> – Options available: 1, 2, 4. Default setting is 1.

(Note1) This item is configurable when **Aggressor Static Lane Control** is set to **Enabled**.

(Note2) This item is configurable when **Target Static Lane Control** is set to **Enabled**.

2-3-4 NBIO Common Options

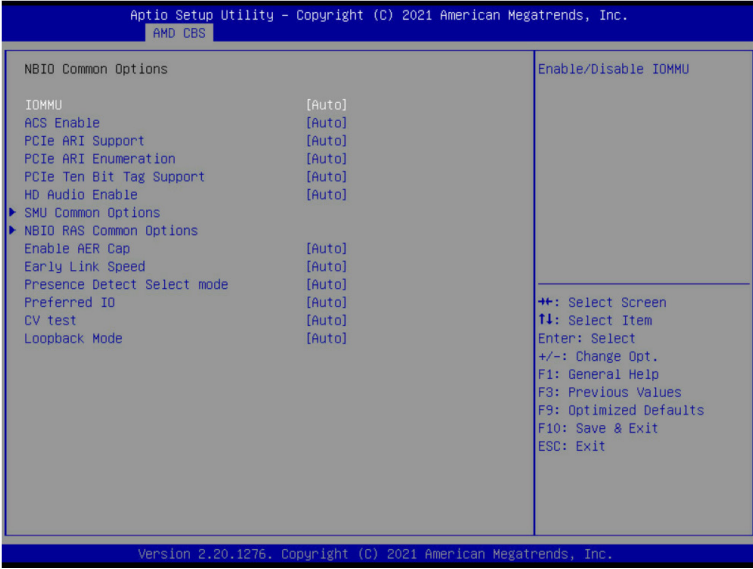

Parameter	Description
NBIO Common Options	
IOMMU	Enable/Disable the IOMMU function. Options available: Enabled, Disabled, Auto. Default setting is Auto .
ACS Enable	AER must be enabled for ACS enable to work. Options available: Auto, Enable, Disabled. Default setting is Auto .
PCIe ARI Support	Enable/Disable Alternative Routing-ID Interpretation. Options available: Auto, Enable, Disable. Default setting is Auto .
PCIe ARI Enumeration	ARI Forwarding Enable for each downstream port. Options available: Auto, Enable, Disable. Default setting is Auto .
PCIe Ten Bit Tag Support	Enable/Disable PCIe ten bit tags for supported devices. (Auto=Disabled) Options available: Auto, Enable, Disable. Default setting is Auto .
HD Audio Enable	Options available: Auto, Enable, Disabled. Default setting is Auto .
SMU Common Options	Press [Enter] for configuration of advanced items. <ul style="list-style-type: none"> ◆ cTDP Control <ul style="list-style-type: none"> - Selects use the fused TDP or set customized TDP. **TDP is used to define the RC thermal model only** - Options available: Auto, Manual. Default setting is Auto.

Parameter	Description
SMU Common Options (continued)	<ul style="list-style-type: none"> ◆ Fan Control <ul style="list-style-type: none"> – Press [Enter] for configuration of advanced items. – Fan Table Control <ul style="list-style-type: none"> » Options available: Auto, Manual. Default setting is Auto. ◆ EfficiencyModeEn <ul style="list-style-type: none"> – Options available: Auto, Enabled. Default setting is Auto. ◆ Package Power Limit Control <ul style="list-style-type: none"> – Selects use the fused PPT or set customized PPT. **PPT will be used as the ASIC power limit** – Options available: Auto, Manual. Default setting is Auto. ◆ APBDIS <ul style="list-style-type: none"> – Options available: Auto, 0, 1. Default setting is Auto. ◆ DF Cstates <ul style="list-style-type: none"> – Enable/Disable DF C-states. – Options available: Auto, Enabled, Disabled. Default setting is Auto. ◆ CPPC <ul style="list-style-type: none"> – Options available: Auto, Enabled, Disabled. Default setting is Auto. ◆ CPPC Preferred Cores <ul style="list-style-type: none"> – Options available: Auto, Enabled, Disabled. Default setting is Auto. ◆ NBIO LCLK DPM <ul style="list-style-type: none"> – Press [Enter] for configuration of advanced items. – NBIO DPM Control <ul style="list-style-type: none"> » This setting controls how the NBIO Power Management is controlled. » Options available: Auto, Manual. Default setting is Auto.
NBIO RAS Common Options	<p data-bbox="335 870 723 901">Press [Enter] for configuration of advanced items.</p> <ul style="list-style-type: none"> ◆ NBIO RAS Global Control <ul style="list-style-type: none"> – Options available: Auto, Manual. Default setting is Auto. ◆ NBIO RAS Control <ul style="list-style-type: none"> – Options available: Disabled, MCA, Legacy. Default setting is MCA. ◆ Egress Poison Severity High <ul style="list-style-type: none"> – Configures the Egress Poison High Severity. Each bit set to 1 enables High severity on the associated IOHC egress port. A bit of 0 indicates LOW severity. ◆ Egress Poison Severity Low <ul style="list-style-type: none"> – Configures the Egress Poison Low Severity. Each bit set to 1 enables High severity on the associated IOHC egress port. A bit of 0 indicates LOW severity. ◆ NBIO SyncFlood Generation <ul style="list-style-type: none"> – The value may be used to mask SyncFlood caused by NBIO RAS options. – Options available: Auto, Enabled, Disabled. Default setting is Auto.

Parameter	Description
NBIO RAS Common Options (continued)	<ul style="list-style-type: none"> ◆ NBIO SyncFlood Reporting <ul style="list-style-type: none"> – The value may be used to enable SyncFlood reporting to APML. – Options available: Auto, Enabled, Disabled. Default setting is Auto. ◆ Egress Poison Mask High <ul style="list-style-type: none"> – Enables mask for masking of errors logged in EGRESS_POISON_STATUS. For each bit set to 1, errors are masked. For each bit set to 0, errors trigger response actions. ◆ Egress Poison Mask Low <ul style="list-style-type: none"> – Enables mask for masking of errors logged in EGRESS_POISON_STATUS. For each bit set to 1, errors are masked. For each bit set to 0, errors trigger response actions. ◆ Uncorrected Converted to Poison Enable Mask High <ul style="list-style-type: none"> – Enables mask for masking of uncorrectable parity errors on internal arrays. ◆ Uncorrected Converted to Poison Enable Mask Low <ul style="list-style-type: none"> – Enables mask for masking of uncorrectable parity errors on internal arrays. ◆ System Hub Watchdog Timer <ul style="list-style-type: none"> – Specifies the timer interval of the SYSHUB Watchdog timer in milliseconds. ◆ SLINK Read Response OK <ul style="list-style-type: none"> – This item specifies whether SLINK read response errors are converted to an Okay response. – Options available: Enabled, Disabled. Default setting is Disabled. ◆ SLINK Read Response Error Handling <ul style="list-style-type: none"> – Options available: Enabled, Trigger MCOMMIT Error, Log Errors in MCA. Default setting is Log Errors in MCA. ◆ Log Poison Data from SLINK <ul style="list-style-type: none"> – Enable/Disable the Log Poison Data from SLINK feature. – Options available: Enabled, Disabled. Default setting is Disabled. ◆ PCIe Aer Reporting Mechanism <ul style="list-style-type: none"> – Selects the method of reporting AER errors from PCI Express. – Options available: Auto, Firmware First, OS First, MCA. Default setting is Auto. ◆ Edpc Control <ul style="list-style-type: none"> – Options available: Auto, Enabled, Disabled. Default setting is Auto. ◆ NBIO Poison Consumption <ul style="list-style-type: none"> – Options available: Auto, Enabled, Disabled. Default setting is Auto. ◆ Sync Flood on PCIe Fatal Error <ul style="list-style-type: none"> – Options available: Auto, True, False. Default setting is Auto.
Enable AER Cap	<p>Enable/Disable Advanced Error Reporting Capability. Options available: Auto, Enable, Disabled. Default setting is Auto.</p>

Parameter	Description
Early Link Speed	Configures Early Link Speed. Options available: Auto, Gen1, Gen2. Default setting is Auto .
Presence Detect Select mode	Controls the Presence Detect Select mode. Options available: Auto, OR, AND. Default setting is Auto .
Preferred IO	Preferred IO select type. Manual: Bus Number manually. Auto: Default. Options available: Auto, Manual. Default setting is Auto .
CV test	Enable/Disable the running PCIECV tool support. Options available: Auto, Enabled, Disabled. Default setting is Auto .
Loopback Mode	Enable/Disable PCIe Loopback Mode. Options available: Auto, Disabled, Enabled. Default setting is Auto .

2-3-5 FCH Common Options



Parameter	Description
FCH Common Options	Press [Enter] for configuration of advanced items.
SATA Configuration Options	<ul style="list-style-type: none"> ◆ SATA Enable <ul style="list-style-type: none"> – Enable/Disable OnChip SATA controller. – Options available: Auto, Enabled, Disabled. Default setting is Auto.
AC Power Loss Options	<p>Press [Enter] for configuration of advanced items.</p> <ul style="list-style-type: none"> ◆ AC Loss Control <ul style="list-style-type: none"> – Selects the AC Loss Control Method. – Options available: Power Off, Power On, Last State. Default setting is Last State.
FCH RAS Options	<p>Press [Enter] for configuration of advanced items.</p> <ul style="list-style-type: none"> ◆ ALink RAS Support <ul style="list-style-type: none"> – Enable/Disable the ALink RAS Support. – Options available: Auto, Enabled, Disabled. Default setting is Auto. ◆ Reset after sync flood <ul style="list-style-type: none"> – Enable/Disable AB to forward downstream sync-flood message to system controller. – Options available: Auto, Enable, Disable. Default setting is Auto.

2-3-6 SOC Miscellaneous Control

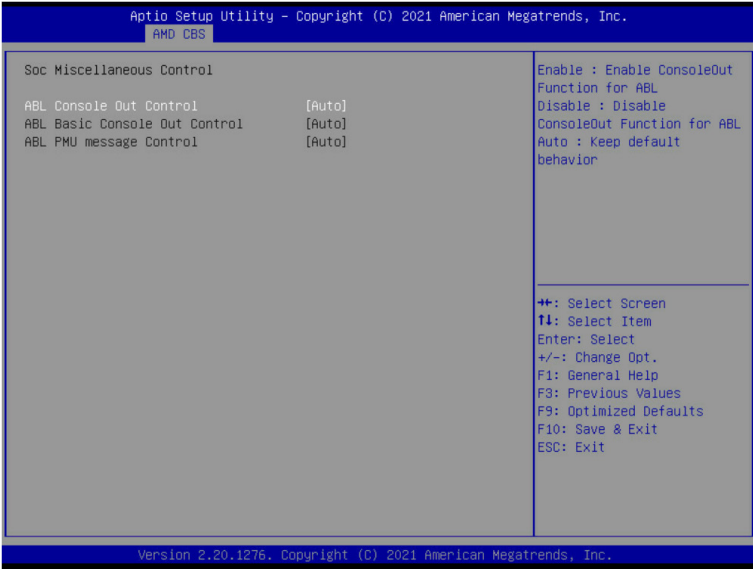

Parameter	Description
SOC Miscellaneous Control	
ABL Console Out Control	Enable/Disable the ConsoleOut function for ABL. Options available: Auto, Enable, Disable. Default setting is Auto .
ABL Basic Console Out Control ^(Note)	Enable/Disable the Basic ConsoleOut function for ABL. Options available: Auto, Enable, Disable. Default setting is Auto .
ABL PMU message Control ^(Note)	To Control the total number of PMU debug messages. Options available: Auto, Detailed debug message, Coarse debug message, Stage completion, Firmware completion message only. Default setting is Auto .

(Note) This item is configurable when **ABL Console Out Control** is set to **Enable**.

2-3-7 Chipset Common Options



Parameter	Description
Chipset Common Options	
Chipset SATA Configuration Options	<p>Press [Enter] for configuration of advanced items.</p> <ul style="list-style-type: none"> ◆ Chipset SATA0/1 Enable^(Note) <ul style="list-style-type: none"> – Enable/Disable Bixby SATA controller. – Options available: Auto, Enabled, Disabled. Default setting is Auto. ◆ Chipset SATA Mode <ul style="list-style-type: none"> – Select Bixby SATA Type. – Options available: AHCI, AHCI as ID 0x7904, Auto, RAID. Default setting is AHCI.

(Note) Advanced items prompt when this item is defined.

2-4 AMD PBS Menu

AMD PBS Option menu displays submenu options for configuring the function of AMD PBS. Select a submenu item, then press [Enter] to access the related submenu screen.

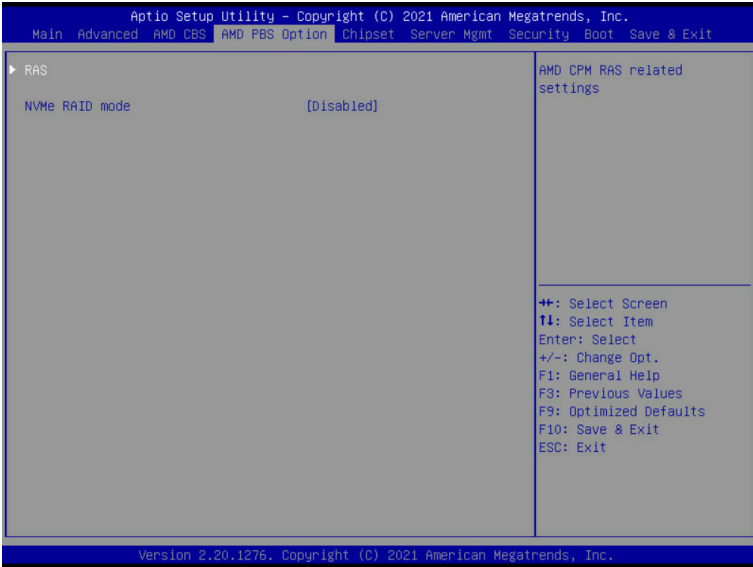

Parameter	Description
RAS	Press [Enter] for configuration of advanced items.
NVMe RAID mode	Enable/Disable NVMe RAID Mode. Options available: Enabled, Disabled. Default setting is Disabled .

2-4-1 RAS

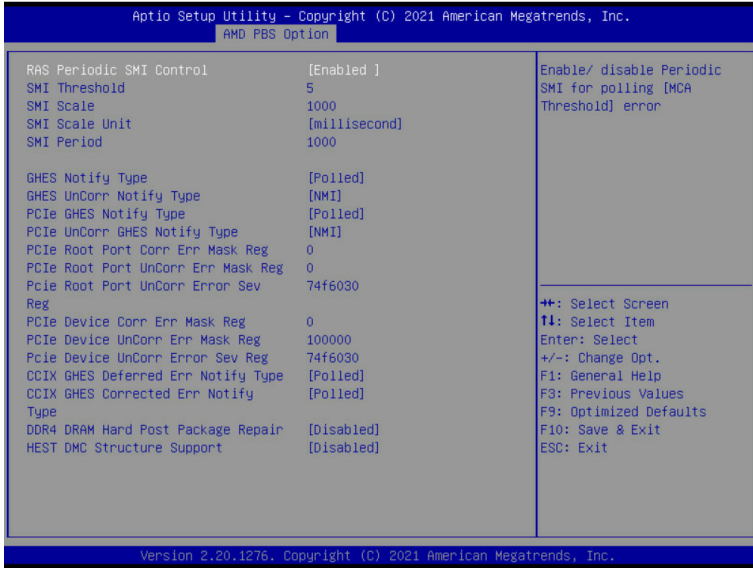

Parameter	Description
RAS Periodic SMI Control	Enable/Disable the Periodic SMI for polling [MCA Threshold] error. Options available: Enabled, Disabled. Default setting is Enabled .
SMI Threshold	Configures the SMI Threshold value.
SMI Scale	Configures the SMI Scale value.
SMI Scale Unit	Defines the unit of time scale. Options available: millisecond, second, minute. Default setting is millisecond .
SMI Period	Configures the SMI Period.
GHEs Notify Type	Selects the Notification type for deferred/ corrected errors. Options available: Polled, SCI. Default setting is Polled .
GHEs UnCorr Notify Type	Selects the Notification type for uncorrected errors. Options available: Polled, NMI. Default setting is NMI .
PCIe GHEs Notify Type	Selects the Notification type for PCIe corrected errors. Options available: Polled, SCI. Default setting is Polled .
PCIe UnCorr GHEs Notify Type	Selects the Notification type for PCIe uncorrected errors. Options available: Polled, NMI. Default setting is NMI .
PCIe Root Port Corr Err Mask Reg	Initialize the PCIe AER Corrected Error Mask register of Root Port.

Parameter	Description
PCIe Root Port UnCorr Err Mask Reg	Initialize the PCIe AER Uncorrected Error Mask register of Root Port.
PCIe Root Port UnCorr Err Sev Reg	Initialize the PCIe AER Uncorrected Error Severity register of Root Port.
PCIe Device Corr Err Mask Reg	Initialize the PCIe AER Corrected Error Mask register of PCIe device.
PCIe Device UnCorr Err Mask Reg	Initialize the PCIe AER Uncorrected Error Mask register of PCIe device.
PCIe Device UnCorr Err Sev Reg	Initialize the PCIe AER Uncorrected Error Severity register of PCIe device.
CCIX GHES Deferred ERR Notify Type	Selects the Notification type for CCIX deferred error. Options available: Polled, SCI. Default setting is Polled .
CCIX GHES Corrected Err Notify Type	Selects the Notification type for CCIX corrected error. Options available: Polled, SCI. Default setting is Polled .
DDR4 DRAM Hard Post Package Repair	This feature allows spare DRAM rows to replace malfunctioning rows via an in-field repair mechanism. Options available: Enabled, Disabled. Default setting is Disabled .
HEST DMC Structure Support	HEST DMC (Deferred Machine Check) Structure Support. Options available: Enabled, Disabled. Default setting is Disabled .

2-5 Chipset Setup Menu

Chipset Setup menu displays submenu options for configuring the function of the North Bridge. Select a submenu item, then press <Enter> to access the related submenu screen.

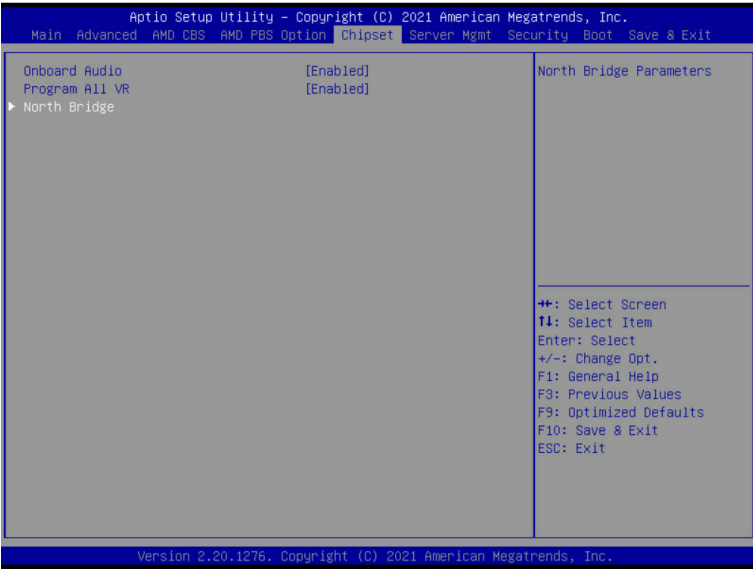

Parameter	Description
Onboard Audio	Enable/Disable Onboard Audio. Options available: Enabled, Disabled. Default setting is Enabled .
Program All VR	Enable/Disable program all VR on MB. Options available: Enabled, Disabled. Default setting is Enabled .
North Bridge	Press [Enter] for configuration of advanced items.

2-5-1 North Bridge

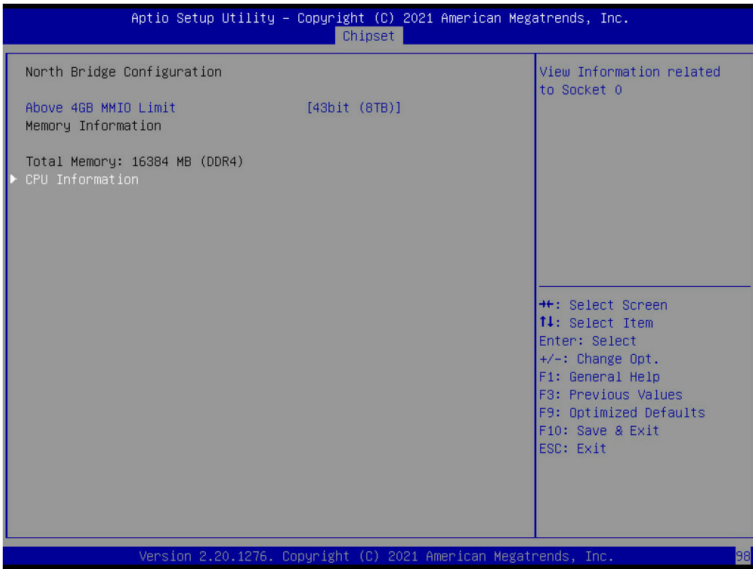

Parameter	Description
North Bridge Configuration	
Above 4GB MMIO Limit	Selects Above 4GB MMIO Limit to 38~43 bits limit. This option works only when "Above 4G decoding" is enabled. Options available: 40bit (1TB), 41bit (2TB), 42bit (4TB), 43bit (8TB). Default setting is 43bit (8TB) .
Memory Information	
Total Memory	Displays the total memory information.
CPU Information	Press [Enter] to view information related to CPU.

2-6 Server Management Menu

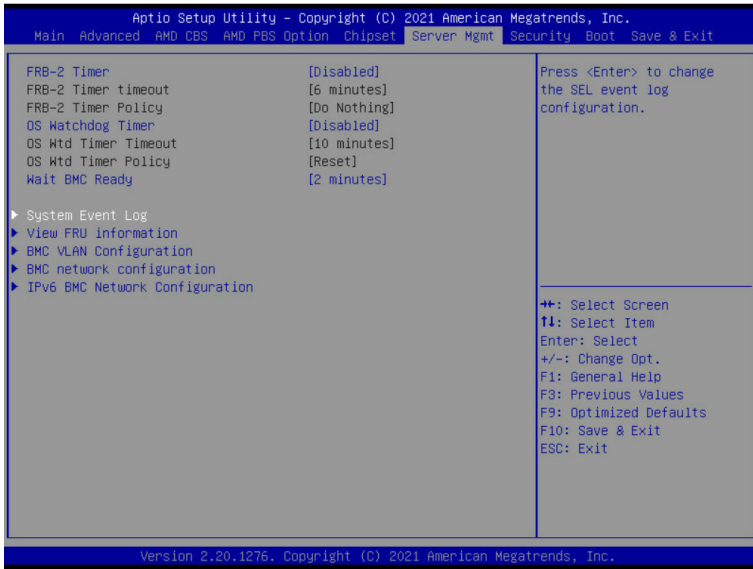

Parameter	Description
FRB-2 Timer	Enable/Disable FRB-2 timer (POST timer). Options available: Enabled, Disabled. Default setting is Disabled .
FRB-2 Timer ^(Note1) timeout	Configures the FRB2 Timer timeout. Options available: 3 minutes, 4 minutes, 5 minutes, 6 minutes. Default setting is 6 minutes .
FRB-2 Timer Policy ^(Note1)	Configures the FRB2 Timer policy. Options available: Do Nothing, Reset, Power Down. Default setting is Do Nothing .
OS Watchdog Timer	Enable/Disable OS Watchdog Timer function. Options available: Enabled, Disabled. Default setting is Disabled .
OS Wtd Timer Timeout ^(Note2)	Configures OS Watchdog Timer. Options available: 5 minutes, 10 minutes, 15 minutes, 20 minutes. Default setting is 10 minutes .
OS Wtd Timer Policy ^(Note2)	Configure OS Watchdog Timer Policy. Options available: Reset, Do Nothing, Power Down. Default setting is Reset .
Wait BMC Ready	Post wait BMC ready and reboot system. Options available: Disabled, 2 minutes, 4 minutes, 6 minutes. Default setting is 2 minutes .

(Note1) This item is configurable when **FRB-2 Timer** is set to **Enabled**.

(Note2) This item is configurable when **OS Watchdog Timer** is set to **Enabled**.

Parameter	Description
System Event Log	Press [Enter] to configure advanced items.
View FRU Information	Press [Enter] to view the FRU information.
BMC VLAN Configuration	Press [Enter] to configure advanced items.
BMC network configuration	Press [Enter] to configure advanced items.
IPv6 BMC Network Configuration	Press [Enter] to configure advanced items.

2-6-1 System Event Log

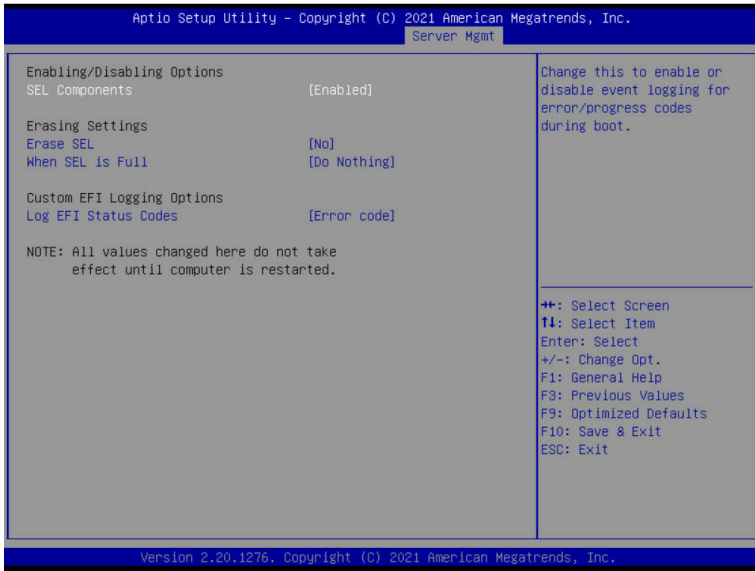

Parameter	Description
Enabling / Disabling Options	
SEL Components	Change this item to enable or disable all features of System Event Logging during boot. Options available: Enabled, Disabled. Default setting is Enabled .
Erasing Settings	
Erase SEL	Choose options for erasing SEL. Options available: No/Yes, On next reset/Yes, On every reset. Default setting is No .
When SEL is Full	Choose options for reactions to a full SEL. Options available: Do Nothing, Erase Immediately, Delete Oldest Record. Default setting is Do Nothing .
Custom EFI Logging Options	
Log EFI Status Codes	Enable/Disable the logging of EFI Status Codes (if not already converted to legacy). Options available: Disabled, Both, Error code, Progress code. Default setting is Error code .

2-6-2 View FRU Information

The FRU page is a simple display page for basic system ID information, as well as System product information. Items on this window are non-configurable.

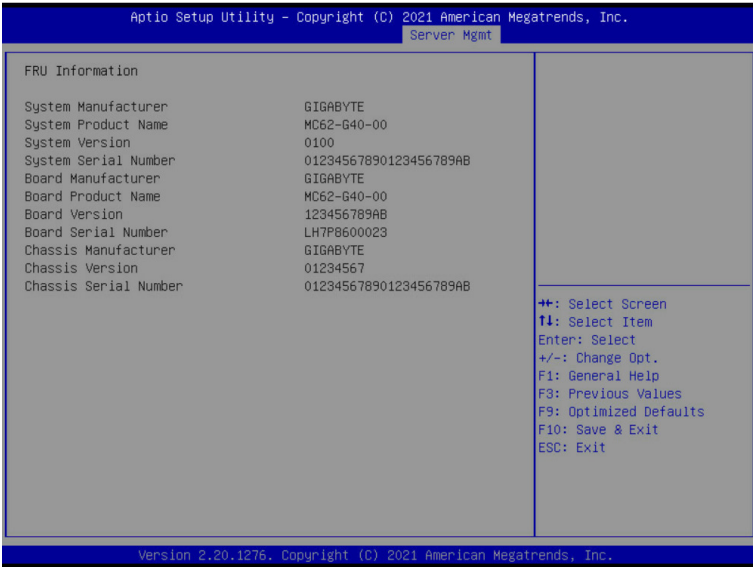

(Note) The model name will vary depends on the product you purchased

2-6-3 BMC VLAN Configuration

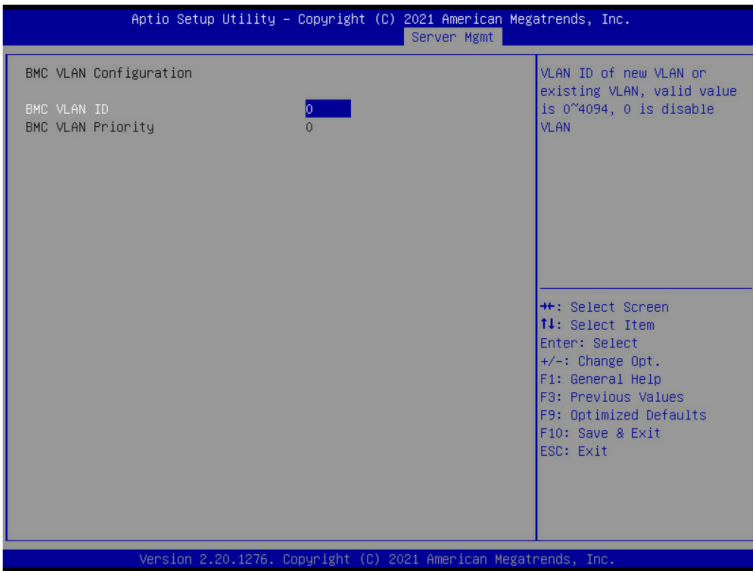

Parameter	Description
BMC VLAN Configuration	
BMC VLAN ID	Sets VLAN ID for a new VLAN or an existing VLAN. Press the <+> / <-> keys to increase or decrease the desired values. The valid range is from 0 to 4094.
BMC VLAN Priority	Sets 802.1Q Priority for a new VLAN or an existing VLAN. Press the <+> / <-> keys to increase or decrease the desired values. The valid range is from 0 to 7.

2-6-4 BMC Network Configuration



Parameter	Description
BMC network configuration	
Lan Channel 1	
Configuration Address source	Selects to configure LAN channel parameters statically or dynamically (DHCP). Do nothing option will not modify any BMC network parameters during BIOS phase. Options available: Unspecified, Static, DynamicBmcDhcp. Default setting is DynamicBmcDhcp .
Station IP address	Displays IP Address information.
Subnet mask	Displays Subnet Mask information. Please note that the IP address must be in three digitals, for example, 192.168.000.001.
Router IP address	Displays the Router IP Address information.
Station MAC address	Displays the MAC Address information.
Real-time get BMC network address	Press [Enter] will set Address source(Static/DHCP) to BMC and then get Station IP address, Subnet mask and Router IP address from BMC.

2-6-5 IPv6 BMC Network Configuration

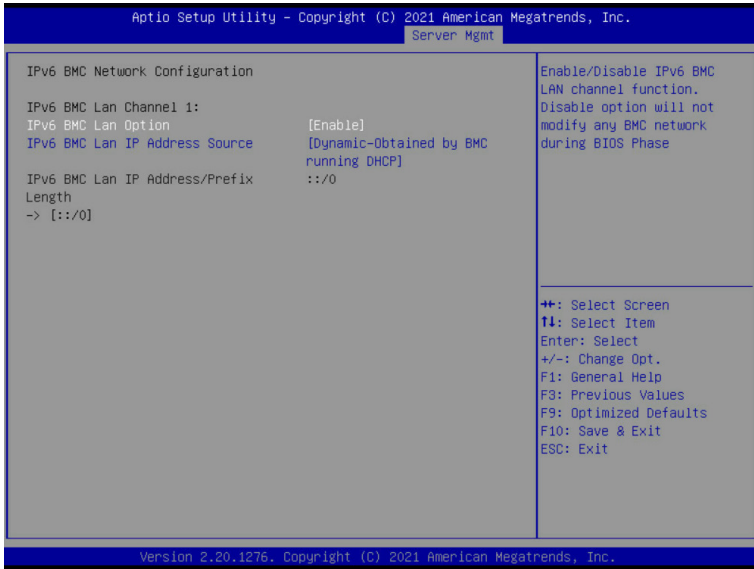

Parameter	Description
IPv6 BMC network configuration	
IPv6 BMC Lan Channel 1	
IPv6 BMC Lan Option	Enable/Disable IPv6 BMC LAN channel function. When this item is disabled, the system will not modify any BMC network during BIOS phase. Options available: Unspecified, Disable, Enable. Default setting is Enable .
IPv6 BMC Lan IP Address Source	Selects to configure LAN channel parameters statically or dynamically (by BIOS or BMC). Options available: Unspecified, Static, Dynamic-Obtained by BMC running DHCP. Default setting is Dynamic-Obtained by BMC running DHCP .
IPv6 BMC Lan IP Address/Prefix Length	Check if the IPv6 BMC LAN IP address matches those displayed on the screen.

2-7 Security Menu

The Security menu allows you to safeguard and protect the system from unauthorized use by setting up access passwords.

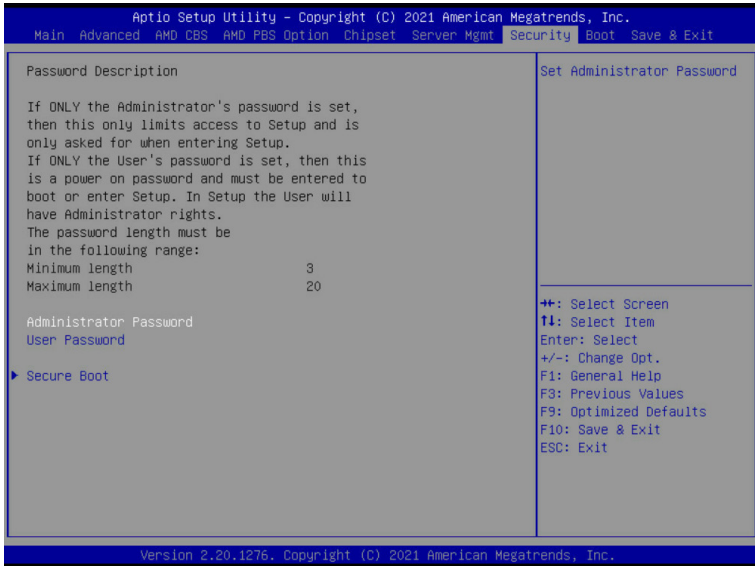

There are two types of passwords that you can set:

- Administrator Password
Entering this password will allow the user to access and change all settings in the Setup Utility.
- User Password
Entering this password will restrict a user's access to the Setup menus. To enable or disable this field, a Administrator Password must first be set. A user can only access and modify the System Time, System Date, and Set User Password fields.

Parameter	Description
Administrator Password	Press [Enter] to configure the administrator password.
User Password	Press [Enter] to configure the user password.
Secure Boot	Press [Enter] to configure advanced items.

2-7-1 Secure Boot

The Secure Boot submenu is applicable when your device is installed the Windows® 8 (or above) operating system.



Parameter	Description
System Mode	Displays if the system is in User mode or Setup mode.
Secure Boot	Enable/ Disable the Secure Boot function. Options available: Enabled, Disabled. Default setting is Enabled .
Secure Boot Mode ^(Note)	Secure Boot requires all the applications that are running during the booting process to be pre-signed with valid digital certificates. This way, the system knows all files being loaded before Windows loads to the login screen have not been tampered with. When set to Standard, it will automatically load the Secure Boot keys form the BIOS databases. When set to Custom, you can customize the Secure Boot settings and manually load its keys from the BIOS database. Options available: Standard, Custom. Default setting is Standard .
Restore Factory Keys	Forces the system to user mode and installs factory default Secure Boot key database.
Reset to Setup Mode	Press [Enter] to reset the system mode to Setup mode.

(Note) Advanced items prompt when this item is set to **Custom**.

Parameter	Description
Key Management	<p data-bbox="334 158 666 177">Press [Enter] to configure advanced items.</p> <p data-bbox="334 186 937 236">Please note that this item is configurable when Secure Boot Mode is set to Custom.</p> <ul style="list-style-type: none"> <li data-bbox="334 246 944 349">◆ Factory Key Provision <ul style="list-style-type: none"> <li data-bbox="370 272 944 323">– Allows to provision factory default Secure Boot keys when system is in Setup Mode. <li data-bbox="370 330 905 349">– Options available: Enabled, Disabled. Default setting is Disabled. <li data-bbox="334 357 926 432">◆ Restore Factory Keys <ul style="list-style-type: none"> <li data-bbox="370 384 926 402">– Installs all factory default keys. It will force the system in User Mode. <li data-bbox="370 410 604 429">– Options available: Yes, No. <li data-bbox="334 440 902 515">◆ Enroll Efi Image <ul style="list-style-type: none"> <li data-bbox="370 467 902 515">– Press [Enter] to enroll SHA256 hash of the binary into Authorized Signature Database (db). <li data-bbox="334 523 700 573">◆ Restore DB defaults <ul style="list-style-type: none"> <li data-bbox="370 550 700 569">– Restore DB variable to factory defaults. <li data-bbox="334 577 896 627">◆ Secure Boot variable <ul style="list-style-type: none"> <li data-bbox="370 603 896 622">– Displays the current status of the variables used for secure boot. <li data-bbox="334 635 802 738">◆ Platform Key (PK) <ul style="list-style-type: none"> <li data-bbox="370 661 802 680">– Displays the current status of the Platform Key (PK). <li data-bbox="370 688 678 707">– Press [Enter] to configure a new PK. <li data-bbox="370 715 600 733">– Options available: Update. <li data-bbox="334 746 942 881">◆ Key Exchange Keys (KEK) <ul style="list-style-type: none"> <li data-bbox="370 773 942 848">– Displays the current status of the Key Exchange Key Database (KEK). <li data-bbox="370 799 905 848">– Press [Enter] to configure a new KEK or load additional KEK from storage devices. <li data-bbox="370 856 671 874">– Options available: Update, Append. <li data-bbox="334 889 905 1023">◆ Authorized Signatures (DB) <ul style="list-style-type: none"> <li data-bbox="370 915 905 934">– Displays the current status of the Authorized Signature Database. <li data-bbox="370 942 942 990">– Press [Enter] to configure a new DB or load additional DB from storage devices. <li data-bbox="370 998 671 1017">– Options available: Update, Append. <li data-bbox="334 1031 902 1166">◆ Forbidden Signatures (DBX) <ul style="list-style-type: none"> <li data-bbox="370 1058 902 1077">– Displays the current status of the Forbidden Signature Database. <li data-bbox="370 1085 891 1133">– Press [Enter] to configure a new dbx or load additional dbx from storage devices. <li data-bbox="370 1141 671 1160">– Options available: Update, Append. <li data-bbox="334 1174 926 1309">◆ Authorized TimeStamps (DBT) <ul style="list-style-type: none"> <li data-bbox="370 1201 926 1219">– Displays the current status of the Authorized TimeStamps Database. <li data-bbox="370 1227 905 1276">– Press [Enter] to configure a new DBT or load additional DBT from storage devices. <li data-bbox="370 1284 671 1303">– Options available: Update, Append. <li data-bbox="334 1317 918 1436">◆ OsRecovery Signatures <ul style="list-style-type: none"> <li data-bbox="370 1343 918 1362">– Displays the current status of the OsRecovery Signature Database. <li data-bbox="370 1370 887 1419">– Press [Enter] to configure a new OsRecovery Signature or load additional OsRecovery Signature from storage devices. <li data-bbox="370 1426 671 1445">– Options available: Update, Append.

2-8 Boot Menu

The Boot menu allows you to set the drive priority during system boot-up. BIOS setup will display an error message if the legacy drive(s) specified is not bootable.

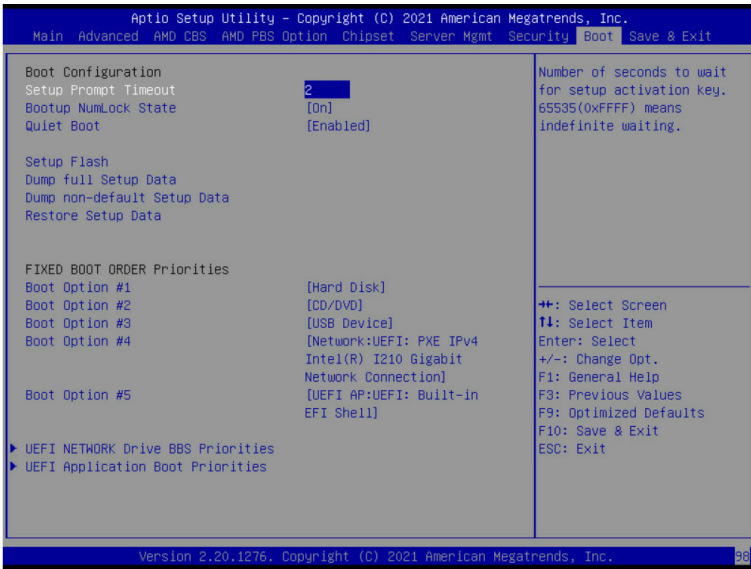

Parameter	Description
Boot Configuration	
Setup Prompt Timeout	Number of seconds to wait for setup activation key. 65535 (0xFFFF) means indefinite waiting. Press the numeric keys to input the desired values.
Bootup NumLock State	Enable/Disable the Bootup NumLock function. Options available: On, Off. Default setting is On .
Quiet Boot	Enable/Disable showing the logo during POST. Options available: Enabled, Disabled. Default setting is Enabled .
Setup Flash	Press [Enter] to run setup flash.
Dump full Setup Data	Press [Enter] to dump full setup data to file.
Dump non-default Setup Data	Press [Enter] to dump non-default setup data to file.
Restore Setup Data	Press [Enter] to restore setup data from file (cJson format).

Parameter	Description
FIXED BOOT ORDER Priorities	
Boot Option #1 / #2 / #3 / #4 / #5	<p>Press [Enter] to configure the boot priority. By default, the server searches for boot devices in the following sequence:</p> <ol style="list-style-type: none"> 1. Hard drive. 2. CD-COM/DVD drive. 3. USB device. 4. Network. 5. UEFI.
UEFI Network Drive BBS Priorities	Press [Enter] to configure the boot priority.
UEFI Application Boot Priorities	Press [Enter] to configure the boot priority.

2-9 Save & Exit Menu

The Save & Exit menu displays the various options to quit from the BIOS setup. Highlight any of the exit options then press <Enter>.

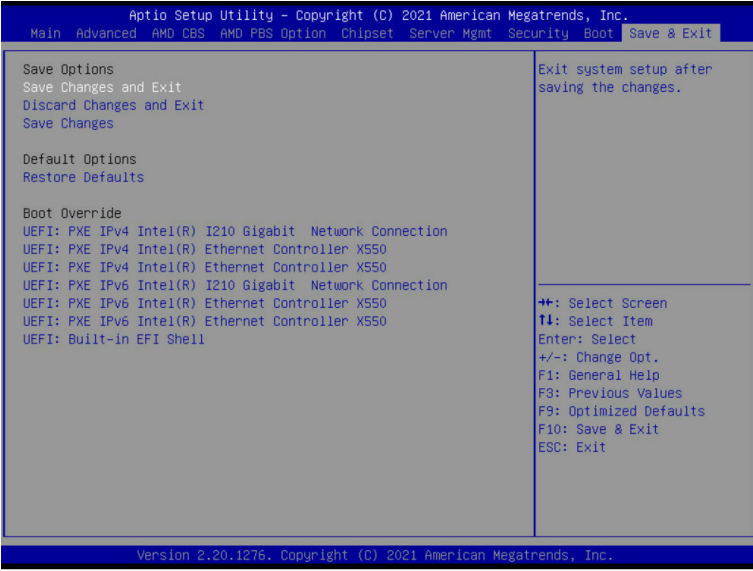

Parameter	Description
Save Options	
Save Changes and Exit	Saves changes made and closes the BIOS setup. Options available: Yes, No.
Discard Changes and Exit	Discards changes made and exits the BIOS setup. Options available: Yes, No.
Save Changes	Saves changes done so far to any of the setup options. Options available: Yes, No.
Default Options	
Restore Defaults	Loads the default settings for all BIOS setup parameters. Setup Defaults are quite demanding in terms of resources consumption. If you are using low-speed memory chips or other kinds of low-performance components and you choose to load these settings, the system might not function properly. Options available: Yes, No.
Boot Override	Press [Enter] to configure the device as the boot-up drive.

2-10 BIOS Recovery

The system has an embedded recovery technique. In the event that the BIOS becomes corrupt the boot block can be used to restore the BIOS to a working state. To restore your BIOS, please follow the instructions listed below:

Recovery Instruction:

1. Copy the XXX.rom to USB diskette.
2. Setting BIOS Recovery jump to enabled status.
3. Boot into BIOS recovery.
4. Run Proceed with flash update.
5. BIOS updated.

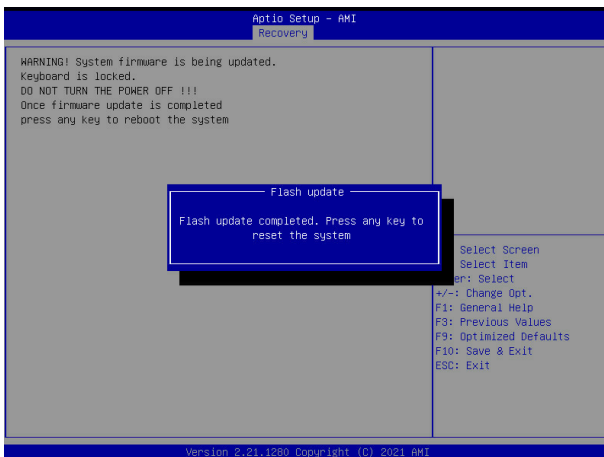
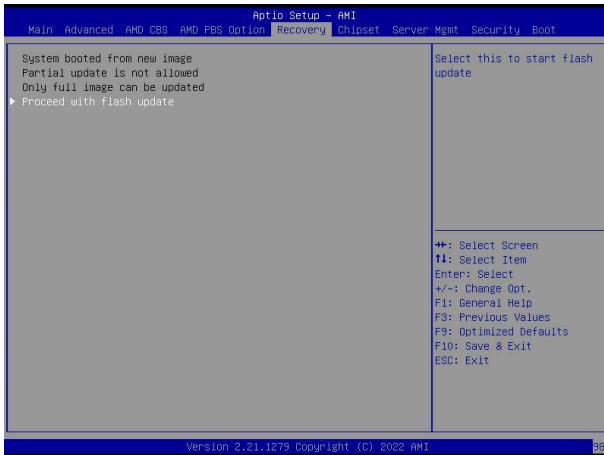

2-11 BIOS POST Beep code (AMI standard)

2-11-1 PEI Beep Codes

# of Beeps	Description
1	Memory not Installed.
1	Memory was installed twice (InstallPeiMemory routine in PEI Core called twice)
2	Recovery started
3	DXE IPL was not found
3	DXE Core Firmware Volume was not found
4	Recovery failed
4	S3 Resume failed
7	Reset PPI is not available

2-11-2 DXE Beep Codes

# of Beeps	Description
1	Invalid password
4	Some of the Architectural Protocols are not available
5	No Console Output Devices are found
5	No Console Input Devices are found
6	Flash update is failed
7	Reset protocol is not available
8	Platform PCI resource requirements cannot be met